

Proceedings



of the

I·R·E

Ralph Dale

NOVEMBER, 1944

VOLUME 32

NUMBER 11

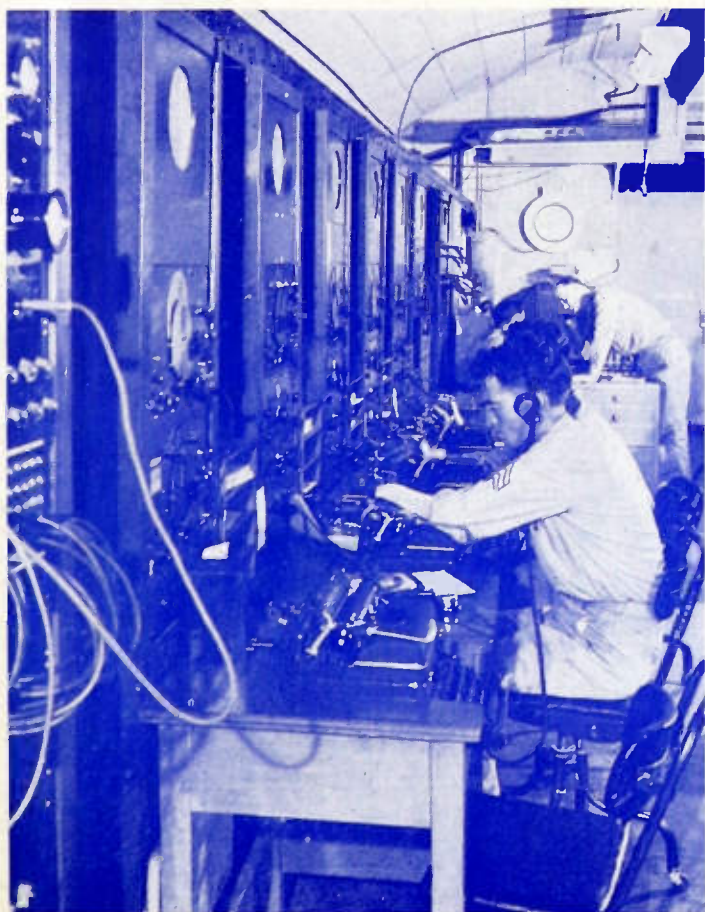

Signal Corps Photo

MODERN ARMY COMMUNICATIONS
A HEADQUARTERS ROOM IN HAWAII

Power Tubes

Magnetic Recording

Directional-Antenna Radiation

I-F System Design

Frequency-Conversion Diagrams

Transmission Lines

Coaxial-Line Discontinuities

Network Theorem

Institute of Radio Engineers

Why

AMPEREX

WATER and AIR COOLED TRANSMITTING and RECTIFYING TUBES

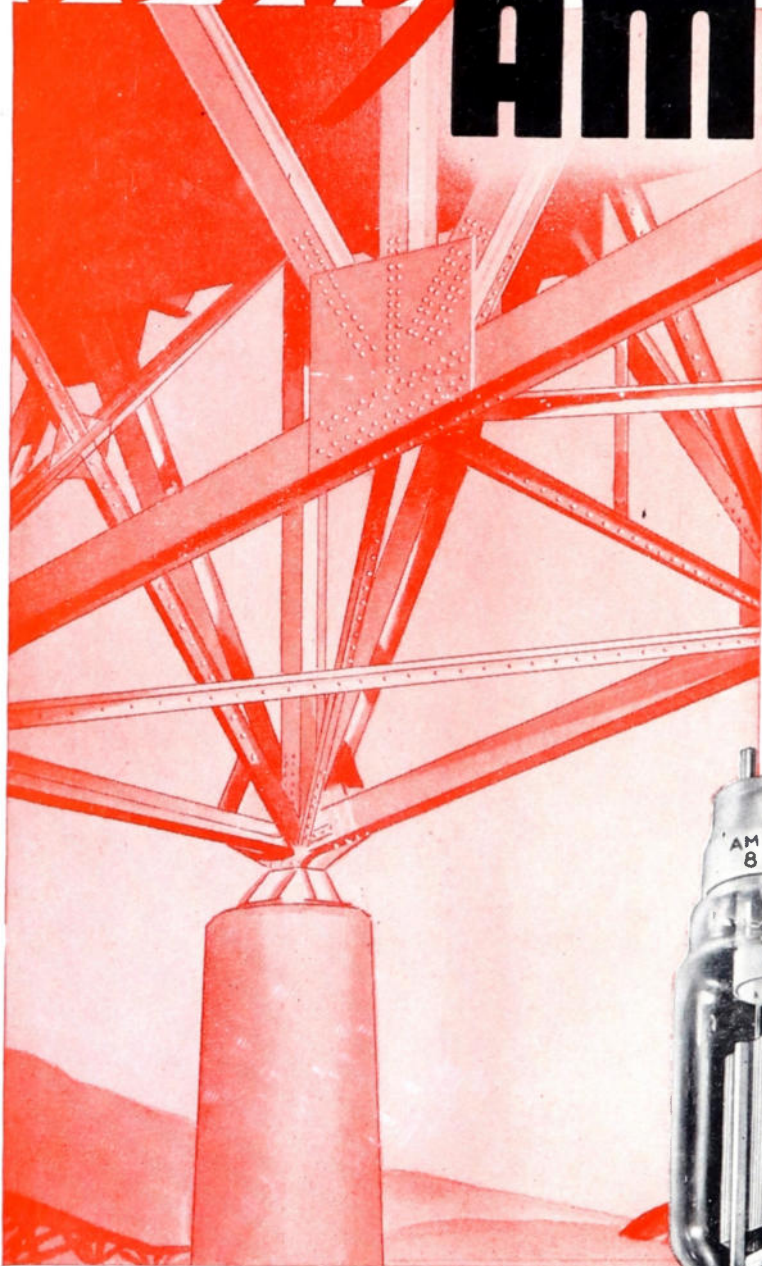

Of exclusive Amperex design! These four words, denoting an "Amperextra" reflected in better performance, have been used in a number of instances when describing our products. Of exclusive Amperex design, for example, is the channel support of our transmitting tubes. This feature results in more rigid support of tube elements. Exact inter-element alignment is assured. This, in turn, means absolute freedom from change in characteristics that might ordinarily arise from shock and vibration either in shipment or service.

There are more than 100 different types of **Amperex** tubes for broadcasting, industrial and electro-medical applications. An **Amperex** engineer will gladly assist you with your present or postwar problems.



AMPEREX . . . *the high performance tube*



*Keep Buying . . .
Keep Holding . . .
More War Bonds*

AMPEREX ELECTRONIC CORPORATION

79 WASHINGTON STREET BROOKLYN 1, N. Y.
Export Division: 13 E. 40th St., New York 16, N. Y., Cables: "Arlab"

Proceedings

of the I·R·E

Published Monthly by

The Institute of Radio Engineers, Inc.

VOLUME 32

November, 1944

NUMBER II

Section Meetings	Next Page
Wartime Methods and Peacetime Applications	A. S. Wells 651
Austin Bailey	652
Review of Demountable Versus Sealed-off Power Tubes	653
I. E. Mouromtseff, H. J. Dailey, and L. C. Werner	
The Mechanism of Supersonic Frequencies as Applied to Magnetic Recording	Hershel Toomim and David Wildfeuer 664
Significant Radiation from Directional Antennas of Broadcast Stations for Determining Sky-Wave Interference at Short Distances	J. H. DeWitt, Jr., and A. D. Ring 668
Aids in the Design of Intermediate-Frequency Systems	Paul C. Gardiner and J. E. Maynard 674
Use of Frequency-Conversion Diagrams	Harry Stockman 679
Graphical Solution of Voltage and Current Distribution and Impedance of Transmission Lines	Robert C. Paine 686
Coaxial-Line Discontinuities	J. R. Whinnery, H. W. Jamieson, and Theo Eloise Robbins 695
A Network Theorem	N. I. Korman 710
Institute News and Radio Notes	
1945 Winter Technical Meeting	712
Board of Directors	713
Executive Committee	714
Constitutional Amendments	714
Inventive Problems of Military Interest	714
Radio and Instrument Hookup Wire	715
Correspondence: "Amplifier Testing with Square and Triangular Waves"	Herbert J. Reich 715
I.R.E. People	715
Books:	
"Radio Direction Finders," by Donald S. Bond	Karl G. Jansky 717
"Maintenance and Servicing of Electrical Instruments," by James Spencer	Ralph R. Batchner 717
"Direct-Current Circuits," by Earle M. Morecock	Frederick W. Grover 717
"Patent Law," by Chester H. Biesterfeld	David B. Smith 717
"Thermionic Valve Circuits," (Second Edition) by Emrys Williams	E. E. Spitzer 718
Contributors	718
Section Meetings	34A
Membership	38A
Positions Open	50A
Television	58A
Advertising Index	72A

Responsibility for the contents of papers published in the PROCEEDINGS rests upon the authors. Statements made in papers are not binding on the Institute or its members.

Entered as second-class matter October 26, 1927, at the post office at Menasha, Wisconsin, under the Act of February 28, 1925, embodied in Paragraph 4, Section 538 of the Postal Laws and Regulations. Publication office, 450 Ahnalt Street, Menasha, Wisconsin. Executive, editorial, and advertising offices, 330 West 42nd Street, New York 18, N. Y. Price, \$1.00 a copy. Subscriptions: United States and Canada, \$10.00 a year; foreign countries, \$11.00 a year. Changes of address (with advance notice of fifteen days) and communications regarding subscriptions and payments should be mailed to the Secretary of the Institute, at 330 West 42nd Street, New York 18, N. Y. All rights of republication, including translation into foreign languages, are reserved by the Institute. Abstracts of papers, with mention of their source, may be printed. Requests for republication privileges should be addressed to The Institute of Radio Engineers.

Copyright, 1944, by The Institute of Radio Engineers, Inc.

PAPERS COMMITTEE

Frederick B. Llewellyn
Chairman

Herman A. Affel
Wilmer L. Barrow
Howard A. Chinn
James K. Clapp
Ivan S. Coggeshall
Murray G. Crosby
Frederick W. Cunningham
Robert B. Dome
Enoch B. Ferrell
Donald G. Fink
H. S. Frazier
Stanford Goldman
Frederick W. Grover
O. B. Hanson
E. W. Herold
John V. L. Hogan
Frederick V. Hunt
Harley Iams
Loren F. Jones
John G. Kreeer, Jr.
Emil Labin
Frederick R. Lack
Hugo C. Leuteritz
De Loss K. Martin
Knox McIlwain
Harry R. Mimno
Ilia E. Mouromtseff
G. G. Muller
Albert F. Murray
Dwight O. North
A. F. Pomeroy
Jack R. Poppele
Simon Ramo
Francis X. Rettenmeyer
Sergei A. Schelkunoff
Donald B. Sinclair
Hubert M. Turner
Dayton Ulrey
Karl S. Van Dyke
E. K. Van Tassel
John R. Whinnery
Irving Wolff
J. Warren Wright
Harold R. Zeamans

PAPERS

PROCUREMENT COMMITTEE

Dorman D. Israel
General Chairman

William L. Everitt
Vice Chairman

GROUP CHAIRMEN

Jesse E. Brown
Warren B. Burgess
Edward J. Content
Harry Diamond
Edward T. Dickey
J. Kelly Johnson
Carl J. Madsen
Dan H. Moore
James R. Nelson
Howard J. Tyzzer
William C. White

Helen M. Stote
Associate Editor

William C. Copp
Advertising Manager
William B. Cowilich
Assistant Secretary

BOARD OF DIRECTORS 1944

Hubert M. Turner
President
Ralph A. Hackbusch
Vice-President
Raymond A. Heising
Treasurer
Haraden Pratt
Secretary
Alfred N. Goldsmith
Editor

Stuart L. Bailey
Wilmer L. Barrow
E. Finley Carter
Adolph B. Chamberlain
Ivan S. Coggeshall
William L. Everitt
Raymond F. Guy
Lawrence C. F. Horle
Charles B. Jolliffe
Frederick B. Llewellyn
Herbert J. Reich
Browder J. Thompson
Arthur F. Van Dyck
Harold A. Wheeler
Lynde P. Wheeler
William C. White

Harold R. Zeamans
General Counsel

BOARD OF EDITORS

Alfred N. Goldsmith
Editor
Ralph R. Batchner
Robert S. Burnap
Philip S. Carter
Lewis M. Clement
E. Maurice Deloraine
William G. Dow
Elmer W. Engstrom
William L. Everitt
George W. Gilman
Peter C. Goldmark
Frederick W. Grover
Lewis B. Headrick
C. M. Jansky, Jr.
John D. Kraus
Donald G. Little
Frederick B. Llewellyn
Samuel S. Mackeown
Edward L. Nelson
Harry F. Olson
Harold O. Peterson
Greenleaf W. Pickard
Ralph A. Powers
Haraden Pratt
Conan A. Priest
Herbert J. Reich
Peter C. Sandretto
V. W. Sherman
Lynne C. Smeby
E. C. Wente
Harold A. Wheeler
William C. White
Laurens E. Whittemore
Gerald W. Willard
William Wilson
Charles J. Young
Vladimir K. Zworykin



THE INSTITUTE OF RADIO ENGINEERS

INCORPORATED

1945 WINTER TECHNICAL MEETING
NEW YORK, N.Y.—JANUARY 24, 25, 26, AND 27, 1945



SECTION MEETINGS

ATLANTA November 17	CHICAGO November 17	CLEVELAND November 23	DETROIT November 17	LOS ANGELES November 21
NEW YORK December 6	PHILADELPHIA December 7	PITTSBURGH November 13	PORTLAND November 13	WASHINGTON November 13

SECTIONS

- ATLANTA**—Chairman, Walter Van Nostrand; Secretary, Ivan Miles, 554—14 St., N. W., Atlanta, Ga.
- BALTIMORE**—Chairman, W. I. Webb; Secretary, H. L. Spencer, Box 6760, Towson 4, Md.
- BOSTON**—Chairman, C. C. Harris; Secretary, Corwin Crosby, 16 Chauncy St., Cambridge, Mass.
- BUENOS AIRES**—Chairman, L. C. Simpson; Secretary, I. C. Grant, Venezuela 613, Buenos Aires, Argentina.
- BUFFALO-NIAGARA**—Chairman, A. J. Dybowski; Secretary, H. G. Korts, 51 Kinsey Ave., Kenmore, N. Y.
- CHICAGO**—Chairman, W. O. Swinyard; Secretary, A. W. Graf, 135 S. LaSalle, St., Chicago 3, Ill.
- CINCINNATI**—Chairman, J. L. Hollis; Secretary, R. S. Butts, Box 1403, Cincinnati 2, Ohio.
- CLEVELAND**—Chairman, A. S. Nace; Secretary, L. L. Stoffel, 1095 Kenneth Dr., Lakewood, Ohio
- CONNECTICUT VALLEY**—Secretary, L. A. Reilly, 989 Roosevelt Ave., Springfield, Mass.
- DALLAS-FORT WORTH**—Chairman, D. J. Tucker; Secretary, P. C. Barnes, WFAA-WBAP, Grapevine, Texas.
- DAYTON**—Chairman, George L. Haller; Secretary, Joseph General, 1319 Superior Ave., Dayton 7, Ohio.
- DETROIT**—Chairman, R. A. Powers; Secretary, R. R. Barnes, 1411 Harvard Ave., Berkley, Mich.
- EMPORIUM**—Chairman, H. D. Johnson; Secretary, Albert Dolnick, Sylvania Electric Products, Inc., Emporium, Pa.
- INDIANAPOLIS**—Chairman, H. I. Metz; Secretary, J. D. Colvin, 328 E. 47 St., Indianapolis, Ind.
- KANSAS CITY**—Chairman, A. P. Stuhrman; Secretary, R. N. White, 4800 Jefferson St., Kansas City, Mo.
- LOS ANGELES**—Chairman, L. W. Howard; Secretary, Frederick Ireland, 1000 N. Seward St., Hollywood 38, Calif.
- MONTREAL**—Chairman, F. S. Howes; Secretary, J. A. Campbell, Northern Electric Co., Ltd., 1261 Shearer St., Montreal, Que., Canada.
- NEW YORK**—Chairman, Lloyd Espenschied; Secretary, J. E. Shepherd, 111 Courtenay Rd., Hempstead, L. I., N. Y.
- PHILADELPHIA**—Chairman, T. A. Smith; Secretary, Samuel Gubin, RCA Victor Division, Radio Corporation of America Bldg. 8-10, Camden, N. J.
- PITTSBURGH**—Chairman, T. C. Kenny; Secretary, R. K. Crooks, Box 2038, Pittsburgh 30, Pa.
- PORTLAND**—Chairman, W. A. Cutting; Secretary, W. E. Richardson, 5960 S.W. Brugger, Portland, Ore.
- ROCHESTER**—Chairman, G. R. Town; Secretary, Harold Goldberg, Stromberg-Carlson Co., Rochester 3, N. Y.
- ST. LOUIS**—Chairman, N. B. Fowler; Secretary, C. H. Meyer, KFUE, 801 DeMun Ave., St. Louis, Mo.
- SAN FRANCISCO**—Chairman, W. G. Wagener; Secretary, R. V. Howard, Associated Broadcasters, Inc., Mark Hopkins Hotel, San Francisco 6, Calif.
- SEATTLE**—Chairman, F. B. Mossman; Secretary, E. H. Smith, Apt. K, 1620—14 Ave., Seattle, 22 Wash.
- TORONTO**—Chairman, E. O. Swan; Secretary, Alexander Bow, Copper Wire Products, Ltd., 137 Roncesvalles Ave., Toronto, Ont., Canada.
- TWIN CITIES**—Chairman, H. S. McCartney; Secretary, C. W. Engelman, 4648 Chowden Ave. S., Minneapolis 10, Minn.
- WASHINGTON**—Chairman, J. D. Wallace; Secretary, F. W. Albertson, c/o Dow and Lohnes, Munsey Bldg., Washington 4, D. C.
- WILLIAMSPORT**—Chairman, H. E. Smithgall, Jr.; Secretary, K. E. Carl, Williamsport Technical Institute, Williamsport, Pa.

WANT 10 OR 20 MILLION... IN 30 OR 60 DAYS?

BTR 1/4-Watt, IRC Insulated "Metallized" Resistor L. 3/8" - Di. 3/32"



No, it's *not* a dream! It's an actual postwar reality. For that's the kind of production capacity we've developed at the IRC plants for turning out these midget 1/4-watt insulated resistors for Uncle Sam. And that's the way we can continue to turn them out . . . for you, immediately we have fulfilled our basic obligation and restrictions are eased to any appreciable extent.

World's Smallest 1/4-Watt Resistor

You'll find the same high quality standards present in these tiny trojans that you have long recognized in the popular IRC type BT's. One of the smallest insulated resistors on the market, the BTR will find wide application in all types of postwar electronic equipment requiring low-power resistors. Samples and technical data sent on request.

INTERNATIONAL RESISTANCE CO.

401 NORTH BROAD STREET

• PHILADELPHIA 8, PA.



IRC makes more types of resistance units, in more shapes, for more applications than any other manufacturer in the world.



Gammatrons help banish 'GHOSTS' FROM EYEGLASSES

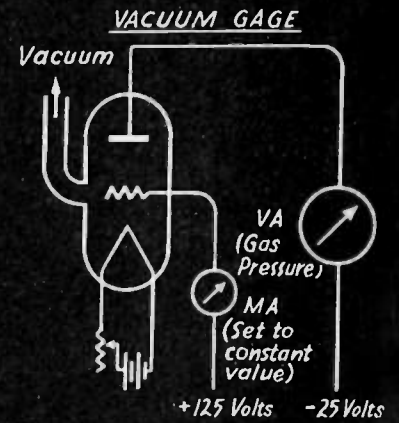
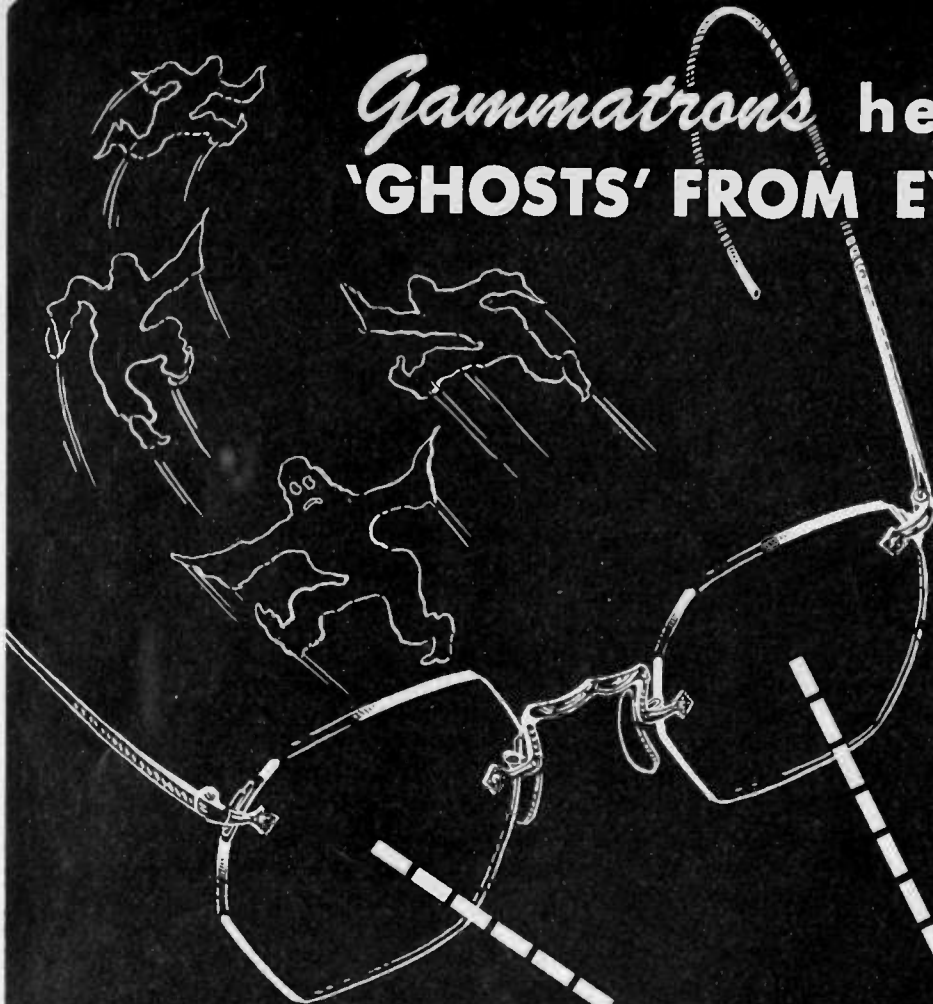

Circuit shows operation of the VG-54 which is essentially a triode vacuum tube. Emission current from cathode ionizes gas molecules in tube by electron bombardment. Number of ions flowing to negative electrode is a measure of gas present, and hence of vacuum pressure.

NEW GLASS COATING TECHNIQUE AIDED BY VG-54 IONIZATION GAUGES

A new technique for making glass transmit up to 50% more light through a lens system, and eliminating troublesome "ghost images", is being aided by a new Gammatron tube — the VG-54.

A transparent, microthin coating of magnesium fluoride is applied to the glass by a unit which produces the high vacuum necessary to vaporize this metallic salt in a few minutes, instead of the several hours previously required.

The VG-54 ionization gauge, a special type of triode which accurately measures vacuum pressure, is currently in use with units which are decreasing the surface and interior reflection of lenses and prisms in Norden bombsights.

Gammatron ionization gauges are now available for checking the operation of all types of vacuum equipment.

HEINTZ AND KAUFMAN LTD.
SOUTH SAN FRANCISCO • CALIFORNIA

 *Gammatron Tubes*

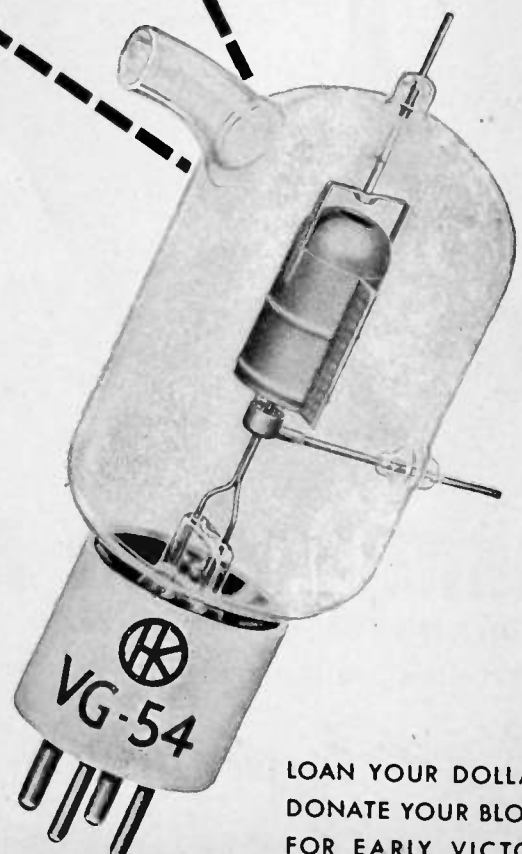

LOAN YOUR DOLLARS
DONATE YOUR BLOOD
FOR EARLY VICTORY

Proceedings of the I.R.E. November, 1944

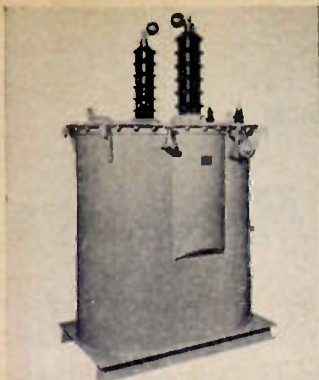

Single phase, half wave rectifier plate transformer, 60 cycles, 220 volts primary, 110,000 volts secondary.



300 VA Filament transformer, single phase, 60 cycles, 6 secondary windings of 5 volts each; 3 secondary windings operating 40 KV above ground and 3 secondaries operating 20 KV above ground.



60 KVA, three phase, 60 cycles, 211 volts, Delta primary, 3900 / 6755 / 7800 / 13510 volts Wye secondary.



150 KVA Distribution transformer, single phase, 600 high voltage, 240/120 low voltage.

Fire!

REDUCE THE HAZARD WITH AMERTRAN ABESTOL IMMERSSED TRANSFORMERS

Fireproof AmerTran Abestol Immersed Transformers reduce both the possibility and the extent of fire damage. That's why they earn lower insurance rates and permit vaultless indoor installation, with its convenience, flexibility and accessibility. To industry, AmerTran Abestol Immersed Transformers offer the advantages of load center installation: copper savings, finer voltage regulation, lower line losses and improved motor performance. If necessary, they may be mounted overhead because the chemically inert Abestol, which requires no maintenance, is sealed. In comparison to transformer oil, Abestol possesses higher insulating properties and similar heat transmission characteristics.

Send for further information.

AMERICAN TRANSFORMER COMPANY
178 EMMET STREET, NEWARK 5, NEW JERSEY



AMERTRAN

MANUFACTURING SINCE 1901 AT NEWARK, N. J.

Pioneer Manufacturers of Transformers, Reactors and Rectifiers for Electronics and Power Transmission

FOR SAFETY'S SAKE!

Electro-Voice Hand-Held Differential Microphone

Model 205-S

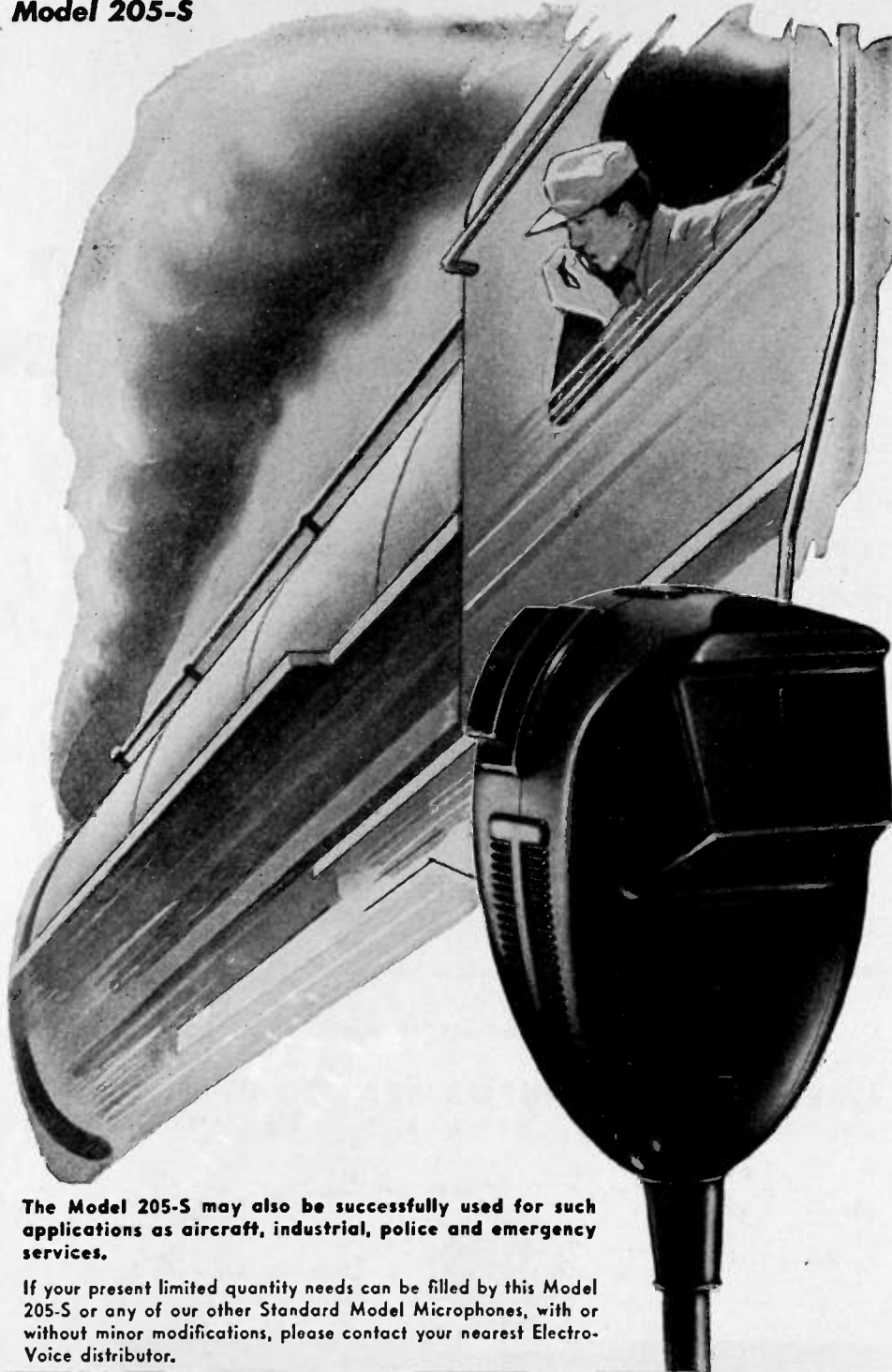

The Model 205-S may also be successfully used for such applications as aircraft, industrial, police and emergency services.

If your present limited quantity needs can be filled by this Model 205-S or any of our other Standard Model Microphones, with or without minor modifications, please contact your nearest Electro-Voice distributor.

The appalling number of railroad accidents in recent months has stimulated the demand for installation of radio communications on railway lines. Eventually, all lines will be thus equipped. Splendidly suited "for safety's sake" is the Electro-Voice Differential Microphone Model 205-S. A noise-cancelling microphone, it enables the transmission of voice clearly and distinctly, unaffected by shrieking whistles or grinding wheels. Ruggedly constructed, it can "take" the punishment of a hard-riding locomotive.

FREQUENCY RESPONSE: substantially flat from 100-4000 c.p.s.

LEVEL: -20 DB (0 DB = 1 volt/dyne/cm²)

ARTICULATION PERCENTAGE: 97% under quiet, 88% under 115 DB ambient noise

TEMPERATURE RANGE: -40° to +185°F

WEIGHT: Less than eight ounces

INPUT REQUIREMENT: standard single button input

BUTTON CURRENT: 10-50 milliamperes

MECHANICAL DETAILS: molded, high impact phenolic housing. Minimum wall thickness, 1/8". Vinylite carbon retainer.

SWITCH: press-to-talk, with or without hold-down lock. Double pole double throw contacts provide an optional wide assortment of switch circuits. Standard circuit provides closing of button circuit and relay simultaneously.

THERMAL NOISE: Less than 1 millivolt with 50 milliamperes through button

IMPACT RESISTANCE: capable of withstanding more than 10,000 drops

POSITIONAL RESPONSE: plus or minus 5 DB of horizontal

CABLE: 5' three conductor, overall synthetic rubber jacketed

BACKGROUND NOISE REDUCTION: 20 DB and higher, depending on distance from noise source

Electro-Voice MICROPHONES

ELECTRO-VOICE CORPORATION • 1239 SOUTH BEND AVENUE • SOUTH BEND 24, INDIANA

Export Division: 13 East 40th Street, New York 16, N. Y., U. S. A. Cables: Arlab





War Gem Today

WHAT WILL THE QUARTZ CRYSTAL DO TOMORROW?

The fabled princes of Hindustan or the wealthy Nizam of Hyderabad never owned a gem more valuable.

The quartz crystal is doing more than rubies or emeralds to protect our way of life against the aggressor.

Cut into tiny wafers the quartz crystal is performing with merit wherever fixed radio frequencies are a "must".

Federal is mass producing frequency control crystals for military use. How many difficult jobs they are doing is a war secret. But their versatility is unlimited.

Even now—in the great FTR research laboratories—men are finding new uses for

quartz crystals—pointing the way to widespread industrial and civilian use after the war is won.

Not alone in communications—but in such widespread applications as precision timing and measuring devices, television, supersonics, pressure gauges, filters, generators, induction heating devices and automatic control equipment, crystals will find new uses . . . a war gem will become a peacetime servant.

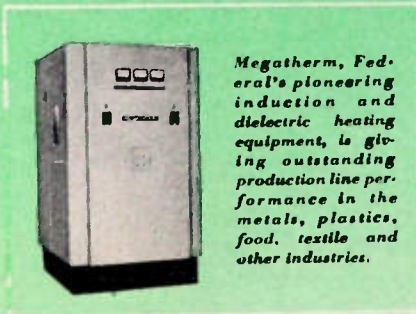

Megatherm, Federal's pioneering induction and dielectric heating equipment, is giving outstanding production line performance in the metals, plastics, food, textile and other industries.

To achieve mass production Federal has installed new machinery and new methods to speed crystals on their way to war—and will continue to be a leader in crystal production. Now is the time to get to know Federal.

Federal Telephone and Radio Corporation



Newark 1, N. J.



SYMBOL OF ACHIEVEMENT IN AMERICAN INDUSTRY

TO THE ELECTRONIC CORPORATION OF AMERICA, the Army-Navy "E" award has always symbolized all that is good in American industry. To us, it means that labor and management are cooperating for the welfare of our country. It means that Americans of different races and religions are working together in harmony. It means that an abundance of creative ideas are thoroughly and speedily carried out. Because we of ECA believe in and practice the ideals for which this award stands, we are extremely proud to announce that we have received the coveted Army-Navy "E".

To the engineers who design our precision electronic equipment and to the men and women who build it... to the members of our two CIO unions and to the members of management—all of whom have given their best during these crucial war years, the Labor-Management Committee of the Electronic Corporation of America extends heartiest congratulations. To our suppliers and the personnel of the military forces, who have so ably and diligently assisted us, we offer our sincere thanks.

We shall continue to keep the quantity and quality of our war production consistently high. And when the war exists only in the pages of history, we shall serve the people of this great country with the same devotion that has characterized our contribution to Victory.

Just Published! "A PLAN FOR AMERICA AT PEACE." A sound workable, realistic plan for a postwar world of abundance and lasting peace, prepared by the Electronic Corporation of America. WRITE FOR YOUR FREE COPY.

ECA
ELECTRONIC CORP. OF AMERICA

45 WEST 18th STREET • NEW YORK 11, N. Y. WATKINS 9-1870

MANUFACTURERS OF E C A . . . the Radio Man's Radio

CHALLENGE!

As you look through the ads in this magazine...

FIND THE GLASS PARTS NOT MADE AT CORNING

IT'S really not much of a gamble on our part. The truth is that most of the electronic glass equipment built today comes from Corning Glass Works. Bulbs, flares, insulators, transformer bushings, tubing, resistor tubes, coil forms, are just a few of the hundreds of electronic glassware products produced under our Army-Navy "E" flag. Here you will find glasses with high electrical insulating qualities; glasses with an expansion coefficient practically equal to that of fused quartz; glasses extremely resistant to mechanical shock; glasses that can now be made into intricate shapes formerly considered impossible. And be-

hind them all, 75 years of pioneering in glass research and experience gained in the development of more than 25,000 glass formulae.

We hope this doesn't scare you. All it means is this: If you have a problem you think glass might be helpful in solving, feel free to call on Corning! Everything we know about glass is at your service. Just to get started we'd like to send you a copy of an informative new booklet, "There Will Be More Glass Parts In Post-war Electrical Products." If interested, write Electronic Sales Dept. P-11, Bulb and Tubing Division, Corning Glass Works, Corning, New York.



CORNING
means
Research in Glass

Electronic Glassware



"PYREX" and "CORNING" are registered trade-marks of Corning Glass Works

Great Events in the History of...

COMMUNICATIONS!



The Telephone Talks! "Mr. Watson, come here, I want you!"—this sentence uttered by Alexander Graham Bell on the evening of March 10, 1876, was the first ever transmitted by telephone. This great event soon led to the beginnings of the Bell Telephone System—for which Western Electric has been the manufacturer ever since 1882.

EVEN BEFORE the first of these events Western Electric—founded on November 18, 1869—was making electrical communications equipment. Bell Telephone maker since '82—pioneer in radio since its beginning—the Company today is the nation's largest producer of electronic and communications apparatus for war. In the peace that's coming, count on Western Electric—with its unique 75-year experience—for continuing leadership.

During the 6th War Loan Drive, buy more Bonds than ever!



The Telephone Spans the Continent! On January 25, 1915, Alexander Graham Bell talked once more to Thomas A. Watson on a momentous occasion—the first time a telephone message crossed America. This great advance was made possible by the use of Western Electric vacuum tube repeaters—the first of many millions we have produced for the Bell System.



Radio Telephone Spans the Atlantic! Just before dawn on October 21, 1915, the first spoken words spanned the Atlantic—transmitted from Arlington, Va., and received in Paris by radio telephone apparatus designed and made by Western Electric. Out of this pioneering came world-wide telephony—broadcasting—aviation, marine and mobile radio.

NEW VIBRATOR CIRCUIT BY ELECTRONIC

Triples
POWER SUPPLY
Capacity!

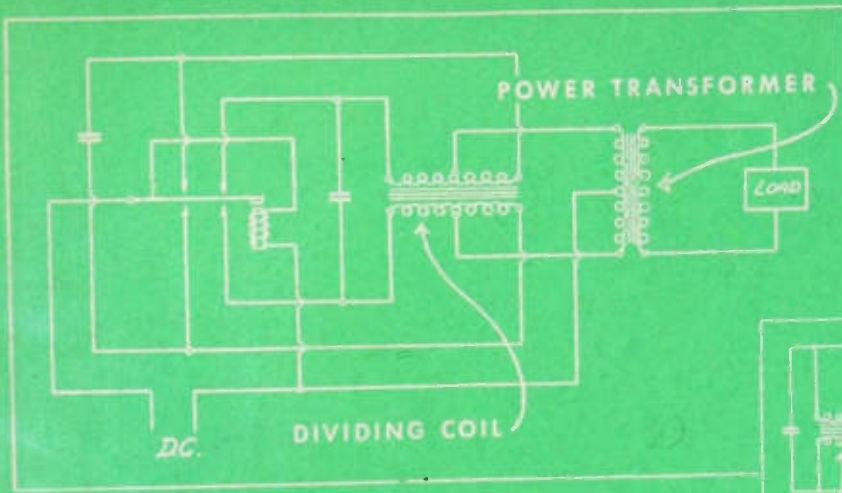

Typical E-L Circuits Which Divide Current Equally Between Multiple Vibrator Contacts

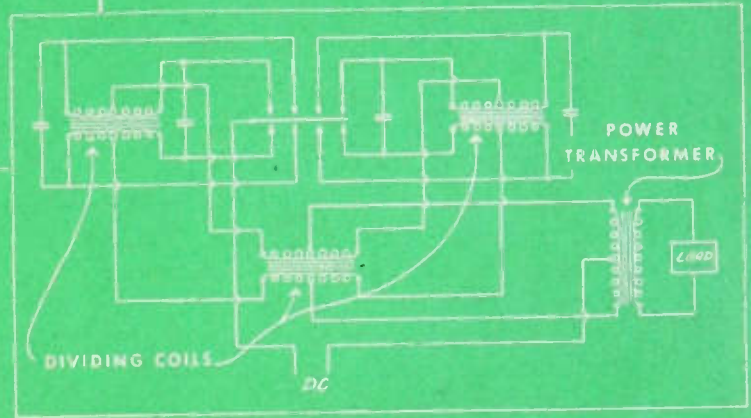

Electrical Current Division Circuit Between Contacts

A tremendous increase in wattage output is one of the striking advances made by Electronic Laboratories in Vibrator Power Supplies in the last few years. Now, 1,000 watts output capacity is easily attainable for Heavy-Duty use while still maintaining all the inherent advantages of vibrator power supply.

The crux of the problem was the development and perfection of a current dividing circuit which actually distributes the current equally between the vibrator contacts. This was necessary because the wattage output of vibrator power supplies depends on the volt-ampere capacity of their vibrators. This in turn is determined by the ability of the electrical contacts which make and break the current at each cycle to resist disintegration. E-L engineers found that multiple and enlarged contacts operating in parallel were not enough. The contacts could not be adjusted with sufficient precision to assure striking at the same instant. Therefore, the first contact which closed received the full burden of the electrical load which caused pitting and burning.

Equal division was finally accomplished with a special electrical current dividing circuit which incorporates a balancing reactor of small inductance relative to that of the main transformer of the power supply. When properly combined with the buffer network, this reactor effectively forces the equal division of the make and break energy in each cycle and at the same time retains the economic advantage of a single large transformer.

The current limiting reactor in the typical circuits shown above, limits by reactance the current which flows in the leg which has the completed circuit. When the second contact closes, the reactive effects are cancelled and the current is limited only by the DC resistance of the reactor. In the tandem type vibrator the division is carried out by first equalizing the current between the pairs of contacts. Then,

by additional reactors, the current is equally divided between the individual contacts. This exclusive and patented* E-L development opens many new fields and applications to the benefits and advantages of Vibrator Power Supplies. Consider your needs in the light of this increased capacity.

E-L Vibrator Power Supplies have wide application in many fields: radio, marine, railroad, electronic and electrical. Their high versatility with multiple input and output voltages enables them to meet many power supply needs. They may be designed to provide any wave form needed for specific equipment. Another important and exclusive E-L feature that can be built into your vibrator power supply is constant output voltage, despite wide fluctuations of input voltage . . . economy is assured because of long, efficient service with minimum maintenance. E-L Engineering Service is available to discuss your power supply problem and to design a vibrator power supply to meet specific voltage, power, size and weight requirements.

(Below: A typical tandem type vibrator, which, used in conjunction with the electric current division circuit (see write-up above) has an input capacity of 1,000 volt-amps. at 110 v. DC.)

*Patent Number 2327577

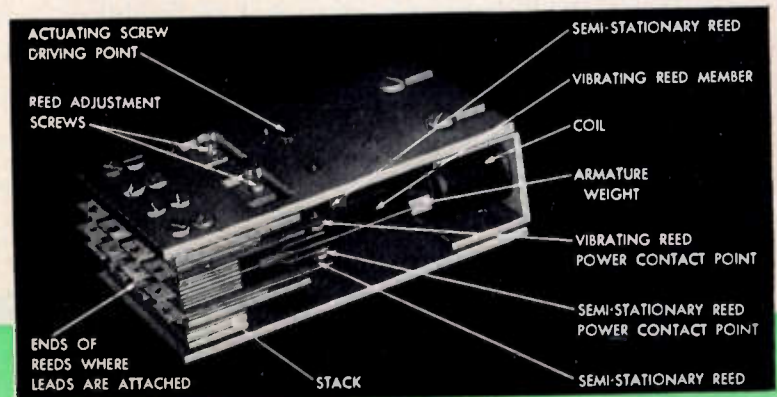

Electronic
LABORATORIES INC.

INDIANAPOLIS

VIBRATOR POWER SUPPLIES FOR LIGHTING, COMMUNICATIONS, AND ELECTRIC MOTOR OPERATION • ELECTRIC, ELECTRONIC AND OTHER EQUIPMENT



new, versatile



instruments

for measuring
Low Audio Frequencies

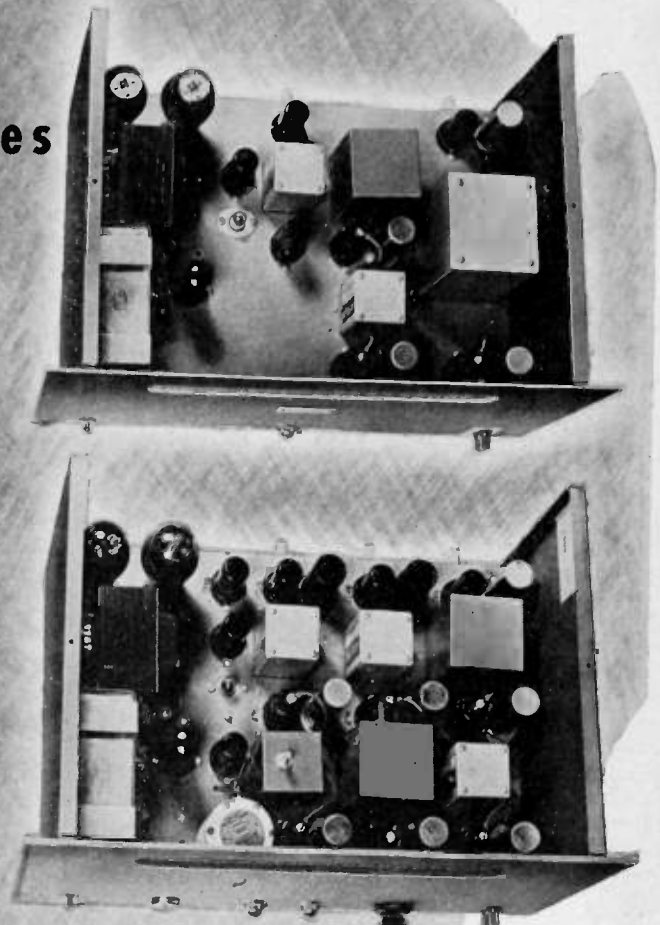
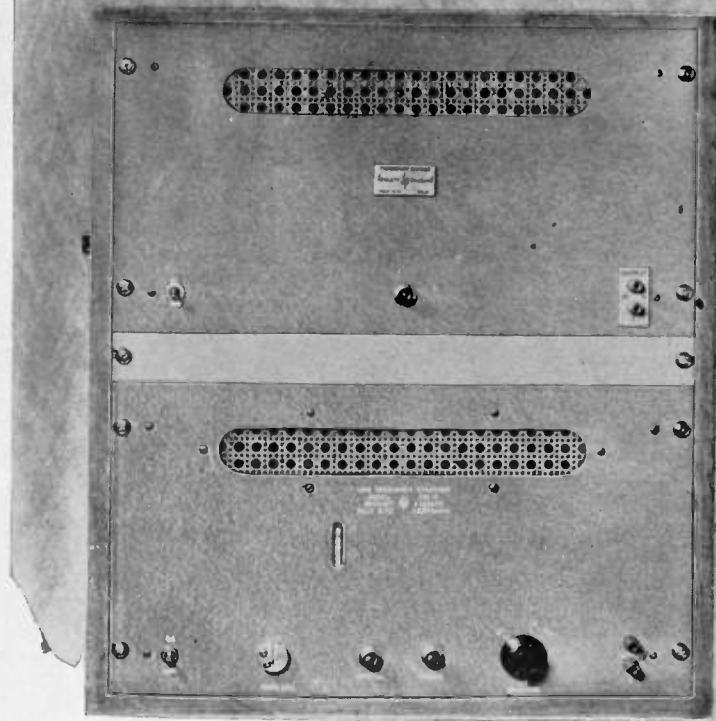

The problems of measuring low frequencies usually require a great deal of flexibility in instruments and in such work it is generally desirable to make measurements by lissajou pattern method. *-hp-* offers a simple solution to such problems with the model 100B Frequency Standard in conjunction with a 10 cycle frequency divider. This combination (illustrated) will give an output of 10, 100, 1000, 10,000 and 100,000 CPS with accuracy within plus or minus .001%. To provide a large num-



ber of harmonics for measuring frequencies above 100KC, generators and mixing panels can be supplied. These additions will provide the means for measuring frequencies up to 50 megacycles. *-hp-* can also supply standardization and measurement equipment for much higher frequencies.

Ask for more detailed data and information. Give us details of your problem so we can provide an intelligent answer. There is, of course, no cost or obligation. Write us today.

HEWLETT-PACKARD COMPANY

Box 880 D • Station A • Palo Alto, California

Some

INTERESTING FACTS ABOUT HYTRON

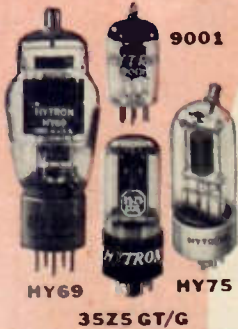

- ★ Hytron is the oldest manufacturer in the United States specializing on radio receiving tubes. The first Hytron tube was made by hand in 1921.
- ★ The now standard BANTAM GT receiving tube is a Hytron origination. Hytron designed and developed over 70 of the popular GT types. These small glass receiving tubes contributed to the development of the miniature table radio and to large scale production of radio and radar equipment for the Services.
- ★ The tiny BANTAM JR. tubes originated by Hytron were the first sub-miniatures. They made possible hearing aids and pocket radio sets. Similar Hytron tubes serve in wartime electronic devices.
- ★ Hytron has pioneered transmitting and special purpose tubes for the radio amateur and for police radio. Its very-high-frequency tubes and its instant-heating r.f. beam tetrodes for mobile communications, have also become extremely popular with the Services.
- ★ Hytron combines long experience in high-speed receiving tube techniques with the know-how of special purpose tube engineering. The result is economical mass production of special tubes.
- ★ First of the receiving tube manufacturers to convert 100% to war production, Hytron will be just as alert in serving the post-war market.

CONSULT HYTRON regarding your needs for these tubes: receiving, ballast, hearing aid, very-high-frequency triodes and pentodes, miniatures, medium and low-power transmitting triodes, r.f. beam tetrodes (particularly instant-heating), r.f. pentodes, gaseous voltage regulators, and rectifiers.

OLDEST EXCLUSIVE MANUFACTURER OF RADIO RECEIVING TUBES

HYTRON

CORPORATION ELECTRONIC AND RADIO TUBES
SALEM AND NEWBURYPORT, MASS.



BUY ANOTHER WAR BOND

DON'T LET OLD-FASHIONED RESISTORS CRAMP YOUR ENGINEERING STYLE!

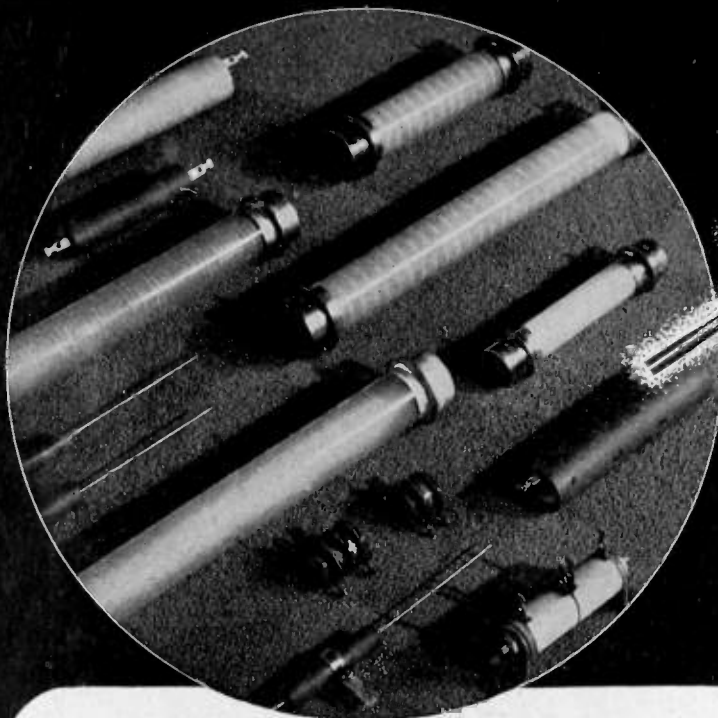

**The only
Resistors
wound with
CERAMIC-INSULATED
WIRE**

**INSULATION APPLIED
BEFORE WIRE IS WOUND**

A Major Resistor Improvement—Not just a minor change

Don't waste time engineering "around" the handicaps imposed by conventional resistors! Use Sprague Koolohms and get exactly what you want.

No power resistor can be one whit better than the insulation given its windings—and Koolohm ceramic insulation applied to the wire before it is wound gives you the maximum in this respect. Koolohms can be used safely up to their full rated wattage values. Their use of insulated wire permits larger wire sizes to be used,

and guards against shorts and changed values. They give more resistance in smaller size, and are readily adaptable to almost any mounting style best suited to your production.

Standard Sprague Koolohms include 5- to 120-watt power types. Other Sprague Resistors include bobbin types, hermetically sealed power resistors, 5- to 150-watts, and meter multipliers. Write for new catalog—just off the press.

SPRAGUE ELECTRIC COMPANY, Resistor Division
(Formerly Sprague Specialties Co.)
North Adams, Mass.



SPRAGUE^{*} KOOLOHMS

Totally Different... Outstandingly Superior

Life Testing ON THE GRAND SCALE!

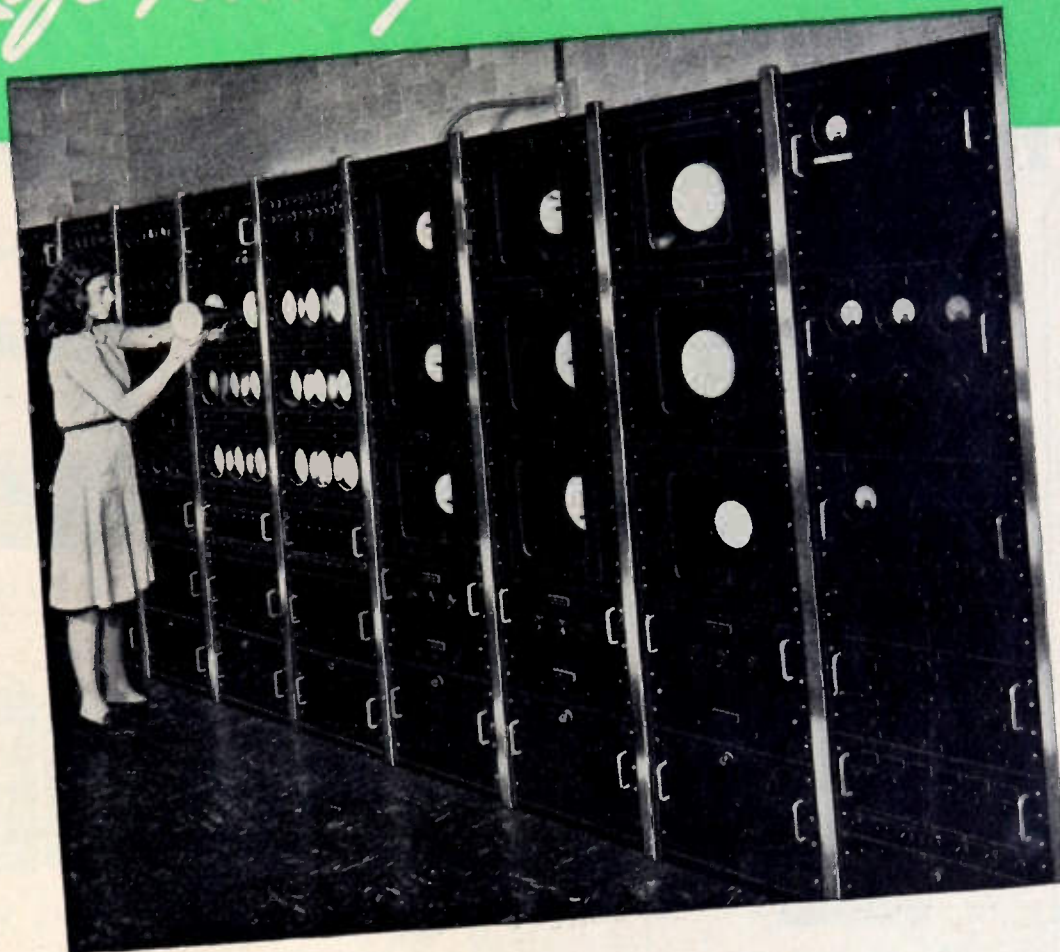

One of the most elaborate cathode-ray tube test racks in this country operates day and night, seven days a week at National Union. For, at N. U., cathode ray tube production is now reaching heights undreamed of in pre-war days. To achieve this production, entirely new testing techniques, on an unprecedented scale, have been developed.

Examples of the newest tried and proven N. U. products are the four cathode-ray tubes illustrated. All of these N. U. cathode ray types

can be produced in a variety of screen materials, which will have various postwar applications in television and industrial electronics.

Here at National Union are many such ultra-modern products ready to serve your peacetime needs. Ready, yes, in large volume—and backed by as fine an electronic tube research service as has ever been available to industry. Ready, indeed, from the day our present obligations are fulfilled and reconversion can get under way. Count on National Union.

NATIONAL UNION RADIO CORPORATION, NEWARK, N. J.
Factories: Newark and Maplewood, N. J.; Lansdale and Robeson, Pa.

NATIONAL UNION RADIO AND ELECTRONIC TUBES



Transmitting, Cathode Ray, Receiving, Special Purpose Tubes • Condensers • Volume Controls • Photo Electric Cells • Panel Lamps • Flashlight Bulbs

What will you need...

IN THE FIRST SIX POST-WAR MONTHS

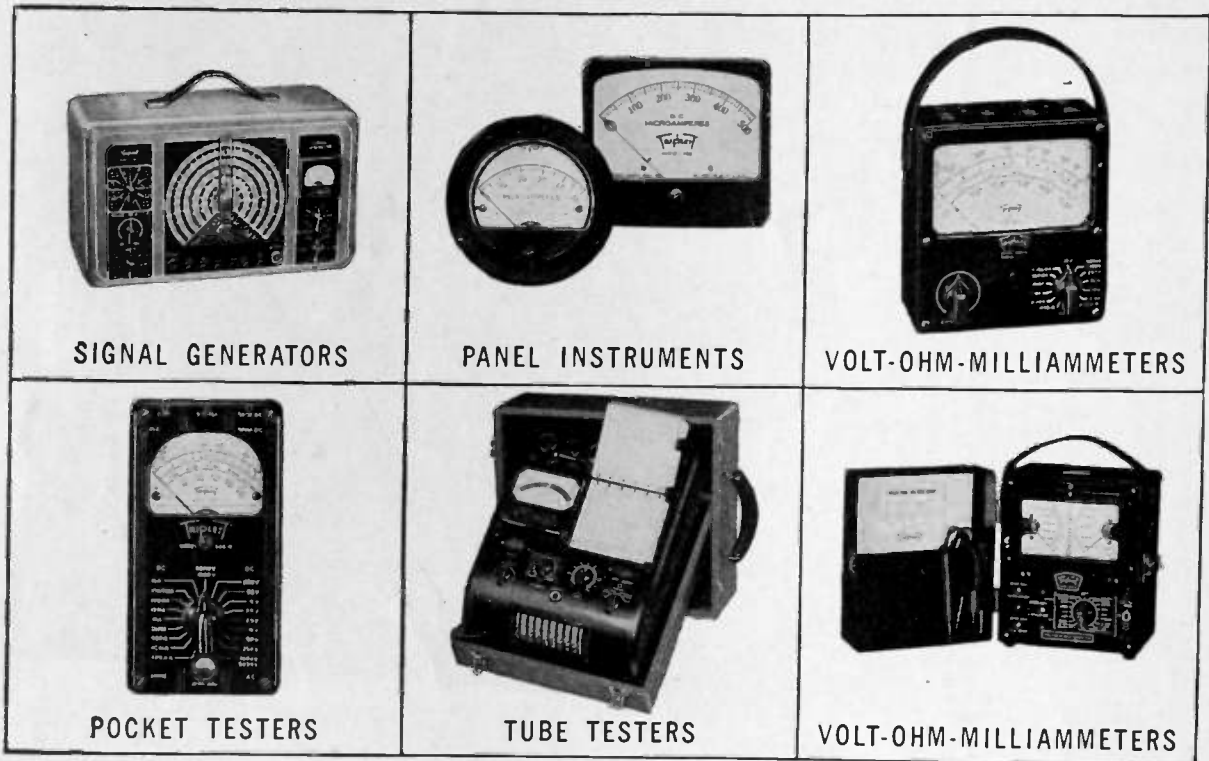

✓ CHECK THE TYPES AND QUANTITY

Now—right now—is the time to protect your post-war business by estimating your future equipment needs. Check those needs, list them and place a *tentative post-war order* with your jobber now. This foresight will enable him to stock the Triplet instruments you will need, and will assure you quicker resumption of civilian business than you could expect if you wait till the last minute. Give best priority you can obtain to facilitate deliveries as production is available.

Newly perfected developments now being produced on important war contracts, and many other outstanding instruments, will be incorporated in Triplet offerings for the first time beginning with our initial civilian production. Be sure you get the complete list of Triplet instruments and radio test equipment.

Triplet
ELECTRICAL INSTRUMENT CO.
BLUFFTON OHIO ***

STANDARDS ARE SET BY
TRIPLET

E ngineering

at



A
MAJOR
FACTOR
LEADING TO OUR
PRESENT POSITION
AS AMERICA'S
LARGEST SUPPLIER OF
TRANSFORMERS
TO THE
ELECTRONIC
INDUSTRY



United Transformer Co.
150 VARICK STREET NEW YORK 13, N. Y.
EXPORT DIVISION: 13 EAST 40th STREET, NEW YORK 16, N. Y., CABLES: "ARLAB"

*May we cooperate with you on design savings
for your applications . . . war or postwar?*

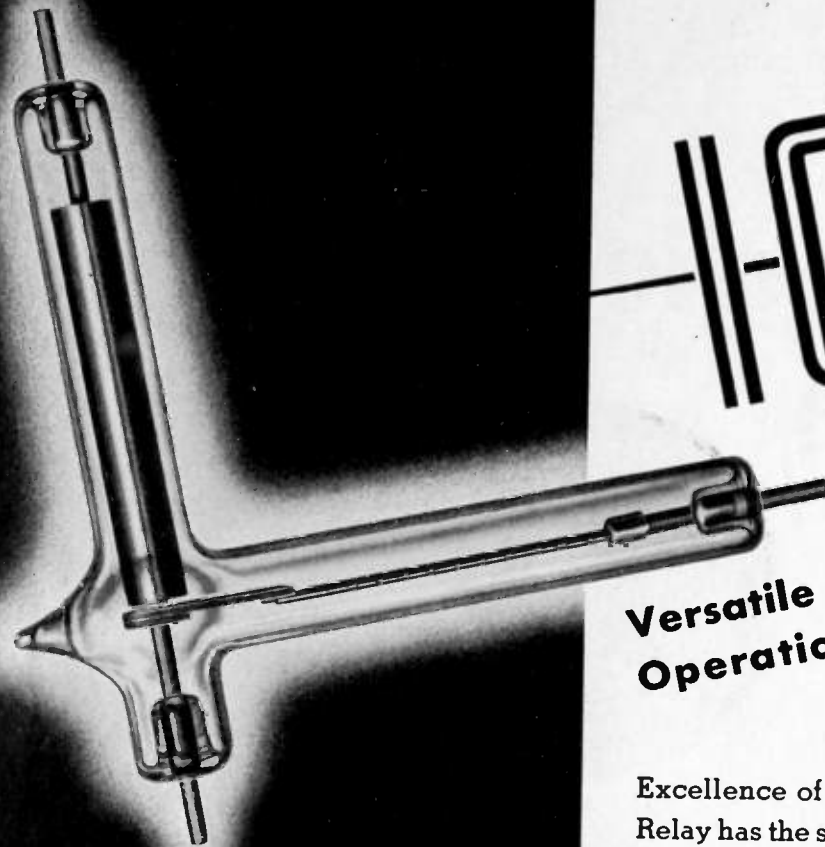

Insulation between open contacts, 20,000 volts peak R. F. or A. C. Contacts break 4 amperes. With suitable coil, requires approximately 4 watts actuating power. Contact D. C. resistance less than 0.05 ohms in either open or closed position.

VACUUM RELAYS
are Rugged and
Versatile . . . Give you Reliable
Operation and Long Life

Excellence of construction means this I. C. E. Relay has the strength to resist vibration, shock and exposure . . . resulting in reliable operation and long life. Versatility means that it can be used to do a score of different jobs for you. And of course . . . I. C. E. *precision engineering* is your assurance of correct adjustment to close tolerances. Large quantities of these I. C. E. vacuum relays are proving themselves on battlegrounds all over the world. We can give immediate delivery, in quantity, of these fine relays . . . your inquiries are invited.

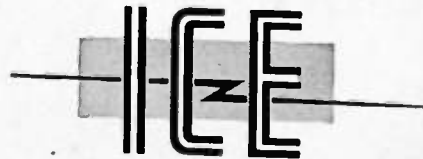

ELECTRONIC TUBES

INDUSTRIAL & COMMERCIAL ELECTRONICS
BELMONT, CALIFORNIA

"HI, FELLOWS, SEE WHAT I FOUND"

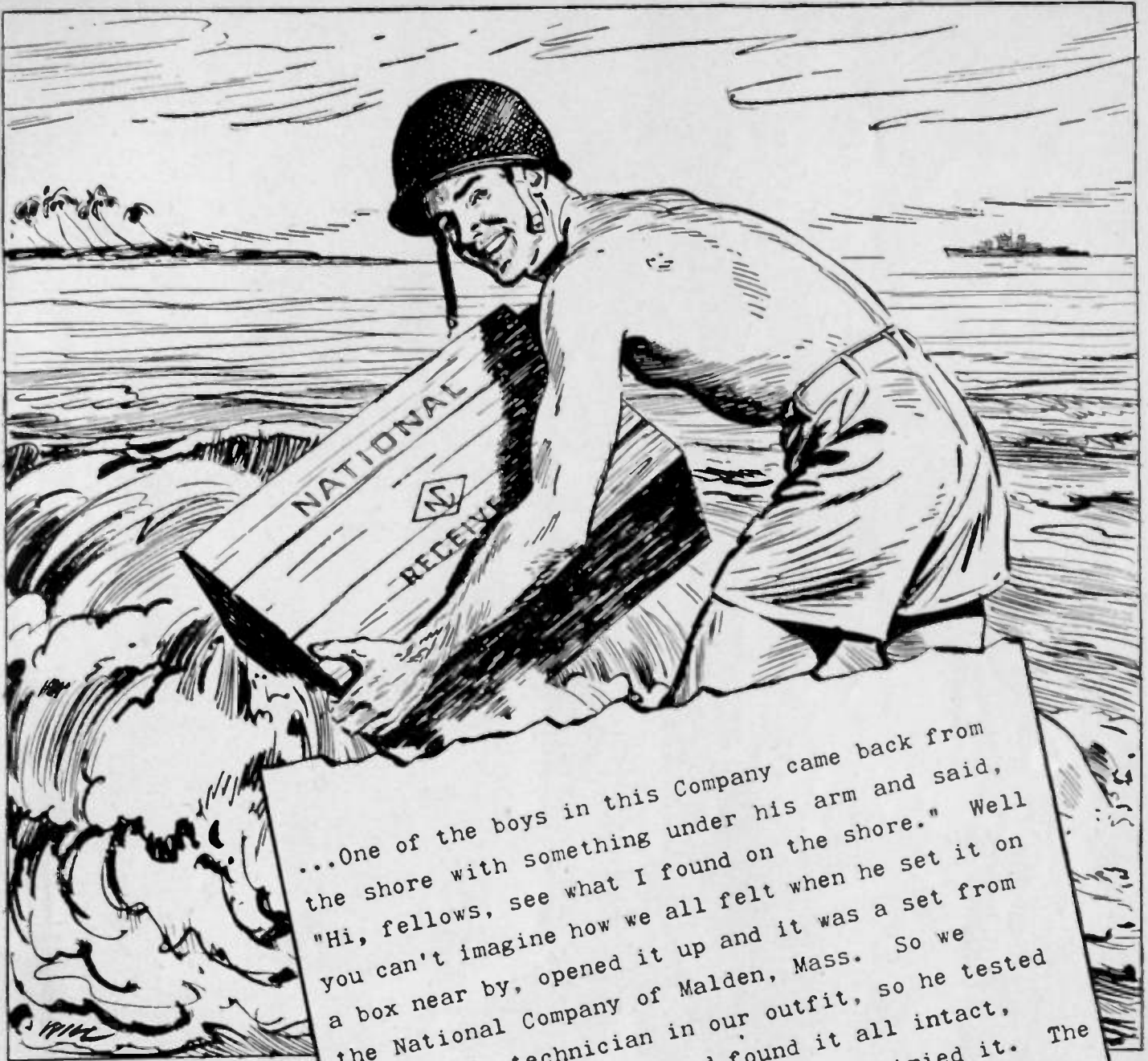

...One of the boys in this Company came back from the shore with something under his arm and said, "Hi, fellows, see what I found on the shore." Well you can't imagine how we all felt when he set it on a box near by, opened it up and it was a set from the National Company of Malden, Mass. So we had a Radio technician in our outfit, so he tested it, looked it all over and found it all intact, closed it up again, grounded it, then tried it. The salt water had not hurt it one bit—it gave us grand reception and each night, we, or about 12 of us, listened in and it seemed like a message from home.

(Excerpt from a letter we received from a soldier in the Pacific.)



NATIONAL COMPANY, INC.

MALDEN  MASS, U. S. A.

NATIONAL RECEIVERS ARE IN SERVICE THROUGHOUT THE WORLD

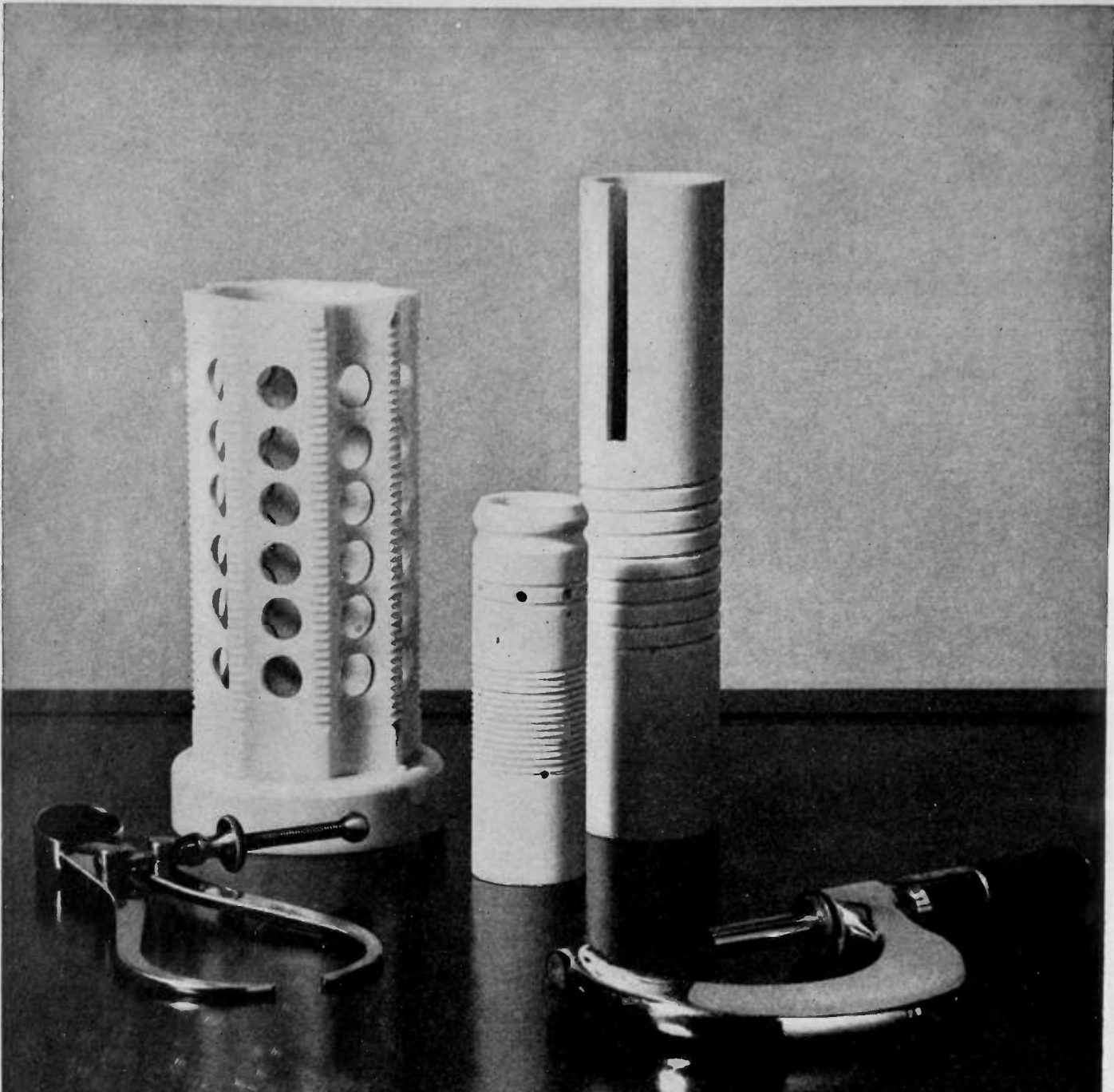

Fine ceramics by



Centralab

Division of GLOBE-UNION INC., Milwaukee

Why *Norelco* Tubes give uniformly high performance

INSPECTION by X-ray is only one of the many rigid tests applied to NORELCO electronic tubes. Misalignment of elements and similar internal faults, which cannot be seen by close visual inspection, may still permit a tube to function. Spot radiographic inspection by Searchray guards against such "invisible" defects creeping into production runs, thus assuring tubes of high performance and long life.

Typical of the thoroughness of our inspection methods on certain tests is the use of Searchray, the self-contained, rayproof, shockproof, easily operated industrial X-ray apparatus designed and developed by North American Philips. In keeping with this organization's traditional watchfulness over the quality of its products, we make our own X-ray tubes, as well as fine wire for tube manufacture and diamond dies for our own fine wire drawing. These many tests and exacting quality control are reasons why NORELCO electronic tubes, with their consistently uniform characteristics, high performance and long life, should be your choice for postwar industrial use.

Although all the tubes we produce now go to the armed forces, we invite inquiries from prospective users. A list of tube types we are especially equipped to produce will be sent on request.



Let us send you our booklet telling the story of North American Philips. Behind this company is a team of outstanding electronic engineers, headed by one of America's leading physicists, and coached by a group with world-wide experience resulting from fifty years of research and development. Today we work for Victory; tomorrow, our aim will be to serve industry.

NORELCO PRODUCTS: Quartz Oscillator Plates; Amplifier, Transmitting, Rectifier and Cathode Ray Tubes; Searchray (X-ray) Apparatus, X-ray Diffraction Apparatus; Medical X-ray Equipment, Tubes and Accessories; Electronic Measuring Instruments; High Frequency Heating Equipment; Tungsten and Molybdenum products; Fine Wire; Diamond Dies.

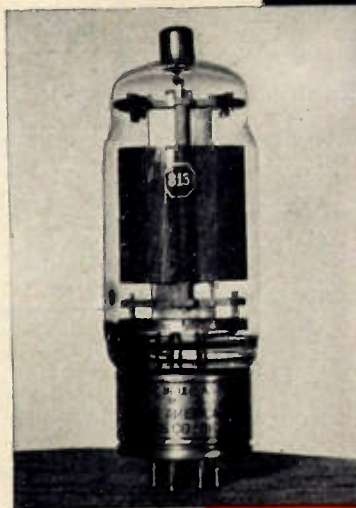

Unretouched radiograph of a defective NORELCO Type 813 tube taken by a NORELCO Model 150 Searchray, showing fractured filament and, on the left side, a misalignment of control and screen grids, as revealed through the surrounding graphite plate.

A NORELCO Type 813 Beam Power Transmitting Tube.



Norelco ELECTRONIC PRODUCTS by
Reg. U. S. Pat. Off.
NORTH AMERICAN PHILIPS COMPANY, INC.

When in New York, be sure to visit our Industrial Electronics Showroom.

Dept. F-11, 100 East 42nd Street, New York 17, N.Y.

Factories in Dubbs Ferry, N. Y., Mount Vernon, N. Y. (Metals Division), Lewiston, Maine (Beam Division)

New VARIABLE RESISTOR

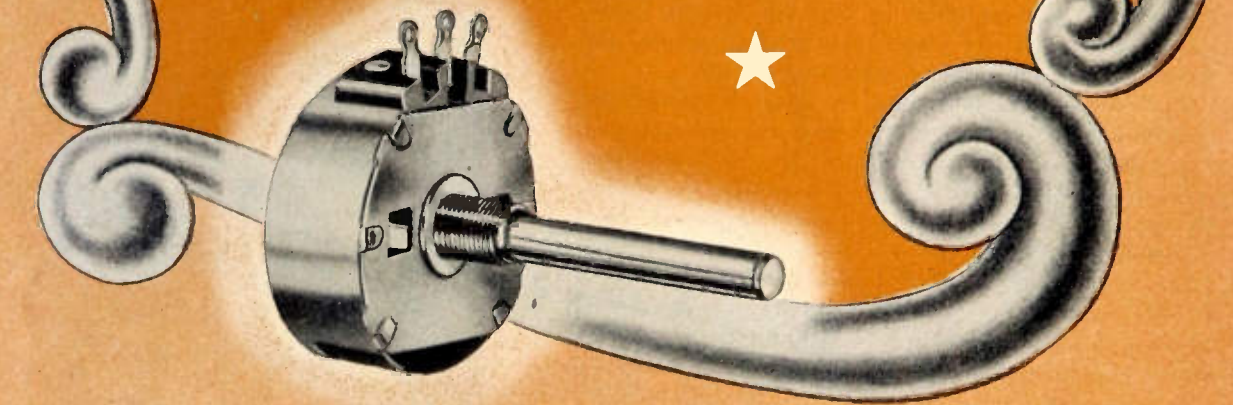

★ Chicago Telephone Supply Company now offers a new 1 1/4" diameter, wire wound variable resistor, 352 Series, with resistance value up to 20,000 ohms linear and with the same bakelite housing and grounded metal construction as the popular 1 1/4" 252 Series. This potentiometer may be used with switches attached and in tandem construction.

This new resistor is another expression of the many years of intensive research and development behind Chicago Telephone Supply Company, a scientific manufacturing

organization devoted to high standards in the mass production of variable resistors, both wire wound and carbon types.

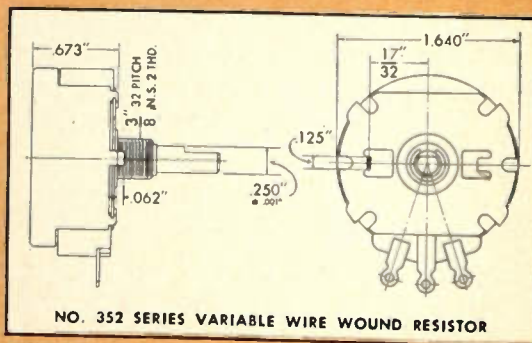

Manufacturers of Quality Electro

Mechanical Components Since 1896

VARIABLE RESISTORS, PLUGS AND JACKS

SWITCHES, TELEPHONE GENERATORS, RINGERS

REPRESENTATIVES
R. W. Farris
2600 Grand Avenue
Kansas City 8, Missouri
Phone: Victory 3070
Frank A. Emmet Co.
2837 West Pica Boulevard
Los Angeles 6, California
Phone: Rochester 9111

CHICAGO TELEPHONE SUPPLY
Company

ELKHART ★ INDIANA

BRANCH OFFICES
S. J. Hutchinson, Jr.
401 North Broad Street
Philadelphia 8, Pennsylvania
Phone: Walnut 5369

IN CANADA
C. C. Meredith & Co.
Streetsville, Ontario

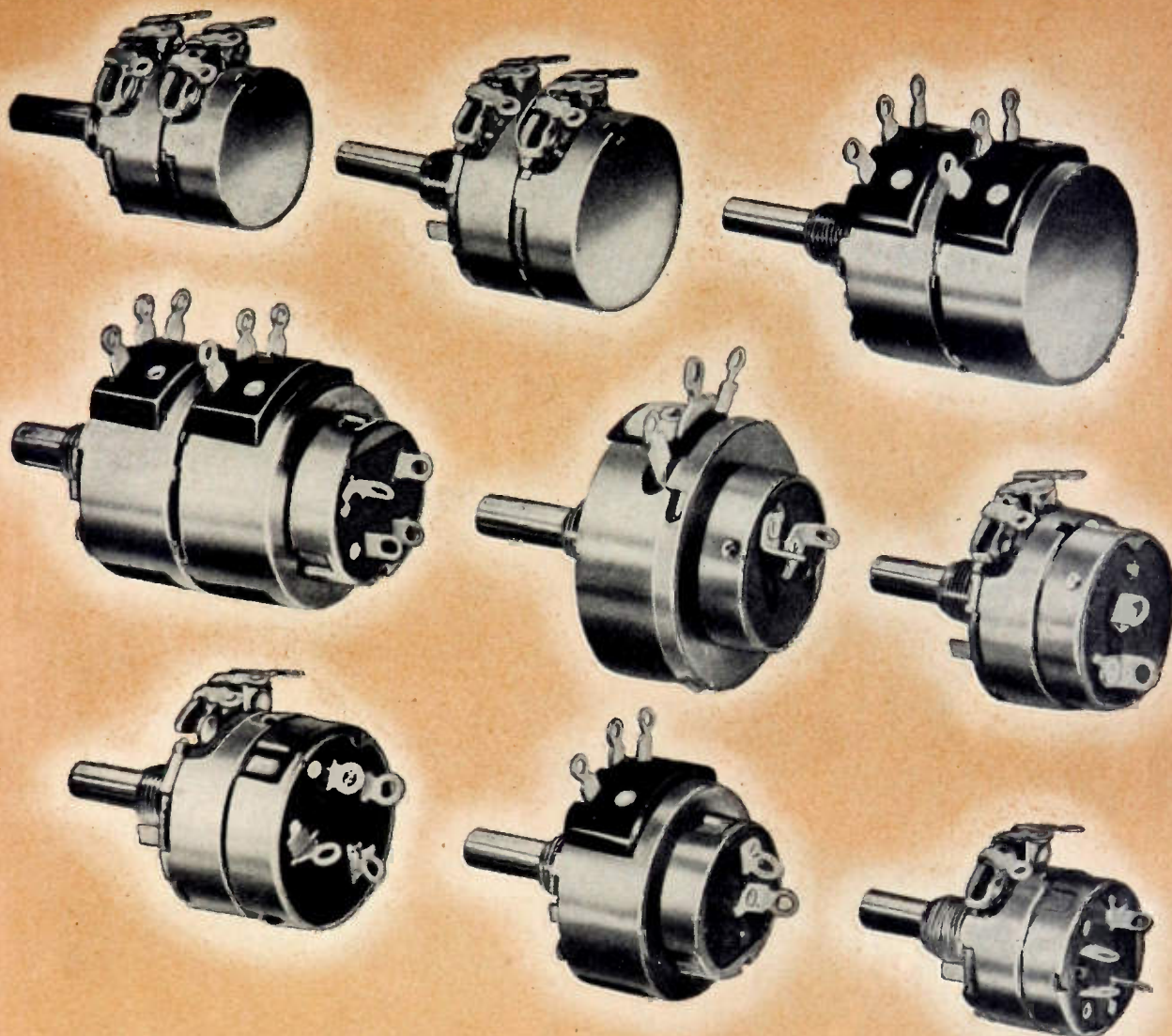

Plugs, Jacks, Switches, Variable Resistors

Telephone Generators and Ringers



Representatives
 R. W. Farris
 127 E. Thirty-first St.
 Kansas City, Mo.
 Phone: LOgan 0234
 Frank A. Emmet Co.
 2837 W. Pico Blvd.
 Los Angeles, Calif.

CHICAGO TELEPHONE SUPPLY
Company

Branch Offices
 S. J. Hutchinson, Jr.
 401 N. Broad St.
 Philadelphia, Pa.
 Phone: Walnut 5369
 In Canada:
 C. C. Meredith & Co.
 Streetsville, Ontario

ELKHART ★ INDIANA

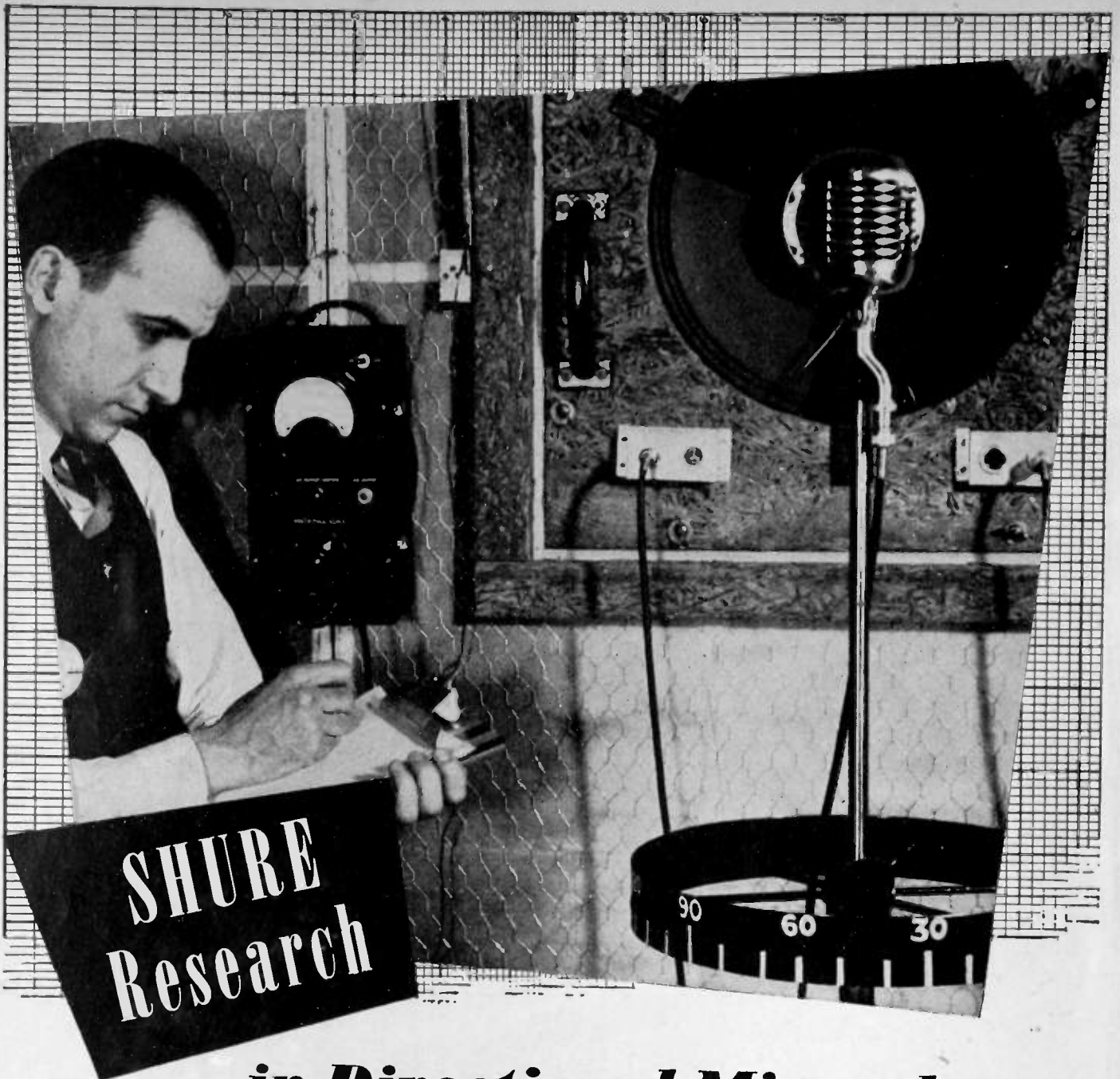

**SHURE
Research**

... in Directional Microphones

It is not enough to design a Microphone that merely converts sound waves into electrical impulses. A Microphone, to be truly useful in modern broadcasting, should be discriminating enough to accept wanted sounds — and reject unwanted sounds. Shure Research was the first to develop a single unit uni-directional Microphone, both crystal and dynamic.

Shure Research is the reason why practically every major broadcasting station uses the Shure 556 Unidyne. Shure Research is your assurance of postwar microphone superiority.

SHURE BROTHERS, 225 West Huron Street, Chicago
Designers and Manufacturers of Microphones and Acoustic Devices



Build *higher* "Q" Inductances with

MYKROY
PERFECTED MICA CERAMIC INSULATION



Q Inductance Losses

"Q" is high when losses are low. That's why Engineers at Federal Telephone & Radio Corp. build their inductance coils on MYKROY supports . . . to keep losses down to a negligible minimum! For MYKROY combines inherent physical stability with remarkably low loss characteristics at high frequencies . . . the ideal mechanical and electrical properties so essential for efficient performance in the high frequency magnetic fields to which coil bars are exposed.

Leading manufacturers of electronic equipment everywhere are now turning more and more to MYKROY for dependable high frequency insulation, since this *perfected mica ceramic* is proving to be one of the best and most usable insulating materials ever developed.

Don't let another day go by without learning more about it. Write for your copy of the MYKROY Engineers Manual containing the facts about this perfected insulation.



MYKROY is the outstanding choice at FEDERAL TELEPHONE & RADIO CORP. for insulating supports in all coils large and small. For coils up to 1 1/2" diameter MYKROY is available in solid rods or can be molded to requirements with pre-threaded surfaces. Illustration shows 10 KW Transmitter coils and small 100 watt inductance . . . both built with MYKROY.

HERE'S TECHNICAL PROOF OF MYKROY SUPERIOR INSULATING PROPERTIES

*MECHANICAL PROPERTIES

MODULUS OF RUPTURE.....18000-21000 psi
HARDNESS

Mohs Scale 3-4 BHN. BHN 500 Kg Load. 63-74
IMPACT STRENGTH.....ASTM Charpy .34-.41 ft. lbs.
COMPRESSION STRENGTH.....42000 psi
SPECIFIC GRAVITY.....2.75-3.8
THERMAL EXPANSION......000006 per Degree Fahr.
APPEARANCE.....Brownish Grey to Light Tan

*ELECTRICAL PROPERTIES

DIELECTRIC CONSTANT.....6.5-7
DIELECTRIC STRENGTH (1/8").....630 Volts per Mil
POWER FACTOR......001-.002 (Meets AWS L-4)

*THESE VALUES COVER THE VARIOUS GRADES OF MYKROY

- GRADE 8. Best for low loss requirements.
GRADE 38. Best for low loss combined with high mechanical strength.
GRADE 51. Best for molding applications.

Special formulas compounded for special requirements.

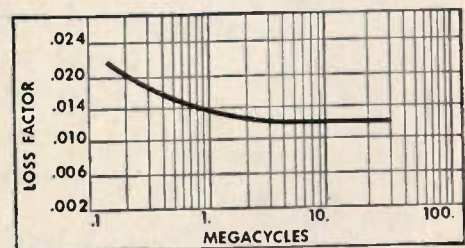

Based on Power Factor Measurements made by Boonton Radio Corp. on standard Mykroy stock.

MYKROY IS SUPPLIED IN SHEETS AND RODS . . . MACHINED OR MOLDED TO SPECIFICATIONS

MADE EXCLUSIVELY BY **ELECTRONIC MECHANICS** INC.

70 CLIFTON BOULEVARD • CLIFTON, NEW JERSEY
Chicago 47; 1917 NO. SPRINGFIELD AVENUE . . TEL. Albany 4310
Export Office: 89 Broad Street, New York 4, N. Y.

Two miles up - with an ear to the ground

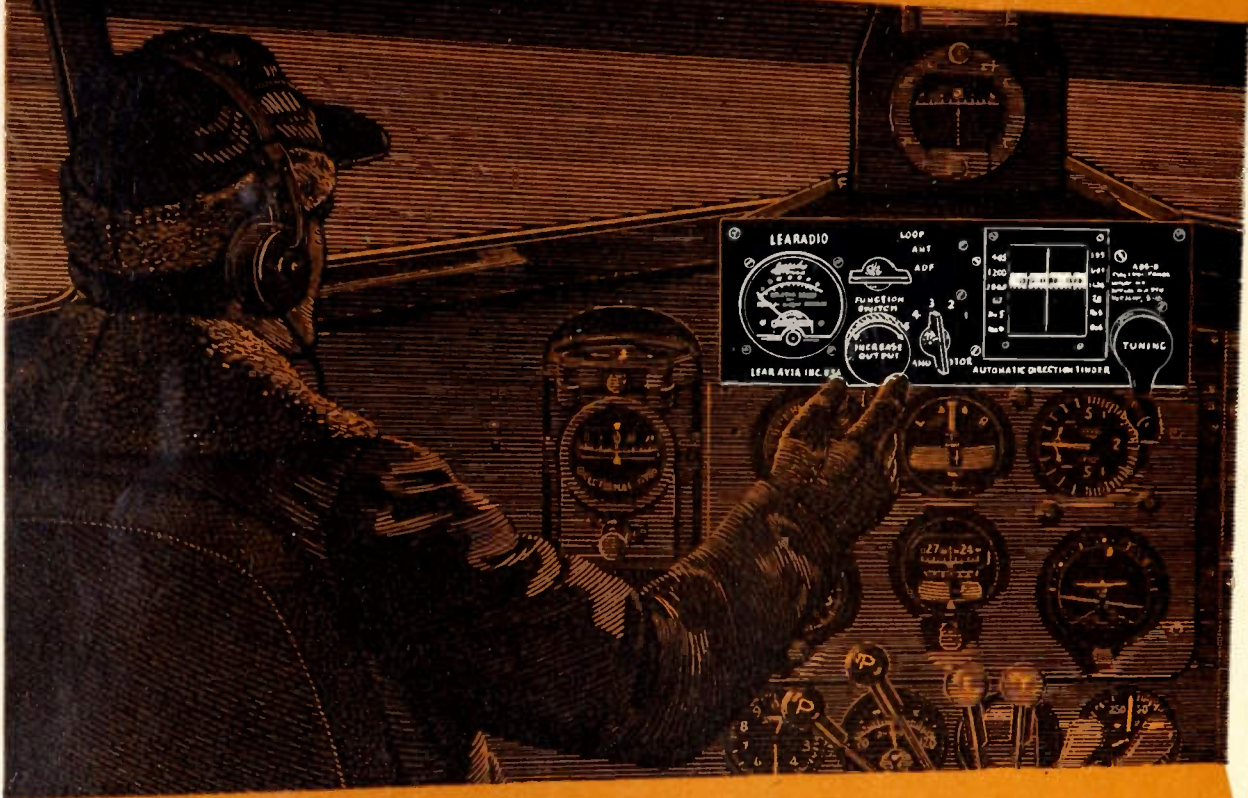

Keeping posted high in the air is one secret of successful flying. The ground keeps track of the plane. The plane knows the weather, the course, and what it's like at the field.

Lear was among the very first to make aircraft radios — had gained an enviable reputation for fine radio and navigation instruments long before the war — was ready when war needs demanded greater and greater technical development.

Some of these developments can't even be mentioned now. They're too secret. Some are in the field of electric aircraft controls. Some will have no use outside of war.

But there are others that hold vast promise for everyone when peace returns.

With its war job done, Lear will turn its discoveries, its developments, the resources of its laboratories and plants toward adding new comforts, new conveniences, new pleasures to the lives of America's families.

PLANTS: Piquette, O., and Grand Rapids, Mich. BRANCHES AT: New York, Los Angeles, Chicago, Detroit, Cleveland.



Formerly Lear Avia, Inc.

Bendix Radio Presents

A NOTABLE IMPROVEMENT IN AIRLINE GROUND STATION EQUIPMENT

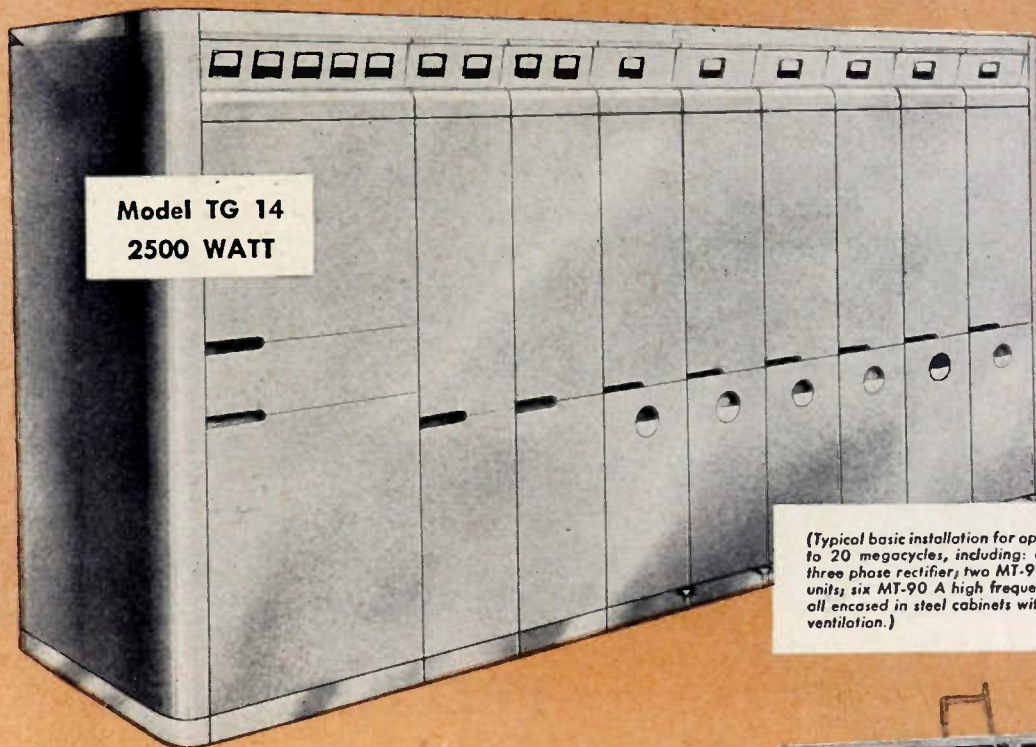

(Typical basic installation for operation on 2.5 to 20 megacycles, including: one MP-36 A three phase rectifier; two MT-92 A modulator units; six MT-90 A high frequency RF units—all enclosed in steel cabinets with forced draft ventilation.)

Great Flexibility . . . Exceptional Sturdiness . . . Complete Tropicalization

Bendix Radio*—center of radio research and production for the aviation industry—has now turned its broad experience and extensive facilities to the production of the finest of ground station equipment—and here is one result: a new, unit-type installation providing an unlimited number of operating channels in the frequency range of 200-425 kc. and 2.5 to 20 mc. . . . with sufficient power supply capacity to permit simultaneous operation of 2 radio telephone, 1 radio telephone and 2 telegraph, or 3 telegraph channels . . . and designed to allow quick installation of additional RF channels as traffic loads increase.

Constructed to the quality requirements which have made the products of Bendix Radio the Standard of the Aviation Industry, this equipment has hermetically sealed transformers for tropical use, and is studded throughout with other features to assure peak performance under all conditions. As a further guarantee of reliability, special attention has been given to adequate overload protection, and improved electrical design assures the effective reduction of Harmonic Radiation to a minimum.

Information as to dimensions, weight, construction, electrical characteristics and easy-service features will be sent promptly on request.



The MS-97 Remote Control Unit, built to individual requirements, provides a method of installing control equipment in a manner which will place all the equipment in locations readily accessible to the operator. The compact low structure of this unit permits it to be installed in such a way that the operator may have a full unobstructed view in all directions.

*TRADE-MARK OF BENDIX AVIATION CORPORATION

Bendix RADIO DIVISION

BENDIX AVIATION CORPORATION BALTIMORE 4, MARYLAND

STANDARD FOR THE AVIATION INDUSTRY

STUPAKOFF

FOUNDED IN 1897

Ceramics for the World of Electronics

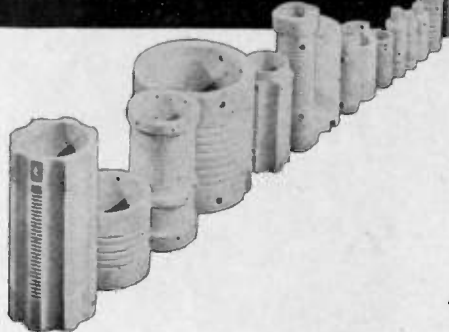
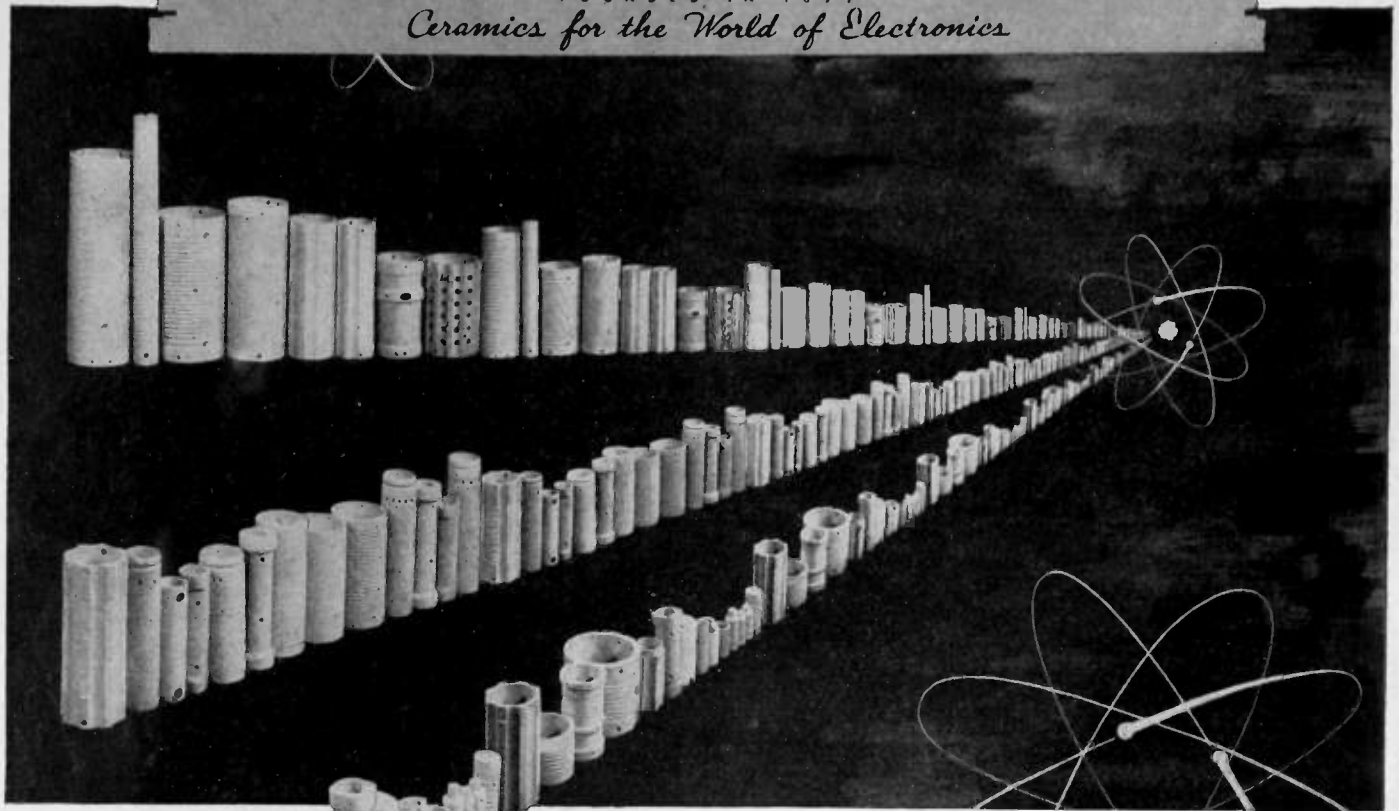

PRECISION MADE COIL FORMS ... PRODUCED IN QUANTITY

LIMITLESS styles and sizes of coil forms, embodying the exacting specifications required of this type of insulator, are manufactured by Stupakoff for the electronic industry. Backed by two generations of experience in the science of ceramics, Stupakoff engineers have the necessary knowledge to produce insulators having the optimum mechanical and electrical properties. Modern production facilities plus trained and efficient personnel are additional assurance that your specifications will be accurately interpreted.

Stupakoff coil forms of steatite and other materials—unglazed, glazed or metallized—can be delivered promptly. Write today for dependable assistance in developing correct insulators for your electronic apparatus. Your inquiries will be given prompt attention by our technical staff.



Do More Than Before—Buy EXTRA War Bonds

STUPAKOFF CERAMIC AND MANUFACTURING CO., LATROBE, PA.

wherever a tube is used...

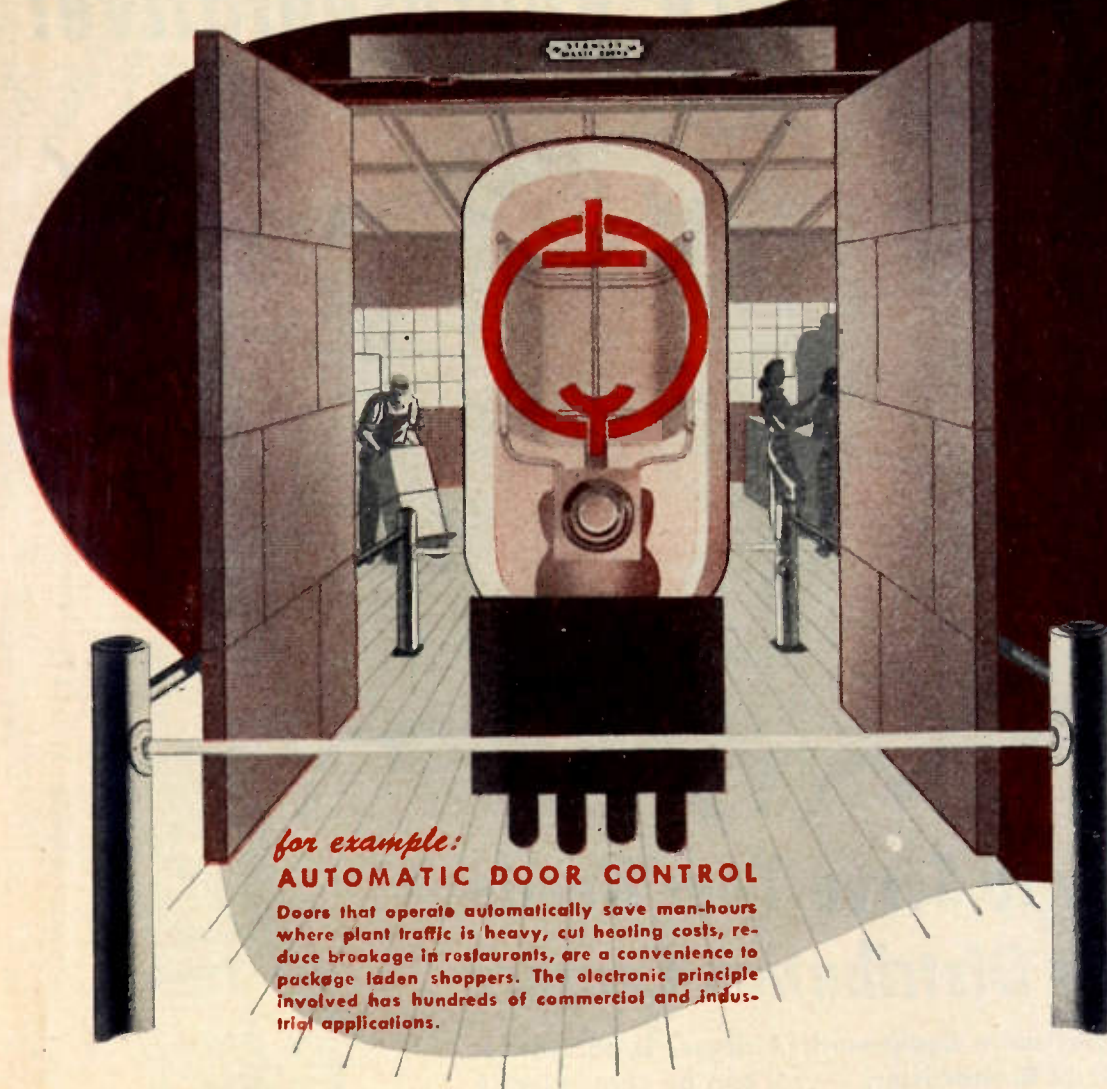

for example:
AUTOMATIC DOOR CONTROL

Doors that operate automatically save man-hours where plant traffic is heavy, cut heating costs, reduce broakage in restaurants, are a convenience to package laden shoppers. The electronic principle involved has hundreds of commercial and industrial applications.



PHOTO-ELECTRIC DOOR CONTROL
Above unit manufactured by General Electric Co., is a part of STANLEY "MAGIC DOOR" CONTROLS.

THERE'S A JOB FOR

Relays BY GUARDIAN

★ The "Magic Door" made by The Stanley Works of New Britain, Conn., uses a General Electric control unit which operates automatically at the approach of a pedestrian or vehicle. In this unit a beam of light focused on the cathode of a phototube causes a tiny current to flow. Enlarged through an amplifier tube this current operates a sensitive telephone type of relay such as the Guardian Series 405. Another phototube with an auxiliary relay, Guardian Series R-100, is employed to hold the doors open for anyone standing within the doorway.

The telephone type of relay is extremely sensitive and able to operate on the small current supplied through the electronic circuit. The auxiliary relay, Series R-100, is required to handle a greater current. It is a small, efficient relay having a contact capacity up to 1 KW at frequencies up to and including 28 megacycles. Contact combinations range up to double pole, double throw. Standard coils operate on 110 volts, 60 cycles, and draw approximately 7 V. A. Coils for other voltages are available. For further information write for Bulletin R-6.

Consult Guardian whenever a tube is used—however—Relays by Guardian are NOT limited to tube applications but are used wherever automatic control is desired for making, breaking, or changing the characteristics of electrical circuits.



Series 405 Telephone Type Relay



Series R-100 H. F. Relay

GUARDIAN ELECTRIC

1628 - M W. WALNUT STREET

CHICAGO 12, ILLINOIS

A COMPLETE LINE OF RELAYS SERVING AMERICAN WAR INDUSTRY

Every TAYLOR TUBE Distributor Is A Direct Factory Representative!

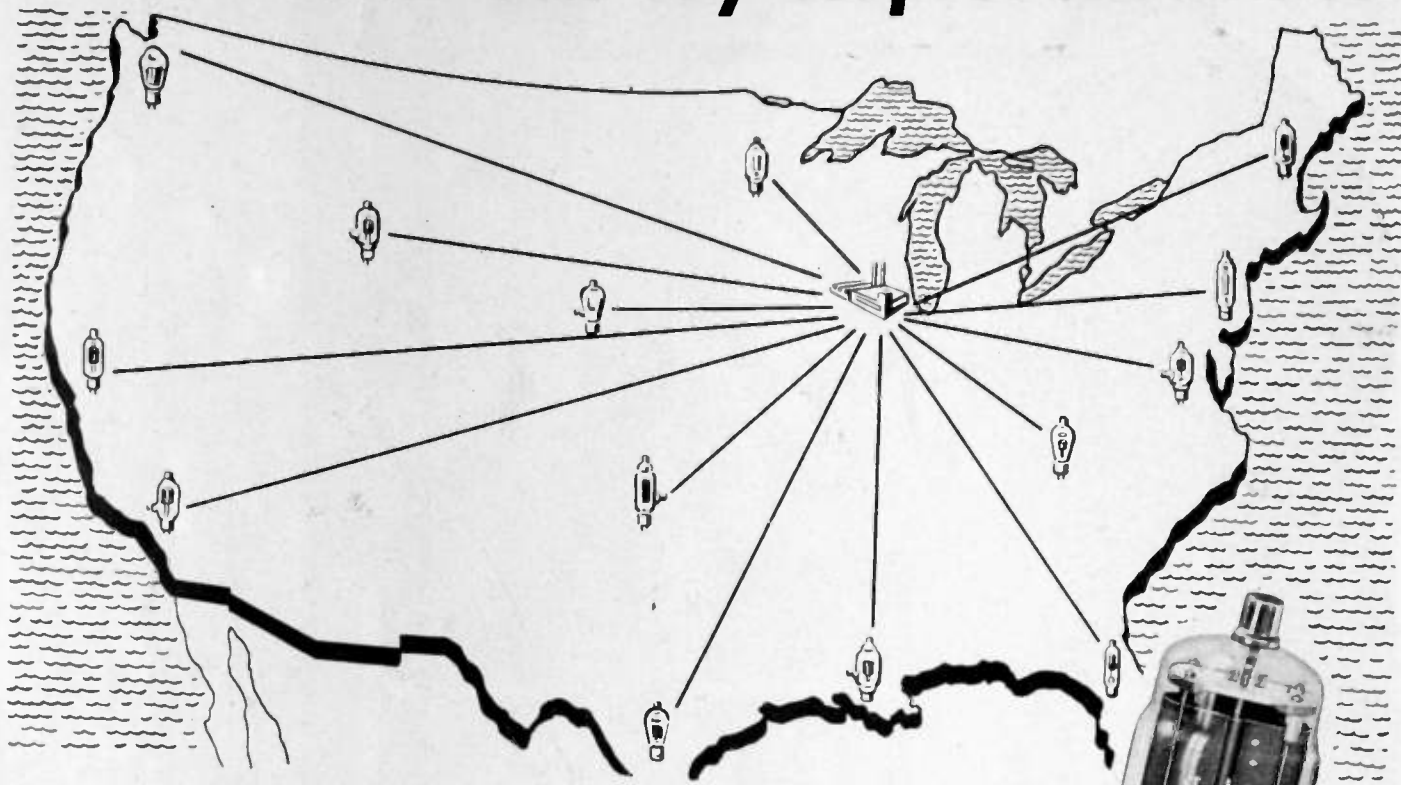

... Ready to Serve Your Needs From Major Distribution Centers

Manufacturers of Electronic Equipment, Airlines, Laboratories, Police and Commercial Broadcasters — all can be conveniently served through Taylor Tube Distributors — leading radio-electronic parts firms with years of experience behind them and a personnel schooled in a wide knowledge of transmitting tube applications.

Taylor Tube Distributors are selected for their ability to function both as distributors and "direct factory sales representatives".

It will be to your advantage to know the men who represent Taylor Tubes in your area. They can help you in many ways. If you do not already know them, we shall be pleased to provide the information.



NEW 1944-45 TAYLOR TUBE MANUAL!

Don't delay—get your copy NOW! A new edition of this famous manual has just been published. Ask your TAYLOR TUBE DISTRIBUTOR for one FREE—or send 25¢ in coin or stamps to Taylor Tubes, Inc.

"MORE WATTS PER DOLLAR"

Taylor HEAVY **CUSTOM BUILT** DUTY **Tubes**

TAYLOR TUBES INC., 2312-18 WABANSIA AVE., CHICAGO 47, ILL.

To facilitate the study of microsecond pulses containing frequency components as high as ten megacycles . . .

New! **TYPE 248 DuMONT** *Oscillograph*

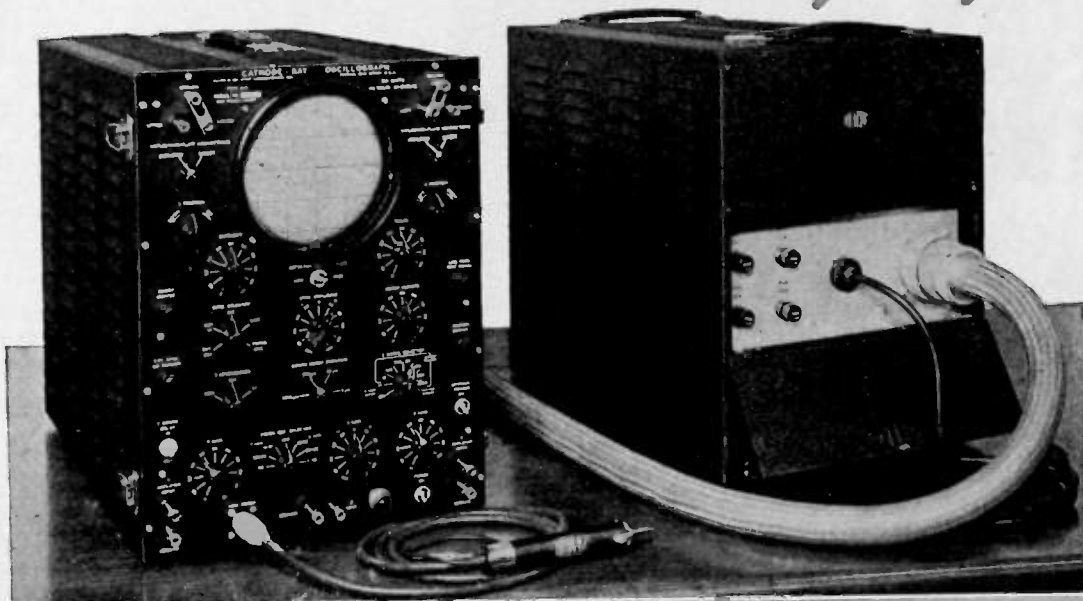

Wide band vertical axis amplifier usable to 10 MC.

4000 volts accelerating potential applied to cathode-ray tube, allowing observation of fast-writing-rate phenomena.

Extremely flexible time-base generator to display signals which heretofore required special sweep circuits.

Delay network in vertical channel, permitting observation of entire wave shape of short duration phenomena.

Useful timing oscillator for quantitative analysis.

Trigger output signal useful for "synchroscope" applications.

Optional low capacitance probe input to vertical amplifier.

Convenient mechanical design which permits placing separate power supply on floor or shelf beneath lab bench.

Storage space for all cables provided in

power unit.

Design is such that modifications to standard specs. can be accommodated to special order in the following respects: (1) Driven sweep durations; (2) Marker oscillator frequencies; (3) Trigger pulse rates.

Both metal cabinets, with carrying handles, measure 14" x 18" x 21" deep. Power supply weighs 80 lbs. Oscillograph, 30 lbs. Units connected by 6-foot shielded cable. Standard A-N connectors used.

◆ Still another DuMont "first". Incorporating the most advanced features, this latest oscillograph is now available at moderate cost as a standard commercial instrument. It will be especially welcomed by the investigator heretofore restricted in his work by the inadequate performance or the prohibitive cost of existing equipment.

Type 248 is a portable instrument. Two units facilitate handling and installation. Either transient or recurrent phenomena can be displayed. Also accommodates phenomena of inconstant repetition rate. The leading edge of short pulses is not

obliterated. The accelerating potential applied to the cathode-ray tube is great enough to permit study of extremely short pulses with low repetition rates, usually observed only with specialized and costly oscillographic equipment. Timing markers are available for quantitative or calibration purposes.

In short, this instrument removes the very noticeable deficiencies in commercial test equipment performance brought to light by recent advances in electronic technique. And it is equally useful as a general-purpose or as a production-test instrument.

◆ Write for Literature . . .

© ALLEN B. DUMONT LABORATORIES, INC.

DUMONT

Precision Electronics & Television

ALLEN B. DUMONT LABORATORIES, INC., PASSAIC, NEW JERSEY • CABLE ADDRESS: WESPXLIN, NEW YORK

REVOLUTIONARY TUBE DESIGN

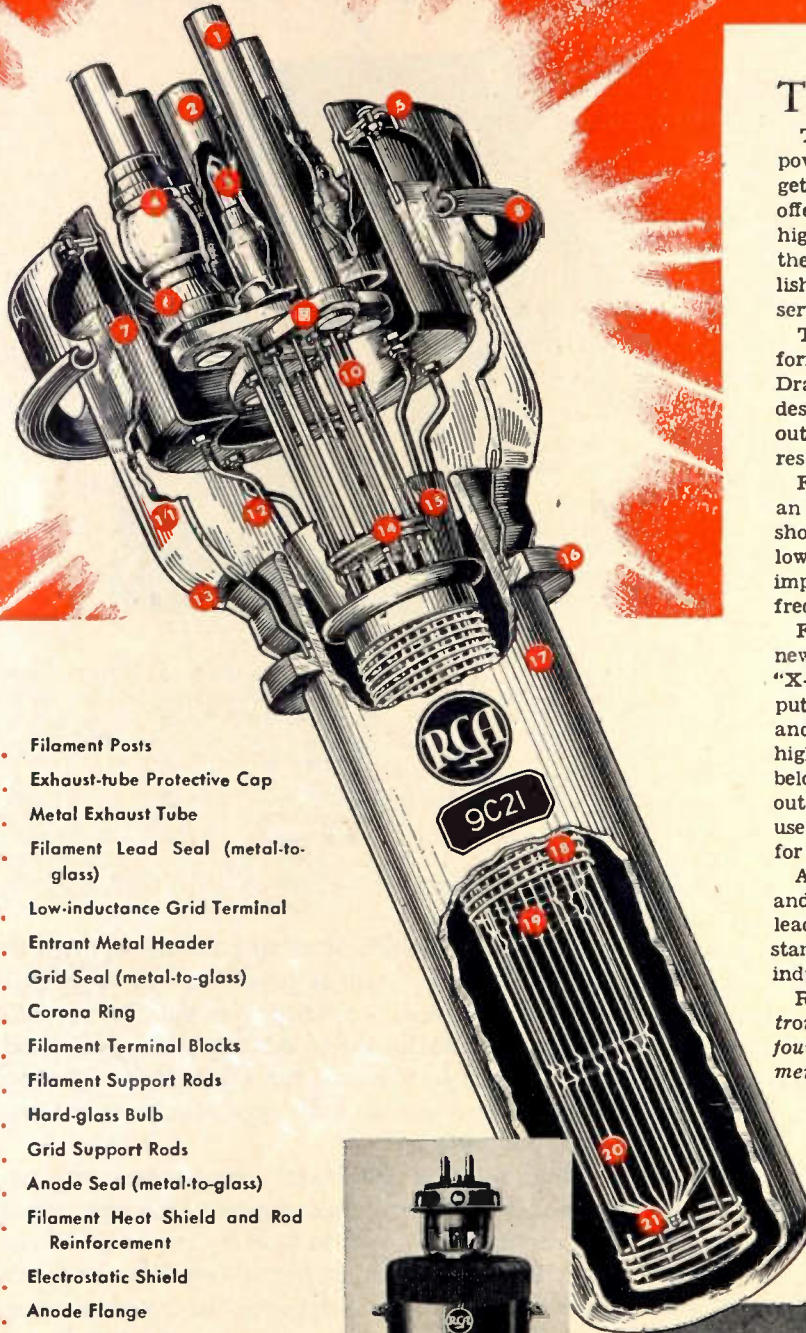

1. Filament Posts
2. Exhaust-tube Protective Cap
3. Metal Exhaust Tube
4. Filament Lead Seal (metal-to-glass)
5. Low-inductance Grid Terminal
6. Entrant Metal Header
7. Grid Seal (metal-to-glass)
8. Corona Ring
9. Filament Terminal Blocks
10. Filament Support Rods
11. Hard-glass Bulb
12. Grid Support Rods
13. Anode Seal (metal-to-glass)
14. Filament Heat Shield and Rod Reinforcement
15. Electrostatic Shield
16. Anode Flange
17. Anode (1/4-inch thick copper)
18. Grid Welded to Supports
19. Tie Wires for Self-Supporting Filament Assembly
20. Filament Strands
21. Common Tie of Self-Supporting Filament Assembly



RCA 9C22, air-cooled twin of 9C21, also offers high performance in industrial and radiobroadcast service

THIS is the story of a new tube design that "rewrites the rule book."

The tube is the new RCA 9C21, a high-power, water-cooled triode . . . which, together with its air-cooled twin, the 9C22, offers important advantages in high-power, high-frequency equipment. In designing these tubes, RCA engineers have established new concepts of tube design for such service.

Their goal was higher frequency performance for tubes of high-power design. Drawing upon their years of experience in designing and building tubes, they worked out unique innovations that produced the results they sought.

For example, one of these innovations is an *entrant metal header* which allows short, internal filament leads, and a short, low-inductance path to the grid . . . highly important factors in improving high-frequency performance.

For industrial oscillator service these new design features, shown here in an "X-ray" view, give the 9C21 a 50-kw output at a maximum frequency of 25 mc, and a 100-kw output at 5 mc or below. In high-level modulated service (at 5 mc or below) the 9C22 provides 38-kw maximum output. Thus a pair of 9C22 tubes may be used conservatively as a tube complement for the output stage of a 50-kw transmitter.

A better tube, for better performance . . . and another example of the engineering leadership that makes RCA tubes the standard of comparison in the electronic industry.

Remember, *the Magic Brain of all electronic equipment is a Tube . . . and the fountain-head of modern Tube development is RCA.*



62-6231-23

RADIO CORPORATION OF AMERICA

RCA VICTOR DIVISION • CAMDEN, N. J.

Listen to "THE MUSIC AMERICA LOVES BEST"
Sundays, 4:30 p.m., E. W. T., NBC Network

The interchange of thought between the commercial leaders in the radio industry and the radio engineers who are responsible for the methods and products used in that industry is believed helpful to both groups.

To promote such understanding there are published in the PROCEEDINGS, in the form in which they are received, guest editorials from the industrialists. Accordingly there is here presented such an expression of viewpoint from the President of Wells-Gardner and Company.

The Editor

Wartime Methods and Peacetime Applications

A. S. WELLS

Although great wars are major world catastrophes, there is the partial consolation that we can profit in peace from what we have learned in war. The radio industry will probably be a particularly fortunate beneficiary in this respect.

The radio industry was always a flexible one. Changing public demands and new engineering methods offered the wide-awake manufacturer many excellent opportunities. Usually the industry availed itself of these opportunities and produced new and appealing merchandise as fast as technical skill made these available and the public responded to their performance and quality. This flexibility has served the industry in good stead during the war period. Here was a great group of manufacturers devoted on one day to peacetime pursuits. Practically the next day it was converted one hundred per cent to the war effort. Few if any industries can show so remarkable a record of instantaneous change-over and speedy adaptation to the new national needs. Clearly the radio industry is a great national asset—a fact which has been made clearly evident by the many commendations which it has received from statesmen and military leaders alike.

Another great asset which the radio-and-electronic material manufacturers possess was an extreme resourcefulness. They have always been accustomed to meeting novel and unusually difficult situations. Their resourcefulness has always been sufficient to overcome the obstacles and to provide the public with equipment meeting all reasonable needs. This same ingenuity has been of inestimable help under war conditions. The equipment required for war purposes is subject to rough usage and unfavorable conditions. Wide ranges of temperature and humidity, vibration, rough transportation, and the like impose severe handicaps on the manufacturer and designer. But the radio industry has met the situation admirably as is well evidenced by the fine performance of our equipment under battle conditions.

Even with those natural advantages and past experiences in its favor, the radio-and-electronic manufacturers have not had an easy time. The rapid changes in their engineering and production methods have imposed a severe burden. Occasionally it was tough sledding. But the industry has gone through its "war-indoctrination" and "boot-training" periods triumphantly. Radio has turned out to be a good soldier in every sense of the word.

We hope and expect that the war methods which have been worked out and the experience which has been gained will greatly contribute to peacetime success. The quality of the merchandise after the war will likely be superior to that before the war. While there is no need to maintain the rigid and elaborate military standards in equipment used in the home, yet experience in building military equipment will help in making more reliable and better performance home apparatus.

The manufacturers will know more about building sturdy equipment easily and at a moderate cost. They will have many production improvements, evolved under the trying conditions of war, at their disposal when peace again is with us. And the new engineering techniques are certain to find attractive and appreciated peacetime applications.

After World War I, the radio industry derived great benefit from its wartime experiences. In World War II the radio-and-electronic workers have operated on a far larger scale, faced greater difficulties, and achieved wider triumphs. It is certain that the benefits which they will receive after the war will be correspondingly larger.

One of the best opportunities offered to engineers after the war will be the adaptation of war methods to appropriate peace needs. Both the public and the industry will greatly benefit from whatever can be done along such constructive lines. Much public benefit can be salvaged from the losses of war, and particularly in our field.



Austin Bailey

Chairman, 1945 Winter Technical Meeting Committee

Austin Bailey has undertaken the chairmanship of the General Committee for the 1945 Winter Technical Meeting of the Institute of Radio Engineers, which will be held at the Hotel Commodore in New York on January 24, 25, 26, and 27, 1945. He first served on a convention committee in 1929 and has been on most of them since that time, being the vice-chairman of the committee for the 1944 meeting.

After receiving his A.B. degree from the University of Kansas in 1915, Austin Bailey entered the graduate school of Cornell University majoring in physics. During World War I he served in the Signal Corps and was commissioned as a Second Lieutenant. After the armistice he resumed his studies at Cornell as a Fellow in physics, receiving his Ph.D. in 1920.

Dr. Bailey's first job was superintendent of the apparatus division of the Corning Glass Works. He resigned in 1921 to accept a position as assistant professor of physics at the University of Kansas, leaving at the end of the academic year to join the department of development and research of the American Telephone and Telegraph Company.

In the field of radio engineering with the Telephone Company Dr. Bailey first was engaged in work which led up to the establishment of the first commercial transoceanic radiotelephone system in 1927

between New York and London. He spent a year in Great Britain in connection with this project. Published papers in the PROCEEDINGS associate his name with radio measurements, transatlantic communications, application of printing telegraph to radio, radio transmission phenomena, and coastal harbor communications. Other published papers and a number of issued patents indicate that these were not the only phases of radio in which he has had a hand.

From 1934 to 1937, Dr. Bailey was a member of the technical staff of Bell Telephone Laboratories returning to the American Telephone and Telegraph Company to work in a newly formed radio section of the operation and engineering department where he is regularly concerned with the technical aspects of numerous radio projects.

In 1922 The Institute of Radio Engineers elected Dr. Bailey as an Associate; in 1925 he was transferred to Member grade and became a Fellow in 1936. He was elected to the Board of Directors and served the Institute in that capacity from 1940 to 1942. He has worked on various committees, having at one time or another been chairman of the Sections, Admissions, and Constitution and Laws Committees. In addition to being a member of three committees at the present time he is serving as Institute Representative on two American Standards Association Sectional Committees.

Review of Demountable vs. Sealed-off Power Tubes*

I. E. MOUROMTSEFF†, ASSOCIATE, I.R.E., H. J. DAILEY†, NONMEMBER, I.R.E., AND
L. C. WERNER†, NONMEMBER, I.R.E.

Summary—The history of demountable and sealed-off types of power tubes is reviewed. Both made their appearance in 1923 as a result of the demand for higher outputs from individual tubes in radio transmitters. The invention of the glass-to-metal seal by Housekeeper made it possible to construct sealed-off water-cooled tubes with copper anodes. Another solution was found by Holweck, in France, who designed a demountable vacuum tube connected to a high-speed rotary molecular pump and continuously exhausted during operation. By designing his molecular pump Holweck could dispense with the mercury-condensation pumps and liquid-air traps which were highly objectionable as a part of standard equipment of a radio transmitter. The main advantage claimed for the demountable tubes by Holweck and other subsequent designers is "unlimited" life. Life of a sealed-off tube is usually determined by the longevity of its filamentary cathode. In a demountable tube a burned-out filament strand can be replaced in a short time. The great majority of radio engineers did not favor the Holweck tubes because of the rotary pump having 4500 revolutions per minute and only 0.001 inch clearance between the rotor and stator. In addition, each time the tube is opened for the filament repair, the actual interruption in tube operation is much longer than the time required to replace the burned-out filament; this is so, because the operating high voltages cannot be applied to the tube until the proper vacuum is re-established. This necessitates having complete duplicate equipment, if uninterrupted operation is of importance. Holweck's tubes were adopted mainly in France.

The advent of the oil-vapor condensation pump invented by Burch, in England, promoted the cause of demountable tubes. Using the new pumps the Metropolitan-Vickers Company immediately built a 500-kilowatt tube for a British Post Office radio station. It was followed by several other types with lower outputs. In this country, the oil-vapor pumps, improved through the work of Hickman and other scientists, served as a basis for designing demountable tubes used in several scientific installations such as super-high voltage X-ray tubes, cyclotrons, etc. In several major European countries, demountable tubes with oil-vapor pumps are now in use in a few radio transmitters and, also, in some industrial installations, mainly, in metallurgical applications.

A review of the sealed-off tubes shows that tubes with 100 up to 350 kilowatts output were designed for radio application during the 1930's both in this country and in Europe by several manufacturing concerns. Their life expectation is up to 10,000 hours instead of the original 2,000 to 3,000 hours with smaller tubes. This makes competition more difficult for the demountable type. It is believed that they have more chance in industrial projects, in which power output required from individual tubes may be greater than conveniently obtained from a sealed-off tube of a practical design, that is, above 400 to 500 kilowatts. Some industrial applications of high-power tubes are reviewed. The application of indirectly-heated cathodes in high-output tubes, similar to the one used in the 350-kilowatt Telefunken tube, is believed probable in the future. Also, a semi-demountable design of the medium-sized tubes is suggested.

ACCORDING to one definition,¹ a demountable vacuum tube, is a tube "which can be taken to pieces and repaired like an engine" at the place of its use. The history of demountable tubes for radio applications is as old as that of water-cooled tubes of the sealed-off type. Both made their appearance² about 1923, as a result of ever-increasing demands for higher outputs from radio transmitters. Previously, only 50- and 250-watt "glass" tubes were available. Thus, in the historical experiments with transoceanic telephony in 1915 between Arlington, Virginia, and the Eiffel Tower, Paris, several hundred 50-watt tubes were used in parallel. The inconvenience of such an arrangement is too obvious to be discussed. In this country it was soon realized that tubes with much higher individual outputs, say, of several kilowatts, were necessary for long-distance communication and better broadcast service. But such tubes could not be designed after the pattern

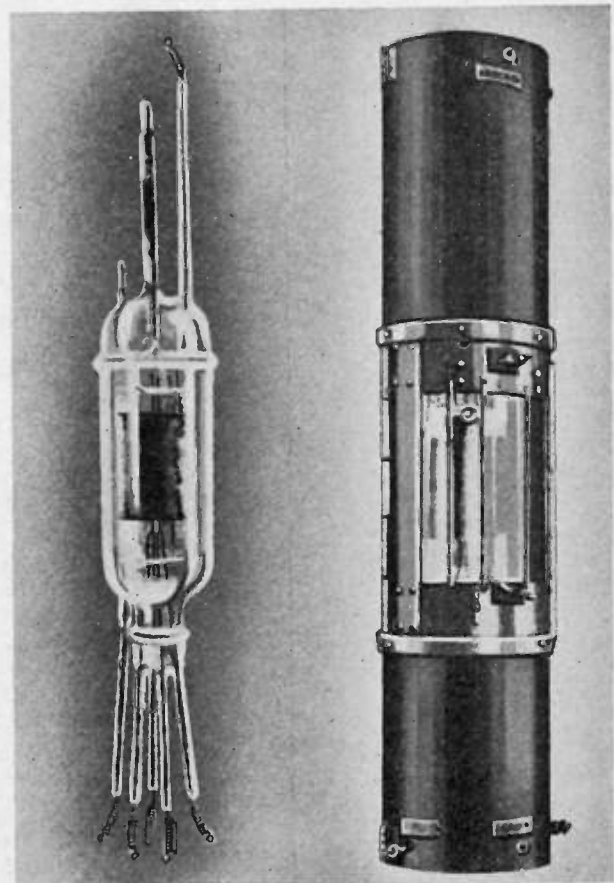

Fig. 1—British silica valve.

* Decimal classification: R331. Original manuscript received by the Institute, January 12, 1944; revised manuscript received, September 6, 1944. Presented, Rochester Fall Meeting, November 8, 1943.

† Westinghouse Electric and Manufacturing Company, Bloomfield, New Jersey.

¹ C. F. Elwell, "The Holweck demountable type valve," *Jour. I.E.E.* (London), vol. 65, pp. 784-785; August, 1927. (Discussion by R. V. Hansford, p. 812.)

² An experimental water-cooled tube with an external copper anode was built by Hauser in Germany in 1918 and another one in Russia by Bonch-Bruevitch. See S. Ganswindt and K. Matties, "Fortschritte in der Entwicklung von Gross-Senderöhren," *Zeit. für Phys.*, vol. 15, pp. 25-30; January, 1934; also, M. A. Bonch-Bruevitch, "High-power tubes with external copper anodes," *Wireless Teleg. and Teleph.* (in Russian), no. 23, pp. 63-67; March, 1924.

of the early 50 and 250 watters. The limitation was in the prohibitively large size of tubes with radiation-cooled anodes mounted within glass envelopes, if power

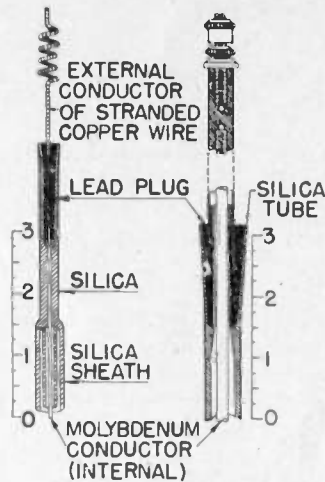

Fig. 2—Silica seals.

output was to exceed 1 or 2 kilowatts per tube. Therefore, the design and construction of tubes with external copper anodes cooled by flowing water or some other

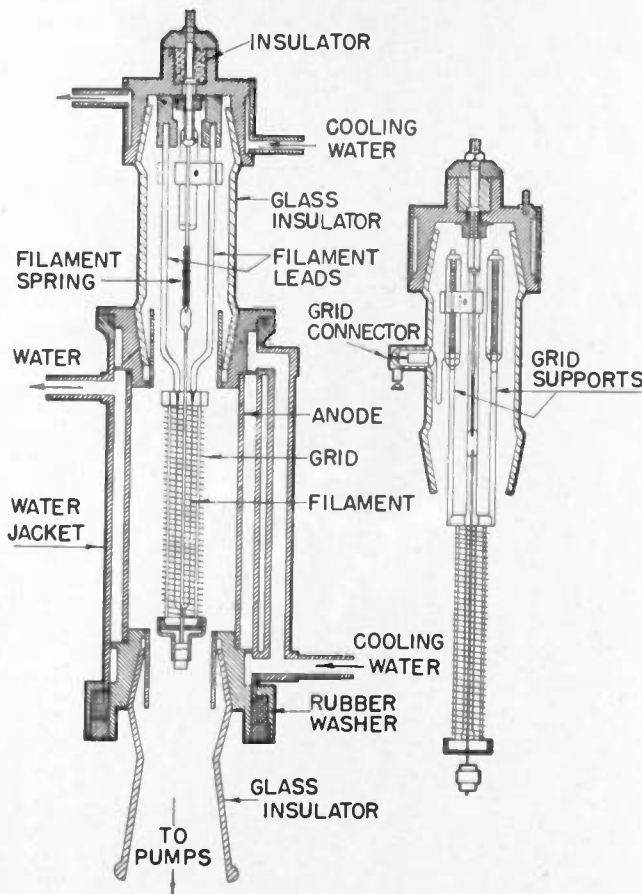

Fig. 3—Holweck's early demountable tube.

fluid was only a natural step for increasing tube output. However, the art of making reliable joints between the copper anodes and the glass bulbs giving support and insulation to the internal tube parts (grid and filament)

was not discovered³ until 1922. Then, for several years following, the art of actually making glass-to-metal seals was considered a mystery revealed only to highly skilled and highly paid glass blowers; very few of them were available to the vacuum tube industry at that time.

No wonder that other solutions to the problem of making high-output tubes were sought. Thus, the British Navy adopted the design of "silica valves" with power input ratings⁴ up to 20 kilowatts⁵ (Fig. 1). The cylindrical envelopes and hemispherical end portions of these tubes were made of pure quartz and sealed together. The metal parts were assembled inside the en-

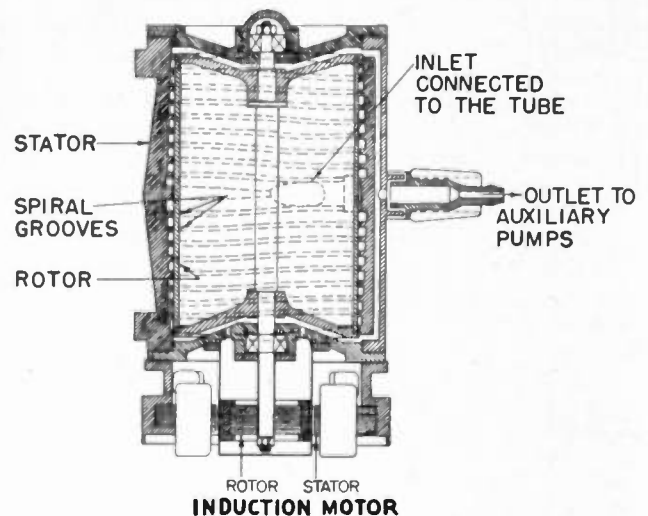

Fig. 4—Holweck's high-speed molecular pump.

velope and supported from the quartz walls. Currents up to 100 amperes could be carried by molybdenum rods sealed through the quartz walls by means of lead plugs formed by molten lead during the tube manufacture (Fig. 2). The silica valves permit higher operating temperature of the anode because the quartz bulbs can stand much higher heat than glass; this type of tube is suitable for low- and medium-power outputs. Their designers asserted that the silica tubes can easily be opened for repair by cutting the end portions on a carborundum disk, reassembled and re-exhausted.

In 1923, Holweck, in France, in order to get around the problem of making glass-to-metal seals, designed a demountable water-cooled tube assembled from several sturdy metal and glass (or quartz) parts with rubber-gasket or ground-glass joints^{1,5} (Fig. 3). During operation the tube is connected to a high-vacuum pump and continuously exhausted for maintaining a proper vacuum. This was a drastic departure from the sealed-off design, which nobody else dared to suggest, because mercury-condensation pumps with liquid-air traps, then in common

³ W. G. Housekeeper, "The Art of sealing base metals through glass," *Trans. A.I.E.E.*, (*Elec. Eng.* June, 1923), vol. 42, pp. 870-876; June, 1923.

⁴ H. Morris-Airey, G. Shering, and H. G. Huges, "Silica valves in wireless telegraphy," *Jour. I.E.E.* (London), vol. 65, pp. 786-790; August, 1927.

⁵ *Compte Rendues de l'Academie de Science*, vol. 177, p. 164; 1923; vol. 178, p. 1803; 1924; vol. 193, July, 1931.

use, would not be acceptable as a part of the standard equipment of a transmitting radio station.⁶ Holweck dispensed with the mercury pumps by cleverly designing a high-speed rotary molecular pump which was capable of establishing as good a vacuum as a mercury-diffusion pump without the objectionable liquid air trap necessary (Fig. 4). The Holweck demountable tube was adopted by the French Navy, and in 1927 there were 80 Navy transmitters with 10-kilowatt tubes of this type in operation. In addition, a few land stations employed several 10- and 30-kilowatt Holweck tubes. Later on a 150-kilowatt model was designed by Holweck⁷ (Fig. 5).

No other country favored demountable tubes of the Holweck type, partly, because of the lack of confidence in the commercial value of the rotary pump with 4500 revolutions per minute and less than 0.001 inch clear-

sealed-off tubes of the same size with satisfactory results. Still, the idea of a demountable tube appealed to the minds of radio engineers, and the opinion could

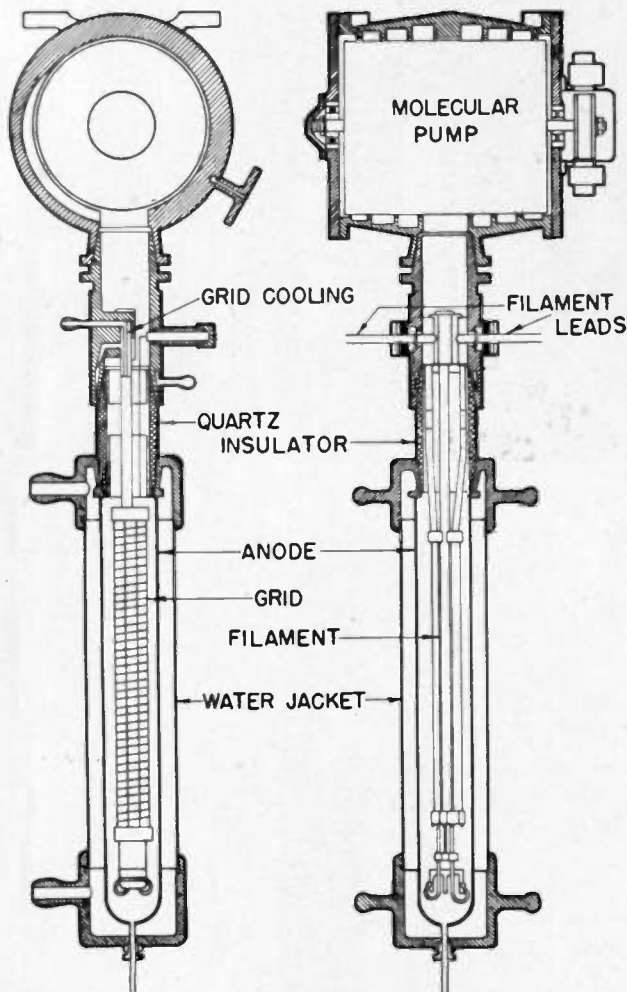

Fig. 5—Holweck's 150-kilowatt demountable tube.

ance between its rotor and stator; but mainly, because at that time all major countries, following the lead of the United States, were in a position to manufacture

⁶ Originally, the idea of the demountable tube was suggested in England during World War I. (See British Patent No. 162367 by Macrorie, Fortescue, Bryan and Morris-Airey.) Experiments were carried out by His Majesty's Admiralty, but were discontinued as unsuccessful.

⁷ F. Holweck and P. Chevalier, "Triode demountable de 150 kilowatt," *Le Genie Civil*, vol. 49, p. 148; June, 1932.



Fig. 6—100- to 200-kilowatt Westinghouse AW-220 tube.

frequently be heard that demountable designs would be in order with tubes of higher outputs than 100 kilowatts. However, with experience rapidly being accumulated, it soon became possible to design and manufacture sealed-off tubes for even higher ratings. The first two large tube types were designed in this country in 1929; these were: the AW-220 of the Westinghouse Company⁸ (Fig. 6) and the UV-862 of the General Electric Company⁹ (Fig. 7). During the 1930's, they were followed by a number of other tubes with outputs from 100 to 350 kilowatts announced here and in Europe by various manufacturers. Some of them are shown in Figs. 8 to 11. The most interesting published data for all these tubes are collected in Table I. There are also tubes of this size made by some other foreign manufacturers not listed in this table. With one exception, all these tubes have a basically similar structure: filamentary cathodes consisting of 6 to 18 parallel tungsten wires 8 to 16 inches long; overwound grids and copper anodes 4 to 5 inches in diameter using

⁸ I. E. Mouromtseff, "A new water-cooled power vacuum tube," *Proc. I.R.E.*, vol. 20, pp. 783-808; May, 1932.

⁹ J. A. Chambers, L. J. Jones, G. W. Fyler, R. H. Williamson, E. A. Leach, and J. A. Hutcheson, "The WLW 500-kilowatt broadcast transmitter," *Proc. I.R.E.*, vol. 22, pp. 1151-1181; October, 1934.

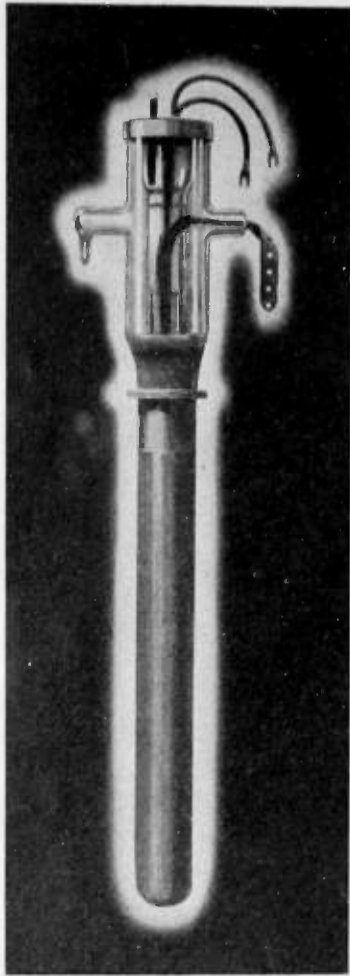

Fig. 7—100-kilowatt General Electric 862 tube.

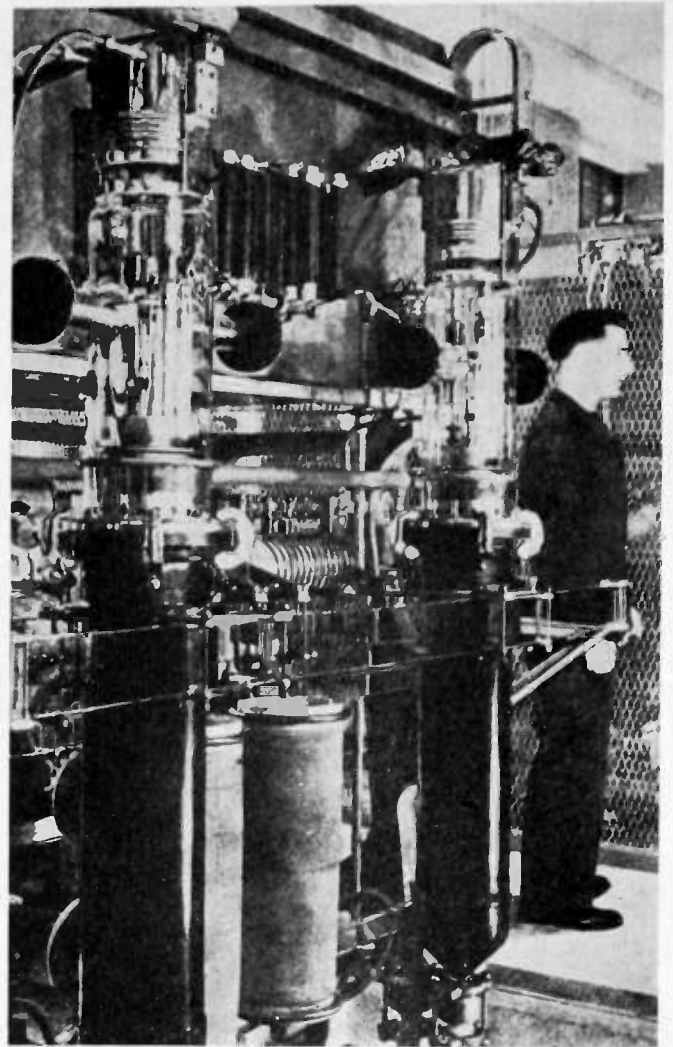

Fig. 9—350-kilowatt tube of Société Française Radio-Électrique.

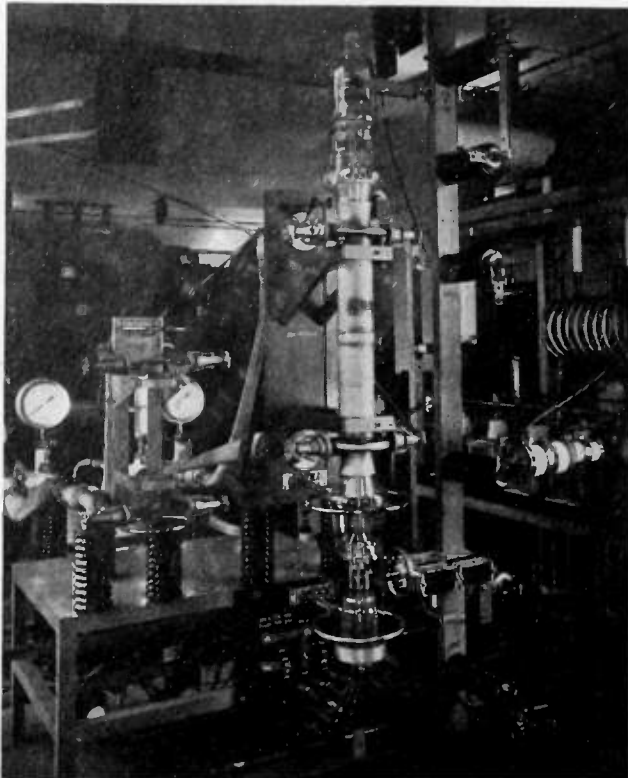

Fig. 8—250-kilowatt Western Electric 320A tube.



Fig. 10—350- to 400-kilowatt tube of LeMateriel Telephonique (designed by Chevigny).

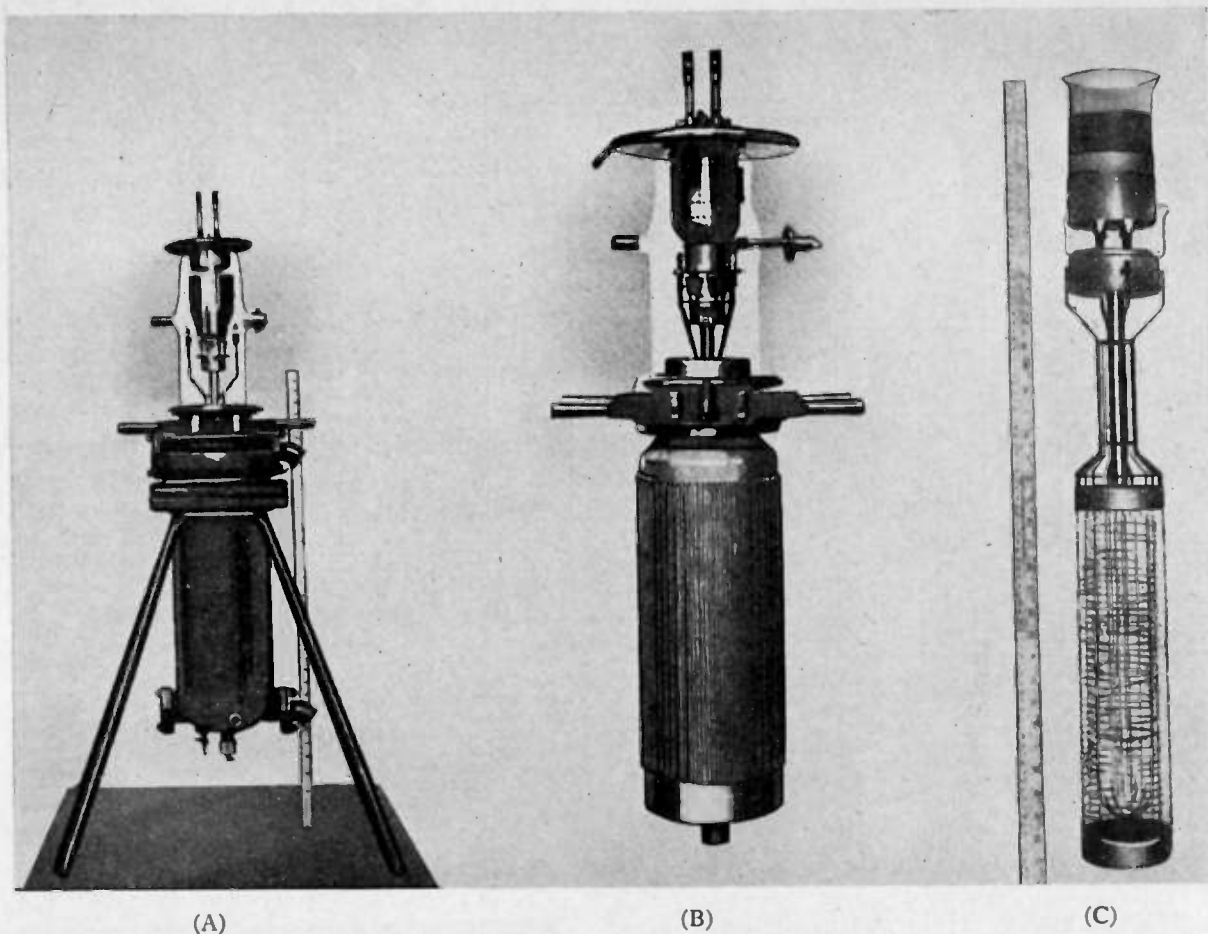

Fig. 11—500-kilowatt (input) Marconi tube.

Housekeeper seals. Filaments and grids are supported from the glass bulb at one end, or on opposite ends of the anode. The filament strands of pure tungsten 0.045 to 0.055 inch in diameter are usually heated by single-phase alternating current, but some tubes are designed for 3- and 6-phase operation. The exception stipulated is the Telefunken tube¹⁰ (Germany) which has an indirectly heated cathode formed by a "Niobium" (=Columbium) cylinder with internal tungsten heaters carrying 1700 amperes at 15 volts. The grid of this tube is made of flat molybdenum rings.

One may notice that all tubes with more than 100 kilowatts output, except for the quite recent Western Electric type 320A, are of foreign make. This is explained by the simple fact that by Federal Radio Commission order No. 115, published more than 10 years ago, the carrier power of the broadcast transmitters in this country is limited to 50 kilowatts. This can easily be taken care of by two tubes in push-pull with 100 kilowatt maximum rating per tube. One may, of course wonder why European countries, being so much smaller than the United States, needed larger tubes than we. The answer is, for disseminating world propaganda under the threat of an approaching World War.

In spite of the evident growth in power output of the sealed-off type of tubes, the idea of building demount-

able tubes has never been abandoned. It was even strongly revitalized in the beginning of the 1930's after a novel oil condensation pump with "apiezon" oil had been developed by Burch of the Metropolitan-Vickers Company to replace the old mercury pumps.¹¹ On the heels of this invention a 500-kilowatt demountable tube was developed by the Metropolitan-Vickers Company utilizing the new pumps.¹² The main advantage of the oil-condensation pump is the elimination of the liquid air or other refrigerants from the exhaust technics. The new huge tube was installed at Rugby radio station (GBR transmitter) of the British Post Office and, after several years experimentation and some improvements, is apparently operated to the satisfaction of the personnel and the owners.¹³ One must note that in our terms this tube would be spoken of as having 350-kilowatt maximum output because the British usually speak of the input, not the output as we do. This first large demountable tube is of a rather complex design. It is actually a combination of 9 tubes within the same anode container (Fig. 12). Its anode is of steel and approximately 24 inches long and 24 inches in diameter. Its internal section is in the form of a polyfoil consisting

¹¹ C. R. Burch, "Some experiments on vacuum distillation," *Proc. Roy. Soc.*, vol. 123, pp. 271-284; March 6, 1929.

¹² "500 kilowatt demountable valves," *Post Office Elec. Eng. Jour.*, pp. 61-64; April, 1932.

¹³ C. R. Burch and C. Sykes, "Continuously evacuated valves and their associated equipment," *Jour. I.E.E.* (London), vol. 77, pp. 129-146; July, 1935.

¹⁰ S. Ganswindt and K. Matthies, "Fortschritte in der Entwicklung von Gross-Senderöhren," *Zeit. für Tech. Phys.*, vol. 15, pp. 25-30; January, 1934.

TABLE I
SEALED-OFF HIGH-POWER TUBES

Designers, Name and Tube Type	Approximate Date of Design	Maximum Output Power	Dissipation Limit	Maximum Operating Potential	Filament Data						Tube Overall Length	Anode Diameter	Net Weight	Remarks	Reference	
					Total Emission Current	Voltage	Current	Power	Number of Strands	Approximate Length						
<i>U. S. A. Designs</i> (W) AW-220	1929	KW 200	KW 150	KV 24	Amps 60		Amps 30	Watts 320		8	15	63	4	35	Double-ended structure; water-cooled grid; filament springs	8
GE UV-862	1929	100	100	20	40		33	207	6,830	6	16	70	4	30	* 1, 3- or 6-phase filament	9
WE 265A	1934	100	(100)	18	(30)		22	180	4,000	(6)					Double-ended structure	P. D.
GE 898	1936	100	100	20	50		33	210	6,930	6*	16	70	4	30		P. D.
FT 125A	1938	100	40	20	35		27.2	204	5,500	(8)		26	3		† per phase; 3-phase filament	P. D.
WE 320A	1939	250	150	18	90		35	435	15,125	(12)	(15)	75	(4)	56		24
(W) 895	1941	110	40	17.5	50		19	138†	7,870	12	9	25	4.5	25		P. D.
<i>Germany</i> Telefunken	1932	350	250	12	200		15	1700	26,000	‡	16	48	4	190‡	‡ Indirectly heated niobium cathode § with jacket	10
<i>England</i> Marconi	1936	350	150	20	110		33	450	15,000	16	1		8			28
<i>France</i> IT and T	1933	120	80	20	40		24	295	5,400	(6)	8	24	3.2	30	Double-ended structure	25
SFR, E-1951	1935	100	50	15	40		30	210	6,300	(6)	(16)		(4)			26
SFR, E-2051	1935	160	80	20	60		35	285	8,550	(8)	(16)		(4)			26
SFR, E-2551	1935	260	135	20	100		35	420	14,700	(12)	(18)		(5)			26
SFR, E-3051	1938	350	160	20	170		35	600	21,000	(18)	(18)		(5)			27
LMT 3067	1939	350	160	17.5	100		30	635	19,050	18	(14)	48	(5)	104		21

Note 1. (W) Stands for the Westinghouse Electric and Manufacturing Company.
 GE General Electric Company.
 WE Western Electric Company.
 FT Federal Telegraph Company.
 IT and T International Telephone and Telegraph Company.
 SFR Société Française Radio-électrique.
 LMT Le matériel Téléphonique (Federal Radio and Telegraph Co. in U. S. A.).

P. D. Published Data.

Note 2. Figures in parenthesis have been indirectly estimated from other data.
 Note 3. Unfilled spaces indicate that no information was available at the time of the preparation of this Table.

²⁴ Information communicated by H. E. Mendenhall.

²⁵ Gibson and Rabuteau, "The new 120 kw thermionic valve," *Elec. Commun.*, vol. 12, pp. 86-89; October, 1933.

²⁶ Bulletin de la Société Française Radio-Électrique, "Lampes d'Émission," 9-me année, no. 1, January to March, 1935 (French and English).

²⁷ R. Warnecke, "Etude et description d'un tube émetteur scelle de 350 KWS utiles," *L'Onde Electrique*, vol. 17, pp. 49-80; February, 1938.

²⁸ Research staff of Marconi-Osram Co., Ltd., "The development of large transmitting valves," *Marconi Rev.*, pp. 19-21; July-August, 1936.

of 9 petals approximately $2\frac{1}{4}$ inches in diameter on a pitched circle of 9 inches. Each foil has its own grid and filament. The anode is water-cooled. It is insulated by porcelain cylinders, at the bottom from the vacuum tank on which the tube rests and, on the top, from the water-cooled metal flanges supporting the filament and grid structures. The filament and grid structures are shown in Fig. 13. The grid is made of flat horseshoe molybdenum washers clamped to their respective supports and is also water-cooled. In addition to the early large tube, Metropolitan-Vickers later on designed several smaller types (50-kilowatt input) used for the excitation of the 500-kilowatt output stage and, also, in the short-wave GRE transmitter. There are also tubes of a similar design in operation in a 10,000-cycle generator energizing a 20-pound furnace in routine production of special alloys and hard metal.

The oil-condensation pump, particularly with the improvements made in this country by Hickman of the Eastman Kodak Company¹⁴ and some other designers, is gradually taking the place of the old mercury pump in the tube-manufacturing industry. It has also brought forward again the discussion of the possible commercial merits of demountable tubes. In fact, the demountable structures in combination with the oil-condensation pumps immediately found application in the field of superhigh voltage X rays, atom smashing, and other cases of scientific research. One such project, the

¹⁴ K. Hickman, "Vacuum pumps and pump oils," *Jour. Frank Inst.*, vol. 221, pp. 215-236; February, 1936; pp. 383-402; March, 1936.

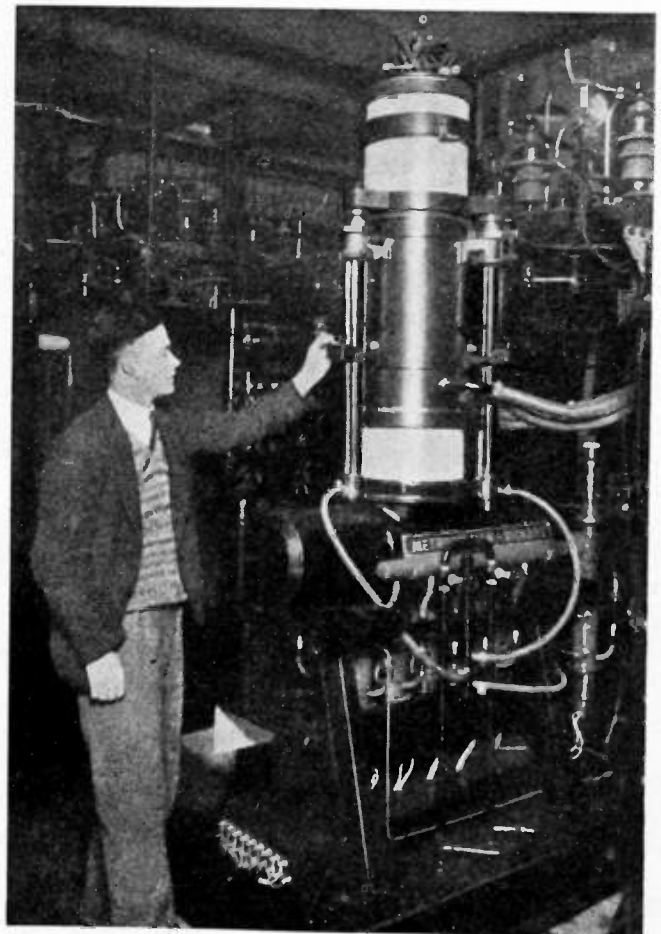

Fig. 12—500-kilowatt (input) Metropolitan-Vickers demountable tube.

cyclotron at the University of California, Berkeley, employs two 100-kilowatt demountable tubes for high-frequency energizing of the cyclotron.¹⁵ The tubes and oil-vapor pumps for them were designed by Sloan. The tubes have 4-inch copper anodes and a wound copper grid cooled by water. They have been in operation for several years, and the University personnel working with the cyclotron seem to be quite satisfied with their tube performance.

However, despite this and other favorable comments, the demountable tubes still do not arouse the enthusiasm of the majority of our radio and vacuum-tube engineers, and most of the modern problems of broadcasting and long-distance communication have been, thus far, solved by the use of sealed-off tubes. The reluctance of our electronics engineers to accept the demountable tubes is explained by the lack of assurance that with equal ratings of both kinds of tube the promised advantages of the demountable type will outweigh the expected and, possibly, unexpected disadvantages.

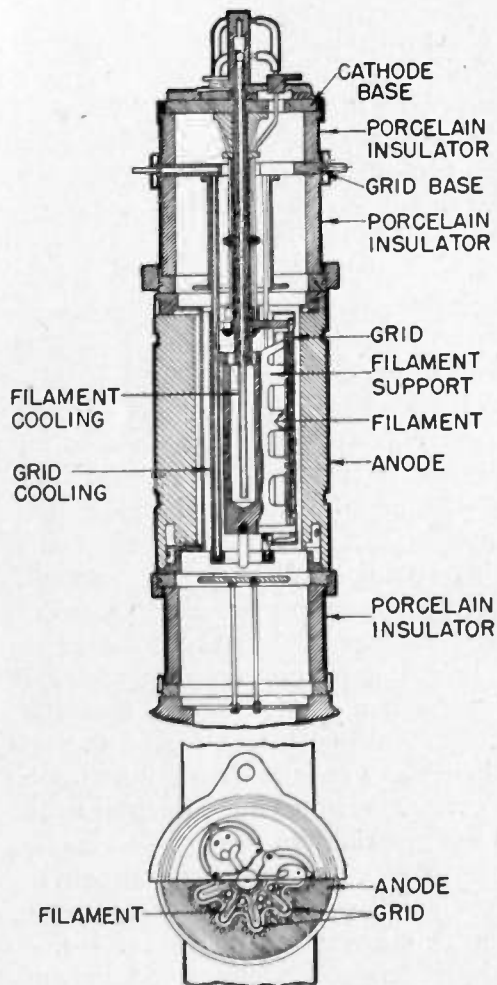

Fig. 13—Inner structure of the 500-kilowatt Metropolitan-Vickers tube.

Yet, there is a field where some of the British and American specialists believe that, even with much lower outputs such as 100 or even 50 kilowatts per tube, one will have to resort to the demountable tubes.

¹⁵ Information received from D. Sloan.

This is the ultra-high-frequency field which utilizes tubes in television and frequency modulation at about or above 60 megacycles. Here, for the suppression of

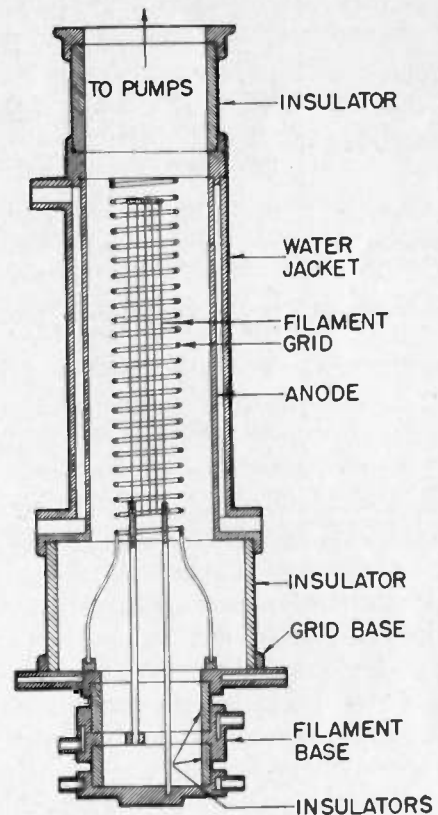

Fig. 14—300-kilowatt Brown Boveri demountable tube with pumping unit.

parasitics, the screen-grid tubes should behave better as power amplifiers than the triodes, and it may seem the demountable type is better adapted to a multielectrode design than the sealed-off type. In fact, demountable screen-grid tubes with 60-kilowatt input ratings have been designed and built by Burch and Sykes in England¹³ for operation at frequencies up to 30 megacycles.

It is interesting to note that quite recently the Brown Boveri Company in Switzerland, obviously under the pressure of the war, entered the field of vacuum-tube production, and they started at once with the demountable design of water-cooled tubes.¹⁶ They have developed a line of demountable type from 10 to 300 kilowatts output for frequencies between 50 and 4 megacycles, respectively. Two 150-kilowatt demountable tubes, DT 20/150 (Fig. 14), are said to have been successfully operated for several months in a broadcast station with 20 kilovolts on the plate. Another type DT 15/25 with 40 kilowatts output for two tubes in push-pull were used in a cyclotron installation in Switzerland.

One may also mention radio station, Allouys, in Southern France, which, according to information obtained from Chevigny, was, in 1939, equipped with two demountable tubes of the French Thomson-Houston

¹⁶ A. Gaudenzi, "High-power demountable transmitting tubes," *Brown Boveri Rev.*, pp. 389-393; December, 1941.

TABLE II
DEMOUNTABLE TUBES

Tube Type	Date of Design	Output		Filament Data						Anode Diameter	Operating Frequency	Remarks	Reference
		KW	Volts	Emission Current	Voltage	Heating Current	Heating Power	Number of Strands	Approximate Length				
				Amps	Volts	Amps	Watts	§	Inches	Inches	MCS		
<i>France</i>													
Holweck, 2LD-10A	1923	10	7,500	6	(17)	38	(640)	2	4	1.75	Low		5
Holweck	1927	30	7,500	16	(17)	100	(1,700)	4	6	1.75	Low		1
Holweck, LD65-10A	1931	150	7,500	(120)	40	400	16,000	8	16	(3)	Low		7
Chevigny	1938	400	17,500	100	30	635	19,050	18	(14)	(15)	20 max		21
French Houston-Thomson Co.	1939	200									15		
<i>England</i>													
Metropolitan-Vickers	1930	350	10,000	(90)	19	160 per phase	9,000	9	(20)	24	Low	Water-cooled molybdenum grid	12
Metropolitan-Vickers, 330A	1934	20	10,000	(21)			1,500				7-20		13
Metropolitan-Vickers	1934	40									30	Screen-grid tube	13
<i>Switzerland</i>													
Brown-Boveri, DT 20/150	1939	300	20,000	(100)	32	430	13,560				43		16
	1939	10	8,000	4	7	75	525				60		16
<i>U. S. A.</i>													
University of California	1935	100	20,000	(50)	12	450	5,400	6	12	4	70	Water-cooled copper-grid tube is used in several research projects	15
GE	1940	150	8,500	(50)	18	100 per phase	5,600	12	—	—	95	Thoria-sprayed filaments	17

Numbers in parenthesis are those indirectly estimated.

Missing figures indicate that no information was available at the time of making this Table.

Between the largest and the smallest tube of Brown Boveri shown in the table there are three tubes with intermediate ratings.

The demountable 350- to 400-kilowatt tube designed by Chevigny in France was built only for design tests of the final sealed-off structure of the 3067 tube shown in Table I.

make; its transmitter was operated at 15 megacycles with 100 kilowatts carrier output.

Some data for the known demountable tubes are collected in Table II. It is necessary to state that in this country some experimental work with demountable tubes for radio application has recently been conducted by several large tube manufacturing companies;¹⁷ however, with the existing limitations in power output of broadcast transmitters there was no particular need for the demountable tubes.

Undoubtedly, the most favorable, though still debatable, field for demountable tubes is for industrial applications other than radio, mostly for the purpose of rapid and easily controllable heating of various materials.

Historically, the first industrial application of high-frequency power was the very field of vacuum-tube manufacturing, where high-frequency heating was used for outgassing tube parts either in the preassembly stage or during the final exhaust. This problem originally required relatively low power. Between 1917 and 1922, pioneered by Northrup, alternating-current induction melting of metals in lots of about 20 pounds,¹⁸ was tried out by many laboratory workers; then, during the 1920's induction furnaces, from 20 to 16,000 pounds capacity, were built in this country and abroad. Power of low frequencies, from 60 to 10,000 cycles per second, seemed to be satisfactory, so that in this application electronic tubes could not compete too successfully with motor generators or spark-gap oscillators.¹⁹ About 10 years ago, with the advent of ultra-high-frequency tubes

capable of generating power of several tens of kilowatts at frequencies²⁰ up to 60 megacycles, many interesting experiments were started in this country. Thus, the Westinghouse Company in co-operation with the prospective users of high-frequency apparatus carried out a series of experiments, such as grain disinfestation in grain elevators; killing moths in chocolate and other food factories, sterilization of expensive breakfast foods in packages; application in industries where glass or other dielectrics had to be heated; drying of tobacco leaves; and other experiments. To this list one also must add the modern therapeutic applications of ultra-high-frequency power. Many of these projects were successful from the research viewpoint. However, commercially the high-frequency methods mostly could not compete at that time with the old methods, such as food desinfestation by simple, or "vacuum" fumigation, or with ordinary furnace heating, because of the high cost of vacuum tubes and associated equipment. With the beginning of the war, many old projects have been revived and a number of new ones started. The question of expense no longer played the first role as soon as there was a physical possibility of doing certain required work. Therefore, the industrial application of high-frequency oscillators progressed rapidly, and in many cases their decided advantages over the old methods could no longer be doubted. An example of the outstanding industrial application of high-frequency power is the tin reflowing project; it not only accelerated the rate of production of tinned iron sheet, but permitted saving up to 66 per cent of tin and simultaneously considerably improved the quality of tinning. Twelve tubes of WL-895 type (Fig. 15) are used in each tin-reflowing installation with the total output of 1200

¹⁷ Commercial Engineering Developments, "Demountable vacuum tubes," Proc. I.R.E., vol. 28, p. ii, April, 1940.

¹⁸ G. H. Clamer, "The development of the coreless induction furnace," number 10 in a series of case histories in metallurgical research, *Metals and Alloys*, vol. 6, pp. 119-124; May, 1935.

¹⁹ C. C. Levy, "Electrical equipment for induction furnaces," *Elec. Eng.*, pp. 43-47; January, 1934.

²⁰ I. E. Mouromtseff and H. V. Noble, "A new type of ultra-short-wave oscillator," Proc. I.R.E., pp. 1328-1345; August, 1932.

kilowatts at 200 kilocycles per second. Another important project, annealing of aluminum sheets, demands almost twice this power. No wonder that the question of the demountable versus sealed-off tubes emerged again as an important problem.

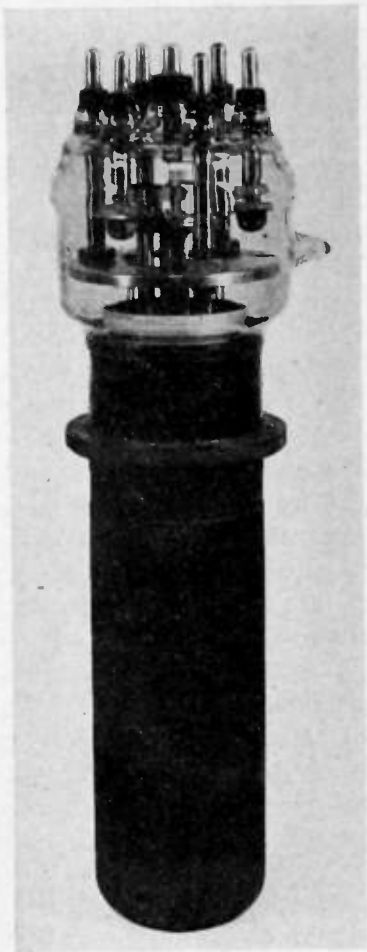

Fig. 15—100-kilowatt Westinghouse 895 tube.

The opinion of the specialists is at great variance on this subject. The designers of the demountable tubes, naturally, are very enthusiastic about them. The Brown Boveri engineers go in this direction so far that they consider the sealed-off tubes almost unnecessary even for low outputs.¹⁶ This however, may be explained by some specific manufacturing conditions. Many other radio specialists are decidedly against the demountable tubes and prefer to have sealed-off tubes of any size, even if they are expensive.²¹

There is no experience available in this country with commercial installations employing demountable tubes. As stated before a few research installations cannot be taken as a basis for sponsoring commercial projects, even if the tubes are favorably commented upon. Indeed, in an industrial project neither scientific nor highly trained personnel will be permanently available for servicing the equipment, nor will casual interruptions

in operation be tolerated; ordinarily, interruptions are not fatal to research projects. On the other hand, as has been frequently and logically suggested, the demountable tubes may be expedient in case a much higher power is required than feasible with the available sealed-off tubes. This opinion has been repeatedly endorsed even by many radio and tube engineers, but as a rule, in a noncommittal way; indeed, thus far in all practical cases the new problems have been solved without resorting to the demountable-tube structure.

The main advantage claimed by the designers and proponents of demountable tubes is the "unlimited" life of the tube in service. In the sealed-off type life of a tube ends with the first burnout of the filament. After this, the tube is to be practically scrapped, as very little of it can be salvaged economically. The life of modern high-power tubes is designed to be approximately 10,000 hours. Thus, with the sealed-off tubes in continuous operation all year around (8800 hours), the customer has to buy an entire tube complement every 14 months. In a demountable tube, a burned-out strand can be replaced on the spot, as has frequently been claimed, in a few seconds⁴ or at least minutes,¹⁸ and the same tube can be used over again almost indefinitely. So it seems that the cost of renewal tubes in the first case must be compared to the corresponding cost of filament renewals in the demountable tubes plus, of course, the cost of acquisition and servicing of the pumps. Considering, in addition, that the demountable tube can be designed in any large size so that it may replace two or more sealed-off tubes, the maintenance expense may shift the economic balance still further in favor of the demountable tube.

A remark must be made here that many designers of the demountable tubes recommend operation of their cathodes at higher temperature than is common with the sealed-off type, in order to take full advantage of the demountable structure and to increase power from a single tube. Then, of course, the filament replacement occurs more frequently than normal. Thus, Holweck operates his filaments at 2700 degrees centigrade; this requires their renewal every 200 or 300 hours.¹ The Metropolitan-Vickers designers¹⁹ indicate that 1500 hours is the normal life of their filaments, but they advise making filament inspection every 500 hours. It may be remarked further that one can hardly recommend the replacement of a single filament strand at a time, for this simple reason: when one strand ends its life by burning out, all other strands are also near the end of their life. Hence, it is expedient to replace all strands each time a burnout occurs in order always to have them of the same age; this will prevent more frequent stoppage in tube operation. The accelerated filament renewal should obviously result in more frequent interruption of tube operation.

Other advantages claimed for the demountable tubes are: the capability of being overloaded almost 50 per cent over a short period without fatally damaging the

²¹ G. Chevigny, "Tubes for high-power short-wave broadcast stations—Their characteristics and use," *PROC. I.R.E.*, vol. 31, pp. 331-340, July, 1943.

tube; the possibility of matching tube characteristics at the place of their use; elimination of glass-blowing work leaving purely mechanical engineering methods for their manufacture, and, therefore, as was implied before, no limit to the size of the demountable tubes. Finally, one can reiterate the contention that demountable structures are better adaptable to multi-electrode designs of large tube than the sealed-off types.

Side by side with the claimed advantages of the demountable type one must list the objections which can be made to it. First, although the act of replacing a filament strand in a demountable tube may be as short as a few minutes or even seconds, in reality by a single burnout the tube is put out of working condition probably for several hours. Indeed, after a burnout occurs and the power is shut off, one must allow a certain time for sufficient cooling of the inner structure before the tube can be opened, to prevent oxidation of the parts. Then, the process of opening the tube also takes a certain time, depending on its structure and the design of vacuum-tight joints, the tube size, etc.; this time may be not inconsiderable, as the use of auxiliary mechanisms may be required; hydraulic jacks are used in the large Metropolitan-Vickers tube. Finally, the tube after it has been open in the atmosphere cannot be put immediately into high-voltage service; it must be seasoned, and seasoning may take many minutes and even several hours. Hence, a definite demand: if uninterrupted service of the installation is of paramount importance, a spare tube and complete equipment for seasoning the tubes are necessary in the case of demountable tubes.

One of the important problems in construction of demountable tubes is the vacuum-tight joints between tube parts. The original rubber gaskets were abandoned both by Holweck, and by the Metropolitan-Vickers designers, in favor of stopcock grease, wax, or some bituminous compounds. The joints need maintenance work and occasional replenishment of the sealing compound. There are, also, suggestions of using tin-soldered joints, the opening and closing of which would, of course, take considerable time.

Another major objection to demountable tubes is the necessity of the inclusion in an industrial installation of a delicate vacuum system with several pumps which have to be continuously operated.

In this respect the description of the original 4-stage exhaust equipment attached to the 500-kilowatt Metropolitan Vickers tube is interesting.²² It consisted of (1) A mechanical backing oil pump, (2) A high-capacity low-speed oil-vapor pump, (3) two high-speed oil-vapor pumps in parallel, and (4) ten high-speed oil-vapor pumps in two groups of five. Undoubtedly, a much simpler exhaust equipment can be and has been

designed, but the pumps are still objectionable for two reasons. They must be attended by specially trained personnel. Then, they must be periodically cleaned and oil replaced; under conditions of industrial operation, this must be done probably more frequently than once a year as is claimed by certain designers; naturally, during cleaning the pumps are always subject to all kinds of hazards. Again, after the vacuum system and oil pumps have been cleaned and reassembled they must be run for many hours or even for a couple of days before the system again can be put in service. Hence, spare vacuum system and pumps must be available.

Even after the tube has been simply idle for some time, without having been opened to the air, the pumps must be started ahead of the time scheduled for tube work. This preparatory period may change, depending on tube design, from 20 minutes to more than an hour.

Finally, it has been indicated by Burch and Sykes¹⁸ that there are greater difficulties in the elimination of flashovers in the 500-kilowatt tubes than in the smaller one;²³ also, that stability of operation and filament life can be different from those of the sealed-off tubes. This is reflected in the relatively low operating voltages prescribed for their demountable tubes.

Undoubtedly, in the absence of positive experience, a psychological element will play an important role in making the choice between the demountable and sealed-off tubes in each particular case. If all the facts are presented to the customer, it remains for him to decide whether he wants to endure certain inconveniences connected with operating demountable tubes in exchange for economic advantages. In each individual case, economic loss through probable interruptions in tube operation must be taken in consideration; also the possibility of elimination of interruptions through preventive replacement of filaments before their life is fully utilized. In this respect, intermittent operation may be relatively favorable to the demountable tubes as it allows time for necessary repair and inspection.

There is another aspect to the problem of whether demountable or sealed-off tubes are to be used in an industrial project. This is, whether the high-frequency power must or can be used concentrated, at a single heating circuit; or if the industrial process will be better performed in a sequence of less powerful high-frequency circuits. In the latter case a single huge tube will be of less advantage than several smaller ones; hence, the demountable structure loses this point in its expediency.

Thus, it seems that the problem of the demountable versus sealed-off tube must be considerably clarified in the future if a customer in co-operation with the tube and equipment manufacturer would decide to pioneer in this field, that is, to go "all out" for the demountable tubes, even without the assurance that this will be the best solution. For encouragement, one may point out that with improved technics, better demountable tubes

²² A. S. Angwin, Wireless Section, Chairman's Address delivered before the Institution, October 22, 1931, *Jour. I.E.E.* (London), vol. 70, pp. 33-34; December, 1931, to May, 1932.

²³ This may perhaps be ascribed to the fact that the anode of this tube is made of iron, not copper.

and better vacuum pumps can be designed now than those described in the literature of several years ago. In addition, one must admit that individual sealed-off tubes can be designed for outputs not above 300 or 600 kilowatts; beyond this rating the sealed-off tubes will, in all probability, become too bulky and too heavy to be conveniently manufactured, handled, and transported. A simple problem of heat dissipation can corroborate this. The practical dissipation limit for a large water-cooled tube is approximately 500 to 600 watts per square inch. Hence, a tube having a filament length of 20 inches and the anode 5 inches in diameter will be capable of dissipating $20 \times \pi \times 5 \times 0.6 = 180$ kilowatts. At 75 per cent efficiency this corresponds to an output of 540 kilowatts. The net weight of such a tube will be over 100 pounds and its length about 7 feet; this is almost the limit of convenient handling of the tube in the factory and in commercial installations.

Looking into the future of high-power industrial and radio tubes, one may anticipate that attempts will be made to design cathodes for longer life, for example, by replacing the present filamentary cathodes by the indirectly heated cathodes in the form of cylinders brought to the proper temperature either by heaters located inside a cathode as has been done in the 300-kilowatt Telefunken tube, or by making the cylinder the anode with respect to the internal auxiliary cathode.

Columbium used in the German tube has an advantage over tungsten as the desired emission current can be obtained with only 60 per cent heating power. Tantalum may be another suitable material, although it requires about 30 per cent more power than Columbium. An indirectly heated cathode even with a hole burned through does not end its life abruptly but gives a timely warning when it should be replaced.

Another avenue of promising development of high- and even medium-power industrial tubes is connected with the ever increasing use of Kovar in high-vacuum-tube structures. Although this metal was invented about 15 years ago, its application in high-frequency tubes was extremely limited for a long time. During the last few years, partly because of considerable progress in the art of welding and brazing tube parts made of different metals, the good points of Kovar were clearly demonstrated: the sturdy Kovar seals have been successfully used in combination with copper anodes even in ultra-high-frequency tubes. On the other hand, through welding Kovar to other metals, the use of steel for tube structural parts is permitted. This leads to designs similar to the sealed-off ignitron in which seam-welding is used as the last operation in assembling a large tube, instead of making a huge conventional glass-to-glass seal between the bulb and a heavy glass dish 5 or 6 inches in diameter. Such procedure permits the design of *semidismountable* tubes (Fig. 16). If properly designed along these lines, a customer's tube with a burned-out filament can be opened *at the factory* mechanically by accurately cutting away of the welded

joints, the defect repaired, and the tube closed again without subjecting it to the high heat and hazards of glass-blowing fires. Reassembling and re-exhausting of such tubes will be easier and cheaper than making a new tube, and all parts, except for the damaged one, will be used over again. The same individual tube can

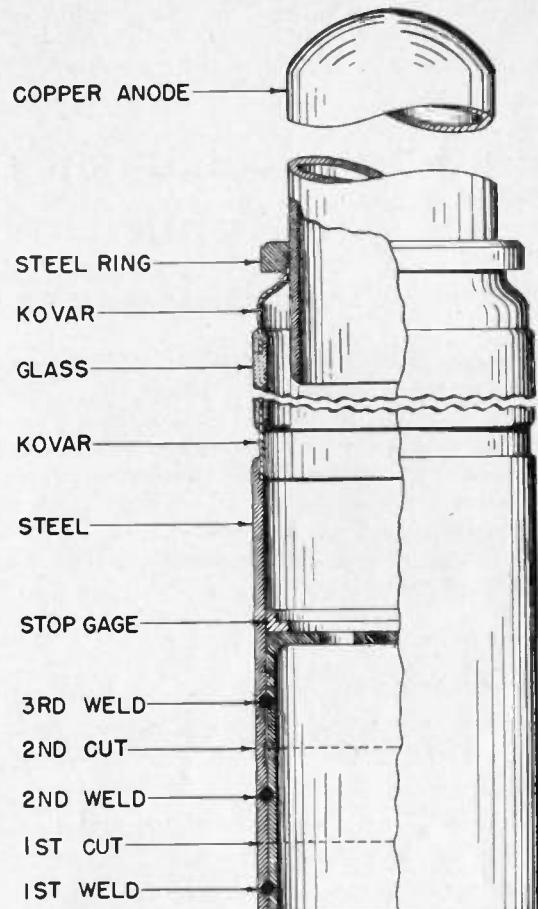

Fig. 16—A feasible semidismountable design with Kovar seals.

be repaired two or three times which will considerably reduce the cost of a unit tube in long-time operation. The semidismountable tubes may possess the good point claimed for the demountable tube, long life; at the same time they do not have the bad points of the demountable tubes, complicated auxiliary equipment and the necessity of skilled personnel to attend it.

CONCLUSIONS

It seems that a careful comparison of the virtues and drawbacks of demountable and sealed-off tubes with equal power per tube would surely lead to a verdict in favor of the sealed-off type. Chevigny, in his study²¹ of the 350- to 400-kilowatt tube arrived at the conclusion that with tube life of 10,000 hours the cost per hour of the sealed-off tube is lower. However, if one demountable tube can replace several sealed-off tubes, the situation may be quite different, as not only the number of tubes in operation will be reduced but the entire equipment may be simplified. In each industrial project the solution may vary. As to the necessity of

having vacuum pumps in operation and the attending personnel, one may be reminded that recent years of defense work showed that even unskilled personnel may be trained sometimes to perform complicated operations. It seems that demountable tubes have much less chance in radio transmitters when even short interruptions are intolerable. This can be illustrated by

the suggestion of Metropolitan-Vickers designers of the demountable tubes to have sealed-off tubes as spares in radio transmitters. Yet, even in radio, demountable tubes can find application in special cases when tubes of a new design are required in numbers not large enough to justify the development and manufacturing expense of the sealed-off type.

The Mechanism of Supersonic Frequencies as Applied to Magnetic Recording*

HERSHEL TOOMIM†, NONMEMBER, I.R.E., AND DAVID WILDFEUER‡, NONMEMBER, I.R.E.

Summary—The addition of a supersonic current to the signal current in recording on a magnetic medium results in recordings of low-harmonic distortion. Recording in this fashion is an accepted part of the art, although it is not well understood. The mechanism whereby this type of recording operates is presented in Part I.

An extension in the oscillographic technique of obtaining *B-H* curves of magnetic specimens is presented in Part II. A circuit is presented which makes possible simultaneous viewing of major and minor hysteresis loops.

PART I

IT IS the objective of this discussion of magnetic recording methods to indicate the mechanism whereby the newly introduced "high-frequency-bias system"¹ operates.

The process of magnetic recording, previous to the introduction of "high-frequency bias," utilized a magnetically saturated medium which was demagnetized by an amount proportional to the amplitude of the recording signal. This system was first developed by a German engineer, Stille, who made a careful study of the problems associated with the recording of sound on a magnetic medium. Magnetic recordings of high quality utilizing this system were made in Great Britain.² Other successful machines have been built all utilizing the same magnetic principle. Those using magnetic tape have used either longitudinal or transverse magnetization, while those using wire have all depended on longitudinal or axial magnetization.

The magnetic recording, as developed by Stille, utilized a magnetic medium, such as steel tape which was drawn consecutively through a magnetizing head and a recording head and subsequently, for the purpose of reproduction, through a reproducing or pickup head. The magnetizing head was utilized to saturate

the medium magnetically and remove simultaneously any previous recording. An alternating or signal magnetomotive force was applied to the recording head in addition to a magnetomotive force of constant amplitude which, in the absence of a signal, was just sufficient to reduce the remanent flux in the medium to zero. The signal either increased or decreased this constant magnetomotive force and therefore the remanent flux in the medium was either positive or negative depending upon the sign of the recording signal. The magnetomotive force of constant amplitude was of opposite polarity to that of the magnetizing head.

In contrast to the above system, the "high-frequency-bias system" of recording takes place on a magnetically neutral medium. This neutral medium is passed continuously through a recording head to which a signal consisting of audio and supersonic components is applied. This current is used to subject the magnetic medium to a concentrated magnetic field. Each elementary length is subjected to a magnetomotive force with a slowly varying component and a high-frequency component which traverses several cycles during the time the element is in the magnetic field. It is important to realize for the understanding of the subsequent discussion that hysteresis loops, as shown in the various figures, refer only to an elementary volume of magnetic material and each new element of material entering the recording head embarks on its magnetic journey on the hysteresis loop from a completely neutral condition. A recording made on a magnetically neutral medium in the absence of "high-frequency bias" contains large amounts of odd-harmonic distortion and has an input-output characteristic of the type of Fig. 1. This shape of transfer characteristic is highly irritating to the ear and results in almost unintelligible speech reproduction. The addition of "high-frequency bias" in the proper amount causes the recording characteristic to be linear to the origin and symmetrical in the first and third quadrants about the origin, as in Fig. 2. It will be noticed from Fig. 2 that the overload characteristic is of a type to which the ear is least

* Decimal classification: 621.385.97X538. Original manuscript received by the Institute, May 2, 1944.

† Research Engineering Division, Lewyt Corporation, New York 7, N. Y.

‡ Eisemann Corporation, Brooklyn, N. Y.

¹ D. W. Pugsley, "Engineering details of magnetic wire recorder," *Electronic Indus.*, vol. 3, pp. 116-118; January, 1944.

² A. E. Barrett and C. J. F. Tweed, "Some aspects of magnetic recording and its application to broadcasting," *Jour. I.R.E.* (London), vol. 82, pp. 265-288; March, 1938.

sensitive. F. H. Shepard,³ in his report before the National Convention at the Rochester Fall Meeting of The Institute of Radio Engineers in 1941, demonstrated

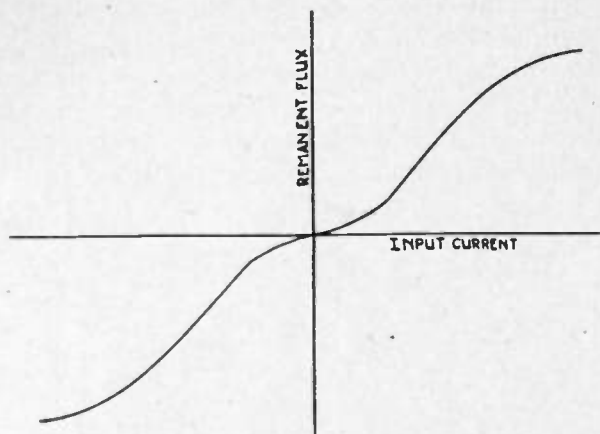

Fig. 1—Curve relating input current to remanent flux for recording on a neutral medium in the absence of supersonic currents.

that a radio amplifier with a transfer characteristic of the shape of Fig. 2 overloads in a manner which is only slightly irritating and maintains the essential intelligibility of speech, even though greatly overloaded.

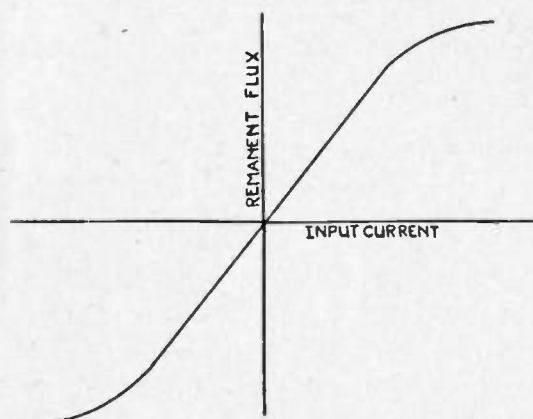

Fig. 2—Improved recording characteristic after addition of supersonic currents.

The explanation for the improved recording characteristics in the region of the origin made by the addition of "high-frequency bias" has been suggested by various writers to be the action of the high-frequency field in overcoming a sort of static friction in changing the magnetic orientation of the fundamental magnetic aggregates. This hypothesis has been recognized by all the above writers to be inadequate, but has been advanced in the absence of a more concrete explanation. It must be realized, of course, that this hypothesis does not explain the failure of the friction to reappear once a cyclic condition has been established in the medium, even at the point where the magnetic induction may be zero.

It has been determined by means of a magnetic-measuring technique to be described in the latter part of this paper that the linearity at the origin is the result of the shape of the cyclical hysteresis loop.

Fig. 3 is a picture of superimposed hysteresis loops of high-carbon steel wire which has been subjected to a series of different maximum magnetomotive forces. A noteworthy characteristic indicated by Fig. 3 is the fact that the steep portions of the descending characteristic of all of the unsaturated loops almost coincide with the saturated loop, and the flat portions are very closely parallel. This is an indication that any minor hysteresis loop will follow a characteristic parallel to the flat portion of the descending loop, which path can be likened to the shortest magnetic path across the saturated loop. This deduction is substantiated by the pictures of the growth of the minor hysteresis loops in Fig. 4. These pictures indicate that the slope of the minor hysteresis loops is the same as that of the flat portion of the major loop. It will be noticed from Fig. 3

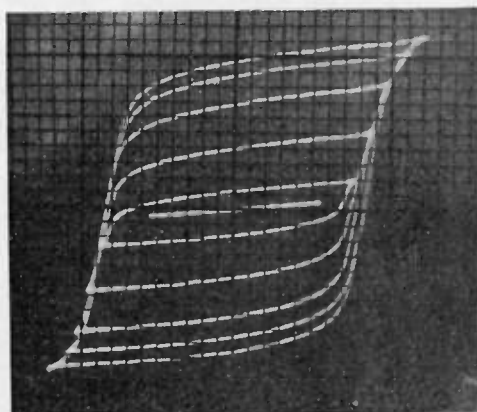

Fig. 3—Superimposed hysteresis loops for different maximum values of magnetomotive force for a sample of a recording medium.

that there is very little flux produced in the material by the alternating magnetomotive force until a value almost equal to the coercive force of the material is reached. In order to produce a linear recording, it is necessary for the supersonic field to equal the above value. Under this condition the addition of the low-frequency magnetomotive force leads to an anhysteretic loop which has been well known to the art for many years. It is discussed adequately in Spooner⁴ where it is shown that these loops which apparently contain only small enclosed areas are formed by minor loops traveling around the major hysteresis loop always with one tip in contact with the major hysteresis loop. The pictures of Fig. 4 would represent anhysteretic loops if many minor loops were imagined growing from the major loop and if the locus of the average points of these loops were plotted as a function of the applied low frequency magnetomotive force. The recording characteristic such as shown in Fig. 2 can, in fact, be derived in the case of "high-frequency bias" from a curve which connects the average points on the minor hysteresis loops. It will be well, however, to consider in detail just what occurs to each element of magnetic material

³ Lewis Winner, "A Report on the I.R.E. Rochester Meeting," *Communications*, vol. 21; pp. 14-18; November, 1941.

⁴ Thomas Spooner, "Properties and Testing of Magnetic Materials," McGraw-Hill Book Company, New York 18, N. Y., 1927, p. 84.

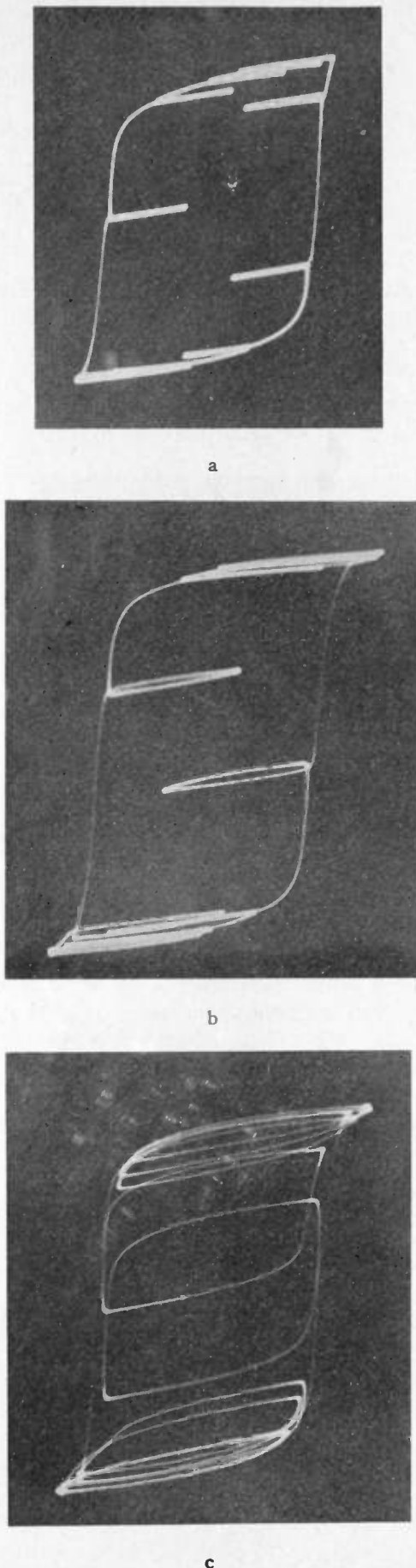

Fig. 4—Progressive stages in the growth of minor hysteresis loops showing the limiting boundary effect in b and c.

as it travels through the recording gap. The pictures of Fig. 4 will be helpful in visualizing this action.

The diagram of Fig. 5 indicates how a remanent flux proportional to the low-frequency magnetomotive force is produced. The minor hysteresis loop AA is hung from a point on the hysteresis curve corresponding to the sum of the instantaneous value of the low-frequency magnetomotive force and the peak value of the high-frequency magnetomotive force. This loop represents

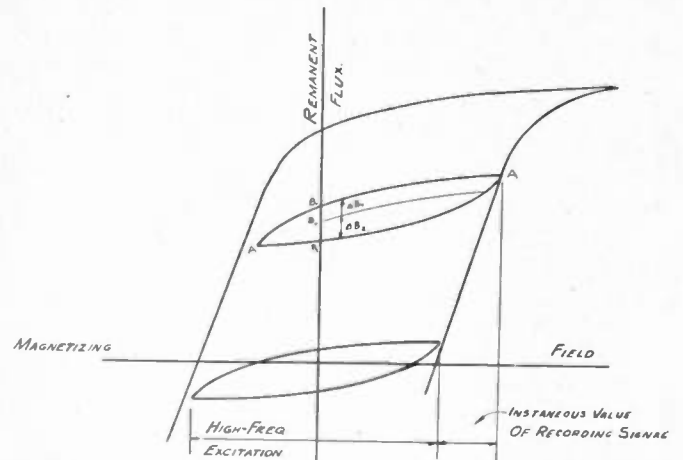

Fig. 5—Construction showing the rise of a minor hysteresis loop as the result of superimposed low-frequency and high-frequency field.

a steady-state condition in the presence of a constant and a variable magnetomotive force. If both of these magnetomotive forces collapse to zero a remanent flux B_r where $B_1 > B_r > B_2$ will be produced by virtue of the fact that a decay to zero from any point on the minor loop will follow a path that lies within the boundary set by the two curves making up the minor loop.

It has been seen above how a remanent flux is produced by the use of "high-frequency bias." It now remains to examine the characteristic about the origin of this recording curve. Fig. 3 shows that little flux is produced until the magnetomotive force applied approaches the coercive force value of the material. This indicates that recording in the absence of "high-frequency bias" will result in very small remanent flux until the peak value of the recording signal is equal to the coercive value of the material. Therefore, the characteristic of Fig. 1 results. If a high-frequency magnetomotive force is now added which is approximately equal to the coercive force of the material, any increase in the peak value of the applied magnetomotive force due to an application of a signal current to the recording head will result in the rise of a minor hysteresis loop along the maximum slope characteristic of the major hysteresis loop. This is shown diagrammatically in Fig. 5. A remanent flux in the region between the limits B_1 and B_2 will be produced upon the collapse of both fields, as described in the above paragraph. This remanent flux will be related to the low-frequency recording signal by the steep ascending portion of the major hysteresis loop. It can be shown similarly that a negative signal will

combine with the negative ascending portion of the hysteresis loop and will result in a remanent flux of opposite sign. Since the positive and negative ascending portions of the hysteresis loop are strictly parallel, the resulting transfer characteristics will be linear at the origin and a recording will take place as illustrated in Fig. 6.

The above observations apply specifically to the re-

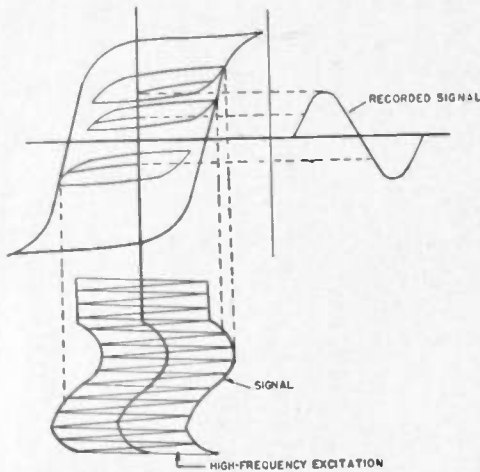

Fig. 6—Construction showing the manner in which a remanent flux is produced which is a function of the low-frequency signal.

recording of low audio frequencies in which the recording signal can be considered to be constant during the time the elementary length of recording medium traverses the recording gap. This condition, of course, does not hold true for the higher audio register. The component of audio signal either may increase during the entire transit of the gap or it may reach a maximum and begin to decrease. For the case of a continuously increasing recording signal the state of the magnetic material will be determined entirely by the condition that obtains at the instant of leaving the gap, and the length of time during which it traverses the gap or the length of the gap will be only of secondary importance. It will be noticed from Fig. 4c that it is not possible to make a minor hysteresis loop extend completely across the major loop. However, these minor loops always extend from one side toward the opposite side of the loop. Therefore, if the recording signal reaches a maximum and begins to decrease while an element of magnetic material is traversing the gap, its magnetic state is determined by the slope of the unattached side of the minor hysteresis loop, such as is shown in Fig. 4c. A continued decrease of instantaneous values of the recording signal will cause a minor loop to grow out of the unattached side of the original minor loop. It will be noticed from Fig. 4c that the unattached side of the large minor hysteresis loop closely approximates that portion of the major loop in the second quadrant. Its shape and slope are sensibly the same. Therefore, it follows that the actual recording will differ only slightly from that obtained on the assumption that the minor loop maintains contact with the major loop regardless of its previous

history. This is the condition for the generation of an anhysteretic loop based on a saturated major hysteresis loop and, therefore, can be taken as an approximate delineation of the recording characteristic.

In considering the travel of more than one element through the gap it must become apparent that the value of the high-frequency field at the instant each element leaves the gap is not constant. Each element leaves the gap at an instant at which the high-frequency field is slightly different from that which applies to the preceding element. Therefore, the remanent flux will go through a series of values corresponding to the sum and difference frequencies between the recording signal and the supersonic signal. The values of remanent flux will always lie within that portion of the zero magnetomotive force axis which is contained within the boundaries of the minor loops. Since these loops are relatively narrow, the component of recorded signal at the sum and difference frequencies will be quite small. In all ordinary cases the difference frequency will be large compared to the highest audio frequency used since the supersonic range is chosen large enough that several cycles are traversed during the transit time of an elementary length of recording medium through the gap.

PART II

The pictures of Figs. 3 and 4 were obtained by an extension of the oscillographic technique of magnetization studies.⁵ Certain simplifications and additions are made, however, which allow greater flexibility in operation and technique. Two sources of exciting current are used which are connected in series and applied to the primary of a sample of the construction shown in Fig. 7. One of these sources operates at a frequency of 100



Fig. 7—Construction on magnetic samples.

cycles and the other at a frequency of 1000 cycles. Synchronization is obtained by means of a frequency-dividing circuit. The voltage from a pickup coil placed on the toroidal sample, after being applied to the primary of an impedance matching transformer, is integrated by a resistance-capacitance network⁵ and applied to the vertical amplifier of a cathode-ray oscilloscope. A voltage proportional to the current in the magnetizing coil is obtained across a $\frac{1}{4}$ -ohm resistor and applied to the horizontal amplifier of the cathode-ray

⁵ Robert Adler, "B-H curve tracer for lamination samples," *Electronics*, vol. 16, pp. 128-131; November, 1943.

oscilloscope. In designing this circuit, care must be exercised in the choice of a matching transformer since the magnetizing current must be quite small in order to avoid low-frequency phase shift. The primary of the one used is made to match a 500-ohm line to grid. Since the windings on the magnetic samples consist of only 60 turns, the primary impedance of the transformer is large compared to the internal impedance of the source.

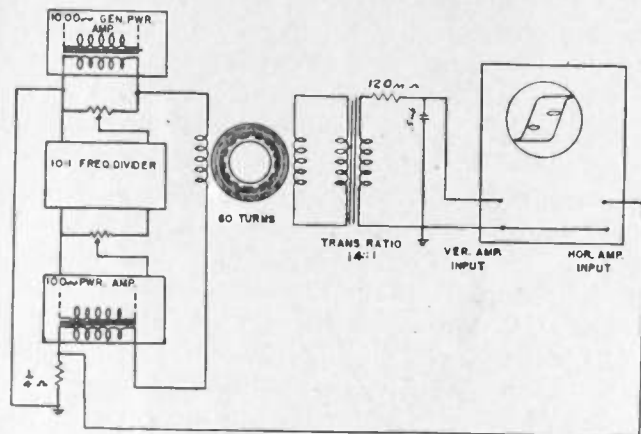

Fig. 8—Block diagram of circuit for obtaining $B-H$ curves.

This results in no measurable low-frequency phase shift. Tests made on the magnetic materials give constant low-frequency results; i.e., the measure of coercive force is independent of the magnetomotive force ap-

plied to the material after saturation is obtained.⁵ If there were low-frequency phase shift in the flux-measuring circuit, this would not be true. This complete circuit is shown in Fig. 8. Utilizing this circuit it is possible to obtain a hysteresis curve with superimposed minor loops which remain fixed and are therefore easy to photograph.

It is very instructive to observe the action on this set-up, when the low- and high-frequency sources are not synchronized. Under these conditions the minor loops progress continuously around the major loop and it becomes possible to determine characteristics of magnetic materials which have not been heretofore well known and understood. For example, the pictures of Figs. 4a, 4b, and 4c indicate the horizontal growth of the minor loops until their tips reach a limiting curve which is contained inside of the major hysteresis loop. Fig. 4c shows the shape of the minor hysteresis loop after it has reached its limiting boundary. The minor loops open rapidly after this boundary is reached and begin to take a shape similar to a displaced magnetization loop.⁴

Note added in proof: Since the preparation of this paper and its receipt by The Institute, the authors have learned of patent No. 2,351,004 issued to Mr. Marvin Camras entitled "Method and Means of Magnetic Recording." The text of this patent is found to be broadly parallel to certain of the subject matter of the present paper.

Significant Radiation from Directional Antennas of Broadcast Stations for Determining Sky-Wave Interference at Short Distances*

J. H. DEWITT, JR.†, SENIOR MEMBER, I.R.E., AND A. D. RING‡, ASSOCIATE, I.R.E.

Summary—The present practice in the design of directional antennas for broadcast stations to prevent sky-wave interference to another station on the channel at short distances does not necessarily accomplish the purpose. The interference signal has been computed from the radiation along one path at a fixed vertical angle. This practice has been generally followed by consulting engineers and has been acceptable to the Federal Communications Commission. Measurements indicating the length of the path of sky-wave signals received at short distances show that the signals take various paths and are not confined to a single path. Measurements were made by pulse transmissions of the relative time required for sky-wave signals to arrive at a receiving point some 230 miles from the transmitter. Control was had of the vertical radiation pattern. The records made of the received signal indicate varying heights and conditions of the reflection layer. To assure that no interference is caused by sky-wave signals, in accordance with the Commission's Standards of Good Engineering Practice, the Standards must be modified to require proper consideration of the radiation at all angles which constitute the "appropriate vertical vector."

THE DEMAND for additional standard broadcast stations to serve centers of population which have insufficient broadcast service has resulted in every effort being made toward maximum possible use

of all duplicated channels. It has been found that by proper use of directional antennas the number of stations on a regional channel may be doubled or even tripled and yet have each station serve adequately the desired center of population. The number of broadcast channels is definitely limited and it is only through the utilization of technical developments that it has been possible to improve and increase the service to many centers of population by the maximum utilization of regional and local stations.

Directional antennas are not used for stations on local channels which are limited in power to 250 watts and allocated without regard to sky-wave interference. Regional stations, however, use a power up to 5 kilowatts, and mutual interference from sky-wave signals

* Decimal classification: R325. Original manuscript received by the Institute, January 10, 1944; revised manuscript received, May 3, 1944.

† Chief Engineer, WSM, Nashville, Tenn., on leave; Major United States Signal Corps, Camp Evans Signal Laboratory, Belmar, New Jersey.

‡ Ring and Clark, Washington, D. C.

at night must be taken into account to prevent serious curtailment of the service area of stations on the channel. The directional antenna permits control of radiation in the various directions so that additional stations or power may be employed on a channel without the creation of objectionable interference.

The design of directional antennas has become increasingly complex, both on account of the great number of directions in which protection must be provided and the small mileage separation between stations. This short mileage means that the signal causing interference is not necessarily determined by the horizontal-plane radiation pattern. The radiation from the antenna as established by the vertical pattern becomes the determining factor when the distance is reduced to a few hundred miles.

Experience with directional antennas indicates that the present design practice of reducing the radiation at one angle in the vertical plane corresponding to one reflection from the E layer of the ionosphere does not necessarily control the interference signal. As a matter of fact, under some circumstances, it has been found that such directional antennas actually increase the interference, even through the method commonly used to determine the antenna characteristics and interference indicated there should have been no objectionable interference. It was evident that the signal arriving at the distant point had not traversed one fixed path but several widely different paths. This apparent condition gave rise to a study of the length of the path of propagation of sky-wave signals arriving at points 175 to 250 miles distant from the transmitter.

In 1939, the Federal Communications Commission published certain standards of allocation for stations in the broadcast band. The method set out for determining nighttime interference between stations is based on a large number of sky-wave measurements which were made in the spring of 1935. The average of all the antennas measured corresponded to one having a height of 0.311 wavelength. In designing directional antennas, the engineer is required to consider all of the "appropriate vertical vectors," but consulting engineers in general have apparently thought it necessary to consider only the radiation at one angle above the earth, corresponding to that of a single reflection from the E layer of the ionosphere. The height of the ionosphere is generally taken as 110 kilometers or 68.4 miles.

In designing a directional antenna for a given situation, it is not always possible to control the radiation in both the horizontal and vertical planes. Certain vertical high-angle lobes must sometimes be tolerated when the signal along the ground is reduced to a low value. In several cases an attempt has been made to protect another station on a channel through the use of an antenna with a vertical pattern in which there is a minimum at the angle corresponding to a single reflection from the E layer. The authors recently undertook the investigation of the action of such an antenna, after serious complaints of interference had been registered

by the station which was supposedly protected. A description of the method employed and the results obtained are given as it is believed that the method may have some usefulness in other cases and also because the results have shown that much greater attention must be paid to the shape of the vertical pattern in the direction of the station to be protected.

The station in question is WING, located at Dayton, Ohio, which operates on a carrier frequency of 1410 kilocycles, with a power of 5000 watts, day and night. The directional antenna of this station must afford protection to stations at Mobile, Alabama; LaCrosse, Wisconsin; and Pittsburgh, Pennsylvania. The calculated horizontal and vertical radiation patterns for the antenna are shown in Figs. 1 and 2. The distance from

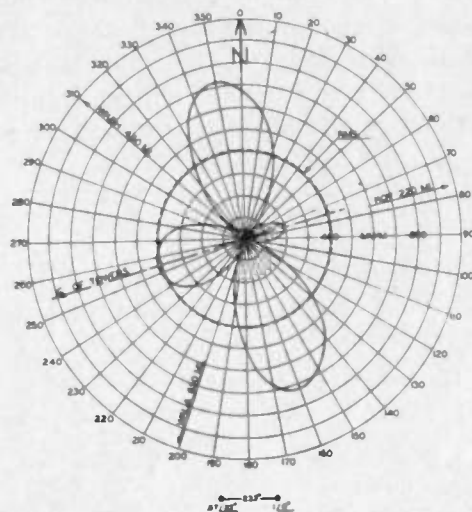

Fig. 1—Horizontal-plane radiation pattern.

Dayton to Pittsburgh is 230 miles. The vertical angle at Dayton, corresponding to a single reflection from the E layer, at a height of 68.4 miles, is 30 degrees. It will be noted from Fig. 2 that the designer has provided a minimum in the vertical pattern at this angle. Assuming that the ionosphere remains fixed in height and

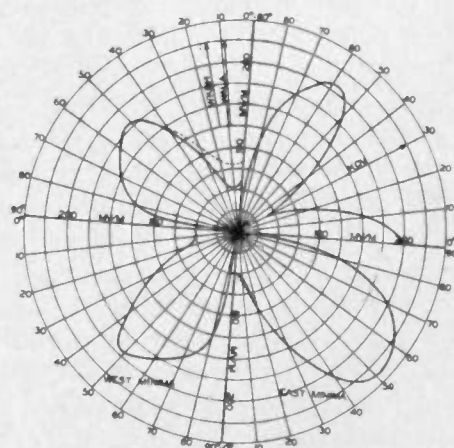

Fig. 2—Vertical-plane radiation patterns.

that only a single reflection takes place, this antenna should give adequate protection to the service area of KQV at Pittsburgh. It was found that such was not the case, as there were many nights during which interference

to KQV was extremely serious, the station's coverage being limited to its 15-millivolt-per-meter contour.

In order to determine the paths over which the signals traveled, it was concluded that a pulse method of transmission, which is similar to the technique employed in measuring the height of the ionosphere, was most suitable. By transmitting sharp pulses of carrier at regular intervals and receiving them on an oscilloscope, having a sweep circuit, it is possible to separate the various reflections because of the difference in time required for the transmitted energy to traverse paths of different lengths.

This method was first tried on WSM, operating with a power of 50 kilowatts on 650 kilocycles. The pulse generator used in all of the tests to be described consisted of a 450-cycle sine-wave oscillator, which was fed into a cascade clipper amplifier and thence to a differentiator circuit. The circuit of this apparatus is shown in Fig. 3. Square waves from the clipper amplifier charge C_1 (a relatively small condenser) through a diode. On the

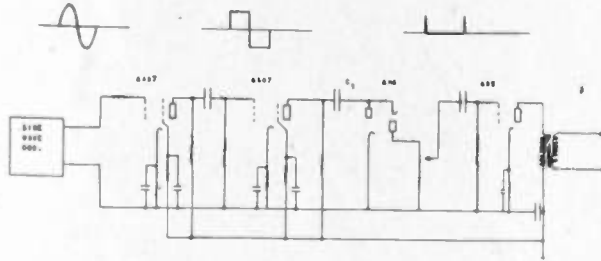

Fig. 3—Pulse-generating circuit.

reverse cycle the condenser is completely discharged by another diode connected in the opposite direction. A small resistance in series, with one of the diodes, provides a voltage which is a replica of the condenser-charging current. The width of this pulse is, of course, determined by the steepness of the square waves and the degree of charge which C_1 receives on each cycle. The circuit constants were adjusted so that the duration of each pulse was approximately 50 microseconds. The time between pulses is 2.22 milliseconds corresponding to the 450-cycle input signal. By adjusting the frequency of the audio oscillator, this interval may be varied at will. A frequency of 450 cycles was used in these tests as it permitted reception of two identical waves on the receiving oscilloscope during one sweep, and at the same time provided sufficient time interval between pulses so that all reflections could be spread on the cathode-ray-tube screen before the next succeeding group of pulses was received. Keying of the transmitter carrier was accomplished by removing the steady plate voltage from the modulated amplifier, and by exciting the modulator tubes to provide positive plate voltage. The excitation corresponded to the narrow vertical pulse. The output of the pulse generator was fed into the transmitter audio input terminals with the correct polarity and at the proper level. A schematic representation of the modulator is shown in Fig. 4.

In adjusting the transmitter, an oscilloscope was connected across the transmission line to the antenna and the deflection was noted for normal power output with a steady carrier. After this the pulse generator was applied and the peak pulse power was adjusted through the audio input so as to equal the normal carrier power.

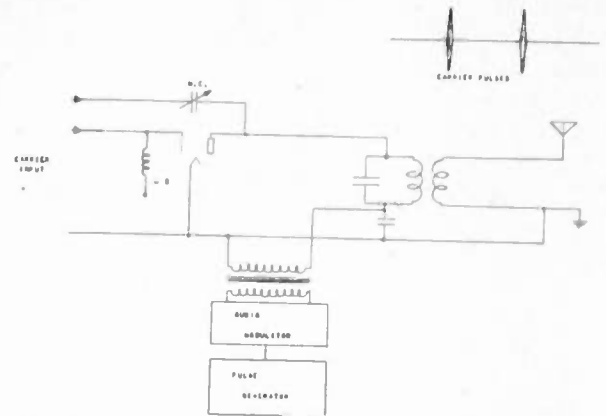

Fig. 4—Transmitter connection for pulse transmission.

It was interesting to note that with the transmitter operating with 50 kilowatts of peak pulse power, the average antenna power is only about 1 kilowatt for the pulse used.

In order to preserve the shape of the pulses, it is essential that the transmitter have a bandwidth of about 10 kilocycles. It must also be free of any transient condition. Otherwise, the transmitted pulses will have the oscillatory character of a damped wave. The radio receiver used in the tests was of the superheterodyne type without automatic volume control, but having an adjustment for over-all radio-frequency gain. The total bandwidth of the receiver was adjusted for 10 kilocycles. A single-stage resistance-coupled audio amplifier was used between the diode-detector output and the vertical input circuit of an RCA 3-inch cathode-ray oscilloscope, type TMV-122B. The horizontal linear sweep circuit in the oscilloscope was used to spread out the received waves. The sweep oscillator was synchronized from the received pulses. This simple method of synchronization proved to be entirely reliable, but there was some trouble experienced from movement of the image when the received pulses changed their relative magnitude.

The measurements on WSM were carried out on January 13, 1942, at Birmingham, Alabama, at an air-line distance of 180 miles. A loop receiving antenna was used, which has a nondirectional vertical pattern. The next day, when all sky-wave transmission had disappeared, the ground wave at this point was measured and found to be 95 microvolts per meter. Some oscillograms of the received pulses are shown in Fig. 5. The ground wave may be seen as the first small received pulse in all of the figures and this has been taken as zero time. Both the first and second reflections are visible in these photographs. The first reflection is present most of the time.

At 2:05 A.M., it reached a peak value of approximately 1.25 millivolts per meter. The time interval between reception of the ground wave and the first reflection corresponds to a path difference of 37.5 miles, which would place the layer at an effective height of 70 miles. Regular fading of the reflections was the rule rather than the exception. When the first reflection began to fade, it was noticed that the crest of the pulse nearly always split into two sections, as may be seen in several

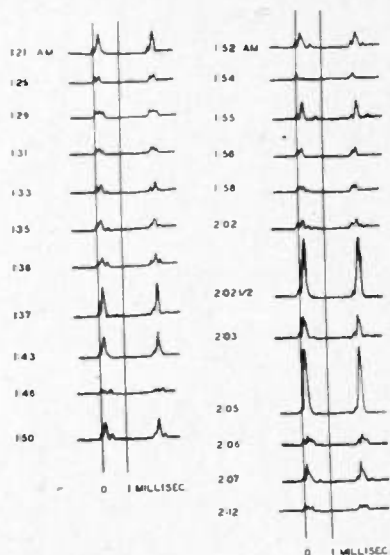

Fig. 5—WSM pulse transmission, 650 kilocycles, received near Birmingham, Alabama. Distance, 180 miles, January 13, 1942.

of the oscillograms. This appears to be due to double refraction. The first part of the pulse is the ordinary ray and the second part is the extraordinary ray. The time interval between the two sections of this reflection corresponds to an apparent difference in layer height of about 20 miles. The second reflection was only evident occasionally. Its strength would not be expected to be great at such a short distance. The vertical pattern of the WSM antenna, as measured in an airplane, is shown in Fig. 6. The arrows shown at angles of 50 de-

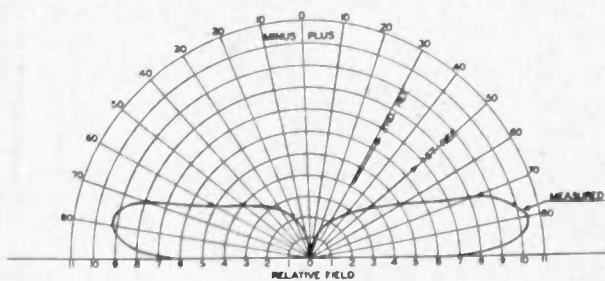

Fig. 6—WSM vertical radiator, measured December 5, 1940.

grees and 32 degrees correspond to the first and second reflections, for a distance of 180 miles.

On February 1, 1942, this technique was applied to the directional antenna at WING, Dayton, Ohio, the signal being received at Pittsburgh on a vertical quarter-wave antenna. When tests were begun at 1:00 A.M., with Dayton operating nondirectionally, the received signal at Pittsburgh was of a character similar to that found

in the tests on WSM. No ground wave was visible because of the relatively high attenuation over this path. The first reflection was predominant, but the second reflection was present most of the time. The first reflection exhibited the same twinning when fading took place. At approximately 1:30 A.M., the pattern of transmission changed. A new strong reflection appeared at a point in time just after the second reflection. The strong first and second reflections which had been observed earlier disappeared almost completely. Subsequent measurements of these oscillograms have convinced the authors that the new reflection took place at the F layer of the ionosphere at a height of about 150 miles, assuming that the height of the E layer was 70 miles. The paths of the signal are illustrated in Fig. 7.

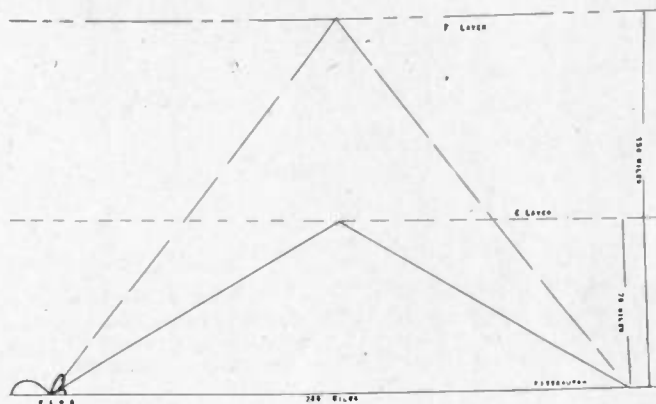

Fig. 7—Signal paths from WING to Pittsburgh.

Before transmission conditions changed, the engineer at WING was asked to switch from nondirectional to directional operation. When this was done, there was a great decrease in the strength of the first reflection and by changing the phasing between the two towers at WING, the first reflection could be substantially eliminated. A change in phase has the effect of moving the vertical minimum in the radiation pattern to a different angle with respect to the horizontal (see Fig. 2). Under these conditions, the first reflection could be eliminated for several minutes at a time, but it would always reappear, necessitating a change in phase between the towers, for its re-elimination. It was concluded from this result that the effective height of the E layer of the ionosphere was changing from minute to minute. This alone is sufficient to prove that such a vertical pattern cannot be relied upon to provide adequate protection.

Later, when the F-layer reflection was the controlling factor, less signal was received at Pittsburgh when the station was operating nondirectionally than when the directional antenna was used. The oscillograms shown in Fig. 8 were all taken after the onset of F-layer reflections. A large amount of scattered radiation may be seen just ahead (to the left) of the strong F-layer reflection.

The condition of the ionosphere at this time seems best explained by assuming that recombination of electrons in the E layer had progressed to such an extent

that very little reflection took place. The waves upon arrival at the E layer were probably split into a number of rays, some of which were absorbed, some reflected with greatly reduced intensity and others allowed to pass with some attenuation to the F layer, where they

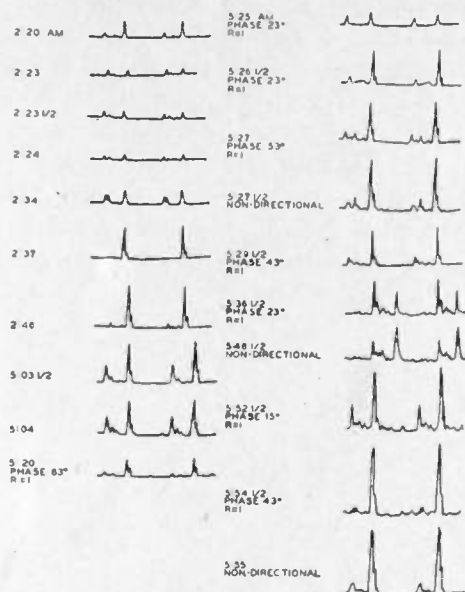

Fig. 8—WING, Dayton, Ohio, 1410 kilocycles, as received on non-directional antenna at KQV, Pittsburgh, Pennsylvania, February 1, 1942. Time between two identical successive waves = 2.22 milliseconds. Scale of all oscillograms not exactly the same.

were refracted back to earth. Further measurements on WING were made at Nashville when this station operated nondirectionally. These oscillograms are shown in Fig. 9. Over the space of time in which they were made, there was no evidence of F-layer reflections, transmission conditions being entirely "normal". The first reflection from the E layer was the predominating factor, but a second reflection was present most of the time.

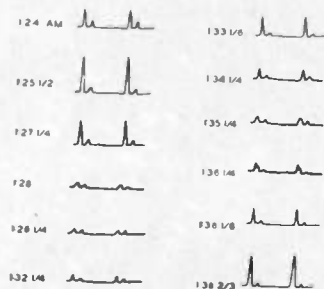

Fig. 9—WING, Dayton, Ohio, received Nashville, Tennessee on non-directional antenna, February 10, 1942, WING operating non-directionally. Time between two successive identical waves is 2.22 milliseconds.

In view of the possibility of F-layer reflections and also the great probability of scattered E-layer reflections, it would seem that the designing engineer must, in the future, give closer attention to the vertical pattern in the direction of the stations to be protected.

What is needed for guidance in future designs is a fund of knowledge on the action of the ionosphere at broadcast frequencies. A tremendous amount of work has already been done on measurement of ionosphere

heights and critical frequencies, but this work has apparently been directed toward the end of providing more information on the subject of long distance communication in the short-wave bands. From published papers it is possible to obtain a tremendous amount of general information on the ionized regions of the atmosphere. Nearly all of the measurements have been carried out with the receiver at approximately the same location as the transmitter, so that the results correspond to a wave reflected at vertical incidence. Under these conditions, the critical frequency for the E layer is very much lower than would be the case for waves reflected at other angles. It has been established that the critical frequency is a function of the secant of the angle of incidence.

Nearly all of the measurements which have been reported on the E layer show its critical frequency only for daytime conditions. During daytime the E layer apparently has just below it a layer of intense ionization, which absorbs waves in the broadcast band. Its critical frequency must be very much higher in the daytime than at night, owing to the intense ionizing effect of the ultraviolet light from the sun. At sunset, recombination of the ions begins and continues throughout the night. One would think, therefore, that the E layer would have its lowest critical frequency in the early hours of the morning just before sunrise. It has been pointed¹ out that the normal E critical frequencies varied fairly regularly, both diurnally and seasonally. The E-layer critical frequency rose rapidly at sunrise out of the broadcast band and came to a broad maximum about noon, both in summer and winter. From this it appears that penetration of the E layer by broadcast waves at night may be a rather common occurrence. This would especially be true at the high-frequency end of the broadcast band and at small angles of incidence.

It would be highly desirable for someone to undertake a complete study of the characteristics of the ionosphere in the broadcast band. We need to know the critical frequency for the E layer at night in order that the designer of a directional antenna may know at what frequency in the broadcast-band penetration of this layer is likely to be encountered. The laws governing penetration and reflection at varying angles of incidence seem to be very well established. It is apparent that penetration of the E layer is much less likely when the waves arrive at large angles of incidence which would correspond to a wide mileage separation between the stations in question. More information on this subject, however, would be highly desirable.

For the present it seems that the design engineer must regard the space between the earth and the upper atmosphere as a vast hall with no walls, a rough floor, and a cloudy ceiling, which may vary in height from 60 to over 150 miles. Since the ceiling is composed of clouds

¹ T. R. Gilliland, S. S. Kirby, N. Smith, and S. E. Reyrer, "Characteristics of the ionosphere and their application to radio transmissions," Proc. I.R.E., vol. 25, pp. 823-841; July, 1937.

of electrons, which are constantly shifting in much the same way that water-vapor clouds shift in the troposphere, we cannot think of single rays of energy being reflected from an object similar to a plane mirror, located at a point halfway between the transmitter and receiver. The probable paths of the sky-wave signal are illustrated in Fig. 10. Such paths would explain the results obtained from the tests.

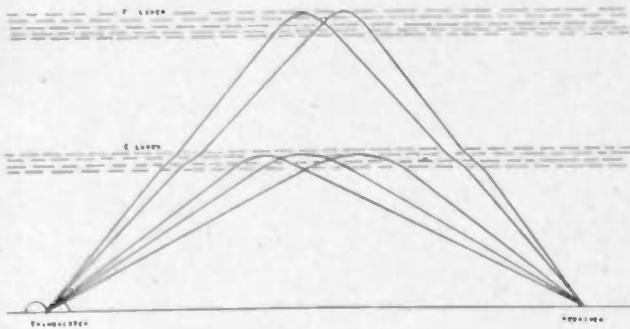

Fig. 10—Possible paths of sky waves.

There are certain types of directional antennas which suppress radiation at all vertical angles in certain azimuth directions. These are usually linear arrays, so phased that the field normal to the line of the array is near zero. A simple example of this type of antenna is a two-tower array with any degree of spacing, but with the two elements operated in phase opposition. It would be interesting to select a few such antennas in the country and to make a study of the degree of protection they afford other stations on the channel, in comparison with the protection afforded by antennas such as that in use at WING.

Recent measurements of the current distribution on each element of a three-element directional antenna indicated that there is a substantial variation in the electrical height or current distribution due to the mutual. In this design the physical height of each element was 146 degrees, assuming propagation at the speed of light. The electrical heights were established from the measured current distribution fitted to a sine wave as 149, 183, and 160 degrees, respectively. This design had several minima in the vertical-plane pattern as computed for an electrical height of 146 degrees for all elements. These minima would not occur as computed for the measured electrical height and, in fact, actual sky-wave measurements indicated that the sky-wave signal was actually increased at these angles over that from a quarter-wave antenna having the same field in the horizontal plane.

It is believed that the pulse method of transmission and measurement may be a very useful tool for anyone who must adjust a directional antenna for specific suppression in the vertical plane pattern. It is not possible, through its use, to determine the vertical pattern of an antenna directly because the conditions of reflection at the ionosphere are not known with certainty at any given time. It is possible, however, to eliminate this

variable through the common practice of comparing the results with an antenna having a known pattern. Most directional arrays are arranged for nondirectional operation in the daytime, and relays are usually provided so that the antenna may be shifted very quickly between the two conditions. It is only necessary then to set up the pulse-receiving equipment at a point within the service area of the station to be protected and then to shift rapidly between the directional and nondirectional conditions. Photographs of the received image may be taken and measurements made later, which will show the relative amount of energy radiated when operating directionally and nondirectionally. The vertical radiation pattern of a simple quarter-wave antenna is fairly well established. This may be used as a reference, both for measurement of directional antennas and also for the measurement of the vertical patterns of top-loaded or other forms of antennas, which are designed to suppress high-angle radiation.

CONCLUSIONS

The measurements disclosed clearly that there is no one sharp beam at a fixed angle which determines the sky-wave signal received from standard broadcast antennas at short distances. To assure protection from interference, as would be afforded from an antenna with the vertical distribution of a 0.311 antenna, the signal must not greatly exceed the value in the vertical plane for a comparable antenna in the horizontal plane. Whether the signal arrives by substantially different bearing routes has not been established, but there are definite indications that the signal computed for one bearing toward another station on the channel does not establish the interfering signal on that bearing. The percentage of time which the stray paths of propagation account for a substantial part of the total received signal has not been established. To establish this, in point of time and percentage, would be an extremely long and tedious job. The Commission's Standards might well be expanded with regard to the requirements with respect to the "appropriate vertical vector" by specifying the significant signal as all angles in a vertical pattern.

ACKNOWLEDGMENT

The authors wish to acknowledge the assistance of Mr. Paul F. Braden of Station WING and Mr. Walter W. McCoy of Station KQV in making the pulse measurements.

Bibliography

- E. V. Appleton, *Proc. Phys. Soc. (London)*, vol. 37, pp. 160-220; 1925.
- A. H. Taylor and E. O. Hulburt, *Phys. Rev.*, vol. 27, pp. 189-215; 1926.
- G. Breit and M. A. Tuve, *Phys. Rev.*, vol. 28, pp. 554-575; 1926.
- T. R. Gilliland, "Ionospheric investigations," *Nature (London)*, vol. 134, pp. 379; September 8, 1934.
- E. O. Hulburt, "Theory of the ionosphere," *Terr. Mag.*, vol. 40, p. 193; June, 1935.
- N. E. Bradbury, "Fundamental mechanisms in the ionosphere," *Jour. Appl. Phys.*, vol. 8; November, 1937.
- A. G. McNish, "Terrestrial magnetic variations and the ionosphere," *Jour. Appl. Phys.*, vol. 8; November, 1937.

Aids in the Design of Intermediate-Frequency Systems*

PAUL C. GARDINER†, ASSOCIATE, I.R.E., AND J. E. MAYNARD†, ASSOCIATE, I.R.E.

Summary—A set of design curves has been developed by means of which the over-all selective performance of an intermediate-frequency amplifier may be predicted with the expenditure of little time or effort. The design chart is based on identical circuits, but with the appropriate conversions, variations in circuit Q can be accommodated readily by determination of the equivalent identical circuits. The design method permits a prediction of the allowable spacing between equal desired and undesired signals in the frequency spectrum to maintain the desired signal within 6 decibels of resonant output and the undesired signal at more than 60 decibels below resonant output, when variations in frequency due to such causes as modulation, drift, and setting are taken into account. Methods of arriving at a rapid approximation to the over-all curve, in those cases in which circuits of different coupling are cascaded, are discussed.

ONE OF the important devices with which the radio engineer works is the resonant circuit. Fortunately, in most of its applications, this is a linear device and its performance may be accurately determined by calculation. Furthermore, when resonant circuits are used with class A amplifiers, as in an intermediate-frequency amplifier, the whole system is linear and its over-all performance is calculable. While the information obtainable from such a calculation does not provide all that is necessary to lay out and build a successful intermediate-frequency amplifier, it does provide a criterion of performance. The selected values of coil Q for the design may be measured in the laboratory, the coils set up on a coil form and adjusted for the desired proportion of critical coupling in a single-amplifier stage and the experimental results matched with the calculated design for these elements. From this basis the amplifier is then constructed. Usually the over-all amplifier will not exhibit the calculated characteristic because of unpredicted regeneration or circuit loading. Then the sources of difficulty are traced down and finally the over-all amplifier characteristic is brought into agreement with the calculated design.

DESIGN REQUIREMENTS

This paper will be limited to the design calculation of the selectivity characteristic of a coupled circuit amplifier. The first step would be to set up the requirements which must be met. Suppose we have a communication system to provide, in which a transmitter and a receiver are to maintain communication after being tuned to a predetermined frequency by their calibrated charts or dials. In addition we shall assume a frequency spacing for adjacent-channel operation. The problem is, then, to find the intermediate-frequency characteristic which is required to hold the desired signal and reject an adjacent undesired signal.

* Decimal classification: R141.2×R363.1. Original manuscript received by the Institute, May 29, 1944.

† General Electric Company, Schenectady, New York.

These requirements specify two features of the characteristic. First, to hold the desired signal requires a portion of the characteristic to pass a range of frequencies with only slight variations in output. Second, after sufficient width of the frequency characteristic has been provided for the desired signal, a certain sharpness is required on the sides of the characteristic to reduce the output from an undesired adjacent signal to a level assumed to be sufficiently small to avoid interference.

General practice has established the level of variations for satisfactory reception to lie within a 6-decibel range. While the amount of attenuation required on an undesired signal (which may be much stronger than the desired signal) is different for each interfering situation, a general accepted amount of attenuation for this purpose is 60 decibels. Both the acceptance width of the

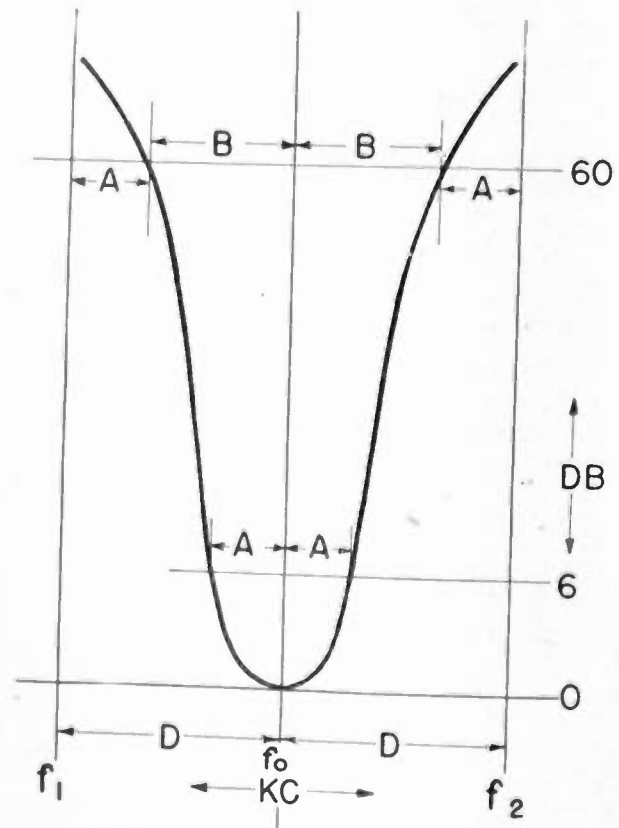

Fig. 1—Communication setup.

frequency characteristic and the attenuation at the adjacent channel for our hypothetical communication system depend upon several factors. The acceptance band must encompass modulation sidebands (frequency or amplitude modulation) and it must allow for errors in chart or dial reading and calibration inaccuracies. Further, it must allow for frequency variations during unattended operation which implies accommodation

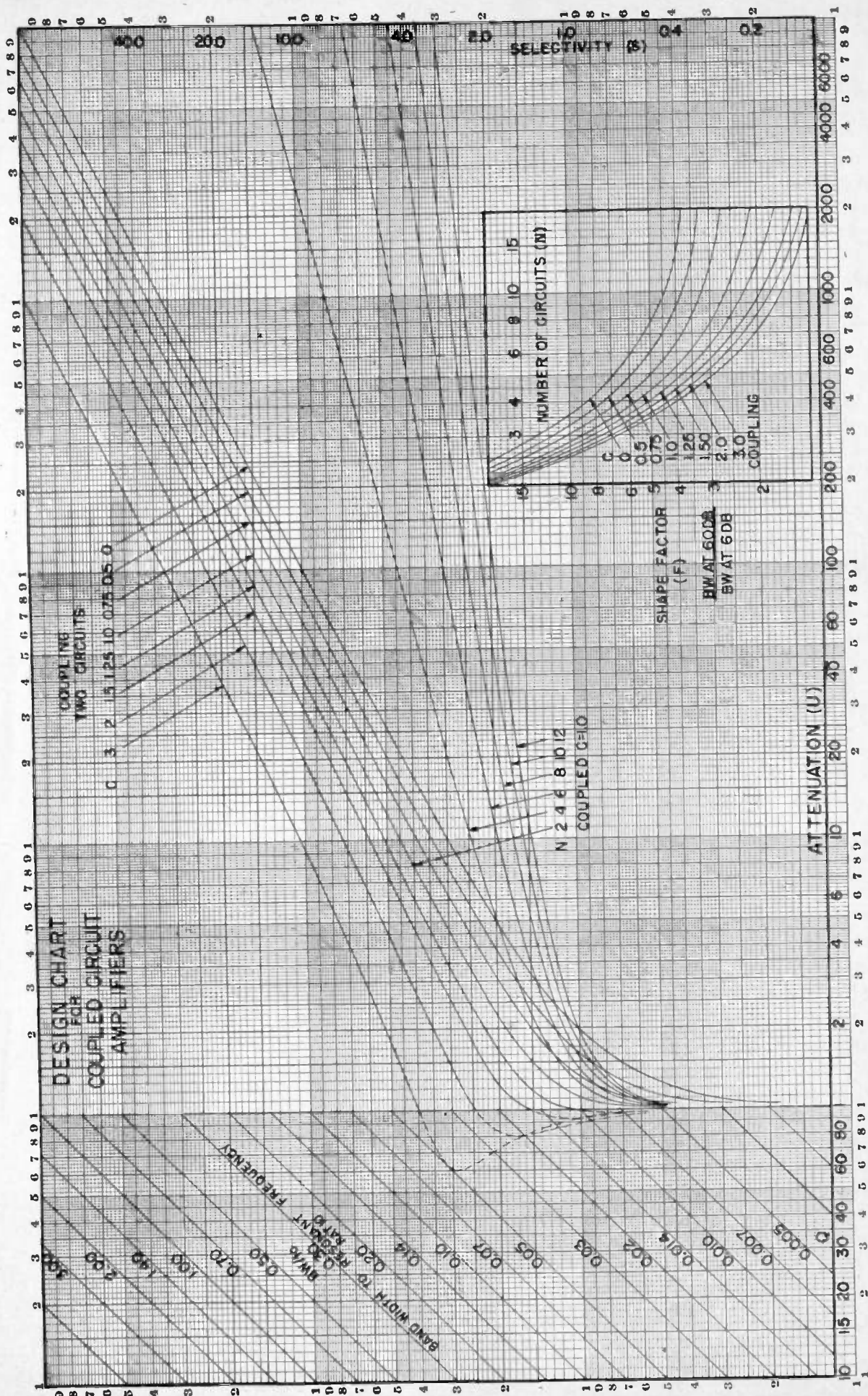

Fig. 2—Design chart for coupled-circuit amplifiers.

of frequency drifts due to climatic or power-supply changes. Since tuning and modulation excursion may not only cause deviations from the desired-signal frequency at receiver and transmitter, but also may cause approaches to and of the undesired signal, these frequency deviations must be considered to occur equally at each attenuation level. The situation is illustrated graphically in Fig. 1. A represents the total frequency deviation allowable to maintain the desired signal (f_0) within a 6-decibel range on the selectivity curve; it also represents the frequency deviation allowable to maintain adjacent signals (f_1, f_2) outside the interference level of 60 decibels below the desired signal. The selectivity curve required to provide a channel spacing D will therefore be specified by the "shape factor" F or ratio of frequency deviations B/A . The shape factor required of the intermediate-frequency amplifier, therefore, is

$$F = D/A - 1. \quad (1)$$

As a concrete illustration we shall use a fictitious set of figures. Assume that a transmitter operates at a frequency of 10 megacycles and that the maximum frequency drifts of transmitter and receiver add up to not more than ± 0.1 per cent of the operating frequency, that errors in setting both transmitter and receiver add up to 0.05 per cent or less of the operating frequency and that the maximum modulation sidebands require ± 5 kilocycles. In addition assume that the channel spacing desired between adjacent signals is 80 kilocycles. The acceptance band will be

$$A = 10 + 5 + 5 = 20 \text{ kilocycles} \quad (2)$$

and the shape factor of the required selectivity curve will be

$$F = 80/20 - 1 = 3. \quad (3)$$

DESIGN CHART

A chart, Fig. 2, has been prepared by means of which the required shape factor may be translated into a definite answer in terms of coil Q , number of circuits and coupling between circuits. The basis of the chart is a set of universal selectivity curves. It may be shown¹ that any pair of coupled resonant circuits may be represented by

$$U = \frac{\sqrt{(1 + C^2 - S^2)^2 + 4S^2}}{1 + C^2} \quad (4)$$

where U is the attenuation through the circuits (unity at resonant frequency), S is a selective variable proportional to frequency deviation from resonance, and C is a coupling parameter expressing proportionality to critical coupling ($C=1$). Critical is used here to define the transition point between single- and double-peaked resonant curves. These terms are specifically defined as follows:

$$U = G_0/G_f \quad (5)$$

$$S = (BW/f_0)Q \quad (6)$$

$$1 + C^2 = (Q_0/Q_a)^2(1 + K^2Q_0^2) \quad (7)$$

$$Q = (Q_0/Q_a)Q_0 \quad (8)$$

where G_0 is amplifier gain at resonant frequency f_0 , and G_f is amplifier gain at the frequency under consideration, BW is the bandwidth of the selectivity curve (twice frequency deviation from resonance), K is the coefficient of coupling between the two circuits, Q_0 is the geometric mean, and Q_a the arithmetic mean of the primary and secondary Q 's. The approximations used in the development of (4) result in selectivity curves which are symmetrical about resonant frequency; lack of agreement with these curves in practice will be found to be largely in this lack of symmetry which is usually, except for very low values of Q , negligible. Since the results are symmetrical, the curves may be plotted on one side of resonance only, as in the chart.

By means of the ratio lines at the left of the chart the attenuation to be obtained for any ratio of bandwidth to resonant frequency may be determined for a given circuit Q by following the Q ordinate to the ratio line, crossing over to the curve for the coupling to be used along the value of S so determined, and then down from the intersection with the selectivity curve to the corresponding value of attenuation U . For instance, using $Q=50$, $BW/f_0=0.10$, we find $S=5.0$ and for critical coupling ($C=1.0$), the attenuation will be $U=12.5$.

In order to extend the use of the curves to an amplifier containing several such pairs of tuned coupled circuits, a set of curves based on the curve for two coupled circuits at $C=1$ have been drawn for cascaded pairs of circuits. If the value of $C=1.0$ is substituted in (4) the formula for a critically coupled pair of circuits is obtained:

$$U = \sqrt{1 + S^4/4}. \quad (9)$$

For four circuits cascaded in critically coupled pairs the attenuation is the square of (9), for six circuits the attenuation is the cube of (9), etc. This implies identical values of Q and C in the coupled circuits. Since for any value of S we move up in attenuation exponentially in the same degree for each pair of cascaded circuits, the whole set of curves for two circuits can be extended graphically to any number of cascaded pairs for which we have the basic critically coupled curve. A numerical example will best illustrate this point. Suppose we wish an attenuation of 100 from eight circuits cascaded in pairs for $BW/f_0=0.10$ and wish to use 25 per cent over-coupling ($C=1.25$). Following $U=100$ to the curve for eight circuits we find $S=2.44$; following this back to the two circuit curve for $C=1$ we arrive at a point corresponding to $U=3.16$; following this up to the two circuit for $C=1.25$ we find a value of $S=2.9$. Follow this value of S to the ratio line $BW/f_0=0.10$ and we have the required $Q=29$.

The shape-factor chart in the lower right corner is a plot of the ratio of bandwidth obtained at 60 to that at 6 decibels attenuation, for various amounts of coupling, against the number of circuits used in the amplifier. These curves are obtainable from the other curves in the chart by taking ratios of S at $U=1000$ to those at $U=2$.

¹ J. E. Maynard, "Tuned transformers," *Gen. Elec. Rev.*, vol. 46, pp. 559-561, October; and pp. 606-609; November, 1943.

APPLICATION

Returning to (3), we wish to design an amplifier to have a shape factor $F=3.0$. First it is necessary to choose a resonant frequency. This involves several interference considerations such as images and harmonic beats; we will assume, however, that 2.0 megacycles is a satisfactory choice. From the shape-factor chart $F=3$ might be obtained with a slight margin from eight circuits cascaded in critically coupled pairs. This would require three amplifier stages containing four intermediate-frequency transformers. The ratio BW/f_0 required is $2A/f_0$ at 6 decibels, or from (2) $BW/f_0 = 40/2000 = 0.02$. Follow $U=2$ to the curve for eight circuits to find $S=1.14$ and following S to $BW/f_0=0.02$, we find the Q required to be 57.

Ordinarily, a radio-frequency amplifier would precede the intermediate-frequency system. Suppose this consisted of two cascaded single circuits. The attenuation would then be found on the two-circuit curve for $C=0$. The resonant frequency for these circuits is 10,000 kilocycles and at the bandwidth for 6 decibels in the intermediate-frequency system, BW/f_0 for the radio-frequency system is $40/10,000 = 0.004$. Assume a Q of 50 in the radio-frequency circuits, then $U=1.05$ so that the over-all attenuation at 40 kilocycles bandwidth will be slightly in excess of 6 decibels. At the intermediate-frequency bandwidth of 120 kilocycles (60 decibels), the radio-frequency attenuation for $BW/f_0 = 120/10,000 = 0.012$ will be $U=1.35$ so that the over-all attenuation at 120 kilocycles bandwidth will be well over 60 decibels. It will be somewhat more than 1350 since the shape factor F is actually 2.9. This might suggest the possibility of using fewer intermediate-frequency circuits and utilizing the additional attenuation in the radio-frequency amplifier to meet the requirements. Going back to the shape factor curves, it will be noticed that we are just slightly short of $F=3$ if we use six circuits at 25 per cent overcoupling ($C=1.25$). The question then will occur: Is this amount of overcoupling desirable? For two circuits the attenuation minimum occurs at $U=0.975$, cubing this for six circuits the over-all intermediate-frequency minimum will be $U=0.925$. Since this will be somewhat alleviated by the radio-frequency characteristic we shall assume it is not objectionable. For six circuits at $U=2$, $S=1.23$; crossing to two circuits at $C=1$ we find $U=1.25$; and up to the curve for $C=1.25$, $S=1.61$; over to $BW/f_0=0.02$ we find that a Q of 80 is required in the intermediate-frequency circuits. The attenuation at $BW=120$ kilocycles would be traced from the intersection of $Q=80$ and $BW/f_0=0.06$ which occurs at $S=4.8$, following to the two-circuit curve for $C=1.25$ we arrive at $U=8.8$, coming down to the two-circuit curve for $C=1.0$ and across to the six-circuit curve along $S=4.2$, the attenuation is $U=700$. Applying the radio-frequency attenuation of 1.35, the over-all attenuation 60 kilocycles from resonance will be (1.35) (700) or 950.

GENERAL OBSERVATIONS

Several pertinent observations¹ on the character of these curves will aid in their use. By differentiating (4) with respect to S and solving for zero slope, the minimum points are found to occur at

$$S_1 = \pm \sqrt{C^2 - 1} \quad (10)$$

$$U_1 = 2C/(C^2 + 1). \quad (11)$$

It will be observed that, on a log-log plot, all the curves for two circuits approach asymptotically a line of the same slope. By taking the limit of (4) as S becomes large, it can be seen that this is a line of slope 2/1 on the chart. Similarly, for any number of circuits N the asymptotic line has a slope N regardless of Q or coupling. This is obviously also true if the curves are plotted against frequency deviation from resonance on a log-log scale. The general outline of any selectivity curve is, therefore, a line of slope N intersecting the line $U=1$ at some value of S . By solving the equation for the asymptotic line (two circuits) for S at $U=1$, the intercept is found to be

$$S_0 = \pm \sqrt{C^2 + 1}. \quad (12)$$

At this value of S the actual attenuation on the curve will be

$$U_0 = 2/S_0. \quad (13)$$

The actual curve intersects $U=1$ at a value of S

$$S_0' = \pm \sqrt{2} S_1. \quad (14)$$

In those cases in which the selectivity curve approaches its asymptote from the outside, it crosses to the inside of the asymptote in the lower part of the curve; this intersection with the asymptote occurs at

$$S_a = \pm S_0^2/S_0' \quad (15)$$

$$U_a = S_a/S_0'. \quad (16)$$

All asymptotes, regardless of slope N , pass through $U=1$ at the same point $S=S_0$, for a given coupling.

We have been considering, up to this point, designs in which the coupled pairs of circuits could be represented by equivalent identical coupled pairs. Although this is usually quite practicable, and in fact usually desirable so that intermediate-frequency transformers are alike, there may be occasions in which it is desired to make succeeding transformers appreciably different. In such cases it is necessary to calculate the characteristic against frequency of each transformer or identical group of transformers and combine the curves so obtained by taking the product of attenuations, in order to obtain an accurate characteristic. It is possible, however, to approximate the over-all characteristic in one operation. The asymptote to any pair of coupled circuits from (4) will be

$$U = (S/S_0)^2. \quad (17)$$

It is apparent that for N circuits cascaded the over-all or product attenuation will be

$$U = (S/S_{0m})^N \quad (18)$$

along the asymptote, where S_{0m} is the geometric mean of all the values of S_0 for the individual pairs of circuits.

Taking logarithms of each side of this equation it can be seen that the plot on log-log paper will be a line of slope N starting from S_{0m} at $U=1$. All factors or products of S or S_{0m} cause a lateral shift in the curve (Fig. 3)

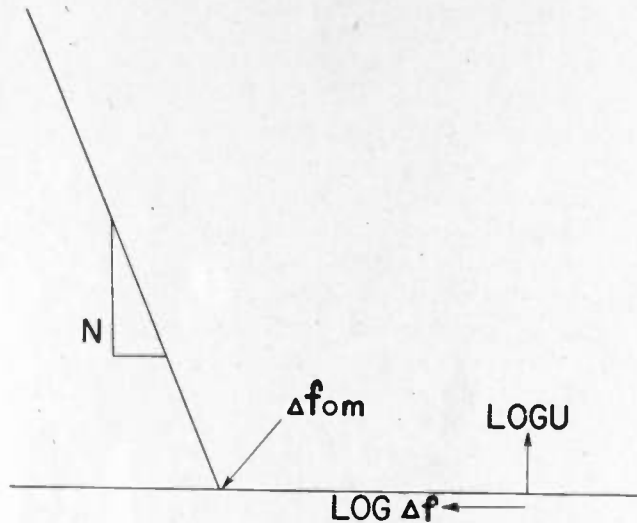

Fig. 3—Approximate boundary of selectivity curve for N circuits.

and can be absorbed in the mean value of S_{0m} . This means that (18) expresses the asymptote for N circuits regardless of how they are coupled or of what Q they have. This may include single circuits if we think of S_0 as unity for a single circuit (zero coupling). Since each value of S_0 is proportional to the product of frequency deviation from resonance (Δf) and Q , the mean S_{0m} is proportional to the product of a mean deviation (Δf_{0m}) and a mean Q_m . Therefore when a plot of attenuation against frequency deviation is made on log-log paper the asymptote will start from Δf_{0m} and have a slope N (Fig. 3), where

$$\Delta f_{0m} = S_{0m} f_0 / 2Q_m \quad (19)$$

$$Q_m = \sqrt[N]{Q_1 Q_2 Q_3 \cdots Q_N} \quad (20)$$

$$S_{0m} = \sqrt[N]{S_{01} S_{02} S_{03} \cdots S_{0N}} \quad (21)$$

with the following interpretation. For a single circuit Q_n is the Q of the n^{th} circuit; for a coupled pair of circuits ($n, n+1$) the product $Q_n Q_{n+1}$ is the square of the Q in (8). For a single circuit S_{0n} is unity; for a coupled pair of circuits ($n, n+1$) the product $S_{0n} S_{0(n+1)}$

is $1+C^2$, as in (7). To obtain a closer approximation to the over-all curve an equivalent mean coupling from the value of S_{0m} may be used. This remains, however, an approximation which is particularly likely to be inaccurate where there is considerable curvature since the cascading of different characteristics will not necessarily give us an over-all shape identical with any power of a curve for a coupled pair. In such cases the use of the shape factor chart needs to be seasoned with good judgment since the curve shape at 6 decibels attenuation may depart appreciably from that used to develop the shape-factor chart.

It should be noted that nowhere has the impedance or the tuning capacity of the circuits entered into the discussion. This occurs because we have been limited to a discussion of selectivity which is a ratio of gains so that impedances cancel out in this ratio. Selectivity, furthermore, is a function of Q which includes the effects of all losses whether in coil, capacitor, or circuit and which is a ratio of kilovolts-amperes to kilowatts so that tuning capacity has no direct bearing on the characteristic except through this Q ratio. As long as Q is 10 or more, all losses may be lumped into an equivalent constant Q in this manner with negligible errors. The preceding definition of Q is somewhat more general than reactance-to-resistance ratio.

CONCLUSION

A general inspection of the chart will reveal some conclusions of interest. In most applications the shape factor will fall between $2\frac{1}{2}$ and 5. Further improvement in shape factor becomes increasingly more difficult of attainment as the number of circuits used increases. Beyond eight or ten circuits, improvement in shape factor is very expensive in terms of circuits required. Increasing coupling to more than 25 per cent over critical is not very effective in improving shape factor. Shape factors using a permissible amount of over-coupling attain a figure approximately half that obtained by cascading the same number of circuits singly ($C=0$). Overcoupling of an amount in the region of 125 per cent critical is usually quite acceptable; a pair of circuits coupled at $C=1.25$ will produce a response curve with 2.5 per cent rise at the double peaks ($U=0.975$).

Use of Frequency-Conversion Diagrams*

HARRY STOCKMAN†, MEMBER, I.R.E.

Summary—The mathematical difficulties involved in analytical treatment of single-mesh mixer circuits with diodes and crystals lead us to consider other methods for the determination of important mixer characteristics. This paper briefly reviews the rectification-diagram method as applied to large-signal detectors, and presents for consideration the Chaffee conversion-diagram method, which treats mixer circuits in the same way as large-signal detector circuits. To demonstrate this method, the rectification diagram for a large-signal detector is used to illustrate conditions when two voltages of different frequencies are applied to the nonlinear element; and it is shown how this rectification diagram may be given a more suitable form, describing the frequency-conversion properties of the nonlinear element. The path of operation in this new so-called frequency-conversion diagram yields numerical values for the output (intermediate-frequency) voltage and current. The equations for the diagram are given as well, and may be used for calculations pertaining to the modulation envelope of the produced intermediate-frequency wave. The measurement setup used to investigate the possibilities of the conversion-diagram method is briefly described, and the frequency-conversion diagrams obtained for ultra-high-frequency diodes and crystals are reproduced in the text. Some of the quantities that can be read off from frequency-conversion diagrams are illustrated by graphs and are discussed further in the paper.

INTRODUCTION

IN THE well-known rectification-diagram method¹ the rectification diagram is merely a model that describes the nonlinear element by relating the input voltage, output voltage, and output current to each other by three detection coefficients. The numerical values of these coefficients are inherent in the slopes, spacings, and scales of the diagram. For a particular resistive load, represented in the diagram by its load line, numerical values for the output quantities are directly obtainable from the projections on the axes; see Fig. 1. In particular cases the results are obtained with advantage by calculation, i.e., by solving the equation relating the three coefficients of the diagram to the three parameters of the practical circuit; input voltage $|E_{\omega_m}|$, output voltage \bar{E} , and output current I . The equation for the output variational current dI may be obtained as the total differential for the output direct current, the partial derivatives constituting the detection coefficients. Another derivation, graphical in its character, has recently been given in literature.² Perhaps the most simple method from the radio engineer's point of view is to associate the rectification diagram with the plate-current—plate-voltage diagram for a triode, the equivalent-plate-circuit equation yielding the required mathematical relation. This leads to the following definitions of the detection coefficients, expressed in variational in-

put voltage $d|E_{\omega_m}|$, variational output voltage $d\bar{E}$, and variational output current dI :

$$g_d = dI/d|E_{\omega_m}|_{\bar{E}} = \text{detection transconductance} \quad (1)$$

$$1/r_d = dI/d\bar{E}|_{|E_{\omega_m}|} = \text{detection conductance} \quad (2)$$

$$\begin{aligned} r_d &= \text{detection resistance,} \\ \mu_d &= g_d r_d = -(d\bar{E}/d|E_{\omega_m}|) | I \\ &= \text{detection amplification factor.} \end{aligned} \quad (3)$$

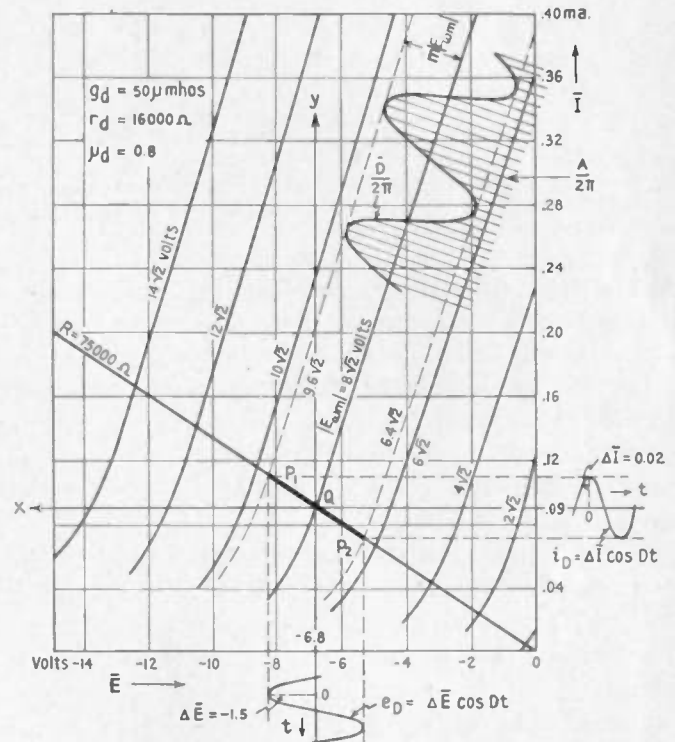

Fig. 1—Rectification diagram for large-signal detector with the Q -point values for the detection coefficients g_d , r_d , and μ_d , defined in text. E_{ω_m} is the input-voltage component across the diode, $\Delta\bar{E}$ the variational output voltage, and ΔI at the variational output current.

With reference to the large-signal detector circuit in Fig. 2, $d\bar{E}$ and dI are the output quantities and $d|E_{\omega_m}|$

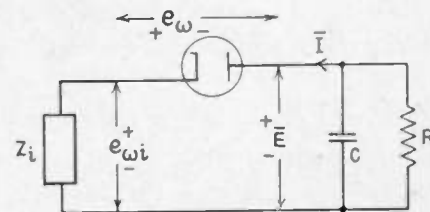

Fig. 2—Conventional large-signal detector circuit with the rectification-diagram parameters input voltage e_{ω_i} , output voltage \bar{E} , and output current I . The input-voltage component across the nonlinear element is e_{ω} .

the amplitude variation of the absolute high-frequency voltage developed across the nonlinear element.³ Subscript i indicates input, $E_{\omega_{im}}$ being the complex amplitude of the modulated input high-frequency voltage.

³ The position of the diode in Figs. 2 and 3, with the cathode turned towards the input terminal, does not necessarily indicate the connection in the physical circuit which is conventionally the reverse.

* Decimal classification: R149. Original manuscript received by the Institute, July 5, 1944; revised manuscript received, September 1, 1944.

† Cruft Laboratory, Harvard University, Cambridge 38, Mass.

¹ E. L. Chaffee, "Theory of Thermionic Vacuum Tubes," McGraw-Hill Book Company, New York 18, N. Y., 1933, p. 565.

² H. Stockman, "A treatment of non-linear devices based upon the theory of related linear functions," *Jour. Appl. Phys.*, vol. 14, pp. 645-658, December, 1943.

In the case of a frequency converter, a local-oscillator voltage e_B is injected in series with a signal voltage e_A , and the high-frequency amplitude across the nonlinear element is then the sum pattern⁴ $e_{AB} = e_A + e_B$ (neglecting circuit impedances and components of A and B frequency produced in the mixer circuit). The frequency-conversion circuit is shown in its simplest form in Fig. 3. If e_A is assumed to be unmodulated, the

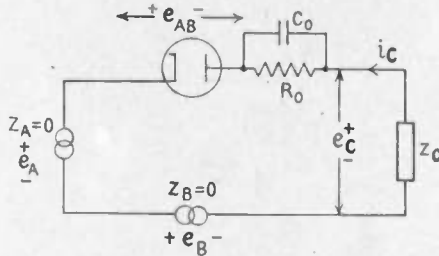

Fig. 3—Single-mesh frequency-converter circuit with the conversion-diagram parameters input voltage e_A , oscillator voltage e_B , output voltage e_C , and output current i_C .

sum-pattern voltage will show up in the rectification diagram as a half envelope of difference frequency $(A - B)/2\pi$ or $C/2\pi$. This half envelope thus corresponds to the half envelope $D/2\pi$ due to tone modulation in the large-signal detector rectification diagram, Fig. 1. These conditions will be discussed further, where the treatment is extended to cover the case of the signal wave e_A being tone-modulated.

As the following discussion intends mainly to show the principle of this diagram technique, certain assumptions will be made to simplify the presentation. To facilitate the discussion further, numerical values will be used extensively, so that particular points referred to in the diagrams can be easily located. The numerical values used in the first part of the paper are mainly illustrative and may differ somewhat from values obtained in practice.

THE RECTIFICATION-DIAGRAM METHOD

The rectification diagram in Fig. 1 is obtained in the conventional way from the large-signal detector circuit in Fig. 2. As most large-signal detectors employ diodes and not crystals, the diagram technique will be described mainly with reference to a diode as a nonlinear element. Assume

$$e_{\omega} = e_{\omega i} = |E_{\omega m}| (1 + m \cos Dt) \cos \omega t, \quad (4)$$

where D is the angular velocity of the modulation and ω the angular velocity of the carrier. The values $|E_{\omega m}| = 8\sqrt{2}$ volts, $m = 0.2$, and $R = 75,000$ ohms, are convenient for illustration of the geometrical construction in the diagram, R being low enough to be practicable as well for the following discussion of frequency conversion. The shunt capacitance C is assumed large enough to prevent appreciable high-frequency voltage drop across the load, but small enough to prevent appreciable shunting of R for the highest modulation frequencies employed.

⁴ H. Stockman, "Superheterodyne converter terminology," *Electronics*, vol. 161, pp. 144-331; November 1943.

The carrier amplitude determines the point of operation Q and traces out the projections 0.09 milliamper and -6.8 volts. The end points P_1 and P_2 of the path of operation are located at $8\sqrt{2}(1 \pm 0.2)$ and trace out the output amplitudes $\Delta I = 0.02$ milliamper and $\Delta \bar{E} = -1.5$ volts. Thus $i_D = 0.02 \cos Dt$ and $e_D = -1.5 \cos Dt$. The signs depend upon which way one prefers to call the variables positive.

For an analytical determination of i_D and e_D , the detection coefficients must be known. They are obtained in the same way as transconductance, plate resistance, and amplification factor for a triode are determined from the plate-current—plate-voltage characteristic for the triode. Thus to find r_d , we may take the ratio between $\Delta \bar{E} = 6.8 - 4$ volts and $\Delta I = (0.265 - 0.090) \times 10^{-3}$ ampere, which is $2.8/0.175 \times 10^{-3}$ or 16,000 ohms. The values for the remaining two coefficients are similarly found to be $g_d = 50$ micromhos and $\mu_d = 0.8$. From the analogy with triode theory, and with proper notation,

$$\Delta \bar{I} = \mu_d m |E_{\omega m}| / (r_d + R) \quad (5)$$

which with given numerical values yields $\Delta I = 0.02$ milliamper and $\Delta \bar{E} = -R \Delta I = -1.5$ volts, the same values as were obtained from projections in the diagram. Equation (5) may be read off as the equivalent circuit in Fig. 4(a), and, after a simple substitution, as the equivalent circuit in Fig. 4(b), both circuits being practical aids in conventional large-signal detector calculation.

THE CONVERSION-DIAGRAM METHOD

Assume in the converter circuit of Fig. 3 that all impedances except the nonlinear-element impedance have zero value for the frequencies $A/2\pi$ and $B/2\pi$. The load is assumed resistive around the frequency $C/2\pi = (A - B)/2\pi$ and of value $Z_C = 75,000$ ohms, but is considered to have zero value for all frequencies considerably higher or lower than $C/2\pi$. The bias arrangement $R_0 C_0$ shown at the right of the diode provides desirable "class B" or "class C" operation.

The rectification diagram in Fig. 1 is now assumed to be valid as well for the case of two applied voltages having the complex amplitudes E_{Am} and E_{Bm} and the instantaneous values

$$e_A = |E_{Am}| \cos At \quad (6)$$

$$e_B = |E_{Bm}| \cos Bt. \quad (7)$$

The values $|E_{Am}| = 0$ and $|E_{Bm}| = 8\sqrt{2}$ set the same operating point Q that was previously obtained for the large-signal detector. With $|E_{Am}| = 1.6\sqrt{2}$, however, and $|E_{Bm}| = 8\sqrt{2}$, there will be a difference-frequency amplitude variation between the limits $8\sqrt{2}(1 \pm 0.2)$, the frequency of the envelope pulsation being $(A - B)/2\pi$ or $C/2\pi$. The difference or intermediate-frequency current is of the general form

$$i_C = |I_{Cm}| \cos (Ct + \phi) \quad (8)$$

with $|I_{Cm}| = 0.02$ milliamper and $|Z_C I_{Cm}| = |-E_{Cm}| = 1.5$ volts. The geometrical construction for the large-signal detector now applies in principle to the frequency

converter as well, although in an actual plot the difference-frequency half envelope in the latter case is likely to be somewhat less sinusoidal than the demonstrated signal half envelope.

The three coefficients for the nonlinear element may be defined as follows:

$$g_c = \frac{|I_{Cm}|}{|E_{Am}|} \Big|_{|E_{Cm}|=0} \Big|_{\text{small amplitudes}} = \text{conversion transconductance} \quad (9)$$

$$\frac{1}{r_c} = \frac{|I_{Cm}|}{|E_{Cm}|} \Big|_{|E_{Am}|=0} \Big|_{\text{small amplitudes}} = \text{conversion conductance} \quad (10)$$

$r_c = \text{conversion resistance}$

$$\mu_c = g_c r_c = - \frac{|E_{Cm}|}{|E_{Am}|} \Big|_{|I_{Cm}|=0} \Big|_{\text{small amplitudes}} = \text{conversion amplification factor} \quad (11)$$

The coefficients are read off directly from the diagram as before to $g_c = 50$ micromhos, $r_c = 16,000$ ohms, $\mu_c = 0.8$. Equation (5) with $|E_{Am}|$ as reference quantity now has the form

$$I_{Cm} = \mu_c |E_{Am}| / (r_c + Z_c) \quad (12)$$

and yields the previously obtained result of 0.02 milliampere peak value. The equation provides the equivalent circuits of Fig. 4(c) and 4(d). These circuits constitute models of the nonlinear element and are linear, although the mixer may be operated in class C.

The study of the rectification diagram may be restricted to the region of the axis system yQx in Fig. 1, for convenience lifted out of the rectification diagram and presented separately in Fig. 5. This axis system constitutes the frequency-conversion diagram, or con-

original diagram in Fig. 1, as the desired conversion diagram is obtained directly from measurements.

It is now of interest to consider an amplitude-modulated input wave such as

$$e_A = |E_{Am}| (1 + m \cos Dt) \cos At \quad (13)$$

where $|E_{Am}|$ is the carrier amplitude. If the degree of modulation m is given the arbitrary value 30 per cent,

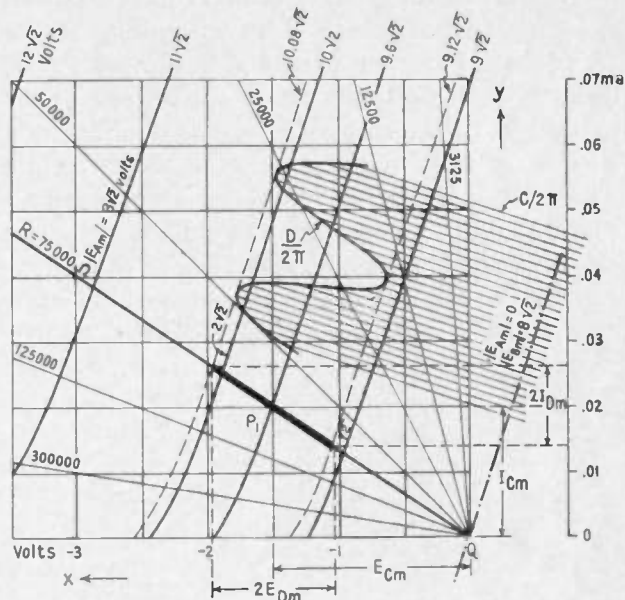

Fig. 5—Conversion diagram for frequency converter showing the signal half envelope of the output intermediate-frequency wave. E_{Am} is the input voltage, E_{Dm} the oscillator voltage, E_{Cm} the output voltage, and I_{Cm} the output current.

the limits for the excursions of the tone half envelope are $(9.6\sqrt{2} \pm 0.3 \times 1.6\sqrt{2})$ or, respectively, $10.08\sqrt{2}$ and $9.12\sqrt{2}$. The projections of the tone half-envelope scale off the current amplitude $|I_{Dm}| \doteq 0.006$ milliampere and the voltage amplitude $|E_{Dm}| \doteq 0.45$ volt, the ratio being $1/Z_c$. Further, under assumed conditions, the modulation percentage in the intermediate-frequency output equals the assumed modulation percentage of the input signal wave. If rectification is applied to the output wave

$$i_c = |I_{Cm}| (1 + m \cos Dt) \cos (Ct + \phi) \quad (14)$$

it follows that the tone-modulation component D will be made available for further amplification. In a superheterodyne receiver this rectification is provided in the receiver detector (formerly known as the "second detector").

MEASUREMENT EQUIPMENT

To facilitate experimental work by engineers interested in this method, the arrangement of the measurement setup used will be discussed briefly. Fig. 6 shows a simple mixer circuit, fed from the signal source A and the local oscillator source B . Both sources are unmodulated. The generator A must have a good attenuator but the required output voltage is small, generally less than 0.01 or 0.1 volt root-mean-square. Generator B is not required to have a good attenuator, but should deliver 5 or 10 volts root-mean-square as a minimum. This requirement is a severe one, for this generator, as well

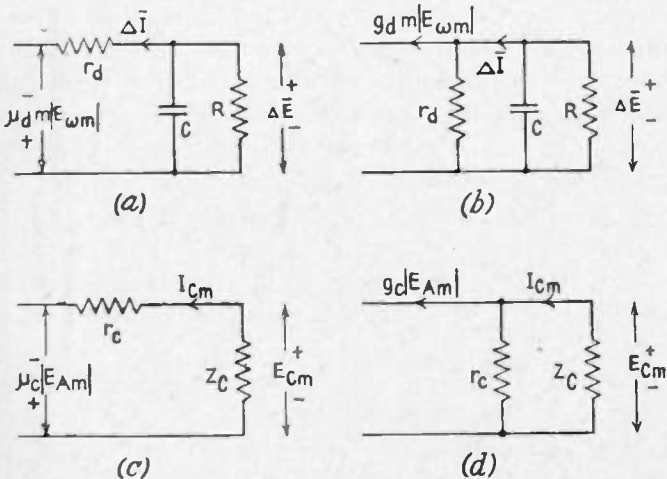

Fig. 4—Equivalent circuits of series and parallel form for large-signal detector (a) and (b), and for frequency converter (c) and (d). The parallel combination resistance-capacitance RC , respectively Z_c , are load impedances, ΔE respectively E_{Cm} variational output voltages, and ΔI respectively I_{Cm} variational output currents. The circuit electromotive forces are functions of the input voltage components across the nonlinear elements $E_{\omega m}$ respectively E_{Am} .

version diagram for short. (Some $|E_{Am}|$ characteristics have been added during the transformation from Fig. 1 to Fig. 5.) In practice we are not concerned with the

parameters, such as $|E_B|$, are of equal interest. It is instructive to combine a set of conversion diagrams into a space model and then to slice this model with horizontal, vertical, and radial planes. In this way a number of so-called "contours" are obtained, which are very helpful in practical design work, and for educational purposes. Even if squared and multiplied by constants, these curves may still be referred to as contours. Fig. 8

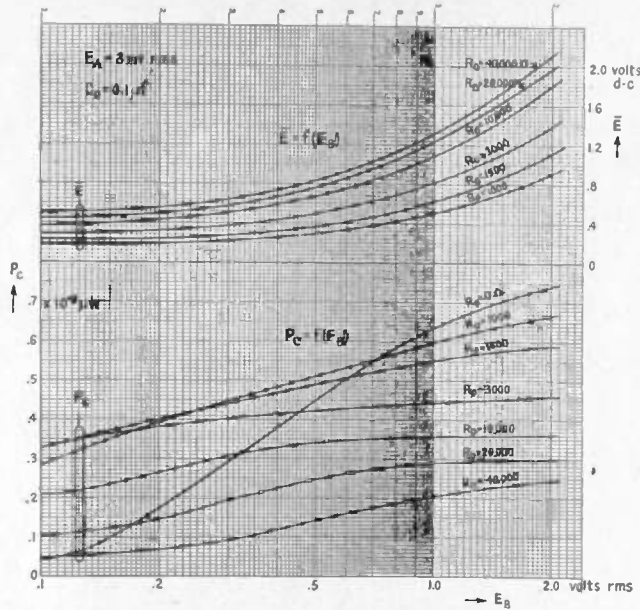

Fig. 8—Example of useful contours plotted from a set of diode conversion diagrams. The output power P_C is shown as function of the oscillator voltage E_B for different values of the bias resistance R_0 . At top curves for the developed direct-current bias E with the input voltage E_A as parameter.

shows the useful contours $P_C = f(|E_B|)$ with R_0 as parameter. This graph reveals that under assumed conditions, for large oscillator amplitude, no increase in output power is possible by means of self-bias. However, if for one reason or another large oscillator voltage cannot be obtained, it is well to insert a by-passed biasing resistor, as the output power may be increased as much as ten times. The chart further reveals that for each value of oscillator amplitude there is an optimum value of R_0 . For $E_B = 0.2$ volt root-mean-square this optimum value is of the order of 1500 ohms. Very large R_0 values are as harmful as zero R_0 value. There is virtually no end to the number of contours that can be plotted from sets of conversion diagrams, and the designer must be guided in his choice by the order of importance of the required data.

Figs. 9 and 10 show measurement results obtained with a silicon-tungsten (cartridge-type) crystal rectifier as nonlinear element in the frequency-conversion circuit. This crystal was chosen among several as having the same order of sensitivity and impedance as the diode. Especially at higher frequencies, this crystal was more sensitive than the diode, and more stable as long as protected from mechanical shocks and overloading currents. As the crystal differs from the diode in many respects, for example, by its two-way conductivity, it is

to be expected that it requires different circuit adjustments. Thus a simple biasing arrangement, such as R_0C_0 in case of the diode, does not generally give increased output power.

The four crystal conversion diagrams in Fig. 9 are selected from a series of six and have the $|E_B|$ values of 0.5, 1.0, 1.5, and 2.5 volts root-mean-square. The areas inside the $3.2\sqrt{I}$ characteristics are predominantly determined by two factors; 1, the dependence of the rectification action upon the oscillator voltage; and 2, the matching conditions. The rectification action, hampered by reversed conductivity, is better at 1 volt than at 0.5, and 1.5 volts, so the area is maximum in the second conversion diagram, Fig. 9. The matching conditions create a gradual displacement of area; in direction to the left when reduced oscillator voltage provides a higher r_c value, in direction to the right when increased oscillator voltage provides a lower r_c value. (Examples: $r_c = R = 540$ ohms for $|E_B| = 0.5$ volt, $r_c = R = 150$ ohms for $|E_B| = 2.5$ volts.) These two factors account for the particular shapes of the diagrams.

In the four conversion diagrams intermediate-frequency power P_C as function of R for $|E_A| = 2.0$ millivolts is indicated by means of the dotted contours (P_C)_{2mv}. The fact that an optional $|E_B|$ value exists for a given R value is better brought out in Fig. 10, plotted directly from the sequence of conversion diagrams. For a given R value, such as 680 ohms, the diagram reveals that a quite carefully adjusted oscillator voltage of 0.70 volt root-mean-square is required for maximum output power. The crystal differs from the diode in this respect, as for the latter the oscillator voltage can be increased considerably above the minimum usable value without any appreciable change in output power, as is to some extent indicated by the curves in Fig. 8.

Each R curve or contour in Fig. 10 indicates a maximum value P_{Cmax} , but the $R = 300$ ohms curve extends above all the others, and as 300 ohms happens to be very close to the optimum R value, this particular maximum is denoted $P_{Cmax-max}$. It occurs at $|E_B|_{opt} = 0.95$ volt. A more exact value on R_{opt} can be obtained if the diagram is plotted with R as abscissa and $|E_B|$ as parameter, and in this way we find $R_{opt} = 280$ ohms. In practical converter design these diagrams $P_C = f(|E_B|)$, respectively, $P_C = f'(R)$ make possible accurate determination of $|E_B|_{opt}$ and R_{opt} , although $|E_B|$ is an unknown function of R and vice versa.

$r_{c match}$ as plotted against $|E_B|$ in Fig. 10 shows the rapid increase in r_c when the oscillator voltage is reduced and matching conditions are maintained, $r_{c match} = R$.

Only a few more diagrams out of the possible collection will be mentioned; conversion transconductance g_c , dynamic conversion transconductance (g_c)_{dyn}, and variational conversion transconductance g'_c , plotted against $|E_B|$. While g_c curves are useful for high-impedance mixers, where they directly give the conversion voltage amplification

$$V.A. = g_c R \quad (19)$$

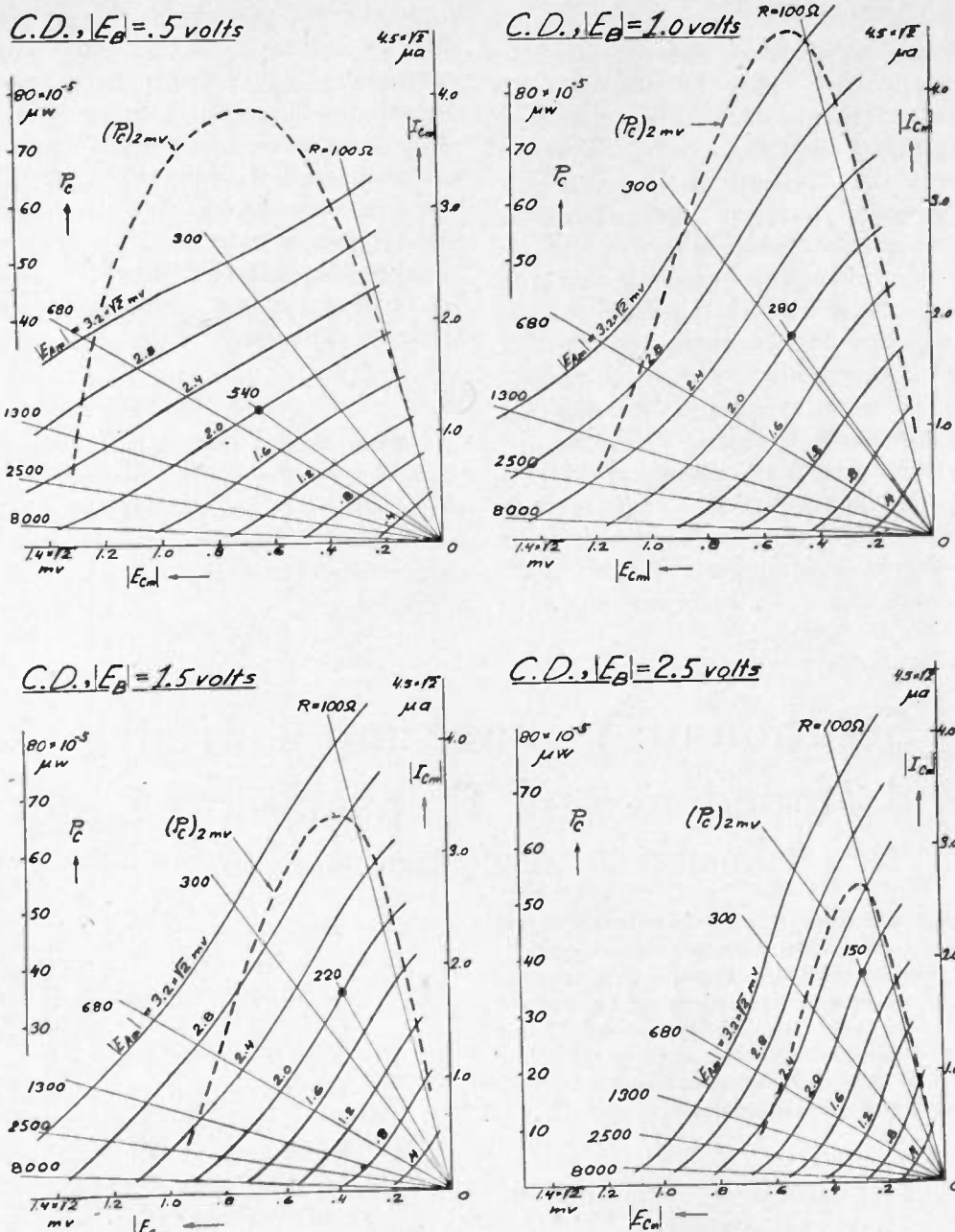

Fig. 9—Four conversion diagrams taken from a set of six, illustrating the frequency-conversion properties of a silicon-tungsten crystal rectifier.

they are not practicable for low-impedance mixers, where the relation has the form

$$V.A. = g_c R / (1 + (R/r_c)) = (g_c)_{\text{dyn}} R. \quad (20)$$

Thus we prefer to plot the dynamic conversion transconductance, which directly gives output voltage, output power, voltage amplification, etc. Variational transconductance curves are practical for estimation of the output voltage and power resulting from tone modulation of the signal wave. Conversion and variational conversion coefficients, inserted in (12) and (15) representing simple equivalent circuits of the type shown in Fig. 4, provide a valuable aid in large-signal detector and converter treatment. Current, voltage, and power values obtained from such calculations are surprisingly accurate.

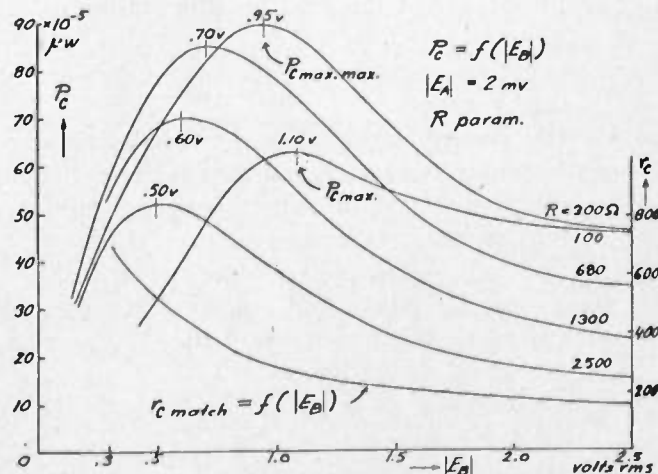

Fig. 10—Contours illustrating the existence of an optimum oscillator voltage E_{Bm} for crystal mixers. The variation of the optimum intermediate-frequency input impedance Z_c with E_{Bm} is also illustrated. E_A is the input voltage and P_C the output power.

CONCLUSION

It has been shown that nonlinear elements, used in frequency-conversion circuits, may be described by conversion diagrams, obtained from practical measurements. Characteristics, not directly given by conversion diagrams, may be obtained in form of contours, read off from sets of conversion diagrams. The information made available in this nonmathematical way refers to the nonlinear element plus intermediate-frequency load and not to the frequency-conversion circuit with all its additional design problems. This method, therefore, is especially suitable for determination of mixer characteristics when it comes to a comparison of different samples or types of nonlinear elements, for example, different types of ultra-high-frequency diodes and crystals. Full knowledge of the characteristics of the circuit in which the measured nonlinear element is to be used is required for successful practical application. It is largely a question of experience to predict the behavior of non-

linear element plus circuit. Many problems enter this phase of the work, as high-input impedances may be unavoidable. These impedances provide voltage drops not only for the applied currents, but also for newly developed currents, produced when output components mix nonlinearly with input components. Complications also arise from the fact that the design cannot be made without proper attention to requirements set by the signal-to-noise ratio and other characteristics, which are not of direct interest in the investigation of the nonlinear element itself.

ACKNOWLEDGMENT

The frequency-conversion diagram was first developed by E. L. Chaffee, Director of Cruft Laboratory. The writer wishes to acknowledge his indebtedness to Professor Chaffee for the use of his idea and for valuable suggestions concerning the method and its practical applications.

Graphical Solution of Voltage and Current Distribution and Impedance of Transmission Lines*

ROBERT C. PAINE†, NONMEMBER, I.R.E.

Summary—On a radio transmission line with reflected waves, geometric construction is used to determine the voltage, current, and impedance at any required point for a known load of resistive or complex impedance. Unknown loads are determined by observation of standing waves and the use of geometric constructions. Charts are shown for the direct determination of voltage, current, and impedance vectors at all points on radio transmission lines for any load condition, for use in solving transmission problems.

SYMBOLS are as follows:

Z_0 = characteristic impedance of a transmission line, assumed to be resistive only.

$Z = R \pm jX$ = impedance of the line at any point.
 $z = Z/Z_0 = r \pm jx$.

Z_L = impedance of the load by which a line is terminated.

E_I, I_I = effective voltage and current of incident or direct wave.

E_R, I_R = effective voltage and current of reflected wave.

E, I = resultant voltage and current of the initial and reflected waves, the effective voltage and current as measured at any point on the line.

E_L, I_L = resultant voltage and current at the load.

$E_{\max}, E_{\min}, I_{\max}, I_{\min}$ = resultant voltage and current at antinodes and nodes where they are at maximum and minimum values.

K = vector value of reflection coefficient = E_R/E_I ;
 $I_R/I_I = -K$.

* Decimal classification: R116. Original manuscript received by the Institute, January 27, 1944; revised manuscript received, July 17, 1944.

† 436 Cornelia St., Boonton, New Jersey.

$|K|$ = absolute value of K .

2θ = angle of reflection coefficient K .

Q = standing-wave ratio = E_{\max}/E_{\min} , or I_{\max}/I_{\min} ,
= $(1 + |K|)/(1 - |K|)$.

Δ = angular wavelength distance from load end of line to first voltage node.

ψ = vector angle of impedance Z of line at any point.

α = vector angle of voltage E referred to E_L for a resistance load, or to the voltage at the virtual load for complex loads.

β = vector angle of current I referred to I_L for a resistance load, or to the current at the virtual load for complex loads.

ϕ = distance in degrees of wavelength from the load end of the line for a resistance load or from the virtual load for complex loads.

INTRODUCTION

STANDING waves on a transmission line can be analyzed effectively by the use of vector diagrams in which the incident or direct wave is combined with the reflected wave to find the resultant voltage or current at any required point on the line. This resultant is the effective voltage or current as measured by conventional means at the required point on the line when a steady state is maintained.

¹ The virtual load is an imaginary resistance load (of greater value than the characteristic impedance of the line) at such position on the line or an imaginary extension of the line as to produce the same distribution of voltage and current along the line as the given load produces.

To simplify the problem the characteristic impedance of the line is assumed to be pure resistance and the attenuation to be negligibly low. These assumptions do not in general result in serious errors for ordinary radio transmission lines. The voltage and current is first considered at the load terminals or receiving end of the line and then at other points progressing toward the sending end. Distance is measured from the load in degrees of wavelength at a given frequency, a complete cycle of 360 degrees being equal to 1 wavelength.

It is well known that the ratio of the reflected voltage to the incident or direct voltage equals the reflection coefficient, $E_R/E_I = K = (Z_L - Z_0)/(Z_L + Z_0)$, and the ratio for current, $I_R/I_I = (Z_0 - Z_L)/(Z_0 + Z_L)$. For a pure resistance load, these values indicate that a load impedance greater than the characteristic impedance results in a reflected voltage in phase with the incident voltage at the load; thus the resultant voltage is at a maximum at the load. Under the same conditions the reflected current is 180 degrees out of phase with the incident current and the resultant current is at a minimum at the load. If the load impedance (resistive) is less than the line impedance, the opposite effect exists and the voltage at the load is at a minimum while the current is at a maximum. The ratio of the voltage (or current) at a point of maximum or antinode to the voltage (or current) at a minimum point or node has been designated Q as shown above.

LINE VOLTAGES AND CURRENTS

To find the effective resultant voltage and current at any point on a line graphically a vector diagram can be used. Fig. 1 represents a line with a pure resistance load Z_L , which in this example is greater than the line impedance Z_0 . The voltage at the load E_L is at a maximum in this case and is the sum of the incident voltage E_I and the reflected voltage E_R , as determined by the reflection coefficient. This is represented in Fig. 2 by the

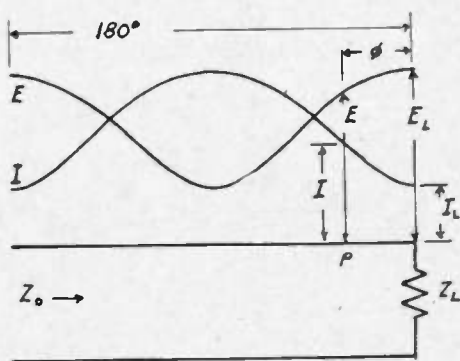

Fig. 1—The distribution of voltage and current for one half of a wavelength on a line terminated by a resistance load of value greater than the characteristic impedance of the line.

vector OE_L , sum of the vectors OE_I and OE_R . At the point p , a given distance from the load ϕ , the vector OE_I has rotated to a new position OE_I' through the angle ϕ ; in a counterclockwise direction, since the incident voltage at the load lags the incident voltage at any point nearer the source of power. At p , the vector

OE_R has rotated through an equal angle to a new position OE_R' , in clockwise direction, since the reflected voltage originates at the load and at that point leads the reflected voltage at any other point on the line. Then the resultant voltage at p is OE , the vector sum of OE_I' and OE_R' .

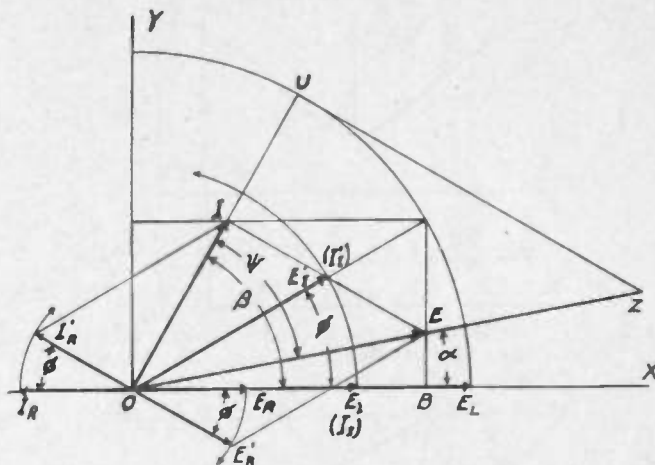

Fig. 2—Graphical solution of the voltage, current, and impedance at a given point p on a transmission line an angular distance of ϕ from a resistance load, corresponding to Fig. 1.

We may let OE_I represent the incident current I_I also, since for a line with a pure resistance characteristic impedance, E_I and I_I are in phase, and Z_0 may be assumed for convenience to have a nominal value of unity. The reflection coefficient for the current is of the same numerical value as for the voltage but of opposite sign, so the reflected current OI_R is equal and opposite to OE_R . The vector sum of OI_I' and OI_R' is OI , the resultant current at the point p . The voltage and current can be found for other points on the line in a similar manner. Fig. 1 shows curves of voltage and current along the line found in this manner for a distance of one-half wavelength.

The impedance Z of the line at any point is equal to the ratio E/I at that point. This value is found graphically for the point p in Fig. 2 by extending OI to meet the unit arc at U and drawing UZ parallel to IE to meet OE extended at Z . This forms two similar triangles, OIE and OUZ , so that, considering absolute values, $OE/OI = OZ/OU$, or $E/I = OZ = \text{impedance } Z$, since OU has been taken as unity. The phase angle of Z is $\alpha/\beta = -\psi$, or Z is capacitive at the given point p .

REFLECTION FOR COMPLEX IMPEDANCE LOADS

The discussion up to this point has concerned pure resistance-load terminations. For such loads the reflection coefficient has an angle of 0 degrees for $+K$ or 180 degrees for $-K$, so that the reflected wave is directly additive to or subtractive from the incident wave at the load and $Q = Z_L/Z_0$. If the load is a complex impedance the reflection coefficient can be found graphically also. To find the reflection coefficient for a line with a capacitive reactance load as shown in Fig. 3, the line OZ_0 is laid out to scale in Fig. 4 to equal the characteristic impedance Z_0 . Then the line Z_0R is drawn equal to the

series resistance component, R , of the load Z_L , and RE_I , equal to the series reactive component X of the load. Then Z_0E_I equals the load impedance, Z_L , and OE_I equals $Z_L + Z_0$ and represents the incident voltage. The line OZ_0' also is drawn equal to the characteristic im-

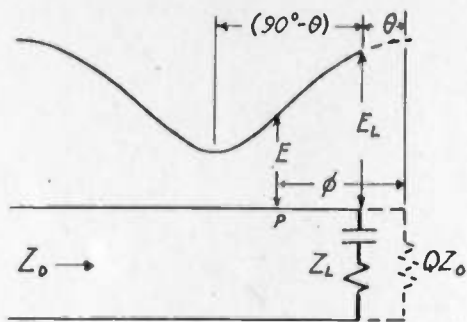

Fig. 3—Voltage distribution for a capacitive load and the virtual resistance load producing the same distribution.

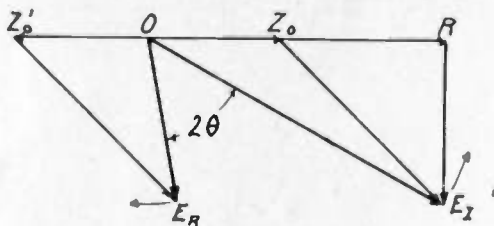

Fig. 4—A graphical solution of the reflection coefficient for a capacitive load on a transmission line corresponding to Fig. 3.

pedance of the line and $Z_0'E_R$ equal and parallel to Z_0E_I . Then $OE_R = Z_L - Z_0$ and represents the reflected voltage. The absolute ratio between these voltages equals the value of the reflection coefficient.

$$|OE_R/OE_I| = |K| \tag{1}$$

The ratio of the angles

$$|\angle ROE_R| / |\angle ROE_I| = 2\theta \tag{2}$$

the angle of reflection. The standing-wave ratio

$$Q = (OE_I + OE_R) / (OE_I - OE_R) \tag{3}$$

in absolute values.

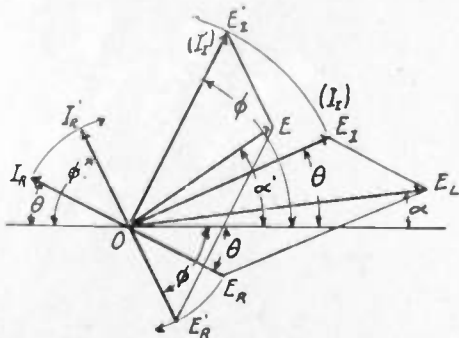

Fig. 5—A graphical method of finding the voltage at any required point on the line after having found the reflection coefficient as in Fig. 4.

To find the voltage or current at a given point on this line Fig. 5 is constructed similar to Fig. 2. The load voltage E_L has been found by adding vectorially the incident and reflected voltages OE_I and OE_R at the load. These have been laid out in their proper ratio and separated by the angle 2θ as found in Fig. 4. The voltage

at the point p , a distance of $(\phi - \theta)$ along the line, is then found by rotating the vectors OE_I and OE_R through the angle $(\phi - \theta)$ to new positions OE_I' and OE_R' and again adding them vectorially to obtain OE . The current vector if required can be found in a similar

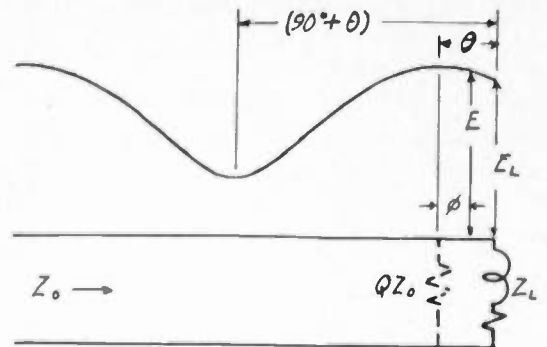

Fig. 6—Voltage distribution for an inductive load and the virtual resistance load producing the same voltage distribution.

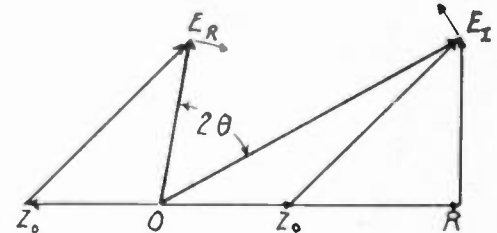

Fig. 7—Graphical solution of the reflection coefficient for an inductive load on a transmission line corresponding to Fig. 6.

manner by adding OI_R and OI_I for the current at the load and OI_R' and OI_I' for the current at the given point. The voltage curve up to the first voltage antinode is shown in Fig. 3. Since the angle of reflection is negative in this case the rotation of the vectors causes a voltage node or minimum to appear nearer the load, before an antinode.

If we imagine the vectors OE_I and OE_R rotated in the reverse direction through θ degrees, they would be in phase and at 0 degrees form a voltage maximum equal to their numerical sum. Then it can be seen that the line described above with a capacitive reactance load is equivalent to a line θ degrees longer with a virtual load

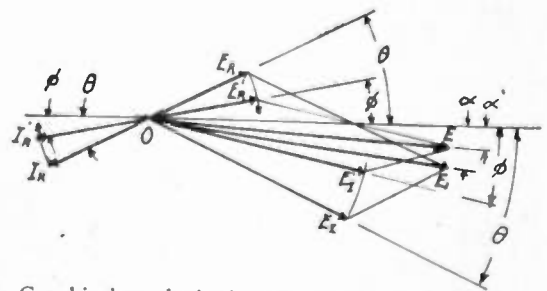

Fig. 8—Graphical method of finding the voltage at any required point on the line after having found the reflection coefficient as in Fig. 7.

of pure resistance of Q times Z_0 , since such a load of QZ_0 would result in the same voltage and current distribution. This virtual load is shown dotted in Fig. 3.

The example of Figs. 3, 4, and 5 has shown a line with a capacitive reactance load; corresponding diagrams are shown in Figs. 6, 7, and 8 for a line with an inductive

reactance load. Here the angle of reflection is positive and the rotation of the vectors OE_I and OE_R cause an antinode of voltage to occur nearer to the load, before the first node. The voltage curve is shown in Fig. 6. Here the line is equivalent to a line θ degrees shorter with a virtual resistance load of Q times Z_0 .

DETERMINATION OF UNKNOWN LOAD GRAPHICALLY

Constructions similar to Figs. 4 and 7 can be used in a reverse manner in the determination of an unknown load by using observations of the value and position of the maximums and minimums of voltage along the line. In Fig. 9 is shown the voltage curve for a line of known

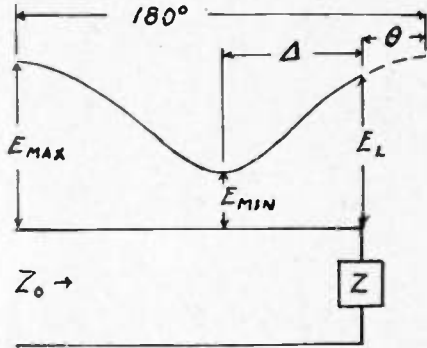

Fig. 9—Voltage distribution on a line terminated by an unknown load, capacitive case.

characteristic impedance (pure resistance) terminated by a load of unknown impedance. In this case the load is seen to be capacitive because a voltage minimum point occurs nearer the load than a maximum, and Δ is less than 90 degrees. The ratio of maximum to minimum voltage is found by measurement, $E_{max}/E_{min} = Q$, and the wavelength from the load to the first minimum is found to be Δ degrees.

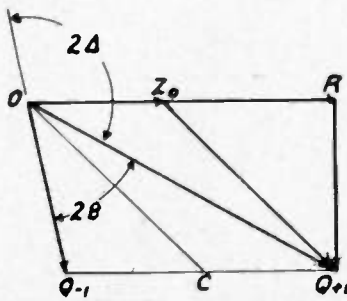

Fig. 10—Graphical solution of the value of unknown load of Fig. 9.

In Fig. 10 the angle $2\theta = 180 \text{ degrees} - 2\Delta$ is laid out with the line OQ_{-1} drawn equal to $Q-1$ and OQ_{+1} drawn equal to $Q+1$. These lines are equivalent to the lines OE_R and OE_I in Fig. 4 and their ratio

$$(Q - 1)/(Q + 1) = |K| \tag{4}$$

The line connecting Q_{-1} and Q_{+1} is bisected at C and the line Z_0Q_{+1} drawn parallel to OC , intersecting at Z_0 , a line OR through O parallel to CQ_{+1} . Then $Z_0Q_{+1}/OZ_0 = Z_L/Z_0$. A perpendicular RQ_{+1} is dropped from Q_{+1} to OR to find the resistive and reactive components of the ratio Z_L/Z_0 . Then the unknown load impedance is

$$Z_L = Z_0(Z_0R/OZ_0 - jRQ_{+1}/OZ_0) \tag{5}$$

Fig. 11 shows the voltage curve for a line terminated by an inductive load, as indicated by the occurrence of a voltage maximum before a minimum. The angle Δ is greater than 90 degrees for this load. The graphic solution is shown in Fig. 12 and is similar to the solution of Fig. 10, but in this case 2θ equals $2\Delta - 180$ degrees.

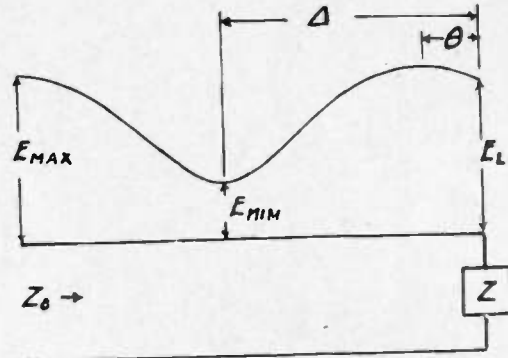

Fig. 11—Voltage distribution on a line terminated by an unknown load, inductive case.

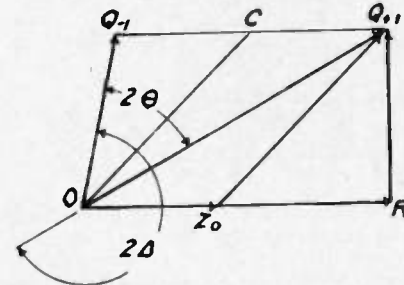

Fig. 12—Graphical solution of the value of unknown load of Fig. 11.

The examples shown here determined unknown loads by observation of voltages. However, using quite similar methods, these determinations can be made from observations of currents along the line, noting that voltage minimum points correspond to current maximums.

IMPEDANCE CHARTS

The vector diagrams described above are very useful for clarifying transmission-line problems and when carefully drawn to a sufficiently large scale, individual problems can be solved by them to any required degree of accuracy. However, for rapid solution of many problems, with a degree of accuracy usually satisfactory, charts are more convenient.

A set of charts for solving line impedance problems is shown in Fig. 13 to 16. These charts can be used to determine input impedance, impedance at any point, or unknown load impedance of a line in terms of its characteristic impedance. They can also be used to find reflection coefficients for various loads and used in the solution of many problems such as matching loads to lines etc. Fig. 13 covers a wide range while Figs. 14, 15, and 16 are enlargements of narrower ranges of this chart for obtaining greater accuracy, within restricted limits.

These charts are based on the fact that the tip of the vector of the impedance at any point on a given line, at

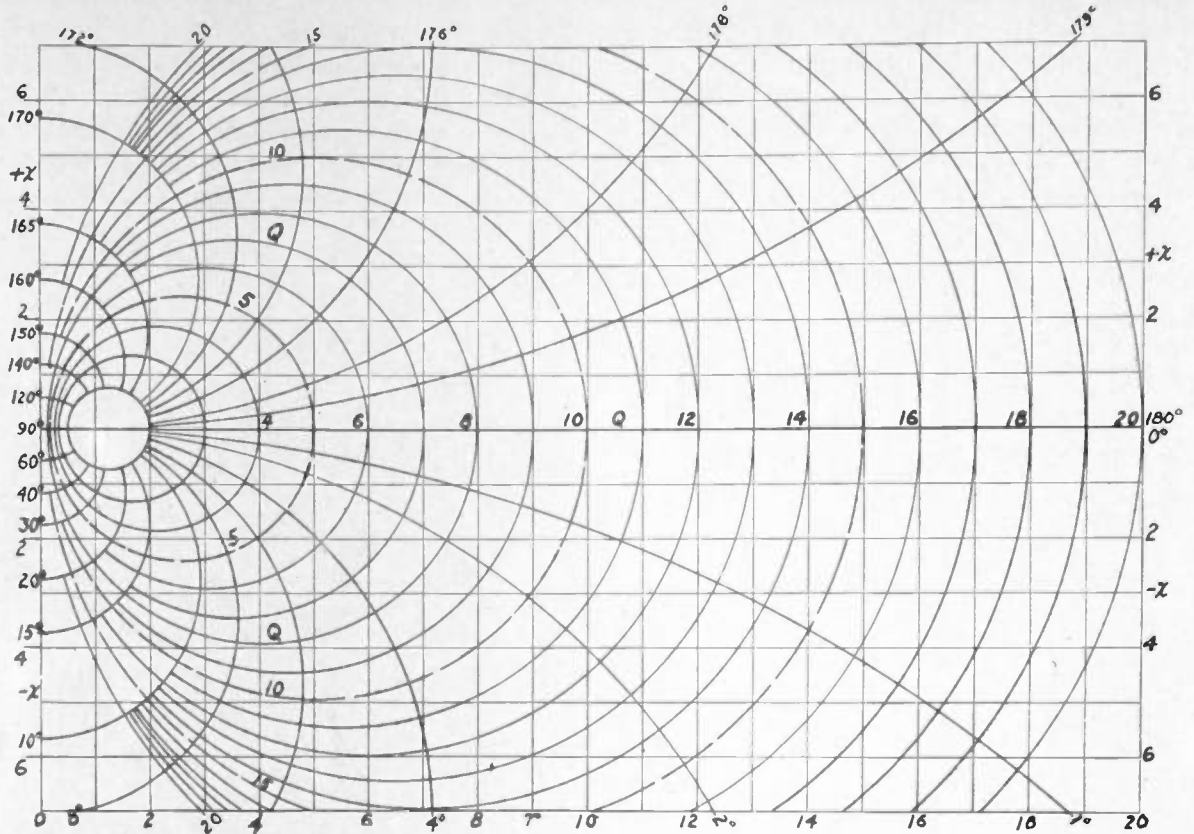

Fig. 13—A chart for finding the impedance of a transmission line at any distance from the load. Each Q circle is for a given standing-wave ratio and is the locus of the tip of the impedance vector, giving the impedance value in rectangular form $r+jx$. The arcs are marked in degrees, representing the angular distance ϕ in wavelength along the line from the load or virtual load.

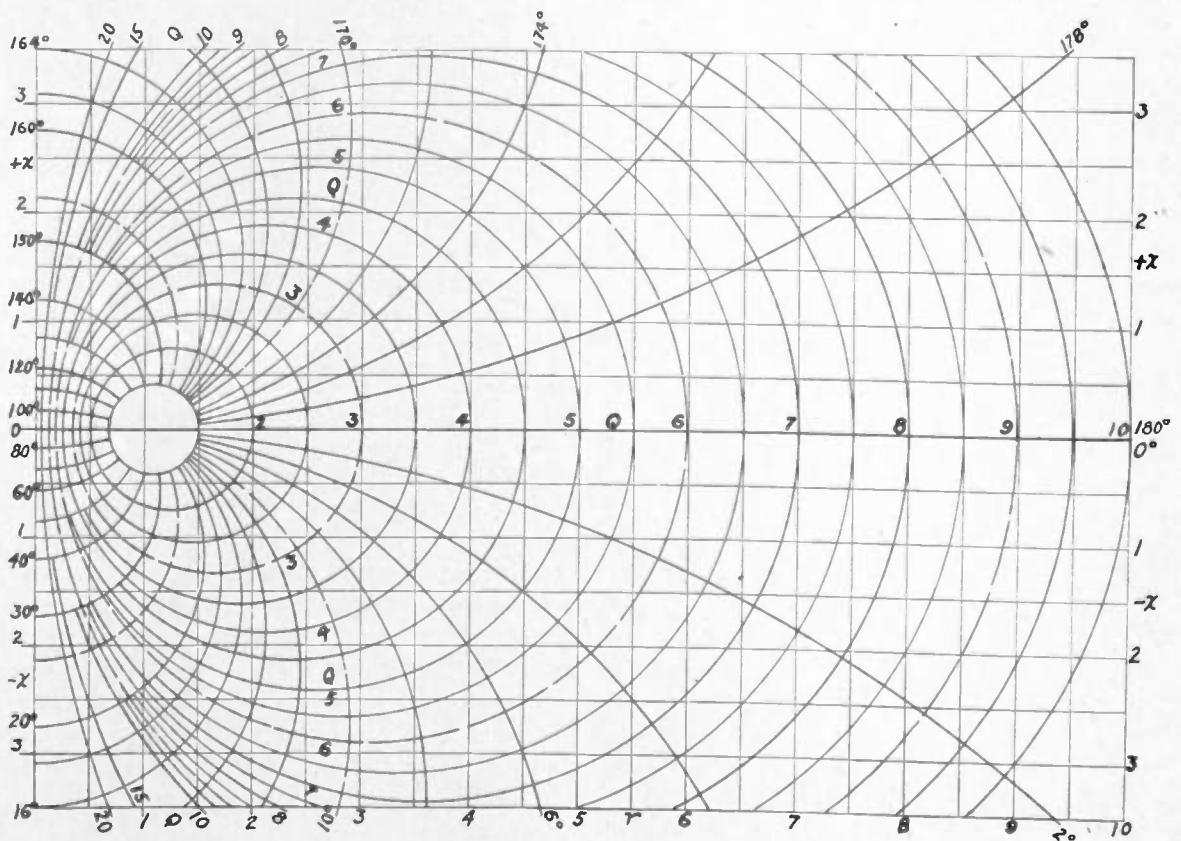

Fig. 14—A chart similar to Fig. 13 for the range $Q=1-10$.

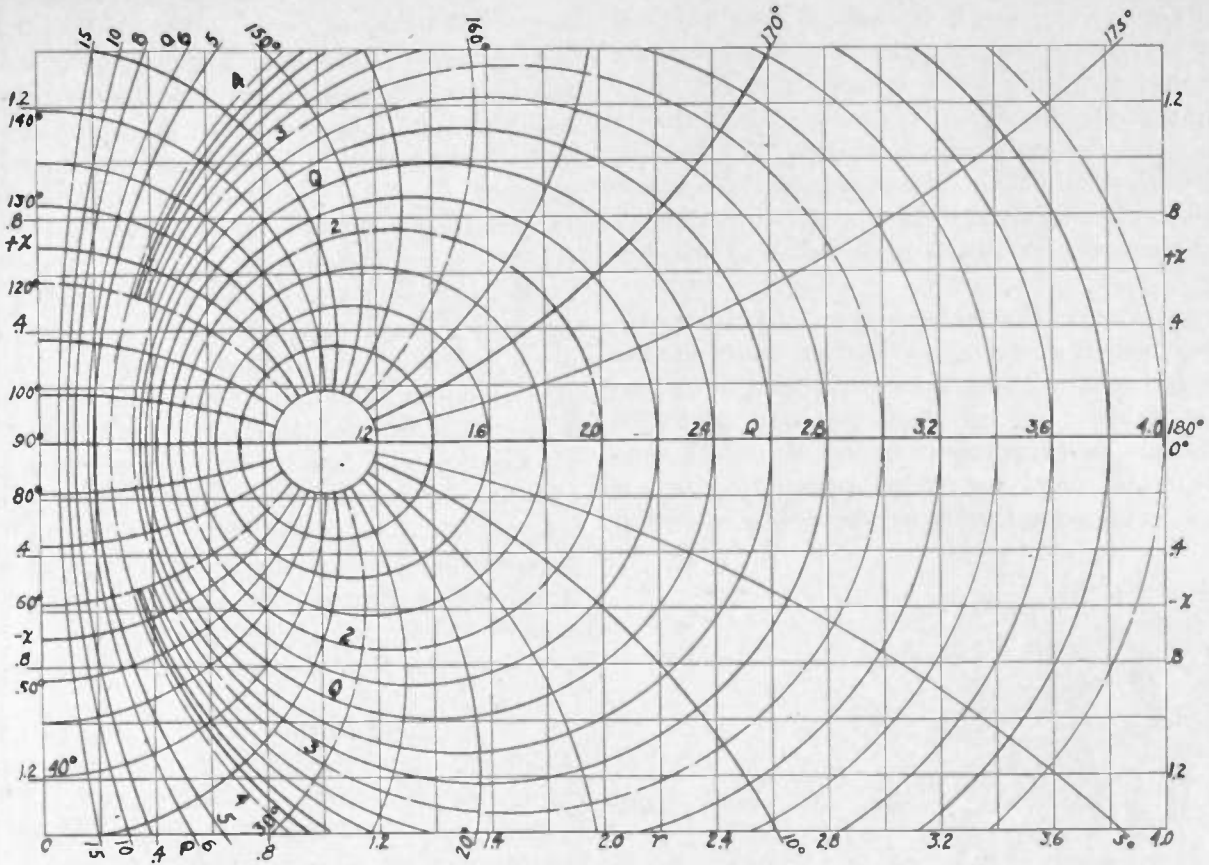

Fig. 15—A chart similar to Fig. 13 for the range, $Q=1-4$.

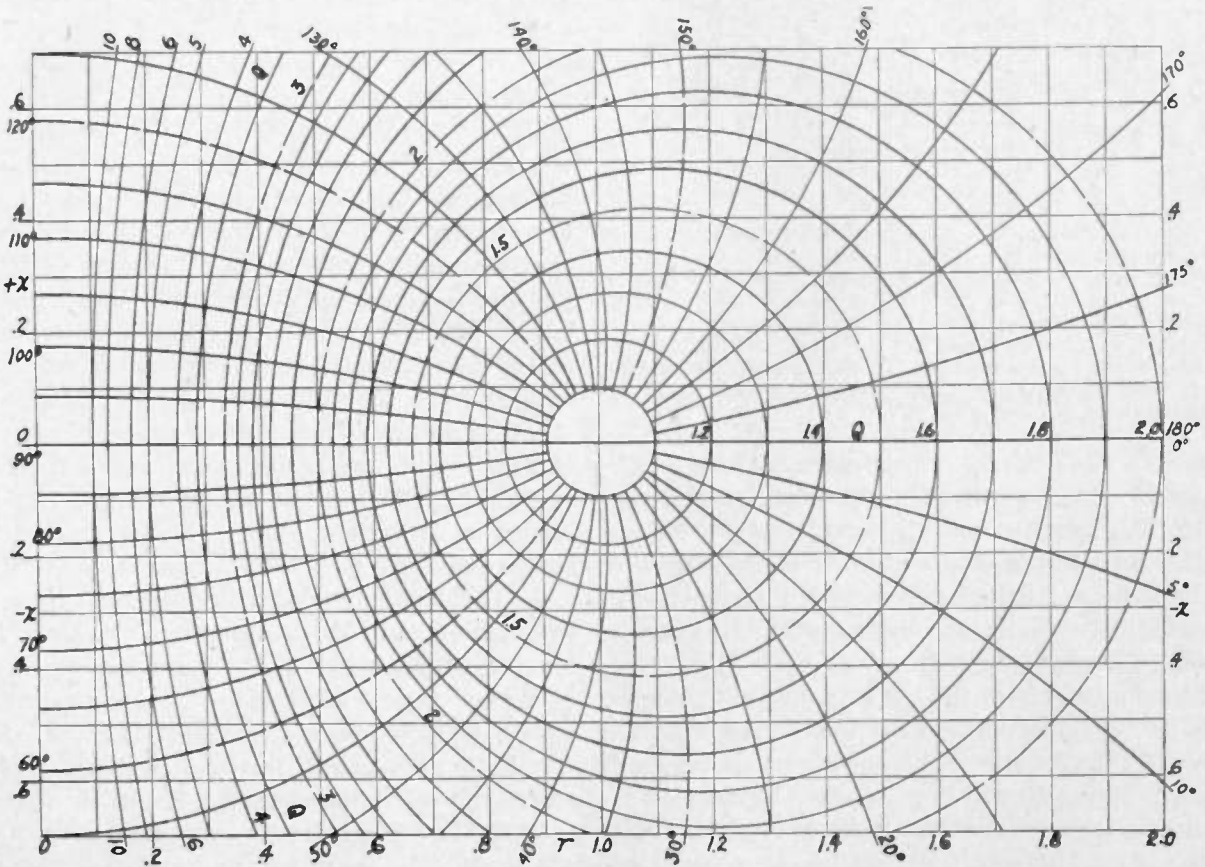

Fig. 16—A chart similar to Fig. 13 for the range, $Q=1-2$.

a given frequency, moves in a circle of constant Q as the point of measurement advances through a distance of 180 degrees along the line. For each value of Q there is a separate circle. Also if any given line is loaded with resistance, and the resistance is varied, thus varying the value of Q , the tip of the vector of impedance at any point a given distance from the load moves in a circular arc of constant angular distance, ϕ , from the load impedance.

These impedance charts have been constructed of families of constant Q circles and constant ϕ arcs against a background of impedance values expressed in rectangular co-ordinates. For more general application this impedance has been expressed by its ratio to a normalized value of unity for the characteristic line impedance. The horizontal units r equal R/Z_0 , while the

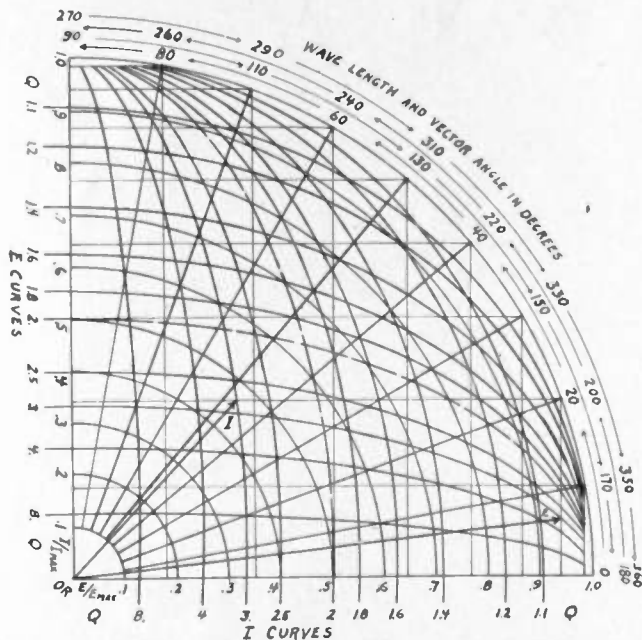

Fig. 17—A chart for finding the voltage and current vectors at any point on a transmission line. Each elliptical curve is the locus of the tip of the voltage vector E or the current vector I for a given standing-wave ratio Q . The circular arcs measure the length of these vectors. The distance along the line is measured in terms of degrees of wavelength shown by the outer arc. The vector angle is measured by the same arc. As an example, the voltage vector E and current vector I are shown for a distance of 20 degrees from the resistance load of $3Z_0$.

vertical units x equal X/Z_0 , $+x$ represents inductive reactance and $-x$, capacitive reactance, actual line impedance, Z_L , being equal to $R+jX$ as previously stated. The load impedance can be a resistance or a complex impedance. If the load is a pure resistance of a value greater than Z_0 the curve of 0 and 180 degrees gives the impedance of the load, which is also the value of Q , and the impedance of the line at points 180 degrees apart, 180, 360 degrees, etc. If the load is less than Z_0 the curve of 90 degrees gives the impedance at the load and at the points 270, 450 degrees, etc. If the load is complex, its position on the chart indicates its half angle of reflection θ and its position relative to a point of pure resistance or virtual load, as will be shown in the following examples.

EXAMPLES OF USE OF IMPEDANCE CHARTS

1. A transmission line has a characteristic impedance Z_0 of 600 ohms with a load, $Z_L = (768 - j768)$ ohms; it is required to find the position of the points of pure resistance or the length of line for pure resistance input impedance. $Z_L/Z_0 = r - jx = 1.28 - j1.28$; this point on Fig. 15 corresponds to $Q = 3$, $\phi = 24$ degrees. Following this Q circle, it is found that the minimum impedance occurs at 90-24, or 66 degrees (also at intervals of 180, or at 246, 426 degrees, etc.) from the load. This impedance is $r = 0.33$, or $rZ_0 = 0.33 \times 600$ ohms = 200 ohms. This is also a point of minimum voltage and maximum current. The maximum impedance occurs at 180-24 degrees, or 156 degrees (also at intervals of 180 degrees, or at 336, 516 degrees, etc.); maximum voltage and minimum current occur at this point. These points are all points of pure resistance. The reflection coefficient, derived from $Q = 3$, $\phi = 24$ degrees, equals $(Q-1)/(Q+1)$, $2(0-24$ degrees), or $K = 0.5 \angle -48$ degrees. This value may be used in finding the voltage and current distribution with Fig. 17.

2. A line in which the load ratio $Z_L/Z_0 = 1.28 + j1.28$; to find the length of line for maximum impedance. Locating this point on Fig. 15 at $Q = 3$, $\phi = 156$ degrees, it is found that a point of maximum impedance and pure resistance of $3Z_0$ occurs at (180-156 degrees) or 24 degrees from the load. A line 24, 204 degrees, or any integral multiple of 180+24 degrees, will then have maximum input impedance. The reflection coefficient for this load equals $(Q-1)/(Q+1)$, $2(180-156$ degrees), or $K = 0.5 \angle +48$ degrees.

3. A line of 600 ohms impedance terminated by an unknown load is found to have a standing-wave ratio of 7 with a voltage node (or point of minimum resistance) at 80 degrees from the load end; to find the impedance of the unknown load. Referring to Fig. 14 at $Q = 7$ and $\phi = (90-80$ degrees) or 10 degrees it is found that this point corresponds to $z = 2.83 - j3.36$. The unknown load then equals 600 ohms times $2.83 - j3.36$.

4. A line as in 3 but with a Q of 4 and a voltage node at 130 degrees from the load. Since the voltage node occurs at more than 90 degrees from the load, the load must be inductive and will be found in the upper half of Fig. 15. Referring to Fig. 15 at $Q = 4$, $\phi = 270 - 130$ degrees, or 140 degrees, it is found that this point corresponds to $z = 0.56 + j1.02$. The unknown load then equals $Z_0(0.56 + j1.02)$.

5. The input impedance of the line in 4 is desired when this line is $6\frac{1}{4}$ wavelengths long. Since the impedance repeats in cycles of one-half wavelength, this value is the same as for one-fourth wavelength, or 90 degrees. This value is found at $\phi = 140 + 90$ degrees, 230 degrees; this is the same as $230 - 180$ degrees or $\phi = 50$ degrees where the input impedance is found as $Z_0(0.41 - j.76)$.

6. A line is terminated by a condenser $X_c/Z_0 = -x = 2$, to find the resonant length. In Fig. 14 this value lies on the vertical line $r = 0$, then $Q = \infty$, $\phi =$ approximately 26 degrees. A voltage minimum occurs at 90-26

degrees, or 64 degrees from the load. A line 64 degrees long terminated by this condenser will be quarter wave resonant, and the actual Q will be high, but it can not have the ideal value of $Q = \infty$, due to finite losses that are present in all lines.

VOLTAGE- AND CURRENT-DISTRIBUTION CHART

It is often desired to determine the distribution of voltage or current along a transmission line; a chart for this purpose has been developed from the construction of Fig. 2. Analyzing that figure, we find that the line

$$OB = OE_I \cos \phi + OE_R \cos \phi = (E_I + E_R) \cos \phi \quad (6)$$

and

$$BE = OE_I \sin \phi - OE_R \sin \phi = (E_I - E_R) \sin \phi. \quad (7)$$

If $E_I + E_R$ is represented by 1, then $(E_I - E_R) = 1/Q$. Then the equation for the path of the point E referred to the axes OX and OY is

$$x = \cos \phi, \quad y = \sin \phi / Q. \quad (8)$$

This is the parametric equation of an ellipse. The major axis of this ellipse equals 1 and lies along OX , its minor axis equals $1/Q$ and lies along OY . The point I also moves in an ellipse the equation of which is

$$x = \cos \phi / Q, \quad y = \sin \phi. \quad (9)$$

This ellipse has axes equal to those of E , but its major axis lies along OY . This is shown in Fig. 18 where $C_1, C_2, C_3,$ and C_4 represent points along the line at distances of 30, 120, 210, and 300 degrees, respectively, from the load. At these points the line voltage vectors are $E_1, E_2, E_3,$ and E_4 and the current vectors, $I_1, I_2, I_3,$ and $I_4,$ respectively.

The current vector I_1 leads the voltage vector E_1 in the first quadrant from 0 to 90 degrees, showing that the impedance of a line of this length is negative or capacitive. In the second quadrant, the current and voltage go through the same absolute values but the current lags the voltage and the impedance is inductive. In the third and fourth quadrants the voltage and current pass through the same relative values as in the first and second quadrants respectively, the only difference being in the phase relation to the load voltage and current.

In Figs. 1 and 2 it was assumed that the load impedance was higher than the characteristic impedance of the line; however, if it is lower, the reflection coefficient K is negative for the voltage and positive for the current. The load terminal will then be a point of minimum voltage and maximum current, so the 90 degree point on the circle of Fig. 18 represents the load terminal, or 0 degrees for this condition, and 180 degrees becomes 90 degrees etc.

Based on Fig. 18 the useful chart shown in Fig. 17 has been constructed for determining the voltage or current at any point on the line. Here families of ellipses have been drawn for varying values of Q . The first quadrant only of Fig. 18 is shown, in order to permit the use of a larger scale for greater accuracy. Since the curves in the second quadrant are the mirror image of those of the

first quadrant, the desired values beyond 90 degrees can be obtained by retracing the first quadrant in the reverse order, thus 80 degrees of the first quadrant becomes 100 degrees of the second quadrant and 0 degrees becomes 180 degrees. These curves can also be used for the third and fourth quadrants, if desired, by following the degrees consecutively as marked. The ellipses with their major axes horizontal are for the E vector, when the load is a resistance greater than the line impedance and K is positive for the voltage. Under the same conditions the ellipses with vertical major axes are for the I vector. When the load is a resistance less than the line impedance, the load becomes a point of minimum voltage and maximum current and the E and I vectors start at 90 degrees for the load terminal and travel counterclockwise over Fig. 17 for the first quadrant.

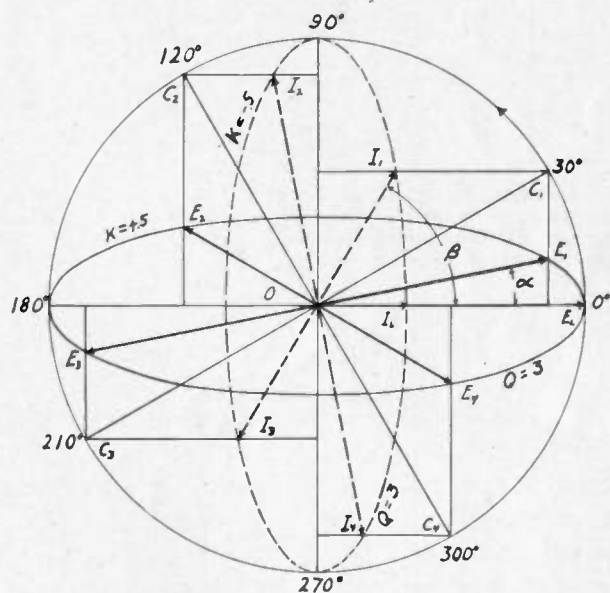

Fig. 18—The loci of the tips of the voltage and current vectors on a transmission line, as the point of observation moves over a wave length or 360 degrees, are ellipses.

EXAMPLES OF USE OF VOLTAGE AND CURRENT CHART

1. On Fig. 17 two vectors are drawn as an illustration of its use. These are for a resistance load of three times the characteristic impedance of the line, $Z_L/Z_0 = 3 = Q$ and they are at a distance of 20 degrees from the load. These vectors are found by locating the 20 degree point on the outer arc and following the vertical line down to its intersection with the E ellipse for the E vector. For the I vector the horizontal line is followed from the 20-degree point to its intersection with the I ellipse. The values so obtained are seen to be $E/E_{max} \text{ (at load)} = 0.95 (+7 \text{ degrees})$ and $I/I_{min} \text{ (at load)} = 0.046/0.33 (+47 \text{ degrees}) = 1.4 (+47 \text{ degrees})$.

2. If the load is a complex impedance the voltages and currents can be found by obtaining the reflection coefficient and corresponding value of Q and considering the equivalent line with its virtual resistance load as shown in Figs. 3 and 6. For example, take a load of $Z_L/Z_0 = 1.28 - j1.28$; this load has been found to have a reflection coefficient of approximately 0.5 (-48

degrees) from the impedance charts as described above. The corresponding virtual line would then have a pure resistance load with a Q of 3 and would be 48 degrees/2, or 24 degrees longer; thus the value of E and I on the chart for 24 degrees would correspond to the voltage and current on the actual line at the load. From the chart $E_L=0.92$ (8 degrees) and $I_L=0.51$ (53 degrees). At the first voltage node at 90 degrees, which is $90-24$ degrees,

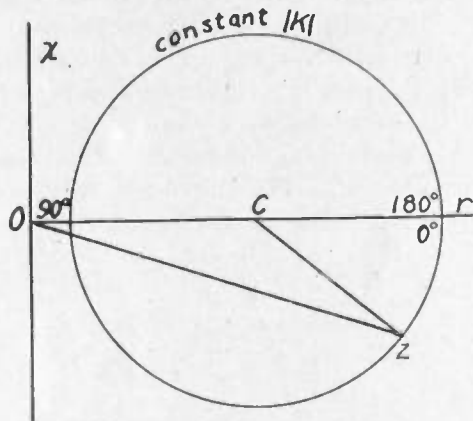

Fig. 19—Analysis of the impedance of a transmission line, showing that the locus of the tip of the impedance vector is a circle for a constant absolute value of the reflection coefficient, $|K|$ and a varying value of the reflection angle 2θ .

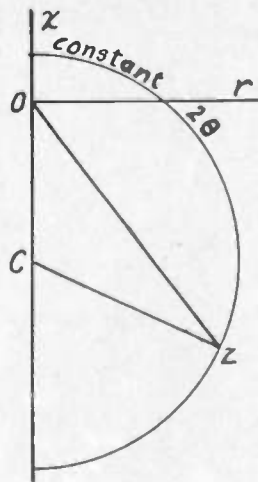

Fig. 20—The locus of the tip of the impedance vector is a circular arc for a constant reflection angle 2θ , and a varying value of its absolute value $|K|$.

or 66 degrees from the load end of the line $E=0.33$ (90 degrees and $I=1$ (90 degrees). Then $E_L/(1st\ nodal\ E)=0.92$ (8 degrees)/0.33 (90 degrees), or the load voltage is 2.76 times the minimum voltage at the first node and lags it by 82 degrees. $I_L/(I\ at\ first\ voltage\ node)$ 0.51 (53 degrees)/1 (90 degrees), or the load current is 0.51 of the maximum current at the first current antinode and lags it by 37 degrees.

3. A load of $Z_L/Z_0=1.28+j1.28$ has been found to correspond to a reflection coefficient of approximately 0.5 (+48 degrees). The corresponding virtual line would then have a Q of 3 and be 24 degrees shorter. The load voltage and current then appears on the chart at $180-24$ degrees, or 156 degrees, as $E_L=0.92$ (172 degrees) and $I_L=0.51$ (127 degrees). A voltage antinode

appears at 0 degrees or $0-(-24)$ degrees, or 24 degrees from the load end of the line. Then $E_L/(first\ antinodal\ E)=0.92$ (172 degrees)/1(180 degrees), or the load voltage is 0.92 of the maximum voltage at the first antinode and lags it by 8 degrees. $I_L/(I\ at\ first\ voltage\ antinode)=0.51$ (127 degrees)/0.33(180 degrees) or the load current is 1.53 times the minimum current at the first current node and lags it by 53 degrees.

These few examples suggest many other problems of voltage and current distribution that can be solved by the aid of Fig. 17.

APPENDIX

The derivation of the curves for the impedance charts is explained with the aid of Figs. 19 and 20. Fig. 19 shows the impedance vector, OZ , expressed in rectangular co-ordinates, r and x (corresponding to the X and Y axes of co-ordinate geometry, respectively) and the path of the point Z as the distance along any given line is varied through all angular distances with the value of $|K|$ remaining constant. Fig. 20 shows the path of the tip Z of the impedance vector OZ as the angle of the reflection coefficient of a line remains constant but the absolute value $|K|$ varies.

As has been shown

$$K = (Z_L - Z_0)/(Z_L + Z_0) \quad (10)$$

but at any point on the line the section of the line between that point and the load, including the load, can be considered as a load presented to the rest of the line. Then, in a more general expression, the reflection coefficient at any point on the line,

$$K = (Z - Z_0)/(Z + Z_0). \quad (11)$$

Taking the normalized values, and considering $Z_0=1 \pm j0$ and $z=r \pm jx$, the impedance of such a line at any point is

$$K = (Z - Z_0)/(Z + Z_0) = (r + jx - 1)/(r + jx + 1) \quad (12)$$

and in absolute values

$$|K|^2 = ((r - 1)^2 + x^2)/((r + 1)^2 + x^2). \quad (13)$$

Clearing the fraction and dividing through by $1 - |K|^2$ we obtain

$$r^2 - 2r(1 + |K|^2)/(1 - |K|^2) + x^2 = -1 \quad (14)$$

adding $\{(1 + |K|^2)/(1 - |K|^2)\}^2$ to each side of (14) to complete the square

$$[r - (1 + |K|^2)/(1 - |K|^2)]^2 + x^2 = [2|K|/(1 - |K|^2)]^2. \quad (15)$$

(15) is the equation of a circle in which the absolute value of the reflection coefficient $|K|$ is constant but its angle 2θ varies through all possible values. The center of this circle is on the horizontal axis at C , and $OC = (1 + |K|^2)/(1 - |K|^2)$ (in this case the vertical axis represents x , reactance, instead of the conventional y of co-ordinate geometry). The radius of this circle is, $CZ = 2K/(1 - |K|^2)$.

The vector value of K in (13) can be rationalized as follows:

$$K = (r^2 - 1 + x^2)/((r + 1)^2 + x^2) + j2x/((r + 1)^2 + x^2) \quad (16)$$

then the tangent of the reflection angle is

$$\tan 2\theta = 2x/(r^2 - 1 + x^2). \quad (17)$$

Transposing,

$$r^2 + x^2 - 2x/\tan 2\theta = 1. \quad (18)$$

Adding $1/\tan^2 2\theta$ to each side of (49) to complete square,

$$r^2 + (x - 1/\tan 2\theta)^2 = (1 + \tan^2 2\theta)/\tan^2 2\theta \\ = 1/\sin^2 2\theta. \quad (19)$$

This is the equation of a circle in which the absolute value of the reflection coefficient $|K|$ varies through all possible values while its angle 2θ remains constant. The center of this circle is on the vertical axis at C , and $OC = 1/\tan 2\theta$, or $\cot 2\theta$, and its radius OZ equals $1/\sin 2\theta$, all values of which are taken as positive. Since physically r can not have negative values in a transmission line, only semicircles are used for the constant 2θ curves. Instead of plotting curves of constant $|K|$ and 2θ , Figs. 13 to 16 have been made more convenient by using the equivalent values of $Q = (1 + |K|)/$

$(1 - |K|)$, and $\phi = 2\theta/2$, distance from any given point to the virtual load (point of maximum pure resistance) as shown in Figs. 3 and 6.

Bibliography

- (1) P. S. Carter, "Charts for transmission line measurements and computation," *RCA Rev.*, vol. 3, No. 3, pp. 355-368; January, 1939.
- (2) W. L. Everitt, "Communication Engineering," McGraw-Hill Book Company, New York, N. Y., 1932.
- (3) Ernst A. Guillemin, "Communication Networks," first edition. John Wiley and Sons, New York, N. Y., 1935.
- (4) R. F. Lewis, "Measurements in u.h.f. spectrum," *Electronics*, vol. 15; April, 1942.
- (5) Walter Van B. Roberts, "Graphical solutions for a transmission line terminated by an arbitrary complex load impedance," *RCA Rev.*, vol. 3, pp. 107-120; July, 1938.
- (6) Hans Roder, "Graphical methods for problems involving radio-frequency transmission lines," *PROC. I.R.E.*, vol. 21, pp. 290-303; February, 1933.
- (7) J. C. Slater, "Microwave Transmission," McGraw-Hill Book Company, New York, N. Y.
Frederick E. Terman, "Radio Engineers Handbook," McGraw-Hill Book Company, New York, N. Y., 1943.
- (8) Paul J. Selgin, "Impedance transformation," *Communications*, vol. 24, pp. 50-104; February, 1944; vol. 24, pp. 40-87; March, 1944.

Coaxial-Line Discontinuities*

J. R. WHINNERY†, ASSOCIATE, I.R.E., H. W. JAMIESON†, ASSOCIATE, I.R.E., AND
THEO ELOISE ROBBINS, NONMEMBER, I.R.E.

Summary—The equivalent circuits representing the effects from certain step-type discontinuities are obtained for coaxial transmission lines. It is shown that for the cases studied the effects of the local waves in the vicinity of the discontinuity can be accounted for exactly for calculation of relation between input- and output-end quantities by placing an admittance at the plane of the discontinuity in a transmission-line or principal-wave equivalent circuit. If frequency is low enough so that transverse dimensions are a small fraction of a wavelength, the discontinuity admittance is found to be a pure capacitance for these cases. Curves are presented giving the discontinuity capacitances in terms of the coaxial-line radii.

Curves of a frequency factor F are calculated showing the amount the discontinuity capacitance must be corrected as transverse dimensions become comparable to wavelength. Curves of a proximity factor P are also given showing corrections to be applied to the discontinuity capacitance if a short-circuiting disk termination is placed near the plane of the discontinuity.

The analysis of the case of a simple-step discontinuity on the inner cylinder is carried through in detail, and analyses of other cases are outlined.

I. INTRODUCTION

DISCONTINUITIES, such as a change of inner-conductor diameter, outer-conductor diameter, or diameter of both conductors, occur frequently in practical applications of coaxial lines. Although such discontinuities may occur even when the lines are for power transmission or measurement purposes, it is particularly true when such lines are used as elements in resonant cavity-type circuits in the centimeter-wave

region. In a recent paper,¹ it was shown that effects from such discontinuities may be calculated from an equivalent circuit in which the local waves excited at the change in section are accounted for by a lumped *discontinuity admittance* shunted between lines at the junction; ordinary transmission-line equations for the principal or transmission-line-type wave are used only in the two lines on either side of the discontinuity.

The analysis and curves of numerical values for the discontinuity admittances were previously derived¹ for a parallel-plane transmission line, although rules were given for approximate application of results to coaxial-line discontinuities. It is the purpose of this paper to give curves calculated for coaxial lines directly, and the analysis leading to these curves. These curves not only supply more accurate values of discontinuity admittance for the coaxial-line problems than are obtainable from the parallel-plane transmission-line curves used with the approximate rules, but also provide the justification for those rules and the degree of approximation resulting from their use.

II. GENERAL DISCUSSION

The detailed discussion of the physical basis for the equivalent circuits was given in the previous paper and will not be repeated here. Certain general remarks concerning such items as the scope of application of the

* Decimal classification: R116. Original manuscript received by the Institute March 15, 1944.

† General Electric Company, Schenectady, New York.

¹ J. R. Whinnery and H. W. Jamieson, "Equivalent circuits for discontinuities in transmission lines," *PROC. I.R.E.*, vol. 32, pp. 98-115; February, 1944.

equivalent circuits, the nature of the discontinuity admittances, and their orders of magnitude are however of interest, and will follow.

A. Nature of the Discontinuity Admittance

Fig. 1 shows typical transmission-line discontinuities of the type studied in this paper and previously,¹ and the form of equivalent circuit found for such discontinuities.

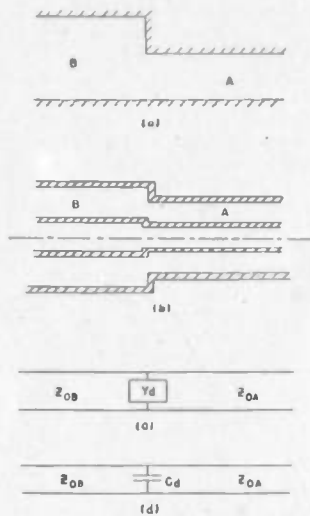

Fig. 1

- (a) Typical discontinuity in parallel-plane transmission line.
- (b) Typical discontinuity in coaxial line.
- (c) Equivalent circuit.
- (d) Equivalent circuit when transverse dimensions are negligible compared with wavelength.

In the problems treated in this and the previous paper, the discontinuity admittance appearing at the plane of the discontinuity in the equivalent circuit is capacitive, at least so long as frequency is below the value for which spacing between conductors of the line is a half wavelength, or the equivalent in the coaxial problem. For frequencies low enough so that transverse dimensions between conductors are negligible compared with wavelength, the discontinuity admittance is a pure capacitance, and may be identified with the "fringing" or "excess" capacity of the corresponding static problem.

B. Order of Magnitude of the Discontinuity Capacitance

The discontinuity capacitance for typical discontinuities in lines of common size is of the order of a few tenths of a micromicrofarad, and is seldom greater than 1 micromicrofarad. It is thus usually of negligible importance for frequencies below a few hundred megacycles, but may be of primary importance in the centimeter-wave region.

C. Behavior as Transverse Dimensions Approach a Half Wavelength

As frequency is increased until transverse dimensions are appreciable compared with wavelength, the discontinuity admittance begins to increase more rapidly with frequency than an admittance resulting from a pure capacitance, finally going through a resonant or infinite admittance point. This resonance occurs in a

parallel-plane transmission line (Fig. 1(a)) when the spacing between conductors on the wider side is a half wavelength; in a coaxial line the resonance occurs when the spacing between conductors is approximately a half wavelength, the exact value depending upon the ratio of line conductor diameters. The ratio of actual admittance to ωC_d , where C_d is the value of the low-frequency discontinuity capacitance, is expressed in this paper as a frequency factor F . For the majority of applications, the spacing between conductors is a small enough part of a wavelength (say less than 0.1) so that the frequency factor is nearly unity and need not be taken into account. Some curves are to be given for aid in estimating this factor when it is important.

D. Scope of Application of the Equivalent Circuit

The equivalent circuit is rigorous to the extent that the fundamental assumptions are satisfied, the most important of these being that the discontinuity should be far enough from the terminations or other discontinuities so that local waves of the discontinuity have effectively died out and do not couple to these. Within the limits of this assumption, it is proper to use the equivalent circuit to relate input-end quantities to output-end quantities for any terminating impedances, and for excitation from either end. Input impedances, amounts of reflected and transmitted waves, resonance conditions, or such items as the 4-terminal network constants and the T and π equivalents of a given section of line including the discontinuity may be calculated from the equivalent circuits. Design calculations on the discontinuities for which curves are presented, which would be fairly complicated boundary-value field problems, are thus reduced to straightforward circuit and transmission-line calculations using well-known equations and charts.

E. Proximity Factors for Terminations Electrically Close to the Discontinuity

If the terminations are close to the discontinuity, the effects of the termination on the local waves excited by the discontinuity must be considered. This may be done

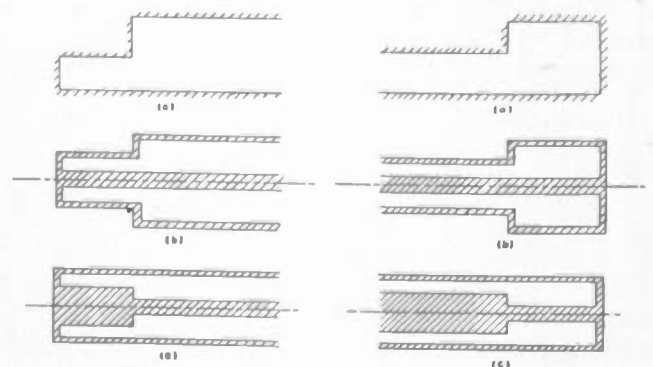

Fig. 2—Short-circuiting disk type terminations near the discontinuity which have a small effect on the discontinuity capacitance.
(a) Parallel-plane line.
(b), (c) Coaxial lines.

Fig. 3—Short-circuiting disk type terminations near the discontinuity which may have an important effect on the discontinuity capacitance.
(a) Parallel-plane line.
(b), (c) Coaxial lines.

fairly easily in the equations if the termination is a short-circuiting disk as in any of the cases of Figs. 2 or 3; the effect on the discontinuity capacity may then be expressed as a proximity factor. If the disk termination is in the line with smaller spacing, as in Fig. 2, the field lines are more nearly straight across in this region and are not affected greatly; this correction is then small and usually may be ignored, even when the disk approaches the discontinuity very closely. If the disk termination is in the line with larger spacing, as in Fig. 3, field-line configurations are affected much more, and the correction becomes important when the distance between the disk and the discontinuity is less than the spacing between conductors. Curves of this factor for some representative cases are to be given later in the paper. Terminations of the several types of Figs. 2 and 3 are often important in resonant cavities incorporating coaxial-line elements.

F. Discontinuities Electrically Close to One Another

If two or more discontinuities are present in a line, these may be treated separately, and the several corresponding discontinuity admittances in the equivalent circuit placed at the proper points of the composite line, so long as the local waves excited at one discontinuity are not appreciably affected by any other discontinuity. If the composite discontinuities are of the types shown in Fig. 4, the field lines are in any case relatively

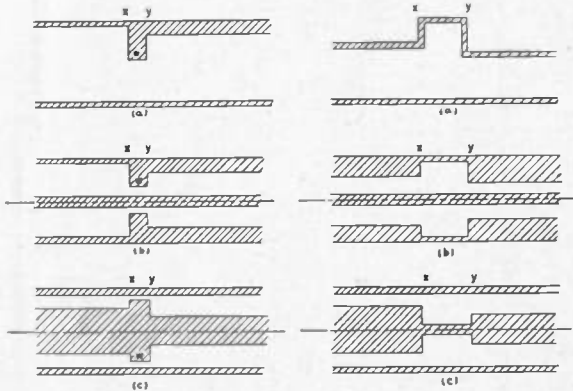

Fig. 4—Double-step discontinuities in which the discontinuity capacitance for one step, as x , is not greatly affected by the presence of the other step, y . (a) Parallel-plane line. (b), (c) Coaxial lines.

Fig. 5—Double step discontinuities in which the discontinuity capacitance for one step, as x , may be appreciably affected by the presence of the other step, y . (a) Parallel-plane line. (b), (c) Coaxial lines.

straight in the constricted portion of the line so that the distorted fields on one side are always shielded to a large extent from those on the other. It is then sufficiently accurate for many applications to neglect any interaction between the two discontinuities in such problems, no matter how thin the separating wall w may be.

If the discontinuities near one another are of the types shown in Fig. 5, the discontinuity admittance to be placed at one discontinuity is decreased by the presence of the other, and by an important amount if the spacing between discontinuities is much less than twice

the separation between transmission-line conductors in the widest section. Some ideas on the importance of this factor may be obtained from Figs. 10 and 15 of footnote reference 1.

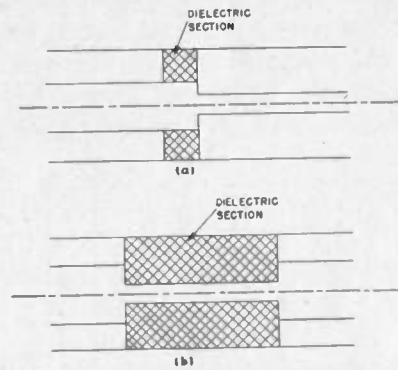

Fig. 6—Dielectric spacers introduced in lines at discontinuities. (a) Type for which discontinuity capacitance is not greatly affected by dielectric spacer. (b) Type for which discontinuity capacitance is increased approximately by dielectric constant of spacer.

G. Change of Dielectric at Change of Section

In certain applications, a dielectric spacer may be placed at one side of a discontinuity, or a dielectric filled section of line may be undercut to maintain constant characteristic impedance (Fig. 6). It is easy to

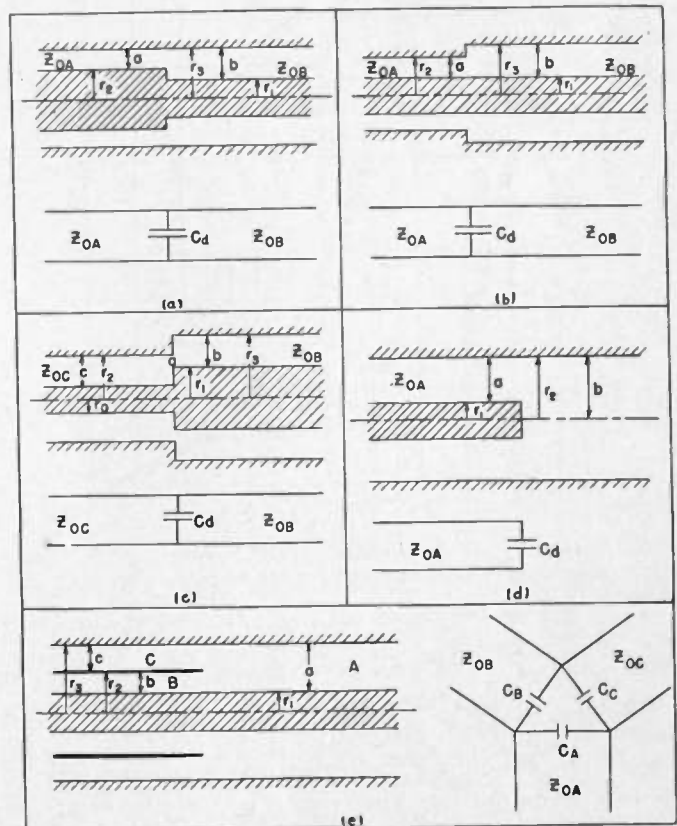

Fig. 7—Important coaxial-line discontinuities and equivalent circuits.

carry through the analysis with different dielectric constants on the two sides of the discontinuity, but since results are presented in curve form, it would require a prohibitive number of curves to provide information for

all combinations of ratio of line radii, ratio of dielectric constants, and step ratio. However, approximate values may be obtained by recognizing as in *E* and *F* above that the major distortion of field occurs in the wider region; this region then has the most important effect upon the discontinuity admittance, and for a first approximation, the discontinuity capacitance for air dielectric may be multiplied by dielectric constant in the line of wider section. Thus in Fig. 6(a), the discontinuity

H. Transmission Lines of General Cross-Sectional Shape

Hahn's unpublished work, referred to in reference 1, in which he obtained the equivalent circuits for transmission-line discontinuities, was for coaxial lines, as in this paper. The previous paper¹ derived the equivalent circuits for the simpler parallel-plane transmission-line problems. It would of course be possible to set up the problem more generally, starting with a principal transverse electromagnetic wave and local waves expressed in terms of general orthogonal function distributions over the cross section. (The sinusoids of the parallel-plane transmission-line and the Bessel functions of the coaxial

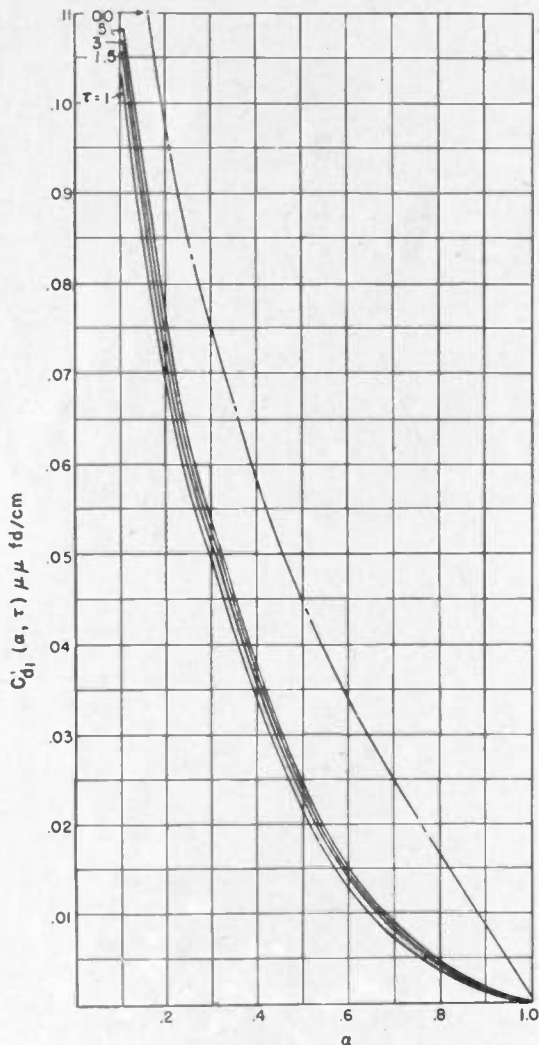

Fig. 8—Curve of $C_{d1}'(\alpha, \tau)$. When multiplied by outer circumference, gives directly the discontinuity capacitance for Fig. 7(a) with $\alpha = a/b, \tau = r_2/r_1$.

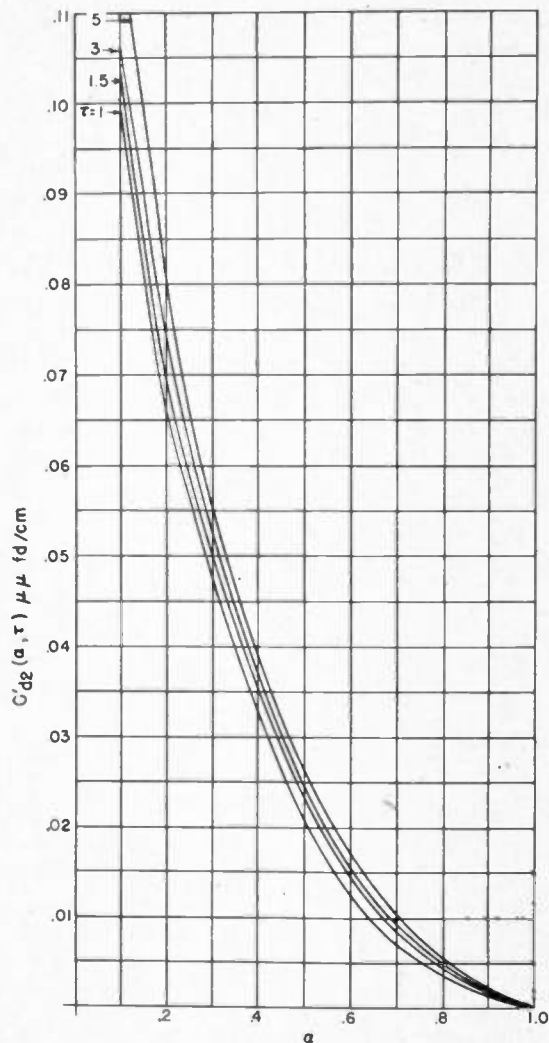

Fig. 9—Curve of $C_{d2}'(\alpha, \tau)$. When multiplied by inner circumference, gives directly the discontinuity capacitance for Fig. 7(b) with $\alpha = a/b, \tau = r_2/r_1$.

capacitance C_d is not greatly changed from that for a completely air-filled line even though the dielectric d is present; in Fig. 6(b), discontinuity capacitances for an air-filled line should be multiplied by approximately ϵ' .

This approximation and the other approximations mentioned in *E* and *F* based on the relative straightness of field lines in the smaller line are poorest for small discontinuities—that is, for discontinuities where the percentage change in section is small. However, since discontinuity capacitances for such cases are very small anyway, it is usually not necessary to be too concerned about their accuracy.

line are two examples of functions having the required orthogonal properties.) The equivalent circuit would then be found to have the same form as that in Fig. 1(c) for all such general cases of sudden discontinuities, and expressions for the lumped discontinuity admittances could be obtained in terms of the general functions. If the local waves were all transverse magnetic or *E* waves, the lumped admittance would behave as a capacitance at low frequency, as inductance if they were all

transverse electric or H waves, and as an inductance and capacitance in parallel if both types of waves are excited.

The same equivalent circuit and mathematical techniques may be applied in certain cases where the dominant wave is not transverse electromagnetic. For example, in a capacitive type discontinuity in a rectangular wave guide, the dominant wave is a TE_{10} wave, and local waves of both E and H types are excited (although in such a manner that the resultant wave is transverse electric to the wide dimension of the guide). The discontinuity admittance then behaves in its first order terms as an inductance and capacitance in parallel, and may be placed at the junction of transmission-line

side. In Fig. 7(d) the lumped discontinuity admittance is placed at the end of the single line of characteristic impedance Z_{0A} . In the "re-entrant" discontinuity of Fig. 7(e), the three lines are connected in series with a discontinuity admittance shunted across each line at the junction.

A. Sudden Change in Diameter of Inner Cylinder of a Coaxial Line (Fig. 7(a))

For this problem, the discontinuity capacitance divided by outer circumference is plotted in Fig. 8 as $C_{d1}'(\alpha, \tau)$, where $\alpha = a/b$, $\tau = r_3/r_1$. Thus the discontinuity capacitance is $C_d = 2\pi r_3 C_{d1}'(a/b, r_3/r_1)$ where $a = r_3 - r_2$; $b = r_3 - r_1$.

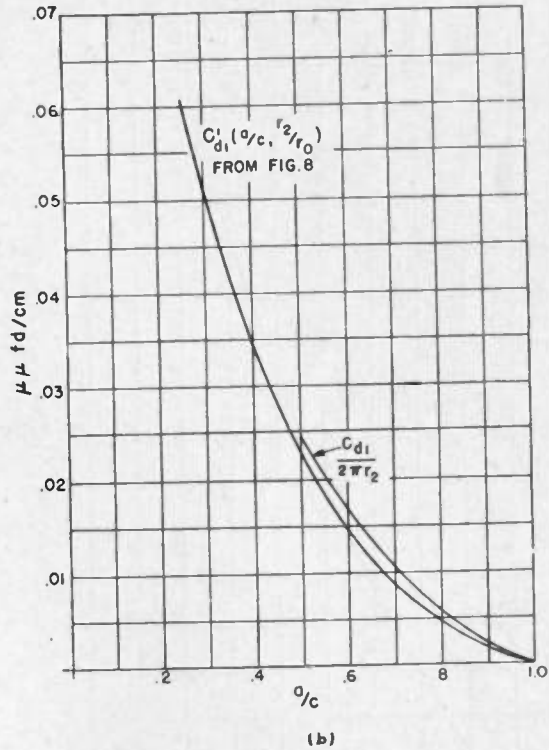
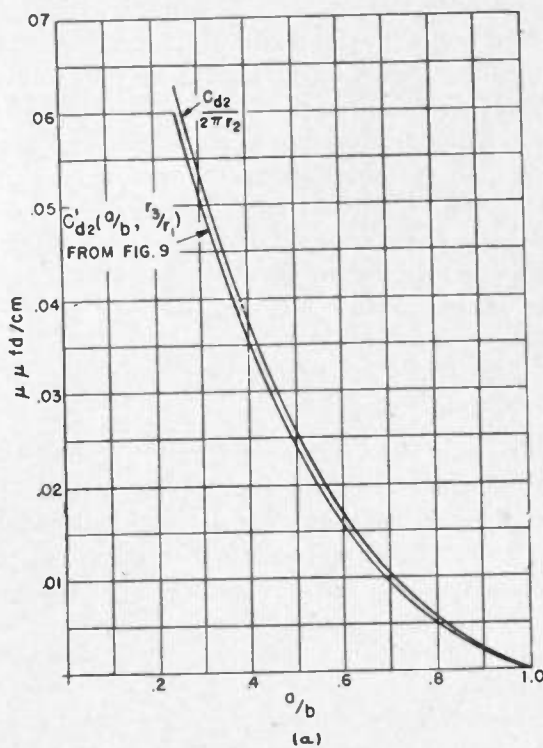

Fig. 10—Comparison of discontinuity capacitance of Fig. 7(c) calculated from approximate rules of IIC and more accurate values calculated from V_c ; specific case of $r_3/r_1 = r_2/r_0 = 3$.

circuits drawn for the TE_{10} wave in the guides on either side of the discontinuity. Proper phase constants and characteristic impedances must of course be used for the guide dimension on the two sides of the discontinuity.

III. USE OF CURVES

The fundamental coaxial-line discontinuities analyzed in this paper are pictured in Fig. 7, with the form of their equivalent circuits. In Figs. 7(a), (b), and (c), the equivalent circuit consists of one line of characteristic impedance Z_{0B} connected to another of characteristic impedance Z_{0B} with a discontinuity admittance shunted between lines at the junction. Lengths in either the A or B line are measured from the plane of the discontinuity, termination may be with any known impedance on either side of the discontinuity, and ordinary transmission-line equations only are used in the lines on either

B. Sudden Change in Diameter of Outer Cylinder of a Coaxial Line (Fig. 7(b))

In Fig. 9, discontinuity capacitance divided by inner circumference is plotted for this problem as $C_{d1}'(\alpha, \tau)$ where $\alpha = a/b$, $\tau = r_2/r_1$. Then $C_d = 2\pi r_1 C_{d1}'(a/b, r_2/r_1)$, where $a = r_2 - r_1$; $b = r_3 - r_1$.

The curves for $\tau = 1$ in Figs. 8 and 9 of course correspond to the discontinuity capacitance for a step in a parallel-plane transmission line, Fig. 14 of reference 1. Study of the curves of Figs. 8 and 9 led to the rule for applying that curve approximately to the coaxial-line problems.

C. Sudden Change in Diameters of both Inner and Outer Cylinders of a Coaxial Line (Fig. 7(c))

An approximate but very good value of discontinuity capacitance is obtainable by breaking it into two parts

and using results from *A* and *B* above. That is, $C_d = C_{d_1} + C_{d_2}$. C_{d_1} is calculated as if the outer cylinder of line *C* continued to the right without discontinuity, and C_{d_2} as if the inner cylinder of line *B* continued to the left without discontinuity.

$$C_{d_1} = 2\pi r_2 C_{d_1}'(a/c, r_2/r_0)$$

$$C_{d_2} = 2\pi r_1 C_{d_2}'(a/b, r_3/r_1)$$

$C_{d_1}'(\alpha, \tau)$ is obtainable from Fig. 8, and $C_{d_2}'(\alpha, \tau)$ from Fig. 9.

The complete equations for this problem are worked out in Section V, C. Complete curves are not plotted because of the large number of parameters involved, and also because of the excellence of the above approxima-

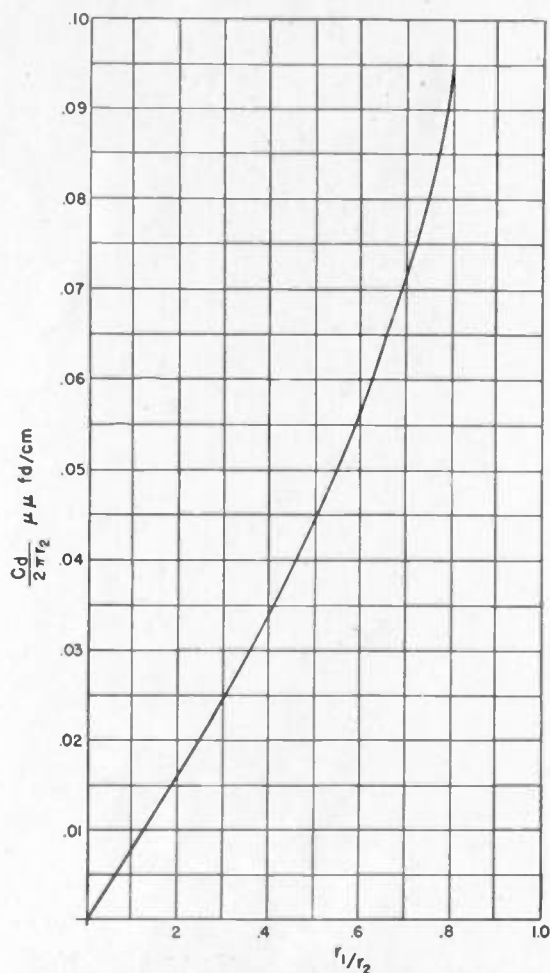

Fig. 11—Discontinuity capacitance of coaxial line with discontinuous inner conductor, Fig. 7(d).

tion over most of the range. As demonstration, results from the complete equations are plotted in Fig. 10 for one set of parameters, $r_2/r_1 = r_2/r_0 = 3$, and compared with results by the above approximate rules. Agreement is seen to be good.

D. Complete Discontinuity in Inner Cylinder of Coaxial Line (Fig. 7(d))

Discontinuity capacitance divided by circumference of outer cylinder is plotted in Fig. 11. Since this is a special case of Fig. 7(a) with $r_3/r_1 = \infty$, results are also plotted in Fig. 8 for comparison purposes.

E. Re-entrant Type of Discontinuity (Fig. 7(e))

Approximate values (higher order corrections were neglected) for the three lumped capacitances to be placed in the equivalent circuit (Fig. 7(e)), are plotted in Fig. 12. Thickness of the wall between lines *B* and *C* of Fig. 7(e) was neglected in plotting Fig. 12; some ideas on the effect of this wall thickness may be obtained from the curves of Fig. 17 of reference 1 for the corresponding parallel plane problem. Here, as in the parallel plane case, C_A is negative.

F. Frequency Factor for Dimensions Comparable with Wavelength

If transverse dimensions are an appreciable part of a wavelength, values of discontinuity capacitances obtained from previous curves (which were functions of dimension ratios only) should be multiplied by a frequency factor *F* as discussed in Section II, C. Curves for this factor have not been calculated over the entire range of variables, because of the large number of parameters involved. However, curves for some representative cases are shown in Fig. 13. Fig. 15 of reference 1 supplied this factor for the parallel-plane transmission-line discontinuities.

G. Proximity Factor for Disk Termination Near the Discontinuity

The effects of short-circuiting disk termination near the discontinuity were discussed in Section II, E. Again complete curves have not been calculated because of the prohibitive number of parameters, but plots of the proximity factor for some representative cases are given in Fig. 14. Fig. 18 of reference 1 supplied the factor for parallel-plane transmission-line discontinuities.

H. Use of Curves with Diaphragms in the Line

Solutions for thin diaphragms in the line may be obtained as simply as for any of the other solutions to be given in Section V. Curves have, however, not been plotted here because it is possible to obtain sufficiently accurate values for most practical cases from previous results, as inferred by the discussion in Section II, F. Fig. 15 shows several of these discontinuities with rules for obtaining the approximate discontinuity capacitance. A few checks with results from the complete equations for these cases indicate that accuracy is usually better than 5 per cent.

I. Use With Dielectric Discontinuities in Addition to Geometrical Discontinuities

The approximation useful for problems of this type was discussed in Section II, G. Typical cases are sketched in Fig. 16 with rules for applying this approximation. Checks from the complete equations gave error of less than 10 per cent in using the approximation for ratios of dielectric constant up to 10 to 1.

IV. EXPERIMENTAL CHECKS

Since the experimental measurements previously reported¹ were made on coaxial lines, they are applicable to curves presented in this paper. More recent data have been obtained, including measurements on the outer diameter step, as well as measurements covering a wider range of step ratios for the inner diameter discontinuity.

The first group of these measurements was again made on the case described in Section IV, B of reference 1. The half-wave slug was this time placed on the inner cylinder of a matched 7/8 inch outer-diameter 3/8 inch inner-diameter coaxial line and standing waves

marized in Table I, showing in addition values calculated from the approximate rules¹ for comparison purposes.

TABLE I
STANDING WAVE RATIOS ($\lambda = 10$ centimeters)

$2r_1$	$2r_2$	$2r_3$	Calculated by this paper	Calculated approximately by reference 1	Measured
inch	inch				
3/8	7/8	0.500	1.08	1.09	1.08
3/8	7/8	0.600	1.26	1.27	1.26
3/8	7/8	0.650	1.45	1.45	1.47
3/8	7/8	0.671	1.58	1.55	1.53
3/8	7/8	0.700	1.77	1.72	1.73
3/8	7/8	0.725	1.92	1.92	1.86
3/8	7/8	0.750	2.18	2.16	2.17

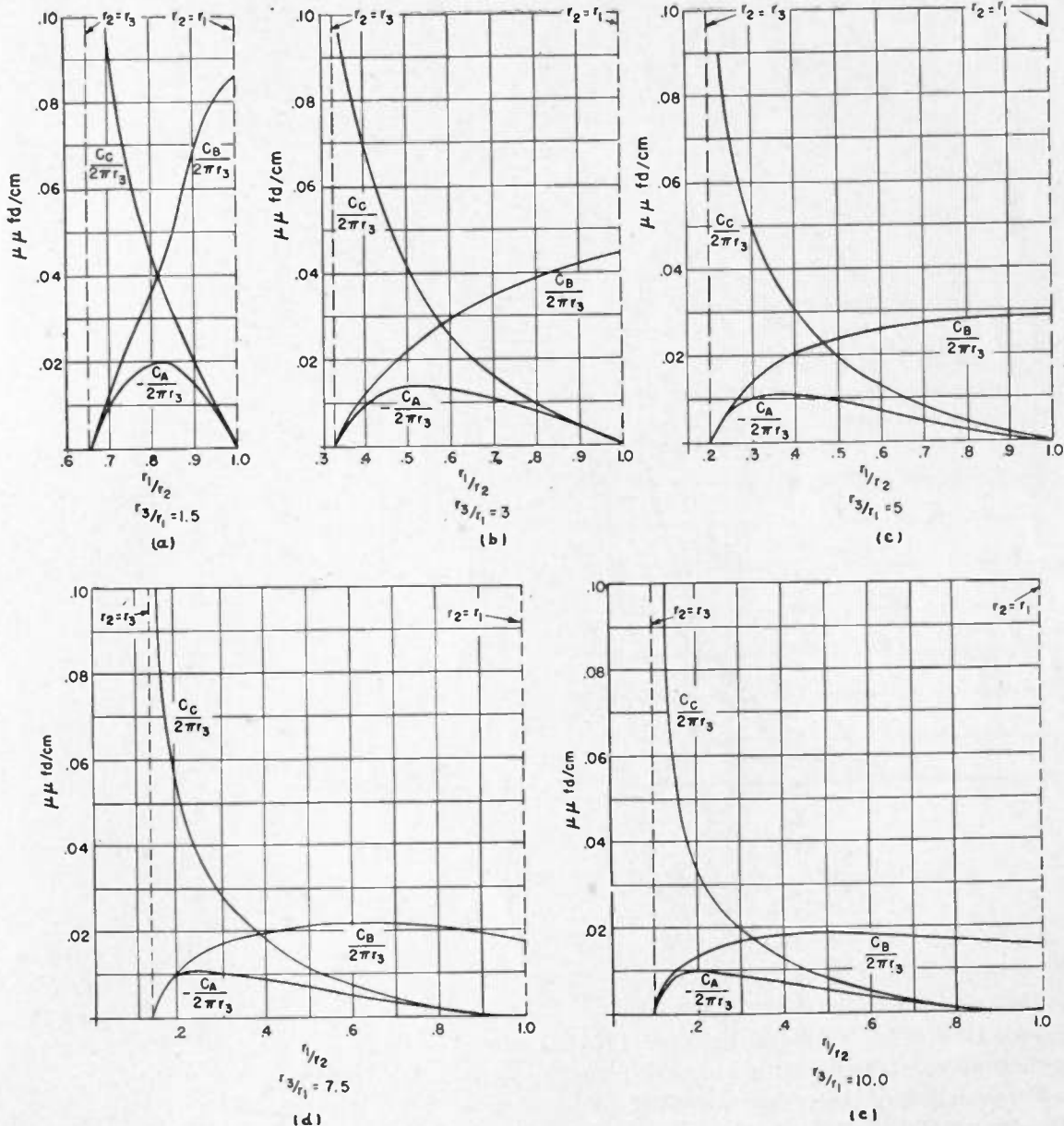

Fig. 12—Approximate values of the three discontinuity capacitances C_A , C_B , C_C for the re-entrant type discontinuity of Fig. 7(e) as functions of the several radii ratios.

observed on the generator side of the slug. Fig. 17 shows the curve of standing-wave ratio calculated from the curves of this report and the experimental points. Agreement seems to be within the accuracy of measurements over the entire range. These data are also sum-

Two additional sets of measurements were made on a coaxial line of outer cylinder inner diameter 1½ inches and inner cylinder outer diameter 9/16 inch. One of these was for a half-wave slug discontinuity in the outer cylinder and the other for a simple step in the inner

cylinder. An impedance-measuring device, somewhat less accurate than that used for the above checks, measured voltage-node positions on the generator side of the discontinuity when known terminations consisting of given lengths of short-circuited line were placed following the slugs. From the voltage-node positions and terminating line lengths, the discontinuity capacitances were determined and compared with the calculated values from the curves presented in this paper. These measured and calculated values are shown in Table II.

TABLE II

Discontinuity	r_1	r_2	r_3	Measured ($\lambda = 10$ centimeters) ($C_d/2\pi r_1$) $\mu\mu\text{f/cm}$	Calculated ($C_d/2\pi r_1$) $\mu\mu\text{f/cm}$
Inner Cylinder (nomenclature as Fig. 7(a))	9/32	7/16	3/4	0.0129	0.0105
Outer Cylinder (nomenclature as Fig. 7(b))	7/16	1/2	3/4	0.070	0.071

enough smaller than a half wavelength so that these latter waves are below cut-off, and so attenuate fairly rapidly in either direction from the discontinuity.

The proper form of the *TM*-wave solutions for the two regions is listed below, the negative exponential being retained for the *A* region and the positive exponential for the *B* region.

$$\begin{aligned}
 & \text{A Region} \\
 E_{r_{Am}} &= A_m Z_1(k_{Am}r) e^{-\gamma_m z} \\
 H_{\phi_{Am}} &= \frac{j\omega\epsilon A_m}{\gamma_m} Z_1(k_{Am}r) e^{-\gamma_m z} \\
 E_{z_{Am}} &= \frac{k_{Am} A_m}{\gamma_m} Z_0(k_{Am}r) e^{-\gamma_m z} \\
 \gamma_m &= k_{Am} \sqrt{1 - (k/k_{Am})^2} \\
 & \text{B Region} \\
 E_{r_{Bn}} &= B_n Z_1(k_{Bn}r) e^{\gamma_n z}
 \end{aligned}
 \tag{1}$$

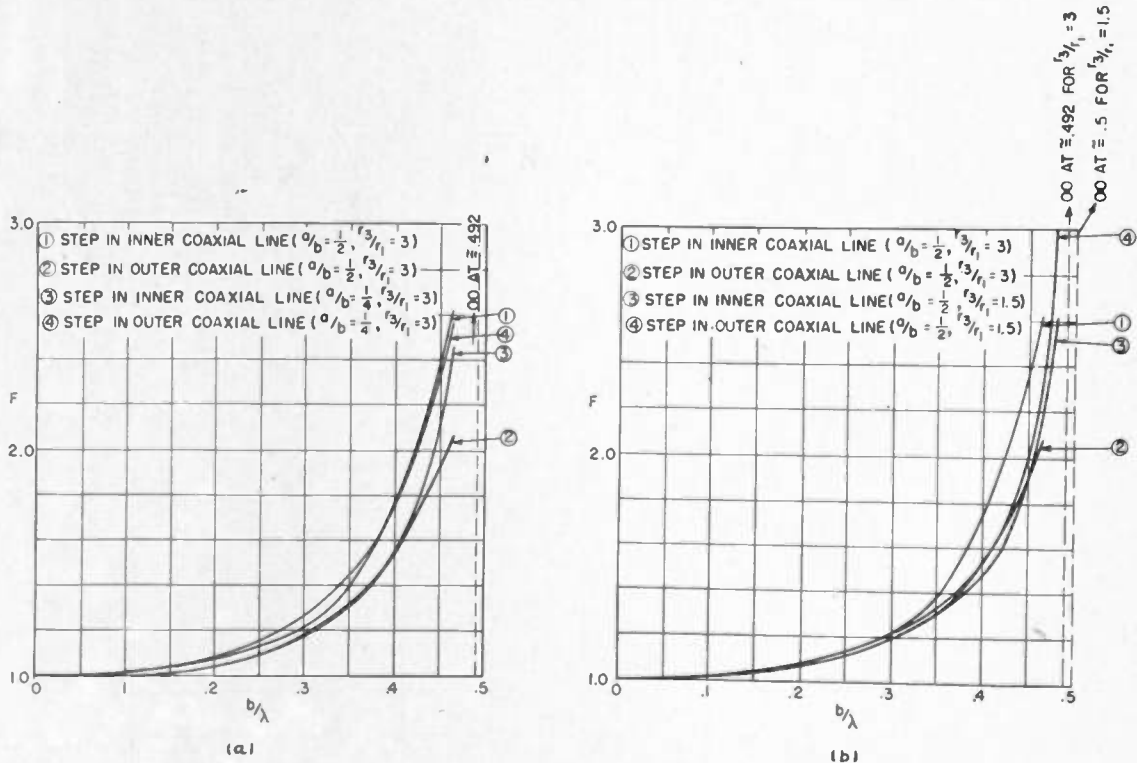

Fig. 13—Frequency factor *F*, correction to use with values from Figs. 8 or 9 when dimensions are comparable to wavelength.

V. ANALYSIS

A. Sudden Change in Diameter of Inner Cylinder

The analysis for this problem follows the same broad procedure as that given¹ for the parallel-plane transmission lines. For selection of the proper wave solutions required by the cylindrical structure, axial symmetry is retained; a study of the discontinuity pictured in Fig. 7(a) shows then that field components E_r , E_z and H_ϕ only are required. Thus, in addition to the principal or transmission-line wave which has components E_r and H_ϕ (both inversely proportional to radius) higher order waves of the transverse magnetic type (*E* waves) are excited. The spacing between conductors is usually

$$\begin{aligned}
 H_{\phi_{Bn}} &= \frac{-j\omega\epsilon B_n}{\gamma_n} Z_1(k_{Bn}r) e^{\gamma_n z} \\
 E_{z_{Bn}} &= \frac{k_{Bn} B_n}{\gamma_n} Z_0(k_{Bn}r) e^{\gamma_n z} \\
 \gamma_n &= k_{Bn} \sqrt{1 - (k/k_{Bn})^2}
 \end{aligned}
 \tag{2}$$

In the above, Z_p denotes the linear combination of *p*th order Bessel functions of the first and second kinds as follows:

$$\begin{aligned}
 Z_0(k_{Am}r) &\equiv J_0(k_{Am}r) + G_{Am} N_0(k_{Am}r) \\
 Z_1(k_{Am}r) &\equiv J_1(k_{Am}r) + G_{Am} N_1(k_{Am}r) \\
 Z_0(k_{Bn}r) &\equiv J_0(k_{Bn}r) + G_{Bn} N_0(k_{Bn}r) \\
 Z_1(k_{Bn}r) &\equiv J_1(k_{Bn}r) + G_{Bn} N_1(k_{Bn}r).
 \end{aligned}
 \tag{3}$$

The conductors of the line (assumed perfect for present purposes) require that E_z be zero at $r=r_2$ and r_3 in the A region, and at $r=r_1$ and r_3 in the B region.

$$\begin{aligned} Z_0(k_{Am}r_2) = 0 = Z_0(k_{Am}r_3) \\ Z_0(k_{Bn}r_1) = 0 = Z_0(k_{Bn}r_3). \end{aligned} \tag{4}$$

From the definitions of (3), these require

$$G_{Am} = -\frac{J_0(k_{Am}r_2)}{N_0(k_{Am}r_2)} = -\frac{J_0(k_{Am}r_3)}{N_0(k_{Am}r_3)} \tag{5}$$

$$G_{Bn} = -\frac{J_0(k_{Bn}r_1)}{N_0(k_{Bn}r_1)} = -\frac{J_0(k_{Bn}r_3)}{N_0(k_{Bn}r_3)} \tag{6}$$

$$J_0(k_{Am}r_2)N_0(k_{Am}r_3) - J_0(k_{Am}r_3)N_0(k_{Am}r_2) = 0 \tag{7}$$

$$J_0(k_{Bn}r_1)N_0(k_{Bn}r_3) - J_0(k_{Bn}r_3)N_0(k_{Bn}r_1) = 0. \tag{8}$$

$$H_\phi = \frac{1}{\eta r} [A_0' e^{-ikz} - A_0'' e^{ikz}] \tag{9}$$

$$\eta = \sqrt{\frac{\mu}{\epsilon}}; \quad k = \omega\sqrt{\mu\epsilon}$$

B Region

$$E_r = \frac{1}{r} [B_0' e^{-ikz} + B_0'' e^{ikz}]$$

$$H_\phi = \frac{1}{\eta r} [B_0' e^{-ikz} - B_0'' e^{ikz}] \tag{10}$$

The relative amounts of positively traveling and negatively traveling waves are dependent upon the termina-

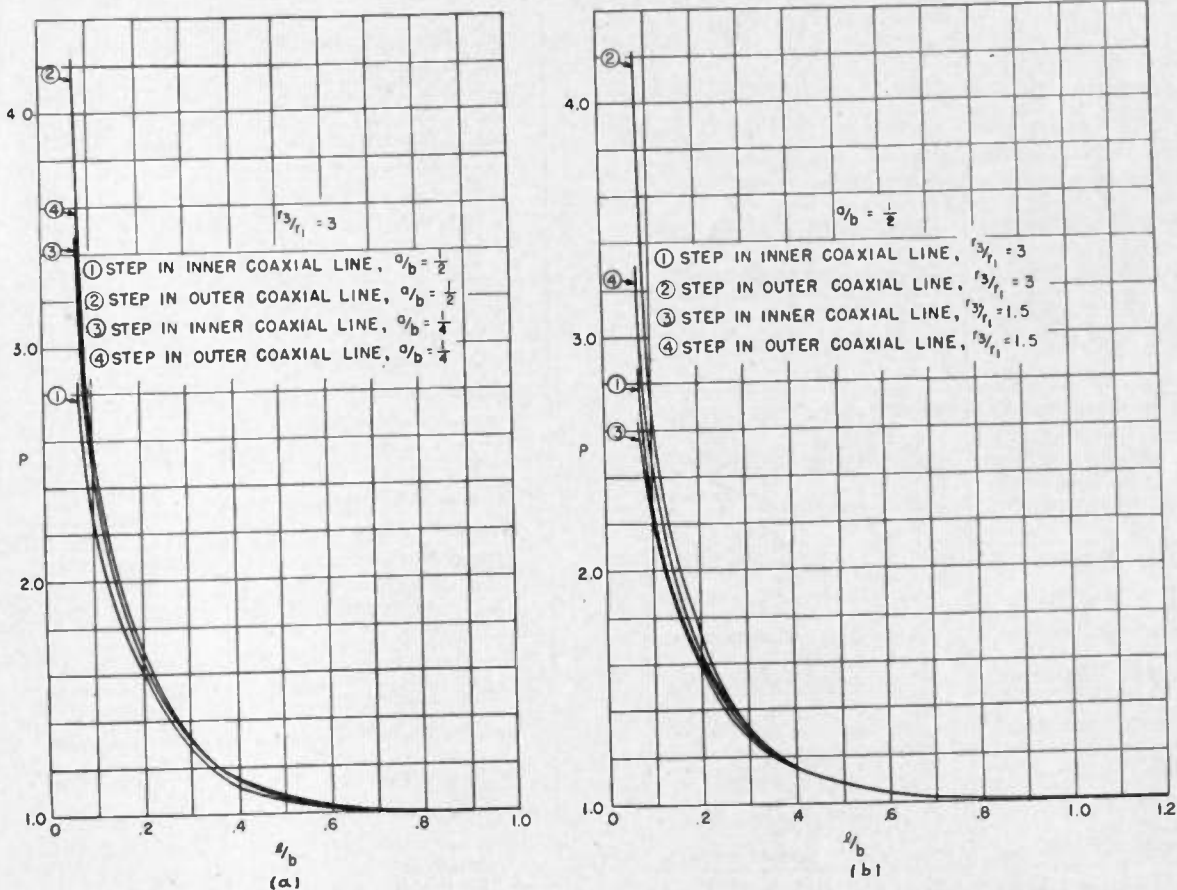

Fig. 14—Proximity factor P , for disk termination near discontinuity in line of larger spacing.

The transcendental equations (7) and (8) have roots tabulated in Jahnke and Emde² so that $k_{Am}r_2$ and $k_{Am}r_3$ may be obtained in terms of the ratio r_3/r_2 , and $k_{Bn}r_1$ and $k_{Bn}r_3$ obtained in terms of the ratio r_3/r_1 . G_{Am} and G_{Bn} are then determinable from (5) and (6) so that the Z_p functions are calculable once the ratios r_3/r_2 and r_3/r_1 are given.

The principal or transmission line waves in the two regions are:

$$\begin{aligned} & \text{A Region} \\ E_r &= \frac{1}{r} [A_0' e^{-ikz} + A_0'' e^{ikz}] \end{aligned}$$

tion of the line, and this need not be specified beyond the restriction that it be kept far enough from the discontinuity so that local waves have effectively died out. This latter restriction was inferred by the retention of the single exponential term in the higher-order wave solutions for each region in (1) and (2). At the plane of the discontinuity, $z=0$, the total field components may be written as the sum of principal and higher order TM -wave components, the positively and negatively traveling principal waves being added to give a single zero-order term.

$$E_{rA} |_{z=0} = \frac{A_0}{r} + \sum_m A_m Z_1(k_{Am}r) \tag{11}$$

² E. Jahnke and F. Emde, "Tables of Functions," Dover Publications, New York, N. Y., 1943.

$$H_{\phi A} |_{z=0} = \frac{Y_{A0}A_0}{r} + \sum_m Y_{Am}A_m Z_1(k_{Am}r) \quad (12)$$

$$E_{rB} |_{z=0} = \frac{B_0}{r} + \sum_n B_n Z_1(k_{Bn}r) \quad (13)$$

$$H_{\phi B} |_{z=0} = \frac{Y_{B0}B_0}{r} + \sum_n Y_{Bn}B_n Z_1(k_{Bn}r) \quad (14)$$

$$Y_{Am} = \frac{j\omega\epsilon}{k_{Am}K_{Am}} \quad Y_{Bn} = -\frac{j\omega\epsilon}{k_{Bn}K_{Bn}} \quad (15)$$

$$K_{Am} = \sqrt{1 - \left(\frac{2\pi}{\lambda k_{Am}}\right)^2} \quad K_{Bn} = \sqrt{1 - \left(\frac{2\pi}{\lambda k_{Bn}}\right)^2} \quad (16)$$

The required matching conditions at the plane $z=0$ are

$$E_{rB} = 0, \quad r_1 < r < r_2 \quad (17)$$

$$E_{rB} = E_{rA}, \quad r_2 < r < r_3$$

$$H_{\phi A} = H_{\phi B}, \quad r_2 < r < r_3 \quad (18)$$

E_{rB} as a function of r is thus formally defined over the range $r_1 < r < r_3$ by the expression (17), and E_{rB} of

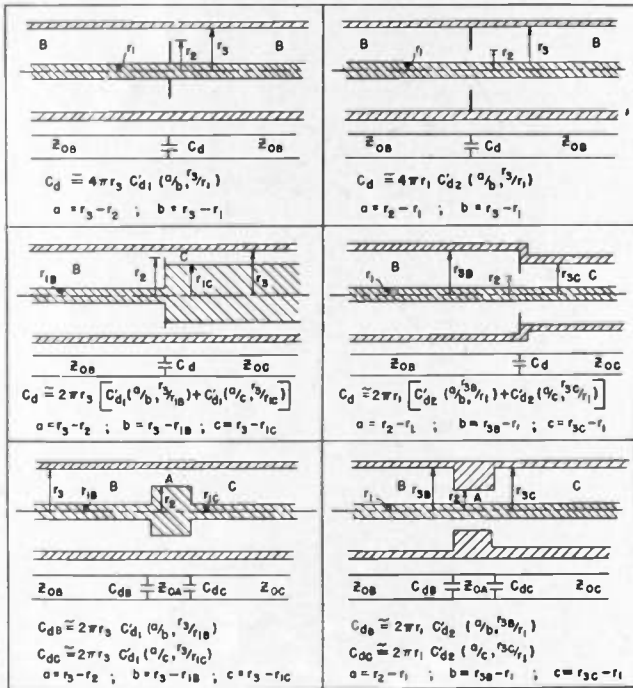

Fig. 15—Diaphragm discontinuities in coaxial lines. $C_{d1}'(\alpha, \tau)$ given by Fig. 8, $C_{d2}'(\alpha, \tau)$ given by Fig. 9.

(13) may be considered as the expansion in a Bessel function series of this function over that range. For the B_0 term, the function itself may be integrated

$$\int_{r_1}^{r_3} \left[\frac{B_0}{r} + \sum_n B_n Z_1(k_{Bn}r) \right] dr = \int_{r_1}^{r_3} E_r dr = \int_{r_2}^{r_3} \left[\frac{A_0}{r} + \sum_m A_m Z_1(k_{Am}r) \right] dr \quad (19)$$

The following integral may be found in the references on Bessel functions:²

$$\frac{B_n}{2} [r_3^2 Z_1^2(k_{Bn}r_3) - r_1^2 Z_1^2(k_{Bn}r_1)] = \frac{A_0}{k_{Bn}} Z_0(k_{Bn}r_2) - \sum_m \frac{A_m(k_{Bn}r_2) Z_1(k_{Am}r_2) Z_0(k_{Bn}r_2)}{k_{Am}^2 - k_{Bn}^2}$$

or

$$\frac{B_n}{k_{Bn}A_0} = \frac{2Z_0(k_{Bn}r_2)}{\{ [k_{Bn}r_3 Z_1(k_{Bn}r_3)]^2 - [k_{Bn}r_1 Z_1(k_{Bn}r_1)]^2 \}} \left[1 - r_2 \sum_m \frac{A_m Z_1(k_{Am}r_2)}{A_0(k_{Am}^2/k_{Bn}^2 - 1)} \right] \quad (25)$$

$$\int Z_1(kr) dr = -\frac{1}{k} Z_0(kr) \quad (20)$$

So integrating, substituting limits, and recalling (4)

$$B_0 \ln(r_3/r_1) = A_0 \ln(r_3/r_2) \quad (21)$$

For the higher-order coefficients, an integration similar to (19) is performed except that both sides are first multiplied by $rZ_1(k_{Bn}r)$.

$$\int_{r_1}^{r_3} \left[\frac{B_0}{r} + \sum_n B_n Z_1(k_{Bn}r) \right] r Z_1(k_{Bn}r) dr = \int_{r_1}^{r_3} E_r r Z_1(k_{Bn}r) dr = \int_{r_2}^{r_3} \left[\frac{A_0}{r} + \sum_m A_m Z_1(k_{Am}r) \right] r Z_1(k_{Bn}r) dr \quad (22)$$

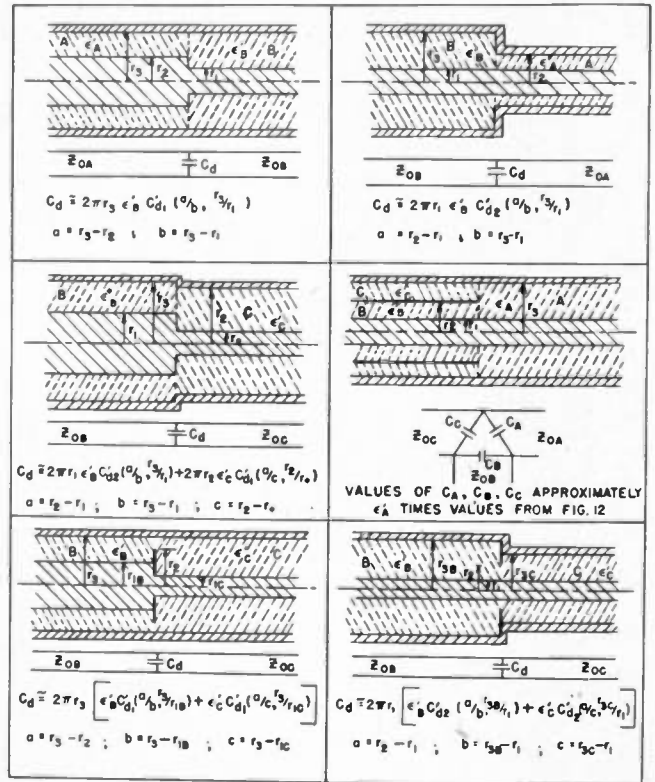

Fig. 16—Dielectric discontinuities in coaxial lines $C_{d1}'(\alpha, \tau)$ given by Fig. 8, $C_{d2}'(\alpha, \tau)$ given by Fig. 9.

The above integrals may be evaluated through Lommel integrals which lead to the orthogonality property of Bessel functions.

$$\int r Z_1^2(\alpha r) dr = \frac{r^2}{2} \{ Z_1^2(\alpha r) - Z_0(\alpha r) Z_2(\alpha r) \} \quad (23)$$

$$\int r Z_1(\alpha r) Z_1(\beta r) dr = \frac{\beta r Z_1(\alpha r) Z_0(\beta r) - \alpha r Z_0(\alpha r) Z_1(\beta r)}{\alpha^2 - \beta^2} \quad (24)$$

If (22) is thus integrated, and limits substituted with reference to (4),

Now (18) is used in a similar manner, being first integrated over the range $r_2 < r < r_3$.

$$\int_{r_2}^{r_3} \left[\frac{Y_{A0}A_0}{r} + \sum_m Y_{Am}A_m Z_1(k_{Am}r) \right] dr$$

$$= \int_{r_2}^{r_3} \left[\frac{Y_{B0}B_0}{r} + \sum_n Y_{Bn}B_n Z_1(k_{Bn}r) \right] dr$$

$$Y_{A0}A_0 \ln \left(\frac{r_3}{r_2} \right) = Y_{B0}B_0 \ln \left(\frac{r_3}{r_2} \right)$$

$$+ \sum_n \frac{Y_{Bn}B_n}{k_{Bn}} Z_0(k_{Bn}r_2). \quad (26)$$

Next (18) is multiplied by $rZ_1(k_{Ap}r)$ before integrating over the range $r_2 < r < r_3$. The integrals (20), (23), and (24) and the limits (4) are again used.

$$\int_{r_2}^{r_3} \left[\frac{Y_{A0}A_0}{r} + \sum_m Y_{Am}A_m Z_1(k_{Am}r) \right] rZ_1(k_{Ap}r) dr$$

$$= \int_{r_2}^{r_3} \left[\frac{Y_{B0}B_0}{r} + \sum_n Y_{Bn}B_n Z_1(k_{Bn}r) \right] rZ_1(k_{Ap}r) dr$$

$$\frac{Y_{Ap}A_p}{2} [r_3^2 Z_1^2(k_{Ap}r_3) - r_2^2 Z_1^2(k_{Ap}r_2)]$$

$$= - \sum_n \frac{Y_{Bn}B_n k_{Bn} r_2 Z_1(k_{Ap}r_2) Z_0(k_{Bn}r_2)}{k_{Ap}^2 - k_{Bn}^2}. \quad (27)$$

In reviewing (21), (25), (26), and (27), we see that in (21) the term on the left is the voltage of the principal wave in line B at $z=0$, while the term on the right is the voltage in the principal wave of line A, so this may

$$Y_d = \frac{j2\pi\omega\epsilon}{\ln^2(r_3/r_2)} \sum_n \frac{2Z_0^2(k_{Bn}r_2)}{K_{Bn}k_{Bn} \{ [k_{Bn}r_3 Z_1(k_{Bn}r_3)]^2 - [k_{Bn}r_1 Z_1(k_{Bn}r_1)]^2 \}} \left[1 - r_2 \sum_m \frac{A_m Z_1(k_{Am}r_2)}{A_0(k_{Am}^2/k_{Bn}^2 - 1)} \right].$$

Writing Y_d in terms of a capacitance C_d , $Y_d = j\omega C_d$. Then

$$\frac{C_d}{2\pi r_3} = \frac{2\epsilon}{\ln^2(r_3/r_2)} \sum_n \frac{Z_0^2(k_{Bn}r_2)}{K_{Bn}k_{Bn}r_3 \{ [k_{Bn}r_3 Z_1(k_{Bn}r_3)]^2 - [k_{Bn}r_1 Z_1(k_{Bn}r_1)]^2 \}} \left[1 - r_2 \sum_m \frac{A_m Z_1(k_{Am}r_2)}{A_0(k_{Am}^2/k_{Bn}^2 - 1)} \right]. \quad (31)$$

be written

$$V_0 = V_{0B} |_{z=0} = V_{0A} |_{z=0} = -A_0 \ln(r_3/r_2). \quad (28)$$

The current in either line may be related to the magnetic field,

$$I_z = -2\pi r_3 H_\phi |_{r=r_3}$$

so (26) may be written in terms of the principal-wave currents in the two lines

$$\frac{A_p \{ [(k_{Ap}r_3)^2 Z_1^2(k_{Ap}r_3)] - [(k_{Ap}r_2)^2 Z_1^2(k_{Ap}r_2)] \}}{4K_{Ap}k_{Ap}A_0 Z_1(k_{Ap}r_2)} = \sum_n \frac{k_{Bn}r_2 Z_0^2(k_{Bn}r_2)}{K_{Bn}(1 - k_{Bn}^2/k_{Ap}^2) \{ [k_{Bn}r_3 Z_1(k_{Bn}r_3)]^2 - [k_{Bn}r_1 Z_1(k_{Bn}r_1)]^2 \}} - \sum_m \frac{A_m Z_1(k_{Am}r_2)}{k_{Am}A_0 k_{Am}r_2} \sum_n \frac{K_{Bn}(1 - k_{Bn}^2/k_{Am}^2)(1 - k_{Bn}^2/k_{Ap}^2) \{ [k_{Bn}r_3 Z_1(k_{Bn}r_3)]^2 - [k_{Bn}r_1 Z_1(k_{Bn}r_1)]^2 \}}{(k_{Bn}\sqrt{2})^3 Z_0^2(k_{Bn}r_2)} \quad (32)$$

$$\begin{aligned} I_{0A} |_{z=0} &= -2\pi Y_{A0}A_0 \\ I_{0B} |_{z=0} &= -2\pi Y_{B0}B_0 \\ (I_{0B} - I_{0A}) |_{z=0} &= V_0 Y_d \end{aligned} \quad (29)$$

where

$$Y_d = - \frac{2\pi}{\ln^2(r_3/r_2)} \sum_n \frac{Y_{Bn}B_n Z_0(k_{Bn}r_2)}{k_{Bn}A_0}. \quad (30)$$

Equation (29) shows that current in the principal waves is not continuous across the change of section, but is

discontinuous by an amount that may be taken care of by shunting across the junction the discontinuity admittance Y_d defined by (30). It remains to be shown that this is calculable.

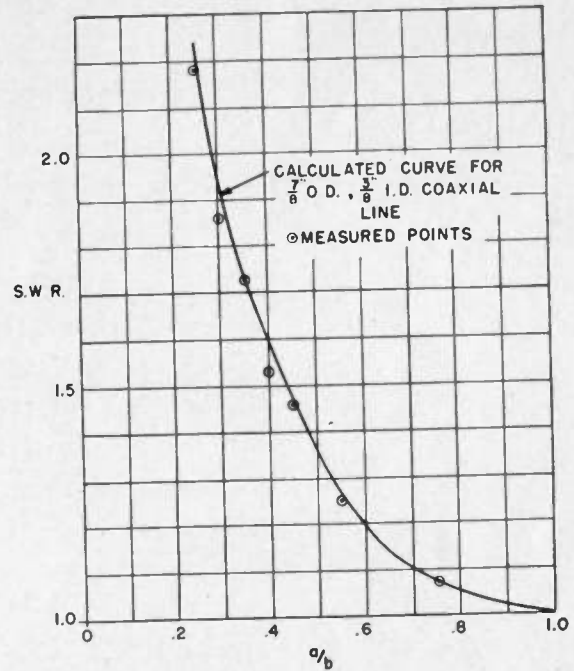

Fig. 17—Comparison of measured and calculated standing-wave ratios for a discontinuity as in Fig. 7(a).

Equation (25) gives an expression for $B_n/k_{Bn}A_0$ appearing in (30), and Y_{Bn} is obtained from (15).

The first part of the summation in (31) may be calculated at once. It turns out that this is the most important part, and for many purposes offers a sufficiently good approximation. However, a matrix may be obtained for determination of the coefficients A_m/A_0 so that the last correction term may also be included. To obtain this, substitute $B_n/k_{Bn}A_0$ from (25) and the relations (15) in (27).

The last summation may be broken into two parts by a partial fraction expression and the infinite matrix of simultaneous equations is thus formally obtained for determination of the coefficients A_p/A_0 .

For purposes of calculation, it is convenient to define certain functions similar to Hahn's functions in sinusoids. In particular, if they are chosen properly, the asymptotic expansions for the Bessel functions show that the n 'th term in one of these series rapidly

approaches the corresponding term in the Hahn function as n increases. Define $a = r_3 - r_2$ and $b = r_3 - r_1$.

$$L_0(a/b, r_3/r_1) = \sum_n \beta_{0n} = S_0(a/b) + \sum_n (\beta_{0n} - \alpha_{0n}) \quad (33)$$

$$L_p(a/b, r_3/r_1) = \sum_n \beta_{pn} = S_p(a/b) + \sum_n (\beta_{pn} - \alpha_{pn}) \quad (34)$$

$$M_p(a/b, r_3/r_1) = \sum_n \gamma_{pn} = U_p(a/b) + \sum_n (\gamma_{pn} - \rho_{pn}) \quad (35)$$

where

$$\begin{aligned} \beta_{0n} &= \frac{\pi^3 k_{Bn} r_2 Z_0^2(k_{Bn} r_2)}{K_{Bn}(k_{Bn} a)^2 \{ [k_{Bn} r_3 Z_1(k_{Bn} r_3)]^2 - [k_{Bn} r_1 Z_1(k_{Bn} r_1)]^2 \}} \\ \beta_{pn} &= \frac{\pi k_{Bn} r_2 Z_0^2(k_{Bn} r_2)}{K_{Bn}(k_{Bn}^2/k_{Ap}^2 - 1) \{ [k_{Bn} r_3 Z_1(k_{Bn} r_3)]^2 - [k_{Bn} r_1 Z_1(k_{Bn} r_1)]^2 \}} \\ \gamma_{pn} &= \frac{(k_{Bn} a)^2 k_{Bn} r_2 Z_0^2(k_{Bn} r_2)}{K_{Bn} p^2 \pi (k_{Bn}^2/k_{Ap}^2 - 1)^2 \{ [k_{Bn} r_3 Z_1(k_{Bn} r_3)]^2 - [k_{Bn} r_1 Z_1(k_{Bn} r_1)]^2 \}} \\ \alpha_{0n} &= \frac{\sin^2(n\pi a/b)}{n^3(a/b)^2} & \rho_{pn} &= \frac{n(a/b)^2 \sin^2(n\pi a/b)}{p^2((n^2 a^2/p^2 b^2) - 1)^2} \\ \alpha_{pn} &= \frac{\sin^2(n\pi a/b)}{n((n^2 a^2/p^2 b^2) - 1)} \end{aligned}$$

The functions $S_0(a/b)$, $S_p(a/b)$ and $U_p(a/b)$ are the Hahn functions for which values are given in Appendix E of reference 1. The divisions (33) to (35) are made since the series $(\beta_{0n} - \alpha_{0n})$, etc. converge extremely rapidly, usually only two or three terms being required. In terms of these defined functions, and the substitution

$$\frac{A_m'}{A_0} = \frac{(-1)^m A_m Z_1(k_{Am} r_2)}{k_{Am} A_0}$$

C_d may be written more simply.

$$\frac{C_d}{2\pi r_3} = \frac{2\epsilon}{\pi^3} \left[\frac{a^2 L_0(a/b, r_3/r_1)}{r_2 r_3 \ln^2(r_3/r_2)} + \frac{\pi^2}{\ln^2(r_3/r_2)} \sum_m \frac{(-1)^m (A_m'/A_0) L_m(a/b, r_3/r_1)}{k_{Am} r_3} \right] \quad (36)$$

or

$$\begin{aligned} B_0 \ln r_3/r_1 &= A_0 \ln r_3/r_2 \\ V_{0B} &= V_{0A} \\ \frac{B_n}{k_{Bn} A_0} &= \frac{-2Z_0(k_{Bn} r_2) [1 - r_2 \sum_m [A_m Z_1(k_{Am} r_2)/A_0 (k_{Am}^2/k_{Bn}^2 - 1)]]}{\{ [k_{Bn} r_3 Z_1(k_{Bn} r_3)]^2 - [k_{Bn} r_1 Z_1(k_{Bn} r_1)]^2 \}} \\ (Y_{A0} A_0 - Y_{B0} B_0) \ln \frac{r_2}{r_1} &= - \sum_n \frac{Y_{Bn} B_n Z_0(k_{Bn} r_2)}{k_{Bn}} \\ Y_{Ap} A_p &= \frac{-2Z_1(k_{Ap} r_2)}{\{ [k_{Ap} r_3 Z_1(k_{Ap} r_3)]^2 - [k_{Ap} r_1 Z_1(k_{Ap} r_1)]^2 \}} \sum_n \frac{Y_{Bn} B_n k_{Bn} r_2 Z_0(k_{Bn} r_2)}{k_{Bn}^2/k_{Ap}^2 - 1} \end{aligned} \quad (39)$$

where the coefficients A_m'/A_0 are obtained by retaining a finite number (usually about 4) of the equations from the following infinite matrix and solving simultaneously by a rapid method of successive approximations.

$$\begin{aligned} [G_{mp}] [A_m'/A_0] &= [h_p] \\ G_{mp} &= \frac{(-1)^m k_{Am} r_3}{p^2 (1 - k_{Am}^2/k_{Ap}^2)} [L_p(a/b, r_3/r_1) - L_m(a/b, r_3/r_1)] \\ G_{pp} &= (-1)^p \left[\frac{\pi r_3 \{ [k_{Ap} r_3 Z_1(k_{Ap} r_3)]^2 - [k_{Ap} r_2 Z_1(k_{Ap} r_2)]^2 \}}{4p^2 K_{Ap} r_2 Z_1^2(k_{Ap} r_2)} + \frac{\pi^2 r_3 M_p(a/b, r_3/r_1)}{k_{Ap} a^2} \right] \\ h_p &= - (r_3/p^2 r_2) L_p(a/b, r_3/r_1). \end{aligned} \quad (37)$$

Equation (36) with the matrix (37) and accompanying definitions was used for calculation of the discontinuity capacity for the problem, enough terms in the series being retained to give accuracy consistent with presentation of results in a graph form. The results are given in Fig. 8.

B. Sudden Change in Diameter of Outer Cylinder

Since the solution for this case closely parallels that in the foregoing example, the main steps will merely be outlined. The wave solutions in the A and B spaces are similar to those given in (1) and (2).

The total field components at $z=0$ are given by (11) through (16). The matching conditions at $z=0$ are

$$\begin{aligned} (a) \quad E_{rB} &= E_{rA} & r_1 < r < r_2 \\ (b) \quad E_{rB} &= 0 & r_2 < r < r_3 \\ (c) \quad H_{\phi A} &= H_{\phi B} & r_1 < r < r_2 \end{aligned} \quad (38)$$

The matching operations using these conditions follow these steps

- Obtain B 's in terms of A 's from 38(a) and (38-b)
- Obtain A 's in terms of B 's from condition (38-c).

The resulting equations are

Equation (39) shows continuity of principal-wave voltage at $z=0$ while (41) states that there is a discontinuity of principal-wave current given by the summation. This

current discontinuity can be written in terms of a lumped capacitance,

$$C_d = - \frac{2\pi\epsilon r_3}{\ln^2(r_2/r_1)} \sum_n \frac{(B_n/A_0 k_{Bn}) Z_0(k_{Bn} r_2)}{K_{Bn} k_{Bn} r_3}$$

$$\text{or } \frac{C_d}{2\pi\epsilon r_1} = \frac{2\epsilon}{\ln^2(r_2/r_1)} \left[\sum_n \frac{Z_0^2(k_{Bn} r_2)}{K_{Bn} k_{Bn} r_1 \{ [k_{Bn} r_3 Z_1(k_{Bn} r_3)]^2 - [k_{Bn} r_1 Z_1(k_{Bn} r_1)]^2 \}} \left\{ 1 - r_2 \sum_m \frac{A_m Z_1(k_{Am} r_2)}{A_0 (k_{Am}^2/k_{Bn}^2 - 1)} \right\} \right] \quad (43)$$

This expression may be written in terms of the L and M functions defined by (33) to (35). For the present problem, $a = r_2 - r_1$ and $b = r_3 - r_1$.

$$\frac{C_d}{2\pi\epsilon r_1} = \frac{2}{\pi^2} \left[\frac{(b-a)^2 L_0((b-a)/b, r_3/r_1)}{r_1 r_2 \ln^2(r_2/r_1)} + \frac{\pi^2}{r_1 \ln^2(r_2/r_1)} \sum_m \frac{(-1)^m A_m' L_m((b-a)/b, r_3/r_1)}{A_0 (k_{Am} r_2)^2} \right] \quad (44)$$

where

$$\frac{A_m'}{A_0} = \frac{(-1)^m A_m Z_1(k_{Am} r_2)}{k_{Am} A_0}$$

Substituting (40) in (42) results in the matrix equation for determination of the wave amplitudes. This can be written in the form

$$[g_{mp}] [A_m'/A_0] = [h_p] \quad (45)$$

$$g_{mp} = \frac{(-1)^m k_{Am} r_1}{\rho^2 (1 - k_{Am}^2/k_{Ap}^2)} [L_p((b-a)/b, r_3/r_1) - L_m((b-a)/b, (r_3/r_1))]$$

$$g_{pp} = (-1)^p \left[\frac{\pi r_1 \{ [k_{Ap} r_2 Z_1(k_{Ap} r_2)]^2 - [k_{Ap} r_1 Z_1(k_{Ap} r_1)]^2 \}}{4 \rho^2 K_{Ap} r_2 Z_1^2(k_{Ap} r_2)} + \frac{\pi^2 r_1 M_p((b-a)/b, (r_3/r_1))}{k_{Ap} \rho^2} \right]$$

$$h_p = - (r_1/\rho^2 r_2) L_p((b-a)/b, r_3/r_1).$$

C. Sudden Change in Diameter of Both Cylinders

The total field components in regions B and C at $z=0$ are again given by (11) through (16) with the additional equations to express the E and H fields in the A space. These equations are

$$\left. \begin{aligned} E_{rA} &= A_0/r + \sum_m A_m Z_1(k_{Am} r) \\ H_{\phi A} &= Y_{A0} A_0/r + \sum_m Y_{Am} A_m Z_1(k_{Am} r) \end{aligned} \right\} \quad (46)$$

$$\left. \begin{aligned} E_{rB} &= B_0/r + \sum_n B_n Z_1(k_{Bn} r) \\ H_{\phi B} &= Y_{B0} B_0/r + \sum_n Y_{Bn} B_n Z_1(k_{Bn} r) \end{aligned} \right\} \quad (47)$$

$$\left. \begin{aligned} E_{rC} &= C_0/r + \sum_q C_q Z_1(k_{Cq} r) \\ H_{\phi C} &= Y_{C0} C_0/r + \sum_q Y_{Cq} C_q Z_1(k_{Cq} r) \end{aligned} \right\} \quad (48)$$

The boundary conditions at $z=0$ are

$$\left. \begin{aligned} E_{rB} &= E_{rA} & r_1 < r < r_2 \\ E_{rB} &= 0 & r_2 < r < r_3 \end{aligned} \right\} \quad (49)$$

$$\left. \begin{aligned} H_{\phi A} &= H_{\phi B} & r_1 < r < r_2 \\ E_{rC} &= E_{rA} & r_1 < r < r_2 \\ E_{rC} &= 0 & r_0 < r < r_1 \end{aligned} \right\} \quad (50)$$

$$H_{\phi C} = H_{\phi A} \quad r_1 < r < r_2$$

Utilizing the above matching operations in the usual way, the following equations result:

$$B_0 \ln r_1/r_3 = A_0 \ln r_1/r_2 \quad (51)$$

$$B_n [r_1^2 Z_1^2(k_{Bn} r_1) - r_3^2 Z_1^2(k_{Bn} r_3)] = 2 \left\{ \frac{A_0 Z_0(k_{Bn} r_2)}{k_{Bn}} - \sum_m \frac{A_m k_{Bn} r_2 Z_0(k_{Bn} r_2) Z_1(k_{Am} r_2)}{k_{Am}^2 - k_{Bn}^2} \right\} \quad (52)$$

$$(Y_{A0} A_0 - Y_{B0} B_0) \ln r_1/r_2 = \sum_n \frac{Y_{Bn} B_n Z_0(k_{Bn} r_2)}{k_{Bn}} \quad (53)$$

$$Y_{Am} A_m [r_1^2 Z_1^2(k_{Am} r_1) - r_2^2 Z_1^2(k_{Am} r_2)] = 2 \sum_n \frac{-Y_{Bn} B_n k_{Bn} r_2 Z_0(k_{Bn} r_2) Z_1(k_{Am} r_2)}{k_{Am}^2 - k_{Bn}^2} \quad (54)$$

$$C_0 \ln r_0/r_2 = A_0 \ln r_1/r_2 \quad (55)$$

$$C_q [r_0^2 Z_1^2(k_{Cq} r_0) - r_2^2 Z_1^2(k_{Cq} r_2)] = -2 \left\{ \frac{A_0 Z_0(k_{Cq} r_1)}{k_{Cq}} - \sum_m \frac{A_m k_{Cq} r_1 Z_0(k_{Cq} r_1) Z_1(k_{Am} r_1)}{k_{Am}^2 - k_{Cq}^2} \right\} \quad (56)$$

$$(Y_{A0} A_0 - Y_{C0} C_0) \ln \frac{r_1}{r_2} = - \sum_q \frac{Y_{Cq} C_q Z_0(k_{Cq} r_1)}{k_{Cq}} \quad (57)$$

$$Y_{Am} A_m [r_1^2 Z_1^2(k_{Am} r_1) - r_2^2 Z_1^2(k_{Am} r_2)] = 2 \sum_q \frac{Y_{Cq} C_q k_{Cq} r_1 Z_0(k_{Cq} r_1) Z_1(k_{Am} r_1)}{k_{Am}^2 - k_{Cq}^2} \quad (58)$$

$$Y_{Am} = \frac{j\omega\epsilon}{K_{Am} k_{Am}} \quad Y_{Bn} = \frac{-j\omega\epsilon}{K_{Bn} k_{Bn}} \quad Y_{Cq} = \frac{j\omega\epsilon}{K_{Cq} k_{Cq}}$$

Now (53) and (57) show that there is a discontinuity of principal-wave current across the plane $z=0$ while (51) and (55) establish continuity of principal-wave voltage. This discontinuity of current can be represented in terms of a lumped capacitance at $z=0$ by the relation

$$j\omega C_d = \frac{I_{0B} - I_{0A}}{V} = \frac{-2\pi [Y_{B0} B_0 + Y_{C0} C_0]}{V} \quad (58a)$$

where $V = -B_0 \ln r_1/r_3 = -A_0 \ln r_1/r_2 = -C_0 \ln r_0/r_2$.

Solving (51) and (55) for $Y_{B0} B_0 - Y_{C0} C_0$ and substituting for $Y_{Bn} B_n$ and $Y_{Cq} C_q$ from (52) and (56) in the resulting expression, the results are

$$\frac{C_d}{2\pi\epsilon r_1} = \sum_n \frac{2Z_0^2(k_{Bn}r_2)}{K_{Bn}k_{Bn}r_1 \ln^2(r_1/r_2) \{ [k_{Bn}r_3Z_1(k_{Bn}r_3)]^2 - [k_{Bn}r_1Z_1(k_{Bn}r_1)]^2 \}} \left\{ 1 - \sum_m \frac{r_2A_mZ_1(k_{Am}r_2)}{A_0(k_{Am}^2/k_{Bn}^2 - 1)} \right\} \\ + \sum_q \frac{2Z_0^2(k_{cq}r_1)}{K_{cq}k_{cq}r_1 \ln^2(r_1/r_2) \{ [k_{cq}r_2Z_1(k_{cq}r_2)]^2 - [k_{cq}r_0Z_1(k_{cq}r_0)]^2 \}} \left\{ 1 - \sum_m \frac{A_mr_1Z_1(k_{Am}r_1)}{A_0(k_{Am}^2/k_{cq}^2 - 1)} \right\}. \quad (59)$$

Substituting (56) in (58) for $Y_{cq}C_q$ gives the matrix equation for A_m/A_0 which can be written as

$$[g_{pm}][A_m/A_0] = [h_p] \\ g_{pm} = \frac{Z_1(k_{Ap}r_2)Z_1(k_{Am}r_2)}{p^2\pi^2r_1(1 - k_{Am}^2/k_{Ap}^2)} [L_p(a/b, r_3/r_1) - L_m(a/b, r_3/r_1)] + \frac{Z_1(k_{Ap}r_1)Z_1(k_{Am}r_1)}{p^2\pi^2r_2(1 - k_{Am}^2/k_{Ap}^2)} [L_p(a/c, r_2/r_0) - L_m(a/c, r_2/r_0)] \\ g_{pp} = \frac{Z_1^2(k_{Ap}r_2)M_p(a/b, r_3/r_1)}{r_1[k_{Ap}r_2 - k_{Ap}r_1]^2} + \frac{Z_1^2(k_{Ap}r_1)M_p(a/c, r_2/r_0)}{r_2[k_{Ap}r_2 - k_{Ap}r_1]^2} \\ h_p = \frac{-1}{p^2\pi^2r_2} [Z_1(k_{Ap}r_2)L_p(a/b, r_3/r_1) + Z_1(k_{Ap}r_1)L_p(a/c, r_2/r_0)].$$

D. Re-entrant Discontinuity

Expressions for the total field components at $z=0$ in the three regions may be written in the same form as for the previous case. Thus (46), (47), and (48) also hold for Fig. 7e. Continuity of fields at $z=0$ required that

$$\begin{aligned} (a) \quad E_{rA} &= E_{rB} & r_1 < r < r_2 \\ (b) \quad E_{rA} &= E_{rC} & r_2 < r < r_3 \\ (c) \quad H_{\phi A} &= H_{\phi B} & r_2 < r < r_3 \\ (d) \quad H_{\phi A} &= H_{\phi C} & r_1 < r < r_2. \end{aligned} \quad (60)$$

The matching operations follow these steps

- (a) Obtain A 's in terms of B 's and C 's utilizing (60-a) and (60-b).
- (d) Obtain equation for $Y_{B0}B_0$ in terms of $Y_{A0}A_0$ and $Y_{Am}A_m$ from (60(c)).
- (c) Obtain equation for $Y_{c0}C_0$ in terms of A 's from (60(d)).

The equations resulting from these operations are

$$A_0 \ln r_3/r_1 = B_0 \ln r_2/r_1 + C_0 \ln r_3/r_2 \quad (61)$$

$$\frac{1}{2}A_m[r_1^2Z_1^2(k_{Am}r_1) - r_3^2Z_1^2(k_{Am}r_3)] \\ = -\frac{B_0Z_0(k_{Am}r_2)}{k_{Am}} + \frac{C_0Z_0(k_{Am}r_2)}{k_{Am}} \\ + \sum_n \frac{-B_n r_2 [k_{Am}Z_0(k_{Am}r_2)Z_0(k_{Bn}r_2)]}{k_{Am}^2 - k_{Bn}^2} \\ + \sum_q \frac{C_q r_2 [k_{Am}Z_0(k_{Am}r_2)Z_1(k_{cq}r_2)]}{k_{Am}^2 - k_{cq}^2} \quad (62)$$

$$Y_{B0}B_0 \ln r_2/r_1 = Y_{A0}A_0 \ln r_2/r_1 \\ - \sum_m (Y_{Am}A_m/k_{Am})Z_0(k_{Am}r_2) \quad (63)$$

$$Y_{c0}C_0 \ln r_3/r_2 = Y_{A0}A_0 \ln r_3/r_2 \\ + \sum_m (Y_{Am}A_m/k_{Am})Z_0(k_{Am}r_2) \quad (64)$$

$$\frac{1}{2}Y_{Bn}B_n[r_2^2Z_1^2(k_{Bn}r_2) - r_1^2Z_1^2(k_{Bn}r_1)] \\ = -\sum_m \frac{Y_{Am}A_m k_{Am} r_2 Z_0(k_{Am}r_2)Z_1(k_{Am}r_2)}{k_{Am}^2 - k_{Bn}^2} \quad (65)$$

$$\frac{1}{2}Y_{cq}C_q[r_3^2Z_1^2(k_{cq}r_3) - r_2^2Z_1^2(k_{cq}r_2)] \\ = \sum_m \frac{Y_{Am}A_m k_{Am} r_2 Z_0(k_{Am}r_2)Z_1(k_{cq}r_2)}{k_{Am}^2 - k_{cq}^2} \quad (66)$$

Equation (61) shows that the voltage in line A is the sum of the voltages in lines B and C . Equations (63) and (64) show that the *zero-order* currents do not add in a simple manner given by Kirchhoff's law at the junction, but differ by the factor of the summation.

Adding (63) and (64) and substituting from (61),

$$\frac{B_0}{A_0} = \frac{(Y_{A0} - Y_{C0}) \ln r_3/r_1}{(Y_{B0} - Y_{C0}) \ln r_2/r_1} \\ \frac{C_0}{A_0} = \frac{(Y_{A0} - Y_{B0}) \ln r_3/r_1}{(Y_{C0} - Y_{B0}) \ln r_3/r_2} \quad (67)$$

Substituting this in (62) and making the change of variable

$$A_m' = \frac{A_m}{(Y_{A0} - Y_{B0}) \ln r_3/r_1 - (Y_{A0} - Y_{C0}) \ln r_3/r_1} \\ \frac{(Y_{C0} - Y_{B0}) \ln r_3/r_2 - (Y_{B0} - Y_{C0}) \ln r_2/r_1} \quad (68)$$

there results the matrix equation

$$\frac{1}{2} \frac{A_m' r_3 [r_3^2 Z_1^2(k_{Am} r_3) - r_1^2 Z_1^2(k_{Am} r_1)]}{A_0 r_2 k_{Am} r_2 Z_0(k_{Am} r_2)} = \frac{1}{(k_{Am} r_2)^2} \\ + 2 \sum_p \frac{Y_{Ap} A_p' k_{Ap} r_2 Z_0(k_{Ap} r_2)}{A_0} \left\{ \left[\sum_n \frac{Z_1^2(k_{Bn} r_2)}{Y_{Bn} [r_2^2 Z_1^2(k_{Bn} r_2) - r_1^2 Z_1^2(k_{Bn} r_1)] (k_{Ap}^2 - k_{Bn}^2) (k_{Am}^2 - k_{Bn}^2)} \right] \right. \\ \left. + \left[\sum_q \frac{Z_1^2(k_{cq} r_2)}{Y_{cq} [r_3^2 Z_1^2(k_{cq} r_3) - r_2^2 Z_1^2(k_{cq} r_2)] (k_{Ap}^2 - k_{cq}^2) (k_{Am}^2 - k_{cq}^2)} \right] \right\}. \quad (69)$$

While this expression is not in the usual matrix form, it is useful in that it formally defines (A_m/A_0) and shows this ratio to be independent of all Y_0 's.

Now substituting in (63),

$$-\sum_m \frac{r_1 Y_{Am} A_m' Z_0(k_{Am} r_2)}{A_0 k_{Am}} = \frac{Y_{B0}(Y_{A0} - Y_{C0}) \ln r_3/r_1 - Y_{A0}(Y_{B0} - Y_{C0}) \ln r_2/r_1}{(Y_{B0} - Y_{A0}) \ln r_2/r_1 + \frac{(Y_{C0} - Y_{A0}) \ln r_3/r_1}{\ln r_2/r_1}} \quad (70)$$

If we now represent the discontinuity of zero-order currents at $z=0$ by an equivalent circuit, Fig. 7(e), as shown and define Y_A , Y_B , and Y_C to be

$$\begin{aligned} Y_A &= A \sum_m \frac{Y_{Am} A_m' Z_0(k_{Am} r_2)}{A_0 k_{Am}} = j\omega C_A \\ Y_B &= B \sum_m \frac{Y_{Am} A_m' Z_0(k_{Am} r_2)}{A_0 k_{Am}} = j\omega C_B \\ Y_C &= C \sum_m \frac{Y_{Am} A_m' Z_0(k_{Am} r_2)}{A_0 k_{Am}} = j\omega C_C \end{aligned} \quad (71)$$

The constants A , B , and C are determined from (70) and are found to be

$$\begin{aligned} A &= -\frac{2\pi}{\ln r_3/r_2 \ln r_2/r_1} \\ B &= \frac{2\pi \ln r_3/r_1}{\ln r_3/r_2 \ln^2 r_2/r_1} \\ C &= \frac{2\pi \ln r_3/r_1}{\ln r_2/r_1 \ln^2 r_3/r_2} \end{aligned} \quad (72)$$

Substitute from (69) for A_m'/A_0 in (71) to obtain the expressions for the discontinuity admittances

$$\begin{aligned} Y_A &= \frac{2A j\omega \epsilon a^2}{\pi^3 r_2} \sum_m \frac{\pi^3 k_{Am} r_2 Z_0^2(k_{Am} r_2)}{(k_{Am} a)^2 K_{Am} \{ [k_{Am} r_3 Z_1(k_{Am} r_3)]^2 - [k_{Am} r_1 Z_1(k_{Am} r_1)]^2 \}} + \sum_m \dots \\ Y_B &= \frac{2B j\omega \epsilon a^2}{\pi^3 r_2} \sum_m \frac{\pi^3 k_{Am} r_2 Z_0^2(k_{Am} r_2)}{(k_{Am} a)^2 K_{Am} \{ [k_{Am} r_3 Z_1(k_{Am} r_3)]^2 - [k_{Am} r_1 Z_1(k_{Am} r_1)]^2 \}} + \sum_m \dots \\ Y_C &= \frac{2C j\omega \epsilon a^2}{\pi^3 r_2} \sum_m \frac{\pi^3 k_{Am} r_2 Z_0^2(k_{Am} r_2)}{(k_{Am} a)^2 K_{Am} \{ [k_{Am} r_3 Z_1(k_{Am} r_3)]^2 - [k_{Am} r_1 Z_1(k_{Am} r_1)]^2 \}} + \sum_m \dots \end{aligned} \quad (73)$$

The $\sum_m \dots$ denotes the rather complex summation resulting from the last terms of (69). The first terms are the most important, and may be identified with the $L_0(a/b, r_3/r_1)$ function defined by (33). The approximate expression for the discontinuity capacitances including only the first terms are

$$\begin{aligned} \frac{C_A}{2\pi r_3} &\cong \frac{-2\epsilon a^2 L_0(a/b, r_3/r_1)}{\pi^3 r_3 r_2 \ln r_3/r_2 \ln r_2/r_1} \\ \frac{C_B}{2\pi r_3} &\cong \frac{2\epsilon a^2 \ln r_3/r_1 L_0(a/b, r_3/r_1)}{\pi^3 r_3 r_2 \ln r_3/r_2 \ln^2 r_2/r_1} \\ \frac{C_C}{2\pi r_3} &\cong \frac{2\epsilon a^2 \ln r_3/r_1 L_0(a/b, r_3/r_1)}{\pi^3 r_3 r_2 \ln r_2/r_1 \ln^2 r_3/r_1} \end{aligned} \quad (74)$$

The values from which the approximate curves of Fig. 12 were plotted were obtained from these equations.

E. Proximity Factors

If a disk termination is electrically close to the discontinuity, both positive and negative exponential terms must be included in the local waves for the line containing the disk. Thus if in Fig. 7(a) or 7(b) the short-circuiting disk is in the B line (the line with wider spacing) the value of Y_{Bn} is modified from the result of (15). If both exponentials are included and E_r set equal to zero at $z = -l$, Y_{Bn} is found to be

$$Y_{Bn} = -j\omega \epsilon / \gamma_n \coth(\gamma_n l)$$

where $\gamma_n = k_{Bn} K_{Bn} = k_{Bn} \sqrt{1 - (k/k_{Bn})^2}$.

This value of Y_{Bn} is then used in (30) in place of (15) for calculation of the discontinuity capacitance accounting for the effect of the disk. The ratio of the result to the corresponding value without the disk is the defined proximity factor.

A Network Theorem*

N. I. KORMAN†, ASSOCIATE, I.R.E.

Summary—A simple equation relating the impedance of a two-terminal network made up of low-loss reactances to the reactance of the same network of zero-loss reactances is developed. Illustrative problems are solved.

IF THE impedance of a two-terminal network of pure reactances is

$$X = X(j\omega) \quad (1)$$

then it may be shown that¹

$$Z = \sqrt{\frac{(j\omega + \omega/Q_L)}{(j\omega + \omega/Q_C)}} X(\sqrt{(j\omega + \omega/Q_L)(j\omega + \omega/Q_C)}) \quad (2)$$

is the impedance of a network identical to it except that each inductor has losses that may be represented by a series resistance $\omega L/Q_L$ and each capacitor has losses that may be represented by a shunt resistance $Q_C/\omega C$.

The radicals may be expanded in power series as follows:

$$\sqrt{\frac{j\omega + (\omega/Q_L)}{j\omega + (\omega/Q_C)}} = \sqrt{\frac{1 + (1/jQ_L)}{1 + (1/jQ_C)}} = [1 - j1/2(1/Q_L - 1/Q_C) + \dots] \quad (3)$$

$$\sqrt{(j\omega + (\omega/Q_L))(j\omega + (\omega/Q_C))} = j\omega[1 - (j1/2)(1/Q_L + 1/Q_C) + \dots] \quad (4)$$

Equation (2) therefore becomes (if $Q_C \gg 1$ and $Q_L \gg 1$)

$$Z = [1 - (j1/2)(1/Q_L - 1/Q_C)] X(j\omega\{1 - (j1/2)[1/Q_L + 1/Q_C]\}) \quad (5)$$

The reactance function X , moreover, is a regular function² except for simple poles (points of infinite impedance) on the imaginary axis. We may, therefore, expand it in a Taylor series about the point $j\omega$. Thus we obtain

$$Z = \left[1 - j \frac{1}{2} \left(\frac{1}{Q_L} - \frac{1}{Q_C}\right)\right] \left[X(j\omega) + \frac{dX(j\omega)}{d(j\omega)} \left\{\frac{\omega}{2} \left(\frac{1}{Q_L} + \frac{1}{Q_C}\right)\right\} + \dots\right] \quad (6)$$

From the theory of the complex variable we know that this series will be convergent if

$$|j\omega - j\omega_\infty| > \omega/2(1/Q_L + 1/Q_C)$$

where $j\omega_\infty$ is the frequency nearest to $j\omega$ at which $Z(j\omega)$

* Decimal classification: R142. Original manuscript received by the Institute, March 21, 1944; revised manuscript received, August 25, 1944.

† Radio Corporation of America, RCA Victor Division, Camden New Jersey.

¹ E. A. Guillemin, "Communication Networks," John Wiley and Sons, New York, N. Y., 1935, vol. II, p. 445. For the readers' convenience, Guillemin's work has been summarized in the Appendix to this paper.

² F. S. Woods, "Advanced Calculus," Ginn and Company, Boston, Massachusetts, 1934, p. 355.

has a singularity. Equation (6) may be written (for regions well within the limits of convergence),

$$Z = X(j\omega) + \frac{\omega}{2Q_L} \left[\frac{dX(j\omega)}{d(j\omega)} + \frac{X(j\omega)}{j\omega} \right] + \frac{\omega}{2Q_C} \left[\frac{dX(j\omega)}{d(j\omega)} - \frac{X(j\omega)}{j\omega} \right] \quad (7)$$

The second and third terms of (7) are real and we may, therefore, conclude that the effect of a small amount of dissipation on the impedance of a two-terminal reactive network is to add a resistive component without appreciably altering the reactance, except near frequencies of antiresonance. We may note, also, in passing, that the above is an adequate proof that in any two-terminal network of pure reactances³

$$(dX(j\omega))/(d(j\omega)) \geq |(X(j\omega))/j\omega| \geq 0 \quad (8)$$

for if (8) were not valid we could obtain a negative resistance by adding a small amount of dissipation at appropriate places in the network. In a similar fashion we can show that if the admittance of a network of pure reactances is

$$B = B(j\omega) \quad (9)$$

then the admittance of a network identical to it except that each inductor has losses that may be represented by a series resistance $\omega L/Q_L$ and each capacitor has losses that may be represented by a shunt resistance $Q_C/\omega C$ is

$$Y = B(j\omega) + \frac{\omega}{2Q_C} \left[\frac{dB(j\omega)}{d(j\omega)} + \frac{B(j\omega)}{j\omega} \right] + \frac{\omega}{2Q_L} \left[\frac{dB(j\omega)}{d(j\omega)} - \frac{B(j\omega)}{j\omega} \right] \quad (10)$$

Equation (10) is valid except near points of zero impedance.

Example I—Let us find the impedance of an inductor in parallel with a capacitor, both having appreciable losses. The susceptance of the loss-free network is

$$B = j\omega C + 1/j\omega L$$

By (10) the admittance of the "lossy" network is

$$Y = \left(j\omega C + \frac{1}{j\omega L}\right) + \frac{\omega}{2Q_C} \left[C - \frac{1}{(j\omega)^2 L} + C + \frac{1}{(j\omega)^2 L}\right] + \frac{\omega}{2Q_L} \left[C - \frac{1}{(j\omega)^2 L} - C - \frac{1}{(j\omega)^2 L}\right] \\ Y = \left[j\omega C + \frac{1}{j\omega L}\right] + \frac{\omega C}{Q_C} + \frac{1}{\omega L Q_L} \quad (11)$$

We recognize this as the correct result.

Example II—Let us calculate the admittance of a section of transmission line short-circuited at its far end. The susceptance of the loss-free line is

$$B = -jY_0 \cot(\omega h/v)$$

³ See page 526 of footnote reference 1.

where Y_0 = the surge admittance of the dissipationless line in mhos
 ω = the angular frequency in radians per second
 h = the length of line in meters
 v = the velocity of the traveling waves on the line in meters per second

By (10) the admittance of the line, including the effect of losses, is

$$Y = -jY_0 \cot\left(\frac{\omega h}{v}\right) + \frac{\omega}{2Q_C} \left[Y_0 \frac{h}{v} \csc^2\left(\frac{\omega h}{v}\right) - Y_0 \frac{1}{\omega} \cot\left(\frac{\omega h}{v}\right) \right] + \frac{\omega}{2Q_L} \left[Y_0 \frac{h}{v} \csc^2\left(\frac{\omega h}{v}\right) + Y_0 \frac{1}{\omega} \cot\left(\frac{\omega h}{v}\right) \right] \quad (12)$$

where $Q_C = R_C \omega C$
 $Q_L = \omega L / R_L$
 L = inductance per unit length of line
 C = capacitance per unit length of line
 R_C = shunt resistance per unit length of line
 R_L = series resistance per unit length of line

Equation (12) is valid except near frequencies at which $\cot \omega h/v$ is infinite. It checks the results obtained experimentally and theoretically by Nergaard and Salzberg.⁴

The short-circuited transmission line approximately an odd number of quarter wavelengths long behaves very much like a parallel L - C - R circuit in the neighborhood of its resonance. It is of interest to find the parallel L - C - R circuit which is equivalent to a section of transmission line.

First, we shall define two circuits to be equivalent in the neighborhood of their resonance if (1) their resonant frequencies (frequencies of zero reactance) coincide; (2) their impedances are equal at resonance; and (3) the derivatives of their reactance functions with respect to frequency are equal at resonance.

Taking the admittance for a parallel L - C - R circuit to be

$$Y_1 = (1/j\omega L_1) + j\omega C_1 + (1/R_1)$$

and comparing it to (12) we obtain the three conditions of equivalence to be

$$1/\sqrt{L_1 C_1} = \omega = (n + 1/2)\pi(v/h), \quad n = 1, 2, 3, \dots \quad (13a)$$

$$R_1 = \frac{1}{(n + 1/2)\pi(v/h) \left[(1/2Q_L) Y_0 (h/v) + (1/2Q_C) Y_0 (h/v) \right]} = \frac{1}{(n + 1/2)(\pi/2)} \frac{Q_C Q_L}{Q_C + Q_L} \frac{1}{Y_0} \quad (13b)$$

$$\frac{(d/d\omega) [\omega C_1 - (1/\omega L_1)]_{\omega=(1/\sqrt{L_1 C_1})}}{2C_1} = \frac{(d/d\omega) [-Y_0 \cot(\omega h/v)]_{\omega h/v=(n+1/2)\pi}}{2C_1} = (h/v) Y_0 \quad (13c)$$

Recalling that $Y_0 = \sqrt{C/L}$ and $v = 1/\sqrt{LC}$, equations (13) may be written

$$\left. \begin{aligned} L_1 &= 2hL/(n + 1/2)^2 \pi^2 \\ C_1 &= hC/2 \\ R_1 &= \sqrt{\frac{L}{C}} \frac{2}{(n + 1/2)\pi} \frac{Q_C Q_L}{Q_C + Q_L} \end{aligned} \right\} \quad (14)$$

⁴ L. S. Nergaard and Bernard Salzberg, "Resonant impedance of transmission lines," Proc. I.R.E., vol. 27, pp. 579-584, September, 1939.

The Q of the parallel L - C - R circuit is given as

$$Q = R_1 \sqrt{C_1/L_1} = (Q_C Q_L)/(Q_C + Q_L). \quad (15)$$

It is worth remarking that (15) is independent of n , the order of resonance of the line.

APPENDIX

Consider first a two-terminal network of pure reactances. The impedance is given by the ratio of two determinants as follows:

$$X = D/B \quad (16)$$

where D = the network determinant
 B = the minor of the first row and column.
 The elements of these determinants are terms of the form

$$j\omega L_{ik} + 1/j\omega C_{ik} \quad (17)$$

where L_{ik} = the mutual inductance between the loops i and k

C_{ik} = the mutual capacitance between the loops i and k (in the case where $i = k$, C and L are the self-capacitance and self-inductance, respectively).

We can multiply each term of the determinants of (16) by $j\omega$. Since D is of an order one greater than B , we obtain

$$X = D^*/j\omega B^* \quad (18)$$

where D^* and B^* are the determinants formed from D and B by multiplying each element by $j\omega$.

We can expand (18) into the ratio of two polynomials in $j\omega$:

$$X = \frac{1}{j\omega} \frac{\alpha_{2n}(j\omega)^{2n} + \alpha_{2n-2}(j\omega)^{2n-2} + \dots + \alpha_0}{\beta_{2n-2}(j\omega)^{2n-2} + \beta_{2n-4}(j\omega)^{2n-4} + \dots + \beta_0} \quad (19)$$

The numerator and denominator of this expression can be factored as follows:

$$X = H \frac{[(j\omega)^2 - (j\omega_1)^2][(j\omega)^2 - (j\omega_2)^2] \dots}{j\omega [(j\omega)^2 - (j\omega_2)^2][(j\omega)^2 - (j\omega_4)^2] \dots} \quad (20)$$

where $\omega_2, \omega_4, \dots$ are the frequencies of parallel resonance

$\omega_1, \omega_3, \dots$ are the frequencies of series resonance

X can be expanded into a power series about the point $j\omega_a$

$$X(j\omega) = X|_{j\omega_a} + j(\omega - \omega_a) [dX/d\omega]_{j\omega_a} + \dots \quad (21)$$

This expansion will be valid if $(\omega - \omega_a) < (\omega - \omega_\infty)$, where ω_∞ is the frequency nearest to ω_a at which X becomes infinite.

Next consider a network of reactances identical to that in (16) except that each inductor has losses that may be represented by a series resistance $\omega L/Q_L$ and each capacitor has losses that may be represented by a shunt resistance $Q_C/\omega C$. The impedance of the network is

$$Z = D'/B'. \quad (16a)$$

The elements of the determinants D' and B' will be made up of terms of the form

$$\left(j\omega + \frac{\omega}{Q_L}\right) L_{ik} + \frac{1}{(j\omega + (\omega/Q_C))C_{ik}} \quad (17)$$

Multiplying each element of the determinants of (16a) by $(j\omega + (\omega/Q_C))$,

$$Z = \frac{1}{(j\omega + (\omega/Q_C))} \frac{D'^*}{B'^*} \quad (18a)$$

Expanding the determinants into polynomials and factoring,

$$Z = \frac{\sqrt{j\omega + (\omega/Q_C)}}{j\omega + (\omega/Q_L)} \frac{1}{\sqrt{(j\omega + (\omega/Q_C))(j\omega + (\omega/Q_L))}} \frac{[(j\omega + (\omega/Q_C))(j\omega + (\omega/Q_L)) - (j\omega_1)^2][\dots]}{[(j\omega + (\omega/Q_C))(j\omega + (\omega/Q_L)) - (j\omega_2)^2][\dots]} \quad (20a)$$

Comparing (20) and (20a)

$$Z = \sqrt{\frac{j\omega + (\omega/Q_C)}{j\omega + (\omega/Q_L)}} X(\sqrt{(j\omega + (\omega/Q_L))(j\omega + (\omega/Q_C))}) \quad (21)$$

Institute News and Radio Notes

1945 Winter Technical Meeting

Preliminary plans for the 1945 Winter Technical Meeting, which will be held at the Hotel Commodore in New York City on January 24, 25, 26, and 27, were discussed by the committee in charge of this affair on September 13, 1944. The chairmen of the various sub-committees pointed out that satisfactory progress of the war gave every evidence of making the Meeting one of the most important and interesting gatherings in the history of the Institute.

TECHNICAL PAPERS

It is planned to have an extensive program of technical papers. The committee in charge of papers anticipates that some new developments which heretofore have not been made available to the public will be released, at least in part, from security limitations and that papers pertaining to them will be presented. While the January gathering will be a war meeting in a sense, the trend of hostilities has taken such a favorable course in late months that the tenor of the Meeting will be one of victory and a tribute to the tools that made the victory possible.

The Saturday-morning session will be devoted to papers of interest to men in the Armed Forces.

SECTIONS MEETING

On Wednesday, January 24, there will be an all-day meeting of the Sections' representatives at which time it is anticipated that the Sections will present their problems and satisfactory solutions reached. At noon on this day there will be a luncheon for the Sections' representatives.

JOINT MEETING I.R.E.-A.I.E.E.

On the evening of Wednesday, January 24, there will be a joint meeting of the I.R.E. and the A.I.E.E. in the Engineering Societies Building, 33 West 39 Street, New York, New York. While definite plans for this meeting have not yet been formulated, the committees of both societies are working on a program which should prove of great interest to all who attend.

EXHIBITS

There will be an exhibition of component parts in the

West Ballroom of the hotel starting on Thursday, January 25, and continuing through Saturday, January 27. It is hoped that these exhibits will reveal some of the new developments which have taken place in the radio-and-electronic field during the past few years. This exhibit should prove of tremendous interest to everyone and should give an opportunity to all to acquaint themselves better with the products displayed.

BANQUET AND PRESIDENT'S LUNCHEON

On Thursday evening, January 25, the Banquet will be held in the Grand Ballroom. There will be several speakers of note including representatives of the Armed Forces.

On Friday, January 26, the President's luncheon will be held in the Grand Ballroom.

WOMEN'S PROGRAM

For the first time since 1942 a program is being planned for women guests of the I.R.E. It is hoped that as many women as possible will be able to be present during the convention.

RESERVATIONS

Because of restrictions on travel and limited hotel accommodations it is imperative that all who plan to attend this meeting make their arrangements at least thirty days in advance. Hotel reservations should be made directly with the Hotel Commodore, mentioning that your stay is occasioned by The Institute of Radio Engineers' Winter Technical Meeting. In the near future reservation cards will be sent to the membership; these should be filled out promptly and returned immediately to the hotel.

WELCOME

The committee for the 1945 Winter Technical Meeting, under the chairmanship of Dr. Austin Bailey, extends to all members of the Institute and their friends a most cordial invitation to attend this Winter Technical Meeting. The members of the committee are looking forward to greeting old friends and making new acquaintances at this time.

Board of Directors

September 6 Meeting: At the regular meeting of the Board of Directors, which was held on September 6, 1944, the following were present: H. M. Turner, president; R. A. Hackbusch, vice-president; S. L. Bailey, W. L. Barrow, E. F. Carter, I. S. Coggeshall, W. L. Everitt, Alfred N. Goldsmith, editor; R. F. Guy, R. A. Heising, treasurer; L. C. F. Horle, C. B. Jolliffe, F. B. Llewellyn, H. J. Reich, B. E. Shackelford, H. A. Wheeler, L. P. Wheeler, W. C. White, H. R. Zeamans, and W. B. Cowilich, assistant secretary.

Executive Committee Action: The actions of the Executive Committee taken during its June 6, July 5, and August 2, 1944, meetings, the minutes of which had been mailed to the Board of Directors; were ratified.

Building-Fund Committee: Chairman Shackelford read a report on the actions, recommendations, and requests for instruction of his committee. The report, dated August 22, 1944, was discussed at length. Certain questions of policy and procedure raised by the Committee were answered by Board resolutions.

Office Alterations: The extension of the office alterations to include the Board Room as additional office space, recommended by the Executive Committee, was unanimously approved.

Committees and Appointments

Admissions: The following members were unanimously appointed to serve on the Admissions Committee:

J. L. Callahan	Stuart W. Seeley
T. T. Goldsmith, Jr.	M. E. Strieby
C. E. Scholz	F. D. Webster
	R. M. Wise

Liaison: President Turner referred to the June 6, 1944, letter from the Institution of Electrical Engineers and called attention to the fact that R. L. Smith-Rose, H. L. Kirke, and C. W. Cosgrove had been named to the Liaison Committee of the I.E.E. Radio Section.

Papers Procurement: The appointment of the following personnel was unanimously approved:

Timers and Technical Controls Group	
H. M. Kleven	K. P. Puchlowski
Thermoelectronics Group	
Wynn Wagener	Eugene Mittelman
J. P. Jordan	S. S. Mackeown
P. D. Zottu	G. E. Ziegler
Electron Therapeutics Group	
	H. D. Gillespie

Professional Recognition: W. C. White, chairman of this committee, stated that the committee's memorandum on the subject of Collective Bargaining for Engineers had again been recently revised to include references on additional material published. It was also reported that a few requests for the memorandum had been received.

Radio Technical Planning Board: The following resolution, on RTPB panel reports in general, was unanimously adopted:

"Where engineering information and knowledge is notably incomplete or engineering study of specific fields is seriously

incomplete, the RTPB should not make definite recommendations on the corresponding topic."

Constitution and By-Laws Amendments

Constitution: These matters, relating to proposed constitutional amendments, were discussed and the following actions taken:

a. Petition to Amend Article IV. Chairman Heising, of the Constitution and Laws Committee, read his August 29, 1944, report relating to a constitutional-amendment petition proposed by Harold P. Westman.

General-Counsel Zeamans explained certain legal aspects on presenting two separate amendments of the same section of the Constitution to the membership at the same time.

b. Second Ballot on Petitioned Amendment: It was unanimously decided to mail the constitutional-amendment ballot as in the past and to issue another ballot, to include the second petitioned amendment of Article IV, after the results of the first of these ballots become known, as recommended by the Executive Committee.

Bylaws: The proposed amendments of the several Bylaws Sections, on which the three notices under the date of August 9, 1944, had been mailed to the Board members, were presented by Chairman Heising of the Constitution and Laws Committee, and acted upon as indicated below:

a. Bylaws Section 5, 6, and 12—The following proposed changes in the Bylaws were unanimously adopted:

Delete Section 5;
Delete Section 6;

In Section 12, delete "and having satisfied the posting Bylaw," and insert the word "and" ahead of the word "paying" in the same sentence.

b. Bylaws Section 51—The amendment of this Bylaw Section, which had been submitted, was adopted in the revised form stated below:

Delete second paragraph of Bylaw Section 51 and substitute the following:

"The Investments Committee is authorized to buy and sell securities in the name of the Institute by means of an order upon the Custodian of the Institute Securities, signed by two members of the Investments Committee authorized to do so by the Board of Directors, directing the Custodian to sell securities owned by the Institute and to deposit the proceeds in the Investment's Account, or ordering the Custodian to buy securities and to charge the cost to the Investments Account, such Account to be maintained in the Custodian's institution. Interest and dividends received from securities shall be deposited in the Investment Account. The moneys in the Investments Account are to be subject to withdrawal by the Board through its regularly constituted officers. The identity of special funds shall be maintained when changes in securities are made. A report on sales and

purchases of securities shall be made to the Board by the Investments Committee at the Board's first meeting after each transaction is consummated.

*Meetings of the Investments Committee may be called on two days' notice by mail, or on one day's notice by telephone or telegraph, by the Chairman, or in his absence or disability, by any member of the committee. A quorum shall consist of two members of the committee."

c. Bylaws Section 35B—The following proposed addition to the Bylaws, indicated as Section 35B was adopted by an unanimous vote:

Section 35B—"The Secretary shall circularize all Section chairmen and secretaries before March first of each year requesting the submission of suitable names to be considered by the Nominations Committee for the various elective offices."

d. Bylaws Section 36B—The motion to adopt this new Bylaws Section was unanimously approved:

Section 36B—"When the Board of Directors has not scheduled a meeting to be held between August 14 and September 1 of each year, the Executive Committee is authorized to take any necessary actions on any petitions and to approve the ballot."

e. Bylaws Sections on "Publications." The actions taken on these proposed Bylaws are explained below:

(1) Section A under "Publications"—The new Bylaws Section A, in the form quoted, was unanimously adopted:

Section A—"The Institute shall publish a periodical under the title, THE PROCEEDINGS OF THE INSTITUTE OF RADIO ENGINEERS. The Board of Directors may establish additional publications either periodical or otherwise in character."

Canadian Membership: Vice-President Hackbusch reported on these matters, relating to the Institute members in Canada, which were discussed and acted upon as indicated:

Collective Bargaining: The summary of the replies to the questionnaire on collective bargaining, recently mailed to 560 Institute members in Canada was reviewed. It was pointed out that 90 per cent of those responding favor organizing engineers to function as a collective-bargaining group, and that the members of other Canadian engineering societies voted on the particular question practically in the same manner.

Canadian Engineers' Council: Attention was called to the steps being taken to form the named organization and to the interest expressed by the Montreal, Ottawa, and Toronto Sections in affiliating with the Council.

Canadian Radio Technical Planning Board: It was stated that the Canadian Government is sponsoring the formation of a Canadian RTPB to be patterned on the organization in operation in the United States.

National Councils: It was moved that, until such time as the Board of Directors decide on a longer-term policy in respect to the formation of Councils to act for members of the Institute resident outside the United States on matters affecting the membership on national matters within any one country, the Board authorizes the chairmen of the Sections affected to set up and operate on an interim plan of action which will not involve the Institute financially or legally but which will permit the immediate functioning of National Councils.

Ottawa Section: It was moved to authorize the establishment of the Ottawa Section, recommended by the Executive Committee, and to specify the territory on the basis of that to which the adjoining Toronto and Montreal Sections agree, or on the basis of the preference of members in the case of areas not agreed upon by the Sections.

Securities: The resolution quoted below providing for the sales of stock and bonds in the Institute's name was unanimously adopted.

"Resolved, That any two of the following: viz., the President, the Secretary, the Treasurer, and the Editor be and they hereby are expressly authorized at all times to make and execute, in name of The Institute of Radio Engineers, Inc., any and all necessary powers of attorney, acts of assignment and/or instruments of transfer, for the sale, assignment, and transfer of any and all bonds and stocks

standing in the name of The Institute of Radio Engineers, Inc."

Inventions: Editor Goldsmith called attention to the inventions which are occasionally submitted with requests for opinions. It was the decision that, as a policy, no opinions would be given in such cases.

The Franklin Institute: Upon the recommendation of the Executive Committee, it was moved that, when the time arrives, consideration would be given to taking favorable action on the celebration of the 200th anniversary of Benjamin Franklin's electrical experiments, being contemplated by The Franklin Institute.

Institution of Electrical Engineers:

Co-operation with the Radio Section of the I.E.E., was considered and acted upon as explained below:

Cross Publication of Subscription Data: Unanimous approval was given to publicizing in the PROCEEDINGS the rates and other information on subscriptions for the "Journal of I.E.E." and to having similar data on PROCEEDINGS subscriptions published in the Journal of the I.E.E.

Executive Committee

August 30 Meeting: The Executive Committee meeting, held on August 30, 1944, was attended by H. M. Turner, president; E. F. Carter, Alfred N. Goldsmith, editor;

R. A. Heising, treasurer, F. B. Llewellyn, Haraden Pratt, secretary; H. A. Wheeler, and W. B. Cowilich, assistant secretary.

Membership: No application for the higher grades of membership were available because the Admissions Committee did not hold a meeting in July. Any higher-grade applications that would have been approved at that meeting would, according to the constitutional procedure, have been submitted for final action at this meeting of the Executive Committee.

The 141 applications for admission to Associate and 23 to Student grades were unanimously elected to membership.

Postwar Publications: In connection with the development of further plans for these publications, reference was made to the reserve fund which had been established by the Board at its March 3, 1943, meeting. This fund amounting to \$14,000, was created through the action indicated in Minute 64 of that meeting which is quoted below:

Min. 64: "Reserve Fund for Postwar Publications—For the major postwar publication policy and in general as recommended by the Executive Committee, approval was given to establishing a reserve fund of \$14,000, to be created by setting aside a lump sum of \$5,000 from the present surplus and by the monthly increments of \$1,000 from current excess income for a period of not longer than a year."

Constitutional Amendments

Members are reminded that the Constitutional-Amendment ballots, sent out in September, must reach the Institute office by November 22 in order to be counted. Those who have not yet sent in their ballots are urged to do so at once.

Constitutional-Amendment Petition

The following additional signatures, of members in good standing, to the petition drawn up by Mr. Harold P. Westman, proposing an amendment to the Constitution on dues, which was published in the October issue of the PROCEEDINGS, have been received:

Page 15

J. C. R. Punchard Montreal, Que., Canada

Page 16

R. G. Anthes Toronto 6, Ont., Canada

Page 17

Gomer L. Davies Silver Spring, Md.
E. Donald Kennedy Silver Spring, Md.
C. B. Pear, Jr. College Park, Md.

Page 18

C. J. LeBel Minneapolis, Minn.
Sumner B. Young Wayzata, Minn.
M. E. Knox Minneapolis, Minn.
George K. Jacobson Minneapolis, Minn.
C. E. Bellinger Minneapolis, Minn.
E. S. Heiser St. Paul, Minn.

L. B. Headrick
L. E. Swedlund

Page 19

Lancaster, Pa.
Lancaster, Pa.

Page 20

H. S. Dawson
W. F. Choat
E. O. Swan
R. C. Poulter
F. H. R. Pounsett
G. J. Irwin
J. R. Longstaffe

Toronto, Ont., Canada
Toronto, Ont., Canada
Toronto, Ont., Canada
Toronto, Ont., Canada
Leaside, Ont., Canada
Toronto, Ont., Canada
Toronto, Ont., Canada

Page 21

A. R. Hodges
Robert D. Avery
H. Riblet
John H. Hidy
Earl G. Sorensen
H. R. Skifter

Manhasset, L. I., N. Y.
Mineola, L. I., N. Y.
Douglaston, L. I., N. Y.
Garden City, L. I., N. Y.
Garden City, L. I., N. Y.
Mineola, L. I., N. Y.

Page 22

F. S. Howes
W. A. Nichols
J. A. Ouimet
J. E. Hayes
Arthur B. Ellis
B. T. McNeil
F. A. A. Baily
R. R. Desaulniers
H. W. Jaderholm
F. A. Barrow
S. H. Rushbrook
L. W. Elliott
A. M. Patience
K. R. Swinton
E. S. Kelsey
J. R. Bain
Sydney Sillitoe
J. Allan Campbell

Montreal, Que., Canada
Montreal, Que., Canada
Montreal, Que., Canada
Montreal, Que., Canada
Montreal, Que., Canada
Montreal, Que., Canada
Mt. Royal, Que., Canada
Mt. Royal, Que., Canada
Montreal, Que., Canada
Mt. Royal, Que., Canada
Mt. Royal, Que., Canada
Montreal, Que., Canada
Ottawa, Ont., Canada
Lachine, Que., Canada
Montreal, Que., Canada
Montreal, Que., Canada
Montreal, Que., Canada

Page 23

Kirby B. Austin
Richard F. Shea
Wm. S. Bachman
F. A. Olson
Florian J. Fox
Arthur W. Sear
Robert B. Dome
C. S. Root
J. C. Coykendall
Stanford Goldman

Bridgeport, Conn.
Bridgeport, Conn.
Fairfield, Conn.
Bridgeport, Conn.
Stratford, Conn.
Stratford, Conn.
Bridgeport, Conn.
Bridgeport, Conn.
Bridgeport, Conn.
Bridgeport, Conn.
Bridgeport, Conn.

Inventive Problems of Military Interest

The following list of new problems, the solutions of which would be helpful to the Military Services, is submitted to the readers of the PROCEEDINGS OF THE I.R.E. It constitutes a selection from a more comprehensive list, the selection being based on the likely interests of the readers of the PROCEEDINGS.

Ideas directed to the solutions of these problems should be addressed to The National Inventors Council, Department of Commerce, Washington 25, D. C. The Institute is advised that these communications will be promptly analyzed and that those which appear novel and promising will be placed in the hands of appropriate Military personnel.

The Editor

1. An accurate simple cable-tension-reading instrument.
2. A device for the quick release of a cargo parachute from the cargo upon contact of the cargo with the ground. This is desirable to prevent the dragging of the cargo on the ground.
3. Positive parachute-opening device, to provide automatic opening at a definite altitude above the ground.
4. Parachute-drop test instruments. Load recorder for parachute openings. Precise time of opening and rate of descent means.

5. A release and exchange mechanism for two targets suitable for exchanging targets without loss of equipment at high speeds.
6. A tow-target "hit indicator" to indicate hits and the direction and magnitude of misses for fixed, flexible, and turret aerial-gunnery practice fire.
7. Design dependable thermostats for control of heating clothing to operate on direct current, small enough to be used in gloves and boots.
8. Development of methods or apparatus for establishing the quality of glue joints in wood without testing to destruction.
9. Development of a material with the electrical properties and heat-resistant characteristics of mica.
10. Automatic ground-speed-measuring devices.
11. Practical two-position or variable compression ratio control.
12. Simple and light detonation indicator for installation in airplanes.

Radio and Instrument Hookup Wire

The War Production Board has long since forseen the existing bottleneck in the production of radio and instrument hookup wire, and as early as February, 1943, took the necessary action to keep in step with production demands by recommended standardization.

The standardization of hookup wire by the American War Standards Committee was started by drawing up a monitor specification in June, 1943. This specification was re-edited in preparation for an Industry Meeting held by the AWS Committee in July, 1943.

The United States Signal Corps Standards Agency effected the completion of the standardization of Radio Hookup Wire. As a result, Signal Corps Standards Specification 71-4943 was approved on March 7, 1944, covering radio and instrument hookup wire. A mailing of this specification was effected by the radio and radar division to all end products manufacturers. Extra copies can be obtained from the Signal Corps Standards Agency, 12 Broad Street, Red Bank, New Jersey.

It was hoped at the time of the organization of the Signal Corps Standards Agency, a joint Army-Navy Signal Corps Standards would be forthcoming; however, due to variance of operating conditions between Ground Forces and the Navy, a separate Bureau of Ships, Insulated Radio and Instrument Hookup Wire Specification is in the making. Preliminary Draft dated April 1, 1944, of this specification 15-C-20 (INT.) has been sent out for industry comment only. This specification does not differ too greatly from that of the Signal Corps specification and when adopted will result in two standard specifications, one for the Signal Corps and another for the Bureau of Ships. Attention of equipment manufacturers is called to these specifications as many are not aware of the extensive work being done by Laboratories of the Armed Forces, radio and radar division, and copper section of the War Production Board.

The two aforementioned wire specifications are performance specifications broad enough to permit the development of new types of insulations, and also the use of several different types of material now available.

In recommending the use of these specifications, no attempt is being made to restrict development of new types of wire or dictate material to be used except where a critical supply situation necessitates controlled use.

The above notice was received from Raymond G. Zender, WPB Consultant, Radio and Radar Division, Electrical Wire and Cable, 1218 N. Marion St., Oak Park, Illinois.

Correspondence

Correspondence on both technical and nontechnical subjects from readers of the PROCEEDINGS OF THE I.R.E. is invited, subject to the following conditions: All rights are reserved by the Institute. Statements in letters are expressly understood to be the individual opinion of the writer, and endorsement or recognition by the I.R.E. is not implied by publication. All letters are to be submitted as typewritten, double-spaced, original copies. Any illustrations are to be submitted as inked drawings. Captions are to be supplied for all illustrations.

Amplifier Testing with Square and Triangular Waves

During the past seven years a number of articles have been published on the subject of amplifier testing with square and triangular waves. The authors of these papers have apparently overlooked an earlier paper on this subject which the writer published in the PROCEEDINGS in 1931. Although this paper dealt primarily with the use of triangular waves as a simple and rapid means of testing for frequency and phase distortion, the suggestion was made in the paper that other nonsinusoidal voltages might also be used. Since future writers on the subject may wish to refer to the original paper, it seems desirable to publish the following bibliography.

1. H. J. Reich, "A new method of testing for distortion in audio-frequency amplifiers," *PROC. I.R.E.*, vol. 19, pp. 401-416; March, 1931.
2. A. C. Stocker, "An oscillograph for television development." *Proc. I.R.E.*, vol. 25, pp. 1012-1034; August, 1937.
3. G. Swift, "Amplifier testing by means of square waves," *Communications*, February, 1939, p. 22.
4. A. V. Bedford and G. L. Fredendall, "Transient response of multistage video-frequency amplifiers," *PROC. I.R.E.*, vol. 27, pp. 277-285; April, 1939.
5. L. B. Arguimbau, "Network testing with square waves," *Gen. Rad. Exp.*, vol. 14, pp. 1-6; December, 1939.
6. D. L. Waidelich, "Steady-state testing with saw-tooth waves," *PROC. I.R.E.*, vol. 32, pp. 339-348; June, 1944.

HERBERT J. REICH
Radio Research Laboratory
Cambridge 38, Massachusetts

I.R.E. People

H. B. MARVIN

H. B. Marvin will be responsible for special assignments in the General Electric Company's tube division, electronics department, according to a recent announcement. Mr. Marvin was formerly assistant engineer of the company's general engineering laboratory.

Born in Charleston, Pennsylvania, he was graduated from Union College, Schenectady, in 1915 with a B.S. degree in electrical engineering, receiving his master's degree in 1925.



H. B. MARVIN

Employed by General Electric Company at Schenectady as a student engineer from 1915 to 1916, he fought in the last war, then returned to the company in May, 1919, as an electrical engineer in the general engineering laboratory. In December, 1931, he was appointed assistant engineer of the laboratory, in charge of high-frequency measurements and development work, where he has remained until his present appointment.

Mr. Marvin is a member of Delta Upsilon and the American Institute of Electrical Engineers. He joined The Institute of Radio Engineers as a Member in 1931 and transferred to Senior Member grade in 1943. He serves as vice-chairman of Panel 12, Radio Technical Planning Board, which deals with industrial, scientific, and medical equipment, and he is affiliated with various other panels of the board.

GARRARD MOUNTJOY

Garrard Mountjoy has been appointed head of the Lear, Incorporated, Radio Laboratories, assuming his new duties September 1. He will have complete supervision over all radio research and development.

Mr. Mountjoy's experience covers work with the RCA Laboratory in New York, which he joined in 1935 as consulting engineer, and where he later became head of the licensee consulting section. Previous to that he worked with Sparks-Withington Company, Jackson, Michigan, doing development work on radio, and becoming chief engineer of the radio development department. He received his B.S. degree in 1929

from Washington University, St. Louis, Missouri.

In 1940, Mr. Mountjoy received the "Modern Pioneer Award" from the National Association of Manufacturers, the award being given for contributions which improved the American standard of living.



GARRARD MOUNTJOY

Mr. Mountjoy's many patents in radio have contributed to the development of this field.

He joined The Institute of Radio Engineers in 1937 as an Associate, transferred to Member grade in 1940, and to Senior Member in 1943.

LESLIE J. WOODS

Leslie J. Woods has been named manager of the industrial radio division of Philco Corporation with headquarters in Detroit.

This division will handle the development and sale of automobile radios to the motorcar industry and also sales of aircraft radio and radar equipment and other industrial electronic devices.

Mr. Woods served in the British Army in the last war. From 1919 to 1923 he was in the Middle East first in military and then in civilian capacities, helping to construct radio stations in Hamadan, Teheran, and Bagdad.

In 1925 he joined Philco, where he assumed positions of increasing responsibility in engineering and sales. For the three years prior to the war, Mr. Woods was in Detroit with the auto-radio division of Philco and was made manager of the division in 1941. On the outbreak of war, he was transferred to Washington. In 1942 he became vice-president and general manager of National Union Radio Corporation, a Philco subsidiary, to assist that company in expanding its organization to meet the greatly increased wartime demands of the Army and Navy. He joined The Institute of Radio Engineers as a Member in 1935.

PINCKNEY REED

After nearly a year on assignment in Brazil, Pinckney Reed (A'37), field engineer of the RCA Service Company, is back in the United States and assigned to the Naval Research Laboratory in Washington, D. C.

WESTON PERSONNEL CHANGES

With postwar planning in view, announcement of changes in the engineering department of the Weston Electrical Instrument Corporation, Newark, New Jersey, has been made.

John H. Miller (A'19-M'25-SM'43), who has been assistant chief electrical engineer, has been promoted to chief electrical engineer.

Francis X. Lamb (A'36) has been made assistant chief electrical engineer. He formerly was a project engineer.

W. N. Goodwin, Jr. (A'14-M'29-SM'43), continues as vice-president in charge of research and engineering. He relinquishes his post as chief engineer, but retains his present title of director of research. He also will be available for consultation and guidance in engineering matters in general.

Mr. Miller, the newly appointed chief electrical engineer, was born in Oak Park, Illinois, June 6, 1893. He was graduated from the University of Illinois with the degree of bachelor of science in electrical engineering in 1915.

Upon completing his studies, Mr. Miller took an apprentice course at the Westinghouse Electric and Manufacturing Company East Pittsburgh, Pennsylvania. Here he was assigned as engineer on watt-hour meters



JOHN M. MILLER

In February, 1918, he enlisted in the United States Signal Corps and was commissioned a second lieutenant in June of that year. He was assigned to Fort Monmouth, New Jersey, but actually functioned on special radio developments for aircraft in the Signal Corps staff office in Washington.

Following his discharge from the Army in 1919, he joined the Jewell Electrical Instrument Company, Chicago, as chief engineer. In 1927, he was appointed vice-president and chief engineer. Along with two other engineers, he formed the Chicago Section of The Institute of Radio Engineers, and served several terms as chairman and secretary of the group. Mr. Miller also was on the board of the Western Society of Engineers for several years.

In 1931, shortly after the Jewell Company was merged with the Weston Electrical Instrument Corporation, Mr. Miller joined the latter organization as assistant chief

engineer. In 1937, he assumed charge of the commercial engineering division.

Mr. Miller is a Fellow of the Radio Club of America and the American Institute of Electrical Engineers. He served as president of the former organization in 1937 and 1938. For several terms, he served on the New



FRANCIS X. LAMB

York Section Communications Group Committee of the A.I.E.E.

A licensed professional engineer in New Jersey, Mr. Miller has issued a total of 27 United States patents and several in Canada and Great Britain.

Mr. Lamb, the new assistant chief electrical engineer, was born in Newark in 1905. He is a graduate of the Newark Technical School and the Newark College of Engineering. He joined the Weston organization in 1921, serving in technical capacities throughout the plant until 1927, when he was transferred to the engineering department. He organized the commercial division of the engineering department in 1928, and headed this section until 1937, when he went to the Orient as resident engineer for the company. He returned in 1939, to become division chief of the engineering department, which position he held until 1942, when he was made project engineer. Mr. Lamb is a member of the American Institute of Electrical Engineers.

POSTHUMOUS AWARD TO W. A. WINTERBOTTOM

On August 1, 1944, William A. Winterbottom was posthumously awarded the Signal Corps' Certificate of Appreciation.

The presentation was made at the RCAC offices in New York City, by Colonel Jay D. B. Lattin, Signal Officer of the Second Service Command, to Mr. Winterbottom's son, Arthur W. Winterbottom, manager of the plant valuation division of R.C.A. Communications. In making the award, Colonel Lattin represented Major Gen. H. C. Ingles, Chief Signal Officer, United States Army.

The citation, read by Colonel Lattin, follows, in part:

"Mr. Winterbottom unstintingly served in a consultant capacity and in a more direct manner for the Signal Corps during a period of phenomenal expansion when the Army was in desperate need of assistance

from commercial communications companies and technicians. He offered valuable radio engineering advice, placed the facilities of his company at the disposal of the Signal Corps, made highly skilled technicians available to the Signal Corps on short notice, and encouraged key personnel to enter the service even though it imposed considerable hardship on him and his company.

"In addition, above and beyond the normal requirements in performance of his duty, Mr. Winterbottom personally directed and supervised special projects for the Signal

Corps, although in numerous instances they required difficult engineering and traffic-operational methods contrary to the ordinary communications procedures.

"These services have been of inestimable value to the Signal Corps in meeting communications necessities beyond the capacity of existing military personnel and facilities. Mr. Winterbottom's assistance in numerous emergencies has been of immense value. As one specific example, he personally directed the transmission of a vitally important message to a high-ranking French official at the

time of the North African invasion. The delicate situation at that time required precise timing and absolutely certain delivery of the message to the addressee. This involved elaborate planning and execution, performed by Mr. Winterbottom as a result of his knowledge and painstaking expenditure of his energy without regard to his own inconvenience or the temporary disruption of his company's normal operation. This service enabled the Signal Corps to fulfill extremely urgent obligations affecting successful prosecution of the North African campaign."

Books

Radio Direction Finders, by Donald S. Bond*

Published (1944) by McGraw-Hill Book Co., 330 W. 42 Street, New York 18, N. Y. 247 pages+13-page index+xii pages. 163 illustrations. 8½×5½ inches. Price, \$3.00.

In recent years there has been an increasing demand for engineers trained in those fundamentals governing the design and operation of radio direction finders. This book is intended to serve as a textbook for the instruction of advanced engineering students desiring to specialize in that field and it is expected that the reader or student will be left in a position to solve those problems he may encounter in the field.

A large portion of the book is, accordingly, devoted to the study of the underlying phenomena governing the operation of all direction finders, particular attention being given to the study of radio wave propagation and to the design of directional antenna systems. The cause and reduction of errors and the effect of the noise level of the receiver on the range and accuracy of direction finders are also discussed in some detail. A brief résumé is given of the standard methods for testing direction finders and direction finder receivers.

The large amount of theory is balanced by a description of the circuits for certain types of aural-null and visual direction finders and a detailed analysis of the operation of three commercial aircraft radio compasses. The book concludes with a chapter devoted to the principles of map making and to radio navigation.

It is believed by the reviewer that the author has been very successful in fulfilling the purposes for which the book was written. Those sections dealing with theory cover the subject matter very thoroughly, and, except for the somewhat long and tedious mathematical derivations, the various topics discussed throughout the book are presented in a clear, concise, and readable manner.

Some readers will be disappointed because the author has placed so much emphasis upon small, portable, low-frequency direction finders and has, accordingly, seen fit to limit that section devoted to commercial models to a detailed description of three very similar aircraft radio compasses. A more balanced treatment of the subject would have included a description of some of the more recent high-frequency fixed-

station, ultra-high-frequency direction finders, and commercial ship installations.

In those sections dealing with errors in direction finding and their causes no mention is made of the "octantal error" or "spacing error" of fixed installations and of its effect on the errors caused by multiple-path propagation. For some installations these errors can be very large. Also omitted is any discussion of site errors for large fixed stations.

In the section on radio navigation and map making the gnomonic projection-type chart has been confused with the azimuthal equidistant projection type.

This book is to be recommended for all engineers or advanced students who wish to become acquainted with the problems encountered in the art of radio direction finding. For those engineers already engaged in the art the large amount of data presented and the numerous references to other publications will be found very valuable. Those radio operators who must handle direction-finding equipment will also find much of interest in the book although the mathematics may be too difficult for them.

KARL G. JANSKY
Bell Telephone Laboratories
New York, N. Y.

Maintenance and Servicing of Electrical Instruments, by James Spencer

Published (1944) by Instruments Publishing Company, Inc., 1117 Wolfendale St., Pittsburgh 12, Pa. 243 pages+12-page index+xii pages. 5×8½ inches. Price, \$2.00.

This book is primarily intended to serve as a guide for teaching the subject of maintenance and servicing of electrical indicating instruments. It covers practical matters dealing with the intelligent handling of meters and their adjustment and, in certain cases, their repair.

In the communication, airline operation and certain industrial fields equipment installations may involve hundreds of instruments. Especially in the latter where these instruments must be accurate and reliable there is a growing tendency to have all instruments serviced by plant instrument men. This book is a well-planned one and will serve as an excellent guide in the art of instrumentation. It deals only with those matters that are usually hidden behind the "sacred" seal of an instrument, and avoids considering any part of the problem of selecting and using instruments.

RALPH R. BATCHER
St. Albans, L. I., N. Y.

Direct-Current Circuits, by Earle M. Morecock

Published (1944) by Harper and Brothers, 49 E. 33 St., New York 16, N. Y. 381 pages+5-page index+xviii pages. 278 illustrations. 9½×6½. Price, \$3.25.

This book is one of a series prepared by the faculty of Rochester Athenaeum and Mechanics Institute with the object of presenting a basic course in direct-current circuits to serve as an introduction to the more specialized occupational courses. It has been written especially for students in technical institutes, junior colleges, and industrial and extension schools, but should be useful for independent study for anyone familiar with algebra and logarithms.

With this object in view, the author has produced a textbook which is eminently practical in its outlook. The treatment of fundamental principles is given simply, clearly, and with considerable attention to detail. The reader's interest is sustained by a judicious inclusion of material descriptive of applications of the theory. Illustrations of modern apparatus are well chosen. With each chapter there is provided a liberal selection of problems for testing the student's grasp of the principles of the chapter but simple numerical examples are solved in the text itself. Answers to the problems are grouped in an appendix. An interesting feature of the book is the inclusion of a list of appropriate laboratory experiments together with notes for the laboratory procedure.

All in all, the author has been successful in turning out a very readable, interesting, and up-to-date treatment of his subject without any sacrifice of exactness of statement.

FREDERICK W. GROVER
Union College
Schenectady, New York

Patent Law, by Chester H. Biesterfeld

Published (1943) by John Wiley and Sons, Inc., 601 W. 26 St., New York 1, N. Y. 220 pages+5-page index+iv pages. 6×8½ inches. Price, \$2.75.

The book cover and preface indicate that this book is prepared for "chemists, engineers, and students" to provide them with that information concerning the law of patents necessary for them effectively to carry out their normal business and technical work. Your reviewer is firmly convinced of the need for such a book.

* Previewed, PROC. I.R.E., vol. 32, p. 243; April, 1944.

The patent law is a highly technical art. It is practiced by legal specialists who concentrate specifically on that field, generally to the exclusion of all other phases of law or allied arts. This being the case, one can well imagine the difficult task facing an author who endeavors to make, in about two-hundred pages, a thorough statement of the entire subject including not only the fields of patent soliciting and claim drafting but also the fields of licensing and patent litigation.

It is felt that the author has done a good job in highlighting the major points of the patent law. He has employed the usual technique of quoting from cases to bring out most of his points. Generally, the leading cases have been cited. However, the reader, particularly if he be of scientific turn of mind, is hereby warned that in patent law he is dealing with legal opinions, not scientific facts. Quotations from two or three cases can often be seriously misleading. Usually there are conflicting legal opinions on almost all topics and one must study the complete opinions both favorable and unfavorable to any issue and seek the fine shades of distinction and basis of reasoning used in each opinion before one can reach an intelligent judgment as to the weight of judicial thinking on the issue involved. The practice of the author of quoting a few sentences from an opinion without a statement of the facts

or theory on which the opinion is based will trap many an unwary reader.

One can recommend this book to patent practitioners or students of patent law and to patent engineers. It is useful to such individuals because it highlights the salient points of law encountered in ordinary practice and provides a good list of cases to study. In other words, it has a substantial bibliographic value for those who have access to the cited court decisions. For those, however, to whom the patent phase of their work is subordinate to the larger technical phase or administrative phase, for those whose training is technical rather than legal, the book is not recommended in the belief that it will confuse rather than assist them.

DAVID B. SMITH
Philco Corporation
Philadelphia, Pennsylvania

Thermionic Valve Circuits, (Second Edition) by Emrys Williams

Published (1944) by Sir Isaac Pitman and Sons, Ltd., 39 Parker St., Kingsway, W. C. 2, London, England. 203 pages+4-page index+viii pages. 127 illustrations. 5½×8½ inches. Price 12s. 6d. net.

This volume is intended as a textbook for third-year students in electrical engineer-

ing and deals with the theory of operation and design of electronic-tube circuits. The first two chapters review alternating-current theory and high-vacuum-tube characteristics. These are followed by a chapter on resistance- and transformer-coupled amplifiers and another on tuned amplifiers negative-feedback amplifiers, etc. The next chapters cover regeneration and oscillation, detectors, and amplifiers and finally frequency changers.

The planned scope is well covered. However, the emphasis is almost entirely on the theory of circuit operation, there is little treatment of design. The theoretical treatment is good, although somewhat detailed at times. Illustration of some of the derivations by experimental data would have been desirable, particularly to show deviations from theory. The emphasis on theory may reduce the application of this volume to American colleges.

The book is reasonably up to date. There is discussion of multivibrator and similar circuits but many of the more recent circuits such as used in television, etc., have been excluded.

On the whole, this volume will be found useful as a textbook, but of limited use to practicing engineers.

E. E. SPITZER
Radio Corporation of America
Lancaster, Pennsylvania

Contributors



H. J. DAILEY

H. J. Dailey was born on December 15, 1905, in Saltville, Virginia. He served as a journeyman electrician and radio repairman until 1931, when he entered Virginia Polytechnic Institute, from which he received the B.S. degree in 1935. In 1936 he was awarded the M.S. degree from the same institution.

Mr. Dailey is at present associated with the Westinghouse Electric and Manufacturing Company, in Bloomfield, New Jersey.



John H. DeWitt, Jr. (A'31-M'38-SM'43) was born in Nashville, Tennessee, on February 20, 1906. He attended Vanderbilt University and from 1929 to 1932 was a member of the technical staff of Bell Telephone Laboratories. From 1932 to 1942 he was chief engineer of WSM, Nashville, Tennessee; from 1942 to 1943, Bell Telephone Laboratories, Whippany, New Jersey. Since 1943 he has been a Major in the Signal Corps, Army of the United States. His present assignment is Technical Executive Officer at Camp Evans Signal Laboratory, Belmar, New Jersey.



Paul C. Gardiner (A'41) was born at Larkspur, California, on September 9, 1900. He received the B. S. degree in electrical engineering from the University of California in 1925.

Upon graduation, he became employed by the radio transmitter engineering department of the General Electric Company at Schenectady, New York. He thereafter became identified with single-sideband radio transmission and later with photoelectric industrial control.

In 1927 he was transferred to work with Dr. E. F. W. Alexanderson on cross-country radio facsimile, on which he was in charge of the West Coast development group at Oakland, California.



JOHN H. DEWITT, JR.



In 1930, Mr. Gardiner returned to the radio transmitter engineering department, where he engaged in work with special government receivers, underwater sound, and radar.

Since October, 1943, he has been working with the Company's research laboratory, following development on secret apparatus for the armed forces.





PAUL C. GARDINER



Nathaniel I. Korman (S'38-A'39) was born in Providence, Rhode Island, on February 23, 1916. He received a B.S. degree from Worcester Polytechnic Institute in 1937. Working at Massachusetts Institute of Technology under a Charles A. Coffin Fellowship, he received an M.S. degree in electrical engineering in 1938. That same year he became a student engineer with the RCA Manufacturing Company. Mr. Korman is now head of the radar and television advanced development section of this company. He is a member of Sigma Xi.



J. E. Maynard (A'29) was born at Pasqua, Saskatchewan, Canada, on September 5, 1906. He received the B.Sc. degree in electrical engineering from the University of Washington in 1929, and the M.Sc. in electrical engineering from Union College in 1932. Since 1929 he has been in the employ of the General Electric Company starting on radio test at Schenectady. His work has been radio development and design in Dr. Alexanderson's laboratory, general engineering laboratory at Schenectady, radio receiver engineering department at Bridgeport, and at present in the transmitter division of the electronics department in Schenectady.



NATHANIEL I. KORMAN



J. E. MAYNARD



I. E. Mouromtseff (A'34) was born in December, 1881, at St. Petersburg, Russia. He received the M.E. degree from the Engineering Academy, St. Petersburg, in 1906, and in 1910 was awarded the Diploma-Ingenieur degree in electrical engineering from the Grand Ducal Institute of Technology, Darmstadt, Germany. During the following year he was dean of the Signal Corps School for Army Officers, in Russia. In 1911 Mr. Mouromtseff was a member of the Franco-Russian Radio Committee.

In 1923 he became affiliated with the Westinghouse Electric and Manufacturing Company in the research laboratories at East Pittsburgh. He was transferred to the vacuum-tube department in 1936, and since 1942 has worked in the electronics engineering department, in Bloomfield, N. J.



Robert C. Paine was born at South Randolph, Vermont, on August 10, 1895. He studied electrical engineering at Worcester Polytechnic Institute, and marine engineering at Webb Institute of Naval Architecture and Marine Engineering from 1914 to 1917. He left college in 1917 to enter the United States Army and served in the 302nd Field



I. E. MOUROMTSEFF



ROBERT C. PAINE



Artillery for two years. After the armistice, he studied at the Royal Technical College in Glasgow, Scotland, for several months in 1919. Mr. Paine was a member of the technical staff of the Bell Telephone Laboratories from 1923 to 1932, engaged in circuit design. He joined the Ferris Instrument Corporation soon after its formation and since 1934 he has assisted in the early development of signal generators. In charge of the testing and calibration of generators, he developed special equipment and methods for this purpose. He is now engaged in testing special equipment for the Armed Forces with the Ferris Instrument Company. Mr. Paine is a member of the Radio Club of America and the Morris County Engineers Club.

Theo Eloise Robbins was born in Highland Park, New Jersey, on June 26, 1920. She received her B.S. degree in mathematics from New Jersey College for Women in June, 1942. Since graduation, she has been doing mathematical work associated with high-frequency problems in the electronics laboratory of the General Electric Company in Schenectady.



THEO ELOISE ROBBINS

Harry Stockman (A'42-M'44) was born in 1905, in Stockholm, Sweden. In 1926 he received a diploma in electrical engineering from Stockholm's Tekniska Institut in Stockholm, and was thereafter associated with Allgemeine-Elektrizitäts-Gesellschaft (AEG), the L. M. Ericson Telephone Company, and other radio manufacturers. From 1929 to 1930 he was connected with the journal *Radio*, in Stockholm, serving in the capacity of technical editor. In 1938 he was graduated from The Royal Institute of Technology, also in Stockholm, and upon graduation joined the faculty of that university as head instructor in radio engineering.



HARRY STOCKMAN

Mr. Stockman has studied the technical developments of radio in various European countries, and in 1940 he was decorated by Field-Marshal Mannerheim with the Liberty Cross for special service in the field of radio engineering in Finland. He came to the United States in the same year, on a scholarship from Henry Ford. After one year of visiting various radio manufacturers and universities, he joined the faculty of Cruft Laboratory, Harvard University, where he has remained to date.



Hershel Toomim was born on June 19, 1916, at Waco, Texas. He received the degree of B.S. in electrical engineering from the University of Illinois in 1940. His education



HERSHEL TOOMIM

in research and development has been largely the result of working under Professor H. J. Reich and Mr. F. H. Shepard.

Among the projects on which Mr. Toomim has worked other than magnetic recording, are trigger circuits, radiophoto, radio sonde, and secrecy systems.

He is a member of Sigma Xi and Phi Eta Sigma.



L. C. Werner was born in November, 1909, at Jagerndorf, Austria. He was edu-



L. C. WERNER

cated at Newark Technical School, Newark, New Jersey, and did graduate work at Stevens Institute of Technology. From 1927 to 1931 Mr. Werner worked with circuit and equipment design at the Western Electric Company. In 1931 he entered Westinghouse Electric and Manufacturing Company, and since 1937 has been associated with the X-ray and electronics engineering departments of that organization.



David Wildfeuer was born on October 3, 1920, in Czechoslovakia. He received the



DAVID WILDFEUER

B.E.E. degree from the College of the City of New York in 1941. Following graduation he became associated with Gibbs and Hill, Inc., consulting engineers, where he worked on the electrical calculator.

After seven and one-half months in the United States Army, Mr. Wildfeuer joined the research laboratory of the Lewyt Corporation as an electrical engineer. He is now connected with the Eisemann Corporation, in Brooklyn, N. Y., as research engineer.



For biographical sketches of John R. Whinnery and H. W. Jamieson, see the PROCEEDINGS for February, 1944.

Specify C. T. C.

CRYSTALS

I-F TRANSFORMERS

TURRET TERMINAL LUGS

SPLIT LUGS

DOUBLE END TERMINAL LUGS

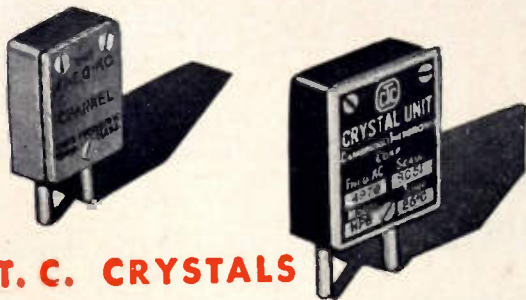

C. T. C. CRYSTALS

Accurate cutting of each slice — thanks to X-RAY ORIENTATION — insures constant frequency over a wide temperature range. Multiple mechanical lapping operations; dimensioning by edge lapping and finishing to final frequency by etching, are other important steps in the manufacture of C.T.C. Crystals that guarantee high activity and constant frequency throughout their entire life.



I-F TRANSFORMERS

These tiny, *ultra-high frequency*, slug tuned I-F Transformers are doing an efficient, thoroughly dependable job in many important radio and electronic applications.

Ask us about LS-1 (pictured above actual size) and LS-2 transformers.



C. T. C. TURRET TERMINAL LUGS

Just swage these heavily silver plated Turret Terminal Lugs to the board and in a jiffy you have a good, firm turret terminal. Quick soldering, too. Sufficient metal is used in the Lugs to give them strength but not enough to draw heat thus increasing soldering time.



C. T. C. Turret Terminal Lugs are stocked to meet $\frac{1}{32}$ ", $\frac{2}{32}$ ", $\frac{3}{32}$ ", $\frac{4}{32}$ ", $\frac{5}{32}$ ", and $\frac{6}{32}$ " board thicknesses.

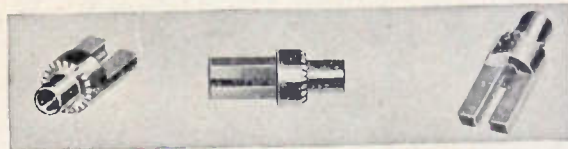

C. T. C. SPLIT LUGS

A .050 hole through the shaft permits wiring to these Split Lugs from either top or bottom without drilling or cutting. Just swage them to the board, then wire. Made of brass, heavily silver plated, C. T. C. Split Lugs are available in two sizes to fit $\frac{3}{32}$ " and $\frac{5}{32}$ " boards.

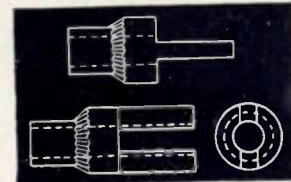

DOUBLE END TERMINAL LUGS

Use these Double End Terminal Lugs when you need terminal posts on both sides of the board. Like C.T.C. Turret Terminal and Split Lugs, C.T.C. Double End Lugs simply swage to the terminal board — provide twin terminal posts which may be wired from top and bottom. Heavily silver plated brass. Stocked to fit $\frac{3}{32}$ " terminal boards.

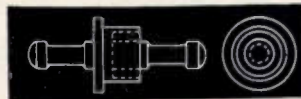

For complete information get in touch with
CAMBRIDGE Thermionic CORP.

447 CONCORD AVENUE
CAMBRIDGE 38, MASSACHUSETTS

*Where
Dependability Counts*



Permoflux Acoustical Devices Are Proving their Superiority!

Much of today's communication equipment is but remotely related to that in use when the war began. New Permoflux developments have meant increased efficiency for our fighting forces. The wide frequency response, extreme sensitivity and rugged mechanical design of Permoflux products have helped to achieve a standard of intelligibility heretofore unknown. Permoflux products will be available for many new post war applications.



TRADE MARK
PERMOFLUX

PERMOFLUX CORPORATION
4916-22 W. Grand Ave., Chicago 39, Ill.

PIONEER MANUFACTURERS OF PERMANENT MAGNET DYNAMIC TRANSDUCERS



BUENOS AIRES

"The Knowledge of Science," by E. E. Galloni, University of Buenos Aires; July 7, 1944.

"Stability of Electronic Oscillators," by R. P. McLoughlin, RCA Victor Argentina; July 21, 1944.

"Voltage and Current Regulators," by L. Koros, RCA Victor Argentina; August 18, 1944.

BUFFALO-NIAGARA

"Electronics In Flight Research," by H. Brundige, Bell Aircraft Corporation; September 20, 1944

CHICAGO

"Electronic Equipment in Geophysical Prospecting," by S. W. Wilcox, Seismograph Service Corporation; September 15, 1944.

"Electronics Aids the Psychiatrist," W. S. McCulloch, University of Illinois; September 15, 1944.

CONNECTICUT VALLEY

"Methods and Equipment Used in Airline Avigation and Communication," by B. E. Montgomery and Robert Dawson, United Air Lines; September 21, 1944.

DALLAS-FORT WORTH

"Radio-Field-Intensity Measurements in Proving Antenna Patterns," by B. B. Honeycutt, Station KRLD; September 14, 1944.

DAYTON

"Ground Communication Equipment," by R. B. Colton, Signal Corps United States Army; September 28, 1944.

DETROIT

"The Communication Engineer Looks into the Future," by E. C. Balch, Michigan Bell Telephone Company; September 21, 1944.

EMPORIUM

"The Application of Compensation Circuits to Electronic Voltage Regulators," by L. I. Knudson, Sylvania Electric Products; September 27, 1944.

Motion Picture, "Your Ship In Action"; September 27, 1944.

KANSAS CITY

"Coaxial Transmission Lines and Wave Guides," by Harner Selvidge, Fournier Institute of the Arthur J. Schmitt Foundation; September 19, 1944.

NEW YORK

"The Use of Radio Facilities by the Office of War Information," by J. O. Weldon, Office of War Information; September 6, 1944.

"Ultra-Short-Wave Receiver for the Cape-Charles—Norfolk Multiplex System," by D. M. Black, G. Rodwin, and W. T. Wintringham, Bell Telephone Laboratories, Inc.; September 13, 1944.

"Cape Charles—Norfolk Ultra-Short-Wave Multiplex System," by N. F. Schlaak and A. C. Dickieson, Bell Telephone Laboratories, Inc.; September 13, 1944.

"Ultra-Short-Wave Multiplex," by C. R. Burrows and Alfred Decino, Bell Telephone Laboratories, Inc.; September 13, 1944.

"Ultra-Short-Wave Transmitter for the Cape Charles—Norfolk Multiplex System," by R. J. Kircher and R. W. Friis, Bell Telephone Laboratories, Inc.; September 13, 1944.

TWIN CITIES

"Postwar Industrial Design in Electronics," by H. W. Darr, The Maico Company, Inc.; September 19, 1944.

WASHINGTON

"What Is To Be Said Now of Facsimile?," by I. S. Coggeshall and J. H. Hackenberg, Western Union Telegraph Company; September 11, 1944.

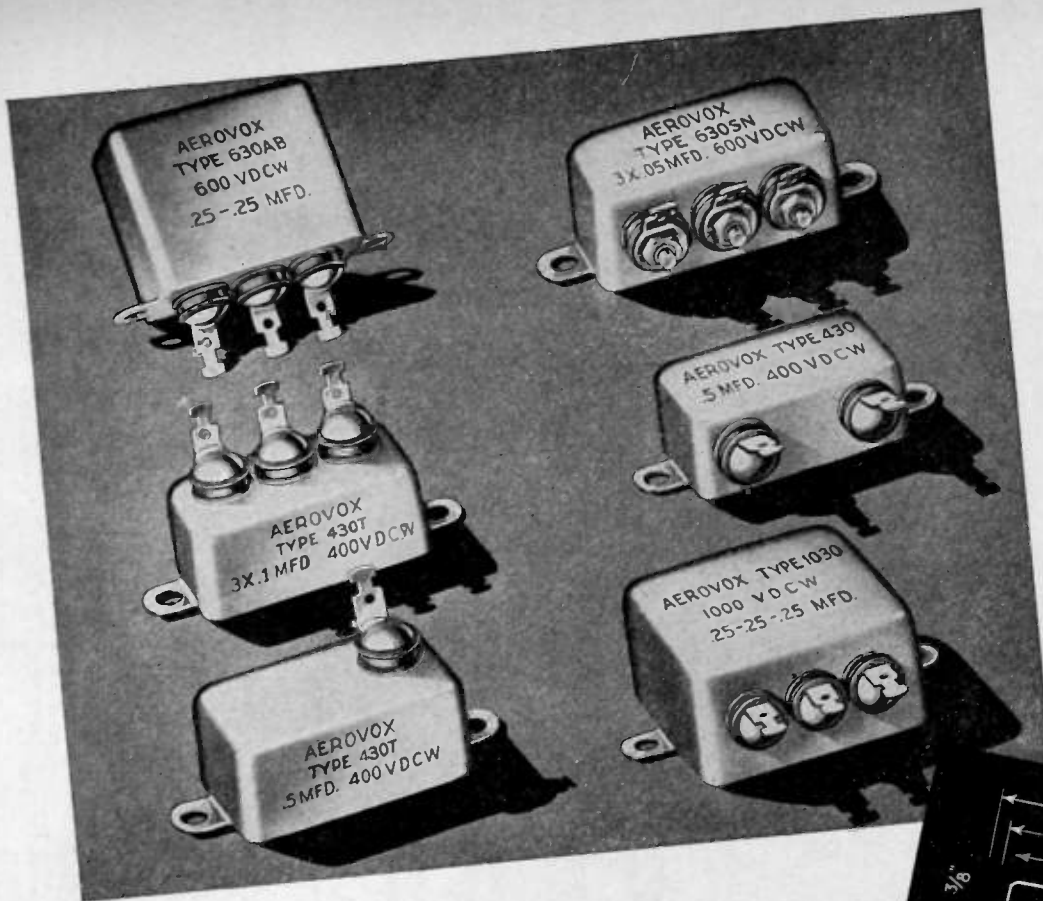

Meeting the severe operating conditions encountered in military, aircraft, police, broadcast, P-A and other equipment...

HYVOL "BATHTUB" Capacitors

● These drawn-container units are designed for applications requiring compact, extra-quality capacitors. Aerovox Type 30 capacitors are specified for equipment that must undergo severe-service operating conditions, more particularly in military, aircraft, police, broadcast, public-address, and other classes of communications equipment, as well as in electronic assemblies operating hour after hour. These "bathtubs" are standard capacitors in Government radio and electronic equipment.

Type 30 is Hyvol impregnated and filled. Type 30M is mineral-oil impregnated and filled. One-piece drawn

metal case with soldered bottom plate. Terminals are constructed with the Aerovox-originated "double-rubber" bakelite insulators permanently riveted to the case, making a sturdy, absolutely immersion-proof assembly. Terminals on side, top, bottom or ends to suit mounting and wiring requirements.

In 400, 600 and 1000 v. D.C.W. Choice of capacitances. Single, dual and triple sections.

● Write for descriptive literature and listings.



Capacitors

INDIVIDUALLY TESTED

AEROVOX CORPORATION, NEW BEDFORD, MASS., U. S. A.

SALES OFFICES IN ALL PRINCIPAL CITIES

Export: 13 E. 40 ST., NEW YORK 16, N. Y. • Cable: 'ARLAB' • In Canada: AEROVOX CANADA LTD., HAMILTON, ONT.

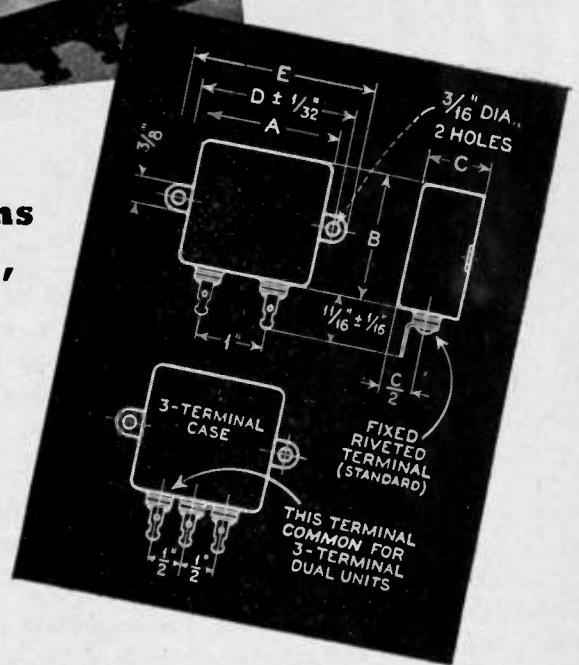



PRODUCTION TESTING WITH PANORAMIC

Any variation in magnitude which can be converted to a variation in frequency—quantities such as length, permeance, volume, and height—can be more quickly and accurately measured by the PANORAMIC COMPARISON TECHNIQUE. Capacitors, inductors, resistors, and crystals are "naturals" for PANORAMIC production testing. A simple jig and a PANORAMIC COMPARATOR will provide your tester with an unbeatable combination for speed and accuracy on the production line.

In application, the component under test is placed into the jig containing the standard. The chosen tolerance may be established quickly by means of the panel control on the PANORAMIC COMPARATOR. From the deflections which appear on the PANORAMIC screen, deviations from the standard become immediately apparent both as to percentage and type. The instrument is usually adjusted so that a visible deflection indicates that the production unit is within the predetermined tolerance range, while the absence of deflection indicates an error in excess of the permissible tolerance. Coincident deflections indicate zero error; displaced deflections tell their own story regarding the percentage of error. PANORAMIC COMPARISON TECHNIQUE is economical in time and energy . . . but extremely accurate in results.

Our engineers will gladly suggest simple jigs for use in any type of production testing.

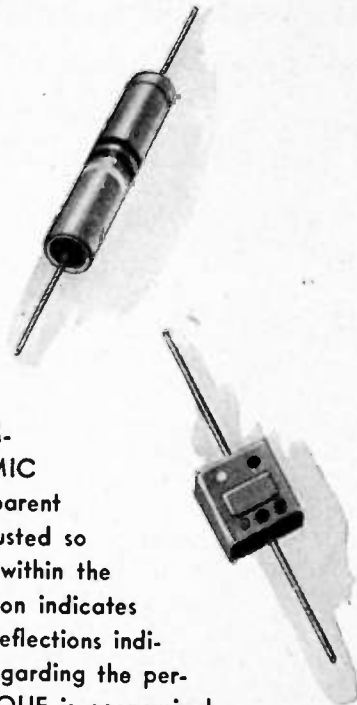
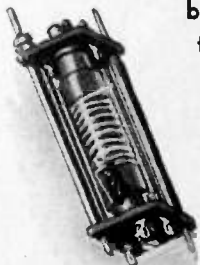

PANORAMIC



RADIO CORPORATION

242-250 WEST 55TH ST. New York 19, N.Y.

In **QUARTZ CRYSTALS**, the most significant advancements
have been introduced by *Bliley*

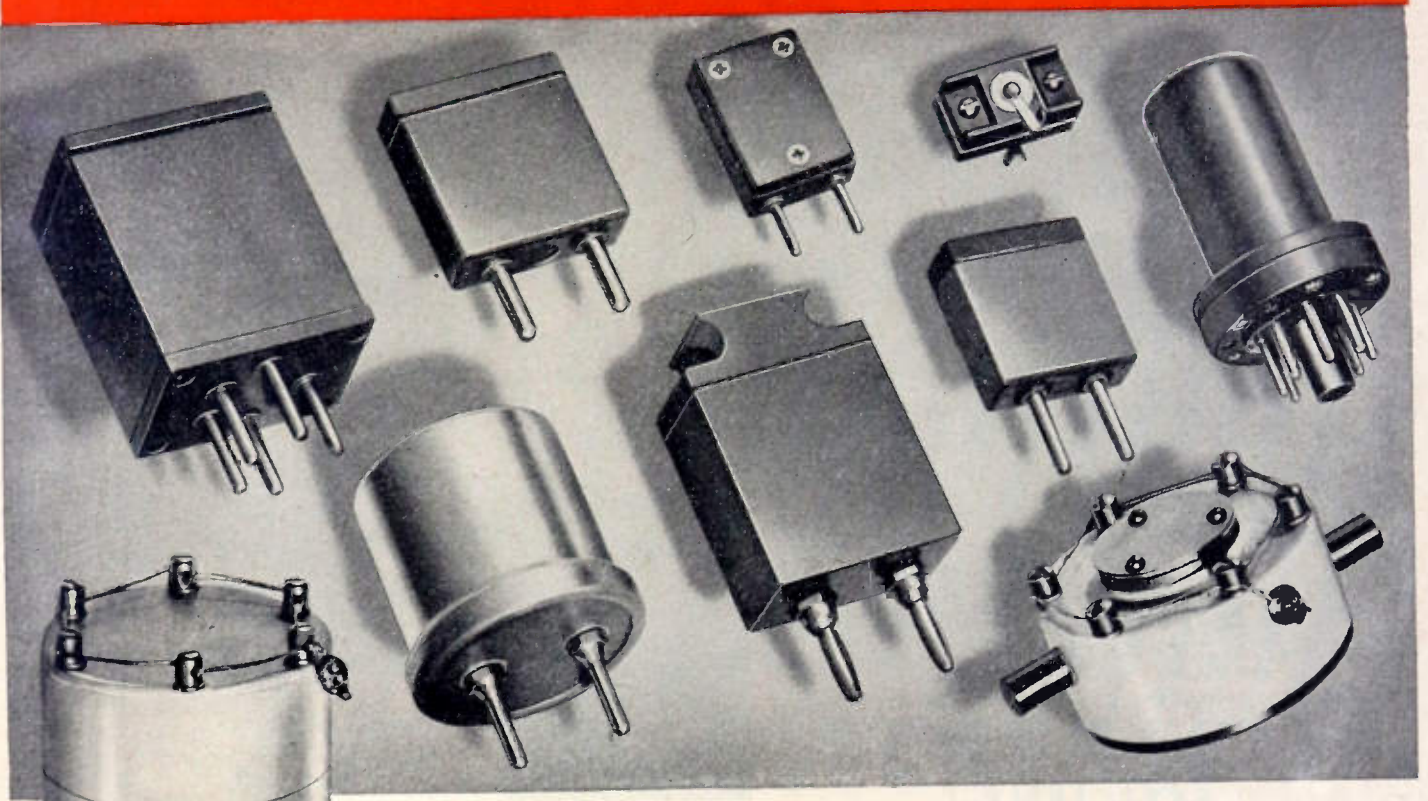

This is a message from Bliley to the thousands of amateurs and professional engineers who are now serving their country in the armed forces and in essential communications industries. Bliley "grew up" with them.

To these men and women Bliley crystals are still a familiar sight. They recognize, in the military crystal units used by our armed forces, many basic features that were pioneered by Bliley for application in peacetime services.

When tremendous production was demanded by our armed forces Bliley had the engineering background, the facilities and the production experience to provide a firm corner stone on which this volume production of radio crys-

tals was successfully built. And, from the ranks of talented amateurs and radio engineers came a host of long-time friends who knew exactly how to use them.

But research has continued and experience has grown mightily to meet the challenge of war requirements. With the return to peace, and relaxation of wartime restrictions there will be better Bliley crystals for every application as well as new Bliley crystals for the new services that loom on the horizon. That's a promise.

To our old friends, amateurs and professional engineers, we say, "Look to Bliley for crystal units that embody every advanced development."

Do more than before . . .

buy extra War Bonds

BLILEY ELECTRIC COMPANY
UNION STATION BUILDING • ERIE, PENN.



Bliley
CRYSTALS

1,001 USES

Condensed Power for Years of Service

VERSATILITY and dependability were paramount when *Alliance* designed these efficient motors — *Multum in Parvo!* . . . They are ideal for operating fans, movie projectors, light home appliances, toys, switches, motion displays, control systems and many other applications . . . providing economical condensed power for years of service.

Alliance Precision

Our long established standards of precision manufacturing from highest grade materials are strictly adhered to in these models to insure long life without breakdowns.

EFFICIENT

Both the new Model "K" Motor and the Model "MS" are the shaded pole induction type — the last word in efficient small motor design. They can be produced in all standard voltages and frequencies with actual measured power outputs ranging upwards to 1/100 H. P. . . Alliance motors also can be furnished, in quantity, with variations to adapt them to specific applications.

DEPENDABLE

Both these models uphold the *Alliance* reputation for all 'round dependability. In the busy post-war period, there will be many "spots" where these Miniature Power Plants will fit requirements . . . Write now for further information.

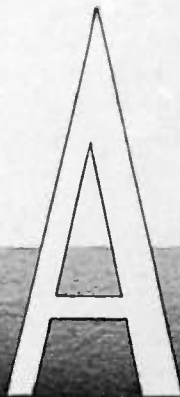

ALLIANCE

MANUFACTURING CO.

ALLIANCE . OHIO

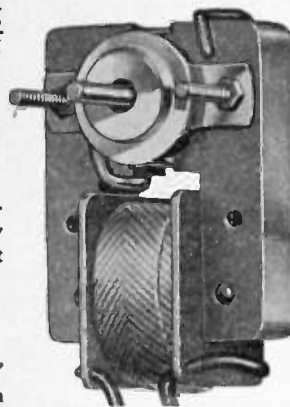

Model "MS" — Full Size
Motor Measures
1 1/4" x 2 x 3 1/8"

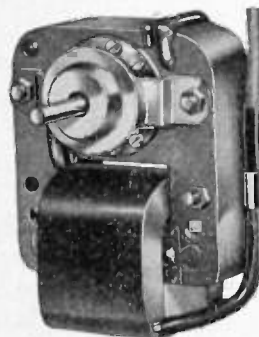

New Model "K" — Full Size
Motor Measures
2 3/8" x 2 3/8" x 3 1/8"

Remember Alliance!
—YOUR ALLY IN WAR AS IN PEACE



The following transfers and admissions were approved October 3, 1944.

Transfer to Senior Member

Anton, N. G., 225 Sterling Pl., Brooklyn, N. Y.
Beam, R. E., Northwestern University, Evanston, Ill.
Christald, P. S., 132 Squire Hill Rd., Upper Montclair, N. J.
Corbett, C. W., 333 E. 53 St., New York, N. Y.
DeVore, L. T., 1245 Arbor Ave., Dayton, Ohio
Donovan, W. E., 40 E. 49 St., New York, N. Y.
Everest, F. A., 1011 Encino Row, Coronado, Calif.
Greig, D. D., 106-15 Queens Blvd., Forest Hills, L. I., N. Y.
Gubin S., 4417 Pine St., Philadelphia, Pa.
MacLean, K. G., R.C.A. Laboratories, Riverhead, L. I., N. Y.
Noble, D. E., 165 Garfield Ave., Elmhurst, Ill.
Ostlund, E. M., 194 Grove St., Montclair, N. J.
Ramo, S., General Electric Company, Schenectady, N. Y.
Scheer, G. H., Jr., R.F.D. 5, Box 379, Dayton, Ohio
Wentz, J., 180 Varick St., New York, N. Y.
Wright, J. W., 122 Webster Ave., Manhasset, L. I., N. Y.

Admission to Senior Member

Duffendack, O. S., North American Phillips Company, Richmond Hill, Irvington-on-the-Hudson, N. Y.
Sherman, V. W., Federal Telephone and Radio Corporation, 200 Mt. Pleasant Ave., Newark, N. J.

Transfer to Member

Campbell, M. E., A.P.O. 518, c/o Postmaster, New York, N. Y.
Deerhake, F. M., 600 Oakwood St., Fayetteville, Edwards, H. H., 186-21—122 Ave., St. Albans, L. I., N. Y.
Ellithorn, H. E., 417 Parkovash Ave., South Bend, Ind.
Espy, W. D., 362—30 Street Dr., S. E., Cedar Rapids, Iowa
Fernandez, M., 20 Ferrying Group, A.T.C., Municipal Airport, Nashville, Tenn.
Fiedler, L., 53 Rosedale, Hamburg, N. Y.
Gorman, D. P., E. 521 Sharp Ave., Spokane, Wash.
Graf, A. W., 4 Midway Ct., Hammond, Ind.
Hirsch, O. C., 324 Broadway, Cape Girardeau, Mo.
McCartney, H. S., 625 Second Ave., S., Minneapolis 2, Minn.
Sharp, W. O., Bell Telephone Laboratories, 395 Hudson St., New York 14, N. Y.
Sokoloff, P. W., 68-19 Burns St., Forest Hills, L. I., N. Y.
Squires, E. G., 319 E. Jefferson Ave., Wheaton, Ill.
Stockman, H., Cruft Laboratory, Harvard University, Cambridge 38, Mass.
Thomas, H. P., 202 Huntleigh Ave., Fayetteville, N. Y.
Wang, T. S., 726 Cooper St., Camden, N. J.
Williamson, R. H., 161 E. Onondaga St., Syracuse 2, N. Y.

Admission to Member

Curtis, R. C., 25 Stanley St., New Haven, Conn.
Davis, F. M., 1429 Wildwood Dr., N. E., Cedar Rapids, Iowa
Feldt, R., 875 W. 181 St., New York 33, N. Y.
Hackett, A. H., Apartado 1226, Telephone Company, Caracas, Venezuela
Laning, W. A., 70 Glen Ridge Ave., Glen Ridge, N. J.
Norman, S. W., 300 Buxton Rd., Falls Church, Va.
Warner, A. W., Jr., Bell Telephone Laboratories, Murray Hill, N. J.
Weid, A. C., Airborne Instruments Laboratory, 150 Old Country Rd., Mineola, L. I., N. Y.
Weissman, S., 321 W. Norman Ave., Dayton 5, Ohio
(Continued on page 40A)

**TYPICAL USES
FOR YOUR
POST-WAR
RADIO**

SS-2 FOR LOOP OR OUTSIDE
ANTENNA SELECTION

SS-15 PUSH SWITCH FOR
DIAL LIGHT ON BATTERY SETS

SS-7 FOR FIXED SETTING FOR
BAT.-A.C.-D.C. OPERATION

SS-7
SS-2 POWER TRANS. PRIMARY TAPS
OR A.C.-D.C. CHANGE OVER

LPSS-3 MAY BE USED
AS VARIABLE TC &
WAVE BAND SWITCH
INSTEAD OF SS-3
AND SS-7

SS-1 POWER SWITCH

SS-7 3-POSITION
TONE SWITCH

SS-15
SS-9 SOLENOID TYPE
PUSH BUTTON TUNING

SS-3 WAVE BAND SWITCH

THE SWITCHES OF HUNDREDS OF APPLICATIONS

*Line, Slide, Rotary-Action Types
Inexpensive but Dependable*

FROM post-war radio equipment to toys; from instruments to appliances. Stackpole switches afford a complete engineering selection. They are compact, dependable, low in price, and are subject to countless adaptations designed to match your specifications *exactly*.

Standard types include 1-, 2-, 3-,

and 4-pole styles, with or without spring return, detent, or other optional features. 3-position and various other types are available. Write today for a copy of the 36-page Stackpole Electronic Components Catalog including Switches, Fixed and Variable Resistors and Iron Cores for a variety of uses.

STACKPOLE CARBON COMPANY, St. Mary's, PA.

STACKPOLE

OTHER STACKPOLE PRODUCTS

BRUSHES - CONTACTS (All carbon, graphite, metal, and composition types)
POWER TUBE ANODES PACKING, PISTON, and SEAL RINGS
BATTERY CARBONS POWDER METALLURGY COMPONENTS

WELDING CARBON PRODUCTS
VOLTAGE REGULATOR DISCS
RHEOSTAT PLATES and DISCS, etc.

FOR

**RADAR • RADIO • TELEVISION
INSTRUMENTS • BRIDGES
DECADE BOXES • TRANS-
FORMERTAPPING • PARALLELING
RESISTORS AND CAPACITORS
TAPPING INDUCTANCES
and dozens of similar
exacting uses**

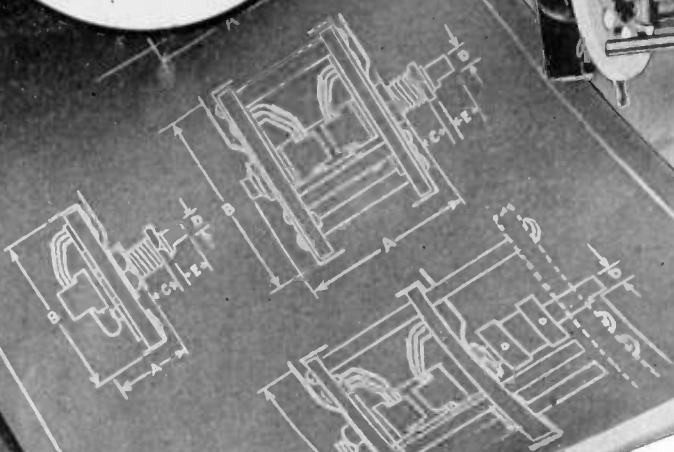
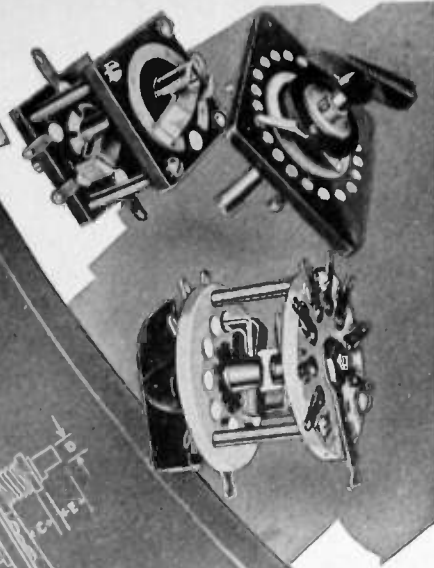

Specially Engineered **SWITCHES**

in Special, Low Contact Resistance Designs

Shallcross Switches are a natural outgrowth of our own need for finely made, specially designed, low contact resistance units for a wide variety of exacting instrument and other applications. Solid silver contacts and contact arms assure highest conductivity, avoid danger from wear, and guard against corrosion. Up to 180 contacts can be supplied on a single switch. Single or multiple sections as required. Although many standard types are available, most switches supplied by us are special adaptations or unique designs to meet special needs. **WRITE!** Send today for technical literature on Shallcross switches. Put your problems up to Shallcross switch engineers for quick, economical, efficient solutions.

ANTI-MOISTURE ANTI-FUNGUS

Special treatment with materials to meet Signal Corps specifications available when required.

SHALLCROSS MFG. CO.

DEPT. IR-114, COLLINGDALE, PA.

ENGINEERING • DESIGNING • MANUFACTURING



(Continued from page 38A)

Admission to Associate Grade

- Abel, C. F., 4067—41 St., San Diego 5, Calif.
Allison, D. M., Jr., 1971 Victoria Ave., Dayton, Ohio
Anderson, C. K., 2 Prescott St., Cambridge 38, Mass.
Askitoglou, T. J., Eglence Sokak No. 3, Arnavutkoy, Istanbul, Turkey
Bahlay, A., 442 Harbor Hills, Lomita 4, Calif.
Balsam, S., 1517 Charlotte St., New York 60, N. Y.
Bartley, G. A., No. 3 Wireless School, Winnipeg, Manit., Canada
Baxter, R. F., Lunenburg, Ont., Canada.
Bedford, C. F., Slxth Ave., McKellar, Westboro, Ont., Canada.
Benton, A., 1841 Glendon Ave., Los Angeles 25, Calif.
Baumelster, E. M., Co. O., AA-3, AAATC, Camp Haan, Calif.
Berg, L. W., 89-11—34 Ave., Jackson Heights, L. I., N. Y.
Beverly, N. E., Sprague Electric Company, North Adams, Mass.
Blanchard, J. W., 350 E. 86 St., New York 28, N. Y.
Bodin, J. A., Box 2175, Houston, Tex.
Brodribb, M. I., Flat 41, 453 St. Kilda Rd., Melbourne, Victoria, Australia
Carson, G. W., 7918 Marquette Ave., Chicago 17, Ill.
Chamberlain, R. D., Box 265, Houma, La.
Chatterton, E. G., 112 Nimitz Dr. (Overlook Homes) Dayton 3, Ohio
Cherry, L. B., 2121 Washington La., Philadelphia 38, Pa.
Clair, F. F., 863 County Line Rd., Copeland Park, Newport News, Va.
Clarke, W. L., Instructors Co., Bks. 10, NATTC, Ward Island, Corpus Christi, Tex.
Clipstone, A. E., 14 Epperstone Rd., West Bridgford, Nottingham, England
Corte, L. P., "Roseneath" 22 Abbotts Rd., Aylesbury, Bucks, England.
Coulter, W. H., c/o Press Wireless Inc., Hicksville, L. I., N. Y.
Demers, R. H., R.C.A.F. Station, Gaspé, Que., Canada
Douglass, J. D., 21265 Kenwood Ave., Rocky River, Ohio
Filman, N. J., 864 McEachran Ave., Outremont, Montreal 8, Que., Canada
Fisher, F. J., 738 Colborne St., London, Ont., Canada
Fogg, C. P., 5 Malvern House, Abbey Rd., Great Malvern, Worcestershire, England
Forrest, W. C., Poynette, Wis.
Fountain, L. R., 15 Cortland, Springfield, Mass.
Ganguly, S. K., 19 Chakrabere Rd., S., Bhawanipore, Calcutta, India
Gilbert, M., Canadian Broadcasting Corporation, Chateau Laurier Hotel, Ottawa, Ont., Canada
Gilbert, R. L., 522 Piccadilly St., London, Ont., Canada.
Goble, R. W., 1360 Speer Blvd., Box 1500, Denver 1, Colo.
Gookin, K. A., Naval Research Laboratory, Bldg. 33A, Anacostia Station, D. C.
Gore, E. M., 3303 Porter St., N. W., Washington, D. C.
Gotch, J. X., 123 S. Monroe St., Streator, Ill.
Greenberg, M. L., 3322 Leslie, Detroit 6, Mich.
Gross, H. R., 1 Miller St., Caldwell, N. J.
Hamilton, J. R., 317 E. 29 St., Brooklyn 26, N. Y.
Himmel, H., 817 West End Ave., New York 25, N. Y.
Himmer, F., Jr., 6703 Cresheim Rd., Philadelphia 14, Pa.
Hobbs, R. P., 232 Madison Ave., New York 16, N. Y.

(Continued on page 46A)

**THIS
ONE'S
"ON
RCA"**



AVERAGE COST PER PREFERRED TYPE TUBE

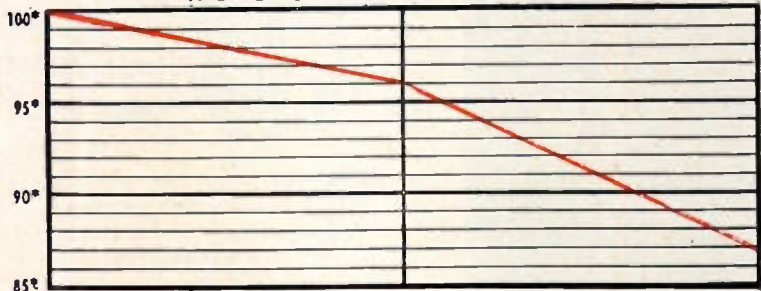

*NOVEMBER 1939 AVERAGE COST = 100, ALL COSTS BASED ON SAME TUBE TYPES

Here's Why — **RCA's Preferred-Type Program Slashed Tube Costs to Manufacturers More Than 13% During Its First Year . . . Giving You One Tube in Eight "On the House" by Former Price Standards**

The Preferred-Type Idea makes sense. And, it works!

Introduced by RCA in January, 1940, the Preferred-Type Program aimed at concentrating a larger demand and production on fewer tube types. This would allow greater manufacturing efficiency, because of longer runs, and would mean higher-quality, lower-cost tubes for you.

Even before civilian radio manufacturing was suspended by war, the program paid off. By November, 1940, the average cost to you of tubes on the RCA preferred list was lower by 13% than the average cost of the same tubes in November, 1939 . . . before the program started.

Yet all the time their cost was being lowered, the tubes improved in quality and performance. And the way was being cleared for simplified tube warehousing and stocking.

Since Pearl Harbor, the value of the "preferred-type" idea has been proved beyond a doubt on the world's battlefields. Most military electronic equipment has been designed around an Army/Navy Preferred List of Vacuum Tubes . . . and our fighting men on every continent are assured

speedy replacements of high-performance tubes as a result.

Will RCA continue the Preferred-Type Program after the war? You bet it will! If you already have specific tube complements in mind for postwar and would like to know if the tubes you need will be on the preferred list, let us know what they are. Write to Radio Corporation of America, Commercial Engineering Section, Dept. 62-12P, Harrison, New Jersey.

The Magic Brain of all electronic equipment is a Tube . . . and the fountain-head of modern Tube development is RCA.

1919

1944



25 Years
of Progress
in Radio
and Electronics

62-6131-12

RADIO CORPORATION OF AMERICA

RCA VICTOR DIVISION • CAMDEN, N. J.

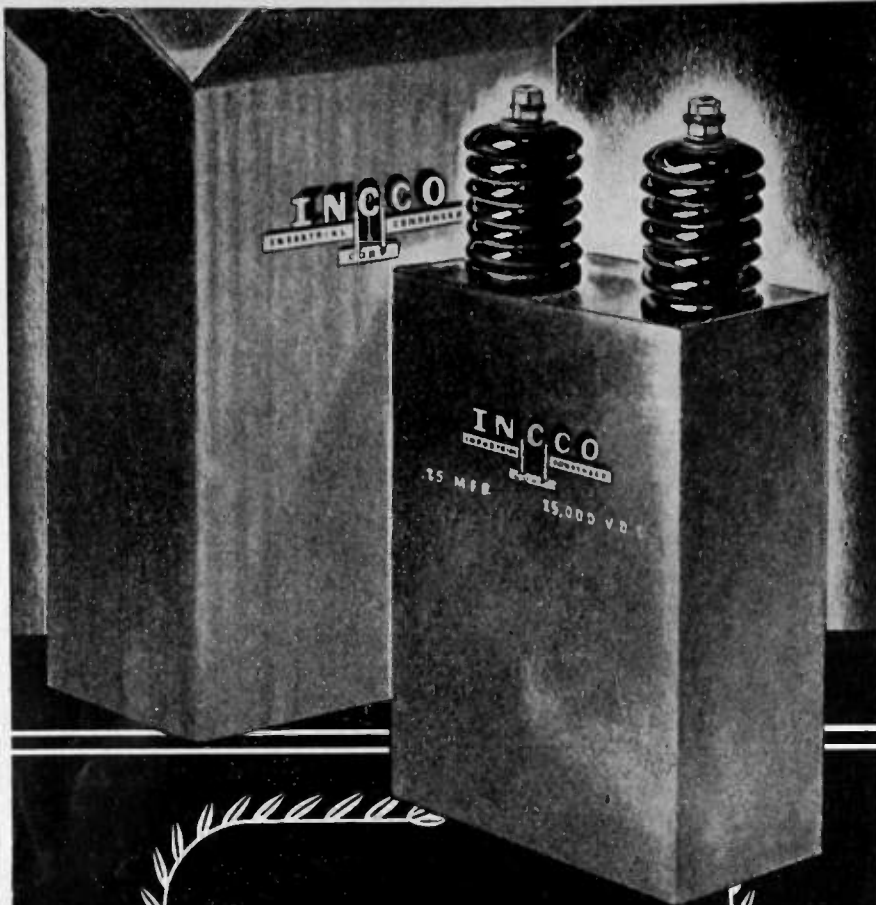

**THE
CONDENSER
LINE OF
UNSURPASSED
QUALITY**

PAPER, OIL AND ELECTROLYTIC CONDENSERS

INDUSTRIAL

CONDENSER CORPORATION

1725 W. NORTH AVE., CHICAGO, U. S. A.

DISTRICT OFFICES IN PRINCIPAL CITIES
QUICK DELIVERY FROM DISTRIBUTOR'S STOCKS



**Example of
N.Y.T. engineering
achievement**

*... which will
make post-war
products tick!*



Out of the maelstrom of war—with its complex of electronic intricacies in communication, control, operation and guidance—have come these N. Y. T. transformer developments. Ranging from units for navigational aid to firing mechanisms, these N. Y. T. components are an integral part of the "sixth sense" of the Army, Navy and Air Forces.

With the quickening tempo of war, and the casting of furtive looks by industry towards the post-war future, the importance of transformer products with comparable accuracy, efficiency and dependability will be emphasized in civilian production. The acid tests of combat will be the proving grounds of tomorrow's simple household gadgets and industry's tools.

N. Y. T. technicians can be instrumental in the fulfillment of electronic-functioning phases of your products, equipment and appliances. Association with leading electrical manufacturers and services—as transformer designers, consultants and producers—will corroborate the distinctive and exceptional nature of N. Y. T. facilities.

**NEW YORK
TRANSFORMER CO.**

24-26 WAVERLY PL., NEW YORK 3, N. Y.

Proceedings of the I.R.E. November, 1944

••• "Among their Latest Triumphs is an inter-communicating telephone for interior use in buildings, which furnishes in itself, by pressing buttons, complete exchange connections, with all parts of the building, and releases the same automatically and comprises the only successful system of its kind of the present age."



The glowing phrases above, written not long after the turn of the century, describe a Connecticut Telephone and Electric "First" which doubtless caused grandpa to wonder, "What won't they think of next!"

The things our engineers are thinking up today in cooperation with U. S. Army engineers are full of interest and promise, but they can't be talked about now. You can count on better communications...in fact, you can confidently expect war-born improvements in all branches of electrical and electronic science.

If your product-development plans involve a problem of electrical or electronic engineering and manufacturing, perhaps we can be of assistance. We also invite preliminary inquiries connected with inter-communicating and signalling systems for postwar buildings now in the design stage.



CONNECTICUT TELEPHONE & ELECTRIC DIVISION

GREAT AMERICAN INDUSTRIES, INC.
MERIDEN, CONNECTICUT



TELEPHONIC SYSTEMS • SIGNALLING EQUIPMENT • ELECTRONIC DEVICES • ELECTRICAL EQUIPMENT • HOSPITAL AND SCHOOL COMMUNICATIONS AND SIGNALLING SYSTEMS • IGNITION SYSTEMS

1945
WINTER TECHNICAL MEETING
of the
Institute of Radio Engineers
INCORPORATED



JANUARY 24, 25, 26, and 27
Hotel Commodore, New York 17, N. Y.

Technical Sessions · Banquet · Exhibit
Special Program for Service Men
President's Luncheon
Women's Program
Cocktail Party

Send In Your Hotel Reservations Early

MEMO TO Purchasing Dept.

In our postwar radio sets, recommend you buy Solar Sealdtite Tubular Capacitors - they're the best we've ever tested - the only way-molded units - superior protection against moisture.

E.M.

ENGINEERING
SPECIFY
SOLAR
DEPARTMENT

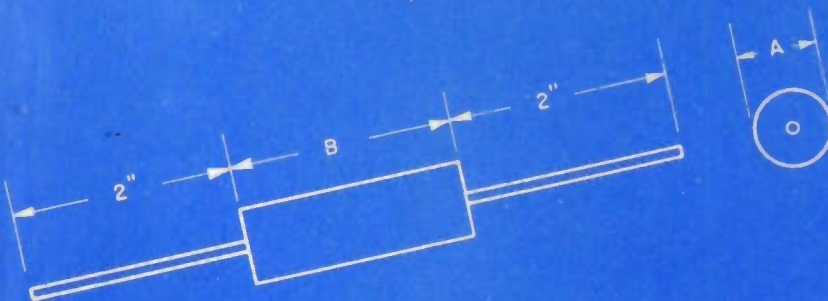

LEADING MANUFACTURERS
EVERYWHERE

ART NO	SOLAR PART NO.	CAPY MED.	WKG VOLTS	DIMENSIONS	
				"A"	"B"
49A40-1	S-0211	.001	600	3/8	1-3/16
49A40-2	S-0215	.005	600	3/8	1-3/16
49A40-3	S-0221	.01	600	7/16	1-3/16
49A40-4	S-0224	.02	600	7/16	1-5/8
49A40-5	S-0230	.05	600	9/16	1-5/8
49A40-6	S-0240	.1	600	9/16	2-1/8

DRAWN E.O.H.
TRACED M.
APPROVED J.C.

DATE 8/15/44
DWG. No. 49A40
ISSUE

Prominent engineers consistently show their preference for Solar Capacitors. Solar pledges continued production of superior quality capacitors to merit that preference. Solar Manufacturing Corporation, 285 Madison Avenue, New York 17, N. Y.

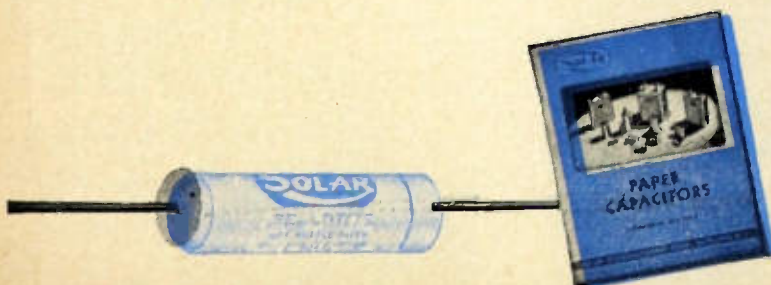

CAPACITORS &
ELIM-O-STATS



IT WON'T BE LONG NOW . . .



... and Stancor will "step ahead" with postwar plans that not only will include units for most every communication and electronic apparatus, but will have inherent in those transformers, design technique which our extraordinary war production has demanded...
Yes, Stancor is worth waiting for. So, before you specify —consult "Stancor for Postwar."

STANDARD TRANSFORMER CORPORATION
1500 NORTH HALSTED STREET, CHICAGO 22, ILLINOIS



(Continued from page 40A)

- Houck, H., Jr., South Milford, Ind.
Hudson, F. E., 90 Beacon St., Boston, Mass.
Jeffries, K., 11 Euclid Ave., London, Ont., Canada
Johnson, C. M., 72 Ellwood St., New York 34, N. Y.
Justice, J. W., 9860 Arv-Ellen Ct., Affton 23, Mo.
Kershner, R. H., 202 S. Rolling Rd., Catonsville 28, Md.
Khosla, H. L., All India Radio, Peshawar, India
Klotzbaugh, G. A., 2150 Branch Ave., S. E., Washington, D. C.
Kostashuk, S. S. R. C. A. F. Station Clinton, Ont., Canada
Krishnamurty, J., Northern Cir., Ellore, South India
Ktistes, P. J., A.P.O. 534, c/o Postmaster, New York, N. Y.
Lipman, C. E., 1555 D St., San Bernardino, Calif.
Lynn, P. R., 95 Valentine Rd., Arlington, Mass.
Mackenzie, N. F., Electronics Division, Aircraft Radio Laboratory, Wright Field, Dayton, Ohio
Mathur, K. B., ATS Todhpur Railway, Todhpur, India
Macdonald, J. A., 136 Fentiman Ave., Ottawa, Ont., Canada
McElhinney, G. S., 1219 MacKay St., Montreal, Que., Canada
Meehan, E. L., 843 Wrightwood Ave., Chicago 14, Ill.
Mihelyi, M., 691 Orange St., New Haven, Conn.
Miller, J. L., 3788 Kent Ave., Montreal 26, Que., Canada
Mitchell, R. J., 6 Bozwell's Dr., Chelmsford, Essex, England
Mollman, L. A., Union Electric Bldg., St. Louis 1, Mo.
Morrow, J. E., Fox Woods Add. RR 8, North Kansas City 16, Mo.
Nash, H. E., 474 Broadway, Cambridge 38, Mass.
Nelson, S. H., R.C.A.F. Detachment, Preston, N. S., Canada
Olmo, M. M., Soledad s/n, Camaguey, Cuba.
Ovitt, M. D., 4319 Mississippi, San Diego 4, Calif.
Parker, E. J., 55 Woodway Rd., Springdale, Conn.
Pawsey, J. L., Radio Physics Laboratory, University Grounds, Sydney, Australia
Payne, J. E., Jr., 16 Lawrence Cir., Portsmouth, Va.
Pelc, T., 117 Washington St., Portsmouth, Va.
Phillips, D., 957 Tiffany St., Bronx 59, N. Y.
Plummer, C. H., 112 Harmon Ave., Springfield 8, Mass.
Radin, B. G., 3 Civic Pl., Dayton 10, Ohio
Ramsay, R. D., 14818 Forrer St., Detroit 27, Mich.
Reese, F. A., 11 E. 32 St., New York, N. Y.
Reitz, J. R., Underwater Sound Laboratory, Harvard University, Cambridge 38, Mass.
Relis, M. J., 1428 Saratoga Ave., N. E., Washington 18, D. C.
Riley, R. N., 204 N. Beechwood Ave., Baltimore 28, Md.
Sanders, G. O., 215 W. Roosevelt Blvd., Philadelphia 20, Pa.
Sayers, H. W. R., R. C. A. F. Station, Clinton, Ont., Canada
Schultz, G. A., 12745 Camden Ave., Detroit 13, Mich.
Shapiro, D. L., 250 W. 99 St., New York 25, N. Y.
Shaw, G. S., 129 Second St., Garden City, L. I., N. Y.
Shears, N. K., Box 45, Clinton, Ont., Canada
Shepherd, W., 316 Central Ave., Dayton 6, Ohio
Shook, W. R., 360 N. Glebe Rd., Arlington, Va.
Smith, C. L., 4354 S. Flower St., Los Angeles 37, Calif.
Smith, H. J., 36 Vandegrift Dr., Dayton 3, Ohio
Spears, R. W., 120 Commonwealth, Boston, Mass.
Stafford, C. B., A.P.O. 650, c/o Postmaster, New York, N. Y.

(Continued on page 62A)

ONE ALWAYS STANDS OUT



ALCO has been awarded for the fourth time the Army-Navy "E" Award for "continued excellence in quantity and quality of essential war production."

IT'S THE QUALITY OF PERFORMANCE THAT COUNTS

ALSIMAG

TRADE MARK REGISTERED U. S. PATENT OFFICE

STEATITE CERAMIC INSULATORS

A lot of people can play the violin, but only the touch of the Master can render all the beauty and poetry of a great musical composition.

Yes, it's the quality of performance that counts. Constant research . . . improved formulations . . . new processes, plus the KNOWHOW gained from 42 years leadership in the ceramic field assure top quality performance of ALSIMAG Steatite Insulators.

ALSIMAG compositions, each with its particular characteristics, are available to meet all insulating requirements.



CHARACTERISTICS OF ALSIMAG INSULATORS

- High Mechanical Strength
- Permanent Rigidity
- Low-Loss Factor
- High Dielectric Strength
- Will Not Absorb Moisture
- Chemically Inert
- Heat Resistant
- Precision Made of Purest Raw Materials

AMERICAN LAVA CORPORATION
CHATTANOOGA 5, TENNESSEE

42nd YEAR OF CERAMIC LEADERSHIP

MOTOR DATA
No. 125

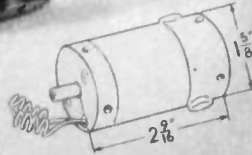
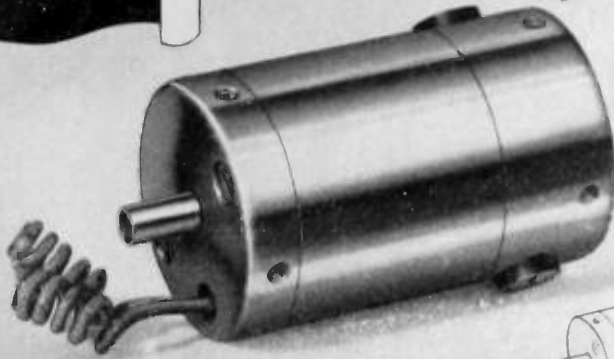

EICOR

1600 FRAME MOTOR

Torque 4.5 in. oz. at 5800 RPM

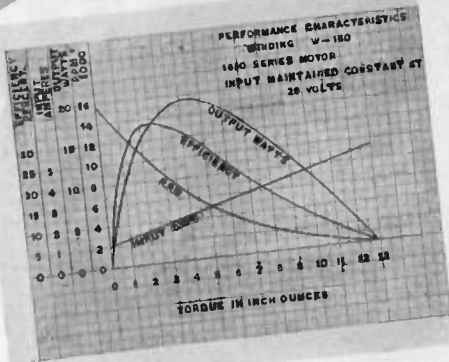

The power output of this precision motor is exceptionally high in proportion to its light weight and small size. Originally developed for numerous aircraft and portable applications, the characteristics of its performance can readily be modified for a variety of new uses.

FEATURES

ELECTRICAL MECHANICAL

- | | |
|-------------------------------|-------------------------------|
| Series or shunt wound | Completely enclosed |
| Unidirectional or reversible | Adaptable for any mounting |
| High starting torque | Laminated field poles |
| Low starting current | Stainless steel shaft |
| Low RF interference | Two precision ball bearings |
| Armature and field windings | Mica insulated commutator |
| Varnish impregnated and baked | Permanent end play adjustment |

1600 FRAME MOTORS		Series	Shunt
Watts Output, Int.	(max.)	22	
Watts Output, Con.	(max.)		5
Torque at 8500 RPM	(in. oz.)	3	
Torque at 5800 RPM	(in. oz.)	4.5	1
Lock Torque	(in. oz.)	12	3
Volts Input	(min.)	5	5
Volts Input	(max.)	32	32
Shaft Diameter	(max.)	.250"	.250"
Temperature Rise		50°C.	40°C.
Weight		12 oz.	12 oz.

EICOR INC. 1501 W. Congress St., Chicago, U. S. A.

DYNAMOTORS • D. C. MOTORS • POWER PLANTS • CONVERTERS

Export: Ad Auriema, 89 Broad St., New York, U. S. A. Cable: Auriema, New York

Power Rheostat
as engineered
by
CLAROSTAT

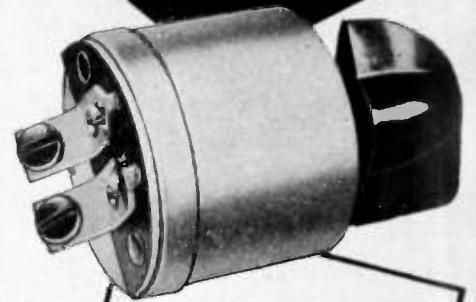

- ★ Insulated metal core supports resistance winding. Element imbedded in cold-setting inorganic cement. Maximum heat conduction and radiation.
- ★ Normal current rating may be exceeded by 50% at any setting up to 1/3 total rotation, without damage.
- ★ Rotor design provides smooth rotation and positive conduction at all settings.
- ★ Exceptionally rugged, electrically and mechanically.
- ★ 25- and 50-watt ratings. Enclosed type here shown. Also in non-enclosed type.

★ Hundreds of thousands of these Clarostat power rheostats are now in daily use. Especially so in aircraft assemblies. Indeed, they are standard equipment in planes, radio, electronic and industrial equipment. They are proving that "They can take it"—and then some.

★ Write for Literature



CLAROSTAT MFG. CO., Inc. • 285-7 N. 6th St., Brooklyn, N. Y.

Proceedings of the I.R.E. November, 1944



ASSURANCE OF PRECISION

Radio Communications Equipment

**WILCOX
ELECTRIC
COMPANY**

Fourteenth and Chestnut
Kansas City, Missouri

The Wilcox trademark on aircraft radio, communications receivers, transmitters and other radio equipment is a symbol of advanced engineering, precision manufacturing and proved performance. Today, Wilcox equipment is in use all over the world in military operations and for the major airlines of the United States. In postwar developments, you can depend on Wilcox for continued leadership in radio communications!

Manufacturers of Radio Equipment

Wanted ENGINEERS

- Radio
- Chemical
- Electrical
- Electronic
- Mechanical
- Metallurgical
- Factory Planning
- Materials Handling
- Manufacturing Planning

Work in connection with the manufacture of a wide variety of new and advanced types of communications equipment and special electronic products.

Apply (or write), giving full qualifications, to:

R. L. D.

EMPLOYMENT DEPARTMENT

Western Electric Co.

100 CENTRAL AV., KEARNY, N. J.

Applicants must comply with WMC regulations

CHIEF LOUD SPEAKER ENGINEER

The Rola Company, Inc. requires the services of an Engineer who has had several years experience and capable of heading this division.

Present work is on 100% urgent war products.

Excellent post-war opportunity with an outstanding, financially sound, long-established manufacturer of radio loudspeakers and transformers.

This Company now has definite plans for an extensive expansion in its Engineering and Manufacturing Divisions.

Salary open.

Write to The Rola Company, Inc., 2530 Superior Avenue, Cleveland 14, Ohio.



The following positions of interest to I.R.E. members have been reported as open. Apply in writing, addressing reply to company mentioned or to Box No.

The Institute reserves the right to refuse any announcement without giving a reason for the refusal.

PROCEEDINGS of the I.R.E.
330 West 42nd Street, New York 18, N.Y.

RADIO ENGINEERS, SUPERVISORS AND TECHNICIANS

Chief Radio Engineers, Transmitter and Studio Supervisors and Technicians between thirty and forty-five years of age are needed at once in important war work in the Pacific to construct and operate radio stations. These positions are with the United States Government, with good salaries and subsistence, and for the duration plus six months. Interested persons with actual broadcast experience should write, giving details of radio work, to Box 356.

RADIO, ELECTRICAL AND MECHANICAL ENGINEERS

In the development and production of all types of radio-receiving and low-power transmitting tubes. Excellent post-war opportunities with an established company in a field of opportunities. Apply in person, or write to Personnel Manager, of Raytheon Manufacturing Company, 55 Chapel Street, Newton, Mass.

RADIO ENGINEERS

Need radio engineers with experience in Frequency-Modulation transmitting and receiving equipment. Familiarity with F.C.C. rules and field operation of equipment desirable. Send complete experience and education in letter of application, and state salary desired. Company located in the Midwest where living conditions are good, and expenses below average. Address to Box 351.

RADIO ENGINEER

Unusual opportunity for experienced radio engineer. Well established medium-size Midwest radio manufacturer. Large post-war program. Nationally advertised radio line. Write qualifications and experience to the Agency Service Corporation, 66 East South Water Street, Chicago 1, Ill.

VACUUM-TUBE DESIGNERS

Engineers and physicists for research and development work on small vacuum tubes.

An opportunity for post-war employment with a growing organization doing both war and essential civilian production. Recent graduates with adequate training and experienced personnel will be considered for these positions.

Certificate of availability required. Write to Director of Research, Sonotone Corporation, Elmsford, N.Y.

ELECTRICAL ENGINEERS

Needed in connection with the manufacture of a wide variety of new and advanced types of communications equipment and special electronic products. Openings available in St. Paul, Minn., Eau Claire, Wis., and Chicago. Apply or write, giving full qualifications and furnish snapshot, to D. L. R., Employment Department, Western Electric Company, Hawthorne Station, Chicago 23, Illinois.

ELECTRONIC SALES ENGINEERS

Established electronic tube manufacturer, located in Midwest, requires sales engineers to cover Midwest or East Coast. Applicants should have electrical-engineering degree, knowledge of electronic circuits and applications, and ability to contact customers. Excellent wartime and postwar opportunity for the right men. Salary and bonus. Send complete information to Box 346.

(Continued on page 52A)

RADIO ENGINEERS

Medium - sized, progressive, Midwest manufacturer has openings for one senior and two junior engineers. Desire men for work on military projects now who will be adaptable later to postwar engineering. Prefer men with experience in radio receiver or television laboratory, and with college education in communication engineering.

Our staff knows of this advertisement.

Box No. 355

**PROCEEDINGS OF THE
I.R.E.**

330 West 42nd Street
New York 18, N.Y.

ENGINEERS

For Design &
Development
Radio-Television

Degree in communications engineering or equivalent in radio design essential. Post war permanence assured right men.

Write full qualifications—education, experience and status of availability.

Box No. 353

Proceedings of the I.R.E.
330 West 42nd Street,
New York 18, N.Y.

"INSIDE" DEPENDABILITY

De JUR Electrical Indicating Instruments

These instruments are normally calibrated for mounting on non-magnetic materials. If desired, instruments will be calibrated for use on magnetic panels. Thickness of the panel should be stated. Scales other than standard type can be supplied and prices will be sent upon request. Special divisions, markings and color combinations are available. Spade pointers are standard equipment. Knife-edge pointers can be supplied at additional cost. Should it be desired to shield the instrument from external magnetic fields, shields can be supplied. These shields increase the body diameter by 3/32 of an inch. Provisions can be made for rear-illumination. For this purpose, translucent scales are necessary. Instruments can be modified to special requirements on orders where the quantity permits such special work. Where these modifications are external, prices will depend upon the instrument sensitivity and range.

Models No. S-210 and No. S-310 are designed to comply with the standards adopted by the American Standards Association for electrical indicating instruments (2 1/2" and 3 1/2" round, flush mounting, panel type).

THREE AND ONE-HALF INCH METERS ROUND, SQUARE AND RECTANGULAR TYPES

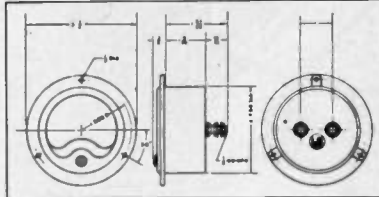

Cross-Section — S-310

TWO AND ONE-HALF INCH METERS ROUND, SQUARE AND RECTANGULAR TYPES

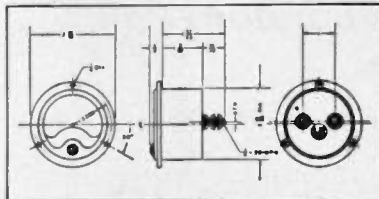

Cross-Section — S-210



Model S-310 MR 25 I DCMA



Model S-210 MR 25 WOO I DCMA

De JUR Rheostat-Potentiometers

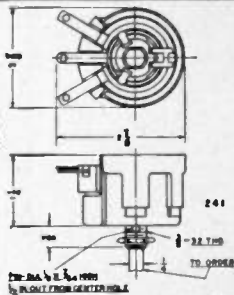
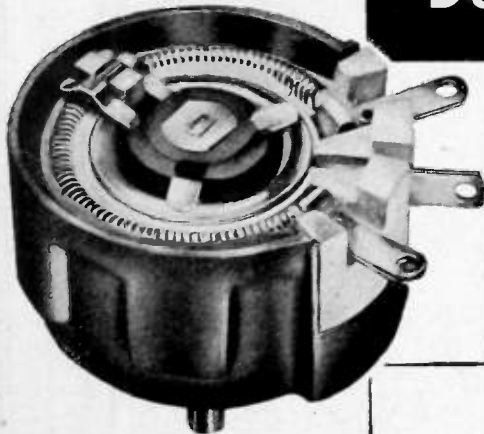

MODEL 241 SPECIFICATIONS

	RANGE IN OHMS	MODEL No.
50 WATTS		
RANGES—10 to 10,000 Ohms.	0- 10	241
	0- 50	241
	0- 100	241
MECH. ROTATION—300°	0- 500	241
ELEC. ROTATION—270°	0- 1,000	241
	0- 5,000	241
WEIGHT—7 OZ.	0-10,000	241

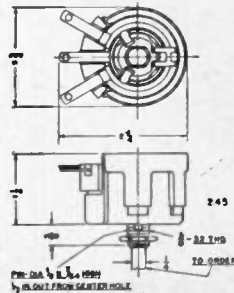

MODEL 245 SPECIFICATIONS

	RANGE IN OHMS	MODEL No.
25 WATTS		
RANGES—10 to 10,000 Ohms.	0- 10	245
	0- 50	245
	0- 100	245
MECH. ROTATION—300°	0- 500	245
ELEC. ROTATION—270°	0- 1,000	245
	0- 5,000	245
WEIGHT—7 OZ.	0-10,000	245

De Jur-Amsco Corporation

GENERAL OFFICE: NORTHERN BLVD. AT 45th ST., LONG ISLAND CITY 1, N. Y.

Now, Even Greater Facilities

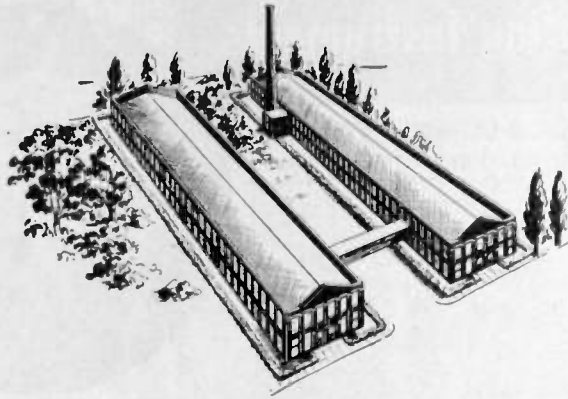

The new and larger Templetone plant at New London, Conn.

Within a few weeks our entire Electronics Division will move into new quarters—affording not only greater facilities to meet ever-expanding wartime production, but also greater scope to anticipate the great electronics developments of peacetime. From this vast, new plant—containing 100,000 square feet of space—will come rich contribution to the vast commercial requirements at war's end.



Electronics Division

TEMPLETONE RADIO MFG. CORP.

New London, Conn.

POSITIONS OPEN

(Continued from page 50A)

PRODUCT ENGINEER

Major manufacturer of electrical-wiring devices interested in employing a designer-engineer with a proved record of accomplishment. Firm possesses far-sighted management, varied production facilities, and ample capital to undertake and promote new products—the scope and opportunity of the position are limited only by the skill, imagination and initiative of the man. Salary open—location, New England. All applications will be held in strict confidence. Even though a USES release might not be immediately available, write to Box 347.

ELECTRICAL ENGINEER

Electrical engineer wanted for position of chief of research and development section of a Metropolitan New York division of nationwide manufacturer. Must have a sound educational background and outstanding design experience on light equipment. Salary open. Reply in confidence giving complete personal data, experience résumé, availability for release, etc. to Box 348.

FIELD SERVICE ENGINEERS

For domestic and foreign service. Must possess good knowledge of radio. Essential workers need release. Write to Hazeltine Electronics Corporation, 58-25 Little Neck Pkwy., Little Neck, L.I., N.Y.

RADIO ENGINEER

Radio engineer thoroughly experienced in ultra-high-frequency theory and technique, with or without patent law experience, preferably young, and with some knowledge of mechanical engineering, desired by established New York City patent law firm for employment as consultant and with view to becoming patent lawyer. State education, experience, age, and salary expected. Write Box 349.

COIL ENGINEER

Engineer wanted with suitable background who can be quickly trained in the manufacturing of coils. Experience in coil-forming processes and insulation problems desirable. Excellent post-war prospects. Write the Supervisor, Technical Employment, Westinghouse Electric & Manufacturing Company, Union Bank Building, Pittsburgh 22, Pa.

AUTO-RADIO-SET DESIGNER

An auto-radio-set design engineer with pre-war experience needed immediately for post-war development. Write fully, outlining experience, salary expected, etc. Address your letter to Box 341.

ELECTRONIC ENGINEER

An engineer is required to head a department of industrial electronics in consulting engineering firm. Must have had experience in this field. Salary as well as a share in the profits. Please write to Box 342 giving detailed information on education and experience.

ELECTRONIC ENGINEER

A desirable position is open in the Electronic Research Division of one of our clients, a well-established industrial concern in Chicago. Man with mechanical engineering background preferred. Position has to do with the manufacturing problems of industrial electronic equipment and is permanent. Give full information to include extent and nature of education and experience, salary expected, age, draft and marital status. Write to Business Research Corporation, 79 West Monroe Street, Chicago 3, Illinois.

ENGINEERS FOR INDUSTRIAL ELECTRONICS

Experienced engineers wanted for design and application engineering of electronics to industry in a consulting engineering firm. Position

(Continued on page 54A)

...a new tool of
incredible speed
and versatility...

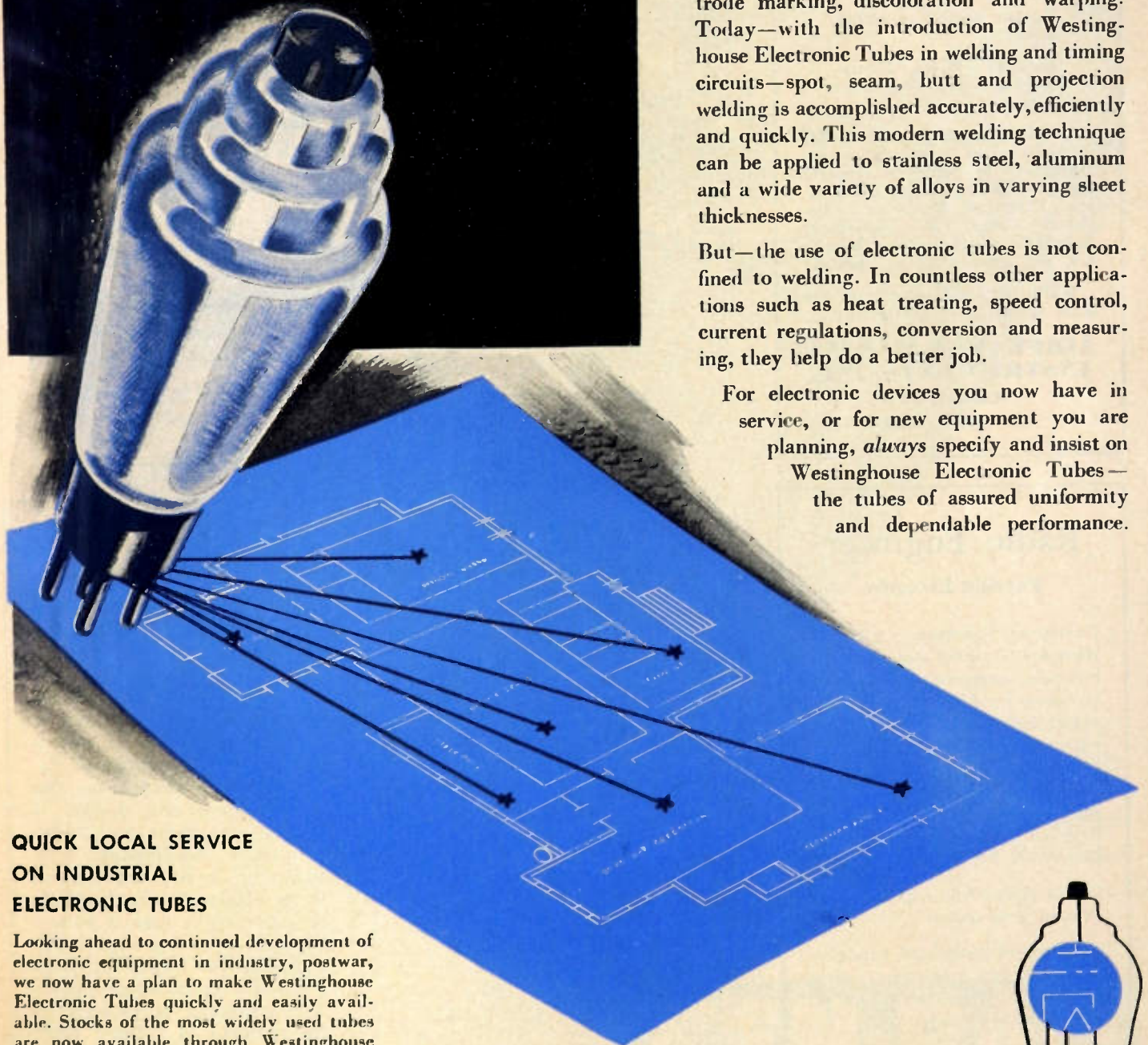

**QUICK LOCAL SERVICE
ON INDUSTRIAL
ELECTRONIC TUBES**

Looking ahead to continued development of electronic equipment in industry, postwar, we now have a plan to make Westinghouse Electronic Tubes quickly and easily available. Stocks of the most widely used tubes are now available through Westinghouse Electronic Tube Distributors and Westinghouse District Warehouses. As rapidly as possible additional types will be added to local stocks to make a complete line of Quality Controlled Westinghouse Electronic Tubes available to everyone.

The electronic tube may easily prove to be one of your most useful tools when you are confronted with reconversion headaches. Electronic tubes have proved that they save money in innumerable operations by increased speed and accuracy.

Take welding for example. For years resistance welding was limited to steel fabrication, permitting a considerable tolerance for electrode marking, discoloration and warping. Today—with the introduction of Westinghouse Electronic Tubes in welding and timing circuits—spot, seam, butt and projection welding is accomplished accurately, efficiently and quickly. This modern welding technique can be applied to stainless steel, aluminum and a wide variety of alloys in varying sheet thicknesses.

But—the use of electronic tubes is not confined to welding. In countless other applications such as heat treating, speed control, current regulations, conversion and measuring, they help do a better job.

For electronic devices you now have in service, or for new equipment you are planning, *always* specify and insist on Westinghouse Electronic Tubes—the tubes of assured uniformity and dependable performance.

Westinghouse

PLANTS IN 25 CITIES OFFICES EVERYWHERE



Quality Controlled Electronic Tubes

WESTINGHOUSE PRESENTS John Charles Thomas • Sunday 2:30 EWT., N.B.C. ★ T-J Malone • Monday, Wednesday, Friday—10:15 EWT—Blue Network.

RADIO ENGINEERS WANTED

This is your chance for immediate and after-war employment with the Company that developed:

The Streamlined loop housing for aircraft

The Cathode Ray Direction Finder

The Capacity Goniometer

Harbor protection equipment

Invasion Radio Equipment and numerous other items.

Qualified engineers are needed for permanent positions in our laboratory to carry on research and development of Radio Receivers, Direction Finders, Radio-Phone Sets, FM Equipment, Broadcast and Television Receivers, and Specialized Equipments.

Write for application form and state condition of availability.

AIRPLANE & MARINE INSTRUMENTS, INC.

Clearfield
Pennsylvania

Radio Engineer

Physicist-Executive

Exceptional opportunity; wide-open salary and future but requiring much-better-than-average qualifications and experience for direction of laboratory and field staff of engineers and technicians of 18-year-old, nationally known professional organization located in New York metropolitan area and working in Communications, Broadcasting, Television & Applied Electronics.

Correspondence held confidential and returned upon request.

Give detailed background, education, experience, past connections, present status, photo, salary requirements. Interview can be arranged.

Extraordinarily fine opening with unlimited future for properly equipped man with energy, imagination, ingenuity, and executive ability.

Box No. 354

PROCEEDINGS OF THE I.R.E.

330 West 42nd Street,
New York 18, N.Y.



(Continued from page 52A)

offers unusual opportunity to qualified, reliable and responsible man. Present work will be on war contracts. Write to Box 343.

ELECTRONIC ENGINEER

The Brush Development Company requires, for one of its research and development programs, the services of an electronic engineer preferably with acoustic or vibration experience, including a working knowledge of electrical-mechanical analogies. The project has immediate war applications and will continue as an important post-war activity. Write Personnel Director, The Brush Development Company, 3311 Perkins Avenue, Cleveland 14, Ohio.

ENGINEERS AND DRAFTSMEN

A nationally known aviation accessory corporation now formulating post-war plans can use the services of several electrical, mechanical and electronic engineers, experienced in research and development work.

Draftsmen: Also a number of design, detail and layout men, excellent working conditions.

Give full details of past experience and education as well as draft status and salary received in first letter. Location, Metropolitan New York. Address Box 338.

DESIGNER

A central New England manufacturer employing over 1000 people needs draftsman-designer on telephone and signaling (mechanical) apparatus.

Knowledge of die-casting and plastic applications desirable. W.M.C. regulations prevail. Write to Box 339.

DEVELOPMENT ENGINEERS

Mechanical and electrical. Graduate or equivalent training. Required for development work in the following branches:

1. Electro-mechanical devices, communication systems. Must be interested in development and familiar with magnetic circuits.
2. Measuring and control instruments. Background should be in electrical engineering, including electronics.

Statement of availability required. Address Box 340.

RADIO-ELECTRONIC ENGINEERS

A young progressive radio-electronic firm needs top-flight men for these key positions:

Electronic engineers and technicians
Electro-mechanical engineers, familiar with mechanical design of electrical and electronic equipment

Chief draftsman—familiar with organization and procedures, radio-electronic equipment
Supplier's contact engineer
Layout draftsman

Electronic draftsman, familiar with schematics and wiring diagrams

Engaged 100% in war work, with excellent of these openings. Write in confidence to Box post-war future and possibilities. Our staff knows 352.

ELECTRICAL ENGINEERS

Electrical engineers for research and development in the field of radio communications and electrical test equipment. Good post war opportunity. Address reply to Allen D. Cardwell Mfg. Corp., 83 Prospect Street, Brooklyn, N.Y.

RESEARCH ENGINEERS

For development work on electro mechanical servo mechanisms and communication equipment. Prefer A-1 men who can take charge of complete projects. Salary commensurate with ability. Permanent positions with excellent post-war opportunities. Address replies to Box 357.

The foregoing positions of interest to I.R.E. members have been reported as open. Apply in writing, addressing reply to company mentioned or to Box No.

Electronic Engineers and Draftsmen

The services are required of several electronic equipment design engineers capable of supervising the system layout of electronic and electro-mechanical devices.

Also, several draftsmen are needed with experience in electronic schematics, circuit layouts, and wiring diagrams, or with considerable experience in other related electrical fields.

Write giving full qualifications to the Personnel Department.

Curtiss-Wright Corp.

Development Division

88 Llewellyn Ave.

Bloomfield, New Jersey

W.M.C. rules observed

EXPERIENCED ELECTRICAL ENGINEERS

Graduate or non-graduate Electrical Engineers with at least three years of recent radio circuit or laboratory experience are needed for the development and design of pocket size radio and audio frequency equipment. The company is well established in the electronics field and offers the right man a salary dependent on his experience and also the opportunity to grow in a relatively new field. The company is located in the suburbs of a large New England City.

Write to—

Box no. 358

THE INSTITUTE OF RADIO ENGINEERS

330 West 42nd Street
New York 18, N.Y.

KEN-RAD

Cathode Ray



Write for your copy of "Essentials" the most complete digest of tube information available

The public has awaited television so patiently and eagerly that unprecedented standards of perfection must be in immediate evidence when commercially sound marketing begins Ken-Rad Cathode Ray Tubes will be the answer



KEN-RAD
EXECUTIVE OFFICES
OWENSBORO · KENTUCKY
EXPORTS 15 MOORE STREET NEW YORK

TRANSMITTING TUBES RECEIVING TUBES
CATHODE RAY TUBES INCANDESCENT LAMPS
SPECIAL PURPOSE TUBES FLUORESCENT LAMPS

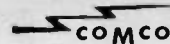

DESIGNERS AND
MANUFACTURERS OF
HIGH FREQUENCY

TRANSMITTERS and RECEIVERS

Pioneers in Aeronautical Communications



Comco Model 132 VHF Receiver 100-156 Mc.

The result of years of practical, in-the-field installation, maintenance and engineering experience dating from the early days of domestic and foreign airline communications. Designed for airport traffic control, aeronautical ground stations, or point-to-point service. If this receiver does not fit your exact needs, write us. Another standard Comco unit may be adaptable, or a special unit may be engineered and built for you.

COMMUNICATIONS
COMPANY, INC.
CORAL GABLES 34, FLORIDA



Plugs

FOR VICTORY

Remler is equipped for the mass production of many types of radio and electronic devices from humble plugs and connectors to complete sound amplifying and transmitting systems. Ingenious production techniques contribute to Remler precision, reduce costs and speed up deliveries. • The Axis is on the run...Victory is in sight. Let us help you finish the job

Wire or telephone if we can be of assistance

REMLER COMPANY, LTD.

2101 Bryant St. • San Francisco, 10, California

PLUGS & CONNECTORS

Signal Corps and
Navy Specifications

Types :	PL			
50-A	61	74	114	150
54	62	76	119	159
55	63	77	120	160
56	64	104	124	291-A
58	65	108	125	354
59	67	109	127	
60	68	112	149	

PLP		PLQ		PLS	
56	65	56	65	56	64
59	67	59	67	59	65
60	74	60	74	60	74
61	76	61	76	61	76
62	77	62	77	62	77
63	104	63	104	63	104
64		64			

NAF

1136-1

No. 212938-1

Other Designs to Order

REMLER

SINCE 1918

Announcing & Communication Equipment

AT 100 MC DILECTENE

A C-D Engineered
U-H-F Insulation

POWER FACTOR
0.0033

◆
**STABLE
UNDER**

DIELECTRIC
CONSTANT
3.57

◆
High Humidity

◆
Temperature
Extremes

READILY
MACHINED

◆
Mechanical
Stress

◆
Chemical
Conditions

For complete technical
data, send for Bulletin DN

CONTINENTAL-DIAMOND
FIBRE COMPANY

DE

NEWARK 48, DELAWARE

Speak no . . . See no . . . Hear no . . .

Do no



post war reconversion

No wonder American industrialists are dizzy! — Columnists, commentators, conferences and a host of critics on the sidelines advising business to “Go ahead” — to “Hold back” — to “Stand still.”

Red lights today, green lights tomorrow.

Through the maze of conflicting regulations, press releases, industry bulletins, it is safe to predict, however, that civilian production will resume shortly. But we must win the war first.

We at G. I., realizing that wars always end more suddenly than they begin, decided long ago on a post war planning schedule. It may help



to clarify your problem to know that we will be under way immediately when Uncle Sam issues the go-ahead signal.

Our products comprise new and improved components in the electronic and radio fields — variable condensers, automatic tuning mechanisms, record changers and new items developed and perfected from the research of our wartime experience.

**GENERAL INSTRUMENT
CORP.**

829 NEWARK AVE., ELIZABETH 3, N. J.

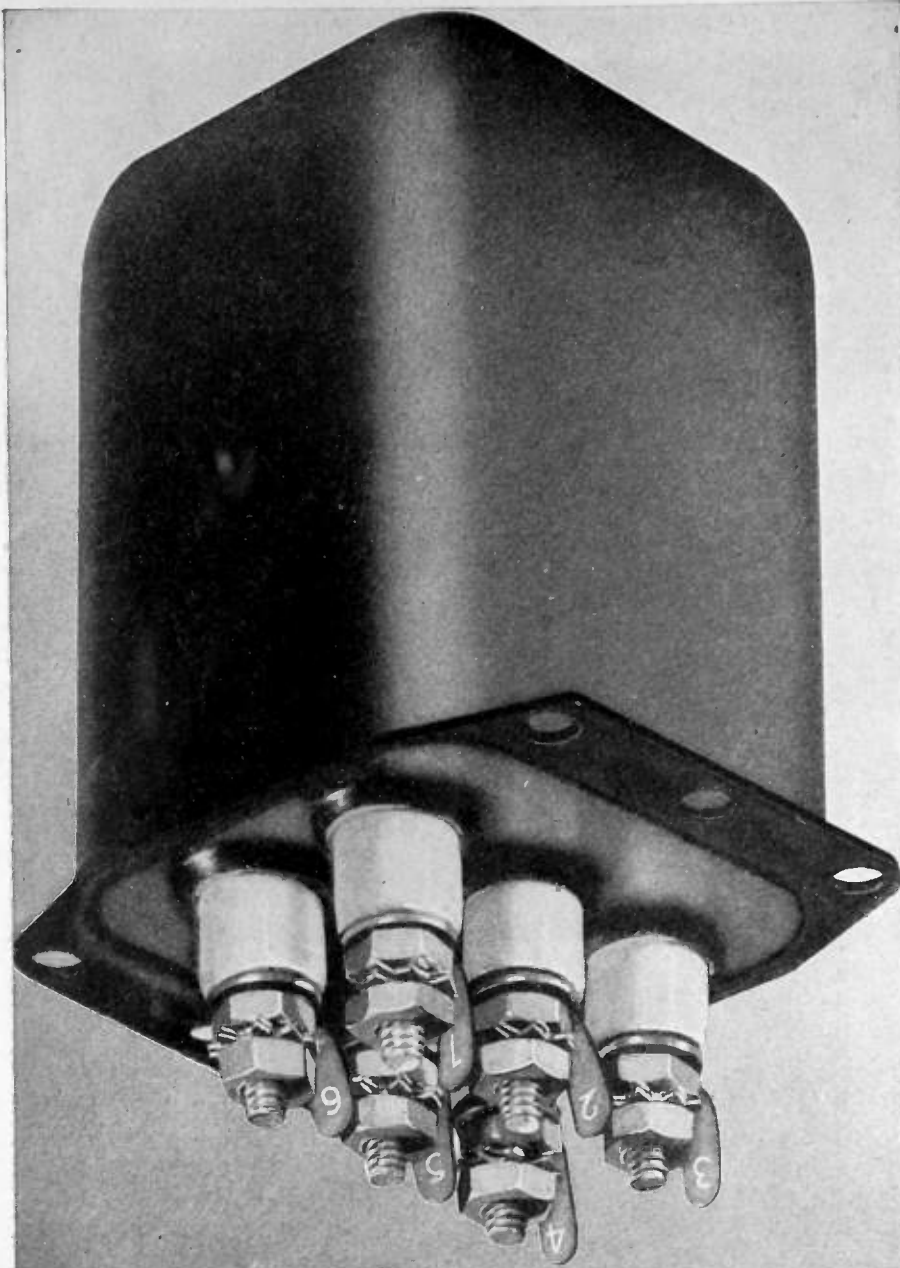

DEPENDABLE

Dependability, long life and accuracy must be built into transformers from the drafting board to final rigid testing.

Our large engineering staff, constant material control, modern manufacturing equipment and careful testing are your insurance of Dependable

CHICAGO TRANSFORMER



DIVISION OF ESSEX WIRE CORPORATION

3501 WEST ADDISON STREET

CHICAGO, 18



Television has New and Potent Industrial Appli- cations

Ralph R. Beal of RCA Tells Detroit Engineering Society Radio Sight Can Be "Eyes" for Plant Control to Speed Production and Assure Optimum Results in Manufacturing

Disclosure of potentialities of television as a new and effective aid to industry after the war enlivened a meeting here tonight at which Ralph R. Beal, Assistant to the Vice President in Charge of RCA Laboratories, told members of the Engineering Society of Detroit of the imminent expansion of this promising art and science.

Declaring it "indeed appropriate" to make his revelations in "one of the world's most forward-looking and busiest industrial communities," Mr. Beal, who arrived today from New York, envisaged television as the coming "eyes" of factories, the "means of coordinating activities in giant manufacturing plants, such as those in Detroit, and the means also of peering into places and situations that might be inaccessible or extremely hazardous to man."

Mr. Beal said that those like himself who are close to television foresee the day after fighting ceases when this type of television application may be in "wide" use.

"We know now," the research engineer declared, "how it can be used to extend the eyesight of the plant manager to critical operations that ordinarily would require much time and effort to reach for personal inspection or which might even be inaccessible—how television can aid immeasurably in plant control.

"Television cameras at strategic points can be connected by wire to receivers where production experts, foremen and supervisors can follow the flow of fabricated or raw materials and watch the progress of the work. Such setups will be particularly valuable in mass production assembly lines, and they may be extended to include loading platforms and shipping rooms."

According to Mr. Beal, television cameras may be used in connection with chemical reaction chambers, making visible to the operator without personal risk the chain of events occurring in complicated chemical production units, and thus enable him to control the process with optimum results. He said specially-built cameras may be used in furnaces to observe steps in the formation of alloys, and others may solve vital problems of analysis in important industrial processes.

"In addition," Mr. Beal declared, "television equipment may facilitate port move-

(Continued on page 66A)



4,300,000 JOBS TO DO TODAY

These are busy days for everybody in the telephone business. About 4,300,000 Toll and Long Distance messages go over the lines in the average business day. (That's in addition to more than 100,000,000 daily local conversations.)

Most of these millions of messages go through all right but sometimes the Long Distance lines to war-busy centers get crowded. Then the Long Distance operator may ask your help by saying — "Please limit your call to 5 minutes."

BELL TELEPHONE SYSTEM



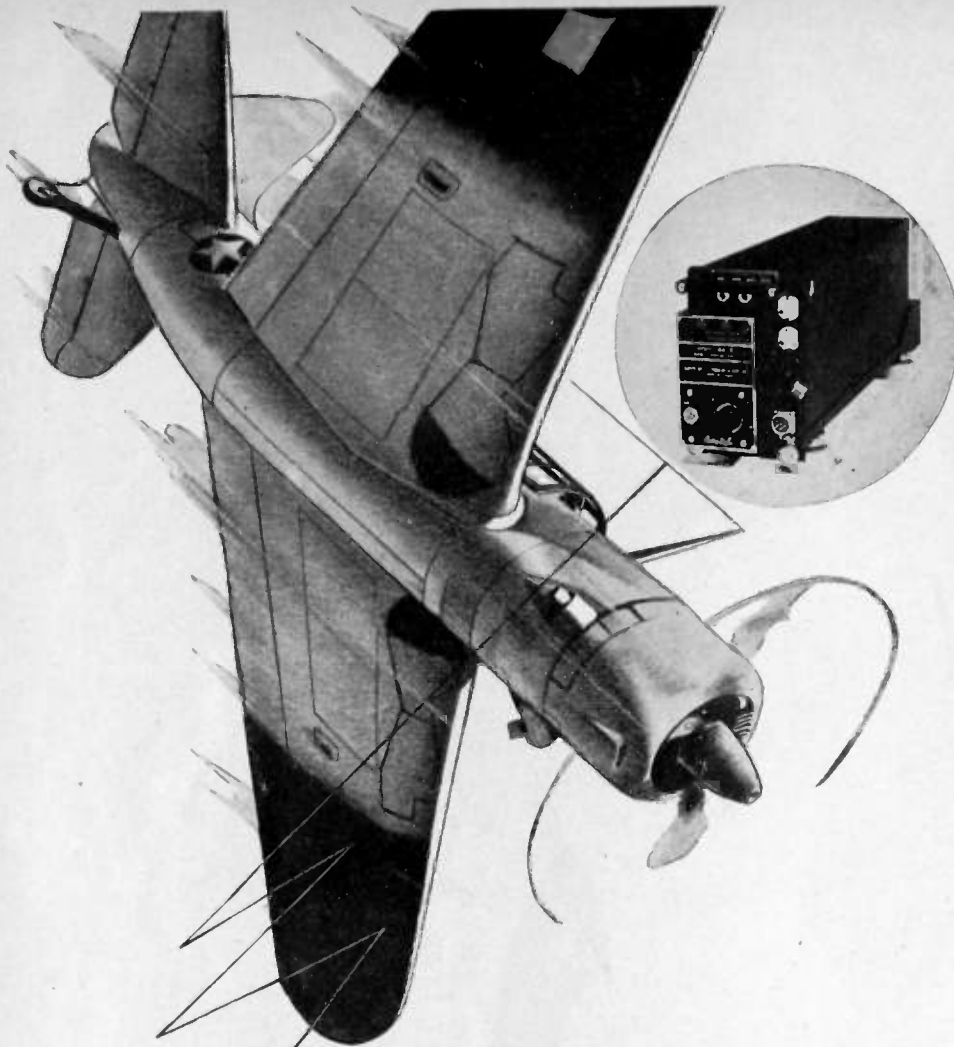

Getting down to EARTH

Let's talk facts. The AR-10-A Receiver shown above is one of the many pieces of precision equipment made by us for the Armed Forces. It has many exclusive features which were developed entirely in our own laboratories . . . The same exclusive features, the same rugged construction, the same unflinching performance found in the AR-10-A have been incorporated in post-war designs for commercial and civilian products. If you are interested in high-grade equipment covered by factory service, we'd like to talk facts with you now.

And face this fact: the war is *not* over! The Sixth War Loan needs your support. Let's all pitch in for the knockout!

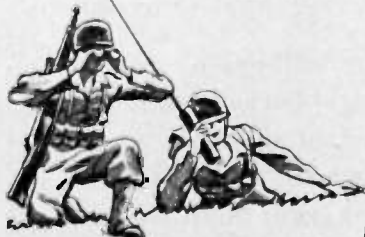

Communications
Aids to Navigation
Electronic Safety Devices

We call this our "CASE BOOK." It's the story of Harvey Wells and their place in Electronics. Send for it today. Your name on your letterhead is sufficient.



Harvey-WELLS
ELECTRONICS

HARVEY-WELLS COMMUNICATIONS, INC. SOUTHBRIDGE, MASS.

AROUND THE GLOBE...

Tropicalized

Q-MAX

A-27 H.F. LACQUER

...Protects Communication
and Electrical Equipment
Against FUNGI

There are many fighting fronts in this global war, but in Burma and the South Pacific especially, our armed forces face another foe—the insidious mold and fungus growths ever-present in the steaming heat of the tropical atmospheres that impair the successful operation of vital radio, communication, electronic and electrical equipment.

Long needed was a fungicide that would combine well with a good dielectric covering lacquer to combat this menace to factory built-in precision performance. Now, Q-Max A-27 H.F. Lacquer meets all these requirements because it has been Tropicalized with an ideal fungicide that does not interfere with Q-Max Lacquer's excellent electrical characteristics and corrosion-resisting properties.

Tropicalized Q-Max A-27 H.F. Lacquer offers manufacturers and our fighting forces a dependable, factory-mixed protection against fungi. Be sure to look for the word TROPICALIZED on the Q-Max label.

Communication
PRODUCTS COMPANY, INC.

744 BROAD ST., NEWARK, N. J.
Factory: 346 Bergen Ave.,
Jersey City, N. J.

Coaxial Transmission Line & Fillings • [Sterling Switches • Auto Dryaire • Antenna & Radiating Switches • Q-Max A-27 Radio Frequency Lacquer.

RE-DESIGNED "TO ORDER"

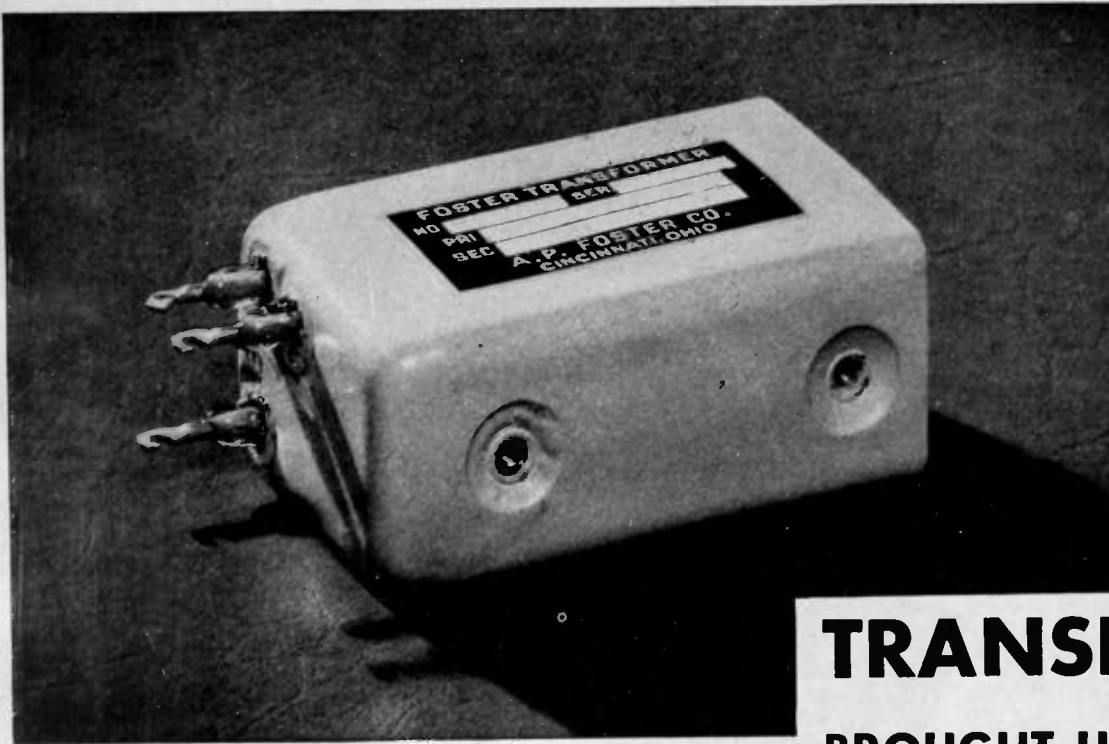

TRANSFORMER BROUGHT UP TO PAR BY **FOSTER**

Some weeks ago a manufacturer brought this unit, as then being supplied to him, to Foster Engineers for examination. Performance of the original model of this transformer had failed to meet a certain high standard of minimum inductance and maximum resistance. Foster re-designed it, met the exacting specifications, somewhat reduced its over-all dimensions, yet kept the new Foster model interchangeable with the old—no costly changes were required in the product of which this transformer is a part.

It is another example of Foster skill and experience in designing and building transformers for specific requirements that will be of great value in the post-war world of electronic equipment. Our experience covers close tolerance vibrator transformers, output transformers, microphone transformers, saturable reactors, power transformers, audio filters and reactors . . . designed and custom-built to the most exacting individual requirements.

SPECIALISTS IN BUILDING TRANSFORMERS SINCE 1938

A. P. FOSTER COMPANY

TRANSFORMER ENGINEERS & MANUFACTURERS
719 WYOMING AVENUE, LOCKLAND 15, OHIO

BROADCAST ENGINEERS — POLICE RADIOMEN

Write Now!

— on your phasing and
tuning gear problems



• Let us know *now* your requirements and specifications for *phasing and tuning gear* for your directional antenna. Andrew custom built equipment will again become available as soon as Uncle Sam releases our engineering and manufacturing facilities from production for war.

This release may come at any moment. Be sure that your needs are listed at the top of our peace-time back-log. The planning you do now will speed your own reconversion to the new high standards of the future.

Andrew engineers will gladly apply their years of skilled experience to the

solution of your special problems in the field of directional antenna equipment:

- Phasing networks and equipment
- Antenna tuning units
- Remote reading antenna ammeters
- Phase monitors
- Coaxial transmission lines and accessories

ANDREW CO.

ANDREW

363 East 75th Street
Chicago 19, Illinois

Easy to Erect



MASTS AND TOWERS

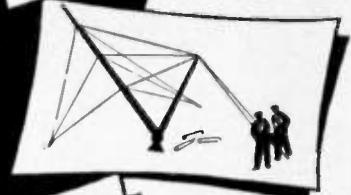

Catalog will be sent to engineers and executives writing on their business letter-head.

Address Dept. X

HARCO

STEEL
CONSTRUCTION CO.
Elizabeth 4, N. J.

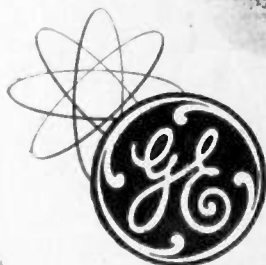
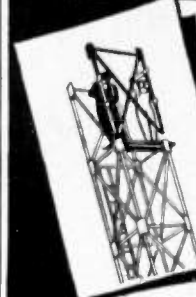

Compact and easily
moved from place
to place.



SQUARE-WAVE GENERATOR

Designed for testing over-all performance of radio systems and networks, this self-contained instrument generates its own frequency with remarkable stability. Can be synchronized from an external source.

Other units in the new General Electric line of ELECTRONIC MEASURING EQUIPMENT include: G-E wave meters, capacitors, power supplies, wide-band oscilloscopes, signal generators and various other instruments in the ultra-high frequency and micro-wave fields for measuring electronic circuits and checking component parts.

GENERAL ELECTRIC

Electronic Measuring Instruments

104-C11



(Continued from page 46A)

- Stone, E. W., 52 Harrison Dr., Larchmont, N. Y.
 Summerlin, W. O., U. S. Naval Air Station, Willow Grove, Pa.
 Swinney, J. G., Jr., Officers Club, Electronics Section, 611 AAF, Base Unit B, Eglin Field, Fla.
 Todd, C. A., A.P.O. 403, c/o Postmaster, New York, N. Y.
 Trzyna, T. S., 6140 Nassau St., Chicago 31, Ill.
 Van Beuren, J. M., Measurements Corporation, Boonton, N. J.
 Vuillomenet, R. H., Matias B. Sturiza 673, Dto. B., Olivos, F.C.C.A., Argentina
 Wald, S., 1100 Magee Ave., Philadelphia 11, Pa.
 Walker, D. D., c/o Fleet Post Office, New York, N. Y.
 Warder, F. C., 613 Grosvenor St., London, Ont., Canada
 Weiss, L., 59 Nagle Ave., New York 34, N. Y.
 Wherritt, J. M., 29 Hobbs Ter., Jefferson City, Mo.
 Williams, H. L., Medical School, London, Ont., Canada
 Winner, A. N., 1112 Dewey Ave., Williamsport 27, Pa.
 Yaffe, P., 367 Lincoln Pl., Brooklyn 17, N. Y.

M. F. M. Osborne Associates
Consulting Physicists

Mathematical Analysis of Physical Problems, Higher Mathematics, Approximations, Electronic Design, Fluid Dynamics, Mechanics, Electromagnetic and Acoustic Wave Propagation, Literature Surveys, Reports.
703 Albee Bldg., Washington 5, D.C.
Telephone District 2415

Would You Pay A WHOLE DOLLAR for your daily paper?

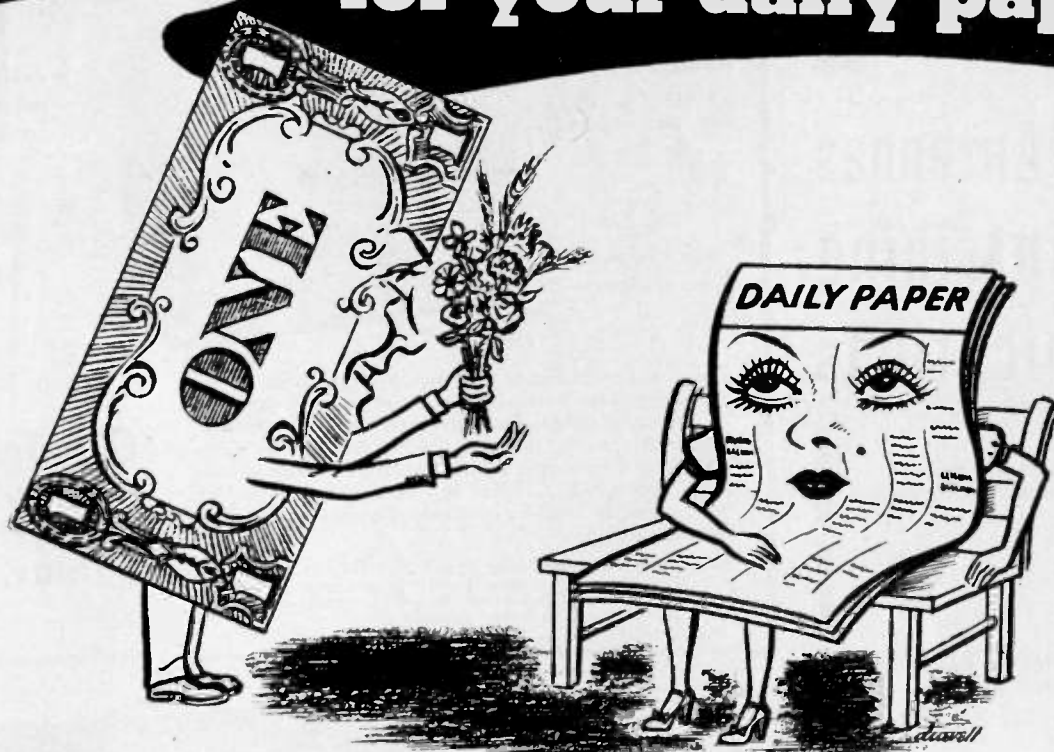

THAT man is here again! The guy who used to say "I can get it for you wholesale" now whispers: "I can get it for you **WITHOUT RATION COUPONS** . . ." The sad thing is that—he **CAN**. But, oh, what a price you pay!

You can't beat arithmetic. If there are ten refrigerators for sale and a hundred eager bidders for them, the seller is going to nick those ten buyers for *all the traffic will bear!* Then prices soar . . . the dollars that buy those refrigerators drop in value. Too few goods, too much money on the loose, connive to breed the worst of all national dangers: **INFLATION**. A 100-cent dollar sinks to 5c—or less—in buying power! Uncontrolled prices . . . *less* for your hard-earned money! A drop in the value of your savings account,

of your insurance, of everything you own. Would you like to pay a whole dollar for your daily paper?

"Ration coupons?" Oh, nuts! "Ceiling prices?" "Listen, fella, I can get you what you want—for only a few dollars more. . . ." Don't you believe him. He can't, *really!* You may not give up ration coupons **THIS** time, but you may have to give up **MUCH** more in the long run. The unhappy spiral of inflation can put every thing you want and need 'way beyond your price-reach! Don't let this happen to *you*—your neighbors, your entire nation. Instead, for a **FAIR** share at a **FAIR** price, take the Consumer's Pledge of Fair Play, and **LIVE UP TO IT**: "I will pay no more than ceiling prices; I will take no rationed goods without giving up ration coupons." **DEFEAT** the scourge of Inflation!



THE MARK OF

EXCELLENCE

Here at Kenyon, we're proud to play our small role on the stage of a **BIG** war. That's why **EVERY** Kenyon transformer used by our fighting forces throughout the world reflects only the highest precision craftsmanship. Kenyon workers are doing their share—bringing Victory closer by turning out top quality transformers *uninterruptedly*—and as fast as possible!

KENYON TRANSFORMER CO., Inc. 840 BARRY STREET
NEW YORK, U. S. A.

PREMAX

**ON SEA
ON LAND
IN THE AIR**

Premax Antennas Are Maintaining Communications

In Standard and Special Designs, Premax Radio Antennas are performing a vital service for the Armed Forces . . . on land and sea . . . in maintaining vital communications.

Police, Airports, Mobile Broadcasting and Civilian Defense Units are using them in all parts of the country.

Emergency repair crews find Premax Antennas admirably suited to their needs.

Your job can probably be handled by a Standard or Special Type of this famous Antenna. Write for Details.

When V-Day Comes

**WATCH
PREMAX**

RADIO ANTENNA

Premax Products

Division Chisholm-Ryder Co., Inc.
4503 Highland Ave. Niagara Falls, N.Y.

• From GATES Engineering Laboratories—A Preview of New Transmitter Designing for the Post-War Radio Industry

GATES "BC-10" 5-10 KW BROADCAST TRANSMITTER

• CAREFULLY ENGINEERED COMPONENT DESIGN

• BUILT-IN PHASING EQUIPMENT

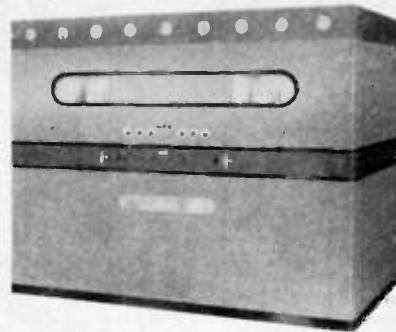

• HIGH TRANSMITTER EFFICIENCY

• HIGH FIDELITY RESPONSE CHARACTERISTICS

Here is one of the new things to come from Gates! Our engineers have already developed and approved engineering designs for this transmitter to be produced as quickly as the demands by the military on Gates' production no longer exist. The "BC-10" may be used for either 5,000 or 10,000 watt carrier. It is high level modulated and will be available complete with built-in phasing equipment.

(Wartime restrictions do not allow the sale of new broadcasting equipment without priority; therefore, this equipment is presented merely to acquaint you with Gates' developments.)

**GATES
RADIO and
Supply CO.
QUINCY, ILL.**

*Laboratory
Standards*



PULSE GENERATOR

MODEL 79-B

SPECIFICATIONS:

FREQUENCY: continuously variable 60 to 100,000 cycles.

PULSE WIDTH: continuously variable 0.5 to 40 microseconds.

OUTPUT VOLTAGE: Approximately 150 volts positive.

OUTPUT IMPEDANCE: 6Y6G cathode follower with 1000 ohm load.

R. F. MODULATOR: Built-in carrier modulator applies pulse modulation to any r.f. carrier below 100 mc.

MISCELLANEOUS: Displaced sync output, individually calibrated frequency and pulse width dials, 117 volt, 40-60 cycles operation, size 14"x10"x10", wt. 31 lbs.

Price: \$295.00 F.O.B. BOONTON

Delivery on priority

MEASUREMENTS CORPORATION
BOONTON • NEW JERSEY

it's **Pre-assembled!**

NEW TWO-PIECE HIPERSIL* CORE SPEEDS ASSEMBLY OF HF EQUIPMENT

Here's a practical short-cut that will speed assembly of High-Frequency Communications Equipment.

Instead of stacking tissue-thin laminations by hand, you can now get pre-assembled, two-piece HIPERSIL cores, ready for quick, easy assembly. Because there are just TWO pieces to handle per loop, valuable man-hours are saved in production—faults in assembly are prevented. HIPERSIL cores are available in a complete range of standard as well as special sizes and forms.

GET ALL THE FACTS ABOUT HIPERSIL TYPE C CORES
 ... write for copy of HIPERSIL Booklet, B-3223-A. It contains performance facts and application data that will help speed the production of vital Communications Equipment for the Fighting Forces. Address: Westinghouse Electric & Manufacturing Company, East Pittsburgh, Pennsylvania, Dept. 7-N.

J-70422

*Registered Trade-Mark, Westinghouse Elec. & Mfg. Co., for High PERmeability SILicon steel.



Westinghouse
PLANTS IN 25 COUNTRIES... OFFICES EVERYWHERE

HIPERSIL CORES

HERE'S HOW TO SPEED COIL ASSEMBLY

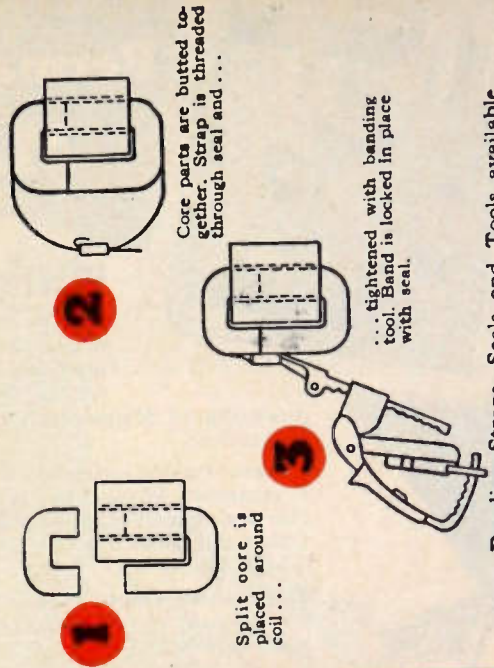

Banding Straps, Seals and Tools available from Westinghouse. See Page 9 of B-3223-A.



Latest Permanent Magnet MANUAL

NEW! A valuable, up-to-the-minute manual on the design, production and application of the modern permanent magnet. Prepared by The Arnold Engineering Company, this is an authoritative treatise based on many years' experience in the

production of Alnico permanent magnets for a wide range of applications.

Contents include such subjects as Magnet Materials, Resistance Comparisons, Physical and Magnetic Properties, Demagnetization and Energy Curves, Fabrication, Design and Testing. Charts and tables illustrate and explain various aspects of the discussion.

Recent improvements have opened many new fields for permanent magnets to reduce the cost and improve the efficiency of many devices.

• Write TODAY for your copy on your company letterhead.

THE ARNOLD ENGINEERING COMPANY

147 EAST ONTARIO STREET, CHICAGO 11, ILLINOIS

Specialists in the Manufacture of ALNICO PERMANENT MAGNETS

Television has New and Potent Industrial Applications

(Continued from page 58A)

ments of ships. The cameras located fore and aft, and on port and starboard sides of vessels, could lessen the hazards of docking and insure safety in crowded shipping lanes.

"We likewise foresee the use of television in metropolitan traffic control and along congested motor routes. Cameras may be installed permanently at busy inter-sections to flash to traffic headquarters running, up-to-the-minute picture accounts that should greatly aid traffic experts in easing congestion."

Mr. Beal said that it is "reasonable to assume" that television tubes and associated electronic devices together with photo-electric cells, may "facilitate increasingly the development of new industrial processes and methods, seemingly far removed from the usual sphere of radio science."

The ultimate aim in television is to match the perfection of the human eye, Mr. Beal said, and added: "The significance of that is obvious. We hope, in years to come, not only to televise the world's still life and action in three-dimensional views, but to transmit scenes in their exact color." He disclosed that research scientists and engineers of RCA Laboratories have already devoted many years of study and experimentation to color television and believe it to be a definite prospect.

Mr. Beal told his Detroit audience how plans for the post-war manufacture of television equipment and the establishment of television networks were, as war conditions permitted, taking definite shape. He said that once industry converts to peacetime enterprise, his company is prepared to build television home receivers and transmitting equipment of high standard at moderate cost and predicted that an all-American network will, a few years hence, link Detroit and other big cities.

One contribution that automotive engineers can make to television service, Mr. Beal asserted, is the suppression of "man-made static," or electrical interference, caused by automobile ignition systems. Many ignition systems, he explained, are in effect small "transmitters" that send out signals which mar television pictures and accompanying sound. Considerable progress has been made toward solving the problem, he reported.

"Television," Mr. Beal declared, "is here to stay—and to grow—and to multiply. . . . A multitude of hopes and dreams of Americans for an expanded production of the good things of life, greater culture, friendship and understanding, and more enjoyable living are joyous in the one word—television."

Proceedings of the I.R.E. November, 1944



Coils are the transformer's heart. Wound on machines of our own design by skilled operators, Peerless coils are uniform in performance and free from failure.

PEERLESS

ELECTRICAL PRODUCTS CO.

6920 MCKINLEY AVENUE, LOS ANGELES 1, CALIFORNIA

20,000 inspections a day

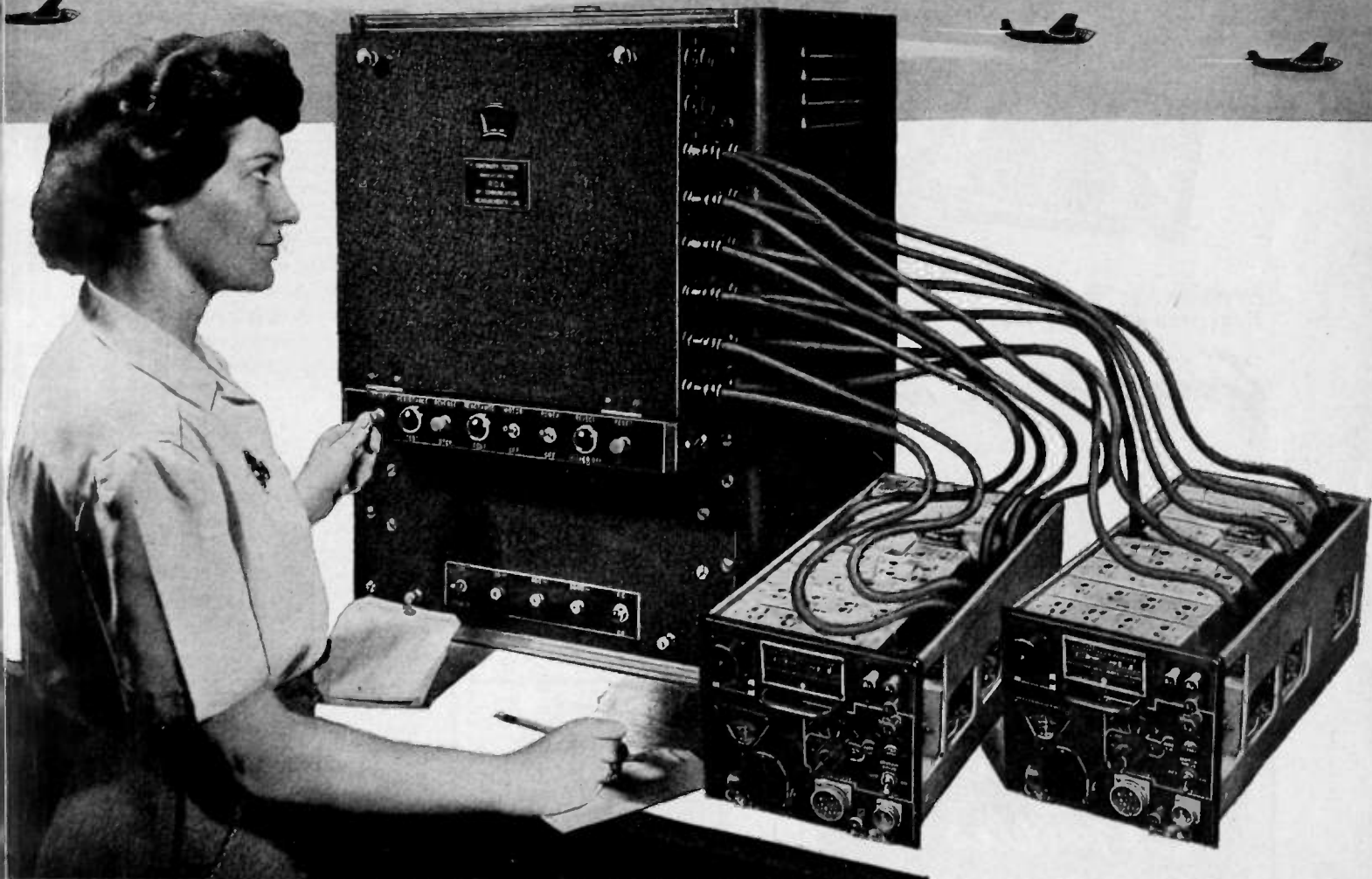

SINCE the Wright Brothers' first flight, the progress of aviation has been accompanied by the addition of one inspection after another. Today, major accessories, such as radio, must pass more rigorous inspections than were applied to engines a few years ago.

With monthly demands for thousands of RCA Aviation equipments, laborious checking of each portion of every circuit by an unaided human inspector would be impractical. However, aided by the robot tester illustrated here, one girl can make 20,000 circuit checks per day. Not only does this tester multiply her productivity, but the uniformity of her effort is equally improved . . . deliveries of RCA Aviation Radio equipment are expedited . . . and the mass-produced unit adheres to closer tolerances than the design engineers originally contemplated.

Wartime necessity has fostered the development of many similar aids and provided a large store of new

inspection experience. In addition to improving present production, this new experience will insure the highest standards of performance for the postwar aviation industry.

*Buy more
War Bonds*



RADIO CORPORATION OF AMERICA

RCA VICTOR DIVISION • CAMDEN, N. J.



Universal Stroboscope

PHONOGRAPH AND RECORDER AID

This handy phonograph turntable speed indicator, complete with instructive folder, is now available gratis to all phonograph and recorder owners through their local dealers and jobbers. As a recorder aid the Universal Stroboscope will assist in maintaining pre-war quality of recording and reproducing equipment in true pitch and tempo.

Universal Microphone Co., pioneer manufacturers of microphones and home recording components as well as Professional Recording Studio Equipment, takes this means of rendering a service to the owners of phonograph and recording equipment. After victory is ours—dealer shelves will again stock the many new Universal recording components you have been waiting for.

Available from local dealers or by writing factory direct.

Yours for the asking!





UNIVERSAL MICROPHONE CO.

INGLEWOOD, CALIFORNIA

More
**Examples of
ACME ENGINEERED
TRANSFORMERS**

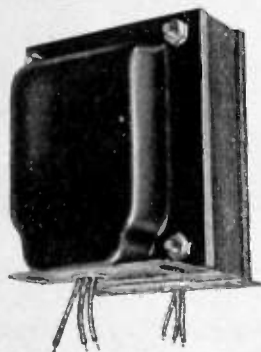

AUDIO TRANSFORMERS

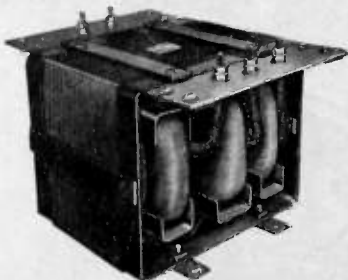

**HIGH LEAKAGE REACTANCE
FILAMENT TRANSFORMERS**

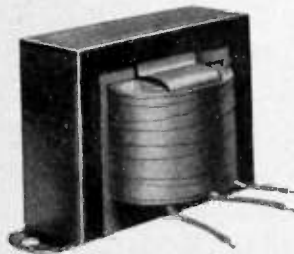

**INTERSTAGE
TRANSFORMERS**

THE ACME ELECTRIC & MANUFACTURING CO. • CUBA, N. Y. • CLYDE, N. Y.

Acme  **Electric**

The Answer
TO YOUR
PROCUREMENT PROBLEMS

MAY LIE
BETWEEN
THESE
COVERS!



OVER
10,000 ITEMS
IN STOCK!

FAST DELIVERY
Assured on Priority

**RADIO PARTS
RADIO TUBES**

and
**INDUSTRIAL
ELECTRONIC
EQUIPMENT**

Send for this
FREE

800 Page
Buying Guide

Available solely
to authorized
purchasing
agents and en-
gineers who
write to us on
company letter-
head. Address
Box VR.

★
Telephone
BARclay,
7-1840

**SUN RADIO
& ELECTRONICS CO.**
212 Fulton Street, New York 7, N. Y.



Beyond what the eye can see . . .

It's an easy matter to disassemble a DAVEN ATTENUATOR, as we have done here. And even a hasty glance is sufficient to gain a favorable impression. The resistive network*, with its demand of infinite skill and patience . . . the new, large detent gear on the stainless steel attenuator shaft . . . the detent gear roller and spring recessed within the steel attenuator cover . . . the new positive stop, eliminating stress on the rotor hub . . . the tarnish-proof silver alloy contacts . . . the unique two-piece, dust-tight steel cover—these, and other features, have won wide acceptance for DAVEN ATTENUATORS. *Because*, beyond what the eye can see is a certainty of dependability that is rooted in DAVEN'S long experience and leadership in designing and building good attenuators. Specify DAVEN ATTENUATORS.

DAVEN ATTENUATORS are made in the following circuits: Ladder, T or H, Potentiometer (Potential Dividers), L and Rheostat, balanced or unbalanced. Any desired impedance, number of steps and DB per step; with or without detent.

*Resistive network completely wire wound under exclusive DAVEN patent. New attenuator construction, patent pending.

Buy More War Bonds and Hold on to Them Until Maturity

THE **DAVEN** COMPANY

191 CENTRAL AVENUE
NEWARK 4, NEW JERSEY

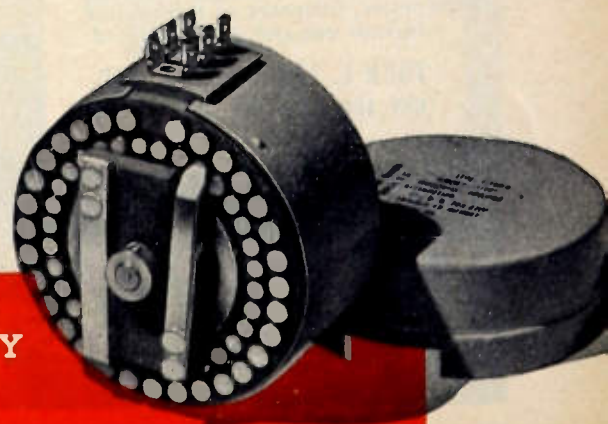

**Now
Available
For Prompt
Delivery**

**LINGO
VERTICAL TUBULAR
STEEL RADIATORS**

are now back in production and
can be supplied promptly,
subject to existing regulations.

Now, after two years of producing thousands of tubular towers for the Armed Forces, Lingo is again ready to serve the Broadcasting Industry. From the earliest days of "wireless" to the threshold of a new era in broadcasting, Lingo has been constructing and erecting vertical structures that have been setting outstanding efficiency and performance records. Vertical tubular radiators are available in standardized heights from 100 to 500 feet. Lingo also produces tubular steel supporting poles for the accommodation of FM, Television and other UHF antennas.

Our staff will be pleased to provide you with the complete story as it applies in your own case. In writing, please give location, power, frequency of station, and indicate radiator height desired.

JOHN E. LINGO & SON, INC.
EST. 1897 CAMDEN, NEW JERSEY

**LINGO VERTICAL
TUBULAR STEEL
RADIATORS**

**ARPIN
RECTIFIERS**
MERCURY
VAPOR
HALF WAVE
575-A
FOR HIGH
VOLTAGE



for

- HIGH POWER TRANSMITTERS
- INDUCTION HEATING EQUIPMENT
- SPECIAL INDUSTRIAL APPLICATIONS

WE SPECIALIZE IN INDUCTION HEATING APPLICATIONS

575-A is a heavy-duty half-wave rectifier tube of exceptional performance. Filament of edge-wise wound ribbon of a new alloy, giving greater thermionic emission reserve. No arc-back at full rating. Used by Signal Corps and many large manufacturers. Two tubes for full-wave rectification in single phase circuits deliver 5000 volts DC at 3 amps, with good regulation. Filament 5 volts, 10 amps. Peak Plate Current 6 amps. Peak inverse Voltage 15,000 volts.

WRITE FOR NEW CATALOG

illustrating and describing the above rectifier and other ARPIN Tubes.

ARPIN MANUFACTURING CO.
422 Alden St. Orange, N.J.

**PLATINUM
and PLATINUM ALLOYS . . .**

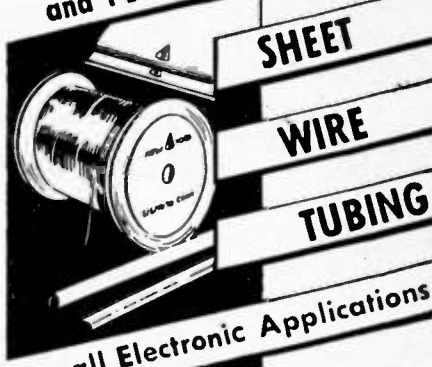

**SHEET
WIRE
TUBING**

For all Electronic Applications

Platinum metals scrap and residues refined and re-worked on toll charges; or purchased outright by us . . .

Write for list of Products.
Discussion of technical problems invited

SIGMUND COHN & CO.
44 GOLD ST. NEW YORK
SINCE 1901

ELECTROPLATING WITH POWERSTAT CONTROL

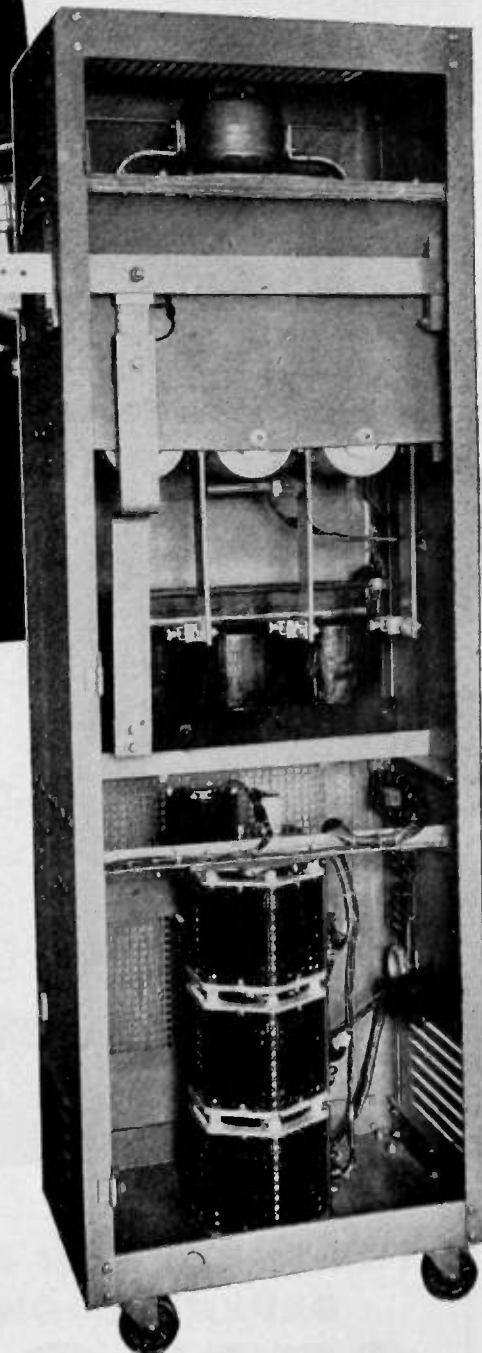
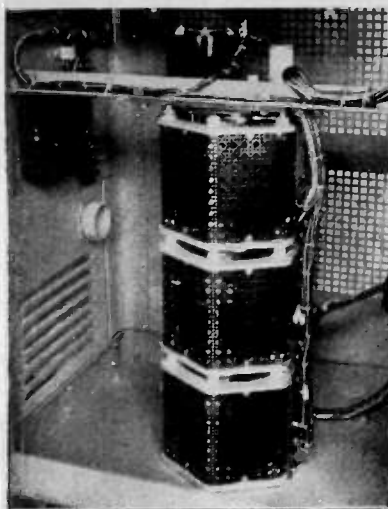

In order to conserve vital floor space and to keep the rectifying equipment away from a corrosive atmosphere, an eastern manufacturer specified that the power supply for the plating tanks be located outside the processing room. This meant remote control of tank voltage and current. To satisfy this requirement the engineers of the W. Green Electric Co., builder of rectifier units, replaced the usual tapped transformer with a Motor-driven POWERSTAT Variable Transformer type M1226-3. Installation of a push-button station in the plating room to control the POWERSTAT'S highly damped synchronous reversible motor provided the remote control feature. By simply pressing a button, any current from zero to maximum flows through the plating tanks.

The use of POWERSTATS in electroplating offers other advantages in addition to finger-tip remote control. Regulation is not limited to "steps" but is continuously variable; there is no interruption of current so characteristic of the tap changing system; and POWERSTATS have a long life with no tap switches to wear out.

For specific information on POWERSTAT control of electroplating processes, consult SECO engineers.

Send for Bulletins 149 ER and 163 ER

SUPERIOR ELECTRIC CO., 325 LAUREL STREET BRISTOL, CONNECTICUT

SUPERIOR *Electric Company*

G-E Safety Door Interlock Switch

OPEN the door and the power's off! Prevents accidents, protects equipment. Will not fail mechanically. For complete details, write:

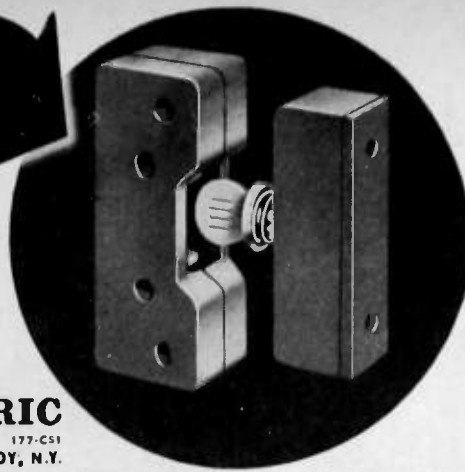

GENERAL ELECTRIC
ELECTRONICS DEPARTMENT SCENECTADY, N.Y.

Products of
"MERIT"

MERIT COIL AND TRANSFORMER CORP.
ENGINEERS AND MANUFACTURERS OF TRANSFORMERS AND ELECTRICAL WINDINGS
TELEPHONE LOWBOARD, 2311
847 N. CLARK STREET
Chicago 40, Illinois

Announcing!
Our new plant is now in full production, greatly increasing our capacity. We believe it to be the most modern and efficient unit now engaged in the production of transformers, coils and allied electronic equipment.
Please take note of our new address, where you will always receive a cordial welcome.
Sincerely yours,
W. H. ...
President.

OUTPUT TRANSFORMER
Hermetic-Sealed
Glass Terminals

MERIT COIL & TRANSFORMER CORP.

4427 North Clark St.

CHICAGO 40, ILL.

**THE TUBES YOU CAN
DEPEND UPON**

CETRON

Rectifiers - Phototubes - Electronic Tubes
Prompt deliveries on most types
SEND FOR CATALOG

CONTINENTAL ELECTRIC COMPANY
CHICAGO OFFICE: 403 MERCHANDISE MART
GENEVA, ILL.
NEW YORK OFFICE: 765 W. 144th ST.

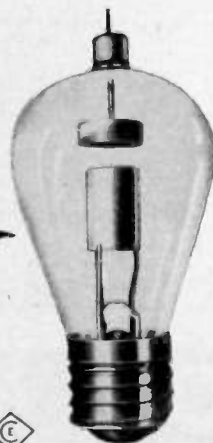

INDEX

Section Meetings	34A
Membership	38A
Positions Open	50A
Television has new Potential Industrial Applications	58A

DISPLAY ADVERTISERS

Acme Electric & Mfg. Co.	68A
Aerovox Corp.	35A
Airplane & Marine Instruments	54A
Alliance Mfg. Co.	38A
American Lava Corp.	47A
American Telephone & Telegraph Co.	59A
American Transformer Co.	5A
Amperex Electronic Corp.	Cover II
Andrew Co.	62A
Arnold Engineering Co.	66A
Arpin Manufacturing Co.	70A
Bendix Aviation Corp.	27A
Bliley Electric Co.	37A
Cambridge Thermionic Corp.	33A
Centralab	20A
Chicago Telephone Supply Co.	22A
Chicago Transformer Corp.	58A
Clarostat Manufacturing Co., Inc.	48A
Sigmund Cohn & Company	70A
Communication Products Co., Inc.	60A
Communications Co., Inc.	56A
Connecticut Telephone & Elec. Div.	43A
Continental-Diamond Fibre Co.	56A
Continental Electric Co.	72A
Cornell-Dubilier Electric Corp.	Cover III
Corning Glass Works	9A
Curtiss-Wright Corp.	54A
Daven Company	69A
Dejur-Amsco Corp.	51A
Tope Deutchman Corp.	73A
Allen B. Dumont Labs., Inc.	31A
Eicor Incorporated	48A
Eitel-McCullough, Inc.	74A
Electronic Corp. of America	8A
Electronic Laboratories, Inc.	11A
Electronic Mechanics, Inc.	25A
Electro-Voice Corp.	6A
Federal Telephone & Radio Corp.	7A
Arnot P. Foster Co.	61A
Gates Radio & Supply Co.	64A
General Electric Co.	62A
General Instruments Corp.	57A
General Radio Co.	Cover IV
Guardian Electric Mfg. Co.	29A
Harco Steel	62A
Harvey-Wells Communications, Inc.	60A
Heintz & Kaufman Ltd.	4A
Hewlett-Packard Co.	12A
Hytron Corp.	13A
Industrial & Commercial Electronics	18A
Industrial Condenser Corp.	42A
International Resistance Co.	3A
International Telephone & Telegraph Corp.	7A
Ken-Rad Tube & Lamp Corp.	55A
Kenyon Transformer Co., Inc.	63A
Lear Incorporated	26A
John E. Lingo & Son, Inc.	70A
Measurements Corp.	44A
Merit Coil & Transformer Corp.	72A
National Co., Inc.	19A
National Union Radio Corp.	15A
New York Transformer Co.	42A
North American Philips Co., Inc.	21A
M. F. M. Osborne Associates	62A
Panoramic Radio Corp.	36A
Peerless Electrical Products Co.	66A
Permoflux Corp.	34A
Premax Products	64A
Radio Corp. of America	32A, 41A
Remler Co., Ltd.	56A
Rola Co., Inc.	50A
Shallcross Mfg. Co.	40A
Shure Brothers	24A
Solar Manufacturing Corp.	45A
Sprague Electric Co.	14A
Stackpole Carbon Co.	39A
Standard Transformer Corp.	46A
Stupakoff Ceramic and Mfg. Co.	28A
Sun Radio & Electronics Co.	68A
Superior Electric Co.	71A
Taylor Tubes Inc.	30A
Templeton Radio & Mfg. Corp.	52A
Triplett Electrical Instrument Co.	16A
United Transformer Co.	17A
Universal Microphone Co.	68A
Western Electric Co.	10A, 50A
Westinghouse Electric & Mfg. Co.	53A, 45A
Wilcox Electric Co.	49A

OLD FAITHFUL GEYSER, Yellowstone National Park. Geologists believe it began erupting before the last glaciation, about a million years ago. Within record, Old Faithful has erupted continuously at about 65-minute intervals, spouting a column of water 95—130 feet high for 4½ minutes.

STILL GOING STRONG

LONG, UNINTERRUPTED service under all operating conditions is the characteristic you want most in a capacitor. Tobe Capacitors serve so well and so long because every step in their manufacture is checked and cross-checked by rigid inspections. Constant improvement through constant research is the promise performed by Tobe engineers. An example is the Tobe TRS Capacitor, shown below, a skillfully designed transmitting condenser. Why not call on Tobe for prompt, specialized help on *all* your capacitor problems?

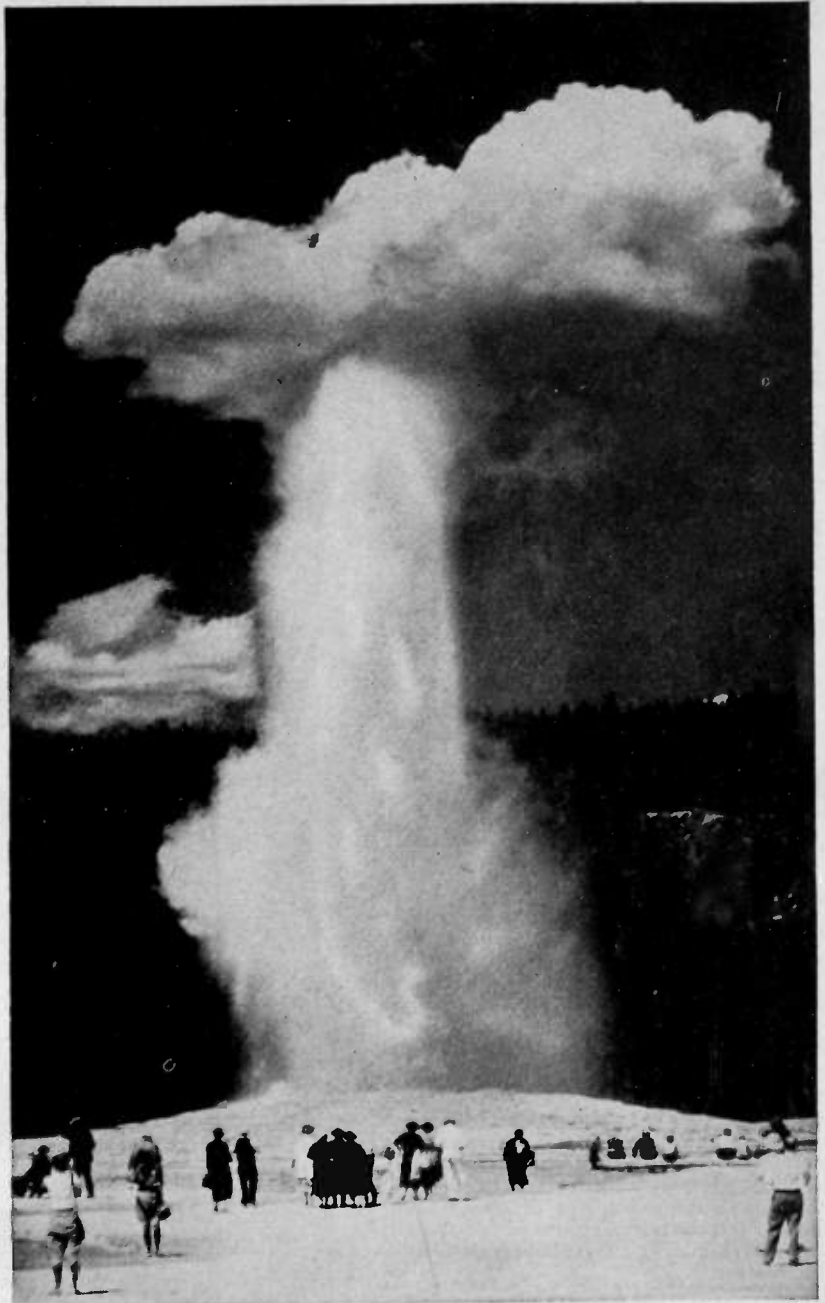

TRS 605,
5 mfd. 600
volts

SIZE—
Overall
height 5"

CONTAINER—
1-3/16" x 2-1/2" x 4"
Dimensions of
other TRS models
on request.

SPECIFICATIONS FOR TRS CAPACITORS

CAPACITY1 to 20 mfd.

WORKING VOLTAGE . . . 600
volts DC to 6,000 volts DC.

SHUNT RESISTANCE . . . 6,000
megohms per mfd.

RESISTANCE, Terminal to Case . .
10,000 megohms minimum:

POWER FACTOR002 to .005

VOLTAGE TEST Terminal to Case
2,500 VDC for 600 volt condenser.

Capacitor unit tested at 2 times rated voltage.

Universal (wrap around) L or foot type and screw
Spade-lug mounting brackets can be supplied.



A small part in Victory today . . .

A BIG PART IN INDUSTRY TOMORROW

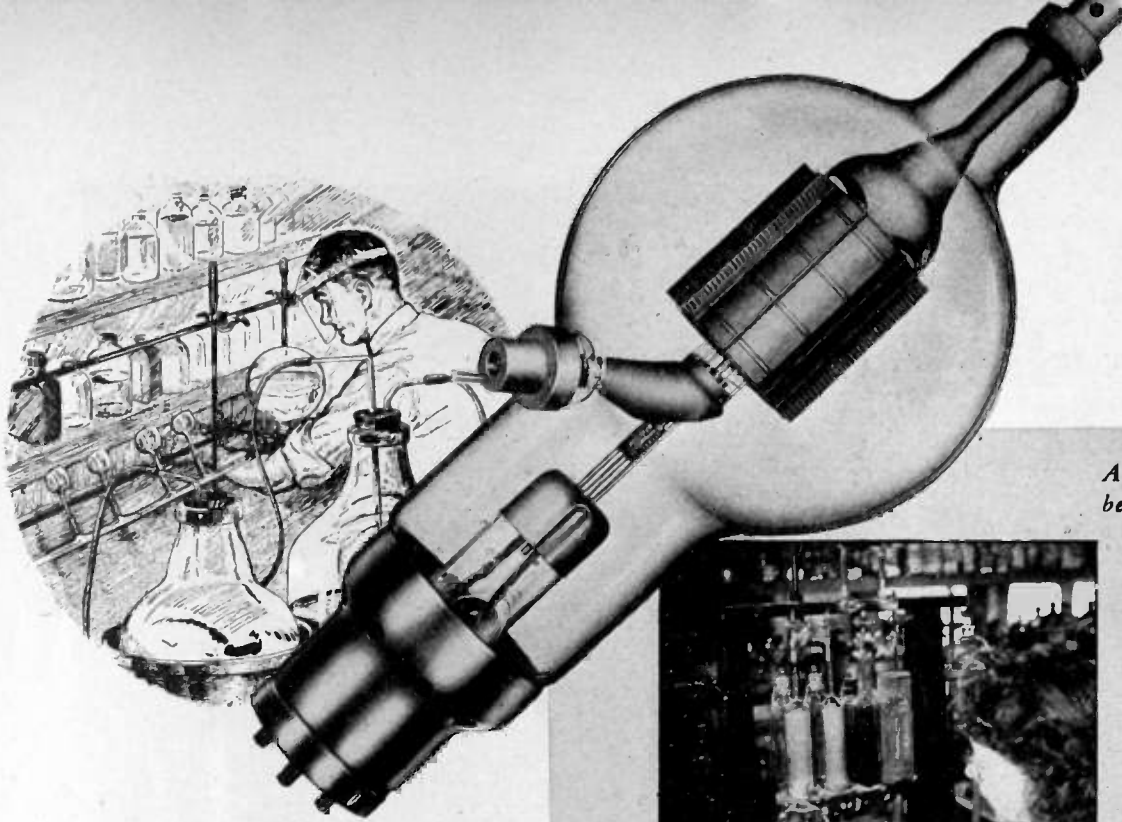

A few of the branches of the Science behind the Science of Electronics

the *Science* behind the science of electronics

The pattern of progress in the science of electronics is determined by the achievements in creating and developing new and more efficient electron vacuum tubes. Therefore, the whole complex task of vacuum tube development — involving the intelligent application of many sciences — comprises the real science behind the science of electronics.

To create and produce the modern vacuum tube requires experience and skill of the highest order in these many sciences in addition to complete facilities for their application. The list includes everything from chemistry and metallurgy — the technology of glass fabrication and vacuum pumping — to physics, optics, thermo-dynamics and most important of all — Electronics.

The resources and resourcefulness of Eimac laboratories have accounted for many outstanding contributions to the science of Electronics. A fact which is attested to by the leadership which Eimac tubes enjoy throughout the world. These comprehensive facilities are continuously being utilized to achieve better and better results for the users of Eimac tubes.

Eimac Engineering is devoted solely to the development and production of electron vacuum tubes. However, since the electron vacuum tube is the heart of all electronic devices it is advisable for users and prospective users of electronics to look first to the vacuum tubes required. A note outlining your problem will bring advice and assistance without cost or obligation.

Write for your copy of *Electronic Teles* — a 64 page booklet fully illustrated — covering fundamentals of Electronics and many of its important applications. Written in layman's language.

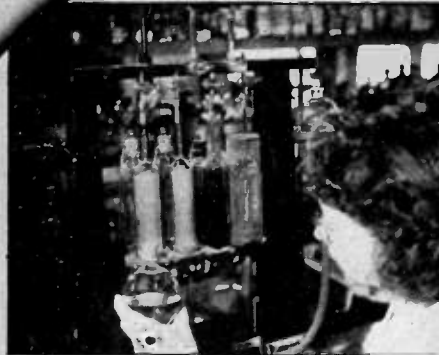

CHEMISTRY—Making Gas Analysis in the Eimac Laboratory



METALLURGY—Spectrographic Analysis of the Rare Metals Used in Vacuum Tubes



VACUUM TECHNOLOGY—Constant Research to Develop Better Vacuum Techniques



PHYSICS—Actually Viewing Emission of Electrons with Electron Microscope



ELECTRONICS—Determining Facts about and Recording Data on Vacuum Tube Capabilities



OPTICS—Studying the Effect Processing has on the Structure of Materials Through Photomicrography

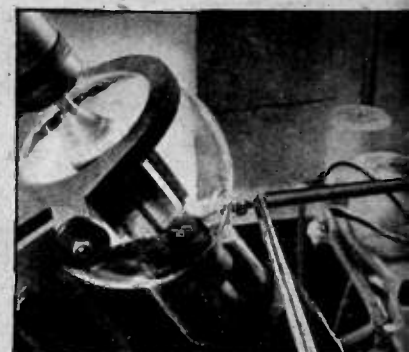

GLASS TECHNOLOGY—Special Equipment and Technique to Produce Complicated Glass Structures

Follow the leaders to

Eimac
REG. U. S. PAT. OFF.
TUBES

EITEL-McCULLOUGH, INC., 869 San Mateo Ave., SAN BRUNO, CALIF.

Plants located at: San Bruno, California

and Salt Lake City, Utah

Export Agents: **FRAZAR & HANSEN, 301 Clay Street, San Francisco, California, U. S. A.**

making mountains
out of molehills

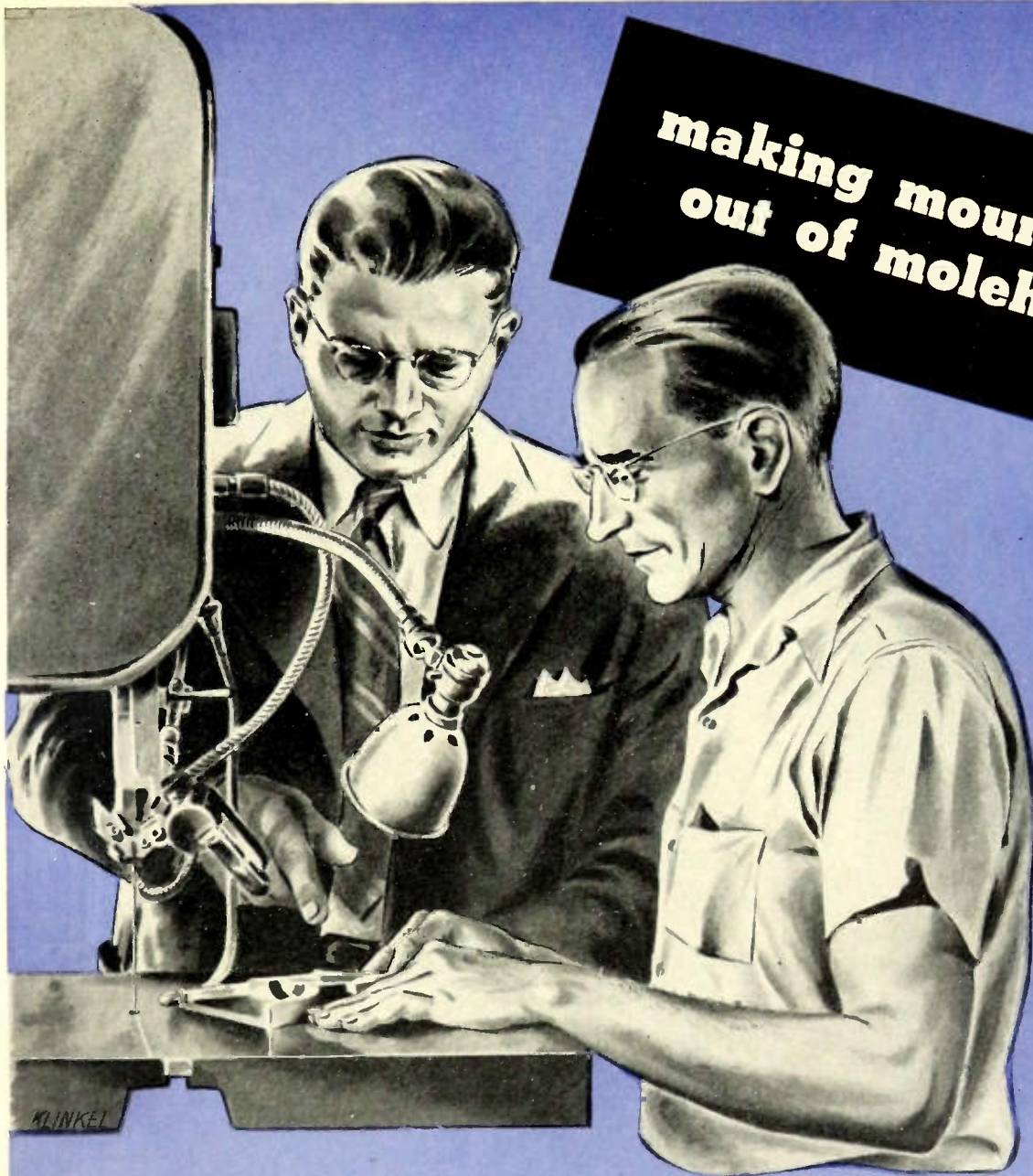

Dependability is a lot of little things that add up—it's the end result of paying due homage to all the molehills of production so that the finished product will give a mountain of service. Like paying strict attention to seemingly unimportant details of workmanship. Like emphasizing the work of skilled technicians who are experts in their special field of building finer capacitors.

That's the way we've been making capacitors since 1910. Many of our men and women have been working on C-D capacitors for nearly 34 years. Others have been with us for five—ten—twenty years of loyal, devoted service.

Dependability is a C-D tradition. Every C-D capacitor has built into it the dependability . . . the skill, experience and research . . . that belong only to the leader, Cornell-Dubilier Electric Corporation, South Plainfield, New Jersey.

TYPE YAT—A compact, low capacity Dykanol "G" bypass capacitor—hermetically sealed in specially-treated drawn metal container. Range at 600V.—.05 mfd. to 1 mfd. at 100V.—.05 mfd. to .5 mfd.



CORNELL-DUBILIER
CAPACITORS 1910  1944

MICA • DYKANOL • PAPER • WET AND DRY ELECTROLYTICS

ALSO AT NEW BEDFORD, BROOKLINE, WORCESTER, MASS.; PROVIDENCE, R. I.

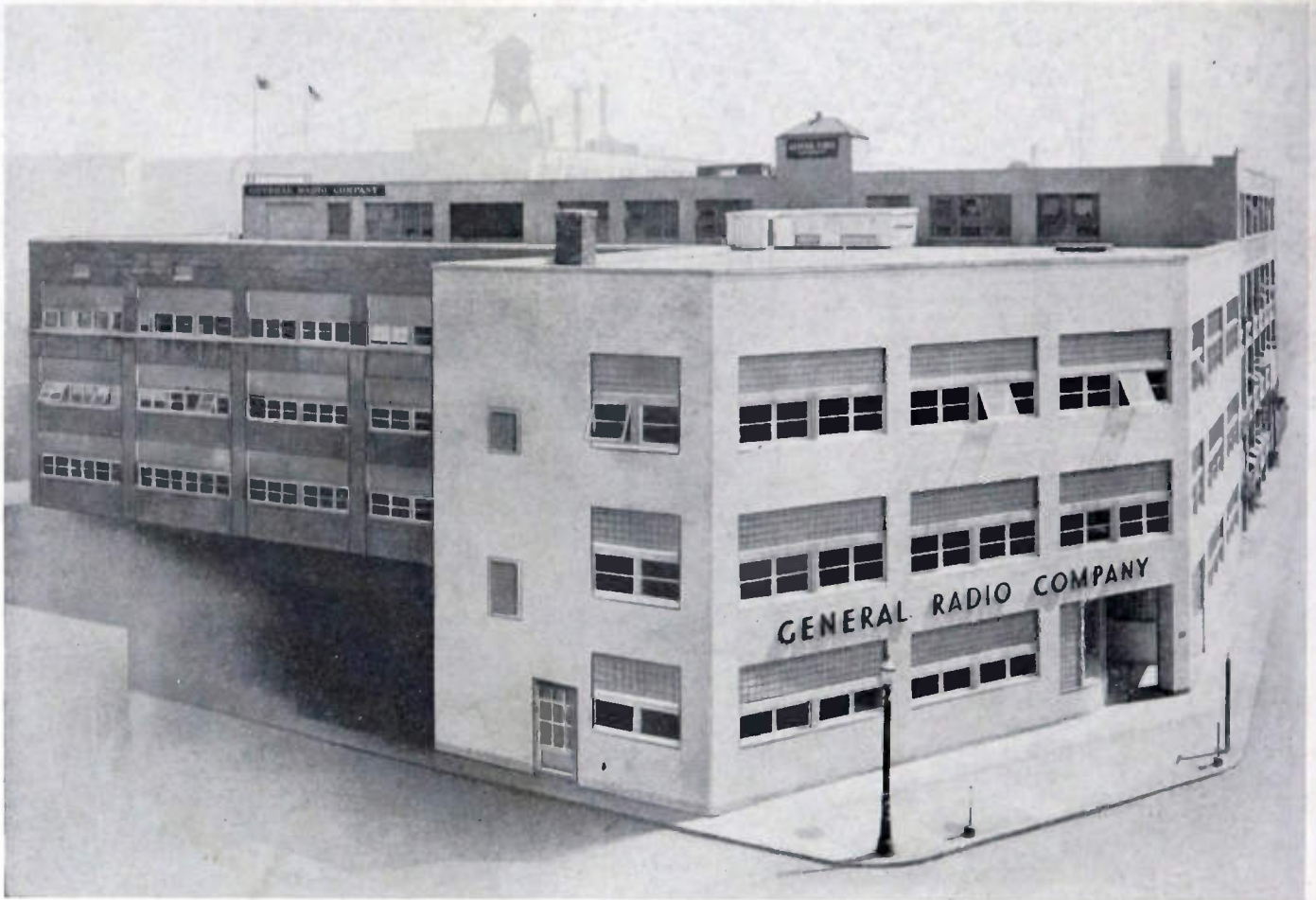

JUST AROUND THE CORNER

● LATELY, persons corresponding with us have noted a new address . . . 275 Massachusetts Avenue. We've moved our engineering and general business offices into a remodeled building at this location. It's just around the corner from 30 State Street, which is still ours, and which is now devoted exclusively to manufacturing.

For a long time we have felt the need for re-arranging our space; for one thing we have been badly cramped in the shop; and our engineering department has been spread over several floors and mixed up with many other activities.

The new building, which is connected by ramps on two floors with the older one, provides about 30 per cent more manufacturing space, and allows all of the engineering department to be on one floor.

Under pressure of the war we have expanded our output in several ways. We have left out the manufacture of several instruments to sub-contractors; we have turned

over the designs, drawings and models of several instruments to other manufacturers for their exclusive use; we have rented considerable extra space in two outside buildings, in one of which we have contracted for a large number of war-time workers under our own foremen.

After the war when the armed guards have left us, we hope that you will come to see our new laboratories and offices. In the meantime we continue to devote our energies to filling war orders for electronic laboratory test equipment.

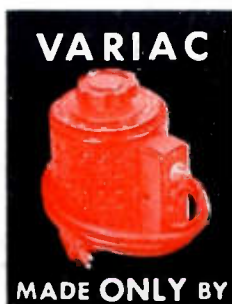
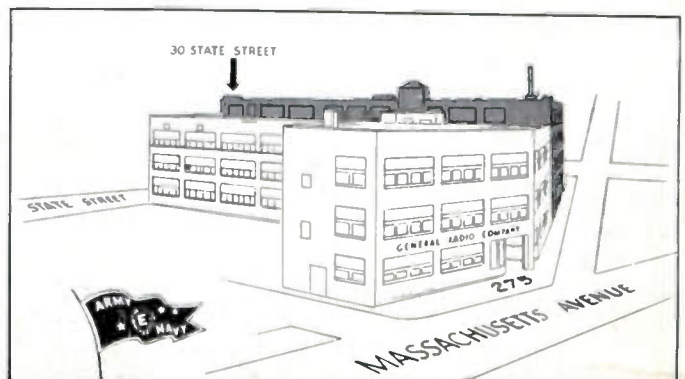

GENERAL RADIO COMPANY

Cambridge 39, Mass.
 NEW YORK
 CHICAGO
 LOS ANGELES

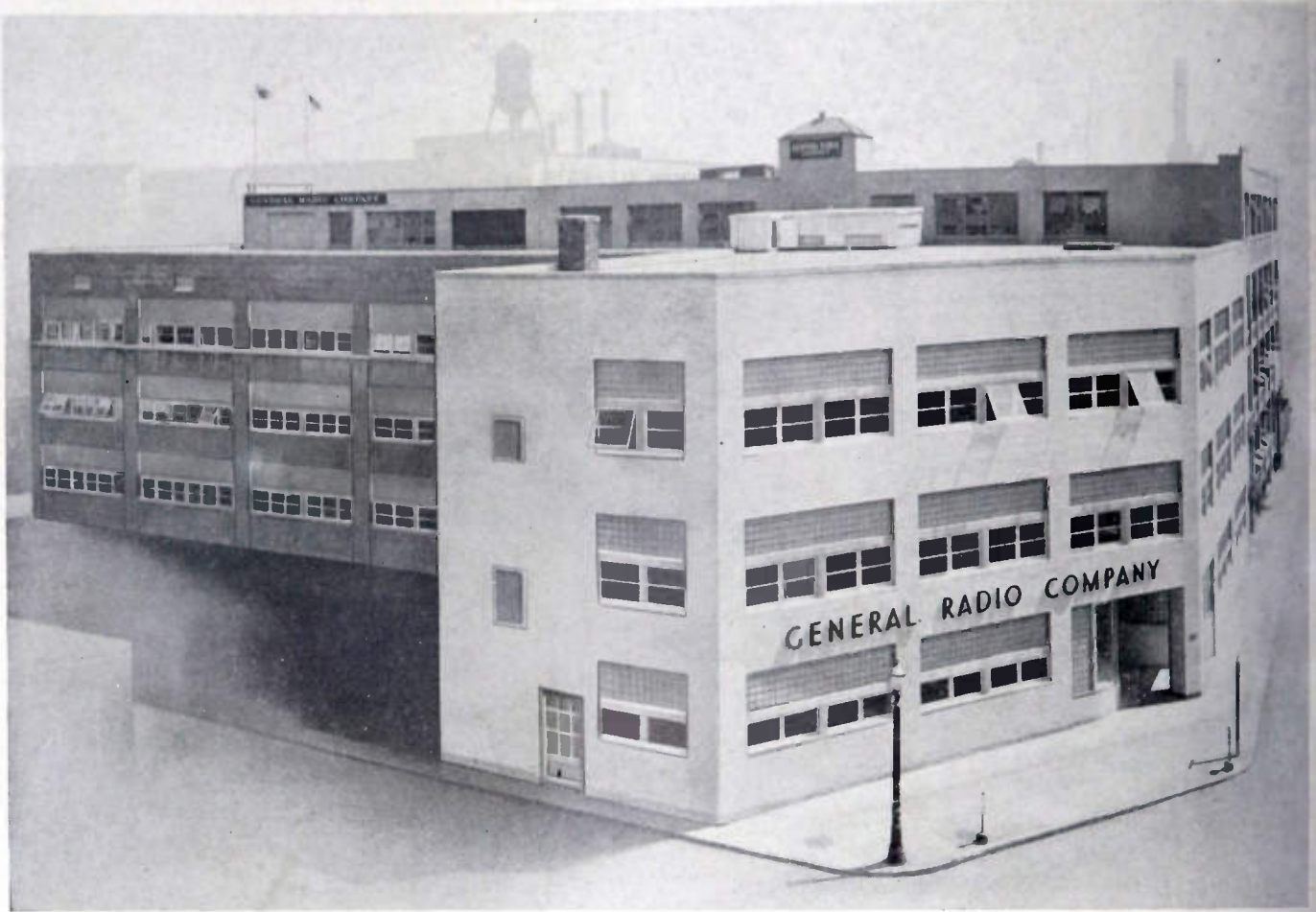

JUST AROUND THE CORNER

● LATELY, persons corresponding with us have noted a new address . . . 275 Massachusetts Avenue. We've moved our engineering and general business offices into a remodeled building at this location. It's just around the corner from 30 State Street, which is still ours, and which is now devoted exclusively to manufacturing.

For a long time we have felt the need for re-arranging our space; for one thing we have been badly cramped in the shop; and our engineering department has been spread over several floors and mixed up with many other activities.

The new building, which is connected by ramps on two floors with the older one, provides about 30 per cent more manufacturing space, and allows all of the engineering department to be on one floor.

Under pressure of the war we have expanded our output in several ways. We have left out the manufacture of several instruments to subcontractors; we have turned

over the designs, drawings and models of several instruments to other manufacturers for their exclusive use; we have rented considerable extra space in two outside buildings, in one of which we have contracted for a large number of war-time workers under our own foremen.

After the war when the armed guards have left us, we hope that you will come to see our new laboratories and offices. In the meantime we continue to devote our energies to filling war orders for electronic laboratory test equipment.

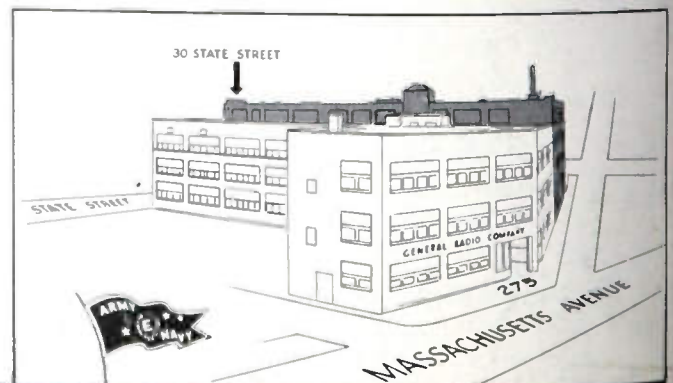

VARIAC



MADE ONLY BY

GENERAL RADIO COMPANY

Cambridge 39, Mass.

NEW YORK
CHICAGO
LOS ANGELES