

Proceedings



of the

I·R·E



1842 - JOSEPH HENRY

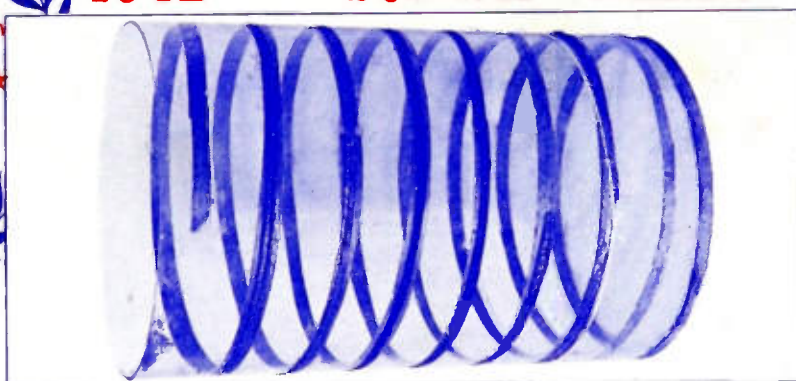

1912 - I. R. E. - 1942

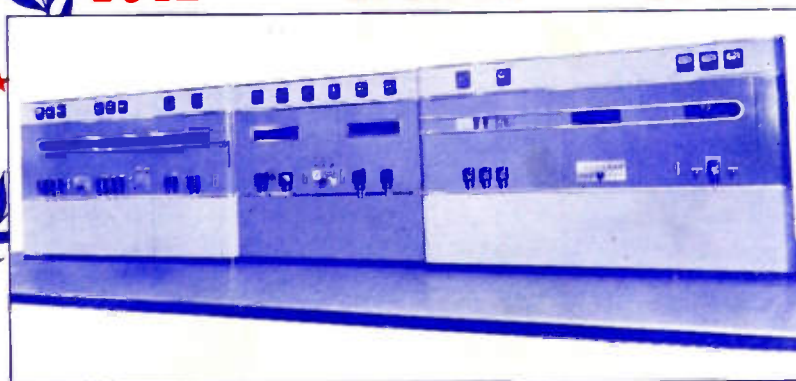

JUNE 1942

Institute of Radio Engineers

*If any old transformer will do...
Any make will do!*

But

If your problem is ● weight (our smallest units weigh only one-third ounce) or ● size (our sheet metal division can run off a case to accurately fit your particular requirements) or ● precise adjustments or tougher than ordinary electrical characteristics or ● mechanical requirements or ● submersion type components, etc. . . . ●

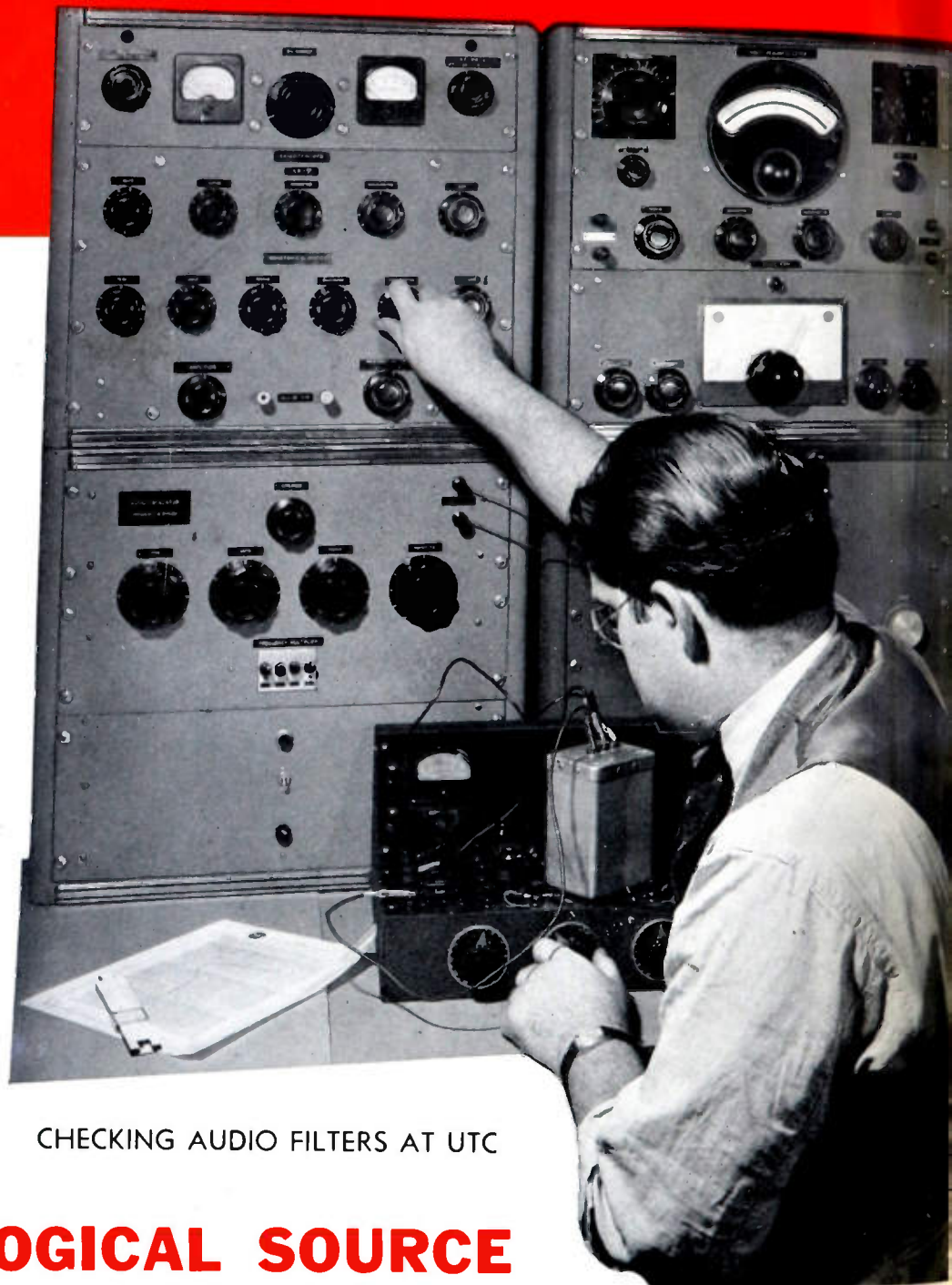

CHECKING AUDIO FILTERS AT UTC

UTC IS THE LOGICAL SOURCE

MAY WE ASSIST YOU? A note to our Engineering Division will bring a quick response with details on units to your requirements.

UNITED TRANSFORMER CO.

150 VARICK STREET



NEW YORK, N. Y.

EXPORT DIVISION: 100 VARICK STREET NEW YORK, N. Y. CABLES: "ARLAB"

BOARD OF DIRECTORS

Arthur F. Van Dyck, *President*
Walter A. Rush, *Vice President*
Haraden Pratt, *Treasurer*
Harold P. Westman, *Secretary*
Alfred N. Goldsmith, *Editor*
Austin Bailey
Adolph B. Chamberlain
Carl C. Chambers
Ivan S. Coggeshall
William L. Everitt
Harold T. Friis
O. B. Hanson
Lawrence C. F. Horle
C. M. Jansky, Jr.
J. Kelly Johnson
Frederick B. Llewellyn
Frederick E. Terman
Browder J. Thompson
Hubert M. Turner
Harold A. Wheeler
Lynde P. Wheeler

Harold R. Zeamans,
General Counsel

BOARD OF EDITORS

Alfred N. Goldsmith, *Editor*
Ralph R. Batcher
Lloyd V. Berkner
Philip S. Carter
Lewis M. Clement
Elmer W. Engstrom
William L. Everitt
Peter C. Goldmark
Frederick W. Grover
C. M. Jansky, Jr.
John D. Kraus
Frederick B. Llewellyn
Samuel S. Mackeown
Edward L. Nelson
Harry F. Olson
Greenleaf W. Pickard
Haraden Pratt
Conan A. Priest
Leon J. Sivian
Lynne C. Smeby
Browder J. Thompson
Harold A. Wheeler
Lynde P. Wheeler
Laurens E. Whittemore
Gerald W. Willard
William Wilson
Charles J. Young

Helen M. Stote, *Assistant Editor*
William C. Copp,
Advertising Manager

Proceedings

of the I·R·E

Published Monthly by

The Institute of Radio Engineers, Inc.

VOLUME 30

June, 1942

NUMBER 6

The cover: Illustrative of a hundred years' progress, the cover contrasts one of the coil systems used by Joseph Henry in his study of induced currents and a modern 50-kilowatt broadcast transmitter. Acknowledgment for the cover design is given to Charles Dreyer of the staff of Egmont Arens and the courtesy of Caldwell Clements, Inc. The photographs are through the kindness of Princeton University and the RCA Manufacturing Company.

Joseph Henry, Pioneer in Space Communication.....	W. F. Magie	261
Hearing, the Determining Factor for High-Fidelity Transmission.....	Harvey Fletcher	266
The Effect of Fluctuation Voltages on the Linear De- tector.....	John R. Ragazzini	277
The Use of Vacuum Tubes as Variable Impedance Ele- ments.....	Herbert J. Reich	288
The Relative Sensitivities of Television Pickup Tubes, Photographic Film, and the Human Eye.....	Albert Rose	293
Institute News and Radio Notes.....		301
Message from the President.....		301
Board of Directors.....		302
Executive Committee.....		302
Walter C. Evans.....		302
Election Notice.....		302
Membership.....		303
Contributors.....		304

The contents of papers published in the PROCEEDINGS are the responsibilities of the authors and are not binding on the Institute or its members.

Entered as second-class matter October 26, 1927, at the post office at Menasha, Wisconsin, under the Act of February 28, 1925, embodied in Paragraph 4, Section 538 of the Postal Laws and Regulations. Publication office, 450 Ahnapp Street, Menasha, Wisconsin. Editorial and advertising offices, 330 West 42nd St., New York, N. Y. Subscription, \$10.00 per year; foreign, \$11.00.

THE INSTITUTE OF RADIO ENGINEERS

INCORPORATED



Summer Convention, Cleveland, Ohio, June 29, 30, and July 1, 1942



SECTION MEETINGS

ATLANTA
June 19

DETROIT
June 19

LOS ANGELES
June 16

SECTIONS

- ATLANTA**—Chairman, J. M. Comer; Secretary, G. V. Waldo, 3166 Peachtree Dr., N. E., Atlanta, Ga.
- BALTIMORE**—Chairman, V. D. Hauck; Secretary, G. J. Gross, Pa. Water & Power Co., 1611 Lexington Bldg., Baltimore, Md.
- BOSTON**—Chairman, J. M. Henry; Secretary, R. O. Oberg, Northeastern Univ., Boston, Mass.
- BUENOS AIRES**—Chairman, P. J. Noizeux; Secretary, L. C. Simpson, RCA Victor Argentina, Bartolome Mitre, 1961.
- BUFFALO-NIAGARA**—Chairman, E. H. Roy; Secretary, Leroy Fiedler, 53 Rosedale Ave., Hamburg, New York.
- CHICAGO**—Chairman, R. A. Kay; Secretary, Walter, Kenworth, RCA Institutes, Inc., 1154 Merchandise Mart, Chicago, Ill.
- CINCINNATI**—Chairman, W. L. Schwesinger; Secretary, Howard Leppele, 4432 Raceview Ave., Cincinnati, Ohio.
- CLEVELAND**—Chairman, P. L. Hoover; Secretary, A. S. Nace, 3209 Archwood Ave., Cleveland, Ohio.
- CONNECTICUT VALLEY**—Chairman, F. G. Webber; Secretary, C. I. Bradford, 187 Glenarden Dr., Fairfield, Conn.
- DALLAS-FORT WORTH**—Chairman, Truett Kimzey; Secretary, P. C. Barnes, Radio Station WFAA-WBAP, Grapevine, Texas.
- DETROIT**—Chairman, M. Cottrell; Secretary, Paul Frincke, 26686 Kenwood Ave., Royal Oak, Michigan.
- EMPORIUM**—Chairman, E. J. Hoffman; Secretary, H. D. Johnson, Hygrade Sylvania Corp., Emporium, Pa.
- INDIANAPOLIS**—Chairman, S. E. Benson; Secretary, B. H. Rinehart, 920 Park Ave., Indianapolis, Ind.
- KANSAS CITY**—Chairman, H. K. Morgan; Secretary G. L. Taylor, Midland Radio School Power and Light Building, Kansas City, Mo.
- LOS ANGELES**—Chairman, C. F. Wolcott; Secretary, E. S. Sievers, Room 567, 417 S. Hill St., Los Angeles, Calif.
- MONTREAL**—Chairman, E. A. Laport; Secretary, W. A. Nichols, Canadian Broadcasting Corp., 1012 Keefer Bldg., Montreal, P. Q., Canada.
- PHILADELPHIA**—Chairman, C. C. Chambers; Secretary, R. L. Snyder, 103 Franklin Rd., Glassboro, N. J.
- PITTSBURGH**—Chairman, P. N. Bossart; Secretary, M. G. Jarrett, Bell Telephone Company of Pennsylvania, 416 Seventh Ave., Pittsburgh, Pa.
- PORTLAND**—Chairman, R. W. Deardorff; Secretary, B. R. Paul, 5960 S. W. 41st. Ave., Portland, Ore.
- ROCHESTER**—Chairman, O. L. Angevine, Jr.; Secretary, G. R. Town, Stromberg-Carlson Tel. Mfg. Co., Rochester, N. Y.
- ST. LOUIS**—Temporary Secretary, H. D. Seielstad, 1017 S. Berry Rd., St. Louis, Mo.
- SAN FRANCISCO**—Chairman, H. E. Held; Secretary, W. G. Wagener, Heintz and Kaufman, South San Francisco, Calif.
- SEATTLE**—Chairman, K. H. Ellerbeck; Secretary, J. F. Johnson, 4316 Whitman Ave., Seattle, Wash.
- TORONTO**—Chairman, R. H. Klingelhoefter; Secretary, L. C. Simmonds, 301 King St., E., Toronto, Ont., Canada.
- TWIN CITIES**—Chairman, C. A. Culver; Secretary, N. B. Coil, 1664 Thomas St., St. Paul, Minn.
- WASHINGTON**—Chairman, E. M. Webster; Secretary, J. D. Wallace, Radio Division U. S. Naval Research Laboratory, Bellevue, Anacostia, D. C.

Joseph Henry, Pioneer in Space Communication*

W. F. MAGIE, † NONMEMBER, I.R.E.

Summary—Joseph Henry, while a teacher at the Albany Academy, brought the electromagnet to its present form and distinguished two types, the “quantity” magnet and the “intensity” magnet. He used the intensity magnet in a circuit containing a mile of wire and rang a bell by sending a current through the circuit. His inventions and discoveries cover the essential features of the electromagnetic telegraph.

In the period Henry spent in Albany, he probably observed the induced current, at a date set by his daughter, Miss Mary A. Henry, as early as 1830, but he postponed publication and before the larger magnet and coil which he was building were ready for use he learned that Faraday had anticipated him in this most important discovery.

Henry came to Princeton in 1832, and there constructed a great magnet for the college, and set up a telegraph line between his laboratory and his house. He also resumed his study of the current of self-induction, which he had noticed in Albany.

After spending a year's leave of absence in Europe, he settled to a definite field in which he made his most important discoveries. He thought that most of the work on electromagnetic induction had been concerned with the relations between the current and the magnetic field, and that no one had properly developed what he called “the purely electrical part of Dr. Faraday's admirable discovery.” For work in this field he used “coils” of insulated copper ribbon; “helices” of insulated wire; a “magnetic spiral,” a spiral of wire wound tightly around a small cylinder in the axis of which a sewing needle could be placed; a low-resistance electromagnet; and other accessory apparatus. He first investigated the currents of self-inductance and showed that the coils gave a quantity current; the long helices, an intensity current. Turning next to the ordinary Faraday current, he showed the conditions in which they would be either quantity or intensity currents. By combining the coils or helices, he used the secondary current to induce a tertiary current, and further currents up to those of the fifth order. He then tried the effect of the discharge of “ordinary electricity” from the Leyden jar for the primary circuit, and found that there resulted a current in the secondary. Anomalies in the direction of the current indicated by the magnetization of the needle in the magnetizing spiral led him to the discovery that the discharge is not in one direction only but is oscillatory in character. While on this part of his investigations he found that the effect of the discharge in the primary could be observed in a secondary many feet removed, and he transmitted the effect for 220 feet from his telegraph line to a parallel wire.

WHEN Joseph Henry resigned his professorship of Natural Philosophy at Princeton to take on the administration of the newly established Smithsonian Institution at Washington, he said, “If I go, I shall probably exchange permanent fame for transient reputation.” In this prediction he was so far right that for many years the important contributions which he made to the science of electromagnetism were largely overlooked and he was esteemed rather as the wise and learned Secretary of the Smithsonian than as a productive investigator of a high order.

Before Henry came to Princeton in 1832 he had done a great deal of valuable work in Albany, where he was a teacher in the Albany Academy. It was then that he conceived the notion, apparently before anyone else, of improving the crude electromagnet of Sturgeon, by insulating the wire of the coil with a wrapping of silk, so that it could be wound closely around the iron core of the magnet, and one layer piled on another so as to enhance the effect of the current. Henry's electromagnets were precisely like those of the present day. In the magnets which he made he distinguished

two types, which he called the “quantity” magnet, and the “intensity” magnet. The first was a magnet wound with a comparatively small number of turns of coarse wire. This magnet would show considerable magnetic force when the current was sent through its coils, so long as the resistance of the circuit was low, but it showed little effect in a circuit of high resistance. The intensity magnet was wound with a large number of turns of relatively fine wire. It performed best when a current was sent through it from a battery with



Fig. 1—The Joseph Henry home located at the corner of Washington and Nassau Streets, Princeton, New Jersey.

a number of cells in series, and was very little affected in its action by being introduced into a long circuit. It was with such a magnet that Henry sent signals through more than a mile of fine wire.

These inventions made possible the development of the electromagnetic telegraph. After Henry came to Princeton in 1832, a complete telegraph line was set up by him between his laboratory and his house, the wire being strung along through the trees in front of Nassau Hall, and the circuit completed through the earth by sinking the ends of the wire in two wells. Over this wire Henry used to send a call for his lunch when he wanted it sent over to the laboratory.

In those early days of electromagnetism it was often suggested that, since electricity could develop magnetism, it ought to be possible to make magnetism develop electricity. Investigators do not often publish their failures, and there is no way of knowing how many times a current was looked for in a circuit near or around a magnet, but there must have been many. Faraday's diary shows that he tried more than once and found nothing. Henry evidently hoped that with the very powerful magnets at his command something might be discovered, so he undertook the construction

* Decimal classification: R097. Original manuscript received by the Institute, April 27, 1942. This paper marks the occasion of the hundredth anniversary of Joseph Henry's first announcement in June, 1842, of his space transmission experiments.

† Dean, Princeton University, Princeton, New Jersey.

of a magnet more powerful than any of which he had any knowledge and of a coil containing a mile of wire with which to look for the desired effect. This work was laid aside for a while, because of other duties. Before it was resumed Henry learned from a notice or two in popular journals of Faraday's discovery of the

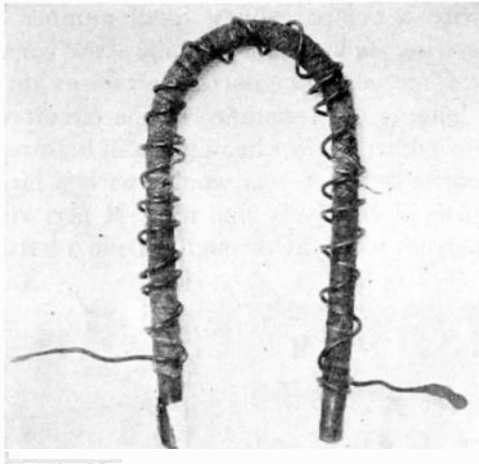

Fig. 2—Coil wound with bare wire on insulated core illustrating earlier practice. Henry used insulated wire in his later experiments.

induced current. This must have been a serious disappointment to him. Henry never made any claims to priority, but as soon as he could after learning of Faraday's discovery, he published a paper in which he described his preparation for the investigation, his check on learning of Faraday's success, and a method for obtaining the induced current which he considers different from Faraday's methods, and which he says he had used before having any knowledge of those methods. Curiously enough, the method by which Faraday first discovered the induced current is exactly the same as Henry's, though it does not appear as first in Faraday's published memoir, and is not mentioned or even hinted at in the little notices of Faraday's work which Henry had seen. His daughter, Miss Mary A. Henry, writes that her father, in the privacy of the family, used to express his regret that he had not followed up his first observations more speedily. She says that he observed the induced current as early as 1830, and that the apparatus which he was planning in 1831 was intended for more exact observations on a larger scale. She quotes Henry's friend, Dr. Theodore Cuyler, as saying: "Your father often spoke to me of his disappointment about that discovery. 'I ought to have published earlier,' he used to say. 'I ought to have published earlier, but I had so little time. It was so hard to get things done. I desired to get out my results in good form, and how could I know that another on the other side of the Atlantic was busy with the same thing.'" It seems probable that Henry really was ahead of Faraday in the observation of the induced current, and that he failed to establish his claim to the discovery because of his desire to show his results on a

larger scale. If he had published at once, his fame would have jumped the Atlantic. As it was he was little known outside of this country.

In November, 1832, Henry came to Princeton as Professor of Natural Philosophy. The early years of his professorship were spent in developing his courses of instruction, and in the installation of much needed apparatus. He constructed the great magnet which is now in the Museum of the Palmer Physical Laboratory, and set up the telegraph line already referred to between his house and the laboratory. The one piece of original work in those years was the development of the observation reported by him in his paper of 1832 of what used to be called the extra current, the momentary increased current which occurs in a circuit carrying a current when it is broken. Faraday reported on the same phenomenon in 1834, and Henry's friends insisted on his again taking up the subject, so that his priority in the discovery might not be overlooked. In the paper presented by him to the American Philosophical Society on February 6, 1835, the extra current was studied by the help of the spark which appears when the circuit is broken, and by the shock which can be felt through the body, if that is made a part of the

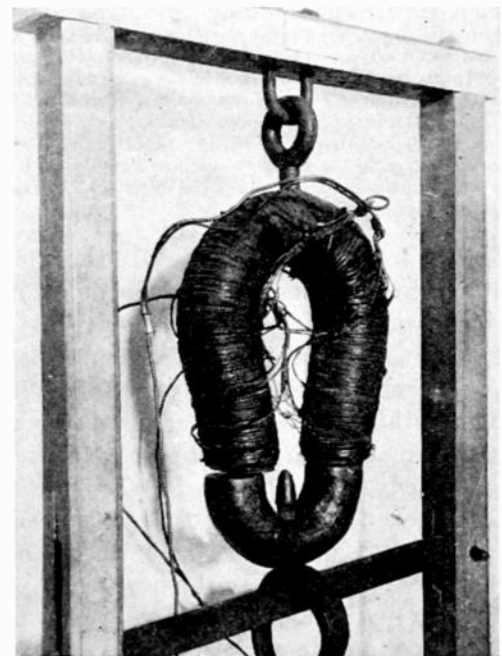

Fig. 3—An early Henry electromagnet capable of sustaining weight of 3600 pounds.

circuit. Henry ascribed the effects observed to "that species of Dynamical *Induction* discovered by Mr. Faraday, which produces the following phenomenon, namely," then follows a short description of the production of the induced current produced in a secondary circuit when a current is made or broken in a primary circuit. He returned to this subject in his later investigations.

In 1837, Henry was given a leave of absence by the

Trustees of the College, on full salary, and he spent the year in a trip to Europe where he made the acquaintance of many of the leading scientific men of England and France. On his return he began the investigations which are of special interest at the present time. He chose for himself a particular field which he felt had not been sufficiently cultivated, and worked in that field until he was transferred to the Smithsonian Institution. He explains his choice of a subject as follows: "The secondary currents, as it is well known, were discovered in the introduction of magnetism and electricity, by Dr. Faraday, in 1831. But he was at that time urged to the exploration of new, and apparently richer veins of science, and left this branch to be traced by others. Since then, however, attention has been almost exclusively directed to one part of the subject, namely, the induction from magnetism, and the perfection of the magnetoelectrical machine; and I know of no attempts, except my own, to review and extend the purely electrical part of Dr. Faraday's admirable discovery." There is perhaps here a sharper distinction than would now be made between the magnetic and electrical fields, but by confining himself to the electrical field alone, Henry was led to discoveries which he could hardly have made if he had complicated his experiments by using magnets. For use in his proposed investigations Henry made several coils of copper strip or ribbon, insulated with two coatings of silk. The length of ribbon used in one of these coils was about 60 feet, though one or two were longer. The ribbon was wound on itself sometimes into a flat spiral, sometimes

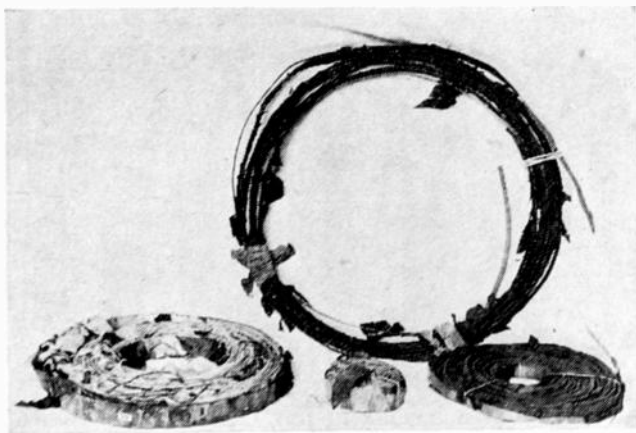

Fig. 4—Helices of copper strips insulated with material from Mrs. Henry's dress.

into a ring. He also made a set of helices or coils of fine insulated wire, of various sizes and containing various lengths of wire. The longest wire of this set was over 1600 feet in length. These could be fitted into each other, so that a spiral containing 3000 feet of wire could be obtained. He was also lent an immense coil containing over five miles of wire. For observing the currents he used a "magnetizing spiral," consisting of "about thirty spires of copper wire, in the form of a

cylinder, and so small as just to admit a sewing needle into the axis." He also used a small horseshoe magnet wound with about five feet of copper bell wire. He refers also occasionally to the use of a galvanometer. The coils and possibly the magnetizing spiral and the galvanometer are in the Museum of the Palmer Lab-

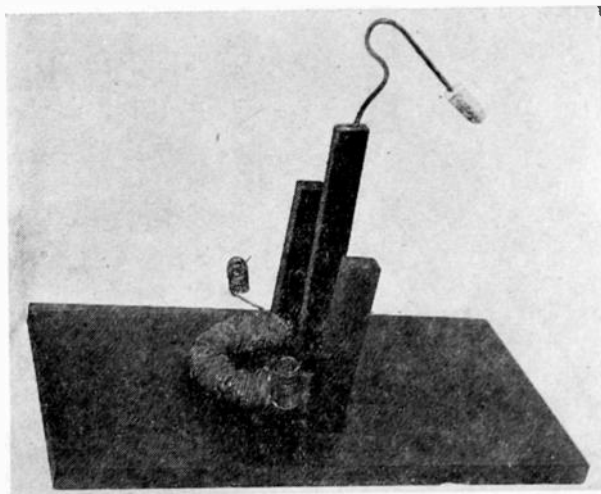

Fig. 5—Electromagnet actuating repulsion-type magnetized armature with attached clapper and gong (not shown). This device, which was located in Henry's laboratory, was connected by wire to his home. Mrs. Henry completed the circuit by placing the voltaic battery plates in the electrolyte to summon Henry by ringing the bell in his laboratory.

oratory, but the helices, containing many feet of wire that could be used for other purposes, have long ago disappeared.

The battery used was often a single cell with zinc and copper elements; sometimes the Cruickshank's trough was substituted to get greater "projectile force" for the current or greater "intensity." Later on in his work, Henry found it more satisfactory to use a battery of Daniell's cells.

Henry first employed these appliances in an investigation of the "induction of a current on itself," which he had previously studied. He verified his former observations, and found that the extra current obtained from his various coils and helices differed in "intensity" and in "quantity." With a comparatively feeble source of current the largest coil, when the circuit was broken, gave "the most brilliant deflagration and the loudest snaps from a surface of mercury." The shocks, however, were very feeble. The current produced was one of "quantity." When several elements of the Cruickshank's trough were used with one of the wire helices the indications of "quantity" were slight, but the shock obtained through the body or fingers was considerable, thus showing a current of "intensity." The contrast could not be better shown than in an experiment in which a current was sent through the spool containing five miles of wire, from a little battery of six cells, each made of a piece of copper bell wire an inch and a half long and a corresponding piece of zinc of the same size.

When this circuit was broken the shock was "given at once to twenty-six persons joining hands."

Henry next proceeded to the examination of the ordinary production of secondary currents, with special consideration of the conditions on which the production of "quantity" or "intensity" currents depended.

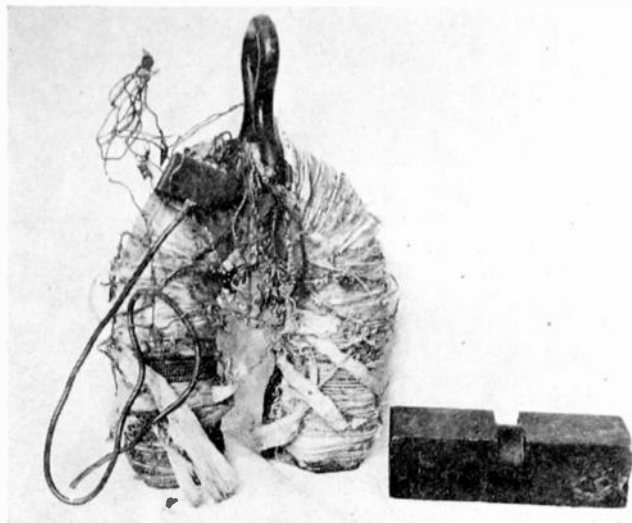

Fig. 6—Henry's experimental magnet with which he discovered magnetic induction. The horseshoe magnet carries 9 coils of insulated wire. The armature is wound with 45 turns of insulated wire.

It appeared that, when one of the large coils was used as primary and another similar coil as secondary, the induced current magnetized needles in the magnetizing spiral, developed magnetism in the horseshoe and generated gases in the electrolytic cell, but gave little or no perceptible shock. In this case, therefore, the current produced was of small "intensity" and considerable "quantity." A compound helix formed by joining two of the original helices so as to make a helix 2600 feet long was placed on the large coil and served as secondary to the large coil used as primary. With this arrangement the evidence of quantity was slight but "the shock was almost too intense to be received with impunity, except through the fingers of one hand." This shock was given at once to fifty-six students of the senior class, and resembled that from a Leyden jar weakly charged. The battery used in these experiments was but a single element.

When the Cruickshank's trough was used the effect produced when the copper ribbon coil was used as primary was insignificant, but when a helix was used as primary and another one as secondary the current induced gave intense shocks but feeble decomposition. In this case an "intensity" current induced an "intensity" current. One of the coils of copper ribbon was then used as secondary, and gave evidence that the current induced was one of "quantity," but it gave no shocks. These experiments showed that a "quantity" current could induce one of "intensity" and that an "intensity" current could induce one of "quantity."

These results remind us of the inductorium and of the "step-up" and "step-down" transformers.

A number of experiments were made on the changes in the induction produced by separating the primary and secondary by different distances. Nothing of special interest was developed, but Henry points out that the falling off in the intensity of the shock as the coils are separated affords a means of graduating the shock when it is used for medical purposes.

An investigation which consumed a great deal of time and trouble and which led to no result of importance was undertaken to ascertain the effect produced by screens of different sorts and sizes interposed between the primary and secondary.

The next set of observations recorded put Henry on his way to his most important results. It occurred to him to test the secondary current, to see if it would induce a current in a third circuit. This he did by joining two coils together in the same plane, putting one of these coils as secondary over the original primary, and putting a third or tertiary circuit over the other coil of the secondary. It was by no means evident that any tertiary current would be produced, for the current in the secondary being only momentary it might be suspected that the effects of its growth and decay might come so close together in time as to annul each other. This turned out to be not the case. When the test was made a current was developed in the tertiary which gave intense shocks. By extending the arrangement of coils, currents of the fourth and fifth order were obtained characterized by their intensity. Consideration of these currents of higher orders and of

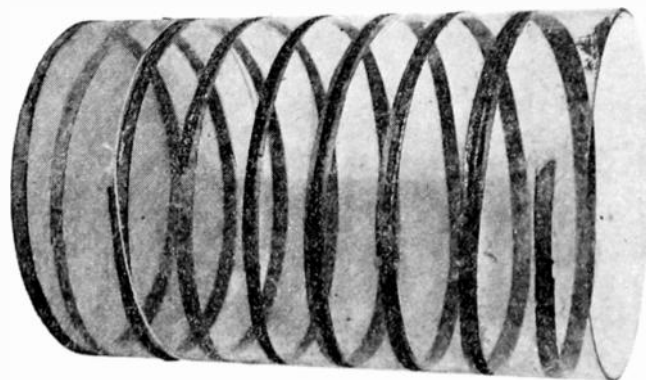

Fig. 7—Glass cylinder wound with 2 spiral strips with which Henry tested the production and direction of induced currents.

their relation to the original current leads to the belief that they must consist of a succession of currents alternating in direction, and becoming more numerous as the order is higher. In this connection a great deal of time and trouble was spent in the examination of the direction of these currents of different orders. Henry's conclusion about this need not be given.

Henry was led to the next step in this series of experiments by considering that: "The fact that the

secondary current, which exists but for a moment, could induce another current of considerable energy, gave some indication that similar effects might be produced by a discharge of ordinary electricity, provided a sufficiently perfect insulation could be obtained." To test this notion, he pasted a narrow ribbon of tin foil spirally around the outside of a hollow glass cylinder, and another similar strip around the inside of the cylinder, so that the spires of the two were directly opposite to each other. One of these cylinders is preserved in the Museum. When the ends of the inner ribbon were joined through the magnetizing spiral and a discharge from a Leyden jar was sent through the outer ribbon the needle in the magnetizing spiral was strongly magnetized. When the ends of the inner ribbon were brought close together, a spark passed through the gap when the discharge was sent through the outer ribbon. By using more cylinders in combination, currents of the third and fourth order were obtained. Certain discrepancies between the direction of these currents and those found for the galvanic current were to some extent explained when it was discovered that the direction of the currents might depend on the distance apart of the two conductors. Many anomalous results appeared in the observations; much time and labor were spent and no explanation of the anomalies was obtained. They were later explained by Henry's discovery of the alternating character of the ordinary electrical discharge.

In Henry's next memoir, presented in 1840 to the American Philosophical Society, he describes observations on the induction produced at the moment of the beginning of the primary current. In these observations he was much assisted by the fairly constant behavior of the battery of Daniell's cells which he used in them. The observations are of little interest. They add nothing essentially new. Henry ends the paper with theoretical considerations relating to the production of the induced currents which he has been describing. It is not important to present this theory. In a paper presented orally to the American Philosophical Society on June 17, 1842, Henry gave an account of further investigations in the same field. Some doubt had arisen in his mind of the magnetizing spiral as an accurate indicator of the direction of the current. Savary had announced in 1826 that when needles were placed at different distances above a wire through which a discharge was passed from a Leyden battery, the needles were not all magnetized in the same direction, and that by increasing the discharge through a spiral several reversals of polarity in the needles could be observed. Henry, after many failures, was finally able to confirm these observations, and was led by considering them to the conclusion that we must admit "the existence of a principal discharge in one direction, and then several reflex actions backward and forward, each more feeble than the preceding, until the equilibrium is obtained." This hypothesis has been confirmed by the observa-

tions of Feddersen and by the theory of Lord Kelvin. It is one of Henry's most important contributions to the science of electricity.

In this same communication Henry described the remarkable result which he obtained in a test made to see how far the inductive effect would be transmitted. He stated that "a single spark from the prime conductor of the machine of about an inch long, thrown on the end of a circuit of wire in an upper room, produced an induction sufficiently powerful to magnetize needles in a parallel circuit of wire placed in the cellar beneath, at a perpendicular distance of thirty feet with two floors and ceilings, each fourteen inches thick, intervening." He also briefly related that using a wire led from the roof of his house and joined in with a magnetizing spiral in his study, he found that needles

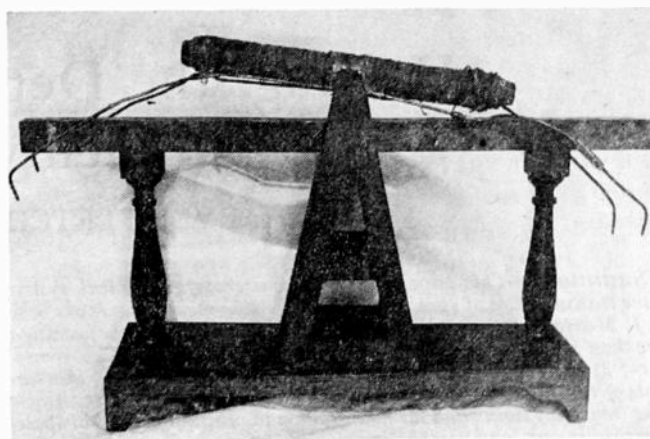

Fig. 8—Henry's electromagnet engine (1837) which is recognized as being the first type of electric motor.

were magnetized by the induction from a lightning flash, even when it occurred seven or eight miles away, and the thunder was scarcely audible.

In another experiment of the same sort, in which the spark was thrown on the telegraph wire running from his laboratory to his house, Henry found needles magnetized in a parallel wire 220 feet away "with the bulk of Nassau Hall intervening." He states that this effect occurred even when there was a gap in the receiving wire, showing that the effect observed was not produced by currents circulating through the earth. This last result he presented orally to the American Philosophical Society on October 21, 1842. The distance apart of the two wires is stated elsewhere by Henry as several hundred feet, but if the distance was much over 250 feet the receiving wire would have had to be placed outside the campus as it was then and on private grounds. It is doubtful whether any greater distance than the definitely stated 220 feet was attained.

Henry seems to have underestimated the importance of this achievement. He certainly did not realize that it was the forerunner of one of the most extensive applications of electricity in modern life. He did recognize, however, its theoretical implications. In a lecture

given before the American Association for the Advancement of Science, in 1851, referring to these experiments he said, "As these are the results of currents in alternate directions, they must produce in surrounding space a series of plus and minus motions analogous to if not identical with undulations."

Something should be said to account for Henry's failure to obtain general recognition of the important work which he had done. Part of it was no doubt his own fault. He was always dilatory about publication. He showed his magnets to the Albany Institute, a local scientific society, but he published nothing about them until he heard of Moll's efforts in the same line. He delayed publication of his observation of the induced current, to his lasting regret, and was anticipated by Faraday. The great work which he did while at Prince-

ton he presented in a few memoirs to the American Philosophical Society, which at that time was a local society of little importance, and they appeared in its *Transactions* two or three years after they were presented. His latest results were not given formal publication, but were simply presented orally to the Society and appeared in its *Proceedings*. It is not likely that they were ever properly brought to the attention of the European workers in the same field. Certainly Faraday when he studied the "induction of a current on itself" was not aware that Henry had already announced the discovery of the same effect. It is perhaps only now, a century after his work was done, that the scientific world is coming to recognize the importance of Henry's pioneering activities in the modern field of radio transmission.

Hearing, the Determining Factor for High-Fidelity Transmission*

HARVEY FLETCHER†, NONMEMBER, I.R.E.

Summary—This paper gives the requirements for ideal systems for the transmission of speech and music. These requirements are based on: 1. Measurements of the threshold and frequency limits of the hearing of more than 500,000 people at the New York and San Francisco World's Fairs; 2. measurements of the discomfort level of sound; 3. measurements of room noise in a wide variety of locations; and 4. measurements of the frequency limits and the maximum and minimum levels of speech, orchestral music, and various instruments of the orchestra.

From this information and from judgment tests it is concluded that substantially complete fidelity in the transmission of orchestral music is obtained by use of a system having a volume range of 65 decibels and a frequency range from 60 to 8000 cycles per second. Substantially complete fidelity for the transmission of speech is obtained by a system having a frequency range from 100 to 7000 cycles per second and a volume range of 40 decibels.

Preliminary experiments comparing a single-channel system and a two-channel stereophonic (auditory perspective) system showed that stereophonic transmission with an upper frequency limit of 5000 cycles per second was preferred to single-channel transmission with an upper limit of 15,000 cycles per second. A definite improvement was obtained in the stereophonic system by using three channels instead of two.

WHENEVER a sound is made by a sudden impact of one solid body upon another, a wave train is set up in the air which contains components ranging in frequency from zero to infinity. As the impact becomes more sudden, the higher-frequency components carry a greater portion of the total acoustic energy. An ideal transmission system from a physicist's standpoint might be defined as one which would transmit such sounds to a distant point and there reproduce a disturbance in the air which is a facsimile of that produced by the original source. The requirements for such a system are very severe and it is difficult, if not impossible, to attain them.

* Decimal classification: 534×R270. Original manuscript received by the Institute, September 24, 1941. Presented, Broadcast Engineering Conference, Columbus, Ohio, February 17, 1941.

† Bell Telephone Laboratories, Inc., New York, N. Y.

The purpose of transmitting sounds to a distant place is usually so that persons may hear them. Certainly this is true of broadcast systems, telephone systems, and sound-picture systems. Under such conditions the properties of the hearing mechanism and the characteristics of the listening location, rather than the properties of the sounds transmitted, will very largely determine the fundamental requirements of the transmission system. This will certainly be true if we wish to transmit all kinds of sounds which can be heard. However, if we are interested in only a limited number of sounds, then the characteristics of these sounds play a greater part in determining the requirements for the transmission system.

During the past two years a survey of the hearing capabilities of persons in a typical population has been made by the Bell Telephone Laboratories. This was done in connection with the exhibits at the World's Fairs at San Francisco and New York City, sponsored by the Bell Telephone companies. At these exhibits records of the hearing of more than one half million persons were analyzed. The record expressed the hearing acuity as a relative hearing loss or gain with respect to an arbitrary reference. Measurements at the Laboratories on this reference have made it possible to express these data on an absolute scale and the results have been published by Steinberg, Montgomery, and Gardner.¹ Fig. 1 has been constructed from data taken from this paper. The lower curve labeled 95 indicates that 95 out of 100 persons in a typical group cannot

¹ J. C. Steinberg, H. C. Montgomery, and M. B. Gardner, "Results of the World's Fair hearing tests," *Bell Sys. Tech. Jour.*, vol. 19, pp. 533-562; October, 1940.

hear pure tones whose frequency and intensity levels lie below this curve. The top curve indicates that 5 out of 100 cannot hear these tones until they exceed the intensity levels indicated by this curve. The middle curve indicates the levels where one half the group can hear and the other half cannot hear. The dashed portions of the curves indicate regions where no measurements have been made. Feeling and hurting levels lie somewhere above 120 decibels as indicated by the field of dots at the top of the chart. Our experience with reproduced music has taught us that it is undesirable and probably unsafe to reproduce sounds for a general audience that have greater intensity levels than 120 decibels.

If the listener is in a quiet place, these curves set the limits for the ideal transmission system. This ideal of no noise is seldom if ever realized by listeners. Measurements of room noise have been made by the Bell Telephone Laboratories and from these measurements the average noise spectrum can be deduced. In a paper by Seacord² it was found that 43 decibels was the average sound level in residences not having radios playing. The standard deviation of levels in different residences from this figure was 5.5 decibels. The distribution about this average value indicated that about one half the residences have noise levels between 39 and 47 decibels, and 90 per cent are in the range between 33 and 52 decibels.

Hoth³ found that the form of the noise spectrum was about the same for all types of rooms. Using his relation, the spectrum for the average room noise having a total level of 43 decibels is that shown in Fig. 2, lower curve. The ordinates give the spectrum level. This is

where I_0 is the reference level of 10^{-16} watt per square centimeter. It has been shown⁴ that the masking level could be obtained directly from the spectrum level. Using this relation, the curve shown in Fig. 2, labeled "Masking Level," was obtained. This curve then gives the level of pure tones which can just be perceived in

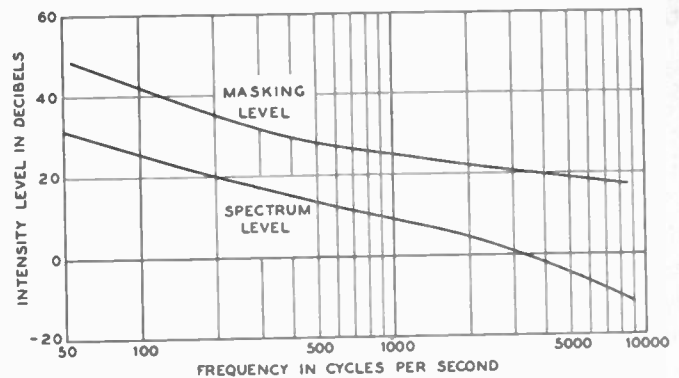

Fig. 2—Average room noise spectrum.

the presence of average room noise. This masking curve is the one which is shown in Fig. 1 as a cross-hatched band. It shows the range of the masking levels for about 90 per cent of the residences in a typical group. The dashed curve gives the average. If we wish to include only the middle 50 per cent of the residences, the top part of this masking-level band would be lowered about 5 decibels.

Fig. 1 then enables us to set several limits for an ideal transmission system. If the noise emitted by the radio set in a typical residence is not to be heard, its level should be below the average threshold of hearing in the room. For an average room this is seen to be determined by the hearing mechanism from low frequencies to 200 cycles, and by the room noise from 200 to 6000 cycles, and again by the hearing mechanism above 6000 cycles. For example, the fundamental of a 60-cycle hum should be kept below a 57-decibel level, whereas any components of this hum around 1000 cycles should be kept below 25-decibel intensity level for the average room. It is seen that for the 5 per cent of the rooms which are quietest the limit is set entirely by the hearing-acuity curve. From Fig. 1 one can also set the frequency limits for an average listener if all sounds that can be heard are to be used in the broadcast. This range is from 20 to 15,000 cycles per second for the highest possible levels, and for any lower levels this frequency range is smaller, as indicated.

Fig. 1 also gives the maximum levels such an ideal system might be called upon to transmit. This maximum level is taken as 120 decibels and the same for all frequencies. There is an uncertainty of about 10 decibels concerning the level that can be tolerated by the average ear. Our experience with reproduced sounds near this level indicates that it is very unlikely that

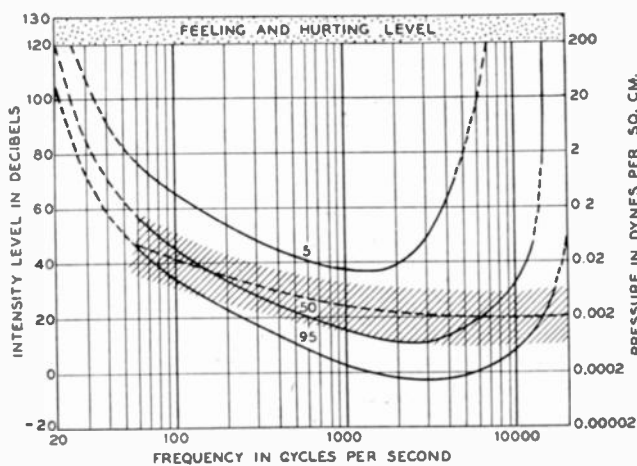

Fig. 1—Contours of hearing loss and room noise.

obtained as follows. The intensity I in a band of frequency width W is measured. Then the ordinates y are given by

$$y = 10 \log I/WI_0$$

² D. F. Seacord, "Room noise at subscriber's telephone locations," *Jour. Acous. Soc. Amer.*, vol. 12, pp. 183-187; July, 1940.

³ D. F. Hoth, "Room noise spectra at subscribers' telephone locations," *Jour. Acous. Soc. Amer.*, vol. 12, pp. 499-504; April, 1941.

⁴ H. Fletcher and W. A. Munson, "Relation between loudness and masking," *Jour. Acous. Soc. Amer.*, vol. 9, pp. 1-10; July, 1937.

higher levels will be used even though levels somewhat higher than 120 decibels may be tolerated by an average listener without producing permanent injury to the ear. It is probable that there will seldom if ever be a demand for such high intensity levels in a home, but if we are thinking in terms of an ideal which is set by human-hearing capabilities the upper limit must be taken at least as high as 120 decibels. The power P for

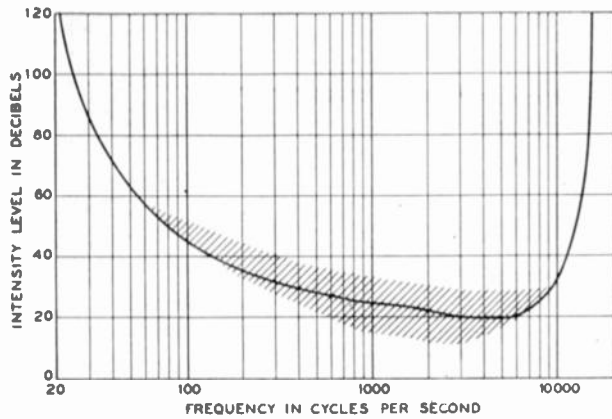

Fig. 3—Hearing limits for pure tones—typical listener in typical residential room noise.

producing the maximum level of 120 decibels varies from 3 watts for a typical residential room to 400 watts for a concert hall such as the Academy of Music in Philadelphia. It may be obtained from the formula

$$P = 0.00012 V/T \text{ watts}$$

where V is the volume of the room in cubic feet and T is the reverberation time in seconds.

If we utilize the entire intensity level range from the average threshold in a room having average noise to 120 decibels level, it will be seen that from 2000 to 6000 cycles this range is approximately 100 decibels. From 500 to 2000 cycles it is about 5 decibels less than this figure, while for 100 cycles the range is only 75 decibels. It should be emphasized that these figures refer to the level range of single-frequency tones. When talking about program material where complex sounds are used which are rapidly varying in intensity and frequency, the matter of measuring intensity level range is not simple as will be evident from later discussions.

A summary of these conclusions is given by the curves in Fig. 3, which give the limits imposed by the hearing of an average person in a room having average room noise. In using this curve it must be remembered that the lower limiting curve may be anywhere in the shaded area, depending upon the room noise condition. This shaded area covers 90 per cent of noise conditions in residences. For an average business office the lower curve will be raised about 15 decibels, and for a factory location the lower curve will be raised nearly 35 decibels, leaving a range of only 60 decibels even if the highest levels that can be tolerated by the ear are used.

Measurements of noise have also been made in motion-picture theaters. Mueller found the average level in theaters without an audience to be 25 decibels and

with an audience present it was 42 decibels. This last figure is within 1 decibel of that given above for the average noise level in residences. So all the limits mentioned above for residence room noise can also be applied to motion-picture theaters, that is, Fig. 3 gives the limits if no limitation is to be placed upon the sounds to be recorded.

Noise measurements made in the Academy of Music in Philadelphia and Constitution Hall, in Washington, D. C., during a quiet listening period indicated levels about 10 decibels lower than that given in Fig. 3 for residences. So at least for these concert halls the lower part of the shaded area should be used for determining minimum levels. It will be seen from Fig. 1 that for the average person in such quiet intervals in these concert halls the lower limit is set by the acuity of hearing rather than by the audience noise.

The above gives the ideal limits of frequency and intensity for high fidelity. It is well known that within these limits the system must have a sufficiently uniform response with different frequencies so that the ear will not detect it from one having a perfectly uniform response. Due no doubt to the fact that persons usually listen in rooms which have resonances, it is difficult to detect departures of 3 or 4 decibels from uniformity, in fact, it is very difficult to measure them. Here again it would be helpful if we had some precise measurements on this point. Also, it is well known that the system must be linear with intensity, that is, the acoustic output must be proportional to the acoustic input. Also there must be no asymmetry in the vibration during transmission. Any departures from these ideals must not be larger than can be detected by the average ear.

When all of these requirements are met, a facsimile of the original source cannot be produced unless another factor is considered which is sometimes overlooked, namely, the spatial or auditory perspective character of the sound. If we are reproducing a moving sound source it must appear to move, and if the sound source is broad it must appear that way when reproduced. In nearly all systems now used this factor is neglected. It can be preserved in two ways, namely, by a binaural system or by a stereophonic system. In the former, two channels only are required while in the latter, theoretically an infinite number is required but practically three give a good illusion.

In the binaural system two microphones are placed in the ears of a dummy who sits in the position where the listener would like to sit if he were listening to the original sound. Two transmission lines meeting the requirements above connect these microphones to two head receivers respectively, one being placed on each ear of the observer. With such a system a complete facsimile of the original sound at the dummy is reproduced to the listener. The Oscar system presented at the World's Fair in Chicago by the Bell System was one meeting the stringent requirements outlined above.

In the stereophonic system an attempt is made to produce this spatial effect by using loudspeakers instead of head receivers in the reproduction. Suppose there were interposed between the source of sound and the audience which would normally listen to it, a sound-transparent curtain. A large number of microphones are mounted all over this curtain. An ideal line connects each microphone to a recording unit of a recording system, or to a loudspeaker if a simple transmission system is used. The loudspeakers are spaced over a similar curtain when the sound is reproduced. If the microphones and loudspeakers are close together a curtain of sound will be reproduced similar in all respects to the original sound. Again three such channels for most stages will give a sufficiently close approximation that, due to the limitations of hearing most observers cannot detect the reproduced from the original when all the other requirements discussed above are met. Indeed two channels go a long way toward this ideal. However, if the sounds were not confined essentially to the level of the stage but were permitted to go up and down as far as they went right and left, then nine channels instead of three would be required. Or if we wished the sounds to appear to come from all directions around the listeners, then channels sufficient to cover a sphere surrounding them would be necessary.

The question then arises, how much loss in quality of the reproduced sound is experienced as we depart from such an ideal? To answer this question we must know the kind of material that is used in the transmission. Without such an ideal transmission system, there is always placed some limitation on the type of material used. In general, this material may be classified as either music, speech or noise.

Sivian, Dunn, and White^{5,6} reported measurements on sound levels created by various types of musical instruments and also by various kinds of speech. If we compare the loudness of a narrow band of thermal noise with that of a pure tone having the same intensity, the two will be judged to have equal loudness if the width of the transmitted frequency band of noise is limited to a critical value⁷ called the critical bandwidth. For this reason the data reported by Sivian, Dunn, and White have been reduced to intensity levels which would have been obtained if the frequency bandwidths used in the filters had been equal to the critical bandwidths. Such levels which remain steady for 1/4 second or more are directly comparable with levels of pure tones, and consequently their position in the chart of Fig. 3 determined. However, when an orchestra is playing or a person is speaking, the inten-

sity levels received by a listener are varying rapidly. Our studies on hearing have indicated that the ear integrates such varying sounds over about 1/4-second intervals. For example, the integrated sound energy in a critical band over a 1/4-second interval will sound as loud as a pure tone in the same frequency band which produces the same sound energy in each 1/4-second interval. The data on music and speech were taken in 1/8-second intervals, the former being only peak values, while the latter were both peak and root-mean-square values. For speech the maximum root-mean-square values for 1/4-second and for 1/8-second intervals were found to be approximately the same and about 7 decibels below the 5 per cent peak values and about 10 decibels below the maximum peak values, being less for the low- and greater for the high-frequency ranges.

For these reasons the data in the Sivian, Dunn, and White papers were reduced as follows. The maximum root-mean-square values for speech in 1/8-second intervals were corrected to a 20-foot distance and for critical bandwidths. The 5 per cent peak values for music were likewise corrected and then reduced by 7 decibels, with the hope that the final values would be at least approximately equal to maximum root-mean-square values that would obtain in 1/4-second intervals in critical bands. There is some uncertainty in this procedure but probably not greater than that due to the sampling of the music. The values thus obtained are shown in Table I.

In the first row in this table the mid-frequency of the critical band is given. In the second row the frequency limits of the bandpass filter used in taking the original data are given. In the next twenty rows opposite the name of each sound source are given maximum root-mean-square levels for 1/4-second intervals which exist in a critical band having the mid-frequency given at the top of the table. Since the data were obtained by averaging, the critical band may be located anywhere in the filter band indicated in the second row. It is important to remember this when drawing conclusions from the data.

For example, consider the bass drum when it is played as a solo instrument. In a band 60 cycles wide in the frequency region between 1000 to 1400 cycles it produces maximum root-mean-square levels at 20 feet distant from it of 65 decibels. Similarly, the clarinet produces maximum root-mean-square levels, at the same distance and in a critical band of width 400 cycles in the frequency region between 5600 and 8000, which reach 36 decibels.

In the last column the maximum root-mean-square levels of the unfiltered sound are given. The transmission system must produce such levels at a distance of 20 feet if it is to recreate the sound.

It will be noticed that the sound sources are arranged in the descending order of total intensity produced. The loud organ produces the greatest intensity, ten times as great as a trumpet. About 100 loud voices

⁵ L. J. Sivian, H. K. Dunn, and S. D. White, "Absolute amplitudes and spectra of certain musical instruments and orchestras," *Jour. Acous. Soc. Amer.*, vol. 2, pp. 330-371; January, 1931.

⁶ H. K. Dunn and S. D. White, "Statistical measurements on conversational speech," *Jour. Acous. Soc. Amer.*, vol. 11, pp. 278-288; January, 1940.

⁷ Harvey Fletcher, "Auditory patterns," *Rev. Mod. Phys.*, vol. 12, pp. 47-65; January, 1940, figure 16.

TABLE I
MAXIMUM ROOT-MEAN-SQUARE LEVELS IN CRITICAL BANDS AND IN 1/4-SECOND INTERVALS AT A DISTANCE OF 20 FEET FROM THE SOUND SOURCE

Mid-Frequency of Critical Band	45	95	190	375	600	850	1200	1700	2400	3400	4800	6800	10,000	All Bands
Frequency Limits of Filter	20 to 62.5	62.5 to 125	125 to 250	250 to 500	500 to 700	700 to 1000	1000 to 1400	1400 to 2000	2000 to 2800	2800 to 4000	4000 to 5600	5600 to 8000	8000 to ∞	
Organ Loud	107	93	90	—	—	—	—	—	—	—	—	67	65	104
Bass Drum	99	97	92	87	77	72	65	64	64	57	51	38	(30)	103
Cymbals	54	57	64	73	68	59	61	66	72	71	79	78	80	105
Snare Drum	61	65	79	85	71	74	67	68	71	67	68	67	64	98
Large Orchestra	72	75	80	82	75	73	73	72	76	66	62	65	67	97
Trombone	51	(39)	62	64	67	64	62	64	63	55	60	64	(29)	94
Organ—Average	81	67	78	82	70	64	68	60	58	47	43	48	59	91
Tuba	72	73	76	76	65	60	51	39	(27)	(23)	(20)	(27)	(12)	87
Trumpet	—	—	56	65	68	65	64	61	55	45	41	50	(19)	84
Bass Saxophone	63	65	67	76	60	64	43	49	50	43	37	33	(16)	84
Piano	56	(40)	67	73	64	63	55	52	47	34	(21)	(12)	(15)	82
Bass Viol	77	79	73	59	46	48	37	39	35	(26)	(26)	(23)	(18)	82
French Horn	—	(31)	61	67	58	48	39	46	34	(22)	(15)	(11)	(10)	77
Clarinet	—	(32)	55	57	46	54	44	55	46	45	44	(26)	(18)	77
Speech—Declamatory	—	70	65	62	56	52	51	48	47	48	32	36	(30)	75
Piccolo	—	—	—	(21)	37	53	55	62	62	42	37	39	(29)	74
Triangle	—	(31)	(21)	(11)	(18)	36	(14)	44	52	44	50	61	52	73
Flute	—	—	—	—	56	59	52	43	36	(28)	(25)	(28)	—	69
Speech—Men	—	—	—	—	—	—	—	—	—	—	—	—	—	—
Conversational	—	46	46	49	44	40	38	34	31	32	(22)	(23)	(12)	60
Speech—Women	—	—	—	—	—	—	—	—	—	—	—	—	—	—
Conversational	—	—	47	46	42	38	35	35	(27)	(25)	(25)	(26)	(19)	58
Minimum Audible Level in Rooms with Noise	70	45-50	35-45	25-35	20-35	18-32	15-30	15-30	15-30	15-30	18-30	22-30	33	
Standard Audible Limit	55	39	24	11	3	0	0	-2	-7	-8	-5	4	9	

are required to equal the intensity produced by a single trombone. The figure indicating the intensity level in the particular frequency band having the highest intensity level in a critical band is in *italics*. In Table II these frequency regions of maximum intensity are collected together. It is interesting to note that for speech, for an orchestra, for an organ, and for a piano the maximum intensity lies within the first octave above middle C. Also it will be noticed that no instrument has its maximum intensity above 1000 cycles except the piccolo. The sounds from the cymbals and the triangle can hardly be called musical, but their maxima lie between 8000 and 15,000 cycles.

TABLE II

Frequency Region of Maximum Power	Instrument
20 to 62.5	Loud Organ—Bass Drum
62.5 to 125	Bass Viol—Declamatory Speech (Male)
125 to 250	Snare Drum—Tuba
250 to 500	Orchestra—Organ—Saxophone—Piano—French Horn—Clarinet and Speech
500 to 700	Trombone and Trumpet
700 to 1000	Flute
1000 to 1400	—
1400 to 2000	—
2000 to 2800	Piccolo
2800 to 4000	—
4000 to 5600	—
5600 to 8000	—
8000 to 15000	Cymbals—Triangle

The threshold levels in listening rooms with typical noise are given at the bottom of Table I. The two figures cover the range of room noise conditions. They were taken from Fig. 3. To assist the eye in seeing the audible range for each instrument all the intensity levels in the table falling in this range or lower are bracketed. The components represented by these bracketed numbers would not be audible to an average ear even if they were sounding alone. For comparison, the threshold values for pure tones which have been adopted as standard are given in the last row. These correspond to values obtained in a very quiet room by young persons of acute hearing who have been

trained to listen carefully. It was found in the survey mentioned above that only about 1-per cent of a typical group will obtain values as low as these. The masking values and levels above threshold used in this discussion are determined from these standard audible-limit values.

It will be seen that the snare drum, the cymbals, and the triangle have components above 8000 cycles which are distinctly audible, while for the bass drum, bass viol, saxophone, tuba, trombone, trumpet, French horn, clarinet, and piccolo similar components are very near or below the threshold. Although no measurements were reported upon violins, our experience indicates that the elimination of frequencies above 8000 produces a detectable although very small change in the tone quality of the violin. It is interesting to note that components of the triangle below 700 cycles are inaudible in the usual listening rooms.

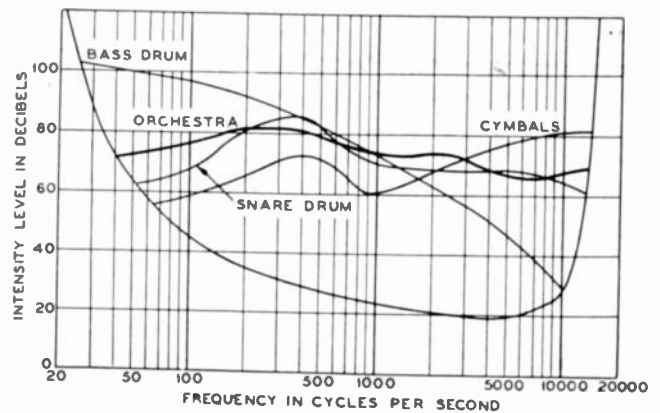

Fig. 4—Intensity levels in critical frequency bands created by orchestral instruments.

The intensity levels taken from Table I are plotted for the bass drum, snare drum, cymbals, and a large orchestra. The resulting curves are shown in Fig. 4. The intersection of these curves with the threshold of

audibility curves gives the frequency limits necessary for complete transmission of all audible components.

It will be seen that when the cymbals and bass drum are played as solo instruments, much higher intensity levels are produced than ordinarily used, at least in the two large orchestras which were tested. The drums and cymbals were at the back in the orchestra setup which may account for a 4- or 5-decibel difference; also, during the solo playing these instruments were purposely played as loud as possible. During the playing of the orchestra a considerably shorter period than 5 per cent of the time is used for such loud

corresponding to the frequency given by the abscissa. For example, for the 75-piece orchestra the ear is stimulated most at frequencies between 2000 and 3000 cycles although the maximum intensities in the air occur in the frequency region of 375 cycles. For the bass drum the maximum stimulation is around 400 cycles, while for the snare drum it is between 2000 and 3000 cycles. The cymbals produce an auditory stimulation which is greater than that produced by any other musical instrument.

An examination of these loudness curves leads one to expect that for most instruments only small effects

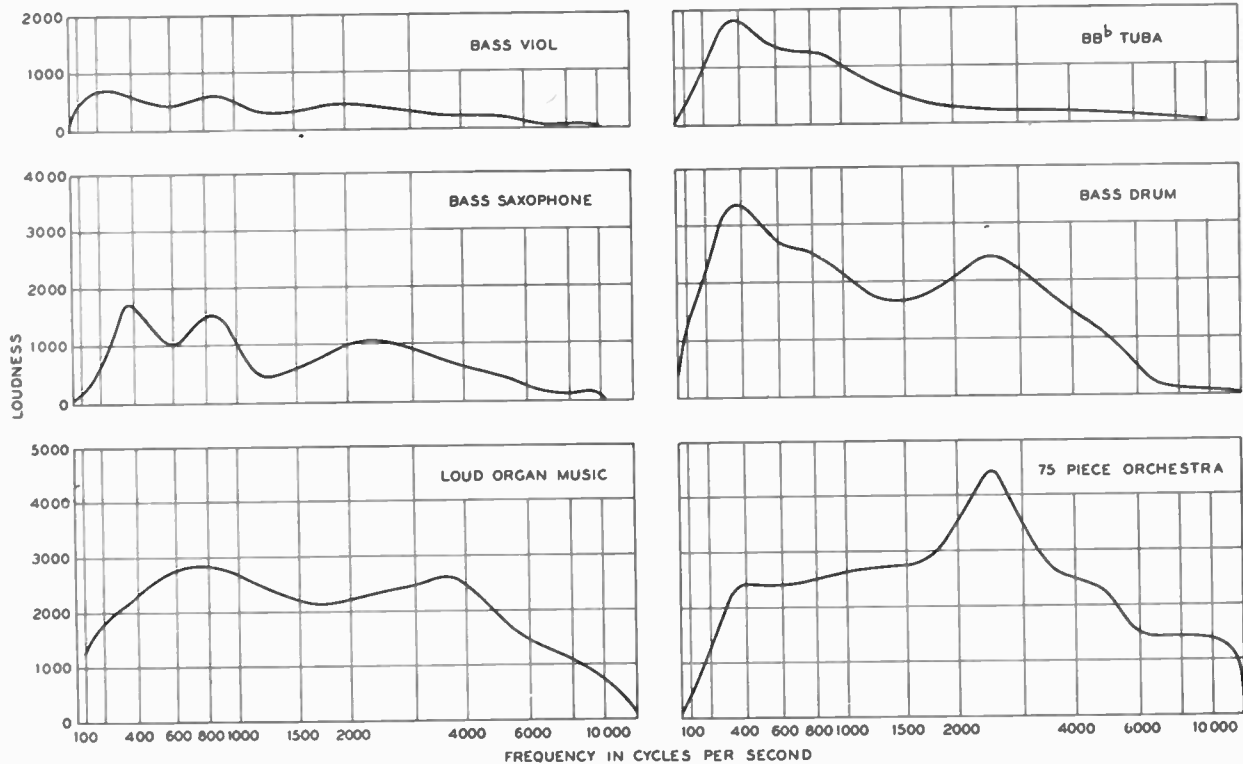

Fig. 5—Loudness per nerve patch versus frequency for musical instruments.

playing. However, one must expect occasionally to have levels as high as indicated for these instruments. Also it will be seen that for the orchestra as a whole the pitch range of audible components is from 40 to 14,000 cycles per second, although for some instruments an 8000-cycle upper limit is adequate.

It has been found experimentally that the masking level of pure tones due to haphazard noise is equal to the intensity level of the noise in a critical band. Consequently it is a fair approximation to assume that the numbers in Table I give also the masking levels in the presence of the various sounds indicated. The loudness produced by each of the instruments playing as solo instruments, the loudness of the orchestra as a whole, and also the loudness of speech was calculated by the methods previously outlined.⁴ The results of these loudness calculations are given in Figs. 5, 6, 7, and 8. The area under each curve is proportional to the loudness. The ordinate is proportional to the stimulation of the auditory nerves at the position in the cochlea

will be noticeable if frequencies above 10,000 cycles or below 100 cycles are eliminated during transmission, the exception being the organ, the cymbals, and the snare drum. For comparison the loudness curves for speech are plotted on the same plot with the orchestra curve. An estimated curve for a chorus of 100 voices is also shown. It is seen that the loudness of this chorus would balance approximately with the 75-piece orchestra. The areas under these curves were measured to determine the total peak loudness. The values thus obtained are tabulated in Table III in the first column.

The audible frequency range of these musical sounds was also determined by direct judgment tests. These results were reported by Snow.⁸ The data from this paper are also included in the table. It will be seen that these values of audible pitch range agree well with what one would expect from the loudness plots. These plots indicate in a general way the degradation to be

⁸ W. B. Snow, "Audible frequency ranges of music, speech and noise," *Jour. Acous. Soc. Amer.*, vol. 3, pp. 155-166; July, 1931.

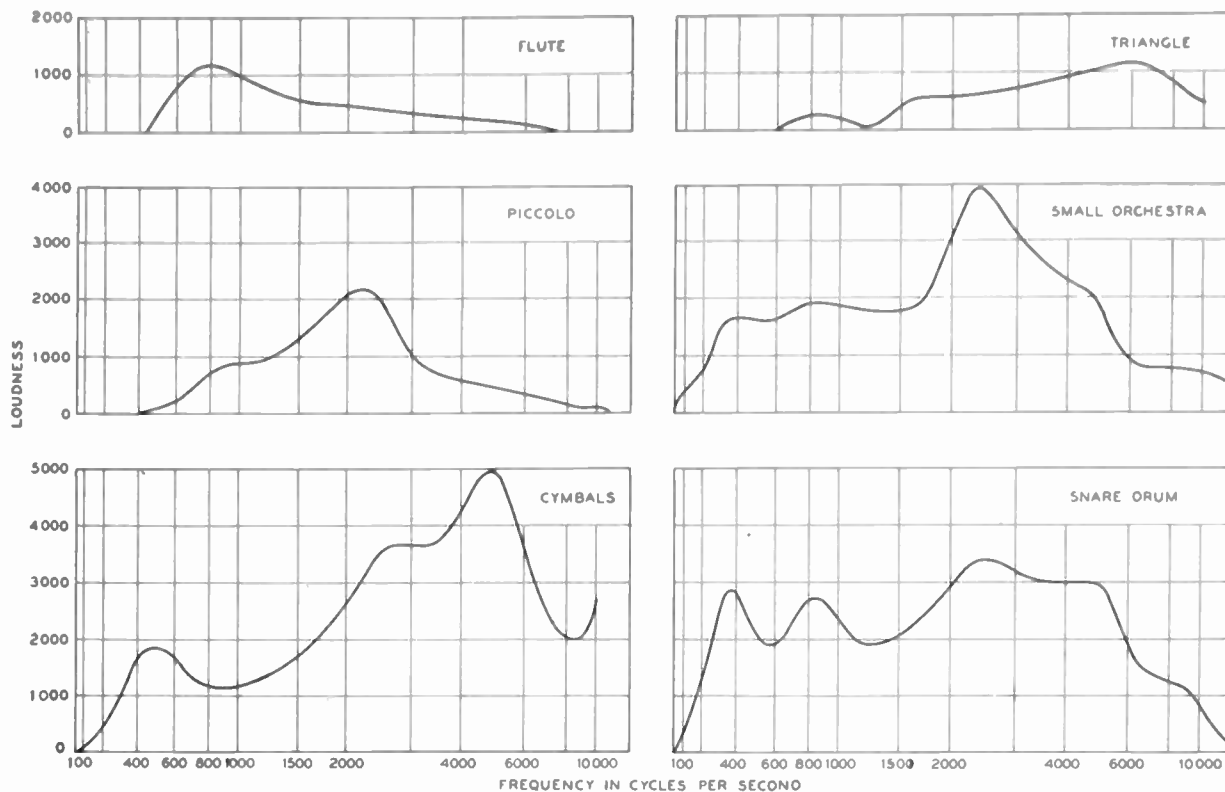

Fig. 6—Loudness per nerve patch versus frequency for musical instruments.

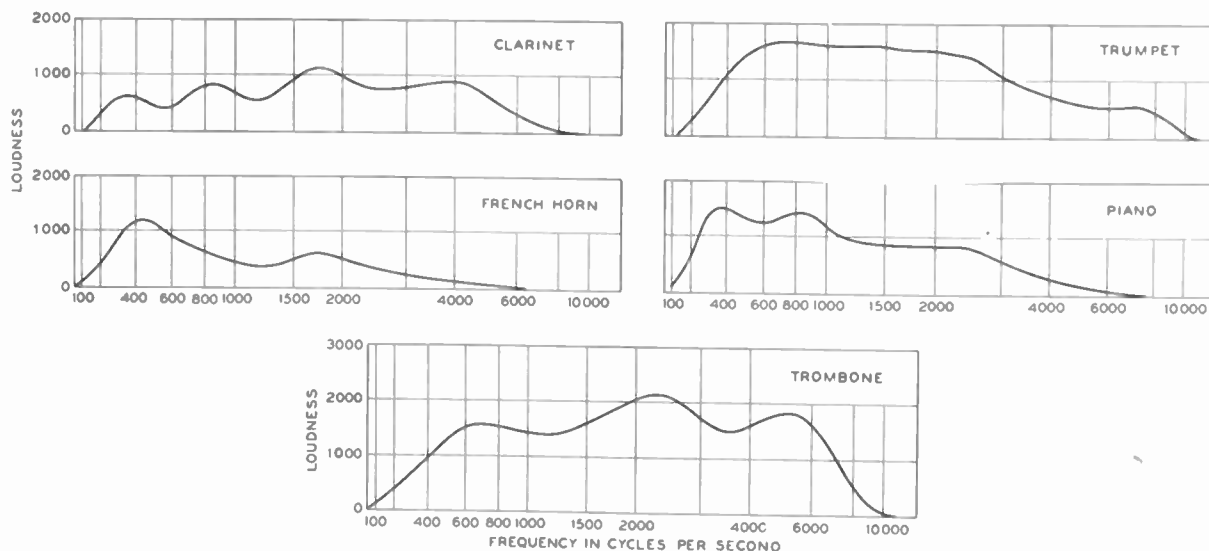

Fig. 7—Loudness per nerve patch versus frequency for musical instruments.

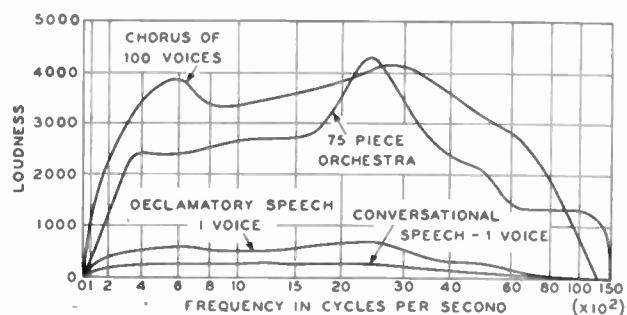

Fig. 8—Loudness per nerve patch versus frequency for a chorus.

expected as one departs from the ideal requirements of frequency range. In Table III these results are arranged according to the total loudness levels produced. It is seen that the cymbals are the loudest and the bass viol is the weakest of the musical instruments. It would take about 100 bass viols to create a peak loudness equal to one pair of cymbals. It is interesting to note that the French horn produces about the same loudness as declamatory speech, which is estimated to be about the same as for a singing voice. For

comparison the maximum peak intensity levels are also shown in this table in column 2.

TABLE III

Musical Instrument	Peak Loudness Level	Peak Intensity Level	Pitch Range of Tone	Pitch Range of Noise
	decibels			
Chorus—100 voices	113	107	—	—
Orchestra—75 pieces	111	107	35-14,000	—
Cymbals	111	112	300-14,000	—
Snare drum	110	108	80-15,000	—
Loud organ	109	113	—	—
18-piece orchestra	108	100	—	—
Bass drum	107	112	50- 5,500	1,500- 5,500
Trombone	105	105	80- 8,000	—
Trumpet	101	93	160- 9,500	—
Organ average	99	102	—	—
Bass saxophone	98	92	55- 9,000	8,500-14,000
Piano	97	91	70- 6,500	—
Piccolo	97	84	520-10,000	10,000-15,000
Clarinet	95	86	140-10,000	10,000-14,000
Tuba	94	96	42- 7,000	4,000- 7,500
Triangle	92	82	—	—
Speech (declamatory)	92	86	—	—
French horn	90	86	87- 6,000	6,000- 8,100
Flute	90	81	250- 9,000	9,000-15,000
Bass viol	89	91	40- 8,000	5,000- 9,500
Speech—conversational				
Men	79	71	100- 8,500	—
Women	76	67	150-10,000	—
Footsteps	—	—	80-14,000	—
Key jingling	—	—	700-15,000	—
Hand clapping	—	—	100-15,000	—
Oboe	—	—	250-15,000	—
Bass clarinet	—	—	80-12,000	15,000

When one tries to put down the maximum and minimum peak pressure levels necessary to transmit completely without distortion the sounds coming from an orchestra one finds the matter rather complicated. It obviously will depend upon the size of the orchestra, how the instruments are played and the selection being rendered. The peak pressure value of 107 decibels given in Table III is the average of four selections rendered by the Roxy Theater orchestra. The measured values from the four selections were +0.8, -1.0, -2.0, and +2.3 compared to 107 decibels. So it is seen that the maximum peak pressure exceeded 109 decibels intensity level. The peak pressure for the bass drum when played loudest was found to be 112 decibels. It is then concluded that for the Roxy 75-piece orchestra the maximum levels at 20 feet away from the orchestra (average distance to instruments) are somewhere between 109 and 112 decibels.

Recently during a recording session a level recorder was used to make a record during a three-hour period while the Philadelphia Orchestra was playing the following selections in the Academy of Music auditorium:

- Pictures in an Exhibition..... Moussorgsky
- Blue Danube..... Strauss
- Night on a Bald Mountain..... Moussorgsky
- Tales from the Vienna Woods.... Strauss
- Brünnhilde's Immolation from
 - Die Götterdämmerung..... Wagner
- Afternoon of a Faun..... Debussy
- Fire Bird..... Stravinsky
- Toccat and Fugue in D Minor.. Bach
- Moonlight..... Debussy
- Tristan and Isolde..... Wagner

The level recorder was capable of following changes in levels at the rate of 200 decibels per second. The high-

est recorded level was near the end of the selection "Fire Bird." At the top of Fig. 9 is shown a photograph of the track made by the level recorder at this time. The differences in decibels shown on the scale are accurate but the absolute values are arbitrary. It is seen that for the maximum level a value of 84 decibels was recorded. Its position is indicated by the arrow. The peak lasts less than 1/10 second. The strip of record shown in the middle shows the levels at the end of this loud passage. Although the level stays very high it never again reaches within 5 decibels of this highest

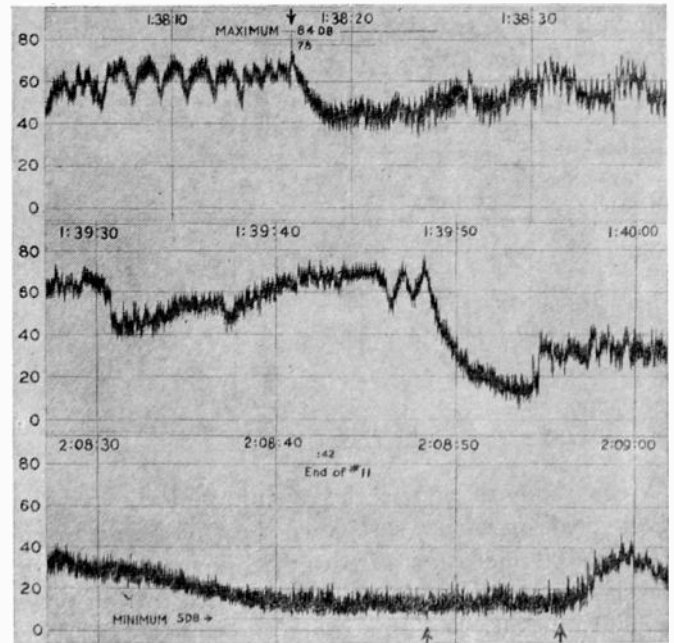

Fig. 9—Readings of level indicator.

peak. This was also true for all of the other selections played. The lowest level was reached at the conclusion of the selection "Moonlight," the record of which is shown at the bottom of Fig. 9. The minimum level is at 5 decibels on this arbitrary scale. The maximum range of levels as recorded by this instrument is seen to be 79 decibels. However, except for the single crash in "Fire Bird" the level range never exceeded 74 decibels but it frequently approached this value. It is probable that this maximum level was due to very loud playing of the bass drum. Unfortunately the level recorder was not calibrated for absolute levels. If, however, we identify the high peak level with the figure of 112 decibels given above, then the range is from 33 to 112 decibels, which fits in as a reasonable range. (See Fig. 3.)

Now if peak values of intensity were recorded the range would be even greater. Comparison of such levels with those obtained on a level recorder indicates that the peaks may reach 5- or 10-decibel higher levels than those recorded. On the other hand, a standard sound-level meter or volume indicator such as is ordinarily used in monitoring circuits may indicate a level range 5 or 10 decibels lower than that indicated by the level recorder. It is seen then that when speaking of level

changes taking place in radio programs it is important to know the type of instrument which is used to obtain the data. The volume indicator is most frequently used. Such measured values are referred to as volume levels.

For a pure tone the level-recorder value or the volume-level value differs from the peak value by only 3 decibels. For other sounds the differences between these three measurements depend upon the character of the sound and may be as much as 20 decibels. Then in terms of volume levels, the maximum range for these orchestral selections is about 70 decibels and for all of the material except the one crash in the "Fire Bird" it is nearer 65 decibels.

TABLE IV
MUSIC—JUDGED QUALITY

Judged Quality	High-Pass Filter Cutoff	Low-Pass Filter Cutoff
100	40	15,000
97	70	12,000
93	80	9,000
90	90	7,800
85	100	6,500
80	120	5,600
70	140	4,800
60	180	4,000
50	220	3,600
40	270	3,000
30	325	2,500
20	500	1,700
10	850	850

Measurements⁹ on speech power have indicated that when speaking with a soft voice the "th" sound carries about 1/100 microwatt of power, while for declamatory speech the "a" sound in "all" may reach a peak power of 5000 microwatts. This range is 56 decibels. When dealing with only one speaker this rarely exceeds 40 decibels. If a system had a range of 56 decibels from overload point to noise level, speech of all kinds could be faithfully transmitted. Here again the reader is cautioned because the long root-mean-square average for speech is usually about 20 decibels below the peak value. For this reason readings on a volume indicator when a single person is talking may not indicate a volume range of more than 20 or 25 decibels. The values given in Table I are averages of voices from six men and five women reading from stories containing a large proportion of conversation.

Noises are so varied in character that it is difficult to make any generalizations. Their intensities and frequencies cover the entire audible range. Footsteps, key jingling, sword clashing, hand clapping, etc., involve audible frequencies from 80 to 15,000 cycles per second.

The question now arises, if some of the audible frequencies are suppressed, what will happen to the quality of the reproduced music or speech? In the paper by Snow,⁸ some judgment tests were reported for music which enable us to deduce some conclusions concerning this. With a group of observers, two conditions were asked to be judged. One was reproducing the orchestra with a system transmitting approximately

uniformly everything between 40 and 15,000 cycles per second. In the second condition, filters were introduced to cut off the various portions of the frequency range. The observers were asked to judge what per cent reduction in the quality was produced by the elimination of part of the pitch range. The values in Table IV were taken from the curve of Fig. 6 of Snow's paper and show the results of these judgment tests. For example, cutting off all frequencies above 6500 cycles degrades the quality the same as cutting off all frequencies below 100 cycles, in both cases reducing it from 100 to 85 per cent. It will be noticed that the results are arranged so that the effect upon judged quality is the same for the high-pass filter indicated in column 2 and the low-pass filter indicated in column 3. For these samples of music and for this group of observers eliminating frequencies above 5600 cycles reduces the quality the same as eliminating frequencies below 120 cycles, both producing a 20 per cent reduction in judged quality.

These data are taken from a curve based on judgment tests of eight engineers listening to an 18-piece orchestra playing the selections "The Beautiful Blue Danube" and "In the Village." If a different orchestra and different kind of music were used there is no doubt that a somewhat different curve would be found. Before one could consider such a curve as typical, more testing of various kinds of music would be necessary. It would be desirable to find such typical curves for the different kinds of orchestras used in broadcasting. It should be emphasized that the experimental points upon which these curves are based are very scattered above 8000 cycles, indicating a wide difference of opinion among the judges, but below this frequency there is a very definite decrease in quality as the upper limiting frequency is lowered. Also, the observed points indicate that there is considerable uncertainty below 60 cycles. There is no doubt that these figures would be different if we were considering music from a dance orchestra, from a large or small chorus, or from individual vocal or instrumental artists.

What will happen to the quality of the music if we reduce the intensity level range from the ideal indicated in Fig. 4? If we desire to listen to music at the same level as produced in a concert hall, then the upper limit may be lowered 10 decibels to an intensity level of 110 decibels. If the lower limit is raised above that in Fig. 3, then parts of the very soft passages may be lost and the listener becomes conscious of noise from the transmission system. I do not know of any judgment tests to evaluate the deterioration of musical quality due to decreasing the upper limit or increasing the lower limit. A curve showing such a relation for various kinds of music would be useful for engineering transmission and recording systems.

Considerable work has been done on the deterioration of speech due to departing from the ideal of Fig. 3. The measurements on conversational speech given in

⁹ Harvey Fletcher, "Speech and Hearing," D. Van Nostrand Company, New York, N. Y., 1929, p. 75.

Table I show that there are no audible components below 125 or above 4800 cycles. This is for a distance of 20 feet between speaker and listener. If this distance is reduced to $2\frac{1}{2}$ feet all the values in Table I must be increased 18 decibels. The audible frequency range is then from 62 to 8000 for men and from 125 to above 8000 for women. For declamatory speech or conversational speech reproduced at a high level, components above 8000 will be distinctly audible. As we reduce the limits from the ideal, what happens to the quality of the reproduced speech? Most of the work done on this problem has been in connection with the development of telephone systems. For this purpose the important characteristic to maintain is the in-

TABLE V
SPEECH—ARTICULATION

Articulation	High-Pass Filter Cutoff	Low-Pass Filter Cutoff
per cent		
98	40	15,000
98	100	12,000
98	250	7,000
96	570	5,000
94	720	3,900
90	960	3,100
80	1,500	2,300
70	1,920	1,970
60	2,300	1,700
50	2,600	1,500

telligibility of the speech. Several different criteria¹⁰ have been set up for measuring this intelligibility but the one most widely used is called the articulation. Lists of meaningless syllables made up from the fundamental sounds of speech are constructed. A speaker pronounces them into the system to be tested. The listener writes what he thinks was spoken. The per cent of the written syllables which are interpreted correctly is called the articulation. A large amount of such testing has been done at the Bell Telephone Laboratories and elsewhere. The results for a listener receiving the speech at optimum intensity are shown in Table V. It represents the average results of several crews, each having several speakers and listeners. The articulation is given in the first column, the cutoff of the high-pass filter in the second, and the cutoff of the low-pass filter in the third column.

It is interesting to note that for this optimum intensity the articulation is reduced the same amount by eliminating frequencies above 5000 cycles as by eliminating frequencies below 570 cycles. It is seen that no detectable loss in articulation results until the lower cutoff is raised to 250 cycles, or until the upper one is lowered to 7000 cycles. The articulation drops from 98 to 96 as the upper cutoff is lowered from 7000 to 5000 or the lower cutoff raised from 250 to 570. It is surprising to note that cutting off at 3100 at the upper limit produces the same loss in articulation as cutting off at 960 at the lower limit. If we cut the frequency range into two parts at 1950, each half will transmit speech with an articulation of about 70 per cent.

¹⁰ Harvey Fletcher and J. C. Steinberg, "Articulation testing methods," *Bell Sys. Tech. Jour.*, vol. 8, pp. 806-854; October, 1929.

If the criterion of the quality of the reproduced speech is taken as the artistic qualities of the voice, we know from our experience with such filtered systems and also from loudness plots of Fig. 8 that the lower-frequency regions turn out to be much more important than indicated by the articulation results shown in Table V.

If loudness were the criterion of judged quality of reproduced speech, the effect of limiting the band has been measured. The loss in loudness due to frequency-band limitation depends upon the level at which the speech is reproduced. In Table VI the values are given for two loudness levels. The upper half of the table

TABLE VI
SPEECH—LOUDNESS

Loudness	High-Pass Filter Cutoff	Low-Pass Filter Cutoff
per cent		
215,000 = 100	40	15,000
98	100	5,000
90	200	3,500
80	300	2,100
70	450	1,500
60	600	1,100
50	800	800
4,000 = 100	40	15,000
98	200	4,000
90	500	2,500
80	770	2,000
70	950	1,700
60	1,125	1,450
50	1,250	1,250

gives values for an initial loudness of 215,000 loudness units corresponding to a loudness level of 110 decibels, and the lower half of the table gives values for an initial loudness of 4000 loudness units corresponding to a loudness level of 59 decibels. When it is realized that under the most favorable circumstances the ear can detect loudness differences only when they are greater than 3 or 4 per cent then it is seen that the elimination of frequencies above 5000 or below 100 would not be detected as any loudness difference. It would be useful if we had a relation such as that exhibited in Tables IV and V obtained from judgment tests of the artistic qualities of the speaking voice. From all these data then it is seen that the frequency range can be considerably more restricted for transmitting speech than for transmitting music, before serious impairment results.

It was seen that the range from the peak value of the loudest phonetic sound to the faintest was 56 decibels but for usual conversation this is reduced to about 40 decibels. One would not expect any degradation in transmitted speech until the intensity level range is decreased below 40 decibels. Measurements on the articulation of conversational speech for smaller ranges have been made.⁹ These were given in terms of the level of the speech above threshold and masking of the noise. The noise used produced a uniform masking between 250 and 10,000 cycles, dropping off at either side of these limits. First let us consider conversational speech of men and assume the listener wishes to hear it at levels he would obtain if he were $2\frac{1}{2}$ feet from

⁹ Loc cit., p. 298.

the speaker instead of 20 feet. The values in Table I would then be raised 18 decibels. From these values then we must deduce the level of the speech above the standard threshold if we are to apply the data referred to above.

Experiments in our laboratories have shown that the threshold level, for observers with acute hearing of conversational speech which is undistorted, is at a long root-mean-square level of 5 decibels. Now the long root-mean-square level for speech was found by Dunn and White to be 10 decibels below the maximum root-

TABLE VII

CONVERSATION SPEECH—SPEAKER 2 1/2 FEET FROM LISTENER
 Level of speech above threshold = 63 db
 Long root-mean-square intensity level = 68 db
 Peak level in 1/8-second intervals exceeded 5 per cent of the time = 85 db
 Root-mean-square level in 1/8-second intervals exceeded only 1 per cent of the time = 78 db

Articulation	Masking	Noise Level	Range
per cent			
97	0	10	68
95	10	36	42
88	20	46	32
77	30	57	21
55	40	67	11
28	50	77	-1

mean-square level in 1/4-second intervals. Consequently at 2½ feet from the speaker the men's conversational speech will be 63 decibels above threshold. The articulation values given in Table VII are taken from Fig. 148 of "Speech and Hearing."⁹ The noise levels corresponding to the various values of masking were obtained directly from the curve in Fig. 3 of the paper, "Relation between Loudness and Masking."⁴ In computing the range the highest level was considered to be the maximum root-mean-square value in 1/4 second, namely, 78 decibels. If we used long root-mean-square values of both speech and noise these ranges would all be reduced 10 decibels. These range values will of course depend upon the spectrum of the noise but the values given here are enough to show that when the range of a system for single-frequency tones is 40 decibels from 100 to 7000 cycles very little or no distortion is produced when speech is transmitted. However, if we wish the noise from the system to be inaudible, the levels must be below the curve of Fig. 3. This means a range of 48 decibels, that is, from 78 to 30 decibels in the frequency region where the maximum speech levels occur.

The third way in which the quality of the transmission can be improved if there are no economic deterrents is by using more than one channel for the transmission. We have found that the quality of reproduced music is very much improved by using two or three channels. As stated above, such transmission makes it possible to produce apparent motion of the sound and provides much greater possibilities in dramatic productions.

Some preliminary tests to determine in a quantitative way the increased quality due to using just two channels instead of one have been made in our laboratories. In one of these a dramatic skit used very simple

program material and was designed to tie together smoothly a number of sounds rich in high frequencies. It opened with a man's voice dictating a letter to a woman on right. Then the man walked from right to left and back and engaged in a short conversation. The typewriter started and the man walked to the center and made a phone call. After another conversation between the man at center and the woman at right, the man walked to the left jingling keys and opened a steel cabinet at left, etc.

For the single-channel condition the plot was the same but the props were shifted in position and the action was adjusted to the restricted space. For each judgment the observers listened first to the single channel full frequency-range version, and then with the smallest possible interval to the filtered two-channel version.

In the two-channel system filters were introduced and a number of observers indicated which system they preferred. In Table VIII are shown the results. When the cutoff for the low-pass filter was somewhere between 5500 and 7000 then one half the group preferred the two-channel system with filters and the other half preferred the single-channel which transmitted all frequencies from 40 to 15,000 cycles. Also it

TABLE VIII
ONE-CHANNEL VERSUS TWO-CHANNEL TRANSMISSION

Low-Pass Cutoff	Speech and Noise Per Cent Preference	
	One Channel Full Range	Two Channels Limited Range
15,000	3	97
11,000	10	90
8,000	27	73
7,000	39	61
5,500	71	29
3,800	85	15
High-Pass Cutoff		
125	3	97
250	19	81
500	47	53

is seen that according to these tests the two-channel system filtering all frequencies below 500 was considered as good as the wide-band single channel. Similar tests were made in a very preliminary way on a 45-piece orchestra during a broadcast and the single channel was found to be equivalent to a two-channel with a low-pass cutoff of about 5000 cycles. These tests are very preliminary and are only indicative of what more accurate tests might show. No direct judgment tests of a quantitative nature have been made between a two- and a three-channel system but comparison between them indicates that three channels are definitely better. This is particularly true when the sound is reproduced from a stage into a large hall.

Although head receivers are seldom used as receivers to listen to music, it may be interesting to describe some tests made in our laboratories to test the judged quality of music transmitted by a binaural system versus that transmitted by a diotic system. In these tests the listener had a pair of high-quality headphones clamped on his ears. He could listen under

condition *A* (binaural) where two high-quality circuits and microphones were used to transmit music to him; condition *B* (diotic) where one channel and one microphone were used to transmit to his pair of headphones. In the diotic system the full range of frequencies from 40 to 15,000 cycles was transmitted. In the binaural system low-pass filters were introduced to eliminate a part of the upper range. Twenty-five engineers took part in the preference tests. The Philadelphia Orchestra, playing various selections, was used as the music for the test. The results are shown in Table IX. The percentage of persons preferring the binaural system with limited range is shown under the title "Binaural." These results show that a binaural system which trans-

TABLE IX

Low-Pass Cutoff	Preference	
	Binaural per cent	Diotic per cent
8,500	68	32
5,500	58	42
4,510	70	30
3,750	50	50
2,850	42	58

mits a frequency band greater than 3750 cycles was preferred to a diotic band transmitting the entire range. In other words, if a band 8000 cycles wide or greater is available for a transmission channel, this indicates that better results may be achieved by using two channels binaurally than one diotically. It is rather remarkable that one half of the observers preferred a binaural system having all frequencies above 3750 cycles eliminated rather than a single-channel

diotic system transmitting all frequencies between 40 and 15,000 cycles.

Before definite conclusions can be drawn as to the improvement of one versus two versus three channels for various purposes, much more data must be collected. It may not be economically feasible to use more than one channel in broadcasting but it should be kept in mind when considering what improvements are possible in the quality of the reproduced sounds.

In conclusion then, it is seen that for an ideal system, one which is determined by the capabilities of hearing, the maximum and minimum intensity levels and frequencies will be determined by Fig. 3 and two or three channels should be used in the transmission. With such a system there will be no limitation upon the type of material used in the broadcast. For economic reasons we may back away from these ideal requirements. Although the best quality cannot be obtained with a frequency range lower than 14,000 to 15,000 cycles, economic necessity may require a compromise to a somewhat lower frequency limit. The ideal volume range for producing a facsimile of such music is 65 decibels. How much this volume range can be reduced below this value without producing serious impairment has not been determined in a quantitative way. There is no doubt that considerable improvement in quality will also result by going to two or more channels instead of one, but whether such improvement is worth the additional cost must be decided for each kind of service in which the transmission system is used.

The Effect of Fluctuation Voltages on the Linear Detector*

JOHN R. RAGAZZINI†, ASSOCIATE, I.R.E.

Summary—A mathematical analysis of the effect which fluctuation voltages have on the operation of a linear detector is presented. Expressions for the audio-frequency noise spectra and the root-mean-square values of the audio noise outputs under various conditions of operation are derived. The demodulation and modulation-compression effects which fluctuation voltages introduce in the useful signal output are evaluated. The harmonic distortion of the useful signal output caused by the presence of fluctuation voltages is given. Finally, an expression for the audio signal-to-noise ratio which results when fluctuation voltages are applied simultaneously with a modulated carrier is derived. Experimental equipment and methods used for checking many of these results are described and experimental results are presented.

INTRODUCTION

AN ANALYSIS of a sensitive radio receiver requires some consideration of the effects of fluctuation voltages which are produced in various circuit elements. Generally, only the contributions of

the first stage of the circuit need be considered. As a result of many investigations, the magnitudes of these fluctuation voltages can be predicted to a fair degree of accuracy. So far as can be determined, however, there has been no direct approach to the problem of how these fluctuation voltages affect the operation of a linear detector, with one exception.¹ Questions arise as to the relations between the magnitude of the audio noise output from the detector and the magnitude of the radio-frequency fluctuation voltages impressed on the detector. The effect of simultaneously applying a signal voltage, with or without modulation, must be considered. The effects of fluctuation voltages on the modulation both as to magnitude and quality are of importance. In addition, the spectrum of the resultant audio noise is of interest. The object of this paper will

* Decimal classification: R134. Original manuscript received by the Institute, September 2, 1941.

† Formerly, College of the City of New York; now, Columbia University, New York, N. Y.

¹ F. C. Williams, "Response of rectifiers to fluctuation voltages," *Jour. I.E.E.* (London), vol. 77, pp. 218-226; February, 1937.

be to clarify as much as possible the mathematical relations that exist describing the behavior of the linear detector upon application of fluctuation voltages and to present such experimental data that may verify the conclusions reached.

MATHEMATICAL ANALYSIS

The representation of fluctuation voltages by a mathematical expression must take into account the fact that at the source they produce a continuous frequency spectrum and that the phase angles of the individual sinusoidal components are completely random. The first condition may be satisfied by representing the fluctuation voltages as sinusoidal terms separated in frequency only by infinitesimal amounts. The second condition cannot be fully represented but

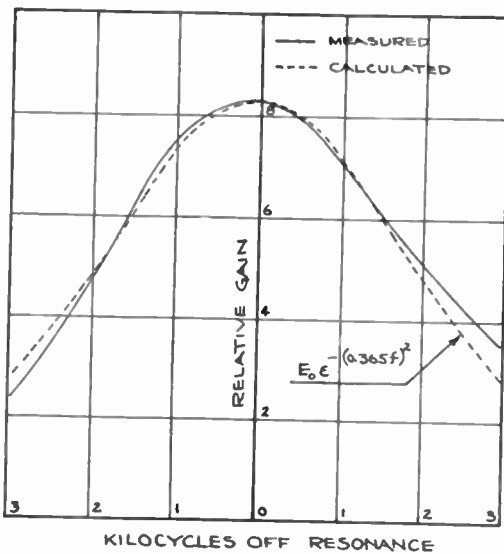

Fig. 1—Gain curve of selective amplifier. Measured curve for amplifier of Fig. 13 shown for comparison.

is only indicated in the equations by a general phase angle.² As a final condition, the sinusoidal terms must all be equal regardless of frequency, resulting in

$$e = E \sin [\omega_0 t + \phi] + E \sin [(\omega_0 + \Delta\omega)t + \phi] + E \sin [(\omega_0 + 2\Delta\omega)t + \phi] \cdots + E \sin [(\omega_0 - \Delta\omega)t + \phi] + E \sin [(\omega_0 - 2\Delta\omega)t + \phi] \cdots \quad (1)$$

where E = the magnitude of one of the harmonic components

$\Delta\omega$ = the radian frequency difference between components

ϕ = a completely random phase angle.

It must be remembered that (1) gives the expression for the fluctuation voltages at their ultimate source where the magnitudes are equal. If these fluctuation voltages are passed through the selective circuits of a

² This angle is not only random at a given instant but continually shifts. The instantaneous value of the angle ϕ given in equation (1) is not the same between the various terms.

tuned amplifier, each of the harmonic components of (1) will be amplified in accordance with the gain curve of the amplifier. Thus, when the fluctuation voltages reach the linear detector which normally follows the selective circuits of a radio receiver, the relative magnitudes of the sinusoidal components will be altered to

$$e = E_0 \sin [\omega_0 t + \phi] + E_1 \sin [(\omega_0 + \Delta\omega)t + \phi] + E_2 \sin [(\omega_0 + 2\Delta\omega)t + \phi] \cdots + E_{-1} \sin [(\omega_0 - \Delta\omega)t + \phi] + E_{-2} \sin [(\omega_0 - 2\Delta\omega)t + \phi] \cdots \quad (2)$$

where the magnitudes E_1, E_2, E_3 , etc., follow the gain curve of the selective amplifier. In order to obtain quantitative results, however, the equation of this gain curve must be known. Some consideration will show that the exponential function

$$e = E_0 e^{\exp-(a\omega)^2} \quad \text{or} \quad E_0 e^{\exp-(at)^2} \quad (3)$$

closely approximates the frequency response of most tuned systems, providing the parameter a is given the proper value. A plot of this function for a value of a of 0.365 is shown in Fig. 1 along with the actual gain curve of experimental equipment used in this work. The radian frequency ω can be expressed either in radians or kiloradians per second, or, if preferred, in cycles or kilocycles per second off resonance. The combination of equations (2) and (3) describes fully the fluctuation voltages which reach the linear detector. The function of the latter is to demodulate the resultant of these various terms.

In the practical case, then, the linear detector receives a combination of the fluctuation voltages just described and a modulated, centrally tuned carrier signal. Thus, the complete expression for the voltages applied to the detector in the general case will be

$$e = E_c \sin \omega_0 t + \frac{mE_c}{2} \cos (\omega_0 - \omega_s)t - \frac{mE_c}{2} \cos (\omega_0 + \omega_s)t + \sum_{x=-\infty}^{x+\infty} E_x \sin [(\omega_0 + x\Delta\omega)t + \phi] \quad (4)$$

where

$$E_x = E_0 e^{\exp-(ax\Delta\omega)^2} \quad (5)$$

and where ω_s = audio-signal radian frequency
 E_c = magnitude of the carrier voltage
 m = modulation.

In words, the linear detector is supplied with a combination of a modulated carrier bounded on either side by a band of fluctuation voltages whose magnitudes are described by (5).

If the linear detector is perfect, it will reproduce at its output the envelope of the applied voltages. As a mathematical problem, then, the expression for this envelope must be determined and analyzed. Only the audio-frequency components will be considered since

it is assumed that the radio-frequency components at the output of the detector are filtered out. At first the problem of analyzing (4) seems a formidable one since it involves an infinite number of terms. However, the fact that the phase angles of the individual fluctuation voltage terms are random permits combination of many terms of like frequency which would otherwise have to be considered separately. The envelope of the resultant voltage produced by (4) is found by the method given by Terman³ resulting in the following expression:

$$e_{\text{envelope}} = \left\{ \begin{aligned} & E_c^2 + E_0^2 + E_1^2 + E_{-1}^2 + E_2^2 + E_{-2}^2 + \dots \\ & + 2mE_c^2 \sin \omega_c t + m^2 E_c^2 \sin^2 \omega_c t + \\ \text{Group A: } & \left[+ mE_c E_1 \cos [(\omega_c - \Delta\omega)t + \phi] + mE_c E_{-1} \cos [(\omega_c - \Delta\omega)t + \phi] + \dots \right] \\ \text{Group B: } & \left[+ mE_c E_1 \cos [(\omega_c + \Delta\omega)t + \phi] + mE_c E_{-1} \cos [(\omega_c + \Delta\omega)t + \phi] + \dots \right] \\ \text{Group C: } & \left[+ 2E_c E_1 \cos [\Delta\omega t + \phi] + 2E_c E_{-1} \cos [\Delta\omega t + \phi] + \dots \right] \\ \text{Group D: } & \left. \begin{aligned} & + 2E_1 E_2 \cos [\Delta\omega t + \phi] + 2E_{-1} E_{-2} \cos [\Delta\omega t + \phi] + \dots \\ & + 2E_2 E_3 \cos [\Delta\omega t + \phi] + 2E_{-2} E_{-3} \cos [\Delta\omega t + \phi] + \dots \end{aligned} \right\}^{1/2} \end{aligned} \right. \quad (6)$$

As given in (6), it is very difficult to derive any clear interpretation of the result so that it is necessary to expand (6) by the binomial theorem. (See Appendix I.) Suitable combinations of terms of like frequency can be made by the use of a theorem commonly employed in light theory which states that the most probable resultant of a group of sinusoidal terms of like frequency but randomly phased is the square root of the sum of the squares of the individual terms.⁴ The root-mean-square value of the resultant is merely 0.707 times this quantity. By using this fact, each of the groups of (6)

Group A:

$$\frac{m\sqrt{2} E_c E_0 \epsilon \exp - [a(\omega_c - \omega_{\text{aud}})]^2}{2\sqrt{E_c^2 + 2\bar{e}_N^2}} \cos (\omega_{\text{aud}} t + \phi) \quad (7)$$

Group B:

$$\frac{m\sqrt{2} E_c E_0 \epsilon \exp - [a(\omega_c + \omega_{\text{aud}})]^2}{2\sqrt{E_c^2 + 2\bar{e}_N^2}} \cos (\omega_{\text{aud}} t + \phi) \quad (8)$$

Group C:

$$\frac{\sqrt{2} E_c E_0 \epsilon \exp - (a\omega_{\text{aud}})^2}{\sqrt{E_c^2 + 2\bar{e}_N^2}} \cos (\omega_{\text{aud}} t + \phi) \quad (9)$$

Group D:

$$\frac{\bar{e}_N 2^{1/4} E_0 \epsilon \exp - (a\omega_{\text{aud}}/\sqrt{2})^2}{\sqrt{E_c^2 + 2\bar{e}_N^2}} \cos (\omega_{\text{aud}} t + \phi) \quad (10)$$

where \bar{e}_N = the root-mean-square value of the fluctuation voltages applied to the detector
 ω_{aud} = the radian audio frequency under consideration.

Since the terms of (7), (8), (9), and (10) are randomly phased terms of like frequency, they may be combined in the manner previously described yielding

$$\bar{e}_{\omega_{\text{aud}}} = \left[\frac{A^2 + B^2 + C^2 + R^2}{2} \right]^{1/2} \quad (11)$$

$$\bar{e}_{\omega_{\text{aud}}} = E_0 \left[\frac{\frac{m^2}{4} \epsilon \exp - [\sqrt{2a}(\omega_c - \omega_{\text{aud}})]^2 + \frac{m^2}{4} \epsilon \exp - [\sqrt{2a}(\omega_c + \omega_{\text{aud}})]^2}{1 + \frac{\bar{e}_N^2}{E_c^2}} + \frac{\bar{e}_N^2}{E_c^2} \frac{1}{2\sqrt{2}} \epsilon \exp - [a\omega_{\text{aud}}]^2 \right]^{1/2} \quad (12)$$

yields the following audio noise terms chosen at an audio frequency ω_{aud} :

where $\bar{e}_{\omega_{\text{aud}}}$ = root-mean-square value of the audio noise component at a radian frequency ω_{aud}
 \bar{E}_c = root-mean-square value of the carrier voltage.

Equation (12) is the complete expression for the audiofrequency noise spectrum which results when a

³ F. E. Terman, "Linear detection of heterodyne signals," *Electronics*, vol. 1, pp. 386-387; November, 1930.
⁴ See, for instance, F. A. Jenkins and H. E. White, "Fundamental of Physical Optics," McGraw-Hill Book Company, New York, N. Y. 1937, p. 35.

modulated signal and a group of fluctuation voltages are simultaneously applied to a linear detector. To study this expression further, three cases will be considered. First the case where the carrier voltage is zero, in other words, where the fluctuation voltages alone are applied to the detector. Equation (12) then reduces to

$$\bar{e}_{\omega_{\text{aud}}} = \frac{E_0}{2^{8/4}} \epsilon \exp - (a\omega_{\text{aud}}/\sqrt{2})^2. \quad (13)$$

This expression is to be contrasted to the equation for the tuning curve, (3). Equations (3) and (13) as well as a spectrum curve obtained experimentally are shown in Fig. 2. It is noted that the spectrum curve of the audio noise output from the detector is considerably broader than the tuning curve.

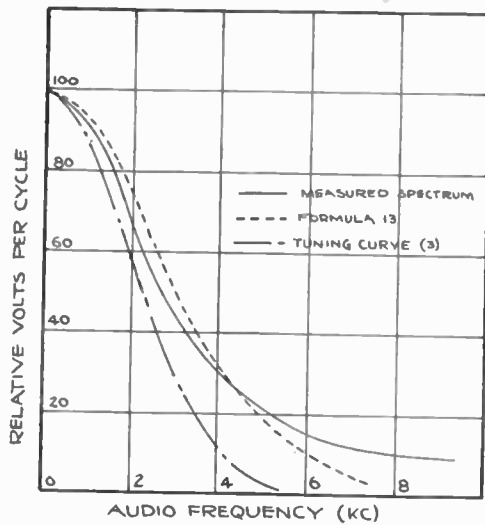

Fig. 2—Measured and calculated audio noise spectrum for pure fluctuation voltages applied to linear detector. Gain curve of selective amplifier plotted for comparison.

The next case to be considered is the one where, in addition to the fluctuation voltages, an unmodulated carrier is added. Making the modulation m equal to 0 in (12), there results:

output as a strong carrier is superimposed on the fluctuation voltages.

Finally, the general case in which all the components of (12) are considered is plotted in Fig. 4. The audio components contributed by each factor, the sidebands, carrier, and beating between the fluctuation voltage components are shown as well as the total spectrum resulting from a combination of these effects.

While these spectra are of interest, the total root-mean-square value of the audio noise is of greater importance, since it is this factor which determines the audible strength of the disturbance. The problem is to sum up the audio noise terms whose root-mean-square values are given by (12) over the entire audible range. This summation is carried out by integration

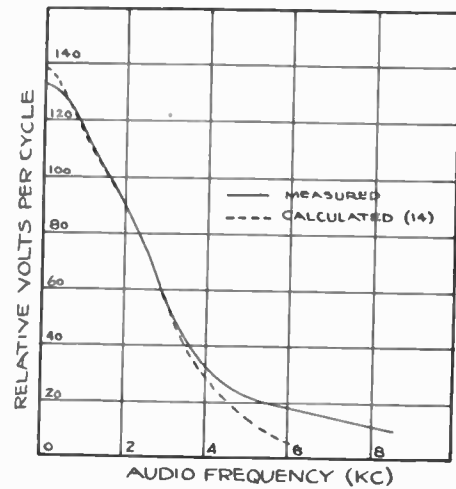

Fig. 3—Measured and calculated audio noise spectrum for fluctuation voltages of 1.0 volt root-mean-square and an unmodulated signal of 1.11 volts root-mean-square applied to linear detector. (Scales same as those of Fig. 2.)

of the squares of the terms of (12) as indicated in Appendix II. Thus, the root-mean-square value of the audio noise which results in the linear-detector output for the general case is given by

$$\bar{e}_{\omega_{\text{aud}}} = E_0 \left[\frac{\epsilon \exp - (\sqrt{2}a \omega_{\text{aud}})^2 + \frac{\bar{e}_N^2}{\bar{E}_c^2} \frac{1}{2\sqrt{2}} \epsilon \exp - (a\omega_{\text{aud}})^2}{1 + \frac{\bar{e}_N^2}{\bar{E}_c^2}} \right]^{1/2}. \quad (14)$$

This expression, as well as an experimental curve, is plotted in Fig. 3. It is noted that as the carrier signal strength E_c is increased, the audio spectrum of the detector output narrows down considerably until, for very large signals, the audio spectrum takes the same shape as the tuning curve. In a radio receiver, this effect can be heard rather easily. As an unmodulated carrier is tuned in, it is noted that a deepening of the audio "hiss" results. This is due to the reduction of higher audio-frequency components in the audio noise

$$\bar{e}_{\text{aud}} = \bar{e}_N \left[\frac{1 + \frac{m^2}{2} + \frac{1}{2} \frac{\bar{e}_N^2}{\bar{E}_c^2}}{1 + \frac{\bar{e}_N^2}{\bar{E}_c^2}} \right]^{1/2}. \quad (15)$$

It is noted that the presence of modulation, as well as the carrier and fluctuation voltages, contributes to the total noise. Again, the same three cases considered previously will be analyzed. When pure fluctuation voltages only are applied to the linear detector, that is

both m and \bar{E}_c are 0, the audio noise will be

$$\epsilon_{\text{aud}} = \frac{\epsilon_N}{\sqrt{2}} = 0.707\epsilon_N. \quad (16)$$

The value given in (16) is not complete since there are additional terms in the expansion of (6) which should

$$\epsilon_{\text{aud}} = \epsilon_N \left[\frac{1 + \frac{1}{2} \frac{\epsilon_N^2}{\bar{E}_c^2}}{1 + \frac{\epsilon_N^2}{\bar{E}_c^2}} \right]^{1/2} \quad (17)$$

This expression along with the experimental curves is

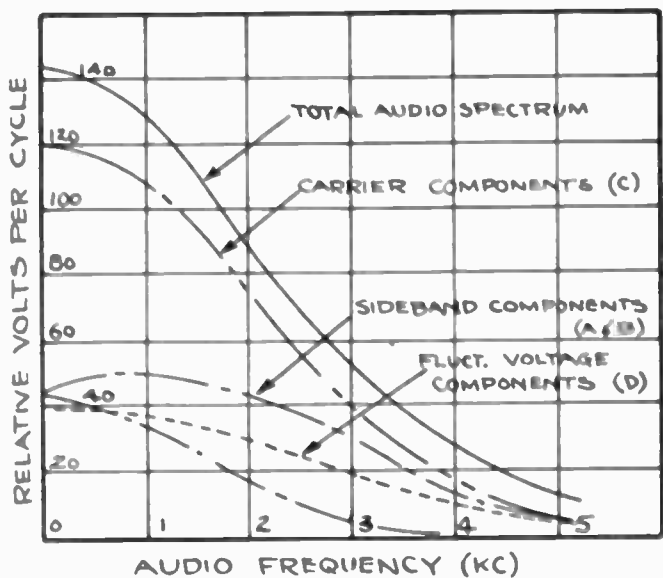

Fig. 4—Audio noise spectrum showing noise components due to various factors. ($\epsilon_N/\bar{E}_c = \frac{1}{2}$, $m = 0.8$, $f_{112} = 1.0$ kilocycle.)

be considered when the carrier strength is low. These correction terms, however, amount to less than 5 per cent of the value indicated by (16) and may be considered negligible in practical cases. Fig. 5 shows a plot of (16) and an experimental curve obtained with

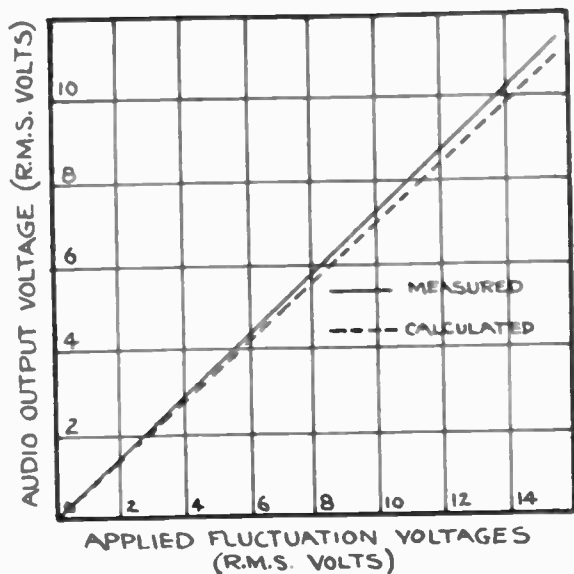

Fig. 5—Audio noise output voltage with pure fluctuation voltages applied to linear detector.

pure fluctuation voltages applied to the linear detector. The experimental curve is slightly high due to the neglect of the correction terms previously discussed in plotting (16).

If an unmodulated carrier is applied as well as the fluctuation voltages, (15) reduces to

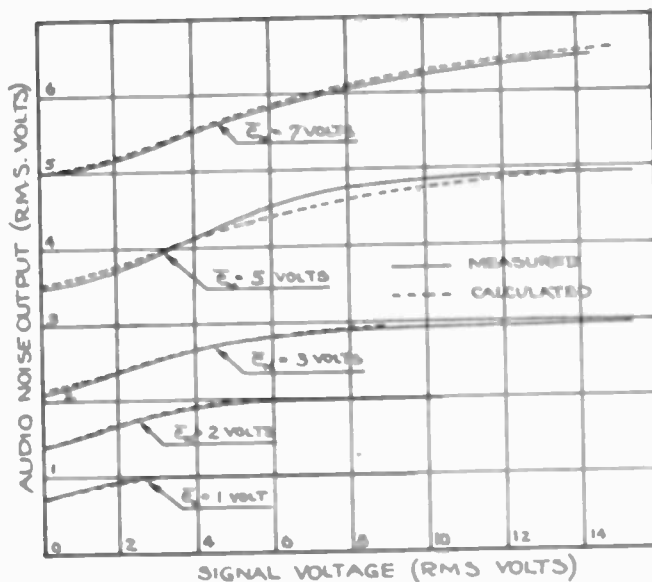

Fig. 6—Audio noise output voltage with fluctuation voltages and unmodulated carrier signal applied to linear detector.

plotted in Fig. 6. These curves show that the application of an unmodulated carrier results in an increase of the audio noise voltage to 1.41 times the value obtained with no signal. This effect is distinctly observed when a carrier is tuned in by a sensitive receiver. The audio noise becomes louder and deeper as indicated

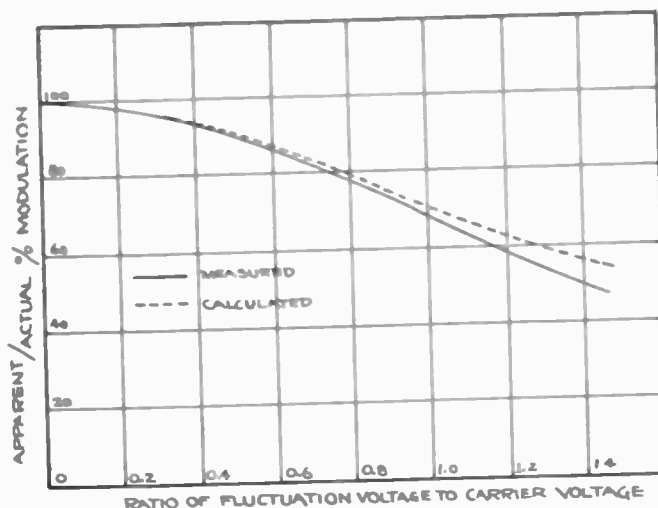

Fig. 7—Ratio of apparent to actual per cent modulation with application of fluctuation voltages and modulated carrier signal to linear detector.

by (17) and (14), respectively. Plots of (15) which take into account all the effects including modulation are similar to those of (17) in Fig. 6 except that it is to be observed that the modulation contributes to the total noise, sometimes as much as 10 to 20 per cent. The use of (15), (16), and (17) will permit the

prediction of the root-mean-square value of the audio noise output from a linear detector if the root-mean-square value of the applied voltages, including fluctuation voltages, carrier, and per cent modulation are specified.

Some consideration will now be given to the effect of fluctuation voltages on the useful audio signal. Re-

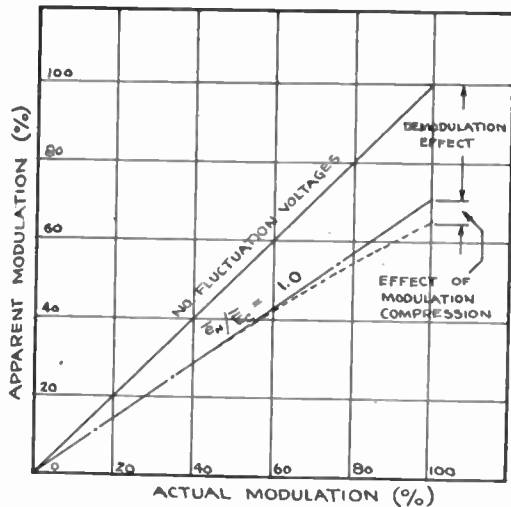

Fig. 8—Curve showing the effect of modulation compression when fluctuation voltages and modulated carrier are applied to a linear detector.

ferring to (6) and carrying out the expansion by the binomial theorem as indicated in Appendix III, the useful audio signal term results as follows:

$$e_s = \frac{mE_c}{\sqrt{1 + \frac{\bar{e}_N^2}{E_c^2}}} \sin \omega_s t + \text{terms of higher order.} \quad (18)$$

The "terms of higher order" will be considered later. If the fluctuation voltages were zero, (18) would become

$$e_s = mE_c \sin \omega_s t. \quad (19)$$

Contrasting (18) and (19), it is observed that an apparent loss of modulation results upon the introduction of fluctuation voltages. This is not to be confused with modulation compression which also occurs and which will be discussed later. In effect, the fluctuation voltages cause a reduction in the strength of the audio signal, but with no distortion. A term "apparent modulation" can be defined by the following expression:

$$m_{app} = \frac{m}{\sqrt{1 + \frac{\bar{e}_N^2}{E_c^2}}} \quad (20)$$

where

$$e_s = m_{app} E_c \sin \omega_s t. \quad (21)$$

Fig. 7 shows a plot of (20) with a curve experimentally obtained.

In obtaining (18), the terms of higher order were omitted since the major signal component is given by the first term of the expansion. Consideration of the

other terms, however, brings out several other effects produced by fluctuation voltages. A more complete expansion of (6) will show the presence of the following significant terms:

$$e_s = \frac{mE_c}{\sqrt{1 + \frac{\bar{e}_N^2}{E_c^2}}} \left[1 - \frac{3}{8} \frac{m^2 \frac{\bar{e}_N^2}{E_c^2}}{\left[1 + \frac{\bar{e}_N^2}{E_c^2} \right]^2} \right] \sin \omega_s t - \frac{m^2 E_c \frac{\bar{e}_N^2}{E_c^2}}{4 \left[1 + \frac{\bar{e}_N^2}{E_c^2} \right]^{3/2}} \cos 2\omega_s t + \frac{m^3 E_c \frac{\bar{e}_N^2}{E_c^2}}{8 \left[1 + \frac{\bar{e}_N^2}{E_c^2} \right]^{5/2}} \sin 3\omega_s t + \dots \quad (22)$$

The first effect noted in (22) is the fact that the fundamental component of the useful audio signal suffers modulation compression as well as a reduction in apparent modulation. These two effects differ from one another in that a reduction in apparent modulation does not result in any distortion but merely in a lower

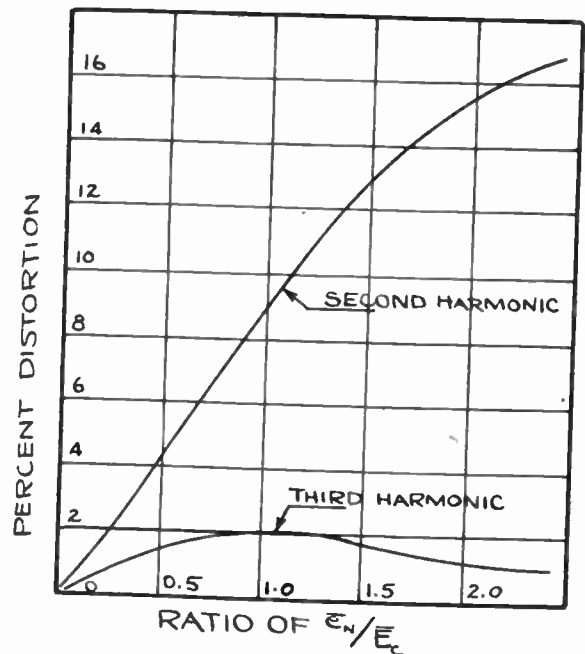

Fig. 9—Second- and third-harmonic distortion effects produced by simultaneous application of fluctuation voltages and modulated carrier signal to linear detector.

audio output than might have been obtained without the presence of fluctuation voltages. The modulation compression, on the other hand, results in amplitude distortion of the audio signal. Fig. 8 shows the effects of the two components. The apparent modulation is reduced from 0.71 to 0.64 by the compression effect at 100 per cent signal modulation. Generally speaking,

however, the latter effect is not large and can be minimized.

Equation (22) also shows the presence of harmonic distortion terms in the output of the linear detector. These terms depend entirely on fluctuation voltages for their presence, for if \bar{e}_n were zero, these terms would disappear. While (22) is not complete, it does include the most important terms which are plotted in Fig. 9. The second-harmonic distortion is the most important, reaching a value of 17 per cent in the presence of extremely severe fluctuation voltages, while the third harmonic reaches a value of only 2 per cent of the fundamental voltage.

Ultimately, when the merit of a receiver is evaluated, the signal-to-noise ratio is of importance. As previously stated, it is possible to calculate the root-mean-square value of the fluctuation voltages \bar{e}_n . Knowing this value and using (19) and (17), the expression for signal-to-noise ratio becomes

$$\frac{\bar{e}_s}{\bar{e}_{aud}} = \frac{m\bar{E}_c}{\bar{e}_N \left[1 + \frac{m^2}{2} + \frac{\bar{e}_N^2}{\bar{E}_c^2} \right]^{1/2}} \quad (23)$$

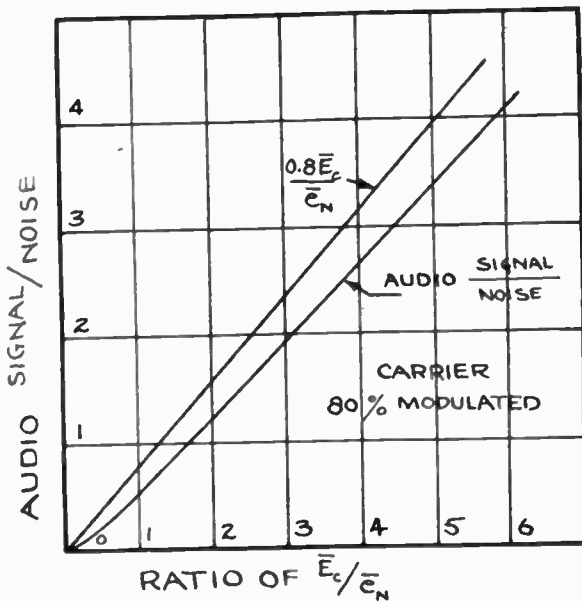

Fig. 10—Audio signal-to-noise ratio output from linear detector on application of fluctuation voltages and modulated carrier signal.

where

\bar{e}_s = root-mean-square value of the useful audio signal

\bar{e}_{aud} = root-mean-square value of the audio noise voltages

\bar{E}_c = root-mean-square value of the carrier voltage

\bar{e}_N = root-mean-square value of the fluctuation voltages applied to the linear detector.

A plot of this expression for a typical case is shown in Fig. 10. On the same set of axes is plotted a curve of the expression $m\bar{E}_c/\bar{e}_n$ which is recognized as the ratio of the theoretical audio signal output from a linear detector to the root-mean-square value of the fluctuation voltages. Experimental curves used to check this

formula are shown in Fig. 11 plotted as a noise-to-signal ratio to make the curves more easily read. The calculated curves are based on (23).

EXPERIMENTAL PROCEDURE

A block diagram showing the arrangement of the experimental equipment used for checking some of

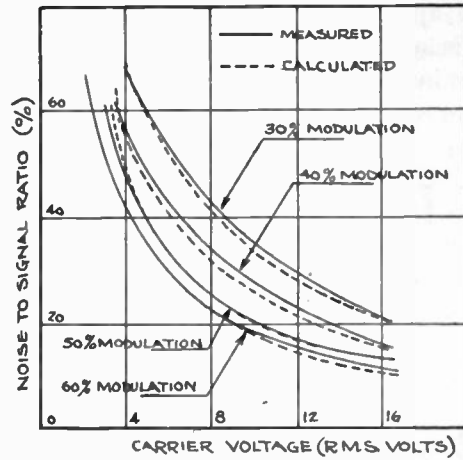

Fig. 11—Measured and calculated noise-to-signal ratio in the output from a linear detector on application of fluctuation voltages and a modulated carrier signal.

the theoretical results is shown in Fig. 12. The high-gain amplifier, vacuum-tube voltmeter, and linear detector were mounted on one chassis and are shown in detail in Fig. 13. As noted in Fig. 13, the output of the selective amplifier is applied to a 6H6 diode detector which in turn is connected to an audio amplifier. The "noise tube" which is used to produce a controlled source of fluctuation voltages is a triode amplifier tube capacitively coupled to the first stage of the selective amplifier. The magnitude of the fluctuation voltages produced by this tube can be controlled in the stand-

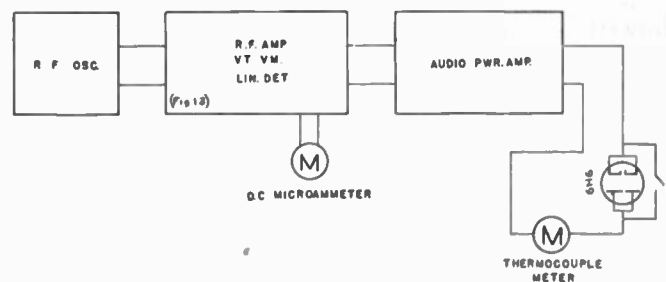

Fig. 12—Block diagram of experimental equipment used to check theoretical results.

ard manner, by changing either its grid resistance or cathode temperature. In all cases, due to the complex nature of the fluctuation voltages and audio noise voltages, measurements of voltage and current must be made with square-law instruments. When measuring the fluctuation voltages before they enter the linear detector, a special square-law vacuum-tube voltmeter⁶ using a 6SJ7 tube incorporated directly in

⁶ J. R. Ragazzini and B. R. Boymel, "A square-law vacuum-tube voltmeter," *Rev. Sci. Instr.*, vol. 11, pp. 312-314; October, 1940.

the equipment was used. The audio-frequency noise voltages from the output of the detector were measured with a thermocouple instrument connected to a standard laboratory power amplifier indicated in Fig. 12, but not shown in detail.

In making measurements, it must be recognized that the diode detector is not the perfect linear detector assumed in the theoretical discussion. At low values of applied voltages, the efficiency of such a detector is much lower than for higher applied voltages. For instance, the detector used in these tests

The spectrum of the audio noise output of the linear detector was measured by means of a General Radio wave analyzer which samples a very narrow frequency band in the audio spectrum and registers the root-mean-square value of the voltages included in that band on a square-law vacuum-tube voltmeter. When fluctuation voltages are contained in this very narrow band, very severe oscillations of the indicating meter take place so that it is necessary to replace the millivoltmeter supplied with this instrument with a more sluggish thermocouple instrument. By scanning the

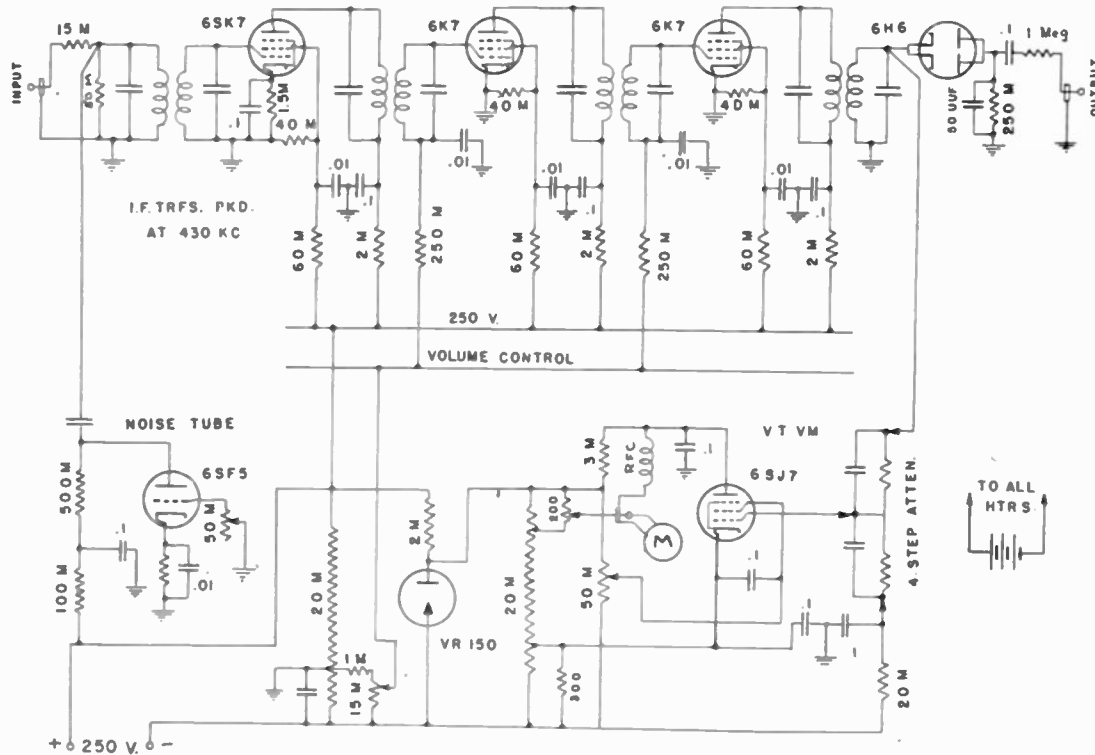

Fig. 13—Diagram of selective amplifier, noise tube, vacuum-tube voltmeter, and diode detector.

showed a variation of efficiency of from 60 to 74 per cent for root-mean-square signals of from 0.5 to 2.0 volts. Yet the efficiency of this same detector changed only from 74 to 79 per cent for input signals of from 2.0 to 14.0 volts. The response of such a detector departs considerably from linearity at these low signal levels. Furthermore, a practical diode detector suffers from negative peak-clipping effects when the modulation dips are large. Since fluctuation voltages are effectively 100 per cent modulated, considerable departure from theoretical action can result. To eliminate these effects as much as possible, a 6H6 diode rectifier was placed in series with the thermocouple instrument measuring noise output. This rectifier was so polarized that it eliminated from the measurement all contributions to the audio noise by negative modulation dips. Obviously, this procedure could not be used in making any measurements involving spectra or signal measurements since the introduction of this rectifier changed the spectral composition of the output. The rectifier was used in obtaining the experimental data given in Figs. 5 and 6.

whole audio-frequency band, relative values of the audio noise volts per cycle are obtainable. The wave analyzer is also used to extract the useful single-frequency audio signal from the accompanying noise. Data for the curves in Figs. 2, 3, and 7 were obtained with the wave analyzer. The results shown in Fig. 7, for instance, were obtained by impressing on the linear detector a combined modulated signal and fluctuation voltage. The output from the detector then consisted of an audio signal and a spectrum of audio noise voltages. The former audio signal voltage was extracted to the exclusion of the noise voltages and measured by the wave analyzer.

The data for the curves shown in Fig. 11 were obtained by means of a Radio Corporation of America distortion and noise meter, Type 69B, which effectively acts by suppressing the useful audio signal and measuring the noise voltages as a percentage of the suppressed signal. This percentage is the noise-to-signal ratio plotted in these curves. Generally speaking, the experimental data confirm a large part of the theoretical derivations.

It was not practicable with the equipment available to measure either the harmonic distortion resulting from the application of fluctuation voltages nor secondary effects such as modulation compression. The harmonic-distortion effects could have been detected only by the wave analyzer. However, since they were small in comparison to the accompanying noise voltages, the analyzer meter oscillated too severely to obtain reliable data. Similarly the effects of modulation compression are too small and well within the experimental errors encountered in making measurements.

It should be pointed out that the experimental results presented here are all corrected to the value which a perfect detector of 100 per cent efficiency would yield. For instance, if the detector output reading was 3 volts at an efficiency of 75 per cent, it is reported in the curves as 4 volts, the output of the detector if it were perfect. The reason for this is that the theoretical results are all based on a perfect detector and if a check is to be obtained, the experimental results must be brought to a comparable basis.

CONCLUSIONS

When a group of fluctuation voltages falling within a limited frequency spectrum governed by a selective amplifier fall upon a linear detector, the root-mean-square audio noise voltage from the detector is closely 0.707 the root-mean-square value of the applied fluctuation voltages. This assumes that the detector is perfect and 100 per cent efficient. If an unmodulated, centrally tuned signal is applied simultaneously with the fluctuation voltages, the audio noise voltage gradually rises from 0.707 to 1.0 times the root-mean-square value of the applied fluctuation voltages, as indicated in Fig. 6. The spectrum, or frequency distribution of the audio noise, is wider than the tuning curve of the selective amplifier as indicated by (13) and Fig. 2, but narrows down to coincide with the tuning

curve when the unmodulated signal is very large.

If a modulated signal is applied simultaneously with the fluctuation voltages, several effects are noted. First, the audio-frequency noise spectrum receives contributions from several sources as shown in Fig. 4. Second, the root-mean-square value of the audio noise rises to a value indicated by (15). The useful audio signal suffers a reduction in strength as indicated by (20) and shown in Fig. 7. In addition, the signal suffers from amplitude distortion, or modulation compression, as shown in Fig. 8 and (22). Harmonic distortion of the useful audio signal is also introduced by fluctuation voltages as shown in (22) and Fig. 9. Finally the expression for the signal-to-noise ratio is given in (23) and Fig. 10. This expression shows that the relative values of the carrier voltage, fluctuation voltages, and per cent modulation affect the signal-to-noise ratio in the output of a linear detector. Again, it must be pointed out that the formulas presented here are based on a perfect linear detector of 100 per cent efficiency and that if the results from a practical detector are to be predicted, the formulas must be multiplied by the detector efficiency to get the true result. This applies to all cases with the exception of the signal-to-noise formula which is independent of detector efficiency.

APPENDIX I

The expansion of (6) is carried out by means of the binomial theorem which states that

$$(a + b)^{1/2} = a^{1/2} + \frac{b}{2a^{1/2}} - \frac{b^2}{8a^{3/2}} + \dots \quad (24)$$

Considering the sum of the squares in (6), $(E_c^2 + E_0^2 + E_1^2 + E_{-1}^2 + \dots)$ as the first term of the binomial a and the remainder of the terms as the second term of the binomial b , the expansion takes the form

$$e_{\text{envelope}} = \sqrt{E_c^2 + E_0^2 + E_1^2 + E_{-1}^2 + \dots} + \frac{mE_c^2}{\sqrt{E_c^2 + E_0^2 + E_1^2 + \dots}} \sin \omega_c t + [\text{terms of higher order}]$$

$$\text{Group A: } \left[\begin{aligned} & + \frac{mE_c E_1}{2\sqrt{E_c^2 + E_0^2 + E_1^2 + \dots}} \cos [(\omega_c - \Delta\omega)t + \phi] + \frac{mE_c E_{-1}}{2\sqrt{E_c^2 + E_0^2 + E_1^2 + \dots}} \cos [(\omega_c - \Delta\omega)t + \phi] + \dots \end{aligned} \right]$$

$$\text{Group B: } \left[\begin{aligned} & + \frac{mE_c E_1}{2\sqrt{E_c^2 + E_0^2 + E_1^2 + \dots}} \cos [(\omega_c + \Delta\omega)t + \phi] + \frac{mE_c E_{-1}}{2\sqrt{E_c^2 + E_0^2 + E_1^2 + \dots}} \cos [(\omega_c + \Delta\omega)t + \phi] + \dots \end{aligned} \right]$$

$$\text{Group C: } \left[\begin{aligned} & + \frac{E_c E_1}{\sqrt{E_c^2 + E_0^2 + E_1^2 + \dots}} \cos [(\Delta\omega)t + \phi] + \frac{E_c E_{-1}}{\sqrt{E_c^2 + E_0^2 + E_1^2 + \dots}} \cos [(\Delta\omega)t + \phi] + \dots \end{aligned} \right]$$

$$\text{Group D: } \left[\begin{aligned} & + \frac{E_0 E_1}{\sqrt{E_c^2 + E_0^2 + E_1^2 + \dots}} \cos [(\Delta\omega)t + \phi] + \frac{E_1 E_2}{\sqrt{E_c^2 + E_0^2 + E_1^2 + \dots}} \cos [(\Delta\omega)t + \phi] + \dots \\ & + \frac{E_{-1} E_{-2}}{\sqrt{E_c^2 + E_0^2 + E_1^2 + \dots}} \cos [(\Delta\omega)t + \phi] + \frac{E_{-2} E_{-3}}{\sqrt{E_c^2 + E_0^2 + E_1^2 + \dots}} \cos [(\Delta\omega)t + \phi] + \dots \end{aligned} \right] \quad (25)$$

The expansion just given in (25) shows only a small fraction of the terms which are to be considered. These terms just given are for a radian audio frequency $\Delta\omega$. In view of the fact that these are terms of the same frequency, but randomly phased, they can be combined into their most probable resultant by taking the square root of the sum of the squares of the individual magnitudes. Before doing so, however, it is noted that the denominators of the terms can be simplified since

$$E_0^2 + E_1^2 + E_2^2 + \dots + E_{-1}^2 + E_{-2}^2 + \dots = 2\bar{e}_N^2 \quad (26)$$

where \bar{e}_N is the root-mean-square value of the fluctuation voltages.

$$\text{Group D: } \sqrt{\frac{E_0^2 E_1^2 + E_1^2 E_2^2 + \dots + E_0^2 E_{-1}^2 + E_{-1}^2 E_{-2}^2 + \dots}{E_c^2 + 2\bar{e}_N^2}} \quad (34)$$

Hence,

$$\frac{1}{\sqrt{E_c^2 + E_0^2 + E_1^2 + E_{-1}^2 + \dots}} = \frac{1}{\sqrt{E_c^2 + 2\bar{e}_N^2}}$$

$$= \frac{1}{E_c \sqrt{1 + \bar{e}_N^2/E_c^2}} \quad (27)$$

since

$$E_c^2 = 2\bar{E}_c^2.$$

The two terms labeled "Group A" have equal magnitudes and random phase angles and upon combination have the following resultant:

$$\text{Group D: } \sqrt{\frac{E_0^2 E_b^2 + E_1^2 E_{b+1}^2 + \dots + E_{-1}^2 E_{b-1}^2 + E_{-2}^2 E_{b-2}^2 + \dots}{E_c^2 + 2\bar{e}_N^2}} \quad (35)$$

$$\text{Group A: } \frac{m\sqrt{2} E_c E_1}{2\sqrt{E_c^2 + 2\bar{e}_N^2}} \cos [(\omega_s - \Delta\omega)t + \phi]. \quad (28)$$

The magnitude E_1 can be expressed by the defining (5), so that

$$E_1 = E_0 \epsilon \exp - (a\Delta\omega)^2. \quad (29)$$

Thus the terms of Group A become

$$\text{Group A: } \frac{m\sqrt{2} E_c E_0 \epsilon \exp - (a\Delta\omega)^2}{2\sqrt{E_c^2 + 2\bar{e}_N^2}} \cos [(\omega_s - \Delta\omega)t + \phi]. \quad (30)$$

In the more general case of an audio frequency $x\Delta\omega$ and using (27),

$$\text{Group A: } \frac{m\sqrt{2} E_c E_0 \epsilon \exp - (ax\Delta\omega)^2}{2\sqrt{E_c^2 + 2\bar{e}_N^2}} \cos [(\omega_s - x\Delta\omega)t + \phi]. \quad (31)$$

Thus, if the term at a radian audio frequency ω_{aud} is desired, the value of x must satisfy the following relation:

$$(\omega_s - x\Delta\omega) = \omega_{\text{aud}}$$

$$x = \frac{\omega_s - \omega_{\text{aud}}}{\Delta\omega} \quad (32)$$

yielding

Group A:

$$\frac{m\sqrt{2} E_c E_0 \epsilon \exp - [a(\omega_s - \omega_{\text{aud}})]^2}{2\sqrt{E_c^2 + 2\bar{e}_N^2}} \cos [\omega_{\text{aud}}t + \phi]. \quad (33)$$

In a similar manner, the terms of Group B and Group C can be reduced to the forms given in (8) and (9). The evaluation of the Group D terms is carried out in a slightly different manner. Summing up the squares of the terms of this group and extracting the square root

The summation indicated in the numerator of (34) can be carried out by integration, since (5) gives a functional definition of the values of the terms. To be more general, however, terms which are separated by a radian frequency $b\Delta\omega$ will be considered. It is noted that the difference between the subscripts of the terms in the numerator will then be the value b . For the case shown in (34), the difference between the subscripts is unity, indicating that they are terms of an audio radian frequency $\Delta\omega$. If this difference is taken as b , the Group D terms will become

In general, then, each term of the numerator indicated in (35) can be expressed as follows:

$$E_0^2 \epsilon \exp - [\sqrt{2a} x\Delta\omega]^2 E_0^2 \epsilon \exp - [\sqrt{2a} (x+b)\Delta x]^2. \quad (36)$$

Replacing $x\Delta\omega$ by ω as a variable, and $b\Delta\omega$ by ω_{aud} , terms of this type must be summed up for all possible values of ω ranging from $\omega = -\omega_0$ to $+\infty$ where ω_0 is the central frequency at which the tuned system is peaked. These limits are indicated in Fig. 14. Assuming for purposes of integration that there are n fluctuation-

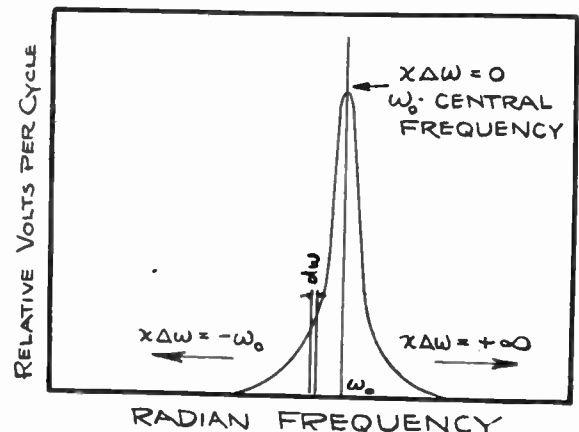

Fig. 14—Diagram showing determination of limits used in integration of (37).

voltage terms per radian, then over a radian frequency range $d\omega$, there will be $n d\omega$ terms, so that the sum of these terms can be written

$$\sum E_x^2 E_{b+z}^2 = \int_{-\omega_0}^{+\infty} E_0^4 \epsilon \exp - [\sqrt{2a}\omega]^2 \epsilon \exp - [\sqrt{2a}(\omega + \omega_{\text{aud}})]^2 n d\omega \quad (37)$$

which, by the regrouping of the exponents, becomes

$$\sum E_x^2 E_{b+z}^2 = \frac{nE_0^4 \epsilon \exp - (a\omega_{\text{aud}})^2}{2a} \int_{-\omega_0}^{+\infty} \epsilon \exp - [2a\omega + a\omega_{\text{aud}}]^2 2a d\omega. \quad (38)$$

The integral is recognized as the error function whose value over infinite limits is $\sqrt{\pi}$. Since ω_0 is so large, it may be considered as infinity for purposes of integration thus yielding

$$\sum E_x^2 E_{b+z}^2 = \frac{nE_0^4 \sqrt{\pi}}{2a} \epsilon \exp - [a\omega_{\text{aud}}]^2. \quad (39)$$

Equation (38) can be simplified further if it is noted that the mean-square value of the fluctuation voltages is given by

$$\bar{e}_N^2 = \sum \frac{1}{2} E_x^2 = \frac{1}{2} \int_{-\infty}^{+\infty} E_0^2 \epsilon \exp - [\sqrt{2a}\omega]^2 n d\omega \quad (40)$$

which is evaluated by a similar procedure to give

$$\bar{e}_N^2 = \frac{nE_0^2 \sqrt{\pi}}{2\sqrt{2} a}. \quad (41)$$

Thus, (38) becomes

$$\sum E_x^2 E_{b+z}^2 = \sqrt{2} \bar{e}_N^2 E_0^2 \epsilon \exp - [a\omega_{\text{aud}}]^2. \quad (42)$$

Replacing the numerator of (35) by its equivalent given in (41), the Group D terms may be rewritten in the following simplified form:

Group D:

$$\frac{\bar{e}_N 2^{1/4} E_0 \epsilon \exp - [(a/\sqrt{2})\omega_{\text{aud}}]^2}{\sqrt{E_c^2 + 2\bar{e}_N^2}} \cos [\omega_{\text{aud}} t + \phi]. \quad (43)$$

APPENDIX II

The determination of the root-mean-square value of all the noise terms over the entire audio-frequency spectrum is accomplished by summing up the squares of the magnitudes of the individual terms and extracting the square root. For a given audio frequency ω_{aud} the terms are given by (7), (8), (9), and (10). Considering, for the moment, a term in Group A, the mean-square value of that term will be

$$\bar{e}_A^2 = \frac{1}{2} \frac{2m^2 E_c^2 E_0^2 \epsilon \exp - [\sqrt{2a}(\omega_s - \omega_{\text{aud}})]^2}{4(E_c^2 + 2\bar{e}_N^2)}. \quad (44)$$

Some thought will indicate that if there were n fluctuation voltage terms per radian of bandwidth (as assumed in Appendix I) there will be produced similarly n audio noise terms per radian of bandwidth in the resultant audio noise spectrum. Thus, for an infinitesimal audio-frequency bandwidth $d\omega_{\text{aud}}$, there will be $n d\omega_{\text{aud}}$ terms to consider. The mean-square value over the entire audio spectrum can then be found by integrating the terms of (43) from zero audio frequency to the limit of audibility. If the bandwidth of the tuned amplifier preceding the detector is well within the audible range, as it usually is, then the limits of integration of the audio-frequency noise terms can be extended from zero to infinity without error. Thus, the contribution to the mean-square audio voltage of the Group A terms will be

$$\sum \bar{e}_A^2 = \frac{m^2 E_c^2 E_0^2}{4\sqrt{2} a (E_c^2 + 2\bar{e}_N^2)} \int_{-\sqrt{2}a\omega_s}^{+\infty} \epsilon \exp - [\sqrt{2a}(\omega_s - \omega_{\text{aud}})] n \sqrt{2} a d\omega_{\text{aud}}. \quad (45)$$

Again, the integral is recognized as the error function which upon integration yields

$$\sum \bar{e}_A^2 = \frac{nm^2 E_c^2 E_0^2 \sqrt{\pi}}{8\sqrt{2} a (E_c^2 + 2\bar{e}_N^2)} \left\{ 1 + \frac{2}{\sqrt{\pi}} \operatorname{erf}(\sqrt{2} a \omega_s) \right\}. \quad (46)$$

But since

$$\bar{e}_N^2 = \frac{nE_0^2 \sqrt{\pi}}{2\sqrt{2} a}$$

and

$$E_c^2 = 2\bar{E}_c^2$$

then

$$\sum \bar{e}_A^2 = \frac{m^2 \bar{e}_N^2}{4(1 + \bar{e}_N^2/\bar{E}_c^2)} \left\{ 1 + \frac{2}{\sqrt{\pi}} \operatorname{erf}(\sqrt{2} a \omega_s) \right\}. \quad (47)$$

Similarly, the contributions of the Group B, C, and D terms will be

$$\sum \bar{e}_B^2 = \frac{m^2 \bar{e}_N^2}{4(1 + \bar{e}_N^2/\bar{E}_c^2)} \left\{ 1 - \frac{2}{\sqrt{\pi}} \operatorname{erf}(\sqrt{2} a \omega_s) \right\} \quad (48)$$

$$\sum \bar{e}_C^2 = \frac{\bar{e}_N^2}{(1 + \bar{e}_N^2/\bar{E}_c^2)} \quad (49)$$

$$\sum \bar{e}_D^2 = \frac{\bar{e}_N^2 (\bar{e}_N^2/\bar{E}_c^2)}{2(1 + \bar{e}_N^2/\bar{E}_c^2)}. \quad (50)$$

Summing up these terms, and extracting the square root, there results

$$\bar{e}_{\text{aud}} = \bar{e}_N \left[\frac{1 + \frac{m^2}{2} + \frac{1}{2} \frac{\bar{e}_N^2}{\bar{E}_c^2}}{1 + \frac{\bar{e}_N^2}{\bar{E}_c^2}} \right]^{1/2} \quad (51)$$

which is recognized as that given in the text as (15).

APPENDIX III

The determination of the effects of fluctuation voltages on the linear detection of a signal involves the consideration of all terms of modulation frequency in the expansion shown in (25). Here most of these terms were combined into a group labeled "terms of higher order." These terms result from the expansion of (6) choosing only certain terms for consideration. They are:

$$e_{\text{envelope}} = \sqrt{E_c^2 + 2\bar{e}_N^2} \left\{ 1 + \frac{2mE_c^2}{\sqrt{E_c^2 + 2\bar{e}_N^2}} \sin \omega_s t + \frac{m^2 E_c^2}{\sqrt{E_c^2 + 2\bar{e}_N^2}} \sin^2 \omega_s t + \text{noise terms} \right\}^{1/2} \quad (52)$$

Expanding (52) in the manner indicated by (24),

$$e_s = \frac{mE_c^2}{\sqrt{E_c^2 + 2\bar{e}_N^2}} \sin \omega_s t + \frac{m^2 E_c^2}{\sqrt{E_c^2 + 2\bar{e}_N^2}} \sin^2 \omega_s t - \frac{4m^2 E_c^4}{8[E_c^2 + 2\bar{e}_N^2]^{3/2}} \sin^2 \omega_s t + \frac{4m^3 E_c^4}{8[E_c^2 + 2\bar{e}_N^2]^{3/2}} \sin^3 \omega_s t$$

$$+ \frac{m^4 E_c^4}{8[E_c^2 + 2\bar{e}_N^2]^{3/2}} \sin^4 \omega_s t + \frac{8m^3 E_c^6}{16[E_c^2 + 2\bar{e}_N^2]^{5/2}} \sin^3 \omega_s t + \dots \quad (53)$$

Combining terms of similar form and expanding the higher-order sine terms into their equivalents such as

$$\begin{aligned} \sin^2 \theta &= \frac{1}{2} - \frac{1}{2} \cos 2\theta \\ \sin^3 \theta &= \frac{3}{4} \sin \theta - \frac{1}{4} \sin 3\theta, \end{aligned} \quad (54)$$

then, (53) reduces to

$$e_s = \frac{mE_c}{\sqrt{1 + \bar{e}_N^2/\bar{E}_c^2}} \left\{ 1 - \frac{3}{8} \frac{m^2 \bar{e}_N^2/\bar{E}_c^2}{(1 + \bar{e}_N^2/\bar{E}_c^2)} \right\} \sin \omega_s t - \frac{m^2 E_c \bar{e}_N^2/\bar{E}_c^2}{4(1 + \bar{e}_N^2/\bar{E}_c^2)^{3/2}} \cos 2\omega_s t + \frac{m^3 E_c \bar{e}_N^2/\bar{E}_c^2}{8(1 + \bar{e}_N^2/\bar{E}_c^2)^{5/2}} \sin 3\omega_s t + \dots \quad (55)$$

which is recognized as the result given in (22).

The Use of Vacuum Tubes as Variable Impedance Elements*

HERBERT J. REICH†, MEMBER, I.R.E.

Summary—The magnitude and phase angle of an impedance may be varied by means of circuits incorporating vacuum tubes. The analyses of several circuits show that they may be considered to be equivalent to a parallel combination of reactance and resistance. In certain circuits the effective resistance may be made infinite, these circuits acting like pure reactance, the magnitude of which may be controlled by means of electrode voltages.

Vacuum-tube circuits containing only resistances and capacitances may act like an inductive reactance shunted by a negative resistance. Some types of "resistance-tuned" oscillators are based upon such circuits and may be readily analyzed from this point of view.

By the use of an inverse-feedback amplifier it is possible to obtain very large effective capacitance or very low negative resistance, the magnitudes of which may be varied by means of the amplifier gain.

CIRCUITS that make use of vacuum tubes to produce a variable reactance have been discussed frequently within the past few years because of their application in automatic tuning and in frequency modulation. The use of vacuum tubes to produce effective reactance, the magnitude of which may be controlled by means of voltage, is only one aspect of the more general field of application of tubes in changing the magnitude or phase angle of an impedance. Included in this field are the production of negative resistance and of effective capacitive reactance without the use of capacitance or of inductive reactance without the use of inductance. Since no

* Decimal classification: R139. Original manuscript received by the Institute, September 11, 1941. Presented, Winter Convention, New York, N. Y., January 13, 1942.

† Department of Electrical Engineering, University of Illinois, Urbana, Illinois.

general discussion of the entire subject appears to have been presented, this paper may be of some value in suggesting new applications of reactance-tube circuits.

PARALLEL TYPE OF CIRCUIT

Fig. 1 shows one type of circuit by means of which a vacuum tube may be used to change the magnitude or phase of an impedance, and by means of which the magnitude or phase angle may be varied by the grid bias of the tube.¹ The equivalent plate circuit is shown in Fig. 2. The signs indicate the relative polarities of the instantaneous impressed voltage e and the fictitious voltage μe_g . The total current that flows through the source of impressed voltage e is

$$i = i' + i_p = \frac{e}{r_1 + 1/j\omega C_1} + \frac{e + \mu e_g}{r_p} \quad (1)$$

From Fig. 1 it can be seen that

$$e_g = e \frac{r_1}{r_1 + 1/j\omega C_1} \quad (2)$$

Therefore

$$i = e \left[\frac{1}{r_1 + 1/j\omega C_1} + \frac{1}{r_p} + \frac{\mu r_1}{r_p(r_1 + 1/j\omega C_1)} \right] \quad (3)$$

¹ Charles Travis, "Automatic frequency control, PROC. I.R.E., vol. 23, pp. 1125-1141; October, 1935.

The equivalent admittance of the circuit between points *A* and *B* is

$$y_e = \frac{i}{e} = \frac{r_p + r_1(1 + \mu) + j/\omega C_1}{r_p(r_1 - j/\omega C_1)}$$

$$= \frac{r_1^2 \omega^2 C_1^2 (1 + \mu) + r_p r_1 \omega^2 C_1^2 + 1}{r_p(r_1^2 \omega^2 C_1^2 + 1)} + j \frac{(r_1 \mu + r_p) \omega C_1}{r_p(r_1^2 \omega^2 C_1^2 + 1)} \quad (4)$$

The circuit therefore acts like a parallel combination of capacitive reactance x_e and resistance r_e of values

$$x_e = - \frac{r_p(r_1^2 \omega^2 C_1^2 + 1)}{\omega C_1(\mu r_1 + r_p)} \quad (5)$$

$$r_e = \frac{r_p(r_1^2 \omega^2 C_1^2 + 1)}{r_1^2 \omega^2 C_1^2 (1 + \mu) + r_p r_1 \omega^2 C_1^2 + 1} \quad (6)$$

The equivalent capacitance between *A* and *B* is

$$C_e = \frac{C_1}{\omega^2 r_1^2 C_1^2 + 1} (g_m r_1 + 1) \quad (7)$$

Ordinarily $g_m r_1$ is much greater than unity, and so the second term in the parentheses may be neglected. C_e then has its maximum value when $r_1 = 1/\omega C_1$.

$$\text{Maximum } C_e \cong g_m / 2\omega \quad (8)$$

The corresponding value of effective shunting resistance is

$$r_e \text{ at max } C_e \cong 2/g_m \quad (9)$$

The principal application of this circuit is in automatic tuning and in frequency modulation. Since g_m can be varied by means of the bias of one or more grids of the vacuum tube, the control or modulating voltage can be used to vary the effective capacitance of an oscillator tank circuit and therefore the frequency of oscillation. This analysis indicates that the largest

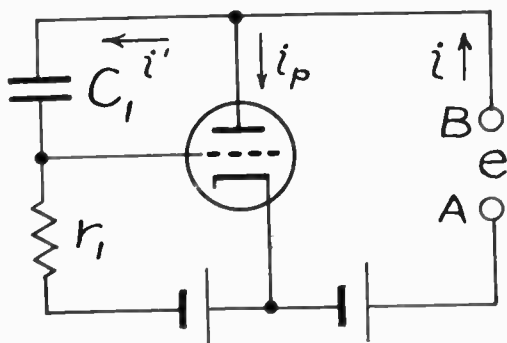

Fig. 1—Parallel type of impedance-conversion circuit.

value of effective capacitance is obtained when the reactance of C_1 equals the resistance r_1 . Equation (8) indicates that large effective capacitance necessitates the use of tubes with high transconductance. Equation (9) shows, however, that the effective shunting resistance varies inversely with transconductance. It follows that the use of a high-transconductance tube in order

to obtain high effective capacitance results in low effective shunting resistance, which may be undesirable when the capacitance is used in the tank circuit of an oscillator. Because the effective capacitance obtainable at 100 cycles does not exceed 10 microfarads and

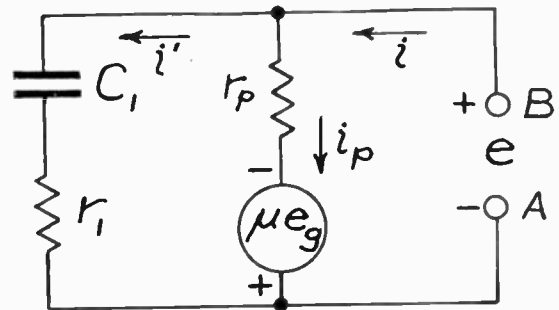

Fig. 2—Equivalent circuit for the circuit of Fig. 1.

is inversely proportional to frequency, and because the ratio of the effective shunting resistance to the effective capacitance is low when the effective capacitance is large,² this circuit is of little value as a means of producing high effective capacitance.

Equations similar to (5) and (6) may be readily derived when C_1 in Fig. 1 is replaced by an inductance L_1 . Between points *A* and *B* the circuit then acts as an effective inductive reactance in parallel with an effective resistance having the following values:

$$x_e = \frac{r_p(r_1^2 + \omega^2 L_1^2)}{\omega L_1(r_p + \mu r_1)} \quad (10)$$

$$r_e = \frac{r_p(r_1^2 + \omega^2 L_1^2)}{r_1 r_p + r_1^2(1 + \mu) + \omega^2 L_1^2} \quad (11)$$

When C_1 and r_1 are interchanged in Fig. 1 the effective reactance and resistance are

$$x_e = \frac{r_p(r_1^2 \omega^2 C_1^2 + 1)}{\omega C_1(\mu r_1 - r_p)} \quad (12)$$

$$r_e = \frac{r_p(1 + r_1^2 \omega^2 C_1^2)}{\mu + 1 + r_1 \omega^2 C_1^2 (r_p + r_1)} \quad (13)$$

Examination of (12) shows that x_e may be either capacitive or inductive, depending upon whether μr_1 is less than or greater than r_p .

If the resistance r_1 and condenser C_1 are interchanged in the circuit of Fig. 1 and C_1 is replaced by an inductance L_1 , the effective reactance and resistance are

$$x_e = \frac{r_p(r_1^2 + \omega^2 L_1^2)}{\omega L_1(r_p - \mu r_1)} \quad (14)$$

$$r_e = \frac{(r_1^2 + \omega^2 L_1^2) r_p}{(r_1 + r_p) r_1 + (\mu + 1) \omega^2 L_1^2} \quad (15)$$

x_e is inductive or capacitive, depending upon whether μr_1 is less than or greater than r_p .

² At 100 cycles, r_e is approximately 159 ohms when C_e is 10 microfarads.

Fig. 3 shows a modification of the circuit of Fig. 1 that has certain advantages.³ The constants of the two coupled coils are assumed to be such that the voltage (measured relative to the cathode) induced in the grid coil is opposite in phase to the voltage impressed across the plate coil and has a magnitude k times as great as

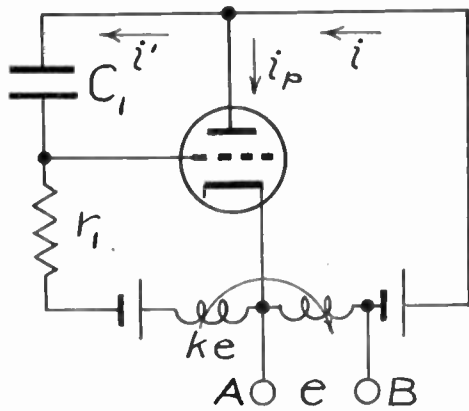

Fig. 3—Variant of the parallel type of impedance-conversion circuit that may act as a pure reactance.

the impressed voltage. The equivalent circuit is that of Fig. 4. The current flowing through the source of applied voltage e is

$$i = \frac{\mu e_0 + e}{r_p} + \frac{(1+k)e}{r_1 + 1/j\omega C_1} \quad (16)$$

and the grid-excitation voltage is

$$e_0 = -ke + (k+1)e \frac{r_1}{r_1 + 1/j\omega C_1} \quad (17)$$

Solution of (16) and (17) gives the following values of

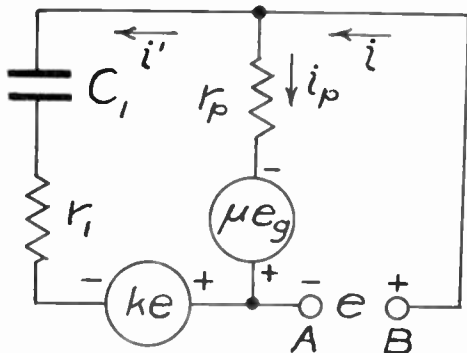

Fig. 4—Equivalent circuit for the circuit of Fig. 3.

effective reactance and resistance:

$$x_o = - \frac{r_p(r_1^2\omega^2 C_1^2 + 1)}{(k+1)(r_p + \mu r_1)\omega C_1} \quad (18)$$

$$r_o = \frac{r_p(r_1^2\omega^2 C_1^2 + 1)}{r_1^2\omega^2 C_1^2(\mu + 1) + (k+1)r_1 r_p \omega^2 C_1^2 + 1 - k\mu} \quad (19)$$

The second term in the denominator of (19) is ordinarily so small in comparison with the first term that

³ C. F. Sheaffer, "Frequency modulator," PROC. I.R.E., vol. 28, pp. 66-68; February, 1940.

it may be neglected. Under this assumption, equating the denominator to zero shows that the r_o is infinite when

$$r_1^2 C_1^2 \omega^2 = \frac{k\mu - 1}{\mu + 1} \quad (20)$$

If $k\mu$ is considerably larger than unity, the resistance is infinite when $r_1^2 C_1^2 \omega^2$ is equal to k ; i.e., when the resistance is equal to \sqrt{k} times the reactance of the condenser. This is also the approximate relation for maximum effective capacitance, and

$$\max C_o \cong \sqrt{k} g_m / \omega \quad (21)$$

Comparison of (21) and (8) shows that when k exceeds 1/4 the circuit of Fig. 3 gives greater maximum effective

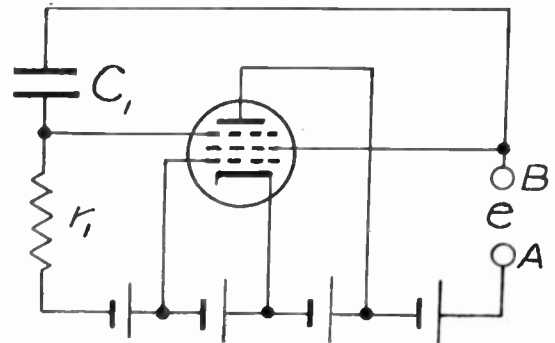

Fig. 5—Parallel type of impedance-conversion circuit using a pentode.

capacitance than the circuit of Fig. 1. The fact that the effective resistance shunting this maximum effective capacitance is theoretically infinite may be a great advantage in the use of the circuit of Fig. 3. When this circuit is used in frequency modulation the two coupled coils may be the grid and plate coils of the oscillator.

Although the tubes in Figs. 1 and 3 are shown as triodes, the plate and grid may be replaced by any two electrodes of a multielectrode tube if the control electrode is maintained sufficiently negative to prevent the flow of electrons to it. In particular, the plate and grid of Fig. 1 may be replaced by the screen and sup-

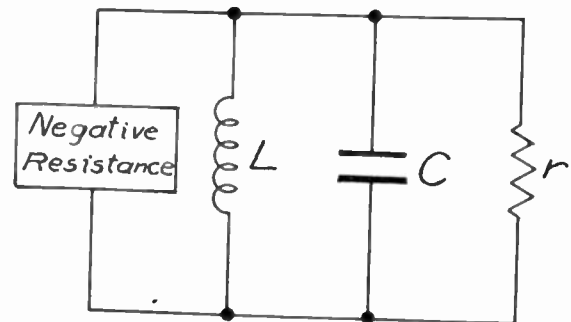

Fig. 6—Basic form of one type of negative-resistance oscillator.

pressor, respectively, of a pentode, the plate and first-grid voltages being maintained constant, as in Fig. 5. Appropriate changes of symbols then transform (5) and (6) into

$$x_e = - \frac{r_{o2}(r_1^2\omega^2C_1^2 + 1)}{\omega C_1(\mu_{23}r_1 + r_{o2})} \quad (21)$$

$$r_e = \frac{r_{o2}(r_1^2\omega^2C_1^2 + 1)}{r_1^2\omega^2C_1^2(1 + \mu_{23}) + r_{o2}r_1\omega^2C_1^2 + 1} \quad (21)$$

in which r_{o2} is the screen resistance, and μ_{23} is the screen-suppressor mu factor. Because an increase of negative suppressor voltage reduces the number of electrons that go to the plate, the screen current increases with a negative increment of suppressor voltage. μ_{23} , therefore, is negative. Since $|\mu_{23}|$ is greater than unity, r_e may be negative; and since $|\mu_{23}|r_1$ may be greater than r_{o2} , x_e may be numerically positive, indicating that the effective reactance between A and B is inductive. The circuit thus acts like a negative resistance in parallel with an inductance.

It has been shown many times that sustained sinusoidal oscillations may occur in a circuit of the form of Fig. 6. For this reason it is to be expected that sustained sinusoidal oscillations may occur if a capacitance C_2 is connected between points A and B of Fig. 5. In order to provide a path for the direct screen current, C_2 must be shunted by the resistance r_2 . The resulting circuit, shown in Fig. 7, is identical with that discussed by DeLaup⁴ and others. Oscillations of constant amplitude take place when the circuit is adjusted so that the effective inductive reactance between A and B is equal to the capacitive reactance of C_2 and the effective negative resistance between A and B is equal to r_2 . By stating these facts in the form of equations and solving the equations simultaneously, it may be shown that the frequency of oscillation is

$$f = \frac{1}{2\pi} \sqrt{\frac{r_2 + r_{o2}}{r_1 r_2 r_{o2} C_1 C_2}} \quad (22)$$

and the criterion for oscillation is

$$|\mu_{23}| \geq \frac{r_2 + r_{o2}}{r_2} + \frac{r_{o2}C_2}{r_1 C_1} + \frac{r_{o2}}{r_1} \quad (23)$$

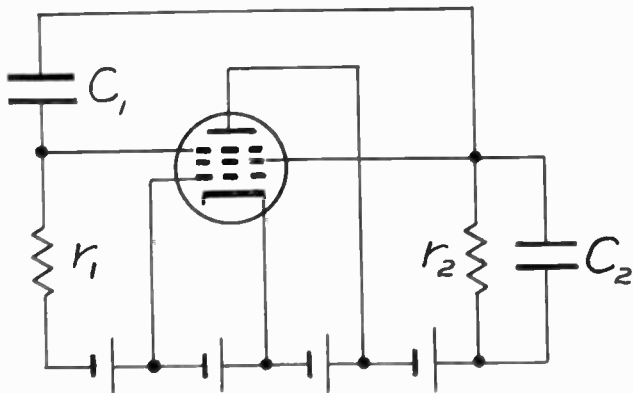

Fig. 7—"Resistance-tuned" oscillator based upon the circuit of Fig. 5.

Equations (22) and (23) are equivalent to those derived by another method by DeLaup.

⁴ P. S. DeLaup, "Sine waves in RC oscillators," *Electronics*, p. 34, January, 1941, (with bibliography).

Sustained sinusoidal oscillation is also theoretically possible if C_1 and C_2 in the circuit of Fig. 7 are replaced by inductances L_1 and L_2 . Experimental verification of this prediction is difficult because of the distributed capacitance of the coils used for L_1 and L_2 .

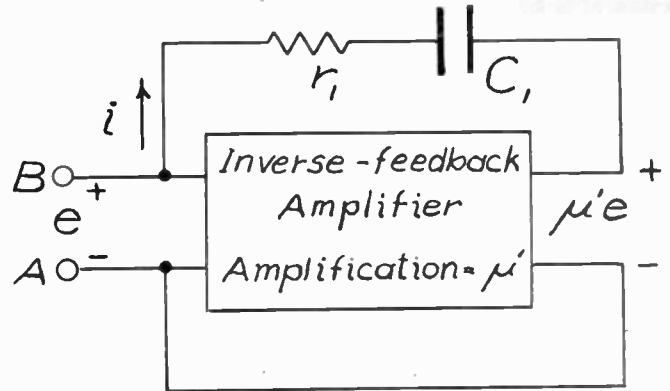

Fig. 8—Amplifier type of impedance-conversion circuit.

AMPLIFIER TYPE OF CIRCUIT

A second type of circuit that may be used in changing the phase angle or magnitude of an impedance is shown in Fig. 8. By the use of inverse feedback and of low impedance in the final stage of the amplifier, the voltage amplification μ' is made independent of r_1 and C_1 throughout the frequency range in which the circuit is to be used. The output voltage $\mu'e$ is in phase with or in phase opposition to the impressed voltage e . μ' is assumed to be positive when the relative polarities of the instantaneous input and output voltages are as indicated by the signs in Fig. 8. Under the assumption that the input impedance of the amplifier is infinite, the current resulting from the application of e is

$$i = \frac{e - \mu'e}{r_1 + 1/j\omega C_1} \quad (24)$$

The input admittance between points A and B is

$$y_e = \frac{i}{e} = \frac{1 - \mu'}{r_1 + 1/j\omega C_1} = \frac{1 - \mu'}{r_1 + 1/r_1\omega^2C_1^2} + j \frac{1 - \mu'}{r_1^2\omega C_1 + 1/\omega C_1}$$

Between points A and B , therefore, the circuit acts like a parallel combination of reactance x_e and resistance r_e of values

$$x_e = - \frac{r_1^2\omega^2C_1^2 + 1}{\omega C_1(1 - \mu')} \quad (25)$$

$$r_e = \frac{r_1^2\omega^2C_1^2 + 1}{r_1\omega^2C_1^2(1 - \mu')} \quad (26)$$

If the amplifier contains an odd number of stages, the output voltage is opposite in phase to the input voltage (both being measured relative to the common (lower) terminals) and the numerical value of μ' is negative in (25) and (26). The effective resistance is

positive and the reactance capacitive. The equivalent capacitance is then

$$C_e = \frac{(1 - \mu')C_1}{\omega^2 r_1^2 C_1^2 + 1} \quad (27)$$

For a given value of C_1 , C_e has its maximum value when r_1 is zero. The maximum effective capacitance is

$$\max C_e = (1 - \mu')C_1 \quad (28)$$

The effective resistance shunting C_e is infinite when r_1 is zero. It is evident that very large values of effective

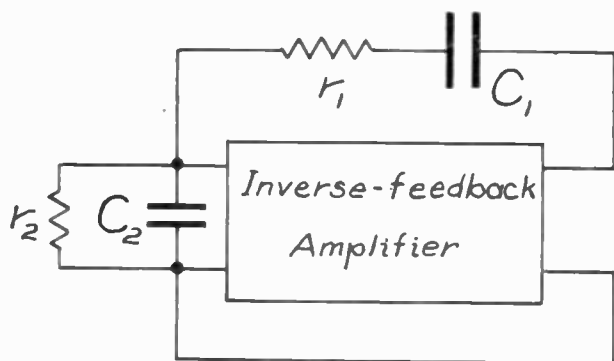

Fig. 9—"Resistance-tuned" oscillator based upon the circuit of Fig. 8.

capacitance can be obtained with this circuit if μ' is large. Since μ' may be varied by means of the bias of one or more grids of one stage to which inverse feedback is not applied, this circuit may also be used in frequency modulation.

It is of interest to note that in a single-stage amplifier the internal grid-plate capacitance of the tube serves the same function as the capacitance⁵ C_1 in Fig. 8.

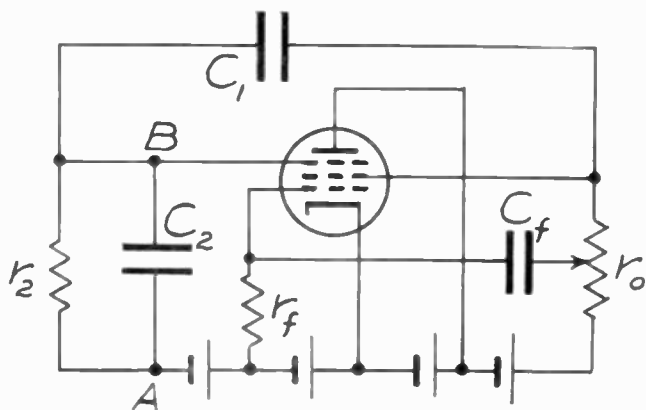

Fig. 10—"Resistance-tuned" oscillator with inverse feedback.

Equation (28) indicates the well-known fact that the effective input capacitance of a vacuum tube used in an amplifier is approximately equal^{6,7} to $\mu' C_{op}$.

If the amplifier contains an even number of stages, the numerical value of μ' is positive in (25) and (26) and the circuit acts like an inductive reactance in

⁵ J. M. Hollywood and M. P. Wilder, "Tube capacitance put to work," *Electronics*, vol. 8, pp. 30-31; October, 1935.

⁶ H. W. Nichols, "The audion as a circuit element," *Phys. Rev.*, vol. 13, pp. 404-414; 1919.

⁷ J. M. Miller, National Bureau of Standards Bulletin No. 351.

parallel with a negative resistance. Sustained sinusoidal oscillations may occur if a capacitance C_2 is connected between A and B . In order to provide the correct bias for the first tube of the amplifier and to make it possible to reduce the total effective resistance of the circuit to zero, C_2 must be shunted by a resistance r_2 , as in Fig. 9.

The circuit of Fig. 9 is basically identical with that of the "resistance-tuned" oscillator designed by Terman, Buss, Hewlett, and Cahill.⁸ Sustained oscillations of constant amplitude take place when the circuit constants are such that r_2 is equal in magnitude to the negative effective resistance r_e , and the reactance of C_2 is equal in magnitude to the effective inductive reactance x_e . This fact may be stated in the form of the equations

$$-\frac{r_1^2 \omega^2 C_1^2 + 1}{\omega C_1 (1 - \mu')} = \frac{1}{\omega C_2} \quad (29)$$

$$-\frac{r_1 + 1/\omega^2 r_1 C_1^2}{1 - \mu'} = r_2 \quad (30)$$

Solution of (29) and (30) shows that sustained oscilla-

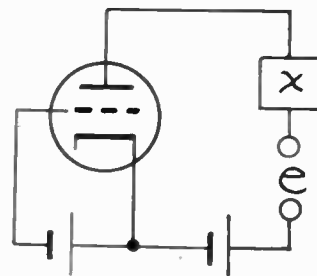

Fig. 11—Series type of impedance-conversion circuit.

tions of constant amplitude take place when μ' is positive and

$$\mu' = r_1/r_2 + C_2/C_1 + 1 \quad (31)$$

and that the frequency of oscillation is

$$f = 1/2\pi\sqrt{r_1 r_2 C_1 C_2} \quad (32)$$

Equation (32) is the same as that derived by Terman, Buss, Hewlett, and Cahill.

By the use of a pentode in which the output is taken from the screen circuit and the input is impressed upon the suppressor grid, μ' may be made positive with a single-stage amplifier. A "resistance-tuned" oscillator based upon such a circuit is shown in Fig. 10. A resistance r_1 is not necessary in this circuit because the action of C_1 causes the output voltage developed across r_0 to be out of phase with the suppressor voltage. Since C_1 is ordinarily much larger than C_2 , this circuit is essentially the equivalent of that of Fig. 7. The purpose of r_f and C_f is to improve the waveform by

⁸ F. E. Terman, R. R. Buss, W. R. Hewlett, and F. C. Cahill, "Some applications of negative feedback with particular reference to laboratory equipment," *Proc. I.R.E.*, vol. 27, pp. 649-655; October, 1939.

means of inverse feedback, which reduces amplitude distortion in the tube.

A number of modifications of the circuit of Fig. 8 are possible. C_1 may, for instance, be replaced by an inductance L_1 . A second modification is obtained by impressing the voltage e between the output terminals, instead of between the input terminals. The objection to such a circuit is that the load resistance of the final stage of the amplifier reduces the effective resistance r_e . If the output voltage of the amplifier in Fig. 8 is caused to be 90 degrees out of phase with the input voltage, a reactance may be made to act like a positive or negative resistance, or a resistance to act like a capacitive or inductive reactance.

SERIES TYPE OF CIRCUIT

A third type of circuit by means of which the magnitude or phase angle of an impedance may be varied by means of a vacuum tube is shown¹ in Fig. 11. Since the plate resistance of the tube may be varied by means of the voltage of one or more grids, the effective reactance and resistance between A and B may be controlled by a voltage. Applications of this circuit are limited for the following reasons: It does not give an inductive reactance when x_1 is capacitive, it will not give a negative effective resistance, the effective capacitance is always less than the capacitance of x_1 , and the effective shunting resistance cannot be made infinite.

The Relative Sensitivities of Television Pickup Tubes, Photographic Film, and the Human Eye*

ALBERT ROSE†, MEMBER, I.R.E.

Summary—The threshold scene brightness which a picture-reproducing device can record, a measure of its "operating sensitivity," depends not only upon the lens speed and the exposure time, but also upon the amount of detail in the recorded image. A general expression for the "operating sensitivity" of a picture-reproducing device is obtained which includes these factors together with the threshold number of quanta per picture element. This parameter characterizes the "true sensitivity" of the given device. The "true" and "operating" sensitivities of four types of television pickup tubes, photographic film, the human eye, and an ideal picture-reproducing device are obtained. Eye and film have of the order of one one-hundredth the "true sensitivity" of an ideal picture-reproducing device. Some recent television pickup tubes have of the order of one one-hundred-thousandth the "true sensitivity" of an ideal device.

To compare "operating sensitivities," the same exposure time and equivalent lens systems are taken for the three devices. A television pickup tube which has a photoelectric response of 10 microamperes per lumen and makes full use of the storage principle can record scenes with no more illumination than that required by some of the "faster" photographic films. The relatively low "operating sensitivity" of film results from the large amount of intrinsic picture detail (a picture element is taken to be a single grain). The human eye has a range of "operating sensitivities" extending from that of film to a value several thousand times higher. This range depends upon the ability of the eye to coarsen the detail of its perceived image as the scene brightness is lowered.

INTRODUCTION

THE question of the relative sensitivities of television pickup tubes and photographic film has frequently been raised in discussions of the performance of television tubes. In these discussions, sensitivities have usually been compared in terms of the lowest scene brightness at which the given device can still "see." This is a useful criterion for operation of the device but it is not a complete definition of sensitivity.

* Decimal classification: R 583. Original manuscript received by the Institute, September 9, 1941. Presented, Summer Convention, Detroit, Michigan, June 25, 1941.

† Research Laboratories, RCA Manufacturing Company, Inc. Harrison, N. J.

The "operating sensitivity," defined as the reciprocal¹ of the threshold scene brightness, depends upon the lens system, exposure time, and amount of detail in the reproduced image. A variation of any one of these factors may alter the "operating sensitivity." Although the lens system and exposure time usually have been taken into account, the amount of detail in the reproduced image has not been given the same attention.

A picture of fine detail requires, in general, more light than a picture of coarse detail. The most immediate illustration of this is the human eye which automatically coarsens the detail of its image as the scene brightness is reduced; it pays for increased "operating sensitivity" with picture detail. Similarly the "operating sensitivity" of television pickup tubes and photographic film may be altered by designing these devices to record varying amounts of detail. Fast photographic films have, in general, a coarser grain structure than slow films. One finds the characteristics advertised in this manner, "high-speed film permitting moderate enlargement" and "very fine-grain film having moderate speed." Whatever the distribution of emphasis, it is evident that here again "operating sensitivity" and picture detail are in some way related. One is improved at the expense of the other. These observations suggest the desirability of a more intrinsic measure of sensitivity which would determine the relative proportions of "operating sensitivity" and "picture detail" to be

¹ For consistency of language the reciprocal of the threshold light values must be taken as a definition of sensitivity. This permits higher sensitivity to be associated with a larger numerical value. The threshold values themselves are, however, of more immediate interest and will be used throughout the paper.

expected and which would be a characteristic constant of the device. For this constant, the present analysis of the performance of certain types of pickup tubes, film, and the human eye has led to the choice of the threshold number of quanta per picture element. The reciprocal of this quantity will be defined as the "true sensitivity" of a device as distinct from its "operating sensitivity."

It is the purpose of this paper to obtain expressions for, or estimates of, the "true sensitivities" for the three picture-reproducing devices and from them to derive "operating sensitivities." Finally, their relative performance under specified conditions will be compared with particular reference to picture detail.

The quantitative part of the discussion which follows makes no especial attempt at precision. The range of light values considered is more than ten billionfold. The threshold values for eye and film are difficult to measure accurately, and vary appreciably from specimen to specimen. On the other hand, it is hoped that the factors which must be considered in defining the sensitivity of a picture-reproducing device will be clearly set forth.

Photographic film, the human eye, and some television pickup tubes have in common certain formal properties which can be clarified by considering first an ideal picture-reproducing device. Such a device is assumed to have a quantum yield of unity (each incident light quantum excites one electron), to make full use of its exposure time and to be limited in sensitivity only by the random fluctuations in the arrival of light quanta.

IDEAL PICTURE REPRODUCER

The average number of light quanta arriving at a picture element of the ideal picture reproducer during its exposure time constitutes the picture signal. The threshold picture signal is the least number of quanta that can be "seen." A reasonably good approximation to the threshold signal may be taken to be that signal which is just equal to the spurious signal. For the ideal device, the spurious signal, or noise as it is frequently called, is generated by the random fluctuations in the number of quanta that arrive at various picture elements. Thus, if the target is uniformly illuminated so that each picture element receives, on the average, s quanta during the exposure time, the root-mean-square fluctuation² in the number received by individual elements will be $s^{1/2}$. The signal-to-noise ratio will then be $s/s^{1/2}$ or $s^{1/2}$. The signal will be equal to the noise for $s=1$. That is, the threshold number of quanta per picture element is unity, and the "true sensitivity" is its reciprocal, or unity also.

In arriving at the "true sensitivity," note that noth-

² See Thornton C. Fry, "Probability and Its Engineering Uses," D. Van Nostrand Company, New York, N. Y., 1929, p. 471. It is assumed that the arrival times of light quanta satisfy the assumptions on which the Poisson Law is based, namely, that "they are distributed individually and collectively at random."

ing has been said of the lens system, the particular exposure time, or the total number of picture elements. The "true sensitivity" is independent of these quantities and is an intrinsic measure of the sensitivity of the device. The quantities enumerated above do, however, enter into a determination of the "operating sensitivity."

Suppose that the reproduced image is to have N picture elements, an exposure time of t seconds, and a signal-to-noise ratio of R . It follows that the rate of reception of quanta on the target must be $(NR^2/t)n_q$, where n_q is the threshold number of quanta per picture element, in this case unity. In the visible part of the spectrum a lumen of white light is equivalent to about 1.3×10^{16} quanta per second. The target must then receive $(0.8NR^2/t)n_q 10^{-16}$ lumen. If the target area is A square centimeters, the target illumination must be

$$I = \frac{0.7NR^2}{tA} n_q 10^{-13} \text{ foot candle} \quad (1)$$

$$= \frac{0.7R^2}{ta} n_q 10^{-13} \text{ foot candle}$$

where a is the area of a picture element on the target in square centimeters. The scene brightness and intensity of illumination at the target are connected by the relation

$$B = \frac{4}{\pi} \frac{f^2}{T} I \text{ candles per square foot} \quad (2)$$

where B is the scene brightness, and f and T the f number and transmission of the lens. From (1) and (2) the required scene brightness is

$$B = \frac{2.8}{\pi} \frac{f^2}{T} \frac{R^2}{ta} n_q 10^{-13} \text{ candle per square foot} \quad (3)$$

and the threshold scene brightness, letting $R=1$, is

$$B = \frac{2.8}{\pi} \frac{f^2}{T} \frac{1}{ta} n_q 10^{-13} \text{ candle per square foot.} \quad (4)$$

The reciprocal of B in (4) is the "operating sensitivity." Equation (4) may be applied to any device for getting the "operating sensitivity" when the "true sensitivity" is known.

To summarize the above remarks, the threshold number of quanta per picture element for an ideal picture-reproducing device is found to be unity. The "true sensitivity" or the reciprocal of this quantity is also unity. An expression is then derived for the threshold scene brightness, reciprocal of "operating sensitivity," in terms of the "true sensitivity" and the operating conditions which included the f number of the lens, transmission of lens, exposure time, and picture-element area. In particular, the threshold-scene brightness is found to be proportional to the number of picture elements per unit area.

The above discussion of the ideal picture-reproducing device will be used, so far as possible, as the pattern

for the discussion of the particular devices. The treatment of some of the types of pickup tubes will be found to deviate somewhat since for them the threshold number of quanta per picture element is not a characteristic constant but depends in part on the total number of picture elements.

TELEVISION PICKUP TUBES

The range of sensitivity of pickup tubes can be adequately covered by four general classes. The two major classes consist of storage and nonstorage tubes. For each of these, there are two subclasses, those tubes whose sensitivity is limited by the noise of a television preamplifier and those limited by the random fluctuations, or noise, of the original signal. For the latter some form of electron multiplication, which is assumed to introduce no noise of its own, can be employed to amplify the original signal. These classes of tubes will be considered in the order of decreasing sensitivity.

I. Storage Type with Multiplier

The storage type of television pickup tube^{3,4} which uses some form of electron multiplication satisfies all but one of the requirements of an ideal picture reproducer. It makes full use of the exposure time (frame time) since photoemission is collected continuously during its exposure to light and the stored electrostatic image on the target is periodically converted into a picture signal by the scanning beam. It has sensitivity limited by random fluctuations in the charge distribution of the stored image since the original optical image may be converted into an electron image and the electron image multiplied until the fluctuations resulting from the random arrival of multiplied photoelectrons exceeds the fluctuations in the television amplifier. It departs from an ideal picture reproducer in that the quantum yield of its photoprocess instead of being unity is more likely to be about 0.005. A quantum yield of 0.005 corresponds to a photosensitivity of about 10 microamperes per lumen. The threshold number of quanta per picture element, therefore, is

$$n_q = \frac{1}{\theta} \quad (5)$$

where θ is the quantum yield. The threshold scene brightness is, from (4) and (5),

$$B = \frac{2.8}{\pi} \frac{f^2}{T} \frac{1}{ta\theta} 10^{-13} \text{ candle per square foot.} \quad (6)$$

II. Storage Type with Amplifier

It will be convenient to calculate the threshold

³ V. K. Zworykin, G. A. Morton, and L. E. Flory, "Theory and performance of the iconoscope," *PROC. I.R.E.*, vol. 25, pp. 1071-1092; August, 1937. The multiplier arrangement described in this paper would satisfy Class I if the signal conversion efficiency were 100 per cent and the spurious signal were only the fluctuation noise in the picture.

⁴ Harley Iams, G. A. Morton, and V. K. Zworykin, "The image iconoscope," *PROC. I.R.E.*, vol. 27, pp. 541-547; September, 1939. The image iconoscope represents one stage of electron image multiplication.

picture signal of the storage type of pickup tube which uses a television amplifier^{3,5} in terms of electron current since the limiting spurious signal, or noise, introduced by the television preamplifier is usually expressed as an equivalent root-mean-square current in the input resistor. This noise current⁶ is given by

$$\bar{I}_n = 2 \sqrt{\frac{kT}{R} f_m \left\{ 1 + \frac{R_t R (\omega_m C)^2}{3} \right\}} \quad (7)$$

where k = Boltzman's constant
 T = absolute temperature
 R = input resistance
 f_m = pass band of amplifier
 R_t = noise introduced by first tube expressed as equivalent input resistance
 $\omega_m = 2\pi f_m$
 C = total input capacitance.

If R is made large, (7) reduces to

$$\bar{I}_n = 2 \sqrt{\frac{kT f_m R_t (\omega_m C)^2}{3}} \quad (8)$$

For reasonable values of R_t (500 ohms) and C (2.6×10^{-11} farad), (8) becomes

$$\bar{I}_n = 2.8 \times 10^{-19} f_m^{3/2} \text{ ampere.} \quad (9)$$

The pass band f_m is given closely enough by

$$f_m = \frac{N}{2t} \quad (10)$$

where N = total number of picture elements
 t = time in seconds for scanning one frame
 which is also the exposure time.

The amplifier noise current becomes finally, from (9) and (10),

$$\bar{I}_n = \left(\frac{N}{t} \right)^{3/2} 10^{-19} \text{ ampere.} \quad (11)$$

For a threshold picture, the signal current is just equal to the amplifier noise current. The signal current is also the total photoelectron current from the target. From these two statements the threshold number of electrons per picture element may be written

$$n_e = \frac{\bar{I}_n t}{N} 6 \times 10^{18} \quad (12)$$

where the factor 6×10^{18} converts amperes to electrons per second. Equation (12), with the aid of (11), becomes

$$n_e = 0.6 \left(\frac{N}{t} \right)^{1/2} \quad (13)$$

If the quantum yield of the photoprocess is θ , the

⁵ Albert Rose and Harley Iams, "The orthicon, a television pickup tube," *RCA Rev.*, vol. 4, pp. 186-199; October, 1939.

⁶ H. B. DeVore and Harley Iams, "Some factors affecting the choice of lenses for television cameras," *PROC. I.R.E.*, vol. 28, p. 370, August, 1940.

threshold number of quanta per picture element may be written

$$n_q = \frac{n_e}{\theta} = \frac{0.6(N)}{\theta(t)}^{1/2} \quad (14)$$

The threshold scene brightness is, from (4) and (14),

$$B = \frac{1.7}{\pi} \frac{f^2}{T} \frac{N^{1/2}}{t^{3/2}a\theta} 10^{-13} \text{ candle per square foot.} \quad (15)$$

III. Nonstorage Type with Multiplier

The nonstorage pickup tube which makes use of an electron multiplier^{7,8} is 1/N times as sensitive as the corresponding storage tube. This relationship follows

TABLE I

Type of Pickup Tube	n_q Threshold Number of Quanta per Picture Element	B Threshold Scene Brightness Candles per Square Foot
Storage + multiplier	$\frac{1}{\theta}$	$\frac{2.8}{\pi} \frac{f^2}{T} \frac{1}{t a \theta} 10^{-11}$
Storage + amplifier	$\frac{0.6}{\theta} \left(\frac{N}{t}\right)^{1/2}$	$\frac{1.7}{\pi} \frac{f^2}{T} \frac{N^{1/2}}{t^{3/2} a \theta} 10^{-11}$
Nonstorage + multiplier	$\frac{N}{\theta}$	$\frac{2.8}{\pi} \frac{f^2}{T} \frac{N}{t a \theta} 10^{-11}$
Nonstorage + amplifier	$\frac{0.6}{\theta} \frac{N^{1/2}}{t^{1/2}}$	$\frac{1.7}{\pi} \frac{f^2}{T} \frac{N^{1/2}}{t^{3/2} a \theta} 10^{-11}$

from the fact that the photoelectric current generated during only a picture-element time, instead of a frame time, is used. The threshold number of quanta per picture element is, therefore, from (5)

$$n_q = \frac{N}{\theta} \quad (16)$$

and the threshold scene brightness,

$$B = \frac{2.8}{\pi} \frac{f^2}{T} \frac{N}{t a \theta} 10^{-13} \text{ candle per square foot.} \quad (17)$$

IV. Nonstorage Type with Amplifier

Similarly, the threshold values for the nonstorage pickup tube which uses a television amplifier⁷ may be obtained from (14) and (15) by multiplying the right-hand sides by N

$$n_q = \frac{0.6}{\theta} \frac{N^{3/2}}{t^{1/2}} \quad (18)$$

$$B = \frac{1.7}{\pi} \frac{f^2}{T} \frac{N^{3/2}}{t^{3/2} a \theta} 10^{-13} \text{ candle per square foot.} \quad (19)$$

The threshold values derived for the four classes of pickup tubes are listed in Table I. It is important to

remember that *these are threshold values* and that, in general, about thirty times the threshold light is required for a good picture. Also, the values in Table I are based on a limitation of the spurious signal to the fundamental fluctuation phenomena in amplifiers and in photoprocesses. If there are other spurious signals, the threshold values must be increased accordingly.

The criterion for a threshold picture was taken to be a picture signal equal to the spurious signal. It is, nevertheless, true that pictures which are "in the noise," that is, their signal is less than the spurious signal, can still be seen. This is not a contradiction of the threshold criterion since, when viewing such a picture, the observer either deliberately ignores, or moves back from the receiver until he cannot resolve, the fine detail. In either event, the observer has lowered the total pass band of the television system and, thereby, the amplitude of the noise signal until it is comparable to or less than the picture signal. The observer can, by this procedure, improve the "operating sensitivity" of the television system at the expense of picture detail.

PHOTOGRAPHIC FILM

It is of particular interest to determine how closely photographic film approaches the sensitivity of an ideal picture reproducer since the photoprocess is a volume effect much like photoconductivity and, therefore, capable of high quantum yield. Further, there is an element in the processing of film similar to electron multiplication of the signal in a television pickup tube. This element is the complete development of a silver bromide grain after only a few silver atoms have been released by light. The gain in the process is about 10⁹.

The formation of opaque grains, on the other hand, introduces a complication not usually present in picture-reproducing devices. If one considers a single grain to be a picture element, the signal associated with the element is either all or none. It is either transparent or opaque. There are no intermediate transmissions. Thus, from the point of view of each grain as a picture element, film could transmit black-and-white pictures but no half tones. It is, nevertheless, useful to approach film from this point of view in order to calculate its threshold values. Later, the problem of how, in practice, half-tone response is obtained by combining many grains into one picture element will be considered.

The immediate question is, "How many quanta are required to make a grain developable?" There are two aspects of this question, namely "how many quanta are actually used" and "how many quanta must be incident on a grain" to render it developable. The corresponding situation in photoemission is that about 1000 quanta must be incident on a surface to liberate one photoelectron, but only one of these quanta is actually used in the liberation process. The determination of the number of quanta that are useful in rendering a grain developable has been the subject of many

⁷ P. T. Farnsworth, "Television by electron image scanning," *Jour. Frank. Inst.*, vol. 218, pp. 411-444; October, 1934.
⁸ C. C. Larson and B. C. Gardner, "The image dissector," *Electronics*, vol. 12, pp. 24-27; October, 1939.

investigations in the literature.⁹ While there is not agreement on a specific number there is some agreement that the number is small and probably takes on a range of values for grains of any one size. The determination of the number of incident quanta necessary to make a grain developable is a simpler problem and subject to more direct measurement. Table II lists

TABLE II

Emulsion	Average Grain Size (Square Centimeter)	Number of Incident Quanta per Grain to Produce Density of Unity
I	7×10^{-9}	38
II	7×10^{-9}	58
III	5×10^{-9}	69
IV	1×10^{-9}	66

some values published by J. H. Webb¹⁰ which, he states, give the "order of magnitude." From the table, the approximate threshold number of quanta per grain may be taken¹¹ as 60. It is especially to be noted that the number per grain is substantially independent of grain size. The threshold scene brightness, accordingly, may be written

$$B = \frac{2.8}{\pi} \frac{f^2}{T} \frac{1}{ta} n_q 10^{-13} \text{ candle per square foot} \quad (20)$$

with

$$n_q = 60 \text{ quanta per picture element.} \quad (21)$$

The range of grain area a is from 10^{-3} to 1 square micron or in the units of (20), 10^{-11} to 10^{-8} square centimeter. Exposure times¹² t have been used as short as 10^{-5} second for high-speed motion pictures and as long as weeks for X-ray crystal study work.

The above discussion has been predicated on the assumption of a picture element equal to one grain. This is not generally the condition under which film is used since the usual optical system does not resolve the individual grains but rather areas containing 100 to 10,000 grains.¹³ Although the individual grains cannot be seen, "graininess" or the statistical fluctuations in

⁹ J. H. Webb, "Number of quanta required to form the photographic latent image as determined from mathematical analysis of the H and D curve," *Jour. Opt. Soc. Amer.*, vol. 29, pp. 309-313; August, 1939, and "Graphical analysis of photographic exposure and a new theoretical formulation of the H and D curve," *Jour. Opt. Soc. Amer.*, vol. 29, pp. 314-326; August, 1939. These papers contain an extensive bibliography and discussion of the problem.

¹⁰ J. H. Webb, "The relationship between reciprocity law failure and the intermittency effect in photographic exposure," *Jour. Opt. Soc. Amer.*, vol. 23, pp. 157-169; May, 1933. (Table on p. 168.)

¹¹ These values are, to a certain extent, arbitrary. They refer to a density of unity or to an exposure which renders 90 per cent of the film area opaque. The values, nevertheless, serve to locate the range of sensitivity of film.

¹² For a discussion of the range of validity of the reciprocity law see footnote (10) and L. A. Jones and J. H. Webb, "Reciprocity law failure in photographic exposures," *Jour. Soc. Mot. Pic. Eng.*, vol. 23, pp. 142-159; September, 1940.

¹³ Although many grains are combined to form a picture element in the ordinary use of film, it is of interest to note that advantage can be taken of the fact that the basic picture elements are the individual grains. Von Ardenne in his paper "Resolving power of photographic film for electron beams," *Zeit. für Phys.*, vol. 114, pp. 379-388, November, 1939, shows a photograph in which the trace of a very narrow line beam of electrons on the photographic plate is only a few grains wide.

the distribution of the grains is still visible.¹⁴ As was mentioned earlier, the association of a picture element with one grain leads to a picture without half tones. The introduction of half tones is made possible by two facts; first, that the picture element contains not one but many grains, and second, that all the grains do not become developable at a sharply defined threshold light value but rather over a range of light values. This spread in light values is caused by a combination of factors among which are a statistical spread in the incidence of the critical number of quanta per grain, the variation of grain size in any one emulsion, and the variation in "true sensitivity" of grains of any one size. The result is that one may expose on the average one or more grains per picture element depending upon the incident light intensity and in this way arrive at a range of transmissions or tone values. This secondary or optical enlargement of the picture element, to include many grains, while primarily for the purpose of getting half tones and suppressing graininess, also effects a minor improvement in "operating sensitivity." The improvement comes about in this way. A threshold picture must contain on the average at least one exposed grain per picture element. If a picture element contains only one grain, the threshold scene brightness must be sufficient to expose about half the grains in the film. If, on the other hand, a picture element contains many grains, only a small fraction of these need be developed for a threshold picture and a smaller scene brightness may be used. The amount of improvement in "operating sensitivity" depends upon the size of picture element, the spread in light values over which the grains become developable (γ), and the fog density of the film. No attempt will be made to analyze these interrelations. An experimental approach to the problem would require the measurement of threshold exposures as a function of resolution.

The following remarks summarize the sensitivity properties of film. The basic picture elements of film are the individual grains. The threshold number of incident quanta per grain is of the order of 100 and independent of grain size. Since picture elements the size of single grains do not permit the reproduction of half tones, the picture element is augmented in actual use to contain of the order of thousands of grains. This results not only in half-tone reproduction but also in a somewhat improved "operating sensitivity." For a thousandfold increase in picture-element size, by combinations of grains, the improvement in "operating sensitivity" is of the order of tenfold. This is to be contrasted with variations of grain size for which the "operating sensitivity" increases substantially in direct proportion to the size of the grain. In both cases, picture detail suffers when the "operating sensitivity" is improved.

¹⁴ A. van Kreveld and J. C. Scheffer, "Graininess of photographic material in objective absolute measure," *Jour. Opt. Soc. Amer.*, vol. 27, pp. 100-109; March, 1937.

It is well to remark that the threshold number of quanta per grain used in this discussion of film is not necessarily the same for all emulsions. It does serve to locate the range of sensitivities in which some recent films lie and to bring out the formal facts underlying an estimate of sensitivity. It is possible that some variation in film sensitivity is obtained by variations in the number of incident quanta necessary to render a grain developable. To the extent that this is true, increased "operating sensitivity" does not come at the expense of picture detail but because the intrinsic quantum efficiency of the film has been improved.

THE HUMAN EYE

From common experience the eye seems to surpass in sensitivity in the visible spectrum, other known picture reproducers. One can see pictures that the camera or pickup tube cannot. This is not unreasonable, perhaps, since the eye has had millions of years in which to be developed while cameras and pickup tubes are comparative newcomers in the field of "seeing." Even so, the "true sensitivity" of the eye, based on data in the literature, is not greater than that of film. The eye appears relatively more sensitive because it can convert much of its resolving power into "operating sensitivity." And it is "operating sensitivity" by which the eye is usually judged.

To get a quantitative measure of both the "true" and "operating" sensitivities of the eye, information is needed on the threshold number of quanta per picture element, the range of sizes of the picture element, the ability of the eye to store light sensations, and the f number of its lens. The following is an attempt to supply this information in terms of published data.

The eye lens and retina form an optical system which has an f number of about $f/2$ for scenes of very low brightness, $f/3.5$ for normal scenes, and $f/8$ for intense light. The focal length of the lens is approximately 15 millimeters. The area of the retina or target upon which an image may be received is between one and two square inches. The retina is made up of the receptor ends of rods and cones. The cones function at scene brightnesses above about 10^{-2} candle per square foot and the rods at scene brightnesses below this value. The centers of neighboring rods or cones subtend approximately one minute of arc at the eye lens. This represents the limit of resolution of the eye under normal conditions.

While the smallest picture-element size is set by the individual rods and cones, the largest picture-element size is determined by the ability of the eye to combine sensations from nerve fibers of neighboring rods. For scenes of low illumination, as many as several thousand neighboring rods may be combined to form a single picture element. Further, the threshold number of quanta required to excite a picture element is, according to Ricco's law, independent of the size of the element up to angular sizes of one or two degrees. Ricco's

law is usually stated in the following terms: "If an object subtends less than two degrees at the eye, its threshold visibility depends only on the total light coming from the object." Luckiesh and Moss¹⁵ give data which substantiate Ricco's law and extend its range of validity to include objects subtending as much as ten degrees.

The ability of the eye to store light sensations is given by Blondel and Rey's law¹⁶

$$Ft_0 = F_{\infty}(t_0 + 0.21) \quad (22)$$

where F is the threshold light intensity required for an exposure time of t_0 seconds and F_{∞} is the threshold light intensity for an infinite exposure. F_{∞} is obtained in practice for exposures in excess of two or three seconds. By (22) the eye obeys a reciprocity law,¹⁷ like photographic film, if $t_0 \ll 0.21$. In this range, Ft_0 is equal to $0.21 F_{\infty}$. Thus, if the threshold value of quanta per second is known for the eye for a long exposure, the threshold number of quanta may be obtained from it by multiplying by 0.21.

To summarize the above remarks, (4) may be applied to the eye for exposure times less than about 0.05 second, for a range of picture-element size from 10^{-7} to 10^{-3} square centimeter, and for an $f/2$ lens. An $f/2$ lens is chosen since, in the range of scene brightnesses for which the threshold scene brightness is proportional to picture detail, the diameter of the dark-accommodated iris is substantially seven millimeters. This range includes picture detail of the order of a rod diameter. At higher scene brightnesses the picture detail improves much more slowly, as one might expect, when the picture detail approaches the fineness of the rod and cone distribution.

The remaining quantity to be determined is the threshold number of quanta per picture element. The literature does not give this quantity directly. It may, however, be derived from published data on the threshold visibility of point sources,^{18,19} the experimental verification of Ricco's law,¹⁴ and measurements of visual acuity.^{20,21} The results of translating these diverse measurements into threshold quanta per picture element are that for white light from 100 to 1000 quanta are required to produce a visual sensation, and

¹⁵ M. Luckiesh and F. K. Moss, "The Science of Seeing," D. Van Nostrand Company, New York, N. Y., 1937, p. 153

¹⁶ A. Blondel and J. Rey, *Jour. de Physique et le Radium*, pp. 530-551; 1911.

¹⁷ Recently the reciprocity law for the eye was verified for moderate illumination in the range of 10^{-8} to 10^{-2} second by T. E. Gilmer, "Integrating power of the eye for short flashes of light," *Jour. Opt. Soc. Amer.*, vol. 27, pp. 386-388; November, 1937.

¹⁸ Observations of P. Reeves, H. Ives, and H. Russel reported in "The Science of Seeing," D. Van Nostrand Company, New York, N. Y., 1937, p. 152.

¹⁹ I. Langmuir and W. F. Westendrop, "A study of light signals in aviation and navigation," *Physics*, vol. 1, pp. 273-317; November, 1931.

²⁰ J. P. Connor and R. E. Ganoung, "Experimental determination of visual thresholds at low values of illumination," *Jour. Opt. Soc. Amer.*, vol. 25, pp. 287-294; September, 1935.

²¹ A. König, "Die Abhängigkeit der Sehschärfe von der Beleuchtungsintensität," *Gesammelte Abhandlungen zur Physiologischen Optik*, 1903; quoted on p. 149, of "The Science of Seeing."

for light in the neighborhood of 5500 angstrom units, the region of maximum visual efficiency, 30 to 300 quanta are required. Some of this spread is, of course, real and caused by variations in the sensitivities of different eyes. Some of it, however, may be ascribed to the difficulties of making accurate measurements and to the uncertainties of reducing a variety of measurements made under a variety of conditions to common terms. The important facts for this discussion are that the eye has a "true sensitivity" which holds for a large range of picture-element sizes and that its "true sensitivity" is of the order of that for photographic film.

DISCUSSION AND CONCLUSIONS

The threshold number of quanta per picture element for the picture-reproducing devices considered have

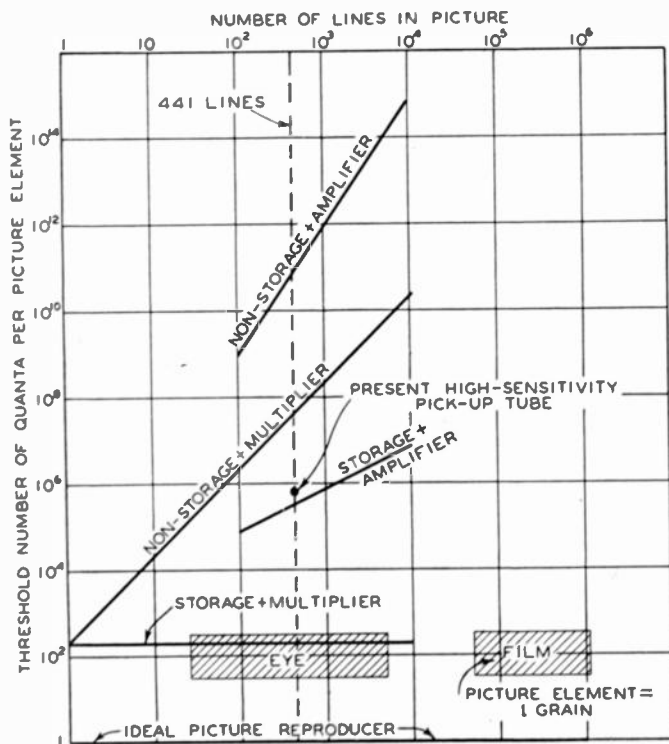

Fig. 1

been plotted in Fig. 1 as a function of the number of lines resolution in the recorded image. For pickup tubes the units of the abscissa is a natural choice since the resolution of television pictures is customarily expressed in terms of the number of scanning lines. The number of picture elements is approximately the square of the number of lines. For reasons to be discussed later, a target area of 4 square inches was taken to compute the number of lines resolution for those devices whose target size can be freely chosen. The area of the retina of the eye, about 1.5 square inches, of course is fixed and defines its target area. The number of lines in the photographic image was computed on the basis of a picture element equal to a grain. The extents of the plots for eye and film along the abscissa are a measure of the working ranges of the devices. The plots for pickup tubes which use an amplifier do not extend

below a 100-line picture since the assumptions on which (9) for the noise in a television amplifier was derived would then require an input resistance in excess of 10 megohms. Also, the upper limits of the pickup-tube plots are not reliable since at these frequencies electron transit-time effects are likely to play a role.

The points of interest in Fig. 1 are that eye and film have the same order of "true sensitivities" and have already attained about a hundredth of their maximum possible sensitivity. One of the more sensitive of current pickup tubes, on the other hand (indicated in Fig. 1), has attained only about a hundred thousandth of the sensitivity of an ideal device. Finally, the range of resolution of film is much higher than that of the eye.

Fig. 2 is an attempt to compare the performance of the several devices in terms of the normally observable quantities, threshold scene brightness, and number of lines of resolution. The operating conditions were chosen so far as possible to be the same for all devices and at the same time to be reasonably consistent with common practice. An exposure time, for example, of

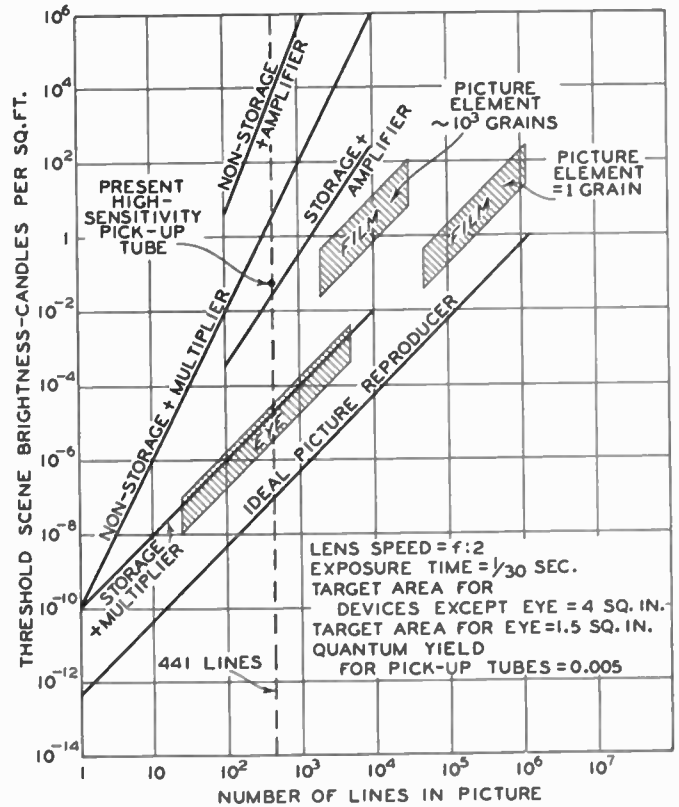

Fig. 2—Note that the plot for the eye is confined to the range of low scene brightness for which range the threshold scene brightness is proportional to the number of picture elements. For higher scene brightness the resolving power of the eye increases very slowly since already, at the upper end of the range plotted, the picture element is only slightly larger than the size of the rods and cones which determine the limit of resolution.

1/30 second was selected as satisfactory to reproduce motion. This is the present television standard and is close to that of motion-picture practice. It is also likely that the eye tends toward this exposure time in viewing moving objects. The *f* number of the eye lens, at the threshold scene brightnesses considered here, and its

target area are fixed at $f/2$ and about 1.5 square inches, respectively. The target area of pickup tubes and photographic film has a range of possible values. Nevertheless it is true that for targets larger than 1.5 inches on a side the fastest lenses readily available are such that the total amount of light on the target tends to be constant. For example, the fastest lens generally used for television tubes with targets 2 inches on a side is $f/2$ and for those with targets 4 inches on a side, $f/4.5$. This fact makes the choice of target area not a very critical one. The particular area used in plotting the curves in Fig. 2 was 4 square inches. With this target an $f/2$ lens with a transmission factor of 0.7 was assumed.

It is interesting to note that when the area of film is increased, keeping the total amount of light on the target constant, the "operating sensitivity" decreases and the picture detail increases. A pickup tube, under the same conditions, retains the same "operating sensitivity" and picture detail. The reason for the difference is that an increase in film area increases proportionately the number of picture elements since their size remains constant while an increase in television target area is accompanied by a proportionate increase in the area of a picture element since the total number of elements is kept constant.

Two separate plots are shown for film in Fig. 2. The one labeled "picture element = 1 grain" is derived from the film plot in Fig. 1 and (20). The other labeled "picture element = $\sim 10^3$ grains" was estimated from data on some commercial films and data published by L. Silberstein and A. P. H. Trivelli²² showing the H

²² L. Silberstein and A. P. H. Trivelli, "Relations between sensitometric and size frequency characteristics of photographic emulsions," *Jour. Opt. Soc. Amer.*, vol. 28, pp. 441-459; November, 1938.

and D speeds of a series of emulsions proportional to average grain size for grain areas from 3×10^{-10} to 1.5×10^{-8} square centimeter. This plot locates the range of performance of film in actual use and brings out the relatively large loss of detail and small gain in "operating sensitivity" accompanying the optical grouping of many grains into one picture element. A quantum yield (θ) of 0.005 was used to compute the pickup-tube curves. This corresponds to a photoelectric sensitivity of about 10 microamperes per lumen and is of the order of the sensitivity found in most television tubes.

The curves in Fig. 2 emphasize the importance of the effect of picture detail on "operating sensitivity." It is responsible for the large range of "operating sensitivities" of both eye and film; it is also responsible for the large difference in "operating sensitivities" of the two devices even though their "true sensitivities" (Fig. 1) are nearly the same. Fig. 2 shows that the more sensitive types of current pickup tubes and of photographic film may record scenes at about the same low level of scene brightness. Pickup tubes, however, have at 441 lines a still unrealized improvement in "operating sensitivity" of over a 100,000 fold. Film can count, at the most, on only a hundredfold improvement, unless its grain size is increased. The eye surpasses both pickup tubes and film in versatility and "operating sensitivity."

ACKNOWLEDGMENT

The writer has profited from discussions of the subject of this paper with Dr. D. O. North and other members of this laboratory.

Institute News and Radio Notes

MESSAGE FROM THE PRESIDENT

I have just read Brigadier-General Doolittle's account of his educational flight over Tokyo, delivering lectures which the Japs can understand. That news thrilled all Americans, but it was a double thrill to me. It reminded me of my first airplane flight—because General Jimmy was the pilot. In those days, as now, he was no average pilot. Among other things, he was a Doctor of Science—a working one—and he was engaged in the job of enlisting the aid of the country's engineering forces in the study of aviation's problems. He showed me the problem of blind landing, including close-up views of Philadelphia's smokestacks and office windows, and racing turns on airport boundary markers. Yes, I remember General Jimmy—and the feeling that blind landing is accompanied by muscular contraction in the region of my center of gravity.

Whether Jimmy took off for Tokyo from Shangri-La may be a question, but he certainly landed there. The Germans and Japs do not seem to know where that is, and I hope that the censor will let me tell them that it is the land where Americans are going, where morality triumphs over brutal force, where freedom and peace are ageless. In the years when the Japs took advantage of our hospitality,

taking copious notes on everything they saw, they missed that point completely. They did not see that it was an inner spirit in the American system which had brought about the industrialization which they admired. So they copied us—with the most essential element left out. More Doolittle lectures with demonstrations will teach them that.

Before I read the account of that exploit, I had some things in mind to write about. Now any writing seems puny. I am sure that all of us feel an urge to *do* something—anything which will harmonize with that accomplishment and help make possible more like it.

What to do? Unfortunately, we all cannot hop into planes and fly to Shangri-La via Tokyo. But we know that the place of radio and its men is an exceedingly important one in this war—we are a most necessary element of the team which is going to fly increasingly over Nipponville and Hitlertown. Some of us are inventing, some are designing, some are building, some are testing and some are teaching, but each is doing something necessary to the job.

This year of 1942—the thirtieth of the Institute—will be a crucial one in world history. In years to come we will look back at it, as today we look at 1918. And what we

will see then, depends upon what we do now—today and the few tomorrows. Let's do all we can, as well as we can, because radio is a vital factor in keeping our boys flying and in keeping the enemy from it.

The conditions of war necessarily circumscribe Institute participation, and the function of disseminating information by technical papers on various new subjects is limited especially. This cannot be helped, but every effort is being made to obtain and to publish papers which can be published without endangering the national interest.

In connection with membership, we have an opportunity and a duty. Thousands of men are entering radio, are studying it intensively, and are eligible to membership. They should be encouraged to join the Institute, in justice to themselves and to the profession.

A little later, not just now, the Institute will have a large task in preparing for peace, with opportunity to assist greatly in the solution of several problems which war developments will leave on our doorstep. At the moment, our individual connections to the war effort are paramount, whether they be in the Services, in laboratories, factories, or schools.

Arthur Van Dyck,
President

Board of Directors

On April 1, a regular meeting of the Board of Directors was held. Those in attendance were A. F. Van Dyck, president, Austin Bailey, A. B. Chamberlain, C. C. Chambers, I. S. Coggeshall, H. T. Friis, Alfred N. Goldsmith, L. C. F. Horle, C. M. Jansky, Jr., F. B. Llewellyn, B. J. Thompson, H. M. Turner, L. P. Wheeler, and H. P. Westman, secretary.

The report of the auditor covering the fiscal year ending December 31, 1941, was received and ordered filed.

The Secretary reported that a conference had been held by the American Standards Association to explore the possibility of setting up uniform standards to control the manufacture of all radio components used in equipment being built for the armed forces of the United States Government. A temporary Committee was established with S. K. Wolf of the War Production Board as Chairman and the Institute's Secretary as Secretary. The subject of fixed mica capacitors was chosen as an initial project and the Committee responsible for this work will be under the Chairmanship of the Secretary.

The New York Program Committee was authorized to devote the regular May meeting to an informal commemoration of the 30th Anniversary of the founding of the Institute.

The regular May meeting of the Board of Directors was held on the 6th and was attended by A. F. Van Dyck, president; Austin Bailey, C. C. Chambers, I. S. Coggeshall, H. T. Friis, O. B. Hanson, F. B. Llewellyn, Haraden Pratt, B. J. Thompson, H. M. Turner, H. A. Wheeler, L. P. Wheeler, and H. P. Westman, secretary.

All technical papers offered for export are now required to carry a license issued after suitable examination by a censor. A number of actions were taken to make the PROCEEDINGS and its mailing list conform to the requirements of the censor.

The Secretary reported that the American Standards Association project on radio components had been formally established at a meeting on May 4. The work on fixed mica capacitors is progressing rapidly.

The following nominations for Officers and Directors were made.

For President—1943

L. P. Wheeler

For Vice-President—1943

F. S. Barton

For Directors—1943-1945

W. L. Barrow	F. R. Lack
C. C. Chambers	F. B. Llewellyn
E. W. Engstrom	H. A. Wheeler

The Secretary was instructed to include these names in the ballots to be mailed to the membership between August 15 and September 1.



Pach Bros.

WALTER C. EVANS NAMED WESTINGHOUSE VICE PRESIDENT

Walter C. Evans (M'36) was recently elected Vice President of the Westinghouse Electric and Manufacturing Company. He continues to have charge of the radio, X-ray, and broadcasting divisions of that organization.

Mr. Evans was born in Columbus, Ohio, on August 27, 1898. He studied engineering at the University of Illinois for three years, taking time out to serve in the United States Navy during the first World War.

In 1921, he joined the Westinghouse organization as a radio operator at KYW in Chicago. The following year he was put in charge of technical operations and in 1926 was named station manager. He became superintendent of radio operations in charge of all technical matters for Westinghouse broadcast stations in 1929. In 1933 he became manager of the radio division and since 1936 he has been in charge of the company's broadcasting activities.

Executive Committee

On March 31, a meeting of the Executive Committee was held and attended by A. F. Van Dyck, chairman; I. S. Coggeshall, Alfred N. Goldsmith, R. A. Heising (guest), F. B. Llewellyn, B. J. Thompson, and H. P. Westman, secretary.

Approval was granted of 77 applications for admission to Associate, 3 for admission to Junior, 54 for admission to Student, and 102 for transfer to Associate.

The auditor's report was considered.

Consideration was given to the requirements established by the Office of Censorship in regard to the licensing of technical publications which are to be forwarded beyond the borders of the United States.

The Secretary reported on a conference called by the American Standards Association looking toward the establishment of an emergency technical committee to standardize radio components.

Several changes in Institute Representatives were made.

On May 1, a meeting of the Executive Committee was held. It was attended by A. F. Van Dyck, chairman; I. S. Cogges-

shall, Alfred N. Goldsmith; R. A. Heising (guest), F. B. Llewellyn, Haraden Pratt, B. J. Thompson; and H. P. Westman, secretary.

Associates numbering 56, 2 Juniors, and 124 Students were admitted to membership. In addition, 22 applications for transfer to Associate were approved.

Several Committee appointments and changes in Institute Representatives were made.

The Secretary reported that a license for exporting the April issue had been received. Consideration was given to a number of points raised by the censor.

Election Notice

Article VII, Section 1, of the Institute's Constitution is reprinted below as it contains all of the information pertinent to the election of Officers and Directors. Following it will be found the names of the candidates nominated by the Board of Directors. The names of these nominees will appear on the ballot to be mailed to the membership between August 15 and September 1.

"On or before July first of each year, the Board of Directors shall submit to qualified voters a list of nominations containing at least one name each for the office of President and Vice President and at least six names for the office of elected Director and shall call for nominations by petition.

"Nominations by petition may be made by letter to the Board of Directors setting forth the name of the proposed candidate and the office for which it is desired he be nominated. For acceptance a letter of petition must reach the executive office before August fifteenth of any year and shall be signed by at least thirty-five voting members.

"Each proposed nominee shall be consulted and if he so requests his name shall be withdrawn. The names of proposed nominees who are not eligible under the Constitution shall be withdrawn by the Board.

"On or before September first, the Board of Directors shall submit to the voting members as of August fifteenth, a list of nominees for the offices of President, Vice President, and elected Director, the names of the nominees for each office being arranged in alphabetical order. The ballots shall carry a statement to the effect that the order of the names is alphabetical for convenience only and indicates no preference.

"Voting members shall vote for the candidates whose names appear on the list of nominees, by written ballots in plain sealed envelopes, enclosed within mailing envelopes marked "Ballot" and bearing the member's written signature. No ballots within unsigned outer envelopes shall be counted. No votes by proxy shall be counted. Only ballots arriving at the executive office prior to October twenty-fifth shall be counted. Ballots shall be checked, opened, and counted under the supervision of the Teller's Committee be-

tween October twenty-fifth and the first Wednesday in November. The result of the count shall be reported to the Board of Directors at its first meeting in November and the nominees for President and Vice President and the three nominees for Director receiving the greatest number of votes shall be declared elected. In the event of a tie vote the Board shall choose between the nominees involved."

For President—1943

L. P. Wheeler

For Vice President—1943

F. S. Barton

For Directors—1943-1945

W. L. Barrow	F. R. Lack
C. C. Chambers	F. B. Llewellyn
E. W. Engstrom	H. A. Wheeler

Membership

The following admissions or transfers (where indicated as such) to Associate grades were approved by the Board of Directors on May 6, 1942.

- Adams, G. J., Thomson Club, Baker St., Lynn, Mass.
- Akey, O. M., 1325 Crane St., Menlo Park, Calif.
- Anderson, G. R., Riderwood, Md.
- Baker, A. L., 560th Technical School Squadron, Scott Field, Ill.
- Begley, W. W., 2200 Good Hope Rd., S. E., Anacostia, Washington, D. C.
- Bernier, V. A., 1341 N. Parker, Indianapolis, Ind.
- Booth, J. L., 226 Provencal Rd., Grosse Pointe Farms, Mich.
- Brown, W. N., Aircraft Radio Laboratory, Wright Field, Dayton, Ohio (Transfer)
- Campbell, C. A., 1101 E. Caldwell, Compton, Calif.
- Camras, M., 1418 S. Karbon Ave., Chicago, Ill. (Transfer)
- Chambers, T., 116 Ardmore Ave., Ardmore, Pa. (Transfer)
- Chen, T. S., National Central University, Chungking, Szechuan, China
- Crawford, R. V., 11 Wellesley Ave., Yonkers, N. Y.
- Crispell, H. L., Comm. Radio Equipment Co., Hollywood, Calif. (Transfer)
- Davis, K. E., 874 Ackerman Ave., Syracuse, N. Y.
- Dehn, R. A., 2011 Wabash Ave., Schenectady, N. Y. (Transfer)
- Deshaw, B. F., 749 E. 12 Ave., Vancouver, B. C., Canada (Transfer)
- Dubin, L., 34 Hillside Ave., New York, N. Y.
- Erickson, J. S., 17 Adams St., Port Washington, N. Y.
- Fenner, J. J., Box 798, Del Rio, Texas
- Fidelman, D., 1312 Euclid St., N. W., Washington, D. C.
- Fiet, O., 419-29 S. 48 St., Philadelphia, Pa. (Transfer)
- Freeman, E. D., 860 The Alameda, Berkeley, Calif.
- Garren, R. A., 3rd Communications Squadron, Duncan Field, San Antonio, Texas
- Gould, R. V., 27 Ross Rd., Scarsdale, N. Y. (Transfer)
- Grashoff, A. W., 3343 N. Hoyne Ave., Chicago, Ill.
- Green, A. P., Box 6150, Apex Station, Washington, D. C. (Transfer)
- Gwaltney, H. G., 169 Dale Drive, Portsmouth, Va.
- Hayes, W. D., 429 Perkins Ave., Oakland, Calif. (Transfer)
- Head, H. T., Signal Corps Radar Laboratory, Camp Evans, Belmar, N. J.
- Hershey, R. L., Radio Laboratory, Navy Yard, Philadelphia, Pa.
- Holling, K., 32 Spa Croft, Tibshelf, Derby, England
- Holmes, P. J., 2326 Lyric Ave., Los Angeles, Calif.
- Horowitz, I., 762 E. Third St., Brooklyn, N. Y.
- Horrocks, R. D., 10 Washway Rd., Sale, Man., England (Transfer)
- Horsey, R. M., 6930 Sherbrooke St., W., Montreal, Que., Canada
- Hough, R. R., Bell Telephone Laboratories, Inc., Whippany, N. J. (Transfer)
- James, G. E., 1652 Avenue B, Schenectady, N. Y. (Transfer)
- Joseph, H. M., 3818 Davis Pl., N. W., Washington, D. C.
- Julian, R. S., 64 Maple Ave., Morristown, N. J. (Transfer)
- King, A. D., Monsanto Chemical Co., Indian Orchard, Mass.
- Lester, B. R., 20 Llewellyn Ave., Bloomfield, N. J. (Transfer)
- Marischen, J. P., 2787 Shaffer, Ave., Cincinnati, Ohio
- Mason, V. V., 1355 Kingston Rd., Toronto, Ont., Canada (Transfer)
- Matthews, R. W., Naval Training School, Bowdoin College, Brunswick, Maine
- Mauldin, C. W., First Communications Squadron, McClellan Field, Calif.
- McAllister, J. F., Jr., 1135 Eastern Ave., Schenectady, N. Y.
- McFaul, Z. F., Box 55, Echo, Ore.
- Miehle, W., 183 W. Sparks St., Philadelphia, Pa.
- Morrison, L. H., 65 Bennett St., Waltham, Mass.
- Needham, D. P., 5758 Byron St., Chicago, Ill.
- Nicolosi, J., 1657-75th St., Brooklyn, N. Y. (Transfer)
- Owyang, N. K. H., 416 S. Superior St. Angola, Ind.
- Pillet, J. P., Naval Training Station, Brunswick, Maine
- Pinard, A. J., 838 Lakewood Ave., Schenectady, N. Y.
- Pool, W. G., E. 1223-33 Ave., Spokane, Wash.
- Powers, J. T., M.I.T. Dormitory, Box 144, Cambridge, Mass.
- Pullis, F. D., Big Bethel Radio Station, Box 241, R. D. 2, Hampton, Va.
- Regan, E. J., 82 Bay State Rd., Boston, Mass.
- Ryburn, P. W., 3027 Logan Blvd., Chicago, Ill.
- Rzeppa, T. S., 618 S. Jackson St., Belleville, Ill.
- Savage, J. W., 201 South Ave., Wilkesburg, Pa. (Transfer)
- Shelton, A. C., 303-28 Ave. N., Nashville, Tenn.
- Shulman, J. M., 1103 Richie Ave., Lima, Ohio (Transfer)
- Silverman, D., Stanolind Oil and Gas Co., Box 591, Tulsa, Okla.
- Sokoloski, A. F., 31 Page St., New Bedford, Mass.
- Spartana, A. R., 2129 Mount Holly St., Baltimore, Md.
- Stratton, D. A., 2448 N. Spaulding, Chicago, Ill.
- Taylor, D. R., 343 Winchester St., Winnipeg, Man., Canada
- Taylor, L. A., 219 Arlington Ave., Berkeley, Calif.
- Toulis, W. J., 235 Cattell Ave., West Collingswood, N. J. (Transfer)
- Von Alven, W. H., 3224-16 St., N. W., Washington, D. C.
- Watts, G. J., c/o Veteran Facility, Fort Harrison, Mont. (Transfer)
- Webb, R. C., c/o Royal Oak Apartments, Route 6, East Joppa Rd., Towson, Md.
- West, S. F., 4-133, Massachusetts Institute of Technology, Cambridge, Mass. (Transfer)
- Wightman, E. R., Doane College, Crete, Neb.
- Wilson, D. F., 565 W. 39 St., San Pedro, Calif.
- Winzemer, A. M., 556 W. 186 St., New York, N. Y.

Contributors



HARVEY FLETCHER

Harvey Fletcher was graduated from the Brigham Young University in 1907 and received the Ph.D. degree from the University of Chicago in 1911. He joined the Bell Telephone Laboratories in 1916 where he has been identified with investigations in the field of speech and hearing and is the author of a book on this subject. For a number of years, as Acoustical Research Director, he was in charge of groups occupied in studying the many aspects of sound in connection with telephonic research work on the production, transmission, and reception of speech and music. Dr. Fletcher is now director of Physical Research of the Bell Telephone Laboratories.



William Francis Magie was born in Elizabeth, New Jersey, on December 4, 1858. He was graduated from Princeton University in 1879. He then became assistant to Professor C. F. Brackett in the physics laboratory, and thus began his connection with Princeton, which con-



WILLIAM FRANCIS MAGIE

tinued through the successive stages of assistant, instructor, assistant professor, and professor of physics, retired. He studied in the University of Berlin during 1884 and 1885, under Helmholtz and Kirchhoff and received the Ph.D. degree. He received an honorary LL.D. in 1916 from Wooster College, and an honorary D.Sc. in 1929 from Princeton University.

Dean Magie has published papers on surface tension and on the specific heat of solutions. He also revised and enlarged Anthony and Brackett's "Textbook of Physics," translated Christiansen's "Elements of Theoretical Physics," published a textbook entitled "Principles of Physics," and compiled a "Source Book in Physics,"



JOHN R. RAGGAZZINI

He helped to organize the American Physical Society and was later its President for two years. He is also a member of the American Philosophical Society.



John R. Ragazzini (A'41) was born in New York City on January 3, 1912. He received the B.S. degree in 1932 and the E.E. degree in 1933 from the College of the City of New York and the A.M. degree in 1938 and the Ph.D. degree in 1941 from Columbia University. He was an engineering assistant in the Department of Parks of New York City in 1933 and 1934. From 1934 to 1941 he was on the teaching staff of the electrical engineering department of the College of the City of New York. In 1941 he joined the electrical engineering department at Columbia University. He is an associate member of the American Institute of Electrical Engineers and a member of Phi Beta Kappa, Sigma Xi, and Tau Beta Pi.



Herbert J. Reich (A'26-M'41) was born on October 25, 1900, at Staten Island, N. Y. He received the M.E. degree from



HERBERT J. REICH

Cornell University in 1924 and the Ph.D. degree in physics in 1928. He was an instructor in machine design at Cornell University during 1924 and 1925; instructor in physics, Cornell University, from 1925-1929; assistant professor of electrical engineering, University of Illinois from 1929 to 1936; and associate professor from 1936 to 1939 when he was made a professor. He is the author of "Theory and Applications of Electron Tubes" and "Principles of Electron Tubes." Mr. Reich is a member of the American Physical Society and the American Association for the Advancement of Science and others.



Albert Rose (A'36-M'40) was born in New York City on March 30, 1910. He received the A.B. degree from Cornell University in 1931 and the Ph.D. degree in physics in 1935. From 1931 to 1934 he was a teaching assistant at Cornell University and since 1935 he has been a member of the research laboratories, RCA Radiotron Division of the RCA Manufacturing Company. Dr. Rose is a member of Sigma Xi.



ALBERT ROSE



7 SPECIAL-PURPOSE TUBES

Having WAR EQUIPMENT APPLICATIONS

**COMBINING SMALL SIZE WITH EXCEPTIONAL RUGGED-
NESS AND OUTSTANDING HIGH-FREQUENCY PERFORMANCE
FOR BOTH TRANSMITTING AND RECEIVING USES**

Incorporating requisite mechanical ruggedness with small size, these RCA miniature and acorn-type tubes have been specifically designed for Transmitter and other applications where good high-frequency performance must be combined with extreme portability. Although catalogued here for the first time, the tubes

have been thoroughly tested and proved, and are now being supplied for war equipment use on suitable priorities.

Complete descriptions and operating characteristics for each of the seven tubes are given in the following tabulations of technical data.

RCA-9004

U-H-F DIODE
Acorn Type (Tentative Data)

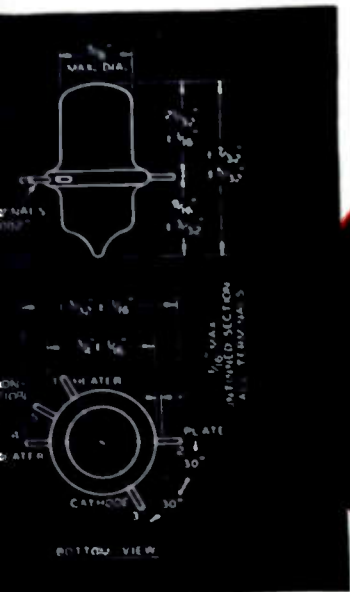

RCA-9005

U-H-F DIODE
Acorn Type (Tentative Data)

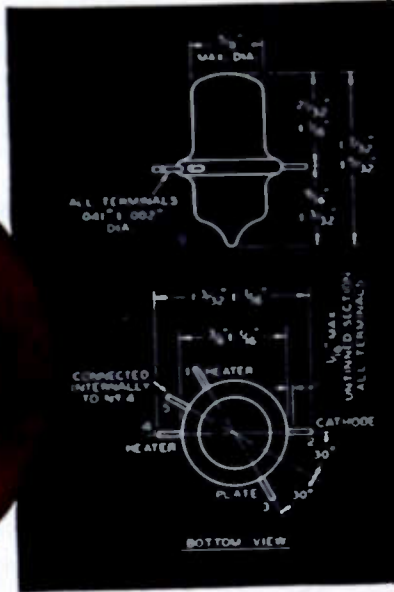

The 9004 is a heater-cathode type of Acorn diode suitable for use as a detector, mixer, or measuring device in u-h-f circuits. The resonant frequency of the 9004 is approximately 850 megacycles.

HEATER VOLTAGE (A.C. or D.C.)	6.3	Volts
HEATER CURRENT	0.15	Ampere
DIRECT INTERELECTRODE CAPACITANCES:		
Plate to Cathode	1.3	μf
Plate to Heater	0.3 approx.	μf
Heater to Cathode	2.2 approx.	μf
OVERALL LENGTH	1 1/2" \pm 1/32"	
OVERALL DIAMETER	1 1/8" \pm 1/32"	
BULB	T-4 1/2	
RCA SOCKET	Stock No. 9925	
MOUNTING POSITION	Any	

RECTIFIER

Maximum Ratings Are Based on a Line-Voltage Design Center of 117 Volts
A-C PLATE VOLTAGE (RMS) 117 max. Volts
D-C OUTPUT CURRENT 5 max. Milliamperes

The 9005 is a heater-cathode type of Acorn diode suitable for use as a detector, mixer, or measuring device in u-h-f circuits. The resonant frequency of the 9005 is approximately 1500 megacycles.

HEATER VOLTAGE (A.C. or D.C.)	3.6	Volts
HEATER CURRENT	0.165	Ampere
DIRECT INTERELECTRODE CAPACITANCES:		
Plate to Cathode	0.8	μf
Plate to Heater	0.2 approx.	μf
Heater to Cathode	1.1 approx.	μf
OVERALL LENGTH	1 1/2" \pm 1/32"	
OVERALL DIAMETER	1 1/8" \pm 1/32"	
BULB	T-4 1/2	
RCA SOCKET	Stock No. 9925	
MOUNTING POSITION	Any	

RECTIFIER

Maximum Ratings Are Based on a Line-Voltage Design Center of 117 Volts
A-C PLATE VOLTAGE (RMS) 117 max. Volts
D-C OUTPUT CURRENT 1.0 max. Milliamperes



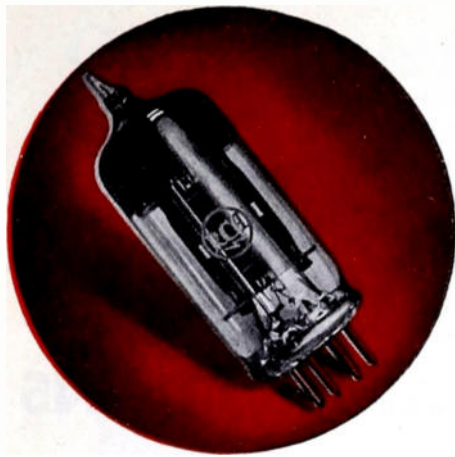

RCA 6C4

H-F POWER TRIODE

Miniature Type (Tentative Data)

The 6C4 is a heater-cathode type of Miniature tube intended for use as class C amplifier and oscillator in compact, light-weight, portable equipment, but it is useful in other applications where a medium-mu miniature triode with high transconductance is desired. In class C service, the 6C4 will deliver a power output of about 5.5 watts at moderate frequencies, and 2.5 watts at 150 megacycles. The heater is designed to operate at 6.3 volts, 0.15 ampere.

HEATER VOLTAGE (A.C. or D.C.)†	6.3	Volts
HEATER CURRENT	0.15	Amp.
DIRECT INTERELECTRODE CAPACITANCES:*		
Grid to Plate (C _{gp})	1.6	μf
Grid to Cathode [C _g (h + k)]	1.8	μf
Plate to Cathode [C _p (h + k)]	1.3	μf
MAXIMUM OVERALL LENGTH	2 1/8"	
MAXIMUM SEATED HEIGHT	1 1/8"	
MAXIMUM DIAMETER	3/4"	
BULB	T-5 1/2	
BASE	Miniature Button 7-Pin	
MOUNTING POSITION	Any	

* With no external shield.

A-F AMPLIFIER

PLATE VOLTAGE	300 max.	Volts
PLATE DISSIPATION	3.5 max.	Watts

Characteristics—Class A₁ Amplifier:

Plate Voltage	100	250	Volts
Grid Voltage**	0	-8.5	Volts
Amplification Factor	19.5	17	
Plate Resistance (Approx.)	6250	7700	Ohms
Transconductance	3100	2200	μmhos
Plate Current	11.8	10.5	Ma.

** The type of input coupling used should not introduce too much resistance in the grid circuit. Transformer- or impedance-coupling devices are recommended. Under maximum rated conditions, the resistance in the grid circuit should not exceed 0.25 megohm with fixed bias, or 1.0 megohm with cathode bias.

R-F POWER AMPLIFIER & OSCILLATOR— CLASS C TELEGRAPHY

D-C PLATE VOLTAGE	300 max.	Volts
D-C GRID VOLTAGE	-50 max.	Volts
D-C PLATE CURRENT	25 max.	Ma.
D-C GRID CURRENT	8 max.	Ma.
PLATE DISSIPATION	5 max.	Watts

Typical Operation†

D-C Plate Voltage	300	Volts
D-C Grid Voltage	-27	Volts
D-C Plate Current	25	Ma.
D-C Grid Current (Approx.)	7	Ma.
Driving Power (Approx.)	0.35	Watt
Power Output (Approx.)	5.5	Watts

† Approximately 2.5 watts can be obtained when the 6C4 is used at 150 Mc as an oscillator with grid resistor of 10,000 ohms and maximum rated input.

‡ In circuits where the cathode is not directly connected to the heater, the potential difference between

heater and cathode should be kept as low as possible. Ratings are to be interpreted according to RMA Standard M8-210 (Jan. 8, 1940 Rev. 11-40).

‡ The center hole in sockets designed for this base provides for the possibility that this tube type may be manufactured with the exhaust-tube tip at the base end. For this reason, it is recommended that in equipment employing this tube type, no material be permitted to obstruct the socket hole.

BOTTOM VIEW OF SOCKET CONNECTIONS

- Pin 1—Plate
- Pin 2—Internal Connection
- Pin 3—Heater
- Pin 4—Heater
- Pin 5—Plate
- Pin 6—Grid
- Pin 7—Cathode

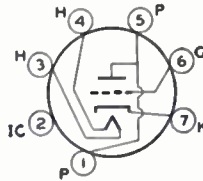

RCA 1L4

R-F AMPLIFIER PENTODE

Miniature Type (Tentative Data)

The 1L4 is an r-f pentode of the Miniature type with a sharp cut-off characteristic. It is recommended for use wherever a sharp cut-off pentode is required in compact, light-weight, portable receivers. The tube is, therefore, of interest in FM receivers and other circuits not requiring avc. The 1L4 features internal shielding which eliminates the need for an external bulb shield, but a socket with shielding is essential if minimum grid-plate capacitance is to be obtained.

FILAMENT VOLTAGE (D.C.)	1.4	Volts
FILAMENT CURRENT	0.05	Amp.
DIRECT INTERELECTRODE CAPACITANCES:*		
Grid to Plate [C _{g1p}]	0.008 max.	μf
Input [C _{g1} (f & g ₂ & internal shield + g ₂)]	3.6	μf
Output [C _p (f & g ₂ & internal shield + g ₂)]	7.5	μf
MAXIMUM OVERALL LENGTH	2 1/8"	
MAXIMUM SEATED HEIGHT	1 1/8"	
MAXIMUM DIAMETER	3/4"	
BULB	T-5 1/2	
BASE	Miniature Button 7-Pin	
MOUNTING POSITION	Any	

* With no external shield.

AMPLIFIER

PLATE VOLTAGE	110 max.	Volts
SCREEN VOLTAGE (Grid No. 2)	90 max.	Volts
SCREEN SUPPLY VOLTAGE	110 max.	Volts
GRID VOLTAGE (Grid No. 1)	0 min.	Volts
TOTAL CATHODE CURRENT	6.5 max.	Ma.

Typical Operating Conditions and Characteristics —Class A₁ Amplifier:

Plate Voltage	90	90	Volts
Screen Voltage	67.5	90	Volts
Grid Voltage	0	0	Volts
Plate Resistance	0.6	0.35	Meg.
Transconductance	925	1025	μmhos

Grid Bias for Plate Current

=10 μamp.	-6	-8	Volts
Plate Current	2.9	4.5	Ma.
Screen Current	1.2	2.0	Ma.

Ratings are to be interpreted according to RMA Standard M8-210 (Jan. 8, 1940 Rev. 11-40).

‡ See RCA 6C4

BOTTOM VIEW OF SOCKET CONNECTIONS

- Pin 1—Filament (-), Grid No. 3, Internal Shield
- Pin 2—Plate
- Pin 3—Screen
- Pin 4—No Connection
- Pin 5—Filament (-), Grid No. 3, Internal Shield
- Pin 6—Grid
- Pin 7—Filament (+)

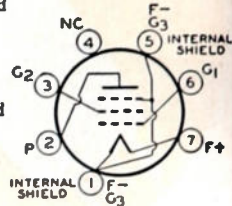

RCA 1A3

H-F DIODE

Midget Type (Tentative Data)

The 1A3 is a heater-cathode type of Midget diode particularly useful as a discriminator tube in portable FM receivers, and in portable high-frequency measuring equipment. Its interelectrode capacitances are very low, being in the order of 0.5 micro-micro-farad. The resonant frequency of the 1A3 is approximately 1000 megacycles. The glass button base provides short leads and low lead inductance.

HEATER VOLTAGE (A.C. or D.C.)	1.4	Volts
HEATER CURRENT	0.15	Amp.
DIRECT INTERELECTRODE CAPACITANCES		

(Approx.):*		
Plate to Cathode (C _{pk})	0.4	μf
Plate to Heater (C _{ph})	0.6	μf
Heater to Cathode (C _{hk})	0.6	μf
MAXIMUM OVERALL LENGTH	1 1/8"	
MAXIMUM SEATED HEIGHT	1 1/8"	
MAXIMUM DIAMETER	3/4"	
BULB	T-5 1/2	
BASE	Miniature Button 7-Pin	
MOUNTING POSITION	Any	

* With no external shield.

RECTIFIER

A-C PLATE VOLTAGE (RMS)	117 max.	Volts
D-C OUTPUT CURRENT	0.5 max.	Ma.

Ratings are to be interpreted according to RMA Standard M8-210 (Jan. 8, 1940 Rev. 11-40)

‡ See RCA 6C4

BOTTOM VIEW OF SOCKET CONNECTIONS

- Pin 1—Heater
- Pin 2—Plate
- Pin 3—Cathode
- Pin 4—No Connection
- Pin 5—No Connection
- Pin 6—Plate
- Pin 7—Heater

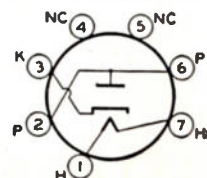

SPECIAL-PURPOSE TUBE DATA



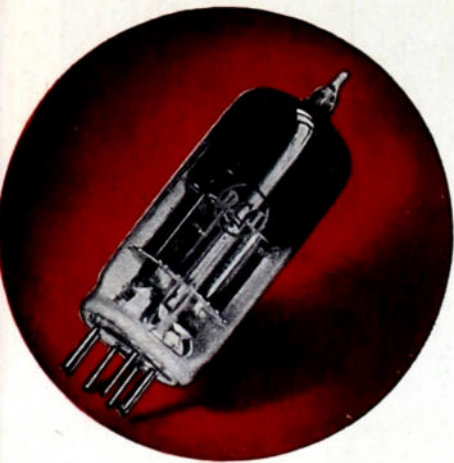

RCA 3A4

POWER AMPLIFIER

PENTODE

Miniature Type (Tentative Data)

The 3A4 is a Miniature type of power amplifier pentode designed for use in compact, light-weight, portable equipment. The relatively large filament employed in the 3A4 enables it to supply the high peak currents required in r-f power applications. In r-f amplifier service, the 3A4 will deliver a power output of about 1.2 watts at 10 megacycles. The filament of the 3A4 can be operated either with series connection on 2.8 volts or parallel connection on 1.4 volts.

	Series Filament Arrangement*	Parallel Filament Arrangement**	
FILAMENT VOLTAGE (D.C.)	2.8	1.4	Volts
FILAMENT CURRENT	0.1	0.2	Amp.
DIRECT INTERELECTRODE CAPACITANCES:†			
Grid to Plate (C _{gp})			0.2 max. μf
Input [C _{g1} (f & g ₁ + g ₂)]			4.8 μf
Output [C _p (f & g ₁ + g ₂)]			4.2 μf
MAXIMUM OVERALL LENGTH			2 1/8"
MAXIMUM SEATED HEIGHT			1 1/2"
MAXIMUM DIAMETER			3/4"
BULB			T-5 1/2
BASE			Miniature Button 7-Pin†
MOUNTING POSITION			Any

A-F POWER AMPLIFIER

PLATE VOLTAGE	150 max.	Volts
SCREEN VOLTAGE	90 max.	Volts
PLATE DISSIPATION	2 max.	Watts
SCREEN DISSIPATION	0.4 max.	Watt
TOTAL ZERO-SIGNAL CATHODE CURRENT††	18 max.	Ma.

Typical Operating Conditions and Characteristics
— Class A₁ Amplifier †

	Parallel Filament Arrangement*	
Plate Voltage	135	Volts
Screen Voltage (Grid No. 2)	90	Volts
Grid Voltage (Grid No. 1)	-7.5	-8.4 Volts
Peak A-F Grid Voltage	7.5	8.4 Volts
Zero-Signal Plate Current	14.8	13.3 Ma.
Max.-Signal Plate Current	14.9	14.1 Ma.
Zero-Signal Screen Current	2.6	2.2 Ma.
Max.-Signal Screen Current	3.5	3.5 Ma.
Plate Resistance	90,000	100,000 Ohms
Transconductance	1900	1900 μmhos
Load Resistance	8000	8000 Ohms
Total Harmonic Distortion	5	6 %
Max.-Signal Power Output	0.6	0.7 Watt

R-F POWER AMPLIFIER

D-C PLATE VOLTAGE	150 max.	Volts
D-C SCREEN VOLT. (Grid No. 2)	135 max.	Volts
D-C GRID VOLT. (Grid No. 1)	-30 max.	Volts
D-C PLATE CURRENT	20 max.	Ma.
D-C GRID CURRENT	0.25 max.	Ma.
TOTAL D-C CATH. CURRENT††	25 max.	Ma.
PLATE INPUT	3 max.	Watts
SCREEN INPUT	0.9 max.	Watt
PLATE DISSIPATION	2 max.	Watts

Typical Operation †

	Parallel Filament Arrangement**	
D-C Plate Voltage	150	Volts
D-C Screen Voltage	135	Volts
Grid Resistor	0.2	Meg.
D-C Plate Current	18.3	Ma.
D-C Screen Current	6.5	Ma.
D-C Grid Current	0.13	Ma.
Power Output (Approx.)	1.2	Watts

* Filament voltage applied across the two sections in series between pins No. 1 and No. 7. Grid voltage is referred to pin No. 1.

** Filament voltage applied across the two sections in parallel between pin No. 5 and pins No. 1 and No. 7 connected together. Grid voltage is referred to pin No. 5.

†† For series-filament operation, a shunting resistor must be connected across the section between pins No. 1 and No. 5 to by-pass excess cathode current in this section. The value of the shunting resistor should be adjusted to make the voltage across the shunted section equal to the voltage across the section between pins No. 5 and No. 7. When other tubes in series-filament arrangement contribute to the filament current of the 3A4, an additional shunting resistor may be required between pins No. 1 and No. 7.

‡ Typical operating values for the 3A4 with filament sections in series will be approximately the same as those shown for parallel-filament operation. Ratings are to be interpreted according to RMA Standard M8-210 (Jan. 8, 1940 Rev. 11-40).

† See RCA 6C4

BOTTOM VIEW OF SOCKET CONNECTIONS

- Pin 1—Filament (— for series operation)
- Pin 2—Plate
- Pin 3—Screen
- Pin 4—Grid
- Pin 5—Filament Mid-Tap (— for parallel operation), Grid No. 3
- Pin 6—Plate
- Pin 7—Filament (+)

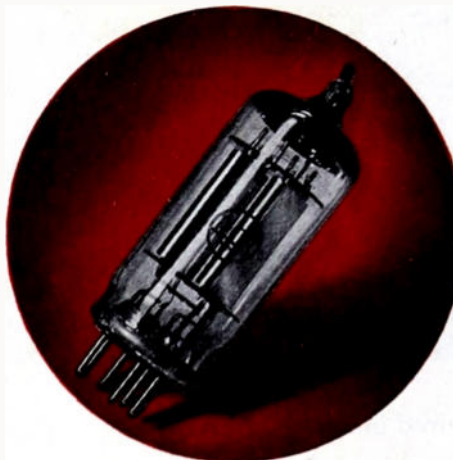
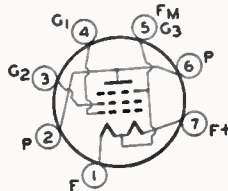

RCA 3A5

H-F TWIN TRIODE

Miniature Type (Tentative Data)

The 3A5 is a twin triode of the Miniature type intended for use in high-frequency applications. The relatively large filament employed in the 3A5 enables it to supply the high peak currents required in r-f power applications. In class C service, a 3A5 with its units in push-pull will deliver a power output of approximately 2 watts at 40 megacycles. It may be used at still higher frequencies with reduced efficiency. Each triode may be used independently of the other. The filament of the 3A5 can be operated

either with series connection on 2.8 volts or parallel connection on 1.4 volts.

	Series Filament Arrangement*	Parallel Filament Arrangement**	
FILAMENT VOLTAGE (D.C.)	2.8	1.4	Volts
FILAMENT CURRENT	0.11	0.22	Amp.
DIRECT INTERELECTRODE CAPACITANCES:†			
	Triode Unit	Triode Unit	
	T ₁	T ₂	

Grid to Plate (C _{gp})	3.2	3.2	μf
Grid to Filament (C _{gf})	0.9	0.9	μf
Plate to Filament (C _{pf})	1.0	1.0	μf
Plate to Plate (C _{ptpta})	0.32		μf
MAXIMUM OVERALL LENGTH			2 1/8"
MAXIMUM SEATED HEIGHT			1 1/2"
MAXIMUM DIAMETER			3/4"
BULB			T-5 1/2
BASE			Miniature Button 7-Pin†
MOUNTING POSITION			Any

† With no external shield.

A-F AMPLIFIER—Each Unit

PLATE VOLTAGE	135 max.	Volts
PLATE CURRENT	5 max.	Ma.
PLATE DISSIPATION	0.5 max.	Watt

Characteristics—Class A₁ Amplifier

Plate Voltage	90	Volts
Grid Voltage	-2.5	Volts
Amplification Factor	15	
Plate Resistance	8300	Ohms
Transconductance	1800	μmhos
Plate Current	3.7	Ma.

R-F POWER AMPLIFIER & OSCILLATOR— CLASS C TELEGRAPHY

D-C PLATE VOLTAGE	135 max.	Volts
D-C GRID VOLTAGE	-30 max.	Volts
D-C PLATE CURRENT (per unit)	15 max.	Ma.
D-C GRID CURRENT (per unit)	2.5 max.	Ma.
PLATE INPUT (per unit)	2.0 max.	Watts
PLATE DISSIPATION (per unit)	1.0 max.	Watt

Typical Operation at 40 Mc with Both Units:

Push-Pull Power Amplifier & Oscillator

(Key-down conditions per tube without modulation)		
D-C Plate Voltage	135	Volts
D-C Grid Voltage		
From a fixed supply of	-20	Volts
From a grid resistor of	4000	Ohms
From a cathode resistor of	570	Ohms
Peak R-F Grid-to-Grid Voltage	90	Volts
D-C Plate Current	30	Ma.
D-C Grid Current (Approx.)	5	Ma.
Driving Power (Approx.)	0.2	Watt
Power Output (Approx.)	2	Watts

* Filament voltage applied across the two sections in series between pins No. 1 and No. 7. Grid voltage is referred to pin No. 1. For series-filament operation, a shunting resistor must be connected across the section between pins No. 1 and No. 4 to by-pass excess cathode current in this section. The value of the shunting resistor should be adjusted to make the voltage across the shunted section equal to the voltage across the section between pins No. 4 and No. 7. When other tubes in series-filament arrangement contribute to the filament current of the 3A5, an additional shunting resistor may be required between pins No. 1 and No. 7.

** Filament voltage applied across the two sections in parallel between pin No. 4 and pins No. 1 and No. 7 connected together. Grid voltage is referred to pins No. 1 and No. 7 tied together.

† Ratings are to be interpreted according to RMA Standard M8-210 (Jan. 8, 1940 Rev. 11-40).

† See RCA 6C4

BOTTOM VIEW OF SOCKET CONNECTIONS

- Pin 1—Filament (—)
- Pin 2—Plate (Triode T₁)
- Pin 3—Grid (Triode T₂)
- Pin 4—Filament Mid-Tap (+ for parallel operation)
- Pin 5—Grid (Triode T₁)
- Pin 6—Plate (Triode T₁)
- Pin 7—Filament (+ for series operation)

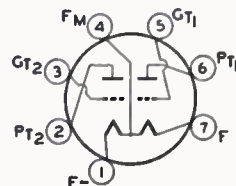

RCA MANUFACTURING CO., INC.
CAMDEN, NEW JERSEY

(NOTE: For additional copies of literature on these tubes, address RCA, Commercial Engineering Section, Harrison, N. J.)

SPECIAL-PURPOSE TUBE DATA

INTRICATE CERAMIC PARTS

PRODUCED WITHOUT SPECIAL TOOLS

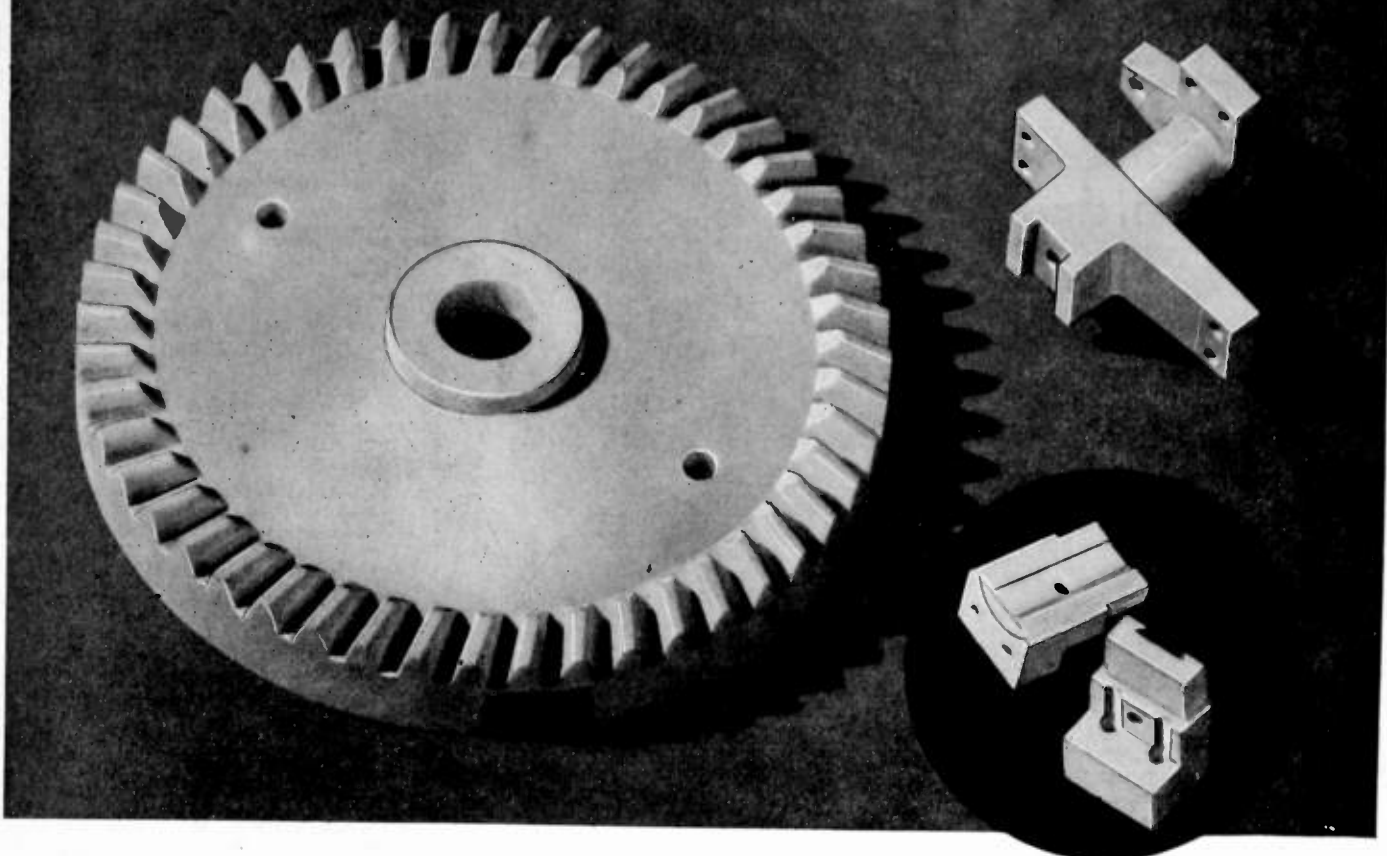

WHEN special ceramic parts are required in small quantities for vital wartime applications, the adaptability of Isolantite* to the production of intricate shapes is a feature of major importance.

Through years of experience in the manufacture of steatite ceramics, Isolantite Inc. has developed fabricating techniques that permit the production of intricate shapes without the necessity of providing expensive special tools. In addition, Isolantite's manufacturing processes permit extremely close dimensional tolerances as compared with general ceramic requirements. Critical dimensions can be held within close limits to facilitate equipment assembly.

Suitability for the production of intricate shapes to accurate dimensions is only one of Isolantite's many advantages. Uniformity of product, high mechani-

cal strength, electrical efficiency, nonabsorption of moisture—these factors all contribute to dependable insulation performance. Because of its unique combination of properties in a single ceramic body, Isolantite is the choice of leading manufacturers, not only in the high-frequency fields, but for all applications where high-grade insulation is required in intricate shapes.

ISOLANTITE

CERAMIC INSULATORS

ISOLANTITE INC., BELLEVILLE, NEW JERSEY

*Registered trade-name for the products of Isolantite Inc.

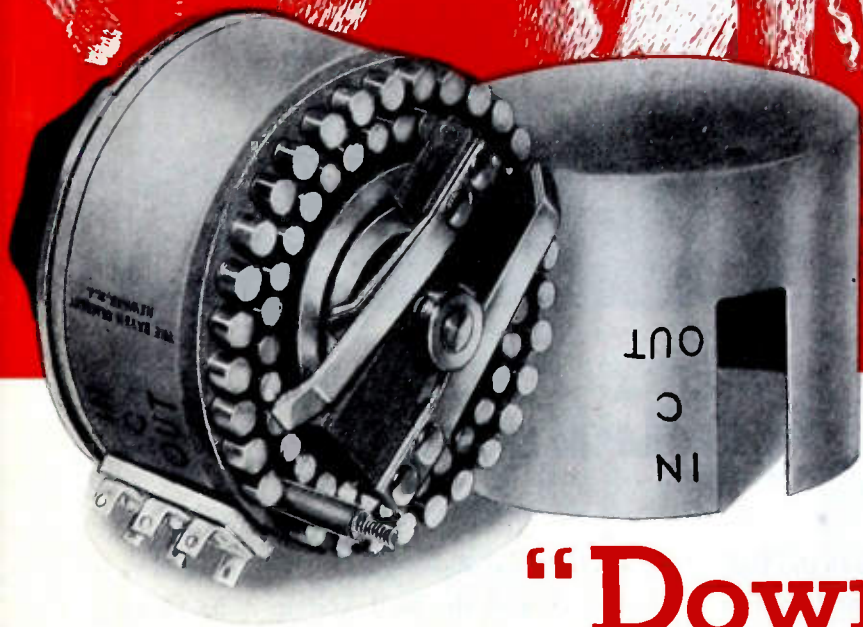

“Down-to-Earth”

Because every effort in the design and construction of DAVEN components and equipment has always been devoted toward the one, elementary objective: **efficient operation**, our products are universally recognized for their absolute dependability.

Where performance is the prime consideration, specify DAVEN attenuators.

THE DAVEN COMPANY

158 SUMMIT STREET

NEWARK, NEW JERSEY



A Message of Confidence

THE war has brought many changes to the Bell System. The nation needed telephone facilities in new places. It needed more facilities in the usual places. It needed all facilities in a hurry.

Shortages of essential materials brought new problems and new achievements in research and in manufacturing. Telephone calls increased about ten million a day.

Yet all this has been done without great change in your telephone service. Millions of subscribers have felt no difference. The record

as a whole has been good. That is the way it should be and the Bell System aims to keep it that way.

But when war needs delay your call, when you can't get just the service or equipment you need, let's put the blame right where it belongs — on the war.

BELL TELEPHONE SYSTEM



SERVICE TO THE NATION IN PEACE AND WAR



CORNERSTONE FOR V + 2*

Some year the war will end.

There will be a swing back to the things we buy because we want them, not because they are a grim necessity. Today's work is to win the war. Executives now driving for all-out production should also be planning for V + 2. Products for tomorrow should be designed today.

For every new product, the cornerstone is Research. The Research

Division of American Lava Corporation is outstanding in its field. It welcomes any call for cooperation in planning for today's production . . . or for long range planning for the insulation of the future.

Meanwhile, for 1942 and as far as we can see, we pledge our utmost efforts to supply our customers with the best in steatite ceramic compositions as rapidly as possible under wartime conditions.

* 2 years after Victory, probable time required to resume full peacetime production. (Bouquets to the G. E. executive who coined this expression.)

ALSIMAG
Trade Mark Reg. U. S. Pat. Off.

AMERICAN LAVA CORPORATION

CHATTANOOGA, TENNESSEE

CHICAGO • CLEVELAND • NEW YORK • ST. LOUIS • LOS ANGELES • SAN FRANCISCO • BOSTON • PHILADELPHIA • WASHINGTON, D. C.

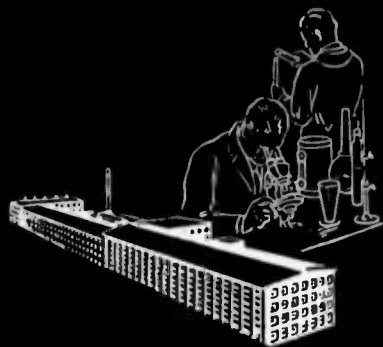

The more exacting your capacitor problem, the better we like it. Since the beginning of Radio, the Sprague reputation has been based on the ability to supply finer units to particular users.

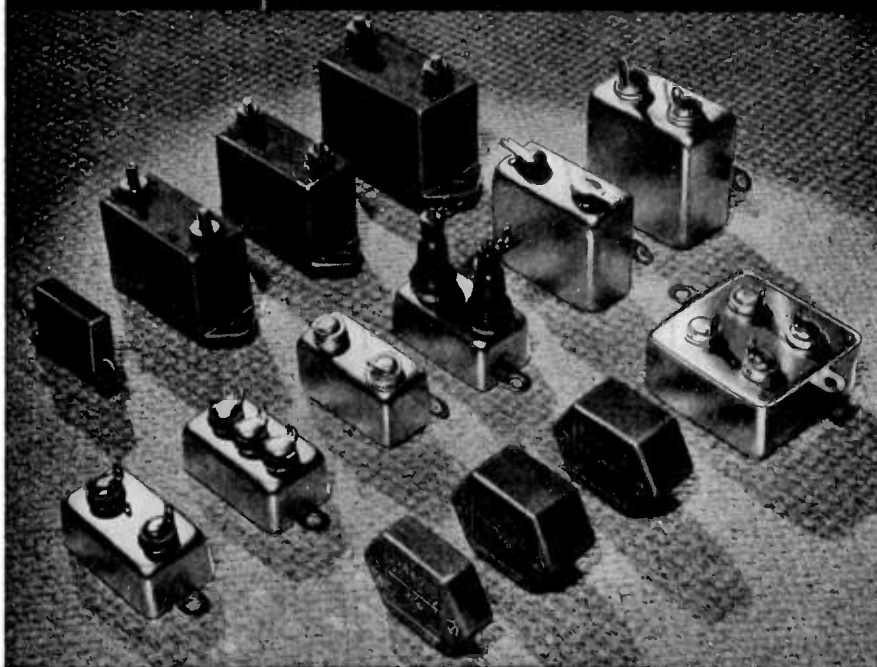

The particular Sprague condenser types illustrated are widely used in exacting Army and Navy applications.

SPRAGUE

CONDENSERS—KOOLOHM RESISTORS

Quality Components • Expertly Engineered • Competently Produced

SPRAGUE SPECIALTIES COMPANY, NORTH ADAMS, MASS.

THE INSTITUTE serves those interested in radio and allied electrical communication fields through the presentation and publication of technical material.

THE PROCEEDINGS has been published without interruption since 1913 when the first issue appeared. The contents of each paper published in the **PROCEEDINGS** are the responsibility of the author and are not binding on the Institute or its members. Material appearing in it may be reprinted or abstracted in other publications on the express condition that specific reference shall be made to its original appearance in the **PROCEEDINGS**. Illustrations of any variety, however, may not be reproduced without specific permission from the Institute.

STANDARDS reports are published from time to time and are sent to each member without charge. The four current reports are on Electroacoustics, Electronics Radio Receivers, and Radio Transmitters and were published in 1938.

MEMBERSHIP has grown from a few dozen in 1912 to about seven thousand. Practically every country in the world in which radio engineers may be found is represented in our roster. Dues for the five grades of membership range from \$3.00 to \$10.00 per year. The **PROCEEDINGS** is sent to each member without further payment.

SECTIONS in twenty-six cities in the United States, Canada, and Argentina hold regular meetings. The chairmen and secretaries of these sections are listed on the page opposite the first article in this issue.

SUBSCRIPTIONS are accepted for the **PROCEEDINGS** at \$10.00 per year in the United States of America, its possessions, and Canada; when college and public libraries order direct from the Institute, the subscription price is \$5.00. For other countries there is an additional charge of \$1.00.

The Institute of Radio Engineers, Inc.
Harold P. Westman, Secretary
330 West 42nd Street
New York, N.Y.

The Institute of Radio Engineers

Incorporated

330 West 42nd Street, New York, N.Y.

To the Board of Directors

Gentlemen:

I hereby make application for ASSOCIATE membership in the Institute of Radio Engineers on the basis of my training and professional experience given herewith, and refer to the sponsors named below who are personally familiar with my work.

I certify that the statements made in the record of my training and professional experience are correct, and agree if elected, that I shall be governed by the Constitution of the Institute as long as I continue a member. Furthermore I agree to promote the objects of the Institute so far as shall be in my power.

.....
(Sign with pen)

.....
(Address for mail)

.....
(City and State)

.....
(Date)

SPONSORS

(Signatures not required here)

Mr.

Address

City and State

Mr.

Address

City and State

Mr.

Address

City and State

REMITTANCE SCHEDULE

MONTH DURING WHICH APPLICATION REACHES I.R.E. HEADQUARTERS	AMOUNT OF REMITTANCE (= ENTRANCE FEE + DUES) WHICH SHOULD ACCOMPANY APPLICATION	PERIOD COVERED BY DUES PAYMENT
GRADE →	ASSOCIATE	
Jan., Feb.	\$7.50 (= \$3 + \$4.50*)	Apr.-Dec. (9 mo. of current year)†
Mar., Apr., May	6.00 (= 3 + 3.00*)	July-Dec. (6 mo. of current year)†
June, July, Aug.	4.50 (= 3 + 1.50*)	Oct.-Dec. (3 mo. of current year)†
Sept., Oct., Nov.	9.00 (= 3 + 6.00*)	Jan.-Dec. (entire next year)†
Dec.	7.50 (= 3 + 4.50*)	Apr.-Dec. (9 mo. of next year)†

† You can obtain the PROCEEDINGS for the entire year by including with your application a request to that effect and a remittance of \$9.00.
 * Associate dues include the price of the PROCEEDINGS, as follows: 1 year, \$5.00; 9 months, \$3.75; 6 months, \$2.50; 3 months, \$1.25. This may not be deducted from the dues payment.

TO APPLY FOR ASSOCIATE MEMBERSHIP

To Qualify for Associate membership, an applicant must be at least 21 years of age, of good character, and be interested in or connected with the study or application of radio science or the radio arts.

An Application should be filed, preferably on blanks obtainable on request from I.R.E. Headquarters or from the secretary of your local Section. If more convenient, however, the accompanying abbreviated form may be submitted. Additional information will be requested later on.

Sponsors who are familiar with the work of the applicant must be named. There must be three, preferably Associates, Members, or Fellows of the Institute. Where the applicant is so located as not to be known to the required number of member sponsors, the names of responsible nonmembers may be given.

Entrance Fee and Dues: The Associate entrance fee is \$3.00. Annual dues are \$6.00 per year, which include the price of the PROCEEDINGS as explained in the accompanying remittance schedule.

Remittance: Even though the I.R.E. Constitution does not require it, you will benefit by enclosing a remittance with your application. We can then avoid delaying the start of your PROCEEDINGS.

Your PROCEEDINGS will start with the next issue after your election, if you enclose your entrance fee and dues as shown by the totals in the accompanying remittance schedule. Any extra copies sent in advance of the period for which you pay dues (see last column) are covered by your entrance fee.

Should you fail to be elected, your entire remittance will be returned.

OTHER GRADES are available to qualified applicants. Those who are between the ages of eighteen and twenty-one may apply for Junior grade. Student membership is for full-time students in engineering or science courses in colleges granting degrees as a result of a four-year course. A special application blank is provided and requires the signature of a faculty member as the sole sponsor. Member grade is open to older engineers with several years of experience. Fellow grade is by invitation only. Information and application blanks for these grades may be obtained from the Institute.

SUPPLIES

BACK COPIES of the PROCEEDINGS may be purchased at \$1.00 per copy where available. Members of the Institute in good standing are entitled to a twenty-five per cent discount.

VOLUMES, bound in blue buckram, may be purchased for \$14.25; \$11.25 to members.

BINDERS are \$1.50 each. The volume number or the member's name will be stamped in gold for fifty cents additional.

INSTITUTE EMBLEMS of fourteen-carat gold with gold lettering on an enameled background are available. The lapel button is \$2.75; the lapel pin with safety catch is \$3.00; and the watch charm is \$5.00. All of these are mailed postpaid.

(Typewriting preferred in filling in this form) No.

RECORD OF TRAINING AND PROFESSIONAL EXPERIENCE

Name
 (Give full name, last name first)

Present Occupation
 (Title and name of concern)

Business Address

Home Address

Place of Birth Date of Birth Age

Education

Degree
 (College) (Date received)

TRAINING AND PROFESSIONAL EXPERIENCE
 (Give dates and type of work, including details of present activities)

.....

.....

.....

.....

.....

.....

.....

.....

.....

.....

Record may be continued on other sheets this size if space is insufficient.

Receipt Acknowledged Elected Notified

ROUND CAN OIL-FILLED Capacitors

● Careful choice of paper, foil, the exclusive Hyvol dielectric oil and conservative design, have kept step with the steady trend towards higher working voltages and longer hours of gruelling service in the radio and electronic fields. These hermetically-sealed round-can oil-filled capacitors are widely used today. And their performance records truly speak for themselves.

AEROVOX TYPE '10

Designed for inverted screw mounting with can grounded. May be insulated from metal chassis if preferred, by means of insulating washer. Extremely compact for use in crowded assemblies. As convenient to install as usual metal-can electrolytics. 600, 1000 and 1500 v. D.C.W.

AEROVOX TYPE '12

Available in higher voltages than other standard Hyvol types. For use especially in cathode-ray tube circuits. New high-voltage molded cover with insulating barriers and pillar terminals, reduces surface leakage and danger of flashover. Adjustable ring mounting, upright or inverted. 2000, 3000, 4000, 6000 and 7500 v. D.C.W.

AEROVOX TYPE '14

Grounded can with single pillar terminal. Adjustable ring mounting, upright or inverted. A neat, space-saver capacitor. 3000 v. D.C.W.

AEROVOX TYPE '05

The popular round-can high-voltage oil-filled capacitor. Tens of thousands in daily use. Pillar terminals. Adjustable ring mounting, upright or inverted. 600, 1000, 1500, 2000, 2500 and 3000 v. D.C.W.

Write for DATA . . .

Write on your business stationery for copy of latest catalog, listing these and other standard types of capacitors for all radio and electronic purposes. Submit that capacitance problem for engineering collaboration, specifications, recommendations, quotations.

NEW BEDFORD, MASS.,
U. S. A.
Sales Offices in All
Principal Cities

AEROVOX

CORPORATION



In Canada
AEROVOX CANADA LTD.
Hamilton, Ont.
EXPORT: 100 Varick St., N. Y.
Cable 'ARLAB'

COMPLETE YOUR FILES OF

PROCEEDINGS

of

The Institute of Radio Engineers

WHILE BACK ISSUES ARE STILL AVAILABLE

Now is the time to fill out the gaps on your *Proceedings* shelf and replace lost or borrowed copies. Already, more than 25% of all back numbers are no longer available. The following issues were in stock on September 1, 1941 and are available (subject, of course, to prior sale):

1913-1915 **Volumes 1-3** **QUARTERLY** **\$1.00 per copy**
1913 Vol. 1 Jan. (a reprint).

1916-1926 **Volumes 4-14** **BI-MONTHLY** **\$1.00 per copy**

1916	Vol. 4	Aug.	1922	Vol. 10	All 6 issues
1917	Vol. 5	Apr., June, Aug., Oct., Dec.	1923	Vol. 11	All 6 issues
1918	Vol. 6	Apr., June, Aug., Dec.	1924	Vol. 12	Aug., Oct., Dec.
1919	Vol. 7	Dec.	1925	Vol. 13	Apr., June, Aug., Oct., Dec.
1920	Vol. 8	Apr., June, Aug., Oct., Dec.	1926	Vol. 14	All 6 issues
1921	Vol. 9	All 6 issues			

1927-1941 **Volumes 15-29** **MONTHLY** **\$1.00 per copy**

1927	Vol. 15	Apr. to July, inc., Oct., Dec.	1936	Vol. 24	Jan. to April, inc., June
1928	Vol. 16	Feb. to Dec., inc.	1937	Vol. 25	Feb. to Dec., inc.
1929	Vol. 17	Apr. to June, inc., Aug., Nov.	1938	Vol. 26	All 12 issues <i>New Format—Large Size</i>
1930	Vol. 18	Jan., Apr. to Dec., inc.	1939	Vol. 27	Jan. to July, inc.
1931	Vol. 19	All 12 issues	1940	Vol. 28	All 12 issues
1932	Vol. 20	Jan., March to Dec., inc.	1941	Vol. 29	All 12 issues
1933	Vol. 21	All 12 issues.	1942	Vol. 30	Jan. to date
1934	Vol. 22	All 12 issues			
1935	Vol. 23	All 12 issues			

I.R.E. MEMBERS . . . PUBLIC AND COLLEGE LIBRARIES

I.R.E. members in good standing are entitled to a discount of 25% from the above prices. Information about discounts to accredited public and college libraries will be supplied on request.

POSTAGE

Prices include postage in the United States and Canada. Postage to other countries: 10 cents per copy.

Remittance should accompany your order

THE INSTITUTE OF RADIO ENGINEERS, Inc.
330 WEST 42nd STREET, NEW YORK, N. Y.

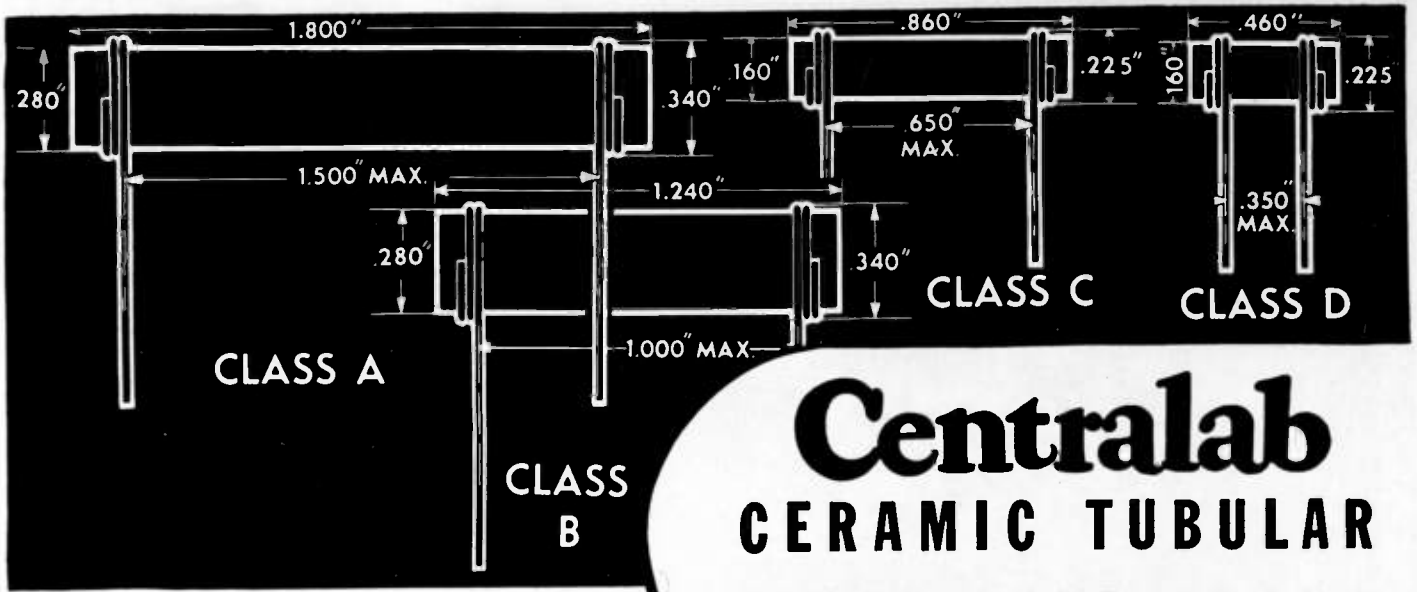

Centralab CERAMIC TUBULAR FIXED CAPACITORS

Write for Data

Bulletin 597 describes the CENTRALAB CERAMIC TUBULAR Fixed Capacitors with controlled temperature sensitive characteristics.

Centralab Ceramic Trimmers feature capacity ranges and stability, the equivalent of air trimmers, plus a saving in space and weight. Write for bulletins that supply full Ceramic Trimmer data.

Centralab CERAMIC TRIMMERS

Always specify Centralab — whether for ceramic products . . . Fixed Resistors . . . or Volume Controls . . .

CENTRALAB
DIV. OF GLOBE-UNION INC.
MILWAUKEE WISCONSIN

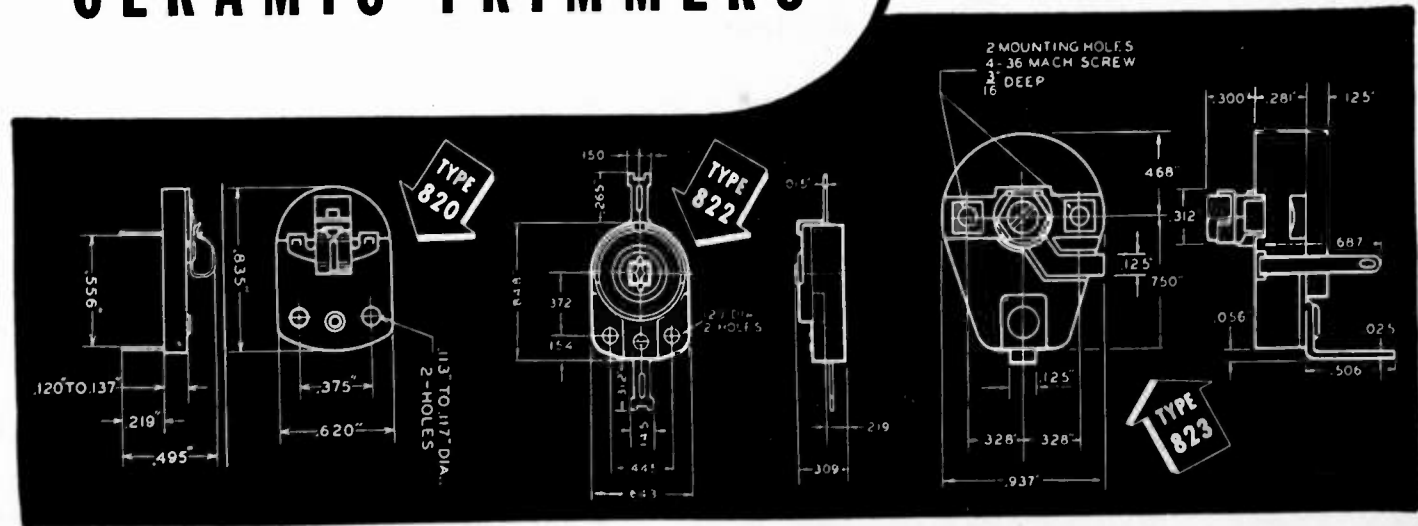

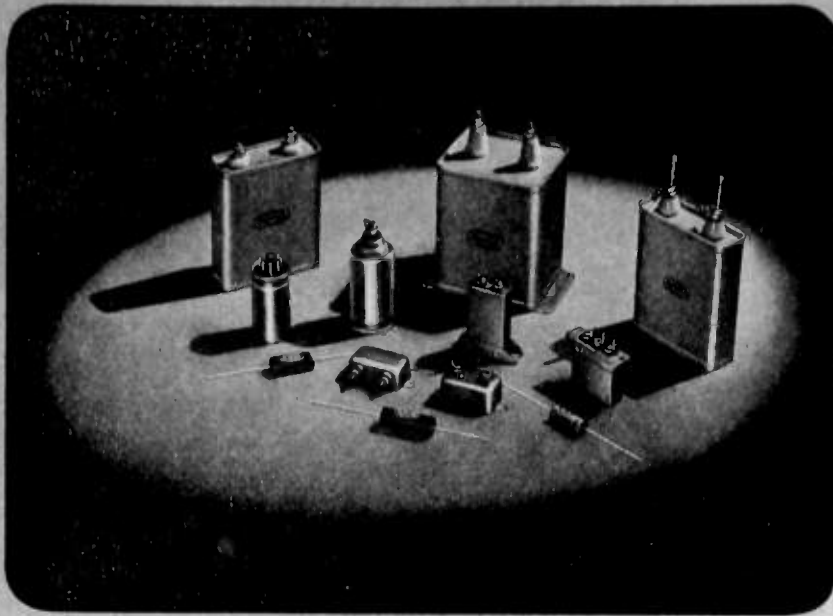

PAPER CAPACITORS - *at their best!*

Solar experience plays a vital part in the production of completely dependable paper capacitors for the Armed Service Branches of our Government.

Consult Solar for prompt solution of your paper capacitor problems

SOLAR MFG. CORP. . . . BAYONNE, N. J.



"QUALITY ABOVE ALL" CAPACITORS

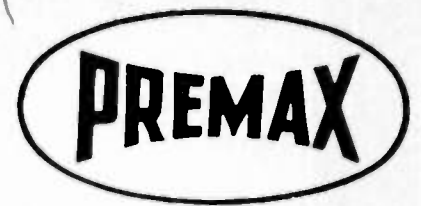

Antennas *are playing a leading role in America's war communications*

On land, at sea and at airports, as well as on mobile units, Premax Telescoping, Adjustable Antennas are maintaining communications under the most critical conditions.

In this all-out war emergency, Premax has enlisted its entire personnel, experience and resources in the manufacture of Aluminum, Monel and Steel Antennas. They are demonstrating their ability to meet requirements under most adverse conditions.

Send for catalog of standard Antennas and Mountings, or submit your specifications if special designs in fully telescoping and adjustable equipment is required.

Premax Products

Division of Chisholm-Ryder Co., Inc.

4215 Highland Ave., Niagara Falls, N.Y.

Proceedings of the I. R. E. June, 1942



Wanted: Future Faradays and Curies

ALL OVER AMERICA there are high school seniors . . . boys and girls . . . who have potential scientific ability and budding creative genius of a high order. These talents are latent . . . awaiting the opportunity for further development through higher education.

To provide this opportunity, Science Clubs of America, sponsored by Science Service, is now conducting an *Annual Science Talent Search* . . . made financially possible by Westinghouse. This Talent Search has three major objectives:

- 1. To discover and foster the education of boys and girls who possess exceptional scientific skill and ability.**
- 2. To focus the attention of large numbers of gifted youth on the need for perfecting their creative and research skill . . . as future contributions to winning the war and the peace to follow.**
- 3. To help make the American public aware of the role of science in war and in the post-war reconstruction.**

High school seniors, who enter the Science Talent Search competition, must take special examinations in their local schools to determine their aptitude for science, and must submit essays and school records.

Each year, forty winning contestants are to be given all-expense trips to Washington, D. C., during July where they will meet some of the country's foremost scientists, visit scientific institutions, and take part in scientific programs. While at the Nation's Capital, these embryo scientists will be given additional written and oral tests.

Judges will then select the two most talented youngsters . . . a boy and a girl . . . who will be awarded Westinghouse Grand Science Scholarships of \$2400 each. Additional Westinghouse Science Scholarships . . . each valued at \$200 . . . will be given to eighteen contestants.

By aiding the education of these gifted boys and girls today, we hope to help develop the scientists of tomorrow who will lead the way in the advancement of research and engineering.



Westinghouse

WESTINGHOUSE ELECTRIC AND MANUFACTURING COMPANY, PITTSBURGH, PENNSYLVANIA

THORDARSON

*Quality
Transformers*



TRANSFORMERS
FOR ALL USES. ASK
FOR FREE CATALOG
NO. 400 F. X.

Other catalogs available are No. 500, illustrating and describing many types of transformers for broadcast, aircraft, military and other communications uses; Catalog No. 600 covers the complete line of Thordarson amplifiers.

The Industrial Department will be glad to discuss with you special types of any characteristics, size or quantity.

THORDARSON

ELECTRIC MFG. CO.

500 WEST HURON STREET • CHICAGO, ILLINOIS

TRANSFORMER SPECIALISTS SINCE 1895

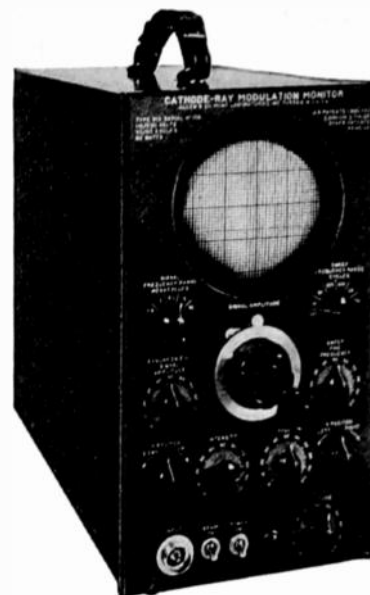

MONITORING

*For efficiency,
quality, coverage*

● DuMont Type 213-A Cathode-Ray Modulation Monitor is a "must" piece of equipment in safeguarding today's high broadcasting standards. Permits monitoring and study of radio-frequency transmissions, while eliminating necessity for connecting deflection plates of cathode ray tube to bulky externally-provided tuned circuits. In other words, it is entirely self-contained with its own resonant circuit tuned to transmitter frequency and coupled by means of low-impedance link to source of modulated radio frequency.

Modulated envelope or trapezoidal modulation patterns. Tuned circuit frequency range of from 400 kc to beyond 40 mc per second. Horizontal deflection effected either by internally-provided linear sweep circuit for modulated envelope type of study, or by audio-frequency voltage taken from transmitter modulator circuit.

This instrument is typical of DuMont cathode-ray oscillographs available for any laboratory, production, station or field requirements.

● Write for Literature . . .

DU MONT

ALLEN B. DU MONT
LABORATORIES, Inc.

Passaic ★ New Jersey

Cable Address: Wesplexin, New York

EXTRA STAMINA



HK 854
450 watt plate
dissipation
1800 watt
output

So great is the pounding of these speedy, torpedo firing mosquito boats that their men must be heavily padded and lashed to their stations. Every part, screw and fiber must have extra stamina if these craft are to carry through their mission successfully.

This kind of extra stamina is built into every GAMMATRON tube. Sturdy mechanical construction and ability to handle enormous electrical overload makes it possible for them always to complete their mission...even in the face of terrifying abuse.

Complete tantalum construction, special exhaust process, and modern design assure this extra stamina. Write for data on all GAMMATRON tubes 50 to 5000 watt capacity.

HEINTZ AND KAUFMAN
SOUTH SAN FRANCISCO, CALIFORNIA U.S.A.

GAMMATRONS OF COURSE!



If you have an electrical-resistance measurement problem . . . this new Shallcross Bulletin undoubtedly will help you.

Shallcross has so simplified instruments that their practical use is no longer confined to the Laboratory and Class Room. Shallcross instruments are effective tools for mass production testing.

Write for your copy of Bulletin D-23

SHALLCROSS MFG. CO. COLLINGDALE PENNSYLVANIA
INSTRUMENTS • RESISTORS • SWITCHES

DISPLAY ADVERTISERS

A

Aerovox Corporationxi
American Lava Corporationvii
American Telephone & Telegraph Co.vi

B

Bliley Electric Companyxviii

C

Capitol Radio Engineering Institutexix
Centralabxiii
Cornell-Dubilier Electric Corp.Cover III

D

Daven Companyv
DuMont Laboratories, Inc., Allen B.xvi

G

General Radio CompanyCover IV

H

Heintz & Kaufman, Ltd.xvii
Hewlett-Packard Companyxix

I

Isolantite Inc.iv

P

Premax Productsxiv

R

RCA Manufacturing Company, Inc.
.i, ii, iii, xx

S

Shallcross Mfg. Companyxviii
Solar Manufacturing Corp.xiv
Sprague Specialties Companyviii

T

Thordarson Electric Mfg. Companyxvi

U

United Transformer CompanyCover II

W

Westinghouse Electric & Manufacturing Co. xv

Bliley

Accuracy and dependability are built into every Bliley Crystal Unit. Specify **BLILEY** for assured performance.

QUARTZ CRYSTALS

BLILEY ELECTRIC COMPANY
UNION STATION BUILDING ERIE, PA.

Portrait of OPPORTUNITY

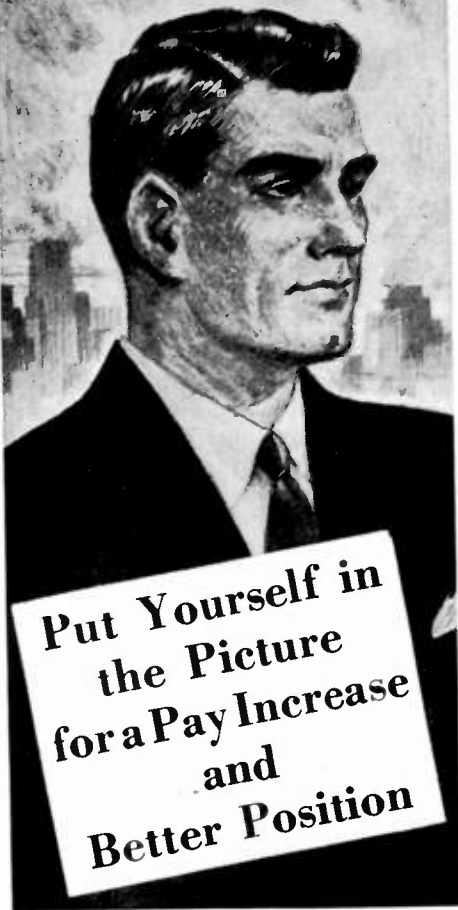

Put Yourself in the Picture for a Pay Increase and Better Position

Now, as never before, professional radiomen have a golden opportunity to go after—and get the higher engineering positions and the increased pay that goes with them. The radio industry needs competent men. CREI training enables the radioman to improve his technical ability . . . and not only help himself, but make him more valuable to his employer and company.

CREI home-study training in practical radio engineering is a proven method of equipping professional radiomen for advancement. For the past 15 years this Institute, its courses and outstanding faculty have been known and respected throughout the industry. Now, with time so important and the need so urgent, every ambitious radioman should investigate the advantages of the CREI planned program of study for advancement and future security.

We will be glad to send our free booklet and complete details to you, or to any man whom you think would be interested.

CAPITOL RADIO ENGINEERING INSTITUTE

E. H. RIETZKE, President

Home Study Courses in Practical Radio Engineering for Professional Self-Improvement

Dept. PR-6, 3224 — 16th Street, N.W. WASHINGTON, D.C.

Contractors to the U. S. Signal Corps—U. S. Coast Guard

Producers of Well-Trained Technical Radiomen for Industry

Proceedings of the I. R. E. June, 1942

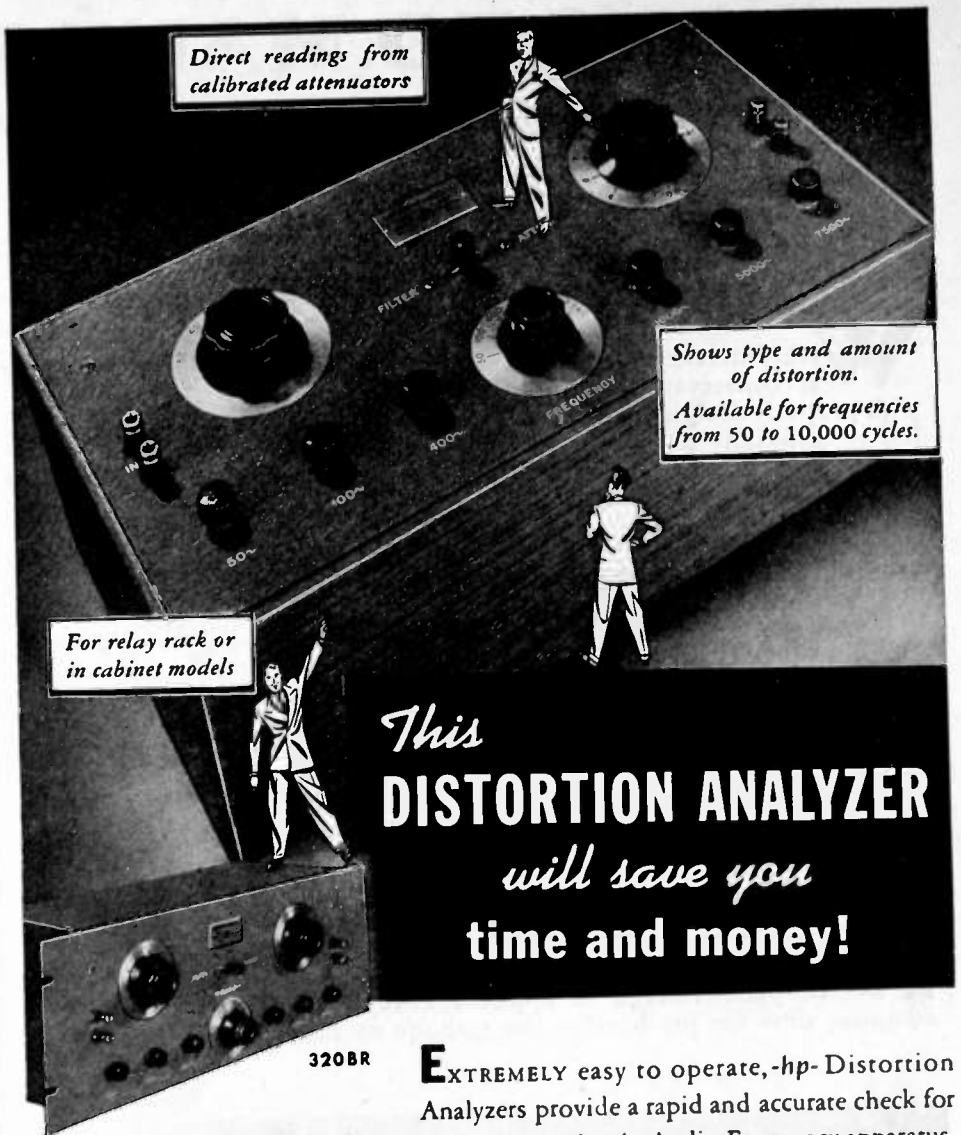

Model 320B in main illustration is also available for relay rack mount, shown above.



The attenuator gives the amplitude of the harmonic voltage directly in decibels below the fundamental.



A switch connects either the filter or the attenuator in the circuit. A second switch selects the frequency to be analyzed.

EXTREMELY easy to operate, -hp- Distortion Analyzers provide a rapid and accurate check for normal operation in Audio Frequency apparatus. When used in development work, their advantages will be readily appreciated because the amount of distortion can be measured at the same time its character is observed.

With the desired voltage adjusted to the proper frequency, the fundamental is entirely eliminated. Elimination filter is then switched out and the attenuator introduced. With proper adjustment, the setting of the attenuator gives the amplitude of the harmonic voltage in direct readings.

Ask for full particulars about -hp- Distortion Analyzers and other equally important measuring devices. There's no obligation. Write today.



HEWLETT-PACKARD COMPANY

BOX 135B, STATION A, PALO ALTO, CALIFORNIA

6 WAYS TO MAKE MERCURY-VAPOR TUBES LAST LONGER

No. 3 of a series devoted to extending the life of Transmitting Tubes which may be difficult to replace.

WHEN mercury-vapor rectifier tubes are operated at conservative ratings and in conjunction with properly designed smoothing filters, rectifier tube life is materially lengthened. However, there are at least six operating precautions which have an important bearing upon how long a rectifier tube will last:

★ Heat the tube adequately (without the application of high voltage) the first time it is used. To do this, merely run the filament at rated voltage for sufficient time to assure evaporation of all mercury from the tube bulb and mount before the plate voltage is applied. The reasons for this operation are: (a) liquid mercury that clings to any part of the mount may cause excessive mercury pressure at that point with resultant local arcs; (b) mercury globules on the anode may act as a pool cathode and cause arc-backs; (c) mercury condensed on the glass may cause mercury-vapor streamers which can produce excessive heating of the bulb.

★ Before putting a rectifier tube into service, always wipe the bulb clean to avoid leakage and resultant heating effects.

★ Before plate voltage is applied, always allow adequate time for pre-heating the cathode to insure

proper mercury-vapor pressure for the best operating conditions. Should the plate voltage be applied too soon, the cathode may be bombarded and harmed because of the high tube drop.

★ Use forced ventilation to obtain specified ambient temperatures as recommended on certain mercury-vapor tube types. On types where forced ventilation is not mentioned, its use may be desirable under some conditions. For any mercury-vapor rectifier, the temperature of the mercury in the base of the tube should be kept within specified limits to insure proper vapor pressure. Too much pressure may cause arc-backs; too little pressure may cause cathode sputtering because the tube drop is high under such operation. Either condition reduces tube life.

★ Maintain filament voltage within the specified limits to provide the proper amount of barium at the surface of the cathode.

★ Limit arc-back current to a reasonable value by including protection in the equipment. Too severe an arc-back may prove disastrous.

Use the RCA Instruction Sheets as your guide to conservative transmitting tube use for long, dependable operation!



Transmitting Tubes

PROVED IN COMMUNICATION'S MOST EXACTING APPLICATIONS
RCA MANUFACTURING CO., Inc., Comden, N. J. • A Service of The Radio Corporation of America



The sound of victory is in the air...

YOU CAN HEAR VICTORY... in the vibrant speeches of the President contrasted to the "intuitive" whining of *der führer*... in the defiant roar of American industry geared to all-out production... in the swift, sure transmission of vital radio messages to which Cornell-Dubilier contributes capacitors that are as infallible as thirty-two years' and two World Wars' experience can make them.

Today manufacturers must have high

priority orders to enjoy C-D's finer performance. But when the war is won, C-D capacitors will again be available to all industry, and C-D's extra dependability, which makes it the most widely used capacitor in the world today, will assure more hours of capacitor use per dollar for industry tomorrow.

Cornell Dubilier Electric Corporation, South Plainfield, New Jersey; New England Division: New Bedford, Mass.



MICA TRANSMITTER CAPACITORS
Copied, imitated...but never duplicated.

Type 6 Mica Transmitter Capacitors in moulded cases are designed for a wide variety of radio frequency applications, where size and weight must be kept at a minimum. They are specially suited for use as grid, plate, coupling, tank and by-pass units. The type 6 is one of the smallest types employing the Dubilier patented series-stack construction, permitting their use on higher r.f. voltages.



Cornell Dubilier Capacitors

MICA • PAPER • DYKANOL • WET & DRY ELECTROLYTIC CAPACITORS

M O R E I N U S E T O D A Y T H A N A N Y O T H E R M A K E

TWO PARTS PER MILLION



The Type 815 Precision Fork is calibrated in terms of the G-R Primary Standard of Frequency. A harmonic of the frequency standard drives a 1,000-cycle motor to which is affixed a paper stroboscopic disc. The output of the Fork is amplified and flashes a G-R STROBOTAC, used to illuminate the stroboscopic disc. By counting the number of spots on the paper disc passing a given index per unit of time, the frequency of the fork can be measured to within a few parts per million.

A TYPICAL ILLUSTRATION of the care used in manufacturing and testing G-R equipment is the Type 815 Precision Fork, widely used as a low-frequency standard, in geophysical exploration, general laboratory testing, and in rating clocks and watches. These forks are supplied for frequencies of 50, 60 or 100 cycles. They are calibrated to an accuracy of two parts per million.

The material from which the forks are made is low-temperature-coefficient stainless steel, received from the supplier in the form of bars. As the temperature coefficient of different lots of steel varies, a sample fork is made from each new lot and the coefficient is obtained after a protracted temperature run.

From previously determined mechanical tolerances, the forks are then machined in our shop. The average fork as received from the shop is about two cycles below its nominal frequency. The initial frequency is measured to within one millicycle. From data previously obtained, the amount of material to be milled from the ends of the tines is determined and the fork is returned to the shop for the first rough adjustment. A second check to within one millicycle is then made and if necessary the fork is returned to the shop again for further adjustment. Occasionally a third rough check and adjustment are required.

The fork is then ready for final adjustment and calibration. A hole is drilled and tapped in the end of each tine to receive two adjustable loading screws. The frequency is measured to within one millicycle with both tine holes empty, with an inner tine screw in each hole and then with an outer tine screw set up tightly against the first screw. From these measurements the approximate amount of material to be cut from the tine screws to bring the frequency very close to its nominal value is ascertained.

The fork is then allowed to run for a half-hour at a controlled temperature of 77 degrees F. after which the final frequency measurement is made. Appropriate adjustments of the tine screws set the frequency to within 0.001% of the nominal value. The voltage coefficient of frequency is now obtained. This is approximately 0.005% per volt. The output voltage and harmonic content are then measured.

The forks are then placed in stock. When orders are received the forks are returned to the laboratory and the frequency is measured at a driving voltage of exactly four volts. A calibration certificate showing the exact frequency to within 0.002% at a stated temperature between 70 and 80 degrees F., and showing the temperature and voltage coefficients of frequency is supplied with each fork.

GENERAL RADIO COMPANY

CAMBRIDGE, MASSACHUSETTS

Branches in New York and Los Angeles