

Proceedings

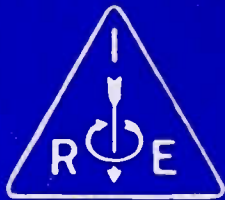

of the

I · R · E

FEBRUARY 1942

VOLUME 30 NUMBER 2

Radio Progress During 1941

Air-Cooled 5-Kw Transmitter

Stabilized F-M System

Spurious Radiations

Frequency Converters for Super-
heterodyne Reception

Electron Guns

Institute of Radio Engineers



We're "nuts" about our
UTc SUBMERSION
TYPE COMPONENTS

Yes... we are proud of our submer-
sion type units. They are now avail-
able in a wide range of sizes to cover
practically every requirement in de-
fense and non-defense applications.

These units are designed to take the
most extreme of Navy tests, which
consist of five complete submer-
sion cycles under salt water over a very
wide range of temperatures.

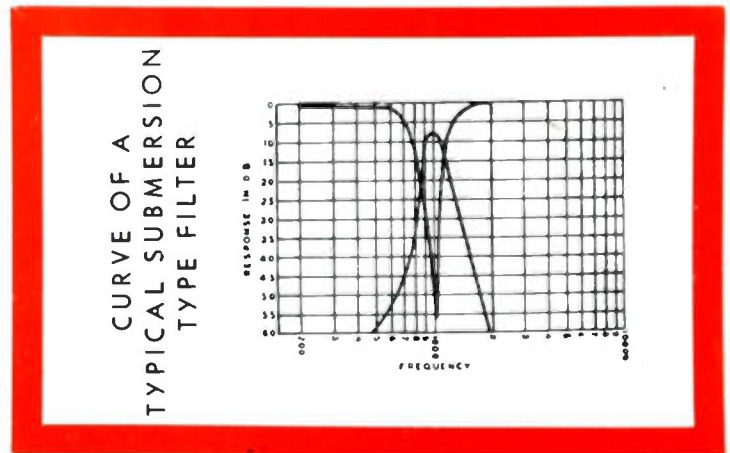

The same engineering development which
perfected these units can be applied to the
solution of your transformer problem.

**MAY WE HAVE AN OPPORTUNITY
TO COOPERATE?**

UNITED TRANSFORMER CO.

150 VARICK STREET



NEW YORK, N. Y.

EXPORT DIVISION: 100 VARICK STREET, NEW YORK, N. Y. CABLES: "ARLAB"

BOARD OF DIRECTORS

Arthur F. Van Dyck, *President*
Walter A. Rush, *Vice President*
Haraden Pratt, *Treasurer*
Harold P. Westman, *Secretary*
Alfred N. Goldsmith, *Editor*
Austin Bailey
Adolph B. Chamberlain
Carl C. Chambers
Ivan S. Coggeshall
William L. Everitt
Harold T. Friis
O. B. Hanson
Lawrence C. F. Horle
C. M. Jansky, Jr.
J. Kelly Johnson
Frederick B. Llewellyn
Frederick E. Terman
Browder J. Thompson
Hubert M. Turner
Harold A. Wheeler
Lynde P. Wheeler

Harold R. Zeamans,
General Counsel

BOARD OF EDITORS

Alfred N. Goldsmith, *Editor*
Ralph R. Batcher
Lloyd V. Berkner
Philip S. Carter
Lewis M. Clement
Elmer W. Engstrom
William L. Everitt
Peter C. Goldmark
Frederick W. Grover
C. M. Jansky, Jr.
John D. Kraus
Frederick B. Llewellyn
Samuel S. Mackeown
Edward L. Nelson
Harry F. Olson
Greenleaf W. Pickard
Haraden Pratt
Conan A. Priest
Leon J. Sivian
Lynne C. Smeby
Browder J. Thompson
Harold A. Wheeler
Lynde P. Wheeler
Laurens E. Whittemore
Gerald W. Willard
William Wilson
Charles J. Young

Helen M. Stote, *Assistant Editor*
William C. Copp,
Advertising Manager
John D. Crawford,
Assistant Secretary

Proceedings of the I·R·E

Published Monthly by
The Institute of Radio Engineers, Inc.

VOLUME 30 *February, 1942* NUMBER 2

Radio Progress During 1941	57
A New Air-Cooled 5-Kilowatt Broadcast Transmitter..... F. W. Fischer	72
A Stabilized Frequency-Modulation System..... Roger J. Pieracci	76
A Note on the Sources of Spurious Radiations in the Field of Two Strong Signals..... A. James Ebel	81
The Operation of Frequency Converters and Mixers for Superheterodyne Reception..... E. W. Herold	84
Factors Governing Performance of Electron Guns in Tele- vision Cathode-Ray Tubes..... R. R. Law	103
Correction to "The Effect of the Earth's Curvature on Ground-Wave Propagation," by Charles R. Bur- rows and Marion C. Gray..... E. Fubini	105
Institute News and Radio Notes.....	106
Board of Directors	106
Broadcast Engineering Conference.....	106
Winter Convention	108
Section Meetings.....	109
Frank Conrad, 1874-1941	109
Membership.....	110
Contributors.....	112

Entered as second-class matter October 26, 1927, at the post office at Menasha, Wisconsin, under the Act of February 28, 1925, embodied in Paragraph 4, Section 538 of the Postal Laws and Regulations. Publication office, 450 Ahnapp Street, Menasha, Wisconsin. Editorial and advertising offices, 330 West 42nd St., New York, N. Y. Subscription, \$10.00 per year; foreign, \$11.00.

THE INSTITUTE OF RADIO ENGINEERS

INCORPORATED



New York Meeting—March 4, 1942



Broadcast Engineering Conference, Columbus, Ohio, February 23–27, 1942

Summer Convention, Cleveland, Ohio, June 29, 30, and July 1, 1942

SECTION MEETINGS

ATLANTA
February 20

CLEVELAND
February 26

DETROIT
February 20

LOS ANGELES
February 17

PHILADELPHIA
March 5

PITTSBURGH
February 9

WASHINGTON
February 9

SECTIONS

ATLANTA—Chairman, A. W. Shropshire; Secretary, G. M. Howard, 856 St. Charles Ave., N. E., Atlanta, Ga.

BALTIMORE—Chairman, Vernon D. Hauck; Secretary, G. J. Gross, Pa. Water & Power Co., 1611 Lexington Bldg., Baltimore, Md.

BOSTON—Chairman, J. M. Henry; Secretary, Rudolph O. Oberg, Northeastern Univ., Boston, Mass.

BUENOS AIRES—Chairman, P. J. Noizeux; Secretary, L. C. Simpson, RCA Victor Argentina, Bartolome Mitre, 1961.

BUFFALO-NIAGARA—Chairman, E. H. Roy; Secretary, Leroy Fiedler, 53 Rosedale Ave., Hamburg, New York.

CHICAGO—Chairman, R. A. Kay; Secretary, Walter Kenworth, RCA Institutes, Inc., 1154 Merchandise Mart, Chicago, Ill.

CINCINNATI—Chairman, William L. Schwesinger; Secretary, Howard Lepple, 4432 Raceview Ave., Cincinnati, Ohio.

CLEVELAND—Chairman, Hollie C. Williams; Secretary, Grant E. Makinson, 98 Palmetto St., Bedford, Ohio.

CONNECTICUT VALLEY—Chairman, F. G. Webber; Secretary, C. I. Bradford, 187 Glenarden Dr., Fairfield, Conn.

DALLAS-FORT WORTH—Chairman, D. A. Peterson; Secretary, P. C. Barnes, Radio Station WFAA-WBAP, Grapevine, Texas.

DETROIT—Chairman, M. Cottrell; Secretary, Paul Frincke, 26686 Kenwood Ave., Royal Oak, Michigan.

EMPORIUM—Chairman, R. K. Gessford; Secretary, C. W. Reash, Hygrade Sylvania Corp., Emporium, Pa.

INDIANAPOLIS—Chairman, Arthur N. Curtiss; Secretary, T. N. Rosser, P. R. Mallory and Company, Indianapolis, Ind.

KANSAS CITY—Chairman, H. K. Morgan; Secretary G. L. Taylor, Midland Radio School Power and Light Building, Kansas City, Mo.

LOS ANGELES—Chairman, C. F. Wolcott; Secretary, Edward S. Sievers, Room 567, 417 S. Hill St., Los Angeles, Calif.

MONTREAL—Chairman, E. A. Laport; Secretary, W. A. Nichols, Canadian Broadcasting Corp., 1012 Keefer Bldg., Montreal, P. Q., Canada.

NEW ORLEANS—Chairman, G. H. Peirce; Secretary, D. W. Bowman, 8327 Sycamore St., New Orleans, La.

PHILADELPHIA—Chairman, C. C. Chambers; Secretary, R. L. Snyder, 103 Franklin Rd., Glassboro, N. J.

PITTSBURGH—Chairman, P. N. Bossart; Secretary, Ralph Overholt, Jr., 7211 Thomas Blvd., Pittsburgh, Pa.

PORTLAND—Chairman, R. W. Deardorff; Secretary, L. M. Belleville, 361 N. E. 75th Ave., Portland, Ore.

ROCHESTER—Chairman, H. J. Klumb; Secretary, O. L. Angevine, Jr., Stromberg-Carlson Tel. Mfg. Co., Rochester, N. Y.

ST. LOUIS—Temporary Chairman, R. L. Glasgow, Washington University, St. Louis, Mo.

SAN FRANCISCO—Chairman, H. E. Held; Secretary, W. G. Wagener, Heintz and Kaufman, South San Francisco, Calif.

SEATTLE—Chairman, K. H. Ellerbeck; Secretary, R. J. Gleason, Pacific Alaska Airways, Inc., 3314 White Bldg., Seattle, Wash.

TORONTO—Chairman, R. H. Klinghoffer; Secretary, L. Claude Simmonds, 301 King St., E., Toronto, Ont., Canada.

TWIN CITIES—Chairman, C. A. Culver; Secretary, N. B. Coil, 1664 Thomas St., St. Paul, Minn.

WASHINGTON—Chairman, E. M. Webster; Secretary, James D. Wallace, Radio Division U. S. Naval Research Laboratory, Bellevue, Anacostia, D. C.

THE INSTITUTE serves those interested in radio and allied electrical communication fields through the presentation and publication of technical material.

THE PROCEEDINGS has been published without interruption since 1913 when the first issue appeared. The contents of each paper published in the PROCEEDINGS are the responsibility of the author and are not binding on the Institute or its members. Material appearing in it may be reprinted or abstracted in other publications on the express condition that specific reference shall be made to its original appearance in the PROCEEDINGS. Illustrations of any variety, however, may not be reproduced without specific permission from the Institute.

STANDARDS reports are published from time to time and are sent to each member without charge. The four current reports are on Electroacoustics, Electronics, Radio Receivers, and Radio Transmitters and were published in 1938.

MEMBERSHIP has grown from a few dozen in 1912 to about seven thousand. Practically every country in the world in which radio engineers may be found is represented in our roster. Dues for the five grades of membership range from \$3.00 to \$10.00 per year. The PROCEEDINGS is sent to each member without further payment.

SECTIONS in twenty-seven cities in the United States, Canada, and Argentina hold regular meetings. The chairmen and secretaries of these sections are listed on the opposite page.

SUBSCRIPTIONS are accepted for the PROCEEDINGS at \$10.00 per year in the United States of America, its possessions, and Canada; when college and public libraries order direct from the Institute, the subscription price is \$5.00. For other countries there is an additional charge of \$1.00.

The Institute of Radio Engineers, Inc.
Harold P. Westman, Secretary
330 West 42nd Street
New York, N.Y.

The Institute of Radio Engineers

Incorporated

330 West 42nd Street, New York, N.Y.

To the Board of Directors

Gentlemen:

I hereby make application for ASSOCIATE membership in the Institute of Radio Engineers on the basis of my training and professional experience given herewith, and refer to the sponsors named below who are personally familiar with my work.

I certify that the statements made in the record of my training and professional experience are correct, and agree if elected, that I shall be governed by the Constitution of the Institute as long as I continue a member. Furthermore I agree to promote the objects of the Institute so far as shall be in my power.

.....
(Sign with pen)

.....
(Address for mail)

.....
(City and State)

.....
(Date)

SPONSORS

(Signatures not required here)

Mr.

Address

City and State

Mr.

Address

City and State

Mr.

Address

City and State

REMITTANCE SCHEDULE

MONTH DURING WHICH APPLICATION REACHES I.R.E. HEADQUARTERS	AMOUNT OF REMITTANCE (=ENTRANCE FEE+DUES) WHICH SHOULD ACCOMPANY APPLICATION	
GRADE →	ASSOCIATE	PERIOD COVERED BY DUES PAYMENT
Jan., Feb.	\$7.50 (= \$3 + \$4.50*)	Apr.-Dec. (9 mo. of current year)†
Mar., Apr., May	6.00 (= 3 + 3.00*)	July-Dec. (6 mo. of current year)†
June, July, Aug.	4.50 (= 3 + 1.50*)	Oct.-Dec. (3 mo. of current year)†
Sept., Oct., Nov.	9.00 (= 3 + 6.00*)	Jan.-Dec. (entire next year)
Dec.	7.50 (= 3 + 4.50*)	Apr.-Dec. (9 mo. of next year)†

† You can obtain the PROCEEDINGS for the entire year by including with your application a request to that effect and a remittance of \$9.00.
 * Associate dues include the price of the PROCEEDINGS, as follows: 1 year, \$5.00; 9 months, \$3.75; 6 months, \$2.50; 3 months, \$1.25. This may not be deducted from the dues payment.

TO APPLY FOR ASSOCIATE MEMBERSHIP

To Qualify for Associate membership, an applicant must be at least 21 years of age, of good character, and be interested in or connected with the study or application of radio science or the radio arts.

An Application should be filed, preferably on blanks obtainable on request from I.R.E. Headquarters or from the secretary of your local Section. If more convenient, however, the accompanying abbreviated form may be submitted. Additional information will be requested later on.

Sponsors who are familiar with the work of the applicant must be named. There must be three, preferably Associates, Members, or Fellows of the Institute. Where the applicant is so located as not to be known to the required number of member sponsors, the names of responsible nonmembers may be given.

Entrance Fee and Dues: The Associate entrance fee is \$3.00. Annual dues are \$6.00 per year, which include the price of the PROCEEDINGS as explained in the accompanying remittance schedule.

Remittance: Even though the I.R.E. Constitution does not require it, you will benefit by enclosing a remittance with your application. We can then avoid delaying the start of your PROCEEDINGS.

Your PROCEEDINGS will start with the next issue after your election, if you enclose your entrance fee and dues as shown by the totals in the accompanying remittance schedule. Any extra copies sent in advance of the period for which you pay dues (see last column) are covered by your entrance fee.

Should you fail to be elected, your entire remittance will be returned.

OTHER GRADES are available to qualified applicants. Those who are between the ages of eighteen and twenty-one may apply for Junior grade. Student membership is for full-time students in engineering or science courses in colleges granting degrees as a result of a four-year course. A special application blank is provided and requires the signature of a faculty member as the sole sponsor. Member grade is open to older engineers with several years of experience. Fellow grade is by invitation only. Information and application blanks for these grades may be obtained from the Institute.

SUPPLIES

BACK COPIES of the PROCEEDINGS may be purchased at \$1.00 per copy where available. Members of the Institute in good standing are entitled to a twenty-five per cent discount.

VOLUMES, bound in blue buckram, may be purchased for \$14.25; \$11.25 to members.

BINDERS are \$1.50 each. The volume number or the member's name will be stamped in gold for fifty cents additional.

INSTITUTE EMBLEMS of fourteen-carat gold with gold lettering on an enameled background are available. The lapel button is \$2.75; the lapel pin with safety catch is \$3.00; and the watch charm is \$5.00. All of these are mailed postpaid.

(Typewriting preferred in filling in this form) No.

RECORD OF TRAINING AND PROFESSIONAL EXPERIENCE

Name
 (Give full name, last name first)

Present Occupation
 (Title and name of concern)

Business Address

Home Address

Place of Birth Date of Birth Age

Education

Degree
 (College) (Date received)

TRAINING AND PROFESSIONAL EXPERIENCE

(Give dates and type of work, including details of present activities)

Record may be continued on other sheets this size if space is insufficient.

Receipt Acknowledged Elected Notified

Radio Progress During 1941

OUTSTANDING during the year was the gradual shift in national interest from a defense to a full war basis. The adjustment of the radio industry from a status in which both personnel and materials were plentiful to one in which both were scarce exercised the creative abilities of design and manufacturing engineers to the utmost. Despite the difficulties placed in the way of production and despite the heavy demands placed upon radio manufacturers by the military services, a greater number of broadcast receivers was built during 1941 than in any previous year. An estimate made on the basis of the first nine months showed that the annual production in the United States would amount to approximately 14,000,000 units. Of these, 44 per cent were small receivers listing at a low average price of \$17.70.

Automobile receivers accounted for 3,000,000 of the total production; and portable receivers were made in numbers totalling over 1,500,000 units.

At the advent of war, amateur radio stations were shut down; communication with ships at sea was discontinued except on a "broadcast" basis, communication by radio or wire with enemy countries was stopped, and censorship of international communications became general.

There was constant demand by military services for trained radio men, to serve as operators of the many kinds of radio equipment in military use, and to act as officers and maintenance men in charge of aircraft locators.

Technical Progress

Much of the technical progress made during the year cannot be revealed until after the war. This is particularly true of ultra-high-frequency and microwave techniques, in which research has been extremely active. Very impressive advances were made in the generation of large amounts of power at very high frequencies and in its utilization for communication and control purposes. New tubes for the generation of ultra-high frequencies were developed; and the practical use of wave guides was accelerated.

Frequencies of the order of 100 megacycles and higher came into moderately general use for various purposes, notably for airport-traffic control, and as carriers for multichannel communication purposes.

A marine radio transmitter and receiver was developed as a single compact unit which very appreciably reduced the time required to put communication equipment aboard ship.

One of the most notable contributions of electronics to science, the electron microscope, was improved technically so that higher voltages (300,000) could be used, making it possible to study thicker specimens. The applications of the instrument to scientific research in-

creased; and definite contributions to knowledge in the fields of biology, chemistry, and metallurgy were made during the year by its means.

In the general field of acoustics, several advances were made. A new series of loudspeaker horns having improved throat-resistance characteristics compared to the exponential horn was produced. These characteristics are adjustable in a manner analogous to an *m*-derived wave filter. An automatic record changer was introduced commercially which plays both sides of a disk record without turning the record over. A permanent-magnet alloy of the aluminum-nickel-cobalt-iron family, having an energy product of about three times the value of alloys now in general use is being produced on a small scale.

By an improved optical system, and use of higher voltages, television projection tubes were built which produced sufficient light for a 15- by 20-foot high-definition picture to be thrown upon the screen of a motion-picture theater.

The similarity between field patterns encountered in acoustic and radio-radiation propagation problems was utilized in an experimental method for predicting the behavior of antenna arrays by the use of acoustic models. A paper, largely mathematical in nature, developed the similarity between loudspeaker horns and directional antennas and contributed an attractive physical picture to antenna operation.

Broadcasting

During the year the trend toward higher power continued, although 50 kilowatts was still the maximum power permitted in the standard broadcast band. A greater use of directional antennas gave effective power increases in preferred directions to many stations. The shift in frequencies of all stations above 740 kilocycles was accomplished on March 29 in accordance with the agreement of the Havana Conference of 1937. Aside from learning new positions on his tuning dials for favorite stations, the average listener was not aware of the shift. The additional number of stations, and the step-up in power, has increased the heterodyne problem; production continued of vast numbers of radio receivers of mediocre tone fidelity, a situation contributed to by the heterodyne problem and by the desire for low-priced receivers.

In the realm of international broadcasting, continued advance in the power of this country's transmitters took place.

An automatic calling system utilizing a so-called "alert" receiver and subaudible modulation at the broadcast transmitters was demonstrated during the year. By its means the alert receiver on a stand-by basis could automatically turn on at a signal sent out from the transmitter.

The greatest developments in broadcasting during the year was the rapid growth of frequency modulation. Although the difficulties of getting raw materials and components for constructing transmitters retarded the growth so far as sending stations were concerned, many thousands of receivers went into service during the year and at year-end were selling at an accelerating rate. It was reported that by the end of November, as many as 180,000 units had been sold. On November 17, 1941, there were approximately 115 frequency modulation broadcast station licenses, construction permits, and applications for construction permits recorded with the Federal Communications Commission. More than 20 stations were maintaining regular transmitting schedules. More applications were on file for the New York area than there are channels available.

Despite the fact that high-fidelity transmissions were taking place it seemed doubtful at the end of the year that the average frequency-modulation receiver would have much better audio response than the average amplitude-modulation receiver.

Frequency modulation was being adopted by police-radio systems and military services.

The television standards proposed by the National Television Systems Committee were adopted by the Federal Communications Commission during the year, and the acceptance of paid programs to be transmitted by television stations was authorized. The war, however, made it virtually impossible to continue the manufacture and sale of television receivers.

General

In its annual report for the fiscal year ended June 30, 1941, the Federal Communications Commission stated that during that year the citizenship of more than 150,000 radio operators and communications employees had been checked. On November 1, 1941, there were 915 standard broadcast stations in operation or under construction; and it was estimated that the number of receivers in use was more than 50,000,000. As of June 30, 1941, commercial radio-operator licenses were held by some 89,000 individuals of which about 60,000 were of the class designated as "restricted radiotelephone permit." It was reported that on that date there were about 60,000 amateur

licenses (several times that of all the rest of the world combined), and that more than 12,600 station licenses for nonprogram services were extant (5214 ship stations; 2961 emergency, such as police; 2888 aviation; 600 Alaskan; 448 experimental; 128 coastal; 78 point-to-point telegraph; 15 point-to-point telephone; and 29 miscellaneous). During the fiscal year covered by its report the Federal Communications Commission made 18,500 routine inspections of radio transmitting stations, more than 35,000 frequency measurements, and examined some 47,000 applicants for radio-operator licenses.

This summary of progress during 1941 covers, in general, the period up to the first of November. It is based on material prepared by members of the 1941 Annual Review Committee of the Institute of Radio Engineers. The final editing and co-ordinating of the material and the preparation of the introductory section in behalf of the Annual Review Committee was carried out by Laurens E. Whittemore, chairman; Harold A. Wheeler, Arthur F. Van Dyck, and Keith Henney, with John D. Crawford acting as secretary.

The individual reports on the special fields were prepared by the following chairmen of the Institute's 1941 technical committees.

- P. T. Weeks, Technical Committee on Electronics
- E. G. Ports, Technical Committee on Transmitters and Antennas
- Garrard Mountjoy (acting for D. E. Foster), Technical Committee on Radio Receivers
- D. E. Noble, Technical Committee on Frequency Modulation
- I. J. Kaar, Technical Committee on Television
- J. L. Callahan, Technical Committee on Facsimile
- J. H. Dellinger, Technical Committee on Radio Wave Propagation
- W. G. Cady (acting for K. S. Van Dyke), Technical Committee on Piezoelectric Crystals
- H. S. Knowles, Technical Committee on Electroacoustics

The chairmen of the above committees wish to acknowledge the assistance given them by the individual members of the committees.

PART I—ELECTRONICS*

Cathode-Ray and Television Tubes—Gas-Filled Tubes—Small High-Vacuum Tubes—
Photoelectric Devices—Ultra-High-Frequency Tubes

CATHODE-RAY AND TELEVISION TUBES

As in other technical fields, many of the developments in cathode-ray tubes during 1941 related to military applications and so have not been discussed in the published literature. Progress along commercial lines is reported below.

The use of the electron microscope in research work became more common and, as a result, contributions were made to such fields as biology, metallurgy, and chemistry. Improvements in the microscope itself made the instrument better suited to commercial use. Higher-voltage models (up to 300,000 volts) to enable the electrons to penetrate thicker specimens were completed.

Apparatus suitable for the irradiation of biological and chemical materials with beams of high-velocity electrons was developed.

The method of reducing the deflecting voltage required for cathode-ray tubes, by deflecting the beam in a region of low potential and then accelerating the electrons to a high-potential screen, has been given further consideration. By this method, deflection sensitivity can be increased in the case of electrostatic deflection but not in the case of magnetic deflection.

A study of the possibility of improving the sensitivity of television pickup tubes showed that the threshold scene brightness required depends upon the amount of detail required in the transmitted picture. For images of equal detail, the human eye is about 10^3 times sensitive as present-day tubes. An improvement in tube sensitivity of 10^5 times is theoretically possible.

The advent of color television raised new problems in the design of pickup and reproduction tubes. Considerable progress was made toward obtaining suitable time-lag and color characteristics.

Television projection tubes were improved so that (with the aid of a greatly improved optical system) there is sufficient light for the projection of a 441-line high-definition picture on the screen of a motion-picture theater. With tubes operated with 60 to 70 kilovolts on the anode, demonstrations were given with a screen 15 feet by 20 feet.

- (1) G. A. Morton, "A survey of research accomplishments with the RCA electron microscope," *RCA Rev.*, vol. 6, pp. 131-166; October, 1941.
- (2) J. Hillier and A. W. Vance, "Recent developments in the electron microscope," *Proc. I.R.E.*, vol. 29, pp. 167-176; April, 1941.
- (3) V. K. Zworykin, J. Hillier, and A. W. Vance, "A preliminary report on the development of a 300-kilovolt magnetic electron microscope," *Jour. Appl. Phys.*, vol. 12, pp. 738-742; October, 1941.
- (4) O. Morningstar, R. O. Evans, and C. P. Haskins, "Electrical bombardment of biological materials—II. Electron tube for production of homogeneous beams of cathode rays from ten to

- one hundred kilovolts," *Rev. Sci. Instr.*, vol. 12, pp. 358-362; July, 1941.
- (5) J. R. Pierce, "After-acceleration and deflection," *Proc. I.R.E.*, vol. 29, pp. 28-31; January, 1941.
- (6) A. Rose, "The relative sensitivities of television pickup tubes, photographic film, and the human eye," *Proc. I.R.E.*, vol. 29, p. 227; April, 1941. (Abstract only.)
- (7) "Color television demonstrated by CBS engineers," *Electronics*, vol. 13, pp. 32-35, 73-74; October, 1940.
- (8) I. G. Maloff and W. A. Tolson, "A résumé of the technical aspects of RCA theatre-television," *RCA Rev.*, vol. 6, pp. 5-11; July, 1941.

GAS-FILLED TUBES

Small rare-gas-filled thyratrons of improved design and sufficiently sensitive for direct operation from a phototube have been made available. Studies of the sputtering process at the cathode of cold-cathode tubes have led to a method of rating these devices in which a curve of life expectancy as a function of current drawn is given rather than a definite peak or average current rating. Advances have been made in the understanding of the current-voltage characteristic of ignitrons in mercury-pool rectifiers. A substantial contribution to the theory of arc-back has been made. It has been shown that two ignitrons placed in series are capable of operating with a much lower frequency of arc-back on the given voltage than one tube alone on half the applied inverse potential.

- (9) W. E. Bahls and C. H. Thomas, "New sensitive and inexpensive gas control tubes," *Electronics*, vol. 14, pp. 33-37, 94; September, 1941.
- (10) G. H. Rockwood, "Current rating and life of cold-cathode tubes," *Trans. A.I.E.E. (Elec. Eng.)*, September, 1941, vol. 60, pp. 901-903; September, 1941.
- (11) E. G. F. Arnott, "Ignitor characteristics," *Jour. Appl. Phys.*, vol. 12, pp. 660-669; September, 1941.
- (12) J. Slepian and W. E. Pakala, "Arc backs in ignitrons in series," *Trans. A.I.E.E. (Elec. Eng.)*, June, 1941, vol. 60, pp. 292-294; June, 1941.

SMALL HIGH-VACUUM TUBES

During the year 1941, very few new receiving-tube types were introduced. All of these utilized previous design principles and, in general, were refinements of existing types. The fact that only a few types were released is not necessarily an indication of lack of activity in this field, since many research men and engineers have been engaged in military projects which cannot now be reported.

The year witnessed a record number of tubes sold with the demand concentrated on fewer types. Part of the increase resulted from government activities, but the demand was high in almost all fields. Tube manufacturers were unable to take care of requirements for many tube types. In the interest of standardization, many G types (ST bulbs and medium octal bases) were discontinued and replaced by GT types (short tubular bulbs with intermediate octal bases).

Studies of fluctuation noise in grid-controlled tubes were continued. A theory, checked by experiments,

* Decimal classification: R330X621.375.1.

describes the fluctuation currents induced in the input circuit with a negative control grid adjacent to the cathode. The induced fluctuations are shown equivalent to the thermal noise currents generated by a passive network at a temperature somewhat higher than that of the cathode and having a conductance equal to the electronic input conductance. The effect is, therefore, another important transit-time phenomenon. For grids not adjacent to the cathode, the analysis is more difficult, but has resulted in a solution which gave satisfactory results for a particular example.

Amplifier tubes utilizing secondary-emission multiplication have been considered from the point of view of general theory, construction, and performance at high frequencies.

- (13) H. Schwarz, "The mechanism of the electrical dissipation ("clean-up") of gas at pressures below 10^{-4} mm. hg.," *Zeit. für Phys.*, vol. 117, no. 1/2, pp. 23-40; December 26, 1940. Reviewed in *Wireless Eng.*, p. 252; June, 1941.
- (14) S. B. Ingram and W. C. White, "A decade of progress in the use of electronic tubes," *Elec. Eng.*, vol. 59, pp. 643-648; December, 1940. Contains bibliography.
- (15) D. A. Bell, "Diode as a rectifier and frequency changer," *Wireless Eng.*, vol. 18, pp. 395-404; October, 1941.
- (16) L. B. Curtis, "New small ultra-high-frequency receiving tubes," *Proc. I.R.E.*, vol. 29, p. 222; April, 1941. (Abstract only.)
- (17) B. J. Thompson, D. O. North, and W. A. Harris, "Fluctuations in space-charge-limited currents at moderately high frequencies," *RCA Rev.*, Part 4, vol. 5, pp. 371-388; January, 1941; Part 5, pp. 505-524; April and pp. 114-124; July, 1941.
- (18) Dwight O. North and W. R. Ferris, "Fluctuations induced in vacuum-tube grids at high frequencies," *Proc. I.R.E.*, vol. 29, pp. 49-50; February, 1941.
- (19) C. J. Bakker, "Fluctuations and electron inertia," *Physica*, vol. 8, pp. 23-43; January, 1941.
- (20) M. J. O. Strutt and A. van der Ziel, "Methoden zur kompensierung der wirkungen vernerchiedes Arten von Schroteffekt in elektronenrohren und augeschlossenn Stromkreisen (Methods of compensating for various types of Schrot effect in electron tubes and closed circuits)," *Physica*, vol. 8, pp. 1-22; January, 1941.
- (21) D. A. Bell, "Measurement of shot and thermal noise," *Wireless Eng.*, vol. 18, pp. 95-98; March, 1941.
- (22) J. Gröber, "Methods of reducing the (shot effect) noise of valves," *Hochfrequenz. und Elektroakustik*, vol. 56, pp. 174-181; December 1940. Review in *Wireless Eng.*, vol. 18, p. 251; June, 1941.
- (23) B. J. Thompson, "Voltage-controlled electron multipliers," *Proc. I.R.E.*, vol. 29, pp. 583-587; November, 1941.
- (24) H. M. Wagner and W. R. Ferris, "The orbital-beam secondary-electron multiplier for ultra-high-frequency amplification," *Proc. I.R.E.*, vol. 29, pp. 598-602; November, 1941.
- (25) M. Sandhagen, "Amplifiers with secondary emission multiplication," *Elek. Tech. Zeit.*, vol. 62, p. 413; April 24, 1941.
- (26) L. Malter, "Behavior of electron multipliers as a function of frequency," *Proc. I.R.E.*, vol. 29, pp. 587-598; November, 1941.

PHOTOELECTRIC DEVICES

As in recent years, there has been a continued expansion of practical applications of phototubes for a wide variety of purposes. A general program directed toward standardized types of phototubes is being fostered to counteract the tendency toward a large number of new types.

The manufacture of barrier-layer photocells has progressed to the point where cells can be adapted to specific requirements. The troublesome fatigue of this type has received further study.

Electron-multiplier phototubes, as well as phototubes, for the visual spectral range, have continued

to receive considerable attention. The electrostatically focused electron multiplier has emerged as a commercial product.

- (27) J. T. Tykociner, J. Kunz, and L. P. Garner, "Photoelectric sensitization of alkali surfaces by electric discharges in water vapour," *Bull. Ill. Eng. Exp. Sta.*, no. 325, (34 pp.) November 26, 1940.
- (28) P. Görlich, "Measurements on composite photocathodes II," *Zeit. für Phys.*, vol. 116, pp. 704-715; December, 1940.
- (29) R. B. Janes and A. M. Glover, "Recent developments in phototubes," *RCA Rev.*, vol. 6, pp. 43-54; July, 1941.
- (30) A. M. Glover, "A review of the development of sensitive phototubes," *Proc. I.R.E.*, vol. 29, pp. 413-423; August, 1941.
- (31) P. Görlich, "Photoelectric cells for the visible spectral range," *Jour. Opt. Soc. Amer.*, vol. 31, pp. 504-505; July, 1941.
- (32) G. Windred, "Review of progress in electronics—V. Photoelectricity," *Electronic Eng.*, vol. 14, pp. 345-347; August, 1941.
- (33) R. A. Houston, "The drift of the selenium barrier-layer photocell," *Phil. Mag.*, vol. 31, pp. 498-506; June, 1941.
- (34) Z. Bay, "Electron multiplier as an electron counting device," *Rev. Sci. Instr.*, vol. 12, pp. 127-133; March, 1941.
- (35) R. C. Winans and J. R. Pierce, "Operation of electrostatic photo-multipliers," *Rev. Sci. Instr.*, vol. 12, pp. 269-277; May, 1941.

ULTRA-HIGH-FREQUENCY TUBES

The year 1941 has been one of intense activity in the ultra-high-frequency range. Published reports, however, contain very few descriptions of new devices.

Developments have been made in space-charge control tubes which include refinements both in the more conventional tube and in tubes where the output is drawn from a cavity resonator through which an electron beam is caused to flow. A new tube containing an orbital beam in connection with secondary multiplication has made its appearance. The theory of magnetrons has been extended by several workers, and a more extensive use of wave guides and cavities in all applications is apparent.

The situation is covered in outline form by the bibliography which is grouped broadly under headings representing the major lines of activity in the field.

Space-Charge Control Tubes (Negative Grid)

- (36) K. C. Dewalt, "Three new ultra-high-frequency triodes," *Proc. I.R.E.*, vol. 29, pp. 475-480; September, 1941.
- (37) O. E. Dow, "Applications of the inductive-output tube," *Proc. Radio Club Amer.*, vol. 18, pp. 56-61; August, 1941.
- (38) W. R. Ferris and H. M. Wagner, "Orbital-beam multiplier tube for 500-megacycle amplification," *Proc. Radio Club Amer.*, vol. 18, pp. 53-56; August, 1941.
- (39) "Inductive-output amplifier," *Rev. Sci. Instr.*, vol. 12, p. 107; February, 1941.
- (40) C. E. Lockhart, "Generation and amplification of microwaves," *Electronic Eng.*, vol. 14, pp. 384-387, 414; September, 1941; vol. 14, pp. 432-434; October, 1941.
- (41) "Midget amplifiers," *Rev. Sci. Instr.*, vol. 12, pp. 514-515; October, 1941.
- (42) M. J. O. Strutt and A. van der Ziel, "New push-pull amplifier valve for decimeter waves," *Philips Tech. Rev.*, vol. 5, pp. 172-181; June, 1940.
- (43) "Transmitting triode," *Rev. Sci. Instr.*, vol. 12, p. 233; April, 1941.

Positive-Grid Tubes

- (44) S. Asai, "Tentative proposition on the mechanism of electronic oscillations," *Electrotech. Jour.* (Tokyo), vol. 5, pp. 59-60; March, 1941.
- (45) S. S. Banerjee and A. S. Rao, "Production of ultra-high-frequency radio waves by electronic oscillations," *Indian Jour. Phys.*, vol. 14, pp. 93-100; April, 1940.
- (46) H. Klinger, "Über die Erzeugung von Decimeterwellen mit Doppelgitterrohren nach der Bremsfeldmethode (On the

- generation of decimeter waves with double-grid tubes by the retarded field method)," *Funk. Tech. Monatshefte*, no. 8, pp. 121-124; August, 1940.
- (47) W. A. Leyshon, "On ultra-high-frequency oscillations generated by means of a demountable thermionic tube having electrodes of plane form," *Proc. Phys. Soc. (London)*, vol. 53, pp. 141-156; March 1, 1941; vol. 53, pp. 490-491; July 1, 1941.
- (48) A. Pincioli, "Oscillatori a transconduttanza negativa a campo frenate nella conversione di frequenza (Frequency conversion by means of negative-transconductance brake-field-type oscillators)," *Alla Frequenza*, vol. 9, pp. 581-593; October, 1940.

Magnetrons

- (49) S. Aoi, "On the characteristics of the magnetron of a symmetrical type," *Nippon Elec. Commun. Eng.*, no. 21, pp. 62-63; July, 1940.
- (50) L. Brillouin, "Theory of the magnetron," *Phys. Rev.*, vol. 60, pp. 385-396; September 1, 1941.
- (51) H. Chang and E. L. Chaffee, "Characteristics of the negative-resistance magnetron oscillator," *Proc. I.R.E.*, vol. 28, pp. 519-523; November, 1940.
- (52) K. Fritz and W. Engbert, "Schwingungsformer und Ordnungszahlen der Magnetfeldrohre (Forms of oscillations and 'orders' of magnetrons)," *Telefunken Mitteilungen*, vol. 21, pp. 41-43; September, 1940.
- (53) F. Hoffmann, "Bremsfeldrohren mit Magnetfeld; statische Kennlinie und Kurzwellenerzeugung (Retarded field tubes with magnetic fields; static characteristics and generation of short waves)," *Hochfrequenz. und Elektroakustik*, vol. 56, pp. 137-148; November, 1940.
- (54) F. B. Pidduck, "Theory of short-wave oscillations with the magnetron," *Wireless Eng.*, vol. 18, pp. 404-405; October, 1941.

Velocity-Variation Devices

- (55) W. E. Benham, "Phase-focusing in velocity modulated beams," *Wireless Eng.*, vol. 17, pp. 514-516; December, 1940.
- (56) V. Guljaev, "Theory of the klystron," *Jour. Phys. (U.S.S.R.)*, vol. 4, no. 1-2, pp. 143-146; 1941.
- (57) H. E. Hollmann and A. Thoma, "Zur Theorie der Triftrohren (On the theory of drift tubes)," *Hochfrequenz. und Elektroakustik*, vol. 56, pp. 181-186; December, 1940.
- (58) B. Kockel, "Geschwindigkeitsgesteuerte Laufzeitrohren. Beitrag zur Theorie (Velocity-controlled transit-time tubes. Contribution to their theory)," *Zeit. für Tech. Phys.*, vol. 22, no. 2, pp. 77-85; 1941.
- (59) R. Kompfner, "Velocity modulation. Results of further considerations," *Wireless Eng.*, vol. 17, pp. 478-488; November, 1940.
- (60) F. Ludi, "Über einen neuartigen Ultrakurzwellengenerator mit Phasenfocussierung (On a new type of ultra-short-wave generator with phase focusing)," *Helv. Phys. Acta*, vol. 13, no. 6, pp. 498-522; 1940.
- (61) J. J. Muller and E. Rostas, "A transit time generator using a single rhumbatron," *Helv. Phys. Acta*, vol. 13, no. 6, pp. 435-450; 1940.
- (62) "Velocity-modulated valves. Modern trends in tubes for ultra-high-frequency operation," *Wireless World*, vol. 47, pp. 248-251; October, 1941.

Guides and Cavities

- (63) W. L. Barrow and H. Schaevitz, "Hollow pipes of relatively small dimensions," *Trans. A.I.E.E. (Elec. Eng.)*, March, 1941), vol. 60, pp. 119-122; 1941.
- (64) T. G. O. Berg, "Teorien för den sfäriska resonatorn (The

- theory of spherical resonators)," *Teknisk Tidskrift*, vol. 49, pp. 200-204; December 7, 1940.
- (65) E. U. Condon, "Forced oscillations in cavity resonators," *Jour. Appl. Phys.*, vol. 12, pp. 129-132; February, 1941.
- (66) W. C. Hahn, "New method for the calculation of cavity resonators," *Jour. Appl. Phys.*, vol. 12, pp. 62-68; January, 1941.
- (67) H. E. Hollmann, "Spherical tank (oscillator) circuits," *Electronics*, vol. 14, p. 111; September, 1941.
- (68) J. E. Houldin, "Wave guides," *Jour. Gen. Elec. Co.*, vol. 11, pp. 172-181; February, 1941.
- (69) H. Iwakata, "On the relation between the inherent value (of the electromagnetic field) of hollow metal tubes and their miscellaneous constants," *Electrotech. Jour. (Tokyo)*, vol. 5, pp. 58-59; March, 1941.
- (70) N. N. Malow, "Elektromagnetische Wellen in einem Hohlleiter mit veränderlichem Schlitze (Electromagnetic waves in a hollow conductor of variable cross section)," *Jour. Phys. (U.S.S.R.)*, vol. 4, no. 5, pp. 473-478; 1941.
- (71) K. Morita, "Theory of frequency stabilizer for decimeter waves using metallic ellipsoid," *Electrotech. Jour. (Tokyo)*, vol. 4, pp. 229-230; October, 1940.
- (72) M. Watanabe, "On the Eigenschwingung of the electromagnetic Hohlraum (A note on resonators and wave guides)," *Electrotech. Jour. (Tokyo)*, vol. 5, pp. 7-10; January, 1941.

Electron Beams

- (73) F. Borgnis and E. Ledinegg, "Zur Phasenfokussierung feradlinig bewegter Elektroenstrahlen (On the phase focusing of electron rays moving in a straight line)," *Zeit. für Tech. Phys.*, vol. 21, no. 11, pp. 256-261; 1940.
- (74) H. E. Hollmann, "Theoretical and experimental investigations of electron motions in alternating fields with the aid of ballistic models," *Proc. I.R.E.*, vol. 29, pp. 70-79; February, 1941.
- (75) S. Ramo, "Traveling waves in electron beams," *Communications*, vol. 20, pp. 5-8, 24-25; November, 1940.

Miscellaneous

- (76) L. Bergmann, "Elektromagnetische Felder und Schwingungen (Electromagnetic fields and oscillations)," *Physica*, vol. 9, no. 1, pp. 1-13; 1941.
- (77) H. Born, "Indirekte Modulation von Zentimeterwellen (Indirect modulation of centimeter waves)," *Hochfrequenz. und Elektroakustik*, vol. 56, pp. 112-118; October, 1940.
- (78) L. Brillouin, "Hyperfrequency waves and their practical use," *Elec. Commun.*, vol. 19, no. 4, pp. 118-130; 1941.
- (79) K. Fritz and A. Lerbs, "Fremdsteuern mit Magnetfeldröhren (Separate control in magnetrons)," *Telefunken Mitteilungen*, vol. 21, pp. 44-48; September, 1940.
- (80) F. W. Gundlach, "Dezimeterwellen-messtechnik (Measuring technique for the decimeter-wave range)," *Elek. Tech. Zeit.*, vol. 61, pp. 853-858; September 12, 1940.
- (81) C. K. Jen, "On the induced current and energy balance in electronics," *Proc. I.R.E.*, vol. 29, pp. 345-349; June, 1941.
- (82) C. K. Jen, "On the energy equation in electronics at ultra-high frequencies," *Proc. I.R.E.*, vol. 29, pp. 464-466; August, 1941.
- (83) W. Kleen, "Entwicklungsstand der UKW-Röhrentechnik (Present status of ultra short wave tube technique)," *Telefunken Mitteilungen*, vol. 21, pp. 17-35; September, 1940.
- (84) W. Kleen, "Stand der UKW-Röhrentechnik (State of ultra-short-wave tube technics)," *Zeit. für Tech. Phys.*, vol. 21, no. 12, pp. 357-367; 1940.
- (85) C. E. Lockhart, "Generation and amplification of micro-waves," *Electronic Eng.*, vol. 14, pp. 336-338, 347; August, 1941.

PART II—RADIO TRANSMITTERS AND TRANSMITTING ANTENNAS*

Standard-Band and International Broadcasting—Aids to Aerial Navigation—Frequency-Modulation Broadcasting, Marine and Airplane Transmitters—Circuits—Antennas

GENERAL

Last year saw the advent, on a commercial basis, of frequency-modulation broadcasting and, to a limited extent, television broadcasting, and a corresponding acceleration in the development of equipment to meet the requirements of these types of transmissions. The development of international broadcasting on a major scale has been greatly accelerated. New developments in portable, semiportable, and mobile equipments have been made. There has been reported, without technical details, a great deal of activity in the development of portable and mobile equipment for military use, as well as of aircraft "radio locaters" and other direction-finding equipment.

STANDARD-BAND BROADCASTING

The trend toward higher power in broadcast stations has continued during the year. Interference has been minimized by the use of directional antenna systems. As the available channels become more congested† it has been necessary to provide protection in many different directions and this has necessitated the use of four- and five-element directional antenna arrays.

There have been several installations of 50-kilowatt transmitters utilizing air-cooled tubes.

The agreement of the Havana Conference of 1937 was consummated on March 29, 1941, when the frequency allocations in the broadcast band were revised. Some 800 stations, all operating on frequencies above 740 kilocycles, were affected, the shift being slight in most instances. The reallocation provides certain exclusive channels for Canada, Mexico, Cuba, and the United States.

(1) James Stokley, "Radio frequencies," *Science*, vol. 93, no. 2413, (supp.) pp. 8-9; March 28, 1941.

INTERNATIONAL BROADCASTING

Major broadcasting systems in the United States published information on current and proposed international broadcasting operations.‡ In one case a network comprising 64 stations in 18 of the 20 Latin-American republics was arranged, the plan being for these stations to rebroadcast, free of charge, Latin-American programs created by a special program department of the broadcaster in this country; they in

* Decimal classification: R350×R320.

† On January 1, 1942, the number of licensed standard broadcast stations in the United States was 887; construction permits had been issued by the Federal Communications Commission for 36 additional stations.

‡ The Federal Communications Commission had granted licenses as of January 1, 1942, to 11 international broadcast stations operating on high frequencies. Construction permits for three additional stations were outstanding.

turn to build up programs for retransmission through the United States. This program is being implemented with the new facilities for transmission now being installed in the United States. These facilities feature three 50-kilowatt radio-frequency units and two modulator units arranged for quick and easy preselection of any one of eight predetermined frequencies; thirteen directional antennas with associated transmission lines, line-type isolation and matching filters, and a complex switching arrangement for associating quickly any one of the three radio-frequency units with any one of the thirteen antennas.

In another case the international facilities are described as providing effective service in six different languages to the Portuguese- and Spanish-speaking countries of South and Central America and to Europe. Recent increases in power to 50 kilowatts and the development and construction of new directive transmitting antennas add to the scope and effectiveness of these international broadcast activities. At times, transmission to Latin America is accomplished with a total power of 100 kilowatts on a frequency in the vicinity of 10 megacycles through the use of dual transmitters and antennas.

In other cases, several stations were modified to provide increased outputs ranging from 50 to 100 kilowatts.

- (2) A. B. Chamberlain, "International short wave facilities, of CBS," *Electronics*, vol. 14, pp. 30-33, pp. 70-71; July, 1941.
- (3) W. S. Paley, "Radio turns south," *Fortune*, vol. 23, pp. 77-79, 108, 111-112; April, 1941.
- (4) R. F. Guy, "NBC's international broadcasting system," *RCA Rev.*, vol. 6, pp. 12-35; July, 1941.

AIDS TO AERIAL NAVIGATION

Studies have been made by the Civil Aeronautics Administration of the United States government on the effects of wave polarization and site determination with the ultra-high-frequency visual radio range. It was found that site requirements are much less severe with horizontal polarization than with vertically polarized transmissions.

The use of ultra-high frequencies (130 megacycles) for airport traffic control was demonstrated using transmitters located at La Guardia, Floyd Bennett, and Philadelphia airports. The equipments at La Guardia and Philadelphia have been in continuous operation for the past year, establishing the practicality of transmitting equipment to provide a ground-to-aircraft circuit for airport traffic-control communication.

The airway between New York and Chicago was equipped with an ultra-high-frequency radio range

system of the four-course aural type. Continuous operation of the range equipment and the instrument landing equipment at Indianapolis have made it possible to establish certain minimum requirements for vacuum tubes and other equipment components to insure 24-hour continuous service at the ultra-high frequencies.

One paper described an omnidirectional radio range system. The advantage of such a system is that it eliminates the course ambiguity that exists in the usual four-course systems.

- (5) J. M. Lee and C. H. Jackson, "Preliminary investigation of the effects of wave polarization and site determination with the portable ultra high frequency visual radio range," Civil Aeronautics Authority Technical Development Report No. 24, February, 1940.
- (6) D. G. C. Luck, "An omnidirectional radio-range system," *RCA Rev.*, vol. 6, pp. 55-81; July, 1941.

TRANSMITTERS, GENERAL

It was announced that a twin-channel single-sideband transmitter was in use on transatlantic telephone service, transmitting two telephone channels on a single carrier.

A push-button-tuned 50-kilowatt broadcast transmitter was described. Automatic push-button tuning on short-wave broadcast transmitters is used to change from one frequency to another with the least possible interruption to programs.

- (7) K. L. King, "Twin-channel single-sideband transmitter, *Bell Lab. Rec.*, vol. 19, pp. 202-205; March, 1941.
- (8) R. J. Rockwell and H. Lepple, "A push-button tuned 50 kw broadcast transmitter," *Trans. A.I.E.E.*, (*Elec. Eng.*, January, 1941) vol. 60, pp. 1-3; January, 1941.

FREQUENCY-MODULATION BROADCASTING

A number of stations have gone into operation in the 42- to 50-megacycle band using frequency modulation. Excellent coverage has been reported in the areas served by these stations, particularly in those regions of high absorption, such as New England. In view of the scarcity of materials and engineering services, the development of frequency modulation has been retarded. Nevertheless, by the end of 1941 approximately 115 applications had been filed with the Federal Communications Commission for construction permits for commercial frequency-modulation stations, of which approximately more than half had been granted.*

Frequency-modulation broadcast transmitters of 10-kilowatt and 50-kilowatt output ratings became available. A new low-power frequency-modulation

* Construction permits issued by the Federal Communications Commission for 60 commercial ultra-high-frequency (frequency-modulation) broadcast stations were outstanding on January 1, 1942. One license had been issued by the Commission to a broadcasting station of this class and one station was operating under special authority. In addition, licenses or special authorizations were outstanding to 16 experimental ultra-high-frequency (frequency-modulation) broadcast stations. The total of these frequency-modulation and broadcast authorizations was 78.

Noncommercial educational broadcast stations operating on ultra-high frequencies were the subject of three licenses and five construction permits.

It was reported that 180,000 frequency-modulation receivers were in use by the general public by the end of November.

transmitter was introduced, intended primarily for point-to-point transmission of high-fidelity frequency-modulation broadcast and television aural programs. One new 10-kilowatt frequency-modulation transmitter uses a single power tube with forced-air cooling in the output stage.

The use of an amplifier with grounded anode in radio transmitters for frequency-modulation service has been commercialized during the year. In this arrangement the anode of the vacuum tube is connected to ground through a condenser having low reactance at the frequency involved. The output power is obtained from the cathode which is at high radio-frequency potential. The grid-drive and filament power are supplied through a concentric transmission-line arrangement, which is also the cathode-anode tuning inductance. Neutralization is accomplished by means of an inductance between the grid and ground. Most of the troublesome stray capacitance which has decreased the effectiveness of high-power vacuum tubes at high frequencies is made harmless in this new arrangement.

- (9) H. P. Thomas and R. H. Williamson, "A commercial 50-kilowatt frequency-modulation broadcast transmitting station," *Proc. I.R.E.*, vol. 29, pp. 537-546; October, 1941.
- (10) "180,000 FM Sets in Nation Claimed," *Broadcasting*, vol. 21, p. 16; December 8, 1941.

MARINE

A new type of commercial marine radio equipment which can be installed on board ship in one fifth the time usually required has been developed in connection with the emergency shipbuilding program. The new unit combines in a single cabinet, radio equipment which ordinarily requires as many as twelve separate units and eliminates the intricate system of interconnecting wiring in the radio room. It includes all of the radio apparatus necessary for safety and communication purposes.

Also announced during the year was a new marine radiotelephone transmitter featuring quick selection of any one of ten pretuned frequencies and quartz-crystal control of both transmission and reception.

- (11) "Marine radio telephone," *Electronics*, vol. 14, p. 88; July, 1941.
- (12) "Simplified and standardized radio equipment for EC-2's," *Southern Marine Rev.*, vol. 16, p. 18; October, 1941.

AIRPLANE TRANSMITTERS

A transmitter for airplanes, designed to provide ten preselected frequencies in the ranges from 300 to 500 kilocycles and from 2 to 15 megacycles, was announced.

- (13) Ten-frequency airplane radio equipment," *Bell Lab. Rec.*, vol. 19, pp. 302-309; June, 1941.

CIRCUITS

The design of large water-cooled resistors suitable for use as high-frequency loads up to 10 kilowatts dissipation was disclosed. The basic material is thinly metallized ceramic tubing bearing a protective coat of

varnish. In particular the units find application as loads on terminated antennas, as terminations for vestigial-sideband filters, as dummy loads for testing transmitters, and the like.

A crystal-oscillator multiplier circuit of high stability and output power was described, and the factors affecting the stability, crystal current, and output power of the oscillator were discussed in a report issued by the Civil Aeronautics Administration.

The Civil Aeronautics Administration also published a report describing a study of direct-current corona in the presence of high-frequency disturbances. The differences between corona under such interfering conditions and without interference were observed. It was demonstrated that the radio-frequency interference arising from a point in direct-current corona can be suppressed entirely by introducing a comparatively small high-frequency field at the point of corona. This work is of importance in substantiating theories concerning the cause of interference in airplane reception.

A considerable amount of work has been done along the lines of eliminating parasitic oscillations in ultra-high-frequency transmitting equipment. Tests of several transmitting equipments have established that much can be accomplished in reducing the tendency for parasitic oscillations in the power-amplifier stage by tuning out the inductance of the grid-coupling leads. A set of specifications covering the methods of observing parasitics and the conditions under which a transmitter shall be operated to determine that it is free from parasitic oscillations has been prepared by the Civil Aeronautics Administration.

Formulas for calculating the impedance of a cavity resonator when excited by a coupling loop or by a capacitive coupling were developed. Methods for improving the performance of linear and grid-modulated amplifiers were described.

- (14) G. H. Brown and J. W. Conklin, "Water cooled resistors for ultra high frequencies," *Electronics*, vol. 14, pp. 24-28, 104-105, 108; April, 1941.
- (15) C. H. Jackson, "Development of an improved crystal exciter unit," Civil Aeronautics Authority Technical Development Report No. 26, July; 1940.
- (16) M. O'Day, "The effect of a high frequency disturbance on the direct-current corona from a sharp point," Civil Aeronautics Authority Technical Development Report No. 27; August, 1940.
- (17) E. U. Condon, "Forced oscillations in cavity resonators," *Jour. Appl. Phys.*, vol. 12, pp. 129-140; February, 1941.

- (18) F. E. Terman and R. R. Buss, "Some notes on linear and grid-modulated radio-frequency amplifiers," *PROC. I.R.E.*, vol. 29, pp. 104-107; March, 1941.

ANTENNAS

A new type of ultra-high-frequency antenna employing stacked tuned loops and an improved turnstile antenna were described. Another paper gave data for the optimum current distribution on a vertical antenna for maximum signal on the horizon.

A new 75-megacycle zone-marker transmitting antenna system was developed. The new antenna extends the useful height of the marker to 20,000 feet as compared to 10,000 feet with the old antenna, and, at the same time, the marker signal "light-on" period at 1000 feet is only one half that of the old system.

The large number of independent variables in antenna arrays makes it advisable to develop means for rapidly surveying the field patterns which may be obtained. The use of acoustic models for this purpose was described. The advantages of the acoustic model were demonstrated in the study of nonsinusoidal current distribution and the effect of such distributions on the field pattern. The measurement of mutual impedance between antennas may also be carried out conveniently with one of the models.

- (19) G. H. Brown and J. Epstein, "A turnstile antenna for ultra-high-frequency broadcasting," *PROC. I.R.E.*, vol. 29, p. 221; April, 1941. (Abstract only.)
- (20) E. C. Jordan and W. L. Everitt, "Acoustic Models of Radio Antennas," *PROC. I.R.E.*, vol. 29, pp. 186-195; April, 1941.

Other papers of interest presented during the past year were:

- (21) W. L. Barrow and H. Schaevitz, "Hollow pipes of relatively small dimensions," *Trans. A.I.E.E. (Elec. Eng.)*, March, 1941), vol. 60, pp. 119-122; March, 1941.
- (22) A. Alford, "Coupled networks in radio-frequency circuits," *PROC. I.R.E.*, vol. 29, pp. 55-70; February, 1941.
- (23) J. A. Stratton and L. J. Chu, "Steady-state solutions of electromagnetic field problems—I. Forced oscillations of a cylindrical conductor; II. Of a conducting sphere; III. Of a prolate spheroid," *Jour. Appl. Phys.*, vol. 12, no. 3, pp. 230-235; March, 1941.
- (24) R. F. Guy, "Engineering factors involved in re-locating WEAF," *RCA Rev.*, vol. 5, no. 4, pp. 435-467; April, 1941.
- (25) G. Builder and J. E. Benson, "Contour-mode vibrations in quartz-crystal plates," *PROC. I.R.E.*, vol. 29, p. 182-186; April, 1941.
- (26) R. King, "The approximate representation of the distant field of linear radiators," *PROC. I.R.E.*, vol. 29, pp. 458-464; August, 1941.
- (27) S. A. Schelkunoff, "Theory of antennas of arbitrary size and shape," *PROC. I.R.E.*, vol. 29, pp. 493-521; September, 1941.
- (28) A. E. Harper, "Rhombic antenna design," D. Van Nostrand Company, Inc., New York, N. Y., 1941.

PART III—RADIO RECEIVERS*

Government contracts took a substantial part of the total receiver industry output. At the same time, a keen demand for civilian receivers was created by the interest in news reports and the expanding purchasing power of the public during 1941. Engineering talent was directed toward the development of substitutes for materials required for military needs, discovery of

new uses for materials, and development of manufacturing methods which would spread the decreased supplies of construction materials over as many receivers as possible.

More broadcast receivers were built during 1941 than in any preceding year, the total amounting to about 13,800,000 units. Analysis of this figure is given in the following table:

* Decimal classification: R360.

STATISTICS ON BROADCAST RECEIVERS FOR 1941
Estimated from First Nine Months of Year

Type	Number of Units	Retail Dollar Volume	Average List Price of Units	Per Cent of Unit Volume	Per Cent of Dollar Volume
Radio Receivers, table models	6,100,000	\$108,000,000	\$ 17.70	44.3	24.65
Radio Receivers, consoles	640,000	46,500,000	72.70	4.64	10.60
Portable Sets	1,660,000	42,800,000	25.70	12.05	9.76
Automobile Sets	3,040,000	111,000,000	36.50	22.10	25.30
Farm Battery Sets	790,000	20,900,000	26.40	5.74	4.77
Radio-Phonograph Combinations, table models	548,000	21,600,000	39.40	3.98	4.93
Radio-Phonograph console models	416,000	61,800,000	148.00	3.02	14.10
Radio-Phonograph Recorders	53,000	7,100,000	134.00	0.38	1.62
Record Players	186,000	4,750,000	25.50	1.35	1.08
Chassis without Cabinets	330,000	13,700,000	41.50	2.39	3.13
Frequency-Modulation Adapters	9,000	360,000	40.00	0.06	0.08
TOTAL	13,772,000	\$438,510,000	\$ 31.80	100.00	100.00

Comparison of 1941 output with that of previous years is given in the following table.

Year	Number of Receivers
1941	13,800,000
1940	11,831,000
1939	10,760,000
1938	7,142,000
1937	8,065,000
1936	8,248,000
1935	6,026,000
1934	4,556,000
1933	4,157,000
1932	2,444,000
1931	3,594,000
1930	3,838,000
Prior to 1930	15,000,000

Phonograph recording disks were constructed with a material of glass base, with a great saving in aluminum. Phonograph developments included a double tone arm, with the second arm operating on the underside of the record. Pickups which reduce surface noise and prolong record life were marketed generally. These were chiefly of the light-pressure type. One development utilized a needle of larger-than-usual diameter which plays from the sides of the record groove, and is intended to improve record life and noise level.

Increased use of the permanent stylus in preference to replaceable needles was noted.

The loop antenna continued as the most common form of built-in signal collector although the increasing use of the metal-plate form has been noted.

Regeneration found increased application in intermediate-frequency circuits and preselector systems. Its use in audio-frequency circuits to produce increased bass response was adopted in several designs.

Communication receivers included noise-limiting circuits in a majority of designs. Crystal-filter systems of wide selectivity range were developed.

An important development in the communication field is an omnidirectional radio range system of particular use in aircraft service.

There was proposed and demonstrated an automatic calling system whereby receivers can stand by continuously but silently and yet can be put into operation at any time by a signal from the transmitter, using subaudible modulation (20 to 50 cycles). This was initially proposed for use in connection with civilian defense to call organized workers to duty, but other commercial applications have been suggested.

- (1) J. H. Little and F. X. Rettenmeyer, "A five-band receiver for automobile service," *PROC. I.R.E.*, vol. 29, pp. 151-166; April, 1941.
- (2) E. B. Passow, "Pre-selection in inexpensive receivers," *Electronics*, vol. 14, pp. 50, 95; September, 1941.
- (3) H. B. Deal, "Receiver control by transmitted signal alert receiver," *RCA Rev.*, vol. 6, pp. 167-182; October, 1941.
- (4) H. Howard, "The personal receiver," *Communications*, vol. 21, pp. 5-9, 26-28; April, 1941.
- (5) B. R. Carson, "A two-side non-turnover automatic record changer," *RCA Rev.*, vol. 6, pp. 183-189, October, 1941.
- (6) J. J. Adams, "Undercoupling in tuned circuits to realize optimum gain and selectivity," *Proc. I.R.E.*, vol. 29, pp. 277-279; May, 1941.
- (7) B. V. K. French, "Inductive tuning for ultra high frequencies," *Electronics*, vol. 14, pp. 32-35, 117-120; April, 1941.
- (8) D. Bacon, "Improved crystal filter performance," *QST*, vol. 24, pp. 58-60; 86; December, 1940.
- (9) W. O. Swinyard, "Measurement of loop-antenna receivers," *PROC. I.R.E.*, vol. 29, pp. 382-387; July, 1941.
- (10) D. G. C. Luck, "An omnidirectional radio-range system," *RCA Rev.*, vol. 6, pp. 55-81; July, 1941.

PART IV—FREQUENCY MODULATION*

Approximately 115 frequency-modulation broadcast-station licenses, construction permits, and applications for construction permits had been recorded by the Federal Communications Commission up to December 31, 1941. Twenty or more of these ultra-high-frequency broadcasting stations now maintain a regular program schedule.†

While priorities and military needs may have had a retarding effect upon the general spread of service to the broadcast listener, the application of frequency modulation to communication services has been accelerated. Many states and municipalities have installed frequency-modulation police equipment. The

* Decimal classification: R414.

† See report on "Frequency-Modulation Broadcasting" in Part II of this review: "Radio Transmitters and Transmitting Antennas," p. 63.

armed forces have also found uses for it, but the story on military applications must wait until the war ends.

The action of the National Television System Committee in adopting frequency modulation as the standard means of transmitting the sound signal is thought to be of considerable significance in connection with the future broadcast services.

No new and startling advances in the frequency-modulation art have been reported during 1941 but the application of the known principles to the development of receivers and transmitters has produced reliable and noteworthy equipment in both the broadcast and communications fields. In the latter field, more than a thousand stations in all have been authorized to operate in the municipal police, state police, and special emergency services.

- (1) "Seventh Annual Report of the Federal Communications Commission (Fiscal year Ended June 30, 1941)," United States Government Printing Office, Washington, D. C., 1941, p. 49.
- (2) J. G. Aceves, "Antennas for FM reception," *Electronics*, vol. 14, pp. 42-45; September, 1941.
- (3) E. H. Armstrong, "Evolution of frequency modulation," *Elec. Eng.*, vol. 59, pp. 485-493; December, 1940.
- (4) M. Artzl and D. E. Foster, "Duplex transmission of frequency modulated sound and facsimile," *RCA Rev.*, vol. 6, pp. 88-101; July, 1941.
- (5) A. W. Barber, C. J. Franks, and A. G. Richardson, "A frequency modulated low signal generator," *Electronics*, vol. 14, pp. 36-38, 92-95; April, 1941.
- (6) J. R. Carson, "Amplitude, frequency, and phase angle modulation," *Wireless Eng.*, vol. 17, p. 477; November, 1940.
- (7) M. G. Crosby, "Observations of frequency-modulated propagation on 26 megacycles," *Proc. I.R.E.*, vol. 29, pp. 398-403; July, 1941.
- (8) M. G. Crosby, "Band width and readability in FM," *QST*, vol. 25, pp. 26-28, 86; March, 1941.
- (9) M. G. Crosby, "Band width and readability in FM," *RCA Rev.*, vol. 5, pp. 363-370; January, 1941.
- (10) M. G. Crosby, "Tuned filter for frequency modulation detection," *Electronics and Telev. and Short Wave World*, vol. 13, pp. 486-487; November, 1940.
- (11) A. V. Eastman and J. R. Woodward, "Binaural transmission on a single channel," *Electronics*, vol. 14, pp. 34-36; February, 1941.
- (12) D. E. Foster and J. A. Rankin, "Intermediate-frequency values for frequency-modulated-wave receivers," *Proc. I.R.E.*, vol. 29, pp. 546-551; October, 1941.
- (13) S. Goldman, "Noise and interference in frequency modulation," *Electronics*, vol. 14, pp. 37-42; August, 1941.
- (14) R. F. Guy and R. M. Morris, "NBC frequency modulation field test," *Radio*, no. 255, pp. 12-31, 136; January, 1941.
- (15) E. Hudeo, "The transmission of pictures by frequency modulation," *Elek. Nach. Tech.*, vol. 18, pp. 12-27; January-February, 1941.
- (16) G. W. O. Howe, "Frequency versus amplitude modulation," *Wireless Eng.*, vol. 18, pp. 1-2; January, 1941.
- (17) O. E. Keall, "Interference in relation to amplitude, phase and frequency modulated systems," *Wireless Eng.*, vol. 18, pp. 6-17, and 56-63; January-February, 1941.
- (18) V. D. Landon, "Impulse noise in FM reception," *Electronics*, vol. 14, pp. 26-30, 73-76; February, 1941.
- (19) G. G. Langdon, "Emergency radio communication for an electric power system," *Electronics*, vol. 14, pp. 40-43, and 83-87; March, 1941.
- (20) V. D. Landon, "Noise in frequency modulation receivers," *Wireless World*, vol. 47, pp. 156-158; June, 1941.
- (21) M. L. Levy, "Frequency modulation receivers," *Communications*, vol. 21, pp. 5-7; March, 1941.
- (22) R. Muniz, D. Oestreicher, and W. Oestreicher, "A pull-swing frequency modulation system for the amateur," *Radio and Telev.*, vol. 11, pp. 598-601; February 1941; vol. 12, p. 96; June, 1941.
- (23) D. E. Noble, "A state police FM network," Part II, *Electronics*, vol. 13, pp. 28-31, 66; December, 1940.
- (24) L. Norton, "Why not narrow band FM for general amateur use?" *Radio*, no. 255, pp. 88-92, 152-153, 159; January, 1941.
- (25) H. E. Rice, "Factory alignment equipment for frequency-modulation receivers," *Proc. I.R.E.*, vol. 29, pp. 551-554; October, 1941.
- (26) "Electronics reference issue: section 3, FM," *Electronics*, vol. 14, pp. 46-49; June, 1941.
- (27) S. Sabaroff, "New system of frequency modulation," *Communications*, vol. 21, pp. 8-9; September, 1941.
- (28) S. W. Seeley, "Frequency modulation," *RCA Rev.*, vol. 5, pp. 468-478; April, 1941.
- (29) R. F. Shea, "Frequency modulation receiver design," *Communications*, vol. 20, pp. 17-23; June, 1940.
- (30) F. L. Sprayberry, "Frequency modulation receivers," *Radio and Telev.* vol. 12, pp. 294-297; September, 1941.
- (31) F. L. Sprayberry, "Principles of frequency-modulation," Part II, *Radio and Telev.*, vol. 11, pp. 744-748; April, 1941.
- (32) F. L. Sprayberry, "Principles of frequency modulation," *Radio and Telev.*, vol. 11, pp. 616-619; February, 1941.
- (33) S. G. Taylor, "AM-FM broadcast tuner," *Communications*, vol. 21, pp. 10-11, 24-26; March, 1941.
- (34) H. P. Thomas and R. H. Williamson, "A commercial 50-kilowatt frequency-modulation broadcast transmitting station," *Proc. I.R.E.*, vol. 29, pp. 537-546; October, 1941.
- (35) H. P. Thomas, "FM transmitter measurements," *Electronics*, Part I, vol. 14, pp. 23-27; May, 1941; Part II, vol. 14, pp. 36-39; July, 1941.
- (36) R. T. Thompson, "An 8 tube converter for FM reception," *Radio*, no. 257, pp. 9-13, 70, 72, 74; March, 1941.
- (37) H. E. Thomas, "The development of a FM police receiver for ultra high frequency use," *RCA Rev.*, vol. 6, pp. 222-233; October, 1941.
- (38) A. Toombs, "The radio battle of 1941 FM vs. AM," *Radio News*, vol. 24, pp. 7, 43-46; March, 1941.
- (39) I. R. Weir, "Operating problems in frequency modulation transmitters," *Communications*, Part I, vol. 21, pp. 5-8, 33-35; May, 1941; Part II, vol. 21, pp. 7-11; June, 1941.
- (40) W. Weiss, "Detection in frequency modulation receivers," *Communications*, vol. 21, pp. 16, 18; March, 1941.
- (41) "Amplitude, frequency and phase modulation," Letter to Editor, *Wireless Engineer*, vol. 17, pp. 441-442; October, 1940.
- (42) H. A. Wheeler, "Two-signal cross modulation in a frequency-modulation receiver," *Proc. I.R.E.*, vol. 28, pp. 537-540; December, 1940.
- (43) A. K. Wing and J. E. Young, "A transmitter for FM broadcast service," *RCA Rev.*, vol. 5, pp. 327-336; January, 1941.
- (44) E. S. Winlund, "Drift analysis of Crosby frequency-modulated transmitter circuit," *Proc. I.R.E.*, vol. 29, pp. 390-398; July, 1941.

PART V—TELEVISION*

During the year, the Federal Communications Commission adopted the television standards proposed by the National Television System Committee and authorized the transmission of commercial television programs. Several commercial television broadcasting licenses were issued and regular programs were started in New York City, Philadelphia, and Schenectady about midyear and continued during the rest of the year. Additional transmitters were planned for Washington, Chicago, Los Angeles, Cincinnati, San Francisco, and Milwaukee.† Several manufacturers modified, at their own expense, the 4000 television receivers already sold. A considerable quantity of receivers remained unsold from the previous manufacture and

no new models were offered for sale. Television development work was largely curtailed during the year except for tests of a large television theater-projector and tests of color-television systems.

Improvements in studio and control-room techniques were made and a new television floodlight and film scanner were developed. Filters for vestigial-sideband type of transmission were described and their transient responses studied. A system was proposed for transmitting both audio and video signals on a single carrier. Further advances were made in the test transmission of television signals over a coaxial cable, a total distance of 800 miles, by connecting the four coaxial units between Minneapolis and Stevens Point in series.

New circuit designs for television receivers included special preselector circuits, improved video-output systems, and radio-frequency high-voltage supplies for picture tubes. Increased signal strength over a wide

* Decimal classification: R583.

† As of January 1, 1942, the Federal Communications Commission had issued licenses and construction permits to television broadcast stations as follows: Licenses—1 commercial and 20 experimental; construction permits—7 commercial and 23 experimental; making a total of 51 television broadcast station authorizations.

pass band was provided by the use of a double fan-type antenna. Special oscilloscope tests were devised for studying television waveforms as well as for measuring linearity of scanning. An investigation was also made of brightness distortion in the over-all television system.

Further advances in the field of color television included simplified receiver designs, studio pickup of color programs, and a projected color picture.

- (1) M. E. Strieby and J. F. Wentz, "Television transmission over wire lines," *Bell Sys. Tech. Jour.*, vol. 20, pp. 62-81; January, 1941.
- (2) B. F. Tyson, "A preselector circuit for television," *Electronics*, vol. 13, pp. 23-25; November, 1940.
- (3) "Groundwork laid for commercial television," *Electronics*, vol. 14, pp. 18-19; 70; April, 1941.
- (4) R. Muniz and A. Tait, "A simple television preamplifier," *Electronics*, vol. 14, pp. 39-41; April, 1941.
- (5) H. E. Kallmann, "Audio and video signals on a single carrier," *Electronics*, vol. 14, pp. 39-42; May, 1941.
- (6) "NTSC proposes television standards," *Electronics*, vol. 14, pp. 17-21, 60-66; February, 1941.
- (7) G. H. Brown and J. W. Conklin, "Water-cooled resistors for the ultrahigh frequencies," *Electronics*, vol. 14, pp. 24-28, 104-105, 108; April, 1941.
- (8) "Electronic view-finder for television camera," *Electronics*, vol. 14, pp. 58-59; July, 1941.
- (9) "Electronics reference issue, section 4—Television," *Electronics*, vol. 14, pp. 49-53; June, 1941.
- (10) D. G. Fink, "Photographic analysis of television images," *Electronics*, vol. 14, pp. 24-29, August, 1941.
- (11) A. H. Rosenthal, "Storage principle in television," *Electronics*, vol. 14, pp. 46-49; October, 1941.
- (12) L. H. Stauffer, "Characteristics of fluorescent materials," *Electronics*, vol. 14, pp. 32-34, 117-118; October, 1941.
- (13) "A brief history of colour television," *Electronics and Telev. and Short Wave World*, vol. 14, p. 228; May, 1941.
- (14) "Television in colour," *Electronics and Telev. and Short Wave World*, vol. 14, insert between pp. 152 and 153; April, 1941.
- (15) P. Nagy, "Some observations relating to reports of colour television in America," *Electronics and Telev. and Short Wave World*, vol. 14, pp. 60-62, 95; February, 1941.
- (16) "J. L. Baird's new colour television system," *Electronics and Telev. and Short Wave World*, vol. 14, pp. 69-70; February, 1941.
- (17) "A fan-type aerial for ultra-short wave lengths," *Electronics and Telev. and Short Wave World*, vol. 13, pp. 538-572; December, 1940.
- (18) "Columbia colour television," *Electronics and Telev. and Short Wave World*, vol. 13, pp. 488-490; November, 1940.
- (19) "Television floodlight," *Gen. Elec. Rev.*, vol. 44, p. 352, June, 1941.
- (20) J. Hillier and A. W. Vance, "Recent developments in the electron microscope," *Proc. I.R.E.*, vol. 29, pp. 167-177; April, 1941.
- (21) A. V. Loughren and W. F. Bailey, "Special oscilloscope tests for television wave forms," *Proc. I.R.E.*, vol. 28, p. 332; November, 1940. (Abstract only.)
- (22) O. H. Schade, "Radio-frequency-operated high-voltage supplies for cathode-ray tubes," *Proc. I.R.E.*, vol. 28, p. 533; November, 1940. (Abstract only.)
- (23) H. E. Kallmann and R. E. Spencer, "Transient response of single-sideband systems," *Proc. I.R.E.*, vol. 28, pp. 557-561; December, 1940.
- (24) C. P. Singer, "A mathematical appendix to transient response of single-sideband systems," *Proc. I.R.E.*, vol. 28, pp. 561-563; December, 1940.
- (25) B. D. Loughlin, "A phase curve tracer for television," *Proc. I.R.E.*, vol. 29, pp. 107-115; March, 1941.
- (26) H. Salinger, "A coaxial filter for vestigial-sideband transmission in television," *Proc. I.R.E.*, vol. 29, pp. 115-120; March, 1941.
- (27) A. G. Jensen, "Film scanner for use in television transmission tests," *Proc. I.R.E.*, vol. 29, pp. 243-249; May, 1941.
- (28) D. E. Norgaard and J. L. Jones, "Versatile multichannel television control equipment," *Proc. I.R.E.*, vol. 29, pp. 250-265; May, 1941.
- (29) J. D. Schantz, "New designs of television control-room equipment," *Proc. I.R.E.*, vol. 29, pp. 303-309; June, 1941.
- (30) D. G. Fink, "Brightness distortion in television," *Proc. I.R.E.*, vol. 29, pp. 310-321; June, 1941.
- (31) M. E. Strieby and C. L. Weis, "Television transmission," *Proc. I.R.E.*, vol. 29, pp. 371-381; July, 1941.
- (32) H. A. Wheeler, "The solution of unsymmetrical-sideband problems with the aid of the zero-frequency carrier," *Proc. I.R.E.*, vol. 29, pp. 446-458; August, 1941.
- (33) P. Mertz, "Television—The scanning process," *Proc. I.R.E.*, vol. 29, pp. 529-537; October, 1941.
- (34) O. B. Hanson, "RCA-NBC television presents a political convention as first long distance pick-up," *RCA Rev.*, vol. 5, pp. 267-282B; January, 1941.
- (35) A. W. Vance, "Stable power supplies for electron microscopes," *RCA Rev.*, vol. 5, pp. 293-300; January, 1941.
- (36) G. H. Brown, "Vestigial side-band filter for use with a television transmitter," *RCA Rev.*, vol. 5, pp. 301-326; January, 1941.
- (37) D. E. Foster and J. A. Rankin, "Video output systems," *RCA Rev.*, vol. 5, pp. 409-438; April, 1941.
- (38) D. Sarnoff, "A new era in television," *RCA Rev.*, vol. 6, pp. 3-4; July, 1941.
- (39) I. G. Maloff and W. A. Tolson, "A résumé of the technical aspects of RCA theatre television," *RCA Rev.*, vol. 6, pp. 5-11; July, 1941.
- (40) V. J. Duke, "A method and equipment for checking television scanning linearity," *RCA Rev.*, vol. 6, pp. 190-201, October, 1941.
- (41) L. C. Waller and P. A. Richards, "A simplified television system for the radio amateur and experimenter," *RCA Rev.*, vol. 6, pp. 245-252; October, 1941.
- (42) H. R. Lubcke, "The photographic aspects of television operations," *Soc. Mot. Pic. Eng.*, vol. 36, pp. 185-190; February, 1941.
- (43) S. Sabaroff, "Scanning theory," *Soc. Mot. Pic. Eng.*, vol. 36, pp. 497-513; May, 1941.
- (44) "Television committee report," *Soc. Mot. Pic. Eng.*, vol. 35, pp. 569-583; December, 1940.
- (45) C. F. Wolcott, "Problems in television image resolution," *Soc. Mot. Pic. Eng.*, vol. 36, pp. 65-81; January, 1941.
- (46) "Television experiments on coaxial cable," *Bell Lab. Rec.*, vol. 19, p. 315; June, 1941.

PART VI—FACSIMILE*

Broadcast Facsimile—Point-to-Point Facsimile Operation by Wire, Ocean Cable, and Radio

BROADCAST FACSIMILE

Although it has been possible to devote comparatively little attention to this field during 1941, premoistened and wet electrochemical recording developments, even with the limited time available, show progress. Speeds at present range from 32 to 144 square inches per minute at 100 lines per inch definition. †

* Decimal classification: R583.

† As of January 1, 1942, the Federal Communications Commission had authorized four broadcast stations to engage in facsimile transmission.

- (1) M. Artzt and D. Foster, "Duplex transmission of frequency modulated sound and facsimile," *RCA Rev.*, vol. 6, pp. 88-101; July, 1941.
- (2) J. V. L. Hogan, "Facsimile and its future uses," *Ann. Amer. Acad. Pol. and Soc. Sci.*, vol. 213, pp. 162-169; January, 1941.

POINT-TO-POINT FACSIMILE

Wire

Newsphoto services have continued to improve their facsimile plant and have expanded facilities to serve new subscribers.

Expansion of facsimile installations which serve as

pickup and delivery facilities for telegraph business in large metropolitan areas has proceeded at an increasingly rapid rate with important improvements, which have been dictated by the experience acquired in service. Since the provision of such facilities in the Atlanta and San Francisco areas, the demand for this type of service has exceeded the supply of equipment available. Further expansion in this field is now in progress.

An increased volume of telegraph business between branch and central offices is being handled by facsimile methods, and a new type of recorder has been designed which is particularly adapted to this type of service. This recorder utilizes cut blanks which are automatically fed into the machine and ejected when the message has been recorded. In addition to requiring less attention than most previous recorders, this machine provides an increased reproduction speed where circuit conditions permit.

A small push-button telegraph facsimile concentrator for use in connection with patron-to-patron transmitter—recorders has been developed and placed in service. This concentrator provides facilities whereby the "home-office" transmitter—recorder may be readily connected to any one of a number of outlying offices at will.

Trunk-circuit telegraph facsimile facilities have been improved, and an increasing volume of business is being handled, particularly between New York and Chicago.

Ocean Cables

During the past year, conditions in England necessitated a change in the method of handling the cable-photo pictures transmitted from London to New York. The system normally intended for noncarrier operation with line frequencies between 0 and 150 cycles, was revised to provide modulation of a carrier for transmission over commercial telephone lines between London and Penzance. At Penzance, the signals are reconverted to the low frequencies required for transmission over the long high-speed ocean cable. The number of scanning lines per inch was also increased with resulting improved quality of transmission.

- (1) J. W. Milnor, "Picture transmission by submarine cable," *Trans. A.I.E.E. (Elec. Eng., March, 1941)*, vol. 60, pp. 105-108; 1941; discussion, *Trans. A.I.E.E. (Trans. Suppl.)*, vol. 60, p. 756; 1941.

Radio

Radiophoto service employing the subcarrier frequency-modulation method was inaugurated on the Moscow-New York circuit in July. Taking into consideration the multipath radio-transmission conditions experienced on this particular circuit, highly acceptable newsphotos have been received in New York and published in the newspapers. Companies active in the radiophoto field have continued to improve their apparatus and have increased their knowledge of the space-circuit propagation problem.

PART VII—RADIO WAVE PROPAGATION*

Radio wave propagation was put on a more nearly quantitative basis by the development and publication of methods, formulas, and curves for the calculation of field intensities in terms of antenna heights, ground conductivity, etc. Transmission curves are given in the first two references cited below.

There was substantial progress in the understanding of sky-wave propagation. By use of a *musa* (multiple-unit-steerable-antenna) system it was determined that scattered reflections at the earth's surface may give radio reception on paths other than the great-circle path of transmission. As a result of a five-year co-operative study an explanation was found for markedly higher received intensities and less variability in high-frequency transmission between North America and South America than between North America and Europe. The predictions of radio transmission conditions published by the National Bureau of Standards monthly in the *PROCEEDINGS OF THE I.R.E.* and quarterly in *QST* were extended in scope and found increasingly useful in the choice of transmission frequencies. Portable ionospheric observation equipment was designed and a description was published.

There was substantial progress in knowledge of prop-

agation at ultra-high frequencies (above 30 megacycles). Besides general data on received intensities and fading characteristics, the results of a number of special studies became available. One was a comparison of experimental with calculated diffraction over mountains. Another was correlation of intensity variations with cold fronts and other meteorological conditions, locating refraction levels at heights of a few kilometers. Data became available on the special transmission conditions met in the use of frequency modulation at frequencies between 40 and 50 megacycles.

Studies were made in the measurement of noise from "static" in the frequency range of 250 to 1500 kilocycles by the warbler method; a definite maximum of field intensity of the noise was indicated at or immediately after local sunset. Standards were developed for the technique of measuring noise and new equipment was under development to meet these standards. Further progress was made in the study of fluctuation noise; formulas were developed for calculating the magnitude of fluctuation noise.

- (1) "Standards of Good Engineering Practice Concerning High-Frequency Broadcast Stations (43,000-50,000 Kilocycles)" and "Standards of Good Engineering Practice Concerning Broadcast Stations (550-1600 Kilocycles)." Federal Communications Commission, Washington, 1941.

* Decimal classification: R. 113.7.

- (2) C. R. Burrows and M. C. Gray, "The effect of the earth's curvature on ground-wave propagation," *PROC. I.R.E.*, vol. 29, pp. 16-24; January, 1941.
- (3) G. F. Edwards and K. G. Jansky, "Measurements of the delay and direction of arrival of echoes from near-by short-wave transmitters," *PROC. I.R.E.* vol. 29, pp. 322-330; June, 1941.
- (4) J. H. Dellinger and A. T. Cosentino, "A radio transmission anomaly; co-operative observations between the United States and Argentina," *PROC. I.R.E.*, vol. 28, pp. 431-438; October, 1940.
- (5) N. Smith, "Oblique-incidence radio transmission and the Lorentz polarization term." *Nat. Bur. Stand. Jour. Res.*, vol. 26, pp. 105-115; February, 1941.
- (6) T. R. Gilliland and A. S. Taylor, "Field equipment for ionosphere measurements," *Nat. Bur. Stand. Jour. Res.*, vol. 26, pp. 377-384; May, 1941.
- (7) A. H. Waywick, "Experiments on the propagation of ultra-short radio waves," *PROC. I.R.E.*, vol. 28, pp. 468-475; October, 1940.
- (8) H. Selvidge, "Diffraction measurements at ultra-high frequencies," *PROC. I.R.E.*, vol. 29, pp. 10-16; January, 1941.
- (9) A. W. Friend, "Further comparisons of meteorological soundings by radio waves and radiosonde data," *Bull. Amer. Met. Soc.*, vol. 22, p. 53; February, 1941.
- (10) S. R. Khastgir and M. Kameswar Rao, "Some studies in high-frequency atmospheric noise at Dacca by the warbler method," *PROC. I.R.E.*, vol. 28, pp. 511-513; November, 1940.
- (11) C. N. Burrill, "Progress in the development of instruments for measuring radio noise," *PROC. I.R.E.*, vol. 29, pp. 433-442; August, 1941.
- (12) V. D. Landon, "The distribution of amplitude with time in fluctuation noise," *PROC. I.R.E.*, vol. 29, pp. 50-55; February, 1941.
- (13) D. O. North and W. R. Ferris, "Fluctuations induced in vacuum-tube grids at high frequencies," *PROC. I.R.E.*, vol. 29, pp. 49-50; February, 1941.
- (14) V. D. Landon, "Impulse noise in FM reception," *Electronics*, vol. 14, pp. 26-30, 73-76; February, 1941.
- (15) S. Goldman, "FM noise and interference," *Electronics*, vol. 14, pp. 37-42; August, 1941.
- (16) O. E. Keall, "Interference in relation to amplitude, phase, and frequency modulated systems," *Wireless Eng.*, vol. 19, pp. 6-17; January, 1941; vol. 19, pp. 56-62; February, 1941.
- (17) J. A. Stratton, "Electromagnetic theory," McGraw-Hill Book Company, New York, N. Y., 1941.

PART VIII—PIEZOELECTRICITY*

The present report covers, generally, the progress made in the field of piezoelectricity during the years 1940 and 1941.

Progress has had mainly to do with the properties of Rochelle salt and quartz. A study has been made of hysteresis phenomena in vibrating Rochelle-salt crystals, and the constants of heavy-water Rochelle-salt crystals have been determined. Several papers having to do with the theory of the physical properties of Rochelle salt have also appeared in which it is claimed that the abnormal dielectric properties of this crystal, which are closely analogous to the ferromagnetic properties of iron, find an explanation in the fundamental properties of the crystal when it is so clamped that no deformations can take place in the electric field.

A considerable amount of work, both theoretical and experimental, has been done on the properties and uses of quartz crystals. For many years the only available data on the elastic constants of quartz were those obtained by Voight. These constants have now been redetermined by a dynamical method over a wide range of temperatures including the high temperatures in which ordinary quartz becomes converted into Beta quartz. Vibrational modes of a number of different cuts were studied in the course of this work. Several papers have also appeared having to do with thickness vibrations, contour-mode vibrations (shear and flexure in Y-cut plates and the coupling between these modes), and torsional vibrations. By means of an oscilloscope the earlier work of Van Dyke on the measurement of Q for vibrating quartz plates has been extended.

Progress has been made in the development of quartz plates of special cuts and dimensions in order to obtain low-temperature coefficients of frequency, the outstanding example being the GT cut. In connection with the orientations of various cuts attention should be called to a careful study that has been made of the distinction between right and left quartz.

* Decimal classification: R214 X537.65.

Crystal filters continue to be an object of research. Progress has been made in the design of filters of variable bandwidth and in the arrangement of electrodes. Flexural vibrations of quartz plates have been suggested in the case of filters in the frequency range from 1 to 60 kilocycles.

The most recent progress in the construction of quartz clocks involves the use of a series of multivibrators giving a final 1000-cycle frequency, consisting of extremely sharp pulses whereby high precision in timing is made possible.

Some experimental work has been done on two different techniques for making use of the etch patterns on the surface of quartz for a reasonably precise determination of the directions of the crystal axes. One of these methods consists in the examination of large-scale patterns on the entire surface of a quartz sphere. According to the other method a narrow beam of light, after passing through a plate cut from a quartz crystal, emerges at the etched surface, producing by means of a lens a sharply defined image which can be examined visually or photographed. From the form of the image the directions of the axes can be ascertained.

- (1) J. V. Atanasoff and P. J. Hart, "Dynamical determination of the elastic constants and their temperature coefficients for quartz," *Phys. Rev.*, vol. 59, pp. 85-96; January 1, 1941.
- (2) J. V. Atanasoff and E. Kammer, "A determination of the c_{44} elastic constant for Beta-quartz," *Phys. Rev.*, vol. 59, pp. 97-99; January, 1, 1941.
- (3) R. Bechmann, "Thickness vibrations in quartz plates," *Hochfrequenz. und Elektroakustik*, vol. 56, pp. 14-21; July, 1940.
- (4) H. A. Brown, "Oscilloscope patterns of damped vibrations of quartz plates and Q measurements with damped vibrations," *PROC. I.R.E.*, vol. 29, pp. 195-199; April, 1941.
- (5) G. Builder, "A note on the determination of the equivalent electrical constants of a quartz-crystal resonator," *A. W. A. Tech. Rev.*, vol. 5, no. 1, pp. 41-45; 1941.
- (6) G. Builder and J. E. Benson, "Simple quartz-crystal filters of variable band-width," *A. W. A. Tech. Rev.*, vol. 5, no. 3, pp. 93-103; 1941.
- (7) G. Builder and J. E. Benson, "Contour-mode vibrations in Y-cut quartz-crystal plates" *PROC. I.R.E.*, vol. 29, pp. 182-185; April, 1941; *A. W. A. Tech. Rev.*, vol. 5, no. 5, pp. 181-189; 1941.

- (8) G. K. Burns, "Manufacture of quartz crystal filters," *Bell Sys. Tech. Jour.*, vol. 19, pp. 516-532; October, 1940.
- (9) E. Giebe and E. Blechschmidt, "On torsional vibrations of quartz rods and their use as standards of frequency," *Hochfrequenz. und Elektroakustik*, vol. 56, pp. 65-87; September, 1940.
- (10) A. N. Holden and W. P. Mason, "Constants of heavy-water Rochelle salt," *Phys. Rev.*, vol. 57, pp. 54-56; January, 1940.
- (11) H. H. Hubbell, "Images projected from etched surfaces of quartz crystals," *Phys. Rev.*, vol. 59, p. 473; March 1, 1941. (Abstract only.)
- (12) A. W. Lawson, "A determination of the elastic modulus ϵ_{12} of Beta-quartz," *Phys. Rev.*, vol. 59, pp. 608-612; April 1, 1941.
- (13) W. P. Mason, "The location of hysteresis phenomena in Rochelle salt crystals," *Phys. Rev.*, vol. 58, pp. 744-756; October, 15, 1940.
- (14) W. P. Mason, "A new quartz-crystal plate, designated the GT, which produces a very constant frequency over a wide temperature range," *Proc. I.R.E.*, vol. 28, pp. 220-223; May, 1940.
- (15) W. P. Mason, "Low temperature coefficient quartz crystals," *Bell Sys. Tech. Jour.*, vol. 19, pp. 74-93; January, 1940.
- (16) W. P. Mason and R. A. Sykes, "Electrical wave filters employing crystals with normal and divided electrodes," *Bell Sys. Tech. Jour.*, vol. 19, pp. 221-248; April, 1940.
- (17) Hans Mueller, "Properties of Rochelle salt, II," *Phys. Rev.*, vol. 57, pp. 829-839; May 1, 1940.
- (18) Hans Mueller, "Properties of Rochelle salt, III," *Phys. Rev.*, vol. 58, pp. 565-573; September, 15, 1940.
- (19) Hans Mueller, "Properties of Rochelle salt, IV," *Phys. Rev.*, vol. 58, pp. 805-811; November 1, 1940.
- (20) L. Rohde and H. Handrek, "The properties of quartz resonators at audio and intermediate frequencies," *Zeit. Tech. Phys.*, vol. 21, pp. 401-405; 1940.
- (21) K. S. Van Dyke, "On the right- and left-handedness of quartz and its relation to elastic and other properties," *Proc. I.R.E.*, vol. 28, pp. 399-406; September, 1940.
- (22) K. S. Van Dyke, "The use of an etched sphere of quartz in identifying the orientation of quartz plates," *Proc. I.R.E.*, vol. 28, p. 144; March, 1940. (Abstract only.)
- (23) P. Vigoureux and H. E. Stoakes, "An all-electric clock," *Proc. Phys. Soc.*, vol. 52, Part 3, pp. 353-358; May, 1940.

PART IX—ELECTROACOUSTICS*

Loudspeakers—Microphones—Room Acoustics—Measuring Apparatus and Techniques— Electromechanical Devices

Nonmilitary development work in electroacoustics and publication of work already done has been greatly retarded by the heavy diversion of workers from this field into military work.

A number of reported developments have applications in several branches of the field.

Acoustic models of antenna arrays with nonsinusoidal current distributions were used to study the effect of this distribution on the radiation pattern. Experimental determination of the mutual antenna impedance is also facilitated. Renewed attention was given to the use of nonlinear distortion to increase the apparent or subjective bass response of systems transmitting a limited low-frequency range.

Commercial production was initiated on a permanent-magnet material of the aluminum-nickel-cobalt-iron family, having an energy product of about three times the value of that of alloys now in general use. This material is cooled from a high temperature in a strong magnetic field which must be in the direction in which the material ultimately is to be magnetized. Substantially reduced weight and corresponding economies result from its use.

Progress in the general field of piezoelectricity appears elsewhere in this review. The driving-point admittance of crystals, which is of special interest in the field of electroacoustics, received further attention. Lattice-type acoustic filters were investigated, broadening the acoustic-filter field which, largely because of the lack of commercial need, continues much narrower than the electric-wave-filter field.

- (1) B. Jonas and H. J. Meerkamp van Embden, "New kinds of steel of high magnetic power," *Philips Tech. Rev.*, vol. 6, pp. 8-11; January, 1941.
- (2) W. E. Ruder, "New magnetic materials," Presented Rochester Fall Meeting, Rochester, N. Y., November 11, 1941.
- (3) S. F. Kayser, "Permanent magnets," *Engineering* (London), vol. 170, p. 183; September 20, 1940.
- (4) E. C. Jordan and W. L. Everitt, "Acoustic models of radio antennas," *Proc. I.R.E.*, vol. 29, pp. 186-194; April, 1941.

* Decimal Classification: 621.385.97.

- (5) K. S. Van Dyke and M. C. Waltz, "Measured admittances of a Rochelle-salt resonator," *Phys. Rev.*, vol. 59, p. 686; April 15, 1941. (Abstract only.)
- (6) H. K. Schilling, "A lattice-type acoustic filter," *Phys. Rev.*, vol. 59, p. 111; January, 1941. (Abstract only.)

LOUDSPEAKERS

Much attention has recently been given to the problem of enhancing the dramatic value of reproduced sound by improving its spatial distribution and dynamic range. Some of the many complex system factors which enter have been investigated. Much work remains to be done on the involved problem of the behavior of multiple microphone-pickup and multiple-speaker reproducing systems although progress is reported. Various combinations of speaker and sound channels and control tracks have been proposed for motion-picture use as desirable compromises between results and cost. While substantially all of the reported work has been in the motion-picture field one receiver was announced that employed a double-cabinet system in which the auxiliary cabinet is fed by a carrier current from the main cabinet.

Curtailed supplies of materials for permanent magnets has led to renewed interest in piezoelectric loudspeakers. Experimental models employing a small directly driven diaphragm and a compact folded horn to provide the necessary high load impedance were developed.

Higher throat resistance near the low-frequency cut-off and better reactance annulling may be obtained in a new family of horns. These characteristics permit improved over-all low-frequency efficiency when these horns are used with conventional driving units. This horn family is related to the exponential horn in the manner that m -derived filters are related to the constant- K type.

An experimental moving-coil sound generator having high efficiency in a narrow supersonic frequency range was reported. The sound is radiated from one end

of a solid duralumin rod, the other end of which is driven by the moving coil. The rod, which also acts as a mechanical transmission line, is supported at a velocity node.

High-efficiency telephone receivers directly connected to microphones, both of the Rochelle-salt type, were introduced primarily for use on ships. Similar systems of this type using magnetic-armature units were previously reported. A high-fidelity telephone receiver intended primarily for monitor work was introduced.

- (7) H. Fletcher, "The stereophonic sound-film system—general theory," *Jour. Soc. Mot. Pic. Eng.*, vol. 37, pp. 331–352; October, 1941.
- (8) E. C. Wentz, R. Biddulph, L. A. Elmer, and A. B. Anderson, "Mechanical and optical equipment for the stereophonic sound-film system," *Jour. Soc. Mot. Pic. Eng.*, vol. 37, pp. 353–365; October, 1941.
- (9) J. C. Steinberg, "The stereophonic sound-film system—pre- and post-equalization of compander systems," *Jour. Soc. Mot. Pic. Eng.*, vol. 37, pp. 366–379; October, 1941.
- (10) W. B. Snow and A. R. Soffel, "Electrical equipment for the stereophonic sound-film system," *Jour. Soc. Mot. Pic. Eng.*, vol. 37, pp. 380–396; October, 1941.
- (11) N. Levinson and L. T. Goldsmith, "Vitasound," *Jour. Soc. Mot. Pic. Eng.*, vol. 37, pp. 147–153; August, 1941.
- (12) W. E. Garity and J. N. A. Hawkins, "Fantasound," *Jour. Soc. Mot. Pic. Eng.*, vol. 37, pp. 127–146; August, 1941.
- (13) V. Salmon, "Hypex horns," *Electronics*, vol. 14, pp. 34–35; July, 1941.
- (14) H. W. St. Clair, "An electromagnetic sound generator for producing intense high frequency sound," *Rev. Sci. Instr.*, vol. 12, pp. 250–256; May, 1941.
- (15) L. Sengewitz, "The Rochelle-salt crystal and its application in the field of telephony," *Elek. Tech. Zeit.*, vol. 62, pp. 463–465; May 15, 1941.
- (16) L. J. Anderson, "High fidelity headphones," *Jour. Soc. Mot. Pic. Eng.*, vol. 17, pp. 319–323; September, 1941.

MICROPHONES

Application of the principles of reciprocity and of similarity have permitted more precise microphone calibrations. An unexplained difference between thermophone and reciprocity calibration was reported. A method of minimizing the leakage difficulties in microphones having very high internal electrical impedance by the use of negative feedback has also been developed.

- (17) H. F. Olson, "Calibration of microphones by the principles of similarity and reciprocity," *RCA Rev.*, vol. 6, pp. 36–42; July, 1941.
- (18) R. K. Cook, "Absolute pressure calibrations of microphones," *Nat. Bur. Stand. Jour. Res.*, vol. 25, pp. 489–505; November, 1940.
- (19) A. L. Williams and H. G. Baerwald, "General and design considerations of low-noise microphones," *Jour. Soc. Mot. Pic. Eng.*, vol. 36, pp. 649–665; June, 1941.

ROOM ACOUSTICS

Much of the work in this field has been directed toward an effort to apply the boundary impedance concept, previously reported, to the practical problem of designing rooms which are good acoustically. While much progress has been made in this direction the acoustical engineer must still draw heavily on the empirical reverberation data accumulated in the last four decades in designing rooms. Experiments were conducted to determine the effect of the width and location of sound-absorbing strips on the reverberation time of a test chamber. The Research Council of the Academy of Motion Picture Arts and Sciences has issued recommendations for the guidance of those designing new theatres.

- (20) P. E. Sabine, "Specific normal impedances and sound absorption coefficients of materials," *Jour. Acous. Soc. Amer.*, vol. 12, pp. 317–322; January, 1941.
- (21) L. G. Ramer, "The absorption of strips, effects of width and location," *Jour. Acous. Soc. Amer.*, vol. 12, pp. 323–326; January, 1941.
- (22) "Research Council of the Academy of Motion Picture Arts and Sciences, Theatre Standardization Committee," *Jour. Soc. Mot. Pic. Eng.*, vol. 36, pp. 267–282; March, 1941.

MEASURING APPARATUS AND TECHNIQUES

A vibration meter covering the frequency range of 2 to 2000 cycles was offered. This has built-in equalizers to give direct-reading root-mean-square values of displacement, velocity, and acceleration. Two sound-measuring rooms were reported. One of these adopted the live-end–dead-end principle to a room used to measure the total sound radiation of a device. The other was a free-field room using 32,000 slender, rock-wool, pyramidal-shaped members, each a meter long with their bases contiguous and covering the entire boundary. The inverse pressure-distance curve is preserved within less than 2 decibels over the audio-frequency range above 60 cycles per second up to a distance of 9 meters from the source.

- (23) H. H. Scott, "A general-purpose vibration meter," *Jour. Acous. Soc. Amer.*, vol. 13, pp. 46–50; July, 1941.
- (24) M. D. Stahl and W. C. Loudon, "A sound measuring room utilizing the live-end–dead-end studio principles," *Jour. Acous. Soc. Amer.*, vol. 13, pp. 9–15; July, 1941.
- (25) E. Meyer, G. Buchmann and A. Schöch, "A novel highly-effective sound-absorbing arrangement and the construction of a dead room," *Akus. Zeit.*, vol. 5, pp. 352–364; 1940. Summary in English, *Jour. Acous. Soc. Amer.*, vol. 13, pp. 191–193; October, 1941.

ELECTROMECHANICAL DEVICES

The marked trend toward the use of low-pressure pickups and "permanent" styli of both the fixed and removable types continued. Nonlinear distortion resulting from tracking error in lateral recordings was investigated analytically and the objective and nuisance effects found to be greater than generally supposed. A novel record changer which plays both sides of a record without turning it over was introduced. A U-shaped tone arm with two pickups is used. The discarded record is dropped gently into a compartment by a mechanism which automatically tilts the turntable and spindle.

Improved stability of the efficiency and frequency response of a crystal cutter was obtained in a temperature-controlled cutter. Experiments on the use of pickup styli with approximately double the normal radius were reported which indicated that reduced record wear and noise result from their use.

- (26) B. R. Carson, "A two-side non-turnover automatic record changer," *RCA Rev.*, vol. 6, pp. 183–189; October, 1941.
- (27) H. G. Baerwald, "Analytic treatment of tracking error and notes on optimal pickup design," *Jour. Soc. Mot. Pic. Eng.*, vol. 37, pp. 591–622; December, 1941.
- (28) S. J. Begun, "Temperature controlled disc recording cutter," *Jour. Soc. Mot. Pic. Eng.*, vol. 36, pp. 666–674; June, 1941.

A development reported in last year's review had its first publication in 1941.

- (29) B. B. Bauer, "Uniphase uni-directional microphones," *Jour. Acous. Soc. Amer.*, vol. 13, pp. 41–45; July, 1941.

A New Air-Cooled 5-Kilowatt Broadcast Transmitter*

F. W. FISCHER†, ASSOCIATE, I.R.E.

Summary—This paper gives details in design and construction of a new 5-kilowatt transmitter for use in the broadcast band of 550 to 1600 kilocycles. By the use of illustrations the arrangement of components in each cubicle is shown and the text refers to the various major details. One method of adapting a single blower to the cooling needs of an entire transmitter is described. The supervisory, sequence interlocked, control system is outlined and the placement of indicator lights, switches, and relays used in conjunction with this control system are outlined.

With the use of a simplified schematic several specialized adaptations of new audio circuits are shown and discussed. These circuits reduce distortion to very low values and a flat frequency response is obtained over wide limits. Distortion values at various percentages of modulation are plotted in a response curve of a typical 5-kilowatt transmitter.

A means of reducing radio-frequency output power with split-second push-button control of a magnetic switch is also touched upon.

The summary at the close of the paper outlines various performance characteristics such as power consumption at several modulation levels, audio response, radio-frequency stability, and power output.

THE 5-kilowatt transmitter considered herewith is designed for use in the standard broadcast band of 550 to 1600 kilocycles. Design emphasis has been placed on the incorporation of a low-audio-distortion characteristic and a flat frequency response. For dependability, high-efficiency rectox units have

blower is fed into this transmitter subbase from which it is distributed to all cubicles.

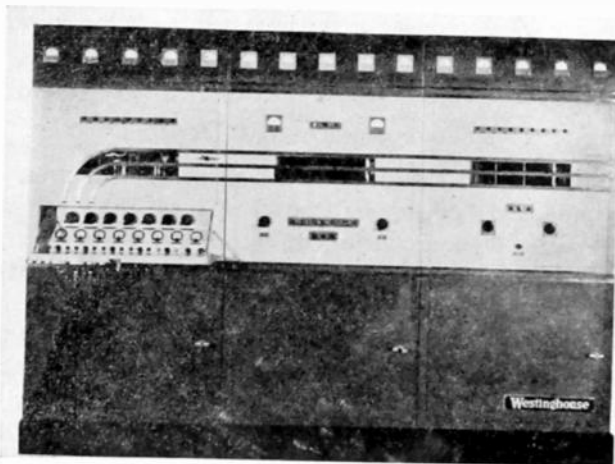

Fig. 1—Front view of transmitter.

been used to replace all low-voltage tube rectifiers. All tubes run well below their maximum ratings. The entire transmitter is fully air-cooled by a single blower. Adequate metering is provided in all circuits.

The equipment is designed to be reasonably compact and still maintain good accessibility to components.

The transmitter proper is composed of three cubicles which, from left to right, contain the exciter, power-amplifier, and modulator circuits. All three cubicles are mounted on a single subbase which serves as an inter-unit wiring trough and air duct. The air from a single

* Decimal classification: R355.21. Original manuscript received by the Institute, June 26, 1941. Presented, Summer Convention, Detroit, Michigan, June 23, 1941.

† Westinghouse Electric and Manufacturing Company, Baltimore, Maryland.

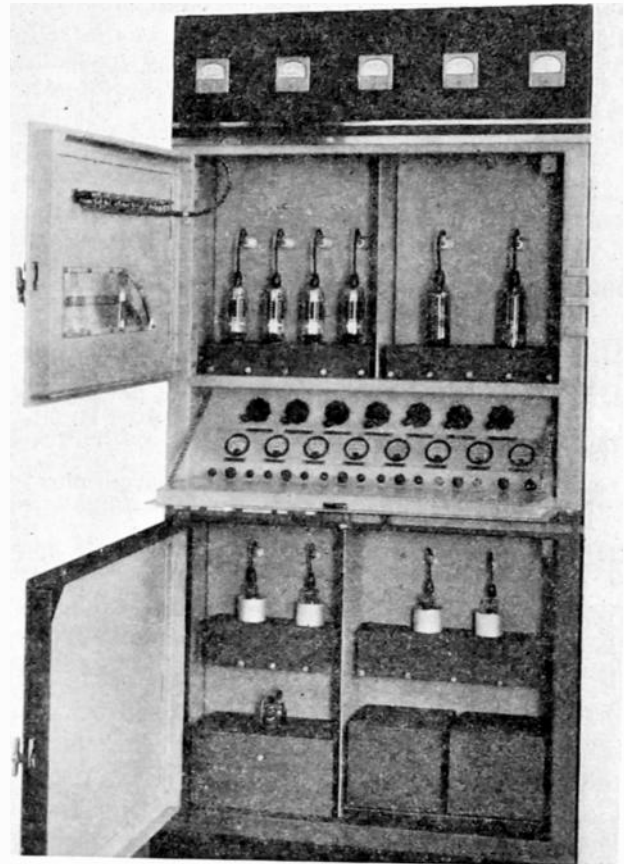

Fig. 2—Front view of exciter.

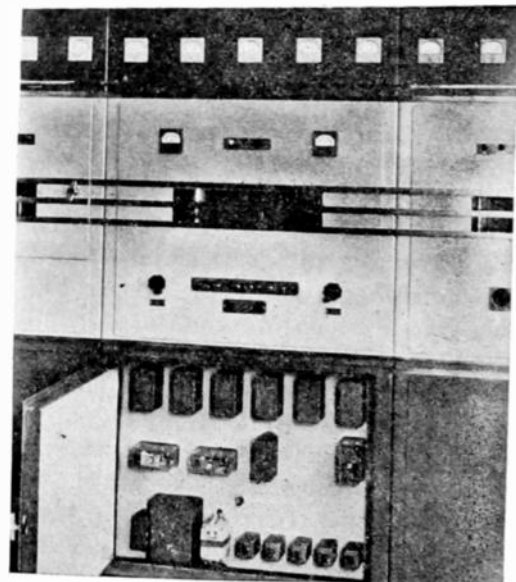

Fig. 3—Front view of power amplifier.

On the exciter and modulator are located groups of nine lights. These lights are used in conjunction with the overload supervisory control circuits. The over-

load supervisory control consists of overcurrent and under- and overvoltage relays in all circuits. When one of these relays operates, an indication is given in the respective circuit by a pilot light which remains lighted until released manually.

The exciter is divided into two sections. The audio stages, consisting of two 1603 tubes, two 807 tubes,

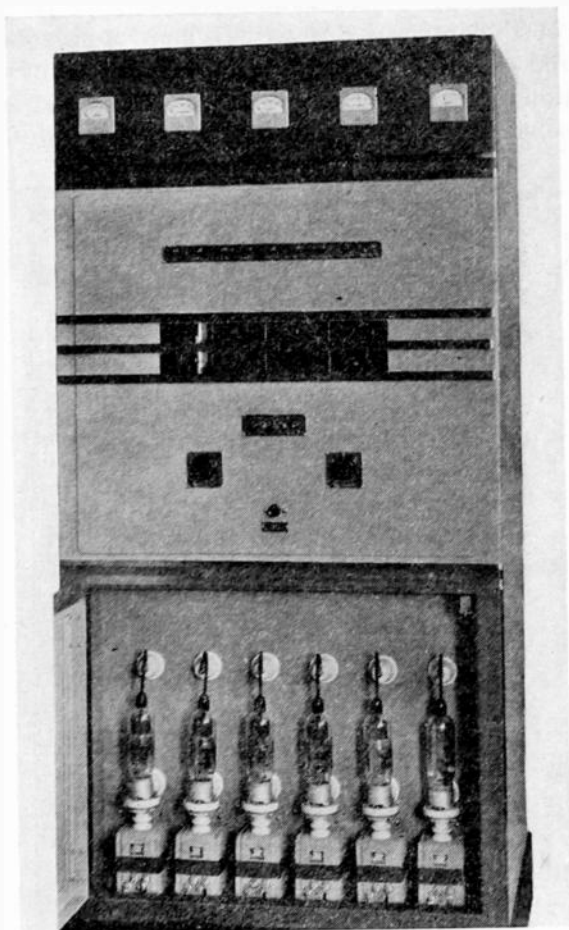

Fig. 4—Front view of modulator.

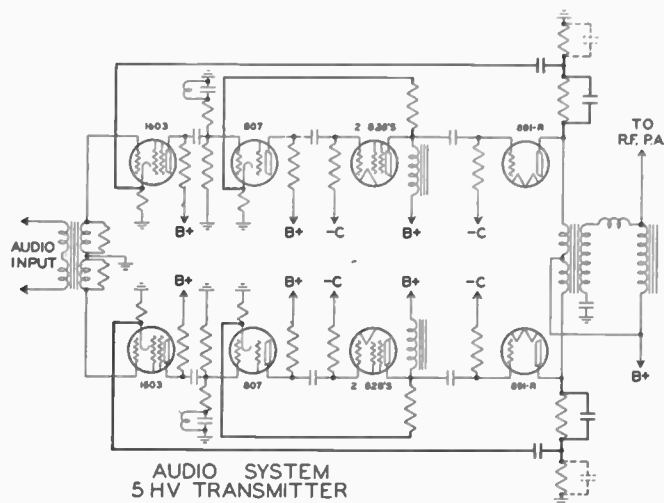

Fig. 6—Fundamental schematic of audio circuits.

and four 828 tubes, are arranged from bottom to top in the left half. In the right half are located the two Westinghouse Type HH crystal oscillators, the 807 radio-frequency buffer stage, and in the upper compartment the 805 radio-frequency driver stage.

Behind the center door are located the exciter OFF-ON switches, the low-power stage indicating instruments, and all bias-voltage and tuning controls. All

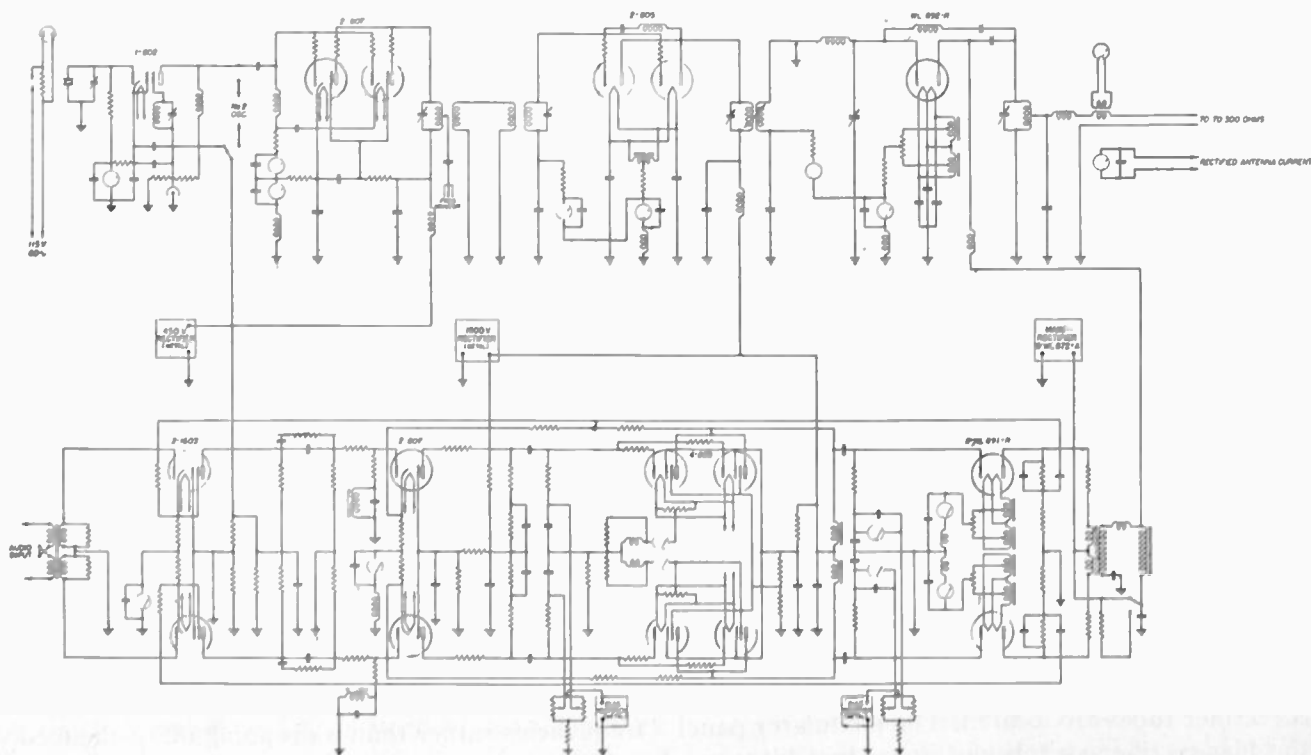

Fig. 5—Fundamental schematic.

circuits are interlocked so that proper sequence starting is fully realized.

Behind the lower door in the power amplifier are located the control relays associated with the power

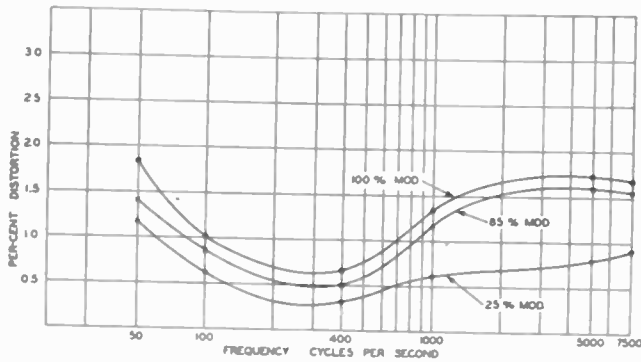

Fig. 7—Distortion curves.

amplifier and the modulator. On the power-amplifier panel the main-rectifier control switches and the rectifier regulator control buttons are located. The grid- and plate-tuning controls are brought out on this

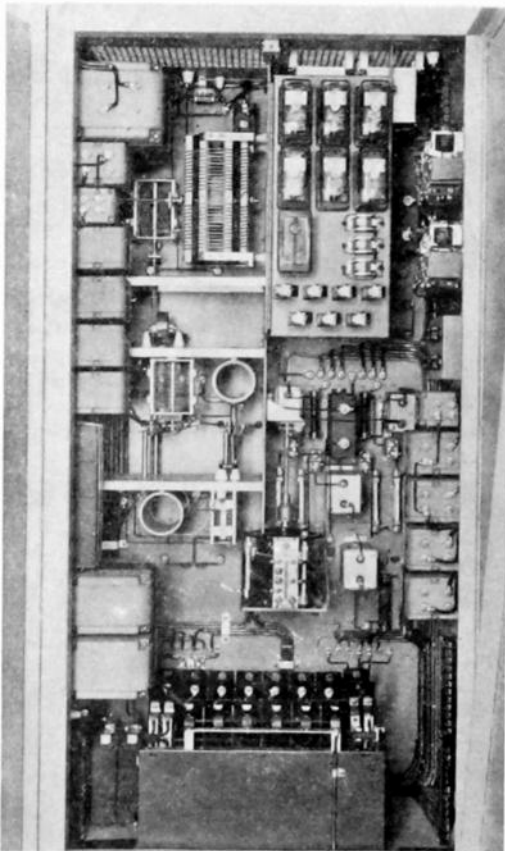

Fig. 8—Rear of exciter.

panel and push buttons for reducing transmitter output power from 5 to 1 kilowatts are located here also. Power reduction is accomplished by reducing final amplifier plate voltage through interlocked contactors.

In the lower front portion of the modulator, the six 872-A rectifier tubes are located. The modulator panel has the bias-rectifier switch and individual bias controls for the 891- ζ tubes.

A new type of inverse audio feedback is used in this

transmitter. It consists first of two loops; one from plate circuits of the 828 driver stage to cathode of the 807 stage; and one from the plate circuit of the 891-R modulator tube to the cathode of the 1603 tube. The use of the internal 828 to 807 loop approaches the desired condition of making the four stages of amplification appear like two stages from the standpoint of phase shift over the frequency bands covered.

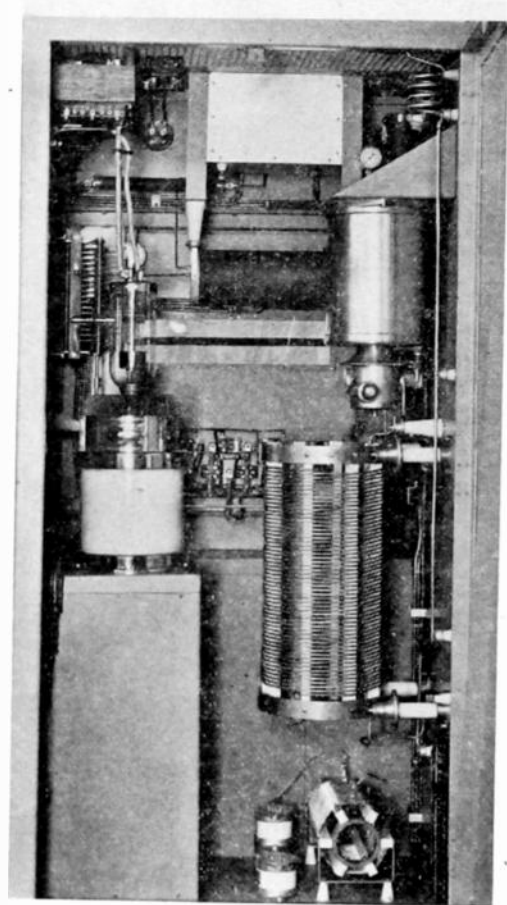

Fig. 9—Rear of power amplifier.

Second, the feedback circuit is brought to a practical application by treating the audio stages as two separate amplifier channels in parallel from the input of the 1603's to the plates of the modulators. This is accomplished by eliminating all common grid, cathode, and plate impedances. Treating the audio circuits in this fashion makes possible the use of feedback loops which have even-order harmonic components as well as odd harmonic components. A conventional push-pull amplifier prevents to a great extent the proper feedback of even-order harmonic distortion.

Third, the inverse-feedback circuit of the inner loop is designed to have a time constant of infinity at the lower frequencies by the elimination of any capacitive reactance in series with the feedback circuit. This has the feature of actually giving "feedback" at the lower frequencies rather than a dropping off of the feedback voltage and a consequent increase of gain through the amplifier.

Fourth, a capacitor, reactor, and resistor combination

with values selected to give a falling gain characteristic at both the very high and very low ends of the audio band covered are included. The function of this combination has the effect of eliminating motor-boating and oscillating caused by a phase displacement due to design limitations of the modulation transformer and reactor.

The modulation transformer and audio reactor are

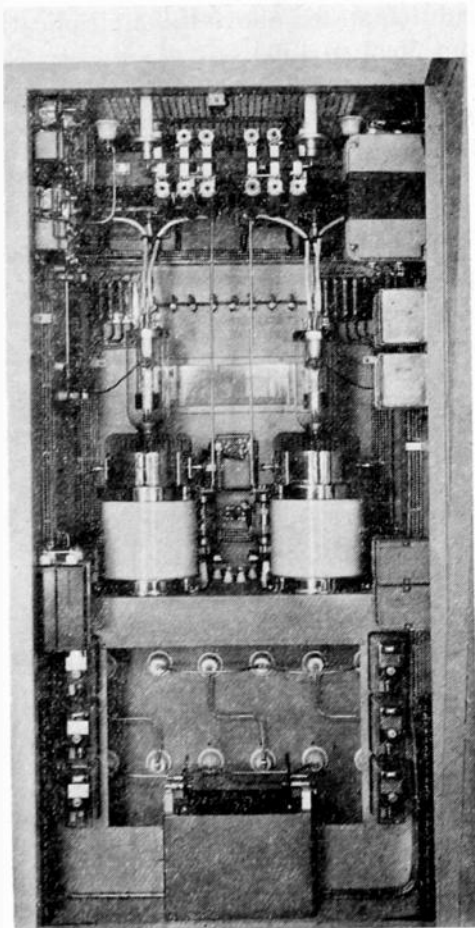

Fig. 10—Rear of modulator.

made to appear as a constant impedance load to the plates of the modulator. This is done by utilizing their capacitances in combination with an inductance to simulate a "low-pass" π -section filter.

By using the circuits as described above, audio distortion from 50 to 7500 cycles per second is reduced to less than 3 per cent and the frequency response is within ± 1 decibel from 30 to 10,000 cycles at all percentages of modulation up to 100 per cent. As a matter of fact, in factory setups over-all distortion is without difficulty reduced to considerably less than 2 per cent from 50 to 7500 cycles per second. Hum and extraneous noise level are at least 60 decibels below 100 per cent sine-wave modulation, unweighted.

Inside of the exciter cubicle are located the radio-frequency circuits for the first three stages, the exciter starting contactors, and the air-cooled metal rectifiers. The radio-frequency lead to the power amplifier and the audio leads to the 891-R modulator grids leave the cubicle through the top.

The power-amplifier cubicle houses all radio-frequency circuits associated with the 892-R radio-frequency power amplifier. The plate tank capacitor for the 892-R is of the compressed-gas type. The inductive neutralizing coil for the 892-R tube is located centrally in the cubicle and suspended from the grid-coil shield can.

The modulator cubicle, as the name implies, houses the 891-R modulator tubes. The air-cooled metal bias rectifier for these tubes is located on the floor of the cubicle. The over-all loop feedback resistors are suspended from the ceiling of this cubicle.

The power and filter frame houses, in addition to various control contactors, the audio coupling ca-

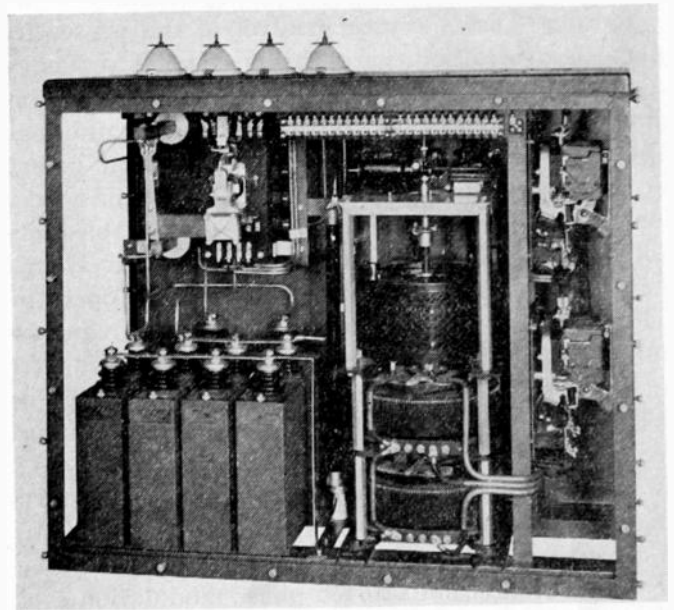

Fig. 11—Power and filter frame.

pacitor, the voltage regulator for the main-rectifier alternating-current plate input, and the filter capacitors and reactor for the main rectifier.

In summarizing the performance of this air-cooled 5-kilowatt transmitter, the following are given:

- (a) 5 kilowatts of radio-frequency power are delivered into a 70- to 300-ohm load.
- (b) 16.5 kilowatts from a 3-phase, 60-cycle, 230-volt line are required at 0 percentage modulation.
- (c) 18 kilowatts are required during average modulation.
- (d) Audio response is flat within ± 1 decibel from 30 to 10,000 cycles at all percentages up to 100 per cent.
- (e) Audio distortion from 50 to 7500 cycles is less than 3 per cent root-mean-square at 95 per cent modulation.
- (f) Rapid reduction from an output power of 5 kilowatts to 1 kilowatt is obtained without retuning or other adjustments.
- (g) Frequency stability is maintained well within ± 10 cycles.
- (h) The entire transmitter is fully air-cooled.

A Stabilized Frequency-Modulation System*

ROGER J. PIERACCI†, ASSOCIATE, I.R.E.

Summary—A wide-band frequency-modulation system in which the center frequency is directly controlled by a single crystal is described. The stability obtainable is that of a single quartz-crystal oscillator.

Further, a system of distortion correction in a phase modulator is described in which the maximum angle of phase shift may be 60 degrees or more with low attendant distortion. This is accomplished by modulation of both the carrier and sidebands.

INTRODUCTION

IT IS important in a system of frequency modulation designed for wide-band high-frequency broadcasting that the center frequency stability be of a high order. Direct crystal control of the center frequency is an ideal solution of this problem, if frequency-modulated signals can be generated without extreme complexity of equipment or difficulty in attaining acceptable fidelity. The use of direct crystal control necessitates the use of a phase modulator in the generation of frequency-modulated signals. A desirable phase modulator would be one which has a relatively high phase-multiplication factor from crystal to operating frequency and at the same time a low frequency-multiplication factor from crystal to operating frequency. While the phase-multiplication factor must be considerably higher than the frequency-multiplication factor, it is desirable to keep both these factors as low as possible from the standpoint of good performance and simplification of apparatus. The minimum value of the phase-multiplication factor is determined by the maximum undistorted phase-modulation capability and the minimum value of audio frequency it is desired to transmit.

The phase-multiplication factor P_m is given by

$$P_m = \frac{m_p}{\theta} \quad (1)$$

where

$$m_p = \frac{\text{frequency deviation}}{\text{audio frequency}}$$

(frequency deviation and audio frequency are expressed in the same units.)

θ = phase shift at oscillator frequency in radians.

In previously described phase modulators, θ has been of the order 0.5 radian and m_p about 1500 (frequency deviation of 75,000 cycles and audio frequency of 50 cycles).

Thus

$$P_m = \frac{1500}{0.5} = 3000.$$

The system to be described permits wider angles of

* Decimal classification: R 414. Original manuscript received by the Institute, July 15, 1941.

† Collins Radio Company, Cedar Rapids, Iowa.

phase shift than 0.5 radian with low attendant distortion and thereby reduces the phase-multiplication factor required. If the phase-shift angle is increased from 30 to 60 degrees, the multiplication is halved or in the condition stated above the multiplication is reduced from 3000 to 1500.

The frequency-stabilizing system and the distortion-correction arrangement will be considered separately in the following discussion.

FREQUENCY-STABILIZATION SYSTEM

A block diagram illustrating the basic operation of the circuit is shown in Fig. 1. V_1 is a crystal-controlled

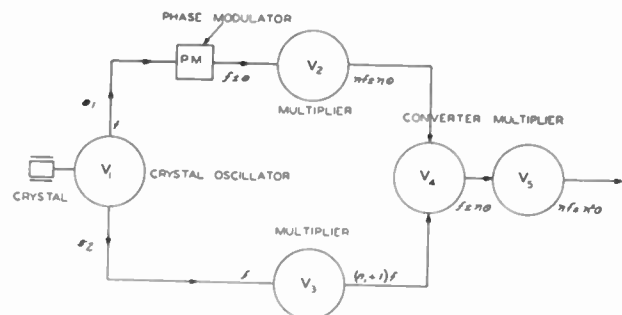

Fig. 1—Stabilized frequency-modulation system using one converter.

oscillator of a conventional type. The radio-frequency energy from oscillator V_1 is divided into two channels. The energy in channel 1 is modulated by means of the phase modulator (PM).

The phase modulator may be of conventional type and incorporate an integrating network in the audio input circuits to convert phase modulation into frequency modulation. This method of generating frequency-modulated waves has been described in past literature on this subject.¹ The output voltage of the phase modulator may be expressed by

$$e = A \sin(\omega t + \theta \sin \rho t) \quad (2)$$

where

$\frac{\omega}{2\pi}$ is the oscillator frequency

$\frac{\rho}{2\pi}$ is the audio frequency

θ is the maximum phase-shift angle at the peak of the audio cycle.

Equation (2) is the expression for a phase-modulated wave. However, when considering a single tone with fixed modulating conditions, there is no difference

¹ Edwin H. Armstrong, "A method of reducing disturbances in radio signaling by a system of frequency modulation," Proc. I. R. E., vol. 24, pp. 689-740; May, 1936.

between a phase-modulated and a frequency-modulated signal. It might be pointed out here that in a phase-modulation system the value of θ remains constant for all audio frequencies; while in a frequency-modulation system θ varies inversely as the audio frequency, thus

$$\theta = \frac{\Delta f}{f_a} \quad (3)$$

Δf = the frequency deviation at the output of the modulator and

f_a = the audio frequency.

In the following discussion it will be more convenient to speak of the multiplication of phase-shift angle θ than multiplication of the frequency deviation Δf . If the frequency of oscillator V_1 is referred to as f , then in an abbreviated notation the output of the phase modulator may be referred to as $f \pm \theta$, where f is the center frequency and θ is the maximum excursion of phase angle during the positive and negative halves of the audio cycle. The notation $f \pm \theta$ does not imply addition of f and θ but a simplified expression of frequency and phase in the system of Fig. 1. The output of the modulator is applied to the multipliers at V_2 where the center frequency and phase shift are multiplied n times to $nf \pm n\theta$.

The energy of the second channel from the crystal oscillator V_1 is unmodulated and carried to the frequency multipliers at V_3 where the frequency is multiplied $(n+1)$ times to $(n+1)f$.

The frequencies of the modulated channel V_2 and the unmodulated channel V_3 are subtracted in the converter V_4 and yield the original oscillator frequency f but with n times the amount of phase shift at the modulator. The output frequency and phase of the converter V_4 is then $f \pm n\theta$. This is obvious from

$$(n+1)f - nf \pm n\theta = f \pm n\theta. \quad (4)$$

The output of the converter V_4 is then carried to a third frequency multiplier at V_5 which may also have a multiplication factor of n . The output frequency of V_5 is then $nf \pm n\theta$. n is the frequency-multiplication factor from crystal to operating frequency, while n^2 is the total phase-multiplication factor. The multiplication factor of the multiplier V_5 may be some other value than n if desired.

The stability of the output frequency of converter V_4 is that of the original crystal oscillator. A numerical example will serve to illustrate this. Suppose the crystal oscillator drifts 10 cycles and that $n=50$ where n is the multiplication factor of modulated channel V_2 . The change in frequency at the output of the modulated multiplier V_2 is the product of the drift and the multiplication factor or $n(10) = (50)(10) = 500$ cycles. The change in frequency at the output of the unmodulated multiplier V_3 is $(n+1)10 = (51)(10) = 510$ cycles. Since the frequency of V_2 and V_3 are subtracted in the converter V_4 , the net drift at V_4 is $510 - 500 = 10$

cycles. This is the same as the original drift at the crystal oscillator. Hence it is seen that the multiplication employed in V_2 and V_3 is not a factor in the stability at the operating frequency. As far as center-frequency stability is concerned, the system acts as if the crystal were located directly at the converter V_4 . In an actual case n and $(n+1)$ would have to be numbers which could be factored to a feasible arrangement of individual frequency-multiplier stages.

If it is desired to reduce the center-frequency multiplication factor and at the same time increase the phase-multiplication factor, more than one frequency conversion may be employed. Fig. 2 shows the plan of a system with a low frequency-multiplication factor and a phase-multiplication factor of high order. However, in practice there is an upper limit to the amount of phase multiplication that may be successfully employed. The operation is the same as described for

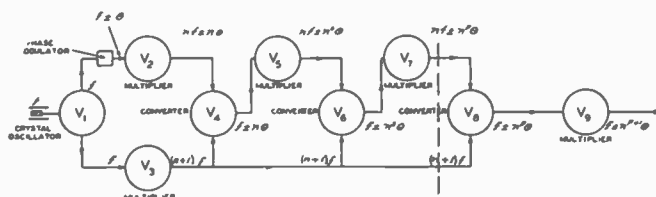

Fig. 2—Stabilized frequency-modulation system using several converters.

Fig. 1 except that the multiplication and conversion process is repeated. After each conversion the crystal-oscillator frequency and stability are restored with a phase-multiplication factor of n^p where n is the multiplication between converters and p is the number of converters. If the multiplication factor from the last converter to the operating frequency is also n , then the total phase multiplication of the system is n^{p+1} . Thus it is seen that the output of various elements of the system are as follows:

$$\begin{aligned} \text{Converter } V_4 &= f \pm n\theta & \text{Converter } V_8 &= f \pm n^p\theta \\ \text{Converter } V_6 &= f \pm n^2\theta & \text{Multiplier } V_9 &= f \pm n^{p+1}\theta \end{aligned}$$

Here again the stability is the same as if the crystal were directly at the input of the multiplier V_9 . In a numerical case, f the crystal oscillator frequency might be 5 megacycles and nf the operating frequency, 50 megacycles. Thus n would be 10. If the number of converters p is 3, then the total phase multiplication of the system is $10^{p+1} = 10^4$ or 10,000.

The values of n and p are entirely arbitrary and may be selected to yield the simplest arrangement to fit the requirements. The only limitation to the selection of the oscillator frequency f is that it be a submultiple of the operating frequency. The value of n for the various multipliers need not be the same. Identical values were chosen for simplicity of exposition.

Fig. 3 shows a photograph of an experimental model using this system, and which is capable of high-fidelity wide-band transmission. This unit uses the stabilizing circuit described above and the system of distortion

correction to be described. It can be seen that the amount of apparatus indicates a reasonable circuit complexity. The performance data on frequency stability are those of a low-temperature-coefficient crystal which are well known and need not be reproduced here.

PRECAUTIONS

Care must be exercised in the mechanical arrangement and in the electrical design of the multiplier circuits. This is necessary to prevent unwanted harmonics of the oscillator frequency from appearing at the input circuits of the converter. The presence of

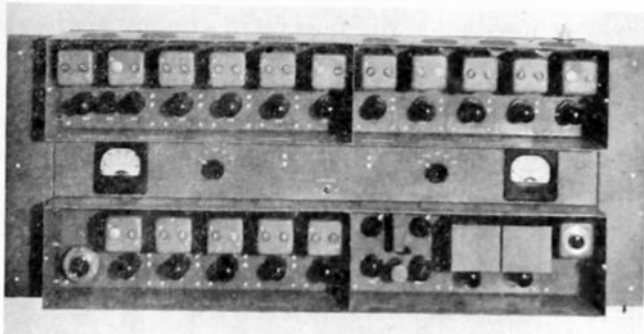

Fig. 3—Experimental unit.

adjacent harmonics along with the desired frequencies will produce voltages in the converter of the same frequency but with differing degrees of phase modulation. Analysis will show that combination of two voltages of the same frequency but with different degrees of phase modulation produces a resultant which contains phase distortion and amplitude variation.² The amount of distortion produced is dependent upon the ratio of the magnitudes of the desired and undesired frequencies. Hence undesired harmonics should be kept as low as possible. The distortion manifests itself as an irregularity in the phase characteristic which is repetitive each time the desired-voltage vector completes one revolution about the undesired-voltage vector. The word "cogging" has been applied to this effect. This is applied descriptively, since slight irregularities resembling cogs appear on the demodulated audio-frequency wave. A cog appears for each complete revolution of phase between the desired and undesired voltages at the converter. This effect can be greatly reduced to allow high-fidelity operation by proper design of the multiplier circuits.

DISTORTION-CORRECTION SYSTEM

The operation of phase modulators in the production of frequency-modulated signals is well known to the art.¹ This system of distortion correction applies particularly to phase modulators in which the sidebands are added to the carrier in phase quadrature. Present systems use a maximum phase shift of the order of 30 degrees at low audio frequencies.

² H. J. Reich, "Theory and Application of Electron Tubes," McGraw-Hill Book Company, New York, N. Y., 1939, pp. 140-143.

Using 30 degrees maximum phase shift, analysis of the demodulated frequency-modulation signal shows that distortions of the order of 7 or 8 per cent are present.^{3,4} At 60 degrees phase shift the distortion is of the order of 28 to 30 per cent. This is due to the nonlinear relation of the phase-shift angle and the amplitude of the sideband voltage. It is the function of the system to be described to provide an approximately linear relation between phase-shift angle and sideband amplitude for maximum phase shifts as high as 60 degrees or more.

PRINCIPLE OF OPERATION

Fig. 4 illustrates the mechanics of the system by vector representation of the carrier and sidebands. The sidebands are added at an angle of 90 degrees as shown in the figure and their amplitude varied in accordance with the audio frequency. However, the carrier is also

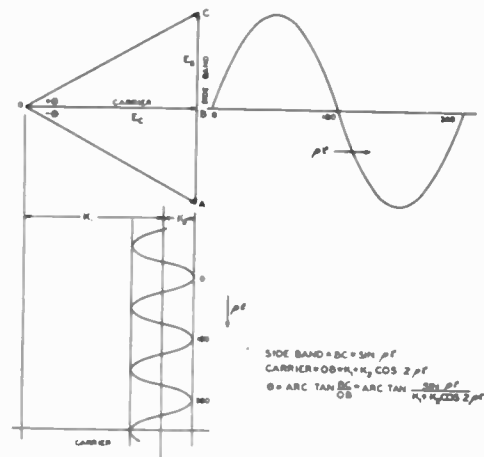

Fig. 4—Vector diagram of distortion-correction system.

amplitude-modulated simultaneously at twice the audio frequency in such a manner that approximately a linear relation obtains between sideband amplitude and angle of phase shift.

In Fig. 4, the sideband amplitude BC is given by

$$BC = \sin \rho t \quad (5)$$

where

$$\frac{\rho}{2\pi} \text{ is the audio modulating frequency}$$

and the carrier amplitude OB by

$$OB = K_1 + K_2 \cos 2\rho t \quad (6)$$

where K_1 and K_2 are arbitrary constants of operation. The reasons for the selection of (6) and the double-frequency modulation of the carrier will be taken up later.

³ D. L. Jaffe, "Armstrong's frequency modulator," *PROC. I.R.E.*, vol. 26, pp. 475-481; April, 1938.

⁴ Samuel Sabaroff, "System of phase and frequency modulation," *Communications*, vol. 20, pp. 11-12; October, 1940.

The angle of phase shift θ is expressed by

$$\theta = \arctan \frac{BC}{OB} \tag{7}$$

$$\theta = \arctan \frac{\sin \rho t}{K_1 + K_2 \cos 2\rho t} \tag{8}$$

If K_1 and K_2 are properly chosen, it can be shown that an approximate linear relation between the phase-shift angle θ and sideband amplitude $\sin \rho t$ exists. Since (8) is a transcendental equation, the solution is not a simple matter. In this case, point-by-point solution is the best means of establishing operating conditions. In an actual case, the maximum value of θ (the limiting value approaches 90 degrees) is selected and $K_1 + K_2 \cos 2\rho t$ considered as a function of time $Kf(t)$. θ is then assumed to be linear with $\sin \rho t$ and $Kf(t)$ computed at intervals of the audio-frequency cycle, so that

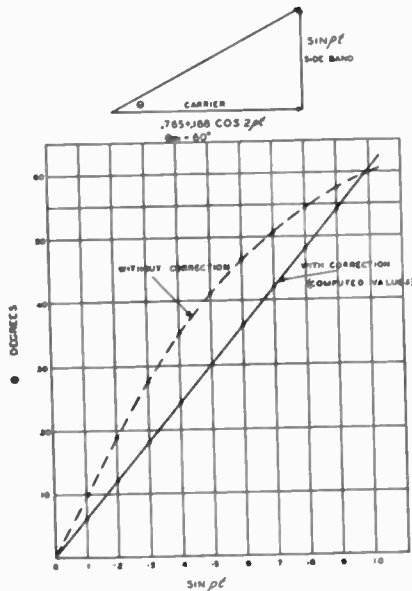

Fig. 5—Theoretical correction characteristics.

this linearity obtains. From the resultant plotting of $Kf(t)$ the constants K_1 and K_2 may be evaluated. Actual plots show that the required modulation of the carrier very closely approximates a double-audio-frequency cosine wave and is the reason for the selection of the expression $K_1 + K_2 \cos 2\rho t$ to represent the carrier.

Table I shows the comparison between the computed value of $Kf(t)$ and the synthesized carrier $0.765 + 0.188 \cos 2\rho t$. The maximum phase-shift angle

TABLE I

Sin ρt	θ assumed	$Kf(t)$	$0.765 + 0.188 \cos 2\rho t$	θ
	Degrees			Degrees
0.1	6	0.952	0.949	6.03
0.2	12	0.940	0.938	12.0
0.3	18	0.922	0.919	18.0
0.4	24	0.899	0.892	24.1
0.5	30	0.866	0.859	30.2
0.6	36	0.825	0.822	36.0
0.7	42	0.778	0.770	42.2
0.8	48	0.720	0.713	48.2
0.9	54	0.652	0.649	54.2
1.0	60	0.577	0.577	60.0

was chosen as 60 degrees. It will be noticed that there is very little difference between the assumed value of θ and the value of θ actually obtained by modulating the carrier in accordance with (6).

The solid line of Fig. 5 shows the computed relation of phase-shift angle θ and sideband amplitude $\sin \rho t$ for the case described in Table I. The carrier modulation was assumed to be a double-frequency cosine wave. The points approximate a straight line very closely and negligible distortion should result. In comparison, the dotted curve shows the relation between θ

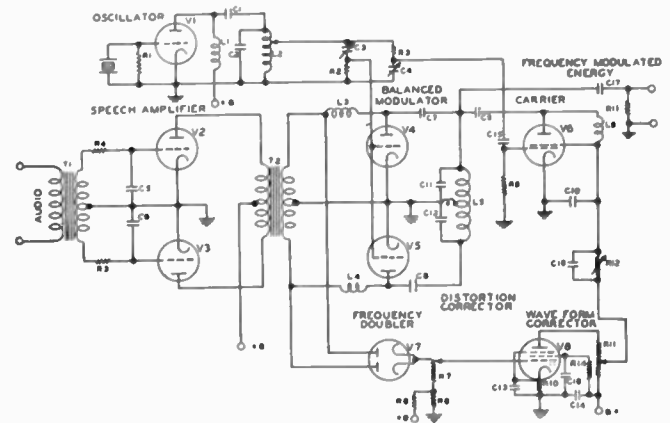

Fig. 6—Circuit diagram frequency modulator and distortion-correction system.

and $\sin \rho t$ when the carrier is unmodulated, which is the case in the conventional type of phase modulator.

CIRCUIT OPERATION

The schematic diagram of Fig. 6 shows a phase-modulator circuit incorporating this system of distortion correction. The speech amplifier V_2 and V_3 ; balanced modulator V_4 and V_5 ; oscillator V_1 ; 90-degree phase-shifting network R_2, C_3, R_3, C_4 ; and carrier tube V_6 provide frequency-modulated signals in a manner which is well known to the art and it is unnecessary to consider the operation of these circuit elements here.

The novel feature of the circuit is obtaining amplitude modulation of the carrier at twice the audio modulating frequency. V_7 is a full-wave rectifier and provides the double-frequency audio voltage. V_7 is supplied from the same source which drives the balanced modulator. The waveform of the voltage delivered by V_7 has high harmonic content and must be passed through V_8 which corrects the waveform to within 5 per cent of true double audio frequency. V_8 is a supercontrol remote-cutoff tube which shapes the half-wave pulses from V_7 to the desired form. The operation of this circuit is described in Fig. 7. The supercontrol tube V_8 is biased to cutoff and the grid voltage limited to the threshold of grid current on audio peaks. (A) shows the voltage output of V_7 which is applied to the grid of V_8 . The characteristics of the supercontrol tube when operated in the manner described above are such that the waveform of the plate voltage and grid voltage are not alike but follow the

general contour shown in (B) of Fig. 7. It can be seen that the plate voltage (solid curve) approximates a true double-frequency cosine wave. Slight discontinuities at the points *ABCD* may be minimized by reducing the operating angle of the diode full-wave

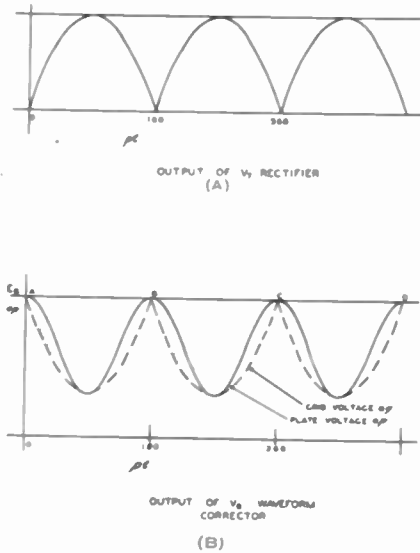

Fig. 7—Input and output voltages of carrier modulator.

rectifier. This is done by applying a small positive bias at the diode cathodes by means of resistors R_8 and R_9 operating from the plate supply voltage.

The plate voltage of the carrier tube V_6 is carried through the output resistor R_{11} of V_6 and is amplitude-modulated in accordance with the voltage appearing across this resistor. Thus the radio-frequency output of tube V_6 is modulated at double audio frequency in accordance with the plate voltage. The resistance R_{12}

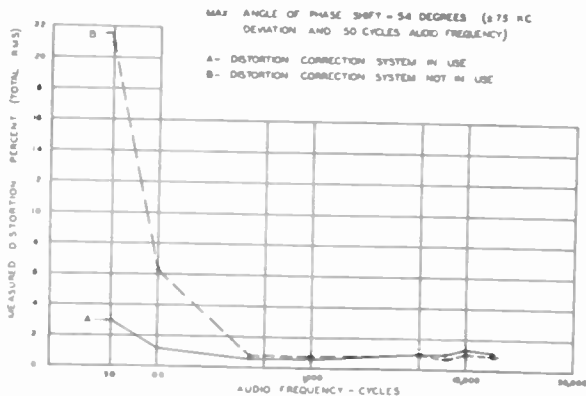

Fig. 8—Distortion characteristics—Maximum angle of phase shift = 54 degrees.

controls the magnitude of the carrier or parameter K_1 while R_{11} controls the depth of modulation of the carrier or the parameter K_2 of (8).

PERFORMANCE

The distortion characteristics for two experimental units using this system are shown in Figs. 8 and 9. One is where maximum phase-shift angle is 54 degrees and the second 32 degrees. The maximum phase-shift angle

is arbitrarily chosen at the modulation condition of 75 kilocycles frequency deviation and 50 cycles audio frequency.

The curves of Fig. 8 show the measured distortion when $\theta_m = 54$ degrees at the modulation condition described above. Curve (A) shows the distortion produced when the correction system is in use, while (B) shows the rise in distortion due to removal of the correction system from the circuit. In this case the distortion at 50 cycles is reduced from 21 to 3 per cent. This figure could possibly be improved by more accurate synthesis of the theoretical modulation of the carrier.

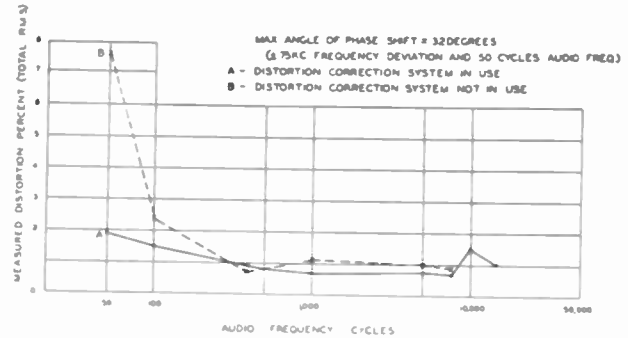

Fig. 9—Distortion characteristics—Maximum angle of phase shift = 32 degrees.

The curves of Fig. 9 show the same relations as Fig. 8 except the maximum phase-shift angle has been reduced to 32 degrees.

Optimum adjustment is made at the lowest audio frequency. This is the point of maximum phase shift for a given frequency deviation and hence requires the greatest correction. The operating constants K_1 and K_2 of (6) change as the audio frequency is varied since the amplitude of the audio-frequency voltage is inversely proportional to frequency. However, the change in operating constants is not sufficient to affect the correction seriously. At the higher audio frequencies the modulation of the carrier is very slight and is effectively out of the circuit.

CONCLUSIONS

A frequency-modulation system has been described in which the center frequency is directly controlled by a single quartz crystal with the attendant high stability. The complexity of apparatus is not appreciably greater than other systems of generating frequency modulation.

The system of distortion correction permits large angles of phase shift at the phase modulator with low distortion. This decreases the amount of phase multiplication necessary for wide-band frequency modulation and results in simpler apparatus and reduction of noise due to random disturbances in the phase modulator and initial multipliers. If the maximum phase angle is increased from 30 to 60 degrees, the phase multiplication may be cut in half, thus requiring the use of fewer multipliers and effecting a 6-decibel improvement in random noise.

A Note on the Sources of Spurious Radiations in the Field of Two Strong Signals*

A. JAMES EBEL†, ASSOCIATE, I.R.E.

Summary—An investigation is made into the source of combination signals in the fields of two strong signals. It is shown that these signals are the results of nonlinearities in conductors which serve as antennas. The nonlinearities are found to be primarily at the junction between the conductor and the ground although other sources of poor contact may also be responsible. Suggestions for reducing the interference due to this phenomenon are given.

RECENTLY, material has been published on the generation of combination signals in the presence of strong fields of two or more broadcast stations.¹ This report is a study of this effect in the area of Champaign and Urbana, Illinois. Impetus has been given to this study due to the fact that the sum signal generated by the stations in question falls in the 1.8-megacycle amateur band and gives rise to objectionable interference. The fact the strength of the signal seemed to vary from day to day also added to the interest of the study.

The stations combining to form the interfering signal operate on 580 kilocycles and 1370 kilocycles.² Station WILL operates on 580 kilocycles with a power of 5000 watts and station WDWS operates on 1370 kilocycles with a power of 250 watts. The separation between the stations, geographically, is 1.28 miles as may be seen from the map in Fig. 1. The field-strength contours of the two stations are superimposed on the map. The difference signal, 790 kilocycles, was selected for study because equipment for that frequency was available and because the possibility of error was somewhat less. Fortunately, that channel was occupied by WGY, Schenectady, whose daytime signal was less than 25 microvolts in the studied area.

The measurements were made with a portable loop battery receiver with the automatic volume control removed and an output meter attached. The receiver selected exhibited no tendency to generate combination signals of itself within the range of field strengths measured. The receiver associated with the field-strength meter was so poor in this respect that it could not be used to measure the combination signal directly. Therefore, it was necessary to calibrate the battery receiver against a standard-signal generator. Since only relative signal strengths were desired, no attempt was made to calibrate the receiver in microvolts per meter. Because of the type of receiver being used, the

* Decimal classification: R270×R430. Original manuscript received by the Institute, May 12, 1941.

† Chief Engineer, WILL, University of Illinois, Urbana, Illinois.

¹ A. V. Eastman and L. C. F. Horle, "The generation of spurious signals by nonlinearity of the transmission path," *PROC. I.R.E.*, vol. 22, pp. 438-443; October, 1940.

² This was prior to the frequency shifts ordered under the North American Regional Broadcasting Agreement. WDWS now operates on 1400 kilocycles and the difference frequency appears at 820 kilocycles.

method of calibration, and a number of other minor factors which could not accurately be controlled, the accuracy of the measurements is estimated at 10 per cent. A greater accuracy is not necessary, however, for the purpose of this study.

Originally an attempt was made to locate the direction from which the signal seemed to come. At a broadcast receiver installation where the signal was very prevalent, an attempt was made to pick up the signal on the loop receiver. This led to the towers supporting the antenna system used for reception at this installation. These towers were located at Point 1 on the map. Considering this to be a primary source for the combination signal, a field-strength survey was started to determine the effective radius of the interference from this source. Strangely enough, it turned out to be only about 50 feet. At a distance greater than 50 feet the signal dropped below the level of the WGY signal strength. Obviously, this was not the source of the interference, except for receivers in the immediate vicinity.

Other tall metal structures were checked and each exhibited a trace of the combination signal. Lightning-rod cables showed the presence of the signal in varying amounts. For further study, five representative locations were selected from more than fifty at which the signal was detected. These were selected so as to give a cross section of the conditions encountered in the preliminary checks. The locations may be described as follows: (Point numbers refer to location on the map).

Point 1. A 140-foot galvanized windmill tower grounded to a buried grid of wires. The tower is 15 years old and has had very little maintenance.

Point 2. A lightning-rod cable on the Huff gymnasium approximately 55 feet high. The installation is 15 years old.

Point 3. A lightning-rod cable on the round cattle barn approximately 48 feet high. The installation is 18 years old.

Point 4. A lightning-rod cable on the power plant smoke stack approximately 204 feet high, less than a year old.

Point 5. A doublet receiving antenna with a 50-foot flat top coupled in the center to twisted-pair feeders by a matching transformer. Feeder length is approximately 30 feet. Water-pipe ground was used, age unknown.

(Note: All lightning-rod grounds were made by extending the cable for a distance of 8 feet, 2 feet below grade level, at the end of which a 6-foot rod was driven.)

At these locations the relative magnitudes of the two carriers and the combination signal was measured. The measurements were made by coupling the loop to the radiator. The set was mounted rigidly with the short side of the loop parallel to and at a distance of 1 inch from the conductor, several feet above the ground. This eliminated most of the capacitance effects. Corrections were made in the indicated readings for the variation of coupling due to the frequency difference of the three signals.

grounded conductors is the result of rectification in the nonlinear components of their impedance. Consider for the moment a voltage e applied to a nonlinear impedance. The current may be expressed in a power series as

$$i = a_1 e + a_2 e^2 + a_3 e^3 \cdots a_n e^n. \quad (1)$$

If e is defined by

$$e = E_1 \cos \omega_1 t + E_2 \cos \omega_2 t \quad (2)$$

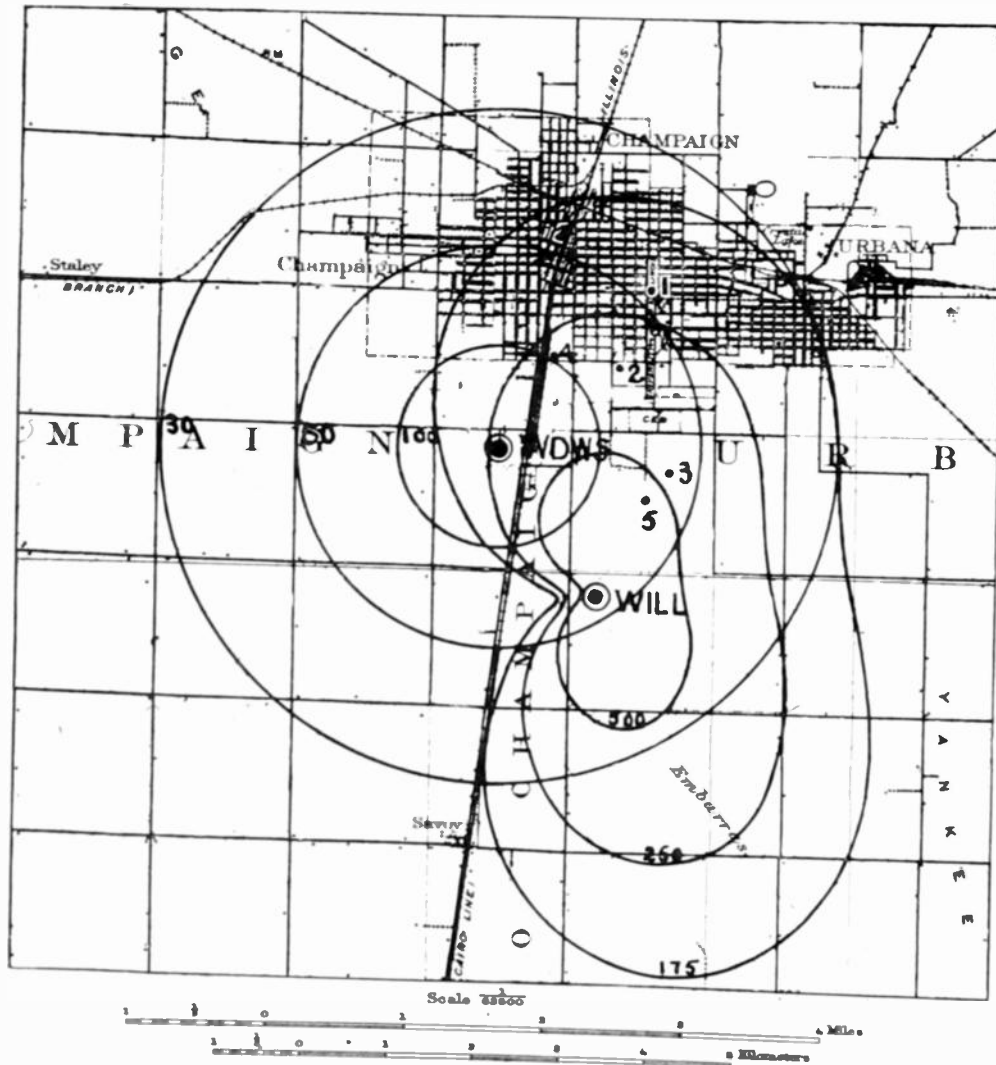

Fig. 1—WILL contours measured. WDWS contours calculated from measured efficiency. Figures on contours are field strength in microvolts per meter.

TABLE I

Location	1370 (I_1)	580 (I_1)	790 (I_1')	a_{sk}/Z_1
Point 1	1.2×10^5	2.0×10^5	1.3×10^5	5.4×10^{-9}
Point 2	9.8×10^4	2.6×10^5	2.0×10^5	7.9×10^{-10}
Point 3	7.1×10^4	1.4×10^5	6.0×10^4	6.1×10^{-9}
Point 4	1.1×10^5	1.9×10^5	5.0	2.4×10^{-10}
Point 5	3.0×10^4	1.1×10^5	1.3×10^5	3.9×10^{-9}

Table I shows the results of these measurements. These data were all obtained within four hours. During that time the carrier power of the two stations was maintained constant. The number of possibilities for error was thereby reduced.

The presence of combination signals in these

the first two terms of the series become

$$i = a_1(E_1 \cos \omega_1 t + E_2 \cos \omega_2 t) + a_2(E_1 \cos \omega_1 t + E_2 \cos \omega_2 t)^2. \quad (3)$$

Expanding,

$$i = a_1 E_1 \cos \omega_1 t + a_1 E_2 \cos \omega_2 t + \frac{a_2 E_1^2}{2} + \frac{a_2 E_1^2}{2} \cos 2\omega_1 t \cdots + a_2 E_1 E_2 \cos (\omega_1 + \omega_2) t + a_2 E_1 E_2 \cos (\omega_1 - \omega_2) t + \frac{a_2 E_2^2}{2} \cdots + \frac{a_2 E_2^2}{2} \cos 2\omega_2 t. \quad (4)$$

The measurements in Table I are proportional to the magnitude of the current in the vertical conductor at a point 2 feet above the ground. They may be related to E by

$$E_1 = k_1 I_1 \quad (5)$$

where I_1 is the magnitude of the current indicated at the point of measurement, E_1 is the voltage developed across the nonlinear impedance, and k_1 is a constant relating the developed voltage to the current indicated on the measuring set. This constant has dimensions of an impedance but may also include a current-distribution factor if the point of measurement is not close to the nonlinear impedance. Also

$$E_2 = k_2 I_2. \quad (6)$$

Since the nonlinear element must be considered as a driving source for each new frequency generated by rectification, the current measured at these frequencies will be a function of k_3 and the impedance of the vertical conductor at that frequency, as well as a function of the developed voltage at the frequency. If the measured value of the difference-frequency component be I' then

$$I' Z_1 k_3 = a_2 k_1 k_2 I_1 I_2 \quad (7)$$

or

$$\frac{I'}{I_1 I_2} = \frac{a_2 k_1 k_2}{Z_1 k_3} \quad (8)$$

where Z_1 is the impedance of the vertical conductor under study at the frequency $(\omega_1 - \omega_2)/2\pi$. Inasmuch as a correction was made in the measurements for the variation of coupling with respect to frequency it can be assumed that

$$k_1 = k_2 = k_3 = k$$

which is independent of frequency. This assumption is valid if the range of frequencies is limited and if the point of measurement is close to the nonlinear element. Then (8) becomes

$$\frac{I'}{I_1 I_2} = \frac{a_2 k}{Z_1}.$$

I' , I_1 , and I_2 were measured so the factor $a_2 k/Z_1$ can be determined. Its value for the various observation points is given in column four of Table I. It may be seen from these figures that the extent of the nonlinearity is very small. The fact that this effect is so small might indicate that a truly linear resistance is the exception rather than the rule. This is especially true of antenna impedances where the ground system involves loose contact with dissimilar conducting materials.

The above development considers only the first two terms of the power series for a nonlinear impedance. Expanding the third term of the series the quantity

$(3a_3 E_1 E_2/4) \cos(2\omega_1 - \omega_2)$ appears. An attempt was made to measure this signal at Point 2 but the receiver was not sensitive enough to give an indication on the output meter. From this it is apparent that the series converges rather rapidly and that the above solution embracing the first two terms is sufficiently accurate to determine the extent of nonlinearity in grounded antennas.

If the current I_1 in a vertical conductor is related to the field strength E' at frequency $\omega_1/2\pi$ by the factor ρ_1 , and if the current I_2 is related to the field strength E'' at the frequency $\omega_2/2\pi$ by the factor ρ_2 , then the magnitude of the difference frequency will be

$$I' = \frac{a_2 k \rho_1 \rho_2 E' E''}{Z_1}.$$

This indicates that the magnitude of the difference-frequency term of any combination frequency depends not only on the field product $E' E''$, but also on the amount of nonlinearity, the effective height of the two combining frequencies, and the impedance at the difference frequency, all characteristics of the vertical conductor being considered.

The term $(a_2 E_1^2/2) \cos 2\omega_1 t$ appearing in (4) indicates that a second-harmonic signal is also generated in the nonlinear impedance. Measurement of this component was impossible because of the masking effect of the radiated harmonic from the transmitter. It was possible to note a difference in the ratio between fundamental and harmonic signals as the receiver was moved from free space into coupling with the grounded conductor. In free space only the transmitter-radiated harmonic was received, while in the field of the grounded conductor the radiated harmonic plus the harmonic generated by rectification was present. This points to harmonic generation within the radiating system of a transmitter installation.

It is of significance to note that the measurements made at some of the locations could not be duplicated after several weeks had elapsed. This was first noted when an attempt was made to measure the difference frequency at a location which exhibited great rectification during the preliminary survey. The signal, which at the time of survey was so intense as to make listening on headphones uncomfortable, could barely be measured several weeks later. During these two weeks the ground had thawed and taken on much moisture from the spring rains. This location had to be discarded in favor of Point 3. Periodical checks on Points 2 and 3 have shown from 15 to 20 per cent variation in the value of a_2 over a period of 30 days. There appears to be no particular correlation between a_2 and wet or dry weather. There may be a correlation between a_2 and the total amount of moisture in the soil.

Table I and numerous observations made show a relationship between the age of the conductor installation and a_2 , the value of a_2 increasing with age. On the

new installation at Point 4 the difference signal was so weak a definite beat with WGY was heard, yet the two combining signals were greater than at any other place except Point 1. At Point 3, a considerably older installation, the situation was just reversed.

The signal was heard at Point 5 when the measuring receiver was coupled to the twisted-pair feeders in accordance with the measuring procedure outlined above. Under this condition the two wires of the feeder system were acting together as the vertical lead of a Marconi antenna working against ground. The broadcast receiver at the receiving end of this feed line did not give any of the signal although it should have been much more sensitive than the measuring set. Evidently since the feeders were essentially balanced to ground, there was no difference signal generated because there was no current flow in the ground circuit.

At another receiver location where the sum signal was very prominent (R_4 on the carrier-level indicator of a communications receiver), a loop antenna was substituted for the regular antenna and balanced to ground. While this materially reduced the sensitivity of the receiving system (three R strength units), yet no sum signal whatsoever could be detected. This observation is further borne out by the fact that at no place, except in the immediate vicinity of a nonlinear source, has the difference signal ever been heard on the measuring set.

CONCLUSIONS

1. Most "spurious radiations" in the field of two strong signals are generated in the receiving antenna system. If an alternating-current receiver is not grounded the situation is even worse, since the electrical-distribution-system grounds are notorious for rectification. The solution to the problem seems to be an antenna system balanced against ground either using a loop or a matched transmission line.

2. It is possible to pick up a re-radiated combination signal from near-by nonlinear elements but the nuisance field of such radiations is very limited.

3. The possibility of a receiving antenna generating combination signals or of a nonlinear element acting as a secondary source of these signals depends on the extent of the nonlinearity of the impedance, the effective heights of the conductors, and the impedance of the conductor at the combination frequency as well as upon the field product. Therefore, the field product cannot always be used as a criterion for the incidence of objectional interference from this source.

ACKNOWLEDGMENT

The Author takes this opportunity to express his sincere appreciation to Professor H. A. Brown and to Professor H. J. Reich for their suggestions in the preparation of this paper.

The Operation of Frequency Converters and Mixers for Superheterodyne Reception*

E. W. HEROLD†, MEMBER, I.R.E.

Summary—This paper presents a general picture of superheterodyne frequency conversion followed by a detailed discussion of the behavior of tubes used with different types of oscillator injection. The general picture shows that the different methods of frequency conversion are basically similar for small signals. A strong local-oscillator voltage (which may be a pure sine wave) causes a periodic variation (which is usually nonsinusoidal) of the signal-electrode transconductance. The coefficient of each Fourier component of the transconductance-versus-time relationship is just twice the conversion transconductance at the corresponding harmonic of the local-oscillator frequency. For most tubes the conversion transconductance g_c at the oscillator fundamental is approximately 28 per cent of the maximum transconductance. At the second harmonic, g_c is about 14 per cent, and at the third harmonic it is about 9 per cent of the maximum transconductance. Fluctuation noise and input resistance at high frequencies of the different methods of conversion may be found from the time average over the oscillator cycle.

Using these general concepts, we discuss the detailed behavior of three conversion methods. In the first method, signal and local-oscillator voltages are impressed on the same electrodes. This method gives best signal-to-noise ratio, but has the disadvantage of bad interaction between signal and local-oscillator circuits. In the second method, the local-oscillator voltage is impressed on an electrode which precedes the signal electrode along the direction of electron flow. In this case, interaction of signal and oscillator circuits is somewhat reduced but is still bad at the higher frequencies because of space-charge coupling. The

third method is that in which the local-oscillator electrode follows the signal electrode along the direction of electron flow. Most of the disadvantages of the third method may be overcome by special tube constructions, some of which are described.

I. INTRODUCTION

THE BETTER modern radio receivers are almost universally designed to use the superheterodyne circuit. In such a circuit, the received signal frequency is heterodyned with the frequency of a local oscillator to produce a difference frequency known as the intermediate frequency. The resultant signal is amplified by a selective, fixed-tuned amplifier before detection. Since the heterodyne action is usually accomplished by means of a suitable vacuum tube, it is the purpose of this paper to discuss the chief similarities and differences among the tubes which might be used, as well as to explain their behavior.

The combination of signal and local-oscillator frequencies to produce an intermediate frequency is a process of modulation in which one of the applied frequencies causes the amplitude of the other to vary. Although this process was originally called heterodyne

* Decimal classification: R361.2×R262.9. Original manuscript received by the Institute, June 20, 1941. Presented, New York Meeting, October 1, 1941.

† Research Laboratories, RCA Manufacturing Company, Inc., Harrison, N. J.

detection and, later, first detection, it is now called frequency conversion. The portion of the radio receiver which produces conversion may, therefore, be identified as the converter. If conversion is accomplished in a single vacuum tube which combines the functions of oscillator and modulator, this tube may logically be termed a converter tube. When separate tubes are used for the oscillator and the modulator portions of the converter, respectively, the tube for the latter purpose is conveniently called a modulator or mixer tube. This terminology will be used in this paper.

Although in some of the earliest superheterodynes, frequency conversion was accomplished by a triode oscillator and a triode modulator,¹ other circuits used a single triode which served as both modulator and oscillator.² A triode used in the latter way could, therefore, be called a converter tube. The introduction of two-grid tubes (i.e., tetrodes) permitted a wide variety of modulator and converter arrangements which frequently gave superior performance to that possible with triodes.³⁻⁷

When indirectly heated cathodes became more common, conversion circuits in which the oscillator voltage was injected in the cathode circuit were used. These circuits reduced considerably the interaction between oscillator and signal circuits which would otherwise be present.⁸ When tetrodes and pentodes became available, the use of the triode was dropped except as the local oscillator. It was not long, however, before the desirability of more complete separation of oscillator and signal circuits became evident. Multigrid converter tubes were, therefore, devised to permit this separation in a satisfactory manner, at least for the frequencies then in common use.⁹⁻¹⁴ In some of these it was also possible to control the conversion gain by an automatic-volume-control voltage, a decided advantage. The most satisfactory of the earlier multigrid tubes was known as the pentagrid converter, a type still widely used. A similar tube having an additional

suppressor grid is used in Europe and is known as the octode.

When it became desirable to add high-frequency bands to superheterodyne receivers which also had to cover the low broadcast frequencies, the converter problem became more difficult. The highest practicable intermediate frequency appeared to be about 450 to 460 kilocycles, a value which was only about 2 per cent of the highest frequency to be received. Its use meant that the oscillator frequency was separated from the signal frequency by only 2 per cent and the signal circuit, therefore, offered appreciable impedance at the oscillator frequency. A phenomenon known as "space-charge coupling," found in the pentagrid converter, indicated that signal and oscillator circuits were not separated as completely as would be desirable.¹⁵ In addition, the permissible frequency variations of the oscillator had to be held to less than the intermediate-frequency bandwidth, namely, 5 to 10 kilocycles; at the highest frequency to be received, the oscillator frequency was required therefore to remain stable within 0.05 per cent. In the pentagrid converter, the most serious change in oscillator frequency occurred when the automatic-volume-control voltage was changed, and was sometimes as much as 50 kilocycles. Economic considerations have led to the use of at least a three-to-one frequency coverage for each band in the receiver. With capacitance tuning, the circuit impedance is very low at the low-frequency end of the high-frequency band so that failure to oscillate was occasionally observed in the pentagrid converter.

In Europe, where converter problems were similar, a tube known as the triode-hexode¹⁶ was developed to overcome some of the disadvantages of the pentagrid converter. In the pentagrid tube, the oscillator voltage is generated by, and therefore applied to, the electrodes of the assembly closest to the cathode (i.e., the *inner* electrodes). In the European form of triode-hexode, the oscillator voltage is generated by a separate small triode section mounted on a cathode common to a hexode-modulator section. The triode grid is connected internally to the third grid of the hexode section. In this way, by the application of the oscillator voltage to an *outer* grid and the signal to the inner grid of the modulator, space-charge coupling was greatly reduced and automatic-volume-control voltage could be applied to the modulator section of the tube without seriously changing the oscillator frequency. In some European types, a suppressor grid has been added so that such tubes should be called triode-heptodes.

The first American commercial development to provide improved performance over that of the pentagrid converter also utilized oscillator voltage injection on

¹ E. H. Armstrong, "A new system of short-wave amplification," *PROC. I.R.E.*, vol. 9, pp. 3-27; February, 1921.

² German Patent No. 324,514, 1918.

³ J. Scott-Taggart, German Patent No. 383,449, 1919.

⁴ J. deMare, R. Barthelemy, H. deBellescize, and L. Levy, "Use of double-grid valves in frequency-changing circuits," *L'Onde Elec.*, vol. 5, pp. 150-180; 1926.

⁵ "A four-electrode valve supersonic circuit," *Exp. Wireless*, vol. 3, p. 650; October, 1926.

⁶ R. Barthelemy, "Valve frequency changers," *Gen. Elec. Rev.*, vol. 19, pp. 663-670; 1926.

⁷ See also: M. Gausner, French Patent No. 639,028; G. Thebault, French Patent No. 655,738; and H. J. J. M. deRegnauld de Bellescize, United States Patent No. 1,872,634.

⁸ V. E. Whitman, United States Patent No. 1,893,813; H. A. Wheeler, United States Patent No. 1,931,338.

⁹ F. B. Llewellyn, United States Patent No. 1,896,780.

¹⁰ H. A. Wheeler, "The hexode vacuum tube," *Radio Eng.*, vol. 13, pp. 12-14; April, 1933.

¹¹ W. Hasenberg, "The hexode," *Funk. Tech. Monatshefte*, pp. 165-172; May, 1933.

¹² Application Note No. 3, RCA Radiotron Co., Inc.

¹³ E. Y. Robinson, British Patent No. 408,256.

¹⁴ J. C. Smith, Discussion on H. A. Wheeler paper, "Image suppression and oscillator-modulators in superheterodyne receivers," *PROC. I.R.E.*, vol. 23, pp. 576-577; June, 1935.

¹⁵ W. A. Harris, "The application of superheterodyne frequency conversion systems to multirange receivers," *PROC. I.R.E.*, vol. 23, pp. 279-294; April, 1935.

¹⁶ E. E. Shelton, "A new frequency changer," *Wireless World*, vol. 35, pp. 283-284; October 5, 1934.

an outer grid but required a separate tube for oscillator.¹⁷ This development, therefore, resulted in a modulator or mixer tube rather than a converter. There were many advantages accompanying the use of a separate oscillator tube so that such a solution of the problem appeared to be reasonably satisfactory.

The demand arose shortly, however, for a one-tube converter system with better performance than the original pentagrid type for use in the standard all-wave receiver. A tube, the 6K8, in which one side of a rectangular cathode was used for the oscillator and the other side was used for the mixer section, was developed and made available.¹⁸ This tube used inner-grid oscillator injection, as with the pentagrid converter, but had greatly improved oscillator stability. Another solution, also introduced in the United States, was a triode-heptode which is an adaptation of the European triode-hexode. This type used outer-grid injection of the oscillator voltage generated by a small auxiliary triode oscillator section. A recent converter (the SA7 type) for broadcast use is designed to operate with oscillator voltage on both cathode and first-grid electrodes.¹⁹ This tube, in addition to having excellent performance, requires one less connecting terminal than previous converter tubes.

This paper will present an integrated picture of the operation of converter and modulator tubes. It will be shown that the general principles of modulating or mixing by placing the signal on one grid and the oscillator voltage on another, or by placing both voltages on the same grid, are the same for all types of tubes. The differences in performance among the various types particularly at high frequencies are due to a number of important secondary effects. In this paper, some of the effects such as signal-grid current at high frequencies, input impedance, space-charge coupling, feedback through interelectrode capacitances, and oscillator-frequency shift will be discussed.

II. GENERAL ANALYSIS OF OPERATION COMMON TO ALL TYPES

A. Conversion Transconductance of Modulator or Mixer Tubes

The basic characteristic of the converter stage is its conversion transconductance, i.e., the quotient of the intermediate-frequency output current to the signal input voltage. The conversion transconductance is easily obtained by considering the modulation of the local-oscillator frequency by the signal in the tube and, as shown in another paper,¹⁷ is determined by the

¹⁷ C. F. Nesslage, E. W. Herold, and W. A. Harris, "A new tube for use in superheterodyne frequency conversion systems," *PROC. I.R.E.*, vol. 24, pp. 207-218; February, 1936.

¹⁸ E. W. Herold, W. A. Harris, and T. J. Henry, "A new converter tube for all-wave receivers," *RCA Rev.*, vol. 3, pp. 67-77; July, 1938.

¹⁹ W. A. Harris, "A single-ended pentagrid converter." Presented, Rochester Fall Meeting, Rochester, N. Y., November 15, 1938. See Application Note No. 100, RCA Manufacturing Co., Inc., Radiotron Division, Harrison, N. J.

transconductance of the signal electrode to the output electrode. The general analysis of a modulator, or mixer tube, is applicable to all mixers no matter how or on what electrodes the oscillator and signal voltages are introduced.

Under the assumption that the signal voltage is very small and the local oscillator voltage large, the signal-electrode transconductance may be considered as a function of the oscillator voltage only. The signal-electrode-to-plate transconductance g_m may, therefore, be considered as periodically varying at the oscillator frequency. Such a periodic variation may be written as a Fourier series

$$g_m = a_0 + a_1 \cos \omega_0 t + a_2 \cos 2\omega_0 t + \dots$$

where ω_0 is the angular frequency of the local oscillator. Use of the cosine series implies that the transconductance is a single-valued function of the oscillator electrode voltage which varies as $\cos \omega_0 t$. When a small signal, $e_s \sin \omega_s t$, is applied to the tube, the resulting alternating plate current to the first order in e_s may be written

$$\begin{aligned} i_p &= g_m e_s \sin \omega_s t \\ &= a_0 e_s \sin \omega_s t + e_s \sum_{n=1}^{\infty} a_n \sin \omega_s t \cos n\omega_0 t \\ &= a_0 e_s \sin \omega_s t + \frac{1}{2} e_s \sum_{n=1}^{\infty} a_n \sin (\omega_s + n\omega_0) t \\ &\quad + \frac{1}{2} e_s \sum_{n=1}^{\infty} a_n \sin (\omega_s - n\omega_0) t. \end{aligned}$$

If a circuit tuned to the frequency $(\omega_s - n\omega_0)$ is inserted in the plate, the modulator tube converts the incoming signal frequency ω_s to a useful output at an angular frequency $(\omega_s - n\omega_0)$ which is called the intermediate frequency. Since n is an integer, it is evident that the intermediate frequency, in general, may be chosen to be the difference between the signal frequency and any integral multiple of the local-oscillator frequency; this is true even though a pure sine-wave local oscillation is applied to the tube. The harmonics of the local-oscillator frequency need only be present in the time variation of the signal-electrode transconductance. The ordinary conversion transconductance is simply a special case when $n = 1$. The conversion transconductance at the n th harmonic of the local oscillator is given by

$$g_{c_n} = \frac{i_{\omega_s - n\omega_0}}{e_s} = \frac{a_n}{2}$$

Substituting the value of the Fourier coefficient a_n it is found that

$$g_{c_n} = \frac{1}{2\pi} \int_0^{2\pi} g_m \cos n\omega_0 t d(\omega_0 t);$$

When n is set equal to unity, this expression becomes identical with the one previously derived.¹⁷

Thus, the conversion transconductance is obtained by a simple Fourier analysis of the signal-electrode-to-output-electrode transconductance as a function of time. Such an analysis is readily made from the tube characteristics directly by examination of the curve of signal-electrode transconductance versus oscillator-electrode voltage. The calculation of the conversion transconductance at the n th harmonic of the oscillator is made from this curve by assuming an applied oscillator voltage and making a Fourier analysis of the resulting curve of transconductance versus time for its n th harmonic component. The analysis is exactly similar to the one made of power output tubes, except that, in the latter case, the plate-current-versus-control-electrode-voltage curve is used. Fig. 1 shows a

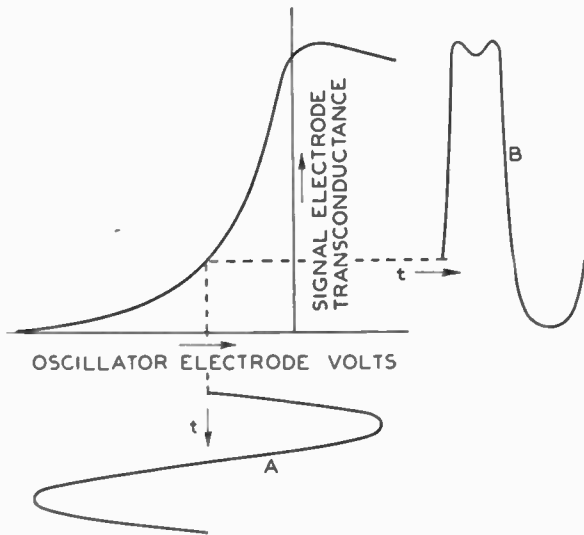

Fig. 1—Signal-electrode transconductance versus oscillator-electrode voltage for a typical mixer tube. The applied oscillator voltage is shown at A and B is the resulting time variation of transconductance.

curve of signal-grid transconductance versus oscillator-electrode voltage for a typical modulator or mixer tube. In the usual case, the oscillator voltage is applied from a tuned circuit and so is closely sinusoidal in shape as at A in the figure. The resulting curve of transconductance versus time is shown at B. Any of the usual Fourier analysis methods may be used to determine the desired component of curve B. Half of this value is the conversion transconductance at the harmonic considered. Convenient formulas of sufficient accuracy for many purposes follow. Referring to Fig. 2a, a sine-wave oscillator voltage is assumed and a seven-point analysis is made (i.e., 30-degree intervals). The conversion transconductances g_{c_n} are

$$g_{c_1} = \frac{1}{\sqrt{2}} [(g_7 - g_1) + (g_6 - g_2) + 1.73(g_5 - g_3)]$$

$$g_{c_2} = \frac{1}{\sqrt{2}} [2g_4 + \frac{3}{4}(g_3 + g_5 - g_6 - g_2) - (g_7 + g_1)]$$

$$g_{c_3} = \frac{1}{\sqrt{2}} [(g_7 - g_1) - 2(g_6 - g_2)].$$

The values g_1, g_2 , etc., are chosen from the transconductance characteristic as indicated in Fig. 2a. The values computed from the above formulas are, of

course, most accurate for g_{c_1} and of less accuracy for g_{c_2} while a value computed from the formula for g_{c_3} is a very rough approximation.

Simple inspection of the formula for g_{c_1} , the conversion transconductance used for conversion at the fundamental, is somewhat instructive. It is evident that highest conversion transconductance, barring negative values, as given by this formula, occurs when g_1, g_2 , and g_3 are all equal to zero, and g_5, g_6 , and g_7 are high. These requirements mean that sufficient oscillator voltage should be applied at the proper point to cut off the transconductance over slightly less than half the cycle as pictured in Fig. 2b. For small oscil-

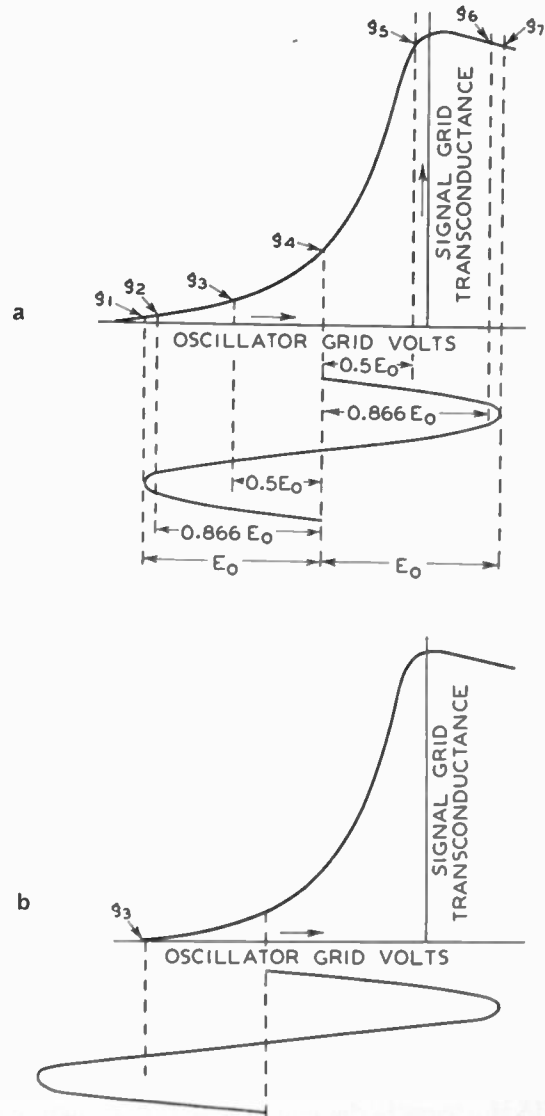

Fig. 2—a. Points used for 30-degree analysis of conversion transconductance; b. Oscillator amplitude and bias adjusted for high conversion transconductance at oscillator fundamental, i.e., $g_1 = g_2 = g_3 = 0$.

lator voltages optimum operation requires the differences $(g_7 - g_1)$, $(g_6 - g_2)$, and $(g_5 - g_3)$ to be as large as possible; this is equivalent to operation at the point of maximum slope. It should be noted that the minimum peak oscillator voltage required for good operation is approximately equal to one half the difference between the oscillator-electrode voltage needed for

maximum signal-grid transconductance and that needed to cut off this transconductance. Thus, inspection of the curve of transconductance versus oscillator-electrode voltage gives both a measure of the fundamental conversion transconductance which will be obtained and the amount of oscillator excitation required. Conversion at a harmonic, in general, requires considerably greater oscillator excitation for maximum conversion transconductance.

In practical cases using grid-controlled tubes of the usual kind, the maximum fundamental conversion transconductance which a given tube will give can quickly be determined within 10 per cent or so by simply taking 28 per cent of the maximum signal-grid-to-plate transconductance which can be attained. For conversion at second harmonic, optimum oscillator

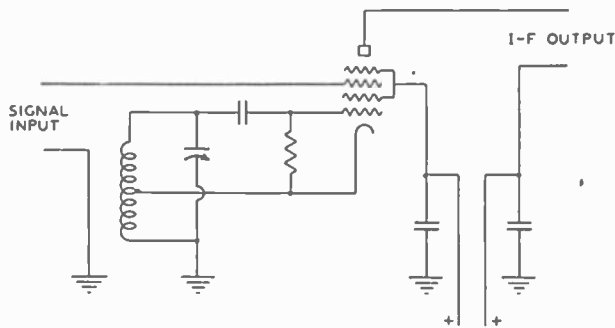

Fig. 3—Converter circuit with oscillator voltage on both grid No. 1 and cathode.

excitation gives a conversion transconductance of half this value, while for third-harmonic conversion the value is divided by three.

Although the same characteristic of all modulator or mixer tubes is used to determine the conversion transconductance, the shape of this characteristic varies between different types of mixers. This variation will be more clearly brought out in the later sections of the paper.

B. Conversion Transconductance of Converter Tubes

In converter tubes with oscillator sections of the usual kind, the oscillator voltage is usually present on more than one electrode. Furthermore, the phase of the oscillator-control-grid voltage is opposite to that of the oscillator-anode alternating voltage, so that the two would be expected partially to demodulate each other. The transconductance curve which should be used in this case is the one in which the oscillator electrode voltages are simultaneously varied in opposite directions.

Fortunately, with most of the commonly used converter tubes such as the pentagrid, octode, triode-hexode, etc., the effect of small variations of oscillator-anode voltage on the electrode currents is so small that usually it may be neglected. Thus, the conversion transconductance of these converter tubes may be found exactly as if the tube were a modulator or mixer, only.

With the circuit of Fig. 3,¹⁹⁻²¹ a Hartley oscillator arrangement is used and oscillator-frequency voltage is present on the cathode. The effect of such a voltage is also to demodulate the electron stream through the action of the alternating cathode potential on the screen-to-cathode and signal-grid-to-cathode voltages. When a relatively high-transconductance signal grid is present, as in the figure, this demodulation is considerably greater than in the normal cathode-at-ground circuit. In order to determine the conversion transconductance of a tube to be used in this circuit, a signal-grid transconductance curve is needed. Such a curve, however, must be taken with cathode and oscillator-grid potential varied simultaneously and in their correct ratio as determined by the ratio of cathode turns to total turns of the coil which is to be used. However, because the conversion transconductance is approximately proportional to the peak value of signal-grid transconductance, it is often sufficiently accurate to disregard the alternating-current variation of cathode potential and simply shift the signal-grid bias in the negative direction by the peak value of the alternating cathode voltage. If the resulting signal-grid-transconductance-versus-oscillator-grid-voltage curve is used for an analysis of conversion transconductance, the data obtained will not be far different from the actual values obtained in the circuit of Fig. 3 where normal (unshifted) signal-grid bias values are used.

C. Fluctuation Noise

The fluctuation noise of a converter stage is frequently of considerable importance in determining the over-all noise. The magnitude of the fluctuation noise in the output of a converter or mixer tube may be found either by direct measurement using a known substitution noise source such as a saturated diode or by making use of the noise of the same tube used as an amplifier and finding the average mean-squared noise over an oscillator cycle.^{22,23} Since these methods give values which are substantially in accord and, since the noise of many of the usual tube types under amplifier conditions is readily derived from theory,²⁴ the latter procedure is convenient. Thus, if $\overline{i_{pn}^2}$ is the mean-squared noise current in the output of the converter or mixer tube considered as an amplifier (i.e., steady

²⁰ P. W. Klipsch, "Suppression of interlocking in first detector circuits," *Proc. I.R.E.*, vol. 22, pp. 699-708; June, 1934.

²¹ *Radio World*, p. 13; December 24, 1932.

²² E. Lukacs, F. Preisach, and Z. Szepecsi, "Noise in frequency changer valves," (Letter to Editor), *Wireless Eng.*, vol. 15, pp. 611-612; November, 1938.

²³ E. W. Herold, "Superheterodyne converter system considerations in television receivers," *RCA Rev.*, vol. 4, pp. 324-337; January, 1940.

²⁴ B. J. Thompson, D. O. North, and W. A. Harris, "Fluctuations in space-charge-limited currents at moderately high frequencies," *RCA Rev.*, vol. 4, pp. 269-285; January, 1940; vol. 4, pp. 441-472; April, 1940; vol. 5, pp. 106-124; July, 1940; vol. 5, pp. 244-260; October, 1940; vol. 5, pp. 371-388; January, 1941; vol. 5, pp. 505-524; April, 1941; vol. 6, pp. 114-124; July, 1941.

direct voltages applied) the mean-squared intermediate-frequency noise is

$$\overline{i_{i-f}^2} = \frac{1}{2\pi} \int_0^{2\pi} \overline{i_{pn}^2} d(\omega t)$$

or the average of $\overline{i_{pn}^2}$ over an oscillator cycle. The values of $\overline{i_{pn}^2}$ obtained from theory require a knowledge of the currents and transconductance of the tube and are usually proportional to these quantities. Thus, the converter-stage output noise, which is the average of $\overline{i_{pn}^2}$ over the oscillator cycle is usually proportional to the average electrode currents and average transconductance when the oscillator is applied. Specific examples will be given in following sections of this paper treating typical modes of converter operation.

Tube noise is conveniently treated by use of an equivalent grid-noise-resistance concept whereby the tube noise is referred to the signal grid. The equivalent noise resistance of a converter or mixer tube is

$$R_{e,q} = \frac{\overline{i_{i-f}^2}}{(4kT_R\Delta f)g_{cn}^2}$$

where $k=1.37 \times 10^{-23}$, T_R is room temperature in degrees Kelvin, and Δf is the effective over-all bandwidth for noise purposes. Since Δf is invariably associated with $\overline{i_{i-f}^2}$, the bandwidth cancels in the determination of $R_{e,q}$ which is one of the advantages of the equivalent-resistance concept. For $T_R=20$ degrees centigrade,

$$R_{e,q} = 0.625 \times 10^{20} \frac{1}{g_{cn}^2} \frac{\overline{i_{i-f}^2}}{\Delta f}$$

A summary of values of $R_{e,q}$ for common types of converter will be found in a preceding paper.²³

The equivalent noise resistance $R_{e,q}$ alone does not tell the entire story as regards signal-to-noise ratio, particularly at high frequencies. For example, if the converter stage is the first stage of a receiver, and bandwidth is not a consideration, the signal energy which must be supplied by the antenna to drive it will be inversely proportional to the converter-stage input resistance. On the other hand, the noise energy of the converter or mixer tube is proportional to its equivalent noise resistance. The signal-to-noise ratio therefore, will vary with the ratio of input resistance to equivalent noise resistance, and this quantity should be as high as possible. When bandwidth is important, the input resistance should be replaced by the reciprocal of the input capacitance if it is desired to compare various converter systems for signal-to-noise ratio.

III. THE OSCILLATOR SECTION OF CONVERTER TUBES

The oscillator section of converters is often required to maintain oscillation over frequency ranges greater than three to one for circuits using capacitance tuning. Although this requirement is easily met at the lower

broadcast frequencies, the effect of lower circuit impedances, transit-time phenomena in the tube, and high lead reactances combine to make the short-wave band a difficult oscillator problem. Ability to oscillate has, in the past, been measured by the oscillator transconductance at normal oscillator-anode voltage and zero bias on the oscillator grid. Recent data have shown that, in the case of pentagrid and some octode converters, an additional factor which must be considered is the phase shift of oscillator transconductance (i.e., transadmittance) due to transit-time effects.^{25,26}

The ability of a converter to operate satisfactorily at high frequencies depends largely on the undesirable oscillator frequency variations produced when electrode voltages are altered. The frequency changes are mainly caused by the dependence on electrode voltages of oscillator-electrode capacitances, oscillator transconductance, and transit-time effects. There are many other causes of somewhat lesser importance. Because of the complex nature of the problem no satisfactory quantitative analysis is possible. In the case of the pentagrid and the earlier forms of octode converters there are indications that the larger part of the observed frequency shift is due to a transit-time effect. It is found that the phase of the oscillator transadmittance and, therefore, the magnitude of the susceptible part of this transadmittance varies markedly with screen and signal-grid-bias voltages. Since the susceptible part of the transadmittance contributes to the total susceptance, the oscillation frequency is directly affected by any changes.

IV. THE DETAILED OPERATION OF THE MODULATOR OR MIXER SECTION OF THE CONVERTER STAGE

This section will be devoted to a consideration of the modulator or mixer portion of the converter stage. This portion may be either a separate mixer tube or the modulator portion of a converter tube. Since with most of the widely used converter tubes in the more conventional circuits the alternating oscillator-anode voltage has a negligible effect on the operation of the modulator portion, only the effect of oscillator control grid need be considered. Thus the analysis of the operation of most converter tubes is substantially the same as the analysis of the same tubes used as a mixer or modulator only, just as in the treatment of conversion transconductance.

There are three methods of operation of mixer or modulator tubes. The oscillator voltage may be put on the same grid as the signal voltage, it may be put on the inner grid (the signal applied to an outer grid), or it may be impressed on an outer grid (with the

²⁵ M. J. O. Strutt²⁶ has published data on this phase shift in octodes. It was measured to be as high as 60 degrees at 33 megacycles.

²⁶ M. J. O. Strutt, "Electron transit-time effects in multigridded valves," *Wireless Eng.*, vol. 15, pp. 315-321; June, 1938.

signal on the inner grid). Each of these modes of operation has characteristics which depend on the mode rather than on the tube used in it. Tubes which may be used in any one mode differ from one another mainly in the degree in which they affect these characteristics. The treatment to follow, therefore, will not necessarily deal with specific tube types: instead, the phenomenon encountered will be illustrated by the use of data taken on one or more typical tubes for each of the modes of operation.

A. Tubes with Oscillator and Signal Voltages Applied to Same Grid

Typical tubes used for this type of operation are triodes and pentodes. The oscillator voltage may be introduced in series with the signal voltage, coupled to the signal input circuit inductively, capacitively, and/or conductively, or it may be coupled into the cathode circuit. In all but the last case, by operating below

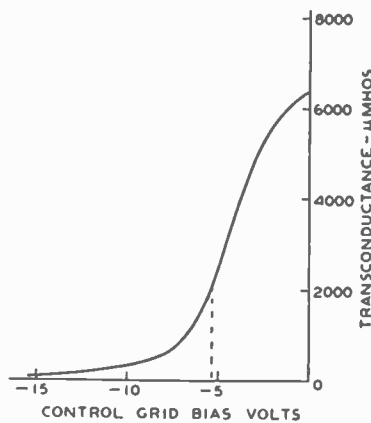

Fig. 4—Transconductance characteristic of a typical variable- μ radio-frequency pentode.

the grid-current point, the oscillator circuit is not loaded directly by the mixer tube. When cathode injection is used, however, an effective load equal to the mean cathode conductance (slightly greater than the mean transconductance) is imposed on the oscillator circuit. The cathode injection circuit has the advantage that oscillator-frequency voltage between the signal input circuit and ground is minimized, thus reducing radiation when the converter stage is also the first stage of the receiver.

A typical transconductance-versus-bias curve for a variable- μ radio-frequency pentode is shown in Fig. 4. The use of the Fourier analysis for conversion transconductance at oscillator fundamental indicates that a value of approximately a quarter of the peak transconductance can be attained. Because of the tailing off of the lower end of the curve, highest conversion transconductance requires a large oscillator swing. Very nearly the maximum value is obtained, however, at an operating bias shown by the dotted line, with an oscillator peak amplitude approximately equal to the bias. With lower oscillator amplitudes, and the same fixed bias, the fundamental conversion transconductance

drops in approximate proportion to the oscillator amplitude.

Strictly speaking, when the cathode injection type of operation is used the effect of the oscillator voltage which is impressed between screen and cathode, and plate and cathode should be considered. Practically, however, there is little difference over the simpler circuit in which the oscillator voltage is impressed on the signal grid only. It is for this reason that the cathode-injection circuit is placed in the same category as those in which the oscillator voltage is actually impressed on the same electrode as the signal.

In a practical circuit the effective oscillator voltage is, of course, the oscillator voltage actually existent between grid and cathode of the tube. When the oscillator voltage is impressed in series with the signal circuit or on the cathode, this effective voltage is different from the applied oscillator voltage by the drop across the signal circuit. In the usual case, with the oscillator frequency higher than the signal frequency, the signal circuit appears capacitive at oscillator frequency. This capacitance and the grid-to-cathode capacitance, being in series, form a capacitance divider and reduce the effective oscillator voltage. The reduction would not be a serious matter if it remained a constant quantity; but in receivers which must be tuned over an appreciable frequency range this is not the case. The result is a variation in conversion gain over the band. A number of neutralizing circuits have been described in the patent literature which are designed to reduce the oscillator-frequency voltage across the signal circuit and thus minimize the variations.^{27,28}

Coupling of the oscillator voltage into, or across, the signal circuit is also accompanied by changes in effective oscillator voltage when the tuning is varied. These changes are not so great with pure inductive coupling as with pure capacitance coupling. In many practical cases, both couplings are present.

A method of reducing the variation of conversion gain with effective oscillator voltage in tubes in which oscillator voltage and signal are placed on the same grid, employs automatic bias. Automatic bias may be obtained either by a cathode self-bias resistor (bypassed to radio frequency) or by a high-resistance grid leak, or both. An illustration of the improvement which may be obtained in this way is shown in Fig. 5. Three curves of conversion transconductance, at oscillator fundamental, against effective peak oscillator volts are shown for the typical variable- μ pentode of Fig. 4 used as a mixer. For the curve *a*, a fixed bias was used at approximately an optimum point. The curve is stopped at the grid-current point because operation beyond this point is not practicable in a receiver. Curve *b* shows the same tube operated with a

²⁷ H. J. M. deRegnauld de Bellescize, United States Patent No. 1,872,634; M. Gausner, French Patent No. 639,028.

²⁸ V. E. Whitman, United States Patent No. 1,893,813.

cathode self-bias resistor. This curve is also stopped at the grid-current point. Curve *c* shows operation with a high-resistance grid leak. It is evident that, above an oscillator voltage of about 3, curve *b* is somewhat flatter, and *c* is considerably flatter than the fixed-bias curve *a*. The high-resistance grid leak used for *c* may be made a part of the automatic-volume-control filter but care must be taken that its value is considerably higher than the resistance in the automatic-volume-control circuit which is common to other tubes in the receiver. If this is not done, all the tubes will be biased down with large oscillator swings. When a high-resistance leak is used, the automatic-volume-control action does not begin in the mixer tube until the automatic-volume-control bias has exceeded the peak oscillator voltage. Because of the high resistance of the leak, the signal circuit is not loaded appreciably by the mixer tube. In a practical case, precautions must be taken that a pentode in the converter stage is not operated at excessive currents when accidental failure of the oscillator reduces the bias. A series dropping resistor in the screen-grid supply will prevent such overload. When a series screen resistor is used, the curve of conversion transconductance versus oscillator voltage is even flatter than the best of the curves shown in Fig. 5. Series screen operation, therefore, is highly desirable.²³

One of the effects of feedback through interelectrode capacitance in vacuum tubes is a severe loading of the input circuit when an inductance is present in the cathode circuit. Thus, in mixers using cathode injection, the signal circuit is frequently heavily damped, since the oscillator circuit is inductive at signal frequency in the usual case. The feedback occurs through the grid-to-cathode capacitance and can be neutralized to some extent by a split cathode coil with a neutralizing capacitance.²⁸ Such neutralization also minimizes the voltage drop of oscillator frequency across the signal circuit.

Loading of the signal circuit by feedback from the plate circuit of modulators or mixers may also be serious when the signal-grid-to-plate capacitance is appreciable. This is especially true when a low-capacitance intermediate-frequency circuit, which presents a comparatively high capacitive reactance at signal frequency, is used, as in wide-band intermediate-frequency circuits. The grid-plate capacitance of radio-frequency pentodes is usually small enough so that the effect is negligible in these tubes. In triodes, however, feedback from the intermediate-frequency circuit may be serious and the grid-plate capacitance should be minimized in tube and circuit design. Although neutralization is a possible solution to the plate feedback, a more promising solution is the use of a specially designed intermediate-frequency circuit which offers a low impedance at signal frequency by the equivalent of series tuning and yet causes little or no sacrifice in intermediate-frequency performance.

At high frequencies, the converter stage exhibits phenomena not usually observable at low frequencies. One group of phenomena is caused not by the high operating frequency, per se, but rather by a high ratio of operating frequency to intermediate frequency (i.e., a small separation between signal and oscillator frequencies). Among these phenomena may be listed pull-in and interlocking between oscillator and signal circuits and poor image response. In mixers in which oscillator and signal are impressed on the same grid, the first of these effects is usually pronounced because of the close coupling between the oscillator and signal circuits. It can be reduced by special coupling from the local oscillator at an increase in the complexity of the circuit.

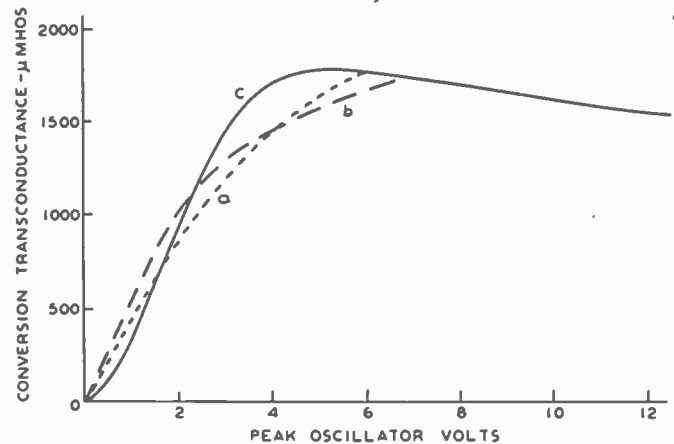

Fig. 5—Conversion transconductance of a typical variable- μ , radio-frequency pentode. Oscillator and signal voltages both applied to grid No. 1. *a*, fixed-bias operation; *b*, cathode resistor used to obtain bias; *c*, bias obtained by means of a high-resistance grid leak.

Other phenomena, which are due to the high operating frequency, occur in mixers irrespective of the intermediate-frequency. The most important of these are those caused by transit-time effects in the tube and by finite inductances and mutual inductances in the leads to the tube. When the oscillator and signal are impressed on the same grid of a mixer, the effects are not dissimilar to those in the same tube used as an amplifier. So far as the signal is concerned, the operation is similar to that of an amplifier whose plate current and transconductance are periodically varied at another frequency (that of the oscillator). The effects at signal frequency must, therefore, be integrated or averaged over the oscillator cycle. The input conductance at 60 megacycles of the typical radio-frequency pentode used for Figs. 4 and 5 as a function of control-grid bias is shown in Fig. 6. The integrated or net loading as a function of oscillator amplitude, when the tube is used as a mixer at this frequency, is given in Fig. 7, both with fixed-bias operation and with the bias obtained by a grid leak and condenser. The conductance for all other frequencies may be calculated by remembering that the input conductance increases with the square of the frequency. The data given do not hold

for cathode injection because of the loading added by feedback, as previously discussed.

When automatic volume control is used on the modulator tube, an important effect in some circuits is the change in input capacitance and input loading with bias. This is especially true when low-capacitance circuits are in use, as with a wide-band amplifier. With tubes having oscillator and signal voltages on the same grid, because of the integrating action of the oscillator voltage, the changes are not so pronounced as with the same tube used as amplifier. A small, unby-passed cathode resistor may be used with an ampli-

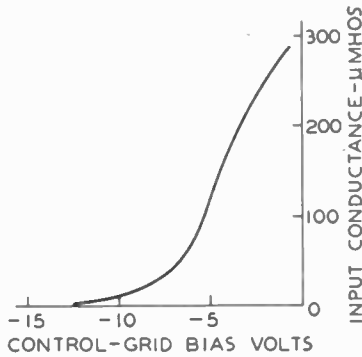

Fig. 6—Input conductance of a typical variable- μ , radio-frequency pentode, at 60 megacycles.

fier tube^{29,30} to reduce the variations; it should give a similar improvement with the modulator.

The question of tube noise (i.e., shot-effect fluctuations) is important in a mixer, or modulator, especially when this tube is the first tube in a receiver. There is little doubt that triode or pentode mixers, in which signal and oscillator voltages are impressed on the control grid, give the highest signal-to-noise ratio of any of the commonly used types of mixers. The reason for this has been made clear by recent studies of tube noise.²⁴ It is now well established that tube noise is the combined result of shot noise in the cathode current which is damped by space charge to a low value and additional fluctuations in the plate current caused by random variations in primary current distribution between the various positive electrodes. Thus, in general, tubes with the smallest current to positive electrodes other than the plate have the lowest noise. It is seen that the tetrode or pentode modulator, with a primary screen current of 25 per cent or less of the total current, is inherently lower in noise than the more complex modulators in which the current to positive electrodes other than the plate usually exceeds 60 per cent of the total current. The triode, of course, has the lowest noise assuming an equivalent tube structure. The conversion transconductance of triode, tetrode, or pentode mixers is usually higher than that of multielectrode

²⁹ M. J. O. Strutt and A. van der Ziel, "Simple circuit means for improving short-wave performance of amplifier tubes," *Elek. Nach. Tech.*, vol. 13, pp. 260-268; August, 1936.

³⁰ R. L. Freeman, "Use of feedback to compensate for vacuum-tube input-capacitance variations with grid bias," *Proc. I.R.E.*, vol. 26, pp. 1360-1366; November, 1938.

tubes using a similar cathode and first-grid structure. That this is so is again largely due to the lower value of wasted current to other electrodes.

The noise of triodes and pentodes used as mixers in the converter stage is conveniently expressed in terms of an equivalent noise resistance R_{eq} as mentioned in Section II C. The noise as a mixer, of both the triode and the pentode, may be expressed in one formula based on the now well-understood amplifier noise relations.²⁴ The equivalent noise resistance of the triode is obtained simply by equating the screen current to zero. An approximate formula for equivalent noise resistance of oxide-coated-cathode tubes is

$$R_{eq} \text{ (of triode and pentode mixers)} = \frac{2.2 \bar{g}_m + 20 \bar{I}_{c2}}{g_c^2} \frac{1}{1 + \alpha}$$

where \bar{g}_m is the average control-grid-to-plate transconductance (averaged over an oscillator cycle), \bar{I}_{c2} is the average screen current, g_c is the conversion transconductance, and α is the ratio of the screen current to plate current. Valuable additions to the above rela-

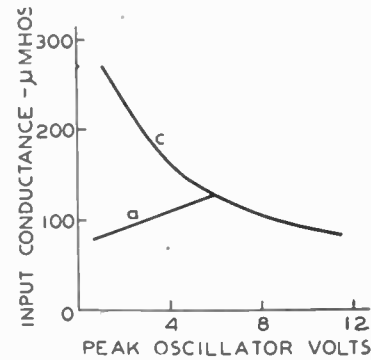

Fig. 7—Input conductance of a typical pentode when used as a mixer at 60 megacycles. *a*, fixed-bias operation; *c*, bias obtained by means of a high-resistance grid leak.

tion are given by formulas which enable a simple calculation of noise resistance from amplifier data found in any tube handbook. These additional relations are approximations derived from typical curve shapes and are based on the maximum peak cathode current I_0 and the maximum peak cathode transconductance g_0 . The data are given in Table I. It has been assumed that oscillator excitation is approximately optimum. In this table, E_{c0} is the control-grid voltage

TABLE I
MIXER NOISE OF TRIODES AND PENTODES
(Oscillator and Signal both Applied to Control Grid)

Operation	Approximate Oscillator Peak Volts	Average Transconductance \bar{g}_m	Average Cathode Current \bar{I}_k	Conversion Transconductance g_c	Equivalent Noise Resistance R_{eq}
At Oscillator Fundamental	$0.7 E_{c0}$	$\frac{0.47}{1 + \alpha} g_0$	$0.35 I_0$	$\frac{0.28}{1 + \alpha} g_0$	$\frac{13}{g_0} + 90 \frac{I_0}{g_0^2} \alpha$
At Oscillator 2nd Harmonic	$1.5 E_{c0}$	$\frac{0.25}{1 + \alpha} g_0$	$0.20 I_0$	$\frac{0.13}{1 + \alpha} g_0$	$\frac{31}{g_0} + 220 \frac{I_0}{g_0^2} \alpha$
At Oscillator 3rd Harmonic	$4.3 E_{c0}$	$\frac{0.15}{1 + \alpha} g_0$	$0.11 I_0$	$\frac{0.09}{1 + \alpha} g_0$	$\frac{38}{g_0} + 260 \frac{I_0}{g_0^2} \alpha$

needed to cut off the plate current of the tube with the plate and screen voltages applied, and α is the ratio of screen to plate current.

As an example of the use of the table, suppose it is desired to find the equivalent noise resistance of a particular triode operated as a converter at the oscillator second harmonic. The local oscillator can be permitted to swing the triode mixer grid to zero bias. With a plate voltage of 180 volts and zero bias, the tube data sheet shows a transconductance, $g_0 = 2.6 \times 10^{-3}$ mho. Thus the equivalent noise resistance is $31/g_0$ or 12,000 ohms and the conversion transconductance at second harmonic is $0.13 g_0$, or 340 micromhos. Since, with this plate voltage the tube cuts off at about 8 volts, a peak oscillator voltage of around 12 volts will be required.

The above table may also be used to obtain a rough estimate of the input loading of pentode or triode mixers, since the high-frequency input conductance is roughly proportional to the average transconductance \bar{g}_m and to the square of the frequency. Thus, if the loading at any transconductance and frequency is

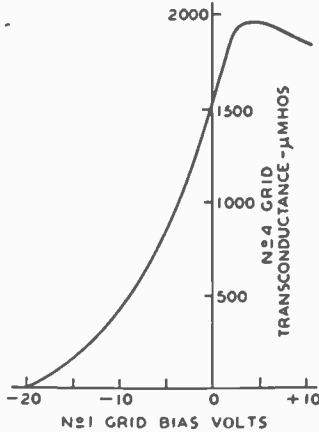

Fig. 8—Signal-grid-(grid No. 4) to-plate transconductance versus oscillator-grid (grid No. 1) voltage curve of a typical mixer designed for inner-grid injection. Signal-grid bias = -3 volts.

known, the loading as a mixer under the conditions of the table may quickly be computed.

B. Tubes with Oscillator Voltage on an Inner Grid, Signal Voltage on an Outer Grid

When the oscillator voltage is impressed on the grid nearest the cathode of a mixer or converter, the cathode current is varied at oscillator frequency. The signal grid, on the other hand, may be placed later in the electron stream to serve only to change the distribution of the current between the output anode and the other positive electrodes. When the two control grids are separated by a screen grid, the undesirable coupling between oscillator and signal circuits is reduced much below the value which otherwise would be found.

The signal-grid-to-plate transconductance of the inner-grid injection mixer is a function of the total current reaching the signal grid; this current, and hence the signal-grid transconductance, will vary at

oscillator frequency so that mixing becomes possible. The signal-grid transconductance as a function of oscillator-grid potential of a typical modulator of this kind is shown in Fig. 8. It will be observed that this characteristic is different in shape from the corresponding curve of Fig. 4 for the tube with oscillator and signal voltages on the same grid. The chief point of difference is that a definite peak in transconductance is found. The plate current of the tube shows a saturation at approximately the same bias as that at which the peak in transconductance occurs, indicating the formation of a partial virtual cathode. The signal grid, over

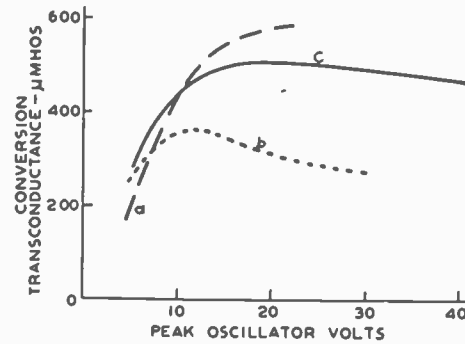

Fig. 9—Conversion transconductance of a typical mixer designed for inner-grid injection of oscillator. Signal-grid bias = -3 volts. *a*, fixed-bias operation of oscillator grid; *b*, oscillator-grid bias obtained through high-resistance grid leak; *c*, oscillator-grid bias obtained through a 50,000-ohm grid leak.

the whole of these curves, is biased negatively and so draws no current. The oscillator inner grid (No. 1 grid), however, draws current at positive values of bias. This separation of signal and oscillator grids is advantageous, inasmuch as the signal circuit is not loaded even though the oscillator amplitude is sufficient to draw grid current. In fact, in the usual circuit, the oscillator grid is self-biased with a low-resistance leak and condenser and swings sufficiently far positive to attain the peak signal-grid transconductance.

The conversion transconductance of such a tube has a maximum with an oscillator swing which exceeds the point of maximum signal-grid transconductance in the one direction and which cuts off this transconductance over slightly less than half the cycle, in the other. Curves of conversion transconductance against peak oscillator voltage are shown in Fig. 9. Curve *a* is for fixed-bias operation of the oscillator grid, curve *b* is with a high-resistance (i.e., several megohms) grid leak and condenser for bias, and curve *c* is with the recommended value of grid leak (50,000 ohms) for this type of tube. It is seen that best operation is obtained with the lower resistance value of grid leak. With this value, the negative bias produced by rectification in the grid circuit is reduced enough to allow the oscillator grid to swing appreciably positive over part of the cycle. An incidental advantage to the use of the low-resistance leak when the tube is self-oscillating (i.e., a converter) is that undesirable relaxation oscillations are minimized.

In mixers or converters in which the oscillator voltage

is present on both the cathode and the oscillator grid in the same phase (e.g., Fig. 3) it is usually necessary to utilize a relatively sharp cutoff in the design of the oscillator grid so as to cut off the cathode current when the signal grid is positive.¹⁹ By this means, the signal grid is prevented from drawing current. At the same time, however, the high currents needed for a high peak value of signal-grid transconductance cannot be obtained without a greater positive swing of the oscillator grid than with a more open oscillator grid structure. Thus, it is clear that it is desirable to have a negative bias on the oscillator electrode which is considerably smaller than the peak oscillator voltage. For this reason, optimum results are obtained on these tubes with very low values of oscillator grid leak (e.g., 10,000 to 20,000 ohms).

The effects of feedback through the interelectrode capacitance are small in well-designed multigrid mixers and converters of the kind covered in this section. The signal-grid-to-plate capacitance is usually small enough to play no part in the operation; even with a high L -to- C ratio in the intermediate-frequency transformer, the capacitive reactance of the intermediate-frequency circuit at signal frequency is only a very small fraction of the feedback reactance. The other interelectrode capacitance which plays some part in determining circuit performance (excluding, of course, the input and output capacitances) is the capacitance from the oscillator electrode or electrodes to the signal grid. This capacitance is a source of coupling between these two circuits. In well-designed converter or modulator tubes of the type discussed in this section, however, the coupling through the capacitance may be made small compared with another form of internal coupling known as "space-charge coupling," which will be treated later in this discussion.

Coupling between oscillator and signal circuits is of no great consequence except when an appreciable voltage of oscillator frequency is built up across the signal-grid circuit. This is not usually possible unless the signal circuit is nearly in tune with the oscillator as it is when a low ratio of intermediate frequency to signal frequency is used. The effect of oscillator-frequency voltage induced across the signal circuit depends on its phase; the effect is usually either to increase or to decrease the relative modulation of the plate current at oscillator frequency and so to change the conversion transconductance. This action is a disadvantage, particularly when the amount of induced voltage changes when the tuning is varied, as usually occurs. In some cases, another effect is a flow of grid current to the signal grid; this may happen when the oscillator-frequency voltage across the signal-grid circuit exceeds the bias. Grid current caused by this effect can usually be distinguished from grid current due to other causes. By-passing or short-circuiting the signal-grid circuit reduces the oscillator-frequency voltage across the signal-grid circuit to zero. Any remaining

grid current must, therefore, be due to other causes.

Current to a negative signal grid of a tube operated with inner-grid oscillator injection is sometimes observed at high frequencies (e.g., over 20 megacycles) even when no impedance is present in the signal-grid circuit. This current is caused by electrons whose effective initial velocity has been increased by their finite transit time in the high-frequency alternating field around the oscillator grid. These electrons are then able to strike a signal grid which is several volts negative. The magnitude of the signal-grid current is not usually as great as with tubes applying the oscillator voltage to an outer grid²¹ although it may prevent the use of an automatic-volume-control voltage on the tube.

An investigation of coupling effects in the pentagrid converter showed that the coupling was much larger than could be explained by interelectrode capacitance. It was furthermore discovered that the apparent coupling induced a voltage on the signal circuit in opposite phase to that induced by a capacitance from oscillator to signal grid.¹⁵ The coupling which occurred was due to variations in space charge in front of the signal grid at oscillator frequency. A qualitative explanation for the observed behavior is that, when the oscillator-grid voltage is increased, the electron charge density adjacent to the signal grid is increased and electrons are repelled from the signal grid. A capacitance between the oscillator grid and the signal grid would have the opposite effect. The coupling, therefore, may be said to be approximately equivalent to a negative capacitance from the oscillator grid to the signal grid. The effect is not reversible because an increase of potential on the signal grid does not increase the electron charge density around the oscillator grid. If anything, it decreases the charge density. The equivalence to a negative capacitance must be restricted to a one-way negative capacitance and, as will be shown later, is restricted also to low-frequency operation.

In general, the use of an equivalent impedance from oscillator grid to signal grid to explain the behavior of "space-charge coupling" is somewhat artificial. A better point of view is simply that a current is induced in the signal grid which depends on the oscillator-grid voltage. Thus, a transadmittance exists between the two electrodes analogous to the transconductance of an ordinary amplifier tube. Indeed, the effect has been used for amplification in a very similar manner to the use of the transconductance of the conventional tube.^{22,23}

It is found that the transadmittance from the oscillator to the signal electrode $Y_{m_{0-s}}$ is of the form

$$Y_{m_{0-s}} = k_1\omega^2 + jk_2\omega.$$

²¹ The next part of this section contains a more detailed discussion of signal-grid current in outer-grid oscillator injection tubes.

²² C. J. Bakker and G. de Vries, "Amplification of small alternating tensions by an inductive action of the electrons in a radio valve," *Physica*, vol. 1, pp. 1045-1054, October-November, 1934.

²³ A. M. Nicolson, United States Patent No. 1,255,211 (applied for in 1915).

At low frequencies (i.e., $k_1\omega^2 \ll k_2\omega$) the transadmittance is mainly a transsusceptance but, as the frequency rises, the transconductance component $k_1\omega^2$ becomes of more and more importance, eventually exceeding the transsusceptance in magnitude. The early work on "space-charge coupling" indicated that the effect was opposite to that of a capacitance connected from oscillator to signal grid and could be canceled by the connection of such a capacitance of the correct value.^{15,34} The effect of such cancellation could be only partial, however, since only the transsusceptance was balanced out by this arrangement. For complete cancellation it is also necessary to connect a conductance, the required value of which increases as the square of the frequency, between the oscillator grid and the signal grid so that the transconductance term is also balanced out.^{35,36}

The cancellation of "space-charge coupling" may be viewed in another way. A well-known method of measuring the transadmittance of a vacuum tube is to connect an admittance from control grid to output electrode and to vary this admittance until no alternating-current output is found with a signal applied to the control grid.³⁷ The external admittance is then equal to the transadmittance. In exactly the same way, the transadmittance which results from the space-charge coupling may be measured. As a step further, if an admittance can be found which substantially equals the transadmittance at all frequencies or over the band of frequencies to be used, this admittance may be permanently connected so as to cancel the effects of space-charge coupling. As has been previously stated, the admittance which is required is a capacitance and a conductance whose value varies as the square of the frequency. Such an admittance is given to a first approximation by the series connection of a capacitance C and a resistance R . Up to an angular frequency $\omega = 0.3/CR$ the admittance of this combination is substantially as desired. At higher values of frequency, the conductance and susceptance fail to rise rapidly enough and the cancellation is less complete. Other circuits are a better approximation to the desired admittance. For example, the connection of a small inductance, having the value $L = 1/2CR^2$, gives a good approximation up to an angular frequency $\omega = 0.6/CR$. The latter circuit is, therefore, effective to a frequency twice as high as the simple series arrangement of capacitance and resistance. Inasmuch as in some cases the value of inductance needed is only a fraction of a microhenry, the inductance may conveniently be de-

rived from proper proportioning and configuration of the circuit leads.

It is of interest to note the order of magnitude of the transadmittance which is measured in the usual converter and mixer tubes.^{26,35,36,38} In the formula for Y_{m0-s} given above, k_1 is in the neighborhood of 10^{-21} and k_2 is around 10^{-12} . Cancellation is effected by a capacitance of the order of one or two micromicrofarads and a series resistance of 500 to 1000 ohms.

The correct value of the canceling admittance may be found experimentally by adjustment so that no oscillator voltage is present across the signal-grid circuit when the latter is tuned to the oscillator frequency. Another method which may be used is to observe either the mixer or converter plate current or the oscillator grid current as the tuning of the signal circuit is varied through the oscillator frequency. With proper adjustment of the canceling admittance there will be no reaction of the signal-circuit tuning on either of these currents.

There are two disadvantages which accompany the cancellation of space-charge coupling as outlined. In the first place, the signal-grid input admittance is increased by the canceling admittance. This point will be brought up again after discussing the input admittance. The second disadvantage is that the oscillator frequency shift with voltage changes in converter tubes may be somewhat increased by the use of this cancelling admittance. When separate oscillator and mixer tubes are used, the latter effect may be made less serious.

The next point to be considered is the input admittance of the signal grid. Signal-grid admittance curves of a typical modulator designed for use with the oscillator voltage impressed on the first grid are shown under direct-current conditions (i.e., as a function of oscillator-grid bias for several values of signal-grid bias) in Fig. 10. The admittance is separated into conductive and susceptive components, the latter being plotted in terms of equivalent capacitance. The admittance components of the "cold" tube (no electrons present) have been subtracted from the measured value so that the plotted results represent the admittance due to the presence of electrons only. The data shown were taken at 31.5 megacycles with a measuring signal which did not exceed 1.0 volt peak at any time. A modified Boonton Q meter was used to take the data. It should be noted that the presence of a marked conductive component of admittance is to be expected at frequencies as high as those used.

The most striking feature of the data of Fig. 10 is that both susceptive and conductive components are negative over a large portion of the characteristic. The Appendix discusses this feature in somewhat more detail. The measurements show that the susceptive component is analogous to a capacitance. The capacitance

³⁸ M. J. O. Strutt, "Frequency changers in all-wave receivers," (Letter to Editor), *Wireless Eng.*, vol. 14, p. 606; November, 1937.

³⁴ M. J. O. Strutt, "Frequency changers in all-wave receivers," *Wireless Eng.*, vol. 14, pp. 184-192; April, 1937.

³⁵ E. W. Herold, "Frequency changers in all-wave receivers," (Letter to Editor), *Wireless Eng.*, vol. 14, pp. 488-489; September, 1937.

³⁶ E. W. Herold, United States Patent No. 2,141,750.

³⁷ F. B. Llewellyn, "Phase angle of vacuum tube transconductance at very high frequencies," *Proc. I.R.E.*, vol. 22, pp. 947-956; August, 1934.

curves given are independent of frequency up to the highest frequency used (approximately 50 megacycles). The conductive component, on the other hand, increases as the square of the frequency also up to this frequency. The conductance is, therefore, negative

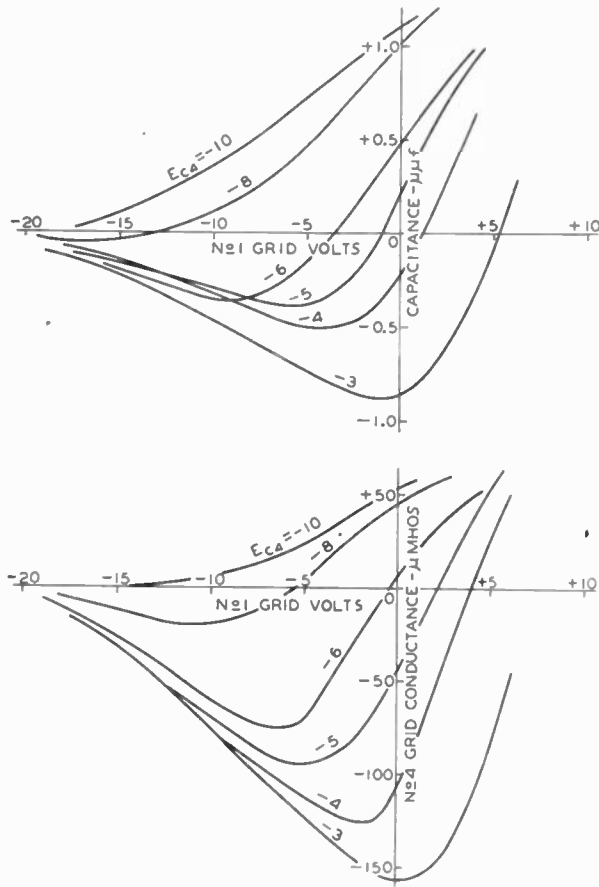

Fig. 10—Signal-grid (grid No. 4) admittance of a typical mixer designed for inner-grid injection of oscillator at 31.5 megacycles. Curves taken with no oscillator voltage applied. Data represents electronic admittance only (i.e., "cold" values were subtracted from measured values before plotting).

even at very low frequencies although its magnitude is then very small. Thus, the conductance curves of Fig. 11 are valid for any frequency by multiplication of the conductance axis by the square of the ratio of the frequency considered, to the frequency used for the data (i.e., 31.5 megacycles). Data taken at various frequencies for two particular values of grid bias voltage E_{c4} are plotted in Fig. 11. The square-law relation is shown to check very closely.

Fig. 10 should be considered remembering that the oscillator voltage is applied along the axis of abscissas. Considering an applied oscillator voltage, the admittance curves must be integrated over the oscillator cycle to find the admittance to the signal frequency. The operation is just as if the tube were an amplifier whose input admittance is periodically varied over the curve of Fig. 10 which corresponds to the signal-grid bias which is used. Curves of the modulator input conductance at 31.5 megacycles for various applied oscillator voltages are shown in Fig. 12. The oscillator-grid

bias is obtained by means of the recommended value of grid leak for the tube (50,000 ohms). Curves are shown for two values of signal-grid bias voltage E_{c4} .

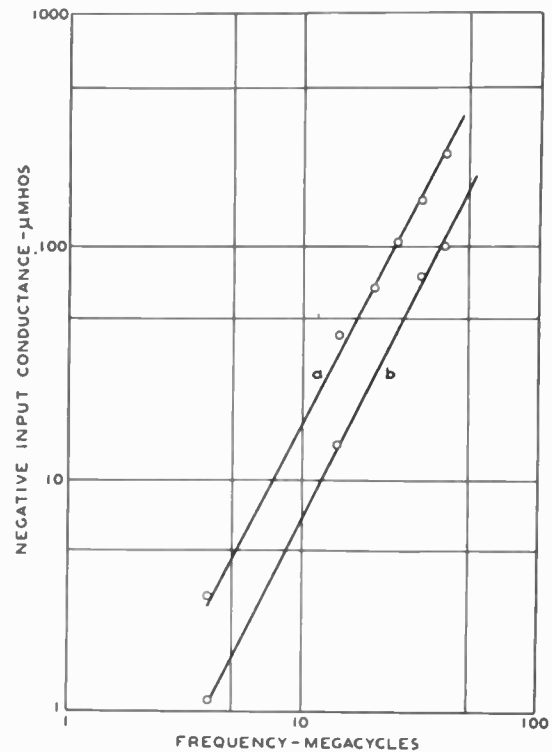

Fig. 11—Signal-grid (grid No. 4) conductance of a typical mixer designed for inner-grid injection of oscillator. Lines are drawn with slope of 2. Curve *a* taken with $E_{c1}=0$, $E_{c4}=-3$ volts. Curve *b* taken with $E_{c1}=-6$, $E_{c4}=-6$ volts.

As before, data for other frequencies are obtained by multiplying the conductance by the square of the frequency ratio.

The practical effect of the negative input admittance in a circuit is due to the conductive portion only,

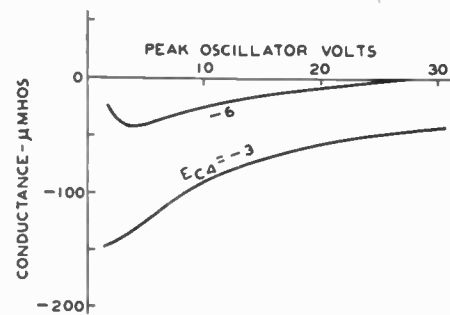

Fig. 12—Signal-grid (grid No. 4) conductance of a typical mixer designed for inner-grid injection of oscillator, at 31.5 megacycles. Oscillator voltage applied. Oscillator-grid bias obtained through 50,000-ohm grid leak. Electronic portion of conductance, only, plotted.

inasmuch as the total input capacitance remains positive in general.³⁹ An improved image ratio, and somewhat greater gain to the converter signal grid over

³⁹ It should not be forgotten that the data given do not include the "cold" susceptance and conductance of the tube. The latter is a relatively small quantity, however.

other types of modulator is to be expected when this type of oscillator injection is used. At high frequencies, when a comparatively low intermediate frequency is used, it is usually desirable to cancel the space-charge coupling of the tube in the manner previously discussed. When this cancellation is made reasonably complete by the use of a condenser and resistor combination connected from the oscillator grid to the signal grid, the losses in this admittance at signal frequency are usually sufficient to wipe out the negative input admittance. The net positive input conductance however is often less than that found with other types of mixer.

The change in signal-grid input capacitance with automatic-volume-control voltage is small in this type of modulator, particularly with the larger values of oscillator swing because of the integrating action of the oscillator voltage.

The fluctuation noise which is found in the output of inner-grid oscillator-injection mixers and converters is not readily evaluated quantitatively. The fluctuation noise is primarily due to current-distribution fluctuations but is complicated by the possibility of a virtual cathode ahead of the signal grid. Data have been taken, however, which indicate some degree of proportionality between the mean-squared noise current and the plate current. The signal-to-noise ratio for this type of modulator is, therefore, approximately proportional to the ratio of conversion transconductance to the square root of the plate current. It is considerably less than for the pentode modulator with both signal and oscillator voltages on the control grid.

The noise of the converter or mixer with oscillator on an inner grid may be expressed in terms of an equivalent grid resistance as

$$R_{eq} = \frac{20 \bar{I}_b}{g_c^2} F^2$$

where \bar{I}_b is the operating plate current, g_c is the conversion transconductance, and F^2 is a factor which is about 0.5 for tubes with suppressor grids and at full gain. For tubes without suppressor or for tubes whose gain is reduced by signal-grid bias, F^2 is somewhat larger and approaches unity as a maximum. With this mode of operation there is not so much value in expressions for R_{eq} based on maximum transconductance and maximum plate current because these quantities are neither available nor are they easily measured. For operation at second or third harmonics of the oscillator (assuming optimum oscillator excitation) the plate current \bar{I}_b and the conversion transconductance g_c are roughly $\frac{1}{2}$ or $\frac{1}{3}$, respectively, of their values with fundamental operation so that the equivalent noise resistance for second-harmonic and third-harmonic operation is around two and three times, respectively, of its value for fundamental operation.

C. Mixers with Oscillator Voltage on an Outer Grid, Signal Voltage on Inner Grid

With this type of mixer, the cathode current is modulated by the relatively small signal voltage which is impressed on the control grid adjacent to the cathode. The oscillator voltage, on the other hand, is impressed on a later control grid so that it periodically alters the current distribution between anode and screen grid. The connections of signal and oscillator voltages to this type of modulator are just the reverse, therefore, of the mixer treated in the preceding section. The behaviors of the two types are also quite different although they both include internal separation of signal and oscillator electrodes through a shielding screen grid.

The signal-grid transconductance curve as a function of oscillator-grid voltage of a typical mixer designed for use with the oscillator on an outer grid is shown in Fig. 13. It differs in shape from similar curves for the other two classes of modulator in that an ap-

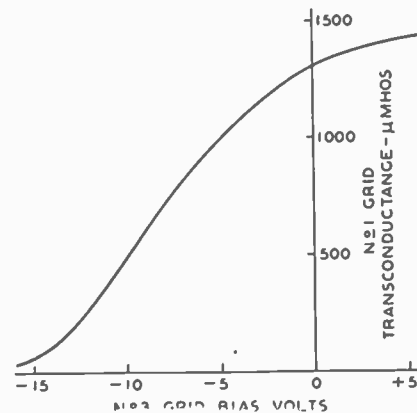

Fig. 13—Signal-grid (grid No. 1) transconductance versus oscillator-grid (grid No. 3) voltage of a typical mixer designed for use with outer-grid injection of oscillator. Signal-grid bias = -3 volts.

proximate saturation is reached around zero bias on the oscillator grid. The conversion transconductance for such a tube is, therefore, more accurately predicted from normal amplifier transconductance. In fact, in the manufacture of this type of mixer, a test of signal-grid transconductance at somewhere near the saturation point (e.g., zero bias) on the oscillator grid has been found to correlate almost exactly with the conversion transconductance. The cutoff point of the curve must remain approximately fixed, of course, since this point affects the oscillator amplitude which is necessary.

The conversion transconductance of the typical outer-grid injection mixer tube which was used for Fig. 13 is shown in Fig. 14. Curve *a* which is for fixed bias on the oscillator grid is seen to be higher than curve *b* for which bias is obtained by a 50,000-ohm grid leak and condenser. The latter connection is most widely used, however, because of its convenience. A compromise using fixed bias together with a grid leak

is most satisfactory of all.⁴⁰ When this combination is used, the curve of conversion transconductance follows curve *a* of Fig. 14 to the intersection with curve *b* and then follows along the flat top of curve *b*.

In a well-designed mixer with the signal voltage on the grid adjacent to the cathode and the oscillator voltage on an outer grid, effects due to feedback through the interelectrode capacitance may usually be neglected. The only effect which might be of importance in some cases is coupling of the oscillator to the signal circuit through the signal-grid-to-oscillator-grid capacitance. In many tubes a small amount of space-charge coupling between these grids is also present and adds to the capacitance coupling (contrary to the space-charge coupling discussed in Section B which opposes the capacitance coupling in that case). Measurements of the magnitude of the space-charge coupling for this type of modulator show that it is of the order of 1/5 to 1/10 of that present in inner-grid-injec-

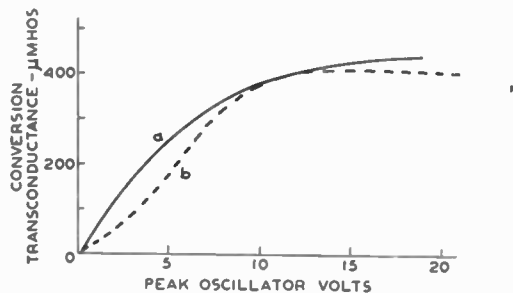

Fig. 14—Conversion transconductance of a typical mixer designed for outer-grid injection of oscillator. Signal-grid bias, $E_{c1} = -3$ volts. Curve *a* corresponds to fixed No. 3 grid bias, $E_{c3} = -8$ volts. Curve *b* corresponds to bias obtained through a 50,000-ohm grid leak.

tion modulators. Coupling between oscillator and signal circuits causes a voltage of oscillator frequency to be built up across the signal input circuit. This oscillator-frequency voltage, depending on its phase, aids or opposes the effect of the normal oscillator-grid alternating voltage. The action is additive when the signal circuit has capacitive reactance to the oscillator frequency, as in the usual case. When the oscillator-frequency voltage across the signal input circuit exceeds the bias, grid current is drawn to the signal grid, an undesirable occurrence. This grid current may be distinguished from signal-grid current due to other causes by short-circuiting the signal-input circuit and noting the change in grid current. With the majority of tubes, another cause of signal-grid current far exceeds this one in importance. This other cause will now be discussed.

The most prominent high-frequency effect which was observed in mixers of the kind under discussion, was a direct current to the negative signal grid even when no impedance was present in this grid circuit. This effect was investigated and found to be due to the finite time of transit of the electrons which pass

through the signal grid and are repelled at the oscillator grid, returning to pass near the signal grid again.^{17,41,42} When the oscillator frequency is high, the oscillator-grid potential varies an appreciable amount during the time that such electrons are in the space between screen grid and oscillator grid. These electrons may, therefore, be accelerated in their return path more than they were decelerated in their forward path. Thus, they may arrive at the signal grid with an additional velocity sufficient to allow them to strike a slightly negative electrode. Some electrons may make many such trips before being collected; moreover, in each trip their velocity is increased so that they may receive a total increase in velocity equivalent to several volts. A rough estimate of the grid current to be expected from a given tube is given by the semiempirical equation

$$I_{c1} = AI_k E_{osc} \omega \tau_{2-3} e^{BE_{c1}}$$

Where *A* and *B* depend on electrode voltages and configuration, I_{c1} is the signal-grid current, E_{c1} is the signal-grid bias, I_k is the cathode current, E_{osc} is the impressed oscillator voltage on the oscillator grid, ω is the angular frequency of the oscillator, and τ_{2-3} is the electron transit time in the space between screen grid and oscillator grid.

Data on the signal-grid current of a typical mixer at 20 megacycles are shown in Fig. 15 where a semi-

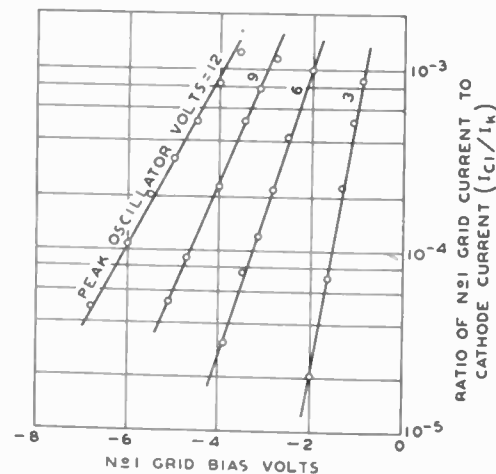

Fig. 15—Signal-grid (grid No. 1) current in a typical mixer with a 20-megacycle oscillator voltage applied to grid No. 3. $E_{c1} = -10$ volts, E_{c2} and $E_{c3} = 100$ volts, $E_b = 250$ volts.

logarithmic plot is used to indicate the origin of the above equation.

The reduction of signal-grid current by operation at more negative signal-grid bias values is an obvious remedy. When this is done, in order to prevent a reduction in conversion transconductance, the screen

⁴¹ K. Steimel, "The influence of inertia and transit time of electrons in broadcast receiving tubes," *Telefunken-Röhre*, no. 5, pp. 213-218; November, 1935.

⁴² K. S. Knol, M. J. O. Strutt, and A. van der Ziel, "On the motion of electrons in an alternating electric field," *Physica*, vol. 5, pp. 325-334; May, 1938.

⁴⁰ E. W. Herold, United States Patent No. 2,066,038.

voltage must be raised. A better method of reducing the undesired grid current lies in a change of tube design. It will be shown in a later part of this discussions that the constant A and/or the transit time τ_{2-3} of the above formula may be reduced considerably by proper electrode configuration.

Another high-frequency phenomenon which is particularly noticed in outer-grid-injection mixers is the high input conductance due to transit-time effects. The cause for this was first made evident when the change of signal-grid admittance with oscillator-grid potential was observed. Fig. 16 gives data on the susceptive and conductive components of the signal-grid admittance of this type of modulator as a function of oscillator-grid bias (no oscillator voltage applied). The data were taken at 31.5 megacycles and, as in the other input admittance curves, show the admittance components due to the presence of electrons only. It is seen that when the No. 3 grid is made sufficiently negative the input admittance is greatly increased. This behavior coincides, of course, with plate-current cutoff. It seems clear that the electrons which are turned back at the No. 3 grid and which again reach the signal-grid are the cause of the increased admittance. Calculations based on this explanation have been published by M. J. O. Strutt⁴³ and show reasonable quantitative agreement with experiment. As in the other cases above, the upper curve of Fig. 16 is

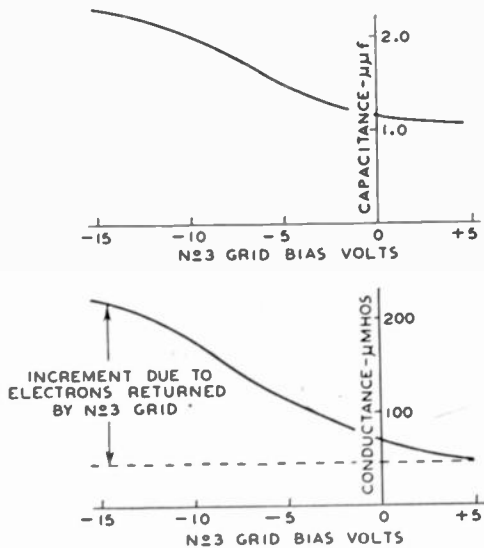

Fig. 16—Signal-grid (grid No. 1) admittance of typical mixer designed for outer-grid injection of oscillator. Data taken at 31.5 megacycles with no oscillator voltage applied. $E_{c1} = -3$ volts, E_{c2} and $E_4 = 100$ volts, $E_b = 250$ volts.

approximately independent of frequency while the lower one may be converted to any other frequency by multiplying the ordinates by the square of the frequency ratio.

When an oscillator voltage is applied, the No. 3 grid bias is periodically varied at oscillator frequency. The

⁴³ M. J. O. Strutt, and A. van der Ziel, "Dynamic measurements of electron motion in multigrad tubes," *Elek. Nach. Tech.*, vol. 15, pp. 277-283; September, 1938.

net input admittance is then the average value over the oscillator cycle. Such net values of the conductance component are shown in Fig. 17. The frequency for these curves is 31.5 megacycles. Values for other frequencies are obtained by multiplying the ordinates by the square of the frequency ratio. Curve a coincides with the fixed bias condition of curve a of Fig. 14 while curve b corresponds to the grid-leak-and-condenser bias as in b of Fig. 14. The conductance is approximately twice as high when the tube is used as a mixer as when it is used as an amplifier. This is a serious disadvantage, particularly at very high frequencies.

It is thus seen that two serious disadvantages of the outer-grid-injection mixer are both due to the electrons returned by the oscillator grid which pass again to the signal-grid region. It was found possible to prevent this in a practical tube structure by causing the returning electrons to traverse a different path from the

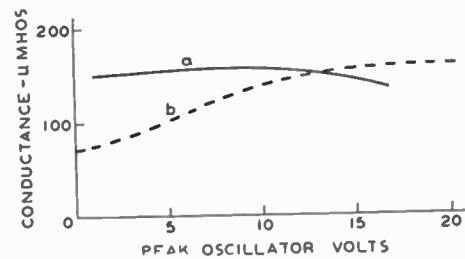

Fig. 17—Signal-grid (grid No. 1) conductance of typical mixer designed for outer-grid injection of oscillator. Frequency, 31.5 megacycles, signal-grid bias, $E_{c1} = -3$ volts. Curve a corresponds to fixed No. 3 grid bias, $E_{c3} = -8$ volts. Curve b corresponds to bias through a 50,000-ohm grid leak.

one which they traveled in the forward direction.^{44,45} The progressive steps towards an improvement of this kind are illustrated in Fig. 18 where cross-sectional views of the portion inside the oscillator grid of various developmental modulators are shown. The drawing (a) shows the original design, data on which have been given in Figs. 15, 16, and 17. Drawing (b) of Fig. 18 shows a tube in which two side electrodes operated at a high positive potential were added. In a tube of this kind many of the electrons returned by the No. 3 grid (oscillator grid) travel paths similar to the dotted one shown; they are then collected by the auxiliary electrodes and thus do not re-enter the signal grid space. Tubes constructed similarly to (b) showed a considerable improvement in the signal-grid admittance increment due to returned electrons. Construction (c) shows the next step in which the side electrodes are increased in size and operated at somewhat lower potential. Because of the undesirability of an additional electrode and lead in the tube, the construction shown at (d) was tried. In this case the auxiliary electrodes are bent over and connected electrically and mechanically to the screen grid. Curves showing the progressive reduction

⁴⁴ The same principles have now been applied to inner-grid-injection mixers and converters. See references 19 and 45.
⁴⁵ A. J. W. M. van Overbeck and J. L. H. Jonker, "A new converter valve," *Wireless Eng.*, vol. 15, pp. 423-431; August, 1938.

in the signal-grid conductance increment due to returned electrons are shown in Fig. 19. The curves are labeled to correspond with the drawings of Fig. 18. It should be noted that the use of the oscillator-grid support rods in the center of the electron streams as shown in Fig. 18 (d) was found to improve the per-

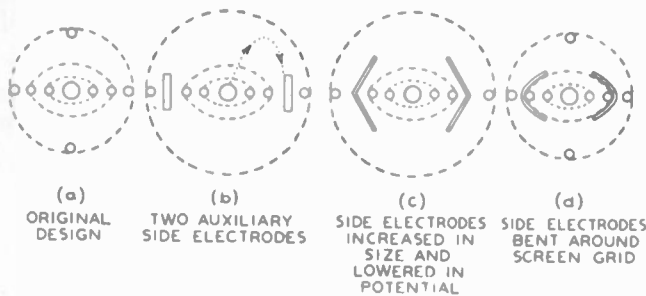

Fig. 18—Cross-sectional views of mixer designed for outer-grid injection of oscillator. The views show only the portions of the tube inside of and including the oscillator injection grid.

formance. No change in signal-grid conductance with oscillator-grid potential could be observed with this construction.⁴⁶ The conductance of the tube as a modulator, therefore, was reduced to less than half of that of construction (a). At the same time, a check of signal-grid current with a high-frequency oscillator applied to the No. 3 grid showed that this current was reduced to 1/20 of that of the original construction (a). The change in construction may be looked upon as dividing the constant A in the grid-current formula previously given, by a factor of more than 20.

Another method of reducing the effect of electrons returned by the oscillator grid is to reduce the effect of electron transit time in the tube. This may be done

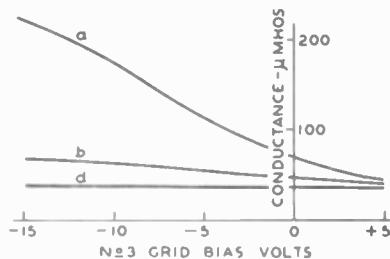

Fig. 19—Signal-grid (grid No. 1) conductance of the outer-grid-injection mixers shown in Fig. 18. Data taken at 31.5 megacycles with no oscillator voltage applied.

by reducing the spacings, particularly the screen-grid-to-oscillator-grid spacing. This method of improving modulator performance has two disadvantages compared with the one discussed in connection with Fig. 18. The reduction in spacing is accompanied by a more sloping (i.e., less steep) signal-grid transconductance versus oscillator-grid voltage curve. This change in

⁴⁶ It should be mentioned that it is also possible to construct tubes in which the signal-grid conductance decreases somewhat with increasingly negative No. 3 grid bias. This effect is caused by the inductance of the inner screen-grid lead which causes a negative conductance in the input circuit when the inner screen current is high, as at negative No. 3 grid bias values. This negative conductance cancels part of the positive conductance of the signal grid.

construction requires an increase in applied oscillator voltage to attain the same conversion transconductance. The second disadvantage is that such a method reduces the transit time and hence, the undesirable high-frequency effects only by an amount bearing some relation to the reduction in spacing. Since this reduction is limited in a given size of tube, the method whereby electron paths are changed is much more effective. The method of reducing spacing, on the other hand, is extremely simple to adopt. A combination of both methods may be most desirable from the point of view of best performance with least complexity in the tube structure.

In a mixer which must operate at high frequencies, it is not usually sufficient to eliminate the effects of returned electrons in order to assure adequate performance. For this reason the development of the principles shown in Fig. 18 was carried on simultaneously with a general program of improving the tube. To this end, tubes were made with somewhat reduced

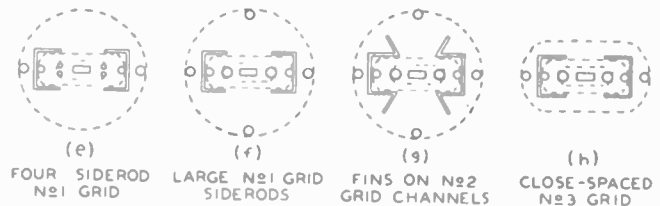

Fig. 20—Cross-sectional views of improved mixers designed for outer-grid injection of oscillator. The views show only the portions of the tube inside of and including the oscillator injection grid.

spacings and with a rectangular cathode and a beam-forming signal grid (i.e., one with comparatively large supports). A number of developmental constructions are shown in Fig. 20. Construction (g), it will be noted, has finlike projections on the screen-grid channel members.⁴⁷ In construction (h) a reduction of spacing between screen and oscillator grids was combined with the channel construction. The relative performance of these constructions, so far as signal-grid current is concerned is shown in Fig. 21. The frequency used was 20 megacycles. The curve for the original design (taken from Fig. 15) is included and is drawn as a . All four of the constructions of Fig. 20 were satisfactory as regards signal-grid conductance; in every case the change in conductance as the oscillator grid was made negative was a negligible factor. Construction (h) required approximately 20 per cent more oscillator voltage than (e), (f), or (g) because of the reduction in slope of the transconductance versus No. 3 grid voltage curve which accompanied the reduced spacing between the screen and the No. 3 grid.

Outer-grid-injection mixers have the same or slightly greater signal-grid capacitance changes with automatic volume control as are found in amplifier tubes.

⁴⁷ This construction was devised by Miss Ruth J. Erichsen who was associated with the writer during part of the development work herein described.

In this respect they are inferior to inner-grid-injection converters or mixers. The use of a small un-by-passed cathode resistance^{29,30} is a help, however.

In closing this section, the subject of fluctuation noise will be considered. Experimental evidence indicates that the major portion of the noise in mixers with oscillator voltage on an outer grid is due to current-distribution fluctuations.²⁴ The oscillator voltage changes the current distribution from plate to screen so that the mixer noise is given by the average of the distribution fluctuations over the oscillator cycle. In terms of the equivalent noise resistance the average has been found to be²³

$$R_{eq} = \frac{20 \left[\bar{I}_b - \frac{\overline{I_b^2}}{I_a} \right]}{g_c^2}$$

where \bar{I}_b is the average (i.e., the operating) plate current and $\overline{I_b^2}$ is the average of the square of the plate current over an oscillator cycle. I_a is the cathode current of the mixer section and is substantially constant over the oscillator cycle. This relation is not very useful in the form given. It is usually sufficiently accurate for most purposes to use an expression identical with that which applies to tubes with inner-grid oscillator injection, namely,

$$R_{eq} = \frac{20 \bar{I}_b}{g_c^2} F^2,$$

where F^2 is about 0.5 for tubes with suppressor grids and somewhat higher for others. By assuming a typical tube characteristic, the noise resistance may be expressed in terms of the cathode current I_a of the mixer section and the maximum signal-grid-to-plate transconductance g_{max} as

$$R_{eq} = 120 \frac{I_a}{(g_{max})^2}$$

for operation at oscillator fundamental. For operation at second or third harmonic of the oscillator, the noise resistance will be approximately doubled, or tripled, respectively.

V. CONCLUSION

It has been shown that the principle of frequency conversion in all types of tubes and with all methods of operation may be considered as the same (i.e., as a small-percentage amplitude modulation). The differences in other characteristics between various tubes and methods of operation are so marked, however, that each application must be considered as a separate problem. The type of tube and method of operation must be intelligently chosen to meet the most important needs of the application. In making such a choice, it is frequently of assistance to prepare a table comparing types of tubes and methods of operation on the basis of performance data. An attempt has been

made to draw such a comparison in a qualitative way for general cases and for a few of the important characteristics. Table II is the result. It must be understood, of course, that the appraisals are largely a matter of opinion based on experience and the present state of knowledge. Furthermore, in particular circuits

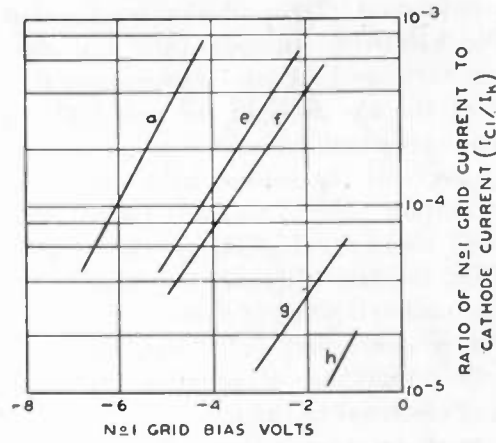

Fig. 21—Signal-grid (grid No. 1) current of the outer-grid injection mixers shown in Fig. 20. Curve a corresponds to the original design (a) of Fig. 18 and is shown for comparison. Data taken with a 20-megacycle oscillator voltage of 12 volts peak amplitude applied to the oscillator-grid. $E_{c3} = -10$ volts, $E_{c2 \text{ and } 4} = 100$ volts, $E_b = 250$ volts.

and with particular tubes, the relative standings may sometimes be quite different. A study of the fundamentals brought out in the previous sections of this paper should help in evaluating such exceptions.

TABLE II
APPROXIMATE COMPARATIVE APPRAISALS OF METHODS OF FREQUENCY CONVERSION

Desirable Characteristic	Oscillator and Signal Voltages on No. 1 Grid		Oscillator Voltage on No. 3 Grid, Signal on No. 1 Grid		Oscillator Voltage on No. 1 Grid, Signal on No. 3 Grid
	Triode	Pentode	Pentode	Hexode or Heptode	Hexode or Heptode
High conversion trans-conductance	Good	Good	Fair	Fair	Fair
High plate resistance	Poor	Good	Poor	Good	Good
High signal-to-noise ratio	Good	Good	Poor	Good	Poor
Low oscillator-signal circuit interaction and radiation	Poor	Poor	Good	Good	Fair
Low input conductance at high frequencies	Poor ¹	Fair	Poor	Poor ²	Good
Low signal-grid current at high frequencies	Good	Good	Poor	Poor ²	Fair
Low cost of complete converter system	Good	Fair	Fair	Poor	Good

¹ Due to feedback; may be increased to Fair by proper circuit design.
² May be increased to Fair by special constructions as described in text.

APPENDIX

Discussion of Negative Admittance of Current-Limited Grids

In Figs. 10, 11, and 12 it was seen that the electronic signal-grid (i.e., input) admittance components (i.e., the admittance due to the presence of electrons) of a mixer designed for No. 1 grid injection of the oscillator are negative over a considerable portion of the normal operating range. Figs. 10 and 11, however, were taken with static voltages applied and so indicate that

the phenomenon is not caused by an alternating oscillator voltage but is associated with the characteristics of the tube itself.

The input admittance of negative grids in vacuum tubes is the sum of three factors: (1) the "cold" admittance, or the admittance of the tube with the electron current cut off; (2) the admittance due to feedback from other electrodes through tube and external capacitance, etc.; and (3) the admittance due to the presence of the electrons in the tube. The first two factors have been well known for many years although certain aspects of the second have only recently received attention.^{29,30,48} The third factor, however, is not so well understood although the excellent work done during the last ten years has paved the way for a complete understanding of the subject.⁴⁹ The present discussion is concerned only with this last point, namely the admittance of negative grids due to the presence of electrons in the tube.

Early work on transit-time effects in diodes and negative-grid triodes had indicated that, at very high frequencies, the conductance became negative in certain discrete bands (i.e., at large transit angles). It was not, at first, appreciated that conditions were possible with negative-grid triodes in which the input conductance could become negative even at low frequencies (i.e., at small transit angles). Data taken on the input (No. 4 grid) conductance of pentagrid converters by W. R. Ferris of this laboratory during 1934 showed that these tubes had a negative input conductance which varied as the square of the frequency and which remained negative at low frequencies. The conductance appeared, therefore, to behave in the same way as the positive input conductance of ordinary negative-grid tubes, except for a reversal in sign. The data on the pentagrid were taken with an external oscillator voltage applied to the No. 1 grid. The work of Bakker and de Vries⁵⁰ disclosed the possibility of a negative input conductance at small transit angles in a triode operated under current-limited conditions. They gave an experimental confirmation for a triode operated at reduced filament temperature. Data taken by the writer during 1936 on a pentagrid converter showed that the negative conductance was present in this tube even when direct voltages, only, were applied and that it was accompanied by a reduction in capacitance. A fairly complete theory of the effect was developed in unpublished work by Bernard Salzberg, formerly of this laboratory, who extended the theory of Bakker and de Vries to the more general case of multigrid tubes with negative control grids in a current-limited region.

Other experimental work was done on the effect during 1936 by J. M. Miller and during the first half of 1937 by the writer. In the meantime, the papers of H. Rothe,⁵¹ I. Runge,^{52,53} and L. C. Peterson⁵⁴ showed that independent experimental and theoretical work had been done on the negative-admittance effect in other laboratories.

In a rough way, the negative admittance found under current-limited conditions may be explained as follows: The electron current in a tube is equal to the product of the charge density and the electron velocity. If this current is held constant, a rise in effective potential of the control electrode raises the velocity and so lowers the charge density. A reduction in charge density with increase in potential, however, results in a reduction in capacitance, provided no electrons are caught by the grid. Thus, the susceptive component of the part of the admittance due to the current through the grid, is negative. Because of the time lag due to the finite time of transit of the electrons, there is an additional component of admittance lagging the negative susceptance by 90 degrees, i.e., a negative conductance. The value of the negative conductance will be proportional to both the transit angle and to the value of the susceptance. Since both of these quantities are proportional to frequency, the negative conductance is proportional to the square of the frequency.

The general shape of the curves of Fig. 10 may be explained as follows: At a No. 1 grid bias of about -20 volts, the cathode current is cut off and the electronic admittance is zero. At slightly less negative values of No. 1 grid bias, the electron current is too small to build up an appreciable space charge ahead of the signal grid (No. 4 grid). The latter grid, although it exhibits some control of the plate-current does not control the major portion of the current reaching it and is thus in a substantially current-limited region. Its susceptance and conductance are, therefore, negative. Higher currents increase the negative admittance until, at some value of No. 1 grid bias, the electron current is increased to the point at which a virtual cathode is formed in front of some parts of the signal grid. At these parts, the current which reaches the grid is no longer independent of this grid potential and, as a result, a positive susceptance and conductance begin to counteract the negative admittance of other portions of the grid. The admittance curves reach a minimum and for still higher currents approach and attain a positive value. The current necessary to attain the minimum admittance point is less when the signal-grid

⁴⁸ M. J. O. Strutt and A. van der Ziel, "The causes for the increase of admittances of modern high-frequency amplifier tubes on short waves," *Proc. I.R.E.*, vol. 26, pp. 1011-1032; August, 1938.

⁴⁹ An excellent historical summary of this work is found in W. E. Benham, "A contribution to tube and amplifier theory," *Proc. I.R.E.*, vol. 26, pp. 1093-1170; September, 1938.

⁵⁰ C. H. Bakker and C. de Vries, "On vacuum tube electronics," *Physica*, vol. 2, pp. 683-697; July, 1935.

⁵¹ H. Rothe, "The operation of electron tubes at high frequencies," *Telefunken-Röhre*, no. 9, pp. 33-65; April, 1937; *Proc. I.R.E.*, vol. 28, pp. 325-332; July, 1940.

⁵² I. Runge, "Transit-time effects in electron tubes," *Zeit. für Tech. Phys.*, vol. 18, pp. 438-441; 1937.

⁵³ I. Runge, "Multigrid tubes at high frequencies," *Telefunken-Röhre*, no. 10, pp. 128-142; August, 1937.

⁵⁴ L. C. Peterson, "Impedance properties of electron streams," *Bell. Sys. Tech. Jour.*, vol. 18, pp. 465-481; July, 1939.

bias is made more negative so that the minima for increasingly negative No. 4 grid-bias values occur at increasingly negative No. 1 grid-bias values.

It may be noted that the signal-grid-to-plate transconductance is at a maximum in the region just to the

right of the admittance minima of Fig. 10 (compare Fig. 8). The admittance of such a tube used as an amplifier remains negative, therefore, at the maximum amplification point.

Factors Governing Performance of Electron Guns in Television Cathode-Ray Tubes*

R. R. LAW†, MEMBER, I.R.E.

Summary—On the basis of Langmuir's¹ limiting-current-density relationship, it is shown that the useful beam current in a conventional television cathode-ray tube has an upper limit defined by

$$I_s = 1.13 i_0 E_2 \frac{e}{kT} \frac{A^2}{N^2} \tan^2 \phi$$

where

- I_s = the beam current;
- i_0 = the cathode-current density;
- E_2 = the second-anode voltage relative to the cathode;
- e = the electron charge;
- k = Boltzmann's constant;
- T = the absolute temperature of the cathode;
- A = the aperture of the final focusing system;
- N = the number of scanning lines; and,
- ϕ = the equivalent deflection angle.

This result is derived for the case of an ideal electron gun with no defining apertures. In practice this upper limit of beam current is not attained because of aberrations and space-charge mutual repulsion effects.

INTRODUCTION

IN DISCUSSIONS of the performance of electron guns in television cathode-ray tubes, questions frequently arise as to what will be the effect of changing this or that parameter. For example, such questions are asked as: how does the brightness of the picture depend upon the resolution?; does wide-angle deflection offer other advantages than reduction in tube length?; or, what will be the effect of increasing the operating voltage? Although the answers to these and many other questions may be derived from the fundamental principles of electron optics,¹⁻⁴ there is need for a simple, easily interpreted relationship correlating the various factors governing electron-gun performance. It is the purpose of this paper to present such a relationship.

THEORETICAL ANALYSIS

To formulate the problem, consider a conventional⁵ electron gun of the form illustrated schematically in

* Decimal classification: R388XR583. Original manuscript received by the Institute, July 7, 1941.

† Research Laboratories, RCA Manufacturing Company, Inc., Harrison, N. J.

¹ D. B. Langmuir, "Theoretical limitations of cathode-ray tubes," *PROC. I.R.E.*, vol. 25, pp. 977-991; August, 1937.

² L. Jacob, "Electron distribution in electron-optically-focused electron beams," *Phil. Mag.*, vol. 28, pp. 81-98; July, 1939.

³ E. G. Ramberg and G. A. Morton, "Electron optics," *Jour. Appl. Phys.*, vol. 10, pp. 465-478; July, 1939.

⁴ J. R. Pierce, "Limiting current densities in electron beams," *Jour. Appl. Phys.*, vol. 10, pp. 715-724, October, 1939.

⁵ V. K. Zworykin, "Description of an experimental television system and kinescope," *PROC. I.R.E.*, vol. 21, pp. 1655-1673; December, 1933.

Fig. 1. This device operates in the following manner. First, the cathode-region or first-crossover-forming lens L_1 concentrates the electron beam into a small diameter at a first crossover. Second, the electrons emerging from this first crossover are refocused to a small spot on the fluorescent screen by the final focusing

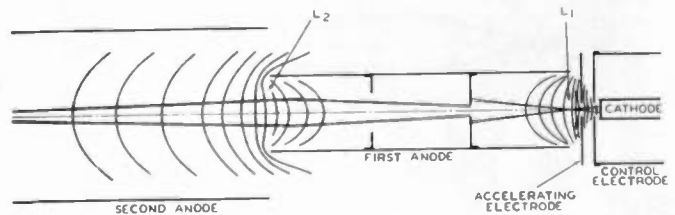

Fig. 1—Schematic representation of a conventional electron gun.

lens L_2 . The electron beam so formed is deflected by electrostatic or electromagnetic means to trace out the picture raster.

What factors determine the performance of this device? The analysis will be facilitated by the use of suitable nomenclature and symbols. Let

- H = picture height
- s = scanning-spot diameter
- N = number of scanning lines to be resolved
- ϕ = equivalent deflection angle
- A = aperture of final focusing lens
- q = half angle of beam spread
- a = first-crossover to final-focusing-lens distance
- b = final-focusing-lens to screen distance
- d = first-crossover diameter
- D = cathode diameter
- i_0 = cathode-current density
- i_r = first-crossover current density
- E_1 = first-anode potential
- E_2 = second-anode potential
- e = electronic charge
- k = Boltzmann's constant
- T = absolute temperature of the cathode

The definitions of symbols having to do with the geometric configuration of the structure are further clarified in the schematic drawing of Fig. 2.

Consider the performance of this device. By definition, if the picture height is H and the number of scanning lines to be resolved is N (the meaning of

resolution will be amplified later on when the question of light distribution across a beam trace is examined), the effective diameter of the scanning spot may be stated as

$$s = H/N \tag{1}$$

This scanning spot will be an image of the first crossover. If space charge is neglected, and the familiar² electron-optical magnification formula is applied, an ideal electron gun would produce such a scanning spot from a first crossover which had an effective diameter of

$$d = \frac{H}{N} \sqrt{\frac{E_2}{E_1}} \frac{a}{b} \tag{2}$$

The distances between gun and screen and between first crossover and final focusing lens may be expressed

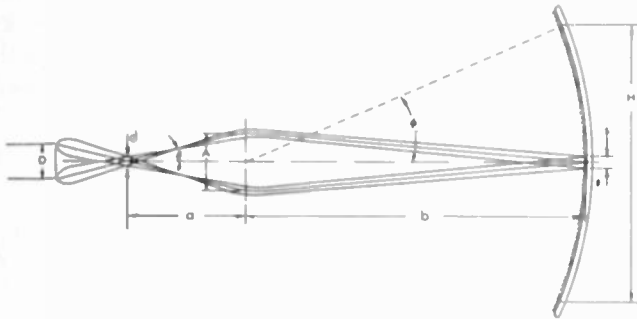

Fig. 2—Schematic representation of geometric factors determining performance of the electron gun in television cathode-ray tubes.

in terms of the equivalent deflection angle, the aperture of the final focusing lens, and the spread of the beam as it enters the final focusing lens. If ϕ is the equivalent deflection angle,

$$b = \frac{H}{2 \tan \phi} \tag{3}$$

If θ is the half angle of beam spread and A is the aperture of the final focusing lens,

$$a = \frac{A}{2 \tan \theta} \tag{4}$$

Equation (2) may then be written

$$d = \frac{A}{N} \sqrt{\frac{E_2}{E_1}} \frac{\tan \phi}{\tan \theta} \tag{5}$$

How much beam current may be concentrated into a crossover of given size? What will be the light distribution across a beam trace when the scanning spot is an image of this first crossover? In terms of the present nomenclature, Langmuir¹ has shown that the current density in a crossover in an ideal electron optical system is

$$i_r = i_0 \sin^2 \theta \left\{ 1 + E \frac{e}{kT} \left[1 + \frac{\frac{d^2}{D^2} \sin^2 \theta}{1 - \frac{d^2}{D^2} \sin^2 \theta} \right] \right\} e^{-E \frac{e}{kT} \frac{\frac{d^2}{D^2} \sin^2 \theta}{1 - \frac{d^2}{D^2} \sin^2 \theta}} \tag{6}$$

In general $1 \ll E(e/kT)$, and $(d^2/D^2) \sin^2 \theta \ll 1$. If the value of d given by (5) is substituted in this expression and it is remembered that $\sin \theta \approx \tan \theta$ for the angles commonly encountered, integration between the limits 0 and $d/2$ gives

$$I = \frac{\pi D^2}{4} i_0 \left(1 - e^{-E \frac{e}{kT} \frac{A^2}{N^2 D^2} \tan^2 \phi} \right) \tag{7}$$

where I is the current within a spot of effective size H/N . But $\pi D^2 i_0 / 4 = I_s$, where I_s is the total beam current if the system contains no limiting apertures. Equation (7) may, therefore, be written

$$\frac{I}{I_s} = 1 - e^{-E \frac{e}{kT} \frac{A^2}{N^2 D^2} \tan^2 \phi} \tag{8}$$

This result warrants further examination. I/I_s is the ratio of the beam current within a particular zone to the total beam current. This zone is to be of such width as to give the resolution N . But how shall resolution be defined? In the absence of defining apertures, the spot has no definite boundary, and irrespective of the spacing, the scanning lines must overlap to a certain extent. For a given resolution, how much may they overlap? To answer these questions, it is necessary to know the brightness distribution across a beam trace.

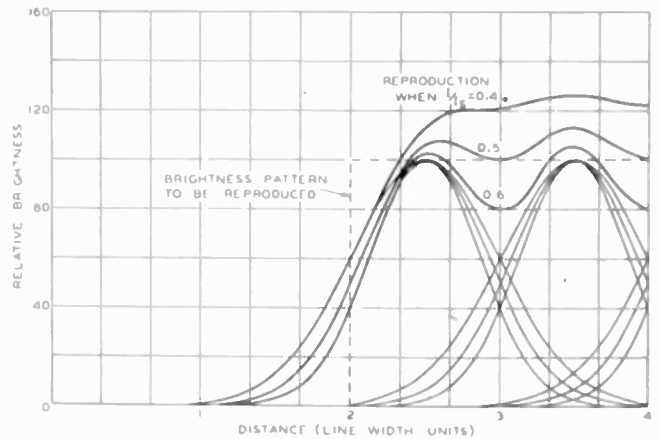

Fig. 3—Fidelity of reproduction as a function of degree of overlap.

The author⁶ has shown that (6) may be expressed in the form

$$i_r = C_1 e^{-B \frac{d^2}{4}} \tag{9}$$

To determine the brightness distribution across an individual beam trace, let x be the co-ordinate expressing distance from the center of the spot perpendicular to the direction of scanning, and let y be the co-ordinate expressing distance from the center of the spot in the direction of scanning. The excitation occasioned by a single beam trace will be

$$\text{excitation} = C_2 e^{-Bx^2} \int_{-\infty}^{+\infty} e^{-By^2} dy = C_3 e^{-Bx^2} \tag{10}$$

⁶ R. R. Law, "High current electron gun for projection kinescopes," Proc. I.R.E., vol. 25, pp. 954-976; August, 1937.

If the light output of the phosphor is directly proportional to the excitation, this equation represents the brightness distribution also. In terms of a given resolution, how much may these traces overlap? Can the degree of overlap be expressed in terms of the ratio I/I_s ?

Fig. 3 shows the resultant brightness distribution in a reproduction of a portion of a scene containing relatively large adjacent white and dark areas. The brightness distribution is shown for three values of the ratio I/I_s . When $I/I_s=0.5$, the reproduction is substantially equivalent to that which would be obtained from a cosine-squared distribution having the same maximum value and a total width equal to twice the spacing between adjacent lines. Under these conditions the cosine-squared distribution would give a flat field.^{7,8} Although the present exponential function does not give a flat field, the practical limiting resolution may be said to occur when the spot size is such that the brightness of the beam trace drops to one half its maximum value in one half the distance between the centers of adjacent scanning lines. As may be seen from Fig. 3, this condition is satisfied when $I/I_s=0.5$. But if the degree of overlap at which N lines may just be resolved is defined by the condition $I/I_s=0.5$, (8) gives

$$I_s = 1.13i_0E_2 \frac{e}{kT} \frac{A^2}{N^2} \tan^2 \phi. \quad (11)$$

I_s , therefore, represents an upper limit to the useful beam current that may be obtained with an ideal electron gun having no defining apertures. With suitable defining apertures the useful beam current may be increased. This comes about because the peak current density may be maintained over the entire spot. For

⁷ P. Mertz and F. Gray, "A theory of scanning," *Bell Sys. Tech. Jour.*, vol. 13, pp. 464-515; July, 1934.

⁸ H. A. Wheeler and A. V. Loughren, "The fine structure of television images," *Proc. I.R.E.*, vol. 26, pp. 540-575; May, 1938.

example, with a circular spot of uniform intensity overlapping to such an extent as to give a flat field as before, the beam current may be increased by the factor $\pi/1.13$. Inasmuch as aberrations and space-charge mutual repulsion effects operate to increase spot size, these values will not be realized in practice. For any given structure, the ratio of the measured beam current to the computed limiting value affords a figure of merit describing the performance of the gun. This ratio is ordinarily about one tenth,² but by minimizing the effects of space charge in the first-crossover-forming region, Pierce⁹ has obtained current densities of over one half the limiting value.

DISCUSSION

By virtue of this simple relationship, describing the performance of an ideal electron gun in a television cathode-ray tube, it is now possible to answer the original questions as to what will be the effect of changing this or that parameter. Thus, if a linear relationship between picture brightness and the product of beam current is assumed, the picture brightness will vary inversely as the square of the number of lines, and directly with the square of the voltage. Wide-angle deflection does offer other advantages than reduction in tube length provided deflection introduces no defocusing; this analysis indicates that the picture brightness should vary directly with the square of the tangent of the equivalent deflection angle. In addition to correlating the various factors governing electron-gun performance, this relationship may prove useful in evaluating the performance of developmental models of electron guns by affording a direct means of computing the ideal performance of the particular structure.

⁹ J. R. Pierce, "Rectilinear electron flow in beams," *Jour. Appl. Phys.*, vol. 11, pp. 548-554; August, 1940.

Correction

Mr. E. Fubini of the Columbia Broadcasting System has just called the authors' attention to an error in their paper, "The Effect of the Earth's Curvature on Ground-Wave Propagation."* The definition of the distance parameter for horizontally polarized waves (equation 4) should read

$$\zeta_m = \frac{2\pi d}{\lambda} \epsilon_m,$$

and the caption of Fig. 1 should be changed correspondingly to

$$|\zeta_m| = \frac{2\pi d}{\lambda} \sqrt{(\epsilon - 1)^2 + (60\sigma\lambda)^2}.$$

* *Proc. I.R.E.*, vol. 29, pp. 16-24; January, 1941.

Institute News and Radio Notes

Board of Directors

The annual meeting of the Board of Directors was held on January 7, 1942, and those present were: A. F. Van Dyck, president; Austin Bailey, W. L. Everitt, H. T. Friis, Alfred N. Goldsmith, editor; O. B. Hanson, L. C. F. Horle, F. E. Terman, B. J. Thompson, H. M. Turner, L. P. Wheeler, and H. P. Westman, secretary.

Haraden Pratt was appointed treasurer, Alfred N. Goldsmith was named editor, and H. P. Westman was designated to serve as secretary during 1942.

Five directors to serve during 1942 were appointed and are C. C. Chambers, I. S. Coggeshall, C. M. Jansky, Jr., J. K. Johnson, and F. B. Llewellyn.

The personnel of the numerous committees which serve the Institute during the year was named.

A budget for 1942 was adopted.

In the case of former members who desire to rejoin the Institute during 1942, the payment of a new entrance fee was waived.

Section 8 of the Institute Bylaws was revised to read as follows:

"A notice of his election shall be sent to each newly admitted member together with a bill for his entrance fee and dues, if not previously paid, dues being computed for the remainder of the calendar year beginning with the quarter next succeeding the date of his election. His entrance fee or dues remaining unpaid, additional bills shall be sent the newly elected member sixty days and one hundred and twenty days after notification of his election, in the last instance accompanied by a warning that his election will be considered void if his admission fee and dues are not received within six months of his notification of election.

"The names of all individuals elected to membership who fail to pay admission fees or dues within the six months of notification of election shall be turned over to the Membership Committee."

At a previous meeting, the decision to award the Institute Medal of Honor to

Dr. Taylor was reached. A citation for this presentation was approved and is as follows:

"To Albert Hoyt Taylor for contributions to radio communication as an engineer and organizer, including pioneering work in the practical application of piezoelectric control to radio transmitters, early

service to the government of the United States as an engineering executive of outstanding ability in directing the Radio Division of the Naval Research Laboratory."

Citations for the nine Fellow awards which were decided on at a previous meeting were also approved and are given below.

Wilmer L. Barrow for pioneering investigation of ultra-high-frequency wave propagation and many of its practical applications.

George H. Brown for studies and publications in the field of radio antennas.

Geoffrey Builder for contributions as an engineer, executive, and organizer and for his work in behalf of the radio engineering profession, notably in Australia.

Adolph B. Chamberlain for engineering leadership in broadcast transmission and operation.

Ellsworth D. Cook for contributions to a wide range of important radio engineering projects.

Warren P. Mason for investigations of piezoelectric crystals and their application to quartz-crystal filters.

Hugh S. Knowles for engineering leadership in the field of acoustics and its radio applications.

Harold O. Peterson for engineering leadership in radio

communications and contributions to the ultra-high-frequency field.

George C. Southworth for pioneering investigations in ultra-high-frequency communication and transmission.

Broadcast Engineering Conference

The fifth annual Broadcast Engineering Conference will be held on February 23 to 27, 1942, at Ohio State University, Columbus, Ohio. The conference this year will be devoted almost entirely to problems with which the broadcast engineer will be confronted as a result of the war.

The ordinary problems have been augmented by many new ones introduced by the emergency. Procedures and plans must be made for any eventuality and it

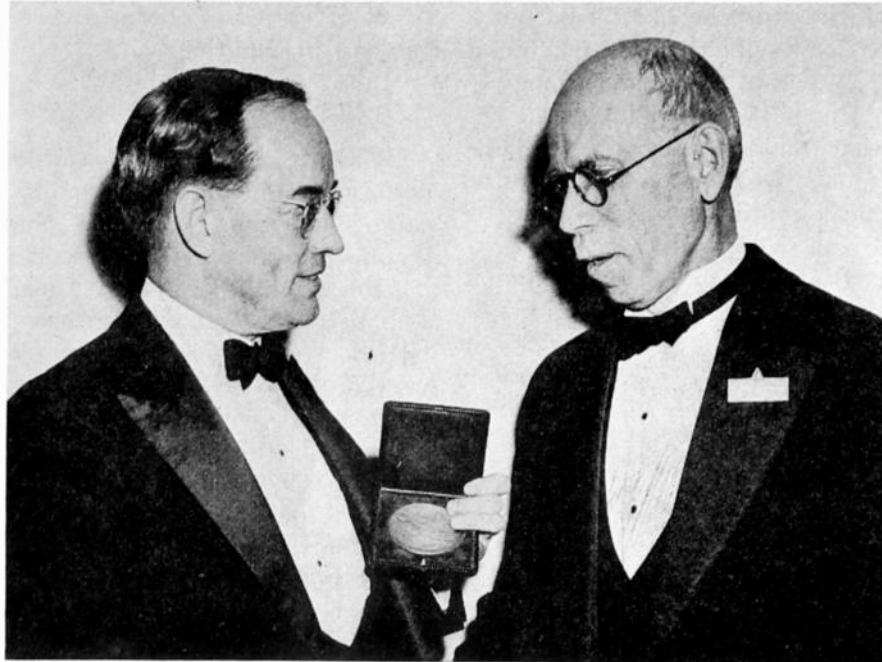

PRESENTATION OF MEDAL OF HONOR TO DR. TAYLOR
BY PRESIDENT VAN DYCK

At our Thirtieth Anniversary Banquet the Institute's Medal of Honor was presented by President Van Dyck to Albert Hoyt Taylor for contributions to radio communication as an engineer and organizer, including pioneering work in the practical application of piezoelectric control to radio transmitters, early recognition and investigation of skip distances and other high-frequency wave-propagation problems, and many years of service to the government of the United States as an engineering executive of outstanding ability in directing the Radio Division of the Naval Research Laboratory. Doctor Taylor is the only person to have received all of the three highest honors that are conferred by the Institute; the Presidency, the Medal of Honor, and the Morris Liebmann Memorial Prize.

recognition and investigation of skip distances and other high-frequency wave-propagation problems, and many years of

**FORTHCOMING
MEETINGS**
Broadcast Engineering Conference
Columbus, Ohio
February 23 to 27, 1942
Summer Convention
Cleveland, Ohio
June 29, 30, and July 1, 1942

is particularly important for broadcast engineers to meet in discussions led by those who have been making an exacting study of the situation.

E. K. Jett, chief engineer of the Federal Communications Commission and chairman of the important Co-ordinating Committee of the Defense Communications Board, will open the session with a discussion of the many problems confronting communication engineers under the present situation.

The panel on "Broadcast-Station Operation during Wartime," which has been organized by L. C. Smeby of the National Association of Broadcasters, will discuss subjects such as priorities and procurement, fire fighting and property protection, telephone lines, battery-operated equipment for emergency use, radio broadcast silencing systems, temporary and auxiliary antennas, and emergency equipment. Members of the panel will be F. A. Cowan, American Telephone and Telegraph Company; J. D'Agostino and R. F. Guy, National Broadcasting Company, R. V. Howard, KSFO; W. B. Lodge, Columbia Broadcasting System; and A. D. Ring, consulting engineer. With the exception of Mr. Howard, all have participated in the work of various committees of the Defense Communications Board and have given extensive consideration to the subject matter. Mr. Howard has had experience with the precautions taken on the Pacific coast since the declaration of war. Mr. Cowan has been instrumental in installing Interceptor Command information centers and special defense communication networks. Mr. Ring is secretary of the Domestic Broadcasting Committee of the Defense Communications Board.

One of the outstanding applications of broadcast facilities in time of emergency, which has taken place in this country, was the work done at WHAS during the Ohio

River flood which engulfed a large portion of Louisville. The experience which this emergency taught contains many lessons applicable to the problems of national defense and will be discussed by O. W. Towner, chief engineer of that station.

G. C. Gross, assistant chief engineer of the Federal Communications Commission, recently made a trip to England to study the operation of broadcast stations there. The report which he gives will be both interesting and instructive.

Karl Troeglen of WIBW will lead a discussion on engine-driven emergency power plants. The installation of such emergency equipment has just been made in both the studio and transmitter at that station.

In times of emergency the use of radio links for various purposes becomes important. D. E. Noble, who has done important work in the development of frequency-modulation police systems, will discuss the operation of mobile frequency-modulation equipment and J. H. De Witt, Jr., of WSM will cover the subject of studio-transmitter links and high-frequency antennas.

A. F. Van Dyck, president of the Institute of Radio Engineers, will discuss the application of the alert calling system in wartime.

Increasing difficulty in obtaining repair materials and changing of personnel because of induction into the armed forces, aggravate the problem of proper transmitter maintenance under wartime conditions. Charles Singer of WOR prominent exponent of organized transmitter maintenance, will lead a round-table discussion on this subject.

The Recording and Reproducing Standards Committee co-ordinated by the National Association of Broadcasters, was formed last June. Although its work has not been entirely finished, nevertheless enough important items have been standardized so that engineers can begin to

make their equipment conform to the standards. H. A. Chinn, in charge of audio facilities for the Columbia Broadcasting System and a member of the committee, will discuss the standards and point out the modifications that must be made in existing equipment.

The problem of educating new engineers and technicians for replacement and the assistance which broadcast-station engineers can give in the training of technicians for the military services will be covered in the round-table discussion led by W. L. Everitt. The other members of the group will be C. M. Jansky, Jr., consulting engineer; Carl E. Smith, WHK; and G. F. Leydorf, WLW.

Phillips Thomas, of the Westinghouse Electric and Manufacturing Company, will give an interesting demonstration-lecture on the evening of February 24. Dr. Thomas is well known for his presentation in an entertaining manner of scientific material and the products of research.

The conference again will serve as the engineering convention of the National Association of Broadcasters. The complete program has been arranged with the advice and assistance of L. C. Smeby, its director of engineering. This year the Institute of Radio Engineers also will act as a co-operating organization.

The scope of the subjects offered by the conference is such that the engineers in many activities, such as airway and police communication, general receiver and laboratory development, and the military services, will find it of interest. All are welcome. Correspondence regarding the conference should be addressed to the Director, Dr. W. L. Everitt, Ohio State University, Columbus, Ohio.

A list of the subjects to be considered in the order in which they are introduced during the conference follows. The "Transmitter Maintenance Round Table" will be



PRESIDENTIAL GAVEL CHANGES HANDS

At the opening session of the 1942 Winter Convention, the address of the retiring president was presented by Dr. Terman. Symbolic of the completion of his year of service as president, Dr. Terman handed over the presidential gavel to his successor, Arthur F. Van Dyck. The above photograph shows this ceremony with President Van Dyck holding the gavel.



CONVENTION GUESTS FROM BUENOS AIRES

Four members of our Buenos Aires Section attended the Winter Convention. In the above photograph are (left to right) LeRoy Simpson, Archie M. Stevens, Adolpho T. Cosentino, and Luis Guaraña. Mr. Cosentino is the retiring vice-president of the Institute, a past chairman of the Buenos Aires section, and chief of radio communications of Argentina. Mr. Stevens, also a past chairman of the Buenos Aires section, is manager of the Compania Internacional de Radio Argentina. Mr. Simpson, secretary of the section, and Mr. Guaraña are on the engineering staff of the RCA of Argentine.

continued on February 25 and the round table on "Broadcast-Station Operation during Wartime" will carry over to February 26 and 27.

Monday, February 23

- "Communications in Nation Defense," E. K. Jett.
 "Emergency Operation of Broadcast Transmitters," O. W. Towner.

Tuesday, February 24

- "Engine-Driven Emergency Power Plants," Karl Troeglen.
 "Mobile Frequency Modulation," D. E. Noble.
 "Transmitter Maintenance Round Table," Charles Singer, chairman.

Wednesday, February 25

- "Broadcast-Station Operation during Wartime," L. C. Smeby, chairman of the round table, and F. A. Cowan, J. D'Agostino, R. F. Guy, H. V. Howard, and A. D. Ring.
 "Round Table on Training of Engineers and Technicians," W. L. Everitt, chairman and C. M. Jansky, Jr., G. F. Leydorf, and Carl E. Smith.

Thursday, February 26

- "Wartime Broadcast Experiences in England," G. C. Gross.
 "Recording Standards," H. A. Chinn.

Friday, February 27

- "Studio-Transmitter Links and High-Frequency Antennas," J. H. DeWitt, Jr.
 "Alert Calling System," A. F. Van Dyck.

On Tuesday evening, February 24, a popular scientific lecture will be given by Dr. Thomas. The banquet will be held on Thursday, February 26.

Winter Convention

The winter convention was held in New York City on January 12, 13, and 14, 1942. Headquarters was at the Hotel Commodore. There were 1753 men and 37 women registered during the three days. This attendance is within a dozen or so of the previous peak registration which occurred in 1938. A list of the papers presented at the convention follows.

Monday, January 12

- "The Mobilization of Science with Special Reference to Communication," by F. B. Jewett, President, National Academy of Sciences; Member, National Defense Research Committee of the Office of Scientific Research and Development.
 "Half a Year in Commercial Television," by Noran E. Kersta, National Broadcasting Company, Inc., New York, N.Y.
 "Automatic Radio Relay Systems for Frequencies Above 500 Megacycles," by J. Ernest Smith, R. C. A. Communications, Inc., New York, N. Y.
 "Loop Antennas for Aircraft," by George F. Levy, United Air Lines Transport Corporation, Chicago, Ill.
 "Simultaneous Aural and Panoramic Reception," by Marcel Wallace, Panoramic

- Radio Corporation, New York, N. Y. (Demonstration.)
 "Color Television," by P. C. Goldmark, J. N. Dyer, E. R. Piore and J. M. Hollywood, Columbia Broadcasting System, New York, N. Y. (Demonstration.)

Tuesday, January 13

- "How to Prepare Technical Papers for Publication," by B. Dudley, Managing Editor, *Electronics*, McGraw-Hill Publishing Company, New York, N. Y.
 "The Use of Vacuum Tubes as Variable Impedance Elements," by H. J. Reich, University of Illinois, Urbana, Ill.
 "A Wide-Range, Linear, Unambiguous, Electronic Phasemeter," by J. E. Shepherd, formerly Harvard University, Cambridge, Mass.
 "Variable-Frequency Bridge-Stabilized Oscillators," by W. G. Shepherd and R. O. Wise, Bell Telephone Laboratories, Inc., New York, N. Y.
 "Space-Charge Relations in the Magnetron with Plane Electrodes," by E. U. Condon, Westinghouse Electric and Mfg. Co., East Pittsburgh, Pa.
 "Bioelectric Research Apparatus," by Harold Goldberg, formerly University of Wisconsin, Madison, Wis.; now, Stromberg-Carlson Telephone Manufacturing Company, Rochester, N. Y.
 "The Dynetric Balancing Machine," by H. P. Vore, Westinghouse Electric and Manufacturing Company, Baltimore, Md.
 "Ionospheric Investigations at Huancayo Magnetic Observatory (Peru) with Applications to Wave-Transmission Conditions," by H. W. Wells, Carnegie Institution of Washington, Washington, D. C.

Wednesday, January 14

- "Modern Techniques in Broadcasting," by J. V. L. Hogan, Interstate Broadcasting Company, Inc., New York, N. Y.
 "Modern Developments in Electronics," by B. J. Thompson, RCA Manufacturing Company, Harrison, N. J.
 "Demonstration of Facsimile Equipment," by J. H. Hackenberg, Western Union Telegraph Company, New York, N. Y.
 "The Fort Monmouth Laboratory of the Signal Corps," by Lieutenant Colonel Rex V. D. Corput, Jr., United States Army, Fort Monmouth, N. J.
 "Note on the Sources of Spurious Radiations in the Field of Two Strong Signals," by A. J. Ebel, WILL, University of Illinois, Urbana, Ill.
 "RCA 10-Kilowatt Frequency-Modulated Transmitter," by E. S. Winlund and C. S. Perry, RCA Manufacturing Company, Inc., Camden, N. J.
 "A Stabilized Frequency-Modulation System," by R. J. Pieracci, Collins Radio Company, Cedar Rapids, Iowa.
 "The Absolute Sensitivity of Radio Receivers," by D. O. North, RCA Manufacturing Company, Inc., Harrison, N. J.
 "An Analysis of The Signal-to-Noise Ratio of Ultra-High-Frequency Receivers," by E. W. Herold, RCA Manufacturing Company, Inc., Harrison, N. J.
 "A New Direct Crystal-Controlled Oscillator for Ultra-Short-Wave Frequencies," by W. P. Mason and I. E.

Fair, Bell Telephone Laboratories, Inc., New York, N. Y.

"An Ultra-High-Frequency Two-Course Radio Range with Sector Identification," by Andrew Alford and A. G. Kandoian, International Telephone and Radio Laboratories, New York, N. Y.

It should be noted that preprint copies of these papers are not available from the Institute. It is hoped that most of them will appear in the PROCEEDINGS during the next several months but there is no assurance that this will occur.

As a result of conditions beyond Institute control, both of the inspection trips which had been arranged for the men were cancelled.

The banquet, which was attended by 250 members and guests, commemorated the thirtieth anniversary of the founding of the Institute in 1912. A roll call of past presidents was well answered.

The Institute Medal of Honor was presented to Dr. A. Hoyt Taylor by President Van Dyck.

Diplomas were presented to the following newly elected Fellows: Wilmer L. Barrow, George H. Brown, Geoffrey Builder, Adolph B. Chamberlain, Ellsworth D. Cook, Hugh S. Knowles, Warren P. Mason, Harold O. Peterson, and George C. Southworth.

Retiring Vice-President Adolfo T. Cosentino devoted his remarks chiefly to the problems of establishing interconnected broadcast networks throughout the Americas.

An address on "Radio's Expanding Role in International Affairs" was given by Donald Francisco, Director of Communications of the Office of the Co-ordinator of Inter-American Affairs.

President Van Dyck read the following message which was forwarded by Pedro Noizeux, chairman of the Buenos Aires section:

"The Buenos Aires Section of the Institute of Radio Engineers, appreciating the vital task that the Institute, and in particular the members of the home section are being called upon to perform in the present emergency, wishes to express its sympathy with the ideals and sentiments of all fellow members assembled at this convention and its good will for the continuance of a widespread collaboration towards our common ideals."

Committee and Section Reports

In the answers to the recent questionnaire sent to the membership of the Institute, the members indicated their preference for *more space devoted to papers*. The membership approved reduction in space devoted to other matters, including information on section and committee meetings.

Accordingly, the new policy desired by the membership has been put into immediate force.

Section Meetings

BALTIMORE

- "Development of Radio Range Beacons," by W. G. McConnell, Bendix Radio Corporation, December 19, 1941.
- "Fluorescent and Phosphorescent Materials," by B. S. Ellefson, Hygrade Sylvania Corporation, January 16, 1942.

BUFFALO-NIAGARA

- "Frequency Modulation," by Lee McCanne, Stromberg-Carlson Telephone & Manufacturing Company, January 21, 1942.

CHICAGO

- "A Practical Analysis of Noise Suppression in Frequency-Modulation Systems," by H. J. Reich, University of Illinois, November 21, 1941.
- "Zenith Radio's New 50-Kilowatt Frequency-Modulation Transmitter," by J. E. Brown, Zenith Radio Corporation, November 21, 1941.
- "Impedance Measurements From 1 to 100 Megacycles," by R. F. Field, General Radio Company, December 5, 1941.
- "Radio in Illinois State Police," by A. Dodman, Illinois State Police, December 12, 1941.
- "Fundamental Considerations in Wave-Filter Design," by W. L. Everitt, Ohio State University, December 12, 1941.

CINCINNATI

- "Application of Permeability-Tuned Circuits," by J. R. Gelzer, Crosley Corporation, December 16, 1941.

CLEVELAND

- "The Recording of Transients," by S. J. Begun, Brush Development Company, December 19, 1941.

CONNECTICUT VALLEY

- "The Simplified Design of Resistance-Coupled Amplifiers," by F. E. Terman, Stanford University, November 6, 1941.
- "The Design of Inverse Feedback Systems With Particular Reference to the Problem of Avoiding Oscillations with Large Amounts of Feedback," by F. E. Terman, Stanford University, November 6, 1941.
- "Recent Advances in Recording Systems," by S. K. Wolf, Acoustic Consultants, Inc., December 18, 1941.

DALLAS-FORT WORTH

- "Modern Conception of Acoustical Design," by C. P. Boner, University of Texas, December 30, 1941.

DETROIT

- "Frequency Modulation as Applied to Mobile Communication Systems," by D. E. Noble, Galvin Manufacturing Company, November 21, 1941.
- "Radio Aids in Aerial Navigation," by F. F. Preston, Avigation Instrument Corporation, December 19, 1941.

EMPORIUM

- "Some Studies of Chemical Reactions in Vacuum," by L. A. Wooten, Bell Telephone Laboratories, December 4, 1941.

- "Industrial Standardization Activities in Wartime," by P. G. Agnew, American Standards Association, December 18, 1941.

LOS ANGELES

- "Frequency-Modulation Station Coverage with Particular Reference to K45LA," by F. M. Kennedy, Don Lee Broadcasting System, November 18, 1941.
- "Experience With the Tuning of a Western Electric Frequency-Modulation Transmitter; Transmission Line and Matching Sections Feeding a Four-Bay Turnstile Antenna," by R. C. Moody, Don Lee Broadcasting System, November 18, 1941.

- "Design and Construction of Dividing Networks for Loudspeaker Systems," by C. Campbell, Altec-Lansing Corporation, December 16, 1941.

- "Design of Audio-Frequency Transformers," by E. O. Woodward, Hollywood Transformer Company, December 16, 1941.

MONTREAL

- "CBS International Broadcast Facilities," by A. B. Chamberlain, Columbia Broadcasting System, November 28, 1941.
- "Improved Insulators for Broadcast, Radio Range, and High-Power Low-Frequency Stations," by A. O. Austin, December 3, 1941.
- "Ultra-High-Frequency Antennas," by G. H. Brown, RCA Manufacturing Company (Camden), January 21, 1942.

NEW ORLEANS

- "Fundamentals of Acoustics," by G. C. Kerr, Taylor-Seidenbach, Inc., November 14, 1941.

PHILADELPHIA

- "Human Engineering," by F. J. Chesterman, Bell Telephone Company of Pennsylvania, January 12, 1942.

PITTSBURGH

- "Wire Transmission of Radio Programs" by R. T. Griffith, Bell Telephone Company, December 8, 1941.

PORTLAND

- "The KGW Directional Antenna," by H. C. Singleton, KGW-KEX, December 10, 1941.

SAN FRANCISCO

- "KWID—A New 100-Kilowatt International Broadcasting Station," by F. R. Brace and A. Towne, KSFO, December 10, 1941.

TORONTO

- "The Manufacture of Phonograph Records," by B. Graham, Sparton of Canada, Ltd., January 12, 1942.

WASHINGTON

- "Selenium-Rectifier Applications in Vital Industries," by J. E. Yarmack, International Telephone and Radio Manufacturing Corporation, January 12, 1942.

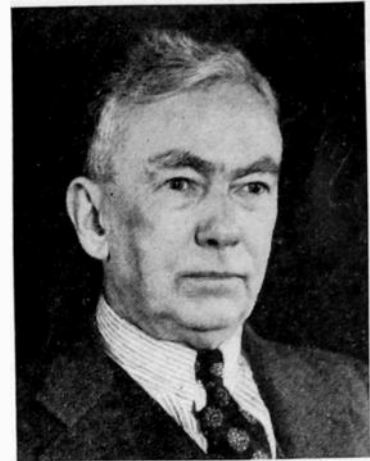

FRANK CONRAD 1874-1941

Frank Conrad, assistant chief engineer of the Westinghouse Electric and Manufacturing Company, died on December 10, 1941, in Miami, Florida.

Born in Pittsburgh, Pennsylvania, in 1874, his formal education terminated with the completion of the seventh grade in grammar school.

He entered the employ of the Westinghouse Electric and Manufacturing Company in Pittsburgh in 1890 as an assistant in the shops manufacturing ampere-hour meters. Seven years after leaving school, he developed the round-type electric meter which is now in general use.

His attention was directed to radio as a means of obtaining accurate time signals. Full amateur activities then ensued and 8XK was built.

His interest in radiotelephony resulted in the establishment of KDKA to provide a broadcast service to the general public. Its initial broadcast on November 2, 1920, featured returns on the presidential election.

During fifty-one years of activity with the Westinghouse Company, there were granted to Dr. Conrad over two hundred patents. Many of his inventions were unrelated to radio and include lightning arresters, circuit breakers, electric clocks, arc lamps, automobile electric systems, and electric-trolley apparatus. In 1921 he was made assistant chief engineer of the company.

In 1928, an honorary doctorate in science was conferred on him by the University of Pittsburgh. The American Institute of Electrical Engineers presented to him its Edison Medal in 1931 and its Lamme Medal in 1936. The John Scott Medal of the City of Philadelphia was given to him in 1933 and the Gold Medal of the American Institute of the City of New York in 1940.

Dr. Conrad joined the Institute of Radio Engineers as a Member in 1917, transferring to Fellow ten years later. He received the Morris Liebmann Memorial Prize in 1925 for his early work in connection with high-frequency radio transmission. He served as vice-president during 1927.

Membership

The following indicated admissions and transfers of memberships have been approved by the Admissions Committee. Objections to any of these should reach the Institute office by not later than February 28, 1942.

Transfer to Member

Aiya, S. V. C., Poona No. 4, India
 Canon, H. B., 1523 Woodbine Ct., Deerfield, Ill.
 Davis, G. C., 501-507 Munsey Bldg., Washington, D. C.
 Gebhard, L. A., Naval Research Laboratory, Anacostia Station, Washington, D. C.
 Herrick, R. H., 1033 W. Van Buren St., Chicago, Ill.
 Hoffman, R. B., 36 S. Munn Avenue, East Orange, N. J.
 Hood, J. T., 4816 N. Ill. Street, Indianapolis, Ind.
 Labin, E., 25 Fifth Avenue, New York, N. Y.
 Sykes, R. A., 180 Varick St., N. Y. C.
 Wesser, C. H., 3441 21st St., Wyandotte, Michigan

Admission to Member

Aboussleman, W., 122 Woodlawn Ave., Collingswood, N. J.
 Anderson, H. V., Radio Station WJBO, 444 Florida St., Baton Rouge, La.
 Boswau, H. P., 2447 E. Erie Ave., Lorain, Ohio
 Chesnut, R. W., 463 West St., N. Y. C.
 Condon, E. U., Westinghouse Research Labs., East Pittsburgh, Pa.
 Davis, R. J., Towson and Morris Ave., Lutherville, Md.
 Ferguson, J. G., 463 West St., N. Y. C.
 Kendall, Burton W., 463 West St., N. Y. C.
 Licuanan, F. H., Jr., 28 Alfonso XIII, San Juan, Rizal, Philippines
 Mathes, R. C., 463 West St., N. Y. C.
 Sherman, J. M., 5033 Portland Ave., S. Minneapolis, Minn.
 Sweeney, C. P., 16 Jackson Ave., Chatham, N. J.
 Wagner, W. J., Box 1040, Anchorage, Alaska
 Whitney, M. E., 308 Corinthian Ave., Willow Grove, Pa.
 Young, M. G., University of Delaware, Evans Hall, Newark, Del.

The following indicated admissions and transfers of memberships were approved by the Board of Directors.

Transfer to Fellow

Barrow, W. L., Massachusetts Institute of Technology, Cambridge, Mass.
 Brown, G. H., RCA Mfg. Co., Camden, N. J.
 Builder, G., Amalgamated Wireless Australasia, Ltd., 47 York St., Sydney, N. S. W., Australia
 Chamberlain, A. B., Columbia Broadcasting System, Inc., 485 Madison Ave., N. Y. C.
 Cook, E. D., General Electric Co., 1 River Rd., Schenectady, N. Y.

Knowles, H. S., Jensen Radio Mfg. Co., 6601 S. Laramie Ave., Chicago, Ill.
 Mason, W. P., Bell Tel. Labs., 463 West St., N. Y. C.
 Peterson, H. O., R. C. A. Communications, Inc., 66 Broad St., N. Y. C.
 Southworth, G. C., Bell Telephone Labs., 463 West St., N. Y. C.

Transfer to Member

Fox, R. A., 1311 Terminal Tower, Cleveland, Ohio
 Leonard, S. E., 2651 Kerwick Rd., University Heights, Cleveland, Ohio
 Pierce, R. M., 1080 Sylvan Ave., Cleveland, Ohio
 Scott, H. J., Dept. of E E, University of California, Berkeley, Calif.
 Sear, A. W., 1285 Boston Ave., Bridgeport, Conn.
 Smeby, L. C., 4801 Conn. Ave., Washington, D. C.
 Troeglen, K., 646 Grandview, Topeka, Kans.

Admission to Member

Busignies, H. G., 742 Burns St., Forest Hills, L. I., N. Y.
 Dumeresque, J. S., 19 E. 98th St., New York, N. Y.
 Hoover, P. L., Case School of Applied Science, Cleveland, Ohio
 Loughridge, D. H., University of Washington, Seattle, Wash.
 Quarles, L. R., Proffit, Va.
 Quale, J. C., Grassendale, Manley, Helsby, via Warrington, Lancs, England
 Smith, F. W., 5 Sullivan Rd., Easton, Pa.
 Van Atta, L. C., 79 Wildwood St., Winchester, Mass.

Admission to Associate

Adair, G. P., 101 Allegheny Ave., Takoma Park, Md.
 Adams, H. E., 4500 Sutherland Ave., Indianapolis, Ind.
 Alagna, G. I., 179 S. Oxford St., Brooklyn, N. Y.
 Amatneek, K., 17 Union Square West, N. Y. C.
 Anderson, N. J., Fayson Lakes, Butler, N. J.
 Atwater, C. K., 340 N. Fullerton Ave., Upper Montclair, N. J.
 Bady, I., Myrtle Ave., Eatontown, N. J.
 Baird, G. H., Box 676, Clarendon, Tex.
 Barnes, R. R., 1365 Cass Ave., Room 1512, Detroit, Mich.
 Beauchemin, A. K., State Police Barracks, Station K, Colchester, Conn.
 Bender, J. H., 200 Franklin St., Bloomfield, N. J.
 Benham, M. J., RCA Institutes, Inc., 1154 Mdse. Mart, Chicago, Ill.
 Berkoff, S., 1920 Harrison Ave., Bronx, N. Y. C.
 Best, N. R., 3925 Pennsylvania Ave., S. E., Washington, D. C.
 Bonner, A. L., Room 1026, 180 Varick St., N. Y. C.
 Bradford, R. C., 26 Carew Rd., Hamden, Conn.
 Bressler, J. J., 25 Dongan Pl., N. Y. C.

Brooks, P. J., 934 Chew St., Allentown, Pa.
 Broomfield, J. L., 496 Milton Rd., Rye, N. Y.
 Browne, J. H. B., P.O. Box 1515, Kelowna, B. C.
 Brubaker, G. P., Jr., 533½ Kelton Ave., West Los Angeles, Calif.
 Burbage, G. H., 1320 Fairmont St., N. W., Washington, D. C.
 Burkert, J. W., 5414 N. Fairhill St., Philadelphia, Pa.
 Burnight, T. R., 144 Forrester St., S. W., Washington, D. C.
 Carpenter, F. H., 317 E. Dixon Ave., Dayton, Ohio
 Carter, G. E., Jr., c/o Hygrade Sylvania Corp., Loring Ave., Salem, Mass.
 Chalmers, E. D., Radio Dev. Lab., Stromberg-Carlson, Rochester, N. Y.
 Cheeks, J. A., 2300 Fairdale Ave., Cleveland, Ohio
 Chromak, L. P., 611 W. 148th St., N. Y. C.
 Coffman, B. C., 25 Park St., Montclair, N. J.
 Colosi, A., 420 Fayette St., Washington, Pa.
 Comber, C. T. T., Oficina 630, Plaza Constitucion F.C.S., Buenos Aires, Argentina
 Copp, W. C., P.O. Box 252, Closter, N. J.
 Crosby, C., 16 Chauncy St., Cambridge, Mass.
 Cosmas, A., 56 Beechnoll Rd., Forester Hills, N. Y.
 Courtad, R. V., 14522 Superior Rd., Cleveland Heights, Ohio
 Craig, LeRoy, H., Little Silver Pt. Rd., Little Silver, N. J.
 Cramer, K. H., 239 Alameda St., Klamath Falls, Ore.
 Crawford, J. D., U. S. S. Idaho, c/o Postmaster, New York, N. Y.
 Curl, G. H., 6622 Broad St., Brookmont, Station A, Washington, D. C.
 Cushing, P., Fayson Lakes, Butler, N. J.
 D'Acre, F. G., 4410 Van Buren St., Hyattsville, Md.
 Daspit, J. I., Loyola University, 6363 St. Charles Ave., New Orleans, La.
 Davis, D. W., U. S. Naval Academy, Annapolis, Md.
 Davis, J. C., 910 N. Jefferson St., Albany, Ga.
 Davis, M. F., 3972 Nichols Ave., S. W., Washington, D. C.
 Della'Rocco, M., U. S. Naval Research Laboratory, Anacostia Station, D. C.
 del Valle, A. P., P.O. Box 857, San Juan, P. R.
 Dezettel, L. M., 6329 N. Magnolia Ave., Chicago, Ill.
 Donoghue, J. J., 1411 Monroe St., N. E., Washington, D. C.
 Duff, J. E., R.D. 7, N. Canton, Ohio
 DuVal, M. V., Hampton House, 219-46 93rd Ave., Queens Village, N. Y.
 Engelmann, H. F., Naval Research Laboratory, Washington, D. C.
 Engels, V. A., 2347 S. St., S. E., Washington, D. C.
 Fairweather, B. A., 180 Varick St., Room 1125, N. Y. C.
 Fott, L. D., 225 E. 31st St., N. Y. C.
 Friedman, M., 6030 Christian St., Philadelphia, Pa.
 French, H. E., River Rd., Carlisle, Mass.

- Fry, W. J., Naval Research Laboratory, Washington, D. C.
- Garrett, E. T., 808 Union Ave., Belleville, Ill.
- Gleason, C. H., 807 Maryland, Columbia, Mo.
- Grandmont, P. E., 141 Berkeley Ave., Bloomfield, N. J.
- Gray, C. M., 308 Customhouse, New Orleans, La.
- Gregory, L. W., 2519 Wilkens Ave., Baltimore, Md.
- Hafely, C. H., 8083 88th Ave., Woodhaven, N. Y.
- Hamilton, G. E., 602 S. Vine St., Urbana, Ill.
- Hanley, T. E., 4029 1st SW, Washington, D. C.
- Hanson, C. F., 463 West St., N. Y. C.
- Harris, F., Naval Research Laboratory, Washington, D. C.
- Hickman, D. H., 16 S. Clayton St., Wilmington, Del.
- Holi, F., Bell Telephone Laboratories, 180 Varick St., N. Y. C.
- Hollweck, F. J., 3424 B St., S. E., Washington, D. C.
- Hopkins, G. C., 116 Tuthill St., Port Jefferson, N. Y.
- Hornickel, H. C., c/o Frost, Broad St., Shrewsbury, N. J.
- Hewitt, C. D., 60 Harmon St., Hamden Conn.
- Houston, C. E., 1811 McDuffie, Houston, Texas
- Hubbard, L. O., 3005 N. Washtenaw, Chicago, Ill.
- Huetten, C., 3 Woodland Dr., Indianapolis, Ind.
- Huffman, E. B., R.F.D. 4 Box 659-D, Akron, Ohio
- Humphreys, T. I., 3937 Nichols Ave., S. E., Washington, D. C.
- Hunter, H., Canadian Westinghouse Co., Ltd., Hamilton, Ontario
- Ingham, R. M., Jr., 4929 Graceland Ave. Indianapolis, Ind.
- Ittelson, R. W., 1845 Emerson Ave., Dayton, Ohio
- Jacobson, T. E., 1 Kircher Pl., Belleville, Ill.
- Jensen, L. J., 7049 The Paseo, Kansas City, Mo.
- Johnson, H. R., 200 $\frac{1}{2}$ Stevenson St., Montgomery, Ala.
- Johnson, R. Y., 840 S. Canal St., Chicago, Ill.
- Johnston, H. M., 1309 W. Elizabeth St., Brownsville, Tex.
- Jones, M. C., 421 3rd Ave., Haddon Heights, N. J.
- Jorgenson, T. O., WEAU Transmitter R R 1, Eau Claire, Wis.
- Jucius, S. W., 1904 S. 50th Ave., Cicero, Ill.
- Judkins, L. G., 4625 Terrace St., Kansas City, Mo.
- Kaye, P., 1025 Linwood Ave., St. Paul, Minn.
- Kezer, C. F., 1426 21st St., N. W., Washington, D. C. (Transfer)
- Klantz, L. M., 1043 Pennfield Rd., Cleveland Heights, Ohio
- Kilpatrick, E. L., 5225 11th Rd. North, Arlington, Va.
- Koch, J. S., 129 Lehigh Ave., Newark, N. J.
- Koether, G. H., Jr., Severna Pk., P. O. Round Bay, Md.
- Krause, E. H., Naval Research Laboratory, Anacostia, D. C.
- Kyle, J. W., 2707 Kenwood Ave., Richmond, Va.
- Kusack, W. P., 1640 Chase Ave., Chicago, Ill.
- Labin, E., Herrera, 527, Buenos Aires, Argentina
- Lee, P. H., 252 Genesee Park Dr., Syracuse, N. Y.
- Lemmo, T. J., 23 Carew Terr., Springfield, Mass.
- Lippert, H. B., 164 Alpine Ave., Bridgeport, Conn.
- Lerch, Q. A., 415 W. Broadway, Port Jefferson, L. I., N. Y.
- Lind, P. C., 720 33rd Ave. S., Seattle, Wash.
- Logan, G. R., 254 St. James St., St. John New Brunswick, Canada (Transfer)
- Lovering, C. B., Jr., U. S. Naval Radio Station, Winter Harbor, Me.
- Lowe, P. E., 511 Clinton Ave., Bridgeport, Conn.
- Lyons, E. F., 2115 Dorchester Dr., Oklahoma City, Okla.
- MacConnell, C. W., 55 Columbus Ave., Southbridge, Mass.
- MacLean, W., 256 Henry St., Brooklyn, N. Y.
- Maguire, J. C., 4400 Alice Ave., Austin, Tex.
- Magnusson, P. C., 1852 Mintwood Pl., Washington, D. C.
- Mansfield, E. E., Jr., 125 Main St., Niagara Falls, N. Y.
- Martin, N. F., 1014 E. Rudisill Blvd., Fort Wayne, Ind.
- McBrair, H. C., 150 E. Pierrepont Ave., Rutherford, N. J.
- McComb, C. T., 2059 38th St., S. E., Washington, D. C.
- McCurdy, G. E., 1338 Quелlette Ave., Windsor, Ontario, Canada
- McDonough, D. M., 4116 N. 19th St., Tacoma, Wash.
- McFarren, L. E., 73 N. Ewing St., Indianapolis, Ind.
- McKee, L. H., 58-25 Little Neck Pkwy., Little Neck, N. Y.
- McKnight, G. P., 214 Columbus, St. Marys, Pa.
- Merkle, W. W., 103 E. Coulter Ave., Collingswood, N. J.
- Mercer, W. R., 135 White Horse Pike, West Collingswood, N. J.
- Meth, I., 612 Marcy Ave., Brooklyn, N. Y.
- Meyer, M. A., 280 Delaware Ave., Dayton, Ohio (Transfer)
- Miles, J. M., 142 Chesapeake St., S. W., Washington, D. C.
- Monfon, L., 1455 W. 63rd St., Chicago, Ill.
- Moon, R. B., Brooklandville, Md.
- Mostrom, R. A., 23 Trask St., Denver, Mass.
- Motta, N., 45 Belvidere St., Nazareth, Pa.
- Moyer, G. W., R.R. 10 Box 60 Indianapolis, Ind.
- Murphy, O. R., 1200 Belleforte Ave., Oak Park, Ill.
- Newson, J. V., #260, A.M.E.S., R.A.F., M.E. Forces
- Noble, J. C., Rt. 8, Box 492-A, Dayton, Ohio
- O'Connor, A. P., 151 W. 32nd St., Los Angeles, Calif.
- Ogas, M. J., University of New Mexico, Box 91, Albuquerque, N. M.
- Ostheimer, E. J., 43-28 55th St., Woodside, L. I., N. Y.
- Packard, G. N., 463 West St., N. Y. C.
- Packmann, E. N., Cangallo 2550, Buenos Aires, Argentine
- Palmquist, J. F., 3807 Somerset Dr., Los Angeles, Calif.
- Paulsen, J. F., 1263 Sussex Rd., West Englewood, N. J.
- Paulson, C. N., 334 King St., E., Kingston, Ontario
- Perry, H. G., 720 8th St., Hermosa Beach, Calif.
- Pensak, L., RCA Mfg. Co., Harrison, N. J.
- Peterman, R. S., 313 Reed St., Clearfield, Pa.
- Peters, T. A., Radio Station KTRI, Sioux City, Iowa
- Pitzer, J. H., 4385 West 212 St., Cleveland, Ohio
- Phelps, F. P., National Bureau of Standards, Washington, D. C.
- Pilling, J., Radio Station CHWK, Chilliwack, B. C., Canada
- Popkin-Clurman, C. R., 26 Marlborough St., Rockville Center, L. I., N. Y. (Transfer)
- Rackle, E. E., 2059 Springhill Ave., Mobile, Ala.
- Rawlings, H. L., 1403 Maple Row, Elkhart, Ind.
- Reinsmith, G. M., 1757 Easter Pkwy, Schenectady, N. Y.
- Rhodes, H. E., 4828 N. Illinois, Indianapolis, Ind.
- Roberts, F. F., P.O. Radio Laboratories, Palace of Engineer, Wembley, Mddx, England
- Robinson, K. H., LTRN Broadcasting Co., Houston, Tex. (Transfer)
- Rogers, G. F., Box 65, Coral Gables, Fla.
- Van Rosenbergh, W., 187-50—115th Rd., St. Albans, N. Y.
- Ruplenas, R. J., c/o General Radio Co., 36 State St., Cambridge, Mass.
- Sabaroff, S., 5003 C St., Philadelphia, Pa.
- Sampson, R. T., 863 Cocton Ave., San Bernardino, Calif.
- Sanders, R. W., 1302 W. 3rd St., Marion, Ind.
- Schwarz, C. J., 3907 N. 25th St., St. Louis, Mo.
- Seifert, F. F., PR 7, Box 339, Dayton, Ohio
- Shattuck, J. C., 321 Alesio Ave., Coral Gables, Florida
- Shepperd, I. J., 711 N. Carolina Ave., S. E. Washington, D. C. (Transfer)
- Shepherd, W. G., 14 W. End Ave., Summit, N. J.
- Simonis, F. J., N. Y. State Troopers, Troop "K," Hawthorne, N. Y.
- Skrivseth, A. G., 176 W. Utica St., Buffalo, N. Y.
- Smaha, N. F., c/o Mackay Radio & Tel. Co., 22 Battery St., San Francisco, Calif.
- Smith, C. H., Jr., 1722 19th St., N. W., Washington, D. C.
- Sorenson, E., 141-22 73 Terrace, Flushing, L. I.
- Spector, S., 165 Park Ave., E. Orange, N. J.
- Stafford, H., 5526 E. Michigan St., Indianapolis, Ind.

- Stair, R., 5068 Sherrier Pl., N. W., Washington, D. C.
- Stenzel, E. R., 71 College Ave., Flourtown, Pa.
- Stephenson, H. B., 102 Byron Ave., Kenmore, N. Y.
- Strahlman, R. H., 109 Linden Ave., Irvington, N. J.
- Sturdy, E. W., 1471 Crest Dr., Los Angeles, Calif.
- Thoman, C. A., Jasmine St., West Columbia, S. C.
- Thomason, J. F., 3411 A. St., S. E., Washington, D. C.
- Thompson, E. O., 412 Wischman Ave., Orerland, Pa.
- Thompson, T., R.F.D. 5, Box 85, K S. Perkins Rd., Memphis, Tenn.
- Torsch, C. E., 6925 Collins Ave., Merchantville, N. J.
- Tourshou, S., 1716 Spring Garden St., Philadelphia, Pa.
- Triman, E. L., 6 North Hamlin, Chicago, Ill.
- Trowbridge, F., 5755 N. Maplewood Ave., Chicago, Ill.
- Turner, J. S., c/o CAA Box 1699 Forth Worth, Tex.
- Urlovic, W. C., 1358 E. 28th St., Oakland, Calif. (Transfer)
- Vacca, R. H., 45 Waverley St., Brighton, Mass.
- Varone, R. A., 256 White Horse Pike, Audubon, N. J.
- Veilleux, T. A., 1453 Fairmont St., NW., Washington, D. C.
- Walker, J. R., 12757 Terry, Detroit, Mich.
- Wallace, E. B., 122 Orchard St., Rocky Hill, Conn.
- Welch, A. M., Trenton, Western Ave., Cardiff, S. Wales, Great Britain
- West, H. E., 1306 N. Rural St., Indianapolis, Ind.
- Whittier, L. G., 103 Aycrigg Ave., Passaic, N. J.
- Williams, M. A., 1504 E. Broadway, Long Beach, Calif.
- Williams, W. D., P.O. Box 473, Miami Springs, Fla.
- Willson, J. E., 605 N. Linwood, Indianapolis, Ind.
- Wilson, Roger T., 154 Chesapeake St., S. W., Washington, D. C.
- Winter, H. F., Bell Tel. Labs., 180 Varick St., N. Y. C.
- Wolfe, H., 10415 McCormick St., N. Hollywood, Calif.
- Wolff, H. R., 3 Woodland Dr., Indianapolis, Ind.
- Wylie, T. C., R.R. 1, Glencoe, Ontario, Canada
- Young, L. L., Rocky Point, N. Y.
- Yung, C. F., Box 302, Westport, Conn.
- Zuschlag, T., 1108 Magnolia Rd., West Englewood, N. J.

Contributors

A. James Ebel (J'33-A'35) was born on May 30, 1913, at Waterloo, Iowa. He received his A.B. degree in 1937 from the University of Iowa, and has continued graduate study from 1937 to date at the University of Illinois. He was an engineer at radio station KFJB, Marshalltown, Iowa, in 1930; KJDE, Fergus Falls, Minnesota in 1931; and at WMT, Cedar Rapids, Iowa from 1932 to 1937. Since March, 1937, he has been employed as chief engineer of the University of Illinois Radio Service, WILL, in Champaign, Illinois. Mr. Ebel is a member of Sigma Xi.



E. W. Herold (A'30-M'38) was born on October 15, 1907, in New York City. He received the B.Sc. degree from the University of Virginia in 1930. From 1924 to 1925 Mr. Herold was in the engineering department of the Western Electric Company; from 1925-1926, Bell Telephone Laboratories; and 1926-1929, E. T. Cunningham, Inc. In 1930 he entered the research and engineering department of the RCA Manufacturing Company (Harrison)



E. W. HEROLD

and is now a member of the research laboratories of that organization.



Russell R. Law (A'35-M'40) was born on January 11, 1907, at Hampton, Iowa. He received the B.S. degree in electrical

engineering in 1929 and the M.S. degree in 1931 from Iowa State College; in 1933 he received the D.S. degree from the Harvard Engineering School. From 1933 to 1934 he was a research associate in geophysics at Harvard University. Since 1934 Mr. Law has been in the research and engineering department of the RCA Manufacturing Company. He is a member of Sigma Xi and the American Physical Society.



Roger J. Pieracci (S'40-A'40) was born at Yoder, Iowa, on March 19, 1911. He received the B.S. degree in electrical engineering from Iowa State College in 1932. From 1934 to 1939 he was a member of the engineering staff of the Collins Radio Company, and during 1939-1940 he took a year's leave of absence to resume study in communication engineering at Ohio State University, serving as Graduate Assistant to Dr. W. L. Everitt during this period. At the present time he is on the engineering staff of Collins Radio Company, where he is carrying on research in the field of frequency modulation. Mr. Pieracci is an associate member of Sigma Xi.



A. JAMES EBEL



R. R. LAW



ROGER J. PIERACCI

PRESENTING—

the SECO automatic VOLTAGE REGULATOR

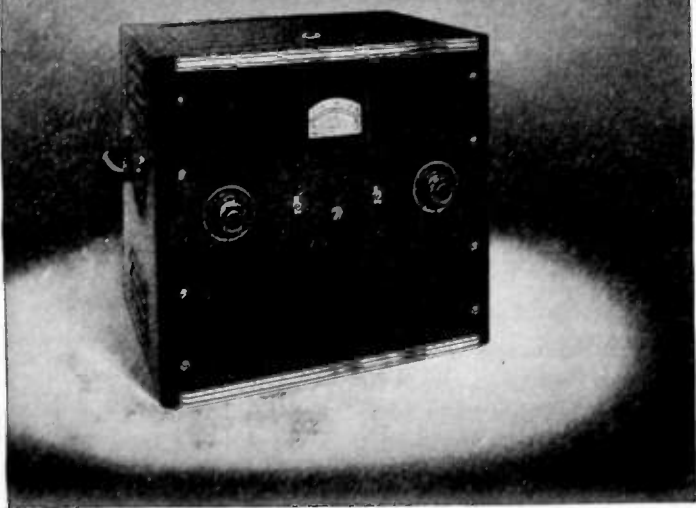

THE MODERN A-C LINE VOLTAGE CONTROL

THIS improved type regulator consists of a thyatron tube circuit controlling a motor-driven variable voltage transformer. It maintains a constant output voltage with variations in input voltage or load current.

- **CORRECTS FOR WIDE RANGE OF INPUT VOLTAGES**—standard 115 volt units, for example, correct for input voltage variations of plus and minus 17.5% of output voltage.

- **HIGH EFFICIENCY**—has the high efficiency characteristic of the variable voltage auto-transformer.

- **NO INTERNAL MECHANICAL ADJUSTMENTS**—does not use a contact-making voltmeter—no critical relay adjustments.

- **OUTPUT VOLTAGE AND SENSITIVITY ADJUSTABLE** over a wide range by means of knobs on front panel.

- **NEGLIGIBLE WAVE-FORM DISTORTION**—low exciting current.

- **LOW COST PER KVA.**

- **QUICK RESPONSE**—time for full range travel is six seconds.

- **OPERATION NOT AFFECTED BY LOAD POWER FACTOR.**

APPLICATIONS

Maintains correct constant voltage for—

- Electronic Equipment
- Electrical Testing
- Manufacturing Equipment
- Fluorescent Lighting

SEND FOR BULLETIN 163 ER

Available for 115, 230, or 440-volt circuits in capacities up to 75 KVA—single or three phase.

SUPERIOR ELECTRIC CO.

170 HARRISON ST.

BRISTOL, CONN.



Radio...all out for Victory

Research and invention have placed radio in the first line of battle

COMMUNICATION—rapid communication—is a vital necessity, on land, at sea and in the air. RCA research and engineering developments in both radio and electronics are strengthening—and will further fortify—the bulwarks of our communications system. At Princeton, New Jersey, the new RCA Laboratories—the foremost center of radio research in the world—are under construction.

★ ★ ★

International circuits, operating on short and long waves, have made the United States the communication center of the world. Today, R.C.A. Communications, Inc., conducts direct radiotelegraph service with 49 countries.

★ ★ ★

Production of radio equipment is essential for news and timely information, for military and naval communications, for dissemination of news among foreign countries. The “arsenal of democracy” has a radio voice unsurpassed in range and efficiency. In the RCA Manufacturing Company’s plants, workers have pledged themselves to “beat the promise,” in production and delivery dates of radio equipment needed for war and civilian defense.

★ ★ ★

American life and property at sea are being safeguarded by ship-and-shore stations.

The Radiomarine Corporation of America has equipped more than 1500 American vessels with radio apparatus and is completely engaged in an all-out war effort.

★ ★ ★

Radio broadcasting is keeping the American people informed accurately and up-to-the-minute. It is a life-line of communication reaching 55,000,000 radio sets in homes and automobiles. It stands as the very symbol of democracy and is one of the essential freedoms for which America fights. The National Broadcasting Company—a service of RCA—and its associated stations, are fully organized for the coordination of wartime broadcasting.

★ ★ ★

New radio operators and technicians must be trained for wartime posts. RCA Institutes, the pioneer radio school of its kind in the United States, has more than 1,200 students enrolled and studying in its New York and Chicago classrooms.

★ ★ ★

When war came and America took its place on the widespread fighting front, radio was At the Ready . . . with radio men and radio facilities prepared to answer the call to duty “in the most tremendous undertaking of our national history.”

PRESIDENT



Radio Corporation of America

RADIO CITY, NEW YORK

The Services of RCA: RCA Manufacturing Co., Inc. • RCA Laboratories • R.C.A. Communications, Inc. National Broadcasting Company, Inc. • Radiomarine Corporation of America • RCA Institutes, Inc.



Reykjavik off the port bow!

TONIGHT, somewhere at sea, a man stands on the bridge of a freighter with the life line of a nation in his hands.

He is straining his eyes for sight of one of those islands which are our country's first line of defense. To these islands must be transported huge quantities of munitions and food. And the only answer is ships, ships, and more ships.

How is America meeting this tremendous responsibility? You'll get a fair idea at such great factories as the Westinghouse plant where the machinery to drive many of those supply ships is being built, or at the huge Westinghouse-operated Maritime Commission plant which is now being erected alongside it.

The "know how" that works 24 hours a day

There, in these factories is a dramatic example of how Westinghouse "know how" is doing a job for National Defense.

Proceedings of the I. R. E. February, 1942

What is this "know how"? It is the ability to get things done in the best possible way—learned in building products for the general welfare and now used in building materials for the common defense.

The same skill and ingenuity that are building those turbines for the merchant fleet, not long ago built more efficient electric refrigerators and washing machines. Again, the research skill that

developed intricate new radio equipment has found ways of utilizing that equipment in important defense work.

At 17 Westinghouse Divisions, and in the plants of more than 300 sub-contractors, our energies are almost exclusively turned to the creation of \$400,000,000 worth of defense materials. It's our way of speeding the day when our "know how" will be serving you again—in the home, the farm, and the factory.

Westinghouse

For the Common Defense

Armor-piercing shot
Seadrome lighting equipment
for planes

Bomb fuses
Navy ship turbines and
gears

Naval Ordnance
Airplane generators
Lighting equipment

For the General Welfare

Street Lighting
Electric Irons

Generators
Electric Refrigerators

Motors and Controls
Stokers

These lists mention only some of the many thousands of Westinghouse products.

WESTINGHOUSE ELECTRIC & MANUFACTURING CO., PITTSBURGH, PENNSYLVANIA

Copy, 1942, Westinghouse Electric & Manufacturing Co.



TRANSMITTING CAPACITORS . . .

● Yesterday, *special* or made to order; today, *standard*, in regular production, lowered prices, available for prompt delivery. That's the story of Aerovox transmitting capacitors for transmitting, electronic and other extra-heavy-duty services.

In loose-leaf form, the Aerovox Transmitting Catalog is kept right up to date with new pages issued from time to time. This handy catalog lists these communications-type capacitors in great detail, for your convenience.

Therefore, before you go to the trouble, time and expense of ordering *special* capacitors, be sure you check over the Aerovox line.

Submit Your Problem . . .

Write on business letterhead for latest catalog. Submit that capacitance problem for engineering collaboration, recommendations, specs., quotations.

NEW BEDFORD, MASS.,
U. S. A.
Sales Offices in All
Principal Cities



In Canada
AERVOX CANADA LTD.
Hamilton, Ont.
EXPORT: 100 Varick St., N. Y.
Cable 'ARLAB'

Accurate measurement of POWER and IMPEDANCE with ... DAVEN OUTPUT POWER METERS

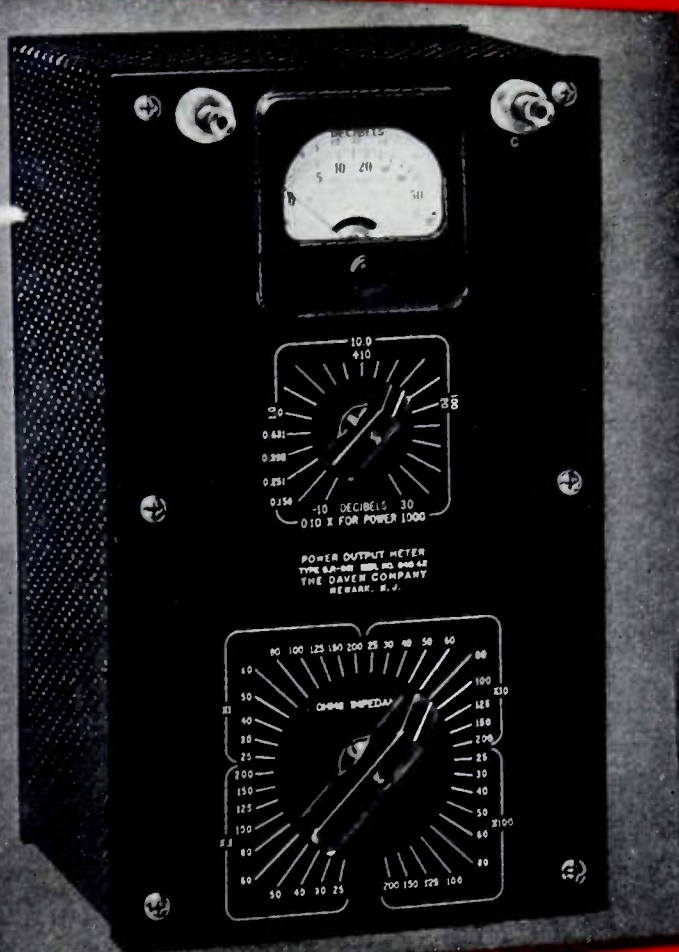

OP-961

A rugged, handy Output Power Meter for accurate measurements of audio signal systems having a maximum power output up to 50 watts.

Reliable readings of power at impedances from 2.5 to 20,000 ohms are guaranteed by a meter multiplier network of constant impedance, in combination with a carefully designed impedance changing network that remains essentially resistive throughout virtually the entire audio range.

Power ranges cover from 0.1 mw. to 50 watts in steps of 0.1 mw., indicating meter is calibrated from 0 to 50 mw., and from 0 to 17 db., with a 1 mw. zero level. A 20-step multiplier extends the meter power reading from 0.1x to 1,000x scale value, and the db. reading in steps of 2 db., from -10 to +30 db., with full scale at +47 db. Accurate within 2% at mid-scale.

Expanded DAVEN production facilities are now available for the construction of specialized equipment to specification.

Convenient meter reading is provided in this compact, space saving OP-182 Output Power Meter. It is admirably suited for many power and impedance measurements, such as determining actual power delivered by an audio system to a given load, characteristic impedance or load variation effect on an A.C. source.

Terminal impedance remains essentially resistive over the audio frequency range of 30 to 10,000 cps. Impedances from 2.5 to 20,000 ohms in 40 convenient steps are available.

The indicating meter is calibrated from 0 to 50 mw., and from 0 to 17 db. Zero level at 1mw. Four ranges of full scale readings from 5 mw. to 5 watts, and from -10 to +37 db. are provided by the meter multiplier. Accuracy within 3% at mid-scale.

OP-182

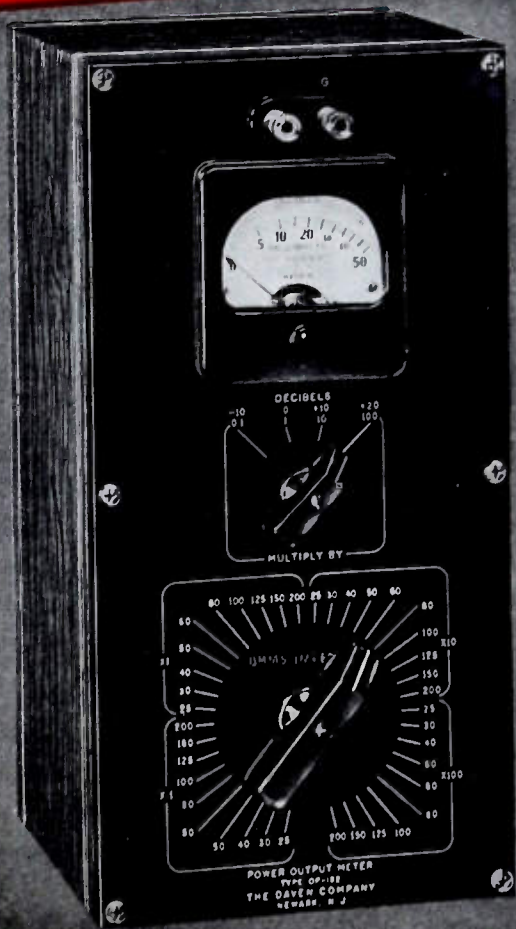

THE DAVEN COMPANY
158 SUMMIT STREET • NEWARK, NEW JERSEY



THEY CAN HANDLE THE TOUGH JOBS

The men and women in the Bell System are used to meeting emergencies and they are trained and equipped to carry on in times of special need. For years they have known the test of fire, flood and storm. That experience

stands in good stead in this greatest emergency of our time. The Nation is counting on telephone workers to prove faithful to the task and they will not fail. Always before them is the tradition that the message must go through.

BELL TELEPHONE SYSTEM . . . SERVICE TO THE NATION IN PEACE AND WAR



The ability to design and produce so many specialized types in a short time is important. It is, however, only a secondary consideration in the selection of Sprague Condensers for Defense applications. Far more important is the assurance of utmost dependability for each and every unit given by Sprague's long record of performance as a leading supplier to the Radio Trade. . . .

Although new condenser mechanical arrangements are sometimes made overnight, basic condenser section design and resulting dependability are not.

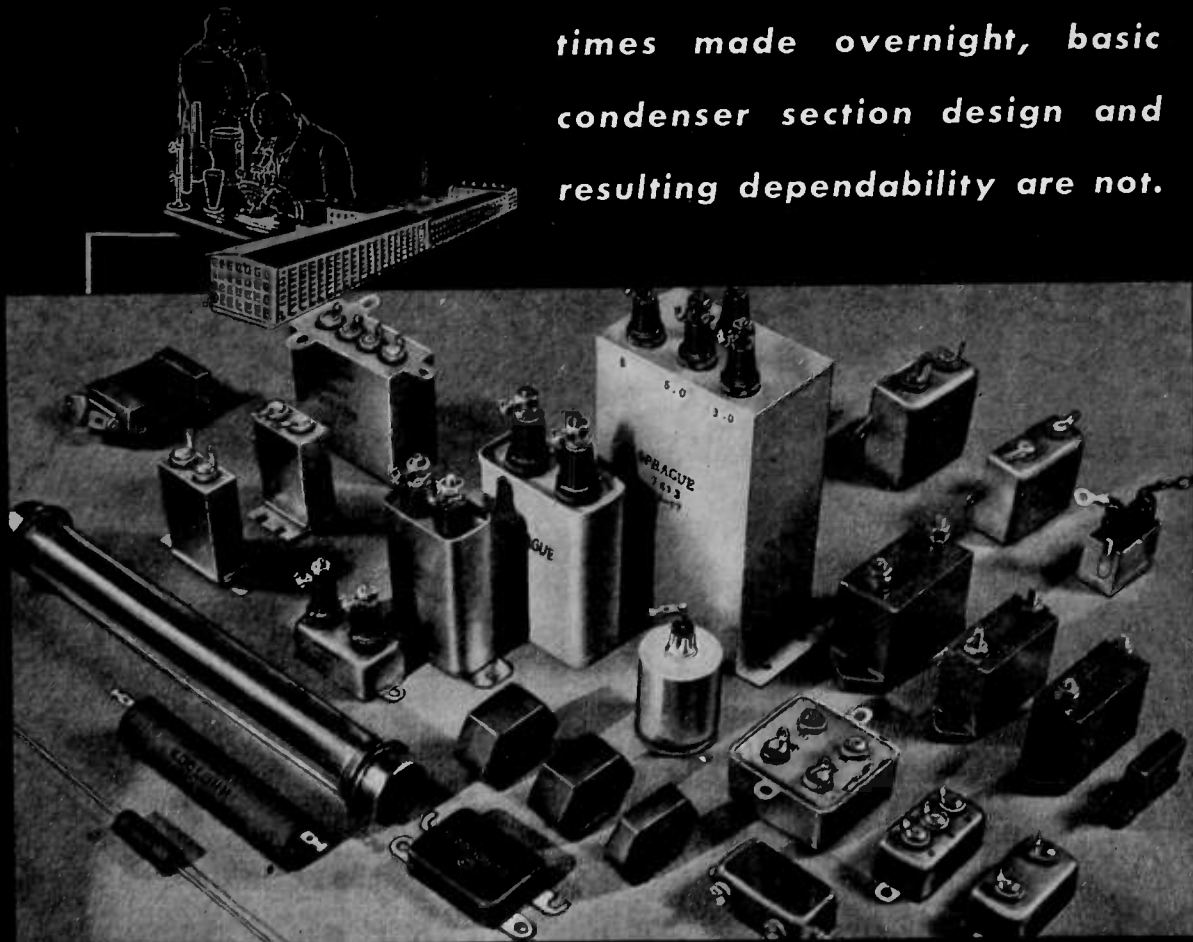

SPRAGUE

CONDENSERS—KOOLOHM RESISTORS

Quality Components • Expertly Engineered • Competently Produced

SPRAGUE SPECIALTIES COMPANY, NORTH ADAMS, MASS.



ALL-METAL

RHEOSTATS

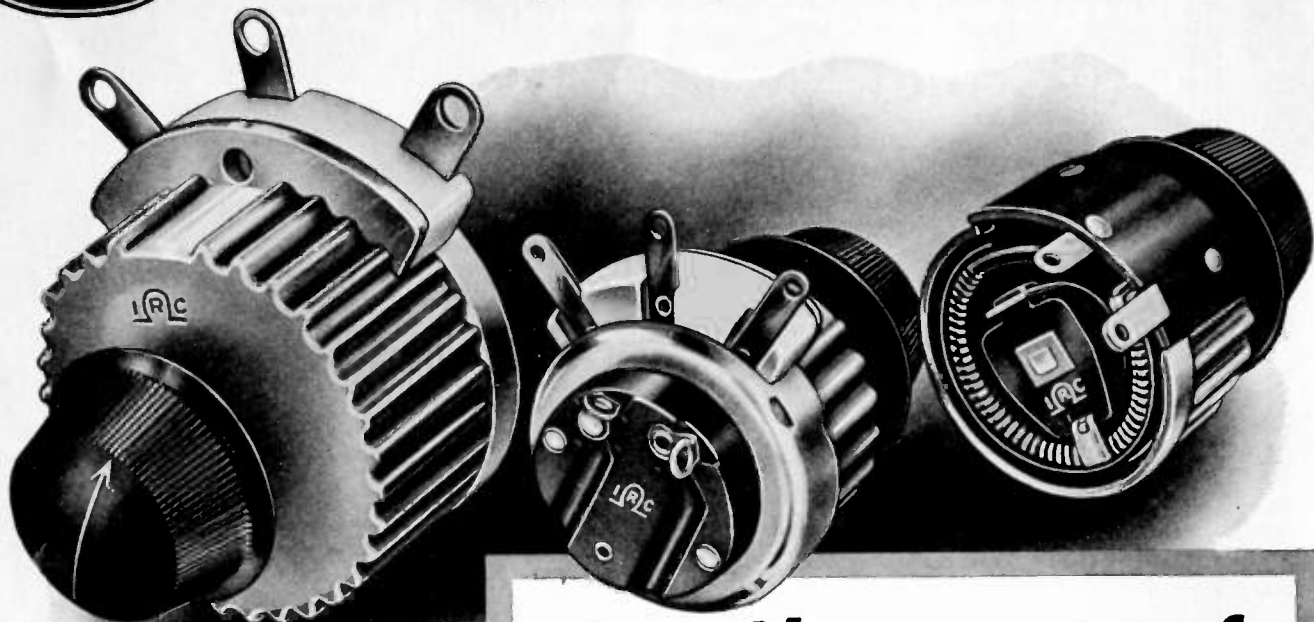

DURABILITY to withstand the concussions of big bombs and gunfire, dependability under conditions of high humidity and other temperature extremes, lighter weight construction, and faster heat dissipation—these, in brief, are the advantages of all-metal construction, that have brought IRC Rheostats to the fore for War-purpose applications. Ask for the IRC Rheostat Catalogs Nos. VI and VI-a.

WRITE FOR THESE DATA BULLETINS



**Shatter-proof
Mechanically
rugged...**

Lighter in weight...

**50% lower temperature rise for
equal size in other types...**

**Available for 200-hour salt-
spray test requirement...**

**Designs available for special
aircraft and ordnance use...**

**Made for high- and low-temper-
ature operation...**

25- and 50-watt sizes

INTERNATIONAL RESISTANCE COMPANY

431 North Broad Street, Philadelphia, Penna. • **Makers of Resistance Units in More Types, Shapes and Sizes, and for More Applications Than Any Other Manufacturer in the World.**

THE MOST WATCHED-FOR SHIP IN THE WORLD

depends upon **ALSiMag** insulation in its communications equipment



LONDON CALLING
 When does the next Clipper leave Lisbon?"

WASHINGTON CALLING
 "Who was on yesterday's Clipper?"

HAVANA CALLING
 "Reserve four seats on the first Clipper"

BUENOS AIRES CALLING
 "Rush shipment by Clipper"

MIAMI CALLING
 "Decision awaits arrival of Clipper"

AT THIS VERY MINUTE in half a hundred far-flung countries, Pan American Clippers are helping to shape history. They carry the hopes of democracy everywhere that war permits. Upon their prompt arrival hinge decisions and events of world importance. Flying Clippers speed their vital cargo of men, mail, materials and merchandise along 6,893 miles of scheduled routes. Under wartime conditions, speed and certainty of communications is, more than ever, vital to this

far-flung network. Only the best in insulation will suffice. Every conceivable climatic condition is faced in Pan American Clippers linking the United States and Europe—binding Alaska, North and South America together—bringing the distant Orient and Australasia within days of our shores.

American Lava Corporation is proud that the performance of ALSiMAG has led it to be the preferred insulation in all communications equipment throughout the Pan American Airways System.



America's Merchant Marine of the Air is a DAILY PROVING GROUND for ALSiMAG INSULATION

CHICAGO - CLEVELAND - NEW YORK - ST. LOUIS - LOS ANGELES
 SAN FRANCISCO - BOSTON - PHILADELPHIA - WASHINGTON, D. C.

ALSiMAG FROM CERAMIC HEADQUARTERS
 AMERICAN LAVA CORPORATION • CHATTANOOGA • TENNESSEE



FOR TRIPLETT CUSTOMERS ONLY

Long before the state of emergency was proclaimed, the Triplett Company was getting ready to do its part in building our national security. We knew that we must meet important new responsibilities. At the same time, we felt keenly our continuing obligations to our customers—old friends with whom we have had happy business relations through many years.

We doubled—then tripled—our output to fill the needs of our old accounts. We added to our production facilities . . . hired many more men . . . are working extra shifts at time-and-a-half.

All this has not been enough. We have been called on to produce more and more for national defense. We are proud of the job we are doing to help meet the emergency, but it is difficult not to be able to serve our old friends equally as well. In the face of these conditions, the Triplett Company has adopted these policies "for the duration."

FIRST: We will continue to serve you by our service to our mutual responsibility—the national emergency.

SECOND: We will continue to do everything we can to fill orders from our regular customers, even though some deliveries may be temporarily delayed. No business from new accounts has been nor will be accepted until after our old friends have been served, except where priorities make it impossible to do so.

THIRD: Our engineering and research departments will continue to work on the development of superior equipment and improved methods to serve you still better when we can resume normal operations.

The present emergency is incidental and as we work towards the future, we will do our best to continue to merit your confidence and loyalty.

President
The Triplett Electrical Instrument Company

Manufacturers of Precision Electrical
Instruments



BLILEY CRYSTAL UNITS

PRECISION-BUILT . . . For Reliable Frequency Control

OUR NO. 1 JOB NATIONAL DEFENSE

Day and night, with ever increasing rate, Bliley Crystal Units are being produced for National Defense in all its phases. Essential needs must come first—immediate attention can be given only when the preference rating is A-10 or better. To avoid delays, secure your highest applicable ratings in advance.

THE present-day emergency demands longer operating hours—an unusual strain on equipment and personnel. More than ever before, breakdowns and subsequent interruptions of service must be avoided. Now is the time that Bliley built-in dependability and precision really pays dividends.

Bliley Crystal Units for all applications and for all frequencies from 20kc. to 30mc. are described in Catalog G-12. Consult your Bliley Distributor or write for your copy.

BLILEY ELECTRIC CO., ERIE, PA.

For DEVELOPMENT ENGINEERS Who Want PROMPT DELIVERY of TRANSFORMERS

The transformers you buy from us meet your three chief requirements. 1—Highest quality in materials and workmanship; 2—Proved Designs that give dependable performance; 3—*Promptness of delivery*, to enable you to beat your own time limitations.

Our wide experience with a variety of designs, serving the most exacting buyers in both the audio and power field gears us to this type of service. The companies we serve testify to the top quality of our product. Our engineers will be glad to help you solve your particular transformer problems.



WRITE THE HEADQUARTERS FOR AMERICA'S TRANSFORMER PROBLEMS

Suppliers to manufacturers demanding highest quality

NEW YORK TRANSFORMER CO.

Sales Department

51 West Third St.

New York, N.Y.

INSULATION HIGHLIGHTS

PROGRESSIVE ENGINEERING characterizes the design of Columbia Broadcasting System's new 50 KW shortwave stations, WCBX and WCRC, at Brentwood, L. I., soon to be placed in operation. Facilities of the stations are planned for efficient shortwave transmission of programs to Latin America and Europe. Because of present-day conditions, improved reception in these parts of the world of programs from the United States is considered essential.

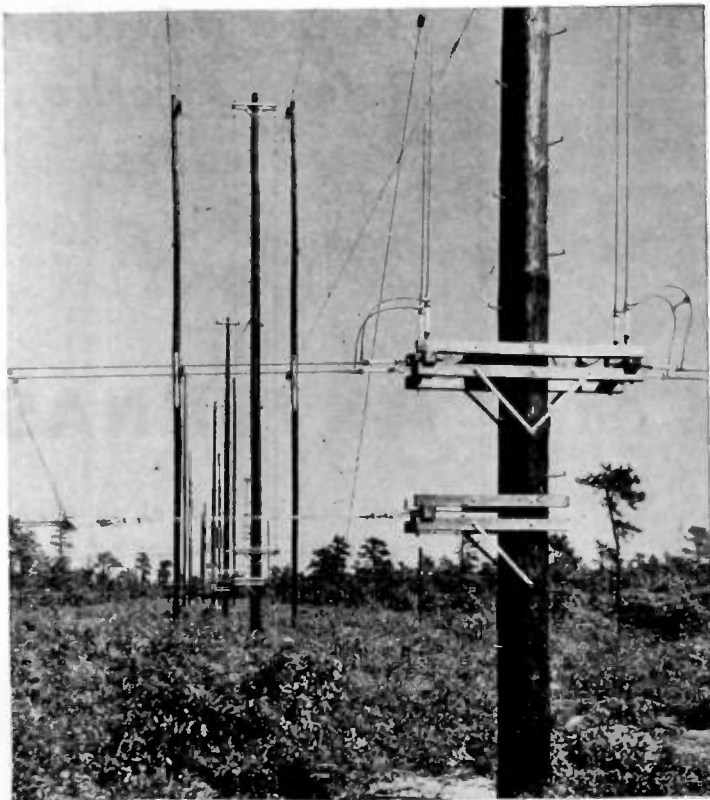

(Above) 13 DIRECTIONAL ANTENNAS are provided at the new stations, and several of them are of the four-section type shown here. Isolantite* strain insulators are extensively used in the construction of these antennas. These insulators find wide application in the radio and communications fields, because of their high mechanical strength and electrical efficiency.

**Registered trade-name for the products of Isolantite Inc.*

ISOLANTITE

CERAMIC INSULATORS

ISOLANTITE INC. FACTORY: BELLEVILLE, NEW JERSEY
SALES OFFICE: 233 BROADWAY, NEW YORK, N. Y.

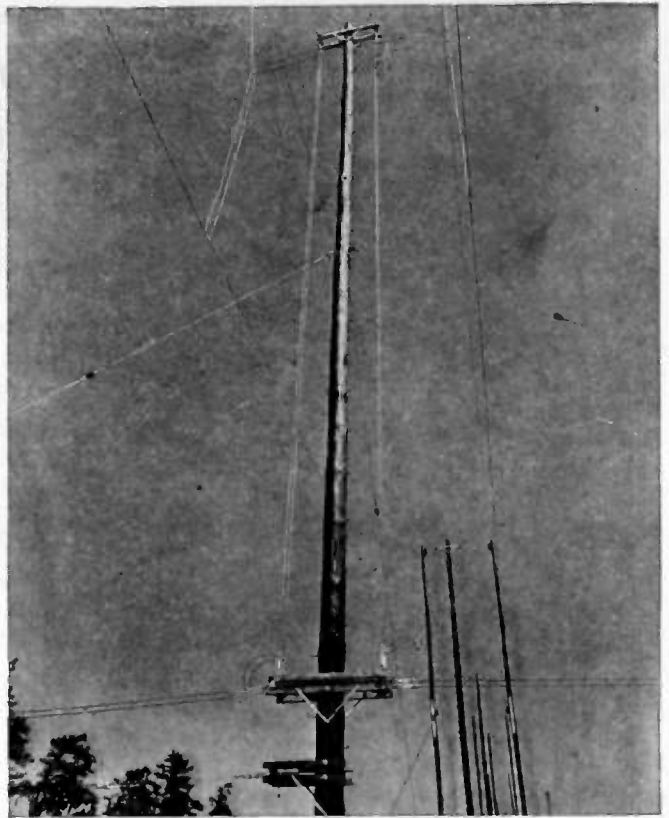

(Above) CONSTRUCTION DETAILS of the antennas are shown here. Horizontal wires at left near base of pole provide means for tuning the antennas through the medium of variable line shunts.

(Below) ISOLANTITE STRAIN INSULATORS are used also on lead-in wires from antennas to the building which houses the transmitting equipment built by Federal Telegraph Company. Transmitters can be quickly switched from one antenna to another, to maintain most efficient transmission at different times of day.

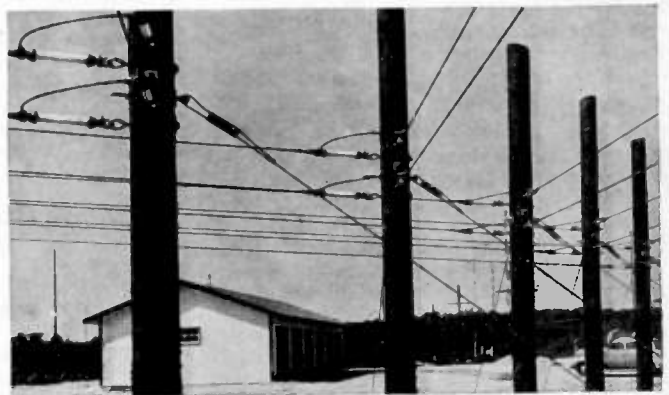

(Below) SPECIAL FITTINGS used on Isolantite strain and other types of Isolantite insulators at the new stations were designed and tested by engineers of Mackay Radio and Telegraph Company and the Columbia Broadcasting System. These fittings were manufactured by Burndy Engineering Company.

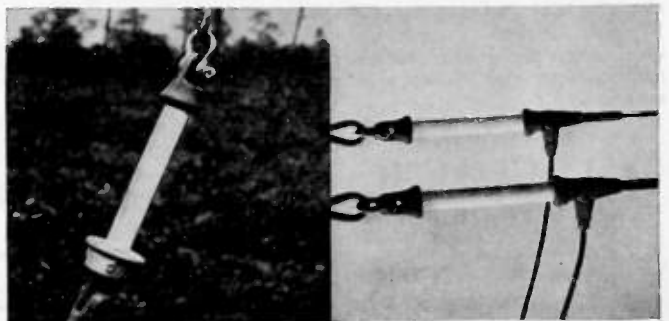

To Serve Well The
Professional Radioman



A Self-Defense Program that began in 1927

For 15 years CREI has helped equip engineers with the technical ability to advance to better positions

Important to ambitious men, before, during and long after any temporary emergency, is a planned program of study that enables them to step ahead into better positions with increased pay. This is a "self-defense" program for advancement that provides a secure future and lasting career.

CREI was founded for that purpose . . . to enable alert professional radiomen to acquire the necessary ability through modern technical training, which enables them to go after the better engineering positions—and get them.

Since 1927, CREI has been training radiomen and providing them with such a planned "Self-defense" program. Our successful record during these 15 years is created by the accomplishments of our graduates. Hundreds of unsolicited letters in our files testify to the fact that CREI training has been helpful in gaining better positions at higher pay in minimum time. Few other educational institutions have so fully gained the respect and confidence of the men of the radio industry. CREI courses have PROVEN their worth—they are recognized by employees and employers alike as the finest possible instructions at the lowest possible cost.

Alert engineers are encouraging CREI training for their employees. Your recommendation of our home study courses to your associates will increase the efficiency of your engineering staff. We will be glad to send our free booklet and complete details to you, or to any man whom you think would be interested.

"Since 1927"

CAPITOL RADIO
ENGINEERING INSTITUTE
E. H. Rietsko, President

Dept. PR-2, 3224-16th St. N.W.
Washington, D.C.

POSITIONS OPEN

The following positions of interest to I.R.E. members have been reported as open on February 1. Make your application in writing and address to the company mentioned or to

Box No.

PROCEEDINGS of the I.R.E.
330 West 42nd Street, New York, N.Y.

ELECTRONICS ENGINEER

Prominent midwestern manufacturer of electronic tubes has substantial opening for electronic tube engineer who is thoroughly grounded in his theory and who, at the same time, has had sufficient practical experience to develop samples and test tubes from drawings and blueprints. Position is permanent and offers an unusually fine opportunity with one of the outstanding companies in this field. In replying, please give complete information concerning yourself, and also if possible include a small photo. Box 261.

CRYSTAL ENGINEER

A midwestern manufacturer with government contract wants precision engineer capable of assuming full charge of crystal laboratory. The man we want must possess intimate knowledge of the business from raw quartz to finished units and be capable of assuming responsibility for quantity production of quality product that will pass government inspection. Please write full particulars which will be held confidential. Box 262.

JUNIOR & SENIOR TRANSMITTER ENGINEERS

A well established manufacturer in the East needs senior and junior engineers for production and installation work on a new industrial device employing a high-power, high-frequency oscillator. Applicants should have had manufacturing and field-service experience on installations at broadcast or higher frequencies. Box 251.

OPERATORS

The United States Civil Service Commission has just announced examinations for two types of positions for persons with operating experience in communications work. The first is for telegraph operator, \$1800 a year, and the second for communications machine operator (multiplex, simplex, or teletype), \$1620 a year. All the appointments will be made in Washington, D.C., and vicinity.

Applications must be on file with the

(Continued on page xvi)



Playing a Leading
Role in America's
Preparedness . . .



ANTENNAS

On sea, on land, at airports—maintaining communications under most critical conditions—serving defense needs.

In this national emergency, Premax has enlisted its entire personnel and experience in the manufacture of monel, aluminum and steel antennas. All are demonstrating their ability to meet critical requirements while maintaining the high standards of Premax service.

Send for catalog of Antennas and Mountings, or submit your specifications if special designs in fully telescoping, adjustable equipment are needed.

Premax Products
Division of Chisholm-Ryder Co., Inc.

4215 Highland Ave., Niagara Falls, N.Y.

FM W51C JUMPS TO 50,000 WATTS

with GL-880's

ZENITH RADIO CORPORATION

ZENITH
RADIO
9001 DICKENS AVENUE
CHICAGO, U.S.A.

October 27, 1942

Mr. Earl Abbott
General Electric Company
840 South Canal Street
Chicago, Illinois

Dear Mr. Abbott:

We have been operating W51C Zenith's Frequency-Modulated Radio Station in Chicago and its predecessor W9XZ for almost two years. Early in October we raised the power of this station to fifty thousand watts in accordance with the terms of our Construction Permit.

The original installation was planned more than a year ago on the basis of ultimately using two GL-880's in the final stage. These plans were based on the fact that the 880's appeared to us to be the most efficient transmitting tubes for high power operation on the high frequency band. It seemed very evident to us at the time that these tubes would permit the best circuit design and should, therefore, be most practical in a high-power frequency-modulation transmitter. Even though these tubes had not seen any commercial field service at the time of our original planning, we believed their use was logical and would represent a forward step.

We are glad to say that we have been very happy with their performance, and feel that we have without doubt made the correct choice. We have found them easy to drive, easy to neutralize, and have found no cooling problems. We believe we are going to receive excellent service from them.

Yours very truly,

ZENITH RADIO CORPORATION
G. E. Gustafson
J. E. Brown
ENGINEERING DEPARTMENT

JEB:BO

THE WORLD'S LARGEST RADIO FACTORY ON ONE FLOOR



"the most efficient tubes . . . for high frequencies"

The GL-880's ingenious "folded" anode reduces internal lead lengths by 10 inches without sacrificing cooling surface.

"easy to drive"

Two GL-880's with only 1500 watts driving power will deliver an easy 50 kw of FM at 50 mc.

"easy to neutralize"

Dual grid leads for separation of excitation and neutralization minimize neutralizing problems.

"no cooling problems"

The GL-880 is just one tube in General Electric's complete line of top performers. Specify "G-E" on your next tube order, and measure the difference yourself. *General Electric Co., Schenectady, New York.*



(Left) G. E. Gustafson, Asst. Vice President in Charge of Engineering; (right) J. E. Brown, Executive Engineer

This tube, although developed for FM and television, has unusual efficiency at international and standard broadcast frequencies. A pair will give a 50-kw plate-modulated carrier at 25 mc!



FOR



ALL YOUR



FM



NEEDS



FM Broadcast Transmitters
250 to 50,000 Watts

S-T Transmitters

Measuring and Testing
Equipment

Receivers for Home
and S-T Service

FM Police and Emergency
Transmitters and Receivers

Tubes

GENERAL ELECTRIC

101-311-8860

The Liberty Fleet...

*standardized for fast production
... adopts standard Radio Unit by*

IT&T





New Idea in Marine Radio Design Speeds Installation . . . Saves Space

Off the ways . . . and on the way, go America's Liberty Ships . . . mile after mile of new cargo vessels, stretching off endlessly down the ocean roadway toward America's allies and united victory. And this vast Armada of Liberty's Arsenal is a credit to the shipbuilders' craft.

Every cubic foot has been made to account for itself against the grim demand for precious cargo space. For example, in the radio room, not eight or ten, but *one*

compact marine radio telegraph unit supplies all needed communications facilities.

This all-in-one radio unit makes it possible to do at the factory practically all wiring and other work usually done aboard ship. Installed in one-fifth the time normally required — practically ready to tune in and plug in—it was designed and manufactured for the first 312 Liberty Ships by I. T. & T.'s subsidiary, The Federal Telegraph Company.



The compact, all-in-one radio unit designed and manufactured for the Maritime Commission by I. T. & T.'s subsidiary, The Federal Telegraph Company.

INTERNATIONAL TELEPHONE AND TELEGRAPH CORPORATION

67 Broad Street, New York, N. Y.

ATR VIBRATORS

"for DEFENSE"



PROVEN UNITS of the HIGHEST QUALITY

Engineered to perfection, ATR Vibrators set high standards of performance and construction. Available for any operating input voltage from 6 volts DC to 220 volts DC in a wide variety of designs for practically any application.

In addition to the most complete line of vibrators, ATR offers a very extensive line of Inverters and other Vibrator-Operated Power Supplies for changing one DC voltage to another DC voltage or to invert DC to AC.

ATR vibrators, the heart of vibrator-operated power supplies, are proven units of the highest quality, engineered to perfection. They are backed by more than ten years of vibrator design and research, development and manufacturing—ATR pioneered in the vibrator field. American Television & Radio Co. has consistently devoted its efforts and energies to the perfection and production of vibrators and associated equipment, and today, after ten years of painstaking, persistent and diligent work resulting in steady development and progress, is considered the World's leader in its field. All ATR Products incorporate only the best materials and workmanship and are carefully manufactured under rigid engineering inspections and tests, making them the finest that can be built.

For Additional Information
Address ATR Vibrator Division of

AMERICAN TELEVISION & RADIO CO.
ST. PAUL, MINN., U.S.A.

POSITIONS OPEN

(Continued from page xii)

Civil Service Commission, Washington, D.C., not later than March 3, 1942. Copies of the examination announcement giving full instructions for filing, and application forms, may be obtained at first- and second-class post offices, or from the Commission's central office in Washington.

ELECTRICAL ENGINEER

Electrical engineer with good physics background for developmental work wanted by an established eastern manufacturer. Experience with the development of transmitting and measuring equipment desirable. State qualifications and salary desired. Box 255.

RECORDING ENGINEER

A well rated, well-known independent recording and production studio requires the services of a design, maintenance and recording engineer to assume charge of their New York studio. Salary commensurate with calibre and standing of that engineer's ability and reputation. This change is made necessary by the loss of some of our present staff to the armed forces. Box 263.

ELECTRONICS ENGINEER

Competent electronics engineer wanted to build experimental electronic test equipment. Must be capable of complete layout, construction and test from a schematic diagram. Engineering background desirable but not essential. Applications not solicited from persons now employed in aircraft manufacturing industry. Apply by letter to Installation Department, Pratt & Whitney Aircraft, East Hartford, Conn.



Attention Employers . . .

Announcements for "Positions Open" are accepted without charge from employers offering salaried employment of engineering grade to I.R.E. members. Please supply complete information and indicate which details should be treated as confidential. Address: "POSITIONS OPEN," Institute of Radio Engineers, 330 West 42nd Street, New York, N.Y.

The Institute reserves the right to refuse any announcement without giving a reason for the refusal.



TIME STANDARD

TUNING FORK CONTROLLED

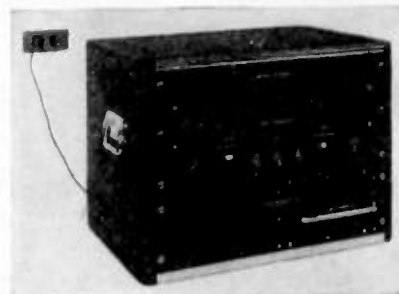

A COMPLETE, self-contained stable fixed frequency power oscillator for:

1. Driving galvanometers for oscillographs, oscillograph cameras, etc.
2. A source of constant frequency sine-wave voltage for all types of a-c. bridge circuits.
3. Driving synchro-chronographs.
4. A time standard for adjusting motors, generators, etc.
5. A source of modulating current for signal generators and radio beacons.

Also for many other uses where an alternating current of constant and known frequency is desired.

★ This instrument consists essentially of an electronically driven 500-cycle tuning fork and an electrically isolated pickup and power amplifier as the source of the output power. *The fork is free of all mechanical connections.*

★ **OUTPUT**—2½ watts maximum undistorted sine-wave stepless power (continuously variable), controlled by a knob on the panel from 0 to 2½ watts.

★ **TUNING FORK**—Frequency, 500 cycles per second $\pm 0.2\%$ at 25° C. (calibrated to tolerances as close as 0.001% at extra cost). Temperature coefficient of frequency, minus 0.012% per degree Centigrade.

The self-starting tuning fork is completely protected and shielded by a heavy metal box, and its temperature is unaffected by its operation, i.e., no heat is generated by the fork.

A thermometer on the front panel (protected by a metal trough) indicates the temperature of the air in the fork compartment. It has a range of 10° to 50° C. and can be read to 0.1° C.

Available also with constant temperature oven.

Time Standards for frequencies other than 500 cycles per second are available.

Fully Described in
BULLETIN IRE2089

AMERICAN
INSTRUMENT CO.
8010-8020 Georgia Ave.
Silver Spring, Maryland

LOW INSTALLATION COSTS

LOW OPERATING COSTS

with this

50 KILOWATT BROADCAST TRANSMITTER

RCA TYPE 50-E

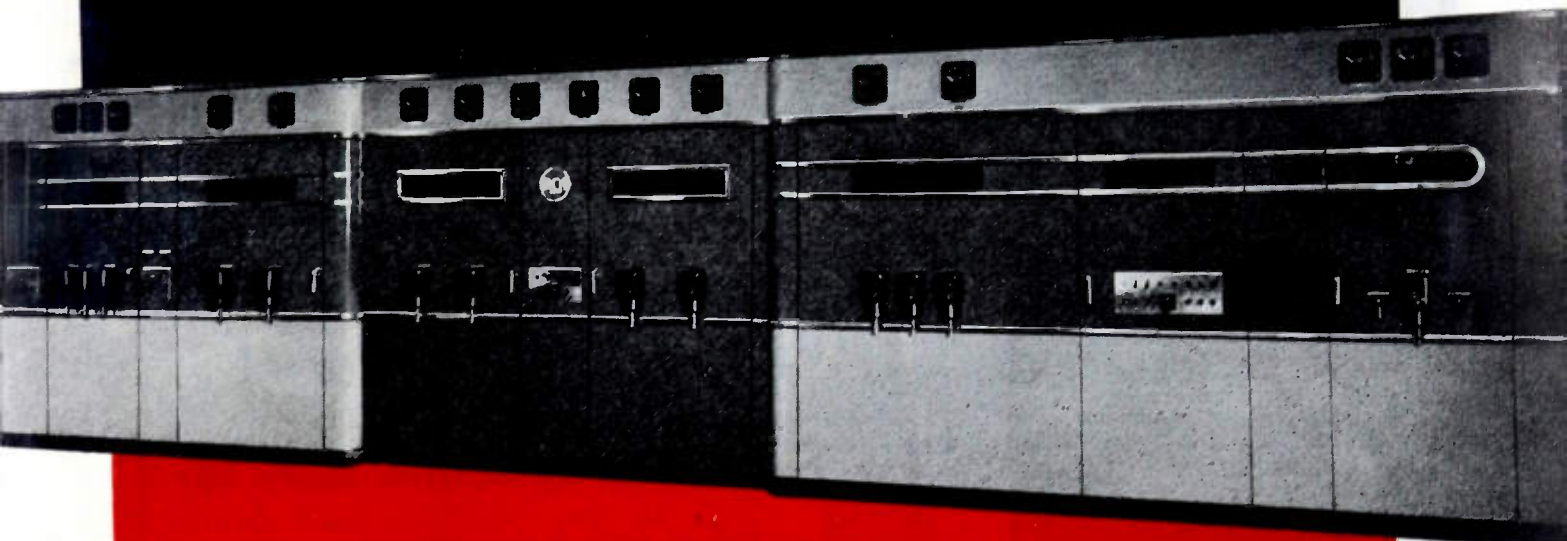

HIGH-FIDELITY quality output, that pleases advertisers and audiences alike, can be combined with impressive savings in a 50 kw. transmitter! Here's how advanced RCA engineering does it:

HIGH-LEVEL CLASS "B" MODULATION in the 50-E gives you the double economy of low power-consumption and extremely long tube life. At average modulation, the transmitter draws approximately 115 kw. from your power line—less than \$2.50 an hour at New York City current rates. And high-level modulation means better audio quality, too . . . the 50-E is virtually free from cross-modulation distortion; flat within ± 1 db. from 50 to 10,000 cycles.

AIR-COOLED TUBES THROUGHOUT cut down both installation and operating costs. No water-pumps. No water-coolers. No water-problems, pipes or

tanks! And no monthly water-bills . . .

BUILT-IN WIRE-DUCT still further reduces your installation costs by eliminating floor-trenches between units. **UNIFIED FRONT PANEL** construction presents a more pleasing appearance combined with cleaner mechanical design and mounting of equipment. **VERTICAL CHASSIS CONSTRUCTION**, without horizontal shelves, makes all parts easily accessible.

Only 281 square feet of floor space is ample for the 50-E (less external blower and transformer equipment). Complicated and cumbersome mechanical controls are eliminated by the use of electrical tuning on the RF power amplifier and exciter stages—adjustments are made by push-buttons on the front panel . . . Ask your nearest district office sales representative to tell you the complete story.

Use RCA Radio Tubes in your station for finer performance



Broadcast Equipment



WIRE and RIBBON

For Direct-Heated
ELECTRON EMITTERS
in
VACUUM TUBES

In a complete range
of sizes and alloys for

- TRANSMITTING
- RECEIVING
- BATTERY and
- HEARING AID TUBES

Melted and worked under close supervision to assure maximum emissivity, uniformity and the highest tensile strength . . .

• WIRES

drawn to .0005" diam.

• RIBBON

rolled to .0001" thick

• SPECIAL ALLOYS

made to meet your individual specifications

Write for list of stock alloys

SIGMUND COHN

44 GOLD ST. NEW YORK

SINCE  1901



**Communication established -
but not without transformers +
dependable transformers!**

THORDARSON

Transformers

THORDARSON ELECTRIC MFG. CO., CHICAGO, ILL.

Transformer Specialists Since 1895



INDEX

Positions Open xii, xvi

DISPLAY ADVERTISERS

A		International Telephone & Telegraph Corp. xiv, xv
Aerovox Corporation iv	American Instrument Company xvi	Isolantite Inc. xi
American Lava Corporation ix	American Telephone & Telegraph Co. vi	N
American Television & Radio Co. xvi	B	New York Transformer Company x
B	Bliley Electric Company x	P
C	C	Premax Products xii
Capitol Radio Engineering Institute xii	Cohn, Sigmund xviii	R
Cornell-Dubilier Electric Corporation Cover III	D	Radio Corporation of America ii
D	Daven Company v	RCA Manufacturing Company, Inc. xvii, xx
G	G	S
General Electric Company xiii	General Radio Company Cover IV	Sprague Specialties Company vii
H	H	Superior Electric Company i
Hygrade Sylvania Corporation xix	I	T
I	International Resistance Company viii	Thordarson Electric Mfg. Company xviii
U	U	Triplett Electrical Instrument Co. x
United Transformer Company Cover II	W	W
Westinghouse Electric & Manufacturing Co. iii		

**THE STOUT HEART
OF SURE
RECEPTION**



DELICATE though the job a radio tube must perform, upon its ruggedness depends the infallibility of the set it serves.

And how importantly such ruggedness counts today — in the many wartime applications of radio.

But fortunately there is a tube that has what it takes to withstand the devastating shocks and concussions of battle—a tube especially engineered to stouten the heart of sure reception.

That's the Sylvania Lock-In Tube—with its connections welded, not soldered — with its fewer joints, its all-glass header, and its vastly improved mount support — each as important as the exclusive lock-in lug

from which it derives its name.

Here alert, progressive Sylvania engineering has scored again—and at a time of vital import in the history of radio's service to America.

SYLVANIA

RADIO TUBE DIVISION

HYGRADE SYLVANIA CORPORATION

New York City

EMPORIUM, PA.

Salem, Mass.

Also makers of HYGRADE Incandescent Lamps, Fluorescent Lamps and Fixtures.

USE THESE RCA TRANSMITTING TUBE INSTRUCTION SHEETS AS YOUR GUIDE



INSURE LONGER LIFE FOR TUBES THAT MAY BE DIFFICULT TO REPLACE!

FOR LONGER TUBE LIFE—

- ▶ For types using pure tungsten filaments, a reduction in filament voltage greatly lengthens tube life.
- ▶ For types using thoriated-tungsten filaments, maintaining filament at rated voltage results in longer life. Operation either under or over normal voltage may result in shorter life.
- ▶ For types using oxide-coated cathodes, maintain filaments at rated voltage.
- ▶ For all types, reduce dissipation in grids and plates to a minimum to avoid overloading and to obtain materially longer life.

Many new Transmitting Tubes for commercial and civilian uses may become even harder to obtain because of the tremendous War-purpose demand. It is, therefore, not only a patriotic duty, but sound business policy as well, for tube users to conserve tube life by observing special care and operating practices which may add thousands of hours of life to tubes now in operation.

It is an old story that RCA Transmitting Tubes are built to withstand plenty of abuse — so much so that abnormal operating conditions are frequently accepted as "normal." Even though tube life has been entirely satisfactory under such conditions, it is by no means as long as might be

obtained, simply by careful, conservative use of the tubes as outlined in the Instruction Booklet packed with each one.

In short, these are days when it is essential to give tubes all the care you can give them. Maximum life now becomes far more important than optimum performance. RCA welcomes the opportunity to cooperate in helping RCA Transmitting Tube users extend tube life to its fullest!

If you do not have Instruction Booklets on the RCA Tube types in your transmitter, write Commercial Engineering Section, RCA Manufacturing Co., Inc., Harrison, N. J., for free copies. Be sure to mention tube number.



Transmitting Tubes



RCA MANUFACTURING CO., Inc., Camden, N.J. • A Service of The Radio Corporation of America
In Canada: RCA Victor Company Limited, Montreal



What it takes to *keep 'em flying*

Back of the safety record of America's leading airlines is the world's most dependable radio equipment. Significantly, Cornell-Dubilier capacitors are used by all these major airlines both in ground station and aircraft communications. Here is convincing proof that C-Ds have what it takes — *extra* dependability not only to "keep 'em flying", but to meet your most exacting capacitor requirements.

CAPACITORS MAY LOOK ALIKE BUT...

There is extra long life, extra uniformity and dependability built into C-Ds. Next time you specify capacitors, look for the Cornell-Dubilier seal of experienced engineering. And get the *hidden* extras at no extra cost. Send for catalog. Cornell-Dubilier Electric Corporation, 1012 Hamilton Blvd., South Plainfield, New Jersey. New England Div., New Bedford, Mass.



EQUIPMENT CHART

PART	50 51 58 59 60 61 251 1251
BEACON RECEIVER	277 195 3
AUXILIARY RECEIVER	1033
MICROPHONE	
HEADSETS	
AUXILIARY BA	
LOOP	
LOOP AMPLI	
LOOP DRIV	
AZIMUT	



Cornell Dubilier

... MORE IN USE TODAY THAN ANY OTHER MAKE ...

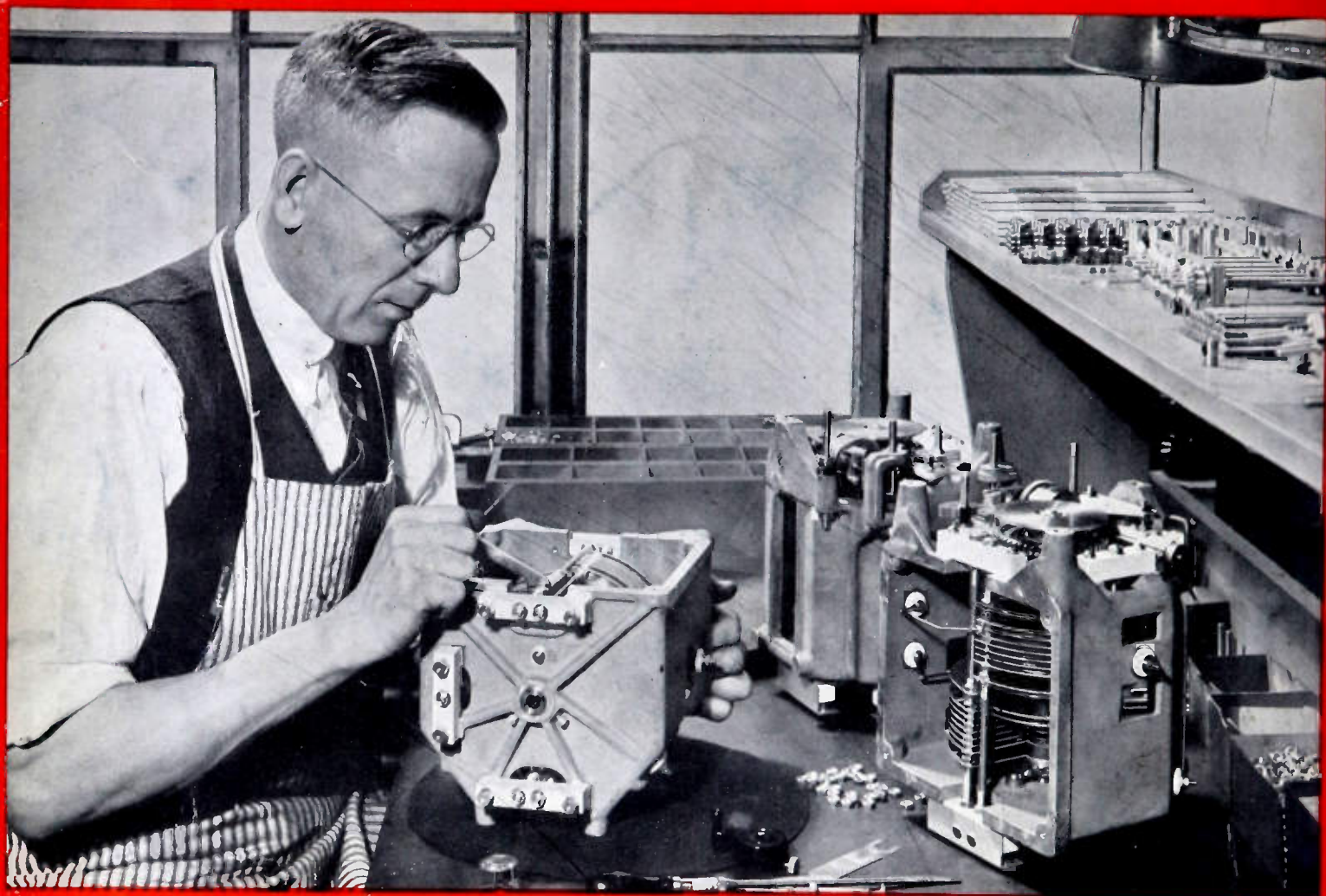

CRAFTSMEN ... 1942 STYLE

BELYING the popular conception of a craftsman . . . a long-bearded gent whose great-grandfather also made fine watches . . . is the modern shop worker whose mechanical skill equals, and often exceeds, that of the Old World mechanic. Even in this modern age of mass production there is more fine craftsmanship shown than the Old World ever dreamed possible.

General Radio, in the manufacture of precision electrical measuring apparatus, has its share of craftsmen whose fine mechanical skill is of the highest order. Take P. A. Sharpe, for example. He came to General Radio in 1924 to assemble intermediate-frequency transformers. Then in 1926 he graduated to the assembly of broadcast-receiver variable condensers. After a brief session with hot-wire meters, thermo-couples and string oscillographs . . . all with enough delicate parts to try the patience of a saint. . . Sharpe returned to condenser manufacture.

Since 1930 Sharpe has devoted his entire time to the manufacture of precision condensers, both the stock laboratory type and the more precise "bath-tub" models used in commercial and governmental frequency meters and similar precision equipment.

If there is doubt that true craftsmanship is required to assemble one of these precision condensers, you should drop in on Sharpe late some afternoon and watch him struggle with a row of condensers in the making, particularly on one of those days when nothing will seem to go together properly. The mechanical tolerances allowed for the numerous parts of a G-R precision condenser are so small that many times it is a feat even to assemble a group of these condensers!

Percy Sharpe is typical of the large majority of General Radio men, most of whom have been working for some years on only a few instruments. In the interest of quality G-R has limited its production to small lots so that each man will concentrate on one or two instruments at a time. As a result G-R workmen know how to assemble G-R equipment rapidly and accurately no matter how complex the job is. In the assembly department G-R has never employed inexperienced and unskilled workmen.

All G-R apparatus is put together by men like Percy Sharpe, men who have been with the company for years and who will continue to show expert craftsmanship on G-R equipment for years to come.

GENERAL RADIO COMPANY

CAMBRIDGE, MASSACHUSETTS

Branches in New York and Los Angeles