

Proceedings

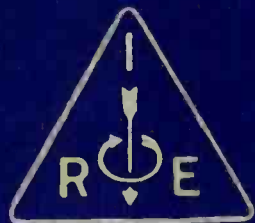

of the

I·R·E

APRIL 1940

VOLUME 28

NUMBER 4

Single-Sideband Musa Receiving
System

Gradation of Television Pictures

High-Frequency Propagation
Characteristics

Damped Electromagnetic Waves

Oscillations of Electrical Cavity
Resonators

Ionospheric Characteristics

Institute of Radio Engineers



Fifteenth Annual Convention
Boston, Mass., June 27, 28, and 29, 1940



Pacific Coast Convention
Los Angeles, Calif., August 27 and 28, 1940

(Submit technical papers by June 15, 1940, to Prof. S. S. Mackeown, California Institute of Technology, Pasadena, Calif.)

New York Meeting—June 5, 1940

SECTION MEETINGS

ATLANTA

May 17

CLEVELAND

May 23

LOS ANGELES

May 21

BALTIMORE

May 17

CONNECTICUT VALLEY

May 23

PITTSBURGH

May 21

CINCINNATI

May 14

DETROIT

May 17

WASHINGTON

May 13

SECTIONS

ATLANTA—Chairman, P. C. Bangs; Secretary, Adolph Andersen, Federal Communications Commission, 411 Federal Annex, Atlanta, Ga.

BALTIMORE—Chairman, C. A. Allert; Secretary, Alexander Whitney, 105 Shady Nook Ct., Catonsville, Md.

BOSTON—Chairman, W. L. Barrow; Secretary, P. K. McElroy, General Radio Co., 30 State St., Cambridge, Mass.

BUENOS AIRES—Chairman, A. M. Stevens; Secretary, E. E. Kapus, Bolivar 1743, Buenos Aires, Argentina.

BUFFALO-NIAGARA—Chairman, K. B. Hoffman; Secretary, E. C. Waud, 235 Huntington Ave., Buffalo, N. Y.

CHICAGO—Chairman, E. H. Kohler; Secretary, P. C. Sandretto, United Air Lines Transport Co., 5936 S. Cicero Ave., Chicago, Ill.

CINCINNATI—Chairman, C. H. Topmiller; Secretary, W. L. Schwesinger, WSAI, Cincinnati, Ohio.

CLEVELAND—Chairman, R. L. Kline; Secretary, J. D. Woodward, WGAR, Hotel Statler, Cleveland, Ohio.

CONNECTICUT VALLEY—Chairman, R. N. Ferry; Secretary, W. M. Smith, 250 Main St., Suffield, Conn.

DETROIT—Chairman, J. D. Kraus; Secretary, Paul Frincke, WJBK, 6559 Hamilton Ave., Detroit, Mich.

EMPORIUM—Chairman, C. R. Smith; Secretary, H. L. Ratchford, Hygrade Sylvania Corp., Emporium, Pa.

INDIANAPOLIS—Chairman, I. M. Slater; Secretary, B. V. K. French, P. R. Mallory & Co., E. Washington St., Indianapolis, Ind.

LOS ANGELES—Chairman, A. C. Packard; Secretary, J. N. A. Hawkins, 3239 Laclede Ave., Los Angeles, Calif.

MONTREAL—Chairman, A. B. Oxley; Secretary, W. A. Nichols, Canadian Broadcasting Corp., 1012 Keefer Bldg., Montreal, Que.

NEW ORLEANS—Chairman, G. H. Peirce; Secretary, D. W. Bowman, 8327 Sycamore St., New Orleans, La.

PHILADELPHIA—Chairman, R. S. Hayes; Secretary, R. L. Snyder, 103 Franklin Rd., Glassboro, N. J.

PITTSBURGH—Chairman, Joseph Baudino; Secretary, Gary Muffly, Gulf Research and Development Corp., Drawer 2038, Pittsburgh, Penna.

PORTLAND—Chairman, Marcus O'Day; Secretary, Earl Schoenfeld, 1627 S. E. Elliott Ave., Portland, Ore.

ROCHESTER—Chairman, W. F. Cotter; Secretary, H. C. Sheve, Stromberg-Carlson Telephone Manufacturing Co., Rochester, N. Y.

SAN FRANCISCO—Chairman, Carl Penther; Secretary, H. E. Held, 420 Market St., San Francisco, Calif.

SEATTLE—Chairman, R. M. Walker; Secretary, L. B. Cochran, University of Washington, Seattle, Wash.

TORONTO—Chairman, G. J. Irwin; Secretary, N. Potter, Canadian National Carbon Co., Ltd., 805 Davenport Rd., Toronto, Ont.

WASHINGTON—Chairman, L. C. Young; Secretary, E. M. Webster, Federal Communications Commission, Rm. 5319, New Post Office Bldg., Washington, D. C.

BOARD OF DIRECTORS
 Lawrence C. F. Horle, *President*
 Frederick E. Terman,
Vice President
 Melville Eastham, *Treasurer*
 Harold P. Westman, *Secretary*
 Austin Bailey
 W. R. G. Baker
 Frederick W. Cunningham
 Henry C. Forbes
 Alfred N. Goldsmith
 Virgil M. Graham
 O. B. Hanson
 Raymond A. Heising
 C. M. Jansky, Jr.
 Frederick R. Lack
 Frederick B. Llewellyn
 Haraden Pratt
 Browder J. Thompson
 Hubert M. Turner
 Arthur F. Van Dyck
 Harold A. Wheeler
 Lynde P. Wheeler

BOARD OF EDITORS
 Alfred N. Goldsmith, *Chairman*
 Ralph R. Batcher
 Philip S. Carter
 Elmer W. Engstrom
 Frederick W. Grover
 J. Warren Horton
 Greenleaf W. Pickard
 Benjamin E. Shackelford
 Karl S. Van Dyke
 Harold P. Westman, *ex officio*
 Harold A. Wheeler
 Lynde P. Wheeler
 Laurens E. Whittemore
 William Wilson

PAPERS COMMITTEE
 William Wilson, *Chairman*
 Frederick B. Llewellyn,
Vice Chairman
 Herman A. Affel
 Edmond Bruce
 Howard A. Chinn
 James K. Clapp
 Tunis A. M. Craven
 Robert B. Dome
 Paul O. Farnham
 Enoch B. Ferrell
 Elmer L. Hall
 Dorman D. Israel
 Loren F. Jones
 De Loss K. Martin
 Harry B. Marvin
 Harry F. Mimno
 Albert F. Murray
 Harold O. Peterson
 Ralph K. Potter
 Hubert M. Turner
 Dayton Ulrey
 Arthur F. Van Dyck
 Paul T. Weeks
 William C. White
 Irving Wolff

Helen M. Stote, *Assistant Editor*
 John D. Crawford,
Advertising Manager

Proceedings of the I·R·E

Published Monthly by
 The Institute of Radio Engineers, Inc.

VOLUME 28 *April, 1940* NUMBER 4

A Single-Sideband Musa Receiving System for Commercial Operation on Transatlantic Radiotelephone Circuits.....	F. A. Polkinghorn	157
The Gradation of Television Pictures.....	Heinz E. Kallmann	170
High-Frequency Propagation Characteristics.....	F. Hamburger, Jr., C. V. Larrick, and Martin Jones	175
Damped Electromagnetic Waves in Hollow Metal Pipes.....	Arthur W. Melloh	179
Natural Oscillations of Electrical Cavity Resonators.....	W. L. Barrow and W. W. Mieher	184
Characteristics of the Ionosphere at Washington, D. C., February, 1940, with Predictions for May, 1940..	T. R. Gilliland, S. S. Kirby, and N. Smith	191
Institute News and Radio Notes.....		193
Board of Directors.....		193
Committees.....		193
New York Meeting.....		194
Sections.....		194
Membership.....		197
Books.....		198
"Engineering Opportunities," edited by R. W. Clyne.....	Frederick W. Grover	
"Electrical Communication," Second Edition, by Arthur Lemuel Albert.....	Frederick W. Grover	
"The Theory and Use of the Complex Variable," by S. L. Green.....	P. S. Carter	
Committee Personnel, 1940.....		199
Institute Representatives on Other Bodies.....		200
Contributors.....		201

Entered as second-class matter October 26, 1927, at the post office at Menasha, Wisconsin, under the Act of February 28, 1925, embodied in Paragraph 4, Section 412 of the Postal Laws and Regulations. Publication office, 450 Ahnaip Street, Menasha, Wisconsin. Subscription, \$10.00 per year; foreign, \$11.00.

THE INSTITUTE

The Institute of Radio Engineers serves those interested in radio and allied electrical-communication fields through the presentation and publication of technical material. In 1913 the first issue of the PROCEEDINGS appeared; it has been published uninterruptedly since then. Over 1800 technical papers have been included in its pages and portray a currently written history of developments in both theory and practice.

STANDARDS

In addition to the publication of submitted papers, many thousands of man-hours have been devoted to the preparation of standards useful to engineers. These comprise the general fields of terminology, graphical and literal symbols, and methods of testing and rating apparatus. Members received a copy of each report. A list of the current issues of these reports follows:

Standards on Electroacoustics, 1938
Standards on Electronics, 1938
Standards on Radio Receivers, 1938
Standards on Radio Transmitters and Antennas, 1938.

MEETINGS

Meetings at which technical papers are presented are held in the twenty-three cities in the United States, Canada, and Argentina listed on the inside front cover of this issue. A number of special meetings are held annually and include one in Washington, D. C., in co-operation with the American Section of the International Scientific Radio Union (U.R.S.I.) in April, which is devoted to the general problems of wave propagation and measurement technique, the Rochester Fall Meeting in co-operation with the Radio Manufacturers Association in November, which is devoted chiefly to the problems of broadcast-receiver design, the Pacific Coast Convention, which is held each year during the summer months and is supervised by a joint committee of our four Pacific Coast sections, and the Annual Convention, which will be held in New York City during January.

MEMBERSHIP

Membership has grown from a few dozen in 1912 to more than five thousand. Practically every country in the world in which radio engineers may be found is represented in our membership roster. Approximately a quarter of the membership is located outside of the United States. There are several grades of membership, depending on the qualifications of the applicant. Dues range between \$3.00 per year for Students and \$10.00 per year for Members. PROCEEDINGS are sent to each member without further payment.

PROCEEDINGS

The contents of each paper published in the PROCEEDINGS are the responsibility of the author and are not binding on the Institute or its members. Material appearing in the PROCEEDINGS may be reprinted or abstracted in other publications on the express condition that specific reference shall be made to its original appearance in the PROCEEDINGS. Illustrations of any variety may not be reproduced, however, without specific permission from the Institute.

Papers submitted to the Institute for publication shall be regarded as no longer confidential. They will be examined by the Papers Committee and Board of Editors to determine their suitability for publication. Suggestions on the mechanical form in which manuscripts should be prepared may be obtained from the Secretary.

SUBSCRIPTIONS

Annual subscription rates for the United States of America, its possessions, and Canada, \$10.00; to college and public libraries when ordering direct, \$5.00. Other countries, \$1.00 additional.

The Institute of Radio Engineers, Inc.

Harold P. Westman, Secretary

330 West 42nd Street

New York, N.Y.



Copyright, 1940, by The Institute of Radio Engineers, Inc.



A Single-Sideband Musa Receiving System for Commercial Operation on Transatlantic Radiotelephone Circuits*

F. A. POLKINGHORN†, FELLOW, I.R.E.

Summary—In the operation of short-wave radiotelephone circuits selective fading is observed which is a result of the combination at the receiving antenna of waves which have arrived from the transmitter over paths of different lengths. The poor quality resulting from this fading may be mitigated by increasing the directivity of the receiving antenna in the vertical plane so as to favor the waves arriving at one angle to the exclusion of others. Friis and Feldman have described an experimental system designed to accomplish this end which they call a "musa" receiving system. This system was found under certain transmission conditions to give an improvement in the grade of circuit which could be obtained. A commercial installation of this type has now been constructed for use on the single-sideband circuits of the American Telephone and Telegraph Company from England. Two receivers have been provided for the operation of four radiotelephone circuits.

The antenna system consists of a row of 16 rhombic antennas two miles long, each antenna connected by a separate transmission line to receivers located near the center of the row of antennas. In each receiver the signals from the antennas are combined in the proper phase to permit simultaneous reception from three adjustable vertical angles. The three signals are then added through delay-equalizing circuits or discretely selected on the basis of amplitude to obtain diversity reception. A fourth branch of the receiver has its vertical angle of reception continuously varying and is used to set automatically the angles of reception of the three diversity branches. The delay-equalization is also automatically adjusted. A recorder is provided which continuously registers the relative carrier field strength with variation of vertical angle of reception, and the amount of delay equalization.

INTRODUCTION

IN THE operation of short-wave radiotelephone circuits fading is observed which is caused by the combination at the receiving antenna of waves which arrive at different vertical angles and which have traveled from the transmitter over paths of different lengths. This fading may be mitigated by increasing the directivity of the receiving antenna in the vertical plane so as to favor the waves arriving over one path to the exclusion of the others.^{1,2} It is not possible, however, to increase this directivity to any great extent with an ordinary antenna system before it is found that the signal arrives outside the angular range of the antenna an appreciable part of the time. To overcome this difficulty Friis and Feldman experimented with a receiving system consisting of a number of antennas, each having moderate directivity and each connected by a separate transmission line to a receiver where the outputs are phased by a variable phase-shifting system in such a manner as to give a system of high, variable directivity. A system of this kind, which they called a "musa" system from the initial letters of "multiple-unit steerable antenna,"

* Decimal classification: R412. Original manuscript received by the Institute, February 9, 1940.

† Bell Telephone Laboratories, Inc., New York, N. Y.

¹ E. Bruce, "Developments in short-wave directive antennas," *Proc. I.R.E.*, vol. 19, pp. 1406-1433; August, (1931).

² E. Bruce and A. C. Beck, "Experiments with directivity steering for fading reduction," *Proc. I.R.E.*, vol. 23, pp. 357-371; April, (1935).

was built and found to give under most transmission conditions an improvement in the grade of circuit which could be obtained.³ Accordingly, it was decided that a commercial system should be built for use on the circuits of the American Telephone and Telegraph Company from England. A corresponding system of modified design has been built by the British General Post Office.⁴ The purpose of this paper is to review a few of the principles upon which a musa receiver operates, to describe the equipment which has been built in this country, and to discuss some of its operating characteristics.

The transmissions which are to be received are of the so-called twin single-sideband reduced-carrier type described by Oswald⁵ and consist of two sidebands, representing two distinct speech channels, on opposite sides of a carrier which is 16 to 26 decibels below the maximum sideband amplitude. Under normal conditions one of the sidebands is adjacent to the carrier while the second is spaced by the width of one sideband from the carrier. A single-sideband receiver for this type of transmission has been described by Roetken⁶ and many of the features discussed by him were developed for use also in the musa receivers. These features include highly stable oscillators, crystal filters, and automatic tuning circuits.

OUTLINE DESCRIPTION OF RECEIVERS

A block schematic of one channel of the commercial musa system is shown in Fig. 1. The 16 rhombic antennas are placed in a line two miles long in the direction of the English transmitting station. Separate transmission lines lead from each antenna to a building placed a little to one side of the rear of the ninth antenna. Two receivers, only one of which is shown in the figure, are connected in parallel to each transmission line. Each receiver is designed to receive five specific frequencies, ranging from 4810 to 18,620 kilocycles, assigned to the corresponding transmitter in England.

After passing through selective input circuits the

³ H. T. Friis and C. B. Feldman, "A multiple unit steerable antenna for short-wave reception," *Proc. I.R.E.*, vol. 25, pp. 841-917; July (1937); *Bell Sys. Tech. Jour.*, vol. 16, pp. 337-419; July, (1937).

⁴ A. J. Gill, Wireless Section, Chairman's Address, *Jour. I.E.E.* (London), vol. 84, pp. 248-260; February, (1939).

⁵ A. A. Oswald, "A short-wave single side-band radiotelephone system," *Proc. I.R.E.*, vol. 26, pp. 1431-1454; December, (1938).

⁶ A. A. Roetken, "A single-side-band receiver for short-wave telephone service," *Proc. I.R.E.*, vol. 26, pp. 1455-1465; December, (1938).

signals from each antenna are demodulated by a common oscillator to a band adjacent to a carrier frequency of 2900 kilocycles. The signals, after going through two stages of intermediate-frequency amplification are then applied to the inputs of four phase-shifter systems in parallel. In each of these phase-shifter systems the signals from the 16 antennas are combined so as to give reception from a particular vertical angle. This angle can be varied by a mechanical movement of a phase-shifter drive shaft. Three of

is connected to the line. Both of these operations are performed automatically. The output of the monitoring phase-shifter group is also heterodyned to 100 kilocycles and after amplifying the carrier only it is rectified and applied to an automatic system for adjusting the phase shifters of the three diversity branches.

A general view of the receivers is shown in Fig. 2. The principal parts of the two musa receivers occupy three rows of bays each about 25 feet long and 11½

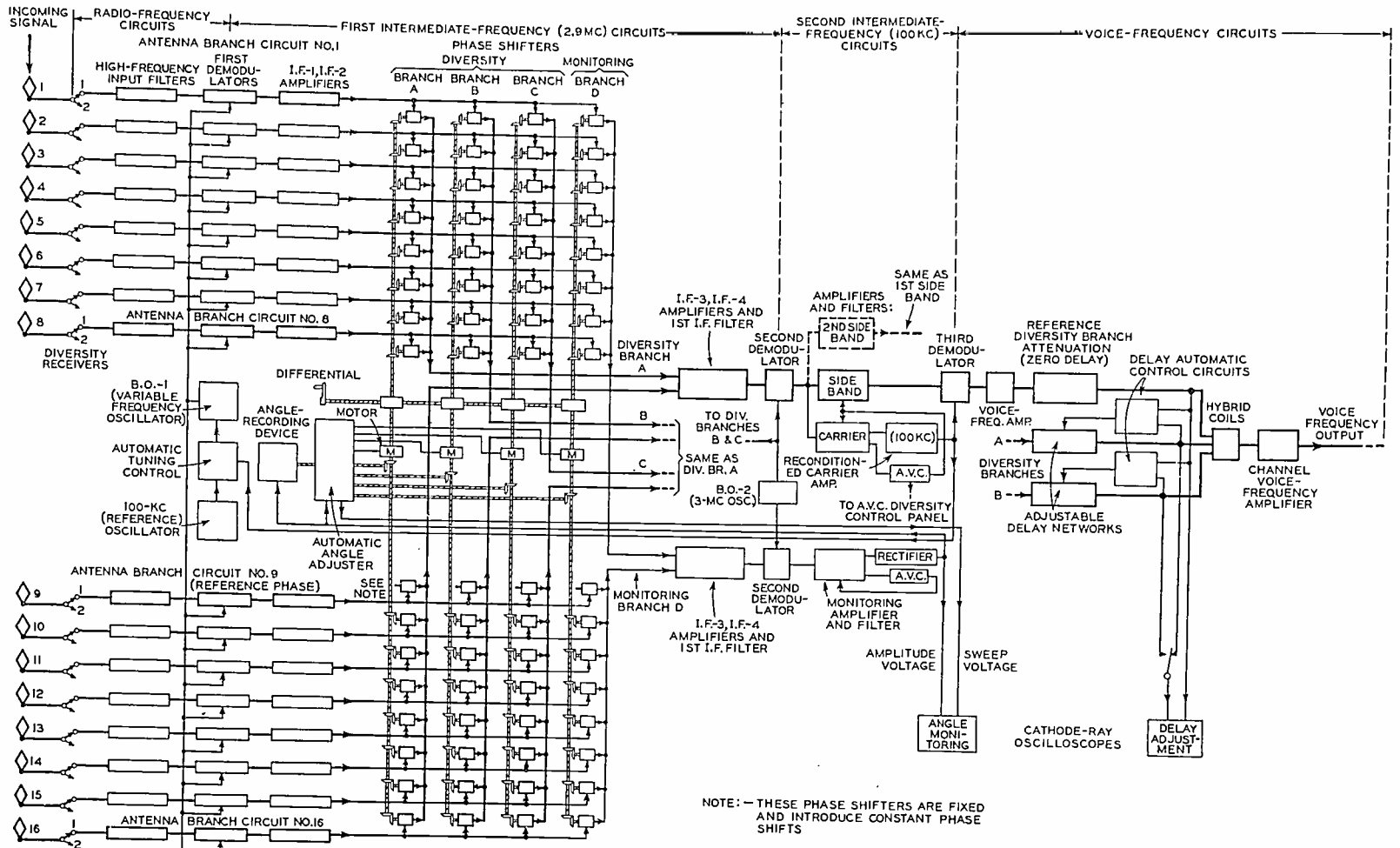

Fig. 1—Block schematic diagram of one musa receiver.

the phase-shifter-system outputs are used for a three-branch angular-diversity system in which the signals arriving over three separate paths are separately received and then either combined or individually selected for connection to the line, while the fourth branch is used for monitoring to determine where the phase shifters of the three diversity branches should be set in order to receive the best signals. From each phase-shifter group the circuit continues through the first intermediate-frequency filter and two further stages of amplification to the second demodulator where the 2900-kilocycle carrier frequency is shifted to 100 kilocycles. The carriers and sidebands of each diversity branch are then amplified separately and again combined in the final demodulators to give three distinct voice-frequency outputs for each sideband. These three outputs are either combined after inserting variable delay in two of the branches or, optionally, the branch having the greatest signal at any instant

feet high. The row shown on the right contains the input circuits and first demodulators for both receivers. The middle row contains the remaining equipment for one receiver and the left row that for the second receiver. In addition there are five bays of rectifiers and power control equipment located in a fourth row which is not shown.

GENERAL

When waves arriving over several paths from the same transmitter are demodulated in a simple receiver the severity of the resultant selective fading is dependent upon the relative amplitudes at the demodulator of the several path contributions, the differences in the times of transmission over the several paths, and the rates at which the path lengths are varying.⁷

⁷ R. K. Potter, "Transmission characteristics of a short-wave telephone circuit," Proc. I.R.E., vol. 18, pp. 581-648; April, (1930).

When the difference in the time of transmission over two paths is t there are alternate maxima and minima in the frequency spectrum caused by these two components which are separated by $1/2t$. Continuous small changes in the lengths of the paths cause these maxima and minima to wander back and forth through the spectrum. By separating the waves arriving at distinctly different angles the musa receiver succeeds, for the most part, in separating those waves which have greatly different transmission times and thus widens the frequency interval between a maximum and an adjacent minimum. As the interval increases the fading appears less selective. The signal appearing to arrive at any one angle, however, is in reality composed of a bundle of waves, the components of which have traveled over slightly different paths and which might be expected to be nearly alike in amplitude and transmission time but not in phase. As a consequence it is to be expected that the general fading on a single-angle musa receiver will be greater than on an ordinary receiver and it is essential that some form of diversity be used to insure a satisfactory output amplitude at all times. Sudden shifts in the received angle of signals will also give general fading which will be greater the greater the angular discrimination of the musa system.

A musa receiver differs from an ordinary receiver in that there are a number of separate antenna branches, the outputs of which must be added in the proper phase over an appreciable band of frequencies.

When delay equalization is used between the various diversity branches, these branches must also have equal phase shifts if the audio-frequency outputs are to add properly. In both antenna and diversity branches the problem of keeping equal phase shifts is complicated by the action of the automatic-volume-control system which changes the operating condition of the vacuum tubes over a wide range. In designing these receivers a nominal over-all value of nonuniformity of ± 10 degrees was taken as acceptable and an effort made to keep the phase uniformity of individual elements to within one or two degrees wherever possible.

Within the receiving station all radio-frequency wiring is made with a flexible coaxial cable having rubber insulation. The various panels composing the receivers are placed on the racks with a view to operation and maintenance rather than ease of wiring and consequently long leads between panels are frequently necessary. For this purpose the circuit impedance is dropped to 70 ohms and at a number of points brought out to jack panels to facilitate testing.

Coaxial jacks are used which fit into the usual jack strips. Normalling jacks are not available and consequently it is necessary to have plugs in jacks during operation. In order to avoid cords, which would be in the way, the jacks to be connected regularly are mounted adjacent to each other and connected together by two plugs mounted in a shell similar to that

commonly used for terminating resistors. Alternating current for cathode heating is supplied to conduit outlets near each panel. Flexible cords with plugs complete the circuit to the panels. All audio-frequency, bias, and signal wiring is made into cables in the usual telephone manner. Wires having a potential of over 150 volts to ground are placed in conduit and safety

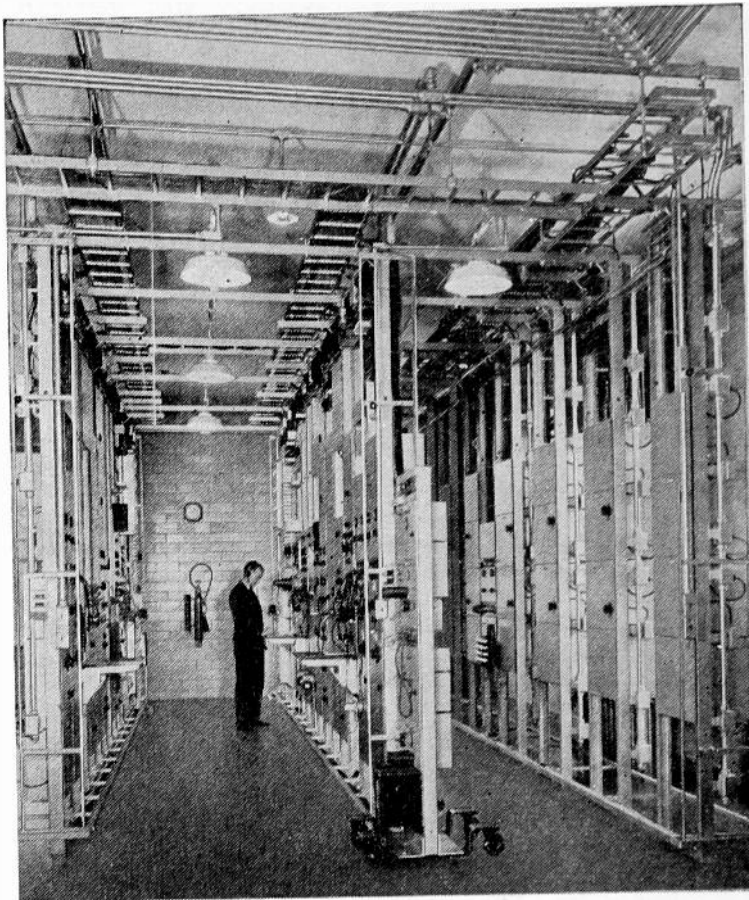

Fig. 2—View of musa receivers.

switches are provided to remove the voltage from a panel when the panel cover is removed.

ANTENNA SYSTEM

The degree of vertical resolution and the signal-to-noise improvement of a musa antenna system are functions of the over-all length and number of unit rhombic antennas used. The decision to build a 16-antenna system was based on experience with the 6-antenna system and took into consideration the land necessary, the cost of antennas and transmission lines, and the complexity of the receiving equipment, as well as the resolution which it would be practical to use and still have it possible for the operator or automatic equipment to follow changes in the direction of signal arrival.

When the spacing between unit antennas of a musa system is several wavelengths there will be more than one vertical angle at which the phase shifters will simultaneously phase the antenna outputs. The spacing between antennas is so chosen that the range traversed by the lowest of these angles will be the range covered by useful signals. Fortunately the angle

of useful signals varies with frequency in such a manner as to permit a variation in frequency over the range desired with a fixed spacing. The unit rhombic antenna is designed to have a null at the position of the second phasing maximum and reception is thus confined essentially to the lowest phasing maximum.

Extensive study did not disclose a better unit rhombic antenna than the one used in the experi-

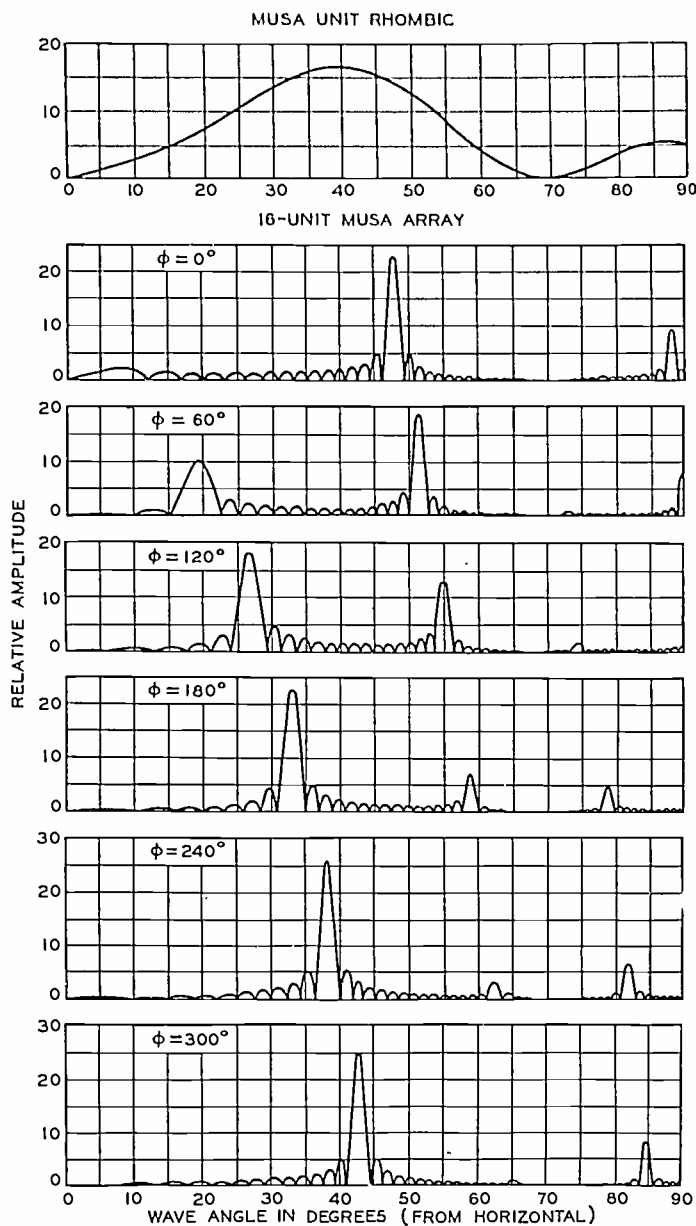

Fig. 3—Directive diagram in the vertical plane of a unit rhombic antenna and the 16-unit MUSA array. Frequency, 4700 kilocycles. ϕ = phase-shifter setting.

mental system and consequently an antenna 590 feet (180 meters) long, 60 feet high, and having each side angle equal to 140 degrees was used. The spacing is 656 feet (200 meters) between corresponding parts of adjacent antennas.

A representative directive diagram of a unit rhombic and the 16-unit array in a vertical plane in the line of the antennas is shown plotted in rectangular coordinates in Fig. 3. A polar diagram of the major lobe in three different positions, corresponding to three possible angles of diversity reception, is shown on Fig. 4(a). In this figure the dotted outline is the diagram of the unit rhombic antenna characteristic en-

larged 16 times. The complete diagram is of course a solid. Fig. 4(b) is an attempt to show how the middle lobe of Fig. 4(a) looks when viewed from the ground plane at a horizontal angle of 45 degrees from the line of the antennas. The contour lines on this leaf-shaped figure are lines of equal reception. All of these diagrams are for a frequency of 4700 kilocycles, near the low end of the range of received signals. At higher frequencies the lobes will be more slender and the angle of maximum reception will be lower. Fortunately the latter corresponds to the trend of the received signals.

When the outputs of several antennas are connected to a receiver and added in the proper phase the total signal can be made equal to the sum of the signal voltages. The set noise, however, adds at random phase with the result that there is an improvement in signal-to-noise ratio over a single antenna equal to the square

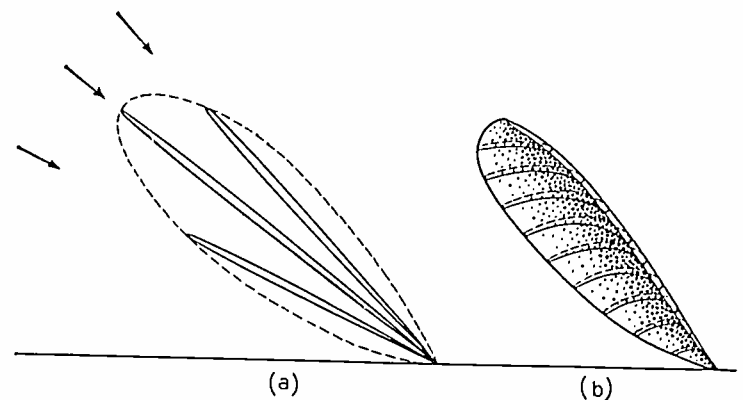

Fig. 4—Polar diagrams of MUSA antenna system. (a) Showing three possible locations of the major lobe. (b) Solid polar diagram of middle lobe shown in (a).

root of the number of antennas, or $10 \log_{10} n$ in decibels. The theoretical improvement of a 16-antenna system is, therefore, 12 decibels. On the assumption that received noise comes from a random direction with respect to the signal a similar result is obtained. At a particular time, however, the principal noise may be arriving from such a direction as to allow of no discrimination by the antenna system, or at another time to allow much more than 12-decibel discrimination.

The received signal in an antenna is a result of both the direct wave, arriving from some angle above the horizon, and the same wave front reflected from the ground at a point ahead of the antenna. If the phase of the induced voltage is to progress uniformly from antenna to antenna it is essential that the ground be homogeneous and flat. For this and other reasons a flat marsh near Manahawkin, N. J., was chosen for the station site. The ground is level to within less than one foot, except where there are inlets, for the entire length of the antenna and for a considerable distance ahead.

As shown in Fig. 3, in addition to the major lobe caused by the phasing factor there are 14 minor lobes. The amplitude of the first three starting from a major lobe are approximately $2/3\pi$, $2/5\pi$, $2/7\pi$ of the major

lobe. However, when the major lobe is at a very low or very high angle it is greatly reduced in amplitude by the unit-antenna directional characteristic while the adjacent minor lobes on one side may not be reduced to any such extent. Consequently the ratio of the amplitude of the major-to-minor lobes may be much less than the values given and signals from two or more angles might be received simultaneously with comparable amplitude on the same diversity branch, and so defeat the purpose of the system.

It has been shown by John Stone Stone and others that if the amplitudes of the currents contributed by the various units of the antenna system are tapered in such a manner that the central units contribute more than the end units a reduction in the amplitude of the minor lobes can be obtained. However, this is accompanied by a widening of the major lobe and a reduction in the signal-to-noise improvement obtained. For antenna systems having only a few units there appears to be a net advantage in tapering but for the 16-unit system under discussion a large amount of tapering broadens the major lobe so that it extends over the normal first and possibly second minor lobes. Since the remaining lobes are already of a low enough amplitude to be comparable with those which might be produced by inescapable errors in phase and amplitude of the various unit contributions, there appears to be no particular advantage in much tapering in this system. Provision has, however, been made to obtain tapering should it ever be found desirable. Under normal conditions all antenna branch amplifiers are operated at the same gain so as to use only the small tapering caused by the losses in transmission lines.

The antennas are coupled to the transmission lines through metallic-core transformers which pass a band from 4000 to over 20,000 kilocycles with a loss of less than 1 decibel. The transformers are equipped with lightning arrestors and arranged so that the total direct-current loop resistance of the transmission line, antenna, transformer, and antenna terminating resistor can be checked from the station.

The transmission lines from the antennas to the receiver are of the coaxial type made of copper tubing $1\frac{1}{4}$ inches in inside diameter surrounding a central conductor of $\frac{3}{8}$ inch outside diameter. Ceramic insulators $\frac{1}{8}$ inch thick are spaced every 16 inches and a locking insulator is placed every 250 feet to prevent creeping of the inside pipe. The velocity of propagation of the line is 0.980 of that in space. The attenuation amounts to about 1 decibel per 1000 feet at 20 megacycles.

The lines are buried to protect them from mechanical injury and to prevent phase errors due to differences in expansion. Bacterial growth in the marsh makes the soil extremely corrosive and it was necessary to protect the lines by coatings of tar and asbestos tape. The lines are kept under gas pressure at all times.

In a musa receiving system a saving of nearly one

half of the transmission line can be made if the receiving equipment is located at the center of the antenna system rather than at one end. Furthermore, since the average length of transmission line will be cut in half, the diameter of the coaxial transmission line also could be cut in half and still maintain the same signal loss. The economic, and to a lesser extent the locational, advantages of the center position were so great that the equipment was so placed in spite of certain technical disadvantages.

THEORY OF PHASE-SHIFTER SYSTEM WITH CENTER LOCATION OF RECEIVERS

At this point some of the theory of the musa phase-shifting system will be reviewed and extension made to cover the situation of the receiver being located near the middle of the antenna system.

Assume a plane wave front progressing toward the earth from the Kennelly-Heaviside layer at an angle δ with respect to the horizon and impinging upon the receiving antennas indicated as points 7, 8, 9, 10, 11, etc. (Fig. 5.) Let the receiving station be located at

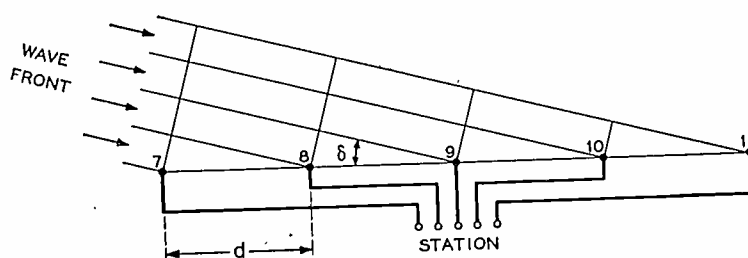

Fig. 5—Diagram of the wave front approaching the antenna.

antenna 9. Let the time of arrival at the receiving station of the voltages induced in the various antennas by this wave front be computed with respect to that of antenna 9. The wave front will arrive at antenna 9 at a time $(1/c)(d \cos \delta)$ later than at antenna 8. The voltage from antenna 8 will require a time d/v to reach the receiving station over the transmission line, making the net time delay between the two outputs equal to

$$t_{9-8} = d \left(\frac{1}{v} - \frac{1}{c} \cos \delta \right), \quad (1)$$

where d is the horizontal distance between antennas
 c is the velocity of transmission in space
 v is the velocity of transmission in the transmission line.

Similarly the difference in time of arrival of the voltages from antennas 9 and 7 will be

$$t_{9-7} = 2d \left(\frac{1}{v} - \frac{1}{c} \cos \delta \right). \quad (2)$$

The voltages from all three antennas could be made to add in phase if a delay of

$$2d \left(\frac{1}{v} - \frac{1}{c} \cos \delta \right) \quad (3)$$

were added to the output from antenna 9, and half as much to the output of antenna 8. For a greater number of antennas these delays would have to be correspondingly increased.

Now consider the outputs of antenna 9, and those antennas which lie behind it. It will immediately be seen that the time between the arrival of the voltage caused by the wave front at antenna 9 and antenna 10 will be the sum of the times of transmission of the wave front from 9 to 10 in space and on the transmission line

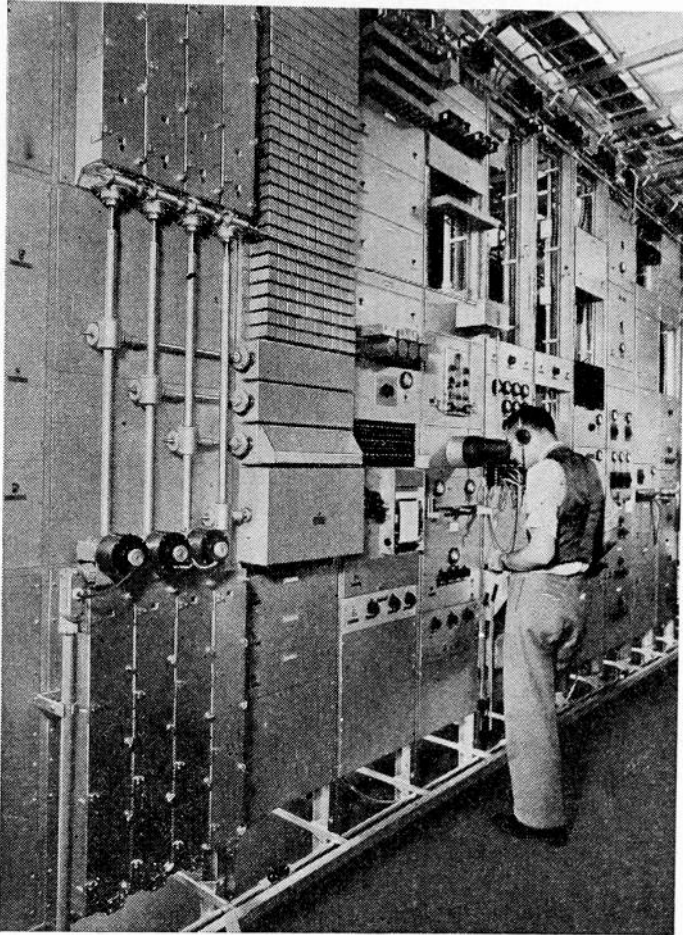

Fig. 6—View of second row of bays showing phase-shifter-drive system (left)

back from 10 to 9, which is similar to (1) except that the sign between the space and transmission-line components is reversed. Similarly the equation for the delay between the outputs of antennas 9 and 11 is similar to that between 7 and 9 with the same sign reversed, and likewise with the other antennas.

Considering either the group of antennas ahead of the station or the group of antennas behind the station, and considering antenna 9 as a part of whichever group is being considered, it will be seen that the delay compensation which it is necessary to insert in the various antenna outputs to make the signal voltages add up in phase at the receiving station is always an integral multiple of either

$$d\left(\frac{1}{v} - \frac{1}{c} \cos \delta\right) \quad (4)$$

or

$$d\left(\frac{1}{v} + \frac{1}{c} \cos \delta\right), \quad (5)$$

so that for either the front or the rear group the delay compensation could be adjusted by means of a single shaft geared to various individual delay compensators through gears having integral ratios.

Practically, the difficulty in building continuously variable delay circuits resulted in the use of continuously variable phase shifters. For any particular delay t there is a corresponding phase shift $2\pi ct/\lambda$ radians. Since this phase shift is a function of frequency, for a given phase-shifter setting the frequencies in a wide-band transmission will not all be in phase. The substitution of phase shifters for delay-compensating circuits therefore results in a restriction of the band of simultaneous reception from a given angle. For the group of antennas ahead of the station the band restriction is small, since the space and transmission-line paths give a partial delay compensation. For the antennas behind the station the net delay differences between antennas is large and the band is restricted to a much greater extent.

When using phase shifters it is possible to get minus as well as plus values of phase shift. This makes it possible to reverse the order in which delay compensation was assumed to be added in the above discussion so that no phase compensation is added to antenna 9, one negative unit is added to antenna 8, two to antenna 7, etc. In the equipment herein described the phase shifters were so designed.

Assume that the phase shifters of the front group are all set alike and then changed so as to receive from an angle δ . There will have been introduced a change of phase of

$$\phi = \frac{2\pi cd}{\lambda} \left(\frac{1}{v} - \frac{1}{c} \cos \delta \right) \quad (6)$$

between each of the antenna outputs.

Similarly if the phase shifters of the rear group were initially set alike, and similar to the initial condition of the front group, and then changed to receive from an angle δ the change of phase which would be required would be

$$\phi = -\frac{2\pi cd}{\lambda} \left(\frac{1}{v} + \frac{1}{c} \cos \delta \right). \quad (7)$$

The negative sign ahead of this equation takes account of the fact that an increase in the angle δ requires that more phase will have to be taken from line 8 while less phase will have to be subtracted from 10.

It will be noted that for a given change in δ , however, the amount of change of phase is the same absolute amount for the two groups. This indicates that it should be possible to connect the front and rear groups of phase shifters together and drive them as a single unit. To do this it will be necessary to connect the shafts together after they have been moved from their initial position by the amounts given in the above equations. The difference in phase is

$$\phi_{8-10} = \frac{4\pi d}{\lambda} \frac{c}{v}. \quad (8)$$

It will be noted that for a given installation this value is dependent upon the received frequency and will have to be changed when the received frequency is changed.

In the receivers herein described the phase shifters connected to antenna 9 are not driven. The phase shifters connected to antennas 1 to 8 are driven at ratios of 8:1, 7:1, 6:1, 5:1, 4:1, 3:1, 2:1, and 1:1, respectively. The phase shifters of antennas 10 to 16 are driven in the opposite direction at ratios of 1:1, 2:1, 3:1, 4:1, 5:1, 6:1, and 7:1, respectively. A differential-gear mechanism is inserted between the two groups. Changing the position of the ring gear of the differential permits a mechanical shift equivalent to the phase shift given in (8) to be inserted between the two groups. This change may be made while the drive shafts are in motion. The ring gear drives of the differentials of the four groups of phase shifters are all connected by a common adjustment shaft so as to insure that the monitoring branch does not give a false indication of receiver performance by being set differently than the diversity branches.

A front view of the phase-shifting system is shown on the left of Fig. 6. The vertical shafts drive the individual phase-shifting condensers through spiral gears of which there are eight inside each of the lower cast boxes and seven inside each of the upper cast boxes. The horizontal shafts connect to the cam switches used with the automatic adjustment feature. A rear view showing a few of the individual phase-shifting condensers is given in Fig. 7. Each phase-shifting condenser consists of four quadrantal stators each consisting of two plates between which revolves an eccentric circular plate. The rotor plates of the condensers in a horizontal row (see Figs. 1 and 7) are connected in parallel through the demountable brushes, and a wire which is behind the brush support, to the output of one of the antenna branch amplifiers. The corresponding stator plates of the condensers in a vertical row are connected together with coaxial wiring and to the four terminals of an artificial quarter-wave transmission line, which in turn is connected to the output amplifier. The quarter-wave line forms a combining network for the contributions of the various phase shifters. The two groups of eight phase shifters forming one diversity branch are each treated as units so as to facilitate isolating one group in case of trouble or the necessity of reducing the resolution of the antenna system.

There are two opportunities for undesirable interchanges of power in the parallel phase-shifter system; there can be an interchange between antenna branches through condensers in the same diversity group, and an interchange between diversity branches through condensers in the same antenna branch. Both of these can be reduced to the required values by a proper proportioning of input and output impedances with respect to the condenser reactance. This results in a large

loss, about 40 decibels, through the phase-shifting system.

INPUT CIRCUITS AND FIRST DEMODULATORS

Obtaining uniformity of phase shift in the circuits preceding the first detectors is facilitated by reducing the number of circuit elements and selectivity to a minimum. No high-frequency amplification is used for this reason. The selectivity required to avoid image reception is materially lowered by the choice of a high

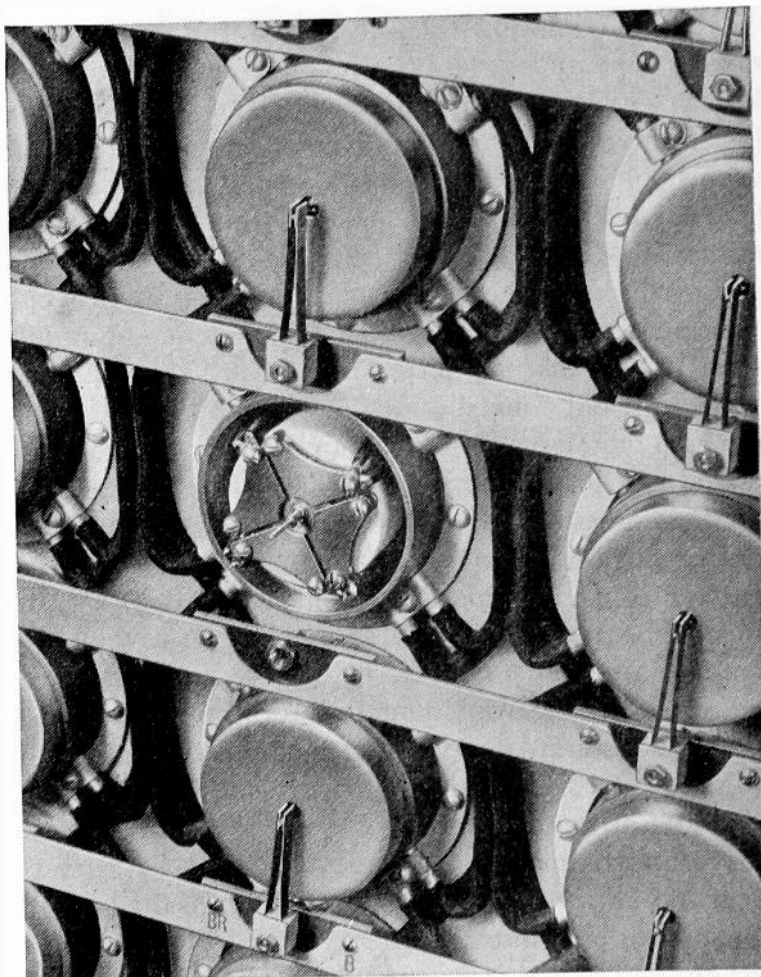

Fig. 7—Portion of a group of phase-shifting condensers. Brush and cover removed from center condenser to show construction.

operating frequency for the first intermediate-frequency amplifiers. In addition to the usual requirement of high selectivity and high voltage-transformation ratio, the input circuits must have uniformity in gain and phase, and must properly terminate the transmission lines so that multiple reflections will not shift the effective input amplitude or phase.

These factors seemed to preclude use of the usual variable tuned circuits on account of the time required to change from one frequency to another, and consequently fixed tuned circuits were used. Five input circuits are mounted on a panel and the switches for changing the input and output circuits of the two panels of each receiver which are mounted on a single bay are ganged. Each input circuit consists of two anti-resonant circuits capacitively coupled to each other and to the transmission line. It operates into the grids of the two first-demodulator tubes which are paral-

leed. The first beating oscillator input is applied in push-pull between the cathodes of the tubes.

OSCILLATORS AND AUTOMATIC TUNING SYSTEM

Three highly stable oscillators are used in the receivers, one for beating the signal frequency down to 2900 kilocycles, the second for beating it down further to 100 kilocycles, and the third for use as a reference frequency for the automatic tuning system, or it may be used in the final demodulator when the automatic branch selector is used.

The first beating oscillator is of the coil-and-condenser type and covers the range from 7000 to 17,000 kilocycles. Automatic tuning is used to compensate for long-time variations in its frequency, as well as any variations in the transmitter frequency, but every effort has been made to keep short-time variations to a minimum. The oscillator is contained in a cast box mounted on rubber supports. The inductance coils have an extremely low temperature coefficient and are mounted on cast supports for rigidity. The condenser is also of rigid construction. A variation in plate voltage of 1 volt gives a frequency variation of about 6 cycles at 18,000 kilocycles.

A buffer amplifier connects between this oscillator and a push-pull power amplifier which delivers 10 watts of output. This output is delivered to a transformer located on the center bay of the row of first-demodulator bays. Coaxial cables of equal length distribute it to the first demodulators on the adjacent bays. A vacuum-tube voltmeter connected across this transformer gives an alarm if the voltage fails.

In the automatic tuning system the incoming carrier at approximately 100 kilocycles is beaten with the local 100-kilocycle oscillator. The phase of the beat frequency is then split and the resultant two-phase output applied to a motor which drives a condenser in the first beating oscillator circuit until the beat frequency is reduced to zero. In order to avoid interruption of control due to fading, all three diversity branch carriers are simultaneously connected to the circuit.

The second beating oscillator operates at 3000 kilocycles and is a standard broadcast oscillator which has been slightly modified.

The 100-kilocycle oscillator is required to have the same frequency as the center of the pass band of the carrier filters. Since these are only 40 cycles wide both filters and oscillators are made with low-temperature-coefficient crystals. The oscillator is of the bridge type described by Meacham⁸ but without temperature control.

AUTOMATIC VOLUME CONTROL AND FINAL DEMODULATORS

Only the carrier is rectified for automatic-volume-control purposes. In the 100-kilocycle amplifiers where

the carrier and sideband are amplified separately, separate automatic-volume-control circuits are used. The time constant of the carrier-amplifier control is made 0.1 second, which is as fast as is practicable with the narrow carrier filter used, and the time constant of the sideband volume control is made variable but is generally set at a value of 1 second.

With the common automatic volume control used with diversity receivers the rectifiers are so connected as to give outputs which vary according to either the square or first power of the branch input. The sum of the rectifier outputs is held substantially constant. If the combined signal output is also to be held constant, the final demodulators of the branch circuits must follow the same law; i.e., if linear rectifiers are used, the final demodulators should be linear, and if square-law rectifiers are used, the final demodulators should be square-law. When linear demodulators are used the output noise is independent of the strength of the incoming carrier and since the gains of all branch amplifiers are the same the noise output of each branch will be the same, assuming that received noise does not vary with the vertical angle of reception. As a consequence the total noise will be equal to the product of a single branch noise and the number of branches regardless of the signal contributions of each branch. If square-law detectors are used, however, the noise output of a branch will go down when the carrier in the final demodulator of that branch goes down and consequently the total noise will be proportional to the total signal. In a three-branch diversity system a theoretical improvement in signal-to-noise ratio varying up to 4.77 decibels can be had by using square-law demodulators rather than linear. For this and other reasons square-law final demodulators have been used in this equipment.

When delay equalization is used between the various diversity branches it is essential that the received carrier be used in the final demodulation process. Small changes in the lengths of the paths in space traversed by the sidebands being received by the various diversity branches make the phases at random and if all branches were demodulated by a common carrier the audio-frequency outputs would not add in phase. By using the carrier arriving over each path for the demodulation of the accompanying sideband the random relation disappears and the audio-frequency outputs can be added in phase.

When using an automatic branch selector which discretely chooses one branch at a time for connection to the line it is no longer necessary to consider phases in the diversity branches and a local carrier is used because it reduces output amplitude variations. With only one diversity branch connected to the output, only the corresponding volume-control rectifier should be contributing to the automatic-volume-control voltage if the output volume is to be held as constant as possible. This result is obtained by putting a rectifier

⁸ L. A. Meacham, "The bridge-stabilized oscillator," *PROC. I.R.E.*, vol. 26, pp. 1278-1294; October, (1938); *Bell Sys. Tech. Jour.*, vol. 17, pp. 574-591; October, (1938).

in the direct-current output lead of each branch volume-control rectifier so that only the volume-control rectifier having the highest amplitude will supply current to the load resistance.

DELAY CIRCUITS AND SWITCHES

Since the waves arriving at different vertical angles have taken different times in transit it is necessary to

provided that the phase distortions of the transmission path, and the other parts of the receiver made it practicable to do so.

The delay circuits each consist of eight units having a delay of 31 microseconds and nine units having a delay of 280 microseconds. Hand-operated switches are provided to vary the delay in the usual decade switch manner. A motor-driven switch is also provided which

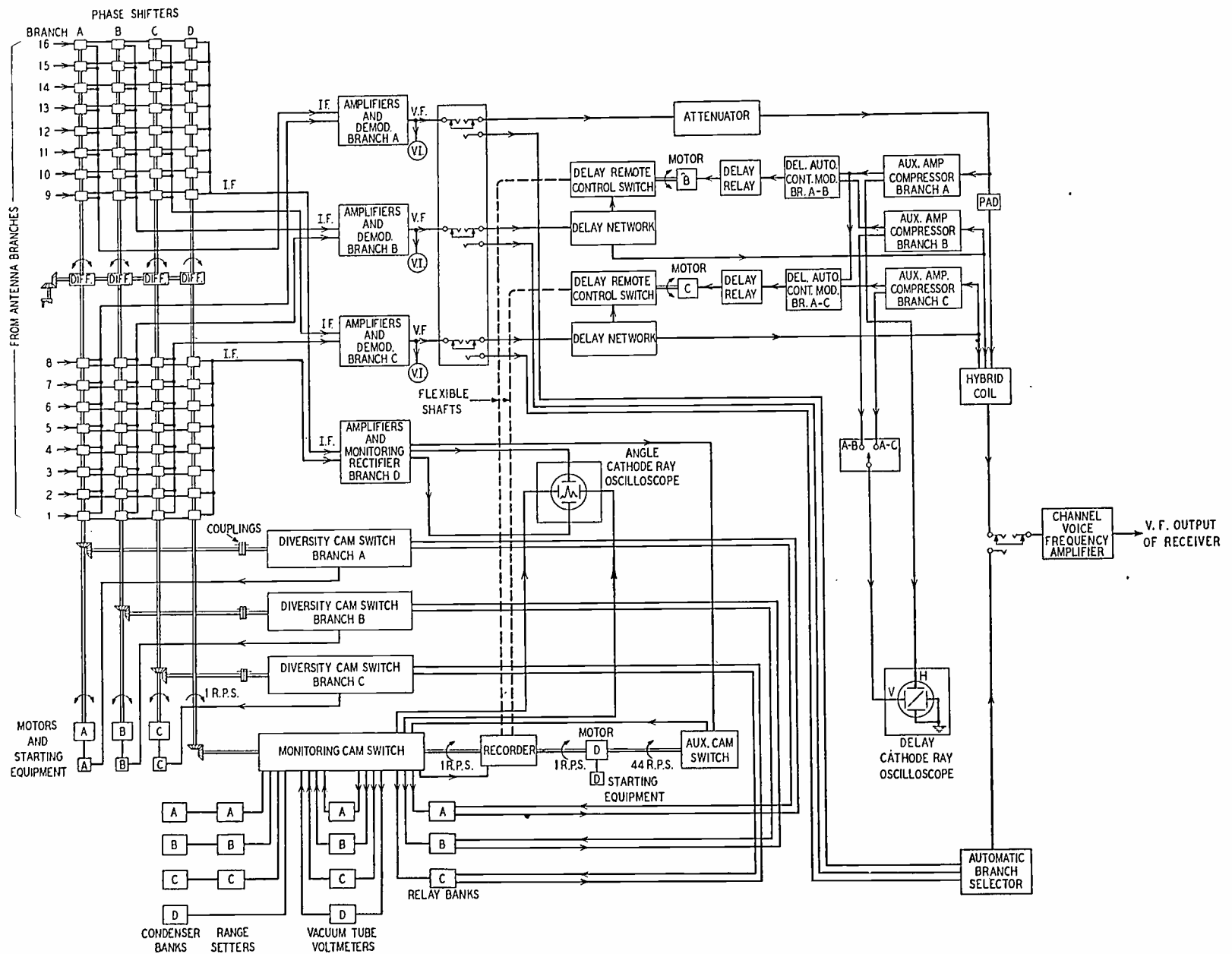

Fig. 8—Block schematic diagram of automatic adjusting circuits.

insert delay compensation in two of the three diversity branches when they are all connected to the output at once so that the audio-frequency outputs will add in phase. The branch receiving the waves at the highest angle, which are always the waves which have traversed the greatest distance, does not contain a delay circuit. The other two branches contain variable delay circuits having a maximum of 2768 microseconds delay in steps of 31 microseconds. The band covered by the delay circuits is 6000 cycles, the same as the width of the filter in the last intermediate-frequency amplifier. The delay steps were made small enough so that it would be technically possible to phase properly over the entire band within less than a quarter cycle pro-

vided that the phase distortions of the transmission path, and the other parts of the receiver made it practicable to do so. The delay circuits each consist of eight units having a delay of 31 microseconds and nine units having a delay of 280 microseconds. Hand-operated switches are provided to vary the delay in the usual decade switch manner. A motor-driven switch is also provided which

AUTOMATIC DELAY-ADJUSTING CIRCUITS

A block schematic of the automatic delay-adjusting apparatus as well as the automatic angle-adjusting and recording equipment is shown in Fig. 8.

The proper delay compensation to phase the output

of two diversity branches can be determined by connecting the outputs of the two branches to the two pairs of plates of a cathode-ray oscilloscope and varying the delay in the lower-angle path until a straight-line pattern is obtained on the oscilloscope screen. This adjustment is facilitated by the restriction of the band in each branch at the oscilloscope to about an octave. If only a single frequency were used for this adjustment several positions of the delay adjustment might be found to give a straight line on the oscilloscope, the number of positions depending upon the frequency. In order that there may be only one position when the maximum delay is 2768 microseconds the phase shift caused by this delay must be less than 180 degrees, and consequently the frequency of operation must be less than 180 cycles. Where a band of frequencies a few hundred cycles wide is used, however, this difficulty is not encountered and there is only one adjustment of the delay which gives a straight line on the oscilloscope.

With the cathode-ray oscilloscope there is no indication as to whether the delay in the circuit is too small or too great, but only that it is either correct or incorrect. A direct indication of whether the delay should be increased or decreased can be obtained by connecting one diversity branch to the push-pull input of a balanced modulator and another diversity branch to the parallel input of the same modulator, after having shifted the phase between the two branches by 90 degrees. When the two receiver branch outputs are in the same phase the two modulator input voltages will add in quadrature and the currents in the plate circuits of the two modulators will be the same, but when the phases are not the same the current in one plate circuit will be greater and the other less than in the in-phase case, the sense of the unbalance depending upon whether too little or too much delay is in the circuit. A center-zero meter in a bridge connection in the plate circuits therefore can be made to indicate the sense of the necessary correction. By substituting a voltmeter relay for the indicating meter a motor drive of the variable-delay circuit can be operated in such a manner as to adjust the delay to the correct value.

This automatic equipment must operate satisfactorily with circuits having types of privacy in which the energy-bearing components of speech are shifted from their normal position in the frequency spectrum. The equipment is made, therefore, to operate on a band of frequencies from 250 to 750 cycles. Volume limiters are provided which keep the input to the automatic equipment from this band substantially constant. If the delay is never incorrect by more than 1000 microseconds, which has been found to be true under all conditions of normal operation, the automatic equipment will bring it to the correct value. For greater errors the equipment tries to set the delay at values about 2000 microseconds higher or lower than the correct value.

Since the delay adjustment operates on speech, the relay operation will be intermittent at a syllabic rate

and the motor-drive relay system must incorporate a suitable hangover circuit to keep the motor operation as constant as possible when the delay is far from the proper value, and still not cause an overrun when the proper adjustment is reached. Freedom from overrun caused by motor inertia is obtained by using a motor having a multiple-pole permanent-magnet armature with a speed of 75 revolutions per minute, which under no load will brake itself in about 20 degrees of armature travel.

AUTOMATIC BRANCH SELECTOR

As an alternative to the combination of the outputs of the diversity branches after delay equalization, it is possible to use a system which discretely chooses one branch for connection to the line. Equipment to do this has been provided.

The common automatic volume control which is used with both systems operates on the carrier and if the carrier and sideband fade alike the output volume is held substantially constant. To the extent that the received noise on the various branches is the same, the branch having the highest output volume will be the most desirable to use. In the equipment used part of the audio-frequency output of each of the three diversity branches is rectified and applied differentially to three polar relays in such a manner that the relay corresponding to the branch having the highest amplitude is operated. This relay reduces the bias of an amplifier which connects between that branch and the output line from a high to a normal value, and thus permits voice-frequency signals to flow through that branch to the output. The noticeable effects of switching are eliminated by several expedients. Push-pull amplifiers with feedback are used so as to balance out the low-frequency thump. The variation of biasing takes place with a time constant of 0.01 second in order to aid in this matter as well as to render unnoticeable the instantaneous differences in amplitude in the two channels. A biasing winding on each relay insures that once a contact is broken the relay moves to the opposite contact in a fixed time, which permits the selection of time constants for the suppression and build-up which are as nearly complementary as possible, and so keeps the volume constant.

A difference in volume of 1 to 2 decibels is required to cause a switch. During the switching period, which lasts about 20 milliseconds, the output varies about ± 1 decibel. When no speech is being transmitted the relays remain inoperative and consequently the line may not be connected to the branch which at the next instant may deliver the highest volume. It might be expected that clipping of the succeeding initial syllable would be intolerable. To reduce selective fading to an unnoticeable amount it is only necessary to suppress the unwanted branches by 12 to 15 decibels. With the equipment adjusted to give this suppression it is found that there is always sufficient signal transmitted

through one or more of the branches practically to eliminate noticeable clipping.

The use of the automatic branch selector has the disadvantage that the effect of having more than one diversity branch contribute to the output at any one time is lost. This is estimated to be equivalent to not more than an increase of one decibel of transmitted power. To offset this there must be considered the possibility of the delay being out of adjustment for brief periods when changes in angle require sudden changes in delay equalization. The necessity for close phase uniformity between the various carrier and sideband amplifiers over a wide range of automatic-volume-control voltage is also eliminated when the automatic branch selector is used. Further, it is no longer necessary to use the received carriers for demodulation of the various branch outputs and a locally generated carrier of uniform amplitude can be used with a resultant increased stability of output volume. The practicability of trying to phase branch outputs by delay equalization over a range of more than 3000 cycles from the carrier has not been demonstrated and consequently the use of automatic branch selection with the channel whose sideband is spaced by one sideband width from the carrier is to be recommended. The use of the branch selector also permits simpler operation of the automatic angle-adjusting equipment as will be explained later. For all of these reasons it is to be expected that the automatic branch selector may eventually be used to the exclusion of the delay-compensating equipment.

AUTOMATIC ANGLE-ADJUSTING EQUIPMENT

In the experimental musa receiver the rectified carrier output of the monitoring branch was connected to one set of deflection plates of a cathode-ray oscilloscope and a sweep circuit mounted on the monitoring phase-shifter shaft connected to the other set of deflection plates. The oscilloscope screen displayed a graph of the amplitude of signal received for each phase-shifter setting. The pattern frequently changed rapidly from moment to moment so that only by constantly observing the screen was it possible to determine at what phase-shifter settings the best signals were being received and to set the diversity phase shifters accordingly.

The attention necessary to operate the equipment satisfactorily in this manner was believed to be too great for commercial operation, particularly since it might vary widely from hour to hour. With a mind to the fact that improper adjustment might give poorer reception than would be obtained with ordinary receivers it was decided to make the settings of the phase shifters of the diversity branches automatic.

In Fig. 8 the motors *A*, *B*, *C*, and *D* drive the phase shifters of the corresponding branches through the vertical shafts. Motor *D* operates continuously so as to vary the phase-shifting system through its complete

range once a second, while motors *A*, *B*, and *C* operate only when a change in the angle of reception is required. Connected to the vertical drive shafts by the horizontal shafts are the three diversity cam switches and the monitoring cam switch.

The incoming carrier in the monitoring branch *D* is amplified in such a manner as to keep the average peak amplitude constant. It is then rectified, and applied to the vertical deflection plates of a cathode-ray oscilloscope in the same manner as in the experimental equipment, the monitoring cam switch being provided with a set of contacts and resistances which act as a sweep circuit for the horizontal plates of the oscilloscope.

The rectified signal from the monitoring rectifier is also connected through the auxiliary cam switch, the monitoring cam switch, a high resistance, and the range setters, to three separate banks of condensers, each consisting of 44 4-microfarad condensers. The condensers in each bank are connected successively to the rectifier circuit once each second for a short period by the cam switch so that each is charged at a rate depending upon the amplitude of the received signal for a particular phase-shifter position. A vacuum-tube voltmeter is connected successively across each condenser of a bank. When one condenser becomes charged to one-half volt or more during the preceding second the vacuum-tube voltmeter operates a relay. With the branch *A*, *B*, and *C* voltmeters this results in a relay corresponding to that particular condenser being locked up and all the condensers in that particular bank being discharged. The operation of the second relay causes the motor of the corresponding diversity branch to start and turn in the right direction so that the branch phase shifters are adjusted with the least movement to the position corresponding to the relay, at which point a contact in the diversity cam switch trips the relay and stops the motion.

If no further control were provided all the diversity branch circuits would be set in the same position and consequently no diversity action would be obtained. To prevent this, the range setters *A*, *B*, and *C* have been provided and are operated manually to limit the angular range of operation of each diversity branch. These switches merely short-circuit the condensers of a particular branch in the range which it is not desired to use. Since the short-circuited condensers do not acquire a charge the automatic adjusting equipment will never move the phase shifters to a position corresponding to a short-circuited condenser in that particular branch.

In setting the range switches when using delay equalization it is necessary to know what the condenser position is which corresponds to the highest angle which it is possible to receive at the particular frequency being used. The short circuit will then be removed from this condenser and from the condensers representing successively lower angles in branch *A* until it seems probable from the recorder or cathode-ray-

oscilloscope pattern that a good signal will be received in that branch. The remaining condensers in that branch are left short-circuited. The short circuits are then removed in a like manner from part of the remaining range for branch *B* and in the remainder of the range for branch *C*, the best division line being determined from the cathode-ray oscilloscope or recorder pattern. This procedure is necessary inasmuch as branch *A* is used for a reference in adjusting the audio-frequency-delay compensation and must always have a satisfactory signal if that equipment is to operate.

When using the automatic branch selector other settings of the range switches are possible. One arrangement is to allow one branch to stop on even-numbered contacts for a part of the range and another branch to stop on the remainder of the even-numbered contacts. The third branch may then stop on any odd-numbered contact. This permits two diversity branches to be set in the range of maximum signal. A difference of one contact has been found sufficient to give satisfactory diversity action in most cases and the recorder pattern always shows that the signal is more than one contact wide. The third branch is free to follow a signal in another part of the range, which may grow to be the strongest at any moment.

In order to improve the accuracy of this equipment and reduce the maintenance of the monitoring cam switch an auxiliary high-speed cam switch is used which operates 44 times faster than the main switch, closes just after each contact of the monitoring switch, and opens just before each contact opens. The charging time for all condensers in a given bank is thus determined by the same cam and set of contacts.

To prevent overrunning on the diversity branches from mechanical inertia a special motor is used. This motor is similar to the one used for automatic delay-adjusting equipment.

At times there may be only one angle at which a satisfactory signal may be arriving. It is possible to get diversity action at these times by setting the diversity branches on opposite sides of the average angle of best reception. Provision is made for doing this with the automatic equipment by allowing one bank of condensers and one voltmeter relay to control all three diversity branches and then mechanically offsetting the phase shifters of two branches by means of adjustable couplings in the diversity cam-switch drives.

It will be seen that to obtain accurate operation of the automatic angle-adjusting equipment it is necessary that the charging voltage should be large as compared with the final voltage on any condenser and that the final voltage must be the sum of a number of charges. The time necessary for a condenser to reach the final voltage can be varied from 8 to 45 seconds or longer and successive movements of a diversity branch phase-shifter drive will not be oftener than this. Once the motor has started, however, it will move the phase-

shifter shaft through an angle of 180 degrees, the maximum which would ever be necessary, in 6 seconds.

RECORDER

In order properly to set the phase shifters manually or to set the range adjusters of the automatic angle-adjusting equipment it is necessary to know the phase-shifter positions corresponding to the angles at which signals are arriving. The angle-monitoring cathode-ray oscilloscope shows how the signal-amplitude versus phase-shifter position varies from second to second. By using a retentive screen on the oscilloscope it is possible to see the traces for the previous few seconds at the same time as the most recent trace. The traces, however, normally vary appreciably in position of maximum amplitude and it is somewhat difficult to form an opinion from looking at the oscilloscope as to just where to set the diversity branches. By integrating the value of received signal over a number of seconds a better conception can be obtained.

In addition to the cathode-ray oscilloscope it also seemed desirable to have a record available to the operator of the variation of signal intensity with phase-shifter position as it changes from minute to minute so that he would not have to observe the oscilloscope continuously to determine whether the range-adjusting switches were set properly. This required one more variable to be considered than the ordinary recorder is designed to register and it was consequently necessary to devise a new type of device.

The scheme of recording operates in a somewhat similar manner to the automatic angle-adjusting equipment. A set of 44 condensers is charged by the incoming signal through the monitoring switch. Each condenser corresponds to a particular position of the phase shifters and consequently with a particular vertical angle of arrival at a particular frequency. A vacuum-tube voltmeter is successively connected to the condensers until one is found which has acquired a predetermined potential in the order of two volts. A relay in the plate circuit of the voltmeter then operates, causing only that particular condenser to be discharged and making a record on a paper strip.

The recorder consists of a mechanism for driving a paper strip 5 inches wide at a constant speed over a drum having a spiral wire on its periphery. Above the drum and paper are a typewriter ribbon and a thin bar which may be made to come down on the ribbon, paper tape, and spiral wire, by the action of an electromagnet. The action of this striker bar is to cause a dot to be made on the paper strip at the position where the striker bar and spiral wire intersect. The drum carrying the spiral wire revolves in synchronism with the phase shifters and there is consequently a lateral position on the paper corresponding to each one of the 44 condensers previously mentioned. When each condenser is discharged by the action of the vacuum-tube voltmeter a dot is made in a particular lateral position on

the paper strip and successive dots caused by the discharge of the same condenser fall in the same longitudinal line on the strip. The frequency of dots in a particular longitudinal line is, therefore, proportional to the relative field strength at a vertical angle corresponding to that line. As a result of the action of the automatic volume control on the monitoring branch amplifier, the maximum frequency of dots along a longitudinal line is kept approximately constant regardless of the absolute value of signal received so that the device does not record the variation of signal at a fixed angle from minute to minute.

A sample of a section of a record is shown on Fig. 9, together with a scale showing the angles corresponding to the rows of dots for a particular received frequency. The angle record is contained in the section above the "Phase-Shifter Position" scale.

In order to have a check on, and a record of, the operation of the automatic angle-adjusting equipment provision has been made so that three longitudinal lines are drawn on the paper corresponding to the three angular positions of the diversity branches.

A record of the operation of the automatic delay-adjusting device is also made by the recorder. This was done by inserting a mechanism which uses the margins of the paper on either side of the main record. The delay-recording device consists of two drums mounted concentrically with the main recorder drive shaft which are similar in nature to the tens and units drums of an ordinary counter. Flexible shafts extend from the delay-adjusting switches to the recorder where they drive the drums on each end of the shaft. The two drums on one end are connected together with an intermittent movement so that one revolution of the small-units drum causes the large-units drum to move forward one step.

With the paper tape normally running at only $\frac{1}{4}$ inch per minute it is impracticable to stamp numbers on the paper since the delay adjustment varies several times in a minute and thus would cause the numbers to record on top of one another. Recourse was accordingly taken to a mark in a definite lateral position to indicate the magnitude of the delay. The drums have segmental ridges on their periphery which are displaced in various lateral positions. Cam-operated hammers descend on the typewriter ribbon above the drums and paper once each second leaving a mark in a lateral position corresponding to the segmental ridge which is beneath and consequently to the delay setting. Two reference lines are used to facilitate the reading of the delay values.

OPERATION AND PERFORMANCE

The musa system can be expected to give an improvement in signal-to-noise ratio and in selective fading over a receiver using only a single antenna. The improvement in signal-to-noise ratio caused by the use of 16 antennas should average 12 decibels, but instan-

taneous improvements might vary from large negative values, if the equipment were not kept properly adjusted, to values of 25 or 30 decibels, which might be expected when the noise came from the direction of a null in the musa directive diagram.

In the operation of radiotelephone circuits there is a minimum signal-to-noise ratio below which commercial service cannot be given. As the signal-to-noise ratio is increased a value is reached where further in-

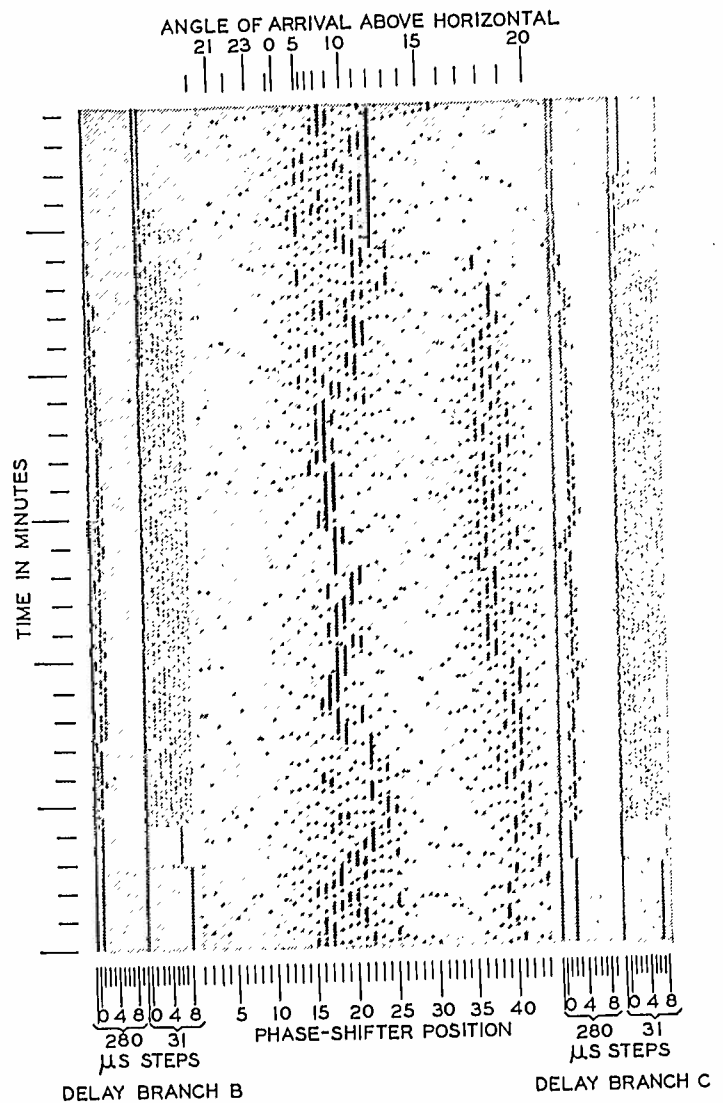

Fig. 9—Sample of musa recorder chart. Station GAW. Frequency, 18,200 kilocycles.

creases give little benefit. The range between these two values is about 25 decibels. Transmitters and receivers generally are designed so that their maximum signal-to-set-noise ratio is somewhat greater than the maximum beneficial circuit value in order that set noise shall not degrade the circuit. The maximum signal-to-noise ratio obtainable with a musa receiver and a single-antenna receiver should be approximately the same.

The 12-decibel average improvement which the musa receivers should give should make it possible to obtain, on the average, commercial circuits with signal field strengths 12 decibels less than those usable with a single-antenna receiver. This in turn will decrease the amount of time in which commercial service cannot be given.⁹ On the other hand the musa receiver should

⁹ R. K. Potter and A. C. Peterson, Jr., "Reliability of short-wave radio telephone circuits," *Bell Sys. Tech. Jour.*, vol. 15, pp. 181-196; April, (1936).

produce its maximum signal-to-noise ratio for field strengths 12 decibels lower than a single-antenna receiver and at field strengths 12 decibels higher the musa receiver would show no improvement over the single-antenna receiver. The net improvement in signal-to-noise ratio therefore should be expected to average from 12 decibels at the lowest usable signal-to-noise ratios to 0 decibels at fields 25 or 30 decibels higher, with fairly wide variations with time from the average.

The results of a comparison between the musa system and a single-sideband receiver operating from one of the same antennas confirm the theoretical expectations to a fair degree. The fraction of the time that given improvements in decibels are obtained follows approximately a normal probability curve.

The reduction in selective fading effected by the musa receivers is difficult to state numerically. Most of the objectionable selective fading is removed. There are times when waves that have traveled over distinctly different paths arrive at so nearly the same angle that they cannot be resolved. Fortunately these times are fairly rare. When waves of closely adjacent angle are present the monitoring system does not give a true indication of reception angles, as can be shown by theory. It is a fairly common occurrence for a wave group, which has apparently traveled over a single general path, to have components which vary in transmission times by 100 or 200 microseconds from others of the same group. The fading caused by such small delay

differences is not distinctly selective in effect and its chief detriment is in causing volume variations which must be overcome by the use of special devices.

During some severe magnetic storms successive traces on the angle-monitoring cathode-ray oscilloscope show little relation to each other. It has been reasoned that a reduction in resolution might be beneficial at such times but sufficient experience to prove this has not been obtained. A reduction in resolution can be obtained easily by switching off the amplifiers associated with one group of 8 antennas. It has been found that fading on the front group of antennas is generally at random to that on the rear group so that the two groups can be used in space diversity if desired. No particular advantage has been found to this arrangement.

The use of delay compensation between the diversity branches does not seem to have any advantage over the use of the automatic branch selector. The output volume variations are slightly greater with delay compensation because of the use of a reconditioned carrier for demodulation. On the other hand the use of the automatic branch selector promises materially to reduce maintenance by eliminating the necessity for keeping the phases of the various carrier and sideband amplifiers alike.

It has been amply demonstrated that the automatic adjusting features provided are essential to the efficient operation of the equipment.

The Gradation of Television Pictures*

HEINZ E. KALLMANN†, ASSOCIATE, I.R.E.

Summary—The requirements of adequate gradation and contrast range in television pictures are discussed in relation to what the human eye can perceive. Thus it is shown that reproduction of the average brightness of the transmitted scene on the receiver screen is unnecessary, besides being possible only at the expense of reduced signal-to-noise ratio and contrast range. Because of the presence of synchronizing pulses, a fraction (15 per cent for the American standard) of the transmitted direct-current component reaches the screen even through pure alternating-current couplings. A comparison is made between the usual assumption of a linear modulation characteristic of the transmitter and linear light-signal characteristic of the receiver and a suggested alternative in which a logarithmic modulation characteristic of the transmitter is combined with an exponential light-signal characteristic of the receiver. The advantages of the latter are higher transmitter economy, measured in signal-to-noise ratio; free choice of contrast in the receiver, the control affecting high lights and shadows evenly; less critical background-light control because it has no effect on contrasts; independence of the contrast ranges of receiver and transmitter; and simpler design of cathode-ray-tube guns.

THE amount of information conveyed by a television picture, as well as its aesthetic appeal, depends not only on its definition, the number of details shown simultaneously, but also on its contrast range and gradation, that is, the number of distinguishable shades in the gray scale and their proper

reproduction. Complete reproduction of all shades from the darkest black to the brightest high lights is outside our technical and economical possibilities; the inevitable compromise between various requirements will have to be based on what the human eye, as the ultimate receiver of the image, can perceive.

CONTRAST SENSITIVITY OF THE EYE

Two different mechanisms enable the human eye to cover the vast range of varying illumination. These are the scotopic or twilight vision for feeble illumination, utilizing the color-blind rods of the retina, and the photopic or daylight vision at brightnesses above 0.0134 millilambert, utilizing the color-distinguishing cones. Television pictures fall well within the range of photopic vision, as the color of even a dark television picture may be clearly recognized.

The eye does not perceive small differences in brightness equally well over its entire working range. This¹ is shown in Fig. 1 in which the ordinates $\Delta I/I$

¹ Plotted after Selig Hecht, "The visual discrimination of intensity and the Weber-Fechner law," *Jour. Gen. Physiology*, vol. 7, pp. 235-237, (1924).

* Decimal classification: R583. Original manuscript received by the Institute, September 14, 1939; revised manuscript received, February 26, 1940. Presented, Rochester Fall Meeting, Rochester, N. Y., November 15, 1939.

† New York, N. Y.

represent the smallest perceivable increase in brightness, the abscissas being brightness in millilamberts. The curve rises towards both ends where the illumination is either too feeble or too glaring for fine distinction of shades. However in the middle range from 0.03 to, perhaps, 2000 millilamberts its value can be taken as approximately constant. Thus within this range, into which all likely television pictures are certain to fall, we may accept as valid the Weber-Fechner law which states that over this wide range a contrast between two surfaces (a ratio between two brightnesses) appears unchanged, whatever the illumination.

In this range the smallest perceivable increase in brightness is found to be about 2 per cent; yet to notice so small a contrast requires unusual attention and for practical purposes it seems safe to reckon that contrasts below 4 per cent will pass unnoticed. A gradual deviation in a gray scale may be even larger without being conspicuous. The value of 4 per cent as the smallest practically noticeable contrast is important as the limit below which noise, interference, and overshooting after transients have to be kept to remain unseen.

A sort of automatic volume control enables the eye to cover the enormous range of $1:10^8$ ($4 \cdot 10^{-5}$ to 4000 millilamberts, estimated to be seen as 572 different shades). Part of this system is the automatic adjustment of the pupil; yet its diameter varies at most from 2 to 8 millimeters thus accounting for a change of transmitted light of only 1:16. Evidently much more effective is the, as yet not fully explained, automatically controlled supply of visual purple to the cones of the retina. The stronger the illumination, the more visual purple is consumed, leaving less to be exposed.

CONTRAST RANGE

Distinct from this large adaptation range of the eye is the maximum contrast which it can perceive, at a given moment, between different parts of a picture. No exact figures for this can be given but a ratio of, at best, 80:1 will serve as a reasonable figure. Thus the eye almost fully appreciates the contrast between the darkest available surface, black velvet, reflecting about 1 per cent, and the brightest, a silver mirror, reflecting about 97 per cent. It also compares well with a good optical projection system, of which it is known that dust in the air and all but freshly polished lens surfaces will reduce the contrasts on the screen to about 100:1, no matter how large the contrasts of the slide or film. Photographic papers are not capable of rendering such contrasts; the best glossy paper offers a contrast range of 60:1, that of "commercial" and matte-surface papers may be as low as 15:1, with 25:1 representing a good average.

The contrasts in a reproduction are not necessarily the same as in the original. The relation between the two contrasts is called gamma; it is equal to, larger or less than, unity if the contrast between any two parts

of the reproduced picture is the same as, larger or less than, in the original. If, according to widespread preference, gamma is larger than unity, then a proportionally larger contrast range is necessary to render the whole number of shades of the original. Moreover, as color differences of a multicolored original are lost in black-and-white reproduction, this loss of information is generally replaced by a further increase in gamma. Thus even outdoor scenes in which the contrasts seldom exceed 40:1 cannot with adequate contrast range be reproduced on paper.

The contrast range of cathode-ray tubes is subject to two independent limitations. The one is purely optical, caused as Law has shown,² mainly by halation,

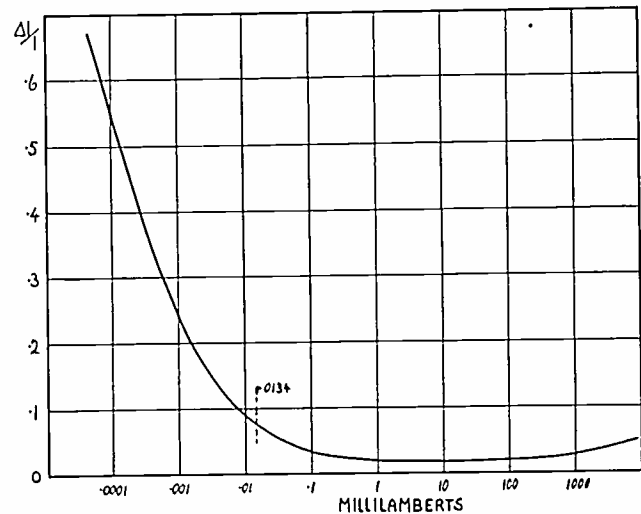

Fig. 1

also by stray light in the screen and internal reflections in the bulb. The other limitation is caused by the electron gun which beyond a certain beam current fails to focus the beam properly. Thus the greatest properly focused brightness on the screen, compared with faint illumination resulting, for example, from external light on its darkest parts, will constitute another limitation to the contrast range. The range so defined may be called the available brightness range. It can be neglected if it is much larger than that allowed by halation. However, inadequate exclusion of external light in conjunction with a poor electron gun may seriously reduce the available contrast range which in good tubes is at present of the order of 25:1, measured between points 1 inch apart.

REPRODUCTION OF THE AVERAGE BRIGHTNESS OF A SCENE ON THE TELEVISION SCREEN

The available brightness range of a cathode-ray tube is bound to be exceeded in any attempt to reproduce the average brightness of the transmitted scene. It is often stated that essential information is suppressed if a television picture does not show an increase in average brightness when the average brightness of the transmitted scene is increased. This however would not be the case in a receiver not utilizing

² R. R. Law, "Contrast in kinescopes," Proc. I.R.E. vol. 27, pp. 511-523; August, (1939).

direct-current coupling to the grid of the cathode-ray tube, the total light from its screen being always constant. Thus in the picture of such a receiver, the opening of a window shutter will darken the remaining parts of the picture although in fact they become brighter also. This argument is quite correct, yet it has no bearing on practical television because only photometry or photography of the screen would be affected by the increase in average brightness. The eye, for which television is intended, remains unaware of it; its automatic volume control responds immediately so that after a very short time the sensitivity of the eye is decreased. A simple experiment will prove that a bright object, or light, brought into the field of view at once obscures the details in the adjacent shadows which were clearly seen before; dazzling motorcar headlamps are an extreme case.

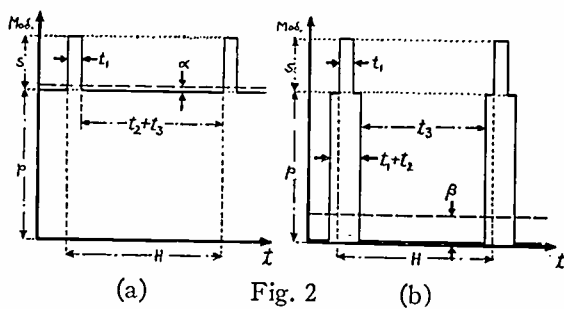

Fig. 2

$$t_1(s - \alpha) = (t_2 + t_3)\alpha$$

$$\alpha = \frac{st_1}{t_1 + t_2 + t_3}$$

$$\text{Shift of average level: } \beta - \alpha = \frac{t_1 + t_2}{t_1 + t_2 + t_3} \cdot p$$

$$t_1s + (t_1 + t_2)(p - \beta) = t_3\beta$$

$$\beta = \frac{st_1 + pt_1 + pt_2}{t_1 + t_2 + t_3}$$

$$\text{United States Standard: } \frac{t_1}{t_1 + t_2 + t_3} = 0.08; \quad \frac{t_1 + t_2}{t_1 + t_2 + t_3} = 0.15$$

Except when measuring the diameter of his pupil, an observer remains unaware of this automatic adaptation unless his attention is directed towards the darker parts of the picture. It may also be recalled that the average brightness of a photographic picture is not related to that of the original scene; it merely depends on the illumination under which the print is viewed. The brightness of the original scene is indicated only indirectly; dim light would be suggested by lack of details in the shadows, resembling scotopic vision.

Although a slow change in brightness remains unseen, a sudden change is clearly noticed. This can be reproduced without direct-current coupling. An alternating-current coupling with a time constant of about 0.07 second has been found fully adequate to render such changes and also to maintain an even background from the top to the bottom of the picture.

That a slow change in average light remains unnoticed would not, by itself, constitute a reason against its transmission. A compelling argument against direct-current transmission arises from the fact that it can be achieved only through a serious sacrifice in signal-to-noise ratio and in available contrast range at the receiver.

If allowance is made in the operation of a transmit-

ter for even moderate changes in average brightness then any picture is restricted to only a small range of the modulation characteristic at a time, reserving large parts near the "black" and the "white" end of it for occasional dark or light pictures. Thus the depth of modulation during any given scene is notably reduced, with proportional reduction of signal-to-noise ratio at the receiver. For the same reason the picture can, at any given time, occupy only a fraction of the available brightness range of the cathode-ray tube and can present only a limited range of contrasts.

Only in very rare cases, such as a brightly illuminated face looking through the opening in a dark theater curtain, has it been observed that direct-current coupling gave a better picture. The absence of the direct-current component allows the large area of the curtain to assume a "medium-gray" level, with the face accordingly appearing very bright and possibly blurred. Such cases are quite rare, however, as compared with the frequency of the need to readjust the background-light control of a receiver with direct-current coupling. Actually the suppression of the direct-current component corresponds to some extent to a photographic ideal, a developer which, regardless of exposure, automatically places the picture near the middle of the available contrast range.

Because of the synchronizing pulses, even in a receiver without direct-current coupling, a part of the transmitted direct-current component reaches the screen of the cathode-ray tube. Fig. 2 shows signals for a black and a white line, based on the American television standard. Only the synchronizing pulses reach the peak level; the black level is at 75 per cent of the peak level and the white level is at zero. In the absence of any direct-current coupling the average grid voltage of the cathode-ray tube will assume the level indicated by the dotted lines, the areas above and below which are just equal.

In the case of the black line, Fig. 2(a), the dotted line is at 77 per cent of the peak level, assuming a duration of the line synchronization pulse of 0.08 of the line time H . In Fig. 2(b) the signal is assumed to be fully white, i.e., 0 per cent, for a period as long as the standard allows, i.e., 0.85 of the line time H . A simple calculation shows that the dotted line, representing the average grid voltage, has now dropped to 13.25 per cent of the peak level; thus during the picture time of $0.85H$ the grid voltage of the cathode-ray tube is more positive than in the case of Fig. 2(a), by an amount of $13.25 - 2 = 11.25$ per cent of the peak level. This change of 11.25 per cent equals exactly 0.15 of the total control range of 75 per cent and it can be stated that quite generally a pure alternating-current coupling "transmits" exactly the same fraction of the direct-current component as the synchronizing pulse and blanking time occupy of the total line time H , that is, $0.15H$ in the American standard (neglecting the smaller contribution of the frame pulse).

The arguments against direct-current coupling to the cathode-ray-tube grid in no way affect the requirement of maintaining constant height of the black level and thus transmitting all synchronizing pulses with equal height. In a system occupying a finite frequency band the fronts of the pulses are not infinitely steep; only if their sloping fronts start always from the same level and thus always reach the firing potential after the same delay can synchronization be independent of the picture content of the previous line.

LINEAR AND CONTRAST MODULATION

Correct reproduction of a picture ($\gamma = 1$) requires that the brightness of each point of the reproduction be proportional to that of the corresponding point of the original. This relation refers to the over-all characteristic which is composed of the modulation-voltage—light characteristic of the transmitter and of the image-brightness versus signal-voltage characteristic of the receiver. Because of the habitual preference for linear relations in engineering a linear characteristic of both the transmitter and the receiver is generally taken for granted, especially since the output of a photocell is in linear relation to light intensity. It is conceivable that a television system may work in this manner, which may be called linear modulation. However, a linear over-all characteristic composed of a logarithmic voltage—light characteristic at the transmitter and of an exponential light—signal-voltage characteristic at the receiver offers a considerable number of important advantages. This system may conveniently be called "contrast modulation" because in it equal steps in the modulation voltage correspond to equal steps in contrast, instead of equal steps in brightness. As had already been stated, the eye, like other sense organs, interprets equal-percentage increases as equal contrasts or steps. Thus to produce the impression of an evenly graded gray scale on the screen of a cathode-ray tube having a linear characteristic its grid has to be modulated with a voltage rising according to an exponential law. What, in such a scale, appears to the eye as "medium gray" is then not represented by that brightness which is one half of the "white" but that corresponding to the geometric mean between the brightness of "white" and "black." In a contrast range of 100:1 this means that "medium gray" is at the brightness level 10, thus being as much brighter than "black" as it is darker than "white."

If the transmitter modulation is linear in brightness the darker half of the contrast range is compressed into 10 per cent of the available modulation range, the lighter half occupying the remaining 90 per cent. This is illustrated by Fig. 3 which is based on the American television standard. Modulation voltage is plotted as the ordinate, from 75 per cent of the peak level for "black" down to 0 per cent for "white." Along the abscissa is plotted brightness, assuming that a range from 100 to 1 is to be covered; the scale is logarithmic

so that equal lengths along the abscissa correspond to equal contrasts. Curve 1, referring to linear modulation shows that for the "medium-gray" level the modulation has only dropped to 67.5 per cent so that the whole darker half of the picture content is described by amplitudes between 75 per cent and 67.5 per cent of the peak level. It is evident that a very strong signal has to reach the receiver if circuit noise and interference shall remain unnoticed even in the darker parts of the picture.

Curve 2 shows for comparison a logarithmic modulation-voltage—brightness characteristic. In this case equal contrasts correspond to equal changes in modulation voltage; "medium gray" is at 37.5 per cent,

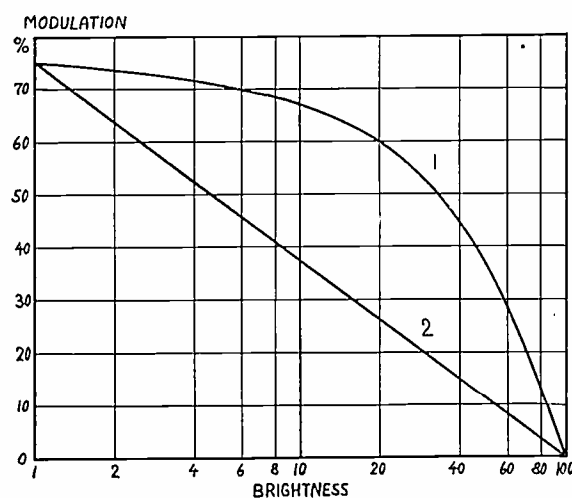

Fig. 3

halfway between 75 per cent and 0 per cent. Sensitivity to noise and interference is evenly distributed over the whole range and is now equivalent to that in the linear system at a brightness level of 25 in a scale from 1:100; the signal-to-noise ratio in the dark parts is improved about 7 times; two thirds of the contrast range benefits; and only in the brightest parts is the signal-to-noise ratio reduced, by a factor of 4 in the high lights.

Another advantage of contrast modulation relates to the so-called contrast control. Assume a truly linear system and that, in the opinion of the observer, the signal delivered to the cathode-ray tube gives a picture with too much contrast. Turning back the contrast control, which is a voltage divider controlling signal amplitude, results only in the brightness of each picture element being reduced; their contrast relations remain unchanged. Looking through a pair of sun glasses would give a similar result.

Having made the picture darker without affecting the contrasts the observer may now advance the background-light control, which adjusts the bias on the cathode-ray tube. This is equivalent to admitting a small amount of external light and the contrasts are now clearly affected, although at the price of bad distortion. An addition of light which is just noticeable in the high lights, say 10 per cent, thus reducing their contrasts by 10 per cent, will triple the light in the

20-fold darker shadows, weakening their contrasts three times. Thus, in a truly linear system, contrast control does not affect the contrasts at all; the only means to control them is the background-light which, however, distorts them by acting strongly in the dark parts while leaving the light parts almost unaffected. Simultaneously it becomes clear why, in such a system, the proper setting of the background-light control is so very critical; a slight maladjustment or change in the transmitted black level or in the received signal strength must unbalance the contrasts in the dark and in the light details.

Although the above is correct for a truly linear system it must be conceded that in present practice contrast control is not quite so useless because actually neither the transmitter nor the receiver characteristics are truly linear. One possible reason why the transmitter characteristic departs from linearity has been found by Maloff³ in the iconoscope which "possesses a logarithmic characteristic to a certain degree." But even if a pickup tube with linear characteristic were used, some contrast distortion is introduced at another stage, as is quite apparent from observation of typical television signals on an oscilloscope. For undistorted linear modulation the superimposed traces of all the lines of a picture should appear bunched together around an average of 67.5 per cent of the peak signal for a contrast range of 100:1, or around 60 per cent for a contrast range of 25:1. That their average is regularly nearer 40 or 50 per cent of the peak signal indicates clearly that the contrasts in the darker half of the range are increased and those in the lighter parts reduced. This agrees well with the appearance of the usual pictures.

In the receiver, the characteristic of the cathode-ray tube also departs from linearity. Good approximation to linearity is usually achieved in the upper half of the available brightness range. Thus the contrasts in the lighter parts of the picture remain as low as transmitted. However, the darker part, the "foot" of the cathode-ray-tube characteristic, is quite generally curved, often approximating very closely an exponential characteristic. This tends to reduce the contrasts in the dark parts and to compensate for some of the increase caused by the transmitter.

The change in gradation at the "foot" of the cathode-ray-tube characteristic has not escaped the observation of those viewers who experiment until they get a well-graded picture. Not seldom they choose to exclude external light rigorously and then to turn the background-light control until the picture is just clearly visible, although rather dark. By thus utilizing only the exponential part of the cathode-ray-tube characteristic, a much more satisfactory gradation is achieved.

Contrast modulation avoids all these difficulties. At

³ I. G. Maloff, "Gamma and range in television," *RCA Rev.*, vol. 3, p. 416; April, (1939).

the receiver it requires only that one control characteristic, preferably that of the cathode-ray tube, approach the shape of an exponential function. The contrast control, which may be identical with the receiver gain control, then becomes a true gamma control. It controls the picture contrasts from extremely soft to "extra hard" without changing the balance between the contrasts in the dark parts and those in the light parts. Moreover, since gamma can be freely chosen to fit the available contrast range, the pickup tube at the transmitter and the cathode-ray tube in the receiver may have different contrast ranges, being independent of each other and individually operated to suit their own characteristics. A picture transmitted with a great contrast range can be received undistorted but somewhat softer on a receiver with poor contrast range and a somewhat flat picture can be made to occupy fully the large contrast range of an especially good receiver.

The background-light control, which varies the bias of the cathode-ray tube, has no influence whatsoever on the contrasts within the entire range over which the brightness is an exponential function of the grid voltage. Once it is set so that even the darkest details are not lost in the external light on the screen, it has no further influence except making the average picture brightness as great as the available brightness range of the cathode-ray tube will permit. Thus there is no reason left why the background-light control should not be changed from the most critical and most manipulated control to a concealed preset control, and adjusted no more than is the grid bias of any other tube.

Finally it may be mentioned that electron guns for cathode-ray tubes require fewer electrodes if an exponential rather than a linear characteristic is desired. Both these shapes can only be approximated, but approximations thus far achieved, and rather cheaply, are fully adequate for those departures from the ideal law which the eye can perceive.

The conversion of an assumedly linear transmitter modulator to logarithmic-law modulator is a minor circuit change requiring at most two additional small tubes.

Extended experiments have confirmed the above statements. Pictures on straight-line law tubes and on tubes with exponential characteristic were compared side by side; the latter were, by general consent, much preferred even when they were only half the size of the former, especially because of their sparkling detail in the high lights.

ACKNOWLEDGMENT

A large part of this paper is based on work in the Research and Design Laboratories of Electric and Musical Industries, Ltd., Hayes, England. I want to thank my former colleagues for their helpful observations and especially Mr. Rolf E. Spencer for his contributions to the analysis of contrast modulation.

High-Frequency Propagation Characteristics*

F. HAMBURGER, JR. †, MEMBER, I.R.E., C. V. LARRICK ‡, ASSOCIATE, I.R.E.,
AND MARTIN JONES §, NONMEMBER, I.R.E.

Summary—The results of an urban field-strength survey at 35.6 megacycles are given. These results are interpreted in terms of the characteristics of the terrain as determined from a study of contour maps. It is shown that the signal varies inversely as the square of the distance within the optical horizon, and inversely as the 3.6 power of the distance beyond the optical horizon. The value of the field at one mile is shown to be affected by the slope of the ground near the radiator. A quantitative correlation with a propagation formula given by Beveridge has been obtained.

INTRODUCTION

THE continuing increase in interest in the high-frequency portion of the spectrum centering around frequencies of 30 to 40 megacycles prompted the authors to investigate the propagation characteristics of frequencies in this range. The frequency selected for study was 35.6 megacycles and the study was carried out with a view towards increasing the knowledge of the propagation characteristics of this frequency in a densely populated region and the surrounding urban and suburban territory. The investigation was carried out in Baltimore, Maryland, as a co-operative research of The Johns Hopkins University and the Monumental Radio Company, licensees and owners of Radio Station WCAO.

EXPERIMENTAL TRANSMITTER

The high-frequency station, used for the propagation studies, transmitted the regular programs of WCAO experimentally from 6:00 P.M. to 12 midnight daily, using conventional amplitude modulation and signing the call letters W3XES. The station was located on the same site as the broadcast transmitter and antenna of WCAO, near the center of the city of Baltimore in an area surrounded largely by dwelling houses. The broadcast antenna is supported by two steel towers 165 feet high and the 35.6-megacycle antenna was mounted on top of one of these towers. It consisted of a half-wave vertical radiator connected to one side of a quarter-wave matching section which was fed through a coaxial transmission line from the transmitter located near the base of the tower. This antenna is referred to throughout the following discussion as "the high antenna." Another antenna system referred to as "the low antenna" had the same configuration as the high antenna except that it was located on top of the transmitter house only 35 feet above the ground and overshadowed by buildings on at least two sides. The transmitter was crystal-controlled and had a plate input of 240 watts to the final amplifier, corresponding to a power output of about 150 watts.

* Decimal classification: R270. Original manuscript received by the Institute, January 5, 1940.

† The Johns Hopkins University, Baltimore, Md.

‡ General Electric Company, Schenectady, N. Y.

§ Monumental Radio Company, Baltimore, Md.

MEASURING TECHNIQUE AND PROCEDURE

The field-intensity measurements were carried out using a superheterodyne receiver built for the purpose by the authors and consisting of an acorn-tube converter, two stages of amplification at an intermediate frequency of 1600 kilocycles, and a diode detector. The preselector and intermediate-frequency stages used variable- μ pentodes with a common variable cathode bias. The output of the receiver was indicated by a bridge-type vacuum-tube voltmeter actuated by the rectified voltage at the plate of the last intermediate-frequency stage. The output meter was substantially linear against signal strength for any value of cathode bias.

The receiver, together with 6-volt storage batteries and a dynamotor for power supply, was installed in a truck having a fabric top. A piece of copper screen about 10 square feet in area was mounted on the fabric top and above this screen and insulated from it was placed a quarter-wave vertical telescoping automobile antenna. Antenna and screen were connected respectively to the inner and outer conductors of a coaxial transmission line 12 feet long leading to the receiver.

Calibration was accomplished with a signal generator identical in appearance with that shown by Schelleng, Burrows, and Ferrell¹ consisting essentially of a shielded oscillator feeding a balanced loop radiator with a thermoammeter at its electrical center. The field laid down by the signal generator was calculated from the following formula given by the above-mentioned authors:

$$E = \frac{120\pi^2 N A I}{\lambda^2 D} \left(1 - \frac{j\lambda}{2\pi D} \right)$$

E = field at receiving antenna in volts per meter

N = number of turns in loop

A = area of loop in square meters

I = current in loop in amperes

D = distance between loop and antenna in meters

λ = wavelength in meters

The calibrations were conducted and repeated every few days in an open field by setting up the signal generator at a height equal to the center of the receiving antenna and a half wavelength distant from the antenna. Since the output meter was substantially linear against signal strength for any value of cathode bias, as could be determined easily by varying the signal-generator loop current, the cathode resistor, which consisted of three controls in series, was calibrated in terms of the setting of these controls to give full-scale

¹ J. C. Schelleng, C. R. Burrows, and E. B. Ferrell, "Ultra-short-wave propagation," Proc. I.R.E., vol. 21, p. 430; March, (1933).

reading on the output meter, first at the largest signal obtainable from the generator (16.7 millivolts per meter) and then at signal strengths of 1/2, 1/4, 1/8, etc., of this value. The step reductions in signal strength just indicated were obtained by reducing the signal-generator output or by moving it farther away from the antenna, or by using a smaller loop. Having obtained the setting for the first point, that is, maxi-

this occurred more than a few city blocks from the transmitting antenna.

Measurements of field intensity were made by following the signal as far out as it could be measured in all directions from the transmitting antenna. Measurements were made every block within the urban area and at the top and bottom of every hill outside the urban area, thus giving a point of measurement about

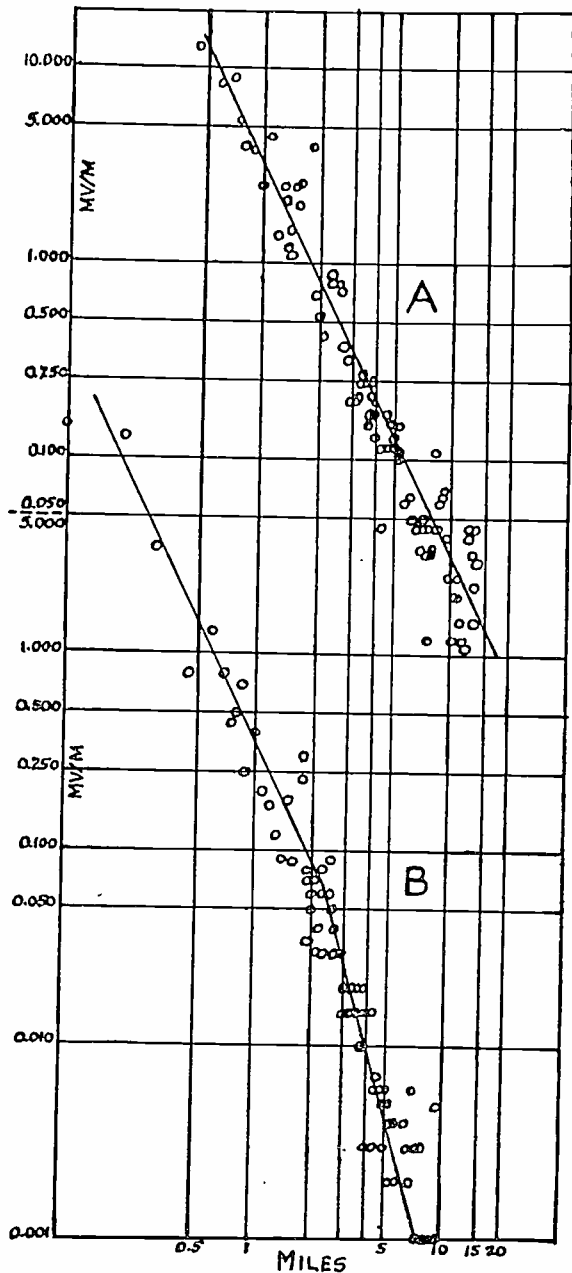

Fig. 1—Field-strength—distance curves along Reisterstown Road (direction 45 degrees west of north). A—Using high antenna. B—Using low antenna.

mum available signal strength from the generator, the generator's output was reduced until the output meter of the receiver indicated one half of its original reading. The gain controls were then increased until full scale was again obtained on the output meter thus calibrating the gain control for a signal strength of 8.35 millivolts per meter. Twelve or thirteen such doublings of the gain enabled calibration to be carried to a point where full-scale indication on the output meter corresponded to a few microvolts per meter. The maximum value of 16.7 millivolts per meter was sufficient since no signals from the station of greater value than

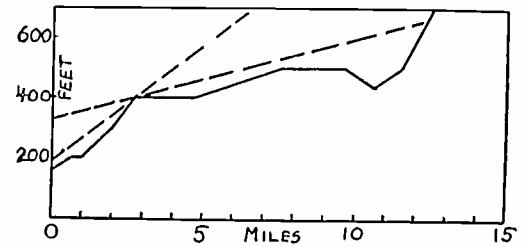

Fig. 2—Simplified section showing elevations along Reisterstown Road (direction 45 degrees west of north). Earth curvature neglected.

every 0.3 of a mile. The percentage variation in the signal intensity over short distances was always rather large, but no attempt was made to pick out good or bad points. The justification for this procedure was found in the fact that if the points so obtained were

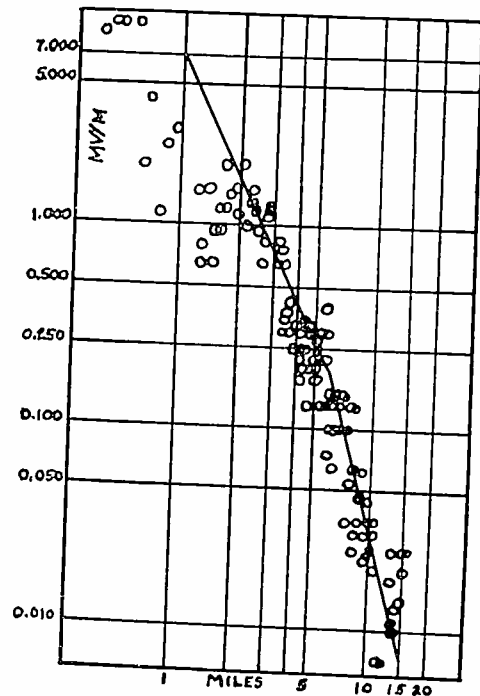

Fig. 3—Field-strength—distance curve along Harford Road (direction 45 degrees east of north) using high antenna.

plotted against distance using log-log co-ordinates, all but a very few of the points would lie between a pair of parallel lines representing a ratio of maximum to minimum signal at any point of about 10 to 1 or less. By drawing a third parallel midway between the first two, an empirical field-strength—distance curve was obtained whose relation to the existing field strengths was such that at any point, uphill or down, the field strength would not be greater than three times nor less than one third the value given by the curve. It was further decided that in plotting field-intensity contours these "geometric mean lines" should be used

rather than to attempt to give weight to each point taken, which would yield a field-intensity contour map resembling the contour lines on a topographic map of the same region. It is clear, however, that such a simplified field-intensity map yields much useful information for at any point on the 0.5-millivolt-per-meter contour, for example, the actual field strength will lie between about 1.5 and 0.15 millivolts per meter, which is about as closely as it can be predicted. Furthermore, such a map will reveal some of the more fundamental effects of the terrain as will be shown later.

EXPERIMENTAL RESULTS

In almost every case the field-strength curve clearly followed the inverse-square law sometimes throughout the entire investigated length of the radial and sometimes only for the first few miles nearest the radiator. In the latter case, the rate of attenuation would suddenly become greater, and excellent agreement was found with the inverse-3.6-power law found by Beverage² for propagation beyond the horizon in this range of frequency.

A typical example of this behavior is shown in Fig. 1, which gives the data along one radial, using first the high antenna and then the low antenna. Obviously the slope of the field-strength—distance curve is the negative of the exponent n in the proportionality $E \propto 1/D^n$, where E is the field intensity, and D is the distance from the radiator. A simplified plot of the elevation of the ground along this radial at various distances from the transmitter is given in Fig. 2. The dotted lines represent "rays" from the two antennas. The steeper "ray," coming from the low antenna, encounters a very definite horizon about 2 1/2 miles out, and the field-strength—distance curve changes slope at about this distance. The "ray" from the high antenna

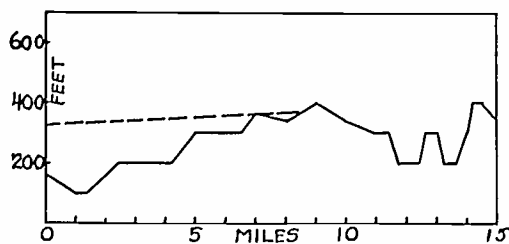

Fig. 4—Simplified section showing elevations along Harford Road (direction 45 degrees east of north). Earth curvature neglected.

meets a less-definite horizon, and the curve for this case does not change slope. Not all the correlations between the break in the curve and the optical horizon are as striking as this one, but the authors have found that where a break does occur, a study of contour maps will yield some reason for its occurring.

More serious difficulties were encountered when an attempt was made to obtain a plot of the field at one mile to show up any directivity of the radiator. It is

² H. H. Beverage, "Some notes on ultra high frequency propagation," *RCA Rev.*, vol. 1, pp. 76-87; January, (1937). Reprinted in "Television," vol. II, pp. 98-109, (1937), published by RCA Institutes Technical Press, New York, N. Y.

not possible to obtain a value for the "unattenuated field" by multiplying field intensity by distance and plotting against distance to semilogarithmic co-ordinates as this applies to an approximate exponential-plus-inverse-distance attenuation near the radiator, whereas the present data, as far as can be seen, shows a pure inverse-square law right up to the radiator. Accordingly any values of antenna efficiency in milli-

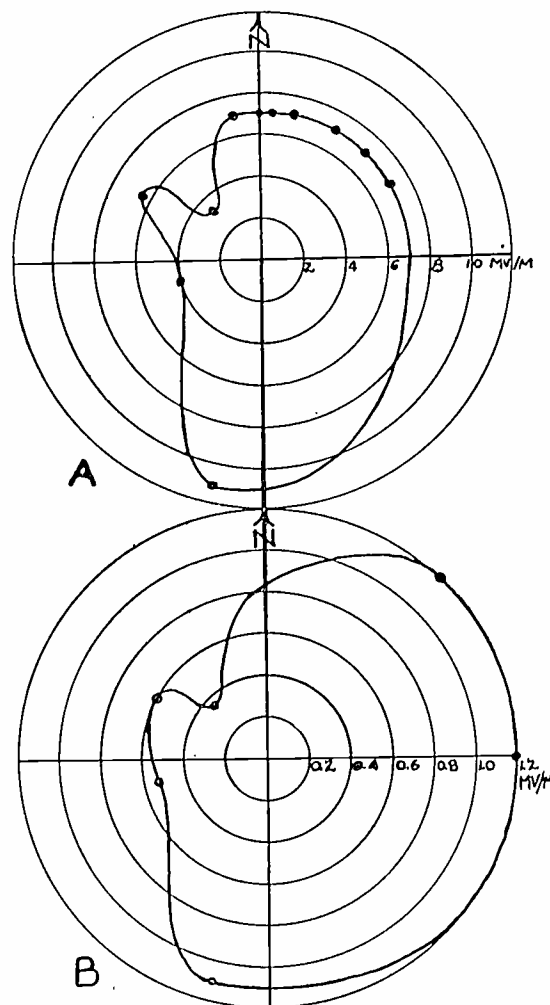

Fig. 5—Polar plots of field at one mile. A—High antenna. B—Low antenna.

volts per meter at one-mile-per-kilowatt input to the antenna must be on the basis of measured field strengths. The principal difficulty that arose was that in several cases the field strength followed the inverse-square law for one or two miles from the radiator and then remained constant for a mile or so, after which it would follow the inverse-square law again. If a pattern were drawn using the field actually measured at one mile in all cases, it would be necessary to assume a directivity in some directions too sharp to be explained. However, if the inverse-square portions of the field-strength—distance curves corresponding to more-remote distances are extrapolated back to one mile, and these values used in a pattern, the results are reasonable. A typical radial showing this behavior is given in Fig. 3, and a section through the terrain over which it was taken is given in Fig. 4. The kink in the data points is seen to coincide with a valley in the early part of the radial.

The polar plots of fields at one mile, which if atten-

uated according to the inverse-square law out to the optical horizon, and according to the inverse-3.6-power law beyond, will give the mean field strengths measured in the survey, are shown in Fig. 5. There is a general suppression of signal to the west and northwest. The shape of the polar plots is related to the slope of the terrain in different directions, for the first mile or so from the radiator. Directly north and east of the station, there is a stream valley. In these directions the slope of the terrain is downward from the station, and the signal is relatively good. Likewise, to the south, the slope is downward, and the signal is also good in this direction. However, to the west and north-

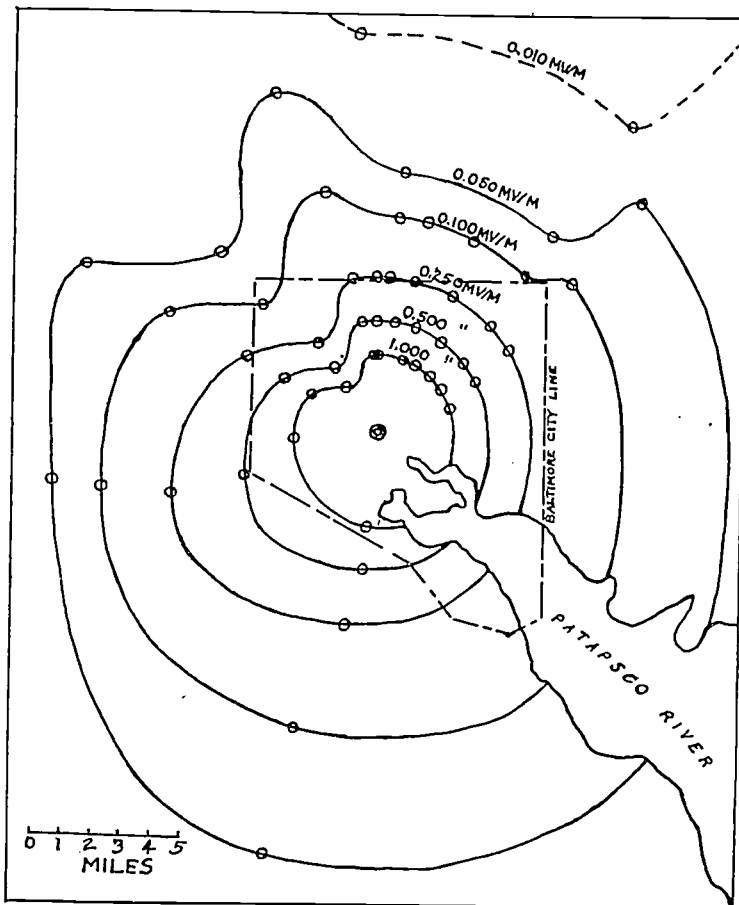

Fig. 6—Field-intensity contours in millivolts per meter using high antenna. (The points on the radial running due west from the station follow an inverse-1.33-power law for the first 6 miles.)

west, the terrain slopes upward from the station, and in that direction in which the suppression of signal is greatest, the terrain is rising most rapidly. This relationship, once arrived at, is not particularly astonishing, but in view of the rather gradual slopes that actually occur, it is doubtful whether it would be arrived at without a careful study of the topographic contour maps of the region in question.

The field-intensity contours using the high antenna are given in Fig. 6. The most striking effect of the terrain that is brought out by this plot is the distance from the source of a given contour in a direction where the 3.6-power law is operating as compared with a direction where no optical horizon occurs, the field at one mile being the same in both cases. This condition occurs in the northeast quadrant with the high antenna,

and produces a pair of "ears" on the field-intensity contour map. The depression between the "ears" is due to the 3.6-power law setting in six miles from the station. The left-hand "ear" pointing about 10 degrees west of north represents a radial running in a stream valley (Jones Falls) where the intensities are greater than on the high ground on either side. The high ground fails to be the superior receiving location in this case because particularly to the northeast it is a plateaulike area having an elevation of about 400 feet. Since the elevation of the transmitting antenna is only 325 feet, the area is screened from the station, just as a table top is screened from a candle placed on the floor.

Great differences in area covered do not appear until the 10-microvolt-per-meter contour is reached. To the northeast this contour is 13 miles from the station where the 3.6-power law is operating, but would be 26 miles from the station if the inverse-square law operated over the entire distance.

Beverage² gives an inverse-square-law propagation formula with which an extremely good quantitative correlation has been found. Using this formula together with the available data, and calculating the field at one mile for the experimental transmitter, yields for the high antenna a value of 7.43 millivolts per meter. In the first or northeast quadrant, representing average performance, a value of 7 millivolts per meter at one mile was measured. This corresponds to a value of 18.1 millivolts per meter at one mile per kilowatt. Outside the first quadrant all the observed values of field intensity at one mile were less than 7 millivolts per meter, except to the south along the Annapolis Road radial. In this direction, the ground at the base of the antenna is sharply elevated by 60 feet above the average ground level. If this elevation is added directly to the height of the tower, the Beverage formula predicts a field of 10.1 millivolts per meter at one mile, which is in good agreement with the measured value of 11 millivolts per meter.

Throughout the present study the authors have avoided averaging and mass-plot procedures which mask the peculiarities of individual radials, and it is their opinion that a careful study of contour maps is well repaid in a survey of this type.

CONCLUSIONS

1. The Beverage formula predicts in a satisfactory fashion the field strengths obtained from an antenna of moderate height, situated in an urban area, and radiating over hilly terrain.

2. The signal varies inversely as the square of the distance for points between the transmitter and the horizon, and for the frequency studied (35.6 megacycles) varies inversely as the 3.6 power of the distance beyond the horizon. The horizon in this case is not the horizon determined by the curvature of the earth, but is roughly the horizon that limits vision from the top of

the tower supporting the transmitting antenna. The distance to this horizon may be estimated by a study of contour maps.

3. The slope of the terrain in the immediate vicinity of the transmitting antenna has a marked effect on the performance of the installation. If the ground slopes downward from the transmitter for a mile or more in some direction, the performance in that direction will

be relatively good. If the ground slopes upward in some direction, the performance in that direction will be relatively poor. In this respect, the Beverage formula predicts the performance in the more favorable directions.

4. A spread in the observed field strengths of from one third to three times the mean or predicted value is to be expected.

Damped Electromagnetic Waves in Hollow Metal Pipes*

ARTHUR W. MELLOH†, ASSOCIATE, I.R.E.

Summary—Simple apparatus for the production of damped waves in hollow-pipe wave guides is described. The results of some measurements at free-space wavelengths down to 4.59 centimeters in circular air-filled pipes as small as 2.86 centimeters in diameter show that such apparatus can be successfully employed for the investigation of the properties of hollow-pipe waves. Some data are given which confirm part of a previous theoretical analysis of the behavior of electromagnetic waves in a pipe of elliptical cross section, and a possible method of detecting small deformations in a supposedly circular pipe is discussed.

INTRODUCTION

AN IMPORTANT factor in limiting experimental work on hollow-pipe transmission has undoubtedly been the supposed necessity for using apparatus not easily obtainable or having inconvenient dimensions. Excitation by vacuum-tube generators of the type ordinarily available calls for the use of pipes with diameters larger than can be conveniently handled in a small laboratory or the use of a dielectric other than air, while the use of air-filled pipes of small diameter demands special kinds of high-frequency generators. Since there must be available a source of electromagnetic waves having a maximum free-space wavelength of about 10 centimeters in order to excite convenient sizes of air-filled pipes, say 3 inches in diameter or less, the use of damped waves suggests itself, and while such waves were employed in one of the first experimental confirmations¹ of hollow-pipe transmission, no systematic investigation of their possibilities in wave-guide work seems to have been undertaken. Preliminary work previously reported² indicated that good results might be obtained with relatively simple apparatus.

APPARATUS

The damped-wave generators used in this investiga-

* Decimal classification: R210. Original manuscript received by the Institute, October 16, 1939; abridgment received, March 21, 1940.

† Institute of Technology, University of Minnesota, Minneapolis, Minn.

¹ R. H. Weber, "Elektromagnetische Schwingungen in Metallröhren," *Ann. der Phys.*, vol. 8, pp. 721-751; July 10, (1902).

² H. E. Hartig and A. W. Melloh, "The transmission of damped electromagnetic waves through small hollow metal tubes" (letter to the editor), *Phys. Rev.*, vol. 54, p. 646; October 15, (1938).

tion were similar to those described by Cole³ and more recently by Nichols and Tear⁴ for generating wavelengths as short as 1.8 millimeters. The oscillating doublet consisted of cylindrical tungsten electrodes energized from a small 110-volt, 60-cycle ignition transformer as indicated in Fig. 1. The auxiliary air

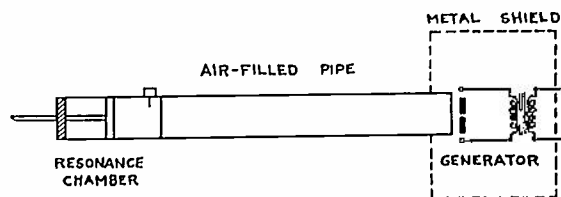

Fig. 1—Apparatus for measuring wavelengths in a hollow-pipe transmission system.

gaps between the electrodes and transformer terminals were of the order of 8 millimeters each while the main gap in kerosene was carefully adjusted by means of a thumbscrew for maximum output which usually occurred when this gap was of the order of 0.04 millimeter. The mechanical arrangement of the generator provided convenient means for securing satisfactory gap adjustment, removal of the electrodes for cleaning, and occasional renewal of the oil. The electrode configuration of the generator shown in Fig. 1 is particularly well adapted for exciting hollow-pipe waves of the H_{11} mode in pipes of circular cross section and all that was found necessary in order to excite the pipe was to place the generator at the end of the pipe with the electrodes parallel to a diameter. In order to confine the output of the generator to the hollow-pipe system, the transformer and generator were placed in a large metal shield.

For the measurement of wavelengths inside the pipe a simple resonance chamber⁵ formed of a 30-centi-

³ A. D. Cole, "The measurement of short electrical waves and their transmission through water cells," *Phys. Rev.*, vol. 7, pp. 225-230; November, (1898).

⁴ E. F. Nichols and J. D. Tear, "Short electric waves," *Phys. Rev.*, vol. 21, pp. 587-610; June, (1923).

⁵ G. C. Southworth, "Hyper-frequency wave guides—general considerations and experimental results," *Bell Sys. Tech. Jour.*, vol. 15, pp. 284-309; April, (1936).

meter section of the pipe was found to be satisfactory. As shown in Fig. 1 this section was fitted with a crystal detector probe and an adjustable piston of reflecting material.

RESULTS WITH CIRCULAR PIPES

The measurements with circular pipes were made primarily to determine the nature of the waves set up in a hollow pipe by the damped-wave generators em-

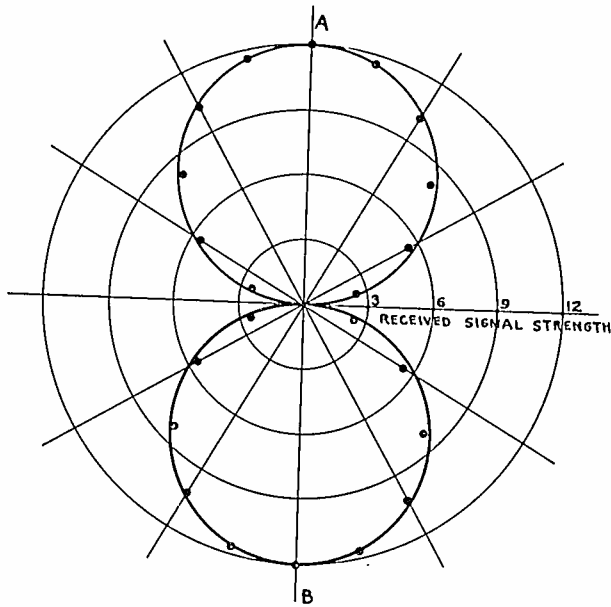

Fig. 2—Radial field distribution in hollow pipe 7.3 centimeters in diameter and 230 centimeters long. Generator electrodes parallel to AB and $\lambda_0 = 10.1$ centimeters.

ployed. Preliminary tests indicated that with the method of excitation described only the H_{11} wave was present as was carefully verified by an examination of the field pattern over a cross section of the pipe. A typical curve showing the radial field distribution over a cross section is given in Fig. 2. The experimental points, which are seen to agree closely with the theoretical curve, were obtained near the center of a pipe system 230 centimeters long, 7.3 centimeters in diameter, and excited with a generator whose free-space wavelength was 10.1 centimeters.

The wavelength of the exciting source, the pipe diameter, and the wavelength in the pipe are connected by simple mathematical relations, the fundamental equations⁶ for the H_{11} mode for air-filled pipes of circular cross section being

$$\lambda_{11} = \frac{\pi d}{1.84} \quad (1)$$

$$\lambda_{pipe} = \frac{\lambda_0}{\sqrt{1 - (\lambda_0/\lambda_{11})^2}} \quad (2)$$

where d = pipe diameter
 λ_{11} = critical wavelength corresponding to the H_{11} mode
 λ_{pipe} = wavelength in the pipe
 λ_0 = free-space wavelength of the exciting source.

⁶ J. R. Carson, S. P. Mead, and S. A. Schelkunoff, "Hyper-frequency wave guides—mathematical theory," *Bell Sys. Tech. Jour.*, vol. 15, pp. 310–333; April, (1936).

The results of a series of wavelength measurements in small air-filled copper pipes are shown in Fig. 3 where each of the plotted wavelengths is the average of five independent determinations for each size of pipe and generator. The excellent agreement between the measurements and the curves calculated from (2), together with Fig. 2, is offered as evidence of what may be done with relatively simple apparatus.

The damped-wave generators designated No. 2 and No. 3 in Fig. 3 differed only in the dimensions of the tungsten electrodes employed as indicated in Table I which also includes data for a larger pair on which fewer measurements were made. In Table I, L is the total length of the pair of electrodes and D is their diameter. It is interesting to observe that the ratio λ_0/L for the two larger pairs compares favorably with the value 2.53 derived theoretically by Macdonald⁷ and the value 2.52 found experimentally by Cole⁸ for electrodes of comparable dimensions. This ratio has been found⁴ to increase quite rapidly as the dimensions of the electrodes are decreased.

TABLE I

Generator No.	L cm.	D cm.	λ_0 cm.	λ_0/L
1	4.0	0.2	10.1	2.52
2	2.2	0.1	5.56	2.52
3	1.2	0.1	4.59	3.82

RESULTS WITH ELLIPTICAL PIPES

Since it has been shown that the waves set up in a hollow pipe by the damped-wave generators previ-

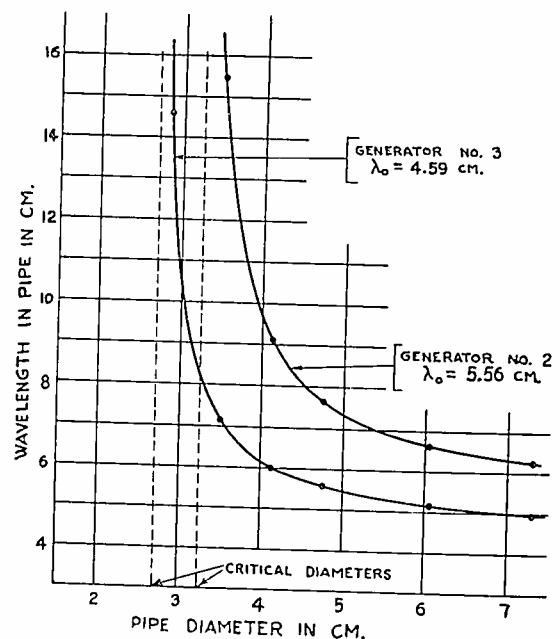

Fig. 3—Measured wavelengths in small air-filled copper pipes.

ously described behave in very much the same way as those set up by continuous-wave excitation, similar apparatus may be used for investigating experimentally the transmission of electromagnetic waves through a pipe of elliptical cross section, a problem on which no

⁷ H. M. Macdonald, "Electric Waves," p. 111, Cambridge University Press, New York, N. Y., (1901).

⁸ A. D. Cole, "The tuning of thermoelectric receivers for electric waves," *Phys. Rev.*, vol. 20, pp. 268–272; April, (1905).

data have been reported. Tubes of circular cross section will probably be the most convenient to use in certain applications of hollow-pipe systems, and since some departure from true circularity is likely to be unavoidable in any practical case, the effect of deformations on the wave propagation in the pipe is a matter of engineering concern.

It is convenient for ease of calculation to assume that the deformations will be such as to change the cross section of the pipe from a circle to an ellipse, and a thorough theoretical analysis of the transmission in pipes of elliptical cross section has already been given L. J. Chu⁹ whose investigation shows that if an elliptical pipe is properly excited along its maximum diameter an "odd" or ${}_oH_1$ wave may be set up in the pipe, while excitation along the minimum diameter may produce an "even" or ${}_eH_1$ wave. The patterns produced by these waves across a section of the pipe are similar to that produced by the H_{11} mode in a circular pipe and become more nearly identical with it as the eccentricity of the elliptical section approaches zero. The analysis also shows that the critical wavelengths for the ${}_oH_1$ and ${}_eH_1$ modes are functions of the eccentricity of the pipe and that the functions are different for the two waves. Chu gives a calculated curve showing the relation between the eccentricity and the critical wavelength for a pipe of constant periphery and since, for a fixed excitation frequency, the wavelength in the pipe depends on the critical wavelength as given by (2) of the present paper, this theoretical curve may readily be checked by a series of wavelength measurements in a pipe of elliptical cross section. A curve of λ_{pipe} as a function of the eccentricity for a pipe of 31.4 centimeters periphery excited with $\lambda_0 = 10.1$ centimeters is given in Fig. 4. This curve was obtained by taking the critical wavelengths from Fig. 2 of Chu's paper and calculating λ_{pipe} from (2) of the present paper. It is observed, for this particular case, that the wavelength in the pipe tends to very large values for high eccentricities when excited with an ${}_oH_1$ wave while λ_{pipe} tends to a definite limit as the eccentricity approaches unity for the ${}_eH_1$ wave.

Data for an experimental verification of this curve were obtained with a wave guide which consisted of a piece of No. 28 gauge galvanized iron conductor pipe approximately 4 inches in diameter and 6 feet long, one end of which was fitted with a probe detector and a movable reflecting surface giving an arrangement similar to that shown in Fig. 1. The pipe was deformed uniformly over its whole length by means of 3 screw clamps applied to wooden strips placed along the sides of the pipe. Although it was realized that the means employed did not yield a true elliptical cross section, it may be remarked that the deformations occurring accidentally in practical systems are likely not to be such as to give an exact elliptical section. Moreover,

⁹ L. J. Chu, "Electromagnetic waves in elliptic hollow pipes of metal," *Jour. App. Phys.*, vol. 9, pp. 583-591; September, (1938).

on the basis of previous experience it may be inferred that some departure from true ellipticity can be tolerated before the wavelength measurements would differ greatly from those obtained with an exactly elliptical pipe. The procedure followed in making the measurements was to deform the pipe a definite amount and then to measure the wavelength in the pipe when the pipe was excited with the same oscillator first along the maximum diameter and then along the minimum diameter, these two conditions corresponding to the excitation of ${}_oH_1$ and ${}_eH_1$ waves, respectively. The results of these measurements on the galvanized iron pipe 186 centimeters long with a periphery of 31.4 centimeters and excited by a generator having $\lambda_0 = 10.1$ centimeters are given in Fig. 4 where each experimental point is the average of five inde-

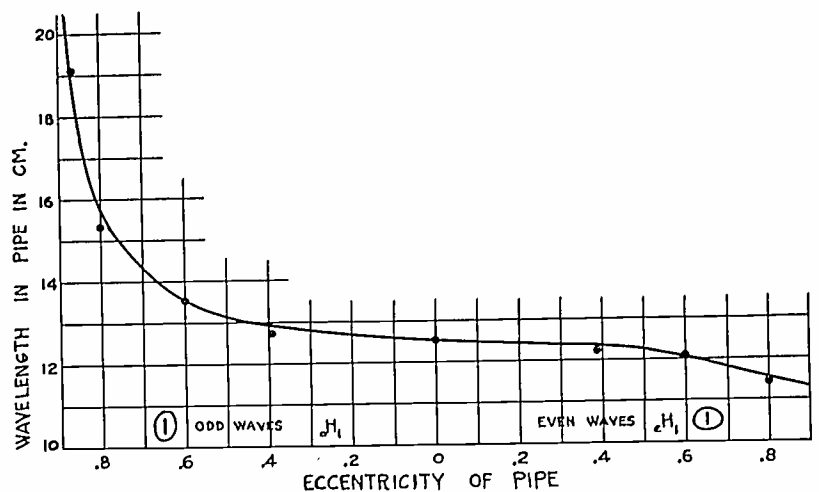

Fig. 4—Wavelengths in elliptical pipe 186 centimeters long, 31.4 centimeters periphery, and $\lambda_0 = 10.1$ centimeters.

pendent determinations for each deformation and for each manner of excitation. The agreement between the measurements and the calculated curve is thought to be sufficiently good to show that the behavior of the ${}_oH_1$ and ${}_eH_1$ waves in a deformed pipe is correctly predicted by the theory. Also, what is important from a practical standpoint, the exact geometrical conditions on which the theory is based apparently do not have to be met in order that the theory may be used to predict results with an accuracy sufficient for engineering purposes. A few representative measurements with an elliptical pipe made from a piece of sheet copper having a periphery of 12.7 centimeters and with $\lambda_0 = 5.56$ centimeters also gave satisfactory results since the measured wavelengths differed from the calculated values by less than 4 per cent in all cases.

Another problem which is likely to occur in the use of hollow-pipe systems is that of eliminating one or more undesired modes of propagation. Grids or filters of various kinds have been used for this purpose^{10,11} but no data have been given to demonstrate their effectiveness. Such data may be obtained readily with

¹⁰ G. C. Southworth, "Some fundamental experiments with wave guides," *Proc. I.R.E.*, vol. 25, pp. 807-822; July, (1937).

¹¹ W. L. Barrow and F. M. Greene, "Rectangular hollow-pipe radiators," *Proc. I.R.E.*, vol. 26, pp. 1498-1519; December, (1938).

a pipe of elliptical section since the deformation itself may be used to produce more than one mode in the pipe and no complicated generating system is required. If the elliptical pipe is oriented so that the generator electrodes are along a line which lies between

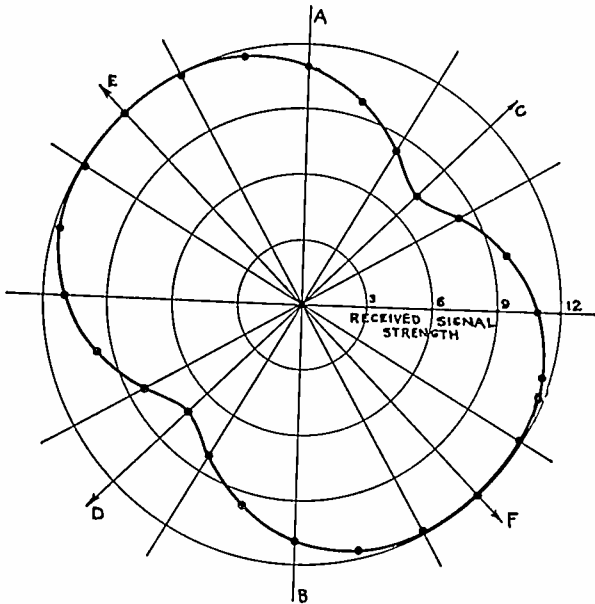

Fig. 5—Radial field distribution at end of elliptical pipe excited along AB with $\lambda_0 = 10.1$ centimeters.

the maximum and minimum diameters, both an ${}_0H_1$ and ${}_1H_1$ wave will be set up in the pipe and the field pattern over a cross section of the pipe will be that produced by all components present. Using the galvanized iron pipe excited with $\lambda_0 = 10.1$ centimeters along a line making a 45-degree angle with the maximum and minimum diameters, the pattern shown in Fig. 5 was ob-

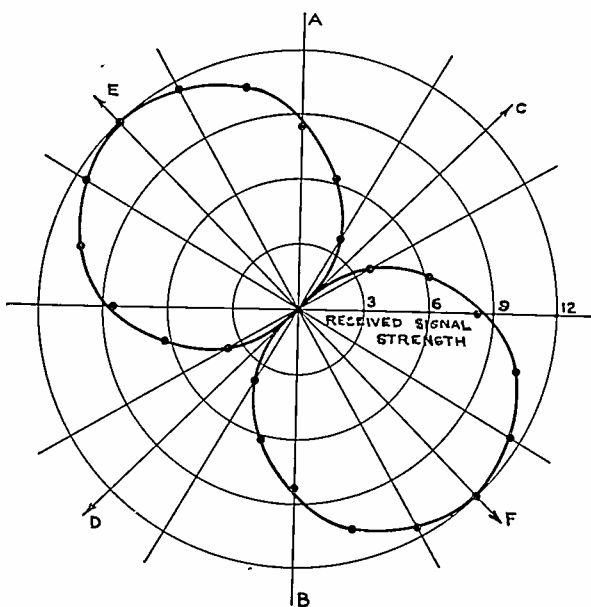

Fig. 6—Same as Fig. 5 but with filter wires parallel to the minimum diameter CD .

tained. The experimental points, through which a smooth curve is drawn, were obtained at the open end of the pipe 186 centimeters long with extreme diameters of 11.7 and 7.6 centimeters and represent the output of a doublet receiver rotated in a plane perpendicular to the tube axis. A grid, consisting of 11 evenly spaced No. 19 gauge copper wires, insulated from each other and extending to within 2 or 3 millimeters of the pipe, was

mounted parallel to the minimum diameter on a thin sheet of insulating material cut to conform to the cross section of the pipe. This sheet was inserted into the pipe about 5 centimeters from the receiver end, and the field pattern obtained with this arrangement is given in Fig. 6 which shows practically complete elimination of the ${}_0H_1$ wave leaving only the ${}_1H_1$ component, corresponding to excitation along the maximum diameter. A similar grid consisting of 7 wires parallel to the maximum diameter gave the pattern of Fig. 7 showing that now only the ${}_0H_1$ wave reached the detector. It did not seem to make much difference where the filter was placed along the pipe, equally good results being obtained with the grid near the generator end; however, a longer pipe system might require the use of several grids distributed along the tube axis.

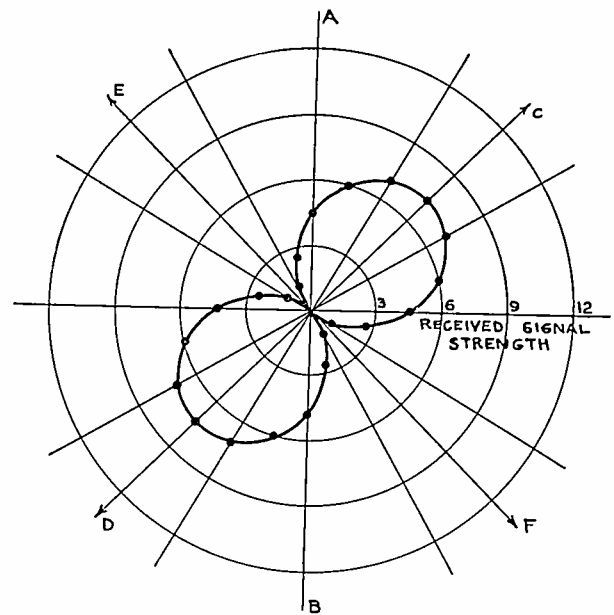

Fig. 7—Same as Fig. 5 but with filter wires parallel to the maximum diameter EF .

DETECTION OF SMALL DEFORMATIONS

The use of hollow-pipe systems in electrical communication will probably always require that the wavelength of the exciting source be sufficiently removed from the critical wavelength of the system to insure stable propagation and low attenuation. For other applications, however, it may be desirable to work very near to the critical condition. An examination of Fig. 4 shows that the greatest variation in the propagation phenomena, as indicated by the change of wavelength in the pipe, occurs for rather large eccentricities and the changes are more pronounced for the odd waves than for the even waves. For the case there depicted, the pipe size and wavelength of excitation are so related that λ_0 is only 59.5 per cent of λ_{11} for the undeformed pipe, and small deformations, corresponding to eccentricities in the neighborhood of zero, do not produce much change in the wavelength in the pipe. However, by simply increasing the wavelength of excitation keeping the pipe size constant, the curve of Fig. 4 would be shifted to the right without altering its general shape. Consequently by choosing λ_0 sufficiently

large, the rapidly rising portion of the curve would occur in the neighborhood of zero eccentricity and small deviations from circularity would produce relatively large changes in the propagation. These changes were found to be observable as a variation in the intensity of the radiation from the end of the pipe as the pipe was rotated about its axis, the generator and receiver being fixed in position.

The first experiments which resulted in observations of the effect just described were conducted with a piece of copper pipe 100 centimeters long having a nominal inside diameter of 6.04 centimeters, but deformations resulting from machining and handling caused the pipe to have maximum and minimum diameters of 6.05 and 6.00 centimeters. This pipe was excited by a damped-wave generator with $\lambda_0 = 10.1$ centimeters and since $\lambda_{11} = 10.3$ centimeters for the undeformed pipe the exciting wavelength was 98 per cent of the critical value. The generator electrodes were maintained in a vertical position at all times and a doublet antenna 7 centimeters long with a crystal detector at its center was placed at the open end of the pipe to measure the output. When the receiving doublet was vertical no change in the output was observed when the pipe was rotated, but when the receiver was placed perpendicular to the generator electrodes the output changed in the ratio of 1.33 to 1 as the pipe was turned. The output was a minimum when either the maximum or minimum diameter was parallel to the generator electrodes and maximum for an intermediate position. These results agree with Figs. 5, 6, and 7 which show that the output changes more rapidly in the neighborhood of a minimum than a maximum, and that when the pipe is excited along a diameter between the two extreme values considerable output may be expected for positions which give negligible transmission when one or the other component wave is present alone. That the observed change was no larger than 1.33 to 1 was due primarily to the short length of the pipe. With $\lambda_0 = 10.1$ centimeters and $\lambda_{11} = 10.3$ centimeters the wavelength in the pipe is calculated to be 50.5 centimeters, hence the pipe was only 1.98 wavelengths long. It has been found previously¹² that the pipe must be 5 or 6 wavelengths long before the wave patterns attain their theoretical configurations, therefore this ratio would be expected to increase with the pipe length at least until the pipe was several wavelengths long. In the case under discussion conditions were such that there was considerable energy reaching the receiver which did not possess the characteristics of hollow-pipe waves.

¹² L. J. Chu and W. L. Barrow, "Electromagnetic waves in hollow metal tubes of rectangular cross section," *PROC. I.R.E.*, vol. 26, pp. 1520-1555; December, (1938).

To prevent some of this undesirable radiation from reaching the receiver a filter consisting of 11 parallel No. 19 gauge copper wires was placed between the receiver and the open end of the pipe. This grid was kept fixed in position so its wires were parallel to the generator electrodes and hence perpendicular to the receiver. With this filter in place the output changed in a ratio of 4 to 1 when the pipe was rotated, the pipe positions which resulted in maximum and minimum outputs remaining the same as before. To emphasize the sensitivity obtainable it may be recalled that the ratio of 4 to 1 corresponds, in this case, to a difference in diameters of 0.05 centimeter in 6.04 centimeters or 0.83 per cent. With the particular apparatus employed in this experiment an output ratio of 1.02 to 1 could have been observed and consequently it is certain that deformations considerably smaller than 0.83 per cent can be detected. Tests with other pipe sections of about the same degree of eccentricity confirmed the conclusion that the ratio of maximum to minimum intensity obtained without the filter should increase with longer pipe sections. The results are given in Table II

TABLE II

Pipe Length	Ratio without Filter	Ratio with Filter
λ_{pipe}		
0.54	1.0	1.0
1.98	1.3	4.0
4.38	1.7	4.2
6.36	2.0	3.9

where the first column gives the length of the pipe in terms of $\lambda_{pipe} = 50.5$ centimeters and the last two columns give the ratio of maximum and minimum outputs of the receiver obtained as the pipe was rotated. This table shows that in a very short pipe the wave phenomena are not sufficiently established to give measureable results, while for the three longer pipes the ratio obtained without the filter increases as the length is increased. The ratios obtained when the filter was used are practically constant showing that the filter was sufficiently effective to make the ratio depend only on the eccentricity. It should be stated that the choice of λ_0 in relation to the pipe size employed in these tests was governed by available apparatus and probably does not represent the value yielding the highest sensitivity.

ACKNOWLEDGMENT

The writer wishes to express his sincere thanks to Dr. Henry E. Hartig of the Department of Electrical Engineering of the University of Minnesota for his help and encouragement during the course of the investigation described in this paper.

Natural Oscillations of Electrical Cavity Resonators*

W. L. BARROW†, ASSOCIATE, I.R.E., AND W. W. MIEHIER‡, NONMEMBER, I.R.E.

Summary—Resonance phenomena in cavity resonators of coaxial and hollow-pipe types are described and the transition from a resonator of one type to the other is discussed. Measured curves of resonance frequencies for the first twelve modes are reported. The principle of similitude is proved and other aspects of these resonant circuit elements are considered.

INTRODUCTION

THIS paper deals with resonant electric circuit elements of the closed chamber or cavity type in which a dielectric space is substantially completely inclosed by a conducting material. These elements are becoming increasingly important in ultra-high-frequency engineering because of their perfect shielding, low loss factor, and adaptability to various electronic systems. A familiar example of such a resonator is a section of coaxial line, which has found numerous applications in communication technique. A hollow cylindrical cavity is an example of more-recent origin, and cavities of other shapes, too, have been proposed. A closed coaxial section in which the inner member conductively connects the two ends will be termed a *perfect-coaxial* resonator. If the center conductor of this resonator is slowly withdrawn a hybrid type results that continuously alters form until, when the conductor is completely removed, it becomes a *perfect cylinder* or a *perfect-cylindrical* resonator.

These two *perfect* types of resonators may be analyzed in detail by the use of Maxwell's equations and pertinent engineering information derived. The *hybrid* type, on the other hand, has not yet been adequately analyzed, nor have comprehensive measurements been heretofore available. In this paper, we shall provide a comprehensive set of measurements of resonant frequencies showing the transition from one perfect type of resonator to the other.

THEORETICAL BACKGROUND

Perfect-Coaxial Resonators

The resonators discussed herein all comprise hollow circular cylinders that are closed by plane ends at right angles to their axes. Cylindrical co-ordinates r , θ , x will be employed.

Resonance phenomena in perfect-coaxial resonators may be conveniently thought of as the result of standing waves caused by the multiple reflections of traveling waves of the various types that exist on coaxial transmission lines.^{1,2} Two general classes of traveling

waves are distinguished,³ namely: (1) Transverse Electric (*TE*), having the *electric* field transverse to the axis; and, (2) Transverse Magnetic (*TM*), having the magnetic field transverse to the axis. Both classes of waves have field configurations that vary with the angular variable θ and the radial variable r . The number of full-period variations along the angular or θ co-ordinate will be denoted by l and the number of half-period variations along the radial or r co-ordinate by m . Thus, the order of the wave is designated by subscripts l, m . The wavelength λ of a traveling wave in a uniform transmission line may be expressed as follows:

$$\lambda = \frac{c}{\sqrt{f^2 - f_0^2}} \quad (1)$$

where c = velocity of light in the dielectric medium of the line in meters per second, f = the frequency of the excitation in cycles per second, and f_0 = the critical frequency below which transmission of the given type of wave cannot occur. The critical frequency depends on the radii of the inner and outer conductors a and b , respectively, and on the order of the wave, and differs for waves of the transverse electric and transverse magnetic classes.

$$TM \text{ waves } \dots f_0 = \frac{cr_{l,m}}{2\pi b} \quad (2)$$

$$TE \text{ waves } \dots f_0 = \frac{cr'_{l,m}}{2\pi b} \quad (3)$$

The quantities $r_{l,m}$ and $r'_{l,m}$ are the roots of the equations

$$TM \text{ waves } \dots \frac{J_l(r_{l,m})}{Y_l(r'_{l,m})} - \frac{J_l\left(\frac{a}{b}r_{l,m}\right)}{Y_l\left(\frac{a}{b}r_{l,m}\right)} = 0 \quad (4)$$

$$TE \text{ waves } \dots \frac{J'_l(r'_{l,m})}{Y'_l(r'_{l,m})} - \frac{J'_l\left(\frac{a}{b}r'_{l,m}\right)}{Y'_l\left(\frac{a}{b}r'_{l,m}\right)} = 0 \quad (5)$$

where J and Y are Bessel functions of first and second kinds respectively, and J' and Y' their derivatives with respect to the arguments.

When a section of line of length L is made into a resonator by closing both ends with conducting disks, it is generally possible to satisfy the new boundary conditions only when the frequency is such that the length of the waves in the line is given by

³ S. A. Schelkunoff, "Transmission theory of plane electromagnetic waves," Proc. I.R.E., vol. 25, pp. 1457-1492; November, (1937).

* Decimal classification: R141.2. Original manuscript received by the Institute, February 13, 1940.

† Massachusetts Institute of Technology, Cambridge, Mass.

¹ S. A. Schelkunoff, "The electromagnetic theory of coaxial transmission lines and cylindrical shields," *Bell Sys. Tech. Jour.*, vol. 13, pp. 532-580; October, (1934).

² A different viewpoint may be taken in which the field equations are solved directly for the natural frequencies of the cavity. Either viewpoint is legitimate and gives the same results for cylindrical cavities.

$$\lambda = \frac{2L}{n}, \quad n = 1, 2, 3, \dots \quad (6)$$

The integer n denotes the number of half-period variations of field along the axial or x co-ordinate. The particular value of f obtained from (6) and (1) is the "resonant" frequency:

$$f_{l,m,n} = \sqrt{\left(\frac{cn}{2L}\right)^2 + f_0^2}. \quad (7)$$

There will be a distinct resonance for each combination of l, m, n , which will be referred to as a resonant mode of the system. Although a triple infinity of modes for each class is theoretically possible, only the several lowest modes appear to have practical interest. In order to distinguish between the different resonant modes,⁴ we shall employ the following notation:

$TE_{l,m,n}$. . . transverse electric modes

$TM_{l,m,n}$. . . transverse magnetic modes

l = number of full-period variations of radial component of electric field along the angular or θ co-ordinate

m = number of half-period variations of angular component of electric field along the radial or r co-ordinate

n = number of half-period variation of radial component of electric field along the axial or x co-ordinate.

The conventional coaxial mode is $TM_{0,0,n}$ and has a resonant frequency given by

$$TM_{0,0,n} \dots f_{0,0,n} = \frac{cn}{2L}, \quad (8)$$

where n is an integer greater than zero. As is well known, both electric and magnetic fields are transverse to the axis in this mode, which might be termed transverse electromagnetic or TEM . The resonant frequency, as may be seen from (8), is independent of the transverse dimensions of the resonator.

A special situation not included in (6) and (7) arises in the case of the transverse magnetic waves only. This is the situation in which n is zero. At the critical frequencies f_0 , the wavelength λ becomes infinite and the transverse component of electric field vanishes, leaving only a longitudinal component. At this critical frequency, a resonant mode would exist in a line of infinite length. The insertion of conducting disks at the ends of a limited section of line does not disturb the field configuration and hence a corresponding transverse magnetic mode may exist in a perfect-coaxial resonator, and the resonant frequency is not affected by the length L of the resonator. A further consideration of this mode shows that it may be considered to be formed from transverse reflections of the waves be-

tween the cylindrical surfaces of the resonator. The resonant frequency for this degenerate mode is simply

$$TM_{l,m,0} \dots f_{l,m,0} = \frac{cr_{l,m}}{2\pi b}. \quad (9)$$

Some consideration will make it clear that a transverse electric mode of this character cannot exist.

Perfect-Cylindrical Resonators

The resonance phenomena of perfect-cylindrical resonators, like those of perfect-coaxial ones, may be described completely in terms of standing waves of the circular hollow-pipe kind.⁵⁻⁸ Hollow-pipe waves likewise may be classified as transverse electric and transverse magnetic. When standing waves are produced within the hollow cylindrical cavity, variations of the field intensities along angular, radial, and axial coordinates occur, necessitating three indexes l, m, n to distinguish the different resonant modes. The same system of nomenclature will be employed for perfect-coaxial and for perfect-cylindrical resonators. The resonant frequencies of perfect cylinders may be found from the wavelength $\lambda_{l,m}$ within the pipe in a manner exactly analogous to that employed above for perfect-coaxial resonators. In fact the expressions for λ and for $f_{l,m,n}$ are identical with those given above in (1), (2), and (7). The quantities $r_{l,m}$ and $r'_{l,m}$, however, are obtained from different transcendental equations, viz.,

$$TM \text{ waves} \dots J_l(r_{l,m}) = 0 \quad (10)$$

$$TE \text{ waves} \dots J'_l(r'_{l,m}) = 0 \quad (11)$$

These expressions may be derived from (4) and (5) by taking their asymptotic value as a/b approaches zero. There is no mode in a perfect-cylindrical resonator for $l=0, m=0, n=n$, corresponding to the conventional or transverse electromagnetic mode (8) of the perfect-coaxial structure. However, the additional resonant modes $TM_{l,m,0}$ at the critical frequencies f_0 of the transverse magnetic waves described for the coaxial resonator also occur in the perfect cylinder and have resonant frequencies given by the same expression (9), using, of course, the values for $r_{l,m}$ from (10).

RESONANT MODES

The first ten resonant frequencies for each of the

⁵ G. C. Southworth, "Hyper-frequency wave guides," *Bell Sys. Tech. Jour.*, vol. 15, pp. 284-309; April, (1936).

⁶ J. R. Carson, Sallie P. Mead, and S. A. Schelkunoff, "Hyper-frequency wave guides," *Bell. Sys. Tech. Jour.*, vol. 15, pp. 310-333; April, (1936).

⁷ W. L. Barrow, "Transmission of electromagnetic waves in hollow tubes of metal," *Proc. I.R.E.*, vol. 24, pp. 1298-1328; October, (1936).

⁸ A direct derivation for the natural frequencies of the cavity (see footnote reference 2) has been made; see footnote references 9, 10, and 11.

⁹ W. W. Hansen, "A type of electrical resonator," *Jour. Appl. Phys.*, vol. 9, pp. 654-663; October, (1938).

¹⁰ F. Borgnis, "Elektromagnetische Eigenschwingungen dielektrischer Rume," *Ann. der Phys.*, ser. 5, vol. 35, pp. 359-384; Month, (1939).

¹¹ M. Jouquet, "Natural electromagnetic oscillations of a spherical cavity," *Compt. Rend.*, vol. 209, pp. 25-27 and pp. 203-204; July, (1939).

⁴ Other classifications may be employed. The one adopted here is not only in keeping with the conception of resonance employed in this paper, but also it provides a straightforward nomenclature that is easy to remember.

two extreme cases of perfect-coaxial and perfect-cylindrical shapes were calculated for the experimental resonator of Fig. 1 and are given in order of increasing frequency in Table I. The resonant frequencies were also measured. The difference between measured and calculated values was less than one half of one per cent in all cases, and consequently there is no need to record measured values also in the table. The calculation, ac-

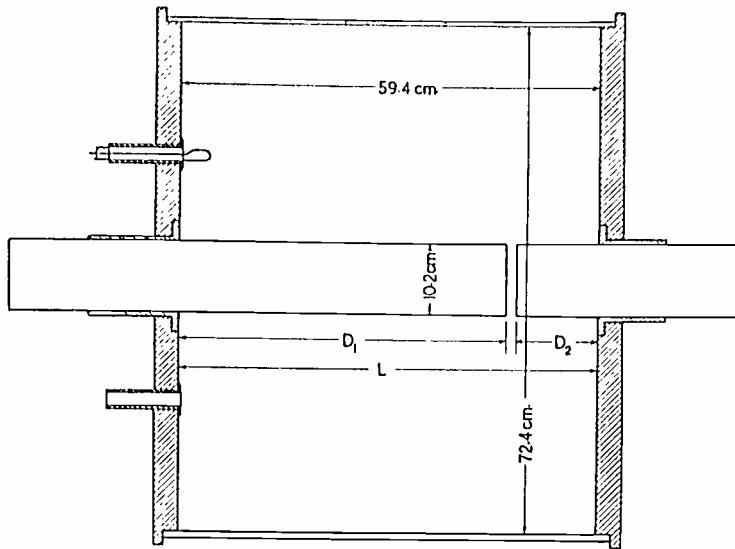

Fig. 1—Cross-sectional view of experimental resonator, showing dimensions.

ording to (7), is straightforward once the roots $r_{l,m}$ and $r'_{l,m}$ are known. Fortunately, tables are available¹² that include most of the desired roots. It will be found that for convenience in using the tables, (4) and (5) are best rewritten with the substitutions $r_{l,m} = bx_{l,m}/a$ and $r'_{l,m} = bx'_{l,m}/a$, and the new roots $x_{l,m}$ and $x'_{l,m}$ sought.

TABLE I
RESONANT FREQUENCIES FOR THE EXPERIMENTAL RESONATORS

Perfect-Cylindrical Resonator			Perfect-Coaxial Resonator		
Frequency in megacycles	Mode l, m, n		Frequency in megacycles	Mode l, m, n	
	TM	TE		TM	TE
317.0	0, 1, 0		252.5	0, 0, 1	
351.0		1, 1, 1	344.0		1, 0, 1
406.0	0, 1, 1		462.0	0, 1, 0	
475.5		2, 1, 1	475.0		2, 0, 1
504.5	1, 1, 0		505.0	0, 0, 2	
561.0		1, 1, 2	525.0	0, 1, 1	
565.0	1, 1, 1		535.5	1, 1, 0	
565.0		0, 1, 1	557.5		1, 0, 2
597.0	0, 1, 2		588.0	1, 1, 1	
608.0		3, 1, 1	590.0		0, 1, 1

The configurations of the electric and the magnetic lines of force are different in each mode. They may be obtained for the two perfect resonators from expressions for the traveling waves, following the general procedure outlined under Theoretical Background. Sketches of the fields of the lowest several modes for each resonator have been made and are reproduced in Figs. 2, 3, and 4. For sake of clarity the electric lines only are shown; the magnetic lines are everywhere orthogonal to the electric lines and may be readily drawn in. For ease in correlation with Table I and the curves of resonant frequencies to be presented below, trans-

verse magnetic and transverse electric modes are separated in Figs. 2 and 3, respectively; the sketches are numbered to correspond to the curves, and are arranged in order of decreasing frequency from top to bottom. We have already described that a continual transition from one coaxial mode to a corresponding cylindrical mode occurs as the center conductor is withdrawn. The pairs of modes thus associated have been grouped together in Figs. 2 and 3 to emphasize this relation; this grouping has been made on the basis of experimental determinations in our resonator. It is found that a transverse electric mode in the perfect-coaxial case always goes over into a transverse electric mode in the perfect-cylindrical form, and a transverse magnetic always goes into a transverse magnetic. Furthermore, the circular symmetry of the configuration, indicated by the subscript l , always remains unchanged in the transition, although the radial and axial

ASSOCIATED TM MODES

CURVE NO. IN FIG. 6	PERFECT CYLINDER	PERFECT COAXIAL
5	0,1,2	0,1,0
4	1,1,1	1,1,1
3	1,1,0	1,1,0
2	0,1,1	0,0,1
1	0,1,0	0,1,0

Fig. 2—Sketches of the configurations of the electric field for the associated transverse magnetic modes in perfect-cylindrical and perfect-coaxial resonators.

symmetries of the associated modes may be different. The two perfect-coaxial modes of Fig. 4 are included within the frequency range of the measurements although the frequencies of their associated perfect-cylinder modes lie well above this range and therefore have not been shown.

¹² Jahnke-Emde, "Tables of Functions," pp. 237-276. Teubner, Leipzig, (1933).

EXPERIMENTAL PROCEDURE

The experiments to be described in subsequent paragraphs were carried out mainly with the resonator shown in the drawing of Fig. 1, whose dimensions were as follows: length of outer cylinder $L=59.4$ centimeters, radius of inner conductor $a=5.1$ centimeters, and radius of outer conductor $b=36.2$ centimeters. Unless otherwise stated, one conductor of length D_2 was completely withdrawn, i.e., $D_2=0$. By adjusting the other plunger of length D_1 , the resonator can be made to undergo the transition from the perfect-coaxial to the perfect-cylindrical form. This resonator had brass center conductors, wooden end plates covered with copper foil, and a heavy cylindrical outer conductor of galvanized iron. Tightly fitting cast-brass hubs held the adjustable center conductors, which were moved by hand to the desired positions. A half-scale model resonator, to be referred to later, had a

ASSOCIATED T E MODES









CURVE NO. IN FIG. 6	PERFECT CYLINDER	PERFECT COAXIAL
12	 3, 1, 1	 3, 0, 1
11	 0, 1, 1	 0, 1, 1
10	 1, 1, 2	 1, 0, 2
9	 2, 1, 1	 2, 0, 1
8	 1, 1, 1	 1, 0, 1

Fig. 3—Sketches of the configurations of the electric field for the associated transverse modes in a perfect-cylindrical and perfect-coaxial resonators.

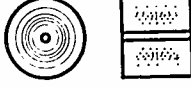
similar construction, except that the outer conductor was copper. Coupling inlets were provided at diametrically opposite positions on one end plate and at two positions on the outer cylinder midway between the ends and 45 degrees apart circumferentially. These inlets were flush fitting on the inside and took the $\frac{3}{8}$ -

inch outer conductors of the coaxial coupling probes. A schematic diagram of the experimental arrangement is shown in Fig. 5. The resonator was excited by a triode oscillator of adjustable frequency¹³ through a coaxial line and one of the coupling probes described below. A very small amount of power was taken from the resonator through another coupling probe at a different position and rectified in a crystal detector. Direct-current meters of ranges between 50 microamperes and 30 milliamperes indicated the strength of the os-

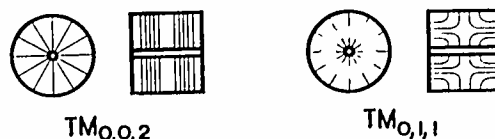

Fig. 4—Sketches of the configurations of the electric field for the $TM_{0,0,2}$ and $TM_{0,1,1}$ modes in a perfect-coaxial resonator.

cillations in the resonator. Frequency was measured with a heterodyne frequency meter in conjunction with an amplifier and loud speaker. Frequent checks were made to assure that the excitation of the resonator was at the fundamental frequency of the oscillator and not at a harmonic.

COUPLING WITH THE RESONATOR

Connection between the resonator and external circuits was made by means of small coupling probes inserted into the cavity through tightly fitting inlets. Two types of coupling probes were used, one a small loop one square centimeter in area and the other a straight rod four centimeters long. The loop probe may be considered to provide coupling with the magnetic field within the resonator and the rod probe with the electric field. To obtain coupling, a loop must be so

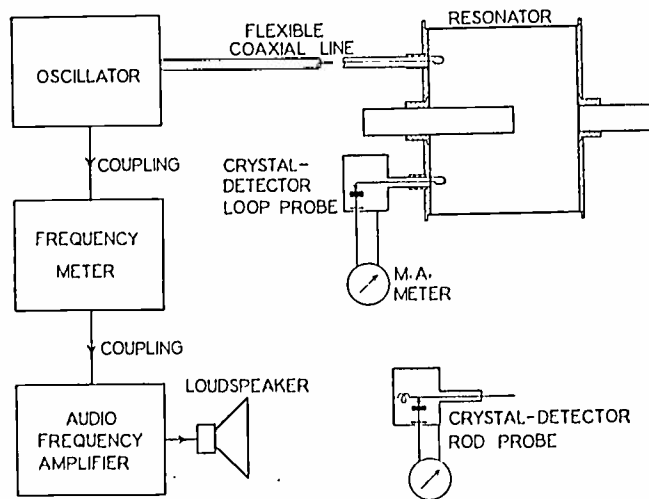

Fig. 5—Schematic diagram of arrangement of apparatus for the measurements.

disposed in the resonator that it is linked by magnetic lines. For maximum coupling its plane should be orthogonal to the magnetic lines. For maximum coupling with a straight rod, the rod should be disposed tangential to electric lines (if the electric lines are curved,

¹³ W. L. Barrow, "An oscillator for ultra-high frequencies," *Rev. Sci. Inst.*, vol. 9, pp. 170-174; June, (1938).

the rods should be bent accordingly). The degree of coupling also depends on the location of the probe in the resonator. Table II has been prepared giving the preferred arrangements for maximum coupling for four modes in a perfect-cylindrical resonator and for one mode in a hybrid resonator. Reference to Figs. 2, 3, and 5 should make the meaning of this table clear. By suitably locating and orienting the probe, not only can the degree of coupling with the resonator be

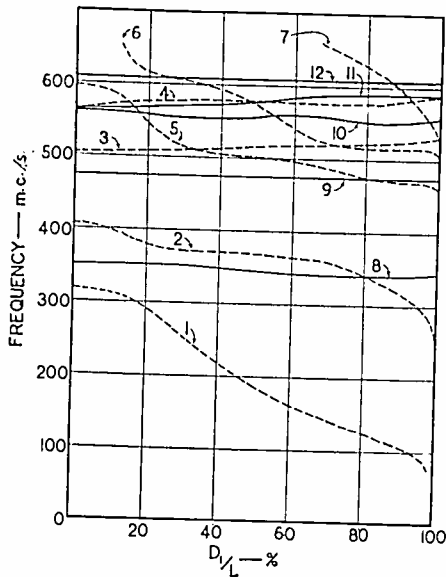

Fig. 6—Measured values of resonant frequencies for the lowest modes in the resonator of Fig. 1 for $D_2=0$.

varied, but also definite information about the field configuration can be obtained.

Naturally, other means of coupling may be employed. For example, by the use of coupling probes of appropriate shape, location, and orientation, one mode in the resonator may be employed and undesired modes suppressed. The choice of proper coupling means is important when higher-order modes are employed. Coupling with an electron stream has been described in recent papers dealing with ultra-high-frequency tubes and will not be discussed here.

TABLE II
MAXIMUM COUPLING MEANS FOR PERFECT-CYLINDRICAL RESONATORS

Mode	Type Coupling	Location	Orientation
$TM_{0,0,p}$ (hybrid)	Loop Rod	End plate opposite gap End plate near gap	Plane A Axial
$TM_{0,1,0}$	Loop Rod	End plate End plate	Plane A Axial
$TE_{1,1,1}$	Loop Rod	End plate on axis Outer cylinder mid-point	Plane A Radial
$TM_{0,1,1}$	Loop Rod	End plate End plate on axis Outer cylinder mid-point	Plane A Axial Radial
$TE_{0,1,1}$	Loop Rod	Outer cylinder mid-point	Plane B

Plane A—a plane through the axis.
Plane B—a plane perpendicular to the axis at its midpoint.

RESONANT FREQUENCIES

The measured values of resonant frequencies for the lowest modes in the resonator of Fig. 1 are plotted in Fig. 6 as a function of the ratio D_1/L of the inner conductor to the length of the outer cylinder. The figure includes every mode whose frequency for the perfect-

cylindrical shape is less than 608 megacycles. Smooth curves have been drawn through the measured points, which were taken in adequate number (an average of 27 points for each curve) to assure the exact shape of each curve. The accuracy of measurement of frequency was generally better than one megacycle, i.e., an error less than one third of one per cent. Inasmuch as the dimensions of the resonator could also be measured precisely, a high degree of accuracy has been obtained. In fact it has been possible to determine the roots of the transcendental equations (4), (5), (10), and (11) to three-figure accuracy by means of the experimental measurements of resonant frequency.

Certain generalizations may be drawn from Figs. 2, 3, 4, and 6. It is found that the resonant frequencies of those transverse magnetic modes that have circularly uniform distribution $l=0$ always decrease as D_1/L is increased from zero to unity. Also the resonant frequencies of the transverse electric modes having the same symmetry always increase with increasing D_1/L . The curves for modes of either class in which $l=0$ may either increase or decrease irregularly as the center conductor is inserted. Although the curves for most modes show considerable variation with the length of the center conductor, certain others, notably, $TE_{1,1,1}$, heavy front, remain remarkably constant. For example, the frequency of the $TM_{3,1,1}$ mode changed less than 0.1 per cent for the entire range $0 \leq D_1/L \leq 1$. It is clear from Fig. 6 that the separation in frequency of

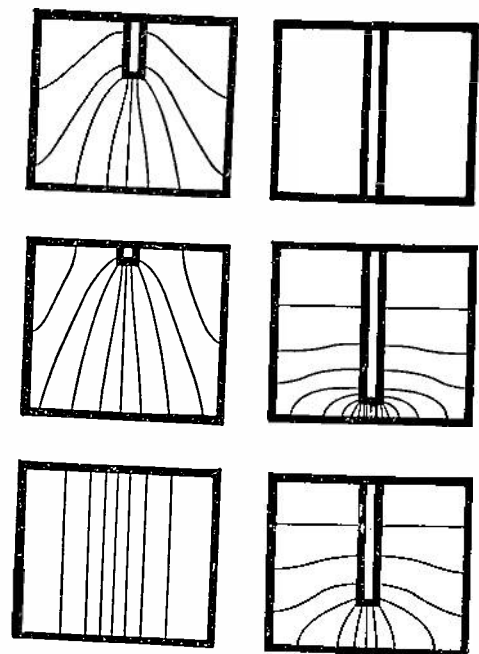

Fig. 7—Sketches of the probable configuration of the electric field of the lowest mode during transition from a perfect-cylindrical to a perfect-coaxial resonator. The perfect-cylindrical mode $TM_{0,1,0}$ becomes the usual capacitively loaded coaxial mode $TM_{0,0,p}$ for small gap lengths.

adjacent modes becomes less as the order of the mode increases. For certain adjustments of the resonator, it is even possible to have two or more modes coexistent at the same frequency. When the resonant frequencies of two or more modes are very close together or coincide, energy from either mode may be transferred to

the other and a coupling of the oscillatory phenomena occurs. Such coupling between modes will affect the practical applications of cavity resonators; it may give rise to a broadening of the response curve and a lowering of the effective Q value. Also it might be advantageously employed to provide circuit elements having band-pass and other characteristics.

One mode of particular practical importance is the $TM_{0,1,0}$ in a perfect-cylindrical resonator and its associated mode in a hybrid, or "imperfect-coaxial," resonator. When D_1/L is close to unity, this mode corresponds to a coaxial line of conventional character short-circuited at one end and capacitively loaded at the other;¹⁴ it will here be designated $TM_{0,0,p}$, where p is a fraction usually small compared to unity. As may be seen in Fig. 6, the resonant frequency decreases as the center conductor is inserted, slowly at first and then rapidly, until zero frequency is approached asymptotically for $D_1 \rightarrow L$. Thus, arbitrarily low frequencies may be obtained by making the spacing between the end of the center conductor and the end plate sufficiently small. When $D_1 = L$, this mode vanishes; the lowest frequency in such a perfect-coaxial resonator is obtained with the $TM_{0,0,1}$ mode. The resonant frequency of this kind of a resonator, as is well known, may be obtained by treating it as a parallel connection of inductance L' and capacitance C' . The inductance is calculated by conventional transmission-line theory and the capacitance by electrostatic theory, taking into account the effect of fringing, from which $f = 1/2\pi\sqrt{L'C'}$. When the resonator is operated in this way, the electric field is concentrated between the end of the inner conductor and the end plate and the magnetic field is concentrated near the opposite end of the resonator, a typical quasi-stationary electromagnetic system. The usual resonators that have been used in oscillators, velocity-variation tubes, and elsewhere have had this shape and have employed this mode of oscillation. As the center conductor is withdrawn and $D_1 \rightarrow 0$, the character of the resonance departs from that of a conventional coaxial line and becomes that of the perfect-cylinder resonator, as illustrated by the sketches of electric field configurations of Fig. 7. The value of resonant frequency for $D_1 = 0$ is that for the $TM_{0,1,0}$ mode in the perfect-cylindrical. Thus, these experiments prove that the resonant frequency cannot be made to assume arbitrarily high values by simply shortening the center conductor, as has sometimes been supposed.

Two other modes having circular uniformity of fields in the perfect-cylindrical resonator are worthy of note. First, the $TM_{0,1,1}$ mode goes over into the $TM_{0,0,1}$ mode in the perfect-coaxial form, which is the

¹⁴ Most previous applications of cavity resonators have been based on this mode of resonance. Recent theoretical papers include footnote references 15 and 16.

¹⁵ W. W. Hansen, "On the resonant frequency of closed concentric lines," *Jour. Appl. Phys.*, vol. 10, pp. 38-46; January, (1939).

¹⁶ L. S. Nergaard and Bernard Salzberg, "Resonant impedance of transmission lines," *Proc. I.R.E.*, vol. 27, pp. 579-584; September, (1939).

lowest legitimate resonance of the latter structure and has a half-sinusoidal distribution along the axis, as seen in Fig. 2. Second, the $TE_{0,1,1}$ mode, which goes over into a mode of identical designation in the perfect-coaxial case, provides simple field configuration and the possibility of comparatively high values of Q . It may be recalled that it is the $TE_{0,1}$ traveling wave in a circular hollow pipe that possesses an anomalous skin effect or attenuation characteristic.^{5,6} An unusual situation is displayed in this resonator in which all electric lines of force close on themselves without terminating on conductors or charges. In a certain sense, the displacement-current lines may be looked on as the windings of a solenoid about which the magnetic lines are disposed in the regular manner and the walls of the

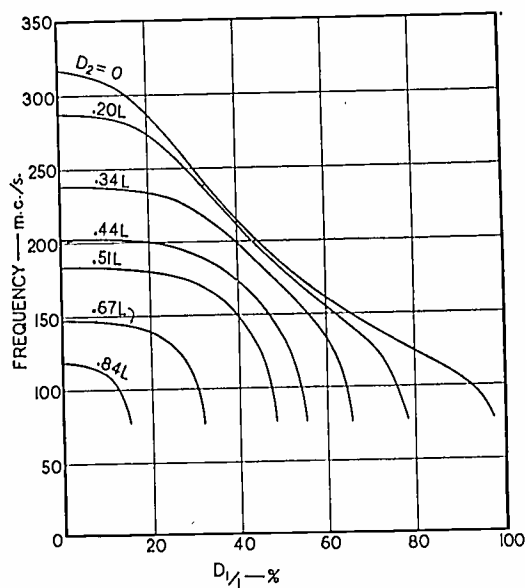

Fig. 8—Measured values of resonant frequencies for the lowest mode $TM_{0,0,p}$ for different lengths D_2 of the second center conductor.

resonator as a shield about the solenoid limiting the extent of its field. In this sense, an ultra-high-frequency coil with displacement-current windings and with very low losses is provided.

The $TE_{1,1,1}$ mode in the perfect cylinder has a field configuration well adapted to applications where the coupling to the resonator is made by a slot in its wall. It also may have the lowest frequency, since for very long resonators $f_{1,1,1} \cong f_0$ for the $TE_{1,1}$ wave, which is lower in value than any other critical frequency (in our experimental resonator, this situation was not established as the $TM_{0,1,0}$ mode had the lowest frequency).

EFFECT OF POSITION OF GAP

A series of measurements similar to those just described was made on the resonator of Fig. 1 when excited in the $TM_{0,0,p}$ mode for different fixed lengths D_2 of the second center conductor. The measured curves are reproduced in Fig. 8. It will be seen that in these curves the frequencies corresponding to $D_1/L = 0$ agree exactly with those in Fig. 6 for a value of D_1/L equal to the corresponding value of D_2/L . As the second inner conductor is made longer, the shape of the curve changes, as well as the absolute magnitude of it; the

inflected curve for $D_2=0$ goes over into the noninflected curves for large D_2 values. This change in shape results, in part, from the different way in which the capacitance between the inner conductors varies with the gap length $L - (D_1 + D_2)$ as the position of the gap is moved along the axis.

In order to show this effect more clearly, curves have been reproduced in Fig. 9 in which the resonant frequency is plotted against the position of the gap along

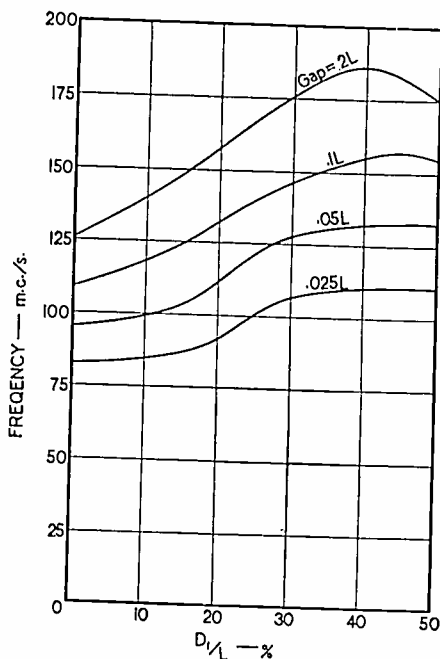

Fig. 9—Measured values of resonant frequencies for the lowest mode $TM_{0,0,p}$ for different positions of the gap for constant gap length.

the axis for several values of gap length. It is evident that the variation in frequency is greater for large gaps than it is for small ones. Not only does the effective capacitance between center conductors change with the position of the gap, but also the inductance changes somewhat too. When the gap length is sufficiently small to make the resonant wavelength great compared to L , there should be no change in inductance with gap position.

RESONATORS WITH TUBULAR CENTER CONDUCTORS

For certain practical applications, particularly to ultra-high-frequency devices employing the periodic variation of amplitude or velocity of an electron beam, it is often desirable to remove the solid conducting disks on the ends of the center conductors, providing open-ended tubular center conductors through which electron beams may be directed. Measurements have been made to determine the effect of these opened ends on the frequency of the resonator when operated in the conventional transmission-line mode $TM_{0,0,p}$ and are reproduced in Fig. 10. The original curve for closed center conductors is reproduced as a solid line and that for the open-ended conductors as a dotted line. (This is not to be confused with the dashed line on the same figure.) There is a remarkably close agreement between these curves for all

values of D_1/L less than about 80 per cent. An appreciable difference occurs only when the gap length is small, but this difference may be quite large for very small gaps, a matter of direct bearing on practical applications. Further changes in the curve for the resonant frequency will occur when the open ends of the inner conductors are partially closed with grids, as in the Klystron oscillator, but it is expected that all such curves will lie between the two extremes presented here. Of course, the resonant frequency may be slightly altered by the presence of the electron beams, an effect not included in these measurements.

RESONATORS WITH OPEN ENDS

Another interesting case is that in which one end of the resonator is removed, leaving an open-ended coaxial line with an outer conductor of fixed length and an inner conductor of adjustable length. Measurements have also been made for this arrangement and are plotted as a dashed curve in Fig. 10. Although this curve coincides with that for the closed resonator for intermediate values of D_1/L , it departs at both ends. For large D_1/L , the capacitive loading is much smaller and the frequency is higher. For $D_1/L = 1$, the resonant wavelength is 2.8 meters, which is substantially different from $4L = 2.4$ meters. The other limiting case $D_1 = 0$ is that of a cylindrical resonator with one end open. It has been observed that the resonance phenomenon is very weak as $D_1 \rightarrow 0$, undoubtedly the result of radiation loss from the open end. The resonant frequency for this limiting case, viz., 327 megacycles, is greater

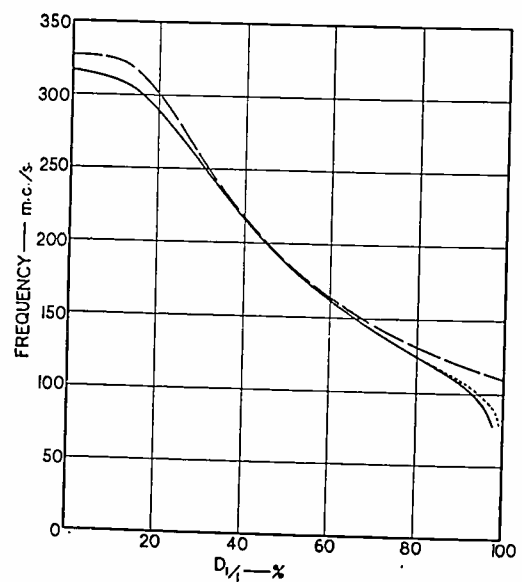

Fig. 10—Measured values of resonant frequencies for the lowest mode in the following resonators; solid curve, as in Fig. 1; dotted curve, as in Fig. 1 but open-ended tubular center conductors; dashed curve, as in Fig. 1, but the complete end plate with conductor D_2 removed.

than that for the case of the closed resonator, which is 317 megacycles. This change indicates a modification of the field configuration from that of the degenerate mode, in which only a longitudinal component of electric field is present, to one having also a radial component near the open end.

SIMILITUDE

The principle of similitude, whereby a change in the linear dimensions of a resonator effects a proportionate change in its resonant wavelength, has been proved in these experiments to apply to all shapes investigated. The proof we submit is based on the measured curves of resonant frequencies for the several lowest-order modes for the resonator of Fig. 1, and for an exact one-half-scale model of it; in every instance, the resonant frequency in the model was exactly twice that of the original resonator. An investigation of (7) will in fact show that if all linear dimensions are changed by a scale factor k , the resonant frequency for perfect-coaxial and perfect-cylindrical resonators is altered by the factor $1/k$, thus

$$f'_{l,m,n} = \frac{1}{k} f_{l,m,n} \quad (12)$$

where $f'_{l,m,0}$ denotes the resonant frequency of the model.

It is believed that the principle of similitude holds

also for resonators of any shape and for all modes of oscillation.

Special cases arise in which the frequency is independent of all but one of the linear dimensions, whereupon the principle of similitude may be expressed in terms of that one dimension only. For example, for those modes in which there is no variation along the axial co-ordinate ($n=0$), the resonant frequency varies only with the transverse dimensions a and b . Similarly, for the conventional transmission-line mode in the perfect-coaxial resonator, the frequency varies only with the longitudinal dimension L . Other special cases, too, have been found.

The principle of similitude permits the results from measurements or calculations on a model of one size to be extended to proportionately scaled models of other sizes, and therefore provides an important engineering tool in resonator design. Thus, the numerical data presented in the curves of this paper possess a general significance for all resonators whose relative dimensions are the same as those of our experimental one.

Characteristics of the Ionosphere at Washington, D.C., February, 1940, with Predictions for May, 1940*

T. R. GILLILAND†, ASSOCIATE, I.R.E., S. S. KIRBY†, ASSOCIATE, I.R.E.,
AND N. SMITH†, NONMEMBER, I.R.E.

DATA on the ordinary-wave critical frequencies and virtual heights of the ionospheric layers during February are given in Fig. 1. Fig. 2 gives the monthly average values of the maximum usable frequencies for undisturbed days for radio transmission by way of the regular layers. The F_2 and F layers ordinarily determined the maximum usable frequencies during the day and night, respectively. Fig. 3 gives the distribution of hourly values of F and F_2 critical-frequency data about the undisturbed average for the month. Fig. 4 gives the expected values of the maximum usable frequencies for radio transmission by way of the regular layers, average for undisturbed days, for May, 1940.

Attention is called to the fact that Figs. 1, 2, and 4 also implicitly give maximum ionization densities of the layers of the ionosphere. The equivalent electron density in electrons per cubic centimeter is 0.0124 times the square of the critical frequency (or zero-distance maximum usable frequency minus 800 kilocycles).

* Decimal classification: R113.61. Original manuscript received by the Institute, March 11, 1940. These reports have appeared monthly in the PROCEEDINGS starting in vol. 25, September, (1937). See also vol. 25, pp. 823-840; July, (1937). Publication approved by the Director of the National Bureau of Standards of the U. S. Department of Commerce.

† National Bureau of Standards, Washington, D. C.

TABLE I
IONOSPHERIC STORMS (APPROXIMATELY IN ORDER OF SEVERITY)

Day and hour E.S.T.	h_F before sunrise (km)	Minimum f_F^0 before sunrise (kc)	Noon $f_{F_2}^0$ (kc)	Magnetic character ¹		Ionospheric character ²
				00-12 G.M.T.	12-24 G.M.T.	
February 23 (after 1700)	—	—	—	—	—	0.3
24	300	2600	7400	0.4	0.3	0.8
25	376	1900	5100	1.0	1.1	1.6
26 (until 0600)	376	1800	—	0.4	0.3	0.3
For comparison: Average for undisturbed days	298	3000	9585	0.2	0.3	0.0

¹ American magnetic character figure, based on observations of seven observatories.

² An estimate of the severity of the ionospheric storm at Washington on an arbitrary scale of 0 to 2, the character 2 representing the most severe disturbance.

TABLE II
SUDDEN IONOSPHERIC DISTURBANCES

Day	G.M.T.		Locations of transmitters	Relative intensity at minimum ¹	Other phenomena
	Beginning	End			
Feb. 7	2000	2020	Ohio, Mass.	0.0	Ter. mag. pulse, ² 1313 to 1320
8	1346	1400	Ohio, Cuba	0.1	
15	1919	1930	Ohio, England, Cuba	0.01	
16	1313	1319	Ohio, England, Cuba, Mass.	0.0	
16	1850	1930	Ohio, Cuba	0.2	
17	1622	1640	Ohio, Cuba	0.1	
17	1835	1910	Ohio, England, Cuba	0.0	Ter. mag. pulse, ² 1835 to 1850
24	1540	1550	Ohio, Cuba	0.0	

¹ Ratio of received field intensity during fade-out to average field intensity before and after, for station WLWO, 6060 kilocycles, 650 kilometers distant.

² As observed on the Cheltenham magnetogram of the United States Coast and Geodetic Survey.

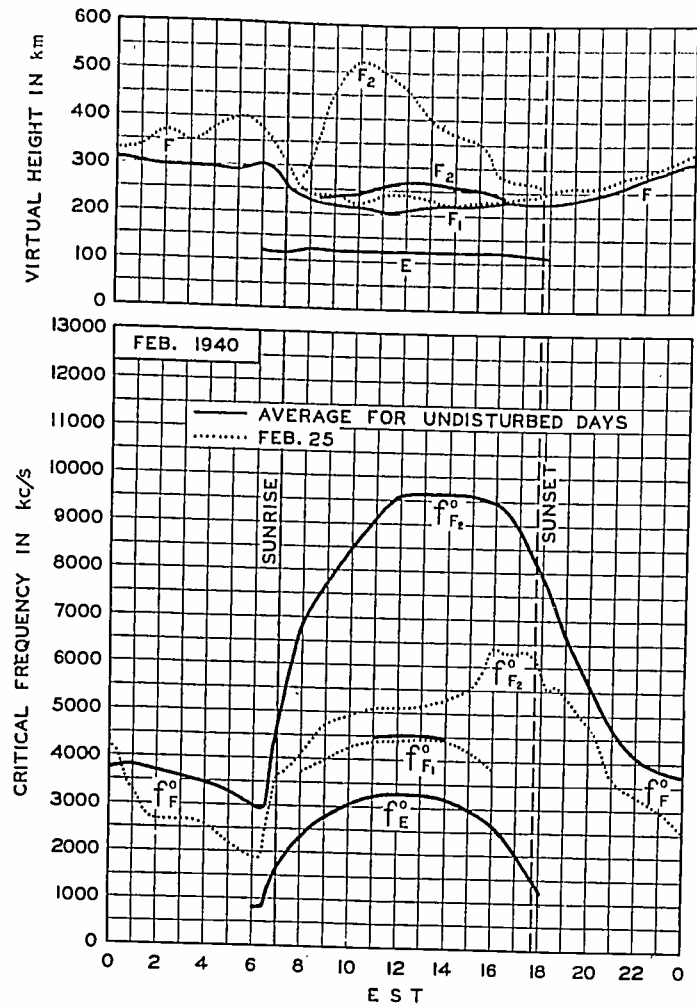

Fig. 1—Virtual heights and critical frequencies of the ionospheric layers, February, 1940.

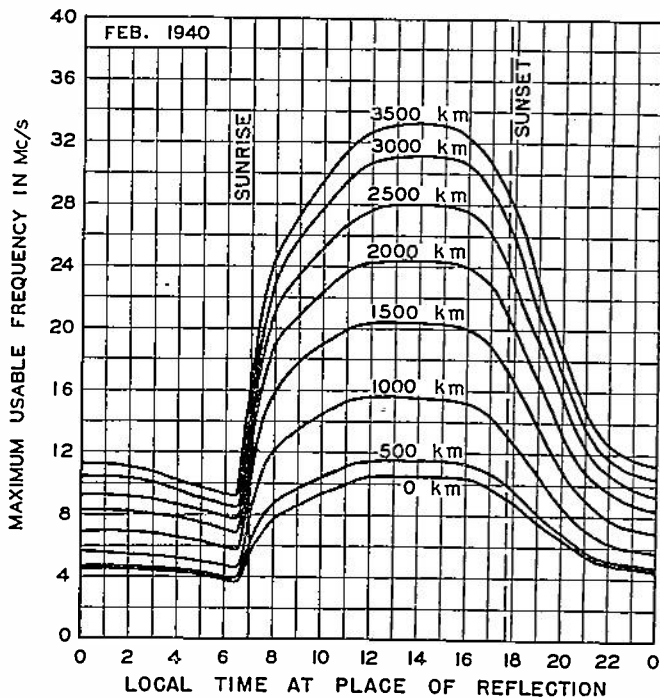

Fig. 2—Maximum usable frequencies for dependable radio transmission via the regular layers, average for undisturbed days for February, 1940. For information on use in practical radio transmission problems, see Letter Circular 575 obtainable from the National Bureau of Standards, Washington, D. C., on request.

Ionospheric storms and sudden ionospheric disturbances are listed in Tables I and II, respectively. Strong vertical-incidence sporadic-E reflections were observed above 8 megacycles on only 2 hours during the month, and above 6 megacycles on only 3 hours.

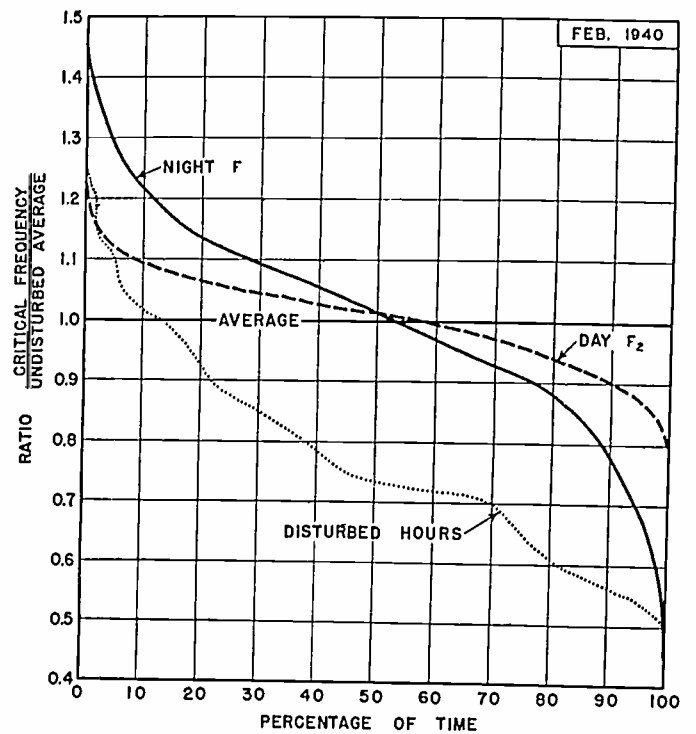

Fig. 3—Distribution of F- and F₂-layer ordinary-wave critical frequencies (and also approximately of maximum usable frequencies) about monthly average. Abscissas show percentages of time for which the ratio of the critical frequency to the undisturbed average exceeded the values given by the ordinates. The solid-line graph is for 325 undisturbed night hours of observation; the dashed graph is for 289 undisturbed day hours of observation; the dotted graph is for 60 disturbed hours of observation listed in Table I.

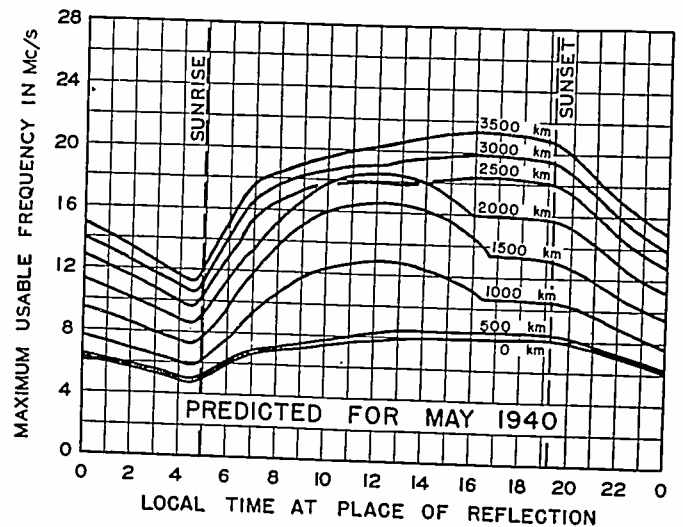

Fig. 4—Predicted maximum usable frequencies for dependable radio transmission via the regular layers, average for undisturbed days, for May, 1940. For information on use in practical radio transmission problems, see Letter Circular 575 obtainable from the National Bureau of Standards, Washington, D. C., on request.

Institute News and Radio Notes

Board of Directors

The February 7, 1940, meeting of the Board of Directors was held in the Institute office and attended by L. C. F. Horle, president; F. E. Terman, vice president; Melville Eastham, treasurer, Austin Bailey, F. W. Cunningham, H. C. Forbes, Alfred N. Goldsmith, Virgil M. Graham, R. A. Heising, C. M. Jansky, Jr., F. R. Lack, F. B. Llewellyn, Haraden Pratt, H. M. Turner, A. F. Van Dyck, H. A. Wheeler, L. P. Wheeler, and H. P. Westman, secretary.

M. H. Biser, D. M. Black, E. T. Burton, R. W. Friis, M. E. Fultz, L. J. Heaton-Armstrong, E. J. Howard, F. A. Hubbard, S. B. Ingram, A. E. Kerwien, Jr., K. L. King, R. J. Kircher, F. R. Norton, George Rodwin, C. F. P. Rose, Harner Selvidge, R. C. Shaw, N. E. Sowers, and J. E. Whitehouse were transferred to Member grade. Admitted directly to Member grade were R. L. Dietzold, C. W. Earp, and Aksel Taranger.

There were thirty-five Associates, one Junior, and thirty-four Students elected to membership.

On the recommendation of the Membership Committee, the Board authorized the continuation of a Subcommittee on Student Memberships with Professor Terman as its chairman.

Approval was granted for the holding of a Pacific Coast Convention of the Institute coincidentally with a meeting of the American Institute of Electrical Engineers. The meeting is scheduled for August 27 and 28 in Los Angeles. W. W. Lindsay was appointed chairman of the Convention Committee.

The report of the Special Committee on Public Relations Policies was discussed and approved in part.

The March meeting of the Board of Directors was held on the 6th in the Institute office. Those present were L. C. F. Horle, president; Melville Eastham, treasurer, Austin Bailey, W. R. G. Baker, F. W. Cunningham, H. C. Forbes, Alfred N. Goldsmith, Virgil M. Graham, R. A. Heising, F. R. Lack, F. B. Llewellyn, Haraden Pratt, B. J. Thompson, H. M. Turner, A. F. Van Dyck, H. A. Wheeler, and H. P. Westman, secretary.

Associate applications numbering thirty-nine and thirty-five Student applications were approved.

It was agreed that all back issues of the PROCEEDINGS would, hereafter, be sold at \$1.00 per copy less the usual discounts of twenty-five per cent to members and fifty per cent to colleges and public libraries.

A report of the Convention Policies Committee was discussed. The Engineering Department of the Radio Manufacturers Association agreed to appoint a joint committee with the Institute to study all mutual organization matters and policies. An invitation for the Institute

to participate with the Engineering Department of the Radio Manufacturers Association in the holding of a Rochester Fall Meeting on November 11, 12, and 13, under the sponsorship of the Rochester Fall Meeting Committee, was accepted.

The Technical Committee on Electronics was authorized to proceed with the organization of an electronics conference to be held during 1940.

On recommendation of the Standards Committee, the formation of a Technical Committee on Frequency Modulation of the subject standards on all aspects of the subject except frequency-modulated-wave receivers was authorized.

As a trial for the balance of this year, an Executive Committee, comprised of L. C. F. Horle, president; Melville Eastham, R. A. Heising, H. A. Wheeler, and H. P. Westman, secretary; was established to handle routine matters which would otherwise come before the Board.

Committees

Admissions

A meeting of the Admissions Committee was held in the Institute office on February 7 and was attended by A. F. Van Dyck, chairman; Ralph Bown, F. W. Cunningham, C. W. Horn, C. M. Jansky, Jr., I. J. Kaar, W. B. Marvin, H. M. Turner, R. A. Wise, and H. P. Westman, secretary. Five of the six applications for transfer to Member grade were approved as were two of three applications for direct admission to that grade.

Awards

H. M. Turner, chairman; Virgil M. Graham, H. B. Marvin, Haraden Pratt, and H. P. Westman, secretary; attended a meeting of the Awards Committee on March 6 which was held in the Institute office.

For the first time, the Awards Committee has the responsibility of recommending to the Board the names of candidates to be admitted to the Fellow grade. The major portion of the time of the committee was spent in surveying this problem and developing a procedure to follow in reaching its recommendations. A number of letters suggesting candidates for Fellow grade were read. These proposals were made during the past year after the right to apply for Fellow grade was withdrawn by the change in Constitution.

Board of Editors

Co-ordinating Committee

On January 19 a meeting of the Co-ordinating Subcommittee of the Board of Editors which was attended by R. R. Batcher, Helen M. Stote, assistant editor; L. E. Whittemore, and H. P. Westman, secretary; was held. A number of papers on which opinions of members of the Papers Committee and Board of Editors

had already been received were examined and final decisions as to their acceptability for publication in the PROCEEDINGS were reached.

Convention Policies

The special committee on Convention Policies which was established by the Board of Directors met on January 23. Those present were H. P. Westman, chairman and secretary; Ralph Bown, F. W. Cunningham, Alfred N. Goldsmith, Virgil M. Graham (guest), R. A. Heising (guest), L. C. F. Horle, C. M. Jansky, Jr., and B. J. Thompson (guest).

A second meeting of this committee which was attended by H. P. Westman, chairman and secretary; Ralph Bown, F. W. Cunningham, Alfred N. Goldsmith, L. C. F. Horle, and C. M. Jansky, Jr., was held on February 29 in the Institute office. The committee adopted an interim report treating the relations of the Institute, the Engineering Department of the Radio Manufacturers Association, and the Rochester Fall Meeting Committee in the holding of Rochester Fall Meetings.

Membership Committee

A meeting of the Membership Committee was held in the Institute office on February 6. Those present were E. D. Cook, chairman; Nathaniel Bishop, I. S. Coggeshall, F. W. Cunningham, H. C. Gawler, L. G. Pacent, J. R. Poppele, Bernard Salzberg, F. E. Terman, John D. Crawford, assistant secretary; and H. P. Westman, secretary.

The major portion of the meeting was devoted to a discussion of the Institute's activities in the academic field as they concern Student grade of membership. Professor Terman, who has been chairman of the special subcommittee on that subject, outlined his activities in the work and submitted a report on the effects of it which are already evident.

New York Program

On February 13, a meeting of the New York Program Committee was held in the Institute office. Those present were H. P. Westman, acting chairman and secretary; Austin Bailey, I. S. Coggeshall, D. E. Harnett, Keith Henney, Wallace James, and G. T. Royden.

The committee discussed possible papers for presentation at the remaining meetings before the summer recess.

Public Relations Policies

The Public Relations Policies Committee which was recently established by the Board of Directors met on January 23. Those present were A. F. Van Dyck, chairman; R. A. Heising, C. M. Jansky, Jr., B. J. Thompson, and H. P. Westman, secretary.

The committee completed a report outlining a number of recommendations re-

garding the Institute's relations with the public. These recommendations were submitted to the Board of Directors.

Annual Review

On January 26, the Annual Review Committee met and did its final editing on the reports of the various technical committees. This final report was published in the March issue of the *PROCEEDINGS*.

Those present at the meeting were A. F. Van Dyck, chairman; F. R. Brick, representing W. G. H. Finch; D. E. Foster, Keith Henney, F. B. Llewellyn, representing P. T. Weeks; J. D. Parker, representing E. K. Cohan; E. G. Ports, L. J. Sivian, representing H. S. Knowles; H. M. Turner, J. D. Crawford, secretary to the committee; and H. P. Westman, secretary.

Facsimile

The Technical Committee on Facsimile met on February 20 and discussed a program of operation looking toward the preparation of standards and of the annual review for 1940.

Those present were J. L. Callahan, chairman; J. C. Barnes, F. R. Brick, representing W. G. H. Finch; W. A. R. Brown, A. G. Cooley, representing G. V. Dilenback, Jr.; John Hancock, H. C. Knutson, P. Mertz, Charles Singer, representing J. R. Poppele; Frank Turner, guest; C. J. Young, and J. D. Crawford, secretary to the committee.

Standards

A meeting of the Standards Committee was held on February 8 in the Institute office and those present were H. A. Wheeler, chairman; J. L. Callahan, I. J. Kaar, G. M. Nixon, representing R. M. Morris; E. G. Ports, A. E. Thiessen, P. T. Weeks, J. D. Crawford, secretary to the committee; and H. P. Westman, secretary.

This meeting was for the purpose of preparing a program of activities for 1940. The existing reports were reviewed to ascertain where most effort should be placed. The work of the Engineering Department of the Radio Manufacturers Association was reviewed and a program prepared which will better co-ordinate the Institute's work with that of the Radio Manufacturers Association.

New York Meeting

R. F. Guy, radio facilities engineer of the National Broadcasting Company, presented a paper on "The International Broadcasting Activities of NBC."

Services to Europe, Central America, and South America were described. It was pointed out that programs were transmitted in six different languages. A brief history of international broadcasting was presented with particular reference to the activities of NBC since 1925.

The facilities of the National Broadcasting Company for this service were described and their flexibility stressed. Two high-power rectifiers and class B modulators drive three 23-kilowatt power amplifiers. Simultaneous transmission on

two separate frequencies or separate services to different areas on a single frequency may be had.

Several antennas were described and included a steerable system for South American service. An antenna with a power gain of twenty-two may have its beam deflected towards either the Brazilian or the Argentine area within a few seconds by remote control from the transmitter-operating position. Six directive antennas are used together with four simple dipoles which may be utilized for comparison purposes or as auxiliaries.

Measurements and observations of service from various points in Europe and South America were described. The paper was closed with a discussion of the coverage which may be obtained for internationally important events and which utilizes the domestic networks in conjunction with the international transmitters and supplemental facilities which include the point-to-point relay system of R.C.A. Communications and the American Telephone and Telegraph Company.

A second paper on "The Status of International Telecommunication Agreements" was by Gerald C. Gross, an engineer of the international division of the Federal Communications Commission.

The author presented first an historical outline of the international communications conferences and agreements resulting therefrom beginning with the St. Petersburg Telegraph Conference of 1875.

After the Washington Radio Telegraph Conference of 1927, there were four meetings of the International Consulting Committee on Radio (CCIR). Particular emphasis was placed on the technical recommendations adopted at these conferences which later found their way into national regulations. Mention was also made of the International Consulting Committees on Telegraphy and on Telephony (CCIT and CCIF), respectively, and the first big conference covering all telecommunication services which was held in 1932 at Madrid. The second conference of this type was held in Cairo in 1938 and resulted in important changes in the allocation tables.

Following this, mention was made of the particular scope of the various regional conferences such as the one in Mexico City in 1933, the two in Havana in 1937 and the Central American Regional Radio Conference at Guatemala City in 1938.

The paper was concluded with a summary of the results of the Second Inter-American Radio Conference which was completed in Santiago, Chile, in January, 1940. In the discussion which followed, considerable attention was given to the effects of the North American Broadcast Agreement originally signed at Havana in 1937 and recently ratified by Mexico, thus making it effective. The magnitude of the reallocation task for broadcast stations in the United States as a result of this was discussed and it was pointed out that, although one of the most comprehensive ever undertaken, the placing of the treaty into operation may be considered as a general insurance policy for the entire broadcast industry of North America.

March 6, 1940, L. C. F. Horle, president, presiding.

Sections

Atlanta

"Engineering Standards and Problems Involved in the Impending Reallocation of Broadcast Stations" was the subject of a paper by W. J. Holey, a consultant of Atlanta, Ga.

The conditions which led to the calling of the Havana Conference and the countries affected by the agreement which resulted from that meeting were first outlined. The problems involved in reaching this agreement were discussed.

The standards on allocation adopted were those used in this country and divided stations into four major groups determined on the basis of their power and the degree to which their services are protected from interference. The adoption of these standards should assist in providing for an orderly growth and development of broadcasting in the Americas.

In so far as the United States is concerned, the agreement will improve conditions chiefly as they concern the operation of stations just across the southern border.

February 23, 1940, G. S. Turner, vice chairman, presiding.

Baltimore

J. D. Booth and A. P. Bock of the Westinghouse Electric and Manufacturing Company described some "Recent Developments in Carrier-Current Communications Equipments."

Mr. Booth pointed out that carrier-current systems have been in use for about sixteen years for the communication over high-tension power lines of information concerning the operation and maintenance of the power system. Irregularities in the line caused by switches, branch lines, and other circuits introduce wide variations in the transmission characteristics as the frequency of transmission is varied. Resonant chokes are employed to isolate, at the communications frequencies, sections which are responsible for the larger variations.

Several types of carrier-current equipment were described and methods of connecting the equipment to the power lines were outlined.

Mr. Bock treated equipment designed for single-frequency simplex operation. This particular system provides for as many as ten different stations, each of which may have ten extensions. The change-over from receiving to transmitting is done automatically by electronic voice-controlled relays. The operation of these relays was illustrated by oscillograms and methods of preventing "singing" and speech clipping were discussed.

Six chassis mounted in a steel cabinet hold the transmitting and receiving equipment. For accessibility in maintenance, each chassis may be pulled forward on filing-cabinet slides and tilted to an angle of forty-five degrees.

March 15, 1940, C. A. Ellert, chairman, presiding.

Buenos Aires

"A Modern Radiotelegraph System" was described by P. J. Noizeux, technical director; H. Krähenbühl, chief of the engineering department, and B. Novics, chief engineer of the "Villa Elisa" station of Transradio Internacional S. A.

The system which was described and demonstrated provides two channels but employs only a single transmitter and output stage. The two channels are operated at 17,690 and 17,660 kilocycles. They can be keyed independently and simultaneously at high speed. The performance is claimed to be equivalent to that obtained when using two transmitters of the same power. The system has been in operation since 1937.

A "Description of Broadcast Stations LS1 and LR5" was then given by Raul Orzabal, chief engineer of the stations.

The transmitter at LS1 is of 50 kilowatts. It was built by the Western Electric Company and utilizes the Doherty system of modulation.

Its performance and economy of operation and maintenance compensate for the high initial cost of equipment of such relatively small dimensions.

The meeting was held at the transmitting stations of Transradio Internacional and the equipment and antennas for LS1 and LR5 were inspected. The stations are at Monte Grande which is about 38 kilometers from Buenos Aires.

December 16, 1939, E. E. Kapus, secretary-treasurer, presiding.

Buffalo-Niagara

D. E. Chambers, assistant engineer in the Transmitter Engineering Department of the General Electric Company, presented a paper on "Television Work in the Helderberg Mountains."

He traced briefly the development of television to the present time and described the elementary functions of transmitters for that purpose.

A description was then given of W2XB, which is located in the Helderberg Mountains near Schenectady. Low-level modulation is used. Various difficulties caused by standing waves in transmitter circuits and the antenna were outlined.

Experience obtained in the operation of the studio and its apparatus was described. Water-cooled mercury-arc lights are used for illumination.

The programs are supplied to the transmitter over a low-power system operating at 157 megacycles. The transmitter in the Helderbergs utilizes the third television channel from 66 to 72 megacycles.

A receiving station is located near the transmitter to pick up transmissions from the New York stations, about 130 miles away, for retransmission of their programs.

March 6, 1940, K. B. Hoffman, chairman, presiding.

Connecticut Valley

"Intermediate-Frequency-Transformer Design and Construction" were discussed by F. J. Frater, an engineer for the F. W. Sickles Company.

The general design and construction of intermediate-frequency transformers were first presented. Developments of recent years have improved operation and reduced the size of these units. The various changes in design which improved the effectiveness of intermediate-frequency amplifiers by increasing their gain and stability were treated. A series of formulas for the preliminary design of these transformers was presented. The effect on operation of the various factors which are under the control of the design engineer were described.

It was noted that the new single-ended tubes have certain characteristics which require careful design of circuits to avoid troubles. Regeneration appears to be their worst fault but can be minimized by careful layout of equipment.

In designing an intermediate-frequency transformer it is necessary to know the frequency of operation, the circuit arrangement, the tubes to be used together with their loads and operating voltages, the proximity of the transformer to metallic masses, the band width and expansion, the gain, and the temperature and humidity which will be encountered in service. The design must be mechanically simple and its electrical characteristics should not involve critical values or else it will probably not be possible to produce them on a production basis.

March 7, 1940, R. N. Ferry, chairman, presiding.

Detroit

"Portable Radiotelephone Equipment for Use in Emergencies" was described by D. H. Baker, an engineer for the Michigan Bell Telephone Company.

The equipment was designed to permit communication under distress conditions resulting from floods, wind and sleet storms, or other catastrophes.

A 50-watt transmitter and a receiver which are rack-mounted, weighing about 150 pounds, are transported by truck to the distressed area. A 500-watt gasoline-engine-driven generator will operate the transmitter for six hours on one gallon of gasoline. A 25-foot vertical rod of four sections comprises the antenna which may be clamped to the cross arm of a telephone pole or any similar structure. Operation is at 2726 kilocycles and the service range is considered as being about 25 miles.

No mechanical controls need be operated. The transmitter is crystal-controlled. A voice-operated relay automatically switches the antenna from the receiving to the transmitting position and starts the transmitter within a few milliseconds of the time when speech is impressed on the microphone. The transmitter continues operating for about a fifth of a second after the speech stops which eliminates false operation between words. The sensitivity of the system is greatest in the speech range of frequencies which minimizes false operation which might otherwise be caused by noise.

The receiver is equipped with a device which will set it in operation on picking up a carrier signal. This is designed to discriminate substantially against noise.

February 16, 1940, J. D. Kraus, chairman, presiding.

Emporium

"Crystal Devices Applied to Miniature Amplifiers" was the subject of a paper by D. Domizi, development engineer for the Brush Development Company.

A discussion of the field and its possibilities, particularly as applied to hearing aids was first presented. The use and characteristics of Rochelle-salt crystals were then described. Equations for various mounting methods and the equivalent electrical circuits were developed.

A description was then given of some miniature crystal microphones. Their properties and the qualities which make them desirable for this use were described. Circuits in which they operate were shown. Crystal earphones have also been employed and some of the problems of their design and mounting were covered.

The paper was closed with a discussion of the vacuum tube and circuits required to obtain optimum results from the crystal microphones and earphones. The small currents involved require considerable care to be given to the over-all design for satisfactory operation.

February 29, 1940, H. L. Ratchford, secretary-treasurer, presiding.

Los Angeles

"Discussion of a number of Electronic Applications to the Motion-Picture Industry" was presented by C. R. Daily, chief engineer for Paramount Pictures.

Dr. Daily described first the use of the new high-pressure mercury-vapor lamps which are required for the slow-speed fine-grain sound-recording emulsions. It was pointed out that the change from water- to air-cooling has improved the stability of the lamps.

New methods of testing for amplitude distortion were described. The disadvantages of single-frequency measurements were outlined. Two tests which employ two frequencies and measure rectification rather than wave-form deformation were discussed. The intermodulation test indicates the magnitude of modulation between a low- and a high-frequency wave transmitted through a nonlinear system. The frequencies commonly used are 60 and 1000 or 60 and 6000 cycles. A cross-modulation test measures the demodulation suffered by a 9000-cycle wave deeply modulated at 400 cycles when passing through a nonlinear system.

The paper was closed with a brief discussion of the use of square waves for testing.

J. N. A. Hawkins, research engineer for Walt Disney Productions, presented some "Brief Notes on Man-Made Variations in Ultra-High-Frequency Received Fields." These notes resulted from an investigation to determine how often transmission impairments of 40 decibels or more were caused by "moving nulls" in the range of frequencies between 21 and 120 megacycles.

Moving nulls are generally caused by shifts in the standing-wave patterns around the receiving antenna caused by

reradiation from moving objects. A 40-decibel variation in received field strength was arbitrarily considered as the maximum variation tolerable with present-day automatic gain and limiting systems.

About 35 common offenders were found and included such devices as automobiles, airplanes, steel doors, elevators, telephone cords, the switching on and off of lights, telephone and telegraph signal circuits, moving signs, and filing-cabinet drawers. Audible flutter caused by rapid variations was studied by the mobile operation of either or both the transmitter and receiver. The most effective method of minimizing these variations was to utilize high antenna directivity and a shielded balanced transmission line connecting the antenna and the receiver.

The equipment for measuring the field strength and the transmitters and receivers employed in the tests were described.

January 16, 1940, A. C. Packard, chairman, presiding.

A "Demonstration of Television Receiving and Test Equipment" was presented by C. F. Wolcott, chief engineer of the television division of Gilfillan Brothers. The demonstration utilized the Don Lee transmitter and Gilfillan receivers.

Mr. Stearns described methods used to generate test synchronizing signals and program material. He discussed and operated a signal analyzer which scans any chosen portion of any line in either field. Thus, received or locally generated signals may be observed in detail. By intentionally impairing certain of the synchronizing pulses, the action of a receiver may be observed and its design modified to permit satisfactory performance under conditions in which a degraded signal is being used.

February 20, 1940, A. C. Packard, chairman, presiding.

Montreal

"Television and Its Recent Developments" was the subject of a paper by W. B. Morrison who was assisted by W. C. Fisher. Both are members of the RCA-Victor Company, Montreal, staff.

Mr. Morrison first outlined generally the problems of producing a television system utilizing electronic apparatus rather than mechanical equipment. A description was given of the RCA system and its characteristics were outlined.

Three receivers were set up in the auditorium and the pickup equipment was located in an anteroom. Coaxial lines coupled the two sets of terminal equipment. The demonstration consisted of a series of interviews with various members.

This meeting was held jointly with the Montreal Branch of the Engineering Institute of Canada.

January 18, 1940, W. H. Moore, chairman, Montreal Branch E. I. C., presiding.

H. E. Olesen of the Weston Electrical Instrument Corporation explained how and why indicating instruments work and their limitations.

The speaker classified indicating in-

struments, in four groups. The iron-vane type is chiefly useful for low-frequency alternating currents and the d'Arsonval or moving-coil type is utilized for direct-current measurements. The dynamometer type of instrument fills a gap between the direct-current and alternating-current units. The thermal type is utilized for the measurement of high-frequency alternating currents. The construction, method of operation, and accuracy of each of these types of instrument were described.

A display of component parts and completed instruments helped to illustrate the various design features which were discussed.

February 7, 1940, A. B. Oxley, chairman, presiding.

V. K. Zworykin, electronic research engineer for the RCA-Victor Company, presented a paper on "Electronics for Radio Engineers."

In introducing his subject, Dr. Zworykin pointed out many analogies between physical optics and electron optics. These analogies have been particularly useful in the development of new electronic devices. The use of mechanical models in obtaining preliminary design data for new devices was described. The paper was concluded with a treatment of the iconoscope and the orthicon.

February 12, 1940, A. B. Oxley, chairman, presiding.

Philadelphia

N. F. Agnew and W. P. Place of the Farmers Engineering and Manufacturing Company presented a paper on "Electronic Fence Controller."

Livestock are discouraged from touching the fence by charging it with a steady direct-voltage bias on which is superimposed recurrent unidirectional pulses. The paper was devoted chiefly to a discussion of the theory and design of a transformer which steps up the pulses generated by the discharge of a condenser through a gaseous tube. The transformer also limits the peak current which may be drawn from the supply. Power consumption of the device is about three watts.

February 20, 1940, J. E. Baudino, chairman, presiding.

"The Development and Design Features of the New Western Electric Models 639A and 639B Microphones" was presented by F. H. McIntosh, West Coast representative of the Graybar Electric Company.

The requirements of a microphone for motion-picture studios, broadcasting, and public-address use were outlined. In addition to a satisfactory frequency range and directional characteristics which are reasonably independent of frequency, the ability to modify readily the directional characteristics is of great utility.

It was shown that the bidirectional characteristic of a ribbon microphone may be combined with the nondirectional characteristic of a moving-coil unit to produce a cardioid pattern. The difficulties of obtaining such a result were outlined and the characteristics of the resulting instrument

were given. The effect of the variation of directional properties on the frequency range of a commercial microphone was outlined graphically.

February 28, 1940, Marcus O'Day, chairman, presiding.

A. M. Skellett of Bell Telephone Laboratories presented a paper on "The Coronaviser, a Television Instrument for Observing the Solar Corona without an Eclipse."

The coronaviser, by using television technique and scanning the image of the sky around the sun separates the coronal image from the glare of the sky by electrical filtering so the corona may be reproduced and photographed. Small particles of dust and insects floating in the air produce bright light streaks across the image which are troublesome.

By permitting the solar corona to be observed at any time when a clear view of the sun is obtainable, it is hoped that this instrument will assist substantially in co-ordinating the effect of the solar disturbances on terrestrial magnetic storms which affect radio transmission.

March 7, 1940, R. S. Hayes, chairman, presiding.

"Effects of Hum-Bucking Construction and Magnetic Shielding in Audio-Frequency Transformers" was the subject of a paper presented by Douglas Fortune, sales engineer for the Thordarson Electric Manufacturing Company.

The hum picked up by transformers depends on the amount of exposure to magnetic fields and the susceptibility of the transformer. The simplest method of correcting for the first is to separate widely the sources of magnetic fields and the transformer in question. This is not always feasible as commercial equipment is usually compactly constructed.

The susceptibility to picking up noise is effectively reduced either by shielding the complete transformer or dividing the windings and mounting them on separate legs of the core.

A combination of both methods has resulted in transformers in which the hum pickup has been reduced 57 decibels compared to a similar transformer which is unshielded and the windings connected to give maximum pickup. Of this reduction, 30 decibels result from the division of the windings and the remaining 27 decibels are attributed to shielding.

Three concentric shells are used for shielding. The inner shells are rolled and the outer drawn from a special alloy known as mu metal. This alloy saturates in the vicinity of 2000 gauss. It has a very high permeability for low flux densities.

The use of mu-metal cores requires that there be practically no direct current flowing in the windings. Push-pull windings may, however, carry direct currents.

Factors determining the upper and lower frequency limits of transformer operation were listed. The use of equivalent-circuit diagrams in the design of transformers and their utilization were described.

March 13, 1940, Marcus O'Day, chairman, presiding.

Rochester

R. H. Manson, vice president and chief engineer of the Stromberg-Carlson Telephone Manufacturing Company, presented a paper on "Most Recent Developments in Radio."

December 12, 1939, L. A. DuBridg, chairman, luncheon meetings, presiding.

A paper and demonstration of "Television" was presented by G. R. Town, an engineer of the Stromberg-Carlson Telephone Manufacturing Company.

February 1, 1940, C. Tuites, chairman, American Institute of Electrical Engineers, presiding.

E. A. K. Culler of the department of psychology of the University of Rochester presented a paper on "Hearing."

February 8, 1940, W. F. Cotter, chairman, presiding.

San Francisco

A "Symposium on Frequency Modulation" was presented by H. J. Scott and J. M. Pettit of the Electrical Engineering Department of the University of California.

Professor Scott treated the fundamentals of frequency modulation. He concluded his talk with a cathode-ray-oscilloscope demonstration of a frequency-modulated wave.

Mr. Pettit discussed methods of producing and detecting frequency-modulated waves. He compared amplitude- and frequency-modulated waves indicating the advantages of the latter in the improvement of the signal-to-noise relationship.

March 6, 1940, L. J. Black, vice chairman, presiding

Seattle

Four papers were given in a "Forum on Frequency Modulation."

A. V. Eastman, professor of electrical engineering at the University of Washington, discussed the "Fundamentals of Frequency Modulation." In it he compared amplitude, frequency, and phase modulation. He pointed out that the equations for frequency and phase modulation were of identical form and differed only in respect to the modulation indexes. In phase modulation the index varies directly with phase while in frequency modulation the index is an inverse function of the modulating frequency.

The Crosby system of frequency modulation in which the oscillator is modulated directly and a reference oscillator is employed to guarantee the constancy of the carrier was compared with the Armstrong system in which the original modulation is secured as amplitude modulation with a balanced modulator in which carrier frequency is eliminated. The carrier is amplified separately and reinserted with a 90-degree phase shift, thus securing frequency modulation. Wide-band frequency modulation results when the narrow-band frequency-modulated wave is passed through a series of multipliers and a frequency-conversion stage. The signal-to-noise characteristics of wide-band fre-

quency-modulated waves were compared with those of amplitude-modulated waves by means of vectors.

L. B. Cochran then discussed "Transmitter and Receiver Circuits."

In considering transmitters, Professor Cochran described the equipment used by the Yankee Network at Boston and Paxton, Massachusetts. These transmitters are of 250 watts and 2 kilowatts, respectively, and employ the Armstrong system.

Emphasis was placed on the limiter, discriminator, and detector circuits of receivers as these are the only portions of frequency-modulated-wave receivers which are not found in receivers for amplitude-modulated waves.

"Coverage of Frequency-Modulated Transmitters" was discussed by M. P. Kiebert, a consulting radio engineer, who presented information obtained in a series of tests made with transmitters located at Albany and Schenectady. He indicated improvements favoring frequency modulation including a maximum gain in signal strength of 25 decibels with respect to amplitude modulation for the range of power used, lack of interference between two transmitters operating on the same frequency when the ratio of one signal to another was at least two to one as contrasted with a ratio of at least 30 to 1 for amplitude modulation, complete separation of signals by a receiver with field strengths of 10,000 to 1 and a carrier separation of 260 kilocycles, and a dynamic range of 65 decibels.

The concluding paper on "Commercial Communication Phases of Frequency Modulation" was presented by A. Kerr, an engineer for Radio Laboratories. Among the various advantages to commercial services listed by Mr. Kerr were the elimination of interference between police transmitters scattered over the country, the reduction in power required for a given coverage which is especially desirable for mobile units, reduction of interference from snow static and ignition noises in the case of aircraft communication, and reduction of interference in harbor and marine services.

The meeting was closed with a general discussion and a demonstration of the reception of frequency-modulated-wave signals.

March 1, 1940, R. M. Walker, chairman, presiding.

The paper on "Effects of Hum-Bucking Construction and Magnetic Shielding in Audio-Frequency Transformers" by Douglas Fortune of the Thordarson Electric Manufacturing Company, which has been reported in the meeting of the Portland Section, was given.

March 8, 1940, R. M. Walker, chairman, presiding.

Washington

B. J. Thompson, head of the research division of the Research and Engineering Department of the RCA Manufacturing Company, spoke on "More Work for the Electron."

The paper was a discussion of new fields of application for new kinds of elec-

tron tubes. Several types of tubes which have been developed to produce and amplify waves of the order of 300 megacycles were described. Recent developments in the iconoscope which have resulted in greater sensitivity and in the elimination of defects resulting in what are called "black spots" were outlined. Other developments in cathode-ray tubes have resulted in obtaining higher light intensity thus increasing the possibility of satisfactory television reception with projected images. The paper was closed with a discussion of the electron microscope which offers an image of higher resolving power than is obtainable by any microscope depending on visible light for its action.

March 11, 1940, L. C. Young, chairman, presiding.

Membership

The following indicated admissions to membership have been approved by the Admissions Committee. Objections to any of these should reach the Institute office by not later than May 31, 1940.

Admission to Associate (A), Junior (J), and Student (S)

- Andresen, E. H., (A) 6257 N. Francisco Ave., Chicago, Ill.
 Barbieri, M., (A) Av. Santa Fe 2128, Buenos Aires, Argentina.
 Barlow, E. P., (A) 2812 Gibbons Ave., Baltimore, Md.
 Bartels, A., (A) 204 Riverside Ave., Buffalo, N. Y.
 Beard, M., (A) "Navua," Poole St., Longueville, N.S.W., Australia
 Beleskas, S. M., (A) 1100 Grant Ave., West Collingswood, N. J.
 Carlson, R. W., (A) 41 Preston St., Depew, N. Y.
 Carroll, F. G., (A) 908 S.E. 9th St., Fort Lauderdale, Fla.
 Cattanes, E., (A) 87 Belmont Ave., Cockfosters, Herts., England.
 Church, R. L., (S) 4414 Military Rd., Sioux City, Iowa.
 Conrad, C. G., (A) 2017 Carter Ave., Ashland, Ky.
 Crane, W. K., (A) 1611-1st Ave. N., Seattle, Wash.
 Crowell, A. W., (A) 308 S. Broad St., Emporium, Pa.
 Del Rio, (A) Huerfanos 764, Santiago, Chile.
 De Pew, R. T., (S) Hughes Hall, Ames, Iowa.
 Evans, D. J., (S) 325 University Station, Grand Forks, N. D.
 Fauner, J., (A) Posta restante, Correo Central, Buenos Aires, Argentina.
 Fenwick, C. E., (A) "Greystones," Catisfield, Fareham, Hants., England.
 Gannon, M. T., (S) School of Electrical Engineering, Purdue Univ., West Lafayette, Ind.
 Gehres, F. A., (A) R.R. 5, Box 178, Evansville, Ind.
 Gerken, G. H., (A) 11525 Long Beach Blvd., Lynwood, Calif.

- Glozer, A., Jr., (A) 1630 S. Cuyler Ave., Berwyn, Ill.
- Goldy, B. H., (S) 236 N. 25th St., Corvallis, Ore.
- Grue, O. E., (A) Maelkevej 7, Copenhagen F, Denmark.
- Hay, R. R., (A) 3811-39th St., San Diego, Calif.
- Headstrom, R. L., (A) 930 Windsor Ave., Chicago, Ill.
- Hedges, C., (S) Hickman Mills, Mo.
- Hopkins, L. A., Jr., (S) 1517 S. University Ave., Ann Arbor, Mich.
- Hull, R. E., (S) 52 Massachusetts Ave., Cambridge, Mass.
- Hulse, E. H., (S) 6018 Colby St., Oakland, Calif.
- Husein, A. E., (A) "Safia Munzil," 18 Sussex Rd., Bombay 12, India.
- Johnson, C. A., (A) 3325 N.E. Siskiyou St., Portland, Ore.
- Johnson, P., Jr., (S) 3425 Douglas Blvd., Chicago, Ill.
- Jones, J. P., (S) 3036-61st Ave., S.W., Seattle, Wash.
- Keast, M. H., (A) 3 Fircroft Rd., Beacon Park, Plymouth, Devon, England.
- Kent, E. L., (A) 3300 Federal St., Chicago, Ill.
- Keranen, E. W., (A) 2026 Pensacola Ave., Chicago, Ill.
- Kocsan, E. S., (A) Pennsylvania Electric Co., Johnstown, Pa.
- Krempel, F. M., (J) 2643 N. Whipple St., Chicago, Ill.
- Kusrow, C. F., (A) Airport Control Tower, Municipal Airport, Salt Lake City, Utah.
- Kyne, T., (A) 602 W. 190th St., New York, N. Y.
- Leonhardi, J. O., (S) 18446 Martin Ave., Homewood, Ill.
- Lemon, E. B., (A) 621 Carolina Ave., Roanoke, Va.
- Lesnick, R., (A) 1421 Arch St., Philadelphia, Pa.
- Levy, M. L., (A) 276 Glen Ellyn Way, Rochester, N. Y.
- Lommen, M. A. K., (S) 582 University Station, Grand Forks, N. D.
- London, C., (A) 4103 Barrington Rd., Baltimore, Md.
- Lowe, L. W., (S) Box 4732, University Station, Tucson, Ariz.
- Luddy, E. N., (S) 722 Cramer Ave., Lexington, Ky.
- Mayder, W., (S) 2718 Myrtle St., Oakland, Calif.
- McCulloch, C. R., (A) 6121 Sunset Blvd., Los Angeles, Calif.
- McDaniel, G. M., (S) 428 Sinclair St., Reno, Nev.
- Melendez, A. F. A., (A) Vicuna Mackenna 649, Santiago, Chile.
- Moran, J. M., (S) 622 Sampton Ave., Plainfield, N. J.
- Nobles, C. E., (A) c/o Westinghouse Elec. & Mfg. Co., 2519 Wilkins Ave., Baltimore, Md.
- Ohlsson, R. L., (S) 326 W. Liberty St., Ann Arbor, Mich.
- Ohmart, P. E., (A) R.F.D. 3, Springfield, Ohio.
- Osorio, A. E., (A) Rivadavia 5038, Buenos Aires, Argentina
- Parnell, J., (S) 59 Bay State Rd., Boston, Mass.
- Renner, W. D., (S) 103 University St., West Lafayette, Ind.
- Robinson, L. P., Jr., (S) 109 James Hall, Durham, N. H.
- Ruse, E., (A) 120 Wilson Ave., London, Ont., Canada.
- Senter, E., (J) 247 Lafayette Ave., Brenton, Wash.
- Spreuer, W. E., (S) 212 Wiggins St., West Lafayette, Ind.
- Sprowl, P. R., (S) 1326 Upsala St., East McKeesport, Pa.
- Steele, R. B., (S) 827 W. College Ave., State College, Pa.
- Steelman, R. J., (A) Signal Corps Aircraft Radio Laboratory, Wright Field, Dayton, Ohio.
- Sundius, H. W., (A) Southern New England Telephone Co., New Haven, Conn.
- Tague, D., (S) 219 Fowler Ave., West Lafayette, Ind.
- Tickner, M. A., (A) 18 Waldeck Rd., West Ealing, London W. 13, England.
- Todd, F. J., (A) 1807 N. Nagle Ave., Chicago, Ill.
- Tyler, R. H., (A) 82 Winter St., North Adams, Mass.
- Veras, A. F., (S) 11517 Harvard Ave., Chicago, Ill.
- White, R. H., (A) 41 West Ave., N., Hamilton, Ont., Canada.
- White, R. W., (A) 12 The Glen, Wembley, Middx., England.
- Wilkinson, W. C., (S) 439 N. Salisbury St., West Lafayette, Ind.
- Wilson, J. L., Jr., (S) 165 Howard St., S. E., Atlanta, Ga.
- Williams, L. L., Jr., (A) 74 Irving Pl., Buffalo, N. Y.
- Wilson, L. B., (S) M.I.T. Dormitories, Cambridge, Mass.
- Yost, K., (S) Dayton, Ind.
- Zalewski, H. V., (S) 33 Rawson St., Dorchester, Mass.
- Zoschke, J. H., (A) 447 N. Beville Ave., Indianapolis, Ind.

Books

Engineering Opportunities, edited by R. W. Clyne.

Published by D. Appleton-Century Company, 35 W. 32nd St., New York, N. Y. 14 plus 387 pages and an index. $5\frac{3}{4} \times 8\frac{1}{4}$ inches. Price \$3.00.

This was written as a guide for young men contemplating the choice of engineering as a profession and for engineering students who are undecided as to the branch in which they intend to specialize.

Each of the twenty-six chapters of the book is devoted to a special field and is written by an engineer prominent in that field. In each case is given a sketch of the history of the industry in question, together with a survey of the present state of its development and trends. Research problems of importance for further development and improvement are indicated.

The presentation is clear and nontechnical, the material interesting and stimulating. The book should be useful both for

instruction and for the inspiration of those for whom it was written.

FREDERICK W. GROVER
Union College,
Schenectady, N. Y.

Electrical Communication, Second Edition, by Arthur Lemuel Albert.

Published by John Wiley and Sons, 440 Fourth Ave., New York, N. Y. 523 pages and index. $6\frac{1}{2} \times 9\frac{1}{4}$ inches. 398 illustrations. Price \$5.00.

This second edition of a work which appeared in 1934 has been revised and reset; the last four chapters, Inductive Interference and Plant Protection, Electronics and Vacuum Tubes, Electronic Applications in Wire Communication, and Wireless Communication, have been rewritten and brought up to date. The lists of references to the literature of the subject which accompany the chapters have been expanded and illustrative problems for class assignment are a feature of the new edition which includes about eighty pages more than the first edition.

The book covers the whole field of electrical communication, telegraphy, telephony, and radio, especial attention being devoted to actual practice. Illustrations of apparatus and instruments are numerous and well chosen. In some portions, for example, those dealing with telephone transmission theory and electrical networks, the treatment is necessarily mathematical, but for the most part only an elementary mathematical preparation is needed by the reader.

The author has been successful in producing a book in which a good balance is maintained between inclusiveness of scope and clearness of exposition. The book is suitable as a college textbook in courses intended to give a general knowledge of the whole communication field.

FREDERICK W. GROVER
Union College,
Schenectady, N. Y.

The Theory and Use of the Complex Variable by S. L. Green.

Published by Pitman Publishing Corp., 2 West 45th St., New York, N. Y., and Chicago, Ill. 136 pages. $5\frac{3}{4} \times 8\frac{3}{4}$ inches. 47 illustrations. Price \$3.00.

"This book is intended to give an introductory account of the fascinating subject of the complex variable and conformal transformation, with some indication of applications to problems of mathematical physics, aeronautics, and electrical engineering. It demands from the reader little more in the way of preliminary equipment than some knowledge of the calculus (including partial differentiation) and analytical plane geometry." The quotation is from the author's Preface and is an accurate statement of the purpose and contents.

The first two chapters deal with complex algebra. The operations of addition, subtraction, multiplication, and division are explained from the geometrical viewpoint and made lucid by illustrations. In the third chapter the properties of the exponential, logarithmic, circular, and hyperbolic functions are treated. After one has solved the numerous exercises given at the end of these chapters he should have obtained more than a sufficient knowledge of complex algebra to handle alternating-current problems including networks and transmission lines.

With exception of the last two short chapters treating applications, the remainder of the book is concerned with the theory of functions of a complex variable and conformal transformations. A discussion of the solution of Laplace equations in two dimensions is followed by brief explanations of singularities, contour integration, and Stokes', Cauchy's, Taylor's, and Laurents' theorems. Considerable space is devoted to conformal transformations, one chapter being given to the Schwartz-Christoffel transformation alone. All of the transformations discussed have important applications to field and flow problems.

The extreme brevity of the account of applications was disappointing to the reviewer. It would seem that unless the reader is already familiar with works of the type of Jeans "Theory of Electricity and Magnetism" or similar treatises applying to other branches of physics, he will fail to grasp the great importance of the theory of the complex variable in physical applications.

To the student of elementary alternating-current theory this treatise offers little that cannot be found in most electrical engineering texts. One desiring a sufficient knowledge of complex algebra and the theory of a complex variable to work with the less-simple electric-circuit problems, such as filter networks and transmission lines, or with field problems in electrostatics, hydrodynamics, aerodynamics, heat flow, etc., should obtain an excellent foundation from this book.

P. S. CARTER

R.C.A. Communications, Inc.

Rocky Point, L. I., N. Y.

Committee Personnel—1940

ADMISSIONS COMMITTEE

A. F. Van Dyck, *Chairman*

F. J. Bingley	C. M. Jansky, Jr.
Ralph Bown	I. J. Kaar
J. E. Brown	H. B. Marvin
A. B. Chamberlain	H. B. Richmond
F. W. Cunningham	J. S. Smith
R. A. Hackbusch	F. E. Terman
C. W. Horn	H. M. Turner
	R. M. Wise

AWARDS COMMITTEE

H. M. Turner, *Chairman*

W. R. G. Baker	R. H. Manson
B. D. Bayly	H. B. Marvin
Ralph Bown	Haraden Pratt
J. E. Brown	F. E. Terman
Virgil M. Graham	A. F. Van Dyck

BOARD OF EDITORS

Alfred N. Goldsmith, *Chairman*

R. R. Batcher	B. E. Shackelford
P. S. Carter	K. S. Van Dyke
E. W. Engstrom	H. A. Wheeler
F. W. Grover	L. P. Wheeler
J. W. Horton	L. E. Whittemore
G. W. Pickard	William Wilson

CONSTITUTION AND LAWS COMMITTEE

H. M. Turner, *Chairman*

Austin Bailey	C. E. Scholz
Ralph Bown	B. J. Thompson
Alfred N. Goldsmith	J. W. Wright
Virgil M. Graham	H. R. Zeamans

MEMBERSHIP COMMITTEE

E. D. Cook, *Chairman*

Adolph Andersen	N. Potter
Nathaniel Bishop	H. L. Ratchford
E. L. Bowles	F. X. Rettenmeyer
D. W. Bowman	C. R. Rowe
L. B. Cochran	Bernard Salzberg
I. S. Coggeshall	P. C. Saudretto
F. W. Cunningham	Earl Schoenfeld
H. F. Dart	C. E. Scholz
B. V. K. French	W. L. Schwesinger
Paul Frincke	H. C. Sheve
H. C. Gawler	J. E. Smith
J. N. A. Hawkins	W. M. Smith
R. M. Heintz	R. L. Snyder
H. E. Held	F. E. Terman
E. E. Kapus	H. J. Vennes
P. K. McElroy	E. C. Waud
Gary Muffly	E. M. Webster
W. A. Nichols	Alexander Whitney
L. G. Pacent	J. D. Woodward
J. R. Poppele	J. S. Webb

NEW YORK PROGRAM COMMITTEE

A. B. Chamberlain, *Chairman*

H. A. Affel	D. E. Harnett
Austin Bailey	Keith Henney
R. R. Beal	D. D. Israel
I. S. Coggeshall	Wallace James
G. C. Connor	J. R. Poppele
W. M. Goodall	G. T. Royden
	A. F. Van Dyck

NOMINATIONS COMMITTEE

Alfred N. Goldsmith, *Chairman*

E. H. Armstrong	C. M. Jansky, Jr.
Ralph Bown	R. H. Manson
Virgil M. Graham	H. B. Richmond
	W. C. White

PAPERS COMMITTEE

William Wilson, *Chairman*

F. B. Llewellyn, *Vice Chairman*

H. A. Affel	D. K. Martin
Edmond Bruce	H. B. Marvin
H. A. Chinn	H. R. Mimno
J. K. Clapp	A. F. Murray
T. A. M. Craven	H. O. Peterson
R. B. Dome	R. K. Potter
P. O. Farnham	H. M. Turner
E. B. Ferrell	Dayton Ulrey
E. L. Hall	A. F. Van Dyck
D. D. Israel	P. T. Weeks
L. F. Jones	W. C. White
	Irving Wolff

SECTIONS COMMITTEE

J. H. Miller, *Chairman*

V. J. Andrew	Virgil M. Graham
I. S. Coggeshall	R. M. Heintz
E. D. Cook	C. E. Scholz

TELLERS COMMITTEE

H. W. Houck, *Chairman*

Austin Bailey	I. G. Maloff
Frederick Ireland	E. W. Schafer

TECHNICAL COMMITTEES

ANNUAL REVIEW COMMITTEE

L. E. Whittemore, *Chairman*

J. L. Callahan	I. J. Kaar
J. H. Dellinger	H. S. Knowles
D. E. Foster	E. G. Ports
Keith Henney	P. T. Weeks
	H. A. Wheeler

ELECTROACOUSTICS COMMITTEE

H. S. Knowles, *Chairman*

L. B. Blaylock	G. G. Muller
R. P. Glover	George Nixon
V. N. James	Benjamin Olney
Knox McIlwain	H. F. Olson
	L. J. Sivian

ELECTRONICS COMMITTEE

P. T. Weeks, *Chairman*

L. B. Blaylock	F. R. Lack
R. S. Burnap	F. B. Llewellyn
H. H. Buttner	G. F. Metcalf
E. L. Chaffee	A. F. Murray
H. P. Corwith	L. S. Nergaard
K. C. DeWalt	G. D. O'Neill
W. G. Dow	H. W. Parker
R. L. Freeman	Balth. van der Pol
Ben Kievit, Jr.	J. R. Wilson

FACSIMILE COMMITTEE

J. L. Callahan, *Chairman*

J. C. Barnes	C. E. Kilgour
W. A. R. Brown	H. C. Knutson
G. V. Dilenback, Jr.	George Lewis
W. G. H. Finch	P. Mertz
John Hancock	J. W. Milnor
Robert Hatch	J. R. Poppele
J. V. L. Hogan	C. J. Young

RADIO RECEIVERS COMMITTEE

D. E. Foster, *Chairman*
 M. W. Angus Virgil M. Graham
 E. H. Armstrong David Grimes
 L. B. Blaylock D. E. Harnett
 R. I. Cole R. S. Holmes
 W. F. Cotter D. D. Israel
 L. F. Curtis J. O. Mesa
 Harry Diamond H. O. Peterson
 E. T. Dickey N. F. Shofstall
 W. L. Dunn A. E. Thiessen
 H. B. Fischer H. J. Tyzzer
 C. J. Franks Lincoln Walsh
 R. M. Wilmotte

STANDARDS COMMITTEE

H. A. Wheeler, *Chairman*
 W. R. G. Baker R. M. Morris
 W. L. Barrow E. G. Ports
 J. L. Callahan F. E. Terman
 J. H. Dellinger A. E. Thiessen
 D. E. Foster H. M. Turner
 Virgil M. Graham H. J. Vennes
 I. J. Kaar P. T. Weeks
 H. S. Knowles William Wilson

SYMBOLS COMMITTEE

H. M. Turner, *Chairman*
 R. R. Batcher E. T. Dickey
 M. R. Briggs H. S. Knowles
 R. S. Burnap O. T. Laube
 C. R. Burrows George Lewis
 J. L. Callahan F. B. Llewellyn
 E. L. Chaffee H. W. Parker
 J. H. Dellinger E. W. Schafer
 L. J. Sivian

TELEVISION COMMITTEE

I. J. Kaar, *Chairman*
 H. S. Baird T. T. Goldsmith, Jr.
 R. R. Batcher A. G. Jensen
 J. E. Brown L. M. Leeds
 A. B. DuMont George Lewis
 E. W. Engstrom H. M. Lewis
 P. T. Farnsworth A. V. Loughren
 D. E. Foster A. F. Murray
 G. W. Fyler R. E. Shelby
 P. C. Goldmark D. B. Sinclair

TRANSMITTERS AND ANTENNAS
COMMITTEE

E. G. Ports, *Chairman*
 Raymond Asserson W. E. Jackson
 L. B. Blaylock W. B. Lodge
 M. R. Briggs J. F. Morrison
 W. W. Brown R. E. Poole
 Harry Diamond D. S. Rau
 F. A. Gunther J. C. Schelleng
 Raymond Guy P. E. Watson
 J. E. Young

WAVE PROPAGATION COMMITTEE

J. H. Dellinger, *Chairman*
 N. I. Adams G. D. Gillett
 S. L. Bailey H. R. Mimno
 L. V. Berkner W. H. Moffat
 C. R. Burrows K. A. Norton
 W. A. Fitch H. O. Peterson
 H. P. Thomas

Institute Representatives on Other Bodies

A.I.E.E.—Subcommittee on Radio of the Committee on Applications to Marine Work..... T. E. NIVISON AND J. L. PRESTON
 American Documentation Institute..... C. M. JANSKY, JR.
 Committee on Applied Physics..... WILLIAM WILSON
 Council of the American Association for the Advancement of Science..... J. C. JENSEN
 Engineering Index National Committee..... MELVILLE EASTHAM
 Joint Co-ordination Committee on Radio Reception of the N.E.L.A., N.E.M.A., and R.M.A..... C. E. BRIGHAM
 Liaison Committee on Aeronautic Radio Research..... F. M. RYAN (C. C. SHANGRAW, alternate)
 National Advisory Council on Radio in Education..... LLOYD ESPENSCHIED, ALFRED N. GOLDSMITH, C. W. HORN, L. M. HULL, AND R. H. MARRIOTT
 New York City Advisory Board on Industrial Education..... H. P. WESTMAN
 Planning Committee, National Conference on Educational Broadcasting, American Council on Education..... C. M. JANSKY, JR., C. B. JOLLIFFE, AND E. L. NELSON
 Radio Broadcasting Committee, American Engineering Council..... MELVILLE EASTHAM
 U.R.S.I. (International Scientific Radio Union) Executive Committee..... C. M. JANSKY, JR.
 U. S. National Committee, Advisers on Electrical Measuring Instruments..... MELVILLE EASTHAM AND HAROLD OLESEN
 U. S. National Committee, Advisers on Symbols..... L. E. WHITTEMORE AND J. W. HORTON

AMERICAN STANDARDS ASSOCIATION

Board of Directors..... HARADEN PRATT
 Standards Council..... ALFRED N. GOLDSMITH (H. P. WESTMAN, alternate)
 Board of Examination..... H. P. WESTMAN
 Electrical Standards Committee..... H. M. TURNER (H. P. WESTMAN, alternate)
 Sectional Committee on Acoustical Measurements and Terminology..... E. D. COOK AND H. F. OLSON
 Sectional Committee on Definitions of Electrical Terms..... HARADEN PRATT
 Subcommittee on Vacuum Tubes..... B. E. SHACKELFORD
 Sectional Committee on Electric and Magnetic Magnitudes and Units..... J. H. DELLINGER
 Sectional Committee on Electrical Installations on Shipboard..... I. F. BYRNES AND V. R. RUSS
 Sectional Committee on Electrical Measuring Instruments..... WILSON AULL
 Sectional Committee on Graphical Symbols and Abbreviations for Use on Drawings..... AUSTIN BAILEY (H. P. WESTMAN, alternate)
 Subcommittee on Communication Symbols..... H. M. TURNER
 Sectional Committee on Letter Symbols and Abbreviations for Science and Engineering..... H. M. TURNER
 Subcommittee on Letter Symbols for Radio Use..... H. M. TURNER
 Sectional Committee on National Electrical Safety Code, Subcommittee on Article 810, Radio Broadcast Reception Equipment..... E. T. DICKEY (VIRGIL M. GRAHAM, alternate)
 Sectional Committee on Preferred Numbers..... A. F. VAN DYCK
 Sectional Committee on Radio..... ALFRED N. GOLDSMITH, HARADEN PRATT, AND L. E. WHITTEMORE
 Sectional Committee on Radio-Electrical Co-ordination..... J. V. L. HOGAN, C. M. JANSKY, JR., AND L. E. WHITTEMORE
 Sectional Committee on Specifications for Dry Cells and Batteries..... H. M. TURNER
 Sectional Committee on Standards for Drawings and Drafting Room Practices..... AUSTIN BAILEY
 Sectional Committee on Vacuum Tubes for Industrial Purposes..... B. E. SHACKELFORD

Contributors

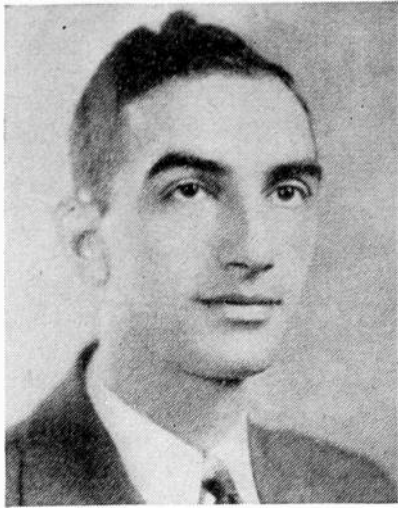

FERDINAND HAMBURGER, JR.

Ferdinand Hamburger, Jr., (A'32-M'39) was born on July 5, 1904, at Baltimore, Maryland. He received the B.E. degree in electrical engineering in 1924 and the Dr. Eng. degree in 1931 from Johns Hopkins University. From 1924 to 1925 Dr. Hamburger was with the Consolidated Gas, Electric Light and Power Company of Baltimore and from 1925 to 1929 he was a research associate at Johns Hopkins for the Underground Systems Committee of the National Electric Light Association. He was a graduate student at Johns Hopkins from 1929 to 1930; a Charles A. Coffin Fellow from 1930 to 1931; instructor in electrical engineering from 1931 to 1939;

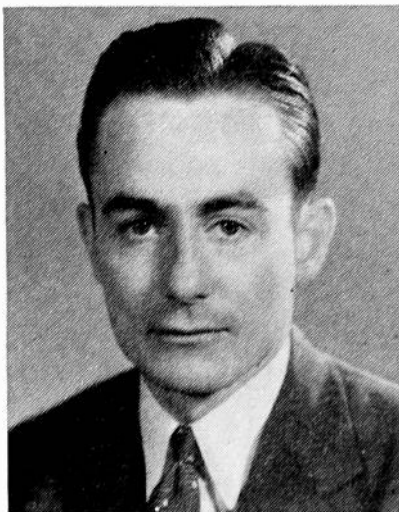

MARTIN LEE JONES

and associate in electrical engineering since 1939. He is a member of Sigma Xi, Tau Beta Pi, and the American Institute of Electrical Engineers.

Martin Lee Jones was born in Baltimore, Maryland, on April 29, 1911. He has taken an active interest in experimental and amateur radio since 1929. In

1930 Mr. Jones entered radio service work and in 1931 he became transmitter and control operator of WCAO. Since 1936 he has been Chief Engineer of that station.



Heinz E. Kallmann (A'38) was born on March 10, 1904, at Berlin, Germany. He received his Ph.D. degree from the University of Goettingen in 1929. From 1929 to 1934 Dr. Kallmann was a research engineer in the laboratories of the C. Lorenz A. G., and from 1934 to 1939 he was an engineer in the Research and Design Department of Electric and Musical Industries, Ltd.



HEINZ E. KALLMANN

Charles V. Larrick (S'38-A'39) was born at Mason Dixon, Pennsylvania, on April 25, 1913. He received the B.S. degree in chemistry from Johns Hopkins University in 1935, and the Dr. Eng. degree in electrical engineering in 1939. From July of 1938 to February of 1939 he was with Page and Davis, Consulting Radio Engineers in Washington, D. C. Since 1939 Mr. Larrick has been with the General Electric Company at Schenectady.



Arthur W. Melloh (A'33) was born at Wrenshall, Minnesota, on December 8, 1907. During 1928 to 1930 he was engaged in marine and broadcast operating, and in 1932 received the B.E.E. degree from the University of Minnesota. From 1932 to 1933 he was engineer at XENT, Nuevo Laredo, Mexico, and from 1934 to 1935 an instructor at the Dodge Radio Institute. In 1936 Mr. Melloh returned to the University of Minnesota from which he received the M.S. in E.E. degree in 1937

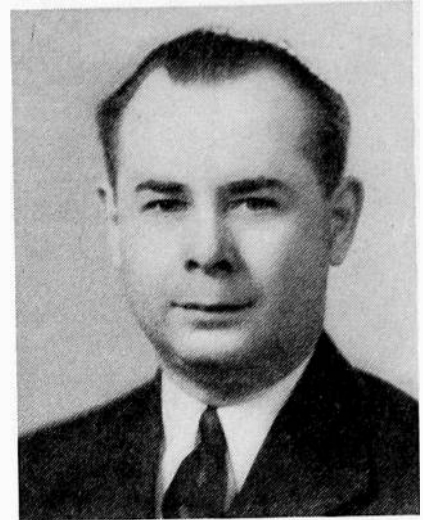

ARTHUR W. MELLOH

and the Ph.D. degree in 1940. Since 1937 he has been an instructor in the Department of Electrical Engineering at the University of Minnesota. He is an associate member of the American Institute of Electrical Engineers.



Walter W. Miehler was born at St. Louis, Missouri, on October 30, 1916. He received the B.S. degree in electrical engineering from Washington University in



CHARLES V. LARRICK

St. Louis in 1938. Since that date he has been a research assistant at Massachusetts Institute of Technology. Mr. Miehler is an associate member of Sigma Xi.



F. A. Polkinghorn (A'25-F'38) was born on July 23, 1897, at Holbrook, Massachusetts. He received the B.S. degree in electrical engineering from the Univer-



F. A. POLKINGHORN

sity of California (Berkeley) in 1922. Mr. Polkinghorn was with the United States Naval Radio Laboratory, Mare Island, California, from 1922 to 1924; A-P Radio Laboratories in San Francisco from 1924 to 1925; and Pacific Telephone and Telegraph Company from 1925 to 1927. In 1927 he became a member of the Technical Staff of Bell Telephone Laboratories, and since 1928 he has been in charge of a group engaged primarily in providing new types of high- and ultra-high-frequency receiving equipment for use in telephone receivers.



For biographical sketches of T. R. Gilliland, S. S. Kirby, and N. Smith see the PROCEEDINGS for January, 1940; for W. L. Barrow, March, 1940.



WALTER W. MIEHER



The perfected PRONG-BASE ELECTROLYTICS

• AEROVOX takes particular pride in presenting its new Series AF electrolytic condensers. Similar in appearance and purpose to the conventional prong-base electrolytics in general use, the new AF construction incorporates several vital improvements in making this type still more popular with designers, manufacturers, servicemen and equipment owners. Here's the brief story:

AEROVOX TYPE AP CONSTRUCTION

• First point of departure is the square can shoulder in place of usual 30° sloped shoulder. With square shoulder the cap or plug can rest solidly in place, making the seal more positive, and eliminating the danger of shearing the cathode tab.

In place of conventional two bakelite discs separated by sheet of flat rubber, AP construction employs a cup-shaped molded soft rubber disc with side walls. The single bakelite disc fits within the walls of the cup-shaped rubber disc which in turn rests squarely on flat shoulder of can.

Cup-shaped rubber disc has several slotted protrusions or sleeves molded in same. Through said sleeves pass the anode or positive tabs which, beyond the bend inside of sleeves, join with soldering lugs. Compare this with straight mechanical leakage path found in conventional construction. AF construction provides soft rubber sealed tabs.

In AF construction, electrolyte cannot reach junction of tab and lug because of this soft-rubber seal.

Mechanically, AF construction offers greater strength. Lugs actually eyeletted to bakelite disc—not just held between discs. All strain removed from anode tabs. Impossible to loosen contacts.

Cathode tab is spot-welded to mounting ring. Perfect contact. Immune to vibration.

No danger of bakelite corrosive effects, since rubber sleeves prevent electrolyte contacting slot walls in bakelite disc. To avoid tab corrosion, hi-purity aluminum is used for tabs.

Positive pin-hole vent instantly responsive to excess gas pressures yet normally self-healing. This in contrast to conventional construction wherein gases oozing through tab slots carry along electrolyte to cause corrosion.

Triple sealing—double sealing between cover and can, and additional sealing of all tabs in soft rubber.

Get the FACTS . . .

Write for engineering bulletin on these new AF prong-base electrolytics. Samples, specifications, quotations, cheerfully submitted to responsible parties.

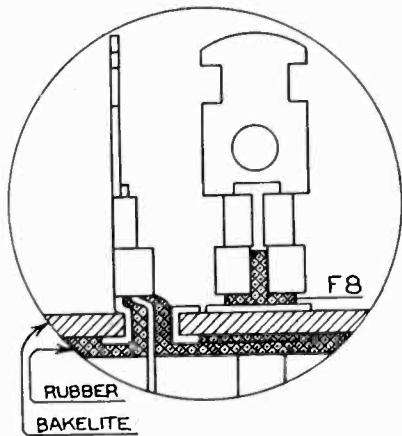

The New Aerovox Construction

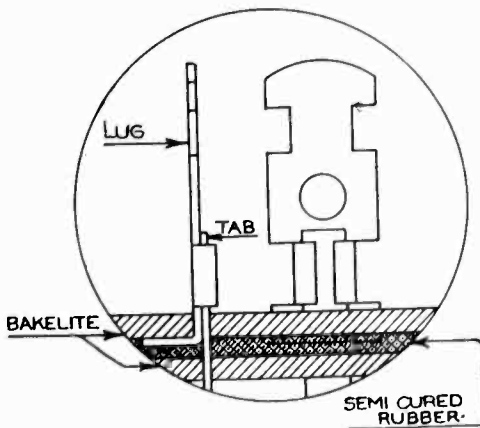

The usual way of doing it

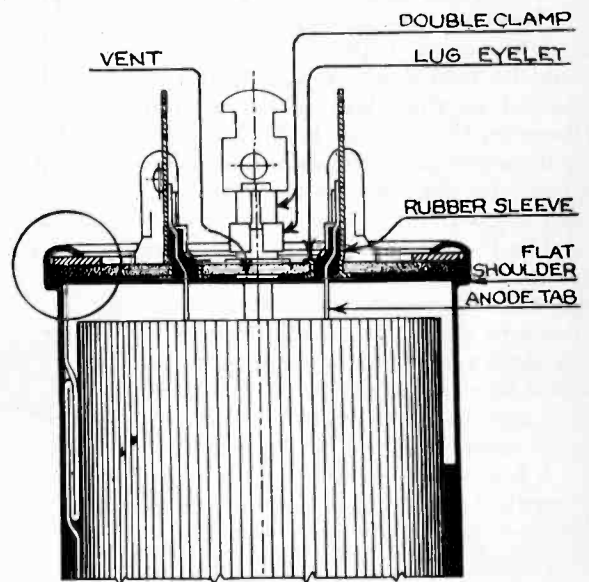

Aerovox AF Way

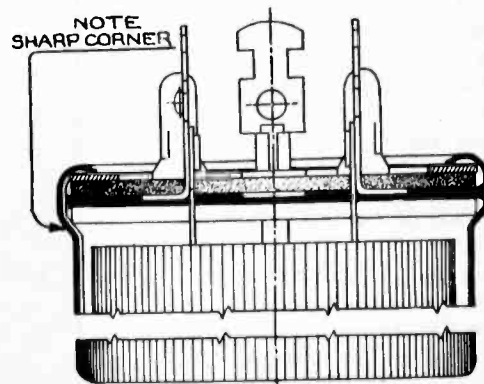

Conventional Way



AEROVOX CORPORATION

New Bedford, Mass.

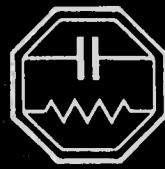

Sales Offices in All Principal Cities

Commercial Engineering Developments

These reports on engineering developments in the commercial field have been prepared solely on the basis of information received from the firms referred to in each item.

Sponsors of new developments are invited to submit descriptions on which future reports may be based. To be of greatest usefulness, these should summarize, with as much detail as is practical, the novel engineering features of the design. Address: Editor, Proceedings of the I.R.E., 330 West 42nd Street, New York, New York.

Demountable High-Vacuum Tubes

At various times in years past, radio engineers have discussed the advantages of a high-vacuum transmitting tube which could be torn down, repaired, and re-exhausted at the place where it is used. However, the obvious lack of a practical vacuum pumping system has always been a powerful deterrent to the realization of such a tube.

The introduction, by Burch,¹ of methods for the production of low-vapor-pressure oils removed this difficulty. These oils, known to the trade as Apiezon oils, allow the design of fast condensation pumps which need no refrigerant. Hickman² has been able to produce other organic fluids which seem to be even better.

A few years ago the General Electric Company³ decided to undertake a program designed to uncover and solve the problems involved in the development of high-power transmitting tubes—tubes with ratings in the order of 250 to 500 kilowatt output. This developmental program is being continued by studying the operation of two smaller tubes which are being used in daily program service at station WGeo operating on 9530 kilocycles.

The following table gives some of the tentative electrical characteristics of one of these tubes and their physical appearance is shown in the photograph.

General Characteristics:

Filament, Three-phase thoria coated	
Filament Voltage, volts per phase . . .	18
Filament Current, amperes per phase	100
Amplification Factor	40
Direct Interelectrode Capacitances, μmf	
Grid-plate	80
Grid-filament	98
Plate-filament	15.5

Class B R-F Power Amplifier:

(Carrier conditions per tube for use with a maximum modulation factor of 1.0; maximum ratings)

D-c Plate Voltage, volts	8500
D-c Plate Current, amperes	18
Plate Input, kilowatts	150
Plate Dissipation, kilowatts	100
R-f Grid Current, amperes	100
Plate Power Output, kilowatts	50

General Layout

Each unit consists of a large vacuum tank which serves as a base and also contains the oil condensation pump. On the top of this chamber is, first, the grid insulating bushing, the grid seal, the anode bushing, and finally, the anode with its water jacket.

Each unit is mounted on a truck which can be locked to the floor when the tube is in service or withdrawn from the amplifier for repairs. The filament leads and ionization gauges are arranged around the top of the base chamber.

Vacuum Seals

The insulator bushings are glass cylinders sealed to fernico rings. These metal rings are soft-soldered to the anode, to the grid ring, and the bottom demountable seals. The seals which are usually broken when repairs are needed are those shown at A on the photograph. These seals are heavy steel flanges separated by a gasket of tin wire. The joint is made vacuum tight by drawing the two flanges together with bolts and compressing the wire gasket.

Electrodes

The anode and grid are of conventional design. The anode is the usual drawn copper shell and the grid is a helical winding welded to six support rods. The cathode structure is unusual in several respects.



Demountable filament assembly

The design shown in the photograph comprises twelve equally spaced filaments each connected to one of three metal disks at the top. These metal disks are mounted on three metal rods which support the entire system and supply three-phase heating power. At the bottom all of the filaments are individually sprung from a common metal disk which forms the filament mid-

*"Very Active . . .
Accurately Calibrated"*

January 1940

BLILEY Electric Company,
Union Station Bldg.,
Erie, Penna.

Gentlemen:

The last shipment of fifty (50) crystals, received from you, ground for 8445 Kilocycles, were placed in service three weeks ago and to date are performing perfectly in our portable mobile Police transmitters.

They are used in a double-double manner for 33780 Kcs., and have been found to be very active, as well as accurately calibrated, which are the important factors for so many units in one coordinated system.

I am well pleased with them in every way.

Yours truly,
Lieut. A. A. Kirchner,
CHIEF ENGINEER

POLICE RADIO BUREAU
CITY OF GRAND RAPIDS, MICH.



BLILEY
CRYSTAL UNITS
FROM 20KC. TO 30MC.

WRITE FOR CATALOG G-11 DESCRIBING COMPLETE LINE
BLILEY ELECTRIC CO., ERIE, PA.



Big enough for the job

We live in a big country and it takes a big telephone company to give good service to millions of people. The Bell System is doing its part in providing for the nation's telephone needs, whatever they may be.

But the Bell System aims to be big in more ways than mere size. It aims to be big in the conduct of its business, in its relations with employees and its plans for the future. All of this helps to give the nation quick, dependable, courteous telephone service at low cost.

BELL TELEPHONE SYSTEM



TRIPLET
AC and DC
VOLT-OHM-
MILLIAMMETER

MODEL
666-H



\$14.50
NET PRICE

POCKET SIZE

Size: 3-1/16" x 5-7/8" x 2-1/8"

5000 VOLTS SELF-CONTAINED

Model 666-H Volt-Ohm-Milliammeter is a complete pocket-size tester—with AC and DC Voltage Ranges to 5000 Volts (self-contained). AC-DC Voltage at 1000 ohms per volt, 0-10-50-250-1000-5000; DC Milliampers 0-10-100-500; Resistance 0-300 ohms, shunt type circuit, 10 ohms reading at center scale; 0-250,000 ohms, series type circuit, 3700 ohms at center scale. Higher resistance measurements available by using external batteries. Selector switch for all instrument readings. The ideal Pocket Volt-Ohm-Milliammeter for amateurs, radio technicians, industrial engineers, research. Black Molded Case and Panel, completely insulated. . . . With RED • DOT Lifetime Guaranteed Measuring Instrument. . . . Dealer Net Price \$14.50.

Model 666 . . . Same as above, but with voltage ranges to 1000 volts . . . Dealer Net Price \$14.00.

WRITE FOR CATALOG

Section 214 Harmon Drive

TRIPLET ELECTRICAL INSTRUMENT CO.
Bluffton, Ohio

(Continued from page ii)

point. A lead to this midpoint provides a direct return circuit to the cathode.

The filaments are tungsten wire coated with thorium oxide. The emission efficiency of this coated wire is somewhat lower than ordinary thoriated wire but the coating is much less susceptible to damage from gas poisoning or positive-ion bombardment. Each filament wire is mounted on threaded studs which permit easy removal and replacement. The whole cathode can be restrung in about one hour.

Vacuum System

The vacuum pumping system consists of two rotary oil pumps connected to a fore-vacuum line which is common to both tubes. The large chamber at the bottom of each tube contains a three-stage condensation pump mounted in the axis of the chamber and the remainder of the chamber serves as a fore-vacuum reservoir. Baffles for the prevention of slow diffusion of pump oil into the tube proper have been abandoned. A charcoal trap placed between the pump throat and tube has given results so far superior to other methods that its use has been accepted as standard practice. This pumping system maintains a tube pressure of about 10⁻⁴ microns and shows no decline in performance after continuous service periods of 2000 to 3000 hours.

Pressure gauges are provided which permit continuous monitoring of the fore and fine vacuum.

The development work has now progressed to the stage where these tubes are performing just as reliably as sealed-off tubes. They are operated and serviced by the regular station personnel, some of whom are capable of performing any service job from a simple filament replacement to a major change in the vacuum system.

¹ Burch and Sykes, "Continuously evacuated valves and their associated apparatus," *Wireless Eng.*, vol. 12, March, (1935).

² K. C. D. Hickman, "Vacuum pumps and pump oils," *Jour. Franklin Inst.*, Part I, February, (1936), Part II, March, (1936).

³ General Electric Company, Schenectady, New York.

Current Literature

New books of interest to engineers in radio and allied fields—from the publishers' announcements.

A copy of each book marked with an asterisk (*) has been submitted to the Editors for possible review in a future issue of the Proceedings of the I.R.E.

* A.S.T.M. METHODS OF CHEMICAL ANALYSIS OF METALS: Analytical Procedures for Ferrous and Non-Ferrous Metals, Spectrochemical Analysis Methods. Philadelphia: American Society for Testing Materials, September, 1939. vi+250 pages, illustrated, 6×9 inches; cloth, \$2.50, paper, \$2.00.

* A.S.T.M. STANDARDS ON ELECTRICAL INSULATING MATERIALS: Specifications,

OHMITE
Helps you 5 ways!

★ Engineered for Your Needs. Our engineers are specialists in resistance control for all types of applications. They'll work out *exactly* what you need, most economically.

★ Many Stock Units for Quick Delivery. Here's the largest, most complete stock of close-control Rheostats, wire-wound Resistors, and high current Tap Switches in the world—*ready* for quick shipment. Saves you time and money!

★ Built Right in Every Way. You get *time-tested, time-proved* construction in Ohmite vitreous-enameled Resistors, smooth-action Rheostats, compact Tap Switches.

★ Trouble-Free Performance. You can *depend* on every Ohmite product for continuous trouble-free performance on the toughest jobs in any climate from the tropics to the arctic!

★ Prompt and Certain Shipment. Every order is acknowledged with a definite shipping date—and this shipping promise is faithfully kept!

Write Today for Catalog 17

OHMITE MANUFACTURING CO.
4860 Flournoy Street, Chicago, U. S. A.

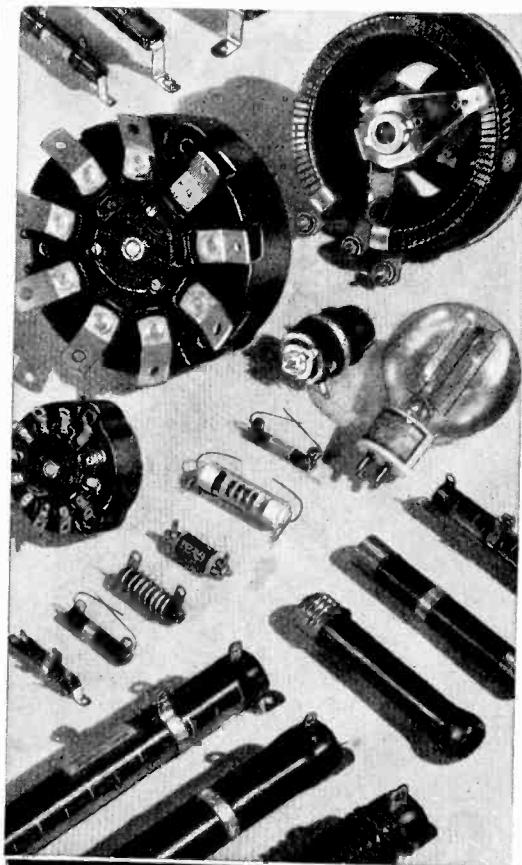

OHMITE
 RHEOSTATS RESISTORS TAP SWITCHES

IRE membership offers many services to the radio engineer

Proceedings—An outstanding publication in the radio engineering field. Over a quarter of a century of service to the world in publishing important radio engineering discoveries and developments, the PROCEEDINGS presents exhaustive engineering data of use to the specialist and general engineer. A list of its authors is a "Who's Who" of the leaders in radio science, research, and engineering.

Standards—Since 1914 our standards reports have stabilized and clarified engineering language, mathematics, graphical presentations, and the testing and rating of equipment. They are always in the process of revision and thus remain up to date.

Meetings—In twenty-two cities in the United States and Canada, meetings of the Institute and its sections are held regularly. Scores of papers on practically every branch of the field are presented and discussed. Several convention meetings are sponsored by the Institute and add materially to its effectiveness in distributing data of value to engineers.

The Institute of Radio Engineers

Incorporated

330 West 42nd Street, New York, N.Y.

To the Board of Directors

Gentlemen:

I hereby make application for ASSOCIATE membership in the Institute of Radio Engineers on the basis of my training and professional experience given herewith, and refer to the sponsors named below who are personally familiar with my work.

I certify that the statements made in the record of my training and professional experience are correct, and agree if elected, that I shall be governed by the Constitution of the Institute as long as I continue a member. Furthermore I agree to promote the objects of the Institute so far as shall be in my power.

.....
(Sign with pen) ^b

.....
(Address for mail)

.....
(City and State)

.....
(Date)

SPONSORS

(Signatures not required here)

Mr.

Address

City and State

Mr.

Address

City and State

Mr.

Address

City and State

(Continued from page iv)

Methods of Testing. Prepared by Committee D-9 on Electrical Insulating Materials. Philadelphia: American Society for Testing Materials, October, 1939. x+309 pages, illustrated, 6×9 inches, paper. \$2.00.

* ELEMENTS OF ACOUSTICAL ENGINEERING. BY HARRY F. OLSON, Acoustic Research Director, RCA Manufacturing Company, Inc. New York: D. Van Nostrand Company, Inc., 1940. xv+335+8 index pages, illustrated, 6×9 inches, cloth. \$6.00.

* FREQUENCY MODULATION. BY JOHN F. RIDER. New York: John F. Rider, Inc., 1940. viii+136 pages, illustrated, 5½×8 inches, cloth. \$1.00.

THE MATHEMATICAL THEORY OF HUYGENS' PRINCIPLE. BY BEVAN R. BAKER, Professor of Mathematics, Royal Holloway College in the University of London, and E. T. COPSON, Professor of Mathematics, University College, Dundee in the University of St. Andrews. New York: Oxford University Press, December, 1939. 162 pages, 6½×9½ inches, cloth. \$4.25.

* M.K.S. UNITS & DIMENSIONS. BY G. E. M. JAUNCEY, Professor of Physics, and A. S. LANGSDORF, Dean of the School of Engineering, Washington University. New York: Macmillan Company, 1940, viii+62 pages, illustrated, 5½×8½ inches, paper board. \$1.00.

* RADIO DIRECTION-FINDING: Supplement to B. S. 205-1936. British Standard Glossary of Terms Used in Electrical Engineering. London: British Standards Institution; New York: American Standards Association (For U.S.A.), December, 1939. 16 pages, 5½×8½ inches, paper. 40 cents.

* SAFETY RULES FOR THE INSTALLATION AND MAINTENANCE OF ELECTRIC UTILIZATION EQUIPMENT: Comprising Part 3 and the Grounding Rules of the Fifth Edition, National Bureau of Standards Handbook H33. Washington: Superintendent of Documents, January, 1940. 80 pages, 5×7½ inches, paper. 15 cents.

* SCREW-THREAD STANDARDS FOR FEDERAL SERVICES 1939 (Superseding the Reports of the National Screw Thread Commission), National Bureau of Standards Handbook H25. Washington: Superintendent of Documents, 1940. 167 pages, illustrated, 6×9 inches, paper. 20 cents.

Booklets, Catalogs and Pamphlets

The following commercial literature has been received by the Institute.

BRIDGE MEASUREMENTS . . . General Radio Company, 30 State Street, Cambridge, Massachusetts. "The General Radio Experimenter," March, 1940, 8 pages, 6×9 inches. Describes the design and use of a guard circuit for use with a capacitance bridge.

CERAMIC INSULATION . . . General Ceramics Company, Steatite Division, 30 Rockefeller Plaza, New York, New York, Catalog 1000, 24 pages+cover, 8½×11 inches. A summary of the various sizes and shapes in which this company's steatite insulation material is available.

This is the book you have been waiting for . . .

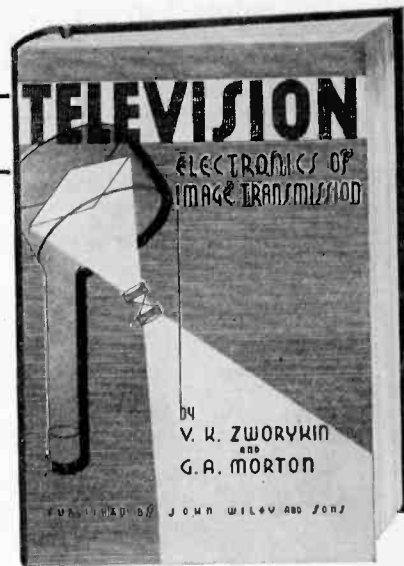

TELEVISION

THE ELECTRONICS OF IMAGE TRANSMISSION

By V. K. ZWORYKIN and G. A. MORTON

RCA Manufacturing Company

From two men well known in the field comes a book on this newest of practical means of communication. Authoritative, well organized, written in direct, clear-cut English, this volume brings to radio and communication engineers, television engineers and service men more than six hundred pages of much needed factual material.

The first part of the book is devoted to a consideration of the fundamental physical phenomena involved in television—emission of electrons, electron optics and fluorescent materials. This is followed by analyses of fundamentals of picture transmission and resolution; various forms of electronic terminal tubes used in television; problems of video amplification, radio transmission and reception, etc. One of the most important sections of the book is the concluding one, in which the RCA-NBC television project is described.

FEBRUARY 1940

646 pages; 6 by 9; 494 illustrations \$6.00

ON APPROVAL COUPON

JOHN WILEY & SONS, INC. 440 FOURTH AVENUE, NEW YORK, N.Y. Please send me a copy of ZWORYKIN AND MORTON'S TELEVISION on ten day's approval. At the end of that time, if I decide to keep the book I will remit \$6.00 plus postage; otherwise I will return the book postpaid.

Name
Address
City and State
Employed by

IRE 4-40



EXPERIENCE Alone DOES NOT Assure SUCCESS

● The difference between the man who hopes to have and the man who has an important engineering job . . . is MODERN TECHNICAL TRAINING. Years of experience on a routine job does not in itself prepare a man for a more advanced position. CREI courses in Practical Radio and Television Engineering provide ambitious radiomen with up-to-date technical training to increase the value of their practical experience, enabling them to take advantage of opportunities that arise. The fact that CREI students in more than 300 broadcasting stations are using CREI courses to modernize and increase their professional knowledge, is proof that training is enabling these men to increase their earning power by increasing their ability.

May we send you our new illustrated booklet?



Every radioman should read of our 48-page booklet—"A Tested Plan." It explains in detail our home study and residence courses and how CREI training can help you. In writing please describe your education and present position.

Capitol Radio ENGINEERING INSTITUTE

E. H. RIETZKE, Pres.
Dept. PR-4
3224 Sixteenth St., N.W.
Washington, D.C.

ENGINEERING DIRECTORY

Consultants, Patent Attorneys,
Laboratory Services

**BRUNSON S. McCUTCHEN and
CHARLES B. AIKEN**
Consulting Engineers

Technical cooperation with Attorneys in connection with patent litigation—Design and Development work—Audio and radio frequency measurements—Equipment studies—Receiver and transmitter problems—A well equipped laboratory.

75 West Street
New York City

Telephone
WHitchhall 4-7275

Use this directory . . .

when you need consulting services

when you are asked to suggest the name of a specialist on an engineering or patent problem

Consulting Engineers, Patent Attorneys, Laboratory Services . . . Applications for card space in the Engineering Directory are invited. Complete data will be sent on request to

PROCEEDINGS of the I.R.E.

330 West 42nd Street New York, N.Y.

INDEX

BOOKLETS, CATALOGS AND PAMPHLETS	vii
COMMERCIAL ENGINEERING DEVELOPMENTS	ii
CURRENT LITERATURE	iv
ENGINEERING DIRECTORY	viii
POSITIONS OPEN	viii

DISPLAY ADVERTISERS

A

Aerovox Corporation	i
American Telephone & Telegraph Company	iii

B

Bliley Electric Company	ii
-----------------------------------	----

C

Capitol Radio Engineering Institute	vii
Cornell-Dubilier Electric Corporation	x

G

General Radio Company	Cover IV
---------------------------------	----------

O

Ohmite Manufacturing Company	iv
--	----

R

RCA Manufacturing Company,	Cover III
--------------------------------------	-----------

T

Triplett Electrical Instrument Company	iv
--	----

W

Western Electric Company	ix
Wiley, John, Sons, Inc.	vii

POSITIONS OPEN

The following positions of interest to I.R.E. members have been reported as open on May 10. Make your application in writing and address to the company mentioned or to

Box No.

PROCEEDINGS of the I.R.E.
330 West 42nd Street, New York, N.Y.

Please be sure that the envelope carries your name and address

TRANSMITTER DESIGN

An established manufacturer of equipment wants an experienced radio transmitter design engineer. He is needed primarily for design work on broadcast transmitters. Engineering graduate preferable, location in the East. All members of the present staff know of this opening. Box 208.



Attention Employers . .

Announcements for "Positions Open" are accepted without charge from employers offering salaried employment of engineering grade to I.R.E. members. Please supply complete information and indicate which details should be treated as confidential. Address: "POSITIONS OPEN," Institute of Radio Engineers, 330 West 42nd Street, New York, N.Y.

The Institute reserves the right to refuse any announcement without giving a reason for the refusal

WIP KIRO
 WKAQ WBNS
 WAIR WJMS
 KWTO WQAM
 KFKA WEEI
 WHAS WMEX
 WSB WICC
 KFJB WEAN
 WCAU WGES
 WLAC WTMJ
 WSM WBT
 WOR WSMB
 WBBM KFAB
 WHN WCBD
 WDAF WNAC
 KSN WHFC
 WTAG WJAR
 KRIC WLNH
 KWKH KDAL
 WDRC WHDL
 KOIN WBAL
 WJR KPQ
 CKLW WIBW
 KMOX KICA
 WKNY WHDH
 KSL WMBD
 KMBC WOOD
 WDWS WLVA
 CBS KOIL
 WKBN WFTL
 WCHS WCCO
 WNAX WELL
 WGN CKLW
 WFBR WHAM
 WHAM WDAY
 WJRP WRYA
 WJSV WESX
 WGES KSFD
 WCB D WSAN
 WCB WJAX
 WGAR WEQB
 WFIL WTNJ
 WSAV WFB
 WJNO WDL
 WMBC WJBK
 Yankee Network WHBI
 Jansky and Bailey
 Armstrong
 Don Lee

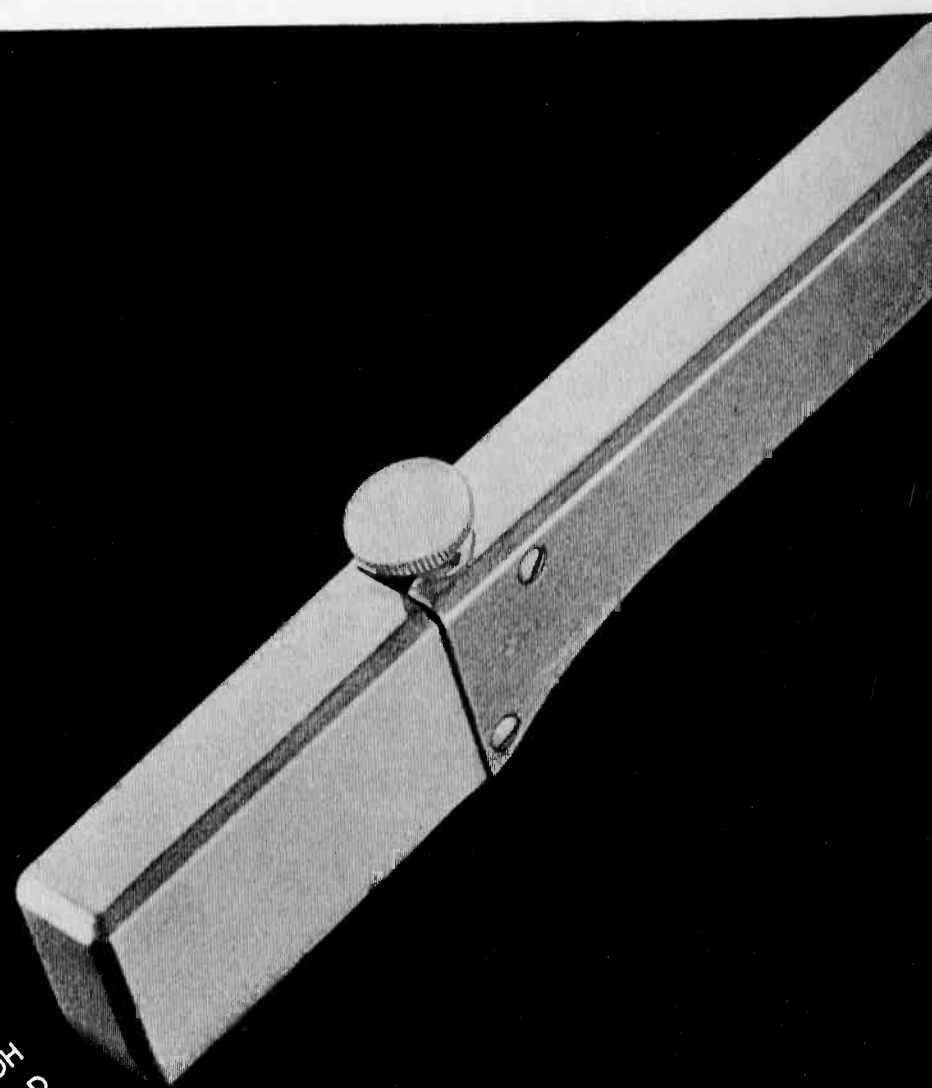

*Swinging into action
in over 100 stations*

No wonder broadcasters like the 9A Reproducer. It plays both vertical and lateral recordings with highest fidelity—can be used with any equipment—priced within reach of all. Ask Graybar for Bulletin T1630—equip your present transcription tables with this pace-setting 2-in-1 pick-up!



DISTRIBUTORS: In U. S. A.: Graybar Electric Co., New York, N. Y. In Canada and Newfoundland: Northern Electric Co., Ltd. In other countries: International Standard Electric Corp.

Ask your engineer about the
Western Electric
9A REPRODUCER

Solving the Need

FOR A COMPACT HIGH-VOLTAGE CAPACITOR



CORNELL-DUBILIER
Dykanol Filter
TYPE TLA

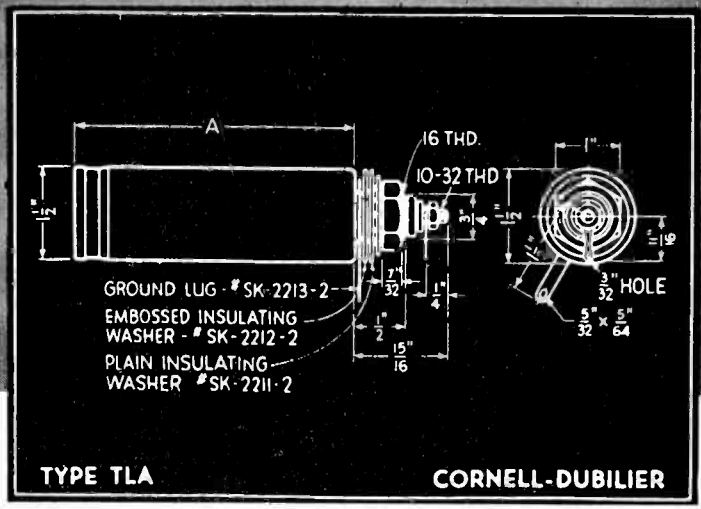

Proud achievement of the most expert group of engineers in the capacitor world—the Cornell-Dubilier staff of specialists—is this Dykanol Unit. C-D Type TLA is a high-quality filter capacitor for use with high fidelity public address amplifiers, power supplies and portable transmitters. How well it solves the need, meeting the universal requirements for compactness and high voltage is another great Cornell-Dubilier "feature" story.

Get full details of Cornell-Dubilier Dykanol Filter Type TLA. Send for Bulletin No. 160-T.

- ★ Withstands transient voltages and high-peak voltages
- ★ Designed to operate under continuous full-load duty
- ★ Enclosed in cylindrical, aluminum container
- ★ Fire-proof—non-inflammable
- ★ Insulated from chassis
- ★ Inverted mounting—easy to install
- ★ Unusually strong physically and mechanically
- ★ Efficiently combines long life with small space



CORNELL-DUBILIER

ELECTRIC CORPORATION

1012 Hamilton Boulevard, South Plainfield, New Jersey

Cable Address: "CORDU"

for
**SOUND
 ECONOMY**

**... RCA AIR-RADIATOR
 TRANSMITTING TRIODES**

Hundreds of RCA-891-R's and 892-R's in daily service in leading broadcast stations testify to the sound economy of operation made possible by these popular RCA Air-Radiator Transmitting Triodes. Lower first cost—simplified installation—no water-cooling worries—ample output for general broadcast requirements!

Similar in construction to water-cooled units, these tubes are equipped with highly efficient air radiators which provide great cooling areas in a minimum of space. Anode heat is dissipated quickly, quietly and efficiently.

Double-unit filaments permit operation from two-phase a.c., thus minimizing hum. Filaments used in these types operate at lower-than-ordinary temperatures and contribute materially to exceptionally long tube life. Ask the station that uses these tubes!

Both the RCA-891-R and 892-R are designed for class B and class C services. The 891-R may also be used in class A. Amplification factor of the 891-R is 8; the 892-R, 50. Maximum ratings of the 891-R for plate modulated class C telephone service are: d-c plate voltage, 8500 volts; d-c plate current, 1 ampere; plate input, 8 kw; plate dissipation, 2.5 kw. Typical power output is 3.5 kw. Net replacement costs compare favorably with water-cooled tubes of equal size.

Complete technical information gladly sent upon request. Write to RCA Mfg. Co., Commercial Engineering Section, RCA Manufacturing Company, Inc., Harrison, N. J.



**No
 Experiments
 Here!**

As essential to the operation of Air-Radiator tubes as good tube construction itself, is the design of the finned radiator with which they are equipped. Pioneered and perfected by RCA, each radiator supplied with RCA-891-R's and 892-R's carries the fine reputation which has been established through more than four years of extensive use in many of the country's leading high-power broadcasting stations. Exceptionally low operating temperatures are assured at all times.

For real economy, it pays to invest in experience—not experiments!

NEW!

**This Triode Takes its Full Rated
 Input of 50 Watts up to 500 Mc.**

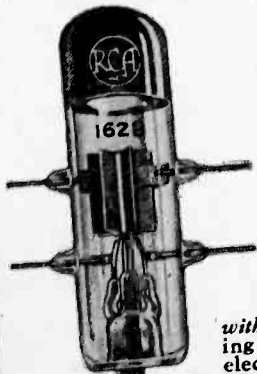

Outstanding engineering features make the new RCA-1628 Transmitting Triode unexcelled in its class. A double-helical filament has a center-tap lead that is brought out of the bulb through a separate seal. By connecting the three filament leads in parallel through r-f by-pass condensers, it is now practical to minimize the effect of filament lead inductance at ultra-high frequencies. Double grid and plate leads, also brought out through separate seals, simplify neutralization in r-f amplifier service at the ultra highs by eliminating common impedances between tank and neutralizing circuits within the tube. Close spacing of grid and plate decreases electron transit time, thereby improving efficiency at high frequencies.

Data bulletin on request



Radio Tubes

FIRST IN METAL—FOREMOST IN CLASS—FINEST IN PERFORMANCE

RCA MANUFACTURING CO., INC., CAMDEN, N. J.

A Service of The Radio Corporation of America

IMPROVED HETERODYNE FREQUENCY METER

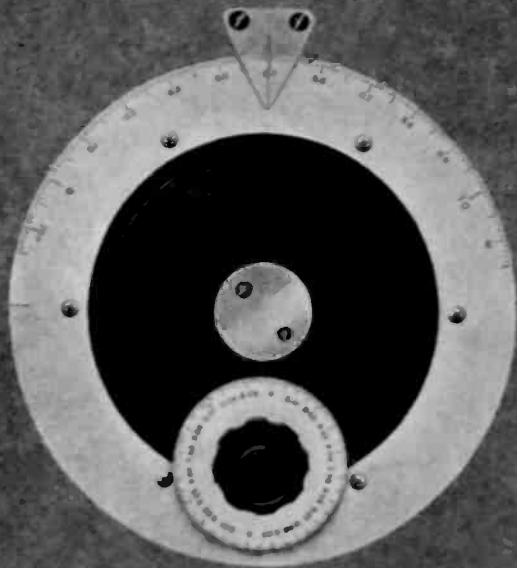
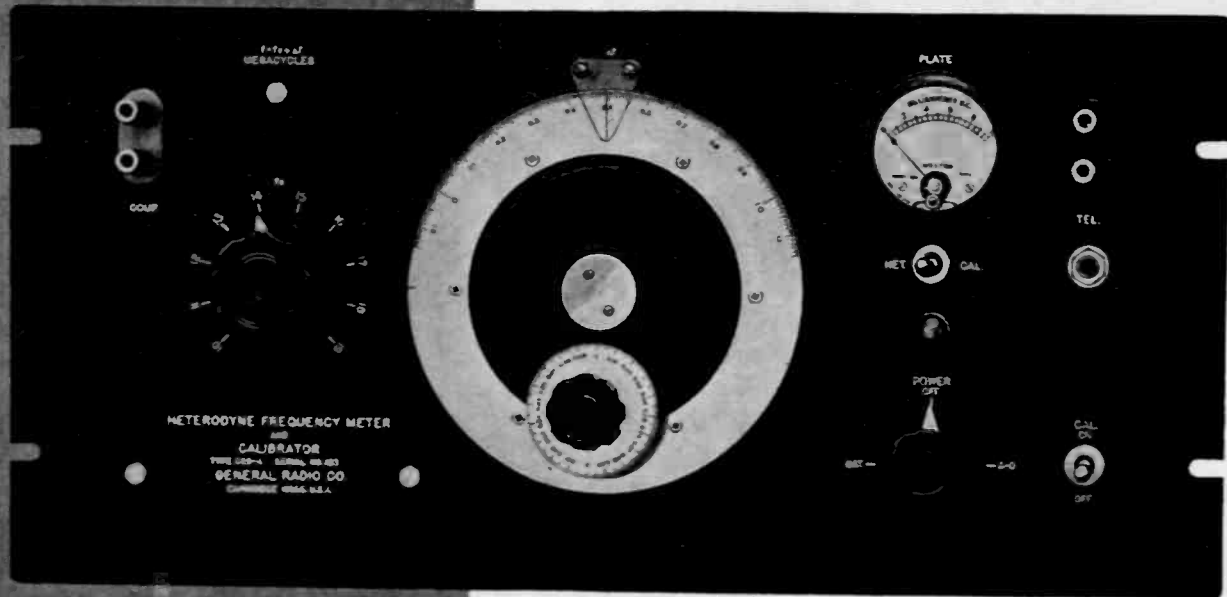

With a new gear driven slow-motion mechanism the reduction ratio is 15-10-1. Internal drive gear is spring-pressed to remove backlash. Fundamental frequency is 10 to 20 Mc. Auxiliary dial subdivides each main scale division into 10 parts; at the 10 Mc end of the main scale the smallest auxiliary scale division is 0.01%; at the 20 Mc end it is 0.005%.

With Greatly Increased Precision

THE POPULAR G-R Type 620-A Heterodyne Frequency Meter and Calibrator is now provided with a geared slow-motion drive and auxiliary dial, greatly increasing the precision of setting and ease of operation. Routine frequency measurements to 0.005% are now possible for communication companies, laboratories, transmitter and receiver manufacturers and inspection services.

Features

- HIGH UPPER-FREQUENCY LIMIT—300 Mc or higher
- VERY WIDE RANGE—300 kc to 300 Mc
- DIRECT READING—no charts or curves
- SELF-CALIBRATING—calibration can be checked instantly from built-in piezo-electric oscillator
- NO COILS TO CHANGE—built-in coil system with 10-point panel selector switch
- GOOD ACCURACY—overall accuracy 0.01% or better—can be used as transmitter frequency monitor for all services having allowable tolerance of 0.02% or greater
- FLEXIBLE POWER SUPPLY—built-in a-c operated supply or external d-c source, either selected by panel switch.

TYPE 620-AR (Relay Rack Model) \$490.00

TYPE 620-AM Portable Model 555.00

WRITE FOR BULLETIN 565 FOR INFORMATION

GENERAL RADIO COMPANY
CAMBRIDGE, MASSACHUSETTS
 Branches in New York and Los Angeles

