

Proceedings

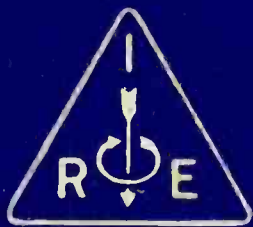

of the

I·R·E

OCTOBER 1939

VOLUME 27

NUMBER 10

Rochester Fall Meeting
Broadcast-Transmitter Location
Tropospheric Reflecting Regions
Deviations of Short Waves
Radio Wave Propagation
Negative-Feedback Applications
Controlled Rectifiers
General Radiation Formula
Single-Sideband Television
Ionospheric Characteristics

Institute of Radio Engineers



Rochester Fall Meeting
November 13, 14, and 15, 1939

SECTION MEETINGS

	DETROIT October 20	
ATLANTA October 20	LOS ANGELES October 17	PITTSBURGH October 17
CLEVELAND October 26	PHILADELPHIA October 5	WASHINGTON October 9

SECTIONS

- ATLANTA**—Chairman, Ben Akerman; Secretary, J. G. Preston, 125 Vance Cir., Marietta, Ga.
- BOSTON**—Chairman, H. W. Lamson; Secretary, E. B. Dallin, 64 Oakland Ave., Arlington, Mass.
- BUFFALO-NIAGARA**—Chairman, H. C. Tittle; Secretary, E. C. Waud, 235 Huntington Ave., Buffalo, N. Y.
- CHICAGO**—Chairman, V. J. Andrew; Secretary, G. I. Martin, RCA Institutes, 1154 Merchandise Mart, Chicago, Ill.
- CINCINNATI**—Chairman, H. J. Tyzzer; Secretary, J. M. McDonald, Crosley Radio Corp., 1329 Arlington, Cincinnati, Ohio.
- CLEVELAND**—Chairman, S. E. Leonard; Secretary, H. C. Williams, Rm. 1932, 750 Huron Rd., Cleveland, Ohio.
- CONNECTICUT VALLEY**—Chairman, E. R. Sanders; Secretary, W. R. G. Baker, General Electric Co., Bridgeport, Conn.
- DETROIT**—Chairman, H. D. Seielstad; Secretary, R. J. Schaefer, 9753 N. Martindale, Detroit, Mich.
- EMPORIUM**—Chairman, R. K. McClintock; Secretary, D. R. Kiser, Hygrade Sylvania Corp., Emporium, Penna.
- INDIANAPOLIS**—Chairman, I. M. Slater; Secretary, B. V. K. French, P. R. Mallory & Co., E. Washington St., Indianapolis, Ind.
- LOS ANGELES**—Chairman, F. G. Albin; Secretary, M. T. Smith, General Radio Co., 1000 N. Seward St., Hollywood, Calif.
- MONTREAL**—Chairman, A. B. Oxley; Secretary, W. A. Nichols, Canadian Broadcasting Corp., 1012 Keefer Bldg., Montreal, Que.
- NEW ORLEANS**—Chairman, G. H. Peirce; Secretary, D. W. Bowman, 8327 Sycamore St., New Orleans, La.
- PHILADELPHIA**—Chairman, R. S. Hayes; Secretary, R. L. Snyder, 103 Franklin Rd., Glassboro, N. J.
- PITTSBURGH**—Chairman, Joseph Baudino; Secretary, Gary Muffly, Gulf Research and Development Corp., Drawer 2038, Pittsburgh, Penna.
- PORTLAND**—Chairman, H. C. Singleton; Secretary, E. R. Meissner, United Radio Supply, Inc., 203 S. W. Ninth Ave., Portland, Ore.
- ROCHESTER**—Chairman, W. F. Cotter; Secretary, H. C. Sheve, Stromberg-Carlson Telephone Manufacturing Co., Rochester, N. Y.
- SAN FRANCISCO**—Chairman, F. E. Terman; Secretary, L. J. Black, 243-30th St., Oakland, Calif.
- SEATTLE**—Chairman, R. O. Bach; Secretary, Karl Ellerbeck, Pacific Telephone and Telegraph Co., 612 Northern Life Tower, Seattle, Wash.
- TORONTO**—Chairman, G. J. Irwin; Secretary, N. Potter, Canadian National Carbon Co., Ltd., 805 Davenport Rd., Toronto, Ont.
- WASHINGTON**—Chairman, Gerald C. Gross; Secretary, M. H. Biser, 3224-16th St., N. W., Washington, D. C.

Proceedings

of the I · R · E

Published Monthly by

The Institute of Radio Engineers, Inc.

VOLUME 27

October, 1939

NUMBER 10

The Selection of a Radio-Broadcast-Transmitter Location	William B. Lodge	621
The Heights of the Reflecting Regions in the Troposphere	A. W. Friend and R. C. Colwell	626
Deviations of Short Radio Waves from the London-New York Great-Circle Path	C. B. Feldman	635
Report of Commission II, Radio Wave Propagation	J. H. Dellinger	645
Some Applications of Negative Feedback with Particular Reference to Laboratory Equipment	F. E. Terman, R. R. Buss, W. R. Hewlett, and F. C. Cahill	649
Critical Inductance and Control Rectifiers	W. P. Overbeck	655
A General Radiation Formula	S. A. Schelkunoff	660
A Theoretical Analysis of Single-Sideband Operation of Television Transmitters	Leon S. Nergaard	666
Characteristics of the Ionosphere at Washington, D. C., August, 1939	T. R. Gilliland, S. S. Kirby, and N. Smith	677
Discussion on "A Contribution to Tube and Amplifier Theory," by W. E. Benham	F. B. Pidduck and W. E. Benham	679
Institute News and Radio Notes		680
Rochester Fall Meeting		680
Board of Directors		680
Committees		680
Sections		681
Membership		683
Committee Personnel		683
Institute Representatives on Other Bodies		684
Contributors		685

BOARD OF DIRECTORS
Raymond A. Heising, *President*
Harold O. Pedersen, *Vice President*
Melville Eastham, *Treasurer*
Harold P. Westman, *Secretary*

Harold H. Beverage
Ralph Bown
Frederick W. Cunningham
Alfred N. Goldsmith
Virgil M. Graham
O. B. Hanson
Alan Hazeltine
Lawrence C. F. Horle
C. M. Jansky, Jr.
Ira J. Kaar
Frederick B. Llewellyn
Albert F. Murray
Haraden Pratt
Browder J. Thompson
Hubert M. Turner
Arthur F. Van Dyck

BOARD OF EDITORS
Alfred N. Goldsmith, *Chairman*
Ralph R. Batcher
Philip S. Carter
Frederick W. Grover
J. Warren Horton
Greenleaf W. Pickard
Benjamin E. Shackelford
Karl S. Van Dyke
Harold P. Westman, *ex officio*
Lynde P. Wheeler
Laurens E. Whittemore
William Wilson

PAPERS COMMITTEE
William Wilson, *Chairman*
Herman A. Affel
Edmond Bruce
Howard A. Chinn
James K. Clapp
Tunis A. M. Craven
Paul O. Farnham
Enoch B. Ferrell
Elmer L. Hall
Loren F. Jones
Frederick B. Llewellyn
De Loss K. Martin
Harry R. Mimno
Albert F. Murray
Harold O. Peterson
Ralph K. Potter
Hubert M. Turner
Paul T. Weeks
Harold A. Wheeler
William C. White
Irving Wolff

Helen M. Stote, *Assistant Editor*
John D. Crawford,
Advertising Manager

Entered as second-class matter October 26, 1927, at the post office at Menasha, Wisconsin, under the Act of February 28, 1925, embodied in Paragraph 4, Section 412 of the Postal Laws and Regulations. Publication office, 450 Alhnaip Street, Menasha, Wisconsin. Subscription, \$10.00 per year; foreign, \$11.00.

THE INSTITUTE

The Institute of Radio Engineers serves those interested in radio and allied electrical-communication fields through the presentation and publication of technical material. In 1913 the first issue of the PROCEEDINGS appeared; it has been published uninterruptedly since then. Over 1500 technical papers have been included in its pages and portray a currently written history of developments in both theory and practice.

STANDARDS

In addition to the publication of submitted papers, many thousands of man-hours have been devoted to the preparation of standards useful to engineers. These comprise the general fields of terminology, graphical and literal symbols, and methods of testing and rating apparatus. Members receive a copy of each report. A list of the current issues of these reports follows:

Standards on Electroacoustics, 1938
Standards on Electronics, 1938
Standards on Radio Receivers, 1938
Standards on Radio Transmitters and Antennas, 1938.

MEETINGS

Meetings at which technical papers are presented are held in the twenty-one cities in the United States and Canada listed on the inside front cover of this issue. A number of special meetings are held annually and include one in Washington, D. C., in co-operation with the American Section of the International Scientific Radio Union (U.R.S.I.) in April, which is devoted to the general problems of wave propagation and measurement technique, the Rochester Fall Meeting in co-operation with the Radio Manufacturers Association in November, which is devoted chiefly to the problems of broadcast-receiver design, and the Annual Convention, the location and date of which are not fixed.

MEMBERSHIP

Membership has grown from a few dozen in 1912 to more than five thousand. Practically every country in the world in which radio engineers may be found is represented in our membership roster. Approximately a quarter of the membership is located outside of the United States. There are several grades of membership, depending on the qualifications of the applicant. Dues range between \$3.00 per year for Students and \$10.00 per year for Members. PROCEEDINGS are sent to each member without further payment.

PROCEEDINGS

The contents of each paper published in the PROCEEDINGS are the responsibility of the author and are not binding on the Institute or its members. Material appearing in the PROCEEDINGS may be reprinted or abstracted in other publications on the express condition that specific reference shall be made to its original appearance in the PROCEEDINGS. Illustrations of any variety may not be reproduced, however, without specific permission from the Institute.

Papers submitted to the Institute for publication shall be regarded as no longer confidential. They will be examined by the Papers Committee and Board of Editors to determine their suitability for publication. Suggestions on the mechanical form in which manuscripts should be prepared may be obtained from the Secretary.

SUBSCRIPTIONS

Annual subscription rates for the United States of America, its possessions, and Canada, \$10.00; to college and public libraries when ordering direct, \$5.00. Other countries, \$1.00 additional.

The Institute of Radio Engineers, Inc.

Harold P. Westman, Secretary

330 West 42nd Street

New York, N.Y.



Copyright, 1939, by The Institute of Radio Engineers, Inc.



The Selection of a Radio-Broadcast-Transmitter Location*

WILLIAM B. LODGE†, MEMBER, I.R.E.

Summary—A radio broadcast station should provide satisfactory reception to as many homes as possible. Most of the engineering considerations which determine the station's performance may be treated analytically. However, ability to serve a large audience is greatly affected by the excellence of the transmitter location selected, and this selection must be governed by experience with intangibles not subject to calculation. In the present article, various factors affecting the choice of a suitable transmitter site are discussed and general recommendations are given.

SELECTION of a suitable site for the transmitter of a modern broadcast station is not an exact science. Few locations are ideal from every point of view. Compromises, placing practical considerations ahead of engineering principles, are often necessary, and an engineer sometimes finds it difficult to balance benefits in one direction which result from sacrifices in another. It is thought that a discussion of the points which should be considered in choosing a new transmitter location would be of some interest.

The relative importance of the various factors will depend upon the economic status of each station, its power, frequency, and also the nature of the territory it serves. However, the most important considerations are:

1. Necessity of a strong signal in the station's home city.
2. The strength of other signals already reaching the area to be served by the station.
3. Population density near the proposed site.
4. Directional antenna limitations which may dictate selection of the station site in a particular direction from the city.
5. Proximity of airports and airways.

In the United States, it is necessary to obtain a construction permit from the Federal Communications Commission before a radio broadcast station can be built or moved from one location to another. Approval of a station site is not governed by a series of arbitrarily applied, inflexible rules concerning population, blanketing, distance from the center of a city, etc. On the contrary, the Engineering Department of the Federal Communications Commission encourages the choice of station locations which provide a satisfactory signal to as many people as possible, and which cause inconvenience to as few listeners as possible. Therefore, the desirability of a particular site may be judged primarily by the field-strength contours which the station using that site will produce and by the population within each con-

tour. At the same time, careful attention should be given to the probable location of areas where the station will be subject to nighttime interference or fading.

The first requisite for locating a transmitter is sufficient propagation data to permit prediction of signal attenuation in all directions from a tentative site. Variations in attenuation are larger than might be expected. While one 5-kilowatt station may deliver a 5-millivolt-per-meter signal 62 miles from its transmitter, another 5-kilowatt station, using an equally efficient antenna, will deliver the same signal to a radius of only 7 miles. This great variation, 7 as compared with 62 miles, can be caused entirely by differences in soil conductivity and operating frequency, emphasizing the need for accurate knowledge of actual transmission conditions. Field-intensity data necessary for determining attenuation may be obtained by measuring the signal produced by a special test transmitter. In most cases, however, signals of existing broadcast stations are measured to determine the propagation characteristics in a particular area, and for this reason, the use of test transmitters is becoming more infrequent. While attenuation varies with frequency, it is possible to make measurements on one frequency and to convert the data to any other frequency in the broadcast band with a high degree of accuracy.

It is necessary for the broadcaster to deliver a signal much greater than that which the public would have accepted 5 or 10 years ago. Although 10 millivolts per meter has been considered adequate signal strength in some cities, experience has shown the desirability of building a transmitting station which will deliver at least 50 millivolts per meter in the congested areas. The relocation of many stations has been necessary within the past few years because the original transmitter site produced signals of only 2 to 5 millivolts per meter in the business district.

Popularity of indoor receiving antennas (or even no antennas at all) in many homes, the introduction of high-fidelity receivers, and interference arising from electrical appliances all call for stronger radio signals. In addition, the construction of new local stations at the center of many cities has emphasized the demand for higher field intensities. A 100-watt local station may deliver a signal exceeding 50 millivolts per meter in a circle two miles in diameter, and a 1000-watt regional competitor delivering 5 millivolts in the same area might have difficulty in justifying a claim that its city coverage was superior to that of the local station.

* Decimal classification: R612.1. Original manuscript received by the Institute, September 6, 1938; abridgment received by the Institute, August 2, 1939. Presented, Thirteenth Annual Convention, New York, N. Y., June 18, 1938.

† Columbia Broadcasting System, Inc., New York, N. Y.

It might be well to indicate here the field intensities necessary to provide satisfactory reception in rural and urban areas. In rural communities, one-half millivolt per meter is generally acceptable. In residential areas, 2 to 5 millivolts per meter is often adequate, although in some instances 25 millivolts per meter is insufficient to overcome local electrical disturbances. Industrial centers and office-building areas are the most difficult to serve, and in cities where the population exceeds 100,000, it is desirable to place a 25- to 100-millivolt-per-meter signal in the downtown district.

The average home receiver can stand fields up to 250 millivolts per meter with no ill effects. Many medium-priced sets will provide satisfactory reception of all desired stations in a field of 2000 to 3000 millivolts per meter, a half mile from a 50,000-watt transmitter. However, since many less-selective receivers are still in home use, it is desirable to choose a transmitter location so that the population within the 250-millivolt-per-meter contour is as small as possible. Furthermore, the older and poorer sections of most cities are not suitable for a transmitter location. In these areas, overhead power lines and telephone wires have usually been in service for 20 or 30 years and house wiring is often old and poorly installed. Very strong radio signals produce cross modulation in such an area and the resulting interference is independent of receiver selectivity. The broadcaster almost invariably assumes the responsibility of correcting reception difficulties which result from excessively high field intensities. Consequently, an expense of several thousand dollars may be incurred by a station whose transmitter is located near an old and densely populated section of the city.

In practice, the choice of a new station location will be greatly influenced by the strength of other signals reaching the same area. In localities where listeners are accustomed to receiving high signal intensities, a transmitter site should be chosen as close to the center of the city as possible. This is sometimes overlooked because of the temptation to serve two cities separated by a considerable distance. Transmitters optimistically located between two cities sometimes fail to render satisfactory service in either one, even if the cities receive only average signal strengths from other stations.

The use of a directional antenna may limit the area in which a broadcast station should be built. For example, if no signal is permissible in a northerly direction, it is obvious that the transmitter should not be placed south of its home city. In addition, the necessity of protecting air transportation further restricts the area in which a site may be selected. Before granting a construction permit, the Federal Communications Commission refers a description of a proposed antenna structure and its exact location to the Bureau of Air Commerce. Approval or disap-

proval by this bureau is usually based upon the recommendations of local airline pilots and airway inspectors. For this reason, it is advisable to obtain the approval of local representatives of the Bureau of Air Commerce¹ before submitting an application to the Federal Communications Commission. No hard and fast rules are involved, but each case is considered on its own merits. A tall tower located at the center of a radio beam was recently approved because near-by hills which airplanes must clear exceeded the height of the antenna. Similarly, in the vicinity of tall buildings or in the center of a city, existing flight limitations are not overlooked, and construction of an antenna at these locations would usually be approved. In open country, however, it is desirable to choose a site more than four miles from an active airport and more than two miles from the nearest "on-course" signal of a radio range beacon.

Limitations imposed by airway restrictions, directional-antenna requirements, the necessity of a strong signal in the home city, and the desirability of keeping signal strengths below 250 millivolts per meter in populous areas often rule out the most promising locations. Then, too, 10, 20, or 40 acres of land may be required to provide for an adequate ground system, and the cost of this land must be within reason. The site should also be satisfactory in the following respects:

1. Accessibility (roads, terrain, etc.)
2. Flood levels.
3. Foundation problems.
4. Zoning ordinances.
5. Availability of a reliable power source.
6. Availability of telephone lines and duplicate program circuits.
7. Availability of water.
8. Conductivity of the soil surrounding the site.
9. Proximity of receiving stations and other transmitters.
10. Possibility of future changes in operating power.

It is no exaggeration to state that in many cases no eligible sites remain after the areas which fail to satisfy all of the above requirements have been eliminated. Compromises must then be made in one or more directions, and, as previously stated, the relative importance of each factor will vary for nearly every station.

Choice of a transmitter site is sometimes complicated by the use of greater power during the daytime than at night. In other cases, a power increase is contemplated in the near future. Where changes in power are involved, the transmitter site should be selected to give good service with the minimum power used.

¹ Since the preparation of this paper, the duties of the Bureau of Air Commerce have been taken over by the newly created Civil Aeronautics Authority. It is anticipated that this change will have no immediate effect upon the problem of locating antenna structures.

Particular reference should be made to the problem of installing a broadcast transmitter on the roof of a tall building. As previously stated, it is usually desirable to build lower-powered transmitters at or near the center of a city, and this sometimes restricts the choice of available sites to the roof of an office building or hotel. If the building is not more than ten or twelve stories high, satisfactory antenna performance is usually obtained. However, extreme caution is necessary when locating a transmitting antenna on a building several hundred feet high. In some rooftop installations, remarkably high antenna efficiency results, but in other instances, the reverse follows. Elaborate tests are necessary to predict the performance of antenna installations on tall buildings.

No recommendation has been made as to the relative merits of a hilltop or a low valley for transmitter sites. While performance can be predicted more accurately if the antenna is located on flat ground, there appears to be no necessity for avoiding the top of a hill unless a directional antenna or a tall antifading antenna for a clear-channel station is contemplated. The most frequent error is overemphasis of the theoretical advantages of good soil conductivity at the transmitter site. It is well known that antenna efficiency will be higher and attenuation less severe if a flat site with high conductivity be chosen. However, it is obvious that a technically perfect site a hundred miles away from the station's market is less desirable than an inferior site close to the listener's home. For many regional and local stations, this is equally true when the technically superior site is only 5 or 10

Since 1929, when the 1-kilowatt transmitter of this station was originally built at Weymouth, Massachusetts, the Federal Communications Commission has adopted regulations permitting regional stations, such as WEEI, to operate with 5000 watts during the daytime. When the Columbia Broadcasting

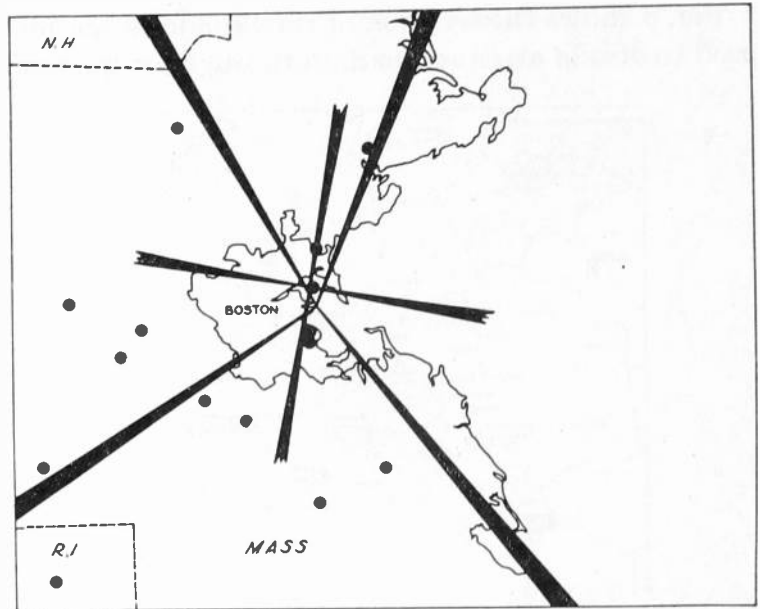

Fig. 2—Airports and airways near Boston.

System leased WEEI in 1936, it desired to increase the daytime power of the station and, at the same time, to relocate it so that a more intense signal would reach the densely populated portions of the metropolitan area. The station has been in operation at its new site for slightly more than one year and it is therefore possible to show how well the site has come up to expectations.

First it was necessary to relocate the transmitter without increasing the interference which WEEI caused to an adjacent-channel station in Worcester, and this, in turn, meant that the signal near Worcester could not be changed. To accomplish this, a directional antenna was required which would keep WEEI's signal low in a large westerly sector. Several desirable locations along the shore line east of Boston were therefore ruled out because the signal inland could not be increased.

Fig. 1 shows the density of population in and around Boston, the original transmitter site at Weymouth, and, by a broken line, the 10-millivolt area which the station served. It will be seen that there were large areas outside of the original 10-millivolt contour having more than 5000 persons per square mile, in which the service of WEEI was not consistent with present-day requirements. This figure also shows the new site and, by a solid line, the additional area which would receive 10 millivolts or better, using 5 kilowatts at the new site.

The airports and airways in and around Boston are shown in Fig. 2. The airway radio beams are represented by wedge-shaped markings which converge near the East Boston airport. Airports are indicated

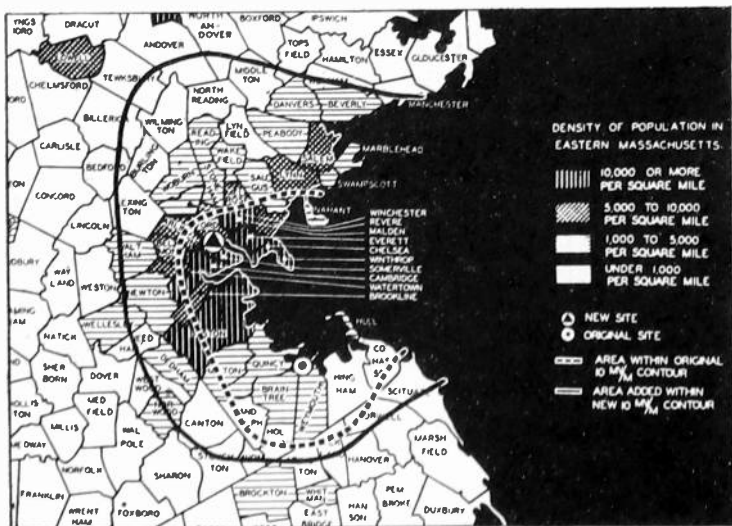

Fig. 1—Population density near Boston, new and original transmitter site, and new and original 10-millivolt-per-meter areas of WEEI.

miles out of town. Projected field-strength contours are a much better guide in site selection than mere consideration of soil conductivity or flatness of terrain.

As a typical example of site selection, a brief description will be given of the problems involved in relocating radio station WEEI, Boston, during 1937.

by black dots. It will be noted that in addition to the high-powered radio range beacon, which it was necessary to avoid, a low-powered approach beacon was also in operation at Boston. Actually, there were 8 legs of radio beams and 7 airports to consider in choosing a site for the new transmitter's 360-foot vertical radiators.

Fig. 3 shows the location of the broadcast stations used to obtain attenuation data throughout Boston's

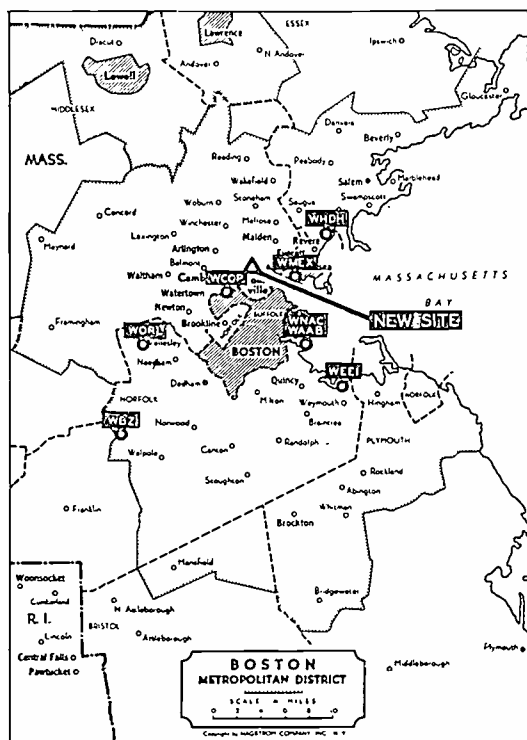

Copyright by Hagstrom Company, Inc., N. Y.

Fig. 3—Location of Boston broadcast stations in 1936.

metropolitan area. A Columbia field engineer, using a specially equipped automobile, spent three weeks measuring the signals of these stations. In preparing field-intensity estimates, it will be seen that radials may be drawn from one of several stations across any proposed site.

In Fig. 4 the broken line represents a typical attenuation curve which was predicted for a northerly direction from the site finally chosen. The solid line is the actual attenuation curve subsequently determined by field-intensity measurements after the new transmitter was placed in operation. Predicted and actual curves are in close agreement, but despite the favorable frequency, 590 kilocycles, which is at the lower end of the broadcast band, attenuation is extremely high. In fact, even with its daytime power of 5000 watts, WEEI could not deliver a 10-millivolt signal more than 15 miles in a northerly direction, for on this transmission path the soil conductivity reaches the unusually low value of 1.8×10^{-14} electromagnetic units. While soil conditions are more favorable in other directions, it was found necessary to choose a site less than 6 miles from the center of Boston to assure an adequate signal on the far side of the city during nighttime operation when the power was reduced to 1 kilowatt.

Fig. 5 is an aerial photograph of Boston showing the new location of WEEI and the city's business district. It is approximately 4 miles from the transmitter site to Boston Common; the heart of downtown Boston. At the Common, WEEI's daytime signal is 161 and its nighttime signal 62 millivolts per meter.

Predicted and actual 0.5-, 2-, and 10-millivolt-per-meter contours for WEEI at its new location are shown in Fig. 6. The broken lines are the predicted contours and the solid are measured. It will be noted that it was possible to predict the coverage with a high degree of accuracy in spite of the fact that the estimates were complicated by transmission across the business district of a large city, by soil having high absorption qualities, by the presence of salt water and marshes, and by the use of a directional

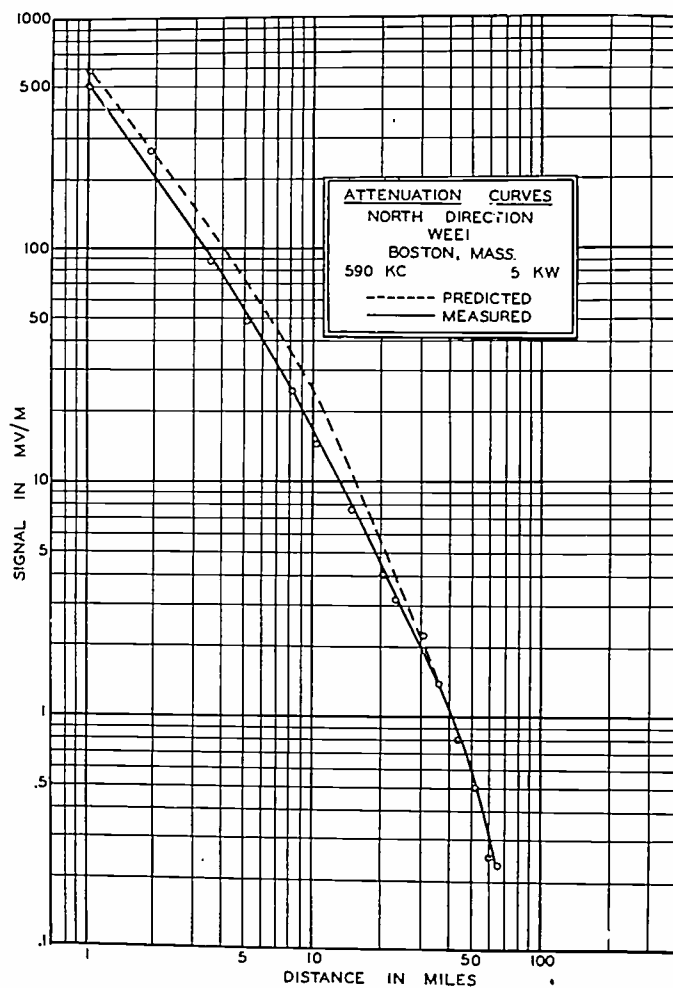

Fig. 4—Distribution of field intensity on a radial north of the new WEEI transmitter location.

antenna. It might be well to mention the compromises which were made in locating WEEI at its new site. Preliminary studies indicated that the high density of population near the new site might be a serious problem. Fortunately, the anticipated interference difficulties did not materialize. While the population within WEEI's 250-millivolt contour exceeds 93,000, only 226 listener complaints were received during the first year of operation, and in all of these cases interference has been cleared up to the listeners' satisfaction.

Then, 22 acres of land were required to accommodate the directional antenna system, and property at the new site is valued at several thousand dollars per acre. Furthermore, it was necessary to extend power, program, and telephone lines more than half a mile. Building a \$3000 water main and \$20,000 worth of foundation piling were also required. Combined, these extras made the cost of the new transmitter approximately \$40,000 higher than that of a station built at an alternate site which sacrificed coverage to reduce construction costs. However, no compromise was made in the effort to serve the largest population possible, and it is believed that WEEI now renders the widest service which is technically possible at its power and in view of the extreme attenuation characteristics of New England.

If a station is located in a seacoast city, it is often desirable to take advantage of transmission across salt water. In a few cases, the shape of the coast line precludes the possibility of improvement, and in other instances, such as WEEI, described above, directional-antenna requirements limit the engineer's freedom of choice. However, in most shore cities, it is possible to take advantage of transmission across salt water to increase the service area of a station.



Fairchild Aerial Surveys, Inc.

Fig. 5—Aerial photograph looking south towards downtown Boston with WEEI transmitter in foreground.

The recent relocation of KNX is a good example of what can be accomplished in this respect. This station, the Columbia Broadcasting System's 50,000-watt outlet in Los Angeles, California, began operation at a new site in August, 1938. The antenna is a 495-foot, uniform-cross-section, guyed vertical radiator. Its cross section is a triangle 4 feet 6 inches on the side, and its height above the base insulator corresponds to 0.53 wavelength at the carrier frequency of 1050 kilocycles. The original KNX transmitter was located at Sherman Oaks, 9.3 miles northwest of the CBS studios² at Columbia Square, Hollywood,

² H. A. Chinn and R. A. Bradley, "CBS Hollywood Studios," *PROC. I.R.E.*, vol. 27, pp. 421-428; July, (1939).

while the new transmitter is at Torrance, 21.6 miles from the old location, and 17 miles south of Hollywood. From the old site, the KNX signal had to pass over a 1400-foot range of hills to reach Hollywood and Los Angeles. It is interesting to note that although the distance between transmitter and studios was practically doubled, the signal at the studios was increased from 53 to 92 millivolts per meter. This apparent anomaly results from the fact that

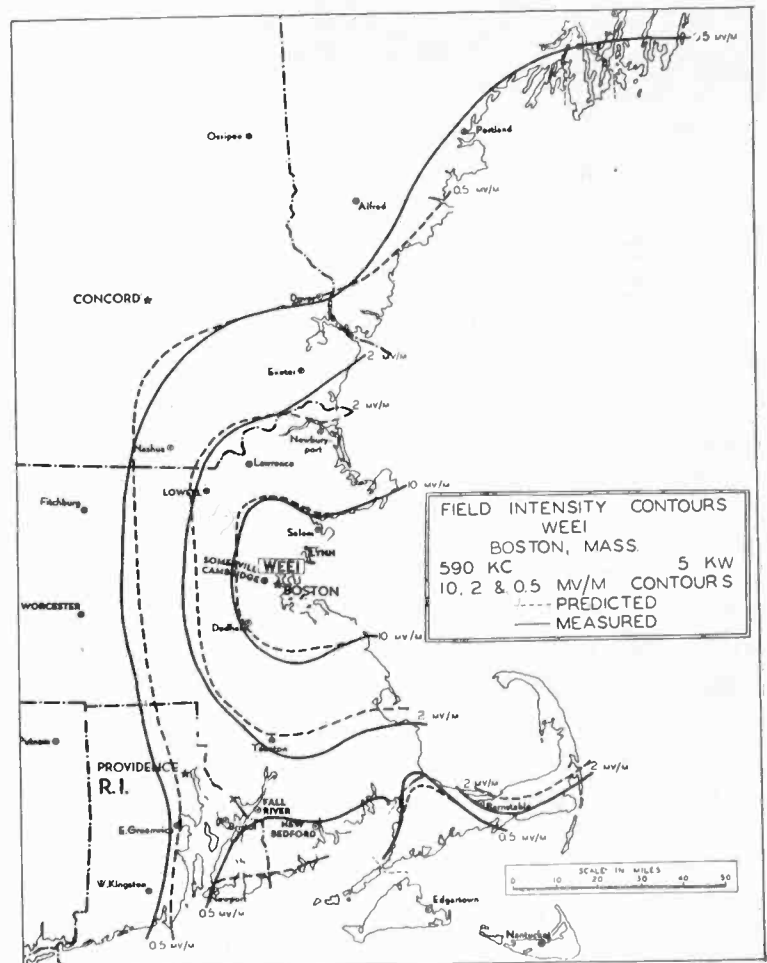

Copyright by Hagstrom Company, Inc., N. Y.

Fig. 6—Map of eastern New England showing WEEI field-intensity contours.

the low plain between Long Beach and Los Angeles is made up of soil of very high conductivity—approximately 25×10^{-14} electromagnetic units, instead of 4×10^{-14} electromagnetic units, the value from the original site.

In moving the KNX transmitter, it was desired to intensify the signal throughout the Los Angeles metropolitan area, and to establish reliable service in the cities of San Diego and Santa Barbara. The map in Fig. 7, showing the new and old 10-millivolt-per-meter areas, indicates the effect of salt-water transmission on coverage. The signal is seen to travel much farther along the shore line than it does inland. The transmission path from Torrance to San Diego contains very little land, with the result that in Balboa Park, San Diego, 107 miles from the new transmitter, the KNX signal is 10.9 millivolts per meter, and is fading-free at night. The old transmitter delivered 1.45 millivolts per meter, at this point, which, in a city of 140,000, was entirely inadequate

and was subject to serious nighttime fading. Though not within the 10-millivolt-per-meter contour, Santa Barbara also receives a signal which travels partially across salt water. This city of 35,000 population, 87 miles from the new transmitter, received a signal increase from 2.1 to 6.4 millivolts per meter, although the original transmitter site was 15 miles closer.

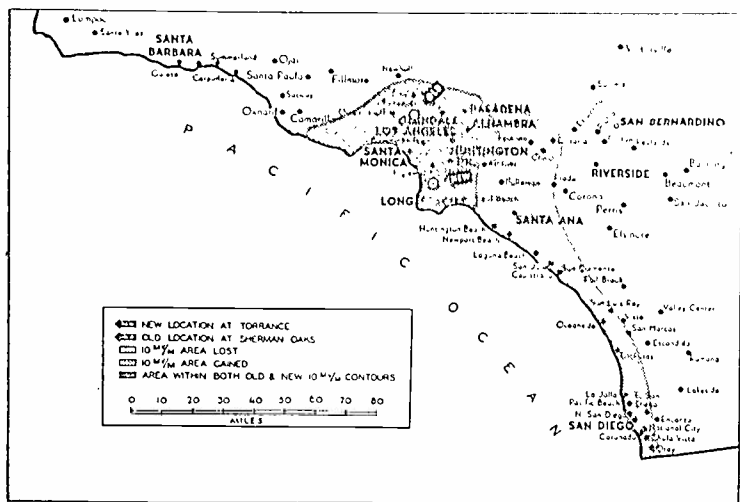

Copyright by Hagstrom Company, Inc., N. Y.

Fig. 7—KNX 10-millivolt-per-meter areas, before and after transmitter relocation.

It will be seen in Fig. 7 that the KNX 10-millivolt-per-meter area was considerably enlarged by the relocation. The land area was increased from 1910 square miles to 3020 square miles, an increase of 58 per cent. Furthermore, besides being smaller in area, the old 10-millivolt-per-meter area was largely confined to mountainous and sparsely populated

localities. As a result, the new 10-millivolt-per-meter contour includes 410,000 more persons than did the old. While an analysis of the 10-millivolt-per-meter area fails to give a complete picture of the coverage improvement, similar gains were realized within signal contours of other value.

It should be emphasized that unless actual measurements are available, large errors may be made in estimating attenuation of a signal crossing sharp discontinuities in conductivity, such as shore lines or mountain ranges. It is recommended that transmission tests be made in every attempt to take advantage of salt-water transmission. Prediction of KNX coverage from the new site was made more accurately than is usually possible, since a broadcast station in Long Beach, California, on 1360 kilocycles with a power of 1000 watts, was already transmitting from a point 9 miles southeast of the site finally chosen for KNX. Extensive field-intensity measurements of the Long Beach station's signal, corrected for difference in power, frequency, and antenna efficiency, provided reliable information on which to base predictions of KNX service.

This article has described a number of factors which affect the choice of a transmitter site. In practice, it will be found that almost every case involves additional problems whose solution will require judicious use of experience and common sense. It is the author's hope that, in some instances, the suggestions contained in this paper will be of assistance in the difficult task of finding the best location for a broadcast station.

The Heights of the Reflecting Regions in the Troposphere*

A. W. FRIEND†, MEMBER, I.R.E., AND R. C. COLWELL†, MEMBER, I.R.E.

Summary—Observations upon the reflecting regions of the atmosphere show that in addition to the reflections from the E, F₁, and F₂ regions, occasional reflections occur from heights of 50 and 25 (circa) kilometers. This has been called the D region. With a very short pulse (4 to 10 microseconds) and a rapid sweep upon the oscilloscope (18,000 inches per second), a reflecting region has been found within the troposphere. At the present time (summer, 1938) the region is about 1.8 kilometers high. This so-called C region changes its height with the change in weather. It may perhaps be influenced by magnetic storms, sunspots, and chromospheric eruptions.

WITH the apparatus described in a preceding article¹ observations have been made for a period of two years on all the regions of the ionosphere. During the last year and a half, records were kept mainly on the lowest reflecting region. At

first this region was several kilometers high but it has gradually fallen to an average height of approximately 2 kilometers. Some early observations showed the heights of the well-known E, F₁, and F₂ regions only; the lower newly discovered regions appear on the later records.

The sending station was first set up at one of the University Experimental Farms, so that the base line was approximately 2.5 kilometers. A few records are given for this station showing the E, F₁, and F₂ regions as well as some multiple reflections.

On February 3, 1936, the new sending station with a short pulse of 4 or 10 microseconds was set up in the Chemistry Building at the University, the base line being thus reduced to 200 meters. The frequency of the station was 1614 kilocycles, with peak power of 80 watts, later increased to 200 watts. Reflections from regions much below the E layer, which had been

* Decimal classification: R113.6. Original manuscript received by the Institute, August 16, 1938; abridgment received by the Institute, June 21, 1939.

† West Virginia University, Morgantown, West Virginia.

¹ A. W. Friend and R. C. Colwell, "Measuring the reflecting regions in the troposphere," *Proc. I.R.E.*, vol. 25, pp. 1531-1541; December, (1937).

TABLE I
FREQUENCY = 3492.5 KILOCYCLES
Records for November 24, 1935

Time	Height E region	Height F in kilometers	Height in kilometers of other reflections
4:30 P.M.	114	243	
4:35	107	254	492
4:40	108	208	331 485
4:50	100	269	508
5:00	100	215	508
5:10	95.2	254	405 507
5:20	88.7	274	403 508
5:50	73.7	246	393 517
6:15	151	203	388
6:25	150	210	388
6:35	172		388

occasionally observed during the summer of 1935, were now observed frequently as will appear in the tables. For purposes of tabulation the D region is arbitrarily placed between 15 and 70 kilometers.

TABLE II
FREQUENCY = 1614 KILOCYCLES
February 11, 1936

Time	Height in kilometers D region	Height in kilometers E region	Height in kilometers F ₁	Height in kilometers of other reflections	Remarks
6:00 P.M.		110	220		E very strong
6:10		105	210		
6:15		110	210	330	
6:23		115	213	335	
6:30		115	210	345	
8:00		105	210	360	
8:15			210	410	
8:20			210	410	
9:00			215	450	F ₁ very steady
9:05		108	220	455	
9:15	28	103	230	350 470	D very strong
9:20		97	230	340 460	fading rapidly
9:25		75 to 105	220	340 460	
9:40		100	225	360 450	

February 13, 1936

Time	Height in kilometers D region	Height in kilometers E region	Height in kilometers F ₁	Height in kilometers of other reflections	Remarks
8:00 P.M.	63		188	376	D-region signal very steady while it lasted. F ₁ region also at fixed height.
8:30	63		188	376	
8:40	63		188	376	
8:42	63		188	376	
8:45			188	376	
9:00			188	376	
9:15			188	370	
9:30			188	350	
9:45			188	350	
9:50			180	350	
10:00			180	350	
10:05			180	350	

February 14, 1936

Time	Height in kilometers D region	Height in kilometers E region	Height in kilometers F ₁	Height in kilometers of other reflections	Remarks
7:45 P.M.	56	95	225		F ₁ on all the time of observation. F ₂ only appeared twice. E region on part of the time.
7:50	50	88	203		
7:51	50	82	207		
8:00	50	106	223	365	
8:05	50	114	207		
8:12	50	85	213		
8:14	55	94	213		
8:16	55	100	213		
8:19	58	94	223		
8:24	59	82	220	385 448	
8:31	61		233	455	
8:37	57		225	450	
8:47	43		222	453	
8:57	41		223	450	
9:02	45		225	450	
9:12	53		207	440	
9:22	53		210	450	

February 15, 1936

Time	Height in kilometers D region	Height in kilometers E region	Height in kilometers F ₁	Height in kilometers of other reflections	Remarks
7:45 P.M.	25		218	395	The D region disappeared at 9:50. No E region was seen.
7:58	25		200	395	
8:10	25		207	450	
8:24	25		218	440	
8:35	28		213	450	
8:45	33		207	438	
8:58	35		232	450	
9:23	27		210	438	
9:38	25		244	468	
9:50	30		245	476	
10:00			250	490	
10:08			255	510	
10:17			250	500	
10:26			250	500	
10:31			250	500	
10:42			250	500	
10:50			250	500	

February 16, 1936

Time	Height in kilometers D region	Height in kilometers E region	Height in kilometers F ₁	Height in kilometers of other reflections	Remarks
7:45 P.M.		95	190	285	No D region. E region disappeared early in the evening. F rose steadily. Multiple reflections became stronger when E disappeared.
8:00		95	190	285	
8:15		110	220	410 660	
8:30			220	440 660	
8:45			250	480 720	
8:55			240	500 750	
9:05			250	500 760	
9:15			250	500 760	
9:30			250	500 775	
9:45			275	530 800	
10:00			275	530 800	

February 17, 1936

Time	Height in kilometers D region	Height in kilometers E region	Height in kilometers F ₁	Height in kilometers of other reflections	Remarks
7:30 P.M.	40	98			D and E regions both measurable all evening.
7:45	40	98	235	368	
7:55	40	112	220		
7:58	40	100	225		
8:05	40	95	212		
8:15	43	115	232		
8:23	45	118	220		
8:28	40	118			
8:35	32	120	250		
8:45	40	125	250		
8:49	37	125	250		
8:53	40	125	250		
9:02	28	125	235	362	
9:08	47	117	225		
9:11	38	125	260	390	
9:23	33	130	260	390	
9:40	30	122	225		
9:49	42	125	175	305	
10:01	32	125	250	300	
10:06	36	120	240		
10:20	37	125	230		
10:37	35	90	225	290 383	
10:44	53	83	230	300 450	
10:57	43		225	300 362	
11:03	34		240	305 450	
11:07	50		235	312 450	
11:13	43			294	
11:20	53			290	

This is approximately the position of the ozone region in the atmosphere. In the same way reflections from 1 to 15 kilometers are put in the C region which roughly embraces the troposphere.

The observations on February 17, 1936, were of particular interest because it was found that the signals from KDKA at Saxonburg, Pennsylvania, were

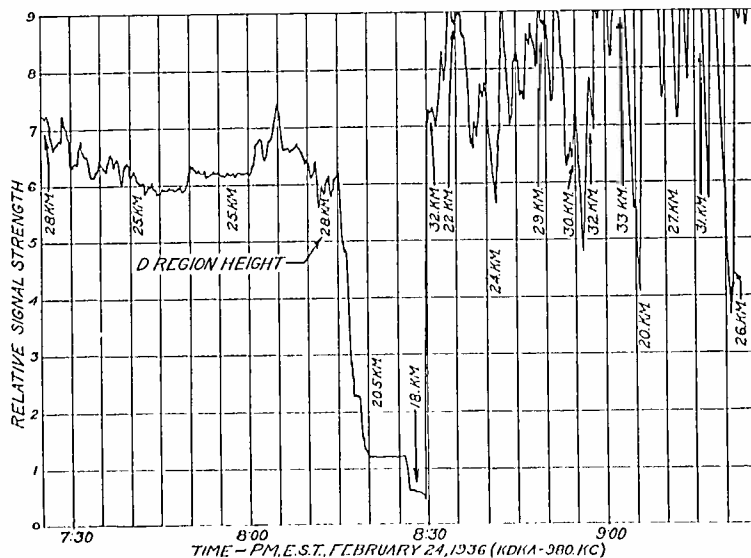

Fig. 1—Fading curve of KDKA signals at Morgantown, West Virginia (February 24, 1936), with notations of simultaneous D-region heights.

fading simultaneously with those of the pulse station at Morgantown, West Virginia. The broadcast and pulse receivers were turned on at the same time. At each change of volume in KDKA and W8XAW (the pulse station) a change in the height of the D region took place in exact synchronism. The phenomenon was noticed on several occasions and a chart is

shown in Fig. 1 for the night of February 24, 1936. These observations show that occasionally but not always the D region causes fading in the broadcast band.

As the so-called ground pulse still continued to fluctuate, it was felt that reflections from still lower regions were mixed with the ground pulse. These fluctuations had been observed very early in 1935 and lead to the present research. Efforts were being made during all these readings to obtain a shorter pulse and a faster sweep upon the oscilloscope. The records from now on in this article will refer only to reflections below and at the D level. It should be understood however, that the E, F₁, and F₂ regions were observed regularly.

TABLE III
FREQUENCY = 1614 KILOCYCLES
February 19, 1936

Time	D (kilo-meters)	Time	D (kilo-meters)	Time	D (kilo-meters)	Time	D (kilo-meters)
8:35 A.M.	23	6:00 P.M.	17	7:17 P.M.	24	8:55 P.M.	30
8:42	23	6:06	17	7:25	19	9:05	30
10:00	12	6:12	15	7:35	19	9:15	25
10:35	18	6:22	15	7:45	30	9:25	32
12:06 P.M.	50	6:34	18	7:55	20	9:35	32
4:07	23	6:43	15	8:05	30	9:45	27
5:38	13	6:52	17	8:25	30	9:56	30
5:47	18	7:05	16	8:35	26	10:05	26
5:55	13	7:12	19	8:45	32		

TABLE IV
FREQUENCY = 3492.5 KILOCYCLES
February 29, 1936

Time	C Region (kilometers)	D Region (kilometers)
1:45 P.M.	10	20 30 40
1:55	10	20 30 40
6:27	—	15 — 46
6:39	—	15 — 46
6:47	—	16 32 50
7:55	10	
9:52	13	
10:30	13	
11:55	10	

The revised commercial receiver which had been used until this time could not resolve the ground wave from the reflections at heights below 10 kilometers but the specially designed radio-frequency receiver described in another article¹ permitted the resolution of very low layers. Thus on March 5, 1936, on 1614 kilocycles, reflections from heights of 4, 7.5, 17, and 25 kilometers were observed and on March 9, 1936, on 3492.5 kilocycles a region was found from 2 to 3 kilometers high along with a D at 23 kilometers and another at 60 kilometers. This receiver gives good resolution at the expense of sensitivity, so that the higher regions of the ionosphere seldom appear on the screen. Another reason for this is that the rapid sweep now adopted for the oscilloscope causes all higher reflections to be swept off the screen of the oscilloscope. The region from 2 to 3 kilometers has gradually descended toward the earth during the last year. The readings for a few days in 1936 are given in Table V.

In the tables given so far it appears that there are several regions of considerable reflecting power at

TABLE V
FREQUENCY = 1614 KILOCYCLES
March 31, 1936 April 10 April 11

Time	C (kilo-meters)	D (kilo-meters)	Time	C (kilo-meters)	Time	C (kilo-meters)
12:28 P.M.	12.5	—	11:50 A.M.	3 to 7	1:12 A.M.	4.5 and 8
2:57	7.5	30	3:55 P.M.	3 to 9	1:21	11
5:45	7.7	18	4:02	7 to 11	1:45	10
5:55	10	—	4:14	8	2:03	7
6:13	7.9	17	6:00	10	2:50	4 and 10
6:27	6.5	17	7:32	8.5	4:20	11
6:53	6.5	19	7:33	8.5	4:30	7
7:22	7.8	—	11:03	4.5	4:48	—

April 25		May 8		May 19	
9:55 A.M.	6	5:23 P.M.	6	2:00 P.M.	3.7
11:05	3 to 6	5:47	7.3	5:45	6
12:25 P.M.	2 to 4	5:45	3	5:50	3.5 to 7
2:30	3	5:50	5.5	9:00	7.5

FREQUENCY = 2398 KILOCYCLES					
May 20		June 2		June 5	
12:15 P.M.	1.5	7:45 P.M.	5	6:25 P.M.	5
4:25	3 to 6.5	7:53	5.5	6:46	6
5:30	5.5	7:57	5.5	6:55	6
5:53	6.7	7:58	5	7:05	5.2

levels much below the E region. In 1930 Appleton² remarked that the D absorbing region was also capable of reflecting the electric waves; but the first actual photograph of such a reflection was published by Mitra and Syam.³ The region at 50 kilometers appears in many of the above records. A new region between 15 to 30 kilometers also is capable of reflecting electric waves. This region is discussed at some length by Watson Watt and his coworkers in his article on the low reflecting layers.⁴ He also finds reflecting regions at average levels of 8.39, 9.33, 10.26, and 10.76 kilometers, respectively. The detection of lower levels is possible at W8XAW, Morgantown, because a 4-microsecond pulse is used for some measurements compared to the 20-microsecond pulse of Watson Watt. That there are no other very important lower reflecting layers is shown by the fact that when all the reflections are resolved out, the remaining ground wave is absolutely steady and unfluctuating. Any fluctuation of the ground wave indicates the presence of reflected pulses. Occasionally as will be shown later the 2-kilometer region may extend to much lower levels sometimes reaching less than 1 kilometer in height and passing beyond the limit of resolution of the receiving instruments. The average coefficient of reflection measured for the C region is 0.01. On rare occasions this value has been greatly exceeded and at times the coefficient has been much less. Most of these measurements have been made by comparing the amplitudes of continuous carrier signals of known signal strength (observed on the cathode-ray oscillograph) with the amplitudes of the pulse signals. After measuring this field strength,

² E. V. Appleton, "Measurements of the equivalent height of the atmospheric ionized layer," *Proc. Roy. Soc., ser. A.*, vol. 126, pp. 542-569; March 3, (1930).

³ S. K. Mitra and P. Syam, "Absorbing layer of the ionosphere at low height," *Nature*, vol. 135, pp. 953-954; June 8, (1935).

⁴ R. A. Watson Watt, A. F. Wilkins, and E. G. Bowen, "The return of radio waves from the middle atmosphere," *Proc. Roy. Soc., ser. A.*, vol. 161, pp. 181-196; July, (1937).

the field at the reflecting region was calculated from the known transmitter constants. From these values an approximate reflection coefficient could be found. A check on the value of the coefficient was obtained by measuring the complete pulse receiver gain. In a third test a continuous carrier wave was used instead of the pulse. The loop receiving antenna was first oriented so as to balance the reflected pulse to a signal input equal to that from the direct pulse. Then the pulse transmitter was shifted to continuous carrier output. With the loop antenna in the same position it was connected to a superheterodyne receiver equipped with a calibrated attenuator control. This signal was found to be fluctuating in much the same manner as the pulse signal. It was possible to make an approximate check upon the reflected signal strength which showed the same order of magnitude of reflection coefficient as measured by the pulse method. This test also indicated that pulse signals are not necessary for the observance of C-region fluctuation effects.

Since our experiments were started some similar tests have been published by Mingins at Cornell University.⁵ In reception tests, using broadcast signals, he found necessary variations in loop angle settings during weather and magnetic disturbances and just before sunset. His notations check very closely with the recorded loop-angle fluctuations for C-region observations at Morgantown.

TABLE VI
FREQUENCY = 2398 KILOCYCLES
June 6, 1936

Time	Horizontal angle	Vertical angle	Height C (kilometers)	Height D (kilometers)	Remarks
11:10 A.M.	51	-10	3.7 to 4.6	18 23	C region very strong and steady. With C becoming lower, 20 meters comes in with shorter skip.
5:05 P.M.	120	-7	4.7	17	
11:07	48	-7	6.8	19 29	
11:11	33	-7	5.3	22 33	
11:17	40	-10	5.9	22 33	
11:25	42	-14	5.7 to 6.3	20 32	
11:29	-120	2	7.5	20 32	
11:32	-117	1	5.7	20 32	
11:35	-121	2	5.0 to 7.5	20 32	
11:38	-123	0	7.5		

June 7, 1936

2:50 A.M.	40	-14	7.4	19 27
2:55	-114	0	8.6	22 29
2:57	-115	-1	8.3	22 29
3:05	-116	1	8.4	22 29
3:07	-114	-2	8.1	22 30

June 8, 1936

11:30 A.M.	-129	2	4.3 and 14.5	
2:22 P.M.	-115	-14	4.8 and 13	
2:26	48	0	5.7 and 21	
2:30	44	1	4.6 and 13	
3:31	43	2	6.3 and 13	
4:00	48	-3	3.5 to 4.7 and 12.5	

Another remarkable characteristic of these reflecting regions in the troposphere is that, although they are influenced by weather conditions, thunderstorms, and perhaps magnetic storms and chromospheric eruptions on the sun, they do not show a great varia-

tion from day to night as do the E and F layers. This also appears in the tables wherever observations were made by night as well as by day. The pulse signals were received upon a square loop rotatable about the vertical and horizontal axes. If the reflected impulse remained upon the screen for a long time without any movement of the loop being necessary, the C region was regarded as fairly steady; if, however, it was necessary to rotate the loop rapidly in order to keep the reflected pulse resolved the C region was unsteady, changing quickly in height, in polarization, in direction, or in a combination of these. This is shown for a few days in the tables below where H and V are the horizontal and vertical angles of the loop measured from an arbitrary set of axes.

The records for July 20, 1936, show two characteristics of the lower region; first, it is strong at night as well as by day; second, just at sunrise, it is extremely disturbed. The latter phenomenon also appears around sunset.

Since an eclipse of the sun was due to occur on June 19, 1936, preliminary observations were made the day before. It happened that an intense magnetic storm was in progress on the day of the eclipse, so that the C region was under observation before, during, and after this storm. The records below show that the C region moved down and became very strong; in fact the strongest reflections ever obtained were found at that time. In addition the familiar radio fade-out (the Dellinger effect) was also much in evidence.

Due to the length of the pulses as delivered from the receiver, during the first year the heights were always measured by the interval between the maximum peaks of the direct pulse and the reflected pulse. At times of low virtual height this practice made the measured values as much as 20 per cent too great, on account of the variations in slope of the rising side of the reflected pulse. There is, in fact, some question as to just what to call the exact virtual height when the reflected signal appears to increase in amplitude gradually with increased height. From January 29, 1937, an improved receiver made possible better accuracy in determination of the virtual heights because of the use of more adequate damping of the semiresonant circuits; therefore, all measurements since that date have been made as nearly as possible from the leading edge of the direct pulse to the peak of the leading edge of the reflected pulse. This practice is believed to give a clearer picture of the actual minimum virtual height of appreciable signal reflection. Even when taking into account these changes in the technique of measurement it is quite evident that the general trend of measured C-region heights has been downward during the years 1936 and 1937 with the greatest sustained drop occurring between February 10, 1937, and May 3, 1937.

While a sufficient period of time has not elapsed

⁵ Charles R. Mingins, "Electromagnetic wave fields near the earth's surface," PROC. I.R.E., vol. 25, pp 1419-1456; November, (1937).

TABLE VII
FREQUENCY = 2398 KILOCYCLES
Observations on C region—June 18, 19, 20, 1936

Time	Horizontal angle	Vertical angle	Height C (kilometers)	Height D (kilometers)	Remarks
June 18					
7:15 P.M.	52°	90°	5.2	11.2	C region giving very strong reflections
7:23	-110	10	4.3		
7:28	-100	10	5.8		
7:35	-95	10	5.0		C region unsteady
7:42	-100	10	6.4		
7:47	-100	10	6.4		C region very steady
7:50	-105	10	5.7	18	
7:55	-105	10	5.1		Height is varying from 5-10 kilometers
8:03	-110	10	5.8		
8:10	-120	18	7.2		
8:12	-120	18	8.6		
8:25	-120	18	8.5		8:25 P.M. Foreign stations are coming in strong on 32 meters, one English and one German station (short wave) are louder than the local broadcast stations.
8:40	-120	-10	6.4		8:40 Foreign stations have faded out completely. Severe fading on broadcast band.
8:50	44	-5	5.8		
8:55	44	-10	5.2	23	
9:22	38	-12	4.0	23	
10:32	-122	-7	4.3	20	
10:50	42	-14	2.8	23	
11:00	46	-5	5.8	26	
11:10	-125	-10	5.8	26	
11:21	42	-10	5.8	26	
11:32	38	-12	3.5	22	
11:45	40	-10	5.1	20	
12:00	-125	-8	6.2	23	
June 19					
2:00 A.M.	55	9	8.1	D region present but no records made	C strong and steady
2:15	56	9	8.0		
2:30	55	10	8.0		
2:45	55	8	7.3		
3:00	55	8	8.0		
3:15	56	8	8.0		
3:30	55	8	7.5		
3:45	56	8	7.2		
4:00	58	9	7.2		
4:15	57	8	7.5	Dawn	Very steady
4:30	54	6	7.9		
4:45	55	6	7.2		Unsteady
5:00	54	5	8.0		
5:10	55	5	8.0		
5:15	55	5	8.0		
5:30	58	11	7.4		Very unsteady
5:40	57	10	7.8		
6:00	54	5	7.2		
11:35 A.M.	49	-2	5.2	18	C region strongest ever observed up to this time. Angle not critical. Simple single-wire antenna used instead of loop. Coincident with magnetic storm. 14-megacycle band faded entirely out before 12:50 P.M.
11:45			3.8	13.3	
11:55			2.8	23	
12:50 P.M.	24	-20	3.8	20	
3:22	16	-20	5.7	20	
4:28	13	-20	3.6	20	
5:30	14	-20	5.7	17	
June 20					
12:15 A.M.	16	-20	4 to 6.5	21	14-megacycle amateur band quite unsteady, sometimes having very short skip, sometimes dead. Distant signals audible occasionally.
1:37	17	-6	1.0	23	
1:40	16	-10	5.7	21	
1:45	26	-3	6.0	20	
1:53	30	-1	6.2	20	
2:00	29	-1	5.9 to 7.3	17	
2:03	34	2	5.7	20	
2:10	37	5	5.7 to 7	22	
2:22	37	5	5.8 to 7.6	23	Short and long skip 14 megacycles.
11:28	12	-10	4.8	18	

to decide if there is a cyclic pattern of long-time variation, it appears that it may be possible that the fall in C-region reflection heights coincides somewhat with the increase in sunspot activity and other connected phenomena.

After many daily observations had been made upon the C region it became clear that the high- and low-pressure areas, which sweep across the continent from west to east, have a noticeable influence upon the height of the lowest C region. In general a high-pressure area passing to the north of Morgantown lowered the height of the C region while a low-pressure area in the same place raised the height. When the pressure areas passed to the south the effect was not so noticeable. All the observations on this phenomenon are summarized at the end of this particular section but first the rise and fall of the C region is shown for specific cases.

TABLE VIII
FREQUENCY = 2398 KILOCYCLES
Weather Cycle and C region

Date	Time	Height C region (kilometers)	D	Remarks
9/12/36	12:00 Noon	4.0 to 5.5 and 11		Low-pressure area to north
	12:03 P.M.	5.7		
	12:20	5 to 6.5		
9/13/36	10:40 A.M.	6.3 and 18		Very large low-pressure area to west
	10:45	6.3 and 16		
	11:12	2.6 and 12		
9/14/36	1:25 P.M.	5.1 and 11		Very large high-pressure area north and northeast. Large low-pressure area toward west; this produced a thunderstorm between two and three o'clock. C region comparatively high.
	2:20	6.1 and 9		
	2:21	6.4 and 9		
	2:26	6.3 and 9		
	2:27	6.3 and 9		
	2:35	5.1 to 6.4 and 9		
	2:45	5.7 and 9		
	2:48	5.7 and 9		
	5:25	4.6 to 5.7 and 8		
	5:55	5.3 to 6.4 and 15		
9/15/36	11:20 A.M.	4.5 to 5.1 and 13		Low area coming in from west.
9/16/36	12:00 Noon	1.5 to 3.5 and 9		
9/17/36	12:05 P.M.	1.3 to 2.0 and 8		High-pressure area over United States.
	9:00	3.5 to 5.0 and 7		
9/18/36	12:05 P.M.	3.8 and 8		High-pressure area. Tornado along eastern coast. High to northwest. Low to northwest. Local high-pressure area. Local high-pressure area. Local high-pressure area. Large low northward.
9/19/36	12:25 P.M.	3.3 and 14		
9/20/36	1:57	4.5 and 13		
9/21/36	12:05	3.5 to 5.5 and 14		
9/22/36	1:30 P.M.	4.4 and 11		
9/23/36	12:00 Noon	4.4 and 14		
9/24/36	12:22 P.M.	4.8 to 6 and 12	19	
	8:25	5.2 to 6 and 13	21	
	8:30	5.5 and 13	21	
	8:33	4.2 to 6 and 13	21	
	8:35	4.2 and 13	21	
	9:30	5.2 and 13	21	
	10:22	4.8 and 13	21	
9/25/36	2:30 P.M.	2 to 4		Very large high has moved in.
	2:35	5		
	2:37	3.5		
9/26/36	12:10 P.M.	1.5 to 2		Large high over station.
	1:00	1.5		

Two weather cycles are shown in Table IX one for the spring and one in the fall. During this time the C region has moved perceptibly lower but the effect of the high- and low-pressure areas is still very much in evidence.

TABLE IX
FREQUENCY = 2398 KILOCYCLES
Weather Cycle in 1937

Date	Time	Height C region (kilometers)	D	Remarks
3/20/37	2:35 P.M.	2.8		Low-pressure area to the west.
3/21/37	4:15 P.M.	1.0 to 2.2		Very large high coming in from west.
3/22/37	3:15 P.M.	1.6		High-pressure area moving away.
3/23/37	1:23 P.M.	1.7		High-pressure area still over station.
8/26/37	9:48 A.M.	1.8		Weather mist and rain. Low-pressure area at Morgantown.
8/27/37	12:06 P.M.	1.3		Weather rain—high-pressure coming from northwest.
8, 28/37	12:03 P.M.	2.05		Weather fair—C region higher.
8/30/37	11:20 A.M.	2.10		Low area in west.
8/31/37	11:14 A.M.	1.8		Weather cloudy—low area in northwest.
9/ 1/37	11:16 A.M.	1.3		Medium pressure to west.
				High-pressure area directly over station.

When the cyclones and anticyclones are moving in from the south rather than from the north or northwest, the changes in height of the C region do not correspond with those given above. This shows very definitely that the C region differs in the different quadrants of the cyclones and anticyclones. This may be a difference in height only but there may also be differences in the reflection conditions. A southwest weather cycle appears in Table X.

The results for all the observations from March 31, 1936, to November 4, 1937, are summarized in Table XI. The differences between highs and lows and the

TABLE X
FREQUENCY = 2398 KILOCYCLES
Weather Cycle for Southwest Quadrant, 1937

Date	Time	C region (kilometers)	Remarks
3/30/37	3:25 P.M.	1.8	Low-pressure area to southwest.
3/31/37	4:10 P.M.	2.1	High-pressure area to southwest.
4/ 1/37	5:10 P.M.	2.9	High moved in from southwest.
4/ 2/37	5:47 P.M.	2.3	High pressure to the west.
4/ 3/37	12:05 P.M.	2.1	High pressure to northwest.
4/ 5/37	4:35 P.M.	2.9	Low-pressure area to west.
4/ 6/37	11:15 A.M.	2.2	Large high in west.
4/ 7/37	2:02 P.M.	1.9	Large high coming in from west.
4/ 8/37	12:20 P.M.	2.6	Low pressure in west.
4/ 9/37	7:00 P.M.	2.4	High pressure northwest.
4/10/37	12:27 P.M.	1.7	High pressure over station.

variations for the four quadrants are very striking. On sixteen days, no definite classification could be made.

TABLE XI
CYCLONES, ANTICYCLONES, AND C REGION

Weather	C Region	Weather	C Region
High N.W.	Higher 16 times Lower 103 times	Low N.W.	Higher 85 times Lower 13 times
High over Morgantown	Higher 7 times Lower 83 times	Low over Morgantown	Higher 27 times Lower 2 times
High west	Higher 5 times Lower 20 times	Low west	Higher 40 times Lower 3 times
High north	Higher 1 time Lower 20 times	Low north	Higher 25 times Lower 3 times
High S.W.	Higher 12 times Lower 18 times	Low S.W.	Higher 0 times Lower 3 times

parent reflection came from the instruments and not from the ionosphere. Although very great care had been taken to exclude any effect from the sending and receiving sets, additional tests were devised to settle this important point.

First. The loop could be moved so as to permit only the ground wave to appear on the screen, or the ground wave could be excluded and the sky-wave pulse made to appear alone. Several photographs of this procedure are shown in Fig. 2.

Second. The ground wave alone was introduced into a receiver which had a "magic eye." With this wave, the "eye" remained exactly fixed in deflection. When the sky wave alone was passed into the receiver, the eye deflection varied showing the characteristic fluctuation of the reflection from the low region.

Third. It is generally agreed that during the daytime, all the propagation for short distances takes place on the ground wave, the sky wave appearing only at night. Extended observations upon the day signals of near-by broadcast stations show tremendous variations in strength from day to day. Such variations are hardly likely to come from changes in

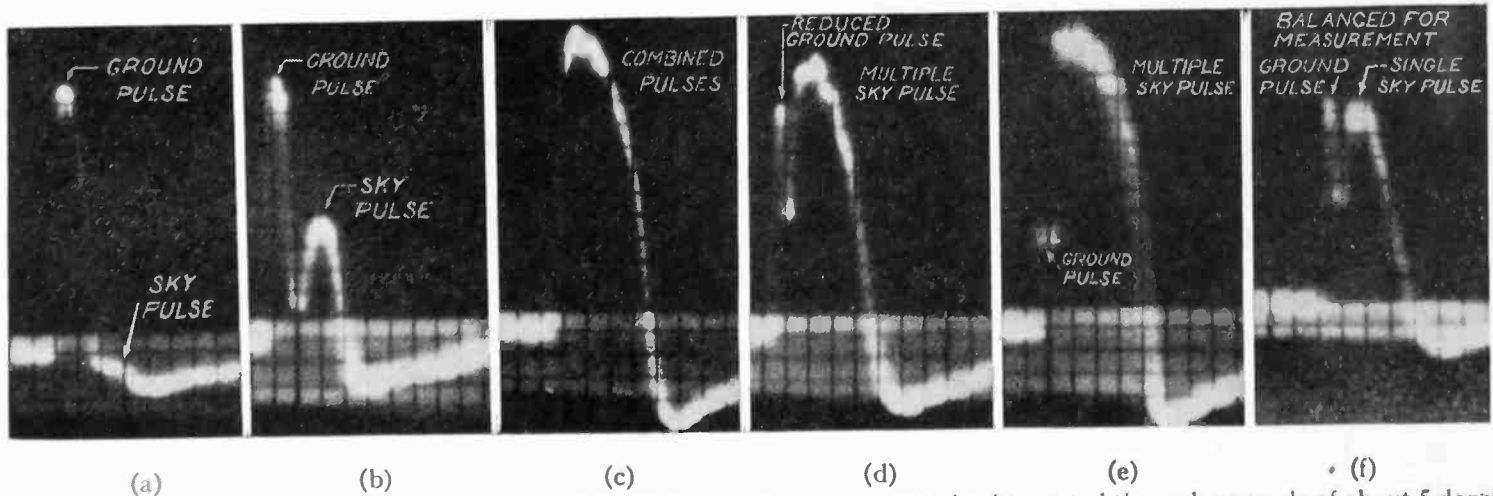

Fig. 2—Photographs of the cathode-ray pulse pattern taken as the loop antenna was slowly rotated through an angle of about 5 degrees.

During one type of thunderstorm in which lightning occurred frequently accompanied by heavy winds, the C region was so disturbed that no records could be made. In a second type when the lightning occurred at fairly long intervals the C region could be seen to gain about two kilometers in height. The height of the region observed was between 5 and 7 kilometers at that time. These observations indicate that at least a part of the well-known variation of radio-frequency signals during thunderstorms^{4,6} is coincident with electrical changes in the troposphere.

When the discovery of the C region was first announced,^{7,8,9} the opinion was expressed that the ap-

⁴ R. C. Colwell, "Effect of thunderstorms upon the ionosphere," *Nature*, vol. 133, p. 948; June 23, (1934).

⁷ R. C. Colwell and A. W. Friend, "The D region of the ionosphere," *Nature*, vol. 137, p. 782; May 9, (1936).

⁸ R. A. Watson Watt, L. H. Bainbridge-Bell, A. F. Wilkins, and E. G. Bowen, *Nature*, vol. 137, p. 866; May 23, (1936).

⁹ R. C. Colwell and A. W. Friend, "The lower ionosphere," *Phys. Rev.*, vol. 50, pp. 632-635; October 1, (1936).

the ground resistance. It is much more probable that the day signals on the broadcast range are transmitted in part through the troposphere or C region. The variations for a few stations are shown in the graphs of Fig. 3.

Fourth. During the last year, several other investigators have emphasized the effect of some region lying below the E layer. For instance, Dellinger explains the radio fade-outs¹⁰ in this fashion "It may, therefore, be concluded that these sudden disturbances involve a sudden great increase of ionization in some region through which radio waves pass on the way to being reflected by a higher region.—The absorbing region must be below the E layer."—Smith and Kirby discovered that waves of broadcast and lower frequencies are propagated in the daytime at certain seasons by reflection from a lower layer than

¹⁰ J. H. Dellinger, "Sudden disturbances of the ionosphere," *Proc. I.R.E.*, vol. 25, p. 1282; October, (1937).

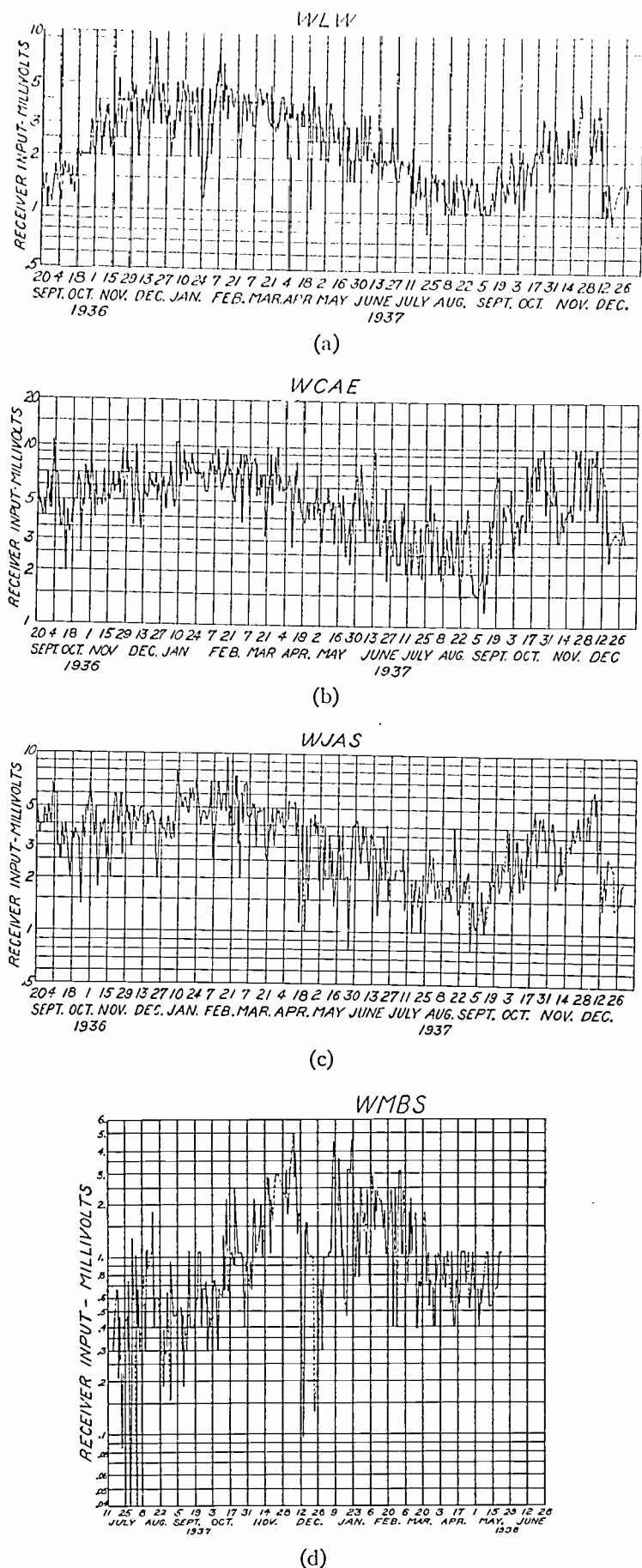

Fig. 3—Noon signal-strength recordings of four different broadcast stations taken at Morgantown, West Virginia.

the E layer.¹¹ These effects may be due either to the D or C regions or both.

Fifth. Smith and Kirby¹² have shown by the use of

¹¹ Footnote reference 10, page 1283.

¹² N. Smith and S. S. Kirby, "Critical frequencies of low ionosphere layers," *Phys. Rev.*, vol. 51, pp. 890-891; May 15, (1937).

their critical-frequency method that a truly refracting layer lies below the E region.

Sixth. Rakshit and Bhar¹³ have taken a photograph of a pulse reflected from a layer about 8 kilometers high. They found that there were several regions lying at heights of 55, 20 to 35, and 5 to 15 kilometers. These observations agree very closely with those mentioned in this paper.

Seventh. In an extended series of observations, Hull¹⁴ found that communications could be held over medium distances (West Hartford and Boston) on 5-meter waves. The fluctuations in field strength were found to depend directly on the change in the positions of the cyclones and anticyclones as they passed over the stations.

On the other hand, theoretical considerations would indicate that no such number of free electrons required for this reflection could exist in the troposphere. Also Gish¹⁵ in the voyage of the *Explorer II* found no large number of free electrons in the lower atmosphere. While this article was in preparation, Englund¹⁶ and his coworkers reported that they had detected reflections from low-lying regions on wavelengths from 1.6 to 5 meters over a 70-mile ocean path. The reflections however took place at grazing incidence and are much easier to explain than the reflections at almost normal incidence observed in Morgantown.

It has been suggested by the authors in various meetings during the past two years that such reflections could be partially explained by the action of polar-water molecules in the atmosphere. A sharp discontinuity of the vapor content at the dividing surface between two different masses might cause an observable reflection at the interface.

LATER DEVELOPMENTS*

Since the first part of this article was written, the video-frequency-type superheterodyne pulse receiver, shown in Figs. 4 and 5, has been constructed. This unit uses the circuit of Fig. 6, and is arranged to operate between the frequency limits of 1.5 to 65 megacycles. The present intermediate frequency is 3.4 megacycles; but an increase to 11 megacycles is contemplated in order to facilitate wider band-pass operation. The band-pass width of the present unit is approximately 0.6 megacycle. This allows satisfactory resolution of reflected pulses from levels above 1 kilometer; but below about 0.5 kilometer the measured heights are not accurate.

¹³ H. Rakshit and N. Bhar, "Some observations on the C region of the ionosphere," *Nature*, vol. 138, pp. 283-284; August 15, (1936).

¹⁴ R. A. Hull, "Air-mass conditions and bending of U. H. F. waves," *QST.*, vol. 19, pp. 3-8; June, (1935).

¹⁵ A. W. Stevens, "The scientific results of the world record stratosphere flight," *Nat. Geog. Soc.*, vol. 69, pp. 693-714; May, (1936).

¹⁶ C. R. Englund, A. B. Crawford, and W. W. Mumford, "Ultra-short-wave transmission and atmospheric irregularities," *Bell Sys. Tech. Jour.*, vol. 17, pp. 489-519; October, (1938).

* Addendum received by the Institute, April 18, 1939.

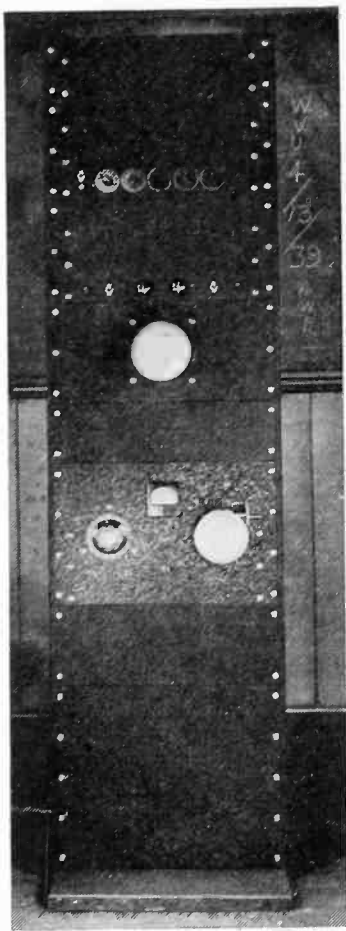

Fig. 4

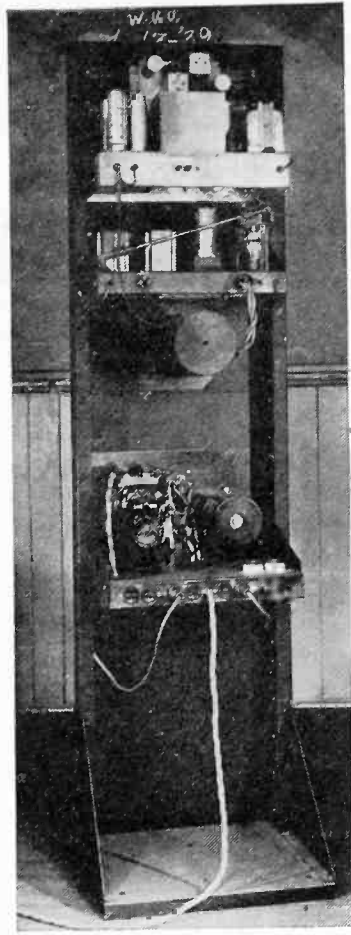

Fig. 5

Fig. 4—Front view of the video-frequency-type superheterodyne receiver for the measurement of tropospheric radio-wave reflections. The upper panels cover the superheterodyne receiver unit. The next two lower units are the oscilloscope control and sweep, and cathode-ray-tube panels. The lower units contain the power-load center, phase shifter, and variac sweep-amplitude controls.

Fig. 5—Rear view of the superheterodyne receiver unit.

Although the over-all gain is about 10^7 , the usable voltage gain is not greater than about 10^6 , on account of interference developed both within the receiver and externally. Thus it may be observed that the loss in gain caused by the projected increase in intermediate frequency and band width should not greatly handicap the operation.

All experimental frequencies up to 17,310 kilocycles per second have been used quite successfully.

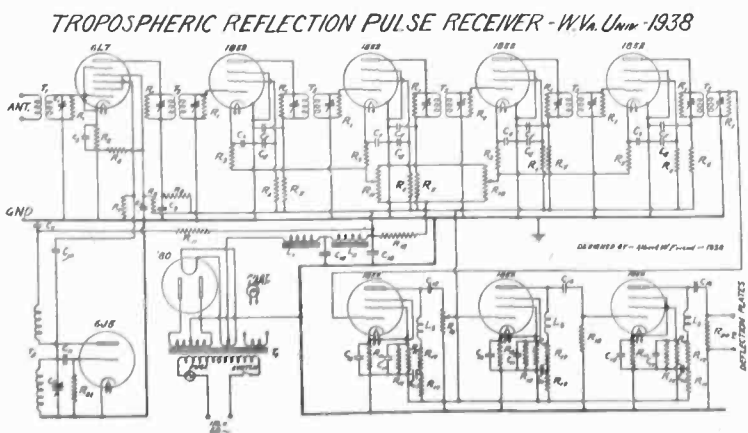

Fig. 6—The circuit diagram of the superheterodyne receiver. The new high-transconductance amplifier tubes are used throughout the amplifier circuits. Types 1851, 1852, and 1231 are equally suitable.

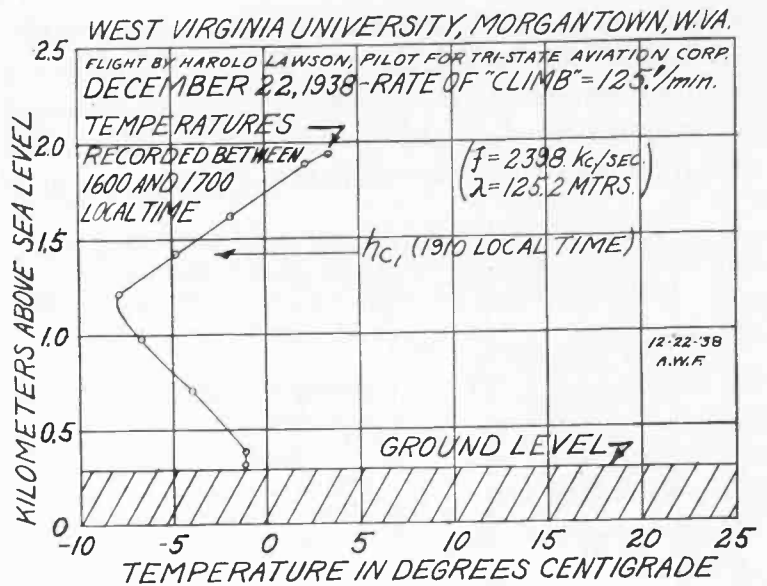

Fig. 7—A comparison between tropospheric-air-temperature conditions and the measured tropospheric radio-wave-reflection height, recorded on December 22, 1938, at Morgantown, West Virginia.

Higher frequencies have not been used, only because the presently available transmitter is not suitable for use on the higher frequencies. Preliminary tests with mobile units have shown that the previously estimated average reflection coefficient on 2398 kilocycles per second was probably slightly too high, due to the presence of several near-by antenna systems, which by induction created excess sensitivity in the vertical direction. The approximately correct value for this frequency seems to be about 10^{-3} at vertical incidence. On the 17,310-kilocycle channel, it is apparent that 10^{-4} should be more nearly correct. Improved resolution should make possible an accurate determination of the reflection coefficient.

TROPOSPHERIC AIRPLANE SOUNDING COMPARISONS

By the courtesy of L. S. Adams, president, and pilot Harold Lawson, of the Tri-State Aviation Corporation, we have been enabled to make a few recordings of local atmospheric temperatures and weather

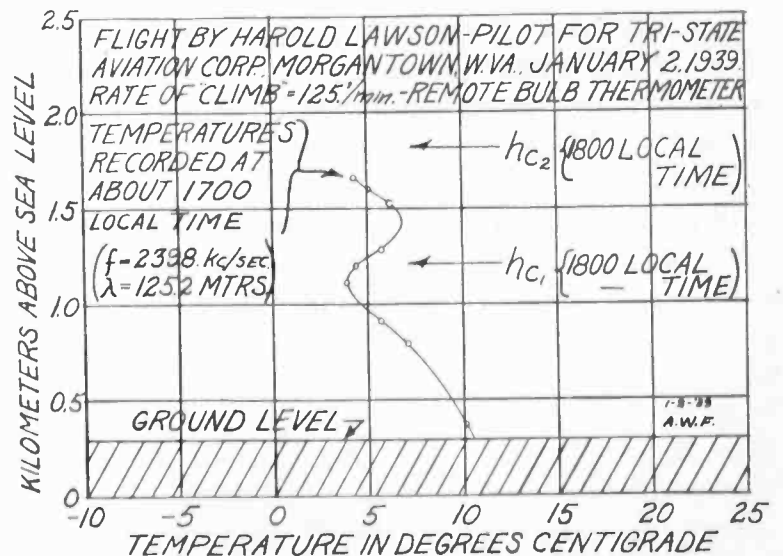

Fig. 8—A temperature—reflection-height comparison when two reflections were observed. The date is January 2, 1939. This record was also taken at Morgantown, West Virginia.

conditions, simultaneous with the tropospheric radio-wave-reflection measurements. Figs. 7 to 9 show the results obtained. It is believed that the chief source of error involved in the temperature readings, was the time lag of the thermometer. The agreement of

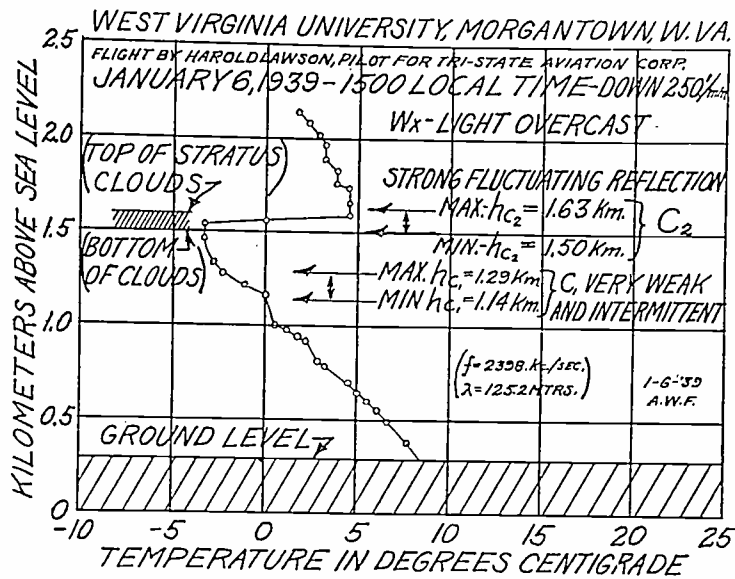

Fig. 9—A very sharp air-mass boundary condition is shown at about 1.55 kilometers elevation. This produced a very strong reflection of somewhat variable height. Below the sharp boundary, at about 1.20 kilometers, an extremely intermittent and variable weaker reflection was found as indicated in the diagram. Date—January 6, 1939. Location—Morgantown.

the two sets of data is quite evident from the figures, but it is not claimed that the total discontinuity effects were shown by the slow-reading thermometers. The humidity effects may be only guessed in an inaccurate manner by personal observations, since no fast-working indicating hygrometer was available at the appointed time. Further tests are indicated. It is believed that temperature, absolute humidity, and ionization recordings should be made in such a fashion that there will be no doubt concerning the recorded values. It is our opinion that most readings are taken far too rapidly to show the actual gradients present.

A series of rather widely spaced readings of the reflection heights taken over the period of the arrival of a cold-front air mass, is plotted against time in Fig. 10. This chart shows quite well the apparent correspondence between these reflections and air-mass boundaries.

Readings taken during overhead lightning-discharge periods, still indicate that for about 5 to 15

seconds after discharge, the reflecting region may rise and then slowly fall again to its original value. Whether this is due to thermal or electrical conditions or to both, is not known, but the effect appears to be quite real.

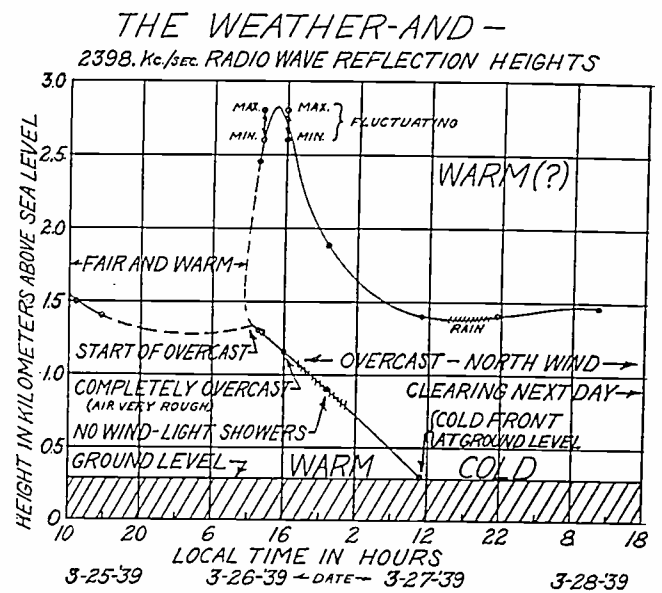

Fig. 10—The arrival and passage of a cold-front weather condition was studied by means of the reflected pulse signals on 2398 kilocycles per second. The recorded heights were plotted against time in hours. An inspection of the chart shows that even the few scattered readings taken during that period reveal quite clearly the nature of the frontal condition.

CONCLUSIONS

In the light of recent work, a few generalizations may be made concerning both the previous work and the physical nature of the tropospheric-reflection phenomena. It is believed that most reflections immediately above the 10-kilometer level, must be of ionic nature and quite erratic. It is observed that strong tropospheric reflections occur generally below about 2.0 kilometers and that the reflection coefficient is usually in the neighborhood of 10^{-3} to 10^{-5} . It is believed that most of the tropospheric reflections occur at air-mass boundaries or other similar discontinuities. Some of the early work in these investigations has undoubtedly shown only the higher weak components, while the major lower-level reflections were not resolved. Some of the intermediate-period recordings showed only the stronger lower reflections. The latest equipment appears to have eliminated many of the earlier inconsistencies; but much investigation still remains to be accomplished.

Deviations of Short Radio Waves from the London-New York Great-Circle Path*

C. B. FELDMAN†, ASSOCIATE MEMBER, I.R.E.

Summary—During the past year experiments have been made to determine the frequency of occurrence and extent of deviations of short radio waves from the North Atlantic great-circle path. For this purpose the multiple-unit steerable antenna (Musa), described to the Institute at its 1937 convention, has been used to steer a receiving lobe horizontally. This is accomplished by arraying the unit antennas broadside to the general direction from which the waves are expected to arrive. The Musa combining equipment then provides a reception lobe in the horizontal plane, steerable over a limited range of azimuth. Two such Musas have been used, one of which possesses a wide steering range but is blunt, while the other is sharp but is restricted in range. Transmissions from England have been studied with this equipment at the Holmdel, N. J., radio laboratory of the Bell Telephone Laboratories. Comparisons of results obtained on transmission from antennas directed toward New York with those from antennas otherwise directed have, to a limited degree, given results representative of the effects of horizontally steerable transmitting directivity. Observations made on these British transmissions during the past eight months have disclosed the following characteristics:

1. During "all-daylight" path conditions, the usual multiplicity of waves distributed in or near the great-circle plane, which constitutes normal propagation, has been predominant. Usually neither ionosphere storms nor the catastrophic disturbances associated with short-period fade-outs seem to affect the mode of propagation.
2. In contrast to 1, during periods of dark or partially illuminated path conditions, the great-circle plane no longer provides the sole transmission path. The extent to which other paths are involved varies greatly. Propagation during ionosphere storms of moderate intensity usually involves paths deviated to the south of the great circle, during afternoon and evening hours, New York time.

I. INTRODUCTION

OCCASIONAL evidence scattered over nearly a decade has suggested that at times anomalous effects occur in short-wave propagation. The gain of broadside receiving arrays has sometimes been found to disappear. Since a broadside array is sharply directional in the horizontal plane only, loss of gain referred to a simple antenna having similar vertical directivity focuses suspicion on the behavior of the waves in the horizontal plane. In 1928, H. T. Friis¹ reported experiments which indicated occasional deviations from the great circle of 16-meter waves from England. Miscellaneous reports of unexplained direction-finder errors have also come to light. A recent paper by Barfield and Ross² reports a study of horizontal deviations found in direction-finding work in England. Observations begun in 1935 on directional broadcast transmissions from Daventry suggested that the horizontal directivity of transmitting antennas often exercised striking

and unexpected effects upon the manner in which waves are propagated to the receiver. It is these observations, and more recent complementary studies made with horizontally steerable receiving antennas, with which this paper deals. Before describing the steerable receiving antennas and the results obtained with them, the observations made with only a simple short-wave receiver will be mentioned.

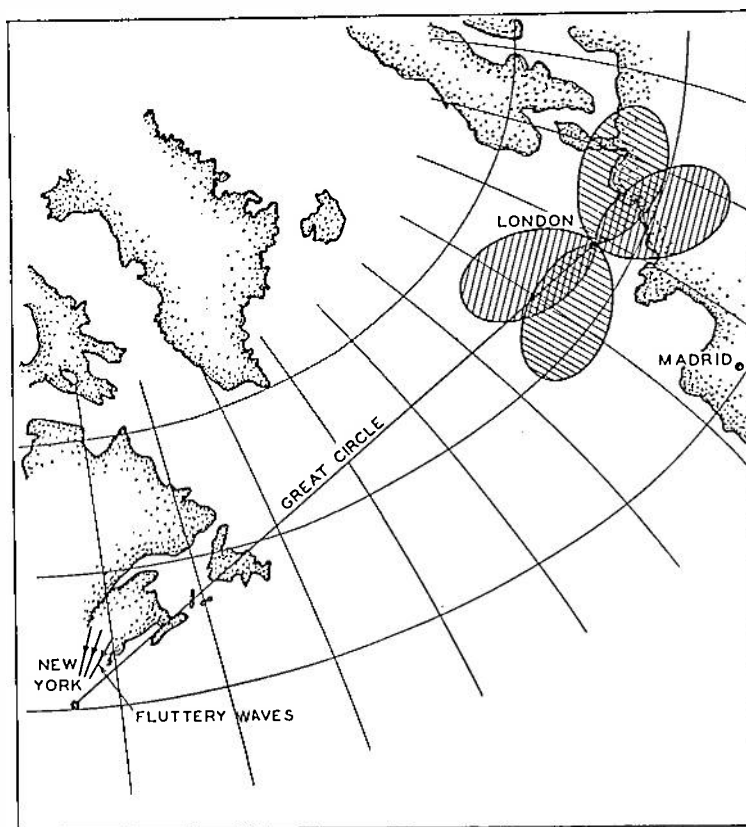

Fig. 1—Directional patterns of two British Broadcasting Corporation transmissions (9.58 and 9.51 megacycles) compared in 1936. The northerly directed antenna greatly emphasized radiation scattered from northern latitudes, and produced flutter fading.

* Decimal classification: R113. Original manuscript received by the Institute, November 17, 1938. Presented, Thirteenth Annual Convention, New York, N. Y., June 18, 1938. Abstract published in *Nature*, vol. 141, pp. 510-511; March 19, (1938).

† Bell Telephone Laboratories, Inc., New York, N. Y.

¹ H. T. Friis, "Oscillographic observations on the direction of propagation and fading of short waves," *Proc. I.R.E.*, vol. 16, pp. 658-665; May, (1928).

² Barfield and Ross, "The measurement of the lateral deviation of radio waves by means of a spaced-loop direction-finder," *Jour. I. E. E.* (London), vol. 83, pp. 98-109; July, (1938). This paper contains a valuable bibliography.

Through the courtesy of the British Broadcasting Corporation, details of the Daventry transmitting arrays, schedules, etc., employed in the short-wave broadcasts to the British Empire were currently available to the writer and his associates. The Empire broadcasts consist of several simultaneous transmissions, in different directions and on various wavelengths, carrying the same program. During the winter months of 1936, transmission 5, received here during early evening, included two frequencies in the 31-meter band, transmitted with the directional patterns shown on the great-circle map of Fig. 1. Nightly observations over a period of three months disclosed an unexpected difference between these transmissions in respect to fading. An ordinary short-wave home receiver and a simple vertical antenna were

used. During 50 per cent of the evenings, roughly, flutter fading³ was noticed. Except when the flutter was extremely violent, the transmission associated with the southward directional pattern displayed milder flutter or none at all. Since the frequency difference between these transmissions was only 70 kilocycles, it could not be expected to account for the consistent difference observed so the cause was narrowed down to either the azimuthal difference or to a difference in vertical-plane directivity. Each antenna

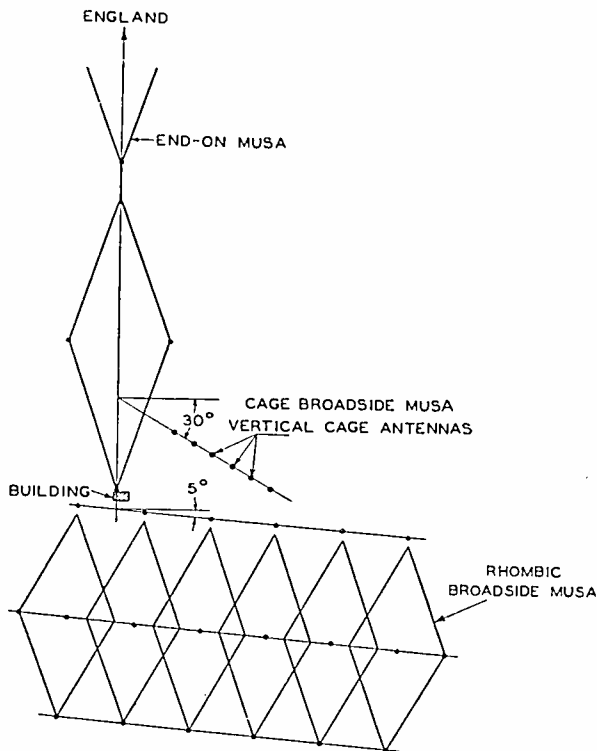

Fig. 2—Layout of steerable antennas at the Holmdel laboratory. Two of the six rhombic unit antennas of the end-on Musa are shown, in addition to the two broadside Musas, each comprising six antennas. The cage antennas are spaced 15 meters and the rhombic antennas 43 meters, center to center.

consisted of a vertical stack of four horizontal elements. The antenna associated with the flutter fading was two wavelengths high while the other was only one wavelength high, measured to the bottom of the stack. Upon being informed of the observed differences, the British Broadcasting Corporation lowered the higher antenna to one wavelength and included transmissions from both during July and October, 1936. Observations still showed the same kind of differences although in July the occurrence of flutter fading was reduced to about 20 per cent.

The inference from these observations was that the ionosphere north of the great circle was capable of deviating energy southward to New York. The fluttery character of the received signals suggested

³ By flutter fading is meant a rapid fluctuation in the signal, apparently highly selective with respect to frequency, which gives to speech a tremulous quality with a trace of gutturalness and which in its violent forms destroys intelligibility. To orchestra music it gives a quality suggestive of mandolins. Extreme examples of flutter fading may often be heard on transmissions from local short-wave broadcast stations in the skip zone. T. L. Eckersley in England has made a study of the scattered reflections within the skip zone. A recent publication of his, "Irregular ionic clouds in the E-layer of the ionosphere," appeared in *Nature*, vol. 140, pp. 846-847; November 13, (1937).

scattering. Receiving with a rhombic antenna directed along the great circle usually reduced the flutter markedly, thus suggesting that the flutter was due to waves arriving off the great circle. A rotatable direction finder of the null type (Adcock) was next brought into use. With this device the flutter could often be reduced by directing the null in a northerly direction but could not be thoroughly suppressed, thus indicating that a horizontal spread of waves to the north of the great circle, such as is shown in Fig. 1, was responsible for the flutter fading. The fact that the transmitting antennas in use at that time were bidirectional is believed to be without significance. Around-the-world echoes seldom occur in the 31-meter band and could not, in any event, be confused with flutter fading. These conclusions were later corroborated by more direct methods employing a steerable reception lobe instead of a null.

Occasionally, without relation to the occurrence of flutter fading, signals from the southerly directed antenna of Fig. 1 were stronger than those from the other antenna. These results led to further studies with the direction finder, which disclosed in 1936 and 1937 that occasionally, and particularly during ionosphere storms, signals from England appeared to arrive from directions considerably off the great circle. These deviated signals, unlike the fluttery scatterings from northern latitudes, appeared to consist of comparatively compact bundles of waves containing the principal energy, and were usually deviated south of the great circle.

It thus became apparent that short-wave propagation over the North Atlantic path does not always consist of the usual ionosphere reflections in or near the great-circle plane. Substantial departures from the great-circle multiple-hop mode, not to be expected on the basis of present ionosphere knowledge, are of general scientific interest and of engineering importance in point-to-point radio services employing directional antennas.

II. EQUIPMENT

The usefulness of the null-type direction finder is seriously impaired by the inherent low gain of such a device, which rendered its use during poor-transmission conditions difficult or impossible. Then too, the null method of rejecting waves from a particular direction is not a desirable means of studying the usefulness of deviated waves. The preferred way of studying azimuthally deviated waves is by means of a horizontally steerable lobe such as may be obtained by the Musa principle. Since the phasing equipment and other apparatus associated with the end-on Musa⁴ were available at the Holmdel laboratory there remained only to design and erect the antenna structures, in order to provide horizontal steering. Two

H. T. Friis and C. B. Feldman, "A multiple unit steerable antenna for short-wave reception," *Proc. I.R.E.*, vol. 25, pp. 841-917; July, (1937).

steerable systems were accordingly built and put into operation early in 1937. Fig. 2 shows the layout of antennas. A photograph of the cage broadside Musa appears in Fig. 3. Eight cages are discernible in the photograph; one at each end is used as a dummy to reduce end effect. The dummies supply the coupling to make the mutual impedance between the antennas of various adjacent pairs more nearly uniform. The antennas are connected directly to six buried coaxial transmission lines of equal length, which

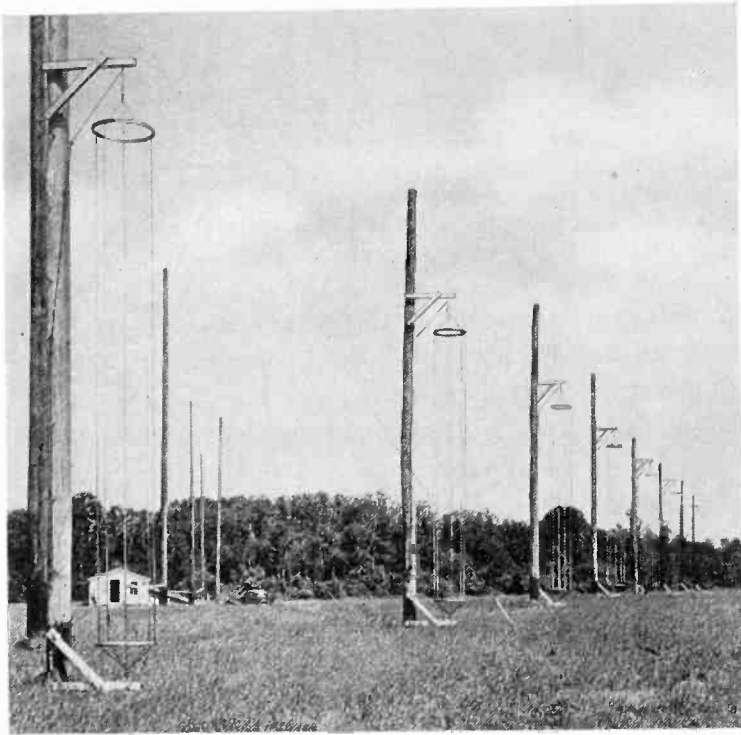

Fig. 3—The cage antennas comprising the wide-range broadside Musa. The end cages are used as dummies.

appear on the Musa high-frequency bay shown in Fig. 4. The cage structure reduces the impedance variation with frequency, compared with what it would be with single-wire antennas. The quarter-wave resonant impedance is of the order of 50 ohms; the half-wave impedance is about 360 ohms and occurs at a wavelength of about 19 meters.

The six antennas comprising the rhombic broadside Musa are equipped with matching transformers and equal-length buried coaxial lines which also appear on the Musa high-frequency bay. These antennas, which are terminated to be unidirectional, are slightly tilted sidewise and overlapped. This yields a better alignment between the unit antenna pattern and the Musa array factor. No dummies are necessary, the mutual impedance, or "cross talk," being satisfactorily small.

For the sake of brevity all discussion of Musa apparatus will be referred to a previous paper⁴ by H. T. Friis and the present author. It will suffice here to say that the outputs of the six unit antennas comprising a Musa can be phased to add for a particular direction and that this direction may be varied by varying the phasing. A schematic diagram of the

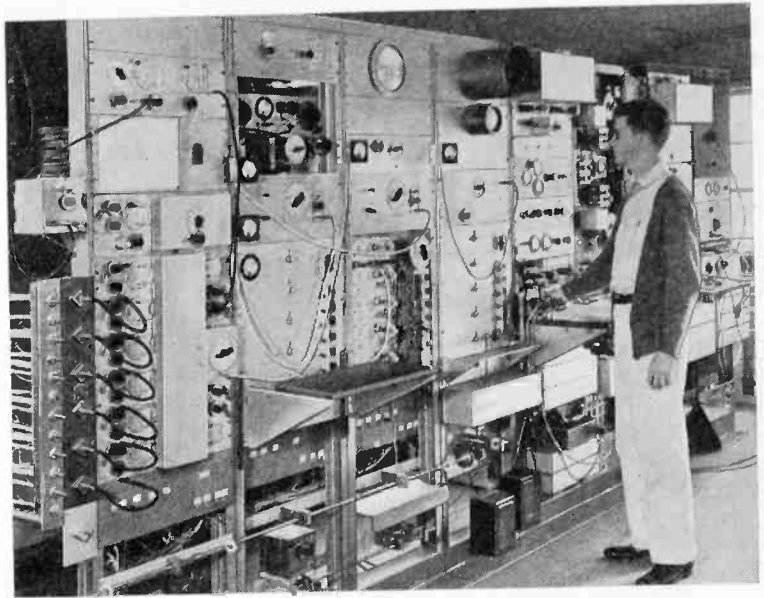

Fig. 4—View of experimental Musa receiving equipment. The three sets of transmission lines from the three Musas terminate in coaxial jacks and can be connected, one set at a time, to the receiver input circuits by means of coaxial patching cords shown at the left. Mr. Edwards, who was closely associated with the work, appears in the photograph.

receiving apparatus appears in Fig. 5. Three independently steerable branches are obtained from one Musa by paralleling three sets of phase shifters. One set comprises the exploring or monitoring branch whose output appears on a cathode-ray oscilloscope. The other two are used for reception and are steered in accordance with wave directions shown by the exploring branch. When two separable wave paths occur their relative delay may be measured by steering one branch at one wave and the other branch at the other, and adjusting the audio-frequency delay until the delays are equal as evidenced by a straight line on a second cathode-ray oscilloscope.

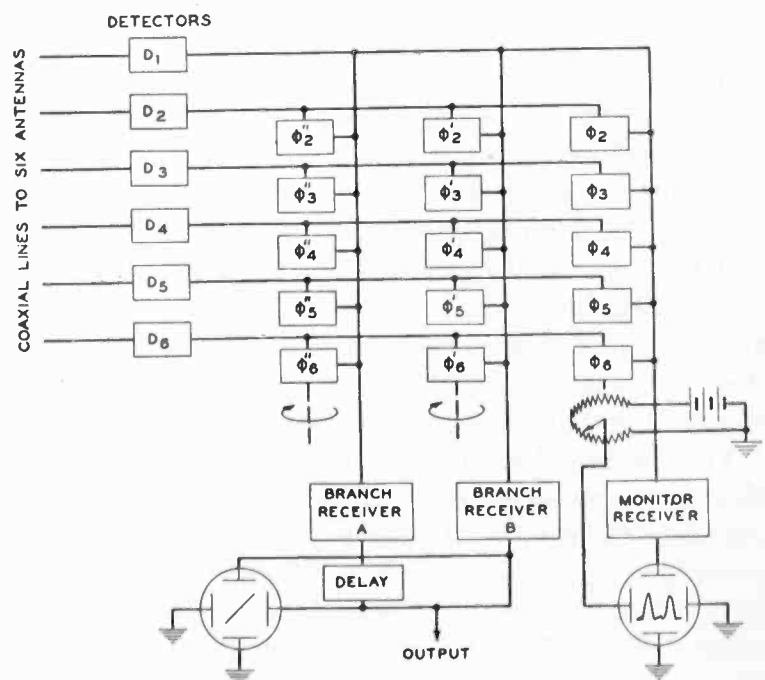

Fig. 5—Schematic of Musa receiving apparatus. The detectors translate the incoming frequency to an intermediate frequency at which the phasing is accomplished. The rotatable phase shifters ϕ_2, ϕ_3 , etc., of each group are geared together in multiple ratios. The two receivers *A* and *B* are usually used with a diversity connection, i.e., common automatic gain control.

The cage broadside Musa was designed to have the highest directivity consistent with single-lobed, unambiguous response. The highest frequency for which the multiple lobes disappear is that for which the antenna spacing is a half wavelength. Since 30-meter wavelengths were much used for night transmission the spacing was made 15 meters. A family of calculated horizontal-plane directional patterns is

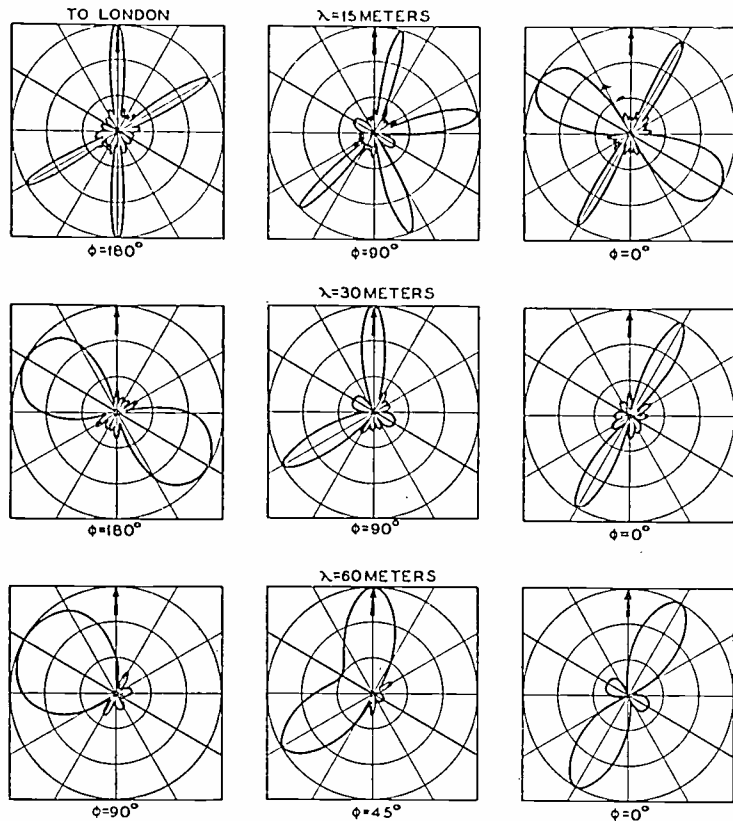

Fig. 6—Sample horizontal-plane directional patterns of the cage broadside Musa showing voltage response versus azimuth. ϕ is the fundamental phase shift (ϕ_2 of Fig. 5) which is varied to steer the array. The axis of the array is the heavy line broadside to a direction 30 degrees south of the great-circle direction to England. More desirable patterns are obtained for directions southward of England by means of this 30-degree offset.

shown in Fig. 6. Aside from the bidirectional characteristic which produces a mirror image symmetrical with respect to the array axis, the response is single-lobed for wavelengths of 30 meters and longer. At 16 meters some ambiguity exists. For instance, a wave at 60 degrees south of the great-circle bearing is indistinguishable from a great-circle wave. These multiple lobes are present in one Musa branch and are not to be confused with other lobes separately obtained in other branches.

The rhombic broadside Musa was designed to provide extreme directivity and high discrimination (freedom from minor lobes) together with moderate steering range. The spacing of 43 meters, obtained by overlapping the rhombic antennas, yields only one major lobe within the range defined by the major lobe of the unit rhombic antenna. This range is between 1 degree north and 11 degrees south of the great circle at 16 meters wavelength and widens approximately linearly with wavelength. Fig. 7 shows horizontal patterns of the rhombic antenna for two

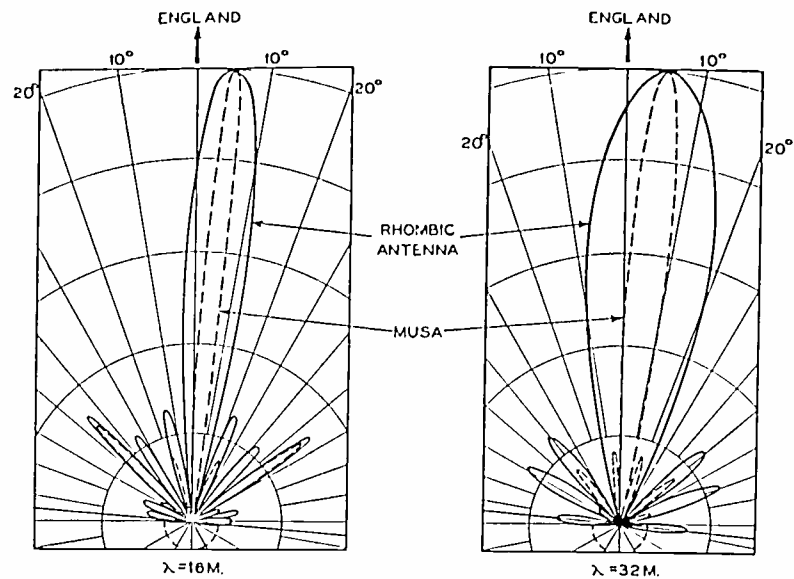

Fig. 7—Sample directional patterns of the rhombic broadside Musa. The steering range is confined to the range defined by the rhombic antenna patterns which are here shown for typical vertical angles.

wavelengths, together with the corresponding Musa patterns steered broadside, i.e., five degrees south of the great circle to England.

The cage broadside Musa was thoroughly tested with a field oscillator at wavelengths in the range from 14 to 62 meters and was found to measure bearings correctly within ± 0.5 degree under such conditions. Other tests indicated that the performance of both systems would be as calculated. Nevertheless, the fact that two almost completely different systems were available to cross-check each other has been valuable in giving credence to the results.

Before dealing with the results obtained with this equipment certain shortcomings inherent in linear arrays will be discussed. The principle of phasing a linear array for maximum response to a wave at a particular direction in space enables a measurement to be made of one direction component, the direction-angle θ in Fig. 8. An end-on Musa determines a false vertical angle if a horizontal deviation is present, i.e., if the Musa is not horizontally end-on. Likewise, a broadside Musa determines a false azimuth (other

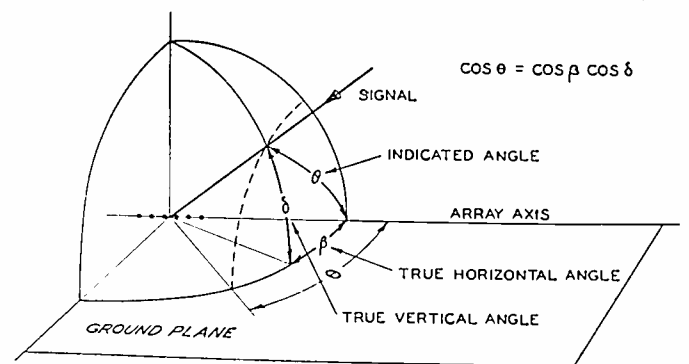

Fig. 8—The geometry of wave-direction determination with linear arrays.

than a true broadside azimuth) if the wave direction has a vertical component. The geometrical factors involved in these errors are shown in Fig. 8 together with the equation of the spherical triangle concerned.

The errors in vertical angles indicated by the end-on Musa are plotted in Fig. 9, and Fig. 10 gives the bearing errors due to vertical angles for the cage broadside Musa. It is apparent, therefore, that to determine the direction of a path in space two coordinates must be measured, such as may be obtained with two differently oriented linear arrays. However, since the cage broadside Musa is oriented 30 degrees south, indicated southern deviations in a range centered around 30 degrees south are not much in error on account of ordinary vertical angles. Corrections, therefore, need be made only to the end-on Musa determinations. Such corrections have occasionally been made but usually the data are left in the form of the indicated values.

As a final commentary on the measuring technique it may be stated that the measured directions are the directions of phase propagation; i.e., they determine equiphase planes or wave fronts. For wave motions supported by free space, i.e., in regions remote from the ionosphere, the direction of phase propagation coincides with the direction of energy flow. Thus, measured deviations from the great circle possess the reality of involving geographically deviated energy flow.

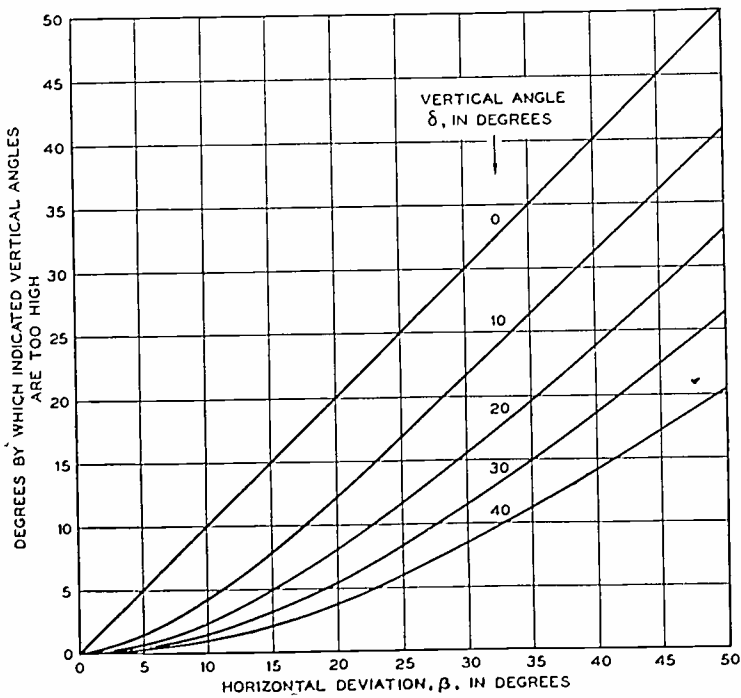

Fig. 9—Errors in vertical-angle determination if the wave direction does not lie in the vertical plane containing the linear array.

III. RESULTS

It was recognized early in the work that on account of the many and varying factors involved, it would be difficult to make significant interpretations of the observed effects and that a written log would not alone be an adequate record of results. A procedure was adopted in which two observers were always present. One kept a detailed log and manipulated the equipment. The other observer, free of responsibility as to those details, was thus in a position to weigh

the observations and make decisions as to the next move. No attempt was made to accumulate vast quantities of data by routine methods or automatic means, to be subjected later to statistical analysis. Phonograph recordings were made of especially striking aural phenomena.

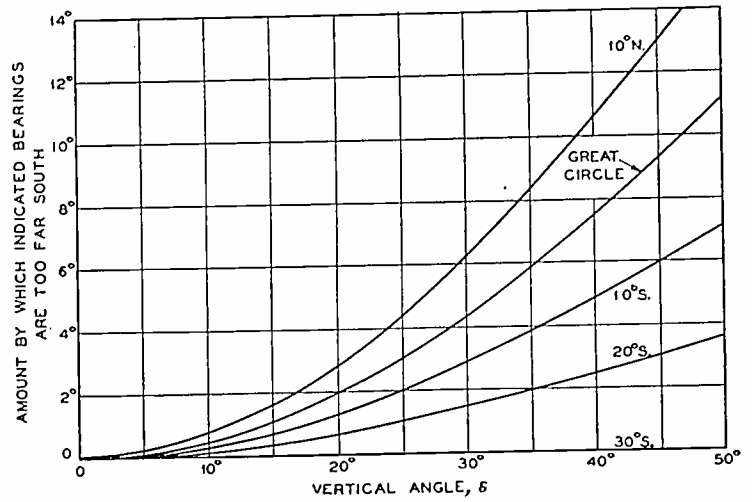

Fig. 10—Errors in horizontal-angle determination due to vertical angle. The bearings refer to north or south of the great circle to England for the cage broadside array disposed as in Fig. 2.

Review of the results of the past years' work seems to establish the following characteristics of propagation over the North Atlantic path:

1. During "all-daylight" path conditions, the usual multiplicity of waves distributed in or near the great-circle plane, which we define as normal propagation, has been predominant. Usually, neither ionosphere storms nor the catastrophic disturbances associated with short-period fade-outs seem to affect the mode of propagation.
2. In contrast to 1, during periods of dark or partially illuminated path conditions, the great-circle plane no longer provides the sole transmission path. In general, the extent to which other paths are involved varies greatly. Outstanding phenomena in these periods are the southerly deviated wave paths found during ionosphere disturbances, which fall sometimes in (b) and sometimes in (c), below.

(a) Usually, transmission from misdirected antennas is accompanied by weak and scattered waves arriving off the great circle, in addition to normally propagated waves. Transmissions which emphasize radiation to the north especially exhibit such scatterings, arriving from north of the great circle with a considerable azimuthal spread. Acceptance of these scatterings by the receiving antenna results in flutter fading.

(b) A considerable number of instances have been observed in which the ionosphere behaves as though it were warped with a resulting shift of the wave path, sometimes to

- the north and sometimes to the south, with little regard to the transmitting directivity.
- (c) Not uncommonly, the transmission medium displays more complex characteristics in that several azimuthal routes exist. None of these routes show scattering, which distinguishes this case from that of (a). The route selected by the waves depends in part upon the transmitting antenna. Under these circumstances, transmitting antennas directed, say, 20 or 30 degrees off the great circle produce received waves, with substantial deviations to the corresponding side of the great circle.
- (d) Upon rare occasions, propagation during periods of dark or partially dark path conditions is entirely normal. That is, occasionally, propagation during dark-path conditions is, like daylight propagation, normal. The waves then travel in or near the great-circle plane and are unaffected by the transmitting antenna directivity, except in amplitude.

Discussion of Daylight Propagation (1) Above

Our experience with all-daylight paths during morning and early afternoon, New York time, has been confined mainly to 18-megacycle reception from Rugby since at those times Daventry uses antennas directed away from New York and has, since early 1937, used reflectors. These observations, extending back to 1935, and including those made with the end-on Musa before the broadside Musas were available, cover about 20 ionosphere storms. In most of these, field depressions occurred during morning hours, a few being very severe. During strictly all-daylight conditions but few abnormalities⁵ in propagation have been suggested. Occasionally, during depressed field conditions, deviations up to 12 degrees south have been found and fluttery scatterings from northerly directions have appeared in several instances. Several short-period fade-outs,⁶ which are daylight phenomena, have been observed; in two cases the decline as well as the return of the signal was observed. No change in vertical angle or azimuth occurred, the phenomena consisting solely of a shrinkage of field intensity. Ionosphere storms are accompanied by a shrinkage in field intensity, of course, and while high-frequency propagation usually remains otherwise normal during the morning, the approach of the shadow wall in England frequently

⁵ Around-the-world echoes, which often occur on the high frequencies in winter mornings, are not considered abnormalities and are disregarded in this paper.

The all-daylight periods in the ionosphere are approximately from 2:30 A.M. to 7:00 P.M., E.S.T., in June, from 4:30 A.M. to 2:30 P.M. in March and September, and from 6:00 A.M. to 12:30 P.M. in December.

⁶ J. H. Dellinger, "A new radio transmission phenomenon," *Phys. Rev.*, vol. 48, p. 705; October 15, (1935).

marks the end of the useful period for the high frequencies on disturbed days. The destructive agency is a kind of scattering which sometimes is so complete that both the end-on and broadside Musas show no marked paths but instead give equal and fluttery outputs over their entire angle range. On a few occasions scattering of 18-megacycle signals from Rugby has occurred before the shadow wall reached the path; once, on July 15, 1938, it occurred several hours before. The recovery of such scattered signals by directional-antenna gain is manifestly impossible and lower frequencies must be invoked to realize directivity gain. Their behavior, when all-daylight conditions no longer prevail is subject to many variations and will be discussed in the next section.

Our experience relating to shadow-wall phenomena is confined mainly to the approach of darkness rather than its departure. The few observations made before dawn were in undisturbed periods on a frequency of 15 megacycles. Five 5-hour periods beginning at 4:00 A.M., E.S.T., were observed in September, 1937. During these tests a single wave characterized the propagation before dawn, with additional waves appearing after dawn. On September 15 a fade-out of short duration took place. We observed the abrupt return of normal signals at about 4:20 A.M., E.S.T.

The great-circle multiple-hop mode of propagation usually observed during all-daylight-path periods with 18-megacycle signals, appears to be properly ascribable to the light conditions along the path rather than to the fact that the observed signals were of high frequency. During the summer of 1937 many abnormalities in propagation were observed on high frequencies (15 megacycles) during evening hours.

Discussion of Nondaylight Propagation (2) Above

By way of illustrating the characteristics listed under (2) a few observation periods will be recounted in some detail. In order to help in evaluating the significance of the observed effects, reference will sometimes be made to the commercially operated London-New York radiotelephone circuits. The condition of these circuits is taken as a standard with which to compare Daventry-Holmdel circuits in which some degree of steerable transmitting directivity is simulated by the Daventry antenna selection.

On the afternoon of November 30, 1937, an ionospherically disturbed day, 9-megacycle transmission from Rugby exhibited rather striking behavior. The following description of the observations portrays also the state of development of the measuring art. Beginning⁷ at 4 P.M. a compact wave bundle was received at a true vertical angle of about 19 degrees and a southerly deviation of 10 degrees. By 4:30 the vertical angle had risen to 23 degrees and the southerly deviation had increased to 16 degrees. By 4:50 the vertical angle reached 35 degrees and the azimuthal deviation had gradually disappeared. During the time the deviation was greatest the cage broadside Musa gave a somewhat better signal-

⁷ All times are given in Eastern Standard Time. -

to-noise ratio than a rhombic antenna directed along the great circle.

At 8 p.m., when observations on Rugby were resumed, the end-on Musa showed two wave bundles at 14 degrees and 21 degrees (not true vertical angles) while the broadside Musa showed what were presumably the same two bundles arriving 2 degrees and 12 degrees south of the great circle. A distinct appearance of flutter components was also observed at 20 degrees to 30 degrees north using the cage broadside Musa.

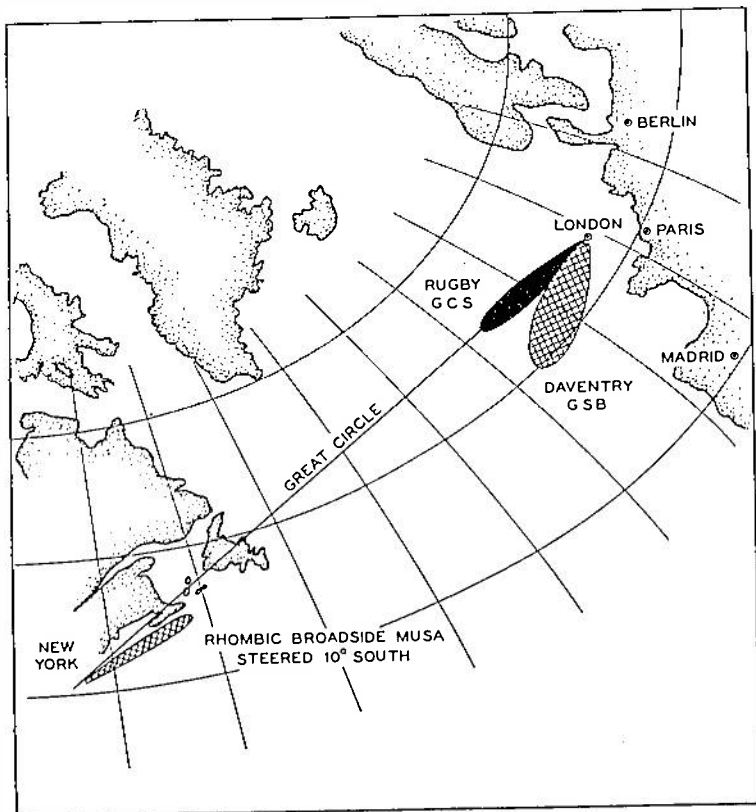

Fig. 11—Great-circle map illustrating the antenna directional patterns involved in a comparison in which GSB was greatly to be preferred over GCS in respect to fading.

At 9 p.m. a series of comparisons between Rugby on 9 megacycles and Daventry on 9.5 megacycles was commenced. The Daventry antenna⁸ was directed at 260 degrees as shown in Fig. 11. Daventry and Rugby had approximately the same field intensity and gave the same vertical and azimuthal angles. The end-on Musa showed 15 degrees to 18 degrees while the broadside Musa showed 9 degrees to 12 degrees south. A striking difference was noticed, however, in that Rugby showed more bundle spread and faded more violently and rapidly than Daventry, both being received with the rhombic broadside Musa. This difference, and also the similar directions of arrival persisted through several comparison cycles up to 11 p.m. During this time the Rugby transmission received at the commercial receiving station of the American Telephone and Telegraph Company was scarcely of commercial grade.

When the transmitting antenna directivity employed at Daventry is appropriate the characteristic mentioned under (c) above is often well enough developed to show two paths sufficiently different in azimuth to be separable by one or the other of the broadside Musas. The difference in the transmission time along such paths has sometimes been determinable by the method of audio-frequency delay equalization. These determinations are given in Table I.

Several instances appear in Table I, in which the two waves of different azimuth were separable with the end-on Musa and could be identified as the same waves by their equal delay differences.

⁸ A second synchronized transmitter using a similar antenna directed at 306 degrees was also used but is believed to have no significant effects upon the observations, since only southerly waves occurred.

TABLE I

Date	E.S.T.	Station			δ_1	δ_2	β_1	β_2	Delay milliseconds
		Call	Frequency megacycles	Array direction*					
1937									
May 28	7:54 P.M.	GSB	9.51	260°	11°	43°	2°S.	40°S.	1.50
Aug. 2	7:20 P.M.	GSF	15.14	260°			4°S.	34°S.	3.35
Aug. 2	9:10 P.M.	GSB	9.51	260°			8°S.	3°N.	1.00
Aug. 27	9:30 P.M.	GSB	9.51	260°			5°S.	19°S.	0.85
Nov. 19	4:10 P.M.	GSD†	11.75	260°/294°	9°	16°	7°N.	7°S.	1.35
Nov. 19	10:25 P.M.	GDS†	6.905	288°			4°N.	18°S.	0.80
Nov. 23	4:35 P.M.	GSD†	11.75	260°/294°			4°N.	12°S.	1.40
Nov. 23	8:00 P.M.	GSD†	11.75	294°	2°	21°	1°N.	9°S.	0.47
Nov. 23	9:00 P.M.	GSB†	9.51	260°/306°			2°N.	14°S.	0.94
Dec. 18	8:20 P.M.	GSC	9.58	294°			0°	30°S.	2.70
Dec. 21	7:00 P.M.	GSC	9.58	294°	13°	22°	5°S.	8°N.	0.54
1938									
Apr. 15	9:00 P.M.	GBS†	12.15	288°	11°	26°	0°	8°S.	1.40

E.S.T. = Eastern Standard Time.
 δ_1 and δ_2 = "vertical" angles measured with end-on Musa.
 β_1 and β_2 = "horizontal" angles measured with broadside Musa in degrees north (N) or south (S) of the great circle.
 Delay is in all cases inserted in the path denoted by the subscript 1. It therefore is the shorter path in point of time.
 * The direction to New York is 288 degrees (measured clockwise from north).
 † Two synchronized transmitters.
 ‡ Rugby.

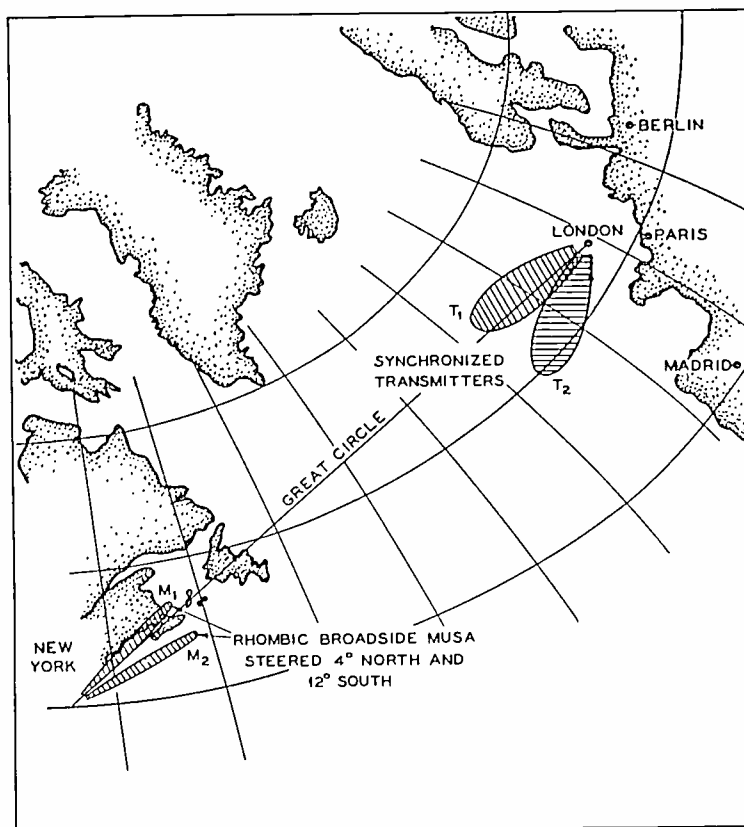

Fig. 12—Great-circle map illustrating the experiment of November 23 in which transmission from T_1 and T_2 could be separately received by Musa branches M_1 and M_2 and identified by a reversal of the audio-frequency inputs to T_1 and T_2 .

The data given in the table for November 23 at 4:35 p.m. are especially interesting. Fig. 12 illustrates the experiment.⁹ The Musa receiving equipment used in this experiment was so phased and wired that when two waves from the same transmitter could be separated and delay equalized, the audio-frequency outputs derived from the two paths added in phase. On November 23, equalizing the delay resulted in phase

⁹ In this and subsequent plots of array patterns with synchronized transmitters operating at the same frequency the separate array patterns are shown. The actual resultant pattern depends upon the spacing and phasing of the arrays but is characterized by possessing many lobes in the range where the patterns overlap. These lobes are but slight undulations except where the amplitudes of the separate patterns are comparable. While such lobes make the directional pattern undesirably complex we are unable to attribute any observed phenomenon to them.

opposition of the audio-frequency outputs. The implication here is that the 4-degree north wave came from the 294-degree transmitter T_1 and the 12-degree south wave came from the 260-degree transmitter T_2 , and that the audio-frequency inputs to these synchronized transmitters were "reversed." On other occasions, before and after the 23rd, phase addition occurred when two azimuthally different waves were received from synchronized transmitters. Assuming that the two waves again came, respectively, from the two transmitters, the inference is that the audio-frequency inputs were not reversed. An additional bit of evidence for reversed audio-frequency inputs on November 23 is that the quality, receiving GSD in the normal way with a broad antenna, was noticeably lacking in low frequencies. Information received from the British Broadcasting Corporation indicates that the above deduction is a possibility, since the two transmitters are similar and the polarity of one of the audio-frequency patches may have been accidentally reversed on the 23rd.

Excepting the northern scatterings mentioned in (a), substantial deviations to the north have been rare, but large deviations to the south, such as the 30- to 40-degree values in the table, have been found frequently. Southern deviations appear to be associated with ionosphere storms. In storms of moderate severity southern deviations appear with noticeable consistency, even on Rugby transmission directed sharply to New York. Under such circumstances Daventry transmissions to the West Indies have been received better with the low-gain broadside Musa steered, for instance, 60 degrees south of the great circle, than a transmission in the same wave band directed to New York and received with a rhombic antenna directed towards England. Under normal conditions the superiority is reversed, of course. This association of large southerly deviations with ionosphere storms may subsequently be found to be confined to storms of moderate intensity, for, in a ten-day storm of extraordinary severity in January, 1938, substantial southerly deviations occurred only during the first and last days of the storm. During the intervening days only small southerly deviations occurred.¹⁰ The following descriptions of observations made on January 18 and 19 illustrate the mid-storm conditions.

January 18 (Earth currents comparatively quiet). Observations made on 18-megacycle transmissions from Rugby during the morning showed normal great-circle propagation and low field intensity. Rugby circuits employing double sideband were decidedly too poor for commercial use although a single-sideband circuit was at times of commercial grade. Two great-circle paths with vertical angles of about 14 and 22 degrees were usually present. By early afternoon the circuit had deteriorated further, so much that at times contact with England was lost. Observations were attempted on a Daventry transmission on 15 megacycles (GSP) directed toward New York and eastern Canada. Somewhat scattered and fluttery waves, spread between 5 degrees and 10

degrees north of the great circle, were observed. The field intensity varied greatly but on the whole became higher as the afternoon progressed. Scattering in the vertical plane was less than in the horizontal plane, the end-on Musa indicating a spread between 10 degrees and 13 degrees.

Beginning at 4:15 P.M., two 9.5-megacycle Daventry transmissions, one directed toward New York and eastern Canada (GSC), the other toward the West Indies (GSB), were compared. (This procedure, in which the southerly directed transmitting antenna could be compared with a great-circle antenna in an effort to evaluate southerly deviated paths, had become an established routine.) Rugby was providing double-sideband circuits on 10 and 7 megacycles which were intermittently of commercial grade. GSB at first displayed weak and fluttery waves in the vicinity of 15 degrees north and 40 degrees south of the great circle. GSC yielded a great-circle wave about 15 decibels stronger than the sum of the GSB waves. Both transmissions suffered from rapid fading, the northerly path from GSB fluttering violently. Later, the northerly and southerly deviated waves disappeared leaving a weak great-circle wave from GSB. A single bundle appeared in the vertical plane at an angle of about 28 degrees. Fading continued to be rapid and was worse on GSB. Field intensities were depressed moderately. Observations were next made on a 6.9-megacycle transmission from Rugby. A moderately depressed field was encountered and a small northerly deviation (up to 8 degrees) was observed. Considerable bundle spread was indicated by the end-on and broadside Musas, the former showing a spread of 5 degrees at about 30 degrees vertical angle. Fading became more rapid and by 7:30 had become decidedly fluttery. Observations on this Rugby transmission were abandoned in favor of a comparison between the 9.5-megacycle Daventry transmissions which again employed the antennas in use at 4:15 P.M. Both transmissions showed slight northerly deviations, GSC being much stronger than GSB but also possessing worse fading. A 9-megacycle transmission from Rugby appeared to be superior to both GSC and GSB in respect to fading.

January 19 (Earth currents comparatively quiet). During the morning of this day 21 megacycles was found to be definitely superior to any lower frequency and Rugby provided a circuit on this frequency which was intermittently of commercial grade. Propagation was substantially on the great circle with vertical angles in the vicinity of 14 degrees and sometimes 19 degrees. The field intensity varied widely. Occasionally, strong fluttery waves appeared from northerly directions (centered on about 20 degrees north). Steering the rhombic broadside Musa 5 degrees south accomplished complete rejection of the flutter, while the end-on Musa output occasionally suffered from it slightly. By 11:45 this frequency became lost in the noise and for nearly two hours no circuits existed. By 2:30 it appeared that 15 megacycles was the most favorable frequency; Rugby was providing an intermittently commercial circuit on this frequency using single sideband. Observations were made at 2:30 on a 15-megacycle Daventry transmission (GSP) directed toward New York and eastern Canada, and later, on a 15-megacycle single-sideband circuit from Rugby. Until 4:15 when other frequencies were observed, the propagation on 15 megacycles was normal but the fields were very weak. No azimuthal deviations occurred and normal vertical angles and slow fading were found. At 4:15 the 9.5-megacycle Daventry transmissions directed toward New York (GSC) and toward the West Indies (GSB) were observed. A path which at the beginning was 10 degrees north, but which later shifted to about 5 degrees south, dominated the propagation although GSB showed, in addition, weaker and widely deviated southerly paths. Fading was slow. The field from GSC was weak but that from GSB was 10 to 15 decibels weaker. Rugby had abandoned 15 megacycles and was unsuccessfully attempting to provide a circuit of commercial grade on 9 megacycles. At 6 P.M. this transmission was observed. Some azimuthal spread and a slight southerly deviation were found. The end-on Musa showed wave bundles at 17 degrees and 26 degrees. At 6:30 Rugby substituted 6.9 megacycles with better success. Observations on this transmission until 8 P.M. showed notable deviations to the north of the great circle. At times clear patterns indicating 35 degrees north were observed but frequently a spread from 30 degrees or 35 degrees north to 0 degrees appeared, due presumably to the emphasis given by the Rugby array to directions nearer the great circle. Although southerly deviations of this order have been observed on Rugby transmissions frequently, this is the only recorded instance of a large northern deviation occurring, without the benefit of northerly directed transmitting antennas.

The following description of observations made on the last day of the storm illustrate the southerly deviations which have characterized milder ionosphere storms before and after that of January, 1938.

¹⁰ This statement neglects weak and unimportant waves of wide southerly deviation which sometimes were found to accompany great-circle waves when southerly oriented transmitting antennas were being used.

January 25 (Largest earth-current variations recorded during the storm; also record-breaking auroral displays observed in Europe; ground-return telegraph service disrupted). Observations were made on 18 megacycles from Rugby from 10:00 A.M. to noon. During that time propagation was normal except that strong fluttery waves appeared between 15 degrees and 20 degrees north. The end-on Musa effectively discriminated against these waves. The field was generally low. By 1:00 P.M. when observations were resumed the signal was arriving from about 20 degrees south of the great circle and was fluttering violently. Rugby next attempted to use 12 megacycles but without success. This signal fluttered violently and was either highly scattered or widely deviated since a rhombic antenna showed no gain over a vertical cage. In the light of the 20-degree south deviation of 18 megacycles and the wide south deviation of 9.5 megacycles observed later it is likely that a south deviation rather than severe scattering was occurring. No Musa observations were made; instead we

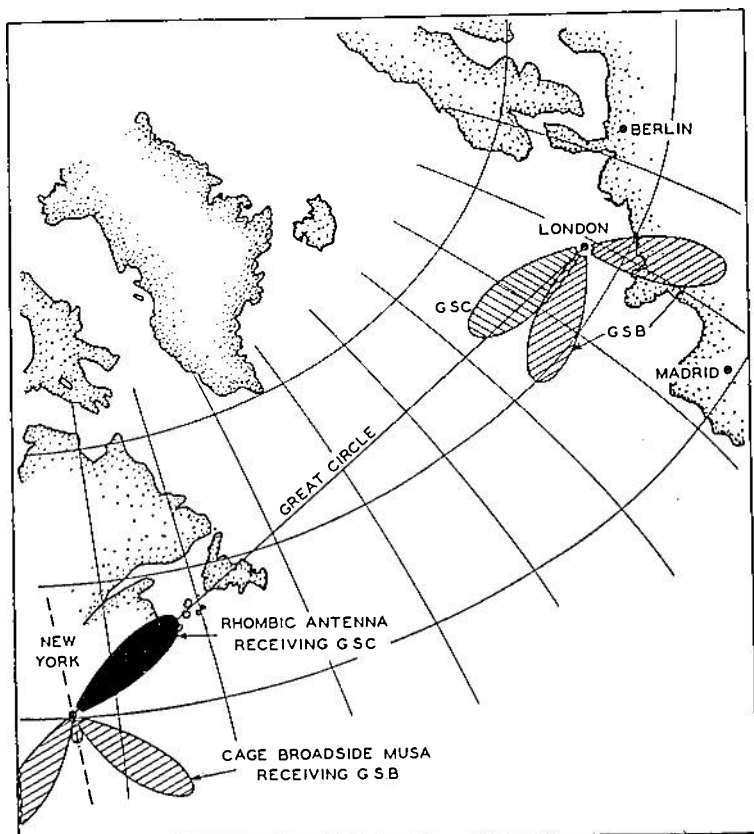

Fig. 13—Antenna layout for an experiment performed during a severe ionosphere storm (January 25, 1938). With the GSC—rhombic-antenna combination the broadcast was lost in the noise. Receiving GSB with the cage broadside Musa steered 75 degrees south of the great circle resulted in a fairly intelligible circuit.

attempted to observe the 15-megacycle transmission from Daventry (GSP). From 2:20 when the Musa receiver was tuned, until 4:00 P.M. when the attempt was abandoned, it was impossible to identify GSP and no results were obtained. In the meanwhile Rugby had attempted to use 15 and 12 megacycles with no more success. At 4:15, following established custom, the 9.5-megacycle Daventry transmissions directed toward New York (GSC) and toward the West Indies (GSB)¹¹ were compared. GSB exhibited a path in the vicinity of 75 degrees south of the great circle with some horizontal spread but free of flutter fading. GSC showed a similar widely deviated wave of greatly reduced amplitude and suffering from violent flutter fading. GSC could be identified only because a crystal beating oscillator and a carrier filter of 50 cycles width were available; the sidebands were completely lost in noise. By steering the cage broadside Musa 75 degrees south the speech program could be heard and was largely understandable. The arrangement illustrated in Fig. 13 was employed for an hour. At no time was the program from GSB lost; at no time did the rhombic antenna receiving GSC yield anything but noise. Not infrequently, before this January storm, the great-circle antenna combination comprising GSC and the rhombic antenna was found to be slightly inferior to the cage broadside Musa-GSB combination, in respect to noise, despite the fact that the nominal directivity

¹¹ In this transmission (No. 4B) GSB comprises two synchronized transmitters, the second one directed toward East Africa. It is not likely that the second transmitter contributed to reception here, however.

gain of the rhombic antenna exceeds that of the cage broadside Musa¹² by about 5 decibels. Such a condition occurred on the first day of the January storm when GSC again succeeded in transmitting only a weak southerly deviated wave. Reception from GSB with the cage broadside Musa steered 60 degrees south was definitely superior to reception from GSC with the rhombic antenna.

During the evening of the 25th all signals were so far lost that no observations could be made. On the following day the storm abated but southerly deviations up to 35 degrees were observed before normalcy was restored.

Following this storm there were no others affecting the North Atlantic path severely until April 15. A 12-megacycle transmission (GBS) from Rugby was observed during the afternoon. Until midafternoon a weak great-circle wave with a vertical angle of about 17 degrees predominated. Later in the afternoon, however, the great-circle path nearly disappeared in favor of a southerly deviated path. This path, at about 60 degrees south of the great circle, completely dominated the propagation. Figs. 14A and 14B illustrate a comparison which was made then. The signal-to-noise ratio obtained by steering 60 degrees south

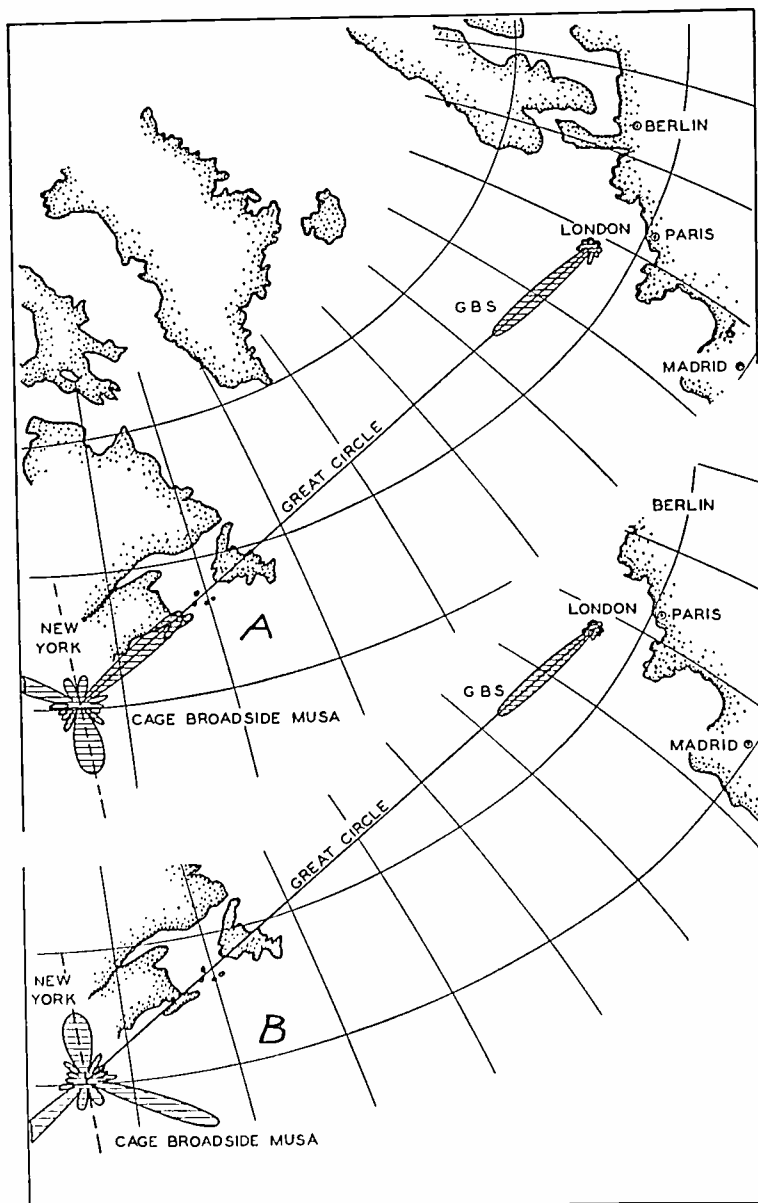

Fig. 14—During the ionosphere storm of April 15 reception from GBS via the cage broadside Musa gave a signal-to-noise ratio 12 decibels higher when steered 60 degrees south (B) than when steered toward London (A).

¹² The power advantage of the rhombic antenna over the cage Musa is considerably more than 5 decibels but the directivity advantage only is pertinent when static is the dominating noise, as it is always on 9.5 megacycles.

was about 12 decibels higher than that obtained by steering along the great circle. Fading was normal in character for both routes.

During the summer of 1937 Daventry provided three simultaneous transmissions in the 15-megacycle band, directed at New York (294 degrees), the West Indies (260 degrees), and South America (222 degrees). During disturbed conditions, the 260-degree transmission was often superior to the 294. Occasionally, the broadcast to South America was best. The superiority could sometimes be observed to shift successively to the more southerly transmissions and gradually to return, in the course of a few hours.

To conclude this chronicle of observations it may be said that wide southerly deviations, up to about 75 degrees, have been found throughout the frequency range from 5 to 15 megacycles. Substantial southerly deviations were sometimes found to occur at the same time on widely different frequencies. Instances of simultaneous deviations of the order of 30 degrees have been observed on 9, 7, and 5 megacycles.

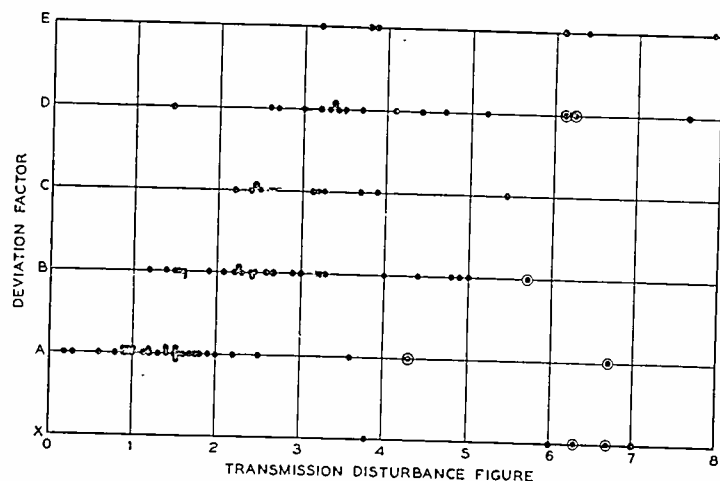

Fig. 15—Plot of deviation-factor-versus-transmission-disturbance figure. The data cover the period from May 28, 1937 to September 30, 1938. The data for the middle period of the January, 1938, ionosphere storm are distinguished by the circles.

A graphical representation of the relation between horizontal deviations and ionosphere disturbance has been attempted in Fig. 15. As explained below, a letter designating the importance of horizontal deviations was assigned to each day on which comprehensive observations were made during afternoon or evening hours (or both). This is plotted against the corresponding transmission-disturbance factor,¹³ which is computed daily from field-intensity measurements made with a "nondirectional" receiving antenna, on Rugby transmissions. The letter *A* denotes that no deviations large enough to be important in the use of rhombic antennas were found; *B* means that small southerly deviations, just beginning to be important, occurred intermittently; *C* denotes that large southerly deviations occurred intermittently,

¹³ The transmission-disturbance factor is proportional to the departure of the average field for the day, from the moving daily average for the ten preceding days having factors of 1.5 or less. A factor of 1.0 corresponds to zero departure and is increased by one unit for each 7 decibels recession from the average.

particularly when emphasized by southerly directed transmitting antennas; *D* means that moderate southerly deviations occurred consistently with Rugby transmissions as well as Daventry transmissions; *E* means that large southerly deviations dominated all transmissions. The few instances in which important northerly deviations occurred are denoted by the letter *X*. By counting the points between disturbance factors of 2.5 and 3.5, say, which fall in each deviation category, one might predict that roughly 40 per cent of the 3.0-class disturbances will fall in the *D* deviation class, 15 per cent in the *C* class, 40 per cent in the *B* class, and 5 per cent in the *E* class. The data are insufficient to permit such a breakdown for the higher disturbance figures, but for the lower ones nearly all of the cases clearly fall in the *A* or *B* classes.

As noted earlier in the present paper the relation depicted in Fig. 15¹⁴ may, possibly, not represent conditions at the height of the ionosphere-disturbance cycle which is expected to occur in about 1940. A review of the meager evidence obtained during the preceding disturbance maximum (1930) indicates that some deviations occurred, however. The statement, made in 1934,¹⁵ that no substantial deviations were found during pulse studies in 1932 and 1933 is, in the light of present knowledge, hardly conclusive evidence that none existed, since these studies were mainly concerned with vertical angles.

It is known that during periods of disturbance the intense magnetic and auroral effects, which are normally found in the auroral zone, extend to more southern latitudes. In such instances North Atlantic circuits, whose great-circle routes lie to the south and east of the London-New York path, suffer less attenuation than London-New York circuits.^{16,17} It seems likely that the southern deviations in transmission might be connected with the southward expansion of the auroral zone during disturbed periods. For example, at such times as the zone extends southward to the London-New York great circle, normal transmission might experience great attenuation. Any southern route which may then exist, because of this zone or for other reasons, may then be superior to the great-circle route. Southerly routes may coexist with the great-circle route at all times but, owing to the limited discrimination of present-day directional antennas, southerly waves can only be de-

¹⁴ By "depicted relation" is meant the trend of greater deviation factor with a higher transmission-disturbance factor, neglecting the January, 1938, points identified by circles.

¹⁵ Friis, Feldman, and Sharpless, "The determination of the direction of arrival of short radio waves," *Proc. I.R.E.*, vol. 22, pp. 47-78; January, (1934).

¹⁶ A recent paper by Kenrick, Braaten, and General discusses the advantage in receiving British transmissions at San Juan, Puerto Rico, rather than at New York. See "The relation between radio-transmission path and magnetic-storm effects," *Proc. I.R.E.*, vol. 20, pp. 831-847; July, (1938).

¹⁷ See also a paper by H. E. Hallborg, "Terrestrial magnetism and its relation to world-wide short-wave communications," *Proc. I.R.E.*, vol. 24, pp. 455-471; March, (1936).

tected if their amplitudes are 10 per cent or more of the great-circle waves. Such a picture of multiple azimuthal routes would be consistent with much but not all of our experience with horizontal deviations. As noted in some of the observations recounted in the foregoing, the path has been observed to shift continuously from the great circle to as far as 35 degrees south.

The severe January storm suggested to my colleague, W. M. Goodall, that the supposed ringlike form of the auroral zone may have a significant bearing upon propagation over the North Atlantic path. Thus, when southerly deviations occurred consistently during ionosphere storms, the explanation may be that the approach of the ring to the great circle deflected the waves southward. In the January storm the southern deviations which occurred at its beginning and end may have marked the approach and recession of the ring, while the middle period, during which no southerly deviations but some northerly deviations were found, may have marked the ring's position as well across the great circle. The lesser attenuation occurring during the middle stage, together with the great attenuation experienced just after the storm's onset and just preceding its end, fit into this picture rather well.¹⁸

IV. CONCLUSIONS

Our general experience strongly indicates that wide-range azimuthal steering of both the transmitting and receiving antennas holds promise of recovering many decibels transmission loss during afternoon and evening hours, particularly during ionosphere storms. These decibels include those comprising the nominal antenna gain lost through wave-path deviations and also those measuring the benefit to be had by discriminating against particularly undesirable directions. To evaluate the possibilities

¹⁸ Since this paper was written, a four-day ionosphere storm nearly attaining the severity of the January storm, occurred in September. The history of this storm is similar to that of the January storm in that southerly deviations occurred only at the beginning and end, definitely in accord with the auroral-ring picture.

Report of Commission II, Radio Wave Propagation, International Scientific Radio Union^{*†}

J. H. DELLINGER[‡], *Chairman*, FELLOW, I.R.E.

I. INTRODUCTION

IN THE four years which have elapsed since the last General Assembly, held in London, highly gratifying progress has been made in knowledge

* Decimal classification: R113. Original manuscript received by the Institute, November 7, 1938.

† Presented, Sixth General Assembly, Venice, Italy, September 4-14, 1938.

‡ National Bureau of Standards, Washington, D. C.

more definitely seems impossible at the present time. It is to be appreciated that the significance of many of our observations is impaired by such factors as (1) the observed effects having been found on inappropriate frequencies or (2) the observed effects having been found on Daventry antennas which might unduly emphasize them. To counteract these objections we mention the not-infrequent southerly deviations found with Rugby antennas which discriminate against southern directions. These cases strongly suggest that at these times southern routes are much more effective than the great-circle route. The premise of this conclusion, namely the assumption that waves arriving here from the south left England in a southerly direction, is supported by the superior performance of Daventry antennas directed south of the great circle, which performance usually is found to accompany southerly directions of arrival.

While sufficient evidence exists to show that first-order improvements are often possible by azimuthal steering it is not so certain that such improvements can be attained with a practical operating technique. To make the terminals of a short-wave radio circuit fully conform to the idiosyncrasies of nature is indeed a difficult art and is made more difficult because hampering of the frequency-changing process must be avoided. Considerable agility in frequency changing must be displayed in order to operate a circuit during ionosphere storms. The straightforward execution of azimuthal steering of transmitting directivity would seem to depend upon the reciprocity principle. There is, however, something to be gained by providing azimuthal steering at the receiver alone.

ACKNOWLEDGMENT

The co-operation of the British Broadcasting Corporation has been essential to the work described herein, and this opportunity is taken to express appreciation, particularly to Mr. L. W. Hayes. The author is indebted to Mr. C. F. Edwards who had an important part in the work, and to Mr. H. T. Friis whose enthusiasm and judgment supported the project.

of radio wave propagation. These advances, furthermore, have realized the hope for substantial mutual aid between radio and such geophysical and cosmic sciences as terrestrial magnetism, meteorology, and astronomy. Hundreds of published papers describing original work on the propagation of radio waves have indicated the widespread interest and the extensive work on radio wave propagation. The extent of this

work is illustrated by the fact that, in the excellent Report¹ to this Commission, "On Investigations on the Propagation of Waves Carried Out in Great Britain from July 1934 to June 1938," Document No. 28 of this meeting, there were references to 51 papers, this being not the total but only the main publications in this field in the journals of a single country.

It would be quite impossible to summarize this progress in a single report, even if there were an opportunity at the present meeting in Venice to consider it. A good cross section of the field is presented by the papers from various authors for consideration by Commission II at this meeting. The present report will do no more than point out certain specific aspects of the subject. The situation regarding the 1934 London Resolutions of Commission II will first be examined.

II. LONDON RESOLUTIONS

The first Resolution (page 110 of the 1934 London Proceedings) was a standardization of terminology and definitions and a list of International Days, for ionosphere measurements. These standards have proved useful and enduring. The recommendation that authority should be sought for an international frequency for ionosphere measurements (particularly continuous P' - t recording) was brought to fruition in the allocation for this purpose of 2925–2930 kilocycles per second (102.6–102.4 meters) for the European region, by the 1938 Cairo Radio Conference.

The Subcommittee on Ionosphere Measurements established by another Resolution has rendered useful service, particularly in the preparation of programs for special observations on the occasions of eclipses. Its personnel is listed on page 38 of the 1934 London Proceedings. The continuation of this Subcommittee is advisable.

The recommendation that efforts be continued to correlate solar phenomena and radio transmission has been particularly fruitful. The appearance of a substantial body of literature along these lines during the last two or three years indicates the widespread recognition that we must look to the sun as the source and the explanation both of the regular characteristics and the vagaries of radio transmission.

A subcommittee was appointed to study the interaction of radio waves in the ionosphere. This subject has been greatly elucidated. The uncertainty in 1934 as to the reality of the effect has given way to an understanding of its character and cause. Some aspects of the phenomenon remain to be investigated.

It was recommended that preparations be made for the radio study of eclipses and that special observations be organized by the Subcommittee on Ionosphere Measurements. This has been done, and the continuation of this work would appear useful.

¹ Report of U.R.S.I. General Assembly, Venice, 1938, Part 1, p. 41.

A recommendation was made, in view of relations between radio phenomena and terrestrial magnetic variations, that values of magnetic activity for shorter periods than 24 hours should be measured by magnetic observatories and made available to other interested workers. This recommendation has been put into effect by the American group of magnetic observatories, which now give separate magnetic character figures for every half day, from 00 to 12, and from 12 to 24, G.M.T. These observatories comprise two in the continental United States, one in Puerto Rico, one in Alaska, one in Hawaii, one in Peru, and one in Australia. A combined American character figure for each half day based on the reports transmitted every day by radio from these seven observatories is disseminated each week in the American Ursigrams, reproduced each month in the Monthly Bulletin of the General Secretary of the U.R.S.I.

III. GROUND WAVE

During these four years there has been a remarkable recrudescence of interest in the determination of ground-wave intensities. This interest has two main springs: the development of ultra-high frequencies (over 30 megacycles per second) to practical utility, and the need of determining the good service area of broadcast stations. The importance of accurate information on ground-wave propagation has been further emphasized by increasing knowledge of the separate effects of sky-wave propagation. A substantial demand for the information has arisen in connection with the work of the C.C.I.R. (Lisbon, 1934, and Bucharest, 1937) and the International Radio Conference (Cairo, 1938). A major compilation of existing knowledge in this field was the "Report of Committee on Radio Wave Propagation" prepared in November, 1937, in London by a meeting of specialists in connection with the preparations for the Cairo Conference. This Report is obtainable in French from the International Telecommunications Bureau, Bern, Switzerland, and was published in English in the October, 1938, issue of the PROCEEDINGS.

Accurate knowledge of ground-wave intensities has been advanced by theoretical studies of the mechanism of propagation. The basic pioneer work of Sommerfeld has served as the starting point for the more precise determination of the effects of ground conductivity and dielectric constant, and for the quantitative effects of diffraction around the round earth.

The successful use of ultra-high frequencies for a great variety of services has been paralleled by increased quantitative knowledge of the intensities receivable at various frequencies, distances, and height of transmitting or receiving antenna above ground. Development of diffraction theory has shown that there is no discontinuity of reception at the

horizon, for any frequencies likely to be used in practice. Experimental work has shown that refraction from air masses of different meteorological properties, a few kilometers above the surface, causes fading and markedly affects received intensities; this work in turn sheds light on the rôle of nonionospheric refraction in transmission at the ordinary lower frequencies.

IV. THE IONOSPHERE

The importance of the ionosphere, and its determining rôle in all long-distance radio transmission, were recognized at the time of the 1934 London General Assembly. Since that time, however, the limited knowledge of its characteristics has been greatly extended and clarified. A vast amount of work and publication has revealed the ionosphere as a domain of dominant importance not only in radio but in geophysical science in general.

In this period, experimental work has standardized upon the pulse-echo method. The automatic multi-frequency technique, formerly used in only one laboratory, is now in regular use at several widespread locations. Ionosphere measurements are regularly made in a large number of laboratories throughout the world. Extension of the number of points at which observations are made continuously is highly desirable, particularly in the polar regions. It appears that ionosphere vagaries and radio-transmission difficulties are increasingly severe and frequent as the magnetic pole is approached, hence the need for consistent observation in polar regions.

The importance of ionosphere data in the realms of radio-communication service and the cosmic sciences suggests the need of regular, prompt, and widespread dissemination of such data. The time is envisaged when such a service will be analogous to present meteorological service.

A first step in this direction is the Ursigrams. The General Secretary of the U.R.S.I. is to be complimented on having inaugurated a monthly bulletin giving the combined Ursigrams of the world. These now carry ionosphere data for only two locations. Extension to include data for other locations should be made at the earliest possible moment.

Additional steps toward more adequate dissemination of ionosphere data have been taken by one institution, the National Bureau of Standards. It publishes monthly, in the PROCEEDINGS of the Institute of Radio Engineers, a detailed report on ionosphere conditions, giving the monthly average for undisturbed days and critical frequency and virtual height for each hour of the day for the E, F, F₁, and F₂ layers; the same data for each severely disturbed (ionospheric stormy) day; detailed data on ionosphere storms and comparison with half-day magnetic character figures; percentage variation of critical frequencies for undisturbed days; intensity and prevalence of sporadic-E reflections; and times of

occurrence of sudden ionosphere disturbances (fade-outs).

The same institution gives a weekly radio broadcast of ionosphere data and maximum usable frequencies calculated therefrom. This is given each Wednesday, and presents the ionosphere conditions for noon of that day and for midnight of the preceding night. The broadcast is given on 5, 10, and 20 megacycles per second (60, 30, and 15 meters), and is thus receivable throughout the world.

It would evidently be desirable that dissemination of ionosphere data by these two means be extended to a number of other institutions and for a considerable number of localities. Here again it may be urged that data for polar regions would be especially valuable.

V. CORRELATION OF REGULAR CHARACTERISTICS OF THE IONOSPHERE WITH RADIO TRANSMISSION

The four years since the last General Assembly have witnessed particular progress in the application of ionosphere knowledge to the elucidation of long-distance radio-transmission problems and, conversely, in the determination of ionosphere conditions from data supplied by observations of radio waves received from a distance.

In the latter respect, especially fruitful results have been obtained by continuous graphical recording of the intensities of radio waves received from a distance. From such graphic records are deduced critical frequencies, times of change of transmission from one layer to another, occurrence of sporadic-E and scattered reflections, etc. Such records were the means of demonstration, in 1937, that there is a layer below the E layer which is responsible for the daytime transmission of broadcast frequencies.

The "Report of Committee on Radio Wave Propagation,"² prepared in November, 1937, and mentioned in Section III above, illustrates well the progress which has been attained in the application of ionosphere data to practical radio-transmission problems. That report recognized that long-distance radio transmission depends entirely on ionosphere conditions, and indeed presented a set of radio-transmission graphs for various times of day, season, and year, based entirely on vertical-incidence ionosphere observations. The possibility of thus determining radio-transmission conditions for various distances in terms of vertical-incidence observations depends on reliable calculation procedures connecting vertical-incidence with oblique-incidence transmission. Such calculation procedures have been developed and published^{3,4} in the past two years. Not

² Proc. I.R.E., vol. 26, pp. 1193-1234; October, (1938).

³ N. Smith, "Application of vertical-incidence ionosphere measurements to oblique-incidence radio transmission," *Jour. Res. Nat. Bur. of Stand.*, vol. 20, pp. 683-705; May, (1938).

⁴ G. Millington, "The relation between ionospheric transmission phenomena at oblique incidence and those at vertical incidence," *Proc. Phys. Soc. (London)*, vol. 50, pp. 801-825; September, (1938).

only single but multiple-reflection transmission can be accurately computed.

An outstanding result⁵ of systematic observations of ionosphere and radio-transmission conditions, which have now been completed for half a sunspot cycle, is that annual average curves of the critical frequencies of all layers, maximum usable frequencies for radio transmission, and sunspot numbers all closely parallel one another. From the sunspot minimum in 1933 to the present maximum, critical frequencies and maximum usable frequencies increased by a factor of 1.25 for the E layer and 2.0 for the F and F₂ layer. This corresponds to increases of the ionization densities for these layers by factors of 1.6 and 4.0, respectively.

VI. IONOSPHERE DISTURBANCES AND COSMIC EFFECTS

The regular characteristics of the ionosphere, referred to in the preceding Section, are a result of ionization conditions in the various layers which follow fairly regular diurnal, seasonal, and other cycles. There are, in addition, irregular changes of ionization which produce effects the time of whose occurrence cannot be predicted. There has been especially intensive study of these effects in the past two or three years, the results of which have established valuable correlations between radio vagaries, ionosphere characteristics, terrestrial magnetism, earth currents, and solar disturbances.

Numerous vagaries to which radio transmission is subject, causing large fluctuations in the received field, have been until recently not distinguishable from one another. They include such things as fading, abrupt change of general level of intensity due to change of transmission from one ionosphere layer to another, disappearance or appearance of field because of change of critical frequency at sunrise or other time of day, changes associated with magnetic storms, prolonged absorption periods, and sudden fade-outs. The work of the past two or three years permits recognition of each of these and its differentiation from the other effects. The last three effects listed may be classed as due to ionosphere disturbances.

A good beginning has been made in establishing the characteristics of the three types of ionosphere disturbances: ionosphere storms, prolonged periods of low-layer absorption, and sudden disturbances causing radio fade-outs. The term "ionosphere storm" has been coined to describe the type of disturbance characterized by diffuse and turbulent ionosphere, high virtual heights, low critical frequencies, large skip distances, increased absorption, and usually accompanied by a terrestrial magnetic storm. Its effects are primarily in the F or F₂ layer.

⁵ N. Smith, T. R. Gilliland, and S. S. Kirby, "Trends of characteristics of the ionosphere for half a sunspot cycle," *Jour. Res. Nat. Bur. of Stand.*, vol. 21, pp. 835-846; December, (1938).

The low-layer absorption periods and sudden disturbances, on the other hand, have their seat below the E layer and are limited to the day hemisphere.

Efforts to study the causative solar disturbances have been generously rewarded, particularly as regards the sudden disturbances. Valuable correlations with visible eruptions on the sun have been established. Resulting research on ionizing effects of solar radiations gives promise of yielding an understanding of the mechanism of production of ionization in the earth's atmosphere causing not only the disturbances but the regular layer conditions as well. This work is of benefit to solar science as well as to radio research, since the radio observations are the only means we have of studying these ionizing solar radiations which are unable to penetrate down to the surface of the earth.

The French National Committee has taken a valued initiative in correlating research work on the sudden disturbances, preparing and distributing a monthly bulletin of observed instances of the effect. This work should be continued and extended. The time is envisaged when such work will be done by an organization at least as extensive as that for studies of the sun which now publishes the Zurich Bulletin for Character Figures of Solar Phenomena.

VII. RECOMMENDATIONS

It is suggested that the ionosphere terminology adopted at the 1934 London General Assembly be examined by the Venice General Assembly to determine what revisions or additions might be desirable. A suitable addition might be the term "ionosphere storm" with the meaning described in Section VI above. The London proposal to use the term "region" and not "layer" in connection with the ionosphere has not been consistently followed, and it seems better now to admit both terms as useful.

It is recommended that the Subcommittee on Ionosphere Measurements be continued, with Professor Appleton continuing as chairman. It is recommended that a Subcommittee on Ionosphere Disturbances be formed. This would in effect continue the work so excellently carried on prior to this meeting by the French National Committee. It is suggested that Dr. Jouaust be designated as chairman.

It is suggested that the General Assembly consider whether observations on long-delay echoes should be organized at this period of sunspot maximum, and that, if so, the Subcommittee on Ionosphere Measurements be requested to organize a program promptly.

It is suggested that a Resolution might well be adopted recommending the extension of regular ionosphere observations to additional localities, particularly in the polar regions.

It is suggested that a Resolution be adopted requesting all agencies engaged in ionosphere research

to publish results promptly and fully by the aid of summaries at least monthly in periodicals, radio broadcasts, and the Ursigrams.

CONCLUSION

The writer takes pleasure in complimenting the General Secretary on his successful work in issuing

the Monthly Bulletin, a publication which can be of considerable value to students of radio wave propagation. He also has the honor of congratulating the numerous workers on radio wave propagation for the magnificent body of knowledge which they have built up and which it has only been possible to indicate remotely in this Report.

Some Applications of Negative Feedback with Particular Reference to Laboratory Equipment*

F. E. TERMAN†, FELLOW, I.R.E., R. R. BUSS†, STUDENT, I.R.E.,
W. R. HEWLETT†, ASSOCIATE, I.R.E., AND F. C. CAHILL†, STUDENT, I.R.E.

Summary—The application of feedback to an entire amplifier rather than just to the final stage makes it possible to realize the characteristics of a perfect amplifier over wide frequency ranges. The use of such amplifiers to give direct-reading audio-frequency voltmeters with permanent calibration and any desired sensitivity is described.

Negative feedback can be used to reduce the distortion in the output of laboratory oscillators for all loads from open circuit to short circuit by the expedient of throwing away a part of the output power in a resistive network.

Means are described for applying feedback to tuned radio-frequency amplifiers so that the amplification depends only upon the constants of the tuned circuit and is independent of the tubes and supply voltages.

The use of negative feedback to develop a stabilized negative resistance substantially independent of tubes and supply voltages is considered, and various applications described.

High selectivity can be obtained by deriving the feedback voltage from the neutral arm of a bridge, one leg of which involves a parallel resonant circuit. It is possible by this means to obtain an effective circuit Q of several thousand, using ordinary tuned circuits, and the selectivity can be varied without affecting the amplification at resonance. The use of these highly selective circuits in wave analyzers is considered.

Feedback can be used to give improved laboratory oscillators. These include resistance-stabilized oscillators, in which the amplitude-limiting action is also separated from the amplifier action, and oscillators in which the frequency is controlled by a resistance-capacitance network. Such resistance-capacitance oscillators represent a simple and inexpensive substitute for beat-frequency oscillators, and have comparable performance.

AN amplifier with negative feedback is an ordinary amplifier in which a voltage is derived from the output and superimposed upon the amplifier input in such a way as under normal conditions to oppose the applied signal voltage. The presence of feedback then reduces the amplification and output distortion by the factor $1/(1-A\beta)$, where A is the amplification in the absence of feedback, and β is the ratio of voltage superimposed on the amplifier input to the output voltage of the amplifier.^{1,2} The quantity $A\beta$ determines the magnitude of the feedback effect, and can be conveniently termed the *feedback factor*. It will be noted that when $A\beta$ is large compared with unity, that the amplification approaches $-1/\beta$.

* Decimal classification: R363. Original manuscript received by the Institute, November 22, 1938; abridged manuscript received by the Institute, August 1, 1939. Presented, Thirteenth Annual Convention, New York, N. Y., June 16, 1938, and Pacific Coast Convention, Portland, Ore., August 11, 1938.

† Stanford University, California.

¹ H. S. Black, "Stabilized feedback amplifier," *Elec. Eng.*, vol. 53, pp. 114-120; January, (1934).

² H. Nyquist, "Regeneration theory," *Bell Sys. Tech. Jour.*, vol. 11, pp. 126-147; January, (1932).

LABORATORY AUDIO-FREQUENCY AMPLIFIERS WITH NEGATIVE FEEDBACK

Although feedback is usually employed in audio-frequency amplifiers for the purpose of reducing the distortion in the power stage, there is much more to be gained in the case of laboratory amplifiers by applying feedback to the entire amplifier. By making the feedback factor $A\beta$ much larger than unity, and arranging matters so the fraction β of the output voltage that is superimposed upon the amplifier input is independent of the tube characteristics, the amplification depends primarily on β and is substantially independent of tube replacements, electrode voltages, aging of tubes, etc. It is then possible to engrave an accurate calibration on the gain control, since the gain calibration becomes as permanent as the characteristics of a small milliammeter. Furthermore, if $A\beta$ is large and the feedback circuit is such as to make β independent of frequency, then the amplification is practically independent of frequency, the phase shift is practically zero over the normal frequency range of the amplifier, and the range for reasonably flat response is greatly increased.

The extent of the improvements obtainable in the performance of an amplifier can be realized by considering Table I, which compares performances with and without feedback in a hypothetical case.

TABLE I
COMPARISON OF RESISTANCE-COUPLED AMPLIFIERS WITH AND WITHOUT FEEDBACK

	No Feedback	With Feedback
Voltage gain (middle-frequency range)	2500	2500
Voltage gain with tube or supply potential change that increases A 25 per cent	3125 (+1.94 db)	2520 (+0.07 db)
Distortion with full output	2%	0.04%
Variation of gain over range 15-30,000 cycles	-50% (-6 db)	-1.4% (+0.33 db)
Frequency range for gain variation of 50 per cent	15 to 30,000 cycles	5 to 95,000 cycles
Phase shift over range 15-30,000 cycles	90°	4°40'

NOTE: Amplifier without feedback is two-stage resistance-coupled. Amplifier with feedback is two such sections in tandem with each section having $A\beta = -49$ in mid-frequency range.

It is apparent that whenever flatness of response, reproducibility of gain, low distortion, or low phase shift are of importance, an amplifier cannot be considered as being properly designed unless full use is made of feedback. This is especially true in amplifiers used in measuring equipment and for oscillograph purposes.

Feedback can also be used to improve the balance between the two sides of a push-pull class A amplifier. Typical circuits for doing this are shown in Fig. 1.

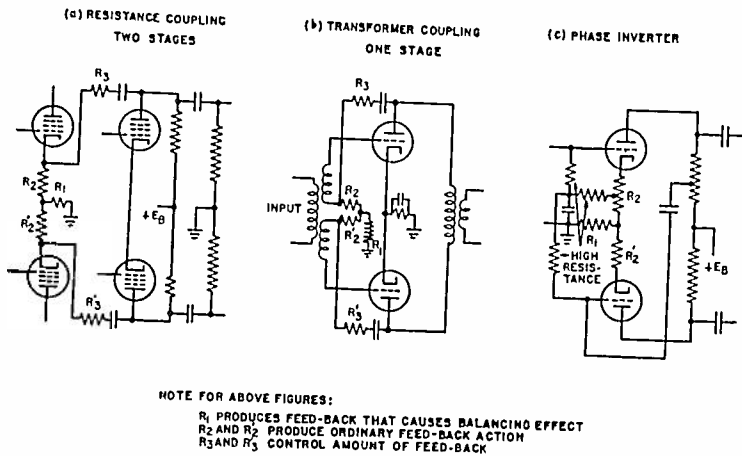

Fig. 1—Use of feedback to maintain balance between outputs of the two sides of a push-pull class A amplifier or phase inverter.

In these arrangements unbalance produces a current through the resistance R_1 , resulting in the development of a feedback voltage that is applied to the tubes in such a manner as to reduce the difference in the outputs of the two sides. The use of feedback in this way makes it possible to maintain extremely accurate balance without the necessity of using carefully matched tubes in each push-pull stage. It also makes possible almost perfect balance when phase inverters are used. The great practical value of the result in laboratory push-pull amplifiers requiring accurate balance is obvious.

USE OF FEEDBACK AMPLIFIERS IN VOLTAGE MEASUREMENTS

The stability of amplification that results when a large amount of feedback is employed in an audio-frequency amplifier is comparable with the stability of the small d'Arsonval meters commonly used in laboratory work. This, coupled with the very uniform response that can be obtained over a wide frequency range opens up many possibilities in measuring equipment.

The instruments shown in Figs. 2 and 3 are indications of what can be done. The first of these consists of a two-stage amplifier with a large amount of feedback, delivering its output to a vacuum thermocouple. This gives the equivalent of a square-law vacuum-tube voltmeter but has a permanent calibration and requires no zero adjustment. Furthermore by proper design the final tube can be made to overload at slightly above full-scale deflection, so

that no matter how large a voltage may accidentally be applied, the thermocouple cannot be burned out.^{1,2} The instrument with the circuit proportions given in Fig. 2 has been in use for several years and found to be highly satisfactory. It has an input resistance of 1 megohm, gives full-scale output with an input of 3 volts, and can be used as a direct-reading instrument in the same manner as an ordinary direct-current voltmeter. The stability and flatness of the frequency response are indicated by the performance tests reported in Table II.

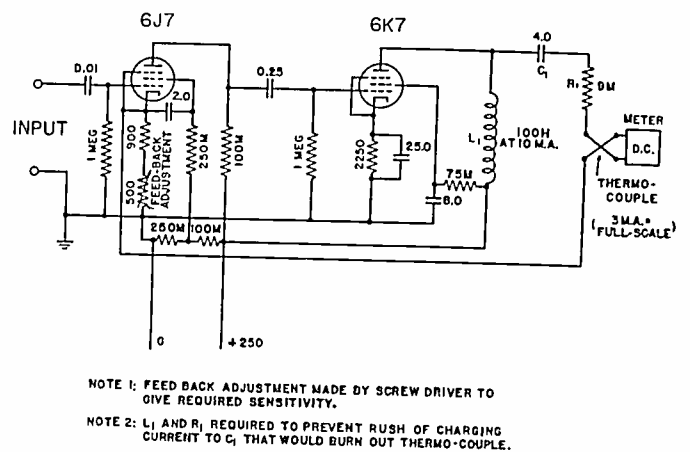

Fig. 2—Circuit diagram of a feedback voltmeter designed for audio-frequency service.

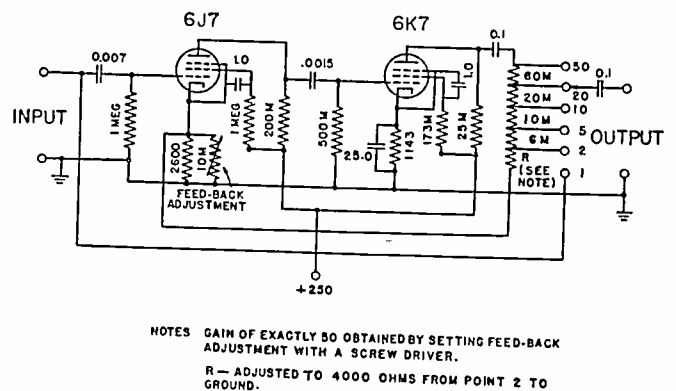

Fig. 3—Circuit diagram of standard-gain amplifier for increasing the sensitivity of vacuum-tube and feedback voltmeters at audio frequencies. The maximum gain is 50, and the output is tapped as shown so that gains of 20, 10, 5, and 2 are likewise available.

TABLE II
CHARACTERISTICS OF FEEDBACK MEASURING INSTRUMENTS

	Feedback Voltmeter of Fig. 2	Standard-Gain Amplifier of Fig. 3
Drop in response at 40 cycles	under -1%	under -1%
Drop in response at 20,000 cycles	under -1%	under -1%
Change in gain when plate-supply voltage is varied from 250 volts to 140 volts	under -1%	under -0.5%
Change in gain when heater voltage varied from 6 volts to 7.5 volts	under +1%	under +0.5%
Change in gain when heater voltage varied from 5.3 volts	under 0.5%	under 1%
	under 0.5%	under 1%

The instrument of Fig. 3 is an amplifier for extending the range of the feedback voltmeter of Fig. 2 and of ordinary vacuum-tube voltmeters. This consists of an amplifier made stable and given a good frequency response by introducing a large amount of feedback. This feedback is set by means of a screwdriver adjustment to give a gain of exactly 50, and

the output resistance is then tapped as indicated so that output voltages that are 2, 5, 10, 20, or 50 times the input voltage can be obtained across a 1-megohm load according to the switch position. The proportions are such that an output of approximately 3 volts effective can be obtained on any range without overload. The design indicated in Fig. 3 was intended for audio-frequency service, and as seen from Table II has excellent stability and practically an ideal frequency response.

Application of Feedback to the Output Amplifier of Laboratory Oscillators

In a well-designed laboratory oscillator the major part of the distortion occurring in the output results from harmonics generated in the output amplifier. The use of negative feedback to reduce this distortion is complicated by the fact that the load impedance to which the oscillator output is delivered may vary from short circuit to open circuit under different conditions of use. The situation can, however, be handled by throwing away a fraction of the output in a resistive network as shown in Fig. 4. Here R_2 prevents the output of the power tube from ever being short-circuited, while the combination $R_1 + R_2$ introduces feedback that makes the voltage E_0 a substantially distortionless reproduction of the input signal E_s .

A quantitative analysis of Fig. 4(a) shows that for maximum output power delivered to the load, the load should be a resistance equal to R_3 , while the resistance formed by $R_1 + R_2$ in parallel with R_3 should equal the plate-load resistance which gives maximum power output from the tube operated as

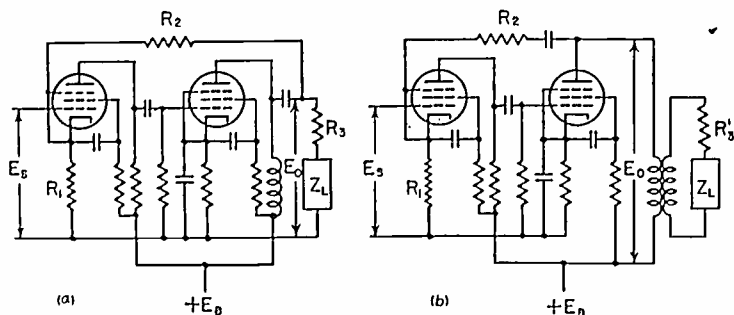

Fig. 4—Circuit arrangements in which feedback is arranged to be effective in reducing the distortion of the output amplifier of a laboratory oscillator irrespective of the load impedance.

an ordinary amplifier. Under these conditions the maximum power that can be delivered to the load is $(P_0/4) \times (R_1 + R_2) / (R_1 + R_2 + R_3)$, where P_0 is the maximum undistorted output which the tube is capable of developing. In the usual case where $(R_1 + R_2) \gg R_3$, the output obtainable hence approaches $P_0/4$.

TUNED AMPLIFIERS EMPLOYING NEGATIVE FEEDBACK

The amplification of a tuned amplifier can be made substantially independent of the tube and the

supply voltages by means of the circuit shown in Fig. 5. Here the current that the tube delivers to the tuned output circuit also flows through a resistance R_1 across which is developed a feedback voltage that is proportional to the current passed through the tuned circuit and is *independent of frequency*. When the feedback factor obtained in this way is large, the voltage developed across the resistance R_1 , and hence the current through the tuned circuit, is stabilized. The amplification is then determined solely by the

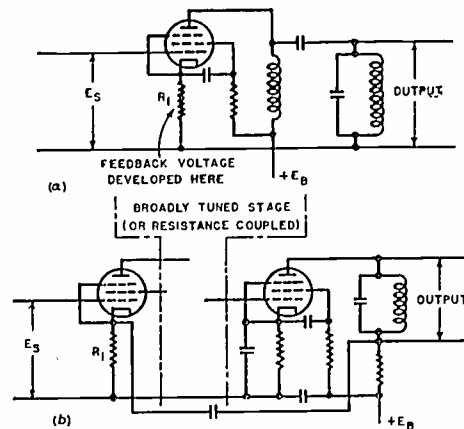

Fig. 5—Circuit diagrams of tuned amplifiers in which feedback is used to make the gain independent of tube conditions. These circuits can be easily modified for band-pass action.

tuned circuit, and becomes independent of the tube or electrode voltages. The two circuits shown in Fig. 5 accomplish the same result, but the arrangement at (b) is by far the better because it gives appreciable gain even when the feedback factor $A\beta$ is large.

Arrangements of the type shown in Fig. 5 can be used to advantage in the intermediate-frequency and radio-frequency stages of field-strength-measuring equipment. *It is possible in this way to avoid the necessity of frequent calibration, and in fact it is entirely feasible to make a calibration of the field strength in terms of gain-control setting, with the assurance that the only factors that will affect the calibration appreciably are temperature effects and misalignment.*

HIGH SELECTIVITY BY MEANS OF NEGATIVE FEEDBACK

Negative feedback provides some remarkable possibilities for obtaining the equivalent of a high- Q tuned circuit. One method of doing this is to use feedback to provide a stabilized negative resistance that can be used for regeneration. Another method of approach is to provide a feedback amplifier in which the feedback network is a circuit having a transmission characteristic that depends upon frequency.

Stabilized Negative Resistance

The circuit of Fig. 6 gives a negative resistance across the terminals aa that is substantially independent of the tubes and supply voltages, and which can be made constant over a wide range of frequencies. This arrangement can be analyzed by assuming a signal voltage E_s is applied to the input, and then

evaluating the ratio E_s/I_s , where I_s is the current that flows into the input terminals aa . Assuming that the grid of the first tube is not allowed to go positive, and referring to Fig. 6, one can write

$$I_s = \frac{E_s - E_0}{R} = \frac{E_s - AE_s}{R} = \frac{E_s}{R/(1-A)} \quad (1)$$

where E_0 is the amplified voltage, and A is the ratio E_0/E_s . If the amplified voltage E_0 has the same phase as E_s , then the resistance which the terminals aa

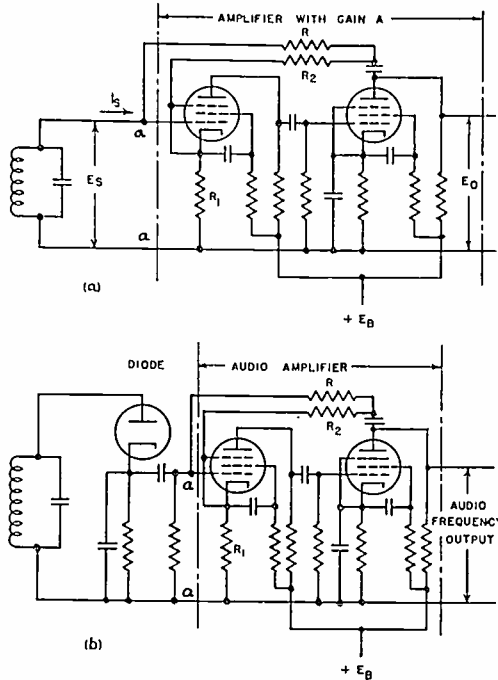

Fig. 6—Circuit for developing a stabilized negative resistance by using a negative-feedback amplifier to give stabilized regeneration, together with several applications.

offer to the voltage E_s is obviously a negative resistance having an absolute magnitude $|R/(A-1)|$. By using a large amount of negative feedback the amplification A can be made substantially independent of tube conditions and supply voltages, and can be made constant over a wide frequency range. The negative resistance under such conditions is correspondingly stabilized.

Such stable negative resistances have a number of uses. If placed in parallel with a tuned circuit as shown in Fig. 6(a), the result is equivalent to reducing the equivalent resistance of the tuned circuit, and hence raising the effective Q . This is a form of regeneration, but unlike ordinary regeneration there is little or no possibility of instability being introduced by variations in the tube or supply voltages. Thus tests in an actual case using a tuned circuit having $Q=100$ at 10 kilocycles showed that with $A\beta=100$ and sufficient negative resistance to raise the effective Q to 2000 when the plate-supply potential was 150 volts, an increase to 400 volts raised the effective Q only 10 per cent.

Another use of a stabilized negative resistance is in the improvement of the (alternating-current) / (direct-current) impedance ratio of diode detectors, by shunting the negative resistance across the diode

output as shown in Fig. 6(b). This eliminates the principal cause of distortion in diode detectors.

High Selectivity by Means of Frequency-Selective Feedback Circuits

This method of obtaining a high effective Q makes use of a feedback network such that there is no feedback at some particular frequency, but increasing feedback as the frequency is increased or reduced. A typical circuit arrangement is shown in Fig. 7(a). Here the combination of R_3, R_4, R_5 , and LC in the amplifier output constitutes a bridge which is balanced at the resonant frequency of the tuned circuit. The feedback voltage, which is derived from the neutral arm, is then zero at the resonant frequency but increases rapidly as the frequency departs from resonance. Since the amplification becomes less the greater the feedback, it is apparent that the amplification is maximum at the frequency for which the bridge is balanced and less at other frequencies, in spite of the fact that the amplifier itself is resistance-coupled. If the circuits are proportioned so that the feedback factor is large the amplification drops to a small value even when the bridge is only slightly un-

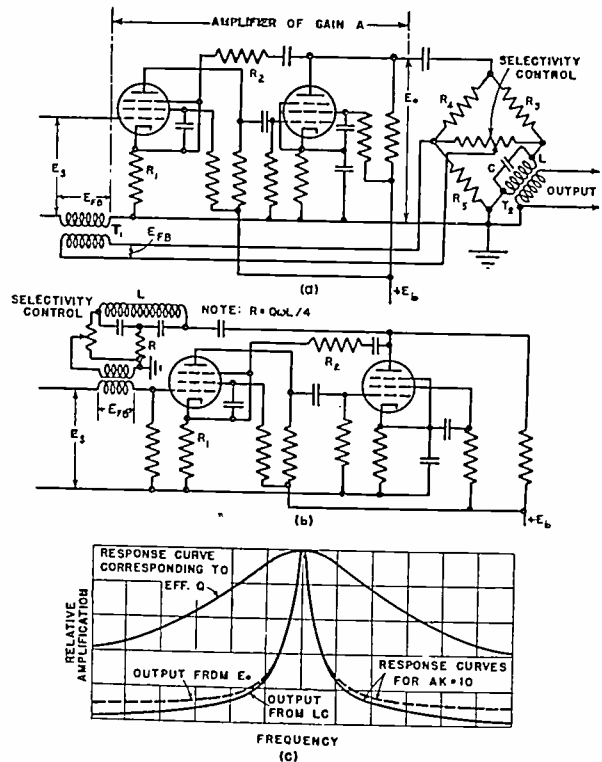

Fig. 7—Circuits in which high selectivity is obtained by using a frequency-selective feedback network.

balanced. The result is a very selective action. An exact analysis shows that when the output voltage is derived from the tuned circuit, the effective Q of the response curve is $(1+kA)$ times the actual Q of the tuned circuit, where $k=R_5/(R_4+R_5)$. Since it is readily possible to make $(1+kA)$ have values of the order 10 to 30, while the actual Q may readily exceed 100, values of Q from 2000 to 5000 are easily realizable at audio and low radio frequencies.

When the output voltage is taken from the plate electrode of the amplifier tube instead of from the

tuned circuit, the response curve no longer has the shape of a resonance curve. In the immediate vicinity of resonance it approximates a resonance curve rather closely, with the effective Q being the same as with the output derived from the tuned circuit, but at frequencies differing appreciably from resonance the output is substantially constant at a value very nearly $1/(1+Ak)$ of the value at resonance. This is indicated by the dotted curve in Fig. 7(c).

The circuit of Fig. 8(a) can be modified by replacing the bridge in the output by a bridged-T arrangement as illustrated in Fig. 7(b). By giving the resistance R the value indicated in the figure, the circuit will have zero transmission at the resonant frequency, and so is equivalent to a bridge, but has the advantage of being a 3-terminal network.

By using the potentiometer to control the feedback in the circuits of Fig. 7, the selectivity obtainable can be varied without changing the amplification at resonance. This possibility of obtaining variable selectivity without affecting the gain is possessed by no other tuned amplifier, and is of particular value in wave analyzers, as discussed below.

A NEW WAVE ANALYZER BASED UPON NEGATIVE FEEDBACK CIRCUITS

The arrangement shown in Fig. 7 for obtaining high selectivity can be made the basis of a simple, inexpensive, and yet very effective wave analyzer. A schematic arrangement of such an instrument is shown in Fig. 8. The wave to be analyzed is applied to a balanced modulator, using a phase inverter to transform from unbalanced input to balanced output. At the modulator the wave is heterodyned with a locally generated oscillation that is adjusted to give a predetermined difference frequency with the desired component. This difference frequency is then

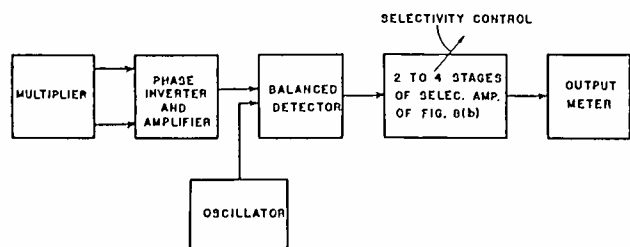

Fig. 8—Schematic diagram of wave analyzer based upon the selective circuits of Fig. 7.

selected from other components that may be present in the modulator output, using a selective system consisting of two to four sections of the type shown in Fig. 7(b). By employing coils having cores that are permalloy dust, or better yet, molybdenum-permalloy dust, it is possible to give the fixed frequency a value of the order of 10 to 15 kilocycles, and still obtain adequate selectivity for analyzing waves having the lowest fundamental frequencies commonly encountered.

The selectivity of a wave analyzer of the type

shown in Fig. 8 can be varied without changing sensitivity by providing each section of the selective system with a potentiometer for controlling the feedback as in Fig. 7(b), and then ganging the individual potentiometers to give a single-dial control of the overall selectivity. This gives a wave analyzer having variable selectivity but constant gain, a feature possessed by no other analyzer now available.

By making generous use of negative feedback throughout the analyzer of Fig. 8 to stabilize the gain of individual stages, the sensitivity and hence the

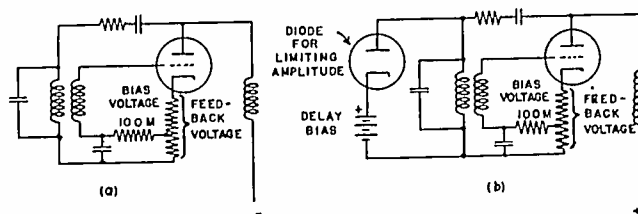

Fig. 9—Resistance-stabilized oscillators with negative feedback.

calibration can be made less dependent on tube changes or supply-voltage variation than is customary. Feedback is also preferably used in the inverter stage to maintain balance.

LABORATORY OSCILLATORS MAKING USE OF NEGATIVE FEEDBACK

Negative feedback can be used to advantage in a variety of ways in laboratory oscillators. A few illustrations of the possibilities are given below.

Resistance-stabilized Oscillators Employing Negative Feedback³

Negative feedback can be introduced in a resistance-stabilized oscillator as shown in Fig. 9(a), resulting in advantages of improved wave form, and higher frequency stability.

Where the ultimate is desired in performance, particularly with regard to wave form, it is desirable to separate the amplifying action required to produce oscillations from the nonlinear action that is necessary to stabilize these oscillations at a definite amplitude. An arrangement for doing this is shown in Fig. 9(b), and involves essentially a regenerative amplifier tube with a large amount of negative feedback, operation on a straight-line part of the tube characteristic, no grid current, and with only a small net voltage applied between the grid and cathode of the tube. The amplitude is then limited by the nonlinear action of the shunting diode and is controlled by the delay bias. With this arrangement most of the distortion in wave form that occurs results from the nonlinear action of the diode, and this will be small if the circuit is adjusted so that the amplifying action is only slightly more than required to start the oscil-

³ For a discussion of ordinary resistance-stabilized oscillators see pages 283-289 of F. E. Terman, "Measurements in Radio Engineering," McGraw-Hill Book Company, New York, N.Y., (1935).

lations. What small distortion is introduced by the diode is readily calculated by taking advantage of the fact that since the current through the diode flows in the form of pulses of very short duration, then the second-harmonic component of these pulses has substantially the same amplitude as the fundamental component. If the effective resistance to the fundamental frequency which the diode must shunt across the tuned circuit in order to stabilize oscillations is $\alpha(Q\omega_0L)$, where α is a constant and $Q\omega_0L$ is the parallel impedance of the tuned circuit at the resonant frequency $\omega_0/2\pi$, then it can be readily shown that

$$\frac{\text{second harmonic voltage}}{\text{fundamental voltage}} = \frac{2}{3\alpha Q}. \quad (2)$$

In a practical case Q will usually be in the range 50 to 200, while with large feedback to stabilize the

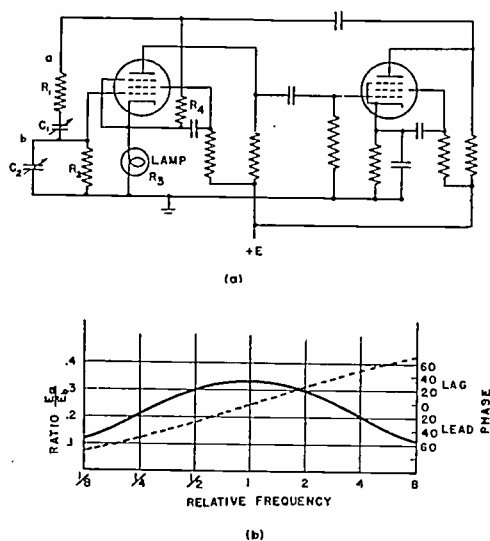

Fig. 10—Oscillator using resistance-capacitance tuning.

amplifying action, it is entirely practicable to operate with values of α as high as 100. The resulting distortion is then of the order of 0.01 per cent, giving a remarkably pure wave.

Two-Terminal Oscillators

The circuit of Fig. 6(a) can be made to operate as an oscillator by making the negative resistance less than the parallel resonant impedance of the tuned circuit. The amplitude of the oscillations in such an arrangement can be limited by allowing the amplifier to overload, or by using an auxiliary diode in the manner of Fig. 9(b).

Oscillator with Resistance-Capacitance Tuning

The use of negative feedback makes possible a practical sine-wave oscillator in which the frequency is determined by a resistance-capacitance network. An example of such a resistance-capacitance tuned oscillator is shown⁴ in Fig. 10. Here $R_1C_1R_2C_2$ pro-

vide the regenerative coupling between the input and output circuits of the amplifier that is necessary to maintain oscillations. By proportioning this resistance-capacitance network so that $R_1C_1 = R_2C_2$ the ratio of voltage at b to voltage at a varies with frequency in a manner similar to a resonance curve, as indicated in Fig. 10. At the maximum of this curve the frequency f_0 is $1/2\pi\sqrt{R_1R_2C_1C_2}$ and the voltages at a and b have the same phase. Oscillations hence tend to occur at the frequency f_0 .

For such an oscillator to be satisfactory it is necessary that the amplifier associated with the resistance-capacitance network have a phase shift that is independent of changes in supply voltage, etc., and furthermore there must be some means of controlling the amplitude of oscillations so that they do not exceed the range over which the tubes will operate as class A amplifiers. The constant amplifier phase shift is necessary in order to insure a stable frequency. This comes about because the phase angle of the transfer impedance of the resistance-capacitance network from a to b varies only slowly with frequency. Hence a small change in amplifier phase shift such as could be produced by a variation in supply voltage requires a very large change in oscillation frequency to produce a compensating phase shift in the resistance-capacitance coupling system. A stable phase characteristic can be readily obtained in the amplifier by employing a large amount of negative feedback, such as is obtained in Fig. 10 by suitably proportioning the resistance combination R_3R_4 .

Amplitude control is obtained by a nonlinear action in the amplifier circuits that prevents the oscillations from building up to such a large amplitude that distortion occurs. It is possible to employ any one of a variety of systems, but the one shown in Fig. 10 is recommended as being both simple and effective. Here the resistance R_3 is supplied by a small incandescent lamp, and the operating conditions so adjusted that the current through this lamp is such that the filament operates at a temperature where the resistance varies rapidly with current. As a result, an increase in oscillation amplitude increases the lamp resistance. This makes the negative feedback larger, so decreases the gain of the amplifier and reduces the tendency to oscillate. Similarly, as the oscillations decrease in amplitude the current through the lamp is reduced, lowering the lamp resistance, reducing the negative feedback, and thereby increasing the tendency to oscillate. The result is that a constant amplitude is maintained, with no tendency to distort the wave shape.

In practical oscillators of this type it is most con-

⁴ This oscillator somewhat resembles that described by H. H. Scott, in the paper "A new type of selective circuit and some applications," PROC. I.R.E., vol. 26, pp. 226-236; February, (1938), although differing in a number of respects, such as being

provided with amplitude control and having the frequency adjusted by variable condensers rather than variable resistors. The latter feature makes the impedance from a to ground constant as the capacitance is varied to change the frequency, and so greatly simplifies the design of the amplifier circuits.

venient to make $R_1=R_2$, and $C_1=C_2$. Under these conditions the frequency of oscillation is

$$\text{frequency} = \frac{1}{2\pi R_1 C_1}. \quad (3)$$

It will be noted that this frequency is inversely proportional to capacitance, instead of inversely proportional to the square root of capacitance as is the case in ordinary tuned circuits. Accordingly if the frequency is varied by means of an ordinary gang-tuning condenser such as used in broadcast receivers, a frequency range of 10 to 1 can be covered on a single dial. Decimal multiplying factors for frequencies can be obtained by changing resistances R_1 and R_2 in decimal values.

The arrangement of Fig. 10 provides an inexpensive and yet highly satisfactory laboratory oscillator capable of performing most of the functions of a beat-frequency oscillator. One version that has been constructed employs a four-gang broadcast condenser with sections paralleled in pairs for tuning and covers the frequency range 20 to 20,000 cycles in three subdivisions (20 to 200, 200 to 2000, and 2000 to 20,000 cycles) by employing three sets of resistances. The output voltage is constant within approximately 10 per cent over the entire frequency range, and has only about 0.25 per cent distortion. A few checks on frequency stability indicate negligible fre-

quency shift (less than 0.1 per cent) with large variations in supply voltage.

Experimental oscillators of this type have been built that operate at frequencies exceeding 2 megacycles.

CONCLUSION

The various applications of negative feedback that have been described in this paper by no means exhaust the possibilities that this new technique opens up, but rather merely suggest the important part that feedback is bound to play in the measuring and laboratory equipment of the future. Merely scratching the surface as has been done in this paper does, however, bring to view such interesting devices as improved forms of vacuum-tube voltmeters with unlimited sensitivity and a permanent calibration, detectors with the main cause of distortion removed, circuits with amazingly high Q , field-strength-measuring sets with a sensitivity that does not vary with tube conditions or supply voltages, new types of wave analyzers, new types of oscillators, etc.

ACKNOWLEDGMENT

The authors wish to express their appreciation for suggestions and helpful discussions contributed by Edward L. Ginzton of the Stanford Communication Laboratory group.

Critical Inductance and Control Rectifiers*

W. P. OVERBECK †, ASSOCIATE MEMBER, I.R.E.

Summary—This paper explains the effect of a choke-input filter when used in connection with controllable rectifier tubes. Many of the difficulties experienced with instability and discontinuities of control of such rectifiers are due to an improper choice of input-choke inductance. A mathematical derivation of the proper value of inductance is given and a simple method of applying it to actual problems is illustrated.

INTRODUCTION

SMOOTHING filters for rectifiers fall into two main classes, condenser input and choke input. For industrial applications, the choke-input filter is considered superior because it lowers peak-current requirements for the rectifier tubes, it improves the form factor of the current pulses through the rectifier tubes and plate transformer, it provides better regulation to load at the output of the rectifier, and it aids in balancing the currents through the tubes.

In order that the input choke may perform these functions adequately, a value of inductance is chosen which is greater than a so-called "critical" value. For ordinary rectifiers, this value has been obtained

by empirical methods which have proved satisfactory.¹ For rectifiers employing controllable tubes such as Permatrons,² Thyratrons,³ or Ignitrons,⁴ it has been found that the duties of the input choke are much more complex and that it plays a large part in the problem of obtaining proper control of the rectifier tubes. The writer has developed an accurate method of determining the proper size of the input choke to meet any given output voltage or load requirements of a controlled rectifier.

DEFINITION OF "CRITICAL INDUCTANCE"

Consider a rectifier circuit such as that of Fig. 1. With the filter choke removed, current will flow through the tubes in short pulses during the anode-voltage peaks. As inductance is added, these pulses

¹ F. E. Terman, "Radio Engineering," page 410, McGraw-Hill Book Company, New York, N. Y., (1932).

² W. P. Overbeck, "The Permatron—a magnetically controlled industrial tube," *Trans. A.I.E.E.*, vol. 58, pp. 224-228; May, (1939).

³ A. W. Hull, "Hot cathode Thyratrons," *Gen. Elec. Rev.*, vol. 32, pp. 213-223; April, (1929); and vol. 32, pp. 390-399; July, (1929).

⁴ D. D. Knowles, "The Ignitron, a new controlled rectifier," *Electronics*, vol. 6, pp. 164-166; June, (1933).

* Decimal classification: R386. Original manuscript received by the Institute, November 22, 1938.

† Raytheon Production Corporation, Newton, Mass.

become spread out over a longer period. Eventually, a value of inductance is reached at which conduction becomes continuous and each tube conducts until the other starts. This value of inductance is the "critical" value.

When the input-choke inductance is greater than the critical value, operation during an alternating-current cycle is as illustrated in Fig. 2. Conditions are shown for a single-phase full-wave control rectifier whose tubes are set to start or "fire" at an angle

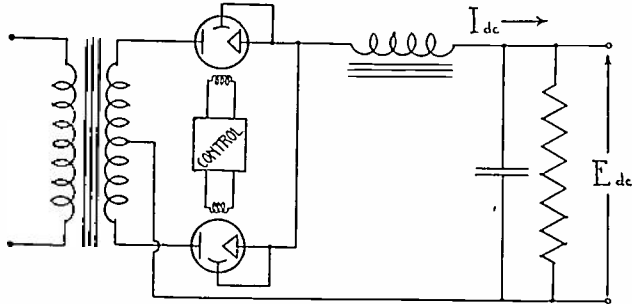

Fig. 1—Fundamental diagram of single-phase full-wave rectifier with controllable tubes.

of about thirty degrees with respect to the anode-voltage waves. The cathode voltage for both tubes is the same and is shown as a heavy line which is equal to the anode voltage of whichever tube is conducting less the drop through that tube. Thus, at the instant of firing, each tube has, across it, a voltage approximately equal to twice the amplitude of its anode sine wave at that instant. Also, each tube continues to conduct until the other fires even though its anode voltage becomes more negative than the negative output terminal of the rectifier.

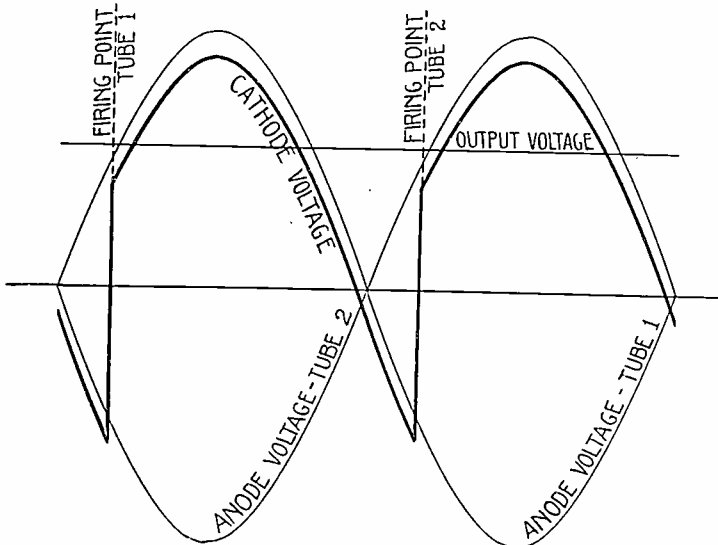

Fig. 2—Voltage distribution in a single-phase rectifier with 30-degree firing delay.

If the output voltage or load is changed so that the inductance is no longer greater than the critical value, one tube will stop before the next one fires. When this happens, the cathode voltage of the next tube immediately shifts to the potential of the positive output terminal of the rectifier. With conditions as shown in Fig. 2, this results in the anode voltage of the second tube being negative with respect to its

cathode at the instant it is supposed to fire. Depending on the type of control circuit which is used, this second tube will either block or fire late; thus introducing a transient surge which often builds up into sustained oscillations in output voltage. It may be shown that this condition will always occur at some point in the adjustment of every controlled rectifier and that proper choice of inductance of the input choke is necessary in order to locate that point outside the normal requirements of the rectifier.

DERIVATION OF DESIGN FORMULAS

Determination of the value of critical inductance is as simple for multiphase rectifiers as for single-phase rectifiers. The following equations apply to the general case in which the number of phases is n . The term "phases" here refers to the number of anodes or tubes involved. Fig. 3 illustrates this case.

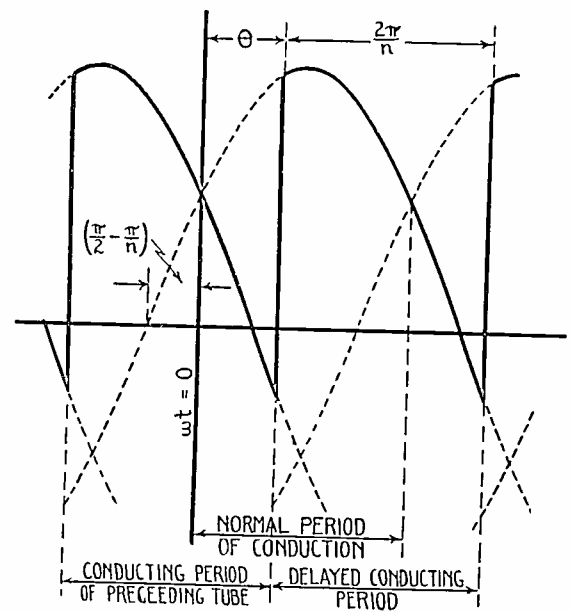

Fig. 3—Cathode-voltage wave in a control rectifier with n phases.

If ω is 2π times the line frequency, and $\omega t = 0$ at the instant one tube would fire if not delayed, the anode voltage of that tube is given by

$$e = E_{max} \sin \left(\omega t + \frac{\pi}{2} - \frac{\pi}{n} \right). \tag{1}$$

Each tube is delayed by an angle θ and conducts through an angle equal to $2\pi/n$. The output voltage E_{dc} is equal to the anode voltage (equation (1)) averaged over this period of conduction minus the tube drop D :

$$E_{dc} = \frac{n}{2\pi} \int_{\theta}^{\theta + 2\pi/n} E_{max} \sin \left(\omega t + \frac{\pi}{2} - \frac{\pi}{n} \right) d(\omega t) - D. \tag{2}$$

Integrated, this equation reduces to

$$E_{dc} = \frac{n E_{max}}{\pi} \cos \theta \sin \frac{\pi}{n} - D. \tag{3}$$

During the period that one tube is conducting, the voltage across the choke is equal to the anode voltage of that tube minus the drop through the tube,

minus the direct output voltage. Since the tube drop cancels out, the choke voltage is given by

$$e_L = E_{max} \left[\sin \left(\omega t + \frac{\pi}{2} - \frac{\pi}{n} \right) - \frac{n}{\pi} \cos \theta \sin \frac{\pi}{n} \right]. \quad (4)$$

The current through the choke is given by the integral of this voltage divided by L , the choke inductance.

$$i = \frac{E_{max}}{L} \int \left[\sin \left(\omega t + \frac{\pi}{2} - \frac{\pi}{n} \right) - \frac{n}{\pi} \cos \theta \sin \frac{\pi}{n} \right] dt$$

(5)

or

$$i = \frac{E_{max}}{\omega L} \left[\sin \left(\omega t - \frac{\pi}{n} \right) - \frac{n \omega t}{\pi} \cos \theta \sin \frac{\pi}{n} + C \right]$$

where C is a constant of integration.

When L is equal to the critical value L_c , this constant may be readily evaluated. As defined above, the critical value of inductance is such that the current has just barely become continuous and therefore must drop to zero at some instant in the conducting period. Since the current rises from zero immediately, the point of zero current is also a point at which di/dt equals zero and must therefore correspond to the point at which the choke voltage passes through zero. This instant is a direct function of the firing angle, as shown later. For the moment, let us consider the instant of zero choke voltage as being at $\omega t = A$.

Substituting $i = 0$ and $\omega t = A$ in (5) gives

$$C = - \sin \left(A - \frac{\pi}{n} \right) + \frac{nA}{\pi} \cos \theta \sin \frac{\pi}{n}. \quad (6)$$

This evaluation of C , it must be remembered, is true only when $L = L_c$.

Equation (5), averaged over the conducting period, is equal to the direct output current of the rectifier I_{dc} . This is expressed in integral form as follows:

$$I_{dc} = \frac{nE_{max}}{2\pi\omega L_c} \int_0^{\theta+2\pi/n} \left[\sin \left(\omega t - \frac{\pi}{n} \right) - \frac{n\omega t}{\pi} \cos \theta \sin \frac{\pi}{n} + C \right] d(\omega t) \quad (7)$$

and when integrated

$$I_{dc} = \frac{nE_{max}}{\pi\omega L_c} \left[\sin \theta \sin \frac{\pi}{n} - \left(\theta + \frac{\pi}{n} \right) \cos \theta \sin \frac{\pi}{n} + \frac{\pi}{n} C \right]$$

or

$$I_{dc} = \frac{nE_{max}}{\pi\omega L_c} \cos \theta \sin \frac{\pi}{n} \left[\tan \theta - \theta - \frac{\pi}{n} + A - \frac{\pi \sin (A - \pi/n)}{n \cos \theta \sin \pi/n} \right]. \quad (8)$$

Substituting from (2):

$$L_c = \frac{I_{dc} + D}{\omega I_{dc}} \left[\tan \theta - \theta - \frac{\pi}{n} + A - \frac{\pi \sin (A - \pi/n)}{n \cos \theta \sin \pi/n} \right].$$

E_{dc}/I_{dc} may be replaced by R the load resistance, and the effect of tube drop may be transferred to a correction factor to be used or discarded at will.

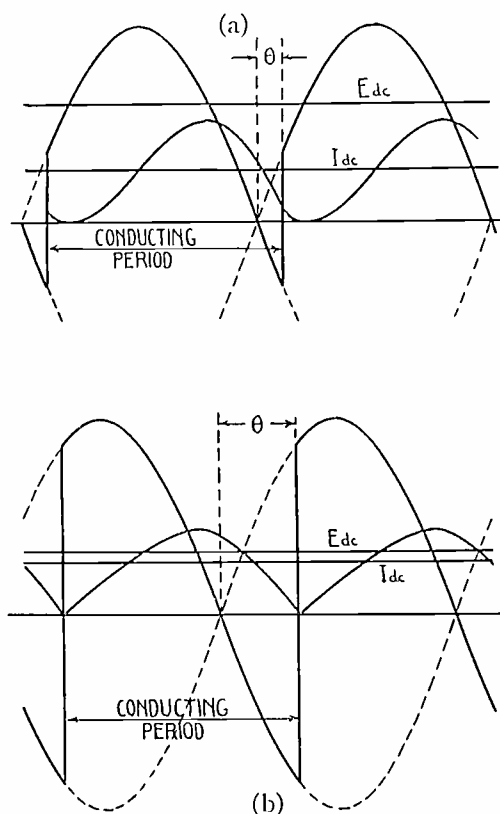

Fig. 4—Voltage distribution and anode current in a single-phase full-wave rectifier, (a) with tubes firing before cathode potential exceeds direct output potential, (b) with tubes firing after cathode potential exceeds direct output potential.

With these changes, the most practical form of the equation is

$$\frac{\omega L_c}{R} = \left(1 + \frac{D}{E_{dc}} \right) \left[\tan \theta - \theta - \frac{\pi}{n} + A - \frac{\pi \sin (A - \pi/n)}{n \cos \theta \sin \pi/n} \right]. \quad (9)$$

A , the value of ωt at which the choke voltage passes through zero, must be evaluated under two different conditions which are illustrated by Fig. 4. In Fig. 4(a) the tube fires before its anode voltage becomes equal to the direct output voltage and the choke voltage passes through zero later in the cycle when these two voltages do become equal. Thus, A is the value of the ωt when

$$\frac{nE_{max}}{\pi} \cos \theta \sin \frac{\pi}{n} = E_{max} \sin \left(A + \frac{\pi}{2} - \frac{\pi}{n} \right)$$

or

$$A = \frac{\pi}{n} - \frac{\pi}{2} + \arcsin \left(\frac{n}{\pi} \cos \theta \sin \frac{\pi}{n} \right). \quad (10)$$

The effect of tube drop cancels out in the same manner as in (4) in this equation and in succeeding equations.

When the tube fires after its anode voltage becomes equal to the direct output voltage as in Fig.

4(b) the choke voltage passes through zero at the time the tube fires or at

$$A = \theta. \quad (11)$$

The borderline case for determining A is when the tube fires exactly at the instant its anode voltage is equal to the direct output voltage or when

$$\frac{nE_{\max}}{\pi} \cos \theta \sin \frac{\pi}{n} = E_{\max} \sin \left(\theta + \frac{\pi}{2} - \frac{\pi}{n} \right)$$

or

$$\theta = \arctan \left(\frac{n}{\pi} - \cot \frac{\pi}{n} \right). \quad (12)$$

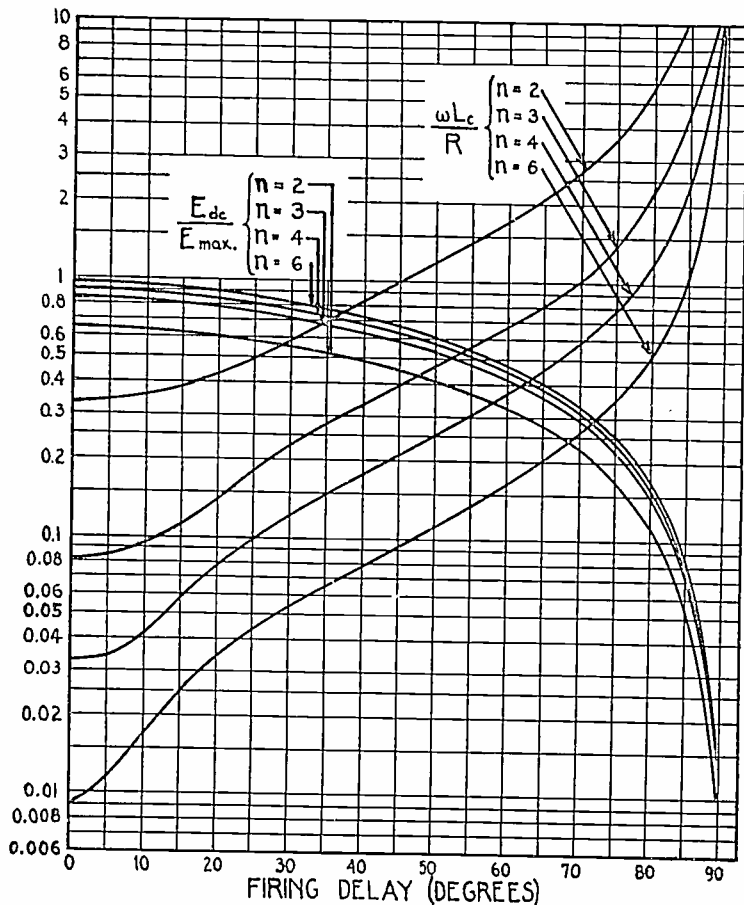

Fig. 5—Critical inductance and direct output voltage as a function of firing delay. n = number of rectifying phases.

SUMMARY OF EQUATIONS

For any controlled rectifier, the value of critical inductance for any load or firing angle is given by (9). For firing angles less than that given by (12), the value of A in (9) is obtained from (10). For firing angles greater than that given by (12), the value of A in (9) is obtained from (11). Summarizing the important symbols:

- $\omega = 2\pi$ times line frequency (cycles per second)
- L_c = critical value of inductance (henrys)
- R = load resistance (ohms)
- D = tube voltage drop (volts)
- E_{dc} = direct output voltage (volts)
- θ = angle of firing delay (radians)
- n = number of anodes or rectifying phases

It is possible to obtain other information from the above equations. For example (5), with proper values of the constant C , will give a complete description of

the current during each period of conduction from which the form factor may be determined. Also, it is possible to use other values of current rather than zero in determining the value of C in (6) and thus to compute currents for values of inductance greater than the critical value. These computations appear to have more academic than practical value. However, the writer has found, by computing wave shapes and form factors in a single-phase full-wave rectifier as a function of firing angle, that the form factor in all cases is never more than 15 per cent higher with an inductance exactly equal to the critical value than if the inductance were infinite.

PRACTICAL DESIGN METHODS

For practical purposes, the information given by (3), (9), (10), (11), and (12) may be combined to obtain curves as shown in Fig. 5. Here, the values of E_{dc}/E_{max} and $\omega L_c/R$ are plotted against firing angle for rectifiers having 2, 3, 4, or 6 phases. The tube-drop correction is left out so that the values of $\omega L_c/R$ must be multiplied by $(1 + D/E_{dc})$ and the values of E_{dc}/E_{max} must be divided by $(1 + D/E_{dc})$. Similar curves may be plotted for any other number of phases. For a three-phase double-Y circuit using an interphase reactor, the values of E_{dc}/E_{max} are taken from the $n=3$ curve while the values of $\omega L_c/R$ are taken from the $n=6$ curve.

As an example of the use of the equations and curves, we may consider the following requirements for a single-phase full-wave controlled rectifier.

$$E_{dc} \begin{cases} = 100 \text{ volts (max.)} \\ = 5 \text{ volts (min.)} \end{cases} \quad I_{dc} \begin{cases} = 10 \text{ amp. (max.)} \\ = 1 \text{ amp. (min.)} \end{cases}$$

$$\omega = 2\pi \times 60 = 377 \quad n = 2.$$

This rectifier is to use tubes having the following constants:

$$\begin{aligned} \text{voltage drop} &= 10 \text{ volts} \\ \text{minimum firing voltage} &= 40 \text{ volts.} \end{aligned}$$

The 100-volt output value corresponds to the minimum firing angle, which must be such that there is sufficient voltage available for starting the tubes, or

$$2E_{\max} \sin \theta = 40 \text{ volts} \quad \text{or} \quad \sin \theta = 20/E_{\max}.$$

From (3)

$$100 + 10 = \frac{2E_{\max}}{\pi} \cos \theta \quad \text{or} \quad \cos \theta = 55\pi/E_{\max}.$$

Thus,

$$\tan \theta = 20/55\pi = 0.116 \quad \text{and} \quad \theta = 6.6 \text{ degrees.}$$

From Fig. 5, when $\theta = 6.6$

$$E_{dc}/E_{\max} = 0.64 \div \left(1 + \frac{10}{100} \right) = 0.582$$

$$E_{\max} = 172 \text{ volts}$$

$$\omega L_c/R = \left(1 + \frac{10}{100} \right) \times 0.33 = 0.36.$$

At 1 ampere output,

$$R = 100 \text{ and } L_c = \frac{0.36 \times 100}{377} = 0.096 \text{ henry.}$$

At 10 amperes output,

$$R = 10 \text{ and } L_c = \frac{0.36 \times 10}{377} = 0.0096 \text{ henry.}$$

At 5 volts output,

$$\frac{E_{dc}}{E_{max}} = \frac{5}{172} = 0.029.$$

This corresponds to a value from the curve for $n=2$ in Fig. 5 of

$$0.029 \times \left(1 + \frac{10}{5}\right) = 0.087 \text{ for which } \theta = 82 \text{ degrees.}$$

At this firing angle,

$$\omega L_c / R = 7 \times \left(1 + \frac{10}{5}\right) = 21.$$

At 1 ampere,

$$R = 5 \text{ and } L_c = (21 \times 5) / 377 = 0.28 \text{ henry.}$$

At 10 amperes,

$$R = 0.5 \text{ and } L_c = (21 \times 0.5) / 377 = 0.028 \text{ henry.}$$

Thus, to meet all conditions, the input choke must have a value of at least 0.28 henry at one ampere and 0.028 henry at 10 amperes. A saturating or "swinging" choke is the most economical choice, although a constant 0.28-henry choke may be used. The plate transformer must be designed for a peak voltage of 172 volts or 122 volts root-mean-square each side of the secondary center tap. The plate-transformer secondary current has approximately the same form factor at all firing angles and the winding should be designed for about 1.5×5 or 7.5 amperes. The filter condenser should be at least sufficient to avoid resonance and may be greater than this to meet ripple requirements. Additional filter sections may be added without affecting the above analysis. Complete filter design for a given ripple requirement may be made by the conventional method of computing the fundamental alternating-voltage component at the input to the filter. This should be done at the maximum firing angle because it not only produces the largest magnitude of ripple voltage but corresponds also to the lowest output voltage thus producing the greatest per cent of ripple in terms of output voltage.

The usefulness of the formulas and curves is not entirely confined to controlled rectifiers. A typical case is that of an engineer who attempted to use two mercury-vapor rectifier tubes, having a drop of 10 volts, in a circuit such as that of Fig. 1. The required direct output was 10 amperes at 6 volts. The filter

condenser was 12,000 microfarads and the choke inductance was 0.001 henry, a value which would be considered sufficient from ordinary methods of computation. When the alternating-current input was applied, it was found that the tubes flickered and that the output voltage fluctuated violently. Sometimes, only one tube would conduct. Tube troubles were suspected until the following explanation was found.

The tubes had a "pickup" or minimum starting voltage of 25 volts which produced a delayed firing angle. With sufficient inductance, this firing angle would have been

$$\left. \begin{aligned} 2E_{max} \sin \theta &= 25 \text{ volts} \\ \frac{2E_{max}}{\pi} \cos \theta &= E_{dc} + D = 16 \text{ volts} \end{aligned} \right\} \begin{aligned} \tan \theta &= 0.49. \\ \theta &= 26.1 \text{ degrees.} \end{aligned}$$

At this firing angle,

$$\omega L_c / R = 0.5 \times \left(1 + \frac{10}{6}\right) = 1.33$$

$$L_c = \frac{1.33 \times 0.6}{377} = 0.0021 \text{ henry}$$

$$E_{dc} / E_{max} = 0.58 \div \left(1 + \frac{10}{6}\right) = 0.22$$

$$E_{max} = \frac{6}{0.22} = 27 \text{ volts.}$$

Thus, the choke inductance was below the critical value, and, when one tube failed to conduct for a full half cycle, the maximum peak voltage available for firing the next tube was less than 21 volts. One tube, and sometimes both tubes, would fail to fire until the filter condenser had discharged through the load long enough to reduce the output voltage to two volts so that there would again be 25 volts available for firing.

Similar conditions are responsible for many failures to obtain proper operation of gas- or vapor-filled tubes at low output voltages. There is a natural tendency to design the input choke too small in order to avoid poor output voltage regulation due to its resistance. In reality, if the inductance were only adequate, much better regulation would be obtained.

CONCLUSIONS

Tests of the above principles have been made in experimental rectifier circuits. They give a good degree of accuracy in spite of the major assumption upon which they are based, that the direct voltage at the output of the first filter section is constant. Applications of controllable rectifier tubes have not advanced as rapidly as should be expected, and it is hoped that a more accurate knowledge of critical inductance will remove one of the obstacles to their development.

A General Radiation Formula*

S. A. SCHELKUNOFF†, NONMEMBER, I.R.E.

Summary—In this paper a general formula is derived for the power radiated in nondissipative media by a given distribution of electric and magnetic currents. Magnetic currents are included not only for the sake of greater generality but also because in problems involving diffraction through apertures and radiation from electric horns, the radiation intensity can be made to depend upon fictitious electric- and magnetic-current sheets covering the apertures or horn openings.

Part I consists of an introductory discussion, summary of the formulas, and examples illustrating the convenience of the general formulas. Part II contains a mathematical derivation of the radiation formulas.

PART I

INTRODUCTION, SUMMARY, AND EXAMPLES

THE purpose of this paper is to disclose a formula which has been found very convenient in calculating the power radiated by ordinary antennas, antenna arrays, and electric horns.

Broadly speaking, there are two well-known methods for calculating the power radiated by a known distribution of electric currents. The older method is based upon the idea that in a nondissipative space the radiated energy must pass through every closed surface surrounding the radiating system and that consequently the radiated power can be calculated by integrating the Poynting vector over some such surface. Inasmuch as the field at great distances from a radiating system is much simpler than the near-by field, it is usually convenient to choose a large sphere as the "closed surface." This "Poynting-vector method" of calculating the radiated power was employed by Hertz¹ in 1889 and since then had been the only method in use until an alternative method, the method of the "induced electromotive force," was suggested by L. Brillouin² in 1921.

The "induced-electromotive-force" method consists in calculating the work done in driving given electric currents against the electric forces produced by them and gives the total energy contributed to the electromagnetic field. The first application of this method to practical antenna problems was made by Kliatzkin³ in 1927 but his work, published in Russian, had remained unknown to the world at large until Pistol Kors⁴ brought it to the attention of the English-speaking public. In 1931 Bechmann⁵ made further applications and since then the method has been employed quite frequently in those cases in which

the required local field could be determined in the form adaptable for carrying out the necessary integrations.

In nondissipative media, the two methods are mathematically equivalent, of course. If the surface over which we integrate the Poynting vector is made to coincide with the outer surface of the radiating system, then the integral is readily interpreted as the work done by the applied forces in sustaining the given current distribution. In practical applications, we are usually interested in systems radiating in air and the limitations of the first method do not concern us. The second method, however, is perfectly general and it can be used, for instance, to find the power radiated by an antenna submerged in water.

It is rather remarkable that the practical use of the induced-electromotive-force method should have been delayed until comparatively recent times in view of the fact that its acoustic analogue had been in use so long ago.⁶ The reason for this must be attributed, at least in part, to inherent mathematical difficulties. The "Poynting-vector method" employs the distant field, the so-called "radiation field," which is considerably simpler than the *local* field needed in the induced-electromotive-force method. Thus it was that only after Kliatzkin and Pistol Kors had succeeded in finding a way to carry out the necessary integrations in certain important cases, the latter method became practicable. As a general rule, however, the first method is still the easier to apply. The formulas of this paper are designed to systematize and facilitate the calculations required by this method and adapt them to more complex radiating systems, such as acoustic horns. Both methods have the same limitations since they assume that the current distribution is known; in practice, this is not the case. Thus the results obtained by either method depend upon how good an assumption has been made with regard to the current distribution.

The power W_{11} radiated by a given electric-current distribution is expressed in terms of an *electric-radiation* vector⁷ N , to be defined presently, as follows:

$$W_{11} = \frac{\eta}{8\lambda^2} \int_0^\pi \int_0^{2\pi} (N_\theta N_\theta^* + N_\phi N_\phi^*) \sin \theta \, d\theta \, d\phi, \quad (1)$$

where the integration is extended over the surface of

⁶ Rayleigh, "The Theory of Sound," Macmillan and Company, London, (1926).

⁷ This radiation vector should not be confused with the "radiation vector" of J. R. Carson⁸ who uses the term as synonymous with the "Poynting vector."

⁸ John R. Carson, "Electromagnetic theory and foundations of electric circuit theory," *Bell Sys. Tech. Jour.*, vol. 6, pp. 1-17; January, (1927).

* Decimal classification: R111.1. Original manuscript received by the Institute, November 10, 1938.

† Bell Telephone Laboratories, Inc., New York, N. Y.

¹ Heinrich Hertz, "Electric Waves," english translation, p. 150, Macmillan and Company, London, (1900).

² L. Brillouin, "Sur l'origine de la résistance de rayonnement," *Radioélectricité*, vol. 3, pp. 147-152; April, (1922).

³ Kliatzkin, *Telegrafia i telefonija bez provodov* (TITBP), vol. 1 (40); p. 33, (1927).

⁴ A. A. Pistol Kors, "The radiation resistance of beam antennas," *Proc. I.R.E.*, vol. 17, pp. 562-579; March, (1929).

⁵ R. Bechmann, "On the calculation of radiation resistance of antennas and antenna combinations," *Proc. I.R.E.*, vol. 19, pp. 1471-1480; August, (1931).

the unit sphere, the asterisk designates conjugate complex numbers, N_θ and N_ϕ are the components of N , tangential to the sphere (Fig. 1), λ is the wavelength, and $\eta = \sqrt{\mu/\epsilon}$ is the intrinsic impedance of the medium surrounding the antenna. The intrinsic impedance of air is $120\pi \doteq 377$ ohms.

Similarly, the power W_{22} radiated by a given magnetic-current distribution⁹ is expressed in terms of a magnetic-radiation vector L

$$W_{22} = \frac{1}{8\eta\lambda^2} \int_0^\pi \int_0^{2\pi} (L_\theta L_\theta^* + L_\phi L_\phi^*) \sin \theta \, d\theta \, d\phi. \quad (2)$$

The mutual power W_{12} , radiated by virtue of the reaction exerted by an electric-current distribution upon a magnetic-current distribution or vice versa, is

$$\begin{aligned} W_{12} &= \frac{1}{16\lambda^2} \int_0^\pi \int_0^{2\pi} [(N_\theta L_\phi^* + N_\phi^* L_\theta) \\ &\quad - (N_\phi L_\theta^* + N_\theta^* L_\phi)] \sin \theta \, d\theta \, d\phi \\ &= \frac{1}{8\lambda^2} \operatorname{Re} \left[\int_0^\pi \int_0^{2\pi} (N_\theta L_\phi^* - N_\phi L_\theta^*) \sin \theta \, d\theta \, d\phi \right]. \quad (3) \end{aligned}$$

Hence the total power radiated by a combination of electric- and magnetic-current distributions may be expressed as

$$W = W_{11} + 2W_{12} + W_{22}. \quad (4)$$

In all cases the radiated power is expressed in the form

$$W = \int \Phi \, d\Omega, \quad (4a)$$

where $d\Omega$ is the differential solid angle

$$d\Omega = \sin \theta \, d\theta \, d\phi \quad (4b)$$

and the radiation intensity Φ is the power radiated in the direction (θ, ϕ) per unit solid angle.

Ordinary antennas and antenna arrays carry only electric currents, and (1) is sufficient.¹¹ Occasionally, however, it is advantageous to replace the given electric distribution by an equivalent magnetic-current distribution and then make use of (2); this is the case, for example, in calculating the power radiated by an electric-current loop. In dealing with radiation from electric horns, theoretically (1) could also suffice; practically it is necessary to use (4). In order to use (1) we must know fairly accurately the distribution of the electric current in the horn under consideration and, at the present time, it seems im-

possible to secure this knowledge. On the other hand, it is possible to assume on physical grounds a fairly satisfactory field distribution over the mouth of the horn; from this field distribution we may calculate immediately¹⁰ the equivalent electric- and magnetic-current sheets and consequently obtain the radiated power with the aid of (4).

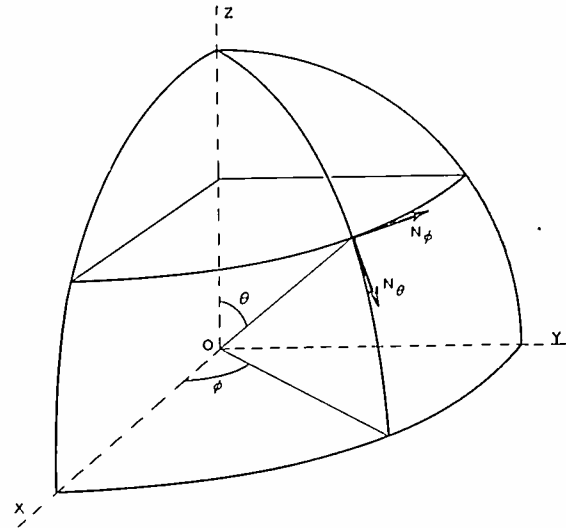

Fig. 1

The radiation vector of an electric element at the origin 0 is defined simply as the moment $I\bar{l}$ of the current element, where I is the current in amperes and \bar{l} is the vector whose length is the length of the element in meters. The radiation vector of a magnetic-current element is $K\bar{l}$, where K is the magnetic current in volts.¹²

The radiation vectors of the above elements situated at points other than the origin are

$$N = I\bar{l}e^{i\beta r' \cos \psi}, \quad L = K\bar{l}e^{i\beta r' \cos \psi}, \quad \beta = \frac{2\pi}{\lambda}, \quad (5)$$

where r' is the distance between the origin and the element and ψ is the angle formed by the radius drawn from 0 to this element and a typical radius from 0. From spherical trigonometry we have

$$\cos \psi = \cos \theta \cos \theta' + \sin \theta \sin \theta' \cos (\phi - \phi'), \quad (6)$$

where (θ', ϕ') are the spherical co-ordinates of the element, and (θ, ϕ) of a typical point in space.

The radiation vector of any set of elements is the sum of the radiation vectors of the individual elements. Frequently the current elements are the differential elements of a thin wire; then these vectors (or rather their Cartesian components) may be expressed in the form of integrals

¹⁰ S. A. Schelkunoff, "Some equivalence theorems of electromagnetics and their application to radiation problems," *Bell Sys. Tech. Jour.*, vol. 15, pp. 92-112; January, (1936).

¹¹ For this case Carson⁸ has also given a compact formula which can readily be converted into (1).

¹² In accordance with Faraday's law of electromagnetic induction the magnetic current passing across a given surface is equal to the electromotive force acting around the periphery of this surface; hence, the practical unit of magnetic current is the volt.

⁹ An oscillating magnetic pole is a magnetic-current element. While there are no isolated magnetic poles, an electric-current loop is equivalent to a magnetic-current element. An oscillating magnetized needle is a pair of parallel magnetic-current elements. In calculations involving Huygens' principle it is frequently necessary to introduce fictitious magnetic-current sheets as well as electric-current sheets. For a more complete discussion of magnetic currents the reader is referred to footnote reference (10).

$$\begin{aligned}
N_x &= \int I(x', y', z') e^{i\beta r' \cos \psi} dx', \\
L_x &= \int K(x', y', z') e^{i\beta r' \cos \psi} dx', \\
N_y &= \int I(x', y', z') e^{i\beta r' \cos \psi} dy', \\
L_y &= \int K(x', y', z') e^{i\beta r' \cos \psi} dy', \\
N_z &= \int I(x', y', z') e^{i\beta r' \cos \psi} dz', \\
L_z &= \int K(x', y', z') e^{i\beta r' \cos \psi} dz',
\end{aligned} \tag{7}$$

where the point (x', y', z') or (r', θ', ϕ') is a typical point on the wire and ψ is the angle formed by the

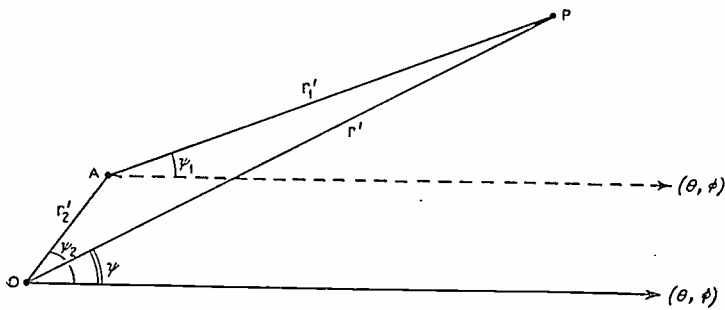

Fig. 2

radii (θ', ϕ') and (θ, ϕ) . If the elements are distributed on a surface or over a volume, then the radiation vectors are given by double or triple integrals. The spherical components, needed in (1), (2), and (3), are then calculated from

$$\begin{aligned}
N_\theta &= (N_x \cos \phi + N_y \sin \phi) \cos \theta - N_z \sin \theta, \\
N_\phi &= -N_x \sin \phi + N_y \cos \phi,
\end{aligned} \tag{8}$$

and an analogous pair of equations for L .

It is frequently advantageous to remember that $r' \cos \psi$ is the projection of the vector drawn from 0 to the typical radiating element upon a typical direction in space and that the projection of the sum of several vectors is equal to the sum of the projections of the components. Thus (Fig. 2)

$$r' \cos \psi = r_1' \cos \psi_1 + r_2' \cos \psi_2, \tag{9}$$

and, therefore,

$$e^{i\beta r' \cos \psi} = e^{i\beta r_1' \cos \psi_1} e^{i\beta r_2' \cos \psi_2}. \tag{10}$$

This last formula may be looked upon as the formula for translating the origin with respect to which the radiation vector is being computed. Thus if N_P , N_A , and N_0 are correspondingly the radiation vectors computed with respect to P , A , and 0, then by (10) we have

$$N_A = N_P e^{i\beta r_1' \cos \psi_1}, \quad N_0 = N_A e^{i\beta r_2' \cos \psi_2}. \tag{11}$$

If the element is located at P , then, by definition $N_P = I\bar{l}$ while with respect to other points N is calculated either directly by (5) or successively by (11), whatever method happens to be more convenient.

Finally if we are dealing with an array of identical radiators, the radiation intensity Φ of the array is equal to the product of the radiation intensity Φ_0 of the individual radiator and the *space factor* Φ_S ; thus

$$\Phi = \Phi_0 \Phi_S, \tag{12}$$

where

$$\Phi_S = |A_1 e^{i\beta r_1' \cos \psi_1} + A_2 e^{i\beta r_2' \cos \psi_2} + \dots|^2.$$

In this equation r_1' , r_2' , \dots are the radii drawn from an origin 0 to the elements of the array, ψ_1 , ψ_2 , \dots are the angles made by these radii with a typical radius from 0, and A_1 , A_2 , \dots are complex numbers whose absolute values represent relative strengths and whose phases relative phases of the elements of the array.

All of the above formulas are for free-space radiation. The field in the presence of a perfect plane reflector is obtained by adding free-space fields of the sources and their images in the reflecting plane. The power radiated above the ground is obtained then by halving the total power radiated in free space by the sources and their images.

If the ground is imperfect, the *approximate* effect of the ground upon the distribution of radiated energy in the space above the ground plane may be obtained by the use of a "selective" image, that is, by the image whose radiation vector is equal to the radiation vector of the perfect image multiplied by the reflection coefficient for the plane waves moving in the direction (θ, ϕ) . If the expression for the radiation intensity is integrated over the half space above the ground we obtain the total power radiated from the antenna minus the power absorbed by the ground, that is, the "free" radiated power. The *approximate* power absorbed in the ground can be obtained by calculating the total field (that of the antenna and of its "selective image") tangential to the ground and integrating the Poynting vector over the surface of the ground. An exact treatment of these questions must be based upon methods similar to the Sommerfeld theory.

RADIATION FROM AN ELECTRIC-CURRENT ELEMENT

In this series of examples illustrating the preceding formulas we shall consider first the simplest radiator, namely, an electric-current element of moment Il , where the length l of the element is very short compared with the wavelength. Assuming that the element is situated along the z axis at the origin, we have $N_z = Il$, $N_x = N_y = 0$, and by (8) $N_\theta = -Il \sin \theta$, $N_\phi = 0$. Hence by (1) we have

$$W = \frac{\eta I^2 l^2}{8\lambda^2} \int_0^\pi \int_0^{2\pi} \sin^3 \theta \, d\theta \, d\phi = \frac{1}{3} \pi \eta \left(\frac{Il}{\lambda}\right)^2 \text{ watts.}$$

In air this becomes $W = 40\pi^2 (Il/\lambda)^2$.

COAXIAL CURRENT ELEMENTS

Consider next a pair of coaxial current elements (Fig. 3). We may choose their common axis as the z axis of our co-ordinate system and the center of one of the elements as the origin. If the distance between the elements is h , the spherical co-ordinates of the second element are $(h, 0, 0)$. Thus for this element $r' = h$, $\theta' = 0$, $\phi' = 0$, $\cos \psi = \cos \theta$, and consequently $N_z = Il e^{i\beta h \cos \theta}$. The radiation vector of the system of two elements with equal moments is then

$$N_z = Il(1 + e^{i\beta h \cos \theta}) = 2Il e^{\frac{1}{2}i\beta h \cos \theta} \cos \frac{\beta h \cos \theta}{2}.$$

By (8) we find N_θ ; multiplying N_θ by the conjugate of itself and substituting in (1), we have

$$W = \frac{1}{2} \eta \left(\frac{Il}{\lambda} \right)^2 \int_0^\pi \int_0^{2\pi} \cos^2 \frac{\beta h \cos \theta}{2} \sin^3 \theta \, d\theta \, d\phi$$

$$= \frac{2\pi\eta}{3} \left(\frac{Il}{\lambda} \right)^2 \left[1 + 3 \left(\frac{\lambda}{2\pi h} \right)^2 \left(\frac{\sin \beta h}{\beta h} - \cos \beta h \right) \right].$$

The details of actual integration are purposely omitted.

It is only fair to state that in this and in some of the following examples the "induced-electromotive-force" method of Brillouin and Pstolkors is decidedly simpler than the present method, or, for that matter, any other known method. Our examples are chosen mostly for the sake of illustrating the technique of setting up (1) for the radiated power. The subsequent integration may be simple in some cases and quite complex in others.

TWO PARALLEL CURRENT ELEMENTS PERPENDICULAR TO THE LINE JOINING THEIR CENTERS

In this case we may assume that the elements are parallel to the z axis, that one of them is at the origin, that the second is on the x axis at the point $(h, 90 \text{ degrees}, 0)$. Here $r' = h$, $\theta' = 90 \text{ degrees}$, $\phi' = 0$; therefore, $\cos \psi = \sin \theta \cos \phi$. For the radiation vector of the system, we have

$$N_z = Il(1 + e^{i\beta h \sin \theta \cos \phi})$$

$$= 2Il e^{\frac{1}{2}i\beta h \sin \theta \cos \phi} \cos \frac{\beta h \sin \theta \cos \phi}{2}.$$

Substituting in (8) and then in (1), we obtain

$$W = \frac{\eta}{2} \left(\frac{Il}{\lambda} \right)^2 \int_0^\pi \int_0^{2\pi} \cos^2 \left(\frac{\beta h \sin \theta \cos \phi}{2} \right) \sin^3 \theta \, d\theta \, d\phi$$

$$= \frac{2\pi\eta}{3} \left(\frac{Il}{\lambda} \right)^2 \left[1 + \frac{3\lambda}{4\pi h} \left(\sin \beta h + \frac{\cos \beta h}{\beta h} - \frac{\sin \beta h}{\beta^2 h^2} \right) \right].$$

A FILAMENT OF FINITE LENGTH l CARRYING A PROGRESSIVE CURRENT WAVE

Assuming that the filament is along the z axis, that it begins at the origin and that the current in it is $I(z') = e^{-i\beta z'}$, we have by (7)

$$N_z = I \int_0^l e^{-i\beta z' + i\beta z' \cos \theta} dz' = \frac{I[1 - e^{-i\beta(1-\cos \theta)l}]}{i\beta(1-\cos \theta)}$$

$$= \frac{2I \sin \frac{\beta l(1-\cos \theta)}{2}}{\beta(1-\cos \theta)} e^{-\frac{1}{2}i\beta l(1-\cos \theta)}. \quad (7a)$$

In this case we have

$$N_\theta N_\theta^* = \frac{4I^2 \sin^2 \frac{\beta l(1-\cos \theta)}{2}}{\beta^2(1-\cos \theta)^2} \sin^2 \theta. \quad (7b)$$

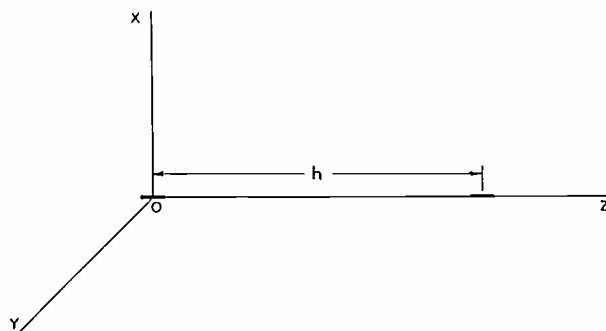

Fig. 3

RADIATION FROM A TRANSMISSION LINE TERMINATED IN ITS CHARACTERISTIC IMPEDANCE

A transmission line terminated in its characteristic impedance may be regarded, apart from the particular type of termination, as a pair of parallel progressive current filaments, 180 degrees out of phase with each other.¹³ Except for this phase difference, the radiation vectors of the filaments with respect to their origins are given by (7a). Assuming the origin of the first filament at 0 and of the second at $(h, 90 \text{ degrees}, 0)$, we find that by (9) the radiation vector of the second filament with respect to 0 is obtained if we multiply (7a) by $e^{i\beta h \sin \theta \cos \phi}$. Hence, the radiation vector of the pair is

$$N_z = \frac{2I \sin \frac{\beta l(1-\cos \theta)}{2}}{\beta(1-\cos \theta)} e^{-\frac{1}{2}i\beta l(1-\cos \theta)} (1 - e^{i\beta h \sin \theta \cos \phi})$$

and, therefore,

$$N_\theta N_\theta^* = \frac{16I^2 \sin^2 \frac{\beta l(1-\cos \theta)}{2} \sin^2 \frac{\beta h \sin \theta \cos \phi}{2}}{\beta^2(1-\cos \theta)^2} \sin^2 \theta.$$

¹³ It is understood that in any actual case the total radiated power is obtained by adding the power radiated by the filaments as here calculated, the power radiated by the termination, and the mutual power. Naturally, the last two terms depend on the particular design of the terminating impedance.

For an application of this method to rhombic antennas the reader is referred to a paper by my former colleague, Donald Foster.¹⁴

RADIATION FROM A MAGNETIC-CURRENT ELEMENT AND AN ELECTRIC-CURRENT LOOP

This problem is similar to that concerning the electric-current element. This time we have $L_z = Kl$, Kl being the moment of the element. Hence, $L_\theta = -Kl \sin \theta$ and by (2)

$$W = \frac{K^2 l^2}{8\eta\lambda^2} \int_0^\pi \int_0^{2\pi} \sin^3 \theta \, d\theta \, d\phi = \frac{\pi(Kl)^2}{3\eta\lambda^2} \text{ watts.}$$

An electric-current loop of area S , carrying I amperes, is equivalent to a magnetic-current element

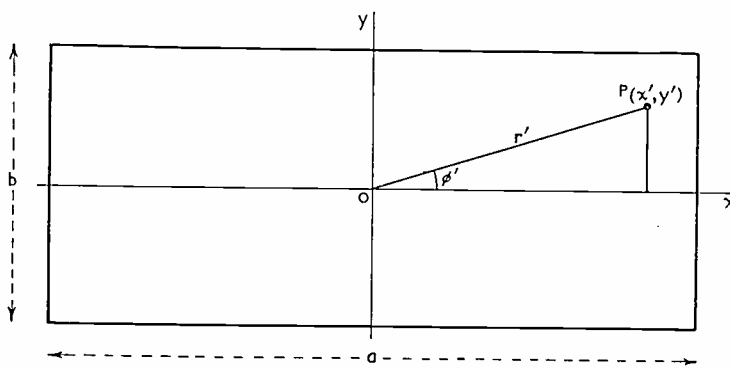

Fig. 4

of moment $Kl = \omega\mu SI = 2\pi\eta(SI/\lambda)$. Hence, the radiated power is

$$W = \frac{4\pi^3\eta(SI)^2}{3\lambda^2}$$

RADIATION FROM A HUYGENS' SOURCE

In accordance with the principle, first enunciated by Huygens, any wave front may be considered as a continuous array of secondary sources. These sources may be regarded as fictitious electric- and magnetic-current sheets whose densities are related in a definite manner to the electric and magnetic intensities tangential to the wave front.¹⁰ Thus, the wave front of an ordinary plane wave (for which the electric and magnetic intensities are connected by the relation $E = \eta H$) may be regarded as a uniform electric-current sheet of density H and a uniform magnetic-current sheet of density E . The electric current flows in a direction opposite to that of E and the magnetic current is opposite to H .

An infinitely small rectangle of area S , with its sides parallel to E and H , will be called *Huygens' source*. Assuming this source to be at the origin in the xy plane and letting

$$E_x = E, \quad H_y = H, \quad E_y = H_x = 0, \quad E = \eta H,$$

so that the plane wave is moving in the positive z direction, we have

$$J_x = -H, \quad M_y = -E = -\eta H,$$

where J_x and M_y are, respectively, the electric- and magnetic-current densities. The moments of the electric and magnetic components of Huygens' source and hence their radiation vectors are

$$N_x = -HS, \quad L_y = -ES.$$

By (8) we obtain

$$\begin{aligned} N_\theta &= -HS \cos \theta \cos \phi, & N_\phi &= HS \sin \phi, \\ L_\theta &= -ES \cos \theta \sin \phi = -\eta HS \cos \theta \sin \phi \\ L_\phi &= -ES \cos \phi = -\eta HS \cos \phi. \end{aligned}$$

By (4) and (4a) we have the following expression for the radiation intensity of Huygens' source

$$\Phi = \frac{\eta H^2 S^2}{8\lambda^2} (1 + \cos \theta)^2 = \frac{E^2 S^2}{8\eta\lambda^2} (1 + \cos \theta)^2.$$

Thus, the radiation intensity is maximum in the direction $\theta = 0$ and vanishes in the opposite direction. Integrating over the unit sphere we have the radiated power

$$W = \frac{2\pi E^2 S^2}{3\eta\lambda^2}$$

In air this becomes $W = (1/180) (ES/\lambda)^2$ watts.

RADIATION THROUGH A RECTANGULAR APERTURE IN AN INFINITE PLANE SCREEN

Let the screen coincide with the xy plane and the origin be the center of a rectangular aperture whose sides A and B are parallel to the co-ordinate axes (Fig. 4). As it is customary in optics, we shall assume that the field over the aperture is the same as if there were no screen. Thus, we shall regard a continuous rectangular array of Huygens' sources distributed over the aperture as the source of the field transmitted across the aperture. Evidently this amounts to ignoring the edge effect.

In the present case for each Huygens' source of our array $\theta' = 90$ degrees and $\cos \psi = \sin \theta \cos (\phi - \phi')$. Thus the radiation vectors of each elementary source of area dS are multiplied by the factor $e^{i\beta r' \sin \theta \cos (\phi - \phi')}$ and, therefore,

$$\Phi = \frac{E^2}{8\eta\lambda^2} (1 + \cos \theta)^2 \left| \int_{(S)} e^{i\beta r' \sin \theta \cos (\phi - \phi')} dS \right|^2$$

Since $r' \cos (\phi - \phi') = r' \cos \phi' \cos \phi + r' \sin \phi' \sin \phi = x' \cos \phi + y' \sin \phi$, we have the following expression for the radiation intensity:

¹⁴ Donald Foster, "Radiation from rhombic antennas," PROC. I.R.E., vol. 25, pp. 1327-1353; October, (1937).

$$\Phi = \frac{E^2}{8\eta\lambda^2} (1 + \cos \theta)^2 \left| \int_{-a/2}^{a/2} \int_{-b/2}^{b/2} e^{i\beta(x' \cos \phi + y' \sin \phi) \sin \theta} dx' dy' \right|^2$$

$$= \frac{E^2 a^2 b^2}{8\eta\lambda^2} (1 + \cos \theta)^2 \frac{\sin^2 \left(\frac{\pi a}{\lambda} \sin \theta \cos \phi \right)}{\left(\frac{\pi a}{\lambda} \sin \theta \cos \phi \right)^2} \frac{\sin^2 \left(\frac{\pi b}{\lambda} \sin \theta \sin \phi \right)}{\left(\frac{\pi b}{\lambda} \sin \theta \sin \phi \right)^2};$$

its integral over the unit sphere represents approximately the total power transmitted through the aperture.

A similar procedure is followed in calculating the power emitted by electric horns. Again it becomes necessary to make assumptions concerning the field distribution over the mouth of each horn as well as over the external surface of the horn itself.

PART II

DERIVATION OF EQUATIONS

By the complex Poynting theorem the average flow of power per unit area of an alternating field is the real part of $\frac{1}{2}E \times H^*$, where E is the electric intensity and H^* is the conjugate of the magnetic intensity. In this equation the *instantaneous* intensities are the real parts of $Ee^{i\omega t}$ and $H^*e^{i\omega t}$, where t is time in seconds and ω the frequency in radians per second. Let all the sources be enclosed by a sphere of radius r . The average power W , transferred across the sphere, is the real part of Ψ given by

$$\Psi = \frac{1}{2} r^2 \int (E_\theta H_\phi^* - E_\phi H_\theta^*) d\Omega, \quad (13)$$

where the integration extends over the sphere, $d\Omega$ and $r^2 d\Omega$ being, respectively, the elementary solid angle and the element of area on the sphere.

Since the radiated power must be independent of r so long as the sphere encloses all the sources under consideration, we have

$$W = \lim_{r \rightarrow \infty} \Psi \quad (14)$$

In order to calculate this limit we need not know the exact expression for the field but only that part which on the average *varies inversely as the distance* from the center of the sphere. This part of the total field is frequently called the *radiation field*. It should be borne in mind, however, that this separation is purely artificial and is only a matter of convenience.

The following are the well-known formulas for the electromagnetic field produced by a given distribution of electric currents in terms of the retarded vector potential A

$$E = -i\omega\mu A + \frac{1}{i\omega\epsilon} \text{grad div } A, \quad H = \text{curl } A, \quad (15)$$

where μ is the permeability and ϵ the dielectric constant of the medium. In this connection the vector

potential of an electric-current element of moment $I\vec{l}$ ampere-meters is defined by

$$A = \frac{I\vec{l}e^{-i\beta R}}{4\pi R}, \quad \beta = \frac{2\pi}{\lambda}, \quad (16)$$

where λ is the wavelength and R the distance from the element. The vector potential of a general distribution is obtained with the aid of the principle of superposition.

In order to include the field produced by a magnetic-current distribution we may introduce a second retarded vector potential F related to magnetic currents in the same manner as A is related to electric currents. Thus for a magnetic-current element of moment $K\vec{l}$ volt-meters, we have

$$F = \frac{K\vec{l}e^{-i\beta R}}{4\pi R}. \quad (17)$$

The complete expression for the field is then

$$E = -i\omega\mu A + \frac{1}{i\omega\epsilon} \text{grad div } A - \text{curl } F, \quad (18)$$

$$H = \text{curl } A + \frac{1}{i\omega\mu} \text{grad div } F - i\omega\epsilon F.$$

Inasmuch as in our problem we are interested only in terms varying inversely as the distance r from the origin of our co-ordinate system, we shall introduce two auxiliary vectors N and L which are related to A and F as follows:

$$N = \lim_{r \rightarrow \infty} (4\pi r e^{i\beta r} A), \quad L = \lim_{r \rightarrow \infty} (4\pi r e^{i\beta r} F). \quad (19)$$

Assuming for the present that these limits exist, we have

$$A = \frac{N e^{-i\beta r}}{4\pi r} + \frac{\delta_1}{r}, \quad F = \frac{L e^{-i\beta r}}{4\pi r} + \frac{\delta_2}{r}, \quad (20)$$

where δ_1 and δ_2 tend to zero as r increases indefinitely. It must be remembered that N and L are independent of r . Substituting A and F from (20) into (18), we have

$$E_\theta = -\frac{i e^{-i\beta r}}{4\lambda r} (\eta N_\theta + L_\phi) + \frac{\delta'_1}{r},$$

$$E_\phi = \frac{i e^{-i\beta r}}{4\lambda r} (-\eta N_\phi + L_\theta) + \frac{\delta''_1}{r}, \quad (21)$$

$$H_\theta = \frac{i e^{-i\beta r}}{4\eta\lambda r} (\eta N_\phi - L_\theta) + \frac{\delta'''_1}{r},$$

$$H_\phi = -\frac{i e^{-i\beta r}}{4\eta\lambda r} (\eta N_\theta + L_\phi) + \frac{\delta^{(IV)}_1}{r},$$

where the δ 's approach zero with increasing r . Differentiation which has to be performed in order to obtain (21) is very simple since we need not calculate explicitly the terms involving the second and higher powers of $1/r$.

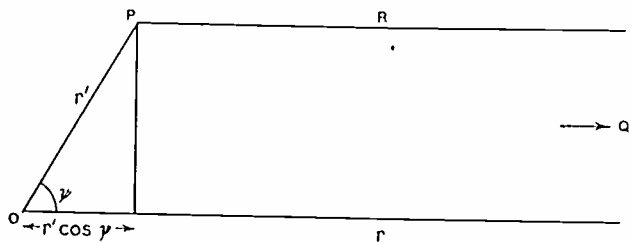

Fig. 5

The relations between E and H components of the radiation field are particularly simple

$$\begin{aligned} E_{\theta} &= \eta H_{\phi}, & E_{\phi} &= -\eta H_{\theta}, \\ E_{\theta} &= 377 H_{\phi}, & E_{\phi} &= -377 H_{\theta}, \quad (\text{in air}). \end{aligned} \quad (22)$$

This was to be expected because at great distances from the sources a limited portion of the wave front is substantially plane.

Substituting from (21) into (13) and passing to the limit, we obtain (4).

Next we shall prove that the limits in (19) actually exist. Fig. 5 makes it clear to the eye that, as r increases indefinitely,

$$\lim \frac{r}{R} = 1, \quad \lim (r - R) = r' \cos \psi. \quad (23)$$

Analytically from the triangle OPQ we obtain

$$\begin{aligned} R &= \sqrt{r^2 - 2rr' \cos \psi + r'^2} \\ &= r \sqrt{1 - \frac{2r' \cos \psi}{r} + \frac{r'^2}{r^2}}. \end{aligned} \quad (24)$$

If r is large, then

$$\begin{aligned} R &= r \left[1 - \frac{r' \cos \psi}{r} + o\left(\frac{1}{r^2}\right) \right] \\ &= r - r' \cos \psi + o\left(\frac{1}{r}\right). \end{aligned} \quad (25)$$

From these equations we obtain (23). By (16), (19), and (23) we have for each current element

$$\begin{aligned} N &= \lim \left(4\pi r e^{i\theta r} \frac{I \bar{l} e^{-i\theta R}}{4\pi R} \right) = \bar{l} \lim \frac{r}{R} \lim e^{i\theta(r-R)} \\ &= \bar{l} e^{i\theta r' \cos \psi}. \end{aligned} \quad (26)$$

Thus we have proved the existence of the auxiliary vector N and obtained the expression (5) for it in the case of a single current element. By the principle of superposition we can apply the theorem to any combination of elements.

A Theoretical Analysis of Single-Sideband Operation of Television Transmitters*

LEON S. NERGAARD†, MEMBER, I.R.E.

Summary—The effect of detuning a transmitter to suppress partially one sideband and increase the width for the other sideband is investigated.

A screen-grid tube driving a simple tuned circuit is assumed. It is also assumed that the tube operates as a class C amplifier and is grid modulated. To establish simple criteria for the performance of the circuit, the voltage amplitude across the tank in response to "unit-function" modulation is studied as a function of the circuit decrement and detuning. The "time of response" is defined as the time required for the tank-voltage amplitude to build up to 0.632 $(1-1/e)$ times its steady-state value. The time of response is found to be a function of the decrement and detuning. It decreases with an increase in decrement or an increase in detuning. The "decay time" is defined as the time required for the tank voltage to drop to 0.368 $(1/e)$ times the initial value and is found to be equal to the reciprocal of the decrement.

The effect of detuning on the carrier-power output is considered. It is assumed that the anode dissipation of the tube is limited and that the operating parameters are adjusted to the optimum values consistent with the specified values of decrement and detuning. It is shown that detuning results in a severe reduction in power output. For example, if the circuit is detuned to reduce the time of response 50 per cent, the output drops approximately 50 per cent if the plate current can be increased, and approximately 65 per cent if the plate current is emission-limited to its value at resonance. If the time of

response is reduced 50 per cent by doubling the decrement, the power output drops about 15 per cent if the current is not emission-limited and 50 per cent if the current is emission-limited. Both examples assume that the screen voltage is 1/10 the plate voltage for normal on-resonance operation.

I. INTRODUCTION

AT THE present time there is great need for a power tube giving high power output for television purposes. Such a tube must operate at a carrier frequency of 30 megacycles or higher in order to permit operation in open channels, and must work into a broad-band circuit in order to reproduce the video-frequency signal faithfully. Unfortunately, the high carrier frequency and broad-band-width requirements evoke a group of limitations which completely circumscribe the design of the tube and limit its maximum power output. These limitations enter as follows:

(a) The tank impedance into which the tube operates is inversely proportional to the product of the band width and the circuit capacitance. Because the band width is fixed the only free parameter is the

* Decimal classification: R583XR355.5. Original manuscript received by the Institute, August 11, 1938; abridgment received by the Institute, September 6, 1939. Presented, Thirteenth Annual Convention, New York, N. Y., June 18, 1938.

† Research and Engineering Department, RCA Manufacturing Company, Inc., Harrison N. J.

capacitance. The capacitance should be small in order that the tank impedance may be high so that full output can be obtained with a low plate current. The capacitance can be reduced by:

(1) Decreasing the area of the anode, but this reduces the dissipating area, and hence the power output;

(2) Increasing the spacing between anode and the adjacent grid, but this increases the electron transit-time between cathode and anode which reduces the plate efficiency.

Therefore, any decrease in the capacitance tends to reduce the possible power output.

(b) Now consider a tube having a fixed plate dissipation working into a given output impedance. The plate-voltage swing is proportional to the plate current. However, the plate voltage must not swing below a certain minimum which is the peak control-grid voltage in a triode and the screen voltage in a tetrode. The plate current is approximately proportional to the control-grid voltage in a triode and the screen-grid voltage in a tetrode. There are now two ways of increasing the power output:

(1) The control-grid or screen voltage, as the case may be, can be increased to give a higher plate current and the plate voltage increased to prevent the plate voltage from swinging below the control-grid or screen voltage. However, this procedure increases the dissipation and is, therefore, ruled out.

(2) The diode factor of the tube can be increased so that more current is obtained for a given control-grid or screen-grid voltage. That this results in an increase in power output can be seen from the following argument: Suppose the plate current is held constant as the diode factor is increased. Then the required control-grid or screen-grid voltage decreases. But the plate-voltage swing remains constant so that the plate voltage can be reduced, thereby reducing the dissipation. This process has resulted in no decrease in power output because the current and output impedance have been held constant. It is now feasible to increase the plate current and control-grid or screen-grid voltage, at the same time increasing the plate voltage to prevent the plate voltage from swinging below the grid voltage, until the tube is dissipation-limited. This results in an increased power output. It should be noted that the value of the control-grid or screen-grid voltage for this final adjustment is less than the original value. The diode factor can be increased in the following ways:

(i) The length of the cathode can be increased. Doing this lengthens the tube structure and increases the output capacitance. The maximum length of the tube must be considerably less than a quarter wavelength or the output will decrease due to voltage distribution on the electrodes. The voltage distribution on the electrodes may,

therefore, impose a further limitation on the length. Then there is the matter of transit-time. As the diode factor is increased by increasing the length, the grid voltage drops, the transit-time increases, and as an end result the tube efficiency drops.

(ii) The diameter of the cathode can be increased. Here again, there are limitations. As the diameter increases, the interelectrode spacings decrease and the capacitances increase. This decrease in spacing cannot be entirely taken up between cathode and control grid because of mechanical difficulties in maintaining close spacing in large structures under widely varying temperatures. Then, finally, as the diode factor is increased and the voltages reduced, the total emission required rises. This necessitates greater cathode power which results in higher grid temperatures and grid emission.

Therefore, the design of a power tube for television purposes consists in striking that balance between all the factors outlined above which will give the maximum output at the required wavelength and band width.

Because the output of a conventional amplifier is definitely fixed by the carrier frequency and band width, it is of interest to inquire whether or not any departure from conventional operation will increase the output for a given carrier frequency and band width. Single-sideband operation would seem to be a definite possibility because it suppresses one side band and doubles the band width for the remaining side band. It is the purpose of this paper to investigate the effect of single-sideband operation on the power output of a transmitter. Before proceedings with this investigation, response criteria must be established. These criteria permit easy visualization of the effect of detuning the transmitter.

II. RESPONSE CRITERIA

(a). *The Standard Signal*

For years it has been customary to describe the performance of amplifiers in terms of their frequency characteristics. It was therefore natural to carry this method over into the field of television equipment and to analyze the television image in terms of its frequency spectrum. After the characteristics of the television picture had been studied and the minimum requirements for satisfactory reproduction had been established,¹ it was possible to set the minimum requirements with regard to the frequency characteristics of the transmitting and receiving equipment. It was found that the video-frequency amplifiers must pass the frequency band of

$$f = \frac{1}{2}a^2RK$$

¹ E. W. Engstrom, "A study of television image characteristics," Part I, *Proc. I.R.E.*, vol. 21, pp. 1631-1651; December, (1933); Part II, *Proc. I.R.E.*, vol. 23, pp. 295-310; April, (1935).

in which

$$\begin{aligned} a &= \text{number of scanning lines} \\ R &= \text{aspect ratio of the picture} \\ K &= 0.64 \end{aligned}$$

and that the phase shift must be a linear function of the frequency.² This method of specifying the circuit requirements is quite satisfactory.

However, there is an alternative method of analyzing the response characteristics of amplifiers which has the advantage of leading to a concrete pictorial result. This is the impulse method. It consists in impressing a signal on the amplifier which is zero for time $t < 0$, rises discontinuously to a definite value at $t = 0$, and retains this value until $t = +\infty$ (a "unit-function signal"). The response to this impulse depicts very clearly how an amplifier reproduces the sharpest conceivable transition from dark to light in a television picture. If this response and any arbitrary signal are suitably substituted in Duhamel's integral, the integrated result gives the response of the amplifier to the arbitrary signal. In the final analysis, the Fourier and impulse methods lead to the same results. However, because of the clarity with which the impulse method expresses these results, it is adopted in the subsequent analysis.

(b). Mathematical Formulation of the Problem

The circuit is assumed to be that of a single-ended power amplifier. The assumption of a single-ended circuit results in no loss of generality because a balanced push-pull circuit will have the same response characteristics. It is assumed that the tube is grid-modulated. Grid modulation is generally considered necessary because of the difficulty in building a modulating reactor which will have a flat characteristic over the entire video-frequency range and which will supply voltage to the anodes with little direct-voltage drop.³

It is assumed that the tube is a tetrode. The assumption of a tetrode introduces a limitation in that the plate voltage must never swing below the screen voltage. However, a triode is subject to a similar limitation because the instantaneous plate voltage must always be greater than the instantaneous grid voltage. This point is of interest in calculating the power output of the amplifier, a matter which will be considered in a later section. The assumption that the tube is a tetrode makes consideration of the effect of plate voltage on the plate current unnecessary.

² Kell, Bedford, and Trainer, "An experimental television system—the transmitter," Proc. I.R.E., vol. 22, pp. 1246-1265; November, (1934).

³ Since this paper was written a new modulation system has been described by W. N. Parker. See *Electronics*, vol. 10, p. 14; December, (1937), and "A unique method of modulation for high-fidelity television transmitters," Proc. I.R.E., vol. 26, pp. 946-962; August, (1938). The response considerations of this paper apply to the antenna and transmission-line systems of the Parker circuit. The power output considerations, however, are inapplicable.

This greatly simplifies the problem because the tube can be treated as a current generator. In a high- μ triode the plate current is nearly independent of the plate voltage, so no serious loss of generality is incurred by assuming the use of a tetrode. It is also assumed that the tank capacitance is the plate-to-ground capacitance and that, therefore, no further reduction is possible.

The specific circuit and tube characteristics will now be described and the mathematical representation formulated.

1. The Circuit

The circuit is as shown in Fig. 1. The nomenclature, as used in the figure, is

$$\begin{aligned} L &= \text{inductance in tank} \\ r &= \text{series resistance of tank} \\ C &= \text{capacitance in tank} \\ i_p &= \text{alternating plate current} \\ i_1 &= \text{current through } r \text{ and } L \\ i_2 &= \text{current through } C \\ e_p &= \text{instantaneous alternating tank voltage.} \end{aligned}$$

Then

$$e_p = i_1(r + pL) = \frac{i_2}{pC} \quad (1)$$

$$i_p = i_1 + i_2 = \left(pC + \frac{1}{r + pL} \right) e_p \quad (2)$$

and

$$e_p = \frac{i_p(r + pL)}{p^2LC + pCr + 1} \quad (3)$$

in which p = the Heaviside operator. Let

$$\frac{\omega_0}{2\pi} = \frac{1}{2\pi\sqrt{LC}} = \text{the resonant frequency of the tank} \quad (4)$$

$$\delta = \frac{r}{2L} = \text{the decrement of the tank.} \quad (5)$$

Then

$$e_p = \frac{p + 2\delta}{p^2 + 2\delta p + \omega_0^2} \cdot \frac{i_p}{C} \quad (6)$$

Let α_1 and α_2 be the roots of the denominator. Then

$$p^2 + 2\delta p + \omega_0^2 = (p - \alpha_1)(p - \alpha_2) \quad (7)$$

$$\alpha_1 = -\delta + i\omega_1 \quad (8)$$

$$\alpha_2 = -\delta - i\omega_1 \quad (9)$$

$$\omega_1 = \sqrt{\omega_0^2 - \delta^2} \quad (10)$$

and

$$e_p = \frac{p + 2\delta}{(p - \alpha_1)(p - \alpha_2)} \cdot \frac{i_p}{C} \quad (11)$$

2. The Plate Current

Assume the grid characteristic of the tube to be as shown in Fig. 2. The nomenclature is

- I_b = total plate current
- E_{c1} = control-grid voltage
- E_{c2} = screen-grid voltage

The assumption that the $I_b - E_{c1}$ curves are linear is an idealization, a highly desirable idealization because it makes the differential equation for e_p linear, and hence amenable to solution by Heaviside's method. This idealization introduces no effects peculiar to this problem and, therefore, results in the same error as it would in a steady-state amplifier problem. This would not be true in the case of an oscillator where the variable damping due to curvature definitely limits the final amplitude.

It is assumed that the tube operates on a definite $I_b - E_{c1}$ characteristic, say the one corresponding to $E_{c2} = 3x$, and that the tube is biased to $E_{c1} = -3y$ for operation at 100 per cent modulation. Because I_b is directly proportional to E_{c1} , e_p can be expressed in terms of i_p without loss of generality. This will be done.

If a carrier signal of fixed amplitude is impressed on the grid at time $t = 0$, the plate current will be zero until $t = 0$, and then will consist of pulses of current as shown in Fig. 3 in which

- I_p' = amplitude of the sine wave
- I_p = peak current
- β = angle of operation

The immediate problem, then, is to express this current in terms of the Heaviside operator p . This expression is easily obtained by means of the Carson integral⁴

$$\frac{i(p)}{p} = \int_0^\infty i(t)e^{-pt} dt.$$

In this case

$$i(t) = \begin{cases} I_p' [\cos(\omega t - \beta/2) - \cos \beta/2]; & 2\pi n \leq \omega t \leq 2\pi n + \beta \\ 0 & ; 2\pi n + \beta \leq \omega t \leq 2\pi(n + 1) \end{cases} \quad n = 0, 1, 2, \dots, m.$$

When this relation is substituted in the integral and the indicated integration is performed, one obtains

$$i(p) = \frac{\omega I_p'}{p^2 + \omega^2} \cdot [(p \sin \beta/2 - \omega \cos \beta/2) + (p \sin \beta/2 + \omega \cos \beta/2)e^{-p(\beta/\omega)}] \cdot \frac{1 - e^{-p(2\pi/\omega)(m+1)}}{1 - e^{-p(2\pi/\omega)}} \quad (12)$$

This is the current during the m th cycle. Let

$$F(p) \equiv (p \sin \beta/2 - \omega \cos \beta/2) + (p \sin \beta/2 + \omega \cos \beta/2)e^{-p(\beta/\omega)} \quad (13)$$

$$G(p) \equiv \frac{1 - e^{-p(2\pi/\omega)(m+1)}}{1 - e^{-p(2\pi/\omega)}} \quad (14)$$

Then the complete differential equation is

$$C e_p = \frac{I_p'}{C} \frac{p + 2\delta}{(p - \alpha_1)(p - \alpha_2)} \frac{\omega}{p^2 + \omega^2} \cdot F(p) \cdot G(p) \quad (15)$$

⁴ For a derivation of this formula, see J. R. Carson, "Electric Circuit Theory and Operational Calculus," Chapter II, McGraw-Hill Book Company, (1926).

or, on transposition,

$$\frac{C e_p}{\omega I_p'} = \frac{p + 2\delta}{(p - \alpha_1)(p - \alpha_2)} \cdot \frac{1}{(p - i\omega)(p + i\omega)} \cdot F(p) \cdot G(p) \quad (16)$$

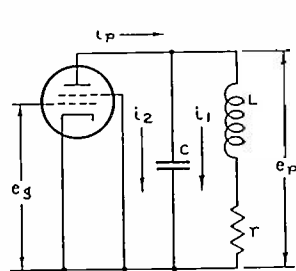

Fig. 1—Circuit of the output stage of transmitter.

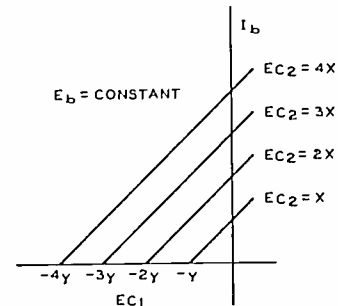

Fig. 2—Grid characteristics of the output tube of the transmitter.

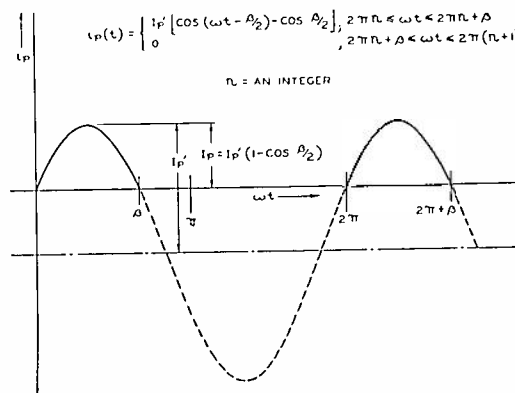

Fig. 3—The plate current of the output tube as a function of time.

(c). The Solution for the Tank Voltage

The differential equation can readily be solved by the Bromwich integral⁵

$$\frac{C e_p}{\omega I_p'} = \frac{1}{2\pi i} \int_{\epsilon - i\infty}^{\epsilon + i\infty} \frac{p + 2\delta}{(p - \alpha_1)(p - \alpha_2)} \cdot \frac{e^{pt}}{(p - i\omega)(p + i\omega)} \cdot F(p) \cdot G(p) \cdot \frac{dp}{p} \quad (17)$$

The integrand has four simple poles, at $p = \pm i\omega, \alpha_1, \alpha_2$, and no other singularities, hence the integral can be evaluated by taking the sum of residues at these poles:

$$\frac{C e_p}{\omega I_p'} = \frac{(i\omega + 2\delta)e^{i\omega t}}{2i\omega(i\omega - \alpha_1)(i\omega - \alpha_2)} \cdot F(i\omega) \cdot G(i\omega) + \frac{(-i\omega + 2\delta)e^{-i\omega t}}{-2i\omega(i\omega + \alpha_1)(i\omega + \alpha_2)} \cdot F(-i\omega) \cdot G(-i\omega)$$

⁵ T. J. I'A. Bromwich, "Normal coordinates in dynamical systems," Proc. London Math. Soc., series 2, vol. 15, pp. 401-448, (1916).

$$+\frac{(\alpha_1+2\delta)e^{\alpha_1 t}}{(\alpha_1-\alpha_2)(\alpha_1-i\omega)(\alpha_1+i\omega)} \cdot I'(\alpha_1) \cdot G(\alpha_1) \\ -\frac{(\alpha_2+2\delta)e^{\alpha_2 t}}{(\alpha_1-\alpha_2)(\alpha_2-i\omega)(\alpha_2+i\omega)} \cdot I'(\alpha_2) \cdot G(\alpha_2). \quad (18)$$

When

$$\frac{\delta}{\omega} \ll 1 \quad (19)$$

and

$$\left| \frac{\omega - \omega_0}{\delta} \right| \equiv \frac{\Delta\omega}{\delta} < 2$$

this rather formidable solution reduces to the following simple form:

$$e_p = \frac{I_p'}{2\pi} \frac{L}{rC} \frac{\beta - \sin \beta}{\sqrt{1 + (\Delta\omega/\delta)^2}} [\cos(\omega t - \beta/2 - \phi) - e^{-\delta t} \cos(\omega_0 t - \beta/2 - \phi)]$$

in which

$$\phi = \tan^{-1} \Delta\omega/\delta. \quad (20)$$

The validity of the two approximations must now be investigated. The most serious error arises from neglecting a term of order $\pi\delta/\omega_0$. Therefore, if this term is negligible compared to unity, both approximations are valid.

Consider a tube operating with a circuit tuned to a frequency of 42 megacycles and having an impedance of 1000 ohms. Suppose the output capacitance to be 50 micromicrofarads. These values represent as un-

is the impedance of the tank circuit when it is detuned an amount $\Delta\omega$.

$$(3). \quad \frac{I_p'}{2\pi} \frac{L}{rC} \frac{\beta - \sin \beta}{\sqrt{1 + \left(\frac{\Delta\omega}{\delta}\right)^2}}$$

is the final steady-state voltage amplitude. The factor $(\beta - \sin \beta)/2\pi$ enters because the tube is operated as a class C amplifier and, therefore, delivers current to the tank only throughout the operating angle β .

(4). $\cos(\omega t - \phi - \beta/2)$ is the harmonic term corresponding to the driving frequency.

(5). $\omega - \Delta\omega = \omega_0$. Therefore the term $e^{-\delta t} \cos[(\omega - \Delta\omega)t - \phi - \beta/2]$

is a shock-excited transient having a frequency equal to the natural frequency of the circuit. It dies out exponentially.

(6). $\phi = \tan^{-1}(\Delta\omega/\delta)$ is the phase angle of the circuit. When $\Delta\omega = \delta$, the phase angle is +45 degrees. This is the detuning at which the amplitude is down to 0.707 times the resonant amplitude, and the power output down to one half of the resonant power.

The solution can also be put in the following form:

$$e_p = \frac{I_p'(\beta - \sin \beta)}{2\pi} \frac{L}{rC} \sqrt{\frac{1 - 2e^{-\delta t} \cos \Delta\omega t + e^{-2\delta t}}{1 + \left(\frac{\Delta\omega}{\delta}\right)^2}} \cos(\omega t - \phi + \chi - \beta/2) \quad (21)$$

$$\chi = \tan^{-1} \frac{e^{-\delta t} \sin \Delta\omega t}{1 - e^{-\delta t} \cos \Delta\omega t}$$

favorable a set of conditions for δ to be small compared with ω_0 as is likely to be encountered in practice. Then

$$\frac{\pi\delta}{\omega_0} = \frac{\pi r}{2\omega_0 L} = \frac{1}{2} \frac{rC}{L} \frac{\pi}{\omega_0 C} \\ = \frac{1}{2} \frac{1}{1000} \frac{1}{2\pi \times 42 \times 10^6} \frac{\pi}{50 \times 10^{-12}} \\ = 0.12.$$

Therefore, the error in a very unfavorable case is of the order of 10 per cent.

It is interesting to examine (20).

(1). L/rC is the resonant impedance of the tank circuit.

$$(2). \quad \frac{L}{rC} \frac{1}{\sqrt{1 + \left(\frac{\Delta\omega}{\delta}\right)^2}}$$

Now, let

$$\frac{L}{rC} = Z_0 = \text{resonant impedance} \quad (22)$$

$$E_p = \frac{I_p' Z_0 (\beta - \sin \beta)}{2\pi} \sqrt{\frac{1 - 2e^{-\delta t} \cos \Delta\omega t + e^{-2\delta t}}{1 + \left(\frac{\Delta\omega}{\delta}\right)^2}} \quad (23) \\ = \text{tank-voltage amplitude.}$$

The voltage amplitude, then, is zero at $t=0$, rises approximately exponentially, and as $t \rightarrow \infty$ becomes

$$E_p = \frac{I_p' Z_0 (\beta - \sin \beta)}{2\pi \sqrt{1 + \left(\frac{\Delta\omega}{\delta}\right)^2}} [1 - e^{-\delta t} \cos \Delta\omega t]. \quad (24)$$

Therefore, it finally consists of an exponentially damped harmonic term having a frequency equal to the detuning expressed in cycles per second superimposed on the final steady-state amplitude.

The phase is also a function of time. It is $+\phi$ at $t=0$ and approaches $+\phi$ again at $t \rightarrow \infty$.

(d). The Voltage Response

Equation (23) shows how the voltage amplitude builds up to its final value when a unit-function modulation is impressed on the amplifier. Now the output of a linear detector is proportional to the amplitude of the impressed carrier. Hence the amplitude represents the image produced on the screen of a perfect television receiver by the unit-function modulation. It is, therefore, of interest to examine the amplitude in some detail.

It is advantageous to express (23) in terms of dimensionless quantities so that the curves plotted from it will refer to any amplifier of the kind postulated. Therefore, we write

$$A = \frac{2\pi E_p}{I_p' Z_0 (\beta - \sin \beta)} = \frac{1 - 2e^{-\delta t} \cos \frac{\Delta\omega}{\delta} \delta t + e^{-2\delta t}}{1 + \left(\frac{\Delta\omega}{\delta}\right)^2} = \sqrt{\frac{1 - 2e^{-T} \cos \mu T + e^{-2T}}{1 + \mu^2}} \quad (25)$$

Then

$$A = \frac{2\pi E_p}{I_p' Z_0 (\beta - \sin \beta)} \quad (26)$$

$$T = \delta t \quad (27)$$

$$\mu = \frac{\Delta\omega}{\delta} \quad (28)$$

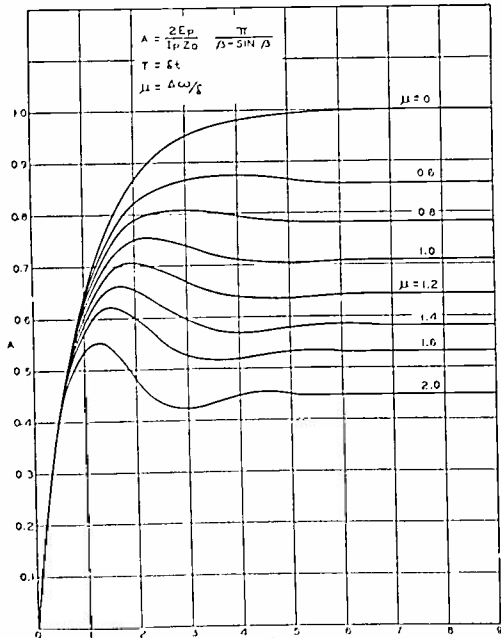

Fig. 4—The tank-voltage amplitude as a function of time in response to the application of grid excitation at time $t=0$, for various amounts of detuning of the tank circuit.

The quantity A will be referred to as the “reduced amplitude.” It is independent of those factors which are common to all amplifiers in normal steady-state operation and is a function of the parameters peculiar to transient operation.

Fig. 4 shows A as a function of T and μ . These curves show:

- (1). The initial rise in amplitude is independent of the detuning. Therefore, the time required for the amplitude to reach $(1 - 1/e)$ times its final value

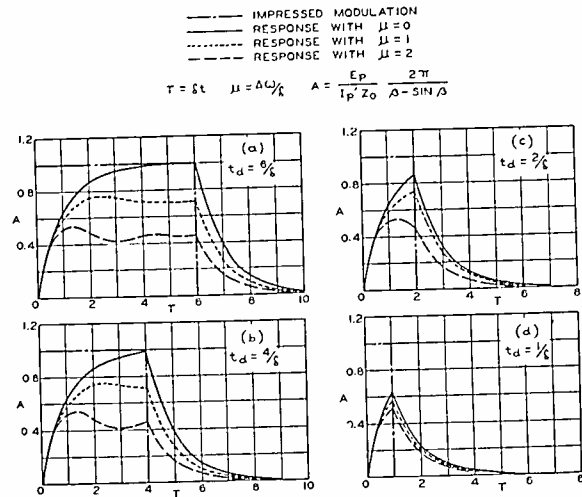

Fig. 5—The tank-voltage amplitude as a function of time in response to single black lines of various widths in a television picture for various amounts of detuning of the tank circuit.

is less for a detuned circuit than for a resonant circuit, since the final value is less.

- (2). When the circuit is detuned, the voltage overshoots the final value.

- (3). As the circuit is detuned still further, the amplitude exhibits a perceptible damped oscillation. This oscillation may give rise to striations in a television picture.

(e). The Criteria

To establish response criteria, consider the tank-voltage response to a single black line (assuming negative modulation) having a time of duration t_1 . During the time $0 < t < t_1$ the voltage rises in accordance with (25). At time t_1 , the grid excitation is removed so that the amplitude drops exponentially and has the value

$$A = e^{-(T-T_1)} \sqrt{\frac{1 - 2e^{-T_1} \cos \mu T_1 + e^{-2T_1}}{1 + \mu^2}}, \quad T > T_1 \quad (29)$$

in which

$$T_1 = \delta t_1$$

Fig. 5 shows the voltage response of the circuit to single black lines of various widths for various amounts of detuning. It should be remembered that these curves represent the upper envelopes of the high-frequency voltage. The following points are of particular interest.

- (1). The envelopes for off-resonance ($\Delta\omega/\delta \neq 0$) operation bear much more of a resemblance to the modulating voltage than does the on-resonance envelope. This is particularly noticeable when the time of duration t_d exceeds twice the time constant ($t_d > 2/\delta$) of the circuit. When t_d is less than $1/\delta$, none

of the envelopes bear much similarity to the modulating voltage.

(2). The decay portion of the response is independent of the detuning. For narrow lines the decay characteristic is relatively worse than for wide lines.

(3). The off-resonance curves for $t_d \geq 4/\delta$ show oscillations. These oscillations have a frequency of approximately $\Delta\omega/2\pi$ and result in faint striations in the reproduction of the lines by a perfect receiver.

(4). The amplitude reached is a function of the time of duration of the line and the detuning, i.e.,

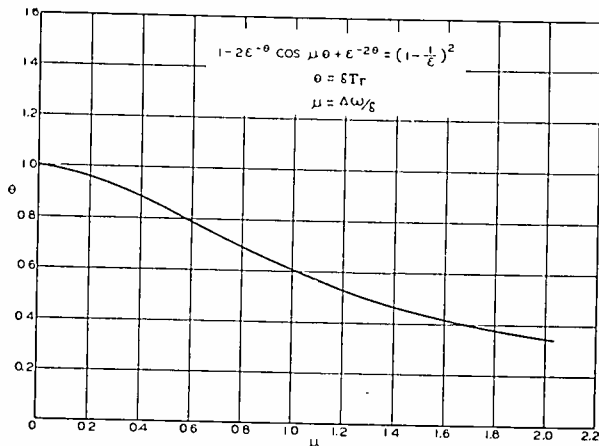

Fig. 6—The time of response of a tank circuit as a function of detuning.

the darkness of the line reproduced by a perfect receiver is a function of the width of the line and the detuning.

The response of the circuit is completely specified by two circuit parameters, the decrement and the detuning $\Delta\omega$. Since the decay of the voltage amplitude in the absence of excitation is completely specified by the decrement and its effect on the decay is easily visualized, the decrement provides the basis for a satisfactory response criterion. This criterion, designated as the decay time τ_d , is defined as the time required for the voltage to decrease to $1/e$ (e = base of Napierian logarithms) times its initial value in the absence of excitation; i.e.,

$$\tau_d = 1/\delta.$$

The rôle of the parameter $\Delta\omega$, which affects the response to excitation, is less easily visualized. Therefore, it will be replaced by a second criterion, the time of response τ_r . This, in analogy with the definition of τ_d , is defined as the time required for the amplitude to build up to $1-1/e$ times the final steady-state value.

The time of response τ_r is by definition the solution of

$$1 - 2e^{-\tau_r} \cos \Delta\omega \cdot \tau_r + e^{-2\delta\tau_r} = \left(1 - \frac{1}{e}\right)^2.$$

Therefore, it is a function of $\Delta\omega$ and δ . Again, it is advantageous to use dimensionless parameters. Hence, define

$$\theta = \delta\tau_r$$

$$\mu = \Delta\omega/\delta.$$

Then

$$1 - 2e^{-\theta} \cos \mu\theta + e^{-2\theta} = \left(1 - \frac{1}{e}\right)^2.$$

Fig. 6 shows the solution of this equation. Inspection of the figure shows that for a given decrement δ the time of response improves about 40 per cent when the circuit is detuned to the 45-degree point ($\Delta\omega/\delta = 1$), and improves about 66 per cent when the circuit is detuned to $\Delta\omega/\delta = 2$.

Since it is now common usage to describe the resonance characteristics of a tuned circuit in terms of its band width instead of in terms of the decrement, it may be worth while to note the relation between band width and decrement. The band width is usually expressed as twice the detuning in terms of frequency at which the voltage amplitude is reduced to $1/\sqrt{2}$ times its value at resonance. Now

$$\frac{E_p}{{}^0E_p} = \frac{1}{\sqrt{1 + \mu^2}} = \frac{1}{\sqrt{1 + \left(\frac{\Delta\omega}{\delta}\right)^2}}$$

where 0E_p = resonant value of E_p . Therefore, the band width is

$$B = \frac{\delta}{\pi}. \quad (30)$$

III. CARRIER-POWER OUTPUT

In this section, the effect of detuning on power output will be considered. It will be assumed that the tube has been designed according to the principles outlined in the Introduction and is intended to operate at resonance. Three cases will be studied.

(a). The case in which the circuit is detuned to improve the time of response and the decrement is held constant to maintain constant time of decay.

(b). The case in which the time of response is held constant as the circuit is detuned.

(c). The case in which the circuit is operated at resonance and the time of response is decreased by increasing the decrement. A comparison of cases (a) and (b) with this case will show whether or not they have any advantage as far as power output is concerned.

In all cases it will be assumed that the other operating conditions are such as to give the maximum output possible without exceeding the dissipation limit of the tube.

Before proceeding to the specific cases, it is advantageous to set up some general relations among the variables involved in the calculation of the power output. It is in the interests of generality to use ratios of the various quantities to their values at resonance rather than the quantities themselves. When this is done, the results are in terms of the normal on-resonance performance. The notation will be that of the previous sections with one addition; the superscript 0 will denote the value at resonance.

(1). The Resonant Tank Impedance

The resonant tank impedance is

$$Z_0 = \frac{L}{rC} = \frac{1}{2C\delta}$$

When the tube is operated at resonance, δ has the value

$$\delta = {}^0\delta$$

so

$${}^0Z_0 = \frac{1}{2C{}^0\delta}$$

When the circuit is detuned, it may be necessary to change the decrement. This is the situation in case (b) in which the time of response is to be kept constant. The time of response in this case is

$$\tau_r = \frac{\theta(\mu)}{\delta} \quad (31)$$

and, as $\mu(=\Delta\omega/\delta)$ is varied, δ must also be varied. Now C has been assumed to have its minimum possible value throughout, so

$$\frac{Z_0}{{}^0Z_0} = \frac{{}^0\delta}{\delta} \quad (32)$$

(2). The Tank-Voltage Amplitude

It is assumed that the tube operates as a class B amplifier at 100 per cent modulation. This is the usual operating condition. At carrier, the peak current is one half the peak current at 100 per cent modulation. Therefore, the carrier operating angle is

$$\beta = \frac{2\pi}{3} \text{ radians.}$$

Then, the carrier amplitude is

$$E_p = \frac{I_p'Z_0}{\sqrt{1+\mu^2}} \frac{\beta - \sin\beta}{2\pi} = \frac{I_p'Z_0}{\sqrt{1+\mu^2}} \frac{2\pi}{3} \frac{\sqrt{3}}{2}$$

$$= 0.196 \frac{I_p'Z_0}{\sqrt{1+\mu^2}}$$

and

$$\frac{E_p}{{}^0E_p} = \frac{I_p'}{{}^0I_p'} \frac{{}^0\delta}{\delta} \frac{1}{\sqrt{1+\mu^2}} \quad (33)$$

(3). The Power Input

In order to keep the plate dissipation as low as possible, the plate voltage should be as low as possible. This is accomplished by making the plate voltage equal to the sum of the screen-voltage and the plate-voltage amplitude at 100 per cent modulation. With 100 per cent modulation, the tube operates as a class B amplifier, so the amplitude with 100 per cent modulation is

$$(E_p)_{100\%} = \frac{I_p'Z_0}{\sqrt{1+\mu^2}} \frac{\beta - \sin\beta}{2\pi}$$

$$= \frac{I_p'Z_0}{2\sqrt{1+\mu^2}}$$

The ratio of the 100-per-cent-modulated amplitude to the carrier amplitude is

$$\frac{(E_p)_{100\%}}{E_p} = \frac{1}{2} \frac{1}{0.196} = \frac{1}{0.391}$$

Therefore, the plate voltage is

$$E_B = E_{c_2} + \frac{E_p}{0.391} \quad (34)$$

The average plate current at carrier is

$$\bar{I}_p = \frac{I_p'}{\pi} \left[\sin \frac{\beta}{2} - \frac{\beta}{2} \cos \frac{\beta}{2} \right]$$

$$= \frac{I_p'}{\pi} \left[\frac{\sqrt{3}}{2} - \frac{\pi}{3} \frac{1}{2} \right]$$

$$= 0.109I_p'$$

Therefore the power input is

$$W_{in} = 0.109I_p' \left[E_{c_2} + \frac{E_p}{0.391} \right] \quad (35)$$

and

$$\frac{W_{in}}{{}^0W_{in}} = \frac{I_p' \left[E_{c_2} + \frac{E_p}{0.391} \right]}{{}^0I_p' \left[{}^0E_{c_2} + \frac{{}^0E_p}{0.391} \right]} \quad (36)$$

(4). The Power Output in Terms of $I_p' / {}^0I_p'$, ${}^0\delta/\delta$, and μ .

The power output is

$$W = \frac{E_p^2}{r^2 + \omega^2L^2} \frac{r}{2} \approx \frac{E_p^2}{\omega^2L^2} \frac{r}{2}$$

$$= \frac{0.196}{2} \frac{E_p I_p'}{\sqrt{1+\mu^2}} \quad (37)$$

$$= \frac{0.196}{2} \frac{I_p'^2 Z_0}{1+\mu^2} \quad (38)$$

Then

$$\frac{W}{{}^0W} = \frac{I_p'^2 {}^0\delta}{{}^0I_p'^2 \delta} \frac{1}{1+\mu^2} \quad (39)$$

(5). The Screen Voltage

The plate current was assumed to be a linear function of the screen voltage. The plate voltage depends on the screen voltage and, therefore, the dissipation depends on the screen voltage. Consequently, if the peak plate current must be reduced for any reason whatsoever, it is advantageous to reduce the screen voltage in proportion. Hence, the following relation between screen voltage and plate current will be assumed:

$$\frac{E_{c_2}}{{}^0E_{c_2}} = \frac{I_p'}{{}^0I_p'} \quad (40)$$

(6). *The Plate Current*

The circumstance that the dissipation is held fixed at its maximum possible value makes it possible to express the plate current in terms of ${}^0E_{c_2}/{}^0E_p$, ${}^0\delta/\delta$, and μ . The derivation of this relation follows:
The dissipation is

$$\begin{aligned} W_d &= W_{in} - W \\ &= 0.109I_p' \left[E_{c_2} + \frac{E_p}{0.391} \right] - \frac{0.196}{2} \frac{E_p I_p'}{\sqrt{1 + \mu^2}} \\ &= 0.109I_p' \left[{}^0E_{c_2} + \frac{{}^0E_p}{0.391} \right] - \frac{0.196}{2} {}^0E_p {}^0I_p'. \quad (41) \end{aligned}$$

Then

$$\frac{I_p'}{{}^0I_p'} \left\{ \frac{E_{c_2}}{{}^0E_{c_2}} \cdot \frac{{}^0E_{c_2}}{{}^0E_p} + \frac{E_p}{{}^0E_p} \left[\frac{1}{0.391} - \frac{0.196}{0.218} \frac{1}{\sqrt{1 + \mu^2}} \right] \right\} = \left\{ \frac{{}^0E_{c_2}}{{}^0E_p} + \left[\frac{1}{0.391} - \frac{0.196}{0.218} \right] \right\}.$$

Substitute (33), (34), and (40) in the equation

$$\begin{aligned} \frac{I_p'}{{}^0I_p'} \left\{ \frac{I_p'}{{}^0I_p'} \frac{{}^0E_{c_2}}{{}^0E_B - {}^0E_{c_2}} \frac{1}{0.391} + \frac{I_p'}{{}^0I_p'} \frac{{}^0\delta}{\delta} \frac{1}{\sqrt{1 + \mu^2}} \left[\frac{1}{0.391} - \frac{0.196}{0.218} \frac{1}{\sqrt{1 + \mu^2}} \right] \right\} \\ = \left\{ \frac{{}^0E_{c_2}}{{}^0E_B - {}^0E_{c_2}} \frac{1}{0.391} + \left[\frac{1}{0.391} - \frac{0.196}{0.218} \right] \right\}. \end{aligned}$$

Then, the desired relation is

$$\left[\frac{I_p'}{{}^0I_p'} \right]^2 = \frac{\frac{1}{{}^0E_B} + [1 - 0.350]}{\frac{{}^0E_{c_2}}{{}^0E_B} - 1} \cdot \frac{1}{{}^0E_{c_2} - 1} + \frac{{}^0\delta}{\delta} \frac{1}{\sqrt{1 + \mu^2}} \left[1 - \frac{0.350}{\sqrt{1 + \mu^2}} \right] \quad (42)$$

(7). *The Power Output in Terms of ${}^0E_{c_2}/{}^0E_B$, ${}^0\delta/\delta$, and μ .*

The power output can now be expressed in terms of ${}^0E_{c_2}/{}^0E_B$, ${}^0\delta/\delta$, and μ by substituting (42) in (39)

$$\frac{W}{{}^0W} = \frac{{}^0\delta}{\delta} \frac{1}{1 + \mu^2} \frac{\frac{1}{{}^0E_B} + [1 - 0.350]}{\frac{{}^0E_{c_2}}{{}^0E_B} - 1} \cdot \frac{1}{{}^0E_{c_2} - 1} + \frac{{}^0\delta}{\delta} \frac{1}{\sqrt{1 + \mu^2}} \left[1 - \frac{0.350}{\sqrt{1 + \mu^2}} \right] \quad (43)$$

Inspection of (42) reveals that when

(i) ${}^0\delta/\delta=1$ and μ is increased or (ii) $\mu=0$ and $\delta/{}^0\delta$ is increased, $I_p'/{}^0I_p'$ increases. If the emission of the tube is limited so $I_p'/{}^0I_p'$ cannot be increased, the power output is given by

$$\frac{W}{{}^0W} = \frac{{}^0\delta}{\delta} \frac{1}{1 + \mu^2} \quad (44)$$

Therefore

$$\begin{aligned} W_d &= 0.109I_p' {}^0E_p \left\{ \frac{{}^0E_{c_2}}{{}^0E_p} \right. \\ &\quad \left. + \frac{{}^0\delta}{\delta} \frac{1}{\sqrt{1 + \mu^2}} \left[\frac{1}{0.391} - \frac{0.196}{2\sqrt{1 + \mu^2}} \right] \right\}. \quad (45) \end{aligned}$$

Then

(i). when ${}^0\delta/\delta=1$, the dissipation decreases as μ is

provided the dissipation does not increase. Therefore, the dissipation with constant I_p' must be checked.

(8). *The Dissipation with Constant Plate Current*

Equation (41) states

$$W_d = 0.109I_p' \left\{ E_{c_2} + E_p \left[\frac{1}{0.391} - \frac{0.196}{2\sqrt{1 + \mu^2}} \right] \right\}.$$

If the plate current is fixed

$$I_p' = {}^0I_p'$$

$$E_{c_2} = {}^0E_{c_2}$$

increased,

or

(ii). when $\mu=0$, the dissipation decreases as δ/δ is increased. Therefore, (44) is valid in these two special cases.

The special cases can now be studied by substituting the appropriate values of δ/δ and μ in (43) or (44).

Case (a).

In this case the decrement is to be held constant as the circuit is detuned. Therefore

$$\frac{\delta}{\delta} = 1$$

and

$$\frac{W}{W} = \frac{1}{1 + \mu^2} \frac{1}{\frac{E_B}{E_{c2}} - 1} + [1 - 0.350] \frac{1}{\frac{E_B}{E_{c2}} - 1} + \frac{1}{\sqrt{1 + \mu^2}} \left[1 - \frac{0.350}{\sqrt{1 + \mu^2}} \right] \quad (46)$$

Fig. 7 shows I_p'/I_p' and W/W as a function of μ for various values of E_{c2}/E_B . The output is seriously reduced by detuning. When $\mu=1$, which corresponds to a tank phase angle of 45 degrees, the output is reduced about 40 per cent when the plate current is not emission-limited, and 50 per cent if the emission is limited.

Case (b).

In this case the time of response is to be held constant as the circuit is detuned. The time of response in terms of μ and δ is

$$\tau_r = \frac{\theta(\mu)}{\delta} \quad (31)$$

Therefore

$$\frac{\delta}{\delta} = \frac{1}{\theta}$$

and the power output is

$$\frac{W}{W} = \frac{1}{\theta[1 + \mu^2]} \frac{1}{\frac{E_B}{E_{c2}} - 1} + [1 - 0.350] \frac{1}{\frac{E_B}{E_{c2}} - 1} + \frac{1}{\theta\sqrt{1 + \mu^2}} \left[1 - \frac{0.350}{\sqrt{1 + \mu^2}} \right] \quad (47)$$

Fig. 8 shows the plate current and output as a function of μ for various values of E_{c2}/E_B . Note that the required plate current decreases so that the emission limitation does not enter. Here again the

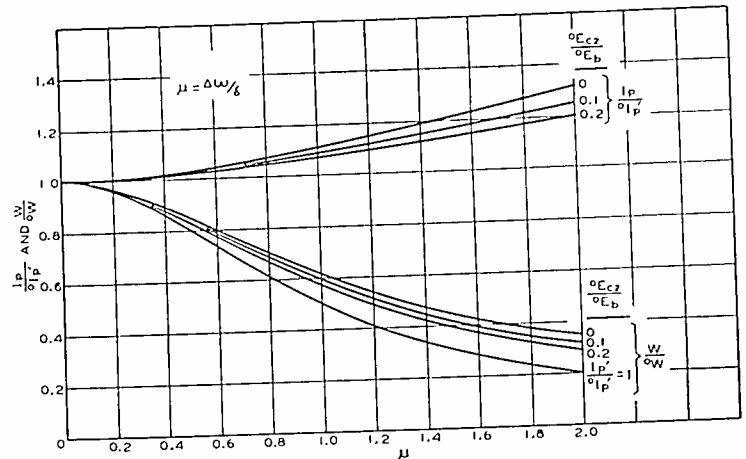

Fig. 7—The variation of power output and required emission current with tank-circuit detuning for various ratios of screen-grid voltage to plate voltage. It is assumed that the tank-circuit decrement is held constant and that the tube is operated at its dissipation limit except for the case in which the tube is emission limited ($I_p'/I_p'=1$).

power output is seriously reduced by detuning. For $\mu=1$, the power output is reduced about 35 per cent.

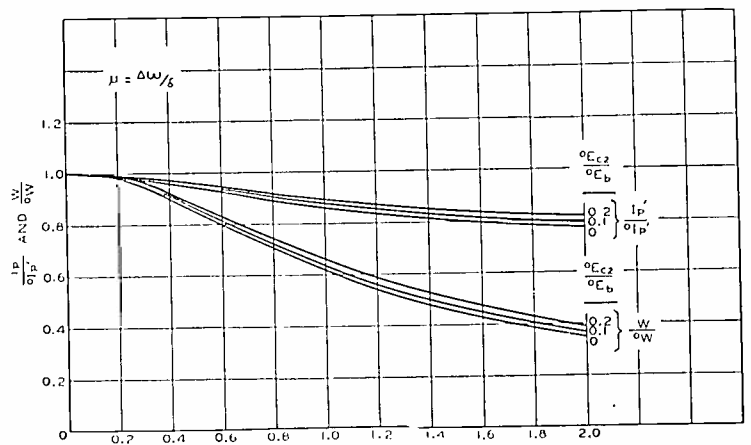

Fig. 8—The variation of power output and required emission current with tank-circuit detuning for various ratios of screen-grid voltage to plate voltage. It is assumed that the time of response of the circuit is held constant and that the tube is operated at its dissipation limit.

The reduction in power output in this case is not quite as severe as in case (a). This is due to the fact that the resonant impedance of the circuit is increased as the circuit is detuned.

The band width in this case decreases as μ is increased:

$$\frac{B}{{}^0B} = \frac{\delta}{\pi} \cdot \frac{\pi}{{}^0\delta} = \frac{\delta}{{}^0\delta} = \theta(\mu).$$

Fig. 6, therefore, gives $B/{}^0B$ as a function of μ when the response time is held constant.

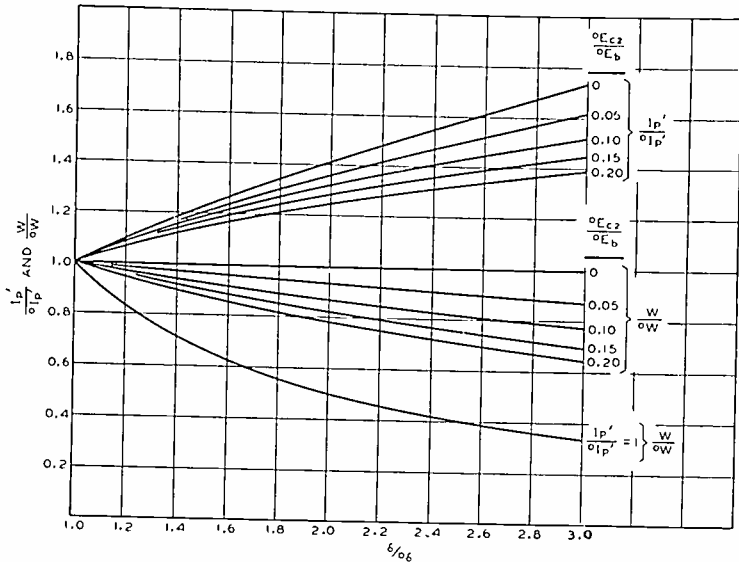

Fig. 9—The variation of power output and required emission current with tank-circuit decrement for various ratios of screen-grid voltage to plate voltage. It is assumed that the circuit is tuned to resonance and that the tube is operated at its dissipation limit except for the case in which the tube is emission limited ($I_p'/{}^0I_p'=1$).

Case (c).

In this case, $\mu=0$. Therefore, the power output is

$$\frac{W}{{}^0W} = \frac{{}^0\delta}{\delta} \frac{1 + [1 - 0.350] \frac{{}^0E_B}{{}^0E_{c2}} - 1}{\frac{1}{{}^0E_B} + \frac{{}^0\delta}{\delta} [1 - 0.350] \frac{{}^0\delta}{{}^0E_{c2}} - 1} \quad (48)$$

Fig. 9 shows the plate current and power output as a function of $\delta/{}^0\delta$ for various values of ${}^0E_{c2}/{}^0E_B$.

In order to compare cases (a) and (c), Fig. 10 has been plotted. It shows the power output against ${}^0\tau_r/\tau_r$ for ${}^0E_{c2}/{}^0E_B=0.10$. It is manifest that operation at resonance gives the larger output. In the detuned case, the decay time remains constant and the band width also remains constant. In the on-resonance case, the decay time is reduced in proportion to the response time, but the band width increases as ${}^0\tau_r/\tau_r$.

These results are summarized in the following statements:

(1). Detuning the circuit with the time of response held constant results in increased decay time, a considerable reduction in power output, and a smaller band width.

(2). Detuning the circuit with the decrement constant results in a reduced response time, unaltered

decay time, a severe loss in power output, and an unaltered band width.

(3). Operating at resonance and increasing the decrement results in an improvement in both the decay and response times of the amplifier, a reduction in power output, and an increase in band width.

One concludes, therefore, that an improvement in the response characteristics is obtained at the expense of power output. The loss in power output is more serious when the improvement is obtained by detuning than by an increase in decrement.

Finally, the writer would like to clarify an irrelevant but important point. He has often heard the statement that a television transmitting tube designed for a given maximum carrier frequency and a given band width will give very much better performance at a lower carrier frequency. Unfortunately, such is not the case. The dissipation is definitely limited by the anode area. The output capacitance is at its minimum for the maximum frequency and it does not seem feasible to reduce it further for a lower frequency. The band width is determined by the output capacitance and the circuit impedance, so the circuit impedance cannot be increased. Therefore, the power output cannot be increased by increasing the circuit impedance. If any improvement occurs at a lower frequency, it will be due to reduced transit time. However, such tubes are already designed with a view to minimizing transit time; and, hence, no great improvement can be expected on this score.

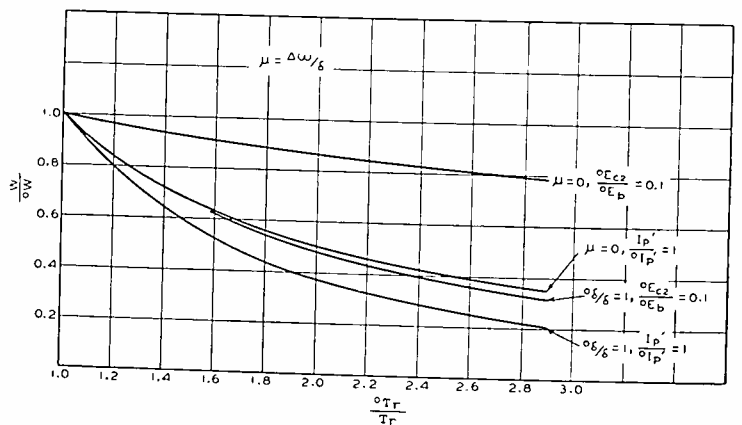

Fig. 10—The variation of the power output with time of response when the time of response is varied (1) by increasing the decrement, and (2) by detuning the tank circuit with dissipation and emission limitations of the power output.

IV. CONCLUSION

It has been shown that detuning a transmitter to suppress partially one sideband and to increase the band width for the other sideband without increasing the total band width results in

(a). An increase in the rate at which the tank voltage builds up, but no improvement in the rate at which it decays. This results in sharper leading edges in the picture and no improvement in trailing edges or in contrast.

(b). A severe reduction in power output when the

emission is ample to supply the increased plate current necessary to run the tube dissipation-limited at resonance or detuned, and a more severe reduction in power when the emission is just adequate for on-resonance operation.

The question of what constitutes a good picture has been left to those whose practical experience qualifies them to judge quality. This paper has been confined to a study of the changes induced in a picture of given quality by detuning of the transmitter.

The coupled-circuit case has not been studied.

Such a study would involve a knowledge of the characteristics of the transmission line and antenna system to be used. Because these systems differ greatly, it was felt that the general conclusions to be drawn from the study of a specific system would not justify the amount of work involved in the analysis.

ACKNOWLEDGMENT

The writer wishes to acknowledge the benefits derived from many discussions of the problem with his associate, Dr. A. V. Haeff.

Characteristics of the Ionosphere at Washington, D.C., August, 1939*

T. R. GILLILAND†, ASSOCIATE MEMBER, I.R.E., S. S. KIRBY†, ASSOCIATE MEMBER, I.R.E.,
AND N. SMITH†, NONMEMBER, I.R.E.

DATA on the critical frequencies and virtual heights of the ionospheric layers during August are given in Fig. 1. Fig. 2 gives the monthly average values of the maximum usable frequencies for undisturbed days, for radio transmission by way of the regular layers. The F layer ordinarily determines the maximum usable frequencies at

night. The effects of the E and F₁ layers are shown by the humps on the graphs during the day. Fig. 3 gives the distribution of hourly values of F and F₂

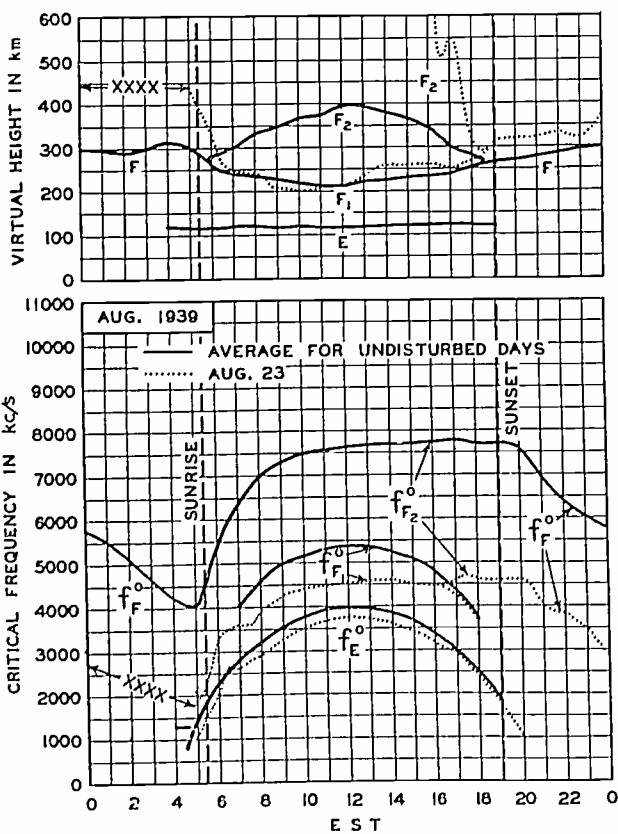

Fig. 1—Virtual heights and critical frequencies of the ionospheric layers, August, 1939. The solid-line graphs are the averages for the undisturbed days; the dotted-line graphs are for the ionospheric storm day of August 23. The crosses represent the times on August 23 when the F-layer reflections were so diffuse that the critical frequencies or virtual heights could not be determined.

It should be noted that all data on critical frequencies are now plotted in terms of the ordinary wave.

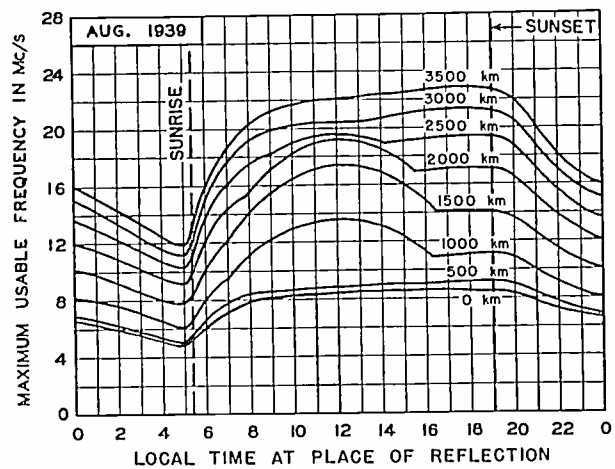

Fig. 2—Maximum usable frequencies for dependable radio transmission via the regular layers. Average for August, 1939, for undisturbed days. The values shown were considerably exceeded during irregular periods by reflections from clouds of sporadic E.

data about the undisturbed average for the month. Fig. 4 gives the expected values of the maximum usable frequencies for radio transmission by way of the regular layers, average for undisturbed days, for November. Ionospheric storms and sudden ionospheric disturbances are listed in Tables I and II, respectively. Table III gives the approximate upper limit of frequency of strong sporadic-E reflections at vertical incidence, for the days during which these reflections were most prevalent at Washington.

* Decimal classification: R113.61. Original manuscript received by the Institute, September 11, 1939. These reports have appeared monthly in the PROCEEDINGS starting in vol. 25, September, (1937). See also vol. 25, pp. 823-840, July, (1937). Publication approved by the Director of the National Bureau of Standards of the U. S. Department of Commerce.

† National Bureau of Standards, Washington, D.C.

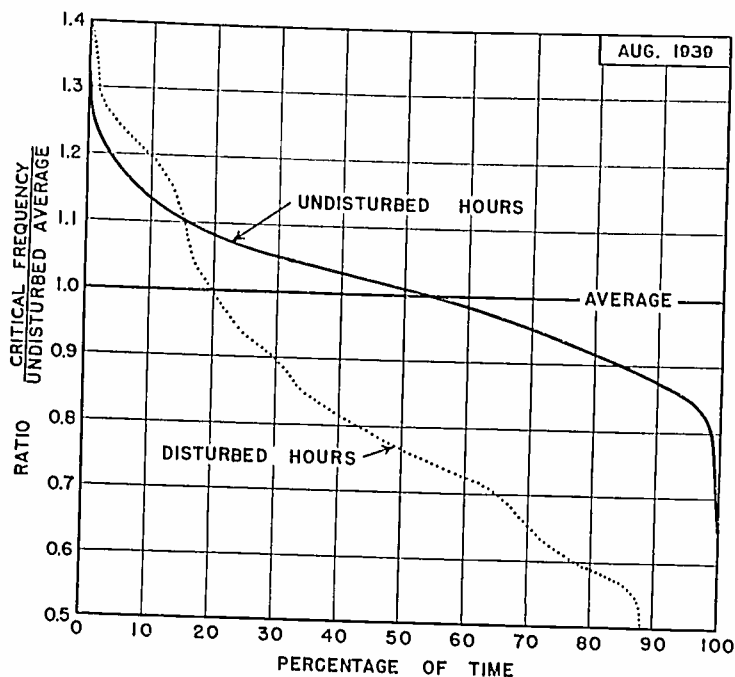

Fig. 3—Distribution of F- and F₂-layer ordinary-wave critical frequencies (and approximately of F- and F₂-layer maximum usable frequencies) about monthly average. Abscissas show percentage of time for which the ratio of the critical frequency to the undisturbed average exceeded the values given by the ordinates. The solid-line graph is for 549 undisturbed hours of observation; the dotted graph is for the 195 disturbed hours of observation listed in Table I.

Attention is again called to an important change made last month in the presentation of the critical frequency data. All critical-frequency data are now given in terms of the ordinary wave.

Concerning the relation between ionospheric storms and sudden ionospheric disturbances, several authors recently suggested that an ionospheric storm follows a sudden ionospheric disturbance by a rather definite time interval of approximately 26 hours. In general the Bureau's ionospheric data do not support this conclusion. Considering the present month's data

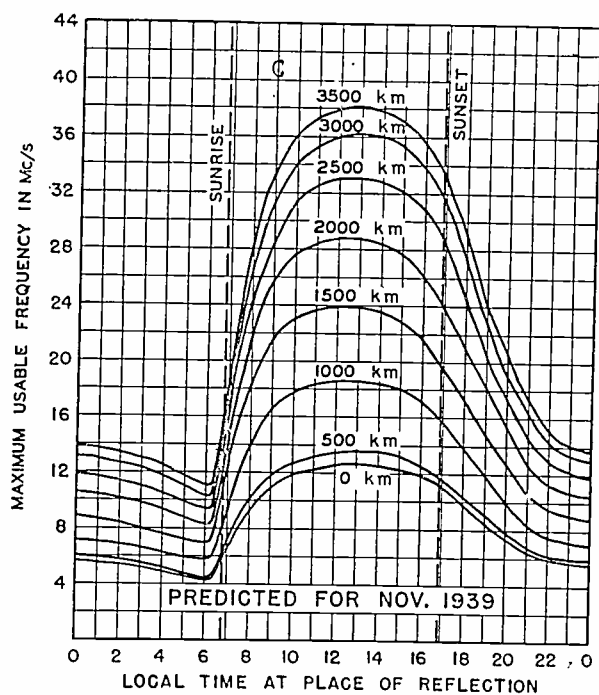

Fig. 4—Predicted maximum usable frequencies for dependable radio transmission via the regular layers, average for undisturbed days, for November, 1939.

TABLE I
IONOSPHERIC STORMS (APPROXIMATELY IN ORDER OF SEVERITY)

Day and hour E.S.T.	h_p before sunrise (km)	Minimum f_p^o before sunrise (kc)	Noon f_p^o (kc)	Magnetic character ¹		Ionospheric character ²
				00-12 G.M.T.	12-24 G.M.T.	
August 21 (after 0500)	—	—	>8300	0.1	0.6	1.0
22	386	2000	<4400 ³	1.8	1.7	1.9
23	— ³	— ³	<4500 ⁴	1.7	0.8	2.0
24	— ³	— ³	4900	0.3	0.2	1.6
25 (until 0500)	338	3000	—	0.2	0.1	0.5
11 (after 0500)	—	—	9100	0.1	1.0	0.8
12	430	2000	6500	1.9	1.1	1.3
13	370	3100	6000	0.9	0.9	1.0
14 (until 0500)	332	3700	—	0.5	0.1	0.3
16 (after 0500)	—	—	6000	0.5	1.3	0.9
17 (until 0500)	354	3000	—	0.9	0.4	0.6
For comparison: Average for undisturbed days	299	4050	7650	0.1	0.2	0.0

¹ American magnetic character figure, based on observations of seven observatories.

² An estimate of the severity of the ionospheric storm at Washington on an arbitrary scale of 0 to 2, the character 2 representing the most severe disturbance.

³ No F-layer reflections at frequencies above 2500 kilocycles from 2100 August 22 to 0400 August 23, inclusive, and from 0200 to 0400 August 24, inclusive.

⁴ F₂-layer virtual heights and critical frequencies not measurable because F₁ critical frequencies were less than F₁ critical frequencies.

TABLE II
SUDDEN IONOSPHERIC DISTURBANCES

Date	G.M.T.		Locations of transmitters	Relative intensity at minimum ¹	Other phenomena
	Beginning	End			
August 9	1610	1635	Ohio, Mass., Ont.	0.0	Terr. mag. pulse, ² 1612-1625
10	1544	1800	Ohio, Mass., Ont., D.C.	0.0	
29	1853	1912	Ohio, Mass., Ont.	0.0	
29	1952	2018	Ohio, Mass., Ont.	0.05	
31	1902	2000	Ohio, Ont., Mass., D.C.	0.0	

¹ Ratio of received field intensity during fade-out to average field intensity before and after; for station W8XAL, 6060 kilocycles, 650 kilometers distant.

² Terrestrial magnetic pulse, observed on magnetograms from Cheltenham Observatory of the United States Coast and Geodetic Survey.

TABLE III
APPROXIMATE UPPER LIMIT OF FREQUENCY IN MEGACYCLES OF THE STRONGER SPORADIC-E REFLECTIONS AT VERTICAL INCIDENCE

		Midnight to noon											
		Hour											
Day		00	01	02	03	04	05	06	07	08	09	10	11
August 3		6	4.5						4.5	4.5	6	6	
19		6	6							6	4.5	6	6
		Noon to midnight											
		Hour											
Day		12	13	14	15	16	17	18	19	20	21	22	23
August 2		8	4.5	8	8								4.5
3		4.5	6	8	8	4.5						8	6
4		4.5			6	9						4.5	6
5							8	8	4.5	9		6	8
7		6		6	4.5							8	8
14							9	8					
16					6	8	9						
17					4.5	4.5							
18					6	6				8	4.5	8	8
23					6	6				6	6	8	8
30		4.5	4.5			10		6	12	6			

there were no sudden ionospheric disturbances for eleven days preceding the severe ionospheric storm of August 21 to 25. It has been pointed out in earlier reports of this series that sudden ionospheric disturbances frequently precede ionospheric storms but no regular and consistent time interval such as 26

hours has been observed. The data indicate that both phenomena are produced by radiations from solar disturbances but not from the same disturbance. To

date the evidence is that a sudden ionospheric disturbance but not an ionospheric storm is produced by a solar flare.

Discussion on

"A Contribution to Tube and Amplifier Theory"*

W. E. BENHAM

F. B. Pidduck:¹ On pages 1158-1160 of his paper Mr. W. E. Benham made some remarks on a paper of mine² on this subject. His method seems to me to be to put on certain passages an interpretation which they will not bear, and then to criticize that interpretation. First, as regards the equation $YY'' + Y^2 = X$. This equation is not mine, but appears to have been first given by Braude,³ to whose paper I refer. It is the extension to magnetic fields of Langmuir's equation for an infinitely fine filament. The series solution, which has been attempted imperfectly by Braude and by Möller,⁴ reduces to its first term when H is small, and is then easily seen to be equivalent to Langmuir's formula. To remark with Benham that $\beta = 1$ is not a sufficiently good approximation is to expect a generalization which has not been attempted.

In the stating of equation (14) that "no approximations have been made so far" I had in mind the fact that u_1 and u_2 were not small. It is incorrect to describe the neglect of initial velocities as a tacit assumption, since I stated early in my paper that electrons are supposed to leave the filament with no velocity. The problem in the sequel proved difficult, and it is not surprising that the field of inquiry should be limited.

Benham mentions the special solution of the differential equation on page 207 in terms which are in several respects inaccurate. He appears to think I am defending that solution when I am pointing out why it is not acceptable. He also says that I provide no statement of any kind in regard to the resistive component of the mass concerned. But in saying that it acts like a self-inductance I mean like a pure self-inductance. This is clear from the equation $IV^* + I^*V = 0$ from which it is deduced; for then I/V is imaginary.

Such differences as remain between Benham and myself may be put down to the difficulty of the subject. Of all the mathematical problems I have tried this is the most awkward. I cut down my paper, which was originally longer, to make it lay out briefly certain points of difficulty which are likely to trouble anyone who tackles them. The turning point is also a turning point for the investigator; and though a mathematician may find much to interest him, the physical results are meagre.

W. E. Benham:⁵ I regret that Dr. Pidduck seems to regard my remarks as in some way personal. These were intended to be factual and objective. I therefore reiterate my criticisms, some of which had, indeed, been previously communicated to Pidduck without eliciting a reply.

As regards the equation $YY'' + Y^2 = X$, it is surely not suggested that the shifting of responsibility of authorship to an earlier worker renders the equation any more exact. Indeed, if we refer to Braude's paper³ we find that the above equation is regarded as giving only a first approximation to the path. A second approximation is obtained, and also a third (equation (27)), which leads, by graphical integration, to the equation (in our notation)

$$\omega_0\tau_0 = 5.30 \quad (29)$$

where τ_0 is here the critical transit-time and $\omega_0 = cH/m$. While the return path shown by Braude was criticized by Bellustin,⁶ no *a priori* objection is seen to Braude's treatment of the outward path, though Pidduck states that some imperfection exists. Equation (29) is in the right direction, Pidduck's value (5.038) corresponding to the first approximation. I myself have not attempted to verify Braude's working. As explained previously my own result $\omega_0\tau_0 = 2\pi$, obtained by inductive reasoning, would willingly be withdrawn in favor of any convincing alternative.

My use of the word "tacitly" to describe Pidduck's neglect of initial velocities was intended to convey that reticence was

observed as to any justification of this (to me) rather crucial assumption. I quite see that this may have appeared a little unfair, but Pidduck may rest assured that the very considerable complication which the retention of terms denoting initial velocities and accelerations involved would have been sufficient deterrent to the publication of the lengthy equations of my first magnetron paper,⁷ were there not the strongest physical grounds for the retention of such terms in order to give meaning to a virtual cathode under alternating-current conditions. Moreover we should, I think, expect to find in the cylindrical problem conclusions of the kind established already for planes; namely, that to portray behavior at the virtual cathode (turning point) the inclusion of initial conditions is necessary in order to avoid singularities.⁸ In the general case a term in $(1/x_0)(\partial V/\partial x)_0$ (or $(1/r_0)(\partial V/\partial r)_0$) gives a finite answer since \dot{x}_0 is not zero. A simple but important treatment due, I believe, to J. J. Thomson⁹ enables us to say that the average kinetic energy of electrons at the virtual cathode region is constant, independently of the nature of the retarding influence, and of the number of electrons already turned back, provided that the velocity distribution at the real cathode is Maxwellian. The effective thickness of the virtual-cathode region, being the spread of the position of the actual turning point of some arbitrarily chosen majority of electrons, is moderate only, both by theory¹⁰ and experiment.¹¹

Pidduck's explanation of his page 207 reminds me that perhaps more allowance should have been made for the fact that Pidduck was writing in a mathematical journal. This does not alter the fact that the real reason why his solution does not hold over the whole range is physical, and that the infinite values which u_1 and u_2 can assume is traceable to the omission of initial velocity terms.

In regard to the equation $IV^* + I^*V = 0$, I did say in regard to the resistive component that one is led to conclude that it is zero. Again, I was arguing from the standpoint of the engineer in raising the point as to what had happened to the resistive component of the "mass." I have since noticed that there may have been a slip on Pidduck's part in momentarily supposing his V as a space integral of Θ , whereas definitions on page 204 would indicate the converse. If I am correct then the equation

$$I \int \epsilon_0 \Theta^* dx + I^* \int \epsilon_0 \Theta dx = 0$$

on page 207 does not yield the equation $IV^* + I^*V = 0$, and it can be shown that I/V is no longer imaginary. This would bring Pidduck's analysis a little more into line, in respect of the general nature of the equivalent impedance, with the results established for planes. This is desirable since the neglect of initial velocities cannot be held responsible for Pidduck's findings that the "mass" behaves like a pure inductance.

I am interested to find myself receiving support of a kind from Pidduck's reply. I have good reason to know how awkward the problem is but Pidduck's endorsement of this view encourages me to forego the conclusion that my difficulties were largely subjective. The question of choice of mathematical technique becomes, therefore, of first importance, and here Müller¹² has done much to guide us. An extension to magnetic fields of the method used for the valve as amplifier proves at least equally satisfactory, and A. Thoma, whose recent paper¹³ with H. E. Hollmann has been the subject of correspondence, writes that he is looking into this question.

⁷ W. E. Benham, *Proc. Phys. Soc.*, vol. 47, p. 1, (1935).

⁸ See page 39 of footnote reference 7. The expression for u , (113c) tends to infinity as Θ tends to $2n\pi$, except $n=0$. See also Table 3, p. 42, when $U_0 = 0$.

⁹ See page 19 of footnote reference 7.

¹⁰ J. J. Thomson and G. P. Thomson, "Conduction of Electricity through Gases, Third Edition, vol. 1, section 110.1, p. 263.

¹¹ G. R. Kilgore, "Magnetron oscillators for the generation of frequencies between 300 and 600 megacycles," *Proc. I.R.E.*, vol. 24, pp. 1140-1157 August, (1936). See photograph on p. 1145.

¹² Johannes Müller, *Hochfrequenz- und Elektroakustik*, vol. 46, p. 145, (1935).

¹³ H. E. Hollmann and A. Thoma, *Hochfrequenz- und Elektroakustik*, vol. 49, p. 145, (1937).

* *Proc. I.R.E.*, vol. 26, pp. 1093-1170; September, (1938).

¹ Corpus Christi College, Oxford, England.

² *Quart. Jour. of Math.*, vol. 7, p. 201, (1936).

³ S. J. Braude, *Phys. Zeit. der Sowjetunion*, vol. 8, p. 667, (1935).

⁴ H. G. Möller, *Hochfrequenz- und Elektroakustik*, vol. 47, p. 115, (1936).

⁵ 9 Cranley Road, Hord, Essex, England.

⁶ S. V. Bellustin, *Phys. Zeit. der Sowjetunion*, vol. 10, no. 2, p. 251, (1936).

Institute News and Radio Notes

Rochester Fall Meeting

The Rochester Fall Meeting of the Institute and the Radio Manufacturers Association which is sponsored by the Rochester Fall Meeting Committee will be held on November 13, 14, and 15 at the Sagamore Hotel in Rochester, New York. The program which follows is composed of seventeen papers distributed among seven sessions.

PROGRAM

Monday, November 13

9:30 A. M. TECHNICAL SESSION

"Spectral Response of Phototubes to New Illuminants," by A. M. Glover, RCA Manufacturing Company, Radiotron Division.

"Observations on Coverage with Frequency-Modulated Waves," by Paul A. De Mars, Yankee Network.

"A Noise Meter for Television Frequencies," by C. J. Franks, Microvolts, Incorporated.

12:30 P. M. GROUP LUNCHEON

2:00 P. M. TECHNICAL SESSION

"Circuit Consideration of Superheterodyne Converter Tubes," by C. R. Hammond and E. Kohler, Jr., Ken-Rad Tube and Lamp Corporation.

"The Use of Cascade Circuits with Staggered Parameters for Obtaining Ideal Filter Characteristics," by V. D. Landon, RCA Manufacturing Company, Victor Division.

6:30 P. M. GROUP DINNER

8:00 P. M. TECHNICAL SESSION

"What Do We Do Next?" by Kenneth Jarvis, Consulting Engineer.

Tuesday, November 14

9:30 A. M. TECHNICAL SESSION

"Annual Message of RMA Director of Engineering," by W. R. G. Baker.

"A Survey of Standard-Signal Generators," by E. Karplus, General Radio Company.

"Compensation of Vacuum-Tube Input Capacitance by Bias-Potential Control," by John F. Farrington, Hazeltine Service Corporation.

12:30 P. M. GROUP LUNCHEON

2:00 P. M. SESSION

"Some Factors Governing Choice of Lenses for Television Cameras," by H. B. DeVore and Harley Iams, RCA Manufacturing Company, Radiotron Division.

"A Demonstration of Audio-Frequency Testing with Square Waves," by L. B. Arguimbau, General Radio Company.

"Vacuum-Tube-Life Probability Versus Consumer Satisfaction," by Henry Parker, Rogers Radio Tubes, Limited.

6:30 P. M. FALL MEETING DINNER

Toastmaster—Alfred N. Goldsmith

Speaker—H. B. Richmond

Subject—Radio Manufacturers Association—Institute of Radio Engineers Cooperation

Wednesday, November 15

9:30 A. M. TECHNICAL SESSION

"The Gradation of Television Pictures," by H. E. Kallman.

"Tubes for High-Frequency Amplification in Receivers," by M. A. Acheson and W. P. Mueller, Hygrade Sylvania Corporation.

11:15 A. M. INSPECTION TRIP

12:30 P. M. GROUP LUNCHEON

2:00 P. M. TECHNICAL SESSION

"Television Receiving Antennas," by Stanford Goldman, General Electric Company.

"Progress in Development of Instruments for Measuring Radio Noise," by C. M. Burrill, RCA Manufacturing Company, Victor Division.

"Summary of the Significance of the Papers Delivered at this Meeting," by D. D. Israel, Emerson Phonograph and Radio Corporation.

Inspection Trip

The inspection trip on Wednesday morning will be to the frequency-modulated-wave transmitting station of the Stromberg-Carlson Telephone Manufacturing Company which is located in the Rochester Gas and Electric Company building, next door to the Sagamore Hotel.

Exhibition

As in the past, an exhibition of radio components, measuring instruments, and manufacturing aids will be held in conjunction with the technical meetings and will give those present an opportunity to discuss their problems with the producers of these essentials.

Board of Directors

The first Fall meeting of the Board of Directors was held on September 6 and those present were R. A. Heising, president; H. H. Beverage, Ralph Bown, F. W. Cunningham, Alfred N. Goldsmith, Virgil M. Graham, F. B. Llewellyn, B. J. Thompson, H. M. Turner, A. F. Van Dyck and H. P. Westman, secretary.

Specific approval was granted for the admission of forty-three Associates and twenty-three Students on July 5, and forty-eight Associates, three Juniors, and twenty-eight Students on August 2.

Forty-one Associates and five Students were admitted as of September 6.

A vote of thanks was extended to W. Noel Eldred and the committee in charge of the Pacific Coast Convention for the highly successful meeting which was held in June.

An invitation was accepted to cooperate with the Veteran Wireless Operators Association in honoring Lee de Forest at a dinner to be given on the evening of September 22. That day will be known as de Forest Day at the New York World's Fair.

A new set of Bylaws, which are consonant with the Constitution adopted earlier in the year, was approved. The Constitution and Bylaws will be published in the December, 1939, issue of the PROCEEDINGS.

A. F. Van Dyck was named to represent the Institute on a committee proposed recently by the American Standards Association on the subject of "Preferred Voltages—100 Volts and Under."

Dr. Goldsmith, chairman of the Board of Editors, reported that the work of its Co-ordinating Committee, in having manuscripts abridged wherever this was possible without seriously affecting their usefulness to the reader, already indicates that by the early part of 1940 the time between the receipt of a manuscript and its publication would be in the neighborhood of six months. At the present time the lag is about twelve months.

Committees

Admissions

The Admissions Committee on September 6 considered thirteen applications for transfer to Member grade. Of these, it approved nine, denied one, and tabled three pending the obtaining of further information. Of seven applications for admission to Member grade, three were approved, two denied, and two tabled. Those present at the meeting were F. W. Cunningham, chairman; H. H. Beverage, F. M. Ryan, C. E. Scholz, H. M. Turner, A. F. Van Dyck, and H. P. Westman.

Board of Editors Co-ordinating Committee

Meetings of the Co-ordinating Committee of the Board of Editors were held on June 22, July 19, and August 24.

The June meeting was attended by Alfred N. Goldsmith, chairman; R. R. Batcher, J. D. Crawford, assistant secretary; and Helen M. Stote, assistant editor. At the July meeting, the attendance consisted of Alfred N. Goldsmith, chairman; R. R. Batcher, Helen M. Stote, assistant editor; William Wilson, and H. P. Westman, secretary. The August meeting was attended by Alfred N. Goldsmith, chairman; R. R. Batcher, Helen M. Stote,

assistant editor; and H. P. Westman, secretary.

At these meetings, thirty-three papers were reviewed and, in practically every case, were returned to the authors with recommendations for abridgment.

It is the purpose of this committee, the membership of which changes from time to time, to re-examine all papers pending publication and those which will be approved in the future to insure that we are making the most effective utilization of PROCEEDINGS space and that all manuscripts are given reasonably uniform editing. As indicated in the report of the September 6 meeting of the Board of Directors, the work of this committee shows strong evidence that the abnormally large delay in publication will soon be reduced to a reasonable value.

Convention

Two meetings of the Convention Committee were held during September. The earlier meeting, on the 5th, was attended by H. P. Westman, chairman and secretary; Austin Bailey, A. B. Chamberlain (representing E. K. Cohan), I. S. Coggeshall (representing E. R. Shute), J. D. Crawford, C. E. Scholz, and Helen M. Stote. The later meeting, on the 11th, was composed of H. P. Westman, chairman and secretary; Austin Bailey, A. B. Chamberlain (representing E. K. Cohan), E. J. Content (representing J. R. Poppele), J. D. Crawford, and Helen M. Stote.

At these meetings the arrangements for our Fourteenth Annual Convention were prepared.

In addition, a meeting of the Convention Papers Subcommittee was held on August 8 and attended by Alfred N. Goldsmith and H. P. Westman.

Electronics Conference

Meetings of the Electronics Conference Committee and three of its subcommittees were held to make preparations for the Electronics Conference scheduled for October 20 and 21 at Stevens Institute of Technology in Hoboken, N. J. At these meetings the subjects to be discussed, the individuals who will be asked to lead the discussions, and lists of those who are to be specifically invited to attend were prepared.

At the June 16 meeting, those present were F. R. Lack, chairman; F. B. Llewellyn, B. J. Thompson, and H. A. Wheeler.

The July 21 meeting of the committee was attended by F. R. Lack, chairman; R. M. Bowie, F. B. Llewellyn, G. A. Morton, R. W. Sears, B. J. Thompson, H. A. Wheeler, J. D. Crawford, assistant secretary; and H. P. Westman, secretary.

The Subcommittee on Photo and Secondary Emission met on August 26 and those present were R. W. Sears, chairman; G. A. Morton, H. Nelson, and H. P. Westman, secretary.

The subcommittee on Tube Noise at which B. J. Thompson, chairman; R. L. Freeman, D. O. North, and H. P. Westman, secretary; were present was held on August 11.

On June 29, F. B. Llewellyn, chairman;

L. S. Nergaard, D. O. North, and J. D. Crawford, assistant secretary; attended the meeting of the Subcommittee on Ultra-High Frequencies.

Wave Propagation

A two-day meeting of the Technical Committee on Wave Propagation was held on July 24-25 and attended by J. H. Dellinger, chairman; S. L. Bailey, L. V. Berkner, C. R. Burrows, W. A. Fitch, G. D. Gillett, H. R. Mimno, K. A. Norton, H. O. Peterson, and H. P. Westman, secretary.

In the field of standardization, the committee reviewed some preliminary reports dealing with the measurement and calculation of the radiation from antennas. A preliminary report on the definitions of terms used in the field within the scope of this committee was also considered.

In preparation for the annual review, the committee divided its field on a subject basis among various members and also made preliminary assignments of the publications active in publishing material of interest to the committee.

Sections

Atlanta

"Broadcasting and the Lottery Law" was presented by G. S. Turner, inspector-in-charge of the Atlanta office of the Federal Communications Commission.

It was pointed out first that a lottery is defined as consisting of three essential elements, consideration, chance, and prize. The Georgia law covering lotteries was then outlined and some of its interpretations were reviewed.

The Radio Act of 1927 did not mention lotteries as such but a definite radio-lottery law is contained in section 316 of the Communications Act of 1934. This was analyzed.

Several cases arising under the Georgia law were cited and two cases under the Communications Act which involved the renewal of broadcast station licenses were discussed.

In concluding it was pointed out that the present radio-lottery law may not be applicable to the transmission of lottery programs by means of television and facsimile.

R. A. Holbrook, transmitter engineer at WSB, outlined "Some Relations of the Ionosphere to Radio Transmission." He presented first a drawing showing the relative positions of the several ionospheric layers and the earth and then defined various terms commonly used in ionospheric discussions. The importance of the various layers in the transmission of signals was outlined.

Field patterns produced by vertical radiators of standard broadcast stations were described and related to the primary service area, fading zone, and selective fading.

The measurement of layer heights was then discussed and their variation throughout the day outlined. An approximate formula for deriving the maximum usable

frequencies from the critical frequencies and the angle of incidence was given.

Transmission irregularities caused by magnetic storms, abnormal ionization, and other unusual conditions were outlined. The Dellinger effect and the variation of conditions throughout the sunspot cycle were covered. In closing it was pointed out that the National Bureau of Standards is now predicting ionospheric conditions for a limited period of time.

June 13, 1939, Ben Akerman, chairman, presiding.

Cleveland

President Heising visited the section and presented his talk on Institute matters and his paper on "Radio Extension Links to the Telephone System" which were summarized on page 477 of the July, 1939, PROCEEDINGS.

April 13, 1939, S. E. Leonard, chairman, presiding.

"Cleveland's Ultra-High-Frequency School Radio System" was described by J. D. Woodward, chief engineer of WBOE.

The subject was introduced with an historical outline of the part which radio has played in the educational system of Cleveland. Beginning with music-appreciation programs in 1925 from commercial stations, developments finally led to the granting of the first construction permit in the ultra-high-frequency band for a school system. The objectives of WBOE are to direct teaching on several grade levels, to supervise instruction, to assist with problems of administration, to stimulate and unify the work of parent-teacher groups and other co-operating organizations, to inform patrons and interested citizens with respect to the policies, program, and needs of the school system, and to present special feature programs such as those of school musical organizations, dramatizations, and short talks on subjects of interest to the pupils.

A 500-watt transmitter operated at 41.5 megacycles is connected to the studios through a 6-mile leased telephone line. A concentric-type antenna 110 feet above ground and about 280 feet above downtown Cleveland is soon to be raised about 200 feet.

The station went into operation in October, 1938. There are 151 receivers located in 117 elementary schools and serving about 65,000 listeners. The receivers are fixed-tuned and are capable of handling up to 32 loud speakers for public address work. They are equipped with volume indicators.

Fishpole antennas are used except in a few of the noisiest locations where single-wire antennas have been installed.

To assist in maintaining receivers and to obtain data on transmission, "Quality of Reception" reports are obtained on a routine basis. In case of trouble, the receivers are replaced so that delay is minimized and all repair work centralized.

The presentation was completed with a demonstration of one of the receivers operating in conjunction with a small portable transmitter located in the same room.

The second paper by R. B. Jacques, an engineer at WBOE, was on "Wrinkles in Recording."

This paper covered recording with acetate and nitrocellulose materials. It was based upon practical operating in connection with the Cleveland school radio system.

It was pointed out that the weather and personal whims of the operators frequently led to unexpected results. Temperature and humidity are both important. Temperatures above 75 degrees result in poor high-frequency response. Most satisfactory conditions appear to be a temperature of about 55 degrees and high humidity.

In adjusting the depth of cut it is first made too deep and then made more shallow until the reflection of the operator's face can be seen in the recorded surface.

The angle of incidence of the cutting stylus was stated to be very critical. A narrow strip of paper is cut to an angle of 92 degrees and slid under the cutting stylus. With the record stationary, the angle of the stylus is adjusted so that light will not pass between it and the edge of the paper. Chatter may sometimes be caused by a worn stylus. At other times it may be the result of nonuniformity of the record material and require the use of stabilizers

With $33\frac{1}{3}$ -revolution-per-minute recording, high-frequency response near the center of the record may be improved by utilizing a 10,000-cycle equalizer. Best results were obtained by varying the equalizer setting six or seven times during a recording. With fewer changes the steps are likely to be noticeable.

To demonstrate the results obtained at WBOE, a number of recordings were played on the studio equipment.

Following the two papers, the studios, transcription room, and control room were inspected.

May 25, 1939, S. E. Leonard, chairman, presiding.

Connecticut Valley

W. E. Bahls of the RCA Manufacturing Company (Harrison), presented a paper on "Cold-Cathode Gaseous-Discharge Tubes." It was introduced with a discussion of some of the fundamental processes involved in the initiation of a cold-cathode discharge. Ionization by collision and the Townsend and Thompson theories of breakdown were explained. The relationships between breakdown voltage and gas pressure, electrode material, spacing, and configuration, and the kind of gas used were considered in detail. It was shown how positive-ion space charge redistributed the potential within the tube and, in many cases, results in a reduced maintaining voltage which is nearly constant with current.

It was then pointed out that if an additional source of ionization is present, the breakdown voltage between electrodes in a gas can be appreciably reduced to a value approaching that required to maintain the discharge.

The application of these theories to the design and operation of starting-anode

and grid-control gas triodes, and glow-discharge regulator tubes was then covered.

May 4, 1939.

"Methods and Apparatus for Measuring Phase Distortion" was the subject of a paper delivered by C. E. Brigham of Kolster Brandes Limited (England) in behalf of the author, M. Levy of Le Materiel Telephonique (Paris).

The paper covered various aspects of phase distortion and methods of measuring it. A Fourier analysis of various pulse or wave trains as applied to generalized circuits was presented. The conditions for distortionless transmission and the need for determining both phase delay and group or envelope delay were given. A satisfactory determination of the circuit's stability has been made possible by the establishment of Nyquist's phase-amplitude diagram for the circuit.

The fundamental methods of phase measurement used in the past were described and their advantages and disadvantages discussed. This was followed by a description of transmission-time measurement equipment and phasemeters which have recently been developed.

The paper was concluded with a description of the automatic recording Nyquist diagram tracer developed by the author and his associates.

June 14, 1939, E. R. Sanders, chairman, presiding.

Emporium

After being discontinued for one year, a summer seminar was held on July 28 and 29. The technical sessions were devoted to the presentation of four papers.

"Method and Apparatus for Measuring Phase Distortion in Television," by M. Levy of Le Materiel Telephonique (Paris), was read by C. E. Brigham and is summarized in the Connecticut Valley Section report in this issue.

"Frequency Modulation" was presented by I. R. Weir of the General Electric Company (Schenectady). R. M. Wise of the Hygrade Sylvania Corporation presented some "Comments on European Radio Developments." The fourth presentation was an informal discussion on "Ratings and Characteristics of 1.4-Volt Tube Types" which was conducted by M. A. Acheson of the Hygrade Sylvania Corporation.

"Frequency Modulation in Television Transmission" was the subject of a paper by C. W. Carnahan of the Hygrade Sylvania Corporation.

A frequency-modulation system with a deviation ratio of unity or less was compared with amplitude-modulation systems for television broadcasting. It was pointed out that band-width requirements are met equally well by both systems provided that the over-all frequency characteristics of the radio-frequency amplifiers are the same. Asymmetries in the transient responses to a frequency-modulated signal are observed but are of minor consequence in picture reproduction.

Some improvement in the signal-to-noise ratio is to be expected for a fre-

quency-modulation receiver employing amplitude limitation even though the deviation ratio is only unity.

Power output and the efficiency of the final stage in a frequency-modulated transmitter are double the values obtainable with existing amplitude-modulated equipment.

When synchronization is considered, frequency modulation offers several alternative methods which may lead to simplification of the transmitter.

September 7, 1939, R. K. McClintock, chairman, presiding.

Los Angeles

"A Review of Radio and Allied Activities in the Southern California Area" was presented by R. O. Brooke of the National Broadcasting Company.

The rapid growth during the past ten years in motion-picture sound engineering and in broadcasting was outlined. It was pointed out that at the present time practically all of the national sponsored programs originate in the Hollywood studios of the Columbia Broadcasting System and the National Broadcasting Company. In the past year and a half, new plants have been built by both organization and are already in the process of expansion.

President Heising visited the section and presented his paper on "Radio Extension Links to the Telephone System."

June 20, 1939, F. G. Albin, chairman, presiding.

New Orleans

Austin Bailey, engineer for the American Telephone and Telegraph Company, presented a paper on "Harbor and Coastal Radiotelephony."

The need for radiotelephone service to small vessels which operated close to shore was pointed out. The system for supplying this service and the equipment used were described. The necessity for using fixed-tuned transmitters and receivers of a design which permits their operation by the general public was discussed.

July 21, 1939, D. W. Bowman, secretary, presiding.

Pittsburgh

This was the annual dinner meeting of the section and no technical papers were presented.

In the election of officers, Joseph Baudio of KDKA was named chairman, R. E. Stark of the Federated Metals Corporation was designated vice chairman, and Gary Muffly of the Gulf Research and Development Corporation was elected secretary-treasurer.

June 20, 1939, W. P. Place, chairman, presiding.

Portland

Ray Simpson of the Simpson Electric Company (Chicago), spoke on "Thirty-two Years of Designing and Making Electrical Instruments."

August 28, 1939, H. C. Singleton, chairman, presiding.

Membership

The following indicated admissions and transfers of memberships have been approved by the Admissions Committee. Objections to any of these should reach the Institute office by not later than October 31, 1939.

Transfer to Member

- Gleason, R. J., Pacific Alaska Airways, Inc., Fairbanks, Alaska.
 Hight, S. C., Bell Telephone Labs., Inc., 463 West St., New York, N. Y.
 Kennedy, F. M., 231 S. Witmer St., Los Angeles, Calif.
 Kohl, W. H., 459 Parkside Dr., Toronto, Ont., Canada.
 Newhouse, R. C., Bell Telephone Labs., Inc., 463 West St., New York, N. Y.
 Smith, C. E., 2826 Brookview Blvd., Cleveland, Ohio.
 Smyth, C. N., 50 Dominic Dr., New Eltham, London, S. E. 9, England.
 Swinyard, W. O., 325 W. Huron St., Chicago, Ill.
 Thomson, J. M., 171 John St., Weston, Ont., Canada.

Admission to Member

- Bostad, J., Trondhjemsveien 164 B IV Oslo, Norway.
 Hirsch, C. J., 2600 W. 50th St., Chicago, Ill.
 Williams, R. C. G., 92 Brookmans Ave., Brookmans Parks, Hatfield, Herts., England.

Admission to Associate (A), Junior (J), and Student (S)

- Adamson, H. D., (A) 1420 2nd Ave., Columbus, Ga.
 Avins, J., (A) 3303 Richmond Rd., New Dorp, S. I., N. Y.
 Bauriedel, J. G., (S) Grants Pass, Ore.
 Beaudoin, A. J., (A) U.S.S. *Detroit*, San Diego, Calif.
 Bowerman, E., Jr., (A) Hygrade Sylvania Corp., Emporium, Pa.
 Brown, M. W., (A) Box 5, Nelson, B. C., Canada.
 Cooper, B. J., (A) 8701 Ridge Blvd., Brooklyn, N. Y.
 Cooper, M. R., (A) "The Cliff," Roghariji Rd., Gowalia Tank, Bombay, India.
 Dieli, F. J., (A) 2261, W. 7th St., Brooklyn, N. Y.
 Dunphey, H. B., Jr., (A) 130 Trammell St., Marietta, Ga.
 Falwell, L. O., (J) U.S.S. *Peary* (226), c/o Postmaster, San Francisco, Calif.
 Fischer, R. E., (A) 714 11th Ave., Huntington, W. Va.
 Fisher, W. H., (A) 34 Roberts Ave., Runholme, Manchester, Lancs., England.
 Freeman, W. C., Jr., (A) Hygrade Sylvania Corp., Emporium, Pa.
 Hanson, R., (A) 1519 33rd Ave., Oakland, Calif.

- Houston, D., (A) 9 Semley Rd., Hassocks, Sussex, England.
 Isbister, E. J., (A) 1126 84th St., Brooklyn, N. Y.
 Johnson, H. D., (A) 236 W. 4th St., Emporium, Pa.
 Joseph, K. A., (A) Marconi School of Wireless Technology, Chelmsford, Essex, England.
 Kowalski, B., (A) 52 Leszno St., Warsaw, Poland.
 Lee, G. F., (A) 924 Patterson St., Ogden, Utah.
 Mac Sorley, O. L., (A) 213 E. Palmer Ave., Collingswood, N. J.
 Mahon, A. C., (A) 5711 Avenue N, Brooklyn, N. Y.
 Miedke, R. C., (A) Illinois State Police Radio Station, WQPG, Sterling, Ill.
 Moncton, H. S., (A) 302 W. 4th St., Emporium, Pa.
 Nace, A. S., (A) Radiart Corp., Cleveland, Ohio.
 Narasimha Rao, V. L., (A) "Vepa House," Main Rd., Vizagapatam, Madras Pres., India.
 Ouimet, J. A., (A) 1440 St. Catherine St., W., Montreal, Que., Canada.
 Pryga, S. A., (A) 5333 Cornelia Ave., Chicago, Ill.
 Rao, G. V., (A) The Radio Electric Institute, Lamington Chambers, Bombay 4, India.
 Seastrom, D. S., (A) 314 W. 5th St., Emporium, Pa.
 Shadow, R. A., (A) 1st Signal Co., M. B., Quantico, Va.
 Siddle, W. T., (A) 2214 18th Ave., Columbus, Ga.
 Storer, W., (A) 8104 Kenwood Ave., Chicago, Ill.
 Threlfall, A. J. C., (A) "Winsted," Burton Joyce, Notts., England.
 Tjarks, B., (A) 44 Camp St., San Francisco, Calif.
 Totman, S., (A) 3737 Georgia Ave., Hapeville, Ga.
 Varshneya, M. C., (A) Manik Chowk, Aligarh, India.
 Weiss, M. E., (A) 236 W. 4th St., Emporium, Pa.
 Werner, W., (A) 21 Kraaienlaan, The Hague, Holland.
 Zinchuk, M., (S) 25 Lowe St., Quincy, Mass.

Committee Personnel—1939

ADMISSIONS COMMITTEE

- F. W. Cunningham, *Chairman*
 H. H. Beverage F. M. Ryan
 Melville Eastham C. E. Scholz
 J. F. Farrington J. S. Smith
 L. C. F. Horle H. M. Turner
 C. M. Jansky, Jr. A. F. Van Dyck

ANNUAL REVIEW COMMITTEE

- A. F. Van Dyck, *Chairman*
 E. K. Cohan H. S. Knowles
 J. H. Dellinger E. G. Ports
 W. G. H. Finch H. M. Turner
 D. E. Foster P. T. Weeks
 Keith Henney L. E. Whittemore

AWARDS COMMITTEE

- Haraden Pratt, *Chairman*
 H. H. Beverage Melville Eastham
 Ralph Bown H. M. Turner

BOARD OF EDITORS

- Alfred N. Goldsmith, *Chairman*
 R. R. Batcher K. S. Van Dyke
 P. S. Carter H. P. Westman, *ex officio*
 F. W. Grover L. P. Wheeler
 J. W. Horton L. E. Whittemore
 B. E. Shackelford William Wilson

CONSTITUTION AND LAWS COMMITTEE

- H. M. Turner, *Chairman*
 Austin Bailey C. E. Scholz
 Ralph Bown B. J. Thompson
 Alfred N. Goldsmith H. R. Zeamans

MEMBERSHIP COMMITTEE

- C. E. Scholz, *Chairman*
 Nathaniel Bishop A. F. Murray
 E. L. Bowles L. G. Pacent
 I. S. Coggeshall J. R. Poppele
 E. D. Cook F. X. Rettenmeyer
 F. W. Cunningham C. R. Rowe
 H. F. Dart B. Salzberg
 Coke Flannagan J. E. Smith
 H. C. Gawler F. E. Terman
 R. M. Heintz H. J. Vennes
 J. S. Webb
 (*Chairmen of Membership Committees of Sections, ex officio*)

NEW YORK PROGRAM COMMITTEE

- I. S. Coggeshall, *Chairman*
 H. A. Affel J. F. Farrington
 Austin Bailey W. M. Goodall
 R. R. Beal Keith Henney
 A. B. Chamberlain G. T. Royden
 A. F. Van Dyck

NOMINATIONS COMMITTEE

- C. M. Jansky, Jr., *Chairman*
 W. G. Cady Melville Eastham
 F. W. Cunningham B. J. Thompson
 L. P. Wheeler

PAPERS COMMITTEE

- William Wilson, *Chairman*
 H. A. Affel DeL. K. Martin
 Edmond Bruce H. R. Mimno
 H. A. Chinn A. F. Murray
 J. K. Clapp H. O. Peterson
 T. A. M. Craven R. K. Potter
 P. O. Farnham H. M. Turner
 E. B. Ferrell P. T. Weeks
 E. L. Hall H. A. Wheeler
 L. F. Jones W. C. White
 F. B. Llewellyn Irving Wolff

PUBLICITY COMMITTEE

- O. H. Caldwell R. C. Poulter
 Martin Codel F. X. Rettenmeyer
 Keith Henney K. B. Warner

SECTIONS COMMITTEE
 E. D. Cook, *Chairman*
 I. S. Coggeshall R. M. Heintz
 Virgil M. Graham J. H. Miller
 C. E. Scholz
 (*Chairmen of Sections, ex officio*)

TELLERS COMMITTEE
 W. M. Goodall, *Chairman*
 H. F. Dart D. G. Fink
 H. P. Westman, *ex officio*

TECHNICAL COMMITTEES
 ELECTROACOUSTICS COMMITTEE
 H. S. Knowles, *Chairman*
 L. B. Blaylock George Nixon
 J. T. L. Brown Benjamin Olney
 R. P. Glover H. F. Olsen
 Knox McIlwain L. J. Sivian

FACSIMILE COMMITTEE
 W. G. H. Finch, *Chairman*
 J. C. Barnes George Lewis
 W. A. R. Brown P. Mertz
 J. L. Callahan J. W. Milnor
 J. V. L. Hogan C. J. Young

ELECTRONICS COMMITTEE
 P. T. Weeks, *Chairman*
 L. B. Blaylock R. S. Burnap

E. L. Chaffee G. F. Metcalf
 H. P. Corwith A. F. Murray
 K. C. DeWalt G. D. O'Neill
 W. G. Dow H. W. Parker
 Ben Kievit, Jr. O. W. Pike
 F. R. Lack B. J. Thompson
 George Lewis Balth. van der Pol
 F. B. Llewellyn J. R. Wilson

RADIO RECEIVERS COMMITTEE
 D. E. Foster, *Chairman*
 E. H. Armstrong C. J. Franks
 C. R. Barhydt Virgil M. Graham
 L. B. Blaylock David Grimes
 R. I. Cole D. E. Harnett
 W. F. Cotter R. S. Holmes
 L. F. Curtis D. D. Israel
 Harry Diamond H. O. Peterson
 E. T. Dickey A. E. Thiessen
 H. B. Fischer H. J. Tyzzer
 Lincoln Walsh

STANDARDS COMMITTEE
 L. P. Wheeler, *Chairman*
 W. R. G. Baker H. S. Knowles
 W. L. Barrow R. M. Morris
 H. H. Buttner E. G. Ports
 J. H. Dellinger F. E. Terman
 W. G. H. Finch A. E. Thiessen
 D. E. Foster H. J. Vennes
 Virgil M. Graham P. T. Weeks
 L. C. F. Horle William Wilson

TELEVISION COMMITTEE
 E. K. Cohan, *Chairman*
 R. R. Batcher T. T. Goldsmith, Jr.
 A. B. DuMont A. G. Jensen
 E. W. Engstrom I. J. Kaar
 P. T. Farnsworth George Lewis
 D. E. Foster H. M. Lewis
 P. C. Goldmark A. F. Murray
 R. E. Shelby

TRANSMITTERS AND ANTENNAS
 COMMITTEE
 E. G. Ports, *Chairman*
 Raymond Asserson W. E. Jackson
 L. B. Blaylock J. F. Morrison
 M. R. Briggs R. E. Poole
 W. W. Brown D. S. Rau
 Harry Diamond J. C. Schelleng
 G. W. Fyler P. E. Watson
 Raymond Guy J. E. Young

WAVE PROPAGATION
 COMMITTEE
 J. H. Dellinger, *Chairman*
 N. I. Adams W. A. Fitch
 S. L. Bailey G. D. Gillett
 L. V. Berkner H. R. Mimno
 C. R. Burrows K. A. Norton
 T. L. Eckersley H. O. Peterson
 Balth. van der Pol

Institute Representatives on Other Bodies

A.I.E.E.—Subcommittee on Radio of the Committee on Applications to Marine Work..... T. E. NIVISON AND J. L. PRESTON
 American Documentation Institute..... C. M. JANSKY, JR.
 Committee on Applied Physics..... WILLIAM WILSON
 Council of the American Association for the Advancement of Science..... J. C. JENSEN
 Engineering Index National Committee..... MELVILLE EASTHAM
 Joint Co-ordination Committee on Radio Reception of the N.E.L.A., N.E.M.A., and R.M.A..... C. E. BRIGHAM
 Liaison Committee on Aeronautic Radio Research..... F. M. RYAN (C. C. SHANGRAW, alternate)
 National Advisory Council on Radio in Education..... LLOYD ESPENSCHIED, ALFRED N. GOLDSMITH, C. W. HORN, L. M. HULL, AND R. H. MARRIOTT
 New York City Advisory Board on Industrial Education..... H. P. WESTMAN
 Planning Committee, National Conference on Educational Broadcasting, American Council on Education..... C. M. JANSKY, JR., C. B. JOLLIFFE, AND E. L. NELSON
 Radio Broadcasting Committee, American Engineering Council..... MELVILLE EASTHAM
 U.R.S.I. (International Scientific Radio Union) Executive Committee..... C. M. JANSKY, JR.
 U. S. National Committee, Advisers on Electrical Measuring Instruments..... MELVILLE EASTHAM AND HAROLD OLESEN
 U. S. National Committee, Advisers on Symbols..... L. E. WHITTEMORE AND J. W. HORTON

AMERICAN STANDARDS ASSOCIATION

Board of Directors..... HARADEN PRATT
 Standards Council..... ALFRED N. GOLDSMITH (H. P. WESTMAN, alternate)
 Board of Examination..... H. P. WESTMAN
 Electrical Standards Committee..... H. M. TURNER (H. P. WESTMAN, alternate)
 Sectional Committee on Acoustical Measurements and Terminology..... E. D. COOK AND H. F. OLSON
 Sectional Committee on Definitions of Electrical Terms..... HARADEN PRATT
 Subcommittee on Vacuum Tubes..... B. E. SHACKELFORD
 Sectional Committee on Electric and Magnetic Magnitudes and Units..... J. H. DELLINGER
 Sectional Committee on Electrical Installations on Shipboard..... I. F. BYRNES AND V. R. RUSS
 Sectional Committee on Electrical Measuring Instruments..... WILSON AULL
 Sectional Committee on Graphical Symbols and Abbreviations for Use on Drawings..... L. E. WHITTEMORE (H. P. WESTMAN, alternate)
 Subcommittee on Communication Symbols..... H. M. TURNER
 Sectional Committee on Letter Symbols and Abbreviations for Science and Engineering..... H. M. TURNER
 Subcommittee on Letter Symbols for Radio Use..... H. M. TURNER
 Sectional Committee on National Electrical Safety Code, Subcommittee on Article 810, Radio Broadcast Reception Equipment..... E. T. DICKEY (VIRGIL M. GRAHAM, alternate)
 Sectional Committee on Preferred Numbers..... A. F. VAN DYCK
 Sectional Committee on Radio..... ALFRED N. GOLDSMITH, HARADEN PRATT, AND L. E. WHITTEMORE
 Sectional Committee on Radio-Electrical Co-ordination..... J. V. L. HOGAN, C. M. JANSKY, JR., AND L. E. WHITTEMORE
 Sectional Committee on Specifications for Dry Cells and Batteries..... H. M. TURNER
 Sectional Committee on Standards for Drawings and Drafting Room Practices..... L. E. WHITTEMORE
 Sectional Committee on Vacuum Tubes for Industrial Purposes..... B. E. SHACKELFORD

Contributors



ROBERT R. BUSS

Robert R. Buss (S'37) was born March 14, 1913, at Provo, Utah. He received the A.B. degree in Mathematics at San Jose State College in 1935. Since that time he has been a Newell Scholar at Stanford University, receiving the E.E. degree in 1938. Mr. Buss was a laboratory assistant in Electrical Engineering during 1936 and 1937. He is a member of Tau Beta Pi and an associate member of Sigma Xi.



F. C. Cahill (S'38) was born on April 27, 1914, at Dixon, Illinois. He received the A.B. degree in 1936 and the E.E. degree in 1938 from Stanford University. Since 1938 he has been employed as an engineer by Heintz and Kaufman, Ltd. Mr. Cahill is a member of Phi Beta Kappa and Tau Beta Pi and an associate member of Sigma Xi.



Robert C. Colwell (A'21, M'29) was born at Fredericton, N. B., Canada, on October 14, 1884. He received the A.B. degree from Harvard University, the M.A.



F. C. CAHILL

degree from the University of New Brunswick, and the Ph.D. degree from Princeton University. From 1913 to 1923 Dr. Colwell was Professor of Physics at Geneva College; since 1924 he has been Assistant Director of the Radio Laboratory at West Virginia University. He is a member of the American Physical Society, the Franklin Institute, and the American Mathematical Society.



John Howard Dellinger (F'23) was born on July 3, 1886, at Cleveland, Ohio. He was educated at Western Reserve University, 1903 to 1907, and in 1908 received the A.B. degree from George Washington University. In 1913 he received the Ph.D. degree from Princeton University, and in 1932 the D.Sc. degree from George Washington University. Dr. Dellinger joined the staff of the National Bureau of Standards as Physicist in 1907. From 1928 to 1929 he was Chief Engineer of the Federal Radio Commission; Chief of the Radio Section, Research Division, Aeronautic Branch, Department of Commerce



ROBERT C. COLWELL

from 1926 to 1934; and Chief of Radio Section, National Bureau of Standards, 1919 to date. Since 1921 he has been the United States representative at numerous international radio and electrical conferences. He was Vice President of the Institute of Radio Engineers in 1924 and President in 1925.



Carl B. Feldman (A'26) was born at St. Peter, Minnesota, on March 26, 1902. He received the B.S. degree in 1926 and the M.S. degree in 1928 from the University of Minnesota. Since 1928 Mr. Feldman has been with the Bell Telephone Laboratories.



Albert W. Friend (A'34, M'39) was born on January 24, 1910, at Morgantown, West Virginia. He received the B.S. degree in Electrical Engineering at West Virginia University in 1932 and the M.S. degree in Physics in 1936. From 1933 to 1934 he was Transmission and Distribution Engineer for the Ohio Power Company; in 1934 De-



JOHN HOWARD DELLINGER



CARL B. FELDMAN



ALBERT W. FRIEND



WILLIAM R. HEWLETT

sign and Consulting Engineer, WPDH; Instructor in Physics at West Virginia University, 1934 to 1937; Assistant Professor of Physics, West Virginia University, 1937 to 1939. Since June of 1939 Mr. Friend has been on leave while acting as Research Fellow for the Blue Hill Meteorological Observatory of Harvard University during the summer and Research Fellow at Cruft Laboratory of Harvard University to date. He is a member of Tau Beta Pi, Sigma Pi Sigma, the American Institute of Electrical Engineers, and the American Meteorological Society.



William R. Hewlett (S'35, A'38) was born in Ann Arbor, Michigan, on May 20, 1913. He received the A.B. degree from Stanford University in 1932, the M.S. degree from Massachusetts Institute of Technology in 1936, and the degree of Engineer from Stanford University in 1939. Mr. Hewlett was appointed a Research Associate at Stanford University



S. A. SCHELKUNOFF

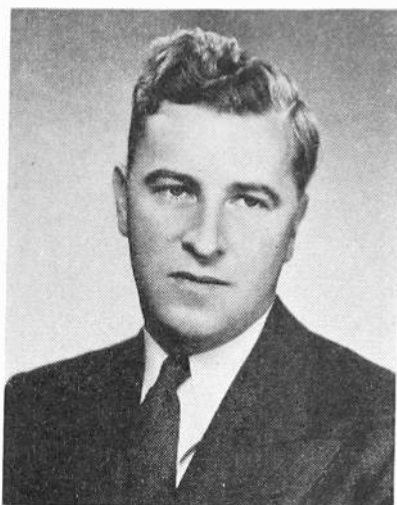

WILLIAM B. LODGE

in 1938, and is a partner in the Hewlett-Packard Company. He is a member of Sigma Xi.



William B. Lodge (A'34, M'37) was born at Whitmarsh, Pennsylvania, on August 17, 1907. He attended Wesleyan University for two years, transferring to Massachusetts Institute of Technology where he received the B.S. and M.S. degrees in 1931. During 1929 and 1930 he engaged in vacuum-tube research at the Bell Telephone Laboratories. Since 1931 he has been a member of the Engineering Department of the Columbia Broadcasting System, where, from 1936 to date, he has been Engineer-in-Charge of Radio Engineering.



Wilcox P. Overbeck (A'37) was born in Glenwood Springs, Colorado, in 1911. He is a former student of the University of Denver and received his B.S. degree from the Massachusetts Institute of Technology in 1934. Since then, Mr. Overbeck has been employed in the Electrical Manufacturing and Vacuum-Tube Production Divisions of the Raytheon Production Corporation. At present, he is a member of the Research and Development Department. He is an associate member of Sigma Xi and of the American Institute of Electrical Engineers.



S. A. Schelkunoff received the B.A. and M.A. degrees in Mathematics from the State College of Washington in 1923, and the Ph.D. degree in Mathematics from Columbia University in 1928. He was in the Engineering Department of the Western Electric Company from 1923 to 1925; the Bell Telephone Laboratories from 1925 to 1926; the Department of Mathematics of the State College of Washington, 1926 to 1929; and Bell Telephone Laboratories,

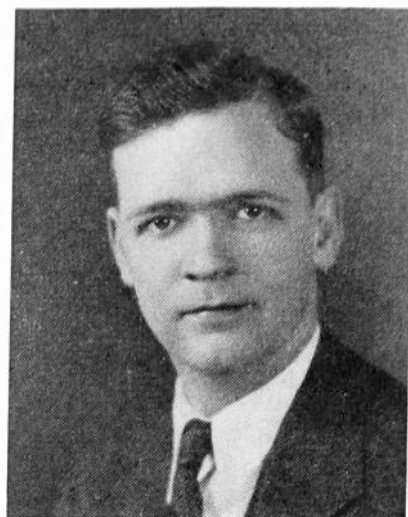

WILCOX P. OVERBECK

1929 to date. Dr. Schelkunoff has been engaged in mathematical research, especially in the field of electromagnetic theory.



Frederick Emmons Terman (A'25, F'37) was born June 7, 1900, at English, Indiana. He received the A.B. degree in 1920 and the degree of Engineer in 1922 from Stanford University, and the Sc.D. degree from the Massachusetts Institute of Technology in 1924. From 1925 to 1937 Dr. Terman was an Instructor, Assistant Professor, and Associate Professor of Electrical Engineering at Stanford University; since 1937 he has been Professor and Head of the Electrical Engineering Department at Stanford.



For biographical sketches of T. R. Gilliland, S. S. Kirby, and N. Smith see the PROCEEDINGS for January, 1939; for Leon S. Nergaard, September, 1939.

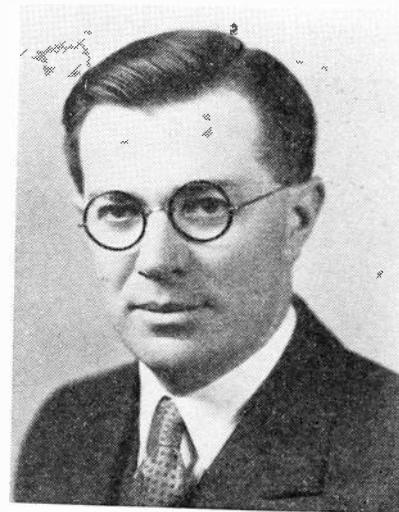

F. E. TERMAN



Compensate
 FOR
FREQUENCY DRIFT
 WITH
ERIE CERAMICONS
REG. U.S. PAT. OFF.



Troublesome, performance-ruining frequency drift due to temperature may occur in as many as 6 or 7 different components. Tracking it down and doing away with it in each individual component is usually a long and expensive process. This procedure is unnecessary since, in most cases, an Erie Ceramicon used as part of the capacitive reactance in the oscillator circuit can effectively compensate for the summation of all the individual drifts.

These ceramic-dielectric condensers can be supplied with any desired permanent and reproducible temperature coefficient between $+ .00012$ and $- .00068$ per $^{\circ}\text{C}$.

If you will send a chassis and wiring diagram of your set, our engineering department will be glad to show you how simply and efficiently an Erie Ceramicon can remedy this frequency drift.

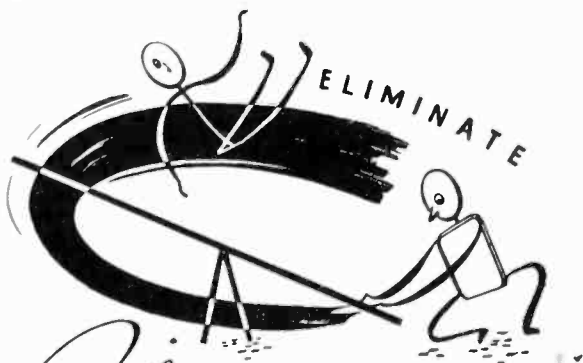

Eliminate
CONDENSER CAPACITY DRIFT
 WITH
ERIE SILVER-MICA CONDENSERS



By using the new molded Type K Erie Silver Micas in place of ordinary mica condensers in tuned circuits, frequency drift caused by condensers can be eliminated.

The low temperature coefficient of Erie Silver-Micas (0 to $+ .00004$ per $^{\circ}\text{C}$ depending on capacity) is unusually stable even under adverse operating conditions. After 5 complete cycles of 5 hours at -30°F and 15 hours at 180°F , capacity change is less than .135%. After 100 hours in 100% relative humidity at 104°F , the capacity will change less than .05%.

Type K molded units are available in ranges from 15 mmf. to 500 mmf. Other types with the same general characteristics are made up to 2500 mmf.

ERIE RESISTOR CORPORATION, Erie, Pa.

TORONTO, CANADA • LONDON, ENGLAND • PARIS, FRANCE - J. E. CANETTI CO.

MANUFACTURERS OF RESISTORS • CONDENSERS • MOLDED PLASTICS

Commercial Engineering Developments

These reports on engineering developments in the commercial field have been prepared solely on the basis of information received from the firms referred to in each item.

Sponsors of new developments are invited to submit descriptions on which future reports may be based. To be of greatest usefulness, these should summarize, with as much detail as is practical, the novel engineering features of the design. Address: Editor, Proceedings of the I.R.E., 330 West 42nd Street, New York, New York.

Constant-Loss Impedance-Transforming network

Lack of a readily available indicating instrument for measuring audio-frequency power—and quantities involving power such as transmission gains and losses—makes it necessary to employ various combinations of voltmeters and calibrated resistance networks. Since both of these circuit elements should operate at fixed and known values of impedance in order to measure power correctly, impedance-

changing networks play an important part in power-measuring systems.

When the amplifiers or lines to be measured operate at a single set of impedance values, impedance-matching transformers and resistance pads are readily designed. When, however, measurements are to be made at many different impedance levels, suitable impedance-matching networks are a more difficult problem. Variable transformers and pads have been used, but tapped transformers are difficult to adjust with accuracy and pads necessarily have large insertion losses when the difference in impedance levels is large.

A simplified impedance-matching network has been developed by the Daven Company* and applied to two new instruments. The network presents a variety of different impedances on its input side, maintaining a constant output impedance and a constant insertion loss.

On application of the network is found in a transmission measuring set developed in cooperation with the General Engineering Department of the Columbia Broadcasting System.† The transmission-measuring set employs the conventional comparison method in which the power delivered to the input of an amplifier is

* The Daven Company, 158 Summit Street, Newark, New Jersey.

† Columbia Broadcasting System, Inc., 485 Madison Avenue, New York, New York.

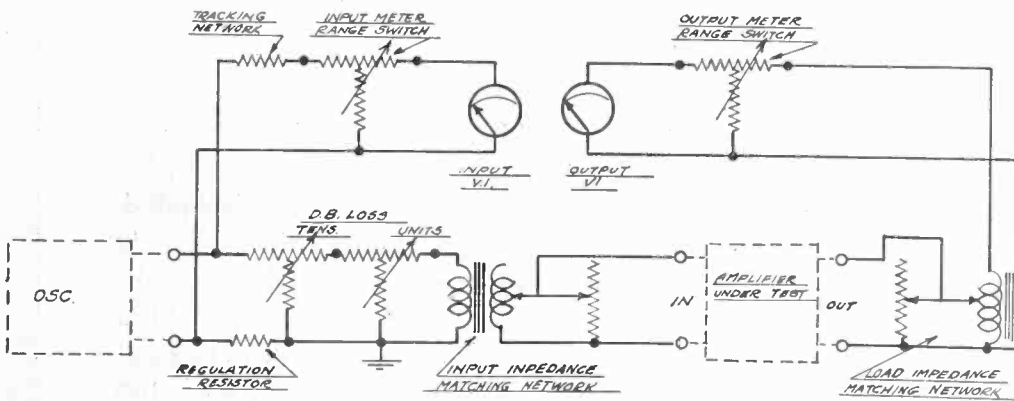

SIMPLIFIED SCHEMATIC OF 6C TRANSMISSION MEASURING SET

Fig. 1—Below: A transmission-measuring set, complete except for the oscillator, that will measure amplifiers and other equipment under any of the terminating-impedance conditions ordinarily encountered. Above: Schematic diagram of the transmission-measuring set

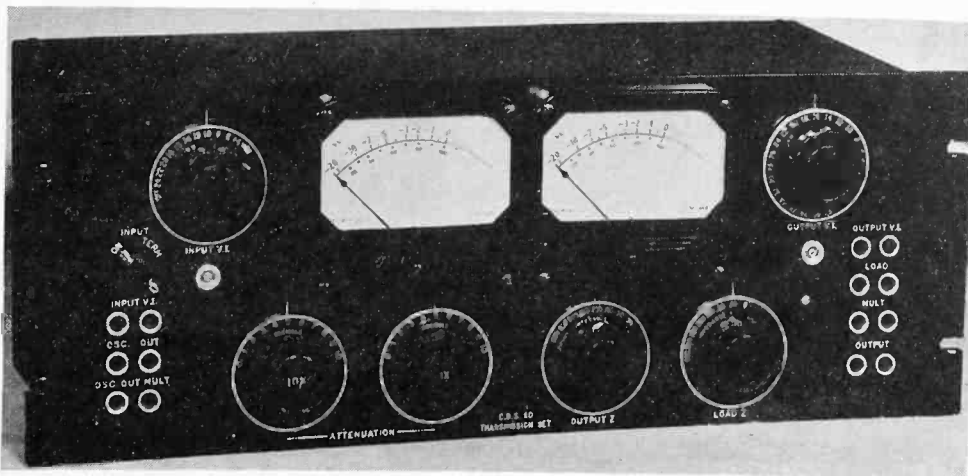

The Answer

... to the question:
"DOES C. R. E. I.
TRAINING PAY?"

The success of a school is not indicated by its number of graduates . . . but by the number of graduates employed! A recent survey made of our residence graduates of 1934 through 1937 disclosed that 96% WERE EMPLOYED in the radio and communication industry within an average elapsed time of ONE MONTH after graduation!

Surely such a record is proof that C.R.E.I. technical training PAYS because it is practical! The sole functions of C.R.E.I. are to help create careers for ambitious men and to provide the radio industry with much-needed trained manpower.

May we send you our new illustrated booklet?



The 48 interesting pages review our Practical Radio Engineering training in its several forms and the newly added course in Television Engineering. We will be glad to send additional copies to any interested associates you might suggest.

Capitol Radio ENGINEERING INSTITUTE

E. H. RIETZKE, Pres.
Dept. PR-10
3224 Sixteenth St., N.W.
Washington,
D.C.

NEW 2-IN-1 PICK-UP

BY

Western Electric

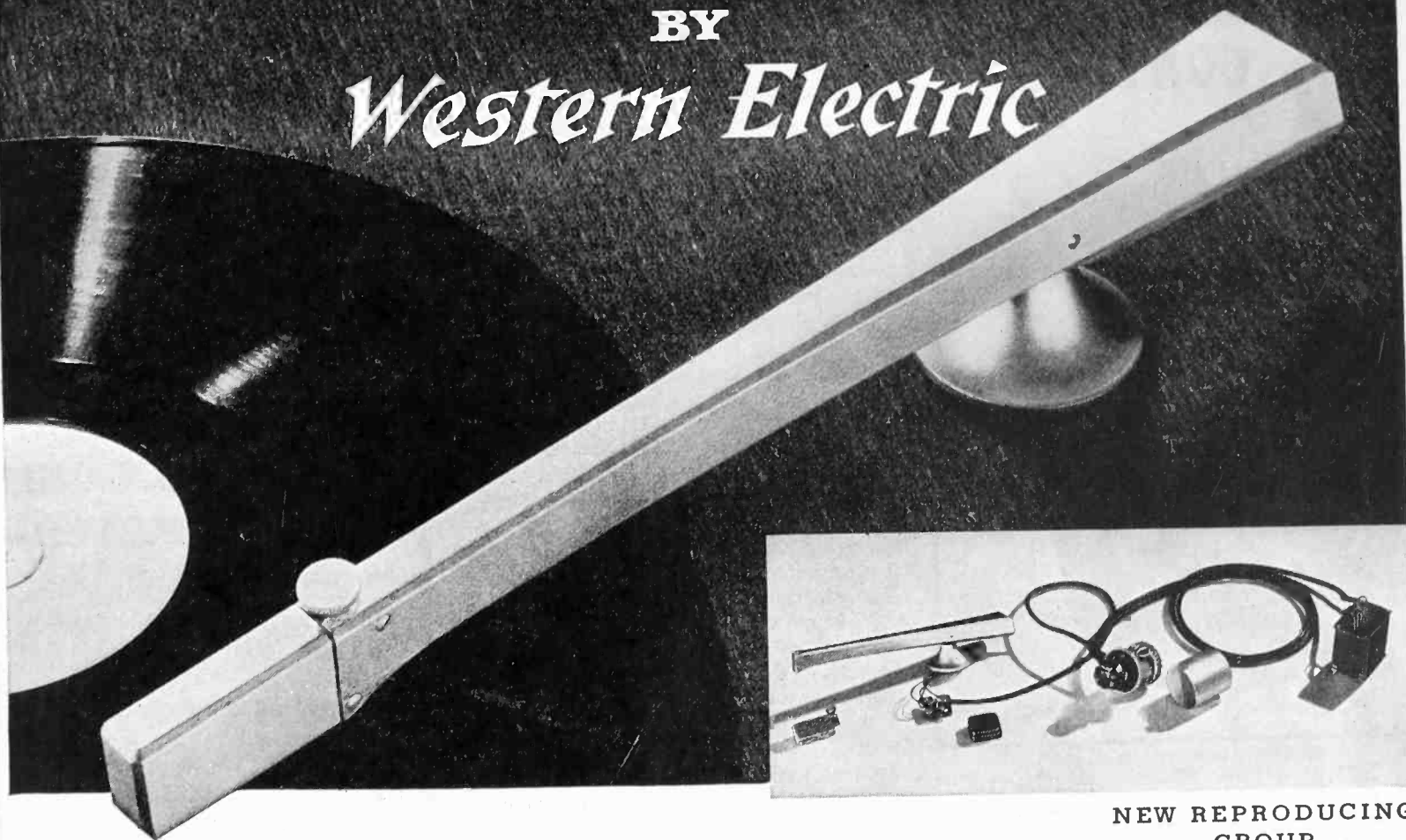

... plays both **VERTICAL** and **LATERAL** recordings!

Here's what you've wanted! A single pick-up that can handle any recording, vertical or lateral—that meets the most exacting requirements of transcription broadcasting. It reproduces faithfully the full quality of the recording—has a diamond stylus giving long record life—costs considerably less than the two pick-ups you'd ordinarily need to do its work.

With Western Electric's new Reproducing Group you can equip your present tables with equalized pick-up facilities matching the recording characteristics of the regularly available discs. A single con-

trol (selector switch illustrated) matches the pick-up circuit to the record and provides two "vertical" characteristics (one flat response to 10,000 cycles—one drooped above 8500 cycles) and five "lateral" characteristics (ranging from "straight through" to "sound effects"). Designed to work into your regular input circuits for broadcast microphones, it will match impedances of 30, 250, 500 or 600 ohms.

Get full details of this latest aid to Better Broadcasting—by Bell Telephone Laboratories and Western Electric. Ask Graybar for Bulletins T1630 and T1631.

ASK YOUR ENGINEER!



DISTRIBUTORS:

Graybar Electric Co., Graybar Building, New York. In Canada and Newfoundland: Northern Electric Co., Ltd. In other countries: International Standard Electric Corp.

NEW REPRODUCING GROUP

Contains reproducer and arm—with diamond stylus of practically unlimited life—equalizing equipment, switch, and necessary accessories.



NEW REPRODUCER SET

Western Electric 1300A—built around the 2-in-1 Reproducing Group. Two-speed flutterless turntable plays vertical or lateral recordings up to 16" in diameter. Operates on 110-120 volts, 60 cycle AC. Speech change entirely electrical. Not necessary to stop the table to change speed from 78 to 33 $\frac{1}{3}$ and vice versa.

DEPENDABLE HIGH FREQUENCY CRYSTAL CONTROL



Bliley High Frequency Quartz Crystal Units are designed to provide accurate, dependable frequency control under the adverse operating conditions encountered with mobile and portable transmitters. Both the rugged type MO2 holder and the compact MO3 temperature controlled mounting are widely employed for U.H.F. services where reliability counts. Catalog G-11 contains complete information on these and other Bliley Crystal Units for frequencies from 20kc. to 30mc.

Write for your copy.

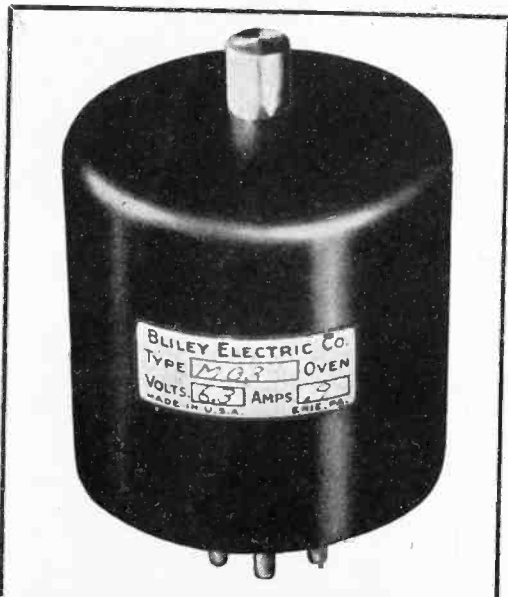

BLILEY ELECTRIC CO.
UNION STATION BUILDING ERIE, PA.

(Continued from page ii)

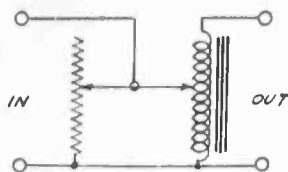

Fig. 2—Basic impedance-transforming network for maintaining constant insertion loss and output impedance for different values of input impedance

compared with the output power. Two of the new networks are employed to keep constant the impedance in the calibrated circuits for any value of input and load impedances that the operator may select for the test. Since the insertion loss in each network is constant no matter what impedance level is selected, the equipment can be made direct reading.

The basic impedance-matching network is shown in Figure 2. It consists of a tapped resistor and a tapped transformer. The impedance of the loaded transformer is many times greater than the resistor is the principal impedance-determining element. Since resistors are more readily adjusted than transformers, the problem of accurately adjusting the input impedance and keeping it constant over a wide frequency range is considerably simplified.

The network has also been applied in a new output-network meter for measuring the power delivered by an amplifier to a load of any given impedance. A voltmeter with a constant—impedance meter multiplier is connected to the output side of the network. Since the voltmeter operates in a constant-impedance circuit, it can be calibrated in units of power.

The new output meter makes available 40 different values of load impedance between 2.5 ohms and 20,000 ohms for amplifier testing. It has full-scale power values of from 50 milliwatts up to 50 watts.

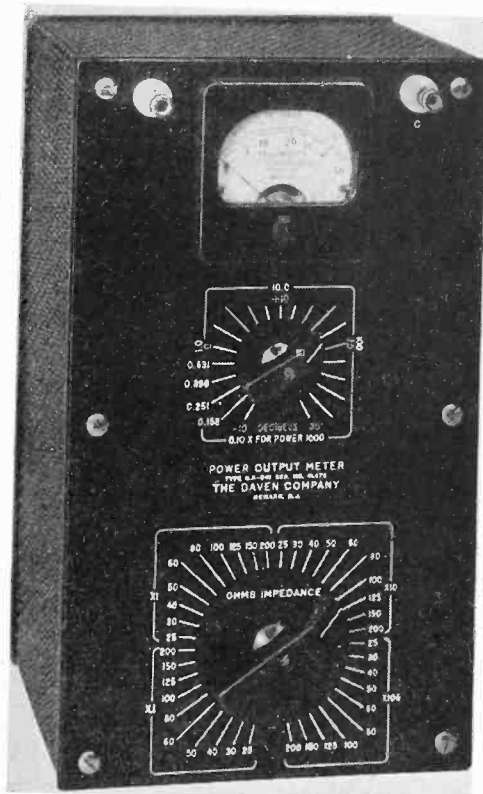

Fig. 3—A 50-watt output-power meter that uses the impedance-matching network to couple the amplifier under test to the constant-impedance meter circuit

The HANDIEST TESTER of all!

Model
666



DEALER NET
\$14.00

POCKET VOLT-OHM- MILLIAMMETER

● Engineers and experimenters pronounce this instrument the most useful tester of all for laboratory, shop or field use. Model 666 is a complete instrument for all AC-DC voltage, current and resistance analyses.

Has 3" Sq. Triplet improved rectifier type instrument. AC-DC Voltage Scales read: 0-10-50-250-500-1000 at 1000 ohms per volt. DC Milliamperes scales read: 0-1-10-50-250. Ohms scales read: Low 1/2-300; High 250,000. Resistance range can be increased by adding external batteries. Size 3-1/16" x 5 7/8 x 2 1/8". Black Molded Case and Panel. Newly improved Low Loss Selector Switch. Complete with Alligator Clips, Battery and Test Leads . . . Dealer Net Price . . . \$14.00.

MODEL 666-H



● Model 666-H Volt-Ohm-Milliammeter is a complete pocket-size tester—same as above but with AC and DC Voltage ranges to 5000 Volts (self-contained). Has complete facilities for Direct Current and Resistance analyses. Just the instrument for servicemen, radio amateurs, industrial engineers and laboratory technicians. With RED • DOT Lifetime Guaranteed Measuring Instrument. . . . Dealer Net Price . . . \$14.50

WRITE FOR CATALOG

The Triplet Electrical Instrument Co.
Section 2110 Harmon Ave., Bluffton, Ohio

TRIPLET
Precision
ELECTRICAL INSTRUMENTS

IRE membership offers many services to the radio engineer

Proceedings—An outstanding publication in the radio engineering field. Over a quarter of a century of service to the world in publishing important radio engineering discoveries and developments, the PROCEEDINGS presents exhaustive engineering data of use to the specialist and general engineer. A list of its authors is a "Who's Who" of the leaders in radio science, research, and engineering.

Standards—Since 1914 our standards reports have stabilized and clarified engineering language, mathematics, graphical presentations, and the testing and rating of equipment. They are always in the process of revision and thus remain up to date.

Meetings—In twenty-two cities in the United States and Canada, meetings of the Institute and its sections are held regularly. Scores of papers on practically every branch of the field are presented and discussed. Several convention meetings are sponsored by the Institute and add materially to its effectiveness in distributing data of value to engineers.

The Institute of Radio Engineers

Incorporated

330 West 42nd Street, New York, N.Y.

To the Board of Directors

Gentlemen:

I hereby make application for ASSOCIATE membership in the Institute of Radio Engineers on the basis of my training and professional experience given herewith, and refer to the sponsors named below who are personally familiar with my work.

I certify that the statements made in the record of my training and professional experience are correct, and agree if elected, that I shall be governed by the Constitution of the Institute as long as I continue a member. Furthermore I agree to promote the objects of the Institute so far as shall be in my power.

.....
(Sign with pen)

.....
(Address for mail)

.....
(City and State)

.....
(Date)

SPONSORS

(Signatures not required here)

Mr.

Address

City and State

Mr.

Address

City and State

Mr.

Address

City and State

Associate membership affiliates you with the Institute and brings you the PROCEEDINGS each month as well as notices of meetings held near you.

(Typewriting preferred in filling in this form) No.....
RECORD OF TRAINING AND PROFESSIONAL EXPERIENCE

Name
 (Give full name, last name first)

Present Occupation
 (Title and name of concern)

Business Address

Home Address

Place of Birth Date of Birth Age

Education

Degree
 (College) (Date received)

TRAINING AND PROFESSIONAL EXPERIENCE
 (Give dates and type of work, including details of present activities)

Record may be continued on other sheets this size if space is insufficient.

Receipt Acknowledged Elected Notified

Requirements—For Associate membership, an applicant must be at least twenty-one years of age, of good character, and be interested in or connected with the study or application of radio science or the radio arts.

Sponsors—Three sponsors who are familiar with the work of the applicant must be named. Preferably these should be Associates, Members, or Fellows of the Institute. In cases where the applicant is so located as not to be known to the required number of member sponsors, the names of responsible nonmember sponsors may be given.

Dues—Dues for Associate membership are six dollars per year. The entrance fee for this grade is three dollars and should accompany the application.

Other Grades—Those who are between the ages of eighteen and twenty-one may apply for Junior grade. Student membership is available to full-time students in engineering or science courses in colleges granting degrees as a result of four-year courses. Member grade is open to older engineers with several years of experience. Information on these grades may be obtained from the Institute.

Current Literature

New books of interest to engineers in radio and allied fields—from the publishers' announcements.

A copy of each book marked with an asterisk (*) has been submitted to the Editors for possible review in a future issue of the Proceedings of the I. R. E.

* **RADIO SERVICE TRADE KINKS.** By Lewis S. Simon, Manager, Rexall Radio Stores. New York: McGraw-Hill Book Company, Inc., 1939. 254+15 index pages, 9×11½ inches, cloth. \$3.00.

* **STATIC AND DYNAMIC ELECTRICITY.** By William R. Smythe, Associate Professor of Physics, California Institute of Technology. New York: McGraw-Hill Book Company, Inc., 1939. xviii+537+22 index pages, illustrated, 6¼×9¼ inches, cloth. \$6.00.

* **A TEXT BOOK ON LIGHT.** By A. W. Barton, Headmaster of King Edward VII School. New York: Longmans, Green and Company, 1939. 421+5 index pages, illustrated, 6×9 inches, cloth. \$3.00.

TERRESTRIAL MAGNETISM AND ELECTRICITY (Volume VIII of Physics of the Earth Series). Edited by J. A. Fleming, Director, Department of Terrestrial Magnetism, Carnegie Institution of Washington. New York: McGraw-Hill Book Company, Inc., 1939. xii+799+15 index pages, illustrated, 7×10 inches, cloth. \$8.00.

Booklets, Catalogs and Pamphlets

The following commercial literature has been received by the Institute.

CONDENSERS • • • *Cornell-Dubilier Electric Corporation, South Plainfield, New Jersey. Catalog No. 175A, 16 pages, 8½×11 inches.* Condensers of all types for radio applications.

COILS • • • *J. W. Miller Company, 5917 South Main Street, Los Angeles, California, Catalog No. 40, 32 pages+cover, 8½×11 inches.* A description of tuning inductors, transformers, chokes, etc.

COMPONENTS • • • *James Millen Manufacturing Company, Inc., 6 Pleasant Street, Malden, Massachusetts. Bulletin, 12 pages, 8½×11 inches.* Brief catalog listing of a new line of condensers, dials, and miscellaneous parts.

COMPONENTS • • • *Radio Wire Television, Inc., 100 Sixth Avenue, New York, New York. Catalog No. 78. 184 pages+cover, 7×10 inches.* Parts, accessories, testing equipment, etc.

GRID-BIAS CELLS • • • *P. R. Mallory & Company, Inc., Indianapolis, Indiana. Bulletin B-302, 8 pages, 8½×11 inches.* Application data on a small cell for supplying grid-biasing voltages to tubes.

OSCILLATORS • • • *Hewlett-Packard Company, Palo Alto, California. Bulletin, 4 pages, 8½×11 inches.* Description of an audio-frequency oscillator, resistance-tuned.

TRANSFORMERS • • • *General Radio Company, 30 State Street, Cambridge, Massachusetts. Bulletin 424-D, 4 pages, 8½×11 inches.* Data on adjustable-voltage power transformers.

INSTITUTE EMBLEMS

Three styles of emblems are available to members of the Institute only. They are all of 14K gold with gold lettering on an enameled background, the color of which indicates the grade of membership. The approximate size of each emblem is as illustrated.



The lapel button is supplied with a screw back having jaws which fasten it securely to the coat. The price is \$2.75, postpaid, for any grade.



The pin which is provided with a safety catch may be obtained for any grade for \$3.00, postpaid.



The watch charm is handsomely finished on both sides and is equipped with a suspension ring for attaching to a watch chain or fob. Price for any grade, \$5.00, postpaid.

INSTITUTE OF RADIO ENGINEERS

330 WEST 42ND STREET, NEW YORK, N.Y.

Uncoated WIRE and RIBBON for Direct-Heated Emitters in VACUUM TUBES

Made under rigid specifications from ingot to accurately finished product. Uniformly providing highest electronic emissivity

CLOSE SCIENTIFIC CONTROL of all specified characteristics, including:

- CHEMICAL COMPOSITION
- SIZE and SHAPE
- WEIGHT
- TENSILE STRENGTH
- ELONGATION
- ELECTRICAL RESISTIVITY

BARE WIRES drawn to .0004" diameter
RIBBON rolled to less than .0001" thick
FOIL rolled to less than .0002" thick

Many special alloys and a complete range of very small sizes for 1.4 volt battery tubes and hearing aid tubes.

SIGMUND COHN

44 GOLD ST. NEW YORK

SINCE  1901

ENGINEERING DIRECTORY

Consultants, Patent Attorneys,
Laboratory Services

**BRUNSON S. McCUTCHEN and
CHARLES B. AIKEN**
Consulting Engineers

Technical cooperation with Attorneys in connection with patent litigation—Design and Development work—Audio and radio frequency measurements—Equipment studies—Receiver and transmitter problems—A well equipped laboratory.

75 West Street Telephone
New York City WHitehall 4-7275

Use this directory . . .

when you need consulting services

when you are asked to suggest the name of a specialist on an engineering or patent problem

Consulting Engineers, Patent Attorneys, Laboratory Services . . . Applications for card space in the Engineering Directory are invited. Complete data will be sent on request to

PROCEEDINGS of the I.R.E.

330 West 42nd Street New York, N.Y.

INDEX

BOOKLETS, CATALOGS AND PAMPHLETSvii

COMMERCIAL ENGINEERING DEVELOPMENTSii

CURRENT LITERATUREvii

ENGINEERING DIRECTORYviii

POSITIONS OPENviii

DISPLAY ADVERTISERS

A

American Telephone & Telegraph CompanyCover III

Aerovox Corporationix

B

Bliley Electric Companyiv

C

Capitol Radio Companyii

Cohn, Sigmundvii

Cornell-Dubilier Electric Corporation ...x

E

Erie Resistor Corporationi

G

General Radio CompanyCover IV

T

The Triplett Electrical Instruments Companyiv

W

Western Electric Companyiii

POSITIONS OPEN

The following positions of interest to I.R.E. members have been reported as open on September 25. Make your application in writing and address to

Box No.

PROCEEDINGS of the I.R.E.
330 West 42nd Street, New York, N.Y.

Please be sure that the envelope carries your name and address

ELECTRICAL ENGINEERS

wanted by transformer manufacturer. Must be capable of designing radio-type transformers, estimate costs, supervise production, etc. Robert M. Hadley Co., P. O. Box 456, Newark, Del.

SALES ENGINEER

wanted by large manufacturer of insulation, material widely used in communications and electronics field. Candidate must preferably have had experience in association with engineers of industry discussing both commercial and technical phases of engineering materials. Only those of outstanding personality, energy, and good education will be considered. Location New York City. Position permanent and opportunity for advancement excellent. Box 201.

PRODUCTION MANAGER

Must be familiar with all modern shop methods, preferably one having served as practical machinist in manufacture and assembly of small parts. Must be capable of managing small shop producing switches, relays and specially designed and constructed electrical parts. Radio experience desirable. Actual service with manufacturer or equipment over a period of approximately ten years considered necessary to properly fill this position which is permanent. Box 202.



Attention Employers . .

Announcements for "Positions Open" are accepted without charge from employers offering salaried employment of engineering grade to I.R.E. members. Please supply complete information and indicate which details should be treated as confidential. Address: "POSITIONS OPEN," Institute of Radio Engineers, 330 West 42nd Street, New York, N.Y.

The Institute reserves the right to refuse any announcement without giving a reason for the refusal

Checking the RADIO Way



• You won't believe such things can be done until you've seen the L-C Checker *in action*. Here's a unique, up-to-the-minute, simple, inexpensive instrument for the serious radio worker. Tests condensers and inductances in the radio-frequency range, under conditions simulating *actual working conditions*. Determines effectiveness of capacity or inductance *while actually connected in its circuit*. It's a true checking—the radio way.

The L-C Checker in Brief:

Completely self-contained. Operates on 105-130v. AC, or DC. Six-coil oscillator covers 60-170, 170-490, 490-1500 kc., and 1.5-4.6, 4.5-15, and 13-26 mc. Only 4¾ lbs. 10½ x 7½ x 5½ in. Handsome panel. Steelcase, black wrinkle and satin-aluminum finish.

Tests combinations of inductance and capacitance thereby determining resonant frequency of combinations and operating effectiveness of circuits. Can be used to adjust circuit or system to proper operating efficiency.

Checks capacity of condensers at radio frequencies without removing them from circuit. No need to unsolder connections.

Simplifies alignment of r.f. circuits, both broad and narrow band u.f. amplifiers. Aids in tracking of super-het. oscillator and tuning of wave traps of image-rejection circuits; checks frequency ranges of receivers. Checks calibration of wave meters.

Checks identifying harmonics of frequency

standard in precision frequency calibration of radio equipment.

Checks natural resonant points of r.f. chokes making sure they are beyond operating range.

Traces resonant absorption trouble in "all-wave" receiver circuits—locating dead spots, etc. Locates resonant points in shorted windings (unused coils) in multi-range oscillators, etc.

Locates resonant frequency of r.f. coupling chokes, making sure of placement to secure enough gain balance over tuning range of r.f. stage.

Checks natural period of antennae and transmission lines. Determines resonant peaks and current looks.

Serves many other functions, especially if auxiliary equipment is used. Elaborate manual with each instrument covers its many uses.

Best of all, the price of this versatile instrument is only \$29.50 net, including tubes!

Ask to See It . . .

• Your local AEROVOX jobber can show you the L-C Checker. Ask to see it. Try it for yourself. Also ask for the descriptive folder. Or write us direct.

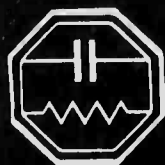
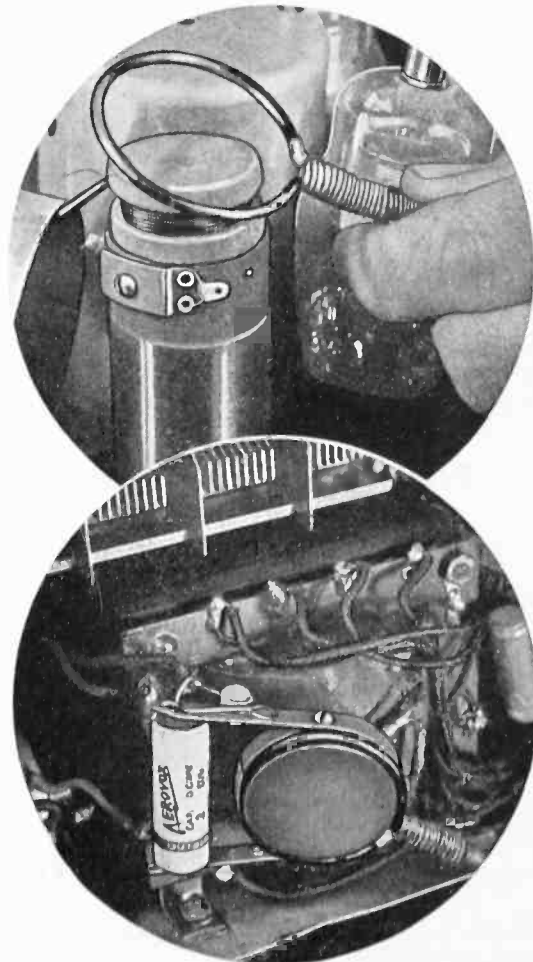

AEROVOX CORPORATION

New Bedford, Mass.



Sales Offices in All Principal Cities

Another C-D Development



TYPE UP

Etched Foil DRY ELECTROLYTIC CAPACITORS

THE advance engineering design of these new type UP Etched Foil Dry Electrolytics is the result of many years of intensive research in the C-D laboratories.

This research has made possible:—

- ★ Minimum capacity change over wide temperature range.
- ★ Great reduction in physical size—up to 40% for some types.
- ★ Increased life expectancy.
- ★ Reduced direct current leakage.
- ★ Reduced equivalent series resistance.
- ★ Higher breakdown voltage.
- ★ Improved audio and radio frequency impedance characteristics.

The type UP is the smallest can type capacitor available, and can be supplied in single, dual, triple and quadruple capacity combinations. Complete physical and dimensional data will be supplied on request.

PRODUCT OF THE WORLD'S OLDEST AND LARGEST MANUFACTURER OF CAPACITORS

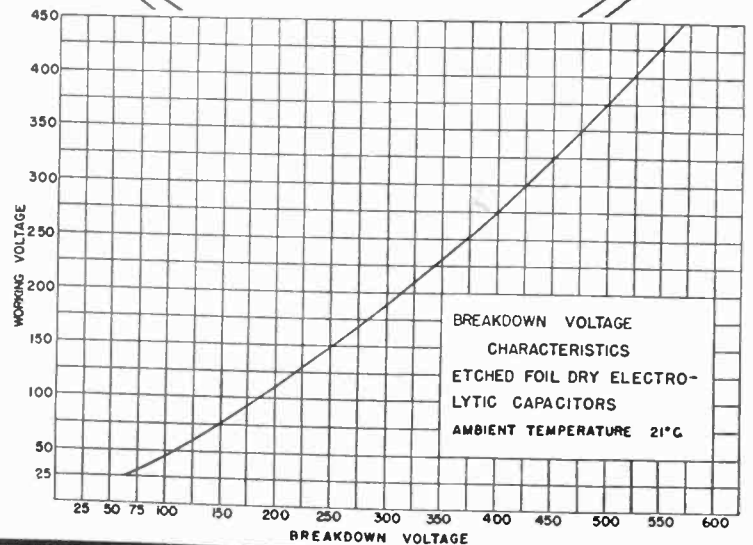
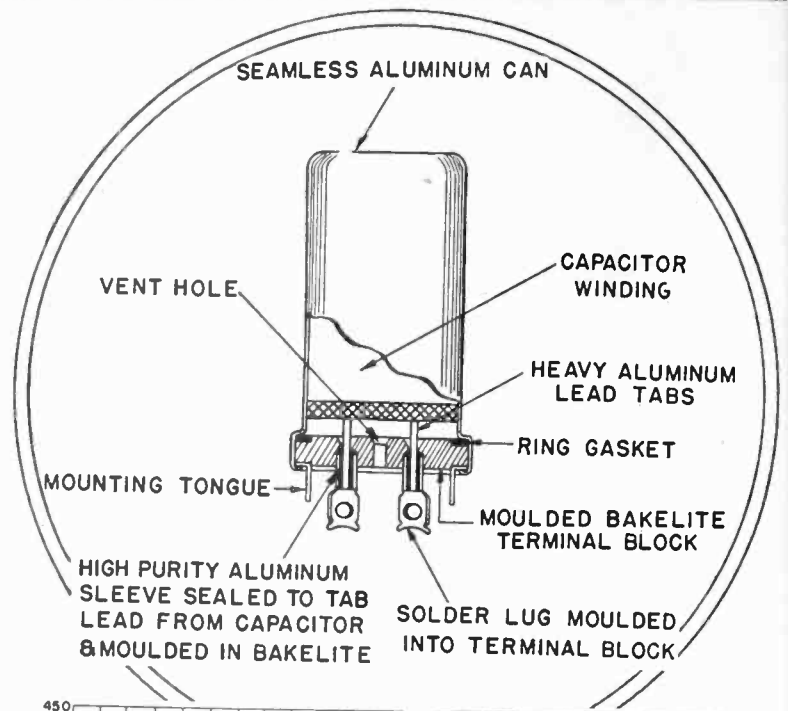

CORNELL-DUBILIER ELECTRIC CORPORATION

1012 Hamilton Boulevard, South Plainfield, New Jersey

Cable Address: "CORDU"



*IT'S A GOOD INSTRUMENT
TO USE BECAUSE BACK OF IT THERE ARE
FRIENDLY AND COMPETENT PEOPLE SERV-
ING YOU . . . ABOUT 300,000 OF THEM*

BELL TELEPHONE SYSTEM



Two New

VARIACS 5 and 7 kw



TYPE 50-A and 50-B VARIACS

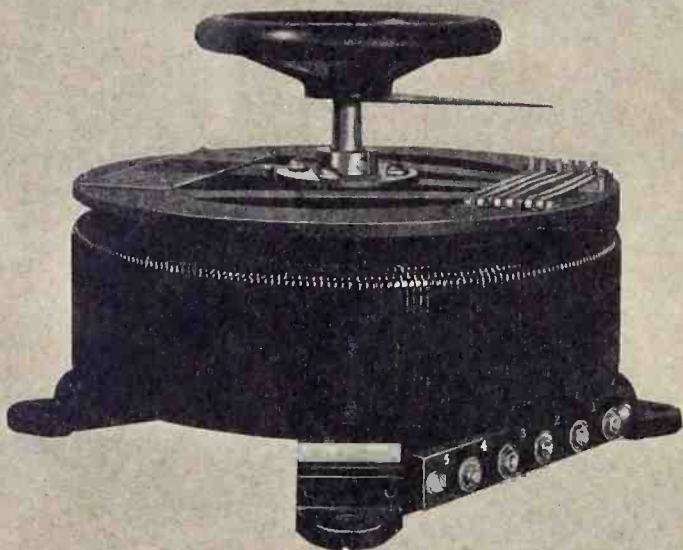

DESIGN FEATURES

Laminated iron core . . . high-temperature Bakelite winding form . . . cast-aluminum brush support and radiating spokes . . . 6-brush contactor with phosphor-bronze springs and pigtails . . . cast-iron frame with four mounting holes for either table or behind-panel mounting . . . $\frac{3}{4}$ inch solid steel shaft with control wheel 7 inches in diameter . . . 340-degree rotation . . . dial engraved on both sides for two output voltage connections.

FOR manually compensating for changes in line voltage in high-power transmitters and for adjusting accurately the voltage supplied to transmitters, rectifiers and other broadcasting and telegraph equipment of high power, two new Type 50 VARIACS rated at 5 and 7 kva are announced by General Radio.

The general design follows that of the small VARIACS; a toroidally-shaped winding on a laminated iron core. Contact to the winding is made by a multiple-contact brush pigtailed to a terminal so that bearing contact resistance is avoided.

The new VARIACS have a number of unique design features which made possible the manufacture of these high power units with the same high efficiency of the popular Type 100 and Type 200 models, thousands of which are in use in the radio industry. Particular care has been taken in the design of the new units to avoid the possibility of breakdown with the resulting damage to equipment consuming relatively high power.

The Type 50-A VARIAC is rated at 5 kva on a 115-volt circuit and can be connected to supply output voltages continuously adjustable from either 0 to 135 or 0 to 115 volts. The dial is calibrated directly in output voltage and is reversible for either output voltage connection.

The Type 50-B VARIAC is rated at 7 kva on a 230-volt circuit and supplies output voltages of either 0 to 270 or 0 to 230 volts. It, also, is supplied with a direct-reading reversible dial.

Both types are supplied in mounted models only (top photo).

TYPE 50 VARIACS SPECIFICATIONS

	Type 50-A	Type 50-B
LOAD RATING:	5000 va	7000 va
Rated Current:	40 amp.	20 amp.
Maximum Current:	45 amp.	31 amp.
Input Voltage:	115	230 (tapped for 115)
Output Voltage:	0 to 135	0 to 270
No-Load Loss:	60 wats	75 wats
PRICE:	\$100.00	\$100.00

● WRITE FOR BULLETIN 490

GENERAL RADIO COMPANY CAMBRIDGE MASSACHUSETTS