

Both, S. F.

VOLUME 26

JUNE, 1938

NUMBER 6

PROCEEDINGS  
of  
The Institute of Radio  
Engineers



Thirteenth  
Annual Convention  
June 16, 17, and 18, 1938  
New York, N. Y.

*Form*

Application Blank for Associate Membership on Page XXIII

**INSTITUTE OF RADIO ENGINEERS  
THIRTEENTH ANNUAL CONVENTION  
HOTEL PENNSYLVANIA, NEW YORK, N. Y.  
JUNE 16, 17, and 18, 1938**

**Wednesday—June 15**

**4:00 P.M.—6:00 P.M. Registration.**

**Thursday—June 16**

- 9:00 A.M.—11:00 P.M. Registration and exhibition.**  
**11:00 A.M.—12:30 P.M. Official welcome and technical session in Ballroom.**  
**1:30 P.M.—5:00 P.M. Women's trip No. 1 to Bache and Frick art collections.**  
**2:30 P.M.—4:30 P.M. Technical sessions in Ballroom and Parlor I.**  
**7:30 P.M.—10:00 P.M. Presentation of Institute awards and technical session in Ballroom.**

**Friday—June 17**

- 9:00 A.M.—5:30 P.M. Registration and exhibition.**  
**10:00 A.M.—3:00 P.M. Women's trip No. 2 to Good Housekeeping Institute and Sky Gardens.**  
**10:30 A.M.—12:30 P.M. Technical sessions in Ballroom and Parlor I.**  
**2:00 P.M.—4:00 P.M. Technical session in Ballroom.**  
**8:30 P.M.—1:00 A.M. Boat trip on the Hudson River.**

**Saturday—June 18**

- 9:00 A.M.—6:00 P.M. Registration and exhibition.**  
**10:00 A.M.—3:00 P.M. Women's trip No. 3 to The Cloisters.**  
**10:30 A.M.—12:30 P.M. Technical sessions in Ballroom and Parlor I.**  
**2:00 P.M.—4:00 P.M. Technical session in Ballroom.**

**EASTERN DAYLIGHT SAVING TIME**

PROCEEDINGS OF  
**The Institute of Radio Engineers**

VOLUME 26

June, 1938

NUMBER 6

Board of Editors

ALFRED N. GOLDSMITH, *Chairman*

R. R. BATCHER

P. S. CARTER

F. W. GROVER

J. W. HORTON

G. W. PICKARD

B. E. SHACKELFORD

K. S. VAN DYKE

H. P. WESTMAN, *ex officio*

L. P. WHEELER

L. E. WHITTEMORE

WILLIAM WILSON

CONTENTS

PART I

Condensed Program of Thirteenth Annual Convention.....	Cover II
Frontispiece, <i>S.S. Sandy Hook</i> .....	648
Institute News and Radio Notes.....	649
Thirteenth Annual Convention.....	649
May Meeting of the Board of Directors.....	678
Nominations.....	679

PART II

*Technical Papers*

Status of Instrument Landing Systems.....	W. E. JACKSON	681
An Audio-Frequency-Response Curve Tracer.....	JESSE B. SHERMAN	700
Sweep Circuit.....	J. L. POTTER	713
✓ Horn-Type Loud Speakers.....	FRANK MASSA	720
✓ A Bearing-Type High-Frequency Electrodynamic Ammeter.....	HARRY R. MEAHL	734
Design Formulas for Diode Detectors.....	HAROLD A. WHEELER	745
Characteristics of the Ionosphere at Washington, D.C., April, 1938.....	T. R. GILLILAND, S. S. KIRBY, AND N. SMITH	781
Correspondence.....		786
Booklets, Catalogs, and Pamphlets Received.....		788
Contributors to This Issue.....		790

*Copyright, 1938, by The Institute of Radio Engineers, Inc.*

# The Institute of Radio Engineers

---

## GENERAL INFORMATION

**INSTITUTE.** The Institute of Radio Engineers was formed in 1912 through the amalgamation of the Society of Wireless Telegraph Engineers and the Wireless Institute. Its headquarters were established in New York City and the membership has grown from less than fifty members at the start to several thousand.

**AIMS AND OBJECTS.** The Institute functions solely to advance the theory and practice of radio and allied branches of engineering and of the related arts and sciences, their application to human needs, and the maintenance of a high professional standing among its members. Among the methods of accomplishing this is the publication of papers, discussions, and communications of interest to the membership.

**PROCEEDINGS.** The PROCEEDINGS is the official publication of the Institute and in it are published all of the papers, discussions, and communications received from the membership which are accepted for publication by the Board of Editors. Copies are sent without additional charge to all members of the Institute. The subscription price to nonmembers is \$10.00 per year, with an additional charge for postage where such is necessary.

**RESPONSIBILITY.** It is understood that the statements and opinions given in the PROCEEDINGS are views of the individual members to whom they are credited, and are not binding on the membership of the Institute as a whole. Papers submitted to the Institute for publication shall be regarded as no longer confidential.

**REPRINTING PROCEEDINGS MATERIAL.** The right to reprint portions or abstracts of the papers, discussions, or editorial notes in the PROCEEDINGS is granted on the express condition that specific reference shall be made to the source of such material. Diagrams and photographs published in the PROCEEDINGS may not be reproduced without making specific arrangements with the Institute through the Secretary.

**MANUSCRIPTS.** All manuscripts should be addressed to the Institute of Radio Engineers, 330 West 42nd Street, New York City. They will be examined by the Papers Committee and the Board of Editors to determine their suitability for publication in the PROCEEDINGS. Authors are advised as promptly as possible of the action taken, usually within two or three months. Manuscripts and illustrations will be destroyed immediately after publication of the paper unless the author requests their return. Information on the mechanical form in which manuscripts should be prepared may be obtained by addressing the secretary.

**MAILING.** Entered as second-class matter at the post office at Menasha, Wisconsin. Acceptance for mailing at a special rate of postage is provided for in the act of February 28, 1925, embodied in Paragraph 4, Section 412, P. L. and R., and authorization was granted on October 26, 1927.

---

Published monthly by

**THE INSTITUTE OF RADIO ENGINEERS, INC.**

Publication office, 450-454 Ahnaip St., Menasha, Wis.

**BUSINESS, EDITORIAL, AND ADVERTISING OFFICES**

Harold P. Westman, *Secretary*

330 West 42nd Street, New York, N. Y.

## INSTITUTE SECTIONS

- ATLANTA—Chairman, C. F. Daugherty; Secretary, J. G. Preston, U. S. Radio Monitoring Station, R.F.D. 3, Marietta, Ga.
- BOSTON—Chairman, H. W. Lamson; Secretary, E. B. Dallin, 64 Oakland Ave., Arlington, Mass.
- BUFFALO-NIAGARA—Chairman, G. C. Crom, Jr.; Secretary, E. C. Waud, 235 Huntington Ave., Buffalo, N. Y.
- CHICAGO—Chairman, J. E. Brown; Secretary, E. Kohler, Jr., Ken-Rad Tube and Lamp Corporation, 2400 Sheffield Ave., Chicago, Ill.
- CINCINNATI—Chairman, R. J. Rockwell; Secretary, M. M. Wells, Crosley Radio Corporation, 1329 Arlington St., Cincinnati, Ohio.
- CLEVELAND—Chairman, L. N. Chatterton; Secretary, R. L. Kline, Winteradio, Inc., 3014 Lorain Ave., Cleveland, Ohio.
- CONNECTICUT VALLEY—Chairman, D. E. Noble; Secretary, C. E. Keeler, 25 Webber St., Malden, Mass.
- DETROIT—Chairman, E. H. I. Lee; Secretary, R. J. Schaefer, 9753 N. Martindale, Detroit, Mich.
- EMPORIUM—Chairman, A. W. Keen; Secretary, M. C. Hoffman, Hygrade Sylvania Corporation, Emporium, Pa.
- INDIANAPOLIS—Chairman, C. F. Wolcott; Secretary, B. V. K. French, P. R. Mallory and Co., Inc., East Washington St., Indianapolis, Ind.
- LOS ANGELES—Chairman, R. O. Brooke; Secretary, A. C. Packard, Station KNX, Columbia Broadcasting System, 5939 Sunset Blvd., Hollywood, Calif.
- MONTREAL—Chairman, A. M. Patience; Secretary, S. Sillitoe, 1261 Shearer St., Montreal, Que., Canada.
- NEW ORLEANS—Chairman, G. H. Peirce; Secretary, D. W. Bowman, 8327 Sycamore St., New Orleans, La.
- PHILADELPHIA—Chairman, A. F. Murray; Secretary, R. L. Snyder, 103 Franklin Rd., Glassboro, N. J.
- PITTSBURGH—Chairman, R. T. Gabler; Secretary, A. F. Shreve, 459 Willow Dr., Mt. Lebanon, Pittsburgh, Pa.
- ROCHESTER—Chairman, L. A. Du Bridge; Secretary, H. A. Brown, 89 East Ave., Rochester, N. Y.
- SAN FRANCISCO—Chairman, Noel Eldred; Secretary, L. J. Black, 243-30th St., Oakland, Calif.
- SEATTLE—Chairman, A. R. Taylor; Secretary, R. M. Walker, 2600-26th Ave., S.W., Seattle, Wash.
- TORONTO—Chairman, R. C. Poulter; Secretary, N. Potter, Canadian National Carbon Co., Ltd., 805 Davenport Rd., Toronto, Ont., Canada.
- WASHINGTON—Chairman, E. H. Rietzke; Secretary, L. C. Young, Naval Research Laboratory, Bellevue, Anacostia, D. C.

**GEOGRAPHICAL LOCATION OF MEMBERS  
ELECTED MAY 4, 1938**

Transferred to the Fellow Grade

Pennsylvania Philadelphia, 4800 Walnut St. . . . . Zworykin, V. K.

Transferred to the Member Grade

New Jersey Fair Lawn, 16 Brearly Crescent . . . . . Crawford, J. D.

Elected to the Associate Grade

California	Berkeley, 1147 The Alameda . . . . .	Ransom, D. H.
	Long Beach, 3545 California Ave. . . . .	Fritzinger, L. E.
	Terminal Island, 184-A Terminal Way . . . . .	Hara, B.
District of Columbia	Washington, 31 Hamilton St., N.W. . . . .	Kriz, W.
	Washington, Federal Communications Commission . . . . .	Link, J. H.
Illinois	Chicago, 60 E. 25th St. . . . .	Melcher, F. H.
	Chicago, 225 W. Huron St. . . . .	Shure, S. N.
	Chicago, 2300 Board of Trade Bldg. . . . .	Wendt, R. H.
Maryland	Takoma Park, 7607 Eastern Ave. . . . .	Klink, G., Jr.
	Takoma Park, 7607 Eastern Ave. . . . .	Rice, L. W.
Massachusetts	Dorchester, 147 Columbia Rd. . . . .	Smith, W. M.
Missouri	Kansas City, 216 E. 74th St. . . . .	Dillard, E. L.
	Kansas City, Radio Station KNBY, Fidelity Bldg., 9th and Walnut . . . . .	Salzer, C. E.
New Jersey	Boonton, Box 1 . . . . .	Minter, J.
	Newark, Federal Telegraph Co., 200 Mt. Pleasant Ave. . . . .	Lappin, L. S.
	Paterson, 519 Madison Ave. . . . .	Hill, E.
	Rutherford, 60 Etrick Ter. . . . .	Claesson, F. S.
New York	New York, c/o National Broadcasting Co., 30 Rockefeller Plaza . . . . .	Gronberg, H. C.
	New York, Bell Telephone Labs., Inc., 180 Varick St. . . . .	Kirkpatrick, W. E.
	Rochester, 365 Augustine St. . . . .	Stafford, C. F.
Oklahoma	Tulsa, 1000 S. Main St. . . . .	Durham, E. R.
Oregon	Corvallis, Elec. Eng. Dept., Oregon State College . . . . .	Everest, F. A.
Pennsylvania	Philadelphia, 6613 Upland St. . . . .	Clarance, A. L.
	Philadelphia, 4531 Pulaski Ave. . . . .	Griffith, T. H.
	Philadelphia, 317 S. 44th St. . . . .	Hoffer, H. N.
	Philadelphia, 5042 Charles St. . . . .	Knoebel, H. L.
	Philadelphia, 3447 "F" St. . . . .	Moore, G.
Texas	Beaumont, 506 San Jacinto Bldg. . . . .	Claiborne, J. G.
Virginia	Arlington, 3904-14th St., N. . . . .	Lee, J. M.
Washington	Spokane, N. 2603 Atlantic St. . . . .	Keenan, W. J.
	Spokane, W. 611 First Ave. . . . .	Young, T. R.
Canada	Toronto, Ont., Northern Electric Co. . . . .	Nelson, C.
	Toronto 3, Ont., 219 Wright Ave. . . . .	Tipple, H. L.
	Toronto, Ont., 490 Castlefield Ave. . . . .	Werry, M. J.
England	Erdington, Birmingham, 656 Chester Rd. . . . .	Haden, V. G. J.
	Walsall, Staffs., 8 Mount St. . . . .	Blakemore, T. R.
France	Paris 50, 71 rue Monge . . . . .	Churg, E.
India	Calcutta, A. D. E. T., Telegraph Storeyard, Alipore . . . . .	Bhashyam, S. R.
	Calcutta, Philips Electrical Co., Ltd., 2 Heysham Rd. . . . .	Pattabi-Raman, S.
	Vijayapuram, Tiruvavur, 112 Tiruturaipundi Rd. . . . .	Eyner, E. V.
Jamaica	Kingston, 5 Church St. . . . .	Sowley, H. A.
Japan	Ibaraki-Ken, Hitati Eng. Works Library, Kaigan-Kojo, Sukegawa . . . . .	Sato, M.
New Zealand	Auckland, c/o Bowers Radio Labs., Colwell Chambers, Swanson St. . . . .	Mosheim, K. R.
	Christchurch, c/o 3YA Transmitting Station, Gebbies Pass . . . . .	Moore, J.

Elected to the Junior Grade

Canada	Toronto, Ont., 356 Berkeley St. . . . .	Patterson, A.
England	London, N. 10, 100 Cranley Gardens, Muswell Hill . . . . .	Davies, B. T.

Elected to the Student Grade

California	Berkeley, 2828 College Ave. . . . .	Johnson, R. M.
	Berkeley, 2411 Bowditch Ave. . . . .	Sternke, E. C.
	Piedmont, 21 Lake Ave. . . . .	Thompson, P.
Connecticut	New Haven, Dunham Lab., 10 Hillhouse Ave. . . . .	Eberhard, E.
	New Haven, 51 Prospect St. . . . .	Starcke, O. A.
	New Haven, 318 Dunham Lab., Yale University . . . . .	Wischnmeyer, C. R.

*Geographical Location of Members Elected*

Indiana	Angola, 113 N. Superior St.....	Hoar, J. E. C.
	Angola, 200 W. South St.....	McPherson, H.
	Angola, 113 N. Superior St.....	Miro, L. G.
	Angola, 500 S. West St.....	Sherman, F. L.
Massachusetts	Angola, 113 S. College St.....	Suther, A. C.
	Cambridge, 106 Auburn St.....	Hillyer, C., Jr.
Michigan	Detroit, 14882 Terry Ave.....	Busch, A.
	Freda.....	Winter, H. A.
Minnesota	Minneapolis, 409 Walnut St., S.E.....	Colander, R. E.
	Minneapolis, Box 379, Pioneer Hall, University of Minnesota.....	Pollei, D.
	Minneapolis, Box 403, Pioneer Hall, University of Minnesota.....	Ritter, T. J.
	Minneapolis, 4532 Pillsbury Ave.....	Westphal, W. B.
New York	Troy, Voorhees Dormitory 32, Sage Ave.....	Wilson, D. G.
Tennessee	Knoxville, 817 S. 15th St.....	Dumas, R. E.
	Knoxville, 509 Watauga Ave.....	Hinedale, E. M., Jr.





## APPLICATIONS FOR MEMBERSHIP

Applications for transfer or election to the various grades of membership have been received from the persons listed below and have been approved by the Admissions Committee. Members objecting to the transfer or election of any of these applicants should communicate with the Secretary on or before June 30, 1938. Final action will be taken on these applications on July 6, 1938.

<b>For Transfer to the Member Grade</b>		
Massachusetts	Lexington, 52 Percy Rd.	Sinclair, D. B.
Washington	Seattle, Federal Communications Commission	Kiebert, M. P. V., Jr.
<b>For Election to the Member Grade</b>		
Canada	Toronto, Ont., 100 Sterling Rd.	Parker, H. W.
<b>For Election to the Associate Grade</b>		
California	Los Angeles, 1036 N. Orange Grove Ave.	Farly, G. M.
District of Columbia	Anacostia, Naval Research Laboratory	Blair, E. W.
	Benning Station, Route 1, Box 428	Forry, H. A.
	Washington, 1601 Minnesota Ave., S.E.	Eittrheim, W. L.
	Washington, 1640 Argonne Pl., N.W.	Parnell, C. C.
	Washington, 1826 Ingleside Ter.	Rainey, G. W.
	Washington, 1857 Ingleside Ter.	Rogers, J. G.
Illinois	Washington, Capitol Radio Institute, 14th and Park Rd., N.W.	Woods, H. J.
	Chicago, Oak Mfg. Co., 711 W. Lake St.	Patterson, W. S.
	Urbana, 105 N. Coler Ave.	ter Veen, L. A. G.
Massachusetts	Medford, 33 Emery St.	Nold, G. W., Jr.
New Jersey	East Orange, 164 Springdale Ave.	Burley, R. M.
	Harrison, RCA Mfg. Co., Inc.	Erickson, E. H.
	Harrison, RCA Mfg. Co., Inc.	Langmuir, D. B.
	Harrison, RCA Mfg. Co., Inc.	Smith, P. T.
	Harrison, RCA Mfg. Co., Inc.	Walley, B.
	Jersey City, 292 Harrison Ave.	Blaisdell, H. L.
	Lincoln Park, 12 Harmon St.	Horrocks, S. W.
	North Arlington, 15 Morgan Pl.	Colton, M.
Ohio	Dayton, Wright Field, Aircraft Radio Laboratory	Peters, A. L., Jr.
	Massillon, 103 Andrew Apartments	Odgers, A. J.
Oregon	Portland, 1961 S.W. 11th Ave.	Holtzman, M.
Pennsylvania	Shenandoah, 104 Schuylkill Ave.	Alinsky, J. W., Jr.
Virginia	Alexandria, 118 W. Bellefonte Ave.	McDonald, L. W.
Washington	Spokane, 622 W. 20th	Sparling, A. G.
Canada	Lachine, Que., 125-34th Ave.	Kelsey, E. S.
	Montreal, Que., Canadian General Elec. Co., Beaver Hall Hill	Dickie, W. G.
	Montreal, Que., Pacific Cable Board, 204 Hospital St.	Fowlie, W. D.
	Montreal, Que., 4127 Beaconsfield Ave.	Jones, A. L. H.
	Montreal, Que., 2057 McGill College Ave.	Paul, K. R.
England	Bulham, London, British Broadcasting Co., Research Dept., Nightingale Sq.	Sandeman, E. K.
	Enfield, Middx., Weston Electrical Instrument Co., Ltd., Cambridge Rd.	Oldham, C. A.
	Suffolk, Worlingham House, Nr. Beccles.	West, S. S.
	Wembley, Middx., 26 Uxendon Cres.	Wishlade, W. P.
India	Agra, Bagh Mwazaffer Khan	Loomba, B. K.
South Africa	Durban, Natal Technical College	Katz, L.
Uruguay	Montevideo, 8 de Octubre 2796	Valverde, R. D.
<b>For Election to the Junior Grade</b>		
District of Columbia	Washington, 1614 Kilbourne Pl.	Carmin, M. H.
<b>For Election to the Student Grade</b>		
California	Clements	Perry, R. E.
	Palo Alto, 1423 Hamilton Ave.	Cahill, F. C.
Idaho	Idaho Falls, 188-3rd St.	Lundburg, F. J.
Indiana	Angola, P.O. Box 35	Goyette, R. E.
Massachusetts	Cambridge, Graduate House, Massachusetts Inst. of Tech.	Goldwag, H.
	Cambridge, 14 Claverly Hall	Gray, H. F., Jr.
	Cambridge, 32 Dana St.	Schapiro, R. M.
Ohio	Canton, 1530 Shorb Ave., N.W.	Penniman, I. B., Jr.
Canada	Montreal, Que., 5230 Clarke St.	Schwartz, H. H.
England	South Shields, Co. Durham, 4 Westcott Rd.	Milburn, E. E.
Japan	Tokyo, 1-4 Omotemati Akasaka-ku	Nakamura, J. H.



## OFFICERS AND BOARD OF DIRECTORS

(Terms expire January 1, 1939, except as otherwise noted)

### *President*

HARADEN PRATT

### *Vice President*

E. T. FISK

### *Treasurer*

MELVILLE EASTHAM

### *Secretary*

HAROLD P. WESTMAN

### *Editor*

ALFRED N. GOLDSMITH

### *Directors*

E. H. ARMSTRONG

J. E. BROWN

R. A. HACKBUSCH

L. C. F. HORLE

VIRGIL M. GRAHAM

E. K. JETT

A. F. MURRAY

B. J. THOMPSON

ALAN HAZELTINE, *Past President*

### SERVING UNTIL JANUARY 1, 1940

H. H. BEVERAGE, *Past President*  
RALPH BOWN

ALFRED N. GOLDSMITH  
H. M. TURNER

### SERVING UNTIL JANUARY 1, 1941

F. W. CUNNINGHAM

O. B. HANSON

C. M. JANSKY, JR.





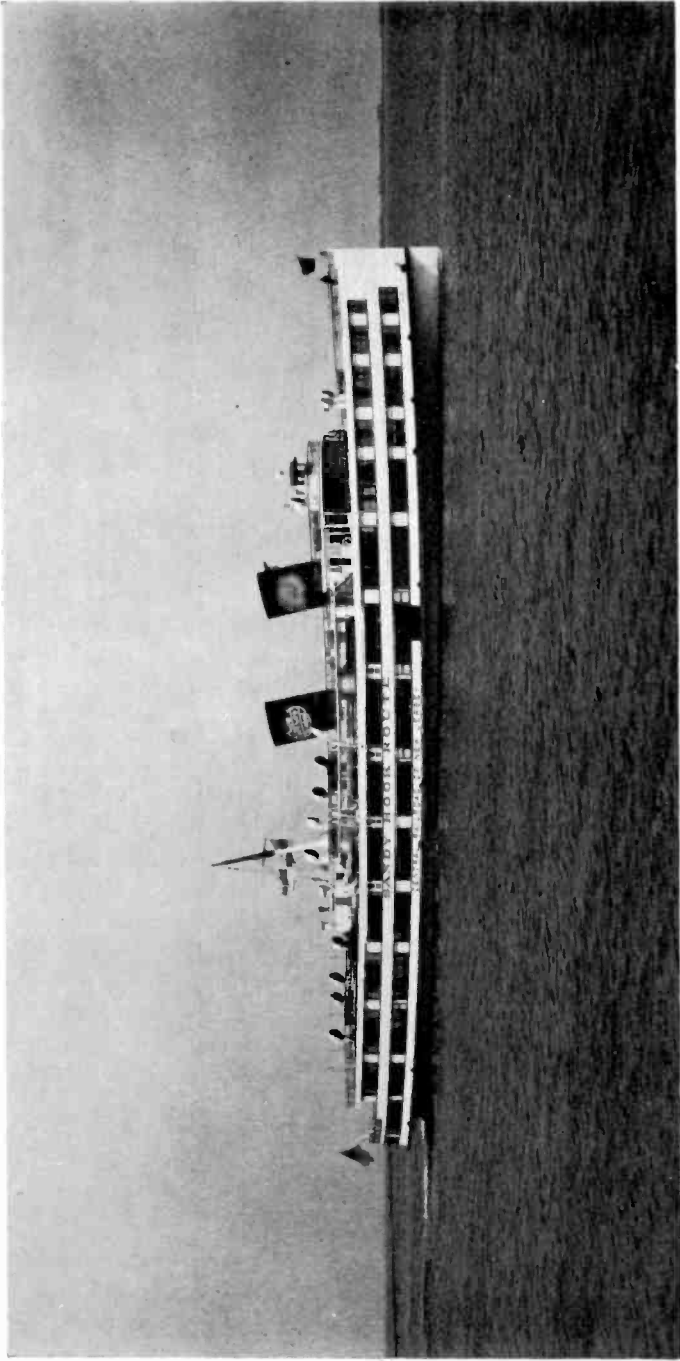

*Courtesy of Central Railroad of New Jersey*

The boat trip on the Hudson River which will replace the banquet this year will be made on the 275-foot steamer *Sandy Hook* which is pictured above. In normal service she plies between New York City and the northern New Jersey summer resorts.

## INSTITUTE NEWS AND RADIO NOTES

### Thirteenth Annual Convention

The Hotel Pennsylvania in New York City will be the headquarters for the Thirteenth Annual Convention of the Institute. This is the same hotel in which our 1937 Convention was held.

The number of technical papers which are scheduled for presentation totals about four dozen and in order that sufficient time be allotted to each paper to permit reasonably satisfactory presentation, it has been necessary to arrange for ten technical sessions. On Thursday afternoon and Friday and Saturday mornings simultaneous technical sessions will be operated. The Convention Papers Committee has endeavored to arrange these programs so that subjects which might reasonably be of interest to a single individual will not be presented simultaneously. Papers are numbered, and during duplicated sessions, notices will be posted when a new paper is to be presented in the other meeting room. The meeting rooms are adjacent and but a few seconds will be required in traveling between them.

Because of the large number of papers, time is not available for inspection trips. None, therefore, are scheduled and because of this and the probability of warm weather, a boat trip has been scheduled in lieu of the annual banquet.

The entire convention schedule is given in eastern daylight saving time which is one hour later than eastern standard time.

Those who are able to register during Wednesday afternoon, are urged to assist us in this way. A heavy registration load is always encountered on the first morning of a convention.

The following program gives full details of the entire convention: no major changes are anticipated.

#### Wednesday, June 15

4:00 P.M.—6:00 P.M.

Registration.

#### Thursday, June 16

9:00 A.M.—11:00 P.M.

Registration and exhibition.

11:00 A.M.—12:30 P.M.—Ballroom

Official welcome by Haraden Pratt, President of the Institute.

1. "KDKA Low-Angle Antenna Array" by R. N. Harmon, Westinghouse Electric and Manufacturing Company, Chicopee Falls, Mass.



*Courtesy of The Metropolitan Museum of Art*

The Bonnefont Cloister shown above will be visited by the women on their Saturday trip. They will see the court of the Frick Collection building pictured below on Thursday.



*Courtesy of The Frick Collection*

2. "A Short-Wave Single-Side-Band Radiotelephone System," by A. A. Oswald, Bell Telephone Laboratories, Inc., New York, N. Y.
3. "A Single-Side-Band Receiver for Short-Wave Telephone Service," by A. A. Roetken, Bell Telephone Laboratories, Inc., New York N. Y.
4. "A New Antenna System for Noise Reduction," by V. D. Landon and J. Reid, RCA Manufacturing Company, Inc., Camden, N. J.

1:30 P.M.—5:00 P.M.

Trip No. 1. Women's trip to the Jules Bache and Frick art collections.

2:30 P.M.—4:30 P.M.—Ballroom

5. "A 50-Kilowatt Broadcast Station Utilizing the Doherty Amplifier and Designed for Expansion to 500 Kilowatts," by W. H. Doherty, Bell Telephone Laboratories, Inc., New York, N. Y., and O. W. Towner, The Louisville Times Company, Inc., Louisville, Ky.
6. "Recent Developments in Radio Transmitters," by J. B. Coleman and V. E. Trouant, RCA Manufacturing Company, Inc., Camden, N. J.
7. "A High-Efficiency Modulating System," by A. W. Vance, RCA Manufacturing Company, Inc., Camden, N. J.
8. "Technical Equipment of the New KYW Studios," by A. G. Goodnow, Westinghouse Electric and Manufacturing Company, Chicopee Falls, Mass.
9. "Design Requirements for Broadcast-Studio Audio-Frequency Systems," by H. A. Chinn, Columbia Broadcasting System, Inc., New York, N. Y.

2:30 P.M.—4:30 P.M.—Parlor I

10. "Application of Quartz Crystals to a Wave Analyzer," by L. B. Arguimbau, General Radio Company, Cambridge, Mass. (Demonstration.)
11. "Bridged-T and Parallel-T Null Circuits for Measurements at Radio Frequencies," by W. N. Tuttle, General Radio Company, Cambridge, Mass.
12. "Some Applications of Negative Feedback with Particular Reference to Laboratory Equipment," by F. E. Terman, R. R. Buss, W. R. Hewlett and F. C. Cahill, Stanford University, Calif.
13. "The Bridge-Stabilized Oscillator," by L. A. Meucham, Bell Telephone Laboratories, Inc., New York, N. Y. (Demonstration.)
14. "Evacuated-Type Crystal-Oscillator Holder," by C. F. Baldwin, General Electric Company, Schenectady, N. Y.

7:30 P.M.—10:00 P.M.—Ballroom

Presentation of Institute Awards.

15. "Input Impedance of Converter Tubes," by J. R. Nelson, Raytheon Production Corporation, Newton, Mass.
16. "A Push-Pull Ultra-High-Frequency Beam Tetrode," by A. K. Wing, RCA Manufacturing Company, Inc., Harrison, N. J. (Demonstration.)
17. "Control of the Effective Internal Impedance of Amplifiers by Means of Feedback," by H. F. Mayer, General Electric Company, Schenectady, N. Y.
18. "Use of Feedback to Compensate for Vacuum-Tube Input-Capacitance Variations with Grid Bias," by R. L. Freeman, Hazeltine Service Corporation, New York, N. Y.
19. "Automatic Selectivity Control Responsive to Interference," by J. F. Farrington, Hazeltine Service Corporation, New York, N. Y.



**Friday, June 17****9:00 A.M.—5:30 P.M.**

Registration and exhibition.

**10:00 A.M.—3:00 P.M.**

Trip No. 2. Women's trip to Good Housekeeping Institute, Castleholm Restaurant, and Sky Gardens at Rockefeller Center.

*Louis Werner*

Claremont Inn on Riverside Drive.

**10:30 A.M.—12:30 P.M.—Ballroom**

20. "Development of an Ultra-High-Frequency Transmitter for Aircraft Instrument Landing," by P. J. Kibler, Washington Institute of Technology, Washington, D.C.
21. "Air-Track System of Aircraft Instrument Landing," by G. L. Davies, F. G. Kear, and G. H. Wintermute, Washington Institute of Technology, Washington, D.C.
22. "Further Developments in the Design and Technique of Operation of Field-Intensity-Measuring Equipment," by W. A. Fitch, National Broadcasting Company, Inc., New York, N.Y.
23. "Lateral Disk Recording for Immediate Playback with Extended Frequency and Volume Range," by H. J. Hasbrouck, RCA Manufacturing Company, Inc., Camden, N.J. (Demonstration.)

24. "A New High-Fidelity Reproducer for Lateral Disk Records," by H. J. Hasbrouck, RCA Manufacturing Company, Inc., Camden, N.J. (Demonstration.)

10:30 A.M.—12:30 P.M.—Parlor I

25. "A Consideration of the Radio-Frequency Voltages Encountered by the Insulating Material of Broadcast Tower Antennas," by G. H. Brown, RCA Manufacturing Company, Inc., Camden, N.J. (Demonstration.)

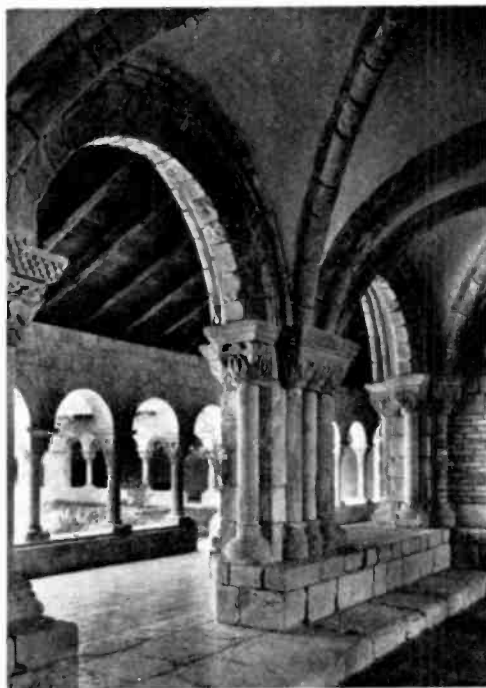

*Courtesy of The Metropolitan Museum of Art*

Another of the Cloisters group, the former abbey house of Notre-Dame-de-Pontaut.

26. "The Operating Characteristics of Radio-Frequency Transmission Lines as Used with Radio Broadcasting Antennas," by C. G. Dietsch, National Broadcasting Company, Inc., New York, N.Y.
27. "Design and Tests of Coaxial-Transmission-Line Insulators," by W. S. Duttera, National Broadcasting Company, Inc., New York, N.Y.
28. "Coupled Transmission-Line Networks," by A. Alford, Mackay Radio and Telegraph Company, New York, N.Y.
29. "Communication by Phase Modulation," by M. G. Crosby, RCA Communications, Inc., Riverhead, L.I., N.Y.
30. "Oscillograph Design Considerations," by G. R. Mezger, Allen B. DuMont Laboratories, Passaic, N.J. (Demonstration.)



*Wendell MacRae*

Views of two of the Sky Gardens at Rockefeller City which will be visited by the women on Friday.

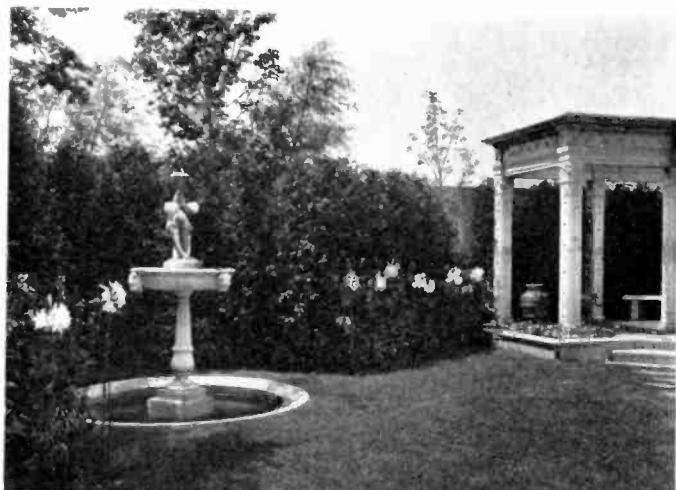

*Mattie Edwards Hewitt*

2:00 P.M.—4:00 P.M.—Ballroom

31. "Contrast in Kinescopes," by R. R. Law, RCA Manufacturing Company, Inc., Harrison, N.J.
32. "Recent Improvements in the Design and Characteristics of Iconoscopes," by R. B. Janes, and W. H. Hickok, RCA Manufacturing Company, Inc., Harrison, N.J.
33. "The Image Iconoscope," by H. Iams, G. A. Morton, and V. K. Zworykin, RCA Manufacturing Company, Inc., Harrison, N.J.
34. "Electrostatic Electron Multiplier," by V. K. Zworykin and J. A. Rajchman, RCA Manufacturing Company, Inc., Harrison, N.J.

8:30 P.M.—1:00 A.M.

Bout trip on the Hudson River.

**Saturday, June 18**

9:00 A.M.—6:00 P.M.

Registration and exhibition.

10:00 A.M.—3:00 P.M.

Trip No. 3. Women's trip to The Cloisters, and luncheon at Claremont Inn.

10:30 A.M.—12:30 P.M.—Ballroom

35. "Radiotelephone System for Harbor and Coastal Service," by C. N. Anderson and H. M. Pruden, Bell Telephone Laboratories, Inc., New York, N.Y.
36. "A Vogad for Radiotelephone Circuits," by S. B. Wright, S. Doba, and A. C. Dickieson, Bell Telephone Laboratories, Inc., New York, N.Y.
37. "Ship Equipment for Harbor and Coastal Radiotelephone Service" by R. S. Bair, Bell Telephone Laboratories, Inc., New York, N.Y.
38. "Remotely Controlled Receiver for Radiotelephone Systems," by H. B. Fischer, Bell Telephone Laboratories, Inc., New York, N.Y.
39. "Coastal and Harbor Ship Radiotelephone Service from Norfolk, Virginia," by W. M. Swingle, The Chesapeake and Potomac Telephone Company, Norfolk, Va., and Austin Bailey, American Telephone and Telegraph Company, New York, N.Y.

10:30 A.M.—12:30 P.M.—Parlor I

40. "Deviations of Short Radio Waves from the London-New York Great-Circle Path," by C. B. Feldman, Bell Telephone Laboratories, Inc., New York, N.Y. (Demonstration.)
41. "The Application of Maximum-Usable-Frequency Graphs to Communication Problems," by N. Smith, S. S. Kirby, and T. R. Gilliland, National Bureau of Standards, Washington, D.C.
42. "Factors Affecting the Selection of a Radio-Broadcasting-Transmitter Location," by W. B. Lodge, Columbia Broadcasting System, Inc., New York, N.Y.
43. "The Effects of Ionosphere Storms on Radio Transmission," by S. S. Kirby, N. Smith, and T. R. Gilliland, National Bureau of Standards, Washington, D.C.
44. "A Study of Ultra-High-Frequency Wide-Band Propagation Characteristics," by R. W. George, RCA Communications, Inc., Riverhead, L.I., N.Y.

2:00 P.M.—4:00 P.M.—Ballroom

45. "The DuMont Television System," by T. T. Goldsmith, Jr., Allen B. DuMont Laboratories, Inc., Passaic, N.J.
46. "Video-Frequency Modulation Detection," by W. S. Barden, RCA License Laboratory, New York, N.Y.
47. "RCA-NBC Television Mobile Units," by John Evans and C. H. Vose, RCA Manufacturing Company, Inc., Camden, N.J., and H. P. See, National Broadcasting Company, New York, N.Y.
48. "Wide-Band Amplifiers for Television," by H. A. Wheeler, Hazeltine Service Corporation, New York, N.Y.
49. "A Theoretical Analysis of Single-Side-Band Operation of Television Transmitters," by L. S. Nergaard, RCA Manufacturing Company, Inc., Harrison, N.J.

### Technical Papers

No preprints of technical papers will be available and there is no assurance that any particular paper will appear in the PROCEEDINGS at a later date.

The operation of duplicate sessions was considered less damaging than the allocation of only ten or fifteen minutes to each paper and the maintenance of a single-session schedule. The average time allotted for presentation is twenty minutes, with thirty minutes as the maximum. As a major reason for the presentation of any paper is a general discussion of it, those who can contribute further to each paper are urged to do so. Time has been provided for this.

A summary of each paper to be presented is given in this issue. Summaries are arranged alphabetically by the names of the authors. Each paper is numbered in the order of its listing in the program so that either the position on the program or the summary of a paper can readily be located.

### Awards

Three awards will be presented this year. As no banquet will be held, presentation will be made by President Pratt at the opening of the technical session on Thursday evening, June 16.

The Institute Medal of Honor will be presented to John Howard Dellinger for his contributions to the development of radio measurements and standards, his researches and discoveries of the relation between radio-wave propagation and other natural phenomena, and his leadership in international conferences contributing to world-wide co-operation in telecommunications.

The Morris Liebmann Memorial Prize will be presented to George C. Southworth for his theoretical and experimental investigations of the propagation of ultra-high-frequency waves through con-

finer dielectric channels and the development of a technique for the generation and measurement of such waves.

In March of 1937 the Board voted a prize of \$100 to the author of that paper of sound technical merit published in the PROCEEDINGS during 1937 which, in the opinion of the Awards Committee, constituted the best presentation of the subject. This award has been voted to A. L. Samuel for his paper on "A Negative-Grid Triode Oscillator and



*Courtesy of Good Housekeeping Institute*

Some of the laboratories at Good Housekeeping Institute.

Amplifier for Ultra-High Frequencies" which appears on pages 1243 to 1253 of the October, 1937, PROCEEDINGS.

### Exhibition

An exhibition of component parts, testing and measuring equipment, and manufacturing aids will, as usual, be a major part of this convention. As in the past, booths will be occupied by the leading manufacturers in these fields. The educational features of this exhibition have been well established and its location adjacent to the meeting rooms permits everyone in attendance to devote sufficient time to it to obtain important data. All booths will be in charge of men who are competent to discuss the engineering aspects of the products displayed.

### Boat Trip

The steamer *Sandy Hook* has been chartered for a trip on the Hudson River on the evening of Friday, June 17. The boat will leave

at nine o'clock in the evening for a four-hour trip. There will be dancing and a buffet supper will be served. This trip will take the place of the annual banquet which is usually held on the evening of the second convention day. Tickets will be \$2.50 each for men and \$1.50 each for women.

### Women's Trips

#### Thursday, June 16—Trip No. 1

Busses will leave the hotel at 1:30 P.M. for the Jules Bache residence on Fifth Avenue. This residence is not a museum but has been



*Courtesy of the Bache Collection*

#### Dutch Room of the Bache Collection.

opened to the women guests of the Institute so that its many interesting art treasures may be seen. The Frick collection, just off Fifth Avenue, will then be visited and the busses will return to the hotel by 5:00 P.M.

#### Friday, June 17—Trip No. 2

Those attending this trip will leave the hotel by bus at 10:00 A.M. for the Good Housekeeping Institute. Several model rooms and the testing laboratories will be open for inspection. Luncheon will be at the Castleholm Restaurant and then the Sky Gardens of the Rockefeller Center skyscrapers will be visited. Because of the many interesting sights in and around Rockefeller Center it is expected that most of those on the trip will prefer to go elsewhere than immediately back to the hotel at the close of this trip.



**Saturday, June 18—Trip No. 3**

This trip will be to The Cloisters where a fine collection of medieval art work will be on exhibition. This collection was started by the late sculptor, George Grey Barnard, and continued by John D. Rockefeller, Jr. After leaving The Cloisters, the party will go to Claremont Inn on Riverside Drive for luncheon and then return to the hotel.

**Sections and Membership Committees**

A joint meeting of the Sections Committee and the Membership Committee will be held in Parlor I, at 4:30 P.M. on Friday, June 17. Each section is urged to arrange for representation at this meeting so that these two committees, which affect membership activities to a considerable extent, may have the benefit of opinions and the knowledge of conditions which exist in the various sections operated by the Institute.

**SUMMARIES OF TECHNICAL PAPERS**

**28. COUPLED TRANSMISSION-LINE NETWORKS**

A. ALFORD

(Mackay Radio and Telegraph Company, New York, N.Y.)

This paper deals with currents induced by one open-wire transmission line in another neighboring line and includes a number of practical applications of this interaction phenomenon.

**35. RADIOTELEPHONE SYSTEM FOR HARBOR AND COASTAL SERVICE**

C. N. ANDERSON AND H. M. PRUDEN

(Bell Telephone Laboratories, Inc., New York, N.Y.)

The provision of suitable facilities for telephone communication between Bell System subscribers and vessels plying in harbors and coastal waters involves numerous technical problems. This paper discusses some of these problems that are of a fundamental character as well as the means which have been developed to meet the special requirements for this type of service.

Features which are of particular importance are the selective signaling system used by the operators in calling ships from the shore and the new type of receiver and control terminal which reduces the technical attendance required.

**10. APPLICATION OF QUARTZ CRYSTALS TO A WAVE ANALYZER**

L. B. ARGUMBAU

(General Radio Company, Cambridge, Mass.)

A brief discussion of the development of a wave analyzer is given with particular emphasis on the crystal-filter elements.

Experimental work on a three-electrode quartz crystal permits the derivation of its equivalent circuit and evaluation of the constants. The circuit is shown to be applicable over a wide variety of terminal conditions. The equivalent circuit of a two-electrode crystal is obtained as a special case. Knowledge of the numerical constants permits the application to a filter circuit.

Mention is made of the application of modulation-monitoring meter circuits to a wave analyzer.

A demonstration of the analyzer shows the flat-top response of the crystal filter and the monitor-type meter action.

### 37. SHIP EQUIPMENT FOR HARBOR AND COASTAL RADIOTELEPHONE SERVICE

R. S. BAIR

(Bell Telephone Laboratories, Inc., New York, N.Y.)

The ultimate objective in the design of radiotelephone apparatus for use on ships is to provide equipment which is as convenient and simple to operate as the telephone at home. To a considerable degree this has been accomplished in the new 15- and 50-watt ship sets that have recently been designed for use on harbor craft and coastwise vessels.

The requirements for sets of this type are discussed and the new equipment is described in this paper.

### 14. EVACUATED-TYPE CRYSTAL-OSCILLATOR HOLDER

C. F. BALDWIN

(General Electric Company, Schenectady, N.Y.)

Some of the disadvantages which were existent in the earlier quartz-crystal oscillators, and the steps taken to correct them are discussed. It is shown that the crystal elements themselves have been improved to a point where many of the remaining causes of instability are largely due to atmospheric effects. Hermetic sealing and air removal as a means of eliminating these effects are discussed and test data given. One practical design is described, together with a brief outline of some of the manufacturing steps involved.

### 46. VIDEO-FREQUENCY MODULATION DETECTION

W. S. BARDEN

(RCA License Laboratory, New York, N.Y.)

Detection of wide-band modulation depends markedly upon various factors. Many of these are readily applied in detection of audio-frequency modulation, but are not readily applied in wide-band modulation. Other factors are found in video-frequency detection. This paper presents a study of the various types of video-frequency detectors, and shows the results of the use of various circuit constants.

The influence of factors such as quasi-single-side-band operation, circuit time delay, and low driver-circuit impedance is shown. Conclusions are drawn as to the most desirable type of detection for any given conditions.

## 25. A CONSIDERATION OF THE RADIO-FREQUENCY VOLTAGES ENCOUNTERED BY THE INSULATING MATERIAL OF BROADCAST TOWER ANTENNAS

G. H. BROWN

(RCA Manufacturing Company, Inc., Camden, N.J.)

A knowledge of the radio-frequency voltages on the insulation of broadcast tower antennas is important to the design engineer since a too-large factor of safety may add unduly to the tower cost.

Attention is first given to the base-insulator voltage. The magnitude of this voltage is also of interest in the design of lighting chokes and coupling equipment. Theoretical values are derived and shown in curve form as a function of antenna height. The theoretical curves are supplemented by experimental data taken on self-supporting tapered, guyed cantilever, and guyed uniform-cross-section towers, and guyed tubular steel masts.

A theoretical treatment is then given concerning the rôle of guy wires from an electrical standpoint. Consideration is given to the currents in the guys and the voltages on the guy insulators. Measurements are presented of the voltages existing on the guy insulators of two guyed masts of different construction.

These voltages are found to be so small that there seems little need for elaborate insulation except for the presence of high static or induced lightning voltages. The paper is concluded by some considerations of ways of providing protection against these high instantaneous and random voltages without the use of expensive and elaborate insulation.

## 9. DESIGN REQUIREMENTS FOR BROADCAST-STUDIO AUDIO-FREQUENCY SYSTEMS

H. A. CHINN

(Columbia Broadcasting System, Inc., New York, N.Y.)

The design of broadcast-studio audio-frequency facilities divides itself naturally into two categories. First, there is the design of the individual circuit components. Second, there is the design of the complete system utilizing these components. This paper, which is confined to this latter concern, outlines present-day operating and performance requirements. Specific fidelity requirements are given and a typical system design presented.

## 6. RECENT DEVELOPMENTS IN RADIO TRANSMITTERS

J. B. COLEMAN AND V. E. TROUANT

(RCA Manufacturing Company, Inc., Camden, N.J.)

This paper outlines and illustrates the mechanical and electrical developments that have been incorporated in the design of radio transmitting apparatus. Various systems of modulation, the application of feedback, and the modulation requirements for broadcast service are discussed. Diagrams and photographs indicate the extent to which multielement tubes are being applied in high-frequency apparatus. Numerous photographs indicate the trend in industrial styling.

## 29. COMMUNICATION BY PHASE MODULATION

M. G. CROSBY

(RCA Communications, Inc., Riverhead, L.I., N.Y.)

Practical methods of generating and receiving phase modulation are described which open up the possibility of using phase modulation as a communication system. A new receiver is described which uses an off-neutralized crystal filter and provides a simple practical receiver which has not been available heretofore for phase modulation. Other methods of reception are described and discussed.

Propagation tests which were conducted in 1931 and 1932 between California and New York indicate that the propagation characteristics of phase modulation are substantially the same as those of amplitude modulation.

The noise characteristics of phase modulation are considered and it is shown that the signal-noise ratio at the output of the phase-modulation receiver is equal to the product of the phase deviation in radians and the carrier-noise ratio.

The chief advantage of phase modulation is realized at the transmitter where a power gain of about four-to-one is realized and modulating equipment is reduced by the ability to modulate at a lower level without the requirement of linearity in the stages following the modulator. The chief difficulty occurs at the receiver where the susceptibility to microphonics is increased and the circuits are slightly more complicated.

## 21. AIR-TRACK SYSTEM OF AIRCRAFT INSTRUMENT LANDING

G. L. DAVIES, F. G. KEAR, AND G. H. WINTERMUTE

(Washington Institute of Technology, Washington, D.C.)

An adequate instrument landing system is one of the elements necessary to permit safe flights through adverse weather conditions. The first work on this problem was performed by the National Bureau of Standards, the research culminating in a demonstration of the complete system at Newark, N.J., in 1933, hundreds of hooded landings and one blind flight having been made. Later in 1933 some members of the Bureau staff engaged in this work joined the Washington Institute of Technology to continue development work and adapt the system for commercial operation. The result of this work is the Air-Track, a system embodying the basic principles proved by the National Bureau of Standards and meeting the specifications set up by the airlines. The ground equipment comprises ultra-high-frequency, visual-localizer, glide-path, and marker-beacon transmitters, all piezo controlled, together with a monitor and remote-control system assuring proper indications in the airplane. The localizer and glide-path transmitters are mounted in a trailer so that they may be located in the best position for the wind conditions existing at the time of use and will not constitute a hazard when not in use.

Immediate installation of instrument landing equipment is desirable, not only from the standpoint of safety, but to begin the accumulation of operating experience which alone will permit lowering of present minimums and increased regularity of service. Relief of present congestion at busy airports in bad weather is another important function of instrument landing equipment, and it may reasonably be expected that the traffic-handling capabilities of airports will be increased from 25 to 50 per cent in bad weather by the addition of landing systems.

## 26. THE OPERATING CHARACTERISTICS OF RADIO-FREQUENCY TRANSMISSION LINES AS USED WITH RADIO BROADCASTING ANTENNAS

C. G. DIETSCH

(National Broadcasting Company, New York, N.Y.)

A brief description of mathematical equations shows the factors causing loss in open-wire and concentric lines. Loss caused by conductor resistance, leakage, and radiation will be discussed with curves to show measured loss at various frequencies and field-intensity patterns about several open-wire lines to show their effect upon the antenna field pattern especially with respect to sky-wave radiation. Some details concerning the mechanical and electrical constructional details of transmission lines as used by NBC with slides to show these lines; methods used to filter out radio-frequency pickup on open-wire lines from other high-power transmitters so as to prevent radiation of signals at spurious frequencies and cross-modulation, methods of terminating transmission lines, design of harmonic filters for use with open-wire and concentric lines, and cost study and comparison of advantages of both types of transmission lines will be outlined. There will be a brief description of the new W3XAL transmitters showing methods of antenna switching and the application of the information above to transfer power correctly from this transmitter to a particular antenna.

## 5. A 50-KILOWATT BROADCAST STATION UTILIZING THE DOHERTY AMPLIFIER AND DESIGNED FOR EXPANSION TO 500 KILOWATTS

W. H. DOHERTY

(Bell Telephone Laboratories, Inc., New York, N.Y.)

AND

O. W. TOWNER

(The Louisville Times Company, Inc., Louisville, Ky.)

Radio Station WHAS purchased the first commercial transmitter employing the Doherty high-efficiency amplifier and has installed it in a completely new transmitting plant which is designed for expansion to 500 kilowatts output. The transmitter extends the use of negative feedback for noise suppression and all vacuum-tube filaments are heated with alternating current, completely eliminating rotating equipment except for fans and pumps. Heat for the building is obtained from the water-cooling system in which porcelain tubes entirely replace rubber hose for the insulating sections. A six-inch concentric transmission line of refined design is used to convey energy from the transmitter to the antenna and for the suppression of harmonics. The novel construction of the feed line to the shunt-excited half-wave antenna makes unnecessary the coupling apparatus ordinarily used between the transmission line and inclined lead to provide the capacitive reactance required at that point in the circuit.

The theory and practice followed in the design of the high-efficiency amplifier and other special features are touched upon as the entire plant is described. Performance data of the transmitter and the antenna system are also included.

## 27. DESIGN AND TESTS OF COAXIAL-TRANSMISSION-LINE INSULATORS

W. S. DUTTERA

(National Broadcasting Company, New York, N.Y.)

The paper describes a series of measurements made to determine the factors affecting the arc-over voltage of various types of coaxial-transmission-line insulators and shows the evolution of an improved insulator. These measurements were made at broadcast frequencies. With the better type of insulating materials the power-handling capabilities of broadcast lines are largely determined by the maximum allowable voltage. The result of repeated breakdown of the various types of insulators is discussed as well as the experience of this company with several types of coaxial lines.

## 47. RCA-NBC TELEVISION MOBILE UNITS

JOHN EVANS AND C. H. VOSE,

(RCA Manufacturing Company, Inc., Camden, N.J.)

AND

H. P. SEE

(National Broadcasting Company, New York, N.Y.)

Fundamental problems governing layout and design of the two new units now undergoing tests in the New York area are discussed.

The subject of equipment for outside television pickups is treated from the standpoints of operating convenience, size and weight limitations, sources of power, service area, and other basic considerations involved in such a project.

## 19. AUTOMATIC SELECTIVITY CONTROL RESPONSIVE TO INTERFERENCE

J. F. FARRINGTON

(Hazeltine Service Corporation, New York, N.Y.)

A broadcast receiver is provided with automatic selectivity control by means of vacuum tubes in feed-back paths. The feedback is so controlled that the band width is increased with the strength of the desired signal. By an auxiliary control, the band width is automatically reduced in response to undesired signals on adjacent channels. This control is established by selecting and rectifying the 10-kilocycle beat note between the desired and undesired signals. As a result, the selectivity is maintained at the optimum compromise with fidelity under all conditions of signal strength and interference.

## 40. DEVIATIONS OF SHORT RADIO WAVES FROM THE LONDON-NEW YORK GREAT-CIRCLE PATH

C. B. FELDMAN

(Bell Telephone Laboratories, Inc., New York, N.Y.)

During the past year experiments have been made to determine the occurrence and extent of deviations of short radio waves from the North Atlantic great-circle path. The multiple-unit steerable antenna (MUSA), described to the Institute at its 1937 Convention, has been used to steer a receiving lobe

horizontally. This is accomplished by arraying the unit antennas broadside to the general direction from which the waves are expected to arrive. The MUSA combining equipment then provides a reception lobe in the horizontal plane, steerable over a limited range of azimuth. Two such MUSAS have been used, one of which possesses a wide steering range but is blunt, while the other is sharp but is restricted in range. Transmissions from England have been studied with this equipment, near Holmdel, N.J. Comparisons of results obtained on transmission from antennas directed toward New York with those from antennas otherwise directed have, to a limited degree, given results representative of the effects of horizontal steerable transmitting directivity. Observations made on transmissions from these British stations during the past eight months have disclosed the following characteristics:

1. During "all-daylight" path conditions, the usual multiplicity of waves distributed in or near the great-circle plane, which constitutes normal propagation, has invariably been predominant. Neither ionosphere storms nor the catastrophic disturbances associated with short-period fade-outs seem to affect the mode of propagation.
2. In contrast to 1, during periods of dark or partially illuminated path conditions, the great-circle plane no longer provides the sole transmission path. The extent to which other paths are involved varies greatly. Ionosphere storms of moderate intensity usually involve paths deviated to the south of the great circle, during afternoon and evening hours, New York time. These and other anomalous phenomena are briefly described and illustrated by phonograph recordings.

### 38. REMOTELY CONTROLLED RECEIVER FOR RADIOTELEPHONE SYSTEMS

H. B. FISCHER

(Bell Telephone Laboratories, Inc., New York, N.Y.)

One of the apparatus units required in a system for giving radiotelephone service to harbor craft and coastwise vessels is a remotely controlled receiver that can be located at strategic shore points to receive the signals from ships most effectively.

A new receiver which can be mounted on a pole and controlled remotely from a telephone central office is described and illustrated in this paper. An outstanding feature of this receiver is the inclusion of a "codan" (carrier operated device antinoise) which operates over a wide range of input signals without false operation from radio noise. While this receiver is undergoing a trial installation as a part of the new radiotelephone system for harbor and coastal service at Norfolk, Virginia, its application is expected to include other types of radiotelephone systems.

### 22. FURTHER DEVELOPMENTS IN THE DESIGN AND TECHNIQUE OF OPERATION OF FIELD-INTENSITY-MEASURING EQUIPMENT

W. A. FITCH

(National Broadcasting Company, New York, N.Y.)

The experience of the National Broadcasting Company in developing mobile field-intensity-measuring equipment is traced beginning with the first field-intensity-measuring car developed in 1932 and extending to the present



new cars just recently put in service. The essential requirements of a measuring unit suitable for the rapid and accurate measuring of field strength are given. The new mobile measuring units are described which include recording equipment for measuring two stations simultaneously as the car is driven along a radial.

#### **18. USE OF FEEDBACK TO COMPENSATE FOR VACUUM-TUBE INPUT-CAPACITANCE VARIATIONS WITH GRID BIAS**

**R. L. FREEMAN**

(Hazeltine Service Corporation, New York, N.Y.)

The input capacitance of amplifier tubes decreases with increasing grid bias, thereby detuning the input circuits of intermediate-frequency stages in a superheterodyne receiver. The phenomenon is caused by a shift in space charge and also by feedback through the grid-plate capacitance. The change in input capacitance is of the order of 1.5 micromicrofarads for each of the two causes. A simple form of feed-back coupling compensates for this change of capacitance. The grid-cathode capacitance and an unby-passed resistor in the cathode lead provide the feed-back coupling.

#### **44. A STUDY OF ULTRA-HIGH-FREQUENCY WIDE-BAND PROPAGATION CHARACTERISTICS**

**R. W. GEORGE**

(RCA Communications, Inc., Riverhead, L.I., N.Y.)

Signals reflected from buildings and other large objects introduce distortion in the received signal because of their relative time delay and phase relations. This distortion is especially evident in the form of blurred and multiple images in television reception. Data in this respect, on the relative merits of vertically and horizontally polarized waves transmitted from the Empire State Building in New York City, were obtained at the two frequency ranges of 81 to 86 megacycles and 140 to 145 megacycles. Some data using circular polarization at the lower frequency range were also obtained.

The effects of indirect-path signals were indicated on recorded curves showing field strength versus frequency. The methods and equipment used to record these data at a number of representative receiving locations are briefly described.

A minimum of indirect-path-signal interference was found to be generally had with horizontal polarization at both signal-frequency ranges. In this respect, circular polarization was found to be slightly preferable to vertical polarization. Horizontal polarization also gave somewhat greater average field strength.

Miscellaneous data and observations are described, including sample propagation-characteristic curves. In conclusion, some relations between direct- and indirect-path signals and propagation paths are discussed.

#### **45. THE DUMONT TELEVISION SYSTEM**

**T. T. GOLDSMITH, JR.**

(Allen B. DuMont Laboratories, Inc., Passaic, N.J.)

This system of television utilizes the actual transmission of the scanning voltages as well as the video-frequency modulating voltage, resulting in several distinct advantages. Higher interlace ratios than two may be obtained in practice, allowing reduction in the frequency band width required for transmission, resulting in simpler receiver design, reduced radio-spectrum space, and the pos-

sibility of transmitting on carrier frequencies with service ranges not necessarily limited to the horizon. Operation of the receiver is simplified as there are no local scanning circuits to be brought into adjustment. Receivers in this system are versatile in being able to receive signals of varying degrees of definition, not being limited to a fixed number of scanning lines, or a given system of interlace.

The conventional studio equipment consisting of photoelectric-mosaic pickup tubes for converting scenes to the appropriate electrical energy is employed. Special transmitting means will be described for sending the two scanning signals, the video-frequency modulation, and the sound signals. A cathode-ray tube is employed for picture reception, the most versatile service being obtained when using electrostatic deflection. This paper describes the features of this system and presents two methods whereby the signals may be transmitted, each system being illustrated by suitable diagrams.

The first transmission system employs a high-frequency carrier modulated by the video-frequency signal alone and an additional high-frequency carrier which is modulated by the three remaining signals, the sweeps, and the audio frequency, in distinct narrow channels.

The second transmission system employs a single high-frequency carrier modulated by the four signals suitably mixed in distinct channels using sub-carrier frequencies.

Finally a brief discussion of some of the advantages and difficulties of this system of television is given.

## **8. TECHNICAL EQUIPMENT OF THE NEW KYW STUDIOS**

A. G. GOODNOW

(Westinghouse Electric and Manufacturing Company, Chicopee Falls, Mass.)

This paper will consist of a brief description of the physical aspects of the KYW studio installation and a description of the capabilities of the equipment from an operating standpoint.

### **1. KDKA LOW-ANGLE ANTENNA ARRAY**

R. N. HARMON

(Westinghouse Electric and Manufacturing Company, Chicopee Falls, Mass.)

The antenna consists of a three-quarter-wave vertical hertzian radiator surrounded by a ring of eight short antennas equally spaced around a circle of one-wavelength diameter. The three-quarter-wave antenna radiates a strong low-angle lobe and a small high-angle lobe. The high-angle lobe of the three-quarter-wave antenna is suppressed by the ring of eight suppressor antennas which generate a radiation identical to the high-angle lobe of the three-quarter-wave radiator but in opposite phase.

## **24. A NEW HIGH-FIDELITY REPRODUCER FOR LATERAL DISK RECORDS**

H. J. HASBROUCK

(RCA Manufacturing Company, Inc., Camden, N.J.)

Departing from conventional design, this new lighter-weight pickup gives a wide frequency-response range, yet retains high sensitivity. A radically different method of obtaining low mechanical impedance has been utilized providing high flexibility and small effective mass reactance.

High-frequency needle losses are compensated for mechanically in the design so that a constant-velocity—frequency record of average diameter running at 33.3 revolutions per minute will give essentially uniform output up to and including 9000 cycles. A permanent diamond stylus is used. The pickup is intended primarily for high-quality transcription records but can be used successfully on all lateral records including lacquer-coated disks for immediate playback.

### **23. LATERAL DISK RECORDING FOR IMMEDIATE PLAYBACK WITH EXTENDED FREQUENCY AND VOLUME RANGE**

H. J. HASBROUCK

(RCA Manufacturing Company, Inc., Camden, N.J.)

This equipment can be attached to a reproducing turntable and provides means for recording on lacquer-coated disks. The records can be played immediately and when the new RCA high-fidelity pickup is used an over-all frequency range which includes 8000 cycles is possible. The new recorder operates on a maximum power of approximately one watt. A standard sapphire stylus normally supplied for instantaneous recording on lacquer is used. When the recommended recording technique is followed records can be made comparable in quality and fidelity with the finest commercially produced transcription records. A volume range of 55 decibels can be obtained.

### **33. THE IMAGE ICONOSCOPE**

H. IAMS, G. A. MORTON, AND V. K. ZWORYKIN

(RCA Manufacturing Company, Inc., Harrison, N.J.)

An Iconoscope having increased sensitivity is to be desired for purposes of improving pickup capabilities in the studio, making possible more universal outdoor work, and permitting greater depths of focus. The new tube described obtains its high sensitivity by making use of an electron image of the scene to be transmitted, projected onto a scanned mosaic. The method permits more efficient and better photocathodes, and also secondary-emission image intensification at the mosaic, resulting in a sensitivity six to ten times greater than that of the standard Iconoscope. Details are given of the construction and theory of operation of the semitransparent photocathode, of magnetic and electrostatic lens systems which may be used in these tubes, and of the mosaic. The performance of this type of Iconoscope is discussed.

### **32. RECENT IMPROVEMENTS IN THE DESIGN AND CHARACTERISTICS OF ICONOSCOPES**

R. B. JANES AND W. H. HICKOK

(RCA Manufacturing Company, Inc., Harrison, N.J.)

The sensitivity and picture-signal output of Iconoscopes have recently been increased by a factor of two or three times. The spectral response of the newer tubes more closely resembles that of the eye and may be controlled by processing. "Dark spot" has been diminished by the use of a cylindrical envelope.

The gun design has been changed to give a constant current as the beam is focused, and to prevent secondary electrons from the gun apertures getting into the primary beam. Use of the cylindrical envelope gives a better picture since a good optical window can be employed. Sandblasting of the mosaic improves the

picture contrast and quality by removing the specular reflection of the mosaic. Methods of measuring signal output, "dark spot," photoemission, secondary emission, spectral response, and resolution have been further refined.

## **20. DEVELOPMENT OF AN ULTRA-HIGH-FREQUENCY TRANSMITTER FOR AIRCRAFT INSTRUMENT LANDING**

**P. J. KIBLER**

(Washington Institute of Technology, Washington, D.C.)

Some factors entering into the design and development of a 500-watt piezo-electric-controlled transmitter designed to operate between 90 and 125 megacycles are presented. Problems encountered are discussed, and some methods for their solution are indicated.

Two of these transmitters, essentially duplicates, are used in the Air-Track ultra-high-frequency system for aircraft instrument landing.

## **43. THE EFFECTS OF IONOSPHERE STORMS ON RADIO TRANSMISSION**

**S. S. KIRBY, N. SMITH, AND T. R. GILLILAND**

(National Bureau of Standards, Washington, D.C.)

Ionosphere storms occur principally in the higher part of the ionosphere. During these storms this part of the ionosphere becomes extremely turbulent and diffused, resulting in increased virtual heights, decreased critical frequencies, and pronounced horizontal inhomogeneities over large geographical areas. These effects produce poor and erratic radio sky-wave transmission at the higher frequencies. The effects are more pronounced at the higher latitudes and sometimes appear to have a fairly sharp southern boundary. The severe storms are observed at lower latitudes than the moderate ones. Disturbances of long-distance radio transmissions are caused by disturbances of the ionosphere in an area in which reflection takes place.

## **4. A NEW ANTENNA SYSTEM FOR NOISE REDUCTION**

**V. D. LANDON AND J. REID**

(RCA Manufacturing Company, Inc., Camden, N.J.)

A discussion is given of a novel antenna system in which a high degree of noise reduction is obtained over a wide frequency band. A feature is the elimination of noise even when the antenna cannot be located in a noise-free area. The apparatus involved is simple and low in cost.

## **31. CONTRAST IN KINESCOPES**

**R. R. LAW**

(RCA Manufacturing Company, Inc., Harrison, N.J.)

One of the problems in the art of reproducing a scene by television is to obtain an image with adequate contrast. Not only is adequate contrast desirable from a technical standpoint, but it plays a significant part in determining the psychological reaction of the observer as well.

The factors harmful to contrast in the Kinescope are well known and may be studied in a variety of ways. In the belief that the psychological reaction of the observer is the ultimate criterion for judging the perfection of the image, the present investigation began with a series of viewing tests designed to deter-

mine the relative psychological effects of the various factors harmful to contrast. On the basis of these tests it was definitely concluded that halation is far more detrimental to image quality than screen curvature or bulb-wall reflections.

Experimental evaluation of the relative importance of the individual factors harmful to contrast leads to definite conclusions and recommendations whereby considerable improvement in contrast could be effected by reducing halation.

A detailed analytical study of halation is presented. From this analysis it appears that a three- to sixfold reduction in halation is practical.

Developmental Kinescopes made in accordance with the principles discussed give greatly improved contrast. Not only does reduction of halation substantially double or triple the length of the scale available for the reproduction of half tones, but it has a marked effect upon the sharpness of the image. This sharpening of the image is analogous to good optical focus in the case of a projected picture, and is very important in determining the psychological reaction of the observer.

## **42. FACTORS AFFECTING THE SELECTION OF A RADIO-BROADCASTING-TRANSMITTER LOCATION**

W. B. LODGE

(Columbia Broadcasting System, Inc., New York, N.Y.)

A radio broadcasting station should provide satisfactory reception to as many homes as possible in the area which it is designed to serve. Most of the engineering considerations which determine the station's performance and coverage may be treated analytically. However, the ability of the station to serve a large audience is greatly affected by the excellence of the location chosen for its transmitter, and this choice must be governed by experience and a consideration of intangibles not subject to calculation. In the present article, various factors affecting the selection of a transmitter site are discussed and general recommendations are made.

## **17. CONTROL OF THE EFFECTIVE INTERNAL IMPEDANCE OF AMPLIFIERS BY MEANS OF FEEDBACK**

H. F. MAYER

(General Electric Company, Schenectady, N.Y.)

The effective internal impedance of an amplifier may either be increased or reduced by the proper choice of one or a combination of several of the following types of feedback: positive current feedback, negative current feedback, positive voltage feedback, and negative voltage feedback.

Impedance-reducing feedback has been applied experimentally to audio-frequency power amplifiers to flatten the response and improve the loud-speaker damping. Impedance-increasing feedback has been applied to intermediate-frequency amplifiers to increase selectivity without loss of stability.

## **13. THE BRIDGE-STABILIZED OSCILLATOR**

L. A. MEACHAM

(Bell Telephone Laboratories, Inc., New York, N.Y.)

A new type of crystal-controlled oscillator of extremely high stability is described. Constancy of output amplitude, purity of wave form, and frequency stabilization against fluctuations in power supply or changes in circuit elements

other than the crystal are provided by a simple self-balancing-bridge arrangement.

The absence of tube overloading and of any other nonlinearity in the oscillator permits a straightforward mathematical treatment using ordinary circuit equations. Expressions for the small frequency deviations caused by changes in the gain and phase shift of the vacuum-tube circuit are derived and are checked experimentally.

Operating characteristics and frequency records are given for a single-tube 100-kilocycle model, which during long trial runs has exhibited no short-time frequency variations greater than  $\pm 2$  parts in 100 million. Convenient means are described for making accurate frequency adjustments over a narrow range to compensate for aging of the mounted crystal.

Although developed for use in frequency standards of the highest precision, this oscillator is applicable more generally. It should be especially useful as a means for obtaining very stable frequencies without accurate control of the operating conditions.

### 30. OSCILLOGRAPH-DESIGN CONSIDERATIONS

G. R. MEZGER

(Allen B. DuMont Laboratories, Passaic, N.J.)

As the cathode-ray oscillograph is becoming more widely used in laboratories, its application to the particular problems under investigation becomes more important. Various methods of application will become apparent, and it is often advantageous to select particular equipment to apply to a specific problem.

This paper discusses the relation of the requirements of the particular problem to the design of a complete cathode-ray oscillograph. Amplifier-design requirements are discussed with respect to their effect upon the electrical and mechanical design of the equipment.

The requirements for linear-sweep-circuit design are discussed with respect to their effect upon amplifier design and wide frequency range. The application of grid modulation to transient studies, frequency determinations, and return-trace elimination is discussed.

The design of the cathode-ray-tube power supply with regard to voltage, ripple elimination, brilliance, amplifier requirements, and their relation to the method of investigation is discussed. Power-supply requirements for amplifier and control circuits are considered especially with regard to their effect upon transformer and filter design.

The physical requirements of the layout of the equipment with respect to electrical, mechanical, and operating requirements are discussed. The complete design of a commercial unit is examined in the light of the design considerations covered in the paper.

### 15. INPUT IMPEDANCE OF CONVERTER TUBES

J. R. NELSON

(Raytheon Production Corporation, Newton, Mass.)

A multielement converter tube is a complex structure and may be expected to have characteristics not expected. There are two signal grids in such structures

and the input impedances of the two are entirely different. Under certain conditions the outer grid may exhibit a negative resistance from approximately 2 to 20 meters which is of such order that it is useful for amplification or oscillation purposes. The values of the negative-resistance characteristics are given for various conditions in typical tubes. Power may be taken from the plate circuit of a converter tube when such a tube is oscillating with a tuned circuit in the outer grid and a tank circuit in the plate. The frequency is constant enough so a superregenerative receiver may be made by oscillating in the outer grid with the quench frequency on the inner grid. It is not known yet just what use may be made of such characteristics but it is expected that they will be useful in the region of 2 to 20 meters where it is desired to introduce an external voltage to mix with an internally generated voltage.

#### 49. A THEORETICAL ANALYSIS OF SINGLE-SIDE-BAND OPERATION OF TELEVISION TRANSMITTERS

L. S. NERGAARD

(RCA Manufacturing Company, Inc., Harrison, N.J.)

The effect of detuning a transmitter to suppress one side band partially and increase the band width for the other side band is investigated.

A screen-grid tube driving a simple tuned circuit is assumed. It is also assumed that the tube operates class C and is grid modulated. A square-top ("unit function") modulation is adopted as standard. The voltage amplitude across the tank in response to the standard modulation is studied as a function of the circuit decrement and detuning. The "time of response" is defined as the time required for the tank-voltage amplitude to build up to 0.632,  $(1 - 1/e)$  times its steady-state value. The time of response is found to be a function of the decrement and detuning. It decreases with an increase in decrement or an increase in detuning. The "decay time" is defined as the time required for the tank voltage to drop 0.36  $(1/e)$  times the initial value and is found to be equal to the reciprocal of the decrement. The effect of the transmitter only on the contrast between narrow dark and light lines in a reproduced television image is determined almost entirely by the decay time of the tank circuit. Detuning has a small effect on the contrast, but this effect is in the nature of a distortion because it depends on the width of the lines. It is apparent that the rate at which the tank voltage builds up can be increased by detuning, but the rate of decay can only be increased by increasing the decrement, i. e., by increasing the band width. A number of curves showing the response to alternate light and dark vertical lines of various widths and for various degrees of detuning illustrate the above effects.

The effect of detuning on the carrier-power output is considered. It is assumed that the anode dissipation of the tube is limited and that the operating parameters are adjusted to the optimum values consistent with the specified values of decrement and detuning. It is shown that detuning results in a severe reduction in power output. For example, if the circuit is detuned to reduce the time of response 50 per cent, the output drops approximately 50 per cent if the plate current can be increased and approximately 65 per cent if the plate current is emission limited to its value at resonance. If the time of response is reduced 50 per cent by doubling the decrement, the power output drops about 15 per cent



if the current is not emission limited and 50 per cent if the current is emission limited. Both examples assume that the screen voltage is 1/10 the plate voltage for normal on-resonance operation.

## **2. A SHORT-WAVE SINGLE-SIDE-BAND RADIOTELEPHONE SYSTEM**

**A. A. OSWALD**

(Bell Telephone Laboratories, Inc., New York, N.Y.)

There is described briefly a short-wave single-side-band system which has been developed for transoceanic radiotelephone service. The system involves the transmission of a reduced carrier or pilot frequency and is designed to include the testing of twin-channel operation wherein a second channel is obtained by utilizing the other side band.

The paper indicates the reasons which led to the selection of this particular system and discusses at some length those matters which require agreement between the transmitting and receiving stations when single-side-band transmission is employed.

## **3. A SINGLE-SIDE-BAND RECEIVER FOR SHORT-WAVE TELEPHONE SERVICE**

**A. A. ROETKEN**

(Bell Telephone Laboratories, Inc., New York, N.Y.)

A new radiotelephone receiver has been developed for the reception of reduced-carrier single-side-band signals in the frequency range from 4 to 22 megacycles. This receiver employs triple detection. The first beating oscillator is continuously variable and the second is fixed in frequency. The first oscillator is a very stable tuned-circuit type, the proper adjustment being positively maintained through the use of an improved type of synchronizing automatic-tuning-control system. The second oscillator is crystal controlled. Separation of the carrier and side band is accomplished in the receiver by means of band-pass crystal filters which provide extremely high selectivity. Unusually good stability and selectivity characterize the performance of the receiver.

## **41. THE APPLICATION OF MAXIMUM-USABLE-FREQUENCY GRAPHS TO COMMUNICATION PROBLEMS**

**N. SMITH, S. S. KIRBY, AND T. R. GILLILAND**

(National Bureau of Standards, Washington, D.C.)

The maximum usable frequency for any distance is the highest frequency which can be effectively used for radio sky-wave transmission over the given distance. Graphs of maximum usable frequencies for the latitude of Washington are being published monthly. These graphs are useful in determining the best frequency for communication over a given circuit at a given time. The diurnal and seasonal variations recur regularly and the variations with the sunspot cycle may be estimated for a reasonable time in advance and therefore predictions of the maximum usable frequencies for undisturbed days may be made. The methods of applying these graphs to communication problems are discussed.

### 39. COASTAL AND HARBOR SHIP RADIOTELEPHONE SERVICE FROM NORFOLK, VIRGINIA

W. M. SWINGLE

(The Chesapeake and Potomac Telephone Company of Virginia, Norfolk, Va.)

AND

AUSTIN BAILEY

(American Telephone and Telegraph Company, New York, N.Y.)

This paper deals with the engineering and operation of a radiotelephone service for harbor and coastal vessels in the Norfolk area. The instrumentalities discussed in companion papers are employed for this purpose.

First, the need for such a service is developed from maritime data concerning the character of water transportation. Then radio-coverage-survey results show that a radiotelephone station of only moderate power can reach satisfactorily the commercially more important parts of this area. A discussion of the power radiated from antennas on the smaller craft logically leads to the determination of suitable receiver locations.

This paper contains a general description of the plant installed at the Virginia Beach radio transmitting station, the radio receiving stations, and the control-switchboard positions in Norfolk, together with a discussion of the interconnection and interplay of these components to give service.

After telling of the facilities available for use by the switchboard operator, the paper concludes with a tracing of the steps followed in handling calls to or from vessels reached through the Norfolk marine operator.

### 12. SOME APPLICATIONS OF NEGATIVE FEEDBACK WITH PARTICULAR REFERENCE TO LABORATORY EQUIPMENT

F. E. TERMAN, R. R. BUSS, W. R. HEWLETT, AND F. C. CAHILL

(Stanford University, California)

The desirability of applying feedback to the entire amplifier rather than merely to the power stage is discussed for the case of laboratory amplifiers, and it is pointed out that by the proper use of feedback the characteristics that can be obtained approach very closely those of a perfect amplifier. Two applications of such amplifiers for measuring purposes are described. In the first, the amplifier operates into a thermocouple, with feedback introduced in such a manner as to stabilize the current through the thermocouple. This gives a direct-reading voltmeter having a permanent calibration and serving all the functions of a vacuum-tube voltmeter for audio and low radio frequencies. In the second, amplifiers stabilized to give standard gains such as 10 or 100 are used to increase the sensitivity of vacuum-tube and feed-back voltmeters.

A method of applying negative feedback to the output amplifier of a laboratory oscillator is described. By the expedient of throwing away a portion of the output power in a resistive network it is shown that the full benefits of feedback in reducing distortion can be realized for all load impedances from open to short circuit. The design principles involved are outlined, and it is shown that the power obtainable approaches one fourth the normal power rating of the tube.

Circuits for applying negative feedback to tuned amplifiers are described. In one of these the feedback operates to stabilize the current through the tuned circuit, which results in making the amplification dependent only upon the impedance of the tuned circuit and independent of the tube conditions. Another involves a tuned amplifier circuit giving band-pass action when the gain is low, and a highly selective characteristic with high gain.

The use of negative feedback to develop a stabilized negative resistance substantially independent of tubes and supply voltages is considered. The application of such a stabilized negative resistance in increasing the selectivity of tuned circuits, in improving the alternating-to-direct-current-impedance ratio in diode detectors, and in resistance-tuned circuits, is discussed.

A method is described for obtaining high selectivity by obtaining the feedback from the neutral arm of a bridge, one leg of which involves a parallel-tuned circuit. By proportioning the bridge so that it is in balance at resonance, feedback occurs only when off resonance, and so increases the discrimination against frequencies off resonance without affecting the response at resonance. It is possible by this means to obtain an effective circuit  $Q$  of several thousand, using ordinary tuned circuits.

The use of these highly selective circuits in wave analyzers is illustrated. By using at least three tuned circuits it is possible to obtain a more desirable shape of selectivity curve than is available in present analyzers, and furthermore the arrangement provides means of obtaining variable selectivity without affecting the calibration.

Various means of using feedback in laboratory oscillators are discussed. Included among these is a resistance-stabilized oscillator with negative feedback to improve the wave shape and frequency stability. There is also included a modification particularly desirable when low distortion is important. This involves separating the amplifying action required to produce oscillations from the nonlinear action necessary to stabilize their amplitude. Oscillators in which the frequency is controlled by a resistance-capacitance combination are considered and it is shown desirable to carry out the tuning by a variable capacitance instead of the variable resistances hitherto used in such arrangements. By this and other modifications an oscillator that is a simple and inexpensive substitute for a beat-frequency oscillator has been devised that is capable of covering the frequency range from 20 to 20,000 cycles in three steps.

## 11. BRIDGED-T AND PARALLEL-T NULL CIRCUITS FOR MEASUREMENTS AT RADIO FREQUENCIES

W. N. TUTTLE

(General Radio Company, Cambridge, Mass.)

Bridged-T and parallel-T null circuits may under some circumstances be preferable to bridge circuits for radio-frequency measurements, as no transformer is required and the generator and detector can have a common grounded terminal. A very simple analysis of the circuits can be made in terms of the transfer impedances of the various possible component  $T$  networks so that the nature of possible null conditions becomes evident by inspection. The circuits considered include arrangements suitable for the measurement of resistance, reactance, frequency, and power factor of dielectrics. Some of the circuits, particularly suited to high-frequency work, employ neither coils nor variable resistances.

## 7. A HIGH-EFFICIENCY MODULATING SYSTEM

A. W. VANCE

(RCA Manufacturing Company, Inc., Camden, N.J.)

A new modulator circuit is described which permits class C efficiency (limited only by the tubes and voltages available) for the unmodulated carrier condition and does not require the excessive tube and audio-frequency circuit complement of the "high-level" system.

In this circuit a class C amplifier drives the antenna load through an impedance-inverting network. Side-band currents are supplied to the load by a class B amplifier which feeds in-phase current to the load for modulation in the upward direction and out-of-phase current for downward modulation. This amplifier may be overbiased so as to absorb negligible power for the unmodulated condition and distortion kept low by the use of feedback.

A small, experimental transmitter with feedback supplied is described. Efficiencies up to 80 per cent (unmodulated condition) were obtained by this transmitter.

## 48. WIDE-BAND AMPLIFIERS FOR TELEVISION

H. A. WHEELER

(Hazeltine Service Corporation, New York, N.Y.)

The maximum uniform amplification that can be secured over a wide frequency band by means of a single vacuum tube is much greater than that of the usual simple circuits. It can be secured by either of two arrangements, one using an individual filter coupling each tube to the next, and the other using degenerative feedback in each stage to make the stage behave as a section of a confluent filter. In either case, the shunt capacitance on each side of each tube is included in an individual full-shunt arm of a band-pass (or low-pass) filter. One end of each interstage filter, or of each filter including one or more feed-back stages, is extended to a dead-end termination with resistance approximately matching the image impedance. The other end is terminated at one of the tubes in a full-shunt arm, where the filter presents the maximum uniform impedance that can be built up across the tube capacitance. These concepts in terms of wave filters lead to practical wide-band circuits adapted to meet any given requirements.

The following general formula is shown to express the maximum uniform amplification that can be secured in one tube:

$$A = \frac{g_m}{\pi f_w \sqrt{C_o C_p}}$$

in which

$A$  is the voltage ratio between input and output circuits of equal impedance,  
 $g_m$  is the transconductance of the tube,  
 $C_o$  and  $C_p$  are the grid and plate capacitance of the tube, and  
 $f_w$  is the width of the frequency band.

## 16. A PUSH-PULL ULTRA-HIGH-FREQUENCY BEAM TETRODE

A. K. WING

(RCA Manufacturing Company, Inc., Harrison, N.J.)

The design of a vacuum tube capable of delivering 10 watts useful power output at frequencies of the order of 250 megacycles and with a direct plate volt-

age of 400 and good economy of space and cathode power is discussed. In order to keep the physical dimensions of the tube small and to make it adaptable to straightforward circuit arrangements, the tube was designed as a push-pull beam tetrode. The unusual constructional features include the use of short, heavy leads sealed directly into the molded glass bulb.

Characteristics of the tube are given. Tests show that the tube will operate as a stable class C amplifier at frequencies up to 300 megacycles. At that frequency a power output of the order of 8 watts with an efficiency of 25 per cent has been obtained. Satisfactory operation as a frequency multiplier or oscillator has also been obtained in the same frequency range. The variation of output and efficiency with frequency is shown.

### 36. A VOGAD FOR RADIOTELEPHONE CIRCUITS

S. B. WRIGHT, S. DOBA, AND A. C. DICKIESON  
(Bell Telephone Laboratories, Inc., New York, N.Y.)

Commercial radiotelephone connections must generally be accessible to any telephone in an extensive wire system. Speech signals delivered to the radio terminals for transmission to distant points vary widely in amplitude due to the characteristics of the wire circuits and individual voices. To provide the best margin against atmospheric noise, it is usually the practice to equalize this wide range of speech amplitudes and thus drive the radiotelephone transmitter at its full capacity.

Many devices have been proposed to adjust automatically the gain in a circuit to equalize speech volumes. The difficulties of providing a device which will respond properly over a wide range to the complex qualities of a speech signal have only recently been overcome to a satisfactory degree.

The voice-operated gain-adjusting device, or "vogad," described in this paper is a practical design based upon more than a year's experience with one of the most promising devices made available by earlier development effort. A trial installation of this latest vogad is now under way at Norfolk in connection with a new radiotelephone system for harbor and coastal service.

### 34. ELECTROSTATIC ELECTRON MULTIPLIER

V. K. ZWORYKIN AND J. A. RAJCHMAN  
(RCA Manufacturing Company, Inc., Harrison, N.J.)

A practical secondary-emission multiplier should be capable of handling large currents, easy to construct and activate, and should require no focusing adjustment. One or more of these qualifications is shown to be lacking in the earlier magnetic and electrostatic multipliers.

The design problem of an electrostatically focused photoelectric multiplier meeting these requirements is discussed, particular emphasis being given the electron-optical aspect. In the solution of this problem, two methods of determining electron trajectories are found convenient. The first involves the use of an electrolytic potential-plotting tank and simple graphical methods of obtaining electron paths. For the second, use is made of the analogy between the motion of a sphere rolling on a suitably stretched rubber membrane and that of an electron in an electrostatic field.

Several multipliers designed by these methods are described and their performance analyzed. Certain special problems, such as methods of separating the photocathode and multiplying stages by partitions, are also discussed.

### Board of Directors

The regular montly meeting of the Board of Directors was held in the Institute office on May 4, 1938 and attended by Melville Eastham, treasurer and acting chairman; E. H. Armstrong, H. H. Beverage F. W. Cunningham, Alfred N. Goldsmith, Virgil M. Graham, O. B. Hanson, L. C. F. Horle, C. M. Jansky, Jr., A. F. Murray, B. J. Thompson, H. M. Turner, and H. P. Westman, secretary.

V. K. Zworykin was transferred to Fellow grade and J. D. Crawford was transferred to Member grade. Forty-four new Associates, two Juniors, and twenty-one Students were elected to membership.

It was decided that starting with the January, 1939, issue, the PROCEEDINGS format would be changed. A trim size of 8½ inches by 11 inches will be adopted together with a number of other changes which include a new cover design, a rougher finish paper, and a new type face.

Upon the recommendation of the Awards Committee, the Medal of Honor for 1938 will be presented to J. H. Dellinger for his contributions to the development of radio measurements and standards, his researches and discoveries of the relation between radio-wave propagation and other natural phenomena, and his leadership in international conferences contributing to world-wide co-operation in telecommunications.

The Morris Liebmann Memorial Prize will be presented to G. C. Southworth for his theoretical and experimental investigations of the propagation of ultra-high-frequency waves through confined dielectric channels and the development of a technique for the generation and measurement of such waves.

The PROCEEDINGS paper prize, voted at the March, 1937, meeting of the Board of Directors, will be presented to A. L. Samuel for his paper on "A Negative-Grid Triode Oscillator and Amplifier for Ultra-High Frequencies" which appears on pages 1243 to 1253 of the October, 1937, PROCEEDINGS.

No agreement was reached as to the future of this prize.

The report of the Nominations Committee was received and the actions of the Board of Directors follows this report.

The reports submitted by the Standards Committee on definitions for radio receivers and transmitters and antennas, and on tests of radio broadcast receivers, were approved. These will be published and distributed to all members of the Institute.

---

## Nominations

In accordance with the Constitutional requirements, there is re-published below Article VII of the Institute Constitution.

### ARTICLE VII

#### NOMINATION AND ELECTION OF PRESIDENT, VICE PRESIDENT, AND THREE DIRECTORS AND APPOINTMENT OF SECRETARY, TREASURER, AND FIVE DIRECTORS

SEC. 1—On or before July 1st of each year the Board of Directors shall call for nominations by petition and shall at the same time submit to qualified voters a list of the Board's nominations containing at least two names for each elective office, together with a copy of this article.

Nomination by petition shall be made by letter to the Board of Directors setting forth the name of the proposed candidate and the office for which it is desired he be nominated. For acceptance a letter of petition must reach the executive office before August 15th of any year, and shall be signed by at least thirty-five Fellows, Members, or Associates

Each proposed nominee shall be consulted and if he so requests his name shall be withdrawn. The names of proposed nominees who are not eligible under the Constitution, as to grade of membership or otherwise, shall be withdrawn by the Board.

On or before September 15th, the Board of Directors shall submit to the Fellows, Members, and Associates in good standing as of September 1st, a list of nominees for the offices of President, Vice President, and three Directors. This list shall comprise at least two names for each office, the names being arranged in alphabetical order and shall be without indication as to whether the nominees were proposed by the Board or by petition. The ballot shall carry a statement to the effect that the order of the names is alphabetical for convenience only and indicates no preference.

Fellows, Members, and Associates shall vote for the officers whose names appear on the list of nominees, by written ballots in plain sealed envelopes, enclosed within mailing envelopes marked "Ballot" and bearing the member's written signature. No ballots within unsigned outer envelopes shall be counted. No votes by proxy shall be counted. Only ballots arriving at the executive office prior to October 25th shall be counted. Ballots shall be checked, opened, and counted under the supervision of a Committee of Tellers, between October 25th and the first Wednesday of November. The result of the count shall be reported to the Board of Directors at its first meeting in November and the nominees for President and Vice President and the three nominees for Directors receiving the greatest number of votes shall be declared elected. In the event of a tie vote the Board shall choose by lot between the nominees involved.

SEC. 2—The Treasurer, Secretary, and five appointive Directors shall be appointed by the Board of Directors at its annual meeting for a term of one year or until their successors be appointed.

In accordance with the above, the Board of Directors submits below its nominations for the following elective offices:

*For President—1939*

R. A. Heising

C. B. Jolliffe

*For Vice President—1939*

P. O. Pedersen

G. A. Mathieu

*For Directors—1939—1941*

H. A. Chinn

F. B. Llewellyn

Virgil M. Graham

A. F. Murray

R. A. Hackbusch

B. J. Thompson





TECHNICAL PAPERS

STATUS OF INSTRUMENT LANDING SYSTEMS\*

BY

W. E. JACKSON

(Chief, Radio Development Section, Safety and Planning Division, Bureau of Air Commerce,  
Department of Commerce, Washington, D. C.)

*Summary*—During the past ten years a large number of instrument landing systems have undergone development and tests and a considerable fund of information has been accumulated concerning the shortcomings and advantages of each. The major airlines of the United States, the Federal Communications Commission, the Bureau of Air Commerce, and the Subcommittee on Instrument Landing Devices of the Radio Technical Committee for Aeronautics have reached an agreement as to the fundamental elements which should be incorporated in a practical instrument landing system and have also outlined a program of projected development. Having this agreement, it is now possible for all interested organizations to proceed with the perfection of a practical system by combining the superior features of the systems which have been tested and to carry on development which will further augment this system. At present, the major airlines are planning to install a number of instrument landing systems, having the fundamental elements agreed upon by the above-mentioned organizations, to be used on an experimental and pilot-training basis. It is recommended that the Bureau of Air Commerce sponsor further development of instrument landing equipment until it meets the approval of all concerned with regard to operation, reliability, and ease of maintenance as well as fundamental elements. When this condition is reached, it is recommended that the Bureau of Air Commerce purchase, install, and operate a number of these instrument landing systems at various airports throughout the United States on an experimental basis.

INTRODUCTION

ABOUT the time that directional radio facilities were being considered as an aid to the navigation of aircraft under conditions of restricted or zero visibility, it became apparent that, with further modifications, directional radio transmission could be utilized to assist a pilot in landing an airplane where a low or zero ceiling prevailed. Although some work was done as early as 1919, no especially promising results were obtained until about 1929 when the Bureau of Standards produced a complete instrument landing system. Following this, several solutions to the problem have been proposed, all of which can be grouped as follows: first, those which employ radio transmis-

\* Decimal classification: R526.3. Original manuscript received by the Institute, January 10, 1938. The views expressed in this report are those of the writer and not necessarily of the Bureau of Air Commerce or the Department of Commerce.

sion merely as a means of enabling an airplane pilot to orient himself in a horizontal plane, after which he must depend on an altimeter in making the final landing maneuver; second, arrangements in which radio transmission supplies the pilot with both lateral and vertical guidance using the altimeter only to check the radio indications; and third, methods employing a medium other than radio for the transmission of landing information to the pilot. In this report, progress in the development of systems falling under the first two classifications will be outlined. Study and development of methods falling under the third group is progressing and will be made the subject of a later report.

#### DESCRIPTION AND DISCUSSION OF DEVELOPMENT

##### *Bureau of Standards Developments*

In 1919 the Bureau of Standards developed experimentally a radio system to aid airplanes landing during poor visibility. The system comprised the use of a direction finder in the airplane in conjunction with a marker beacon to localize the landing field.<sup>1</sup> The marker beacon employed two horizontal loop antennas, one above the other. It produced a vertical distribution of intensity, including a cone of silence, which effectively indicated a position with respect to the landing field. The transmitter used was a half-kilowatt spark transmitter operating on approximately 300 kilocycles.

In 1928 the Bureau of Standards developed for the Aeronautics Branch of the Department of Commerce (now the Bureau of Air Commerce) a blind-landing system comprising a radio range in conjunction with marker beacons. In this system, the radio range is placed near the landing field and one course is aligned with the runway on which it is desired to land. One or more marker beacons are located on the course at suitable distances from the desired point of landing to give the pilot an indication of his distance therefrom and thereby to assist him in suitably controlling the altitude of his airplane as indicated by either a barometric or an absolute altimeter. A report outlining this system was submitted to the Daniel Guggenheim Fund for the Promotion of Aeronautics in 1928. A runway localizer (radio range with course aligned with runway) and marker beacon were installed by the Bureau at Mitchel Field in 1929 for blind-landing experiments.<sup>2</sup> Using the runway localizer and its cone of silence as a

<sup>1</sup> Gregory Breit, "The field radiated from two horizontal coils," Bureau of Standards Scientific Paper No. 431, 1922. U. S. patents, Loop Antenna, No. 1,898,474, filed June 26, 1919, and Aircraft Landing System, No. 1,555,345, filed January 19, 1929.

<sup>2</sup> Pamphlets by the Guggenheim Foundation for Aeronautics "Solving the problem of fog flying," October, (1929) and "Equipment used in experiments to solve the problem of fog flying," March, (1930).

marker beacon, J. H. Doolittle of the Guggenheim Fund made the first successful instrument landing in history on September 24, 1929. Other landings were made in later months, using both the marker beacon and the runway localizer. This type of system, comprising only the radio-range and marker beacons, is sometimes called a radio-approach system.

Doolittle did notable work on the development of the nonradio instruments required in making an instrument landing, and on their grouping on the instrument panel to facilitate use by the pilot. He was one of the first to recognize the need for an artificial-horizon instrument and a directional gyroscope and co-operated with the Sperry Development Company in their design. Both of these instruments and many of his ideas for instrument grouping have since been generally adopted in aviation.

These systems provided the pilot with lateral and longitudinal guidance. The important step of providing guidance in the vertical plane, thus achieving a complete three-dimensional system, was conceived by the Bureau of Standards in 1929.<sup>3</sup> To the equisignal runway localizer and the marker beacons was added a beam in the vertical plane which provided a constant-intensity glide path of convenient shape for easy landing. The equipment was set up and the system developed at College Park, Maryland. The glide path was obtained from an ultra-high-frequency transmitter utilizing a horizontally polarized directive array operating on 90.8 megacycles. The runway localizer utilized small multiturn loops which operated on 278 kilocycles. The marker beacons used long low transmission-line antennas and operated on 3105 kilocycles. A complete monitoring system was added. The first blind landing with this system was made by pilot M. S. Boggs at College Park, September 5, 1931. A second installation was made by the Bureau of Standards at Newark, New Jersey, in 1933, where over a hundred blind landings were made.<sup>4</sup> A third installation was made by the Bureau of Standards at Oakland, California, in 1934. The system was planned to require a minimum of manipulation of radio controls by the landing pilot and to simplify the interpretation of the radio signals received. To this end, visual runway-localizer and landing-beam-course indications were provided on a single crossed-pointer instrument, the need for volume-control manip-

<sup>3</sup> H. Diamond and F. W. Dunmore, "A radio beacon and receiving system for the blind landing of aircraft," *Bur. Stand. Jour. Res.*, vol. 5, pp. 897-931, (1930), (RP238); *Proc. I.R.E.*, vol. 19, pp. 585-626; April, (1931); and in brief, in *Air Com. Bull.*, vol. 2, pp. 79-87; August 15, (1930).

<sup>4</sup> H. Diamond, "Performance tests of a radio system of landing aids," *Bur. Stand. Jour. Res.*, vol. 11, pp. 463-490, (1933), (RP602), and in brief, *Air Com. Bull.*, vol. 4, pp. 441-447; March 15, (1933), and vol. 4, pp. 525-527; May 1, (1933); *Proc. I.R.E.*, vol. 22, pp. 120-121; January, (1934), (abstract).

ulation was eliminated, and distinctive modulation of the approach and boundary marker beacons was employed.

During 1933 and 1934, test flights of the Newark installation by air transport pilots in airplanes equipped for the purpose by the United Air Lines and Transcontinental Western Air served to indicate the practicability of the fundamental principles of the system and pointed to desired improvements. Reduction of cost of the ground-station equipment, elimination of the slight bends in the runway-localizer course caused by the presence of railroad tracks, power lines, etc., and increase of the slope of the landing path were desired. The Bureau of Standards co-operated in the tests and, at College Park, continued its work on improving the system. Tests were made on a combined runway-localizer and landing beam operating on a single ultra-high frequency, and on a method for placing the landing beam (or the combined system) in a pit at the center of an airport in order to increase the slope of the landing path and to afford service for all wind directions.<sup>5</sup> The simplification of the combined system when using vertically polarized waves led to a study of the relative advantages of horizontal and vertical polarization; this study revealed that horizontal polarization was preferable for safe use of the landing beam, inasmuch as the glide path would drop with snowfall when using vertically polarized waves whereas the glide path would rise with horizontally polarized waves under similar conditions. Reverse directional effects in the runway-course indications when using horizontally polarized waves led to the development of special non-directional receiving antennas to overcome this effect.

#### *Airways Division Development*

In 1933 the Airways Division of the Department of Commerce developed and installed at Newark, N. J., what is probably the simplest instrument landing system.<sup>6</sup> It used the conventional radio range augmented by an omnidirectional radio marker and a Kollsman altimeter on the airplane. In this system the radio range is located about two miles from the airport and has one course aligned with the runway on which instrument landings are to be made. The marker transmitter and its antenna are located on the radio-range course 1000

<sup>5</sup> H. Diamond and F. W. Dunmore, "Experiments with underground ultra-high-frequency antenna for airplane landing beam," *Nat. Bur. Stand. Jour. Res.*, vol. 19, pp. 1-19, (1937), (RP1006); *Proc. I.R.E.*, vol. 25, pp. 1542-1560; December, (1937).

<sup>6</sup> Pender and McIlwain, "Blind Landing Aids, Electrical Engineers' Handbook," (Communication and Electronics), pp. 16-48, John Wiley, (1936).

feet outside the airport boundary. A carrier frequency differing from that of the radio range by one kilocycle is used for the marker transmitter. In addition, it is modulated by an audio frequency several hundred cycles below the range modulating frequency.

In order to make a landing through the use of these facilities, the pilot approaches the airport flying at 1000 feet on the course which is the reciprocal of that projecting along the runway. As the airplane passes over the radio range, the pilot observes the cone of silence and immediately reduces the speed of his engines and puts the airplane into a normal glide. As the letdown is continued, the airplane is held on the radio-range course using a directional gyrocompass bearing as a check. When the marker-beacon signal is detected, the airplane should have descended to 100 feet, and this provides the pilot with a check on his progress in the letting-down maneuver. If the airplane has been gliding at the proper angle, this altitude will have been reached and the pilot can proceed to land on the runway. Otherwise, he must climb to 1000 feet and repeat the procedure, making such corrections in the airplane speed as appear necessary to compensate for wind velocity.

A variation in this system was installed at Washington, D. C., in 1933 and is described in detail in the reference.<sup>7</sup> It utilizes an additional radio marker installed  $2\frac{1}{2}$  miles distant from the airport boundary on the course selected for instrument landings. It operates on the same radio frequency as the boundary marker and is modulated by two audio frequencies keyed alternately. The modulation frequency of the boundary marker is not keyed and differs from both of the outer-marker modulations. Also, the radio-range beacon is located on the side of the airport opposite that on which the markers are situated. The procedure followed is different from that of the first system in that the pilot makes his approach flying toward the range station rather than away from it and the signal from the outer marker instead of the radio-range cone of silence is used to warn the pilot that he should begin his glide. Much of the success of either system depends on the accuracy of the barometric altimeter, none of which at the present time can be relied upon to give a reading having a tolerance of less than plus or minus 40 feet. For this reason, instrument landings with either system are not considered feasible since the possibility of undershooting or overshooting the landing area is too great. However, these facilities do assist the pilot to fly in under a 100-foot ceiling and make a contact landing.

<sup>7</sup> "Radio approach system assists airmen to land under low ceilings," *Air Comm. Bull.*, p. 165, January 15, (1934).

### *Early Development of the Lorenz System*

In 1933, Kramar described a blind-landing system which had been tested in Europe. It consisted of an ultra-high-frequency transmitter operating on a frequency of 43 megacycles, which was so located with respect to the airport that an instrument landing could be made. A pilot making a landing with this system first flew over the cone of silence at an altitude of 650 feet. At this elevation, the cone of silence lasted approximately 4 or 5 seconds, depending on the speed of the airplane. Immediately after passing through the cone of silence, the glide to the airport was begun and the airplane was maneuvered along a radio-range course at a gliding angle which would permit it to contact the runway at the proper point.<sup>8</sup>

### *Army Development*

In 1932 and 1933, the Air Corps at Wright Field under the direction of Hegenberger developed an instrument landing system which was unique in its simplicity of operation and the flexibility with which it could be used under varying wind conditions. This system was adopted by the Bureau of Air Commerce and installations were begun at 36 airports throughout the United States.<sup>9</sup> This program was never completed—due primarily to the fact that a majority of the airlines felt that it did not give sufficiently precise indications for safe commercial use. This system is described in the *Air Commerce Bulletin*,<sup>9</sup> by Jackson,<sup>10</sup> and by Jackson and Hromada.<sup>6</sup> The major disadvantage of the Army approach system was that it did not give a precise absolute altitude indication, since that furnished by the Kollsman sensitive altimeter could only be relied upon within plus or minus 40 feet under all practical conditions. Furthermore, it did not provide a well-defined lateral path, but gave a radio-compass heading which would continually change with any cross-wind component. The major advantage of the Army system was that it was simple to fly, which made it possible for the pilot to orient himself quickly and placed no extra burden on the pilot as he followed the radio-compass indicator.

### *Washington Institute of Technology Development*

In 1933, the Washington Institute of Technology was organized for the purpose of further developing and commercializing the Bureau of Standards instrument landing system.

<sup>8</sup> E. Kramar, "A new field of application for ultra-short waves," Proc. I.R.E., vol. 21, pp. 1519-1532; November, (1933).

<sup>9</sup> "Army air corps radio blind landing system adopted as standard by Bureau of Air Commerce," *Air Comm. Bull.*, vol. 5, p. 107.

<sup>10</sup> W. E. Jackson, "Modern aircraft radio," *Nat. Safety News*, October, (1935); *Shell Aviation News*, February, (1936); *Revista de Aeronautica*, April, (1936).

In 1935 this organization produced an experimental setup utilizing the A-I visual-indication method developed by the Bureau of Air Commerce, but, after a short period of flight testing by the United Air Lines, the use of the A-I indicator for the localizer was abandoned. This system consisted of a glide path operated on approximately 93 megacycles, the visual-runway localizer operated on a frequency of 278 kilocycles, and an aural marker beacon on the same frequency as the runway localizer. All of the ground equipment, except the marker beacon, was mounted in an automobile trailer to permit the operation of the system in any direction. Concrete platforms and power outlets for the trailer were provided at the end of each runway. The trailer could be towed to the position best suited for the particular weather condition at the time of landing.

The localizer transmitter had a frequency of 278 kilocycles and a power output of approximately 400 watts transmitting into small multiturn loops enclosed within the trailer. The keying used was that of the A-I system, that is, an "I" transmitted into one loop while an "A" was transmitted into the other loop. The small loops gave very poor radiation efficiency so that the maximum distance over which the range could be used was approximately 15 miles under favorable conditions and less than 2 miles under heavy static conditions.

The glide-path transmitter operated at a frequency of approximately 93 megacycles and had an output of approximately 400 watts. The antenna array utilized horizontal polarization and consisted of 4 half-wave antennas fed in phase and four reflectors. This entire antenna array was mounted on the trailer. The only difficulty obtained in connection with the glide path was that, because of the short runway at College Park, it was necessary to adjust the path so that it was relatively steep and the point of contact fairly close to the transmitter, giving only a few hundred feet for the plane to roll after contacting the ground. This would be eliminated on a larger airport by using either a higher sensitivity setting on the receiver or more power at the transmitter. Under these circumstances the path would be identical to all systems using horizontally polarized waves.

The marker beacon consisted of a transmitter having a frequency of 278 kilocycles and a maximum power output of approximately 4 watts. The carrier was modulated at 1200 cycles. The antenna system consisted of a single insulated wire laid on the ground.

A complete monitoring system was provided whereby the equipment could be turned on or off at a remote point. Monitor lights were provided which indicated when the transmitters were on or off. In addition, each transmitter was provided with a cutout relay which was designed automatically to remove power from the transmitter if

its output varied appreciably from normal, thus precluding the possibility of radiating incorrect signals. A visual indicator device used in the aircraft to indicate the right or left of the course was similar to the A-I indicator, originally developed by the Bureau of Air Commerce.

After these tests, the Washington Institute of Technology then continued the development of a double-modulation localizer based on the principle originally employed in the Bureau of Standards system; that is, one loop was modulated at a frequency of 65 cycles, while the other was modulated at 86.7 cycles. A novel method of accomplishing this modulation was adopted which resulted in a great improvement over the earlier scheme. Originally the transmitter had dual output radio-frequency amplifier channels, each of which was modulated at one of the two frequencies mentioned above. Each power amplifier independently excited one of the loops. The most serious objection to this arrangement was that any change in emission of the tubes in either channel caused localizer-course variations. To overcome this difficulty, a single power amplifier was used with direct-current plate supply. Modulating means, not including any vacuum tubes, were connected to the output of the tank circuit and the output of each of these was supplied to one of the loops. One loop was then modulated at 65 cycles, and the other at 86.7 cycles. This arrangement had the advantage that variations in emission varied each of the figure-of-eight patterns simultaneously, and the course alignment was not affected. The course indications were furnished to the pilot by means of a conventional cross-pointer type of meter, using a reed converter similar to that originally used by the Bureau of Standards.<sup>11</sup>

The original converter has been somewhat redesigned mechanically and a major improvement in calibration procedure developed which gives the device a high degree of service reliability.

Another type of converter unit has been developed, interchangeable with and even lighter than the reed converter, which is known as the torsional type of converter. This type of indicator will be adopted if extensive flight tests prove its superiority over the original reed type of converter.

Although only one trailer platform was established at College Park during the tests with the United Air Lines in 1935, extensive tests conducted since then have shown that not only will the equip-

<sup>11</sup> F. W. Dunmore, "A course indicator of pointer type for the visual radio range-beacon system," *Bur. Stand. Jour. Res.*, vol. 7, pp. 147-170, (1931), (RP336); *Proc. I.R.E.*, vol. 19, pp. 1579-1605; September, (1931).



ment stand up under usage far more severe than that to be encountered on any airport, but also that stable and reproducible courses are obtained by means of the positioning platforms used to locate the trailer. Improvements in the trailer and the method of coupling make possible the change from one position to another a matter of a few minutes.

The present equipment for conducting service tests incorporates a 91-megacycle glide-path transmitter, a medium-high-frequency localizer, and a marker beacon on the localizer frequency, all crystal controlled. The major disadvantage with this system and all other systems using runway localizers operating on relatively low radio frequencies is the fact that the use of these frequencies is apt to give numerous bends and multiple courses which make it difficult, if not impossible, for the pilot to land on an airport consistently under blind conditions. As soon as sufficient data are accumulated on the operation of an ultra-high-frequency localizer, this equipment will be substituted.

#### *Transcontinental and Western Air Development*

In 1935, Transcontinental Western Airlines developed a combination glide-path and localizer unit at the Kansas City airport using a frequency of 85 megacycles. The equipment was crystal controlled and a satisfactory straight path was obtained. However, considerable difficulty was encountered because of variations in the altitude of the glide path when crossing over a river and a dike near the river's edge. This discontinuity in the path was considered to be a serious objection and it was not until later that it was determined that vertically polarized waves were responsible for the discontinuity.

#### *Bureau of Air Commerce Developments*

In 1935 the Bureau of Air Commerce of the Department of Commerce conducted further tests at Newark, New Jersey, on a glide-path system on 93 megacycles and on a localizer system on 227 kilocycles. The localizer was modified to operate on a single side band with a symmetrically disposed vertical antenna continuously excited by a carrier 1020 cycles lower than the single side band. With this system, automatic volume control operated from the carrier could be used and it also permitted simultaneous operation of the radio compass in addition to making it possible to transmit voice communication from the carrier antenna. The course indications were obtained by keying the single side band with "I" and "A" and obtaining a visual indication by energy derived from the transient power. An objection-

able feature of this system was that it gave a kicking indication to the pilot. This caused considerable eyestrain and required an unnecessary amount of concentration to determine whether the plane was gradually approaching or leaving the course. Another difficulty was that static caused the visual indicator to give erroneous course indications, thus making it difficult to fly an accurate course during atmospheric conditions. A further objection to the use of the transient type of visual indicator was the inherently broad-course indication which made accurate flying impossible.

Due to the concentration of traffic at the Newark airport, the entire equipment was moved to Indianapolis, at which point further tests were conducted on this system. After a considerable number of tests, it was determined that it was unnecessary to transmit voice over the carrier antenna, and, furthermore, that the courses obtained were 41 per cent wider, when using this type of transmission than when using the two loops without the vertical antenna. In addition to this, there were the kicking difficulties outlined previously and the kicking meter was abandoned.

Modifications were then made which made use of extremely high speed dots on one side of the course and dashes on the other, each dash having a length 5 times that of one of the dots. It was then possible to obtain a smooth on-course indication. This proved to be much more satisfactory than the kicking-needle type used with the I-A system. However, due to mechanical imperfections in the fast keying of the dots which were at the rate of 600 per minute, random transients were produced by key clicks caused by the link-circuit relay contacting both sides or because of spaces occurring between the dots and dashes tending to give occasional course-indicator fluctuations which were annoying to the pilot. Furthermore, flight tests indicated that the pair of courses in line with the runway were free from key clicks and coincided aurally and visually whereas the pair of courses normal to the runway were found to be located properly aurally although key clicks were apparent, but rotated 8 degrees clockwise on the visual indicator. This error was caused by a key-click figure-of-eight pattern, the axis of which was normal to the runway. This parasitic key-click pattern combined with the normal figure-of-eight patterns to produce a visual course 8 degrees off the true course. Due to the difficulties involved in maintaining the link-circuit-relay adjustment in a mechanically perfect condition, it was decided to abandon the high-speed keying system in favor of a visual system using a mechanical modulator which produced 65-cycle modulation in one loop and 86.7-cycle modulation in the other loop. A

mechanical modulator has been constructed and tests with it are about to be conducted. It is anticipated that the mechanical modulator will overcome all the faults found in previous visual localizer transmitters.

Another improvement made at Indianapolis was to locate the glide-path antenna so that the axis of the beam was projected across the runway at an angle of approximately 13 degrees. Tests indicated that this method was entirely practicable in pushing the point of contact farther out on the field and at the same time preventing the structure housing the antenna array from being a hazard.

Tests on the low-frequency runway localizer at Newark indicated that both multiple courses and bent courses prevailed whereas at Indianapolis using the same frequency under ideal conditions no vagaries were observed. Based on these observations together with the experience gained from other instrument landing installations and radio-range stations located throughout the United States using these low radio frequencies, it would appear that these frequencies are not well suited to provide a straight localizer course. However, experience indicates that the solution to this problem is the use of ultra-high frequencies, provided care is exercised in properly locating the localizer with respect to reflecting objects such as hangars, gas tanks, towers, and buildings. Tests are now being conducted at Indianapolis to determine the feasibility of replacing the low-frequency localizer with an ultra-high-frequency localizer.

#### *Later Development of the Lorenz System*

In 1934 and 1935 E. Kramar of the Lorenz Company in Germany developed a unique and simplified blind-landing system.<sup>12, 13, 14</sup> This system consisted of the same elements originally used by the Bureau of Standards; that is, glide-path, runway radio-range localizer, marker beacons, and monitor system. The glide path and the localizer were combined into one transmitter and radiating system. The transmitter was operated on 33.3 megacycles, and excited a vertical half-wave radiator. On each side of the vertical radiator, a reflector was located with a relay at its center. One reflector was keyed by dots while the other reflector was keyed by dashes. By interlocking the dots and dashes, two elliptical patterns were obtained, the major axes of which

<sup>12</sup> E. Kramar, "The present state in the art of blind landing of airplanes using ultra-short waves in Europe," *Proc. I.R.E.*, vol. 23, pp. 1171-1182; October, (1935).

<sup>13</sup> "Lorenz blind landing system," *Wireless World*, p. 332, April 5, (1935).

<sup>14</sup> "Landing aircraft by sound," *Wireless World*, p. 627, June 26, (1936).

were parallel to the on course. Only one pattern was present at a time, inasmuch as a single source of energy is used to supply the energy in both patterns. These alternately keyed patterns produced an equi-signal zone, which gave two courses. The carrier energy was modulated at 1150 cycles, and the usual type of aural radio-range courses were obtained with an interlocking signal. Visual indication was obtained by means of a rectifier circuit and amplifier which produced off-course indications either to the right or the left, depending upon whether dashes or dots were the predominant off-course signal. This indicator, however, gave a kicking-needle indication. The glide path was produced by the presence of a field pattern in the vertical plane. A field-intensity line of constant amplitude was selected and followed directly to the airport. The outer marker was located approximately 1.9 miles from the airport. The inner marker was located approximately 0.19 mile from the airport. Each of the markers transmitted on a frequency of 38 megacycles. The outer marker was modulated at a frequency of 700 cycles and keyed with dashes 4/10 of a second long. The inner marker was modulated at a frequency of 1700 cycles and keyed with dots 1/15 of a second long. Each marker gave an aural indication in the headphones of the pilot in addition to lighting an individual light on the instrument panel. A complete remote-control apparatus was provided which constantly checked the operation of all units.

#### *Tests at Indianapolis of Lorenz System*

Through the courtesy of the International Telephone and Telegraph Company, one complete set of equipment was installed at the Indianapolis airport for test purposes. Receiving equipment was also furnished to the Bureau of Air Commerce and to several of the airlines. These tests indicated that approaches could be made to the field under conditions of low visibility and low ceilings with good reliability. However, there were several limitations to the use of this equipment. First, it was found that the radio range could be flown better aurally than visually. This was attributed to the fact that the needle indications were of the kicking type rather than of the smooth visual type, which was originally used in the Bureau of Standards installation. It was also found that if the transmitter was keyed with the "N" and "A" that pilots who were familiar with this form of keying could fly the radio-range localizer much better than with the dot-dash signals. When the equipment was originally installed, the course was approximately 6 degrees broad, which it is understood is the width desired in Europe. However, the consensus among all the pilots in

this country who flew this equipment was that the courses were too wide. A considerable amount of work was done in an effort to sharpen the course. When the course was narrowed to approximately 3 degrees, the results obtained were greatly improved. By further manipulation of the position and length of the reflectors, the course width was reduced to approximately 2 degrees. Even though this very definite improvement of course width was made, the consensus was in favor of a further reduction in the width of the course. It is felt that the difference in magnitude of the two patterns should be at least one decibel at a point  $1\frac{1}{2}$  degrees off the center of the course for adequate course sharpness with aural operation; however, with visual operation the difference in pattern magnitudes at the same position needs to be only 0.5 decibel provided the instrument is sufficiently sensitive to give a 10-degree pointer deflection 1.9 degrees off the center of the course.

Another serious difficulty observed was the fact that the glide path was smooth down to a point just beyond the end of the cement runway, at which point the glide path took a definite dive into the ground. Further tests indicated that this was primarily due to the fact that the radiation was vertically polarized and that probably the reinforcing steel in the runways caused a very definite change in the conductivity which affected the reflection coefficient sufficiently to give a very pronounced discontinuity in the glide path. This feature is considered a serious factor, inasmuch as a highway at the end of an airport would probably cause a discontinuity in the glide path. An opportunity has not yet been afforded to confirm this assumption. However, it is definitely known that, in the glide path at Kansas City, using vertically polarized waves at 85 megacycles, there was a discontinuity present in the glide path at the point where the waves crossed over the river. The Bureau of Air Commerce glide-path antenna at Indianapolis which was normally horizontally polarized was rotated so that vertically polarized waves were radiated. This system tuned to 91 megacycles definitely gave the same phenomena which were obtained on the Lorenz system using a frequency of 33.3 megacycles. From the data which are at hand, it is felt that horizontally polarized waves should be used for glide-path purposes.

The frequencies which were used in the Lorenz equipment, namely 33.3 and 38 megacycles, are not believed to be satisfactory for a blind-landing system which would be used universally due to the fact that reflection from the Heaviside layer would occasionally cause interference between stations separated by several thousand miles. Further, these frequencies can not be used in the United States, inasmuch

as this part of the spectrum is already crowded with police and forest-fire-patrol services. Another difficulty which was encountered with the Lorenz equipment was cross modulation in the audio-frequency amplifier which amplified both the marker-beacon frequencies and the radio-localizer, glide-path frequency. It was noted that when the ship was flown over the inner and outer marker beacons, energy from the marker beacons caused erroneous indications in the glide-path meter and the right-left indicator. This, however, was only for a short time interval and could easily have been eliminated by having separate audio-frequency amplifiers. It is understood that this difficulty will be eliminated in later equipment.

This system is unique in that it gives simultaneous visual and aural lateral indication. Furthermore, the simplicity with which the visual indication is obtained should not be overlooked. It is felt, however, that the advantage of having both the visual and aural indication is not sufficient where it is necessary to sacrifice the effectiveness of either indication for the purpose of obtaining both indications. Experience indicates that a visual indicator which operates smoothly and informs the pilot which side of the course he is off and the rate at which he is approaching or leaving the course is the type of indicator which is essential. This type of indication not only gives minimum eye fatigue, but has the advantage that automatic flight control may be readily attached to the meter circuits. Although experience has indicated that a fairly good instrument landing can be made with the aural N-A signals, it is not believed that this type of indication will be ultimately used.

Tests conducted with both the Lorenz and the Bureau of Air Commerce installations indicated that, for a given power, receiver sensitivity, and receiving antenna height, the point of contact using vertically polarized waves was at a distance considerably farther away from the antenna structure than when using horizontally polarized waves. This is a definite advantage in that one of the major limitations of the present system is that the point of contact must be so close to the transmitting antenna that insufficient room is left on the airport for the airplane to roll to a safe stop. Another obvious advantage of the Lorenz system is that a single vertical antenna on the aircraft is used for both the glide-path indications and the localizer indications. In addition to this simplification, only one receiver is required for both of these indications.

One of the most interesting features of the Lorenz system, pointed out by Kramar, is the fact that it is possible to calibrate the receiver by observing the glide-path indication at the moment the outer

marker is received. For example, let it be assumed that the airplane approaches the outer marker at 700 feet and observes the glide-path indicator at the moment the outer marker light on the dash operates. It is only necessary to maintain the same amplitude of the glide-path meter and follow the glide path down until contact is made. It is possible to determine the altitude at the outer marker by means of a Kollsman altimeter with an error of not more than plus or minus 40 feet and at this point select one of the constant-amplitude field-intensity lines and fly from the outer marker to the point of contact with the ground. All of the points of contact with the ground will be relatively close to one another for all absolute altitudes between 660 and 740 feet. From this, it may be seen that it is only necessary that the transmitter output be constant and the receiver sensitivity remain constant for a period of a little over a minute and a half. This simplicity of operation eliminates the necessity of maintaining the receivers with absolutely constant sensitivity adjustments and also eliminates the necessity of checking the receiver with a signal generator before making a landing. Experience has indicated that this method of operation is entirely practicable. Another outstanding feature of the equipment is that it is operated entirely on ultra-high frequencies which are free from the annoying effects of atmospheric interference.

#### *United Airlines and Bendix Development*

In 1934 the equipment originally installed at the Oakland airport by the Bureau of Standards was turned over to United Air Lines for further tests and improvements. Early in 1936 the Bendix Radio Corporation agreed to co-operate with United Air Lines in carrying on an extensive program of tests and improvements. The major improvements which were made with the assistance of the Bureau of Standards in an advisory capacity were the elimination of bends and multiple courses by using an ultra-high-frequency localizer; the use of electrical filters instead of vibrating reeds to separate the modulating frequencies; the use of a single transmitter for both the glide-path and course indication; and the use of a mechanical radio-frequency modulating device, which eliminated the possibility of course variations caused by emission differences in dual radio-frequency channels.

The improved system developed by Bendix and United Air Lines consisted of a crystal-controlled transmitter operated on 91 megacycles, which was used to excite simultaneously two horizontally polarized Yagi arrays. The major axes of each of the patterns produced by these two arrays were displaced by an angle of approximately 40 degrees. The field pattern radiated by each array was modulated by keying

the director next to the antenna on one of the arrays at 70 cycles, while the corresponding director on the other array was keyed at 90 cycles. This arrangement produced a combined glide-path and localizer course. One of the major difficulties to be overcome in this system was the fact that different headings of the ship would tend to give varying receiver outputs due to receiving-antenna directivity. This problem was solved by using a horizontal loop which had a nondirectional characteristic for horizontally polarized waves.

Another contribution was the utilization of the automatic pilot in blind landing. The method of application consisted essentially in getting on course with the plane headed in the proper direction, flying over the outer marker beacon at the proper altitude, and permitting the automatic pilot to fly the airplane as it descended to the runway. This arrangement greatly relieved the strain on the pilot inasmuch as it was not necessary for him to maintain the plane in the proper attitude while making a landing. The pilot was able to concentrate and interpret the indications of the cross-pointer instrument, making only slight adjustments to the controls of the automatic pilot as required. In effect, the airplane was flown down the glide path at approximately 90 miles per hour. After contact was made, the automatic pilot maintained the proper heading of the airplane while the throttles were slowly closed and the airplane was brought to a stop by brakes. Later in 1936 Transcontinental Western Airlines combined their efforts with United Air Lines and the Bendix Corporation to further the development of the system outlined above. During 1936 and 1937 approximately 3000 hooded landings were made on this system in a Boeing 247 and a Douglas DC-3 airplane by pilots from the various airlines, Army, Navy, and Bureau of Air Commerce.

#### *Fundamental Elements and Projected Development*

From the foregoing, it is evident that a considerable fund of knowledge has been gained from the numerous systems which have been described. Each of the systems has its limitations although some are better than others for making completely blind instrument landings consistently under service conditions. In general, it may be said that there are three essential elements in an instrument landing system, localizer, glide path, and markers. A monitor system is necessary in order to inform the landing-system operator that all elements are operating satisfactorily. An adjunct to the system, which is not described in this report is the use of approach lights for the purpose of providing the pilot or copilot with a double check in aligning the airplane with the runway under most conditions of poor visibility. These



lights, however, should be considered only as a supplemental aid to the instrument landing system using radio facilities. Approach lights are now being installed by the Bureau of Air Commerce at a number of airports.

Based on knowledge accumulated as a result of the experience described, the airlines, the Bureau of Air Commerce, the Federal Communications Commission, and the Subcommittee on Instrument Landing Devices of the Radio Technical Committee for Aeronautics have agreed on the fundamental elements which are necessary for a uniform instrument landing system. These elements are as follows:

### 1. Runway Localizer

- (a) The runway localizer should operate on an ultra-high frequency, preferably in the band 92 to 96 megacycles or, if the localizer transmitter is operated as a separate unit, in the band 108 to 112 megacycles.
- (b) Straight course; i.e., one which has no bends or multiple courses perceptible to a pilot flying in still air.
- (c) The difference in the magnitude of the two patterns of the localizer should be 0.5 decibel at 1.5 degrees either side of the center line as measured with a linear detector.
- (d) The vertical needle of the cross-pointer indicator should give a 10-degree deflection indication for a 1.9-degree angular deviation from the center line of the runway.
- (e) The range of use as a runway localizer should be 20 miles at 3000 feet.
- (f) Freedom from interference-pattern effects perceptible to the pilot both in elevation and azimuth.

### 2. Glide Path

- (a) The glide path should operate on an ultra-high frequency, preferably in the band 92 to 96 megacycles.
- (b) A smooth glide path should be provided; i.e., one which is free from interference-pattern effects perceptible to the pilot when on the localizer course.
- (c) The system should be capable of adjustment to provide a suitable glide path.

### 3. Markers

- (a) The markers should operate on 75 megacycles.
- (b) It should be possible to identify positively each marker both aurally and visually by modulation and keying. Modulation frequency of the inner marker should be 1300 cycles and that of the outer marker should be 400 cycles.

- (c) A normal arrangement of markers would be:
    - (1) At the normal intersection with the glide path.
    - (2) Near the boundary of the airport, the exact location to be determined by local conditions.
  - (d) The marker beacons should have an array adjustable so that when installed in the boundary position the beam will cause useful indications of a visual device within 700 feet either side of the on-course path and for 300 feet along the glide-path trajectory. Indications from this marker should be receivable to an altitude of 2000 feet.
  - (e) The outer markers should have sufficient power to accomplish a similar visual indication with the same beam pattern at 2000 feet.
4. Monitor System
- (a) Satisfactory means for indicating visually the operation of all equipment should be provided at a central point.
  - (b) Whatever form of visual indication may be employed should be smooth in performance and have no irregular characteristics.
5. General Characteristics
- (a) Frequency of emission of all of the elements of the system should be equivalent to that obtained with a low-temperature-coefficient quartz crystal.
  - (b) The number of fixed or portable equipments required will depend on conditions prevailing at individual airports.
  - (c) The installation of the foregoing equipment should not constitute an obstruction to a normal approach to a runway.
6. Approach Lights
- (a) The installation of the best known type of approach and runway lights appears to be a most desirable measure in combination with instrument landing facilities.
7. Projected Development

Additionally, certain desirable features should be provided depending upon the state of the art and experience obtained. These represent improvements over and above the performance to be obtained from the fundamental equipment and are in no sense a substitute for such equipment nor do they require the redesign or replacement of such equipment.

- (a) The inclusion of suitable emission for the operation of a radio compass either by
  - (1) the utilization of the ultra-high-frequency runway localizer if practicable, or

- (2) the installation of a low-powered low-frequency transmitter adjacent to the runway localizer.
- (b) The equipment provided should be so designed as to facilitate possible ultimate utilization (with accessories) in a fully automatic landing system in conjunction with a gyropilot.
- (c) Consideration should be given to possible separation of localizer and glide-path transmitter functions in order to
  - (1) permit alteration of glide path, and
  - (2) accomplish independence of horizontal and vertical indication.
- (d) Study should be made of the possibility for obtaining a straight-line constant rate of descent glide path.

Work is going forward in a number of agencies, including the Bureau of Air Commerce, along these lines.

#### CONCLUSIONS

The most satisfactory system is one that uses ultra-high frequencies for each of the three elements outlined in the foregoing. Ultra-high frequencies have the outstanding advantages of being practically free from atmospheric disturbances and of utilizing smaller and more efficient antennas for both plane and ground. With ultra-high frequencies, it is possible to obtain straight courses without bends or multiples by properly locating the localizer with respect to reflecting objects. In the majority of cases, it is impossible to obtain straight courses with low frequencies, particularly in the vicinity of irregular terrain, railroads, high buildings, and transmission lines. Straight localizer courses may be obtained using ultra-high frequencies with either vertically or horizontally polarized waves. With the glide path, however, it is necessary to use horizontally polarized waves in order to obtain a relatively smooth path to the point of contact with the runway. The markers should use horizontally polarized waves and the antenna array should have sufficient directivity to give a width-to-thickness ratio of at least four to one.

#### ACKNOWLEDGMENT

The author wishes to acknowledge the able assistance and co-operation of many people in the air-line companies, radio laboratories, and other government and commercial organizations, without whose valuable contributions this report and the results described therein would not have been possible.

## AN AUDIO-FREQUENCY-RESPONSE CURVE TRACER\*

By

JESSE B. SHERMAN

(RCA Manufacturing Company, Inc., RCA Radiotron Division, Harrison, New Jersey)

*Summary*—A device is described for automatically showing frequency-response characteristics of audio-frequency apparatus on the screen of a long-persistence cathode-ray tube, without mechanical equipment. This device can be used to trace a curve of output voltage on either linear or logarithmic scale versus frequencies from 20 to 15,000 cycles. The frequency scale can be either logarithmic or take special forms in which desired portions are expanded. Typical results of tests on amplifiers and electroacoustic equipment are presented.

### I. INTRODUCTION

THE point-by-point method of investigating frequency-response characteristics of audio-frequency apparatus is at once the simplest from the standpoint of required equipment, and the most cumbersome from the operator's viewpoint. The apparatus under test—an amplifier, for example—is supplied with a constant voltage at a number of frequencies successively and the corresponding output voltages measured; the data thus obtained are plotted with the frequency as logarithmic abscissas and the voltage output as linear or logarithmic ordinates. When the response curve displays rapid rates of change with respect to frequency, as in the case of electroacoustic equipment, the number of points required may become prohibitive for practical work.

Semiautomatic means of recording have been employed which greatly reduce the required labor. A drum carrying co-ordinate paper is driven in synchronism with the variable condenser of the beat-frequency generator supplying the signal; a pointer which is moved manually to follow the indications of an output meter is linked to a stylus which records ordinates on the rotating drum. While far superior to the point-by-point method, the accurate recording of an irregular curve with such equipment is tedious. An improvement consists in the use of a recording output meter, with synchronized drum as before, to make the operation entirely automatic.

The present paper describes a further contribution to the rapid investigation of audio-frequency-response characteristics. The indicator in this case is a cathode-ray tube with long-persistence screen, which permits the simultaneous observation and comparison of several different response curves.

\* Decimal classification: R388. Original manuscript received by the Institute, December 23, 1937. Presented before Rochester Fall Meeting, November 10, 1937; New York Meeting, March 2, 1938.

## II. GENERAL DESCRIPTION OF METHOD

The block diagram of Fig. 1 outlines the cathode-ray-tube method of investigating response curves. A relaxation oscillator employing an 885 gas triode supplies the control voltage to an automatic-frequency-control tube connected to the variable oscillator of a beat-frequency generator. The period of the relaxation oscillator is adjustable over a range of approximately 10 seconds to 1 minute; thus, the audio-frequency range is swept through in like time. Following the usual detector and amplifier circuits of the beat-frequency generator, the audio-

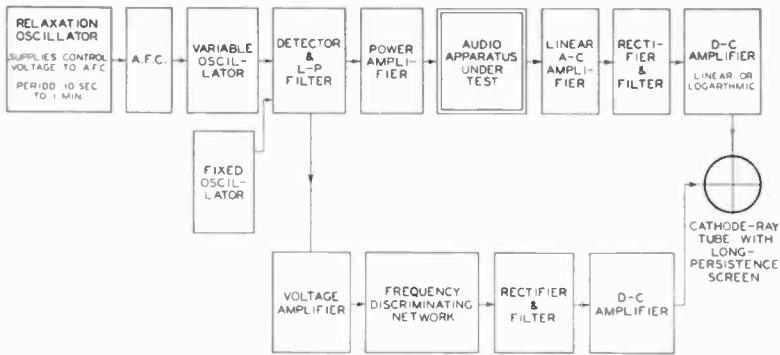

Fig. 1—Components of audio-frequency-response curve tracer.

frequency signal is applied to the apparatus under test. The audio-frequency output of this apparatus is then amplified if necessary, rectified, filtered, amplified by a direct-current amplifier, and supplied to the vertical deflecting plates of the cathode-ray tube. The direct-current amplifier furnishes deflecting voltage varying either linearly or logarithmically with input voltage, as desired.

The beat-frequency generator also delivers a signal through a separate amplifier to a network of resistances and capacitances which are so chosen that the output voltage of the network varies with frequency in some predetermined manner. The output of the network is rectified, filtered, amplified in a linear direct-current amplifier, and supplied to the horizontal deflecting plates of the cathode-ray tube. For constant voltage from the beat-frequency generator, the horizontal deflection of the cathode-ray spot will bear some preassigned relation to frequency depending on the choice of network.

Thus, during the period of the relaxation oscillator, the cathode-ray spot will describe a curve, the ordinates of which vary either linearly or logarithmically with the voltage output of the apparatus under test, and the abscissas of which indicate corresponding frequencies according to a selected scale. The persistence of the screen of the cathode-ray tube

used is such that the completed curve is visible in moderate light for approximately a half minute and for one to two minutes in a darkened room. Thus, a succession of curves may be "drawn" and compared for different conditions of the apparatus under test.

### III. FREQUENCY-DISCRIMINATING NETWORKS AND HORIZONTAL-DEFLECTING CIRCUIT

A response-frequency curve is usually plotted to a logarithmic frequency scale; hence, it is desirable to produce a horizontal deflection on the cathode-ray screen that follows this law. It is possible to design

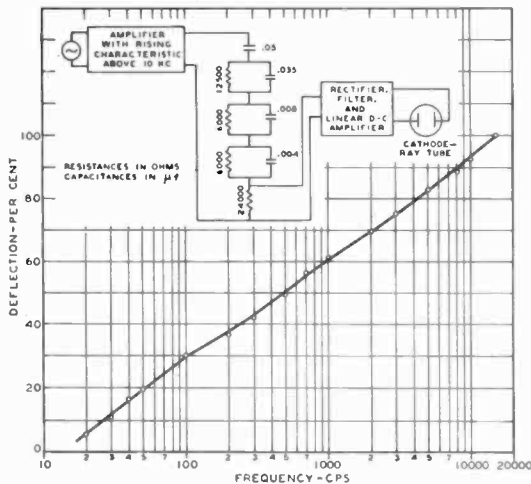

Fig. 2—Network for logarithmic frequency scale.

a network of resistances and capacitances such that its output voltage for constant input voltage will vary approximately as the logarithm of frequency over a considerable frequency range. Fig. 2 shows such a network, modified slightly to compensate for the rising high-frequency characteristic of the amplifier supplying it, so that the over-all characteristic of the horizontal-deflecting system is approximately logarithmic with respect to frequency from 20 to 15,000 cycles. The synthesis of such a logarithmic frequency network will be presented at a later date.

It is sometimes desirable to expand portions of a response curve (with respect to frequency) for closer examination than afforded by the over-all logarithmic frequency scale. Fig. 3 shows the characteristics of a simple network which can be used to expand one portion of the frequency scale and compress the remainder. The usefulness of these characteristics can be further increased by selecting one which just

starts to rise appreciably at the minimum frequency of interest, and then increasing the input voltage to the network until the maximum frequency of interest occurs at the desired maximum voltage. This maximum voltage will, of course, represent the right-hand end of the horizontal deflection of the cathode-ray spot.

The output of the frequency-discriminating network is rectified by a 6H6 tube used as a half-wave rectifier. The output of the rectifier is filtered, amplified by a single-stage direct-current amplifier using a 6J7, and then supplied to the horizontal deflecting plates of the cathode-ray tube.

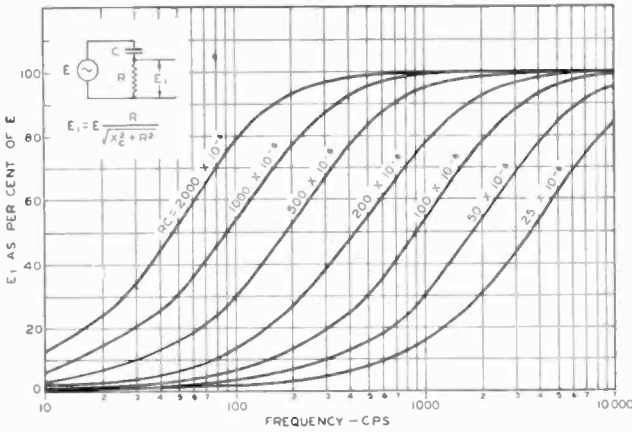

Fig. 3—Network for expanded frequency scales.

#### IV. RELAXATION OSCILLATOR AND AUTOMATIC FREQUENCY CONTROL

Referring to Fig. 4, which shows the complete circuit of the frequency-response apparatus, it will be noted that the automatic-frequency-control circuit<sup>1</sup> is of the type which presents to the oscillator tank circuit a shunted inductance varying inversely as the transconductance of the control tube, the variable control-grid voltage of which thus furnishes the frequency control. In order to obtain maximum frequency stability from the automatic-frequency-control beat-generator combination, the low audio frequencies are made to correspond to low  $g_m$  of the control tube. The 885 circuit supplies to the control tube a slowly varying grid voltage which starts at zero, corresponding to a beat frequency of 15 kilocycles, and becomes increasingly negative, corresponding at its maximum negative value to zero frequency. Now over a small radio-frequency range (15 kilocycles at 350 kilocycles in

<sup>1</sup> Charles Travis, "Automatic frequency control," Proc. I.R.E., vol. 23, pp. 1125-1141; October, (1935).

VERTICAL AMPLIFIER

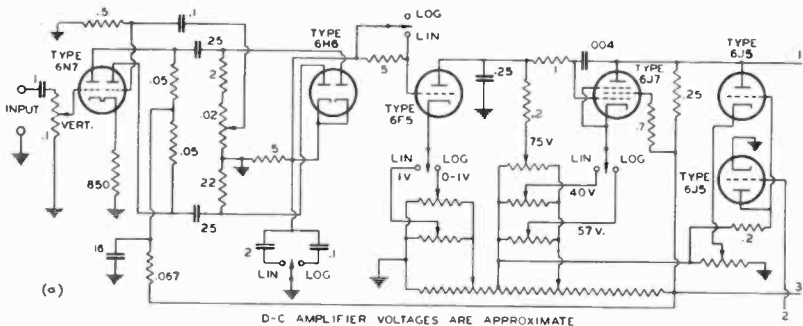

HORIZONTAL AMPLIFIER AND FREQUENCY NETWORK

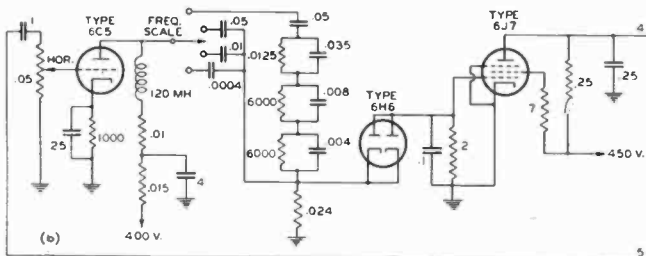

SWEEP AND A.F.C.

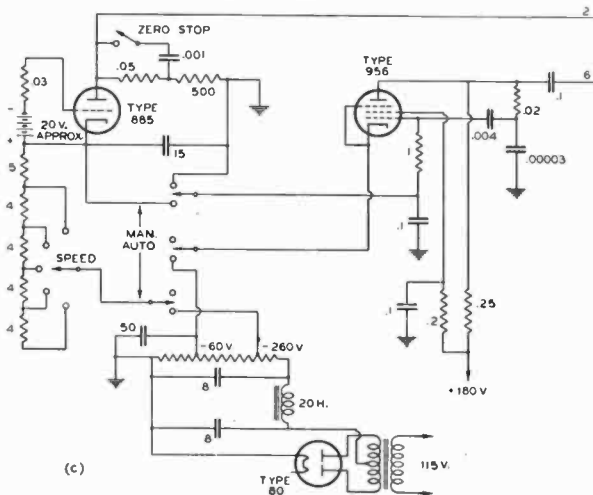



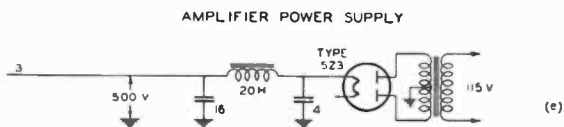
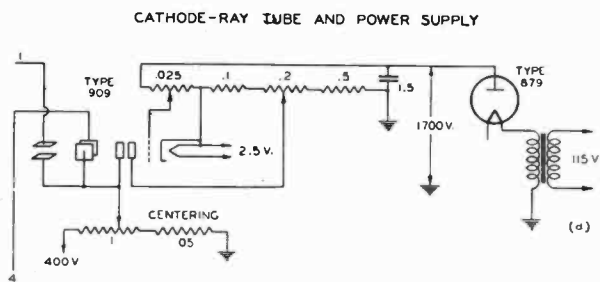

CAPACITANCES IN MICROFARADS  
RESISTANCES BELOW 10000 OHMS ARE IN OHMS  
RESISTANCES ABOVE 10000 OHMS ARE IN MEGOHMS

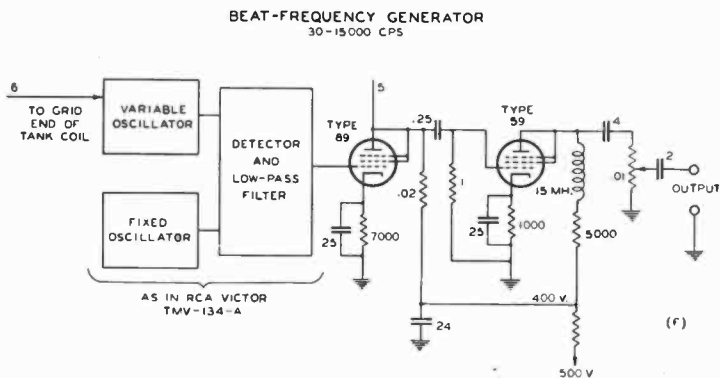

Fig. 4—Schematic wiring diagram of curve tracer.

this case) the relation between the  $g_m$  of the control tube and the developed audio frequency is found to be approximately linear. Therefore, with the use of the logarithmic frequency scale discussed, the cathode-ray spot will move across the screen at a uniform rate if the  $g_m$  of the control tube varies logarithmically with time. Practically, the 885 grid bias is chosen so that a voltage approximately exponential with time is delivered to the 956, and the combination of this voltage variation with the remote-cutoff characteristic of the 956 produces a horizontal cathode-ray deflection at nearly constant speed. This is particularly desirable when traces are to be photographed.

The spot will move at increased speed over the expanded portions of the various "spread" scales but this can be modified at will by adjustment of the variable charging resistor in the 885 circuit.

It is desirable that the voltage supplied by the 885 circuit have a magnitude of about 100 to 125 volts, so that the  $g_m$  of the 956 becomes so low at the maximum negative grid swing as to have negligible effect on the frequency. Since zero beat frequency occurs at this maximum negative voltage, it is necessary, in order to be able to make the usual zero adjustment of the oscillator, to find some expedient which when desired will prevent the 885 from discharging the 15-microfarad condenser and will maintain it at its maximum negative charge. This is accomplished by inserting a resistor (50,000 ohms) shunted by a small condenser (0.001 microfarad) in series with the 885 plate circuit. This combination produces a relaxation oscillation with a frequency of the order of several kilocycles, which will prevent the discharge of the large condenser. Normally the small condenser is disconnected; if it is thrown into the circuit at some time during the charging period of the large condenser, the voltage across the latter reaches its normal maximum (negative) value and remains there. The zero setting can then be made at leisure. On disconnecting the small condenser, the high-frequency oscillation ceases, the large condenser discharges, and the charging period again commences. The voltage developed from the 885 plate to ground by the condenser discharge is used to cut off the vertical amplifier during the return of the cathode-ray spot; this will be described in the next section.

It might seem possible to use for horizontal deflection the same voltage supplied by the 885 for the automatic-frequency-control action. However, the method described not only furnishes a convenient means of scale expansion, but for a given maximum horizontal deflection will serve reliably as a frequency meter, regardless of changes which may occur in the automatic-frequency-control circuit or its associated circuits.

## V. VERTICAL DEFLECTING CIRCUIT

Referring again to Fig. 4, it is noted that the signal from the apparatus under test is supplied to a 6N7 tube connected as a phase inverter so that a full-wave rectifier (6H6) may be operated. The full-wave rectifier is desirable because it reduces the amount of filtering required; a reduction of time constant in the filter means a more rapid response which reduces the time necessary to take a curve. A half-wave rectifier is permissible in the horizontal circuit because the horizontal deflection takes place at a relatively slow speed.

The output of the rectifier is fed to a 6F5 tube which constitutes the first stage of a two-stage direct-current amplifier. This first stage can be operated either linearly or logarithmically, employing for the latter, the scheme described by Payne and Story.<sup>2</sup> Briefly, it is based on the normal logarithmic relation between grid current and grid voltage. Thus, the insertion of a resistance in the grid circuit, large in comparison with the grid-cathode resistance of the tube, will cause the grid-cathode voltage to bear a logarithmic relation to the impressed voltage; and over the range where the plate current is linear with grid-cathode voltage, the plate current will be logarithmic with impressed voltage. A resistance of 5 megohms is used in the grid circuit. The change to linear amplification is accomplished by short-circuiting the grid resistance and changing biases. A range of approximately 30 decibels is obtained in the logarithmic position. A greater range can be had with this type of logarithmic amplifier by choice of appropriate tube voltages.

The second stage of the direct-current amplifier uses a 6J7 tube. Full degeneration of any alternating current remaining from the filtered signal is obtained by omission of screen and cathode bypass condensers and by capacitive feedback from plate to control grid. These factors have no effect on the direct-current operation of the stage. The degeneration, of course, means reduction in filtering requirements.

It is desirable to cut off the vertical amplifier during the return time of the cathode-ray spot. This is accomplished by making use of the large negative voltage developed between the 885 plate and ground during the condenser discharge. In order that the amplifier can be turned off and on promptly, the operation must be performed at some point following the filter, so that the switching is not affected by the time constant of the filter. This is done very conveniently by placing in shunt to the plate circuit of the 6J7 a simple two-stage direct-current amplifier using two 6J5 triodes, the grid of the first being con-

<sup>2</sup> E. L. Payne and J. G. Story, "A portable programme meter," *Wireless Eng.*, vol. 12, pp. 588-594; November, (1935).

ned to the plate of the 885. During the charging period, there is no voltage from the 885 plate to ground; hence, the first triode is at zero bias and the second is adjusted so that it draws nearly zero plate current. During the discharge, the first triode cuts off and the second draws full plate current. Thus, the plate voltage is effectively removed from the 6J7 and vertical deflection of the cathode-ray spot is prevented.

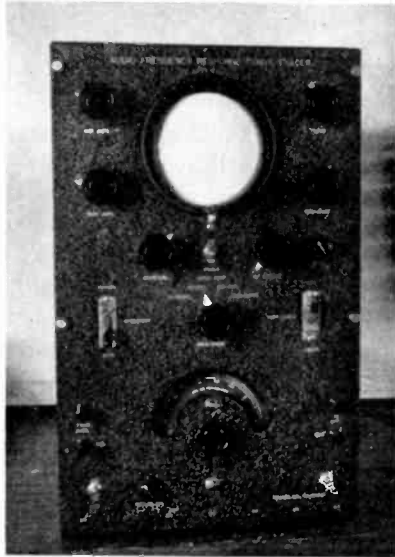

Fig. 5

#### VI. IMAGE-CENTERING ADJUSTMENT

In order that the curve can be centered on the screen, one deflecting plate of each pair is connected to the second anode of the cathode-ray tube, and the combination is connected to a variable potential of about 100 to 200 volts above ground. This permits the spot to be moved obliquely across the screen, so that the origin of the curve may be placed at the lower left. Since the cathode is below ground, the centering voltage is added to the cathode-ground voltage to give the true second-anode—cathode potential difference, and the focusing adjustment (first-anode potential) is accordingly made after the centering has been done.

#### VII. COMPLETE CURVE TRACER

Figs. 5 and 6 show, respectively, external and internal views of the audio-frequency curve tracer. The type 909 cathode-ray tube is mounted on the upper deck and is enclosed by a cylindrical iron shield

as a protection against stray fields, which may affect both focus and deflection. A bakelite tube which can be drawn forward from the front of the panel makes a convenient shield for the screen against extraneous light and permits the use of the apparatus without difficulty in a moderately lighted room. A darkened room permits longer observation of the persistent traces.

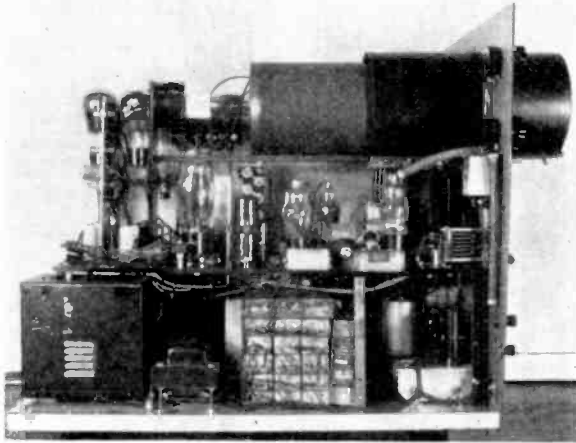

Fig. 6

The power supplies are mounted on the lower deck together with the beat-frequency generator. The RCA-Victor model TMV-134-A has been adapted for the latter purpose by the addition of the automatic-frequency-control circuit and additional output amplification, as shown in the diagram of Fig. 4. The voltage delivered to the output terminals is constant from 30 to 15,000 cycles. Manual operation of the curve tracer can be had by throwing a panel switch which disconnects the automatic-frequency-control circuit. The process of taking a curve manually consists merely in rotating the dial of the beat-frequency generator.

The remainder of the equipment is located on the upper deck. Panel controls provide for adjustment of focus, brilliance, and centering of the cathode-ray spot, for horizontal and vertical deflection amplitudes, for audio-frequency output to the apparatus under test, for manual or automatic control, for linear or logarithmic vertical scales, for speed of horizontal deflection, for zero-frequency setting, for stopping the automatic operation at the end of any cycle to make the zero adjustment, for selection of frequency scale, and for manual frequency control.

## VIII. TYPICAL USES AND RESULTS

To illustrate the application of the curve tracer to amplifier testing, the single-stage resistance-coupled amplifier of Fig. 7 was set up with variable condensers for input, plate by-pass, cathode-resistor by-pass, and cathode tuning. Characteristics are shown with a linear vertical

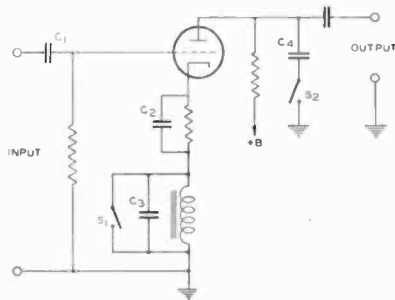

Fig. 7—Test amplifier used in demonstration.

scale. Fig. 8(a) shows a family of input condenser characteristics.  $C_1$  was varied, with  $S_1$  closed,  $S_2$  open, and  $C_2$  very large. This illustrates the familiar low-frequency loss with inadequate input condenser. Fig. 8(b) shows the high-frequency loss introduced by by-passing the plate circuit;  $C_4$  was varied with  $C_1$  and  $C_2$  very large,  $S_1$  and  $S_2$  closed. Fig. 8(c) shows the effect of varying the cathode-resistor by-pass condenser;  $C_2$  was varied, with  $C_1$  very large,  $S_1$  closed, and  $S_2$  open. The lowest curve shows the effect of removing the condenser completely; the response characteristic is the same as when the resistor is completely by-passed, but reduced in level due to uniform degeneration for all frequencies. Fig. 8(d) shows how selective degeneration can be introduced by a tuned circuit in series with the cathode. Here,  $C_1$  and  $C_2$  were very large,  $S_1$  and  $S_2$  open, and  $C_3$  varied. The lowest curve is for the inductance with no capacitance across it, and shows high-frequency degeneration; the others are for various values of shunt capacitance and show minima for resonance.

Some electroacoustic response curves are presented to show the application of the curve tracer in that field. These curves are intended to indicate the results which can be obtained; they were taken in a small room not intended for sound measurements and hence were not expected to show typical performance of the tested apparatus. These curves are taken with logarithmic vertical scale. A 20-second sweep was used for each curve; more detail can be had by increasing the time to about one minute, beyond which there appears to be no further advantage.

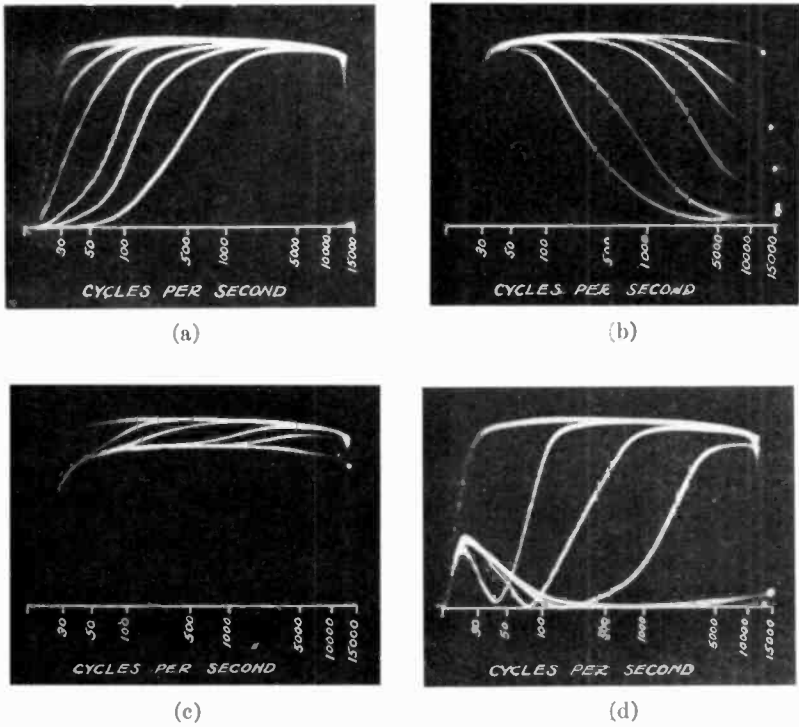

Fig. 8—Amplifier characteristics.

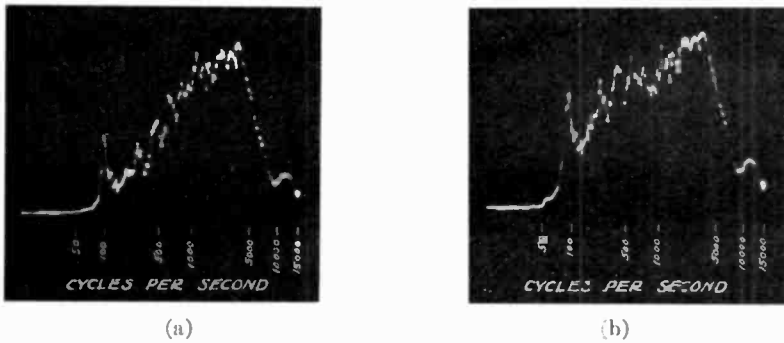
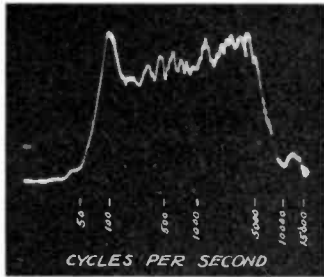

Fig. 9—Loud-speaker characteristics.

Fig. 9(a) was taken with a 12-inch speaker without baffle, 3 feet from the microphone. Fig. 9(b) is for the same distance with a baffle 2 feet square, open on 3 sides and back, and shows the increased low-frequency response.

Fig. 10(a) was taken with the baffle, at a distance of 6 inches from the microphone. The effect of room reflections has been reduced and the apparent low-frequency response increased by the shift in apparent source of sound. The use of the "spread" scales has been illustrated by repeating this test with successive expansion of the 50- to 200-, 100- to



(a)

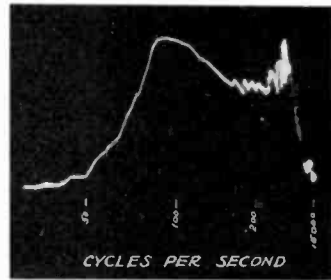

(b)

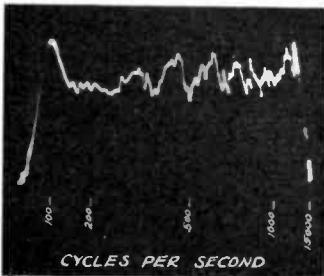

(c)

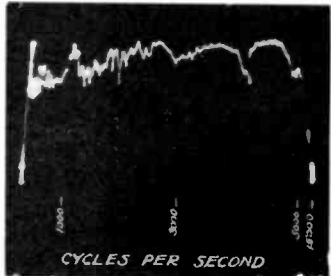

(d)

Fig. 10—Use of expanded scales.

1000-, and 1000- to 5000-cycle ranges. Examination and comparison of Figs. 10(a), (b), (c), and (d) show the increase in detail available by expansion. For example, the two small rounded peaks occurring at the upper right of Fig. 10(a) prove to have the serrated nature indicated between 3000 and 5000 cycles in Fig. 10(d).

Further applications of the curve tracer are the testing of microphones, the testing of transformers, over-all response curves of radio receivers by modulating the radio-frequency signal generator with the curve-tracer output, and the testing of audio-frequency filter circuits. Many others will, no doubt, occur to the user of audio-frequency apparatus.





## SWEEP CIRCUIT\*

BY

J. L. POTTER

(State University of Iowa, Iowa City, Iowa)

**Summary**—This paper describes a new type of sweep circuit for deflecting the electron beam of cathode-ray tubes. The circuit is adaptable for either electrostatic or electromagnetic deflection. Its upper limit of oscillation is approximately 100,000 cycles. The possibility of using the circuit as a multivibrator for generating synchronizing impulses in television is also briefly discussed.

### INTRODUCTION

WHEN the electron beam of a cathode-ray tube using electrostatic deflection plates is deflected it is desirable in most cases to have the deflection vary linearly with respect to time. This requires the deflection voltage to increase linearly with respect to time. In the case of electromagnetic deflection it requires the current through the deflecting coil to increase linearly with respect to time. If a deflecting coil possessing both inductance and resistance is used, a specially shaped voltage wave must be applied to the grid of the deflecting amplifier tube in order to give a linear deflection of the electron beam.

The circuit discussed here is a special type of multivibrator circuit. Other circuits using the multivibrator principle have been used.<sup>1</sup> Circuits using a gaseous tube to charge or discharge a condenser have been used for some time, but these circuits have an upper frequency limit due to the deionization time of the gaseous tube. L. M. Leeds developed a circuit for use at extremely high frequencies.<sup>2</sup>

The circuit discussed here can be adapted to either electrostatic or electromagnetic deflection and has a frequency somewhat higher than can be obtained from circuits using gaseous tubes.

### DESCRIPTION OF CIRCUIT

A schematic diagram of the circuit arrangement is shown in Fig. 1. The twin-triode provides a switching action which essentially short-circuits the condenser  $C_2$  causing it to discharge in a short time and then the switch is opened for a much longer period of time, allowing condenser  $C_2$  to charge through the resistance  $R_2$ . The rise of voltage

\* Decimal classification: R388. Original manuscript received by the Institute, August 27, 1937; revised manuscript received by the Institute, December 24, 1937.

<sup>1</sup> Hoover and Kennedy, U. S. Patents Nos. 1,987,461 and 2,025,208.

<sup>2</sup> Laurance M. Leeds, U. S. Patent No. 2,059,004.

across  $C_2$  is nearly linear with respect to time, since the voltage across  $C_2$  rises to but a small percentage of the applied voltage. This voltage appears in amplified form at the output terminals of the amplifier tube and can be used for either electrostatic or electromagnetic deflection in a cathode-ray tube.

A mathematical analysis of the operation of the composite circuit is complicated due to the fact that the variable parameters of the tubes are involved. However, the general nature of the operation of the device can be described in terms of constant circuit parameters from which description the actual physical operation can be understood.

For the purpose of identification, the elements of the twin-triode of Fig. 1 are designated as triode No. 1 and triode No. 2.

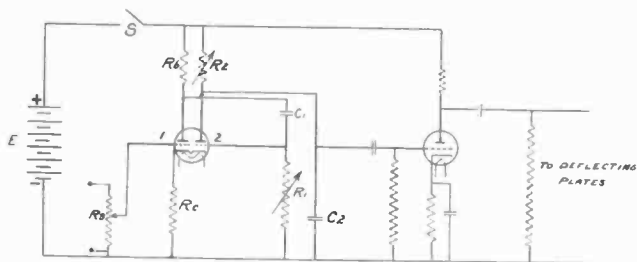

Fig. 1—Schematic diagram of a sweep circuit.

An outline of the circuit operation is given here to aid in following the more detailed discussion:

(1) Return time

- (a) Condenser  $C_1$  is charging through the  $R_{g2}C_1R_c$  path by the way of the grid-to-cathode resistance of triode No. 2.
- (b) The plate voltage of triode No. 1 rises to a maximum value.
- (c) The plate voltage of triode No. 1 then decreases to a minimum value.
- (d) Condenser  $C_2$  remains in essentially a discharged condition.

(2) Sweep time

- (a) Condenser  $C_2$  charges through resistance  $R_2$ .
- (b) Condenser  $C_1$  discharges through  $R_1R_c$  and the plate-cathode resistance of triode No. 1.
- (c) Operation No. 1 is repeated discharging condenser  $C_2$ .

Since the operation of the device depends upon recurring transient phenomena, it is necessary to select a particular time in the cycle of operation as a reference. It will be assumed that the cathodes of the

tubes are heated and that a voltage  $E$  is suddenly applied by closing the switch  $S$  of Fig. 1. An inspection of Fig. 1 will show that a number of events occur simultaneously upon the closing of the switch.

The most significant result of closing the switch  $S$  is that the condenser  $C_1$  begins to charge through  $R_b C_1 R_c$  path by the way of the cathode-to-grid resistance of triode No. 2, since the grid of this triode is momentarily positive with respect to its cathode. The condenser  $C_1$  also charges during this initial period by way of the  $R_b C_1 R_1$  path but the amount of charge thus acquired is small because  $R_1$  is much greater than  $R_c$  plus the grid-to-cathode resistance of triode No. 2. While the condenser  $C_1$  is charging through the paths designated, the charging current flowing through  $R_b$  causes reduced plate-to-ground voltage of triode No. 1. This lowered plate-to-ground voltage of triode No. 1 together with the biasing effect on this triode due to the  $IR_c$  voltage, causes the plate current of triode No. 1 to be zero immediately after the switch  $S$  is closed. However, the plate-to-ground voltage of triode No. 1 will increase as the condenser  $C_1$  acquires charge. Thus the plate-to-cathode voltage rises and at the same time the biasing effect decreases due to the exponentially decreasing charging current. In a very short interval of time the triode No. 1 begins to draw a plate current of its own and in so doing causes an  $I_b R_b$  voltage drop which in turn lowers the plate-to-ground voltage of triode No. 1. The variation of the plate-to-ground voltage of triode No. 1 is shown in Fig. 2(a). The rise to the peak value of the plate-to-ground voltage occurs during the period in which  $C_1$  is charged. The variation of the cathode-to-ground voltage across  $R_c$  is shown in Fig. 2(b).

The decrease in the plate-to-ground voltage of triode No. 1 from its peak value must be accompanied by a reversal in current flow from condenser  $C_1$ , since  $C_1$  and  $R_1$  are in series across these same points. There is also the tendency of the charge on condenser  $C_1$  to discharge through the loop formed by triode No. 1 plate-to-cathode and the triode No. 2 grid-to-cathode paths. The net effect is that the grid of triode No. 2 is suddenly driven highly negative with respect to the cathode.

The condenser  $C_2$  during this period has remained essentially in a discharged state, because of the shunting of the plate-cathode resistance of triode No. 2 and resistance  $R_c$  across  $C_2$ , the resistance of this path being small compared to the resistance  $R_2$ . Likewise the resistance  $R_1$  is large compared to the main charging path of condenser  $C_1$ , namely, the  $R_b C_1 R_c$  path. Since the grid of triode No. 2 is now highly negative with respect to the cathode, triode No. 2 is nonconducting from plate to cathode. The condenser  $C_2$  is now able to receive a charge

from the voltage source  $E$ , through resistance  $R_2$ , and at the same time  $C_1$  is returning to a new voltage equilibrium through resistance  $R_1$  and the plate-to-cathode resistance of triode No. 1, which will eventually allow triode No. 2 to draw current again. When this happens, the discharge current from condenser  $C_2$  will flow through the plate-to-cathode circuit of triode No. 2 and resistance  $R_c$ . This will have a

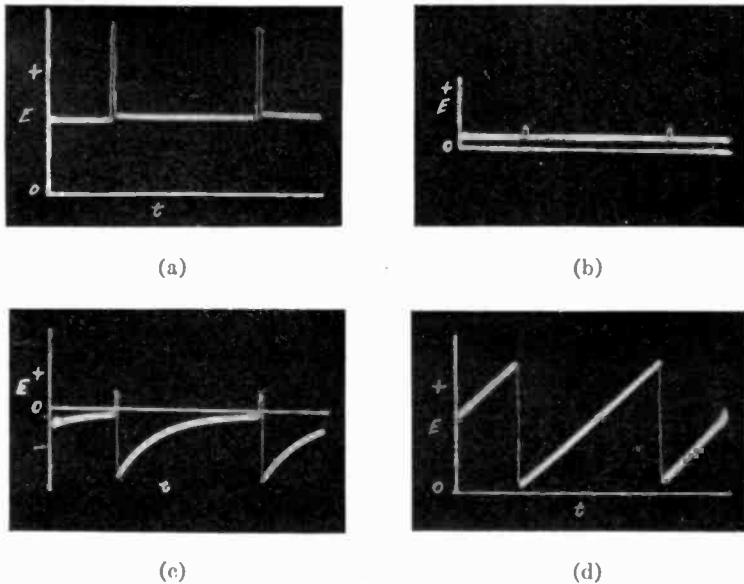

Fig. 2

- (a) Oscillogram of the plate-to-ground voltage of triode No. 1.
- (b) Oscillogram of the cathode-to-ground voltage across  $R_c$ .
- (c) Oscillogram of the grid-to-ground voltage on triode No. 2.
- (d) Oscillogram of the voltage across condenser  $C_2$ .

tendency to cause the cathode-to-ground voltage to increase and hence decrease the plate current of triode No. 1 due to biasing effect of  $IR_c$ . This will decrease the  $I_b R_b$  voltage drop in resistance  $R_b$  which further drives the grid of triode No. 2 positive with respect to the cathode thus accelerating the discharge of  $C_2$ , and condenser  $C_1$  is again being charged as explained in the beginning. Thus the cycle is now being repeated. The variation in voltage from the grid to the ground of triode No. 2 is shown in Fig. 2(c), showing the interval during which the grid is positive and negative. Fig. 2(d) shows the voltage across  $C_2$  which is amplified and used for the sweep.

For electromagnetic deflection a resistance may be inserted in series with condenser  $C_2$  to give the proper wave form.

SWEEP FREQUENCY AND RETURN TIME

The approximate period of oscillation has been determined experimentally and found to be  $f=0.4/R_1C_1$ . The frequency depends on several circuit parameters, so the above equation should be used only as a rough approximation for the frequency.

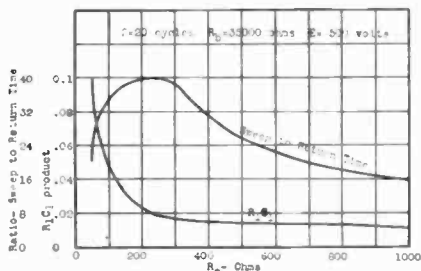

Fig. 3—Curves showing the variation of sweep-to-return time and the variation of the  $R_1C_1$  product with  $R_e \cdot C_1=0.07$  microfarad.

An important requirement in a sweep circuit is to have a large ratio of sweep-to-return time. By the proper choice of circuit parameters this may be made as great as 100:1 at the lower frequencies and about 20:1 at 10,000 cycles. One of the circuit parameters controlling the return time is the resistance  $R_e$ . The variation of sweep-to-return time is shown in Fig. 3 for various values of resistance  $R_e$ . Fig. 3 also shows the variation of the  $R_1C_1$  product with  $R_e$ . These curves show that there is an optimum value of resistance  $R_e$  for the greatest ratio of sweep-to-return time.

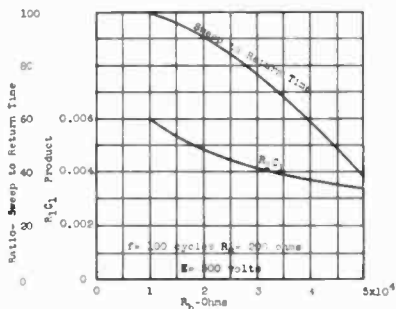

Fig. 4—Curves showing the variation of sweep-to-return time and the variation of the  $R_1C_1$  product with resistance  $R_b \cdot C_1=0.0044$  microfarad.

The return time is also affected by the path through which condenser  $C_1$  must be charged during the return time. This path is the  $R_b$ ,  $C_1$ , the grid-to-cathode resistance of triode No. 2, and  $R_e$ . It is desirable to keep the resistance of this path as low as design will permit as this

shortens the return time. The resistance of this path can best be reduced by reducing the value of resistance  $R_b$ . Fig. 4 shows the change in the value of  $R_1C_1$  and the ratio of sweep-to-return time with the resistance  $R_b$  as determined experimentally.

These optimum circuit conditions will vary with the frequency of operation and these curves are presented only as examples of what might be expected in regard to its operation.

The voltage applied to the grid of the deflecting amplifier tube is determined by the size of condenser  $C_2$  and the resistance  $R_2$ . The desired voltage may be calculated from the equation  $e = E(1 - e^{-t/R_2C_2})$ ,

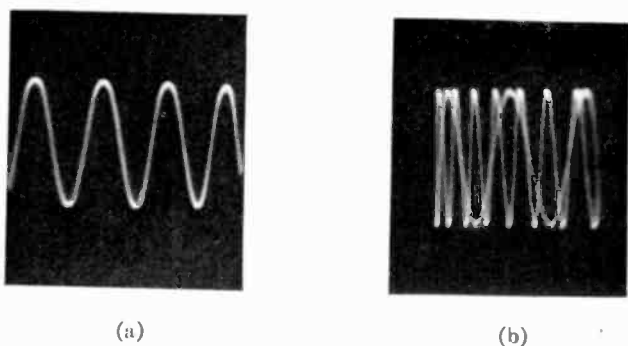

Fig. 5—Oscillograms taken using the sweep circuit described.  
 (a) Oscillogram of a 1000-cycle wave.  
 (b) Oscillogram of a 940,000-cycle wave.

where  $E$  is the source voltage and  $e$  is the voltage across the condenser after a time  $t$ , and where  $t$  in this case is equal to the reciprocal of the frequency of oscillation. It is desirable to keep  $R_2$  large and make the capacitance  $C_2$  as small as possible, as this also shortens the return time. That is, the resistance of the discharge path for  $C_2$  is more or less fixed.

#### OSCILLOGRAPH USE

When the sweep is used for variable-frequency applications it is desirable to keep the output voltage constant as the frequency is varied. This can be accomplished by making the resistances  $R_1$  and  $R_2$  variable and controlled from a single shaft, such as a dual volume control of about 1-megohm resistance. By using a condenser-changing switch a frequency range from 10 to 100,000 cycles can be covered satisfactorily in about four or five settings. Both condensers  $C_1$  and  $C_2$  must be changed together. Fig. 5(a) shows an oscillogram of a 1000-cycle wave and Fig. 5(b) shows an oscillogram of a 940,000-cycle wave.

If the condenser  $C_2$  is replaced with a resistance a voltage peak of short duration is generated. The multivibrator may be synchronized with any frequency source or other multivibrator circuits so that multiples or submultiples of the control frequency may be generated from any given frequency source as required for television. When the condenser  $C_2$  is replaced by a resistance, a negative peaked voltage is obtained. A positive peaked voltage may be obtained across  $R_c$  as shown in Fig. 2(b).

#### SYNCHRONIZING

The synchronizing voltage is impressed across the potentiometer  $R_s$ . The setting of  $R_s$  does not affect the natural period of oscillation of the sweep circuit except at the higher frequencies where the tube capacitance may affect it to some extent, depending on the value of  $R_s$  used. The grid of triode No. 1 does not draw grid current at any point in the cycle of operation, hence there is no danger of the oscillations of the multivibrator affecting the control frequency, thus eliminating the necessity of a buffer tube between the control frequency and the multivibrator or sweep oscillator.

#### ACKNOWLEDGMENT

The writer wishes to express his appreciation to Mr. H. L. Clark, a senior student in electrical engineering, The State University of Iowa, for taking some of the experimental data on the sweep circuit.



## HORN-TYPE LOUD SPEAKERS—A QUANTITATIVE DISCUSSION OF SOME FUNDAMENTAL REQUIREMENTS IN THEIR DESIGN\*

BY

FRANK MASSA

(RCA Manufacturing Company, Inc., Camden, New Jersey)

*Summary*—Horn loud speakers have found widespread commercial application due to their practical possibility of maintaining high efficiency over a relatively wide frequency range. The inherent limitations of such speakers are not generally recognized, however, as neither are the specific relations that must be satisfied in the choice of constants in the electrodynamic system. This paper discusses the limitations of a single speaker to cover the entire range of reproduction. It shows the quantitative relations that must be maintained between the components of the vibrating system in order to secure maximum efficiency at all frequencies. It also demonstrates that certain definite relations must be satisfied if one is to gain by the use of aluminum-wire voice coils. Unless these are satisfied, a loss in efficiency may occur by using aluminum instead of copper. The paper also describes various means that have been employed to avoid the limitations of the single-horn speaker to cover a wide range of reproduction, and concludes with a description of a new experimentally developed speaker employing two entirely separate driving elements mounted on a common magnetic structure; each cone feeding a separate horn. The composite structure takes the approximate form of a cylinder five feet in diameter, two feet deep, and weighs under 100 pounds.

### I. INTRODUCTION

THE primary function of any loud speaker is to transform the electrical signals which may be imparted to it into sound vibrations without change in wave form. Its ability to perform this transformation over a wide range of frequencies and intensities is a measure of the fidelity of the speaker, while the proportion of electrical energy that may be converted into sound is a measure of the efficiency of the loud speaker.

At the present time, it is generally agreed that a horn loud speaker permits the most practical structure for the high-efficiency conversion of electrical to sound energy over a wide frequency range. For this reason, this type of structure has found widespread application in sound-motion-picture theaters and other public-address systems. In order to realize the optimum performance from a horn loud speaker, it is essential that very definite requirements be satisfied, and the purpose of this paper is to discuss quantitatively some of the more important and generally unrecognized conditions that must be met, if best performance is to be obtained.

\* Decimal classification: R365.2. Original manuscript received by the Institute, March 2, 1938.



## II. SOME DESIGN REQUIREMENTS

In the mathematical analyses that have been made by the author, on which the subsequent comments depend, the following idealized conditions have been assumed:

1. The diaphragm driving the horn behaves as a piston. (For the frequency regions in which the effective diaphragm area may become smaller, the conclusions are still valid provided the equivalent piston area and mass are employed for the constants of the system.)

2. The horn is infinite in length and of exponential flare. (In practice, a horn may be generally assumed infinite for frequencies higher than those for which the mouth diameter =  $1/4$  wavelength, without serious error.)



Fig. 1—Simplified horn loud speaker and equivalent electric circuit of the acoustic system.

- $m_o$  = total mass of vibrating system in grams  
 $A_p$  = area of piston in square centimeters  
 $r_A$  = acoustic resistance at throat of horn  
 $A_h$  = throat area in square centimeters  
 $\omega = 2\pi f$ ;  $f$  = frequency in cycles

3. The cutoff frequency of the horn is below the lowest frequency that it has to reproduce.

4. The stiffness of the diaphragm suspension and rear enclosure (if one is employed) are low enough so that the vibrating system is "mass controlled" over its entire frequency range of reproduction.

5. The coupling chamber between the diaphragm and horn throat is so designed that there are no phase interferences from the vibrations coming from various portions of the diaphragm into the throat. The volume of the throat chamber is also assumed to be so constructed that no attenuation of the highest frequency to be generated by the speaker will occur.

6. The electrical characteristic of the voice coil is a pure resistance.

7. The flux density in the air gap is assumed uniform over the region of travel of the vibrating voice coil.

In Fig. 1 are shown the components of a simplified horn loud speaker, and also the equivalent electrical circuit of the acoustic system. The impedance of the diaphragm suspension and throat-coupling chamber have been omitted, since they have been assumed to be of no consequence in the ideal speaker under discussion.

### A. Size of Horn Throat

Referring to Fig. 1, it is obvious that maximum power may be transferred to  $r_A$  (the horn) when the following condition is satisfied:

$$\frac{\omega m_o}{A_p^2} = \frac{42}{A_h} \quad (1)$$

Equation (1) shows that for a fixed vibrating system the area of the horn throat should be inversely proportional to frequency if maximum efficiency at each frequency is to be realized. Thus, relatively large throats are necessary for high efficiency at low frequencies, and relatively small throats are required to secure maximum efficiency at the high frequencies. A fixed throat size must obviously result in a compromise: the wider the frequency range to be covered by a single loud speaker with a fixed horn throat area, the greater will be the over-all departure from maximum possible efficiency.

### B. Size of Diaphragm

One of the major factors in the determination of the diaphragm size in a horn loud speaker is the acoustic power that must be generated at the lowest frequency which the horn must reproduce.

It may be shown that the acoustic power  $P$  generated in a horn loud speaker is given by

$$P = \frac{0.00340 f^2 d^2 A_p^2}{A_h} \text{ acoustic watts} \quad (2)$$

where,

$f$  = frequency of vibration in cycles

$d$  = peak amplitude of diaphragm from its mean position in inches

$A_p$  = area of diaphragm in square inches

$A_h$  = area of horn throat in square inches

From (2) it is apparent that for a fixed amplitude of vibration, the area of the diaphragm driving the horn must increase as the frequency of reproduction is lowered, if constant acoustic output is to be maintained.

Fig. 2 shows the relation, at various frequencies, between the acoustic power generated in horns of different throat areas as a function of diaphragm area and its peak amplitude.

At the higher frequencies the diaphragm size is limited by the necessity of preventing phase distortion in the horn throat. The distances from any part of the diaphragm to the throat opening should vary by less than one fourth the wavelength of the highest frequency

to be reproduced, if serious phase distortion is to be avoided. Thus, from a practical standpoint, low-frequency reproduction requires a relatively large diaphragm area and high-frequency reproduction requires a relatively small diaphragm area.

*C. Flux Density and Voice-Coil Constants*

The proper choice of voice-coil constants and air-gap flux density in horn loud speakers is greatly dependent on the frequency range that must be reproduced. Some rather interesting discoveries were

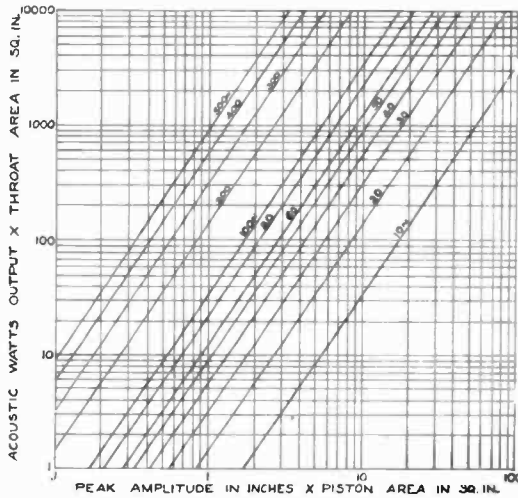

Fig. 2—Relation between acoustic watts output and peak amplitude of a piston driving an exponential horn at the various frequencies (in cycles per second) marked on the individual curves.

made from a detailed mathematical analysis of this problem, some of which were more or less contrary to popular belief.<sup>1</sup> The expression that was developed for the maximum possible efficiency at any frequency for an idealized loud speaker is

$$\text{max per cent efficiency} = \frac{100 B^2}{4\pi f(1 + k)DR \times 10^9 + B^2} \tag{3}$$

where,

$B$  = air-gap flux density in gauss

$f$  = frequency in cycles per second

$k = \frac{\text{mass of entire vibrating system} - \text{mass of voice-coil conductor}}{\text{mass of voice-coil conductor}}$

<sup>1</sup> F. Massa, "Efficiency of horn loud speakers," *Electronics*, vol. 10, pp. 30-32, April, (1937).

$D$  = density of voice-coil conductor material in grams per cubic centimeter

$R$  = resistivity of voice coil conductor in ohms per cubic centimeter.

A careful analysis of (3) reveals many interesting facts, some of which are not generally recognized. Some of the conclusions that may be drawn from the above equation are as follows:

1. The maximum possible efficiency of the loud speaker may be made to increase as the mass of the voice-coil conductor is increased. (As the voice-coil mass is increased, keeping the flux density constant, the value of  $k$  is decreased in (3), which results in an increase in the magnitude of the entire expression.)

2. A horn loud speaker is inherently a highly efficient piece of apparatus at low frequencies (the left-hand portion of the denominator is small in (3)) even though  $k$  may be large and  $B$  small.

3. At high frequencies (left-hand portion of the denominator being large) the horn loud speaker is inherently a low-efficiency device. To keep up the efficiency it is imperative to use very high flux densities and voice coils as large as possible, so that the voice-coil mass may be a large part of the entire mass of the vibrating system ( $k$  small in (3)).

4. The efficiency is independent of the size and length of conductor employed in the voice coil. The controlling factor is the mass of the conductor that is used.

5. The efficiency increases as the product of resistivity times the density of the voice-coil conductor decreases ( $DR$  in (3)). Using a material of low  $DR$  product such as aluminum may be of great advantage in bringing up the inherently low high-frequency efficiency of the speaker.

6. Aluminum wire may be detrimental to efficiency unless the voice-coil mass is made greater than approximately one fourth the entire effective mass of the vibrating system. If a lighter aluminum coil is employed, the design is bad because improved efficiency will result by changing to copper wire. The reason for this is that a copper coil will have three times the mass of the aluminum coil which it replaces, and the factor  $(1+k)$  will therefore be reduced to less than half by changing to copper. Thus, although the factor  $DR$  is doubled by changing to copper, the entire denominator will be reduced with a resultant increase in efficiency. Therefore, to profit from the low  $DR$  product of aluminum, it is necessary that the voice coil be heavier than approximately one third the mass of the remainder of the vibrating system.

Figs. 3 and 4 show the theoretical maximum possible efficiencies

obtainable, as a function of frequency, in an idealized horn speaker. Fig. 3 shows the efficiencies for a copper-wire voice coil, and Fig. 4 shows the efficiencies for an aluminum voice coil. In each set of curves the solid lines assume  $k=0$  in (3), which is the limiting condition ap-

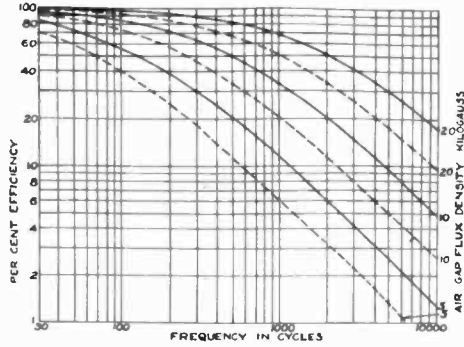

Fig. 3—Maximum efficiencies obtainable in a horn loud speaker employing a copper voice coil at various frequencies and flux densities as computed from (3). For the solid curves the entire mass of the vibrating system was assumed in the voice coil ( $k=0$  in (3)). For the dotted curves the voice-coil mass was assumed equal to one half the entire mass of the vibrating system ( $k=1$  in (3)).

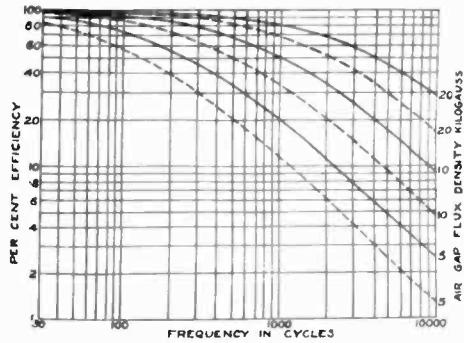

Fig. 4—Maximum efficiencies obtainable in a horn loud speaker employing an aluminum voice coil at various frequencies and flux densities as computed from (3). For the solid curves the entire mass of the vibrating system was assumed in the voice coil ( $k=0$  in (3)). For the dotted curves, the voice-coil mass was assumed equal to one half the entire mass of the vibrating system ( $k=1$  in (3)).

proached by assuming that the voice-coil mass is the entire mass of the vibrating system (mass of diaphragm, etc., is assumed zero). The dotted curves represent the condition in which  $k=1$  (the mass of the voice coil is equal to the mass of the remainder of the vibrating system).

These families of curves clearly show the need for very high flux densities and relatively heavy aluminum voice coils, if high-frequency efficiency is to be realized in a horn loud speaker. They also show that at low frequencies, high efficiency may be easily realized with relatively low flux densities and relatively small copper voice coils, which are important factors to keep in mind if one wishes to design high-efficiency low-cost horn speakers for low-frequency reproduction.

Fig. 5 shows the maximum efficiency that may be obtained at 100, 1000, and 10,000 cycles as a function of  $k$  in (3). At the low frequencies

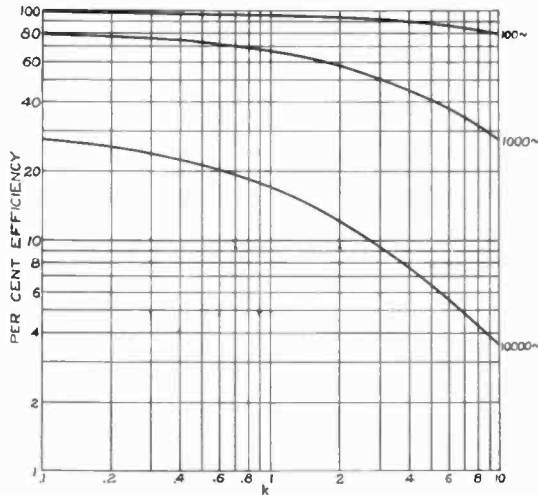

Fig. 5—Efficiency versus  $k$  in a horn loud speaker at 100, 1000, and 10,000 cycles.  $k$  = ratio of entire effective mass of the vibrating system (excluding the mass of the voice-coil conductor) to the mass of the voice-coil conductor. For the curves shown, the air-gap flux density = 20,000 gauss and the voice-coil material is aluminum.

it can be seen that the efficiency is inherently very high for even large values of  $k$ ; that is, the voice-coil mass may be small compared to the mass of the diaphragm. For high frequencies it can be seen that the efficiency decreases quite rapidly as  $k$  becomes greater than unity. Thus, for good high-frequency efficiency it is important that the voice-coil mass be made a large portion of the entire mass of the vibrating system.

### III. DISTORTION IN THE THROAT OF THE HORN

With the present trend toward wide-range reproduction, both as regards frequency and volume level a source of throat distortion which was originally ignored now becomes a matter of serious consideration. This type of distortion is due to the generation of sound

waves of finite amplitude in the throat of the horn. When the sound-wave oscillations are set up in the horn throat, the pressure changes may be appreciable enough to cause instantaneous variations in the velocity of the sound wave being propagated. The crests of the wave will move at a faster rate than the troughs, with a resultant steepening of the wave front, which may cause the introduction of considerable second-harmonic distortion in the output.

The higher the frequency of reproduction and the lower the cut-off frequency of the horn, the greater will be the amount of distortion introduced due to this cause. At the high frequencies, several cycles

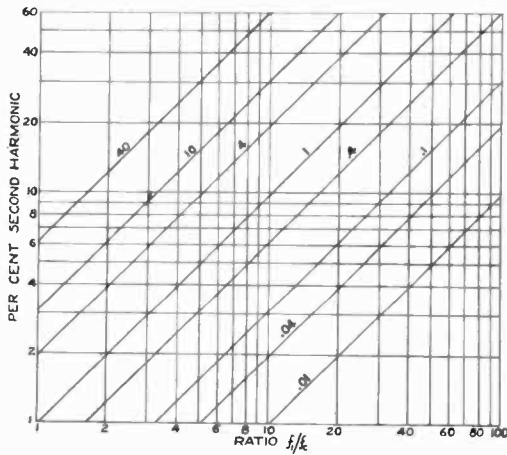

Fig. 6—Second harmonic generated in an exponential horn at a frequency  $f_1$  when the cutoff frequency due to flare  $= f_c$ . The numbers on the curves indicate acoustic watts being radiated per square inch of throat area.

will be confined to the restricted part of the horn, so that the wave front is distorted over many cycles before the pressure is sufficiently reduced. Also, the lower the cutoff frequency of the horn, the less will be the rate of flare, and the number of cycles which are confined to high-pressure propagation will be accordingly increased, thereby causing increased distortion of the wave front for a particular high frequency.

Rocard<sup>2</sup> has made a theoretical analysis of the magnitude of this type of distortion, and his published information was used as a basis for computing the data shown in Fig. 6. This chart shows the per cent of second harmonic generated in the throat of an exponential horn as a function of the ratio of the frequency being generated to the

<sup>2</sup> M. Y. Rocard, *Comptes Rendus*, January 16, (1933).

cutoff frequency of the horn, for the various acoustic power outputs in watts per square inch of throat area marked on the curves.<sup>3</sup>

The curves show quite strikingly the inherent power output limitation that is imposed on a single loud speaker that is to reproduce the entire frequency range. If a 40-cycle cutoff horn is to reproduce a 4000-cycle note ( $f_1/f_c = 100$  in Fig. 5), a 10 per cent second harmonic will be generated in the throat of the horn for the very small value of generated acoustic power equal to 0.01 watt per square inch of horn throat.

If the same frequency range of reproduction were divided between two speakers,  $f_1/f_c$  would be reduced to one tenth its previous value, and the power output at 4000 cycles could be increased 100 times for the same amount of distortion. Thus, for high-fidelity, large-scale reproduction, it is evident that the throat-distortion problem is deserving of serious consideration, and the size of throat, as well as the frequency range of reproduction of a single speaker, is limited by the acoustic power that must be reproduced.

#### IV. INHERENT LIMITATIONS OF A SINGLE-HORN LOUD SPEAKER

From what has been thus far discussed, it is apparent that, generally speaking, there are two different groups of requirements to be met in the design of horn loud speakers for low-frequency and high-frequency reproduction. Some of these requirements are listed below:

<i>Low-Frequency Requirements</i>	<i>High-Frequency Requirements</i>
Large diaphragms	Small diaphragms
Large throats	Small throats
Throat-chamber volume may be relatively large	Throat-chamber volume must be small
Air-gap flux density need not be very high	Air-gap flux density must be very high
Voice-coil mass may be a small fraction of the mass of the vibrating system	Voice-coil mass must be a large fraction of the mass of the vibrating system

If a single speaker is designed to reproduce the entire frequency range, it is, of course, obvious that compromises must be made between what is desirable for good low-frequency reproduction and what is required for the high-frequency range.

<sup>3</sup> Thuras, Jenkins, and O'Neil, "Extraneous frequencies generated in air carrying intense sound waves," *Bell Sys. Tech. Jour.*, vol. 4, pp. 159-172; January, (1935), have published some experimental data on distortion in horns which show about 50 per cent of the theoretical value of the second harmonic predicted by Rocard.



In addition to sacrificing performance by compromises, it has been shown above that the throat distortion may become very serious even for relatively small high-frequency power outputs, if a single horn is employed to reproduce both high and low frequencies.

A further complication may be introduced in a single speaker because of the provision that must be made for large amplitudes of the diaphragm, if low frequencies are to be reproduced. This means that in many cases the throat chamber must be kept larger than would be desirable for best high-frequency reproduction.

#### V. DOUBLE-CHANNEL SYSTEM

To avoid the limitations of a single horn, the double-channel system has come into widespread use in the higher-priced theater installations. In the two-channel system, each loud speaker may be designed to incorporate the most desirable features for its own frequency range of reproduction. In some very special applications, it has been advantageous to employ more than two channels in order to reduce further the amount of compromising that had to be done in designing the loud speakers.

Multichannel systems, although possessing the inherent advantage of permitting the design of the best possible speakers for each part of the frequency range to be reproduced, will generally require electrical circuits to divide the audio-frequency power among the various components. Another factor that must be kept in mind is that if large path-length differences exist between the various horns, peculiar effects may be introduced on transient sounds that are reproduced in the "overlap" region of two speakers. These problems, however, are not particularly serious, and may be usually circumvented by proper design of the system.

Another advantage of the multichannel system is that the distribution of sound at the high frequencies may be made more uniform than can be realized from a single horn which must reproduce the entire frequency range. A single horn will radiate into a sharp beam at the high frequencies, which is usually undesirable; and to avoid this type of concentration in past installations employing single horns to reproduce the entire frequency range, a group of such speakers have had to be employed, each horn pointing along a different axis.

#### VI. SINGLE-DRIVE COMPOUND-HORN LOUD SPEAKER

Although multichannel speaker systems have been employed in many large theaters, the practical considerations of cost and small-space requirements become very important factors in deciding on the

purchase of loud speakers for the smaller theaters and auditoriums. A compact speaker of light weight which is easily portable has a great practical advantage.

To avoid some of the limitations of the single-horn speaker and meet the smaller theater requirements in compactness and weight, a compound-horn loud speaker was developed some time ago.<sup>4</sup> In this speaker a single diaphragm is coupled to two horns, a straight-axis high-frequency horn and a folded low-frequency horn, as shown in Fig. 7. By this arrangement it was possible to employ a large throat

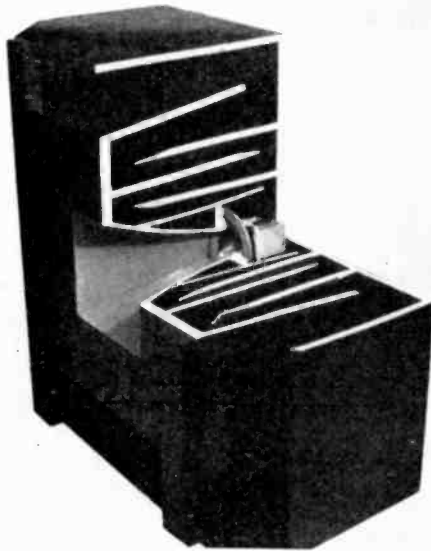

Fig. 7—Sectional view of the single-drive type of compound-horn loud speaker.

for the low-frequency reproduction and a small throat for the high-frequency reproduction. The use of separate horns, aside from increasing the over-all efficiency over the equivalent single-horn speaker, also reduced the throat distortion because the high frequencies did not have to be reproduced through the low-frequency horn.

Due to the use of a single diaphragm, however, it was necessary to compromise on its size, which meant a sacrifice in the power-handling capacity at the low frequencies. Also, since only a single diaphragm was employed, the overlap region had to be controlled solely by acoustic filters and acoustic attenuation in the low-frequency folded horn.

<sup>4</sup> Olson and Massa, "A compound horn loudspeaker," *Jour. Acous. Soc. Amer.*, July, (1936).

In view of the large low-frequency amplitudes that had to be provided, it was necessary to use a relatively large throat-chamber volume in the high-frequency horn.

The performance of the compound horn, however, was superior to the equivalent single-horn speaker which it was intended to replace.

#### VII. DUAL-DRIVE COMPOUND-HORN LOUD SPEAKER

The disadvantages of the single-drive type of compound-horn loud speaker over the two-channel speaker system have been eliminated by a recent laboratory development, which is essentially a two-channel system "wrapped into one." Two entirely separate driving

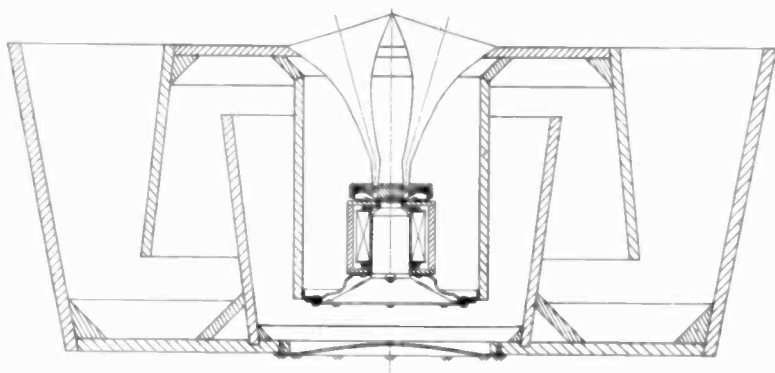

Fig. 8—Cross-sectional diagram showing the structural details of the dual-drive compound-horn loud speaker.

elements are arranged on a common magnetic circuit, each system being independently designed to incorporate the optimum constants required to give best over-all performance. Each diaphragm feeds a different horn; the low-frequency horn being made of re-entrant "tub-like" sections for the purposes of securing light weight and great rigidity of the walls. The high-frequency diaphragm feeds a pair of short horns (inclined at an angle to secure a spreading of the high frequencies) which are nestled within the folded low-frequency horn. A cross section through the structure is shown in Fig. 8. The rear of the high-frequency diaphragm is enclosed in a cylindrical airtight mounting, so that the low-frequency vibrations from the rear of the large diaphragm cannot reach the small diaphragm. The rear of the low-frequency cone is sealed off into the rather large enclosure formed by the horn structures. Both enclosures are made sufficiently large so that their stiffnesses do not affect the low-frequency performance of their respective ranges of reproduction.

The magnetic circuit was so designed that high flux density would occur in the high-frequency air gap where it is most required. By employing a common magnetic circuit, as shown, the same iron is used



Fig. 9—Speaker mechanism employing two separate diaphragms mounted on a common magnetic structure. The low-frequency diaphragm is visible and the high-frequency diaphragm is mounted within the cylindrical enclosure at the right.

twice, so to speak, and actually the structure requires approximately one-half the amount of iron needed if the two driving mechanisms were built separately.

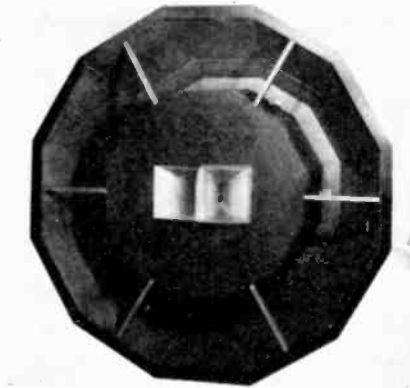

Fig. 10—Developmental model of the dual-drive compound-horn loud speaker.

A view of the composite-speaker mechanism is shown in Fig. 9. The efficiency of such a magnetic structure is quite high. For a field coil employing 13 pounds of copper and 25 watts of excitation, a flux density of 18,000 gauss was obtained in the high-frequency air gap,

whose volume was sufficient to include a one-gram aluminum voice coil; and 14,000 gauss was obtained in the low-frequency air gap, which was of sufficient volume to include an eight-gram copper voice coil. The measured leakage flux in the structure amounted to only 45 per cent of the total active flux in the low-frequency air gap.

A photograph of the developmental model of the completed loud speaker is shown in Fig. 10. The over-all dimensions of the structure are approximately five feet in diameter by two feet deep.

Since this new dual-drive compound-horn loud speaker has entirely separate high- and low-frequency systems, all the advantages of the two-channel system may be incorporated in its design. The advantage over the double-speaker system lies in its extreme compactness and light weight.



## A BEARING-TYPE HIGH-FREQUENCY ELECTRO-DYNAMIC AMMETER\*

BY

HARRY R. MEAHL

(General Engineering Laboratory, General Electric Company, Schenectady, New York)

*Summary*—A jewel-bearing oscillating-ring electrodynamic ammeter is described and the method for calibrating it is explained. Data and calculations are presented to show that it is a standard of current at high frequencies. The frequency characteristics of three miniature thermocouple ammeters are measured with it.

### INTRODUCTION

MOST investigators of high-frequency phenomena have probably wondered why some practical standard of current at high frequencies was not found long ago. It has been standard practice to calibrate thermocouple ammeters at 60 cycles and to calculate the frequency correction factors at high frequencies. When experimental work<sup>1,2</sup> was done to test the validity of this procedure, the photoelectric method was used. This method was not fully satisfactory because it depended somewhat upon the heating effect of the current and was therefore frequency limited as to accuracy in the same way as are thermocouples. It is not evident in the literature that this was appreciated.

A practical standard of current at high frequencies has been found in the oscillating-ring electrodynamic ammeter, the theory of which has been presented.<sup>3</sup>

The oscillating-ring electrodynamic type of ammeter was chosen as a standard of currents above one ampere at high frequencies because it is so much simpler than the Moullin repulsion-type ammeter. To obtain a more sturdy instrument and to simplify the technique of its use, the fine quartz suspension was replaced by special jewel bearings. A photoelectric oscillation timer was also devised.

### THE INSTRUMENT

The bearing-type oscillating-ring electrodynamic ammeter is shown alone in Fig. 1. This is like showing an ordinary ammeter without the pointer and scale. The exciter loop is made of No. 14 solid copper wire,

\* Decimal classification: R242.14. Original manuscript received by the Institute, January 15, 1938. Presented before New York meeting, March 2, 1938.

<sup>1</sup> John H. Miller, "Thermocouple ammeters," Proc. I.R.E., vol. 24, pp. 1567-1572; December, (1936).

<sup>2</sup> J. D. Wallace and A. H. Morse, "Frequency errors in radio-frequency ammeters," Proc. I.R.E., vol. 25, pp. 327-339; March, (1937).

<sup>3</sup> H. M. Turner and P. C. Michel, "An electrodynamic ammeter," Proc. I.R.E., vol. 25, pp. 1367-1374; November, (1937).

as is the center conductor of the concentric lead. The oscillating ring is made of duraluminum to obtain light weight and rigidity. The bearings are polished sapphires and the pivots are polished steel pins of about half the diameter of those used in standard miniature instruments.

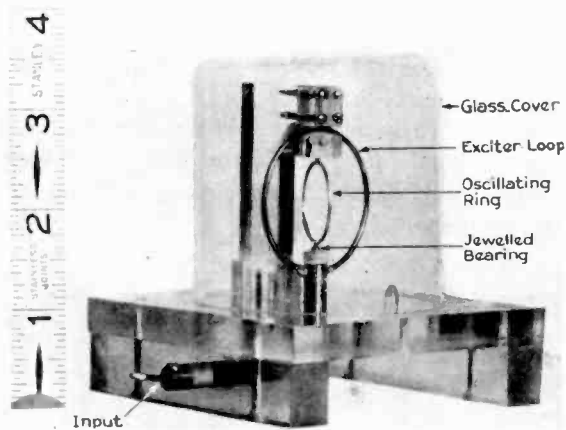

Fig. 1

The two terminals, instead of being side by side are concentric to reduce the inductance, and therefore the impedance, of the instrument.

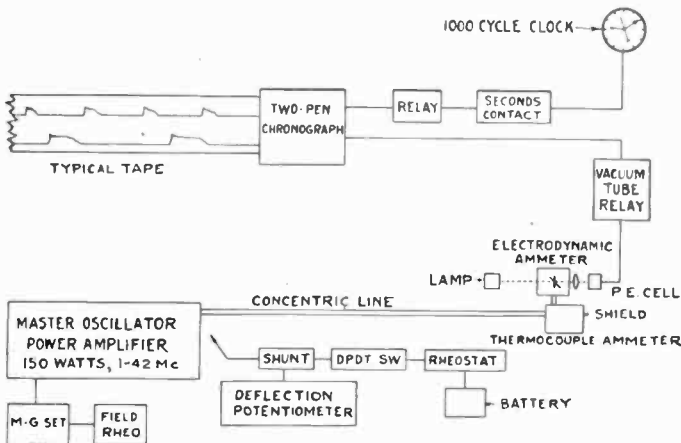

Fig. 2

**AUXILIARY APPARATUS**

The mechanical oscillation frequency of the ring is the measure of the current amplitudes; therefore, provision is made for determining the number of oscillations per unit time accurately. Fig. 2 is a block diagram showing the complete apparatus.

The master-oscillator—power-amplifier is the radio-frequency section of a General Electric 75- to 150-watt, 30- to 42-megacycle telephone transmitter<sup>4</sup> and is the source of high-frequency currents for these tests. Control of the plate voltage, and therefore of the high-frequency current, is obtained by means of the rheostat in the generator field. The current is conducted to the ammeters by a 3/4-inch concentric line about 12 feet long, loosely coupled inductively to the power amplifier.

The deflection potentiometer and associated equipment are used to check the direct-current operation of the thermocouple ammeters before and after operating them at high frequencies, to be sure no changes have taken place in them.

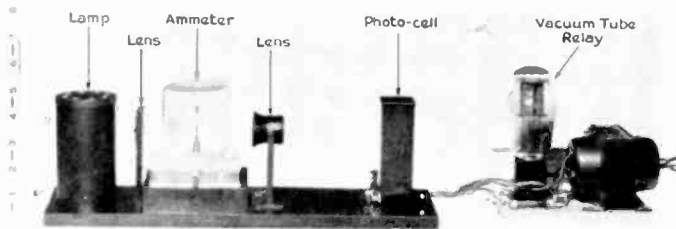

Fig. 3

The photoelectric oscillation counter consists of a lamp, a lens, a phototube, and a vacuum-tube relay. It controls one pen of a two-pen chronograph. The other pen is controlled by a 1000-cycle clock which is part of the primary standard of frequency of the General Electric Company and which marks off standard seconds on the tape.

Fig. 3 shows the electrodynamic ammeter and the photoelectric oscillation counter, and Fig. 4 shows how the electrodynamic ammeter and the thermocouple ammeter are connected in series at the end of the transmission line. One terminal of the thermocouple ammeter is connected to the shield with as short a lead as possible.

#### CALIBRATION

The oscillating-ring electrodynamic ammeter is a standard of current at high frequencies; i.e., its characteristics can be calculated from measurements of length, mass, and time. Proof of this statement has been advanced,<sup>3</sup> and further proof is available.<sup>5</sup> Because a substantial

<sup>4</sup> Stewart Becker and L. M. Leeds, "A modern two-way radio system," *PROC. I.R.E.*, vol. 24, pp. 1183-1206; September, (1936).

<sup>5</sup> P. C. Michel, "A High Frequency Electrodynamic Ammeter," Thesis, Yale University, 1935.



change in design, though not in principle, was made when the jewel-bearing instrument was built, the characteristics of the instrument were carefully measured by experimental means. Briefly, the procedure was to measure the period of the oscillating ring for five different values of current at 1.1 megacycles. This was done at 1.1 megacycles because the frequency errors of thermocouple ammeters are small at this frequency and can be accurately determined. Also, the various shunting effects are small at this frequency. For instance, the shunting effect of the input capacitance of the electrodynamic ammeter is less than 0.002

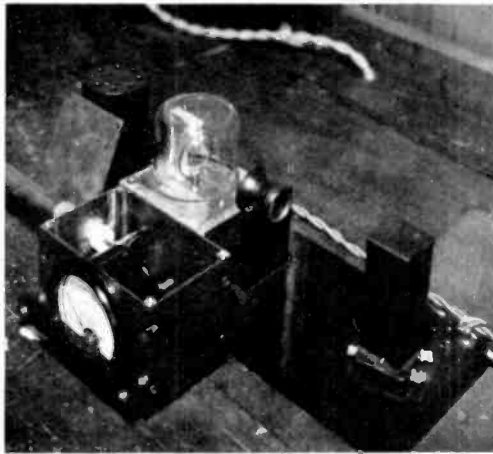

Fig. 4

per cent. This measurement gives the over-all constant of the instrument which is the product of three factors; the mechanical factor  $K_m$ ; the frequency factor  $K_f$ ; and the current factor  $K_i$ . In this instrument the frequency factor  $K_f$  can be accurately calculated, and for currents from three amperes upward the current factor  $K_i$  is unity. (Fig. 5.) Thus a determination of the mechanical factor  $K_m$  is made.

In detail, the operations performed in making this calibration were as follows:

1. The master-oscillator—power-amplifier (Fig. 2) was adjusted to 1.1 megacycles by comparison with the primary standard of frequency of the General Electric Company. A wavemeter was also adjusted and used thereafter as a frequency monitor.
2. A coupling circuit for connecting the power amplifier to the concentric line was adjusted to operate with loose coupling.
3. A thermocouple ammeter of known characteristics was connected

in series with the electrodynamic ammeter at the terminals provided in the copper box of Fig. 4.

4. The photoelectric oscillation counter, the two-pen chronograph, and the deflection potentiometer were made ready for use.
5. With the radio-frequency current source off, the deflection potentiometer was connected to the ammeter circuit and the thermocouple was standardized on direct current at the calibrating value. One operator adjusted and read the potentiometer; the other held the required scale reading on the thermocouple ammeter.
6. The potentiometer was disconnected and the electrodynamic ammeter checked for electrostatic charges on the oscillating ring.
7. The radio-frequency current source was energized and adjusted to cause the required scale reading.
8. While one operator held the scale reading constant by means of the generator field rheostat, the other operated the chronograph and obtained a record of the period of the oscillating ring on a tape.
9. Operation 5 was repeated.
10. Operations 1 to 9 were repeated 4 times for each of 5 current values.
11. The frequency of mechanical oscillation was obtained by measurement and calculation from the tapes.
12. The over-all constant of the instrument at 1.1 megacycles at the particular current value was then obtained by dividing the thermocouple ammeter reading (corrected for frequency error) by the frequency of mechanical oscillations in vibrations per second. The average of the 5 values and the average deviation from the mean were computed.

For example, tape 1 showed 13 vibrations in 29.027 seconds when the current was held at 4.987 amperes. The over-all constant was 11.134 amperes per vibration per second. Only vibrations of low amplitude, less than 40 degrees, were recorded. It was found, by taking a large amount of data, that a determination of the rate from any single vibration checked with that made from the whole tape within 0.2 per cent. This showed that the amplitude effect was small for the amplitudes used.

The average value for the over-all constant of the instrument was  $11.116 \pm 0.033$ . This was the average of 25 determinations at 1.1 megacycles. The mechanical factor  $K_m$  was this value divided by 1.0189, the calculated value of the frequency factor, or 10.909. The calculated value of the mechanical factor agreed within 2 per cent, which was sufficiently close considering the measurement technique used. If better agreement is required, much greater refinement in measurements of dimensions is necessary.

The instrument was then calibrated and the current at any frequency  $f$  could be calculated from

$$I = Kf_m$$

where,

$$K = K_m \times K_f = 10.909 K_f$$

and  $f_m$  = the vibrations per second of the oscillating ring for the current  $I$ .

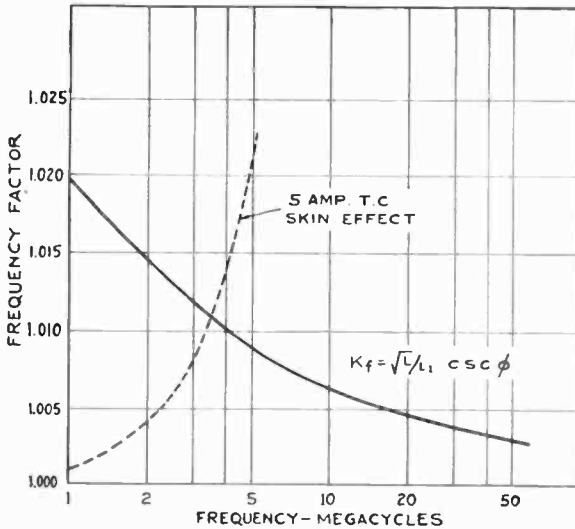

Fig. 5

The frequency factor  $K_f$  was calculated from

$$K_f = \sqrt{L/L_1} \csc \phi$$

where  $L_1$  = the inductance of the oscillating ring at infinite frequency and

$$\phi = \tan^{-1} \omega L/R$$

where  $R$  = the resistance of the oscillating ring at the operating frequency  $f$ .

$K_f$  versus frequency is shown graphically in Fig. 5.

### PROBABLE ERRORS

In determining the mechanical factor  $K_m$  of the instrument, measurements of currents and frequencies of mechanical vibrations were made. The measurements of the frequency of mechanical vibration are accurate to  $\pm 0.2$  per cent, and those of current are accurate to  $\pm 0.1$  per cent. The calculated frequency factor  $K_f$  is accurate to  $\pm 10$  per cent. A 10 per cent error in the frequency factor causes an error of 0.2

per cent in the determination of the mechanical factor  $K_m$ . The maximum probable error in  $K_m$  is, then,  $\sqrt{0.2^2+0.1^2+0.2^2}$  per cent, or 0.3 per cent. These figures are believed to be conservative because they were obtained by analyzing the following sources of error:

1. In  $f_m$ 
  - (a) Error in standard second, 0.001 per cent.
  - (b) Error in chronograph and relay mechanisms, 0.1 per cent.
  - (c) Error in measuring tapes with steel scale, 0.1 per cent.
2. In  $I$ 
  - (a) Error in direct-current potentiometer, 0.01 per cent.
  - (b) Error in observations, 0.05 per cent.
  - (c) Error in holding  $I$  constant, 0.05 per cent.
3. In  $K_f$ 
  - (a) Error in measurements of length, 2 per cent.
  - (b) Error in calculations (assumed), 8 per cent.

#### USING THE INSTRUMENT

It is usually easy to measure the direct current in a circuit without changing the characteristics of the circuit appreciably, but it is seldom easy to measure radio-frequency currents without causing significant changes in the characteristics of the circuit. In measuring the frequency characteristics of miniature thermocouple ammeters at high frequencies, the following precautions were taken:

1. The electrodynamic ammeter and the ammeter being tested were located at the end of a concentric-tube transmission line 12 feet from the power amplifier, in order to reduce stray field effects to negligible values. See Fig. 2.
2. The ammeter being tested was put into a shielded box and one terminal was connected to this shield so that the condition of test might be duplicated easily and yet simulate a condition found in practice. See Fig. 4.
3. The ammeter circuit was loosely coupled to the power amplifier in order to reduce the harmonics present.
4. The operation of the thermocouple ammeter was checked on direct current before and after each radio-frequency calibration to detect any changes in the instrument caused by radio-frequency operation.

The same operating procedure used in calibrating the electrodynamic ammeter was employed to obtain data on the miniature thermocouple ammeters. The ammeter circuit was analyzed to determine whether or not the observed data would have to be corrected for circuit effects i.e., capacitive shunts. It was found that the value of the shunt

capacitance across the electrodynamic ammeter terminals bears such a relation to the reactance of the exciter loop that the current shunted around the exciter loop is within 0.5 per cent of that shunted around

TABLE I  
DATA

Instrument Number	$f_m$ vib/sec	$K$	$I$ Amperes	Scale	Multiplier	$f$ Mc.
1			5.014	5.00	1.003	d-c
1			5.039	5.00	1.008	d-c
1	0.4376	11.004	4.815	4.89	0.985	5
1	0.3565	10.948	3.905	5.00	0.781	35
1	0.3514	10.946	3.848	5.00	0.770	40.1
2			5.027	5.00	1.005	d-c
2			5.017	5.00	1.003	d-c
2	0.4355	11.004	4.791	4.87	0.985	5
2	0.4249	10.968	4.660	4.96	0.940	13.27
2	0.3972	10.959	4.353	5.00	0.871	20
2	0.3528	10.945	3.860	5.00	0.772	42
3			4.995	5.00	0.999	d-c
3			5.008	5.00	1.002	d-c
3			5.027	5.00	1.005	d-c
3			5.028	5.00	1.006	d-c
3	0.4383	11.004	4.823	4.94	0.977	5
3	0.4141	10.968	4.543	5.00	0.908	13.27
3	0.3883	10.959	4.257	5.00	0.851	20
3	0.3813	10.955	4.177	5.00	0.835	25
3	0.3648	10.950	3.995	5.00	0.799	30
3	0.3473	10.948	3.805	5.00	0.761	35
3	0.3502	10.946	3.835	5.00	0.767	40.1
3	0.3403	10.945	3.757	5.00	0.751	42

the miniature thermocouple ammeters by the capacitance of the electrodynamic ammeter and the wiring to the shield.

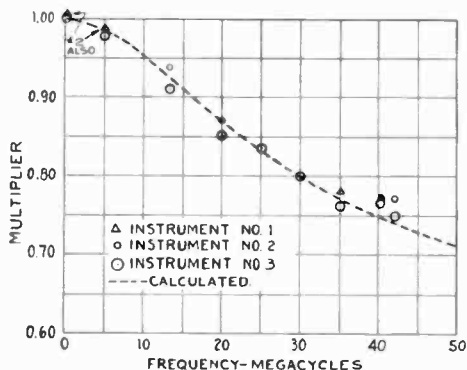

Fig. 6

A summary of the data gathered on three General Electric type DO 5-ampere instruments is given in Table I. Each  $f_m$  is an average of 5 determinations; i.e., 5 tapes were taken to determine each point.

A plot of the data gathered is shown in Fig. 6, together with the skin effect for a 5-ampere thermocouple heater calculated from Bureau

of Standards formulas.<sup>6</sup> This shows that under the conditions outlined, the practice of calibrating miniature thermocouple instruments at 60 cycles and calculating the frequency correction with skin-effect equations is satisfactory up to 42 megacycles. It is not believed safe to extrapolate these data, because it was observed that the addition of about 88 micromicrofarads across the terminals of one of the 5-ampere thermocouple ammeters caused parallel resonance at 30 megacycles. It may be expected that resonance will be found again without the additional capacitor when the frequency reaches about 100 megacycles.

### CALCULATIONS

The oscillating-ring electrodynamic ammeter is a standard of current at high frequencies; i.e., its performance can be calculated from measurements of length, mass, and time. The larger part of the over-all constant of the instrument is the mechanical constant  $K_m$  which may be calculated from

$$K_m = 2\pi\sqrt{JL_1/m} = \frac{20\pi}{m/D}\sqrt{(\pi DW/4)(\ln 8D/d - 2)(1 + 1.25d^2/D^2)}$$

where,

$D$  is the mean diameter of the oscillating ring in centimeters.

$d$  is the cross-sectional diameter of the oscillating ring in centimeters.

$W$  is the mass of the oscillating ring in grams.

$m/D$  is a design constant (a function of exciter-loop diameter and separation from the oscillating ring for circular exciters).

For this instrument

$$K_m = \frac{20\pi}{4.86}\sqrt{(\pi^2 \times 0.1426/4)(\ln 16/0.1016 - 2)(1 + 1.25 \times 0.1016^2/2^2)}$$

$$K_m = 10.72.$$

The frequency factor  $K_f$  for this instrument at 1.1 megacycles is

$$\sqrt{L/L_1} \csc \phi$$

where,

$$L = 0.03987 \text{ microhenry}$$

$$L_1 = 0.03846 \text{ microhenry}$$

$$\phi = \tan^{-1} \omega L/R = \tan^{-1} 0.2756/0.01067$$

$$\phi = 87^\circ 47'$$

$$\csc \phi = 1.00075$$

$$K_f = \sqrt{1 - (F_{m0}/F_m)^2} = 1$$

<sup>6</sup> Bureau of Standards Circular No. 74.

where  $F_{m_0}$  is the natural frequency of the oscillating ring with no exciter-loop current and  $F_m$  is the frequency with exciter-loop current.

### CONCLUSIONS

The oscillating-ring electrodynamic ammeter is a standard of current at high frequencies; i.e., its characteristics can be calculated from measurements of length, mass, and time.

The jewel-bearing oscillating-ring electrodynamic ammeter is a practical instrument; i.e., its application to the accurate measuring of high-frequency currents is not difficult. This was confirmed while col-

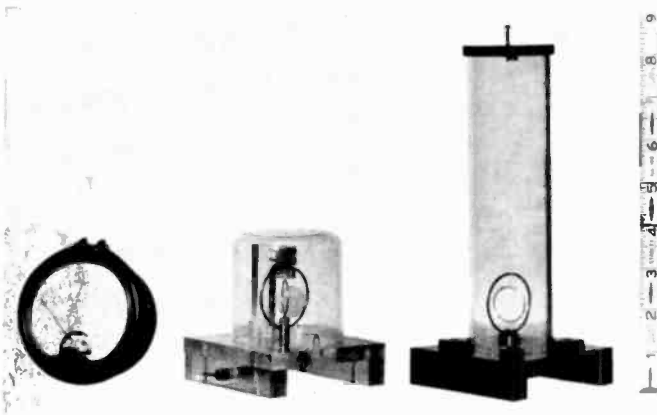

Fig. 7

lecting the data on the miniature thermocouple ammeters. The close agreement between the calculated multipliers and the experimental points on 3 different instruments is significant.

Further evidence of its fitness is presented in Fig. 7 which shows how the jewel-bearing electrodynamic ammeter compares with its predecessor, the suspension type, and with the miniature thermocouple ammeter.

That the oscillating-ring electrodynamic ammeter can be used to measure larger currents at higher frequencies is indicated by the simplicity of its design, by the fact that the frequency factor decreases with increasing frequency, and by the good agreement which was obtained between calculated and experimental results with this, the first experimental bearing-type instrument.

This instrument should prove valuable in improving the accuracy of current measurements at high frequencies.

## ACKNOWLEDGMENT

The author was fortunate in having access to the thesis and advice of P. C. Michel, the aid of S. C. Leonard in designing the bearing-type instrument, and that of E. F. Travis and R. N. Bushman in operating the equipment.





## DESIGN FORMULAS FOR DIODE DETECTORS\*

BY

HAROLD A. WHEELER

(Hazeltine Service Corporation, Bayside, L. I., New York)

*Summary*—Different types of linear rectifiers are defined, and the required properties of linear rectification are outlined. The envelope-type of rectifier is preferred as having greatest efficiency. The ideal diode for this type is defined and its behavior in various circuits is outlined. Formulas are given which enable fairly accurate prediction of performance, especially of such factors as the maximum coefficient of inward modulation which is subject to linear rectification, and the amount of distortion caused by the clipping of the peaks representing unity inward modulation. The formulas indicate desirable relations in terms of the admittance of input and output circuits. It is pointed out that a diode rectifier, under certain conditions, has the effect of shifting along the frequency axis, the admittance curve of the input or output circuit, in a manner similar to the frequency-changing operation on the signal. There are described the effects of practical limitations, such as the departure of the diode from the ideal. Practical examples of circuit design are given.

### I. INTRODUCTION

THERE has been a need for a unified and fairly comprehensive treatment of those properties of the diode rectifier which are most consequential when it is employed as a modulated-carrier signal detector. Some of these properties have been published and are generally recognized; as to these, the need is for a unified collection of basic information and design formulas. Other properties have not been published, although appreciated by a few workers in this field; as to these, the need is for publication in a systematic form. The material comprising this paper has been developed by the writer while working on the problems of the diode detector during the past eleven years.<sup>1</sup> This period has seen the diode detector revived from complete obsolescence and disrepute to its present status of universal use. Its revival has been accomplished by revision of its associated circuits and its conditions of operation. The present diode detector has no more in common with the old Fleming valve detector than the mere fact of its using a vacuum tube with two electrodes.

The advantage that characterizes the present diode detectors is

\* Decimal classification: R134×R362.2. Original manuscript received by the Institute, June 24, 1936; revised manuscript received by the Institute, January 3, 1938.

<sup>1</sup> All of the present material was collected in reports dated December 26, 1933, July 9, 1934, and December 1, 1934. An unpublished earlier report of Charles Travis is acknowledged, which dealt with some of the same subject matter but which was first available to the writer too late to be of assistance in preparing his material.

their securing nearly linear rectification. This requires operating on a large signal voltage, for which the diode is well adapted if properly loaded, because it is not critically susceptible to overloading. The design of diode rectifiers for signal detection is concerned mainly with obtaining nearly linear rectification. Linear rectification of weak modulation is not difficult to realize in most types of detectors. The problem is to secure linear rectification of strong modulation, preferably of unity modulation which is the strongest employed in broadcast transmission. The first requirement is a clear understanding of what constitutes linear rectification and of the different types of linear rectifiers.

*Linear rectification* may be defined in either of two ways. One definition requires the *entire* rectified output (voltage or current) to be directly proportional to the *entire* alternating input (voltage or current). The other definition requires the *variation* of the rectified output (voltage or current) to be directly proportional to the *variation* of the alternating input (voltage or current). The variational linearity is sufficient and necessary for the distortionless rectification of the modulation of carrier waves in radio receivers, and must extend over a sufficient range of modulation. In practical circuits where linear rectification of unity modulation is desired, the absolute and variational linearity may merge as a single requirement.

There are two distinct types of *linear rectifiers*, one of which responds to the *envelope* of a wave form, and the other of which responds to the *average* of the half waves of only one polarity. Any linear rectifier is a compromise between these two types, but may closely approach one type or the other in performance. The envelope type is preferable, since the efficiency has an upper limit of unity as compared with very low efficiency of the average type.

The *average* type of linear rectifier is characterized by the passage of current during the entire duration of all half waves of one polarity. The rectifier must be inherently linear, or must be made effectively linear by connecting in series high resistance which must not be by-passed at the carrier frequency or multiples thereof. All of the input power is dissipated in the rectifier (and series resistance, if used), so the efficiency is zero. The load may be a current-operated device of negligible impedance connected in series, or, if the series resistance is used, may be a voltage-operated device of very high impedance connected across the series resistance through a carrier filter designed not to by-pass the resistance. In the latter case, the maximum voltage output theoretically obtainable from a half-wave rectifier is  $1/\pi$  of the peak voltage, or  $2/\pi$  from a full-wave rectifier. The average type

is merely mentioned in passing to emphasize the differences between this type and the envelope type.

The *envelope* type of linear rectifier is characterized by the passage of current only for an instant at the peak of each half wave of one polarity. This condition is realized by the use of a load resistance much greater than the rectifier impedance, and by-passed at carrier frequencies and multiples thereof. The resulting rectified voltage is nearly as great as the peak voltage so it permits the rectifier to carry only an impulse of current during each cycle of alternation. The rectifier need not be inherently linear. The efficiency is the ratio of the rectified voltage to the peak voltage, which is theoretically unity. This type of rectifier is well adapted to actuate or to control vacuum tubes, and is the subject of this paper.

TABLE I

Note: The prime marks (') are omitted when the input circuit has zero impedance.

Voltages and Currents	Envelope of modulated carrier, $m$ = angular frequency of modulation	Envelope of carrier	Maximum departure of envelope from carrier envelope	Coefficient of modulation	Maximum coefficient of inward modulation subject to linear rectification
Signal Input Voltage (carrier)	$E_c = E_{c0}(1 + k_m \sin mt)$ $= E_{c0} + E_{cm} \sin mt$	$E_{c0}$	$E_{cm} = k_m E_{c0}$	$k_m$	$(k_m)_{\max}$
Diode Input Voltage (carrier)	$E_c' = E_{c0}'(1 + k_m' \sin mt)$ $= E_{c0}' + E_{cm}' \sin mt$	$E_{c0}'$	$E_{cm}' = k_m' E_{c0}'$	$k_m'$	$(k_m')_{\max}$
Diode Input Current (carrier)	$I_c' = I_{c0}'(1 + k_n' \sin mt)$ $= I_{c0}' + I_{cn}' \sin mt$	$I_{c0}'$	$I_{cn}' = k_n' I_{c0}'$	$k_n'$	$(k_n')_{\max}$
Diode Output Current (rectified)	$I' = I_0'(1 + k_n' \sin mt)$ $= I_0' + I_m' \sin mt$	$I_0'$	$I_m' = k_n' I_0'$	$k_n'$	$(k_n')_{\max}$
Diode Output Voltage (rectified)	$E' = E_0'(1 + k_m' \sin mt)$ $= E_0' + E_m' \sin mt$	$E_0'$	$E_m' = k_m' E_0'$	$k_m'$	$(k_m')_{\max}$

The *ideal diode* for use in a linear rectifier of the envelope type, has zero impedance to current in one direction and zero admittance to current in the other direction. Such a diode is assumed in Sections III to VI, dealing with the effects of the circuit on the rectification characteristics, and also in Sections VIII and IX, dealing with special improvements of the circuit. The diodes which are available have a sufficient approximation to the ideal, where the requirements are not too severe and the circuit is carefully designed. The interelectrode capacitance of the diode does not affect the linearity of rectification, but only affects the carrier-frequency circuit design.

*Inward modulation* and *outward modulation* are defined as modulation which respectively decreases and increases the envelope amplitude of the carrier. The maximum coefficient of inward modulation subject to linear rectification is that value beyond which the peaks of inward modulation suffer distortion caused by the rectifier. A form of this distortion is the clipping of the peaks, which commonly appears in the rectified output.

## II. LETTER SYMBOLS

The subject matter of this report is so comprehensive, that a rather complex system of notation is required substantially to avoid ambiguity. The voltage and current notation is outlined in Table I for ease of reference. All the other symbols are listed below in a logical grouping.

The significance of the most used letter subscripts is generally as follows:

0	zero-frequency (direct-current) component
$m$	modulation-frequency (audio-frequency) component
$n$	excess of modulation-frequency admittance (or side-band admittance) over zero-frequency conductance (or carrier-frequency conductance)
$c$	carrier-frequency component
$c0$	unmodulated-carrier component
$cm$	modulation component (side bands)
$nc$	carrier-harmonic component
$i$	input circuit

The use of a prime (') generally denotes that the quantity is affected by the input circuit having finite admittance as distinguished from zero impedance.

The following list contains some of the letter symbols used.

$c$	angular frequency of carrier ( $2\pi f_c$ )
$k_m$	coefficient of modulation of the signal
$k_m''$	relative coefficient of modulation of distorted portion of peaks of envelope
$k_n$	coefficient of modulation of diode currents
$m$	angular frequency of modulation ( $2\pi f_m$ )
$n$	integral number greater than unity
$t$	time
$E$	rectified voltage
$E_c$	modulated-carrier voltage envelope
$E_c''$	signal voltage (Fig. 7)

$(E_c)_{\min}$	minimum value of $E_c$ subject to linear rectification
$I$	rectified current
$I_c$	modulated-carrier current envelope
$I_{nc}$	modulated-carrier-harmonic current envelope
$I_{nc0}$	unmodulated-carrier-harmonic current envelope
$G_{c0}$	rectifier conductance toward unmodulated carrier
$G_{cm}$	rectifier conductance toward modulation (side bands)
$G_i$	input-circuit conductance
$G_i', G_i''$	input-circuit conductance components (Fig. 7)
$G_{i0}$	input-circuit conductance toward unmodulated carrier
$G_m$	output-circuit conductance toward rectified modulation (audio frequency)
$G_n$	$G_m - G_0$
$G_0$	output-circuit conductance toward rectified unmodulated carrier (direct current)
$G_0'$	rectifier conductance toward rectified unmodulated carrier (Fig. 13)
$Y_{cm}$	rectifier admittance toward modulation (Fig. 12)
$Y_{cn}$	$Y_{cm} - G_{c0}$ (Fig. 12)
$Y_{im}$	input-circuit admittance toward modulation (Fig. 11)
$Y_{in}$	$Y_{im} - G_{i0}$ (Fig. 11)
$Y_m$	output-circuit admittance toward rectified modulation (Fig. 11)
$Y_m'$	rectifier admittance toward rectified modulation (Fig. 13)
$Y_n$	$Y_m - G_0$ (Fig. 11)
$Y_n' Y_m' - G_0'$	(Fig. 13)
$C$	capacitance across output circuit
$C_i$	capacitance across input circuit
$C_{im}, C_{in}$	capacitance (input-circuit elements)
$C_m$	capacitance across output circuit
$C_n$	capacitance in series with $G_m$
$C_n$	capacitance in series with $G_n$
$L_i$	inductance across input circuit
$L_{im}, L_{in}$	inductance (input-circuit elements)
$L_m, L_n$	inductance (Fig. 12)
$L_0$	inductance in series with $G_0$

### III. RECTIFICATION CHARACTERISTICS

Signal unmodulated

Input circuit of zero impedance

*Circuit.* Fig. 1 shows the simplest diode rectifier circuit. The signal is unmodulated so the modulation-frequency characteristics of the

load can be disregarded. The input circuit is merely a signal generator whose impedance is so small it can be neglected. The applied carrier voltage has a peak value of  $E_{c0}$  at the carrier frequency. The diode current has alternating components  $I_{c0}$  and  $I_{nc0}$  at the current frequency which are by-passed through the condenser  $C$  and the rectified component  $I_0$  which flows through the load conductance  $G_0$ . The rectified voltage across the load is  $E_0$ , which is free of alternating components since they are by-passed by the condenser. The ideal diode is assumed, which has zero impedance to current in one direction and zero admittance to current in the other direction.

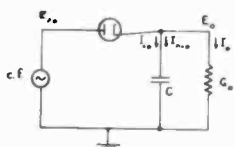

Fig. 1—Simple diode rectifier circuit.

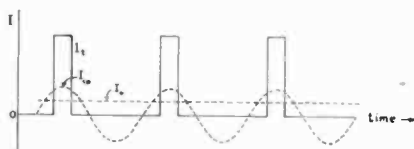

Fig. 2—Instantaneous diode current.

*Operation.* Each positive peak of the input voltage charges the condenser  $C$  to a voltage  $E_0$  equal to the carrier-frequency peak voltage  $E_{c0}$ . During each carrier-frequency cycle, a very small part of this charge leaks off through  $G_0$ , but is immediately replenished by an impulse of charging current at the next positive peak of the input voltage.

Fig. 2 shows the diode current as a function of time. At each positive peak of the input voltage, an impulse of current flows which is just sufficient to build up the charge on  $C$  to the peak voltage  $E_{c0}$ . Each impulse is of very short duration, so that its shape is immaterial (indicated as rectangular in Fig. 2). The diode current comprising this succession of periodic impulses can be represented in terms of the Fourier series

$$I_t = I_0 + I_{c0} \cos ct + \dots + I_{nc0} \cos nct + \dots \quad (1)$$

$$I_0 = E_{c0}G_0 = E_0G_0 \quad (2)$$

$$I_{c0} = I_{nc0} = 2I_0 = 2E_{c0}G_0 = 2E_0G_0. \quad (3)$$

The effective carrier-frequency conductance of the diode across the input circuit is

$$G_{c0} = I_{c0}/E_{c0} = 2G_0. \quad (4)$$

This is the well-known relation that the effective conductance of a diode rectifier is double the conductance of its output circuit. The efficiency is

$$\frac{E_0 I_0}{E_{c0} I_{c0} / 2} = 1. \tag{5}$$

Equal input and output power is consistent with the input conductance double the output conductance because the mean-square input voltage is half the squared output voltage.

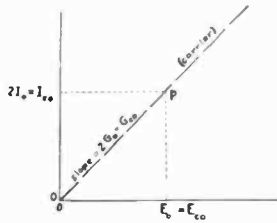

Fig. 3—The linear current-voltage relation of the carrier input ( $I_{c0}$ ,  $E_{c0}$ ) and rectified output ( $I_0$ ,  $E_0$ ).

Fig. 3 shows the linear relation between the currents and voltages in Fig. 1. Both input and output quantities can be represented by the same graph, in view of (3). The point of equilibrium is denoted  $p$ .

#### IV. RECTIFICATION CHARACTERISTICS

Signal modulated

Input circuit of zero impedance

Output circuit of nonuniform conductance

*Circuit.* Figs. 4 and 5 show two equivalent diode rectifier circuits in which the load conductance is greater for rectified modulation than for rectified carrier. The signal is modulated, so this condition of the

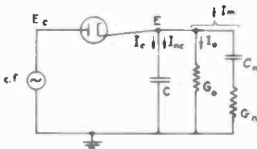

Fig. 4—Diode rectifier circuit including excess load conductance toward modulation ( $G_n$ ).

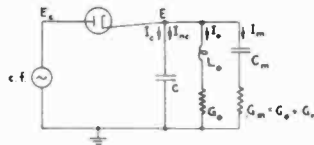

Fig. 5—Diode rectifier circuit including separate load conductance toward modulation ( $G_m$ ).

load cannot be disregarded. The applied modulated-carrier voltage has a peak value  $E_c$  which fluctuates with modulation. In Fig. 4, the load for modulation is greater by the value of the conductance  $G_n$ , which is coupled across  $G_0$  by the condenser  $C_n$ . In Fig. 5, the rectified modulation current of peak value  $I_m$  is filtered out of  $G_0$  by the choke coil  $L_0$ , so the entire load for modulation is  $G_m$ , which is coupled across  $G_0$  by the condenser  $C_m$ . The rectified voltage is  $E$ , which fluctuates with modulation in the same manner as  $E_c$ .

*Assumptions.* The condenser  $C$  has zero impedance at the angular frequencies of carrier and side bands ( $c, c-m, c+m$ ) and of harmonics ( $nc, nc-m, nc+m$ ), and has zero admittance at the modulation frequency. The inductor  $L_0$  has zero impedance at zero frequency and has zero admittance at the modulation frequency. The condensers  $C_m$  and  $C_n$  have zero impedance at the modulation frequency. The conductance  $G_n$  is positive, and therefore  $G_m$  is greater than  $G_0$ . Figs. 4 and 5 are equivalent, except for the division of  $I_m$  between  $G_0$  and  $G_n$  in Fig. 4, whereas all of  $I_m$  flows through  $G_m$  in Fig. 5.

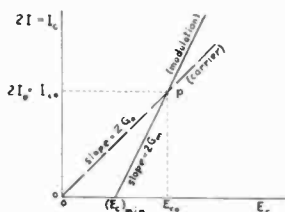

Fig. 6—The current-voltage relations as affected by different load conductance toward modulation.

*Operation.* The positive peaks of an unmodulated carrier envelope charge the condensers  $C$ ,  $C_m$ , and  $C_n$  to a voltage  $E_0$  equal to the carrier peak voltage  $E_{c0}$ , and also maintain in  $L_0$  a uniform direct current  $I_0 = E_0 G_0$ . This relation is shown by the graph of Fig. 6. The point  $p$  indicates the point of equilibrium for an unmodulated carrier.

Fig. 6 shows the behavior of the circuits of Figs. 4 and 5 toward a modulated signal. The average current  $I_0$  is determined by  $G_0$ , and is independent of  $G_n$ . The modulation-frequency changes of current are determined by  $G_m$ , which is greater than  $G_0$  by  $G_n$ , and therefore follow the steeper lines through  $p$ . The carrier-frequency and zero-frequency currents are modulated to the extent of  $k_n$  which is greater than  $k_m$ , the modulation coefficient of the signal, in the ratio

$$\frac{k_n}{k_m} = \frac{G_m}{G_0} = \frac{G_0 + G_n}{G_0} = 1 + \frac{G_n}{G_0} \quad (6)$$

For inward modulation corresponding to  $k_n=1$ , the maximum change of rectified current  $I_m$  is equal and opposite to the average rectified current  $I_0$ . Since current cannot flow in the reverse direction, any greater inward modulation causes no further change of current. For linear rectification, the inward modulation of the currents must not exceed

$$(k_n)_{\max} = 1 \quad (7)$$



and therefore the inward modulation of the signal and of the voltages must not exceed

$$(k_m)_{\max} = \frac{k_m}{k_n} (k_n)_{\max} = \frac{k_m}{k_n} = \frac{G_0}{G_m} = \frac{G_0}{G_0 + G_n} = \frac{1}{1 + \frac{G_n}{G_0}} \quad (8)$$

Reducing  $G_n$  and/or increasing  $G_0$  results in permitting more nearly unity modulation, subject to linear rectification.

Any peaks of inward modulation are clipped off in the process of rectification, to the extent that they exceed these maximum values. It is assumed that such peaks occur so infrequently that their clipping has a negligible effect on the average current  $I_0$ . Outward modulation is free of any such limitation, and may even exceed unity during unsymmetrical peaks of modulation, without suffering nonlinear distortion in rectification.

### V. RECTIFICATION CHARACTERISTICS

Signal modulated

Input circuit of uniform conductance

Output circuit of nonuniform conductance

*Circuit.* Figs. 7 and 8 show two equivalent circuits in which the output circuits correspond respectively to Figs. 4 and 5. The rectifier input circuit of Fig. 7 is a practical circuit in which the modulated-carrier signal voltage is  $E_c''$  generated in the output circuit of a preceding amplifier in series with its internal output conductance  $G_i''$ .

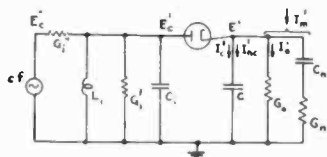

Fig. 7—Diode rectifier circuit including an input tuned circuit added to Fig. 4.

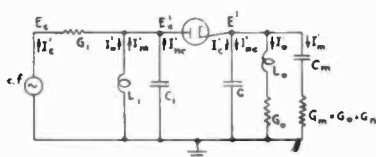

Fig. 8—Diode rectifier circuit including an input tuned circuit added to Fig. 5.

The amplifier is coupled to the rectifier by the tuned input circuit comprising  $L_i, G_i', C_i$ , across which is developed the modulated-carrier voltage  $E_c'$ . In order to simplify the analysis, without detracting from the generality of the conclusions, Fig. 8 shows an equivalent input circuit in which a lesser signal voltage is generated in series with the total conductance  $G_i$  concentrated in the generator circuit, so as to develop the same voltage  $E_c'$  across the rectifier input circuit. The generator then supplies modulated-carrier current  $I_c'$  equal to the corresponding component of the rectifier current, while the harmonic

components  $I_{nc}'$  developed in the rectifier are by-passed through  $C$  and  $C_i$  in series. The rectified carrier and modulation components  $I_o'$  and  $I_m'$  flow through the load conductance and  $L_i$  in series, developing a rectified output voltage  $E'$  which fluctuates with modulation. Fig. 7 corresponds most nearly to the diode detector circuits in common use.

*Assumptions* (in addition to those of the preceding section). The carrier-frequency tuned circuit comprising  $L_i$  and  $C_i$  in parallel has zero admittance at the angular frequencies  $c$ ,  $c-m$ ,  $c+m$ , and has zero impedance at the angular frequencies zero,  $m$ , and  $nc$ ,  $nc-m$ ,  $nc+m$ . Figs. 7 and 8 are equivalent on the assumption that

$$G_i = G_i' + G_i'', \quad \text{and} \quad E_c G_i = E_c'' G_i''. \quad (9)$$

The diode input voltage envelope on open circuit is  $E_c$ .

*Operation.* The inward modulation subject to linear rectification is limited in the same manner as in the preceding section, but the limitation is less severe.

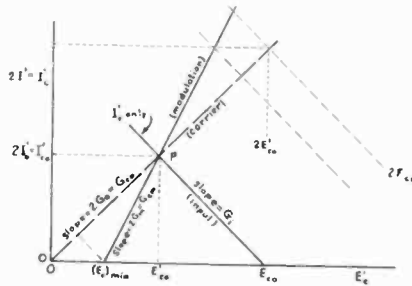

Fig. 9—The current-voltage relations as affected by the input circuit.

Fig. 9 shows the current-voltage relations. The point of equilibrium ( $p$ ) for an unmodulated carrier is determined by the intersection of the carrier "input" line and the "carrier" line. Modulation moves the "input" line parallel to itself. The point of equilibrium during modulation is at the intersection of the "input" line and the "modulation" line. Since the latter is steeper than the "carrier" line, the carrier-frequency and zero-frequency currents are modulated to the extent of  $k_n'$  which is greater than  $k_m$  of the signal:

$$\frac{k_n'}{k_m} = \frac{2G_m G_i}{2G_0 G_i} = \frac{G_m(2G_0 + G_i)}{G_0(2G_m + G_i)} = 1 + \frac{G_n G_i}{G_0(2G_0 + 2G_n + G_i)} \quad (10)$$

For linear rectification, the inward modulation of the currents must not exceed

$$(k_n')_{\max} = 1 \quad (11)$$

and therefore the inward modulation of the signal must not exceed

$$(k_m)_{\max} = \frac{k_m}{k_n'} (k_n')_{\max} = \frac{G_0(2G_m + G_i)}{G_m(2G_0 + G_i)} = \frac{1}{1 + \frac{G_n G_i}{G_0(2G_0 + 2G_n + G_i)}} \quad (12)$$

Reducing  $G_i$  and/or  $G_n$ , and/or increasing  $G_0$ , results in permitting more nearly unity modulation, subject to linear rectification.

Any peaks of inward modulation are clipped off in the process of rectification, to the extent that they exceed these maximum values. It is assumed that such peaks occur so infrequently that their clipping has a negligible effect on the average current  $I_0'$ . Outward modulation is free of any such limitation, and may even exceed unity during unsymmetrical modulation, without suffering nonlinear distortion in rectification.

Since the effective conductance of the diode, across the input circuit, is greater for modulation than for carrier, the carrier-frequency input voltage and the rectified output voltage are modulated to the extent of  $k_m'$  which is less than  $k_m$  of the signal:

$$\frac{k_m'}{k_m} = \frac{\frac{G_i}{G_i + 2G_m}}{\frac{G_i}{G_i + 2G_0}} = \frac{G_i + 2G_0}{G_i + 2G_m} = \frac{1}{1 + \frac{2G_n}{2G_0 + G_i}} \quad (13)$$

The maximum value of  $k_m'$ , subject to linear rectification, is

$$(k_m')_{\max} = \frac{k_m'}{k_m} (k_m)_{\max} = \frac{G_0}{G_m} = \frac{1}{1 + \frac{G_n}{G_0}} \quad (14)$$

The effective conductance of the diode is zero for any excess of inward modulation  $k_m''$  across the input circuit, beyond the range of linear rectification. Therefore that part of the envelope is not attenuated by the diode across the input circuit. This amounts to an augmentation of the inward peaks of modulation, relative to the attenuated carrier across the input circuit, in the ratio

$$\frac{k_m''}{k_m} = \frac{G_i + 2G_0}{G_i} = 1 + \frac{2G_0}{G_i} \quad (15)$$

The corresponding augmentation of the inward peaks of modulation, relative to the more attenuated modulation envelope across the input circuit, is in the greater ratio

$$\frac{k_m''}{k_m'} = \frac{k_m''}{k_m} \cdot \frac{k_m}{k_m'} = \frac{G_i + 2G_m}{G_i} = 1 + \frac{2G_0 + 2G_n}{G_i} \quad (16)$$

The distortion of the modulation envelope across the input circuit increases with the excess ( $k_m''$ ) of inward modulation, and with the excess of the latter ratio over unity. This ratio having a value of two, for example, causes distortion of the envelope, which is equal in amount to that caused by clipping off the corresponding peaks of inward modulation. This envelope distortion is not reflected as peak clipping in the rectified output of the diode causing the distortion.

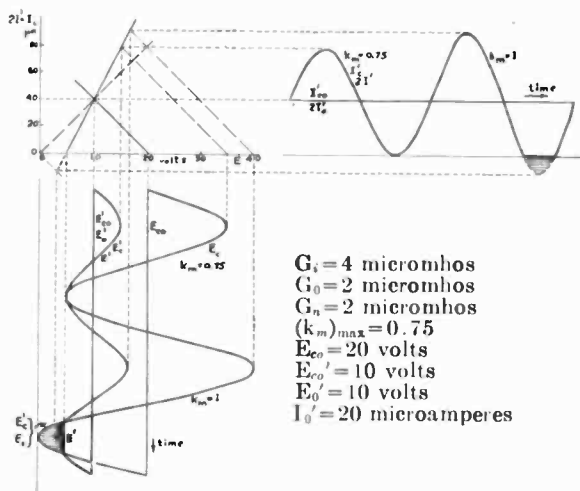

Fig. 10—Graphical analysis of the peak clipping of the rectified output ( $I'$ ,  $E'$ ) and the peak augmentation of the input voltage envelope ( $E_c'$ ).

Fig. 10 shows the operation of the circuits of Figs. 7 and 8 in terms of the relations shown in Fig. 9. Curve  $E_c$  is the modulation envelope of the carrier-frequency input voltage (on open circuit) having one cycle of modulation at  $(k_m)_{\max} = 0.75$  and a second cycle of modulation at  $k_m = 1$ . Curve  $E_c'$  is the resulting envelope of the carrier-frequency voltage applied to the diode. Curve  $E'$  is the rectified voltage. Curve  $I_c'$  is the envelope of the carrier-frequency current component in the diode. Curve  $2I'$  is double the rectified current. These curves show linear rectification of modulation up to  $(k_m)_{\max}$ . At higher modulation (unity) the  $E'$  and  $2I'$  curves show the clipping of the peak of inward modulation. At the same peak, the  $E_c'$  envelope shows the opposite effect. The values chosen to obtain these curves are within the range of current practice.

VI. RECTIFICATION CHARACTERISTICS

Signal modulated

Input circuit of nonuniform admittance

Output circuit of nonuniform admittance

*Circuit.* Fig. 11 shows a circuit corresponding to Fig. 8 except for the modification of the input circuit in such a manner that its admittance toward the modulation side bands corresponds to the load admittance toward the rectified modulation. This case in its most general form, as shown, is only of academic interest, and is included only to emphasize the reciprocal relations between input and output admittance, actual and effective. The input circuit conductance  $G_{i0}$  toward the carrier component  $E_{c0}$  and the output circuit conductance  $G_o$

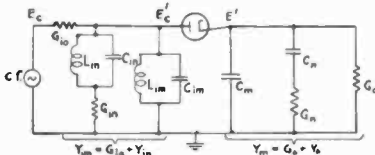

Fig. 11—Diode rectifier circuit with input and output circuits of corresponding admittance variation.

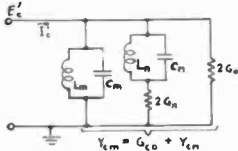

Fig. 12—The apparent input admittance of the diode of Fig. 11 toward components of side-band frequencies.

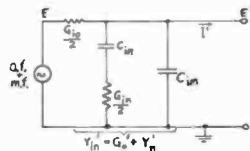

Fig. 13—The apparent output admittance of the diode of Fig. 11 toward components of modulation frequencies.

toward the rectified carrier component determine the behavior toward an unmodulated carrier. All of the other elements, in general, affect the behavior toward modulation. Fig. 12 shows in the form of a two-terminal network the effective input admittance  $Y_{em}$  of the rectifier toward the modulated-carrier voltage  $E'_c$ , as determined by the load admittance  $Y_m$  toward the rectified voltage  $E'$ . Reciprocally, Fig. 13 shows the effective internal voltage  $E$  and output admittance  $Y_{in'}$  of the rectifier toward the rectified voltage  $E'$  as determined by the input circuit admittance  $Y_{im}$  toward the input circuit voltage  $E'_c$ . The ideal diode is still assumed, so its impedance does not enter.

*Assumptions.* Condenser  $C_m$  has zero impedance at the angular frequencies  $c, c-m, c+m$  and  $nc, nc-m, nc+m$ . The condenser  $C_{im}$  has zero impedance at the angular frequencies  $nc, nc-m, nc+m$ .

The inductor  $L_{im}$  has zero impedance at zero frequency and modulation frequency. Each of the resonant circuits is tuned to the carrier-frequency and has zero admittance at the carrier frequency.

*Operation.* The circuit of Fig. 11 is chosen as a basis for describing the apparent admittance transformations which take place when the input or output circuit is viewed from the other side of the diode rectifier. This transformation requires the presence of a carrier with modulation not exceeding the maximum which is subject to linear rectification.

The admittance transformations are based on the relation of (4), stated more generally to take account of the departure from uniform conductance of both input and output circuits.

The input circuit of Fig. 11 has a complex total admittance toward the modulated signal whose value is

$$Y_{im} = G_{i0} + Y_{in} \quad (17)$$

in which  $G_{i0}$  is the pure conductance toward the unmodulated carrier, and  $Y_{in}$  is the complex additional admittance at the side frequencies of modulation. The output circuit has a complex total admittance toward the rectified signal, whose value is

$$Y_m = G_0 + Y_n \quad (18)$$

in which  $G_0$  is the pure conductance toward the rectified unmodulated carrier, and  $Y_n$  is the complex additional admittance at the frequencies of modulation.

The voltages across the input and output circuits may be regarded as alike, except that the input voltage has a high carrier frequency, while the output voltage has zero "carrier frequency." The side frequencies of the output voltage merge in a single side band, which complicates the problem. The envelopes are equal. The diode rectifier has the effect of shifting the signal spectrum along the frequency axis, reducing the frequency of each component by subtracting the carrier frequency. Looking through the diode at the input or output circuit has an analogous effect on the admittance. The admittance curve is shifted along the frequency axis, through a distance representing the carrier frequency.

Fig. 12 shows the appearance of the output circuit as viewed through the diode from the input terminals. This admittance transformation is based on the assumption that the input circuit has impedance, and the input voltage has components, only at frequencies in the neighborhood of the carrier frequency. Therefore only the carrier-frequency component of the diode current is appreciated

by the input circuit. The carrier-frequency admittance of the diode and the output circuit is given by a generalization of (4):

$$Y_{cm} = 2Y_m. \quad (19)$$

This equation means that the apparent admittance across the input circuit at angular frequencies  $c \pm m$  is double the admittance of the output circuit at angular frequencies  $m$ . Fig. 12 is derived on the basis of this relation.

Fig. 13 shows the appearance of the input circuit as viewed through the diode from the output terminals. This admittance transformation is based on the assumption that the output circuit has impedance, and the output voltage has components, only at zero and modulation frequencies. Therefore only the zero-frequency and modulation-frequency components of the diode current are appreciated by the output circuit. The zero-frequency and modulation-frequency admittance of the diode and input circuit is given by another generalization of (4):

$$Y_m' = Y_{im}/2. \quad (20)$$

This equation means that the apparent admittance across the output circuit at angular frequencies  $m$  is half the admittance of the input circuit at angular frequencies  $c \pm m$ . Fig. 13 is derived on the basis of this relation.

In practical cases, the appreciable resistance of the diode appears to introduce resistance in series with the upper terminals in Figs. 12 and 13, which slightly modifies the apparent admittances.

From the preceding admittance transformations, it is derived that the diode currents are modulated to the extent of  $k_n'$  which has the following ratio to  $k_m$  of the signal:

$$\frac{k_n'}{k_m} = \left| \frac{Y_{cm}(G_{c0} + G_{i0})}{G_{c0}(Y_{cm} + Y_{im})} \right| = \left| \frac{Y_m(2G_0 + G_{i0})}{G_0(2Y_m + Y_{im})} \right|. \quad (21)$$

The inward modulation of the currents cannot exceed unity. Therefore, for linear rectification, the inward modulation of the signal must not exceed

$$(k_m)_{\max} = \left| \frac{G_0(2Y_m + Y_{im})}{Y_m(2G_0 + G_{i0})} \right| = \left| \frac{1 + \frac{2Y_n + Y_{in}}{2G_0 + G_{i0}}}{1 + \frac{Y_n}{G_0}} \right|. \quad (22)$$

From the same admittance transformations, it is derived also that the carrier-frequency input and the rectified output voltages across

the diode are modulated to the extent of  $k_m'$  which has the following ratio to  $k_m$  of the signal:

$$\frac{k_m'}{k_m} = \left| \frac{2G_0 + G_{i0}}{2Y_m + Y_{im}} \right| = \left| \frac{1}{1 + \frac{2Y_n + Y_{in}}{2G_0 + G_{i0}}} \right|. \quad (23)$$

For inward modulation corresponding to  $k_m' = 1$ , the maximum change of rectified voltage,  $E_m'$ , is equal and opposite to the average rectified voltage  $E_0'$ . Voltage of reverse polarity cannot occur across the diode, because the diode has zero impedance thereto. Greater inward modulation causes no further change of rectified voltage, so that the inward modulation of the diode voltages cannot exceed unity. Therefore, for linear rectification, the inward modulation of the signal must not exceed

$$(k_m)_{\max} = \frac{k_m}{k_m'} = \left| \frac{2Y_m + Y_{im}}{2G_0 + G_{i0}} \right| = \left| 1 + \frac{2Y_n + Y_{in}}{2G_0 + G_{i0}} \right|. \quad (24)$$

Unity inward modulation of the signal is subject to linear rectification only when neither of the expressions (22) and (24) for  $(k_m)_{\max}$  is less than unity. Whichever expression is less states the principal limitation. The former is usually less.

The simplest condition under which unity inward modulation is subject to linear rectification is expressed by each of the equations

$$\frac{Y_m}{G_0} = \frac{Y_{im}}{G_{i0}}, \quad \frac{Y_m}{Y_{im}} = \frac{G_0}{G_{i0}}; \quad \frac{Y_n}{G_0} = \frac{Y_{in}}{G_{i0}}, \quad \frac{Y_n}{Y_{in}} = \frac{G_0}{G_{i0}}. \quad (25)$$

This condition may be stated, that the admittance-frequency curves of input and output circuits have the same shape and width, and that the side-band selectivity or fidelity characteristics of either circuit are unaffected by the connection thereto of the diode and the other circuit. In the example of Fig. 11, this condition is

$$\frac{2G_0}{G_{i0}} = \frac{2G_n}{G_{in}} = \frac{C_m}{C_{im}} = \frac{C_n}{C_{in}}. \quad (26)$$

In practical cases, the circuit  $L_{in}C_{in}$  is usually difficult or impossible to provide, with sufficiently small dissipation. It is included in the example, merely to show its theoretical utility in obviating the distortion caused by  $G_n$  in the output circuit. Assuming that  $G_n$  and  $G_{in}$  are zero, the remaining elements are subject to the condition

$$\frac{2G_0}{G_{i0}} = \frac{C_m}{C_{im}}, \quad (27)$$



which easily can be satisfied. This condition is modified by any changes affecting the input or output circuit admittance, such as the provision of a pair of optimum-coupled tuned-input circuits. In such cases, (25) can be applied, which always indicates the proper conjugate networks for input and output circuits. For example, a band-pass filter in the input circuit requires a conjugate low-pass filter in the output circuit, insofar as either of these filters affects the terminal admittance on the diode side of the input or the output circuit. These two filters then behave as a single symmetrical filter of either type having a number of sections equal to the total number of both types. Input and output filters which are nonconjugate may be coupled by the rectifier but less than unity inward modulation would then be subject to linear rectification.

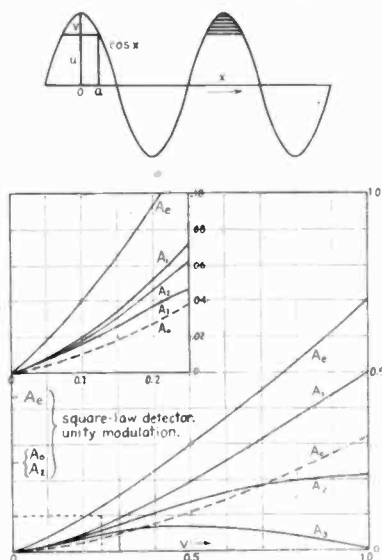

Fig. 14—The total distortion coefficient ( $A_e$ ) and its components, caused by peak clipping.

## VII. ANALYSIS OF NONLINEAR DISTORTION

*Peak clipping.* The form of distortion caused by rectification of excessive inward modulation is an example of peak clipping such as met in various types of radio circuits. As applied to a sine wave, in general, this introduces spurious components at all multiples of the fundamental frequency, including zero-frequency and fundamental-frequency components usually disregarded. Simple approximate expressions are here derived which express quite accurately the quadratic sum of all the distortion components relative to the undistorted sine-wave amplitude.

*Assumption.* All the positive or all the negative peaks of a sine wave are clipped off to the extent denoted by  $v = 1 - u$  in Fig. 14. The angular width of the clipped portion is  $2a$ , related to  $u$  and  $v$  as follows:

$$\cos a = u = 1 - v. \quad (28)$$

When the modulation ( $k_m$ ) exceeds  $(k_m)_{\max}$ , the clipping of the peaks of inward modulation, appearing as nonlinear distortion of the rectified output, occurs to the extent denoted by

$$u = \frac{(k_m)_{\max}}{k_m}, \quad v = \frac{k_m - (k_m)_{\max}}{k_m}. \quad (29)$$

For unity modulation ( $k_m$ ), these values are

$$u = (k_m)_{\max}, \quad v = 1 - (k_m)_{\max}. \quad (30)$$

*Analysis.* The coefficients of distortion are denoted by the  $A$  coefficients in the Fourier series

$$A_0 + (1 + A_1) \cos x + A_2 \cos 2x + A_3 \cos 3x + \dots \quad (31)$$

in which  $\cos x$  is the undistorted wave form. The coefficients have the values

$$A_0 = -\frac{1}{\pi} (\sin a - a \cos a) \quad (32)$$

$$A_1 = -\frac{1}{\pi} (a - \sin a \cdot \cos a) \quad (33)$$

$$A_2 = -\frac{2}{3\pi} \sin^3 a \quad (34)$$

$$A_3 = -\frac{2}{3\pi} \sin^3 a \cdot \cos a \quad (35)$$

$$A_n = -\frac{\sin(n-1)a}{\pi(n-1)} - \frac{\sin(n+1)a}{\pi(n+1)} + \frac{2 \sin na \cdot \cos a}{\pi n}. \quad (36)$$

When  $a$  and  $v$  are very small, these coefficients have approximately the values

$$A_0 = -\frac{1}{3\pi} (2v)^{3/2}, \quad A_1 = A_n = -\frac{2}{3\pi} (2v)^{3/2}. \quad (37)$$

This approximate value of  $A_0$  is accurate within 6 per cent when  $v$  is less than unity.

The above coefficients are all negative, since only the positive

peaks are clipped. If only the negative peaks were clipped, the odd coefficients would be negative and the even coefficients would be positive. If both positive and negative peaks were clipped, the odd coefficients would be doubled and the even coefficients would cancel out.

The total power of all the distortion terms is

$$\begin{aligned} \frac{A_e^2}{2} &= A_0^2 + \frac{A_1^2}{2} + \frac{A_2^2}{2} + \dots \\ &= \frac{a}{2\pi} + \frac{a}{\pi} \cos^2 a - \frac{3}{2\pi} \sin a \cdot \cos a. \end{aligned} \quad (38)$$

The coefficient  $A_e$  is that of a single cosine term which would have the same power as the total of all the distortion terms. When  $a$  and  $v$  are small,

$$A_e = 0.7(v)^{5/4}. \quad (39)$$

This approximate formula is accurate within one per cent when  $v$  is less than unity. The value of  $A_e$  is the best simple indication of the amount of distortion. If both positive and negative peaks were clipped, the total distortion power would be doubled, and the value of  $A_e$  would be multiplied by  $\sqrt{2}$ .

The curves of Fig. 14 show the distortion coefficients as a function of  $v$ . The analogous coefficients are indicated for the case of a square-law detector receiving a signal having unity modulation. The amount of distortion in this case is as great as that caused by clipping 68 per cent of the positive or the negative peaks of a sine wave.

The above analysis takes into account the distortion terms at zero frequency and at the fundamental frequency, both of which are usually overlooked because they are difficult to measure. These terms are inaudible during modulation of a sine-wave form, but they indicate a condition which causes certain audible cross products (beat notes) during modulation of complex-wave form. The latter are even more detrimental than ordinary harmonic distortion, and therefore are not negligible.

The distortion of the modulation envelope  $E_c'$  by the diode, in which the peaks are augmented instead of clipped, can be computed from the above information. In this case, all the above distortion coefficients must be multiplied by

$$1 - \frac{k_m''}{k_m'} = - \frac{2G_m}{G_i} = - \frac{2G_0 + 2G_n}{G_i}. \quad (40)$$

### VIII. BIAS VOLTAGE FOR REDUCTION OF NONLINEAR DISTORTION

Signal modulated

Output circuit of nonuniform conductance

*Circuits.* In the circuits of Figs. 4, 5, 7, and 8, the range of linear rectification, as limited by the excess load conductance  $G_n$ , can be extended by the addition of a bias voltage on the rectifier. The optimum value of this voltage is related to the carrier voltage as well as the relative values of load conductance.

*Assumption.* A bias battery is inserted in series with  $G_0$ . This battery has a voltage  $E_b$ , which is called positive when so connected as to increase the diode current. With reference to the graphs of Figs. 6 and 9, this battery has the effect of shifting the "carrier" line to the left until it intersects the horizontal axis at  $-E_b$ . This changes the point  $p$  and thereby causes the "modulation" line also to shift to the left.

*Operation.* A certain value of bias voltage has the effect of shifting to the origin of co-ordinates the lower end of the "modulation" line. This is a condition for linear rectification of inward modulation up to unity. With reference to Figs. 4 to 6, this condition is

$$\frac{E_b}{E_{c0}} = \frac{E_b}{E_0} = \frac{G_m - G_0}{G_0} = \frac{G_n}{G_0} \quad (41)$$

With reference to Figs. 7 to 9, this condition is

$$\frac{E_b}{E_{c0'}} = \frac{E_b}{E_0'} = \frac{G_m - G_0}{G_0} = \frac{G_n}{G_0} \quad (42)$$

A fixed value of  $E_b$  satisfies one of these conditions for only one value of carrier voltage  $E_{c0}$ . An automatically adjusted value of  $E_b$  can be provided, which satisfies one of these conditions for a range of carrier voltages. Where either of the above conditions is satisfied, all the coefficients of modulation are equal to that of the signal, and all modulation not exceeding unity is subject to linear rectification.

Where a fixed positive bias voltage is used, one of the above conditions is satisfied for only one value of the carrier voltage. For greater carrier voltage, this bias reduces, but does not eliminate, the distortion described above. For much smaller carrier voltage, this bias may greatly increase the distortion. In either case, the distortion is the clipping of the peaks of inward modulation. The cause resides in the fact that the operating point on the "modulation" line cannot swing beyond either of the co-ordinate axes.

The proper bias voltage is not critical where it has to correct only

a small amount of distortion. The present receiving tubes with indirectly heated cathodes, operated in diode circuits, have the equivalent of about 0.8-volt positive bias, which represents the average emission velocity of electrons from the hot cathode. This inherent bias can be used to advantage in circuit design. Departure from the proper bias voltage causes an amount of distortion which depends on the relative values of  $G_i$  and  $G_m$ . Where  $G_i$  exceeds  $2G_m$ , an excess of positive bias causes less distortion than an equal deficiency. Where  $G_i$  is less than  $2G_m$ , a deficiency of positive bias causes less distortion than an equal excess.

In general, a positive or negative bias voltage reduces to zero the rectified output for very small values of carrier voltage. For example, a fixed positive bias can be chosen to reduce distortion in the operating range of carrier voltages, and also to quiet the background noise of much less input voltage. A positive or an equal negative bias has greater quieting effect, where  $G_i$  is respectively less or greater than  $2G_m$ . In practical operation, the finite resistance of the diode gives an advantage to a negative bias for quieting, but the latter usually increases distortion.

#### IX. OUTPUT CIRCUIT OF UNIFORM CONDUCTANCE

*Circuits.* For linear rectification of unity modulation without a bias voltage in the practical circuits of Figs. 4, 5, 7, and 8, it is necessary to have uniform load admittance (conductance) toward zero frequency and modulation frequency. In some cases, the excess conductance  $G_n$  can be omitted in Figs. 4 and 7, but other expedients also are available.

*Assumptions* (in addition to those of the preceding sections). The conductances  $G_0$  and  $G_m$  are equal. The inductance  $L_0$  and capacitance  $C_m$  may depart appreciably from the preceding assumptions relating thereto, if they satisfy the relation

$$\frac{C_m}{L_0} = G_m G_0 = G_0^2. \quad (43)$$

The preceding assumptions or this relation assures that the output circuit has the same conductance at zero frequency and modulation frequency.

*Operation.* If the zero-frequency and modulation-frequency outputs need not be separated, the circuit of Figs. 4 or 7, with  $G_n$  and  $C_n$  omitted, may be used to rectify modulated signals without the distortion described above, since  $G_0$  is then equal to  $G_m$ . This expedient

may be applicable to signal rectifiers, but is not applicable to rectifiers producing a bias voltage for automatic volume control.

In Figs. 5 and 8, equalizing  $G_0$  and  $G_m$  makes  $G_n=0$ , and thereby obviates all the distortion described above. The only practical objection to this expedient is the requirement of an inductor  $L_0$  which is expensive and bulky, and which is likely to pick up hum from the power transformer or choke coils. The voltage across  $G_0$  is applicable as a bias for automatic volume control. All the modulation-frequency output power is dissipated in  $G_m$ .

Several alternative circuits for securing this result are described in the writer's U. S. Patent No. 1,951,685 (March 20, 1934) and also in his British Patent No. 398,882 (April 1, 1931).

In Figs. 5 and 8, it is possible to have  $G_m$  less than  $G_0$ . Some of the above equations are not applicable to this condition. Formulas (41) and (42) are valid, indicating that a certain value of negative-bias voltage is a requirement for linear rectification of inward modulation not exceeding unity. Such a negative bias, if substantial and fixed, gives considerable quieting action, but also causes considerable distortion of signals having about half the normal carrier voltage.

## X. THE DIODE

In the above analysis, the diode is assumed to have zero resistance to current in one direction and zero conductance to current in the other direction. The closest approximation to these properties is secured in a high-vacuum diode having an indirectly heated cathode whose available emission is much greater than the peak currents during operation. The diode current-voltage curve has a gradual transition from an exponential curve (for negative anode voltage) to a 3/2-power curve (for positive anode voltage). This exponential curve is the closest approach to the ideal of any curves that can be realized. Also, the exponential function is the only continuous function that approximates the ideal diode characteristic.

The exponential curve of anode current has the equation

$$I_a = I_{a0} \epsilon^{E_a/E_1} \quad (44)$$

in which  $E_a$  is the anode voltage and  $I_{a0}$  and  $E_1$  are constants. The value of  $I_{a0}$  increases rapidly with cathode temperature. The value of  $E_1$  is relatively independent of structure and operating conditions. For the usual indirectly heated cathodes,  $E_1=0.12$  volt, approximately. The smallness of  $E_1$  determines the sharpness of curvature for small current.

The 3/2-power curve of anode current has the equation

$$I_a = H_a(E_a + E_b)^{3/2} \quad (45)$$

in which  $E_a$  is the anode voltage and  $H_a$  and  $E_b$  are constants. The value of  $H_a$  increases with cathode surface. The value of  $E_b$  increases with temperature. For the usual diodes with indirectly heated cathodes,  $H_a$  is on the order of 300 microamperes for one volt. For the usual temperatures of indirectly heated cathodes,  $E_b = 0.8$  volt, approximately. In effect,  $E_b$  is equivalent to a slight positive bias on the anode relative to the cathode.

The transition between exponential and 3/2-power curves occurs at a current level which is greater for greater cathode surface. The transition current in a representative diode is about 30 microamperes at about 0.6 volt negative anode bias.

The departure of the diode curve from a right angle at the origin causes slight clipping of peaks having unity inward modulation. The corresponding peaks of the rectified voltage have about 0.2 volt clipped off. This value is always greater than  $E_1$ . The amount of clipping from this cause is reduced by reducing the output-circuit conductance and/or increasing the input-circuit conductance. No other expedient contributes to the reduction of clipping from this cause.

The departure of the diode curve from a vertical line reduces the efficiency by causing the rectified voltage to be less than the input-voltage envelope. The efficiency is equal to the ratio of rectified voltage to envelope voltage, which is usually on the order of 80 per cent.

The departure of the diode curve from a straight line causes a slight gradual curvature of the graph of rectified output versus input envelope. The assumption of a 3/2-power diode has been shown<sup>1</sup> to give a total-distortion coefficient, from this cause, during unity modulation, which is approximately

$$A_d = \frac{0.4}{(E_{c0})^{5/6}} \left( \frac{G}{H_a} \right)^{5/8} \quad (46)$$

in which  $G$  is the uniform conductance of the output circuit. This distortion is mostly second and third harmonics and is usually on the order of two per cent during unity modulation. Such distortion is usually negligible, and decreases with the coefficient of modulation.

The departure of the diode from the ideal rectifier therefore contributes in two respects to the distortion during rectification. First, the rectified peaks of unity inward modulation have about 0.2 volt clipped off. Second, unity modulation is subject to about two per cent distortion, mostly second and third harmonics. Both of these effects are usually negligible for rectified carrier voltages on the order of ten volts or





In the circuits of Figs. 15 and 16, to be discussed, the resistance  $R$  appears in the  $G_1$  lead. If  $RG_1$  is substantially less than unity,  $R$  may be regarded as adding to the resistance of  $G_1$ . For the computation of  $R$  in this case,  $C_1$  is the same as  $C$ .

## XII. PRACTICAL CIRCUIT DESIGN

*General requirements.* A high degree of refinement in the design of diode rectifiers is required only in receivers of the better grades. The degree of refinement must be increased with improvement in audio-frequency fidelity, particularly with extension of the high audio-frequency range, because any distortion then becomes much more noticeable and objectionable.

The intermediate-frequency amplifier stage which feeds the rectifier operates at high carrier voltages and much higher peak voltages. Therefore this stage must introduce negligible distortion when operating at these voltages. The ordinary intermediate-frequency amplifier pentodes have sufficient power output, free from distortion, only if they are operated at voltages near their maximum ratings. The bias voltage should be chosen to reduce the plate current to somewhat less than half its value with zero bias. This may reduce the gain, but permits maximum power output. This stage should not be subjected to substantial variation of bias, as by automatic volume control, because excessive bias reduces the power output obtainable. The output transformer of this stage should be designed to meet the power requirements, rather than to secure maximum gain or selectivity.

*Choice of circuit arrangement.* The main factor affecting the design of a diode rectifier, is whether the rectifier is to be used for signal only, for automatic volume control only, or for both. Where used for both, the design is most difficult, but very good performance can be obtained at minimum cost. As will be explained below, there is no advantage in using two separate rectifiers for signal and automatic volume control, if they are to be connected in parallel across the same input circuit. For high-grade receivers, greatest refinement of design is secured in a simple rectifier circuit used for signal only.

The specific use of the rectifier affects the choice between single-tuned and double-tuned transformers for coupling to the rectifier the intermediate-frequency-amplifier output. Greater efficiency can be obtained with the former, having a tuned secondary, close coupling, and a voltage ratio on the order of unity. (The voltage ratio in this case is the ratio of secondary to mutual inductance.) Greatest efficiency is required where the rectifier is used for both signal and automatic volume control; therefore such a single-tuned transformer is preferred for this

case, as in Fig. 15. Least efficiency is required where the rectifier is used for signal only; therefore a double-tuned transformer having substantial selectivity may be preferred for this case, as in Fig. 16.

*Determination of tuned-circuit conductance.* The conductance of the input circuit connected to the rectifier is an important factor in the design of the rectifier and in the computation of its performance. The conductance  $G_i$  of a tuned circuit is easily measured in either of two ways. (This conductance should include any effect of the intermediate-frequency amplifier connected or coupled to the tuned circuit.)

The conductance-variation method is the more direct. An intermediate-frequency carrier is applied at the input terminals of the preceding intermediate-frequency amplifier tube. A vacuum-tube voltmeter of negligible conductance is connected across the tuned secondary circuit in place of the diode rectifier circuit, and the lower side of the secondary is grounded. The secondary voltage is observed to be  $E_1$ , and is observed to fall to  $E_2$  when a known conductance  $G$  is connected in parallel therewith. The required value of conductance is

$$G_i = G \frac{E_2}{E_1 - E_2} = \frac{G}{\frac{E_1}{E_2} - 1} \quad (48)$$

The conductance  $G_i$  of a single-tuned circuit is related to the band width and the apparent power factor of the tuned circuit, as follows:

$$G_i = pcC_i = \frac{p}{cL_i}; \quad p = \frac{\Delta f}{f_c} \quad (49)$$

in which  $c$  is the angular frequency of the carrier,  $p$  is the apparent power factor of the tuned circuit,  $\Delta f$  is the band width thereof at 3 decibels below the peak, and  $f_c$  is the carrier frequency. ( $\Delta f$  is 0.58 times the band width at 6 decibels below the peak.)

In both cases it is assumed that every tuned circuit affecting the conductance is tuned to the carrier, so that the rectifier input circuit presents to the rectifier at the carrier frequency a pure conductance ( $G_i$  or  $G_{i0}$ ).

*Rectifier for signal and automatic-volume-control bias.* The circuit of Fig. 15 is recommended where the same rectifier is required to deliver separately a modulation-frequency (audio-frequency) signal voltage for further amplification, and a zero-frequency (direct) bias voltage for automatic volume control. A single-tuned input transformer is selected as having the most favorable admittance curve, and as adapted to transfer the greatest power from the carrier-frequency (intermedi-

ate-frequency) amplifier to the diode rectifier. The admittance curve is such that it tends to compensate that nonlinear distortion during unity modulation, which is caused by the condenser across the output circuit. Sufficient power is required to deliver about 50 volts rectified carrier, since 30 to 40 volts automatic-volume-control bias is required, and the latter is usually about two thirds of the former.

It is necessary to express the quantities used in the above formulas, in terms of the circuit elements of Fig. 15. The quantities of Fig. 8 are expressed in terms of the circuit elements of Fig. 15 as follows:

$$G_0 = \frac{G_1 G_2}{G_1 + G_2} \quad (50)$$

$$G_m = \frac{G_1(G_2 + G_3 + G_4)}{G_1 + G_2 + G_3 + G_4} \quad (51)$$

$$G_n = (G_3 + G_4) \cdot \frac{G_1}{G_1 + G_2} \cdot \frac{G_1}{G_1 + G_2 + G_3 + G_4} \quad (52)$$

$$\frac{G_n}{G_0} = \frac{G_3 + G_4}{G_2} \cdot \frac{G_1}{G_1 + G_2 + G_3 + G_4} \quad (53)$$

The conductances in the rectifier output circuit should be made as small as permissible, in order to minimize the power requirement, the output voltage being determined by the automatic-volume-control requirements.  $G_3$  and  $G_4$  are determined by practical limitations, after which  $G_1$  and  $G_2$  must be made sufficiently great to secure the required reduction of nonlinear distortion during unity modulation.  $G_3$  must be sufficiently great to carry incidental grid and leakage currents in the automatic-volume-control-bias circuit.  $G_4$  must be sufficiently great to permit of good mechanical properties as a voltage divider.

Referring to Fig. 14 and Section VII, the maximum permissible clipping of the peaks of unity inward modulation is read from the curve or is computed by (39) rewritten as follows:

$$v = 1.33(A_e)^{4/5} \quad (54)$$

in which  $v$  is the fraction of peak clipping and  $A_e$  is the total distortion caused by peak clipping. (Most of the modulation is not subject to such peak clipping, unless the latter is very great.) The maximum inward modulation free of peak clipping is computed by (30) rewritten as follows:

$$(k_m)_{\max} = 1 - v. \quad (55)$$

The relations between  $G_i$ ,  $G_0$ , and  $G_n$ , for a given value of  $(k_m)_{\max}$ , are given by (12), which may be rewritten as follows:

$$\frac{G_n G_i}{G_0(2G_0 + 2G_n + G_i)} = \frac{1}{(k_m)_{\max}} - 1 = \frac{1 - (k_m)_{\max}}{(k_m)_{\max}} \quad (56)$$

This equation can be solved for any one of the three conductances after the other two are given. In order to simplify the solution, let  $G_i = 2G_0$ . This is a reasonable relation where high efficiency is required, because it makes the carrier-frequency conductance of the rectifier equal to that of the input circuit, according to (4). On this assumption, the above relation becomes

$$G_i = 2G_0 = 2G_n \frac{(k_m)_{\max} - 1/2}{1 - (k_m)_{\max}} \quad (57)$$

$$\frac{G_n}{G_0} = \frac{1 - (k_m)_{\max}}{(k_m)_{\max} - 1/2} \quad (58)$$

The latter equation is applicable to Fig. 15 with the aid of (53) above. Having selected  $G_3$  and  $G_4$  on the basis of practical limitations,  $G_1$  and  $G_2$  are related as follows:

$$G_1 = \frac{G_2 + G_3 + G_4}{\frac{(k_m)_{\max} - 1/2}{1 - (k_m)_{\max}} \frac{G_3 + G_4}{G_2} - 1} \quad (59)$$

Various practical values are assumed for  $G_2$ , and the related values of  $G_1$  are computed, until a combination is found which meets the two requirements: (a) that  $G_1$  must be sufficiently small to assist in attenuating the carrier-frequency currents in the output circuit; and (b) that  $G_1$  must be sufficiently great to avoid excessive attenuation of the automatic-volume-control bias relative to the entire rectified carrier voltage. On the assumption of a given ratio between  $G_i$  and  $G_0$ , the relative values of  $G_1$  and  $G_2$  do not affect the power requirement for a given automatic-volume-control bias voltage, the power requirement being determined entirely by  $(G_3 + G_4)$  and  $(k_m)_{\max}$ . Having chosen values for all four of these conductances,  $G_0$  is computed by (50), and is doubled to evaluate  $G_i$ .

This procedure is here applied to the design of a rectifier for receivers of the better grades but not of the highest grade. Five per cent is taken as the permissible total distortion caused by peak clipping in the rectifier. Therefore,

$$A_e = 0.05 = 5\%, \quad v = 0.12, \quad (k_m)_{\max} = 0.88. \quad (60)$$

The following set of values for Fig. 15 are then computed by the above procedure, and are in accordance with good practice.

$$\begin{aligned}
 G_i &= 6.4 \text{ micromhos (0.16 megohm)} \\
 G_0 &= 3.2 \text{ micromhos (0.31 megohm)} \\
 G_n &= 1.0 \text{ micromho (1.0 megohm)} \\
 G_1 &= 9.0 \text{ micromhos (0.11 megohm)} \\
 G_2 &= 5.0 \text{ micromhos (0.2 megohm)} \\
 G_3 &= 2.0 \text{ micromhos (0.5 megohm)} \\
 G_4 &= 1.0 \text{ micromho (1.0 megohm)}
 \end{aligned}
 \tag{61}$$

The condenser  $C_1$ , and  $C_2$  to a less degree, across the output circuit in Fig. 15, tends to increase the amount of peak clipping at the higher modulation frequencies, as described in Section VI. The determining factor is the apparent capacitance  $C$  across the output circuit, which is between two limits,

$$C_1 < C < C_1 + C_2 \left( \frac{G_1}{G_1 + G_2 + G_3 + G_4} \right)^2 \tag{62}$$

The last term is usually much less than  $C_1$ , so that  $C$  may be taken equal to  $C_1$ . The relation (27) expresses the condition for avoiding any increase of peak clipping, caused by  $C$ . This condition, applied to Fig. 15, is approximately

$$\frac{C_1}{C_i} = \frac{2G_0}{G_i} \tag{63}$$

which ratio is assumed to be unity in the above procedure for determining the conductance values.

The values of  $C_i$  and  $C_1$  are limited mainly by the permissible attenuation of the outer side bands and of the output at the higher audio frequencies. An angular frequency ( $m$ ) of modulation is assumed, at which 3 decibels relative attenuation is permissible, caused by the tuned circuit and  $C_1$ . This determines the values of  $C_i$  and  $C_1$ ,

$$2mC_i = G_i; \quad mC_1 = G_0. \tag{64}$$

According to (61) and assuming  $m = 2\pi \times 5000$  cycles,  $C_i = C_1 = 100$  micromicrofarads. The second condenser  $C_2$ , which causes additional attenuation, may be equal to  $C_1$  or about half as great, depending on the permissible attenuation thereby. The combined effect of  $C_1$ ,  $C_2$ , and  $G_1$  should be to attenuate greatly the carrier and higher frequency components in the output circuit.

The value of  $C_1$  should be much greater than the inherent capacitance of the diode and wiring. Otherwise the latter affects the design in a manner difficult to take into account. The condensers  $C_3$  and  $C_4$  should have negligible impedance at the lowest modulation frequency. This requirement is more severe with regard to  $C_3$ , on account of the

tendency of the automatic volume control to smooth out the low-frequency modulation. On the other hand, the automatic-volume-control time constant  $C_3/G_3$  should be less than 0.1 second. The values  $C_3=0.1$  microfarad and  $C_4=0.1$  microfarad are suggested.

*Rectifier for signal only.* The circuit of Fig. 16 is recommended where the rectifier is required to deliver only a modulation-frequency (audio-frequency) signal voltage for further amplification. A double-tuned input transformer is selected as having greater selectivity, and as adapted to transfer sufficient power from the carrier-frequency (intermediate-frequency) amplifier to the diode rectifier. The coupling ( $k$ ) of the tuned circuits is about half of optimum, computed with the rectifier disconnected, so that the admittance curve of the rectifier input circuit is substantially that of the secondary tuned circuit. Such a curve tends to compensate that nonlinear distortion during unity modulation, which is caused by the condenser across the output circuit. Sufficient power is required to deliver about 10 volts rectified carrier, which is sufficient to secure very nearly linear rectification, while operating the carrier-frequency (intermediate-frequency) amplifier much below the overload level. It is assumed that the signal voltage on the rectifier is subject to automatic volume control by a separate rectifier, operated from an auxiliary carrier-frequency amplifier.

The peak clipping caused by nonuniform output-circuit conductance is absent, because this conductance is the same at zero-frequency and modulation-frequency:

$$G_0 = G_m = \frac{G_1 G_2}{G_1 + G_2} \quad (65)$$

The output connection is tapped down sufficiently so that the zero-frequency output contributes to the desired grid bias on the following amplifier, and the modulation-frequency output operates the amplifier well below the overload level.

If  $G_2$  is sufficiently greater than  $G_1$ , a grid condenser and grid leak may be added in the output connection, without appreciably affecting the operation of the rectifier. The same applies to correcting networks, where required. Such additions should be designed so as not to affect appreciably the output-circuit conductance offered to the rectifier.

The condenser  $C_1$ , and  $C_2$  to a less degree, across the output circuit in Fig. 16, tend to cause peak clipping at the higher modulation frequencies, as described in Section VI. As explained above with reference to Fig. 15, the condition for avoiding such peak clipping is approximately

$$\frac{C_1}{C_i} = \frac{2G_0}{G_i} \quad (63)$$

which is applicable also to Fig. 16.

The values of  $C_i$  and  $C_1$  are limited mainly by the permissible attenuation of the outer side bands and of the output at the higher audio frequencies. An angular frequency ( $m$ ) of modulation is assumed, at which 3 decibels relative attenuation is permissible, caused by the secondary tuned circuit and  $C_1$ . This determines the values of  $C_i$  and  $C_1$ :

$$2mC_i = G_i; \quad mC_1 = G_0. \quad (64)$$

In this example, each tuned circuit may be made like that suggested for Fig. 15:

$$\begin{aligned} G_i &= 6.4 \text{ micromhos (0.16 megohm)} \\ C_i &= 100 \text{ micromicrofarads.} \end{aligned} \quad (66)$$

In Fig. 16, however,  $G_0$  may be much less, and is limited mainly by the fact that  $C_1$  should be much greater than the inherent capacitance of diode and wiring, which latter affects the design in a manner difficult to take into account. Therefore the value of one half is suggested for the ratio (63) above. The condensers  $C_1$  and  $C_2$  may well be equal. The following values are suggested for the output circuit, assuming in (65) that  $m = 2\pi \times 5000$  cycles.

$$\begin{aligned} C_1 &= C_2 = 50 \text{ micromicrofarads} \\ G_0 &= G_m = 1.6 \text{ micromhos (0.62 megohm)} \\ G_1 &= 2.0 \text{ micromhos (0.50 megohm)} \\ G_2 &= 8.0 \text{ micromhos (0.12 megohm).} \end{aligned} \quad (67)$$

The only nonlinear distortion remaining when Fig. 16 is well designed, is that caused by the departure of the diode from the ideal, discussed in Section X above. Such distortion is on the order of three per cent during unity modulation, and decreases rapidly with modulation. The frequency distortion is largely under the control of the designer, and may be compensated as required. Therefore this circuit represents a high degree of refinement in the design of diode rectifiers.

*Rectifier for automatic-volume-control bias only.* In order to obtain the advantages of Fig. 16 relating to linear rectification, or other advantages relating to automatic volume control, a separate diode rectifier may be used to deliver only the bias voltage for automatic volume control. The preferred arrangement in such a case is the use of an auxiliary carrier-frequency amplifier stage to feed the automatic-

volume-control rectifier. The output of this stage should be coupled to the rectifier by a broad-band transformer which passes about five signal channels. This transformer may be double tuned with more than optimum coupling. Otherwise the rectifier circuit diagram would be similar to Fig. 15, with  $G_1 = \infty$  (short-circuit), and without  $C_2$ ,  $C_4$ , and  $G_4$ . In this simplified circuit

$$G_0 = G_2, \quad G_n = G_3. \quad (68)$$

Since the  $G_i$  of a broad-band transformer is likely to be great, the formula for  $(k_m)_{\max}$  is approximately that given in Section IV:

$$(k_m)_{\max} = \frac{1}{1 + \frac{G_n}{G_0}}. \quad (8)$$

Nonlinear distortion in this rectifier causes the automatic volume control to respond not only to the carrier but also to the modulation, with a tendency to smooth out the desired fluctuations of modulation. If a tuning meter is used, such distortion also causes the meter deflection to fluctuate continually during strong modulation. These effects are negligible unless the distortion is great, so that it is sufficient if  $(k_m)_{\max}$  exceeds one half, or if  $G_0$  exceeds  $G_n$ . The value of  $C_1$  also becomes less critical, but must not be sufficient to increase greatly the output-circuit admittance to frequencies of strong modulation. The nonlinear distortion caused by  $C_1$  is not even partly compensated by the broad-band input circuit. The following values are suggested, making  $(k_m)_{\max} = 0.67$ :

$$\begin{aligned} C_1 &= 100 \text{ micromicrofarads} \\ G_0 &= G_2 = 4 \text{ micromhos (0.25 megohm)} \\ G_n &= G_3 = 2 \text{ micromhos (0.5 megohm)}. \end{aligned} \quad (69)$$

Nonlinear distortion is greatly increased by applying to the diode a bias voltage which prevents its normal operation on relatively weak signals. This expedient tends to make the automatic volume control more level, but for the above reason it is not recommended. Other expedients which do not contribute to distortion are available for leveling the automatic volume control, and are to be preferred.

There is usually no advantage in using a separate automatic-volume-control rectifier connected in parallel with a signal rectifier across the same input circuit. The automatic-volume-control rectifier so connected must be designed just as carefully as a signal rectifier. Otherwise, the automatic-volume-control rectifier is a varying conductance



across the input circuit, and causes severe distortion of the modulation envelope, as described in Section V. Therefore, it is preferable to use a single diode for both purposes and thereby to minimize the number of circuit elements, as shown in Fig. 15.

If an automatic-volume-control rectifier is to be connected across a carrier-frequency circuit in the signal amplifier, other than the input circuit of the signal rectifier, the requirements of design are severe to avoid envelope distortion of the signal before rectification. Although this expedient is not generally recommended, the principles involved are described in Section V, which could be used as a basis for a reasonable design.

*The losses in rectification.* The modulation-frequency output voltage ( $E_m''$ ) of a rectifier circuit may be compared with the total side-band voltage ( $E_{cm} = k_m E_{c0}$ ) across the input circuit with rectifier disconnected. The ratio of these voltages may be regarded as the entire loss in rectification. Part of this loss is properly attributed to departure from the ideal conditions for rectification, while the remainder depends on fundamental power requirements or on the arbitrary choice of circuit values. The loss is divided easily in terms of superficial causes, but not easily in terms of basic causes. The following division is made with reference to Fig. 15.

(a) The carrier-frequency input voltage is attenuated by the carrier-frequency conductance of the rectifier, in the ratio

$$\frac{E_{c0}'}{E_{c0}} = \frac{G_i}{G_i + 2G_0} = \frac{1}{1 + \frac{2G_0}{G_i}} \quad (70)$$

(b) The modulation coefficient of the input and output voltages is attenuated by the additional modulation-frequency conductance of the output circuit, in the ratio

$$\frac{k_m'}{k_m} = \frac{G_i + 2G_0}{G_i + 2G_m} = \frac{1}{1 + \frac{2G_m}{2G_0 + G_i}} \quad (13)$$

which is described in Section V.

(c) The carrier-frequency voltage on the rectifier is reduced by the inherent capacitance  $C_d$  of diode and wiring, in the ratio

$$\frac{C_1}{C_1 + C_d} = \frac{1}{1 + \frac{C_d}{C_1}} \quad (71)$$

(d) The rectified output voltage is reduced by the resistance of the diode, in the ratio

$$\frac{1}{1 + G_0 R_d} \quad (72)$$

in which  $R_d$  is the apparent resistance of the diode in series with that of  $G_0$ . (The actual resistance of the diode to current in the conductive direction is much less than  $R_d$ .)

(e) The rectified output voltage is reduced by the reactance of  $C_i$  and  $C_1$  at carrier-frequency harmonics, in the ratio

$$\frac{1}{1 + G_0 R} = \frac{1}{1 + \frac{\pi G_0}{c C_i} + \frac{\pi G_0}{c C_1}} \quad (73)$$

in which  $R$  is the apparent resistance of these condensers in series with that of  $G_0$ , as described in Section XI.

(f) The output voltage is reduced by the resistance of  $G_1$  in the ratio

$$\frac{G_1}{G_1 + G_2} = \frac{1}{1 + \frac{G_2}{G_1}} \quad (74)$$

(g) The modulation-frequency output voltage is further reduced by the parallel conductance of  $G_3$  and  $G_4$ , in the ratio

$$\frac{G_1 + G_2}{G_1 + G_2 + G_3 + G_4} = \frac{1}{1 + \frac{G_3 + G_4}{G_1 + G_2}} \quad (75)$$

Of the above seven partial losses, all apply to the modulation. All except (b) and (g) apply also to the automatic-volume-control bias voltage relative to the carrier input voltage with rectifier disconnected.

The above items (a), (b), (f), and (g) are logically grouped as involving only the circuit conductances. Items (c), (d), and (e) are logically grouped as involving causes most closely associated with the diode and its behavior.

The "circuit" loss, as applied to modulation, is the product of items (a), (b), (f), and (g):

$$\frac{G_i}{G_i + 2G_m} \cdot \frac{G_1}{G_1 + G_2 + G_3 + G_4} = \frac{1}{1 + \frac{(G_i + 2G_m)(G_2 + G_3 + G_4)}{G_i G_1}} \quad (76)$$

Substituting the values in (61) for Fig. 15, this ratio is 0.23, representing a loss of 13 decibels from these causes.

The "circuit" loss, as applied to the carrier and the automatic-volume-control bias, is the product of items (a) and (f):

$$\frac{G_i}{G_i + 2G_0} \cdot \frac{G_1}{G_1 + G_2} = \frac{1}{1 + \frac{(G_i + 2G_0)G_2}{G_i G_1}} \quad (77)$$

Substituting the values in (61), this ratio is 0.32.

The "diode" loss, which is applicable both to the modulation and to the carrier and the automatic-volume-control bias, is the product of items (c), (d), and (e), modified to take account of the interdependence of (d) and (e):

$$\frac{1}{1 + \frac{C_d}{C_1}} \cdot \frac{1}{1 + G_0(R_d + R)} \quad (78)$$

This factor is of secondary importance, for two reasons. First, it is nearer unity than the "circuit" factor. Second, the total loss is not as great as indicated by the product of both factors. For example, reducing the "diode" ratio (78) reduces the effective conductance of the rectifier across the input circuit, and thereby makes the effective value of the ratio (a) nearer unity than the value computed by the formula. In the usual cases, the computed "diode" loss is about 3 or 4 decibels, while the actual entire loss is only about 2 decibels more than the computed "circuit" loss.

The entire loss as defined above is not an indication of efficiency, because it is a voltage ratio and neglects the relative conductance of input and output circuits.

The above discussion of losses does not take into account the relative attenuation of the outer side bands and the output at the higher frequencies of modulation.

The entire loss in rectification is susceptible of easy measurement. The measured value is useful in checking the performance of a rectifier circuit, especially as a component of a complete receiver. The test procedure is as follows.

A modulated intermediate-frequency signal of known modulation ( $k_m$ ) at 400 cycles is applied to the grid of the amplifier stage which feeds the rectifier. The voltage of this signal should be representative of normal operation while receiving a signal of average intensity. (It is assumed that no automatic-volume-control bias is applied to this stage. Otherwise, this bias must be disabled for this test, by opening the automatic-volume-control connection to this stage and substituting a fixed bias of representative voltage.) The signal carrier is main-

tained unchanged while the following two observations are made. For each observation, a vacuum-tube voltmeter is used which offers negligible conductance to the voltage being measured.

(a) The voltmeter is connected across the audio-frequency output terminals and the maximum audio-frequency output voltage ( $E_m''$ ) is measured. (It is assumed that the audio-frequency output voltage is free of carrier-frequency or zero-frequency components. Otherwise, means must be provided to filter out these other components without appreciable change of the observed audio-frequency voltage.)

(b) The diode is disabled by disconnecting the anode, or removing the tube from its socket, or disconnecting the heater. The lower side of the rectifier input circuit is grounded. The voltmeter is connected across the input circuit, which is then retuned to the carrier. The modulation is switched off and the carrier voltage ( $E_{c0}$ ) is measured by the voltmeter.

The measured loss as defined above is the ratio

$$\frac{E_m''}{k_m E_{c0}} = \frac{E_m''}{E_{cm}} \quad (79)$$

which should check fairly closely with the entire loss predicted by the above computations.

#### Bibliography

- (1) Unpublished reports (see footnote 1).
- (2) E. H. Armstrong, "Methods of reducing the effect of atmospheric disturbances," *Proc. I. R. E.*, vol. 16, pp. 15-26; January, (1928). (Linear rectification of the "average" type, obtained by diode with series resistance.)
- (3) H. A. Wheeler, "Automatic volume control for radio receiving sets," *Proc. I. R. E.*, vol. 16, pp. 30-34; January, (1928). (Diode detector used also for automatic volume control.)
- (4) Stuart Ballantine and L. M. Hull, "Demodulator and method of demodulation," U. S. Patent No. 1,698,668; January 8, (1929). (Linear detection by special crystal detector.)
- (5) F. M. Colebrook, "Theory of the straight line rectifier," *Exp. Wireless and Wireless Eng.*, vol. 7, pp. 595-603; November, (1930). (Linear rectification by a linear diode.)
- (6) J. R. Nelson, "Some notes on grid circuit and diode rectification," *Proc. I. R. E.*, vol. 20 pp. 989-1003; June, (1932); discussion, pp. 1971-1974; December, (1932); further discussion, vol. 21, p. 630; April, (1933).
- (7) W. B. Lewis, "The detector," *Wireless Eng. and Exp. Wireless*, vol. 9, pp. 487-499; September, 1932. (Linear detection by linear diode; effect of the series condenser.)
- (8) H. A. Wheeler, "Volume control," U. S. Patent No. 1,879,863; September 27, (1932). Reissue No. 19,744; October 29, (1935). British Patent No. 293,462; July 7, (1927). (Diode detector used also for automatic volume control.)
- (9) C. E. Kilgour and J. M. Glessner, "Diode detection analysis," *Proc. I. R. E.*, vol. 21, pp. 930-943; July, (1933). (Linear detection by linear or square-law diode; distortion caused by nonuniform load resistance.)
- (10) H. A. Wheeler, "Peak detector," U. S. Patent No. 1,951,685; March 20, (1934). British Patent No. 398,882; April 1, 1931. (Networks for uniform resistance loading of diode detectors.)

## CHARACTERISTICS OF THE IONOSPHERE AT WASHINGTON, D.C., APRIL 1938\*

BY

T. R. GILLILAND, S. S. KIRBY, AND N. SMITH  
(National Bureau of Standards, Washington, D.C.)

**D**ATA on the critical frequencies and virtual heights of the ionosphere layers for April, 1938, are given in Fig. 1. Fig. 2 gives the maximum frequencies which could be used for radio communication by way of the ionosphere in latitudes approximately that of Washington, calculated from the data of Fig. 1.

Figs. 1 and 2 show that the night F-layer critical frequencies and maximum usable frequencies for April were slightly greater than those for March. The daytime F<sub>2</sub>-layer critical frequencies, however, were considerably lower than during March. The definition of  $f_{F_1}$  increased somewhat during April, and  $f_{F_1}$  could be measured approximately during the latter half of the month. As usual, the definition was very good on ionospherically disturbed days. There was also a gradual decrease of F-layer critical frequencies during the month, representing a seasonal change. Table II shows also that there was slightly more day-to-day variation of F- and F<sub>2</sub>-layer critical frequencies in April than in March, even on ionospherically quiet days. These changes and variations are the results of the transition from winter to summer ionosphere conditions at this season, and have occurred in a similar manner at the corresponding time during preceding years. For this reason the average curve, especially during the daytime, is not so representative of conditions on individual days as was the case during the winter.

The following average undisturbed values of critical frequencies for April, 1938, were greater than those for the corresponding hours in April, 1937, by approximately the following amounts: noon  $f_{F_2}$ , 400 kilocycles; midnight  $f_F$ , 1100 kilocycles; diurnal minimum (0500 local time), 600 kilocycles. The noon  $f_E$  was the same for April of both years.

Very severe ionosphere storms occurred on April 16 and 23. The storm on April 16 was accompanied by a great magnetic storm whereas

\* Decimal classification: R113.61. Original manuscript received by the Institute, May 11, 1938. This is one of a series of reports on the characteristics of the ionosphere at Washington, D. C. For earlier publications see *Proc. I.R.E.*, vol. 25, pp. 823-840; July, (1937), and a series of monthly reports beginning in *Proc. I.R.E.*, vol. 25, pp. 1174-1191; September, (1937). Publication approved by the Director of the National Bureau of Standards of the U. S. Department of Commerce.

the one on April 23 was accompanied by only a moderate magnetic storm. During each of these ionosphere storms the  $f_{F_2}$  was lower than the  $f_{F_1}$  for several hours during the day. As indicated in Fig. 1, there was a period on the morning of April 16 when no reflections could be observed on any frequency above 2500 kilocycles.

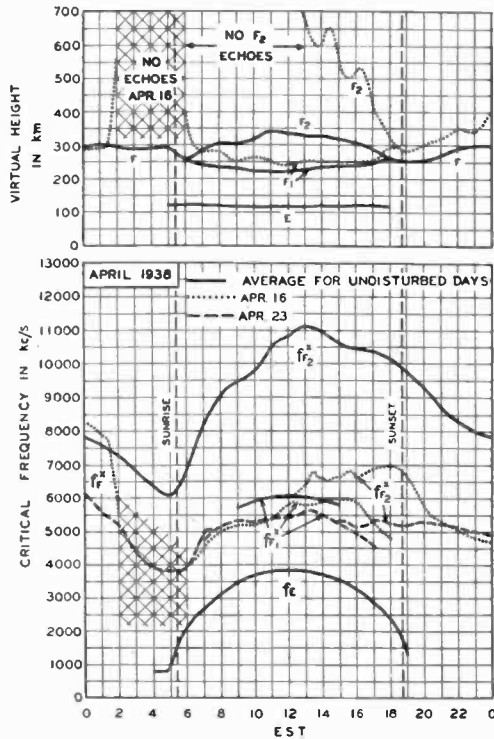

Fig. 1—Virtual heights and critical frequencies of the E, F,  $F_1$ , and  $F_2$  layers of the ionosphere for April, 1938. The solid-line graphs represent the average for undisturbed days. The dotted and dashed graphs represent values for the ionosphere storm days of April 16 and 23, respectively. The cross-hatched portion indicates the time on April 16 at which no reflections could be observed above 2500 kilocycles.

Transmissions from WCKY, 1490 kilocycles, 650 kilometers, and WTIC, 1040 kilocycles, 480 kilometers, showed an increased sky-wave intensity during the daytime of April 16 and a decreased sky-wave intensity during the evening of the same day although the storm had moderated considerably by evening. Reduced night sky-wave field intensities were also observed at broadcast frequencies during and following the very severe ionosphere storm of January 25.

The ionosphere storms of April, 1938, are shown in Table I approximately in the order of their severity.

TABLE I

Date	$h_F$ before sunrise km	Minimum $f_{F_2}^x$ during day (before sunrise) kc	noon $f_{F_2}^x$ kc	Magnetic character <sup>1</sup>		Ionosphere <sup>2</sup> character
				00-12 G.M.T.	12-24 G.M.T.	
April 16	425*	3200*	less than 5000†	2.0	1.7	2
23	394	3800	less than 4800†	0.8	1.0	2
14	404	4400	about 8500	1.6	1.1	1
17 until about 1200 E.S.T.	376	4100	9000	0.7	0.9	1
24 until about 0500 E.S.T.	322	4400	about 9500	0.6	0.4	1/2
13 after 1900 E.S.T.	—	—	—	0.6	1.3	1/2
6 $\bar{I}$	338	5300	—	0.9	0.8	1/2
Average of undisturbed days	293	6080	10860	0.3	0.4	

<sup>1</sup> American magnetic character figure, compiled by the Department of Terrestrial Magnetism, Carnegie Institution of Washington, from data supplied by their two observatories and five observatories of the United States Coast and Geodetic Survey.

<sup>2</sup> The ionosphere character figure represents an estimate of the severity of the ionosphere storm at Washington on an arbitrary scale of 0,  $\frac{1}{2}$ , 1,  $1\frac{1}{2}$ , and 2, the character 2 being assigned to the most severe disturbance.

\* No reflections above 2500 kilocycles, at 0300, 0400, or 0500 E.S.T.

†  $f_{F_2}^x$  less than  $f_{F_1}^x$  at noon.

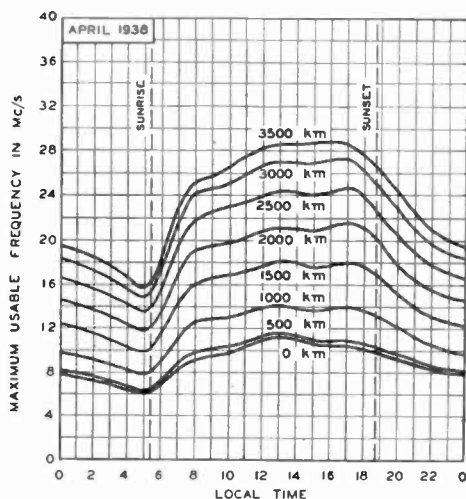

Fig. 2—Maximum usable frequencies for radio sky-wave transmission for the latitude of Washington, average for undisturbed days of April, 1938. Time to be used is local time where the waves are reflected from the layer.

Table II shows the number of hours the night  $f_F^x$  and daytime  $f_{F_2}^x$  differed from the average for the undisturbed days of April by more than the given percentages.

TABLE II

For 387 hours of observations between 1900 and 0800 local time.										
Per cent	-60	-50	-40	-30	-20	-10	-0	+0	+10	+20
Number of hours	3	5	16	34	50	101	223	164	57	14
Disturbed hours	3	5	16	34	44	46	52	9	5	3
Undisturbed hours	0	0	0	0	6	55	171	155	52	11

For 40 hours of observations on Wednesdays between 0900 and 1800 local time.										
Number of hours (all undisturbed)	0	0	0	0	0	12	21	19	11	0

TABLE III

Date	Beginning of fade-out <sup>1</sup>	Beginning of recovery	Recovery complete	Location of transmitter	Minimum <sup>2</sup> relative intensity
April 2	1702	1711	1754	Ohio	0.1
April 4	1619	1624	1640	Ohio	0.1
April 4	2139	2152	2226	Ohio, Mass., D.C.	0.01
April 6	1549	1600	1610	Ohio, Mass., D.C.	0.05
April 6	1628	1642	1658	Ohio, Mass., D.C.	0.02
April 7	1317	1327	1338	Ohio, Mass., D.C.	0.0
April 7	1352	1450	1630	Ohio, Mass., D.C.	0.0
April 7	1650	1810	1930	Ohio, Mass., D.C.	0.01
April 8	2032	2054	2102	Ohio, Mass.	0.01
April 9	1928	1935	2008	Ohio, Mass., D.C.	0.1
April 11	1709	1714	1733	Ohio, Mass.	0.0
April 11	2219	2236	2339	Ohio, Mass., D.C.	0.0
April 12	1636	1639	1707	Ohio, Mass.	0.0
April 16	1703	1719	1740	Ohio	0.2
April 23	1941	2015	2055	Ohio, Mass., D.C.	0.0
April 26	1250	1306	1340	Ohio, Mass., D.C.	0.0

<sup>1</sup> All times G. M. T.

<sup>2</sup> Minimum relative intensity given in terms of received wave intensity from W8XAL, frequency 6060 kilocycles, distance 650 kilometers.

TABLE IV  
Midnight to Noon  
334 Hours of Observation

Hour E.S.T.												
Date	00	01	02	03	04	05	06	07	08	09	10	11
April 5										6.0		4.0
April 23			4.5	4.5				4.5	4.5			
April 26			4.5	8.0								

Noon to Midnight  
332 Hours of Observation

Hour E.S.T.												
Date	12	13	14	15	16	17	18	19	20	21	22	23
April 5	4.5	4.5	4.5	4.5		4.5	4.5	4.5				
April 27											8.0	4.0
April 30							4.5			8.0	8.0	8.0



Sudden disturbances of the ionosphere at Washington during April were marked by the radio fade-outs listed in Table III.

Table IV shows the hours and days of April, 1938, during which strong sporadic-E reflections were most prevalent. In this table the figures indicate approximately the frequency in megacycles up to which strong sporadic-E reflections were observed.

*Note:* The National Bureau of Standards broadcasts ionosphere data and also maximum usable frequencies, on each Wednesday by radiotelephone from its station WWV, in accordance with the following schedule: 1:30 P.M. E.S.T., 10 megacycles; 1:40 P.M. E.S.T., 5 megacycles; 1:50 P.M. E.S.T., 20 megacycles.



## CORRESPONDENCE

### Elimination of Broadcast-Station Carrier Beats

To the Editor:

It is a well-known fact that the chief interference between various broadcast stations now sharing the same frequency channel assignment is due to the beat frequencies between the various carrier waves. Because of the present high standards of accuracy in frequency control these beat notes seldom exceed a very few cycles per second. This low-frequency beat however, is the source of a very serious flutter in signal intensity. The flutter is very often quite objectionable when a broadcast listener tries to receive the program of one of the stations on the channel, even if no other channel-sharing broadcaster has sufficient side-band energy to cause prohibitive program interference.

As an example of the conditions in one locality let us take the normal conditions at Morgantown, West Virginia. The 550-kilocycle channel is worthless at all times (day and night) due to the flutter of stations WGR-Buffalo, New York, WKRC-Cincinnati, Ohio, and KSD-St. Louis, Missouri. Except for this effect WGR would predominate and give usable signals at least 50 per cent of the time. On 560 and 600 kilocycles the flutter is always very severe. On 610 kilocycles the leading signal, from WJAY, Cleveland, Ohio, is given flutter interference by WIP at Philadelphia, Pennsylvania, and also by WDAF in Kansas City, Missouri, at night. 780 kilocycles is mutilated by flutter on the WMC, Memphis, Tennessee, signals, caused by WEAN and WTAR. During the evening 740 kilocycles has predominant WSB, Atlanta, Georgia, fluttered by KMMJ. On 830 kilocycles reception is nil due to flutter only. 880 kilocycles contains several stations of equal intensity none of which can be heard very well. On 890 kilocycles WMMN (1/2 kilowatt at night) 15 miles distant is given very noticeable flutter interference at night due to three or four stations all of which are at least 400 miles distant.

The low-frequency end of the broadcast band is bad enough, but the trouble on the high-frequency end is multiplied many times over that of the low-frequency part. The instances of interference due to carrier beat are far too numerous to mention.

Having briefly summarized the difficulties caused by this effect the next procedure is to find a simple means of elimination of the troubles. The only practical approach to the problem must be by attempting to eliminate the last trace of difference between the carrier frequencies of all stations assigned to any one channel.

At first thought this plan may seem to present almost unsurmountable difficulties. The usual method of synchronization of carrier frequencies has been by transmitting a submultiple of the carrier frequency by telephone line from a master control point to each of the stations to be synchronized.<sup>1</sup> Frequency

<sup>1</sup> K. A. Norton, "Note on the synchronization of broadcast stations WJZ and WBAL", *Proc. I. R. E.*, vol. 22, pp. 1087-1089; September, (1934).

multipliers at each station then provided the synchronized carrier frequencies. By taking a variation of this existing synchronization plan and applying it on a national scale two things could be quite easily and inexpensively accomplished at once.

A government-operated station near the center of the United States could transmit a continuous-wave standard carrier signal on a frequency of 100 kilocycles, with the same frequency accuracy as that maintained by the National Bureau of Standards WWV emissions on 5, 10, and 15 megacycles. Each broadcast station could then pick up the signals on a local receiver and by means of a suitable 10-kilocycle multivibrator and frequency-multiplier system produce its authorized transmitting frequency without the use of a local oscillator. The present quartz-crystal frequency standards could be very easily used as crystal-filter devices for passing only the correct carrier frequency. In case of failure of the standard signal these crystals could then be automatically switched into the old oscillator circuits for maintaining service.

As an optional method of use, the quartz-crystal oscillators could be left intact and used as locked oscillators controlled in frequency, by introducing the standard signal, to the oscillator circuit with sufficient amplitude to insure a positive frequency lock under all conditions of operation. By using this latter method there would be no interruption of program in case of failure of the standard frequency signal.

In addition to use by the broadcasters, this signal would be available at all times, 24 hours a day, for use as a standard frequency by every type of station and in all laboratories. In other words the primary standard of frequency would be made available to everyone who wished to use it at any time. We might even go so far as to substitute this signal for the power-line frequency as a controlling signal for electric clocks. With television and facsimile transmissions coming into commercial use at an early date, the standard of frequency could easily provide means for synchronizing various such equipment at remotely located points.

Here is a very simple plan which it seems can be made to bring great benefit to everyone. What shall be done about it?

A. W. FRIEND

West Virginia University  
Morgantown, West Virginia



## BOOKLETS, CATALOGS, AND PAMPHLETS RECEIVED

The following commercial publications of radio engineering interest have been received by the Institute. You can obtain a copy of any item without charge by addressing the issuing company and mentioning your affiliation with the Institute of Radio Engineers.

### MEASURING INSTRUMENTS—LABORATORY APPARATUS

**SIGNAL GENERATORS AND MICROVOLTERS**, gives thumbnail specifications on the six members of the Ferris signal-generator family. (4 pages,  $8\frac{1}{2} \times 11$  inches.) *Ferris Instrument Corporation, Boonton, N. J.*

**DU MONT OSCILLOGRAPHER**, March-April issue describes the Type 169 Laboratory Oscillograph, a precision-type instrument with a 9 inch screen. (8 pages,  $6 \times 9\frac{1}{4}$  inches.) *Allen B. Du Mont Laboratories, Inc., Passaic, N. J.*

### BROADCAST TRANSMISSION EQUIPMENT

**ADJUSTABLE EQUALIZER**, a bulletin entitled "Broadcast Developments" describes an adjustable equalizer for use on broadcast-transmission and recording circuits. The "ouncer series" of high fidelity transformers for portable service is described. (4 pages,  $8\frac{1}{2} \times 11$  inches.) *United Transformer Corporation, 72 Spring Street, New York, N. Y.*

### MATERIALS—METALS, INSULATION, DIELECTRICS

**ISOLANTITE BUSHINGS**, Bulletin No. 104, lists bushings and lead-in insulators for transformer and condenser service and other applications. (8 pages,  $8\frac{1}{2} \times 11$  inches.) *Isolantite, Inc., 223 Broadway, New York, N. Y.*

### RADIO COMMUNICATION EQUIPMENT

**CO-AXIAL TRANSMISSION LINES** and auxiliary impedance-matching apparatus for transmitter and receiver installations are described. (8 pages,  $8\frac{1}{2} \times 11$  inches.) *Communication Products, Inc., 245 Custer Avenue, Jersey City, N. J.*

### COMPONENTS

**RECTICHARGER** is a storage battery charger whose rate automatically adjusts itself to the battery's rate of discharge, described in Bulletin DL-48-192-A. (2 pages,  $8\frac{1}{2} \times 11$  inches.) *Raytheon Manufacturing Company, 190 Willow Street, Waltham, Mass.*

**HIGH-FREQUENCY IRON CORES**, Catalog 850, gives mechanical details and electrical performance data on Morrill H-F Iron Cores and accessories. (8 pages,  $8\frac{1}{2} \times 11$  inches.) *Morrill and Morrill, 30 Church Street, New York, N. Y.*

**APPROVED PRECISION PRODUCTS**, a new catalog of components for laboratory and replacement use. (40 pages,  $8\frac{1}{2} \times 11$  inches.) *P. R. Mallory & Company, Inc., Indianapolis, Ind.*

**POLARITY CHANGERS** for delivering alternating current power from a direct-current source are described. (1 page,  $8\frac{1}{2} \times 11$  inches.) *Electronic Laboratories, Inc., Indianapolis, Ind.*

**CONTRIBUTORS TO THIS ISSUE**

Gilliland, T. R.: See PROCEEDINGS for January, 1938.

Jackson, W. E.: Born May 8, 1904, at Bridgewater, Massachusetts. Received B.S. degree in electrical engineering, Brown University, 1925. Westinghouse Electric and Manufacturing Company, 1923; New England Telephone and Telegraph Company, 1924; radio engineer, General Electric Company, 1925-1927; radio engineer, Department of Commerce, Air Navigation Division, Bureau of Air Commerce, 1932-1937; chief, Radio Development Section, Safety and Planning Division, Bureau of Air Commerce, 1937 to date. Chairman, Radio Technical Committee for Aeronautics, 1937 to date. Member, Sigma Xi. Associate member, Institute of Radio Engineers, 1929; Member, 1934.

Kirby, S. S.: See PROCEEDINGS for January, 1938.

Massa, Frank: Born April 10, 1906, at Boston, Massachusetts. Received B. S. degree in electrical engineering, 1927; Swope Fellow, 1927-1928; received M. S. degree in electrical engineering, Massachusetts Institute of Technology, 1928. Research engineer, Victor Talking Machine Company, 1928-1929; electroacoustic research, RCA Manufacturing Company, Inc., 1930 to date. Fellow, Acoustical Society of America. Associate member, Institute of Radio Engineers, 1930.

Meahl, Harry R.: Born March 16, 1905, at Jamesport, Missouri. Received B. S. degree in electrical engineering, State College of Washington, 1927. Test department, 1927-1930; radio engineering department, 1930-1936, general engineering laboratory, General Electric Company, 1936 to date. Associate member, Institute of Radio Engineers, 1928.

Potter, J. L.: Born December 4, 1905, at Carthage, Missouri, Received B. S. degree in electrical engineering, 1928; M. S. degree, Kansas State College, 1930. Research assistant, Kansas State College, 1929-1930. Western Electric Company, 1928-1929, summer, 1927. Engineer, WMT, summer, 1935; assistant engineer, Aircraft Radio Laboratory, Wright Field, summer, 1936; radio transmitter department, General Electric Company, summer, 1937; instructor, department of electrical engineering, State University of Iowa, 1930 to date. Member, Sigma Xi; Sigma Tau; and Phi Kappa Phi. Associate member, Institute of Radio Engineers, 1931.

Sherman, Jesse B.: Born February 8, 1910, at New York City. Received B. S. degree in electrical engineering, Cooper Union Night School of Engineering, 1933; B. S. degree in electrical engineering, New York University, Evening Engineering Division, 1935. Service manager, Colen-Gruhn Company, Inc. 1930-1935; research and engineering department, RCA Manufacturing Company, Inc., RCA Radiotron Division, 1935 to date. Junior member, Institute of Radio Engineers, 1928; associate member, 1932.

Smith, N.: See PROCEEDINGS for January, 1938.

Wheeler, Harold A.: See PROCEEDINGS for May, 1938.



Courtesy of Cosmo-Sileo Co.

**JUNE 1938**

SUN.	MON.	TUE.	WED.	THU.	FRI.	SAT.
<small>FIRST Q. 4TH</small>	<small>FULL MOON 12TH</small>	<small>LAST Q. 20TH</small>	<b>1</b>	<b>2</b>	<b>3</b>	<b>4</b>
<b>5</b>	<b>6</b>	<b>7</b>	<b>8</b>	<b>9</b>	<b>10</b>	<b>11</b>
<b>12</b>	<b>13</b>	<b>14</b>	<b>15</b>	<b>16</b>	<b>17</b>	<b>18</b>
<b>19</b>	<b>20</b>	<b>21</b>	<b>22</b>	<b>23</b>	<b>24</b>	<b>25</b>
<b>26</b>	<b>27</b>	<b>28</b>	<b>29</b>	<b>30</b>	<small>NEW MOON 27TH</small>	• •

# EXHIBITION DIRECTORY

(Corrected to May 25)

ON THE FOLLOWING PAGES



## EXHIBITION HOURS

THURSDAY—9 A.M. TO 11 P.M.

FRIDAY—9 A.M. TO 5:30 P.M.

SATURDAY—9 A.M. TO 6:00 P.M.

**ALADDIN RADIO INDUSTRIES, INC.**

466 WEST SUPERIOR ST., CHICAGO, ILL.

*Exhibiting:* Iron-cored coils for intermediate-frequency and radio frequency service

**AMERICAN INSTITUTE OF PHYSICS**

175 FIFTH AVE., NEW YORK, N.Y.

*Exhibiting:* *The Review of Scientific Instruments* and the *Journal of Applied Physics*

*Represented by:* William C. Copp

**AMERICAN LAVA CORPORATION**

CHEROKEE BLVD. AND MANUFACTURER'S RD., CHATTANOOGA, TENN.

*Exhibiting:* Low loss ceramic material for radio tubes, transmitters, and receivers. Insulators for instrument manufacturers, electrical appliances, condensers and resistors

*Represented by:* J. H. Mills, John F. Morse, G. E. Richter

**AMERICAN TRANSFORMER COMPANY**

178 EMMET ST., NEWARK, N.J.

*Exhibiting:* Rectifiers, Transtats, Audio transformers, Reactors, Equalizers, Voltage regulators, Modulation units, Plate transformers, Aircraft transformers, Filament transformers, Controller rectifiers, Television scanning transformers, Crest rectifiers, Gas-filled aircraft transformers

*Represented by:* G. A. Brettell, Jr., C. W. Eichhorn, Walter Garlick, Jr., John F. Harris, Ivor B. Watts

**AMPEREX ELECTRONIC PRODUCTS, INC.**

79 WASHINGTON ST., BROOKLYN, N.Y.

*Exhibiting:* Air-cooled medium- and high-power transmitting tubes, Mercury-vapor rectifiers, Water-cooled transmitting tubes

*Represented by:* S. Norris

**BOONTON RADIO CORPORATION**

BOONTON, N.J.

*Exhibiting:* The Q-Meter and its accessory Dielectric Unit, Beat frequency generator producing audio- and video-frequency voltages.

*Represented by:* L. O. Cook, W. D. Loughlin



**BRYAN DAVIS PUBLISHING COMPANY**

19 E. 48TH ST., NEW YORK, N.Y.

*Exhibiting:* Communications magazine

*Represented by:* S. R. Cowan, R. D. Rettenmeyer, Paul S. Weil

**COMMUNICATION PRODUCTS, INC.**

JERSEY CITY, N.J.

*Exhibiting:* Radio-frequency lacquer, Co-axial transmission line, Magnetite cores for radio-frequency coils, Switches

*Represented by:* J. L. Bernard, H. T. Carey, E. B. Mack

**CORNELL-DUBILIER ELECTRIC CORPORATION**

HAMILTON BLVD., SO. PLAINFIELD, N.J.

*Exhibiting:* Capacitors:—Mica, Paper, Wet and dry electrolytics, Dykanol

*Represented by:* Wm. Bailey, P. McK. Deeley, F. Taylor

**THE DAVEN COMPANY**

158 SUMMIT ST., NEWARK, N.J.

*Exhibiting:* Single and dual potentiometers, Rotary switches, Attenuators, Faders, Volume indicators, Output meters, Line equalizers, Attenuation boxes, Speech-input control apparatus, Decade resistances

*Represented by:* Lewis Newman, Rufus G. Obrecht, J. P. Smith, Jr.

**FAIRCHILD AERIAL CAMERA CORPORATION**

SOUND EQUIPMENT DIVISION, 88-06 VAN WYCK BLVD., JAMAICA, L.I., N.Y.

*Exhibiting:* Disk sound-recording equipment, Sound reproducing equipment

*Represented by:* C. V. Kettering, R. H. Lasche

**FERRIS INSTRUMENT CORPORATION**

BOONTON, N.J.

*Exhibiting:* Standard-signal generators, Frequency standards, Radio noise-measuring equipment

*Represented by:* Robert Doak, C. J. Franks, J. G. Haas, Jerry Minter, J. Redington

(Continued on following page)

**GENERAL CERAMICS COMPANY**  
30 ROCKEFELLER PLAZA, NEW YORK, N.Y.

*Exhibiting:* Ceramic insulators

*Represented by:* J. L. Bernard, H. T. Carey, S. J. McDowell

**GENERAL RADIO COMPANY**  
30 STATE ST., CAMBRIDGE, MASS.

*Exhibiting:* Oscillators, Wave analyzers, Bridges, Standard-signal generators, Condensers, Resistors, Noise meters, Distortion meters, Amplifiers, and other audio-frequency and radio-frequency instruments

*Represented by:* C. T. Burke, M. A. Gilman, F. Ireland, A. E. Thiessen

**GRAYBAR ELECTRIC COMPANY**  
420 LEXINGTON AVE., NEW YORK, N.Y.

*Exhibiting:* A terminal of synchronizing equipment for broadcasting purposes (by Western Electric)

*Represented by:* R. A. Coram, A. J. Eaves, M. C. Youngstrum

**HYGRADE SYLVANIA CORPORATION**  
EMPORIUM, PA.

*Exhibiting:* Vacuum tubes

*Represented by:* George Connor, Dr. Ben Kievit, Walter Jones

**INTERNATIONAL NICKEL COMPANY, INC.**  
67 WALL ST., NEW YORK, N.Y.

*Exhibiting:* Nickel and its alloys

*Represented by:* J. S. Welwood

**INTERNATIONAL RESISTANCE COMPANY**  
401 N. BROAD ST., PHILADELPHIA, PA.

*Exhibiting:* Metallized resistors and volume controls, Wire-wound resistors, New attenuators and power rheostats

*Represented by:* Harry Ehle, William Knowles, Jr., Harry Thompson

**ISOLANTITE, INC.**

**343 CORTLANDT ST., BELLEVILLE, N.J.**

*Exhibiting:* Ceramic insulators, Inductance forms, Strain insulators, Stand-off insulators, Vacuum tube bases, Trimmer bases, Co-axial transmission line and fittings, Oil-Burner ignition insulators and assemblies

*Represented by:* H. G. Beebe, R. S. Bicknell, E. A. Domber, E. J. W. Riess, N. Snyder

**THE MAGNAVOX COMPANY**

**FORT WAYNE, IND.**

*Exhibiting:* Molanode dry electrolytic capacitors with fabricated plates, Wet electrolytic capacitors, Electrodynamic and permanent-magnet dynamic speakers

*Represented by:* R. U. Clark, Burgess Dempster, F. S. Dunleavey, J. C. Koonz

**P. R. MALLORY & COMPANY, INC.**

**3029 E. WASHINGTON ST., INDIANAPOLIS, IND.**

*Exhibiting:* Multiple push-button switches, All-wave switches, Dry electrolytic capacitors, Vibrators, Grid-bias cells, Dry-disc rectifiers

*Represented by:* B. V. K. French, J. L. Nichols, Paul Smalley

**McGRAW-HILL PUBLISHING COMPANY**

**330 W. 42ND ST., NEW YORK, N.Y.**

*Exhibiting:* *Electronics, Radio Retailing,* and technical books

*Represented by:* Wallace B. Blood, Frank Coyle, Beverly Dudley, Donald G. Fink, Keith Henney, Donald H. Miller

**PARKER-KALON CORPORATION**

**200 VARICK ST., NEW YORK, N.Y.**

*Exhibiting:* Hardened self-tapping screws, Cold-forged socket screws, Modern fastening devices

*Represented by:* J. M. Hoghland, J. J. Mathe

**RCA MANUFACTURING COMPANY, INC.**

**CAMDEN, N.J.**

*Exhibiting:* Power tubes, Television tubes, Test equipment

*Represented by:* E. T. Jones

*(Concluded on following page)*

## **RAYTHEON PRODUCTION CORPORATION**

**420 LEXINGTON AVE., NEW YORK, N.Y.**

*Exhibiting:* Vacuum tubes, Voltage regulators

*Represented by:* Niles Gowell, J. R. Nelson, R. M. Purinton, Alan C. Rockwood, Ezra F. Stevens, Dr. P. T. Weeks

## **UNITED TRANSFORMER CORPORATION**

**72 SPRING ST., NEW YORK, N.Y.**

*Exhibiting:* Transformers, Reactors, Voltage regulators, Equalizers, Transmitter kits, Amplifiers

*Represented by:* S. L. Baraf, H. Garber, I. A. Mitchell, J. Y. Schoonmaker, C. R. Strassner

## **WESTON ELECTRICAL INSTRUMENT CORPORATION**

**614 FRELINGHUYSEN AVE., NEWARK, N.J.**

*Exhibiting:* Portable- and panel-type electrical measuring instruments and accessories, Photoelectric-cell equipment

*Represented by:* C. B. Denton, H. L. Gerstenberger, V. E. Jenkins, J. H. Miller, J. O. Morelock, L. C. Nichols, H. L. Oleson

## **THE S. S. WHITE DENTAL MFG. COMPANY**

**INDUSTRIAL DIVISION, 10 E. 40TH ST., NEW YORK, N.Y.**

*Exhibiting:* Flexible shafts and casings for remote control of auto radios, aircraft receivers, and allied equipment. Coupling shafts for use in broadcast receivers and transmitters. Flexible shafts and casings for power drives. Molded resistors, 1000 ohms to 1,000,000 megohms.

*Represented by:* V. J. Giangrande, J. C. Smack, W. Q. Timpson

# Western Electric's NEW 5KW has the DOHERTY CIRCUIT, too!

Be sure to visit Graybar's exhibit  
at the I.R.E. Convention



## A FEW FEATURES OF THE 5KW

Doherty Circuit increases efficiency of final amplifier stage from the usual 30% to over 60%.

Requires less primary power, greatly reduces operating and maintenance costs.

Automatic line voltage regulator.

Improved stabilized feed-back circuit.

Automatic circuit breakers and an automatic reclosing contactor in the power circuit to the rectifier.

Cathode ray oscillograph connections in all important circuits.

Engineered to permit increase in power to 10KW, 50KW and 500KW by adding selected apparatus.

**"ASK YOUR ENGINEER"**

In the new 5KW (as in the new 50KW) the famous Doherty Circuit increases power amplifier efficiency by more than 100%—cuts operating and maintenance costs—saves space. One more proof that Bell Telephone Laboratories and Western Electric are continuing to set the pace in better equipment for broadcasters!

# Western Electric

RADIO TELEPHONE BROADCASTING EQUIPMENT

Distributors:  
Graybar Electric Co., Graybar Bldg., N.Y.  
In Canada and Newfoundland:  
Northern Electric Co., Ltd.  
In other countries:  
International Standard Electric Corp.

When writing to advertisers mention of the PROCEEDINGS will be mutually helpful.

---

# BOOK BARGAINS

---

## OUR INVENTORY OF UNSOLD BOOKS

is tying up funds we prefer to have available for manufacturing new books. At present several important books await publication. To accelerate our work of building up the American Measurement and Control Literature we are making a special inducement to stimulate sales: we are offering this stock at the special prices indicated.

These special prices hold only until August 1, 1938 (or before if stock is depleted). They apply only to the United States. They include postage. Make your selection and mail your order today.

**Photo-Electric and Selenium Cells.** By T. J. Fielding. This book enables the practical man to grasp the fundamentals of the subject, while not delving too deeply into theoretical considerations. 1935. Cloth, 4  $\frac{3}{4}$  x 7  $\frac{3}{4}$  inches, 140 pages, \$1.75.

(Only 115 copies left)      **Special Price \$1.25**

**Fundamentals of Instrumentation.** By M. F. Béhar. Explains for the first time the new science of "robot" control. "More than a book—a tool." Designed for practical men. Opens the door to countless ideas of incalculable value. Cloth, 6 x 9  $\frac{1}{2}$  inches, 109 pages, \$2.00.

(Only 130 copies left)      **Special Price \$1.50**

**The Engine Indicator—Its Design, Theory and Special Applications.** By K. J. DeJuhasz. A mine of information for all engineers who have to investigate forces and motions—not only in engines but in many other applications. Cloth, 5  $\frac{1}{2}$  x 8  $\frac{1}{2}$  inches, 343 pages, \$3.75.

(Only 141 copies left)      **Special Price \$2.00**

**Electrical Measurements.** By H. Cobden Turner & E. H. W. Banner. A general account of almost all types of electrical measurements, suitable to those who have to make such measurements relatively infrequently. At the same time the book should prove of value as a reference on electrical measurements to electrical engineers. 1935. Cloth, 5  $\frac{1}{2}$  x 8  $\frac{1}{2}$  inches, 354 pages, \$4.50.

(Only 4 shelf copies left)      **Special Price \$2.25**

**Dielectric Phenomena in High Voltage Cables.** By D. M. Robinson. 1936. Cloth, 5  $\frac{1}{2}$  x 8  $\frac{1}{2}$  inches, 186 pages, \$5.00.

(Only 50 copies left)      **Special Price \$3.00**

**A Symposium on Illumination.** By C. J. W. Grieveson. Made up of a number of chapters, each written by a specialist. It will be of assistance in the understanding of the theoretical and practical problems connected with modern lighting. 1935. Cloth, 5  $\frac{1}{2}$  x 8  $\frac{1}{2}$  inches, 229 pages, \$5.00.

(Only 110 copies left)      **Special Price \$3.00**

**Automatic Protection of A. C. Circuits.** By G. W. Stubbings. "Material logically presented in lucid manner . . . concise treatment of a subject heretofore requiring extensive reading in diverse publications."—Perry A. Borden. 1935. Cloth, 5  $\frac{1}{2}$  x 8  $\frac{1}{2}$  inches, 293 pages, \$5.00.

(Only 141 copies left)      **Special Price \$3.00**

**Mercury Arc Rectifier Practice.** By Frederic Charles Orchard. "This book is one there need be no hesitation in recommending to anyone concerned with the practical operation of rectifier plants." *Electrical Times*. 1936. Cloth, 5  $\frac{1}{2}$  x 8  $\frac{1}{2}$  inches, 235 pages, \$5.00.

(Only 199 copies left)      **Special Price \$3.00**

**Electrical Engineering in Radiology.** By I. G. H. Sarsfield. "The author is well equipped to write authoritatively." *Instruments*. 1936. Cloth, 5  $\frac{1}{2}$  x 8  $\frac{1}{2}$  inches, 276 pages, \$6.00.

(Only 2 shelf copies left)      **Special Price \$3.00**

**Theory of Alternating Current Wave Forms.** By Phillip Kemp. Probably the first treatment including adequate discussions on non-sinusoidal wave forms. A standard reference. 1935. Cloth, 5  $\frac{1}{2}$  x 8  $\frac{1}{2}$  inches, 218 pages, \$4.50.

(Only 92 copies left)      **Special Price \$3.00**

**Cathode Ray Oscillography.** By J. T. MacGregor-Morris and J. A. Henley. 1936. Cloth, 5  $\frac{1}{2}$  x 8  $\frac{1}{2}$  inches, 250 pages, \$6.00.

(Only 48 copies left)      **Special Price \$4.00**

---

INSTRUMENTS PUBLISHING CO., 1123 Wolfendale St., Pittsburgh, Pa.

---

*When writing to advertisers mention of the PROCEEDINGS will be mutually helpful.*

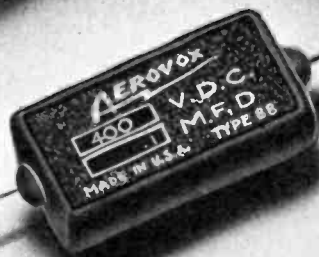

# Molded in Rubber!

Series-88. Actual Size.

• A truly satisfactory paper condenser at last, for critical applications! Molded in live rubber, AEROVOX-88 series condensers mark end of quest for higher leakage resistance and breakdown over longest service life. Check these features:

✓ Humidity cannot penetrate-rubbermolded casing to reach imbedded paper section. A perfect seal.

✓ No moisture released during vulcanization. Unit cannot absorb moisture during production. Also, no excessive pressure or heat to impair section.

✓ Tests indicate insulation resistance and break-down voltage exceeding phenolic resin molded units.

Get the FACTS...

Engineering data, including comparative tests made with other molded types, sent on request. Sample and quotations to responsible parties.



**AEROVOX CORPORATION**

70 WASHINGTON STREET, BROOKLYN, N. Y.



Sales Offices in All Principal Cities

We're glad most condensers are bought on the basis of hard-boiled engineering tests rather than advertising claims. When quality is allowed to speak for itself there can be no mistaking what it says. That's why **Sprague Condensers** are today specified by leading radio and electrical manufacturers throughout the world.

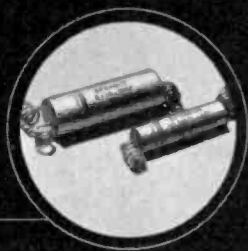

# SPRAGUE

GOOD CONDENSERS—EXPERTLY ENGINEERED—  
COMPETENTLY PRODUCED

SPRAGUE SPECIALTIES COMPANY, NORTH ADAMS, MASS.

*When writing to advertisers mention of the PROCEEDINGS will be mutually helpful.*

XVIII



---

# NEW!

## SENSITIVE ELECTRONIC AC VOLTMETER

FOR THE AUDIO, CARRIER AND SUPERSONIC RANGES

10 to 100,000  
cycles

New principle  
of operation

Extremely  
Compact

Reasonably  
Priced

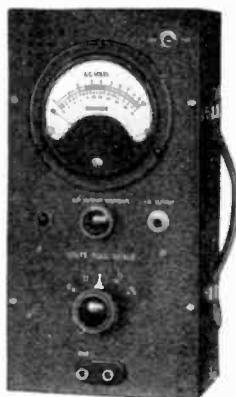

.001 to 100  
volts

Logarithmic  
Voltage Scale

AC Operation  
105—125 v, 60 c.

Accurate and  
Stable Calibration

TYPE 300

- Ordinary vacuum-tube voltmeters are limited in sensitivity to a few tenths of a volt and are useless for many measurements in communication and "weak current" engineering. This new instrument, based upon an entirely different principle, is capable of reading down to 1 millivolt and up to 100 volts over a wide frequency range (10 to 100,000 cycles) with an error of less than 2%.
- Another disadvantage of the conventional vacuum tube voltmeter is the confusion of scales in multirange instruments brought about by the restriction of useful scale-length by square-law or linear response. This is entirely overcome in the Type 300 instrument by using logarithmic indication, which assures uniform accuracy of reading over the whole scale while permitting range switching in decade steps. There is but one scale to read for all ranges, calibrated in both volts and decibels.
- Due to the new principle employed the calibration is extremely stable and is unaffected by line voltage changes from 105 to 125 volts and by changes in tubes or circuit constants.
- An output jack and output control are provided so that the instrument can also be used as a high-grain (70 DB) stable high-fidelity amplifier, thus greatly extending its usefulness in the laboratory.

*Write for Bulletin 2 for complete data.*

## Ballantine Laboratories, Inc.

*Boonton, New Jersey*

---

*When writing to advertisers mention of the PROCEEDINGS will be mutually helpful.*

*Modernized*

# AMPEREX 849A

*and* AMPEREX \*849H

GREATER POWER OUTPUT  
HIGHER PLATE DISSIPATION  
LONGER OPERATING LIFE  
\* HIGHER RATINGS AT HIGH  
FREQUENCY

The application by Amperex of the modern engineering concept of the space relationship of electrodes in a vacuum tube has resulted in the design of a new type with far greater performance capabilities than the standard 849. Simplification of structure because of this new design has also made possible considerable economies in manufacturing processes which are reflected in the price of these tubes.

THE OUTSTANDING FEATURES OF  
THESE NEW TUBES ARE AS FOLLOWS:

- GREATER FILAMENT AREA
- LARGER PLATE SURFACE
- MORE UNIFORM ANODE HEAT DISTRIBUTION
- A MINIMUM OF INTERELECTRODE INSULATING SPACERS
- 1500 WATTS maximum power output per tube as a Class C, CW amplifier
- 750 WATTS Carrier Power Output, as a plate modulated Class C amplifier
- 250 WATTS Carrier Power Output as a grid bias modulated Class C amplifier
- 250 WATTS Carrier Power Output as a Class B Linear R.F. amplifier
- 1600 WATTS maximum signal power output per pair as Class B A.F. modulator
- 150 WATTS Undistorted Power Output as a Class A A.F. Modulator

The features enumerated above clearly demonstrate that not only can these tubes be used profitably to replace 849's in existing equipment but that they also fill a gap in the air cooled line of tubes for use in equipment where severe derating at high frequencies forced the use of much larger and costlier tubes.

\* The 849H can be operated at full ratings up to 30 megacycles in many classes of service. It is identical in its characteristics with the 849A. The only point of difference is the grid lead terminal which in the 849H terminates in an arm extending from the side of the bulb.

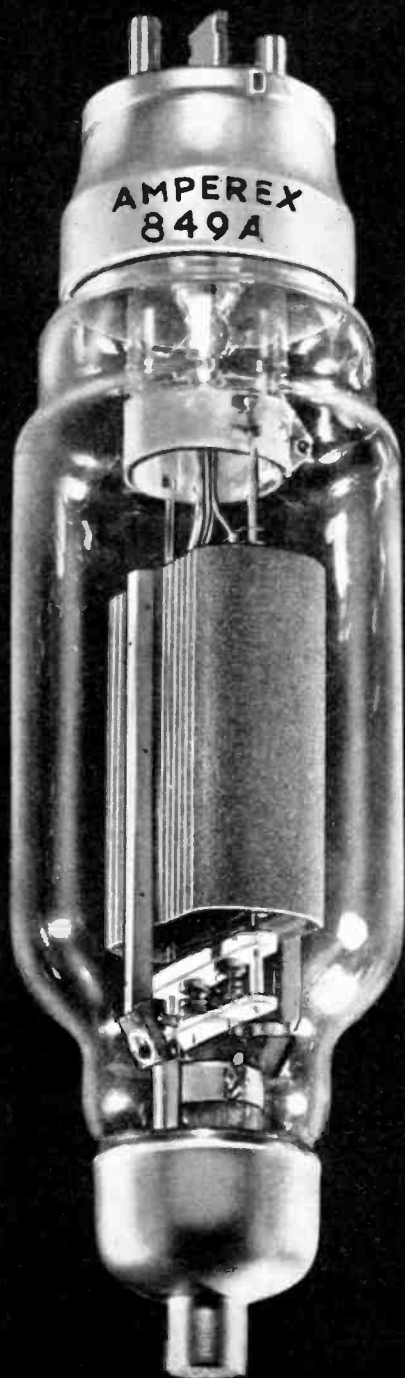

**\$135**

**AMPEREX ELECTRONIC PRODUCTS, Inc.**  
79 WASHINGTON STREET  
BROOKLYN, NEW YORK

# For Ultra-Sensitive Controls

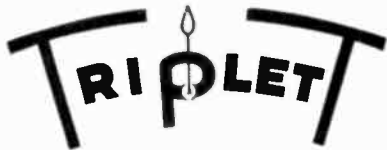

## INSTRUMENT RELAYS

Dependability and flexibility in electrified controls . . . A comprehensive line of highly sensitive relays used in connection with light sensitive cells for signal alarms, automatic inspection, counting apparatus, automatic lighting and many other applications requiring regulation within very narrow limits.

Fixed contacts are set in adjustable screws, allowing a wide adjustment of upper and lower limits of contact. Hardy metal, platinum, silver and platinum-iridium contacts. Single circuit-single contact and double circuit-double contact types (separate circuit or common connection). Among special developments is a locked contact type relay with manual release. Triplett engineers are interested in receiving your inquiries. Write for complete information.

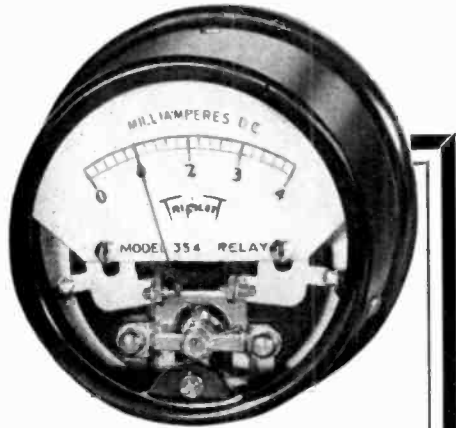

**MODEL 354**

The Triplett Model 354 alarm relay shown here makes contact at 1 and 3 M.A. Other ranges and contact arrangements to order. Three case styles—projection, as shown, flush panel and portable.

**SEE THE NEW  
TRIPLETT  
1938-39 LINE  
AT THE  
CHICAGO JUNE  
RADIO PARTS SHOW  
BOOTHS 213-15  
HENRY AVENUE**



The Triplett Electrical Instrument Co.  
216 Harmon Dr., Bluffton, Ohio

... Please send me complete information regarding relay applications.

Name .....

Address .....

City ..... State .....

*When writing to advertisers mention of the PROCEEDINGS will be mutually helpful.*

• FINE WIRE  
• RIBBON and  
• FOIL . . .

OF  
"CLOSER-THAN-COMMERCIAL"  
TOLERANCES

★  
Obtainable in  
Pt, Au, Ag, Ni, Cu, Fe, Al,  
or any special alloys

★  
BARE WIRES drawn to .0006" diameter  
RIBBON rolled to less than .0001" thick  
FOIL rolled to less than .0005" thick

★  
FILAMENT WIRE  
AND RIBBON

CLOSE SCIENTIFIC CONTROL OF CHEMICAL COMPOSITION AND PHYSICAL CHARACTERISTICS. High purity; exact size, weight and elongation; high tensile strength; accurate torsional properties, resistance and temperature co-efficient of resistance.

★  
Specialists in Precise Control of specifications for difficult alloys for:

- FILAMENTS
- GALVANOMETER SUSPENSIONS
- RESISTANCE and FUSE WIRES

**SIGMUND COHN**

44 GOLD ST.

NEW YORK

SINCE



1901

•  
*We invite you to present your specifications or individual problems. We shall be glad to offer expert counsel and metallurgical data. No obligation on your part.*  
•

*When writing to advertisers mention of the PROCEEDINGS will be mutually helpful.*

# The Institute of Radio Engineers

Incorporated

330 West 42nd Street, New York, N.Y.

## APPLICATION FOR ASSOCIATE MEMBERSHIP

(Application forms for other grades of membership are obtainable from the Institute)

To the Board of Directors

Gentlemen:

I hereby make application for Associate membership in the Institute of Radio Engineers on the basis of my training and professional experience given herewith, and refer to the members named below who are personally familiar with my work.

I certify that the statements made in the record of my training and professional experience are correct, and agree if elected, that I will be governed by the constitution of the Institute as long as I continue a member. Furthermore I agree to promote the objects of the Institute so far as shall be in my power, and if my membership shall be discontinued will return my membership badge.

.....  
(Sign with pen)

.....  
(Address for mail)

.....  
(Date)

.....  
(City and State)

### Sponsors:

(Signature of references not required here)

Mr. .... Mr. ....

Address ..... Address .....

City and State ..... City and State .....

Mr. ....

Address .....

City and State .....

The following extracts from the Constitution govern applications for admission to the Institute in the Associate grade:

#### ARTICLE II—MEMBERSHIP

Sec. 1: The membership of the Institute shall consist of: \* \* \* (c) Associates, who shall be entitled to all the rights and privileges of the Institute except the right to hold any elective office specified in Article V. \* \* \*

Sec. 4. An Associate shall be not less than twenty-one years of age and shall be a person who is interested in and connected with the study or application of radio science or the radio arts.

#### ARTICLE III—ADMISSION AND EXPULSIONS

Sec. 2: \* \* \* Applicants shall give references to members of the Institute as follows: \* \* \* for the grade of Associate, to three Fellows, Members, or Associates; \* \* \* Each application for admission \* \* \* shall embody a full record of the general technical education of the applicant and of his professional career.

#### ARTICLE IV—ENTRANCE FEE AND DUES

Sec. 1: \* \* \* Entrance fee for the Associate grade of membership is \$3.00 and annual dues are \$6.00.

**ENTRANCE FEE SHOULD ACCOMPANY APPLICATION**



# First Use of Radio: Communications. First in Radio Communications: RCA



*First RCA Experimental Laboratory at Riverhead, Long Island—1919.*

**T**HE Radio Age began with radio communications. Practically all present day developments of radio, in broadcasting and in every other direction, have grown out of communications research.

Each advance in one branch of radio contributed to the progress of other branches. Broadcasting has been the most conspicuous radioservice for a number of years, yet its success has not caused any lessening in the advance of older radio services, marine and

international communications.

From its very beginning, RCA has been a research organization. The men who organized this company, and have since conducted it, have always been fully aware of the necessity for unceasing exploration in the vast field opened up by radio's pioneers.

The radio research which RCA has sponsored within a period of nearly 20 years is the foundation for the many ways in which RCA serves millions of people.

*Listen to the Magic Key of RCA, presented every Sunday, 2 to 3 P. M., E. D. S. T., over NBC Blue Network.*



## Radio Corporation of America

RADIO CITY, NEW YORK

RCA Manufacturing Co., Inc.—RCA Institutes, Inc.—RCA Communications, Inc.  
RADMARINE CORPORATION OF AMERICA      NATIONAL BROADCASTING COMPANY

*When writing to advertisers mention of the PROCEEDINGS will be mutually helpful.*

## ALPHABETICAL INDEX TO ADVERTISEMENTS

<b>A</b>	
Aerovox Corporation .....	xxvii
American Telephone and Telegraph Company .....	xxvii
Amperex Electronic Products, Inc. ....	xx
<b>B</b>	
Ballantine Laboratories, Inc. ....	xix
<b>C</b>	
Cornell-Dubilier Electric Corporation .....	xxviii
<b>G</b>	
General Radio Company .....	Cover IV
<b>I</b>	
Instruments Publishing Company .....	xvi
<b>R</b>	
Radio Corporation of America .....	xxv
RCA Manufacturing Company, Inc. ....	Cover III
<b>S</b>	
Sigmund Cohn .....	xxii
Sprague Specialties Company .....	xviii
<b>T</b>	
Triplett Electrical Instrument Company .....	xxi
<b>W</b>	
Western Electric Company .....	xv

## ENGINEERING DIRECTORY

### CONSULTANTS AND DESIGNERS

including  
 Amplifiers • Antennas • Transmitters  
 Receivers • Laboratory Equipment  
 Special equipment designed  
 and constructed

#### RADIO DEVELOPMENT & RESEARCH CORP.

145 West 45th Street, New York, N.Y.  
 Tel. BRyant 9-6898

### Cathode Ray Tubes and Associated Equipment For All Purposes

*Write for Complete  
 Technical Data*

**ALLEN B. DUMONT  
 LABORATORIES  
 PASSAIC, N.J.**

### PRACTICAL RADIO ENGINEERING

One year Residence Course  
 Advanced Home Study Course  
 Combined Home Study-Residence  
 Course

*Write for details*

**Capitol Radio Engineering  
 Institute  
 Washington, D.C.**

### QUARTZ CRYSTALS

for Standard or Special  
 Radio Frequency Applications

*Write for Catalog*

**BLILEY ELECTRIC CO.  
 230 Union Station Bldg.  
 ERIE, PENNA.**

*When writing to advertisers mention of the PROCEEDINGS will be mutually helpful.*





"I WANT A  
TELEPHONE  
IN THIS  
HOUSE!"

"**S**UPPOSE I get sick? After all, I'm only human. And if I do get a touch of colic . . . or have a nervous breakdown . . . do you know what'll bring it on? Worry! Yes, sir, worrying about how long it would take us to get the doctor if anything happens.

"Or suppose a pipe bursts in the bathroom? Or a burglar comes along? When something like that happens you don't write a letter. No, sir, you hop to a telephone!

"And what about my mother?"

She's got marketing to do. Sometimes she needs to get in touch with Dad during the day. And there are errands to be run. Well, she can't do all those things without a telephone . . . and at the same time give me the attention I expect.

"All Dad needs to do to have a telephone is get in touch with the Business Office. I'd do it myself if I could get out. But I can't. Is it any wonder that worry keeps me awake half the day?"

## BELL TELEPHONE SYSTEM

When writing to advertisers mention of the PROCEEDINGS will be mutually helpful.



# FOCALIZATION

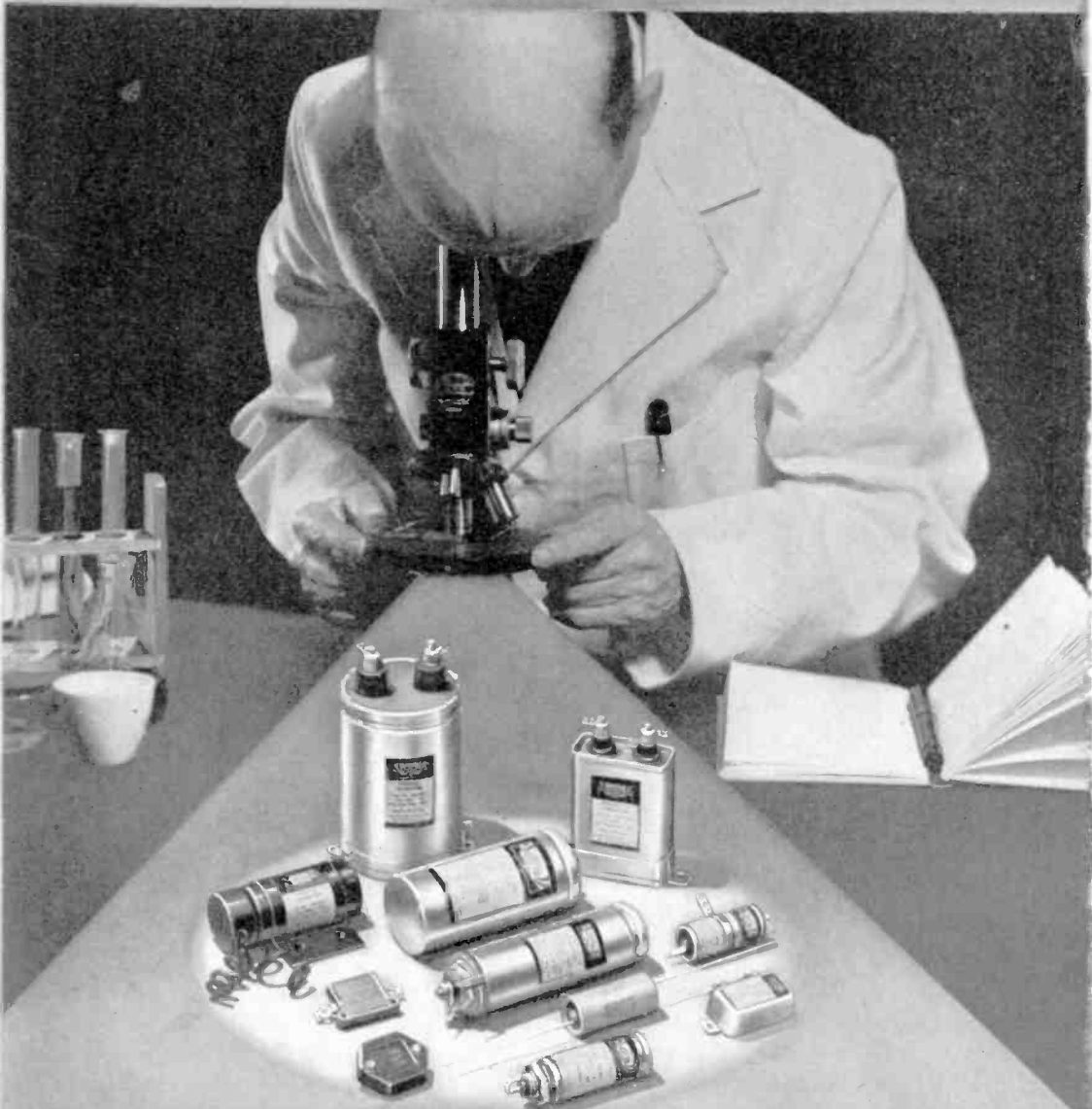

For over a quarter of a century, the combined efforts and ingenuity of Cornell-Dubilier have been focused on the production of capacitors—and capacitors alone. This focalization of research and manufacturing experience is directly responsible

for the production of dependable capacitors. Today, Cornell-Dubilier offers the greatest values obtainable in capacitors for every radio and electrical need. Get to know C-D's. Write for Catalog No. 160, free on request.

*Products of the world's oldest and largest exclusive manufacturer of capacitors*

**CORNELL - DUBILIER ELECTRIC CORP.**  
**1000 Hamilton Boulevard, South Plainfield, New Jersey**

# DIRECT READINGS OF PHASE DIFFERENCE

*with the New RCA Radio  
Frequency Phase Meter 300-A*

RCA announces a new instrument for the convenience of the radio engineer—the type 300-A radio frequency phase meter. This instrument has been designed primarily for adjusting and maintaining the phase relationship between radiator elements in a directive antenna array and as such it will save much time and expense in setting up and adjusting the system for the desired pattern. It is also useful for other applications where a rapid and accurate indication of phase differences is needed.

The instrument is simple to operate. The inputs are connected through concentric cables or transmission lines having the same length or of known characteristics. A figure is produced on a small cathode ray tube. By adjusting a phase shifting device, a straight line can be produced on the oscillograph. The dial will then read the phase difference at the terminals of the 300-A. It is completely AC operated and inexpensive. Every station using a directional antenna will need one.

## SPECIFICATIONS

Reads any phase angle between two elements.  
Switches are provided for measuring between 6 elements.

Range—200 to 1600 kc.

Input Impedance—for 70 ohm lines

Power supply—110 volts, 60 cycles

Dimensions—8-3/4" x 19" x 10-3/4"

*Special purpose RCA tubes help to make possible the 300-A instrument*



## Measuring Equipment

RCA Mfg. Co., Inc., Camden, N. J. • A Service of the Radio Corporation of America

New York: 1270 Sixth Ave.  
Dallas: Santa Fe Building

Chicago: 589 E. Illinois St.  
San Francisco: 170 Ninth St.

Atlanta: 490 Peachtree St., N. E.  
Hollywood: 1016 N. Sycamore Ave

*When writing to advertisers mention of the PROCEEDINGS will be mutually helpful.*



## SMOOTH HIGH-VOLTAGE CONTROL

VARIACS afford the simplest and most efficient means for the *continuous* control of high-voltage direct current. When a VARIAC is used in the primary circuit of the transformer supplying high voltage to a tube rectifier, the direct current output can be varied continuously from the lowest operating point of the rectifier tubes to full output voltage.

VARIACS so used are very efficient. Unlike the resistive control, the output voltage obtained from the VARIAC is practically independent of applied load up to its full load rating.

In experimental set-ups the VARIAC is used extensively when it is desired to control the output voltage quickly through a simple 320 degree rotary motion.

VARIACS are built into the equipment of many stations for manually adjusting the line voltage on rectifiers, transmitting tubes and other a-c operated station apparatus.

VARIACS are supplied in load ratings from 170 va to 2000 va and are priced from \$10.00 to \$40.00.

•Write for the latest Variac Bulletin No. 279

**GENERAL RADIO COMPANY**  
Cambridge, Massachusetts

New York

Los Angeles