

BWS

VOLUME 26

APRIL, 1938

NUMBER 4

PROCEEDINGS
of
The Institute of Radio
Engineers



Application Blank for Associate Membership on Page XVI

Institute of Radio Engineers Forthcoming Meetings

ANNUAL CONVENTION

New York, N. Y.

June 16, 17, and 18, 1938

Papers for presentation must be submitted to the Secretary
not later than April 15, 1938

JOINT MEETING

American Section, International Scientific Radio Union
and

Institute of Radio Engineers

Washington, D. C.

April 29 and 30, 1938

CLEVELAND SECTION

April 28, 1938

DETROIT SECTION

April 15, 1938

LOS ANGELES SECTION

April 19, 1938

MONTREAL SECTION

April 13, 1938

NEW YORK MEETINGS

April 6, 1938

May 4, 1938

PHILADELPHIA SECTION

April 7, 1938

May 5, 1938

PITTSBURGH SECTION

April 19, 1938

WASHINGTON SECTION

April 11, 1938

PROCEEDINGS OF
The Institute of Radio Engineers

VOLUME 26

April, 1938

NUMBER 4

Board of Editors

ALFRED N. GOLDSMITH, *Chairman*

R. R. BATCHER

P. S. CARTER

F. W. GROVER

J. W. HORTON

G. W. PICKARD

B. E. SHACKELFORD

K. S. VAN DYKE

H. P. WESTMAN, *ex officio*

L. P. WHEELER

L. E. WHITTEMORE

WILLIAM WILSON

CONTENTS

PART I

Institute News and Radio Notes.....	387
March Meeting of the Board of Directors.....	387
Joint Meeting of the Institute and the American Section of the International Scientific Radio Union.....	387
Committee Work.....	389
Institute Meetings.....	391
Personal Mention.....	399

PART II

Technical Papers

The Developmental Problems and Operating Characteristics of Two New Ultra-High-Frequency Triodes.....	W. G. WAGENER	401
Constants of Fixed Antennas on Aircraft.....	GEORGE L. HALLER	415
Direct Measurement of the Loss Conductance of Condensers at High Frequencies.....	M. BOELLA	421
The Variation in the High-Frequency Resistance and Permeability of Ferromagnetic Materials Due to a Superimposed Magnetic Field.....	J. S. WEBB	433
A Method of Neutralizing Hum and Feedback Caused by Variations in the Plate Supply.....	K. B. GONSER	442
Harmonic Generation.....	HERBERT J. SCOTT AND LEONARD J. BLACK	449
On Single and Coupled Tuned Circuits Having Constant Response-Band Characteristics.....	HO-SHOU LOH	469
Armstrong's Frequency Modulator.....	D. L. JAFFE	475
Characteristics of the Ionosphere at Washington, D. C., February, 1938.....	T. R. GILLILAND, S. S. KIRBY, AND N. SMITH	482
Contributors to This Issue.....		486
Booklets, Catalogs, and Pamphlets Received.....		488

The Institute of Radio Engineers

GENERAL INFORMATION

INSTITUTE. The Institute of Radio Engineers was formed in 1912 through the amalgamation of the Society of Wireless Telegraph Engineers and the Wireless Institute. Its headquarters were established in New York City and the membership has grown from less than fifty members at the start to several thousand.

AIMS AND OBJECTS. The Institute functions solely to advance the theory and practice of radio and allied branches of engineering and of the related arts and sciences, their application to human needs, and the maintenance of a high professional standing among its members. Among the methods of accomplishing this is the publication of papers, discussions, and communications of interest to the membership.

PROCEEDINGS. The PROCEEDINGS is the official publication of the Institute and in it are published all of the papers, discussions, and communications received from the membership which are accepted for publication by the Board of Editors. Copies are sent without additional charge to all members of the Institute. The subscription price to nonmembers is \$10.00 per year, with an additional charge for postage where such is necessary.

RESPONSIBILITY. It is understood that the statements and opinions given in the PROCEEDINGS are views of the individual members to whom they are credited, and are not binding on the membership of the Institute as a whole. Papers submitted to the Institute for publication shall be regarded as no longer confidential.

REPRINTING PROCEEDINGS MATERIAL. The right to reprint portions or abstracts of the papers, discussions, or editorial notes in the PROCEEDINGS is granted on the express condition that specific reference shall be made to the source of such material. Diagrams and photographs published in the PROCEEDINGS may not be reproduced without making specific arrangements with the Institute through the Secretary.

MANUSCRIPTS. All manuscripts should be addressed to the Institute of Radio Engineers, 330 West 42nd Street, New York City. They will be examined by the Papers Committee and the Board of Editors to determine their suitability for publication in the PROCEEDINGS. Authors are advised as promptly as possible of the action taken, usually within two or three months. Manuscripts and illustrations will be destroyed immediately after publication of the paper unless the author requests their return. Information on the mechanical form in which manuscripts should be prepared may be obtained by addressing the secretary.

MAILING. Entered as second-class matter at the post office at Menasha, Wisconsin. Acceptance for mailing at a special rate of postage is provided for in the act of February 28, 1925, embodied in Paragraph 4, Section 412, P. L. and R., and authorization was granted on October 26, 1927.

Published monthly by

THE INSTITUTE OF RADIO ENGINEERS, INC.

Publication office, 450-454 Ahnaip St., Menasha, Wis.

BUSINESS, EDITORIAL, AND ADVERTISING OFFICES

Harold P. Westman, *Secretary*

330 West 42nd Street, New York, N. Y.

INSTITUTE SECTIONS

- ATLANTA—Chairman, C. F. Daugherty; Secretary, J. G. Preston, U. S. Radio Monitoring Station, R.F.D. 3, Marietta, Ga.
- BOSTON—Chairman, H. W. Lamson; Secretary, E. B. Dallin, 64 Oakland Ave., Arlington, Mass.
- BUFFALO-NIAGARA—Chairman, G. C. Crom, Jr.; Secretary, E. C. Waud, 235 Huntington Ave., Buffalo, N. Y.
- CHICAGO—Chairman, J. E. Brown; Secretary, E. Kohler, Jr., Ken-Rad Tube and Lamp Corporation, 2400 Sheffield Ave., Chicago, Ill.
- CINCINNATI—Chairman, R. J. Rockwell; Secretary, M. M. Wells, Crosley Radio Corporation, 1329 Arlington St., Cincinnati, Ohio.
- CLEVELAND—Chairman, L. N. Chatterton; Secretary, R. L. Kline, Winteradio, Inc., 3014 Lorain Ave., Cleveland, Ohio.
- CONNECTICUT VALLEY—Chairman, D. E. Noble; Secretary, C. E. Keeler, 406 Belmont Ave., Springfield, Mass.
- DETROIT—Chairman, E. H. Lee; Secretary, R. J. Schaefer, 9753 N. Martindale, Detroit, Mich.
- EMPORIUM—Chairman, A. W. Keen; Secretary, M. C. Hoffman, Hygrade Syl- vania Corporation, Emporium, Pa.
- INDIANAPOLIS—Chairman, V. C. MacNabb; Secretary, I. M. Slater, 6433 E. Shelley Ave., Indianapolis, Ind.
- LOS ANGELES—Chairman, R. P. Brooke; Secretary, A. C. Packard, Station KNX, Columbia Broadcasting System, 5939 Sunset Blvd., Hollywood, Calif.
- MONTREAL—Chairman, A. M. Patience; Secretary, S. Sillitoe, 1261 Shearer St., Montreal, Que., Canada.
- NEW ORLEANS—Chairman, G. H. Peirce; Secretary, D. W. Bowman, 8327 Sycamore St., New Orleans, La.
- PHILADELPHIA—Chairman, A. F. Murray; Secretary, R. L. Snyder, 103 Frank- lin Rd., Glassboro, N. J.
- PITTSBURGH—Chairman, R. T. Gabler; Secretary, A. F. Shreve, 459 Willow Dr., Mt. Lebanon, Pittsburgh, Pa.
- ROCHESTER—Chairman, L. A. Du Bridge; Secretary, H. A. Brown, 89 East Ave., Rochester, N. Y.
- SAN FRANCISCO—Chairman, Noel Eldred; Secretary, L. J. Black, 243-30th St., Oakland, Calif.
- SEATTLE—Chairman, A. R. Taylor; Secretary, R. M. Walker, 2600-26th Ave., S.W., Seattle, Wash.
- TORONTO—Chairman, W. H. Kohl; Secretary, N. Potter, Canadian National Carbon Co., Ltd., 805 Davenport Rd., Toronto, Ont., Canada.
- WASHINGTON—Chairman, E. H. Rietzke; Secretary, L. C. Young, Naval Re- search Laboratory, Bellevue, Anacostia, D. C.

**GEOGRAPHICAL LOCATION OF MEMBERS ELECTED
MARCH 2, 1938**

Transferred to the Fellow Grade

Massachusetts	Cambridge, General Radio Co.	Karplus, E.
New Jersey	Harrison, RCA Manufacturing Co., Inc.	Thompson, B. J.
New York	New York, Bell Telephone Labs., Inc., 463 West St.	Carson, J. R.
	New York, Radio Corporation of America, 30 Rockefeller Plaza	Shackelford, B. E.

Transferred to the Member Grade

Iowa	Des Moines, Radio Station WHO	Loyet, P. A.
New Jersey	Camden, RCA Manufacturing Co., Inc.	Jones, L. F.
	Harrison, RCA Manufacturing Co., Inc.	Headrick, L. B.
	Summit, 9 Iris Rd.	Schmit, D. F.
New York	Brooklyn, 1845 E. 47th St.	Dreyer, J. F., Jr.
	Riverhead, L. I., Box 626	Braaten, A. M.
	Riverhead, L. I., c/o RCA Communications, Inc.	Moore, J. B.
Tennessee	Nashville, Radio Station WSM	De Witt, J. H., Jr.

Elected to the Associate Grade

California	Los Angeles, 1984 Park Grove Ave.	Anderson, J. S.
	Los Angeles, 4039 Camero Ave.	Dooley, P.
	Los Angeles, 6900 McKinley Ave.	Downs, G. W., Jr.
	Los Angeles, 1214 N. Alvarado St.	Fodor, F. H.
	New Haven, 127 Hyde St.	Keyworth, J. G.
Connecticut District of Columbia	Washington, 924 National Press Bldg.	Ports, D. C.
Illinois	Chicago, American Airlines	Flynn, J. G., Jr.
	Chicago, 2652 W. Greenleaf Ave.	Gray, F. D.
	Chicago, 2704 N. Kildare Ave.	O'Brien, E.
	Chicago, 5125 N. Ashland Ave.	Osterlund, S. S. G.
	Rock Island, 1537-39th St.	Sinnett, R. J.
Indiana	Fort Wayne, 3229 Hoagland Ave.	Markwalder, W. B
Kansas	Kansas City, 2803 Hiawatha	Browder, J. E.
Nebraska	Omaha, 4603 N. 60th St. R 7	McDonald, P. F.
New Jersey	Carteret, Radio Station WOR	Singer, C.
	Hoboken, P.O. Box 905	Rosenblatt, P.
	Lawrenceville, Box 20	Miller, E. S. G.
	Merchantville, 606 W. Maple Ave.	Rhea, H. E.
	Merchantville, 6748 Rogers Ave.	Washburn, E. M.
	Newark, 57 State St.	Drummond, J. J.
	Oaklyn, 112 Woodland Ter.	Martinelli, C. C.
	Oaklyn, 39 E. Collingswood Ave.	McDonald, E. H.
	Passaic, 98 Grant St.	Kihn, H.
	Tenneck, 613 Ramapo Rd.	Friebele, E. J.
New York	Lancaster, 43 Laverack Ave.	Scott, M. C.
	New York, 580 Park Ave.	Churchill, H. B.
	New York, c/o Columbia Broadcasting System, 485 Madison Ave.	Freundlich, M. M.
	New York, Bell Telephone Labs., 463 West St.	Meacham, L. A.
	New York, Bell Telephone Labs., 180 Varick St.	Reichle, W. E.
North Dakota	Minot, 416-2nd St., S.E.	Meyer, M.
Ohio	Sugar Creek, R. 2	Hershberger, W. O., Jr.
Oklahoma	Stillwater, 215 Monroe St.	Fisher, B. A.
Pennsylvania	Emporium, 314 W. 5th St.	Brown, W. G.
	Germantown, 547 Abbottsford Rd.	King, F. W., Jr.
	Philadelphia, 200 W. Sedgewick St.	Schroeder, A. C.
	Philadelphia, 1335 Walnut St.	Schroeter, R. G.
	St. Marys, 334 Brussels St.	Dickinson, W. A.
	St. Marys, Hygrade Sylvania Corp.	Ellefson, B. S.
	St. Marys, 125 State St.	Gessford, R. K.
	St. Marys, 503 Chestnut St.	Will, L. E.
	St. Marys, 225 N. Michael St.	Zelt, W. J.
Texas	Austin, University of Texas, Elec. Eng. Dept.	Schulz, E. H.
Washington	Seattle, 4025-32nd Ave., S.W.	Barry, F. N.
	Spokane, 1118 Pittsburg St.	McCann, F. H.
West Virginia	Charleston, 706 Park Ave.	Zaharis, G.
Canal Zone	Cristobal, P.O. Box 1734	Sanchez, H. E.
Canada	Valois, Que., 123 Valois Ave.	Bonneville, S.
England	Chelmsford, Essex, Marconi College of Wireless Communication	Atal, S. N.
	Ealing, W. 13, London, 16 Bruton Way	Kallmann, H. E.
	London, S. E. 25, 3 Howden Rd. South Norwood Hill	Tingley, G. R.
	South Farnborough, Hants., 74 Peabody Rd.	Hay, V. J.
	Wembley, Middx., General Electric Co., Ltd., Research Labs.	Gavin, M. R.

Geographical Location of Members Elected

Italy	Rome, 29 Corso d'Italia	Aliotti, N.
Japan	Setagayaku, Tokyo, c/o Sankoso 201, 539, 4-chome, Kita- zawa	Uetsuki, K.
South Africa	Pretoria, c/o H. Polliack and Co.	McBride, W. V
Elected to the Junior Grade		
Idaho	Malad, Box A	Horsley, R.
Elected to the Student Grade		
Connecticut	Bridgeport, 492 Atlantic St.	Lapinski, C. S.
Georgia	Hartwell, 526 Benson St.	Harrison, A. E.
Indiana	West Lafayette, Cary Hall East, Rm. 239	Huffman, M.
Massachusetts	Boston, 1167 Boylston St.	Rosen, L.
New York	North Attleboro, 16 Old Post Rd.	Korman, N. I.
	Jackson Heights, L. I., 35-47-80th St.	Kellogg, D. S.
	New York, 80 Van Cortlandt Park, S.	Antell, S.
Pennsylvania	New York, 1074-3rd Ave.	Purpura, E.
	Bethlehem, Taylor Hall-A.	Brubaker, P. M.
Texas	Houston, 6900 Washington Ave.	Pfeiffer, P. E.
England	London N. 16, 21 Cranwich Rd.	Zienau, S.



APPLICATIONS FOR MEMBERSHIP

Applications for transfer or election to the various grades of membership have been received from the persons listed below and have been approved by the Admissions Committee. Members objecting to transfer or election of any of these applicants should communicate with the Secretary on or before April 30, 1938. These applications will be considered by the Board of Directors at its meeting on May 4, 1938.

For Transfer to the Fellow Grade

Pennsylvania Philadelphia, 4800 Walnut St. Zworykin, V. K.

For Transfer to the Member Grade

New Jersey Fair Lawn, 16 Brearly Crescent Crawford, J. D.

For Election to the Associate Grade

California	Berkeley, 1147 The Alameda	Ransom, D. H.
	Long Beach, 3545 California Ave.	Fritzinger, L. E.
	Terminal Island, 184-A Terminal Way	Hara, B.
District of Columbia	Washington, 31 Hamilton St., N.W.	Kriz, W.
	Washington, Federal Communications Commission	Link, J. H.
Illinois	Chicago, 60 E. 25th St.	Melcher, F. H.
	Chicago, 225 W. Huron St.	Shure, S. N.
	Chicago, 2300 Board of Trade Bldg.	Wendt, R. H.
Maryland	Takoma Park, 7607 Eastern Ave.	Klink, G., Jr.
	Takoma Park, 7607 Eastern Ave.	Rice, L. W.
Massachusetts	Dorchester, 147 Columbia Rd.	Smith, W. M.
Missouri	Kansas City, 216 E. 74th St.	Dillard, E. L.
	Kansas City, Radio Station KXBY, Fidelity Bldg., 9th and Walnut	Salzer, C. E.
New Jersey	Boonton, Box 1	Minter, J.
	Newark, Federal Telegraph Co., 200 Mt. Pleasant Ave.	Lappin, L. S.
	Paterson, 519 Madison Ave.	Hill, E.
	Rutherford, 60 Eltrick Ter.	Claassen, F. S.
New York	New York, c/o National Broadcasting Co., 30 Rockefeller Plaza	Gronberg, H. C.
	New York, Bell Telephone Labs., Inc., 180 Varick St.	Kirkpatrick, W. E.
	Rochester, 365 Augustine St.	Stafford, C. F.
Oklahoma	Tulsa, 1000 S. Main St.	Durham, E. R.
Oregon	Corvallis, Elec. Eng. Dept., Oregon State College	Everest, F. A.
Pennsylvania	Philadelphia, 6813 Upland St.	Clarance, A. I.
	Philadelphia, 4531 Pulaski Ave.	Griffith, T. H.
	Philadelphia, 317 S. 44th St.	Hoffer, H. N.
	Philadelphia, 5042 Charles St.	Knoebel, H. L.
	Philadelphia, 3447 "F" St.	Moore, G.
Texas	Beaumont, 506 San Jacinto Bldg.	Claiborne, J. G.
Virginia	Arlington, 3904-14th St., N.	Lee, J. M.
Washington	Spokane, N. 2603 Atlantic St.	Keenan, W. J.
	Spokane, W. 611 First Ave.	Young, T. R.
Canada	Toronto, Ont., Northern Electric Co.	Nelson, C.
	Toronto 3, Ont., 219 Wright Ave.	Tipple, H. L.
	Toronto, Ont., 490 Castlefield Ave.	Werry, M. J.
England	Erdington, Birmingham, 656 Chester Rd.	Haden, V. G. J.
	Walsall, Staffs., 8 Mount St.	Blakemore, T. R.
France	Paris 50, 71 rue Monge	Churg, E.
India	Calcutta, A. D. E. T., Telegraph Storeyard, Alipore	Bhashyam, S. R.
	Calcutta, Philips Electrical Co., Ltd., 2 Heysham Rd.	Pattabi-Raman, S.
	Vijayapuram, Tiruvarur, 112 Tiruturaipundi Rd.	Eyner, E. V.
Jamaica	Kingston, 5 Church St.	Sowley, H. A.
Japan	Ibaraki-Ken, Hitati Eng. Works Library, Kaigan-Kojo, Sukegawa	Sato, M.
New Zealand	Auckland, c/o Bowers Radio Labs., Colwell Chambers, Swanson St.	Mosheim, K. R.
	Christchurch, c/o 3YA Transmitting Station, Gebbies Pass	Moore, J.

For Election to the Junior Grade

Canada	Toronto, Ont., 356 Berkeley St.	Patterson, A.
England	London, N. 10, 100 Cranley Gardens, Muswell Hill	Davies, B. T.

Applications for Membership

For Election to the Student Grade

California	Berkeley, 2828 College Ave.	Johnson, R. M.
	Berkeley, 2411 Bowditch Ave.	Sternke, E. C.
	Piedmont, 21 Lake Ave.	Thompson, P.
Connecticut	New Haven, Dunham Lab., 10 Hillhouse Ave.	Eberhard, E.
	New Haven, 51 Prospect St.	Starecke, O. A.
	New Haven, 318 Dunham Lab., Yale University	Wischmeyer, C. R.
Indiana	Angola, 113 N. Superior St.	Hoar, J. E. C.
	Angola, 200 W. South St.	McPherson, H.
	Angola, 113 N. Superior St.	Miro, L. G.
	Angola, 500 S. West St.	Sherman, F. L.
	Angola, 113 S. College St.	Suther, A. C.
Massachusetts	Cambridge, 106 Auburn St.	Hillyer, C., Jr.
Michigan	Detroit, 14882 Terry Ave.	Busch, A.
	Freda	Winter, H. A.
Minnesota	Minneapolis, 409 Walnut St., S.E.	Colander, R. E.
	Minneapolis, Box 379, Pioneer Hall, University of Minnesota	Pollei, D.
	Minneapolis, Box 403, Pioneer Hall, University of Minnesota	Ritter, T. J.
	Minneapolis, 4532 Pillsbury Ave.	Westphal, W. B.
	Troy, Voorhees Dormitory 32, Sage Ave.	Wilson, D. G.
New York	Knoxville, 817 S. 15th St.	Dumas, R. E.
Tennessee	Knoxville, 509 Watauga Ave.	Hinsdale, E. M., Jr.



OFFICERS AND BOARD OF DIRECTORS

(Terms expire January 1, 1939, except as otherwise noted)

President

HARADEN PRATT

Vice President

E. T. FISK

Treasurer

MELVILLE EASTHAM

Secretary

HAROLD P. WESTMAN

Editor

ALFRED N. GOLDSMITH

Directors

E. H. ARMSTRONG

J. E. BROWN

R. A. HACKBUSCH

L. C. F. HORLE

VIRGIL M. GRAHAM

E. K. JETT

A. F. MURRAY

B. J. THOMPSON

ALAN HAZELTINE, *Past President*

SERVING UNTIL JANUARY 1, 1940

H. H. BEVERAGE, *Past President*
RALPH BOWN

ALFRED N. GOLDSMITH
H. M. TURNER

SERVING UNTIL JANUARY 1, 1941

F. W. CUNNINGHAM

O. B. HANSON

C. M. JANSKY, JR.

COMMITTEES OF THE INSTITUTE OF RADIO ENGINEERS

1938

ADMISSIONS COMMITTEE

F. W. CUNNINGHAM, *Chairman*

MELVILLE EASTHAM	C. M. JANSKY, JR.
J. F. FARRINGTON	C. B. JOLLIFFE
R. A. HEISING	E. R. SHUTE
L. C. F. HORLE	J. S. SMITH

A. F. VAN DYCK

ANNUAL REVIEW COMMITTEE

A. F. VAN DYCK, *Chairman*

E. K. COHAN	H. S. KNOWLES
J. H. DELLINGER	E. G. PORTS
D. E. FOSTER	H. M. TURNER
KEITH HENNEY	P. T. WEEKS

L. E. WHITTEMORE

AWARDS COMMITTEE

H. H. BEVERAGE, *Chairman*

RALPH BOWN	ALAN HAZELTINE
ALFRED N. GOLDSMITH	H. M. TURNER

BOARD OF EDITORS

ALFRED N. GOLDSMITH, *Chairman*

R. R. BATCHER	B. E. SHACKELFORD
P. S. CARTER	K. S. VAN DYKE
F. W. GROVER	H. P. WESTMAN, <i>ex officio</i>
J. W. HORTON	L. P. WHEELER
G. W. PICKARD	L. E. WHITTEMORE

WILLIAM WILSON

CONSTITUTION AND LAWS COMMITTEE

H. M. TURNER, *Chairman*

AUSTIN BAILEY	C. E. SCHOLZ
RALPH BOWN	B. J. THOMPSON
ALFRED N. GOLDSMITH	H. R. ZEAMANS

MEMBERSHIP COMMITTEE

C. E. SCHOLZ, *Chairman*

NATHANIEL BISHOP	H. C. GAWLER
E. L. BOWLES	R. M. HEINTZ
H. A. CHINN	A. F. MURRAY
T. H. CLARK	L. G. PACENT
J. M. CLAYTON	M. E. PACKMAN
I. S. COGGESHALL	F. X. RETTENMEYER
E. D. COOK	C. R. ROWE
F. W. CUNNINGHAM	B. SALZBERG
COKE FLANNAGAN	J. E. SMITH

H. J. VENNES

(*Chairmen of Membership Committees of Sections, ex officio*)

NEW YORK PROGRAM COMMITTEE

AUSTIN BAILEY, *Chairman*

R. R. BEAL
A. B. CHAMBERLAIN
I. S. COGGESHALL

R. M. HEINTZ
KEITH HENNEY
G. T. ROYDEN

NOMINATIONS COMMITTEE

G. W. PICKARD, *Chairman*

MELVILLE EASTHAM
J. V. L. HOGAN

C. M. JANSKY, JR.
H. M. TURNER

PAPERS COMMITTEE

WILLIAM WILSON, *Chairman*

H. A. AFFEL
EDMOND BRUCE
H. A. CHINN
J. K. CLAPP
T. A. M. CRAVEN
P. O. FARNHAM
E. B. FERRELL
T. R. GILLILAND
E. L. HALL
L. F. JONES

F. B. LLEWELLYN
DEL. K. MARTIN
A. F. MURRAY
H. O. PETERSON
R. K. POTTER
G. G. THOMAS
H. M. TURNER
P. T. WEEKS
H. A. WHEELER
W. C. WHITE

IRVING WOLFF

PUBLICITY COMMITTEE

KEITH HENNEY

K. B. WARNER

R. C. POULTER

SECTIONS COMMITTEE

E. D. COOK, *Chairman*

I. S. COGGESHALL
Virgil M. GRAHAM

R. M. HEINTZ
J. H. MILLER

C. E. SCHOLZ

(*Chairmen of Sections, ex officio*)

TELLERS COMMITTEE

L. G. PACENT, *Chairman*

L. A. KELLEY

H. P. WESTMAN, *ex officio*

F. M. RYAN

TECHNICAL COMMITTEES

ELECTROACOUSTICS COMMITTEE

H. S. KNOWLES, *Chairman*

J. T. L. BROWN
A. M. GRANUM
KNOX McILWAIN

GEORGE NIXON
BENJAMIN OLNEY
H. F. OLSEN

HANS RODER

ELECTRONICS COMMITTEE

P. T. WEEKS, *Chairman*

R. S. BURNAP
E. L. CHAFFEE
H. P. CORWITH
K. C. DEWALT
A. M. GRANUM
BEN KIEVIT, JR.
F. R. LACK

GEORGE LEWIS
KNOX McILWAIN
G. F. METCALF
A. F. MURRAY
G. D. O'NEILL
H. W. PARKER
B. J. THOMPSON

BALTH. VAN DER POL

RADIO RECEIVERS COMMITTEE

D. E. FOSTER, *Chairman*

E. H. ARMSTRONG	H. B. FISCHER
C. R. BARHYDT	VIRGIL M. GRAHAM
R. I. COLE	A. M. GRANUM
W. F. COTTER	DAVID GRIMES
HARRY DIAMOND	H. O. PETERSON
E. T. DICKEY	A. E. THIESSEN

LINCOLN WALSH

STANDARDS COMMITTEE

L. P. WHEELER, *Chairman*

W. R. G. BAKER	L. C. F. HORLE
W. L. BARROW	H. S. KNOWLES
E. K. COHAN	R. M. MORRIS
J. H. DELLINGER	E. G. PORTS
MELVILLE EASTHAM	F. E. TERMAN
D. E. FOSTER	H. J. VENNES
VIRGIL M. GRAHAM	P. T. WEEKS

WILLIAM WILSON

TELEVISION AND FACSIMILE COMMITTEE

E. K. COHAN, *Chairman*

H. S. BAIRD	C. W. HORN
R. R. BATCHER	A. G. JENSEN
J. L. CALLAHAN	C. B. JOLLIFFE
E. W. ENGSTROM	H. M. LEWIS
P. T. FARNSWORTH	R. H. MANSON
P. C. GOLDMARK	J. W. MILNOR
ALFRED N. GOLDSMITH	A. F. MURRAY
J. V. L. HOGAN	R. E. SHELBY

C. J. YOUNG

TRANSMITTERS AND ANTENNAS COMMITTEE

E. G. PORTS, *Chairman*

RAYMOND ASSERSON	D. G. LITTLE
W. W. BROWN	J. F. MORRISON
E. K. COHAN	R. E. POOLE
HARRY DIAMOND	D. S. RAU
A. M. GRANUM	J. C. SCHELLENG
RAYMOND GUY	P. E. WATSON
W. E. JACKSON	J. E. YOUNG

WAVE PROPAGATION COMMITTEE

J. H. DELLINGER, *Chairman*

E. V. APPLETON	G. D. GILLETT
S. L. BAILEY	F. A. KOLSTER
L. V. BERKNER	H. R. MIMNO
C. R. BURROWS	K. A. NORTON
T. L. ECKERSLEY	H. O. PETERSON
W. A. FITCH	G. W. PICKARD

BALTH. VAN DER POL

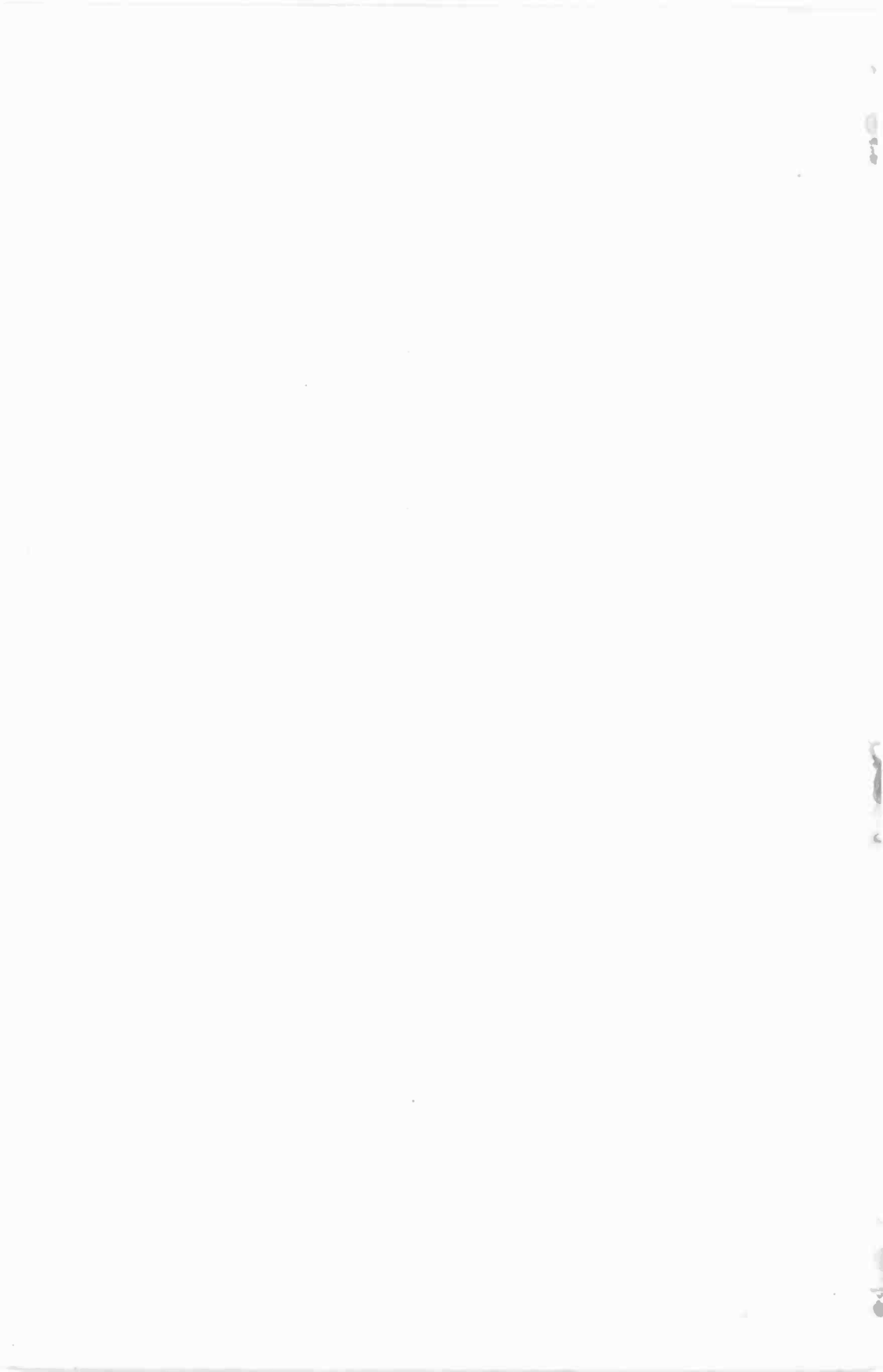

INSTITUTE NEWS AND RADIO NOTES

March Meeting of the Board of Directors

The March meeting of the Board of Directors was held on the 2nd in the Institute office and attended by C. M. Jansky, Jr., acting chairman; Melville Eastham, treasurer; F. W. Cunningham, Alfred N. Goldsmith, Virgil M. Graham, O. B. Hanson, L. C. F. Horle, B. J. Thompson, H. M. Turner, A. F. Van Dyck (guest), and H. P. Westman, secretary.

J. R. Carson, Eduard Karplus, B. E. Shackelford, and B. J. Thompson were transferred to Fellow grade and A. M. Braaten, J. H. DeWitt, Jr., J. F. Dreyer, Jr., L. B. Headrick, L. F. Jones, P. A. Loyet, J. B. Moore, and D. F. Schmit were transferred to Member grade.

Fifty-five Associates, one Junior, and eleven Students were elected to membership.

The dates for the 1938 Convention were shifted to June 16, 17, and 18, from the previously announced dates of June 20, 21, and 22. This avoids a conflict with another engineering convention.

Joint Meeting of the Institute and the American Section of the International Scientific Radio Union

The annual joint meeting of the Institute of Radio Engineers and the American Section of the International Scientific Radio Union will be held in Washington, D.C., on Friday and Saturday, April 29 and 30, 1938. This year two full days, instead of the usual one day, will be devoted to the presentation of scientific papers. The Friday meeting will be held at the National Academy of Sciences, 2101 Constitution Avenue. It is expected that the Saturday meeting will be held in the auditorium of the old building of the Department of the Interior, 18th and F Streets, N.W.

Besides the regular two-day program of scientific papers, tentative arrangements are being made for evening meetings on Thursday, April 28, and Friday, April 29. It is expected that the Thursday evening meeting will be a semipopular lecture on a subject of radio interest.

It has been suggested that Friday evening be devoted to an informal dinner and social meeting. Persons desiring to attend such a dinner are requested to notify the committee so that arrangements can be made. The time and place of this dinner will be announced at the scientific meeting Friday morning.

Further announcements concerning these meetings will be made in the final program of abstracts which will be available for distribution about April 15. Information will also be available at the Institute office in New York. Correspondence should be addressed to Mr. S. S. Kirby, National Bureau of Standards, Washington, D.C. The tentative program of titles is given below.

Tentative Program, April 29 and 30

- "Observations on Sky-Wave Transmission on Frequencies Above 40 Megacycles," by D. R. Goddard, RCA Communications, Inc.
- "Regular Characteristics of the Ionosphere Throughout Half a Sunspot Cycle," by N. Smith, T. R. Gilliland, and S. S. Kirby, National Bureau of Standards.
- "Radio Observations in Puerto Rico," by G. W. Kenrick, University of Puerto Rico.
- "Ionosphere Disturbances Associated with Sunspot Activity," by J. H. Dellinger, S. S. Kirby, T. R. Gilliland, and N. Smith, National Bureau of Standards.
- "Investigations of Radio Fade-Outs at the Department of Terrestrial Magnetism," by L. V. Berkner and H. W. Wells, Carnegie Institution of Washington.
- "The American Magnetic Character Figure and Its Application to Communication Problems," by A. G. McNish and H. F. Johnston, Carnegie Institution of Washington.
- "On the Periodicity of Ionosphere Storms," by S. S. Kirby, N. Smith, and T. R. Gilliland, National Bureau of Standards.
- "Possibilities of Ultra-Short Waves for Air Navigation," by F. A. Kolster, International Telephone and Telegraph Company.
- "Photoelectric Measurements of Ultraviolet Solar Intensities in the Stratosphere, Transmitted from Unmanned Balloons," by R. Stair and W. W. Coblenz, National Bureau of Standards.
- "Some Effects of the Absorption of Solar Radiation in the Upper Atmosphere," by O. Wulf, United States Bureau of Chemistry and Soils.
- "Ultra-Short-Wave Transmission and Atmospheric Irregularities," by C. R. Englund, A. B. Crawford, and W. W. Mumford, Bell Telephone Laboratories, Inc.
- "Nonexistence of Continuous Intense Ionization in the Troposphere and Lower Ionosphere," by O. H. Gish and H. G. Booker, Carnegie Institution of Washington.
- "Peak Field Strength of Atmospherics Due to Local Thunderstorms at 150 Megacycles," by J. P. Schafer and W. M. Goodall, Bell Telephone Laboratories, Inc.
- "Radio-Wave Reflections in the Troposphere," by R. C. Colwell and A. W. Friend, University of West Virginia.
- "The Influence of the Focusing Effect of a Negative Grid on Water-Cooled Tube Ratings," by I. E. Mouromtseff, Westinghouse Electric and Manufacturing Company.
- "The Production of Accurate One-Second Time Intervals," by W. D. George, National Bureau of Standards.
- "The Calculation of the Mutual Inductance of Circular Coils Which Are not Coaxial," by F. W. Grover, Union College.
- "Resistance and Permeability Measurements at Ultra-High Frequencies," by P. D. Zottu, RCA Manufacturing Company, Inc.

- "Notes on a Precise Frequency-Control System for Station W1XJ," by J. A. Pierce, Harvard University.
- "An Application of Phase Modulation to the Measurement of Vibration," by F. W. Lee, United States Geological Survey.
- "Electromagnetic-Horn Radiators," by W. L. Barrow, Massachusetts Institute of Technology.
- "Ground Conductivity Measurements in Canada," by J. A. McKinnon, Canadian Broadcasting Corporation.
- "The Exponential Transmission Line," by C. R. Burrows, Bell Telephone Laboratories, Inc.
- "Absolute Sound Measurements," by V. L. Chrisler, National Bureau of Standards.
- "Electromagnetic Waves in Elliptical Hollow Pipes of Metal," by L. J. Chu, Massachusetts Institute of Technology.
- "Note on the Accuracy of Field-Intensity Measurements at Medium Frequencies," by H. Diamond, National Bureau of Standards, K. A. Norton, Federal Communications Commission, and E. G. Lapham, National Bureau of Standards.
- "Static Emanating from Tropical Storms," by S. P. Sashoff, University of Florida.
- The following program has been definitely arranged by the Committee for Thursday evening, April 28.
- 7:30 P.M. Department of Commerce Auditorium, 14th St. south of Pennsylvania Avenue.
- "The Electric Performance of the Electric Eel" (with demonstration), by R. T. Cox, New York University, and C. W. Coates, New York Aquarium.
- "Electromagnetic waves in free space in metal pipes and in dielectric wires." (an experimental demonstration), by G. C. Southworth, Bell Telephone Laboratories, Inc.

Committee Work

ADMISSIONS COMMITTEE

The Admissions Committee met in the Institute office on February 2. Those present were F. W. Cunningham, chairman; Melville Eastham; J. F. Farrington, R. A. Heising, L. C. F. Horle, C. M. Jansky, Jr., E. R. Shute, A. F. Van Dyck, and H. P. Westman, secretary. Two applications for transfer to Fellow grade and four for admission were approved. Of five applications for transfer to Member, three were approved and nine of twelve applications for admission to Member were approved.

ANNUAL REVIEW COMMITTEE

A meeting of the Annual Review Committee was held in the Institute office on January 11 and was attended by A. F. Van Dyck, chairman; D. E. Foster (representing H. A. Wheeler), Raymond Guy (representing J. C. Schelleng), J. V. L. Hogan, D. G. Little (representing J. C. Schelleng), H. F. Olson, B. J. Thompson, H. M. Turner, L. E. Whittemore, J. D. Crawford, assistant secretary, and H. P. Westman,

secretary. The material prepared by the several technical committees reviewing developments in radio during 1937 were edited at this meeting. These reports were published in the March, 1938, issue of the PROCEEDINGS.

BOARD OF EDITORS

On January 13 the Board of Editors met in the Institute office and those present were Alfred N. Goldsmith, chairman; R. R. Batcher, P. S. Carter, J. W. Horton, B. E. Shackelford, K. S. Van Dyke, L. P. Wheeler, L. E. Whittemore, William Wilson, J. D. Crawford, advertising manager; H. M. Stote, assistant editor; and H. P. Westman, secretary. The meeting was devoted to a discussion of both the mechanical and editorial make-up of the PROCEEDINGS.

MEMBERSHIP COMMITTEE

The Membership Committee met in the Institute office on December 17 and those present were F. W. Cunningham, chairman; Howard Chinn, T. H. Clark, I. S. Coggeshall, E. D. Cook, Coke Flannagan, H. C. Gawler, L. G. Pacent, C. R. Rowe, C. E. Scholz, and H. P. Westman, secretary.

A meeting of the Membership Committee was held on March 2 in the office of the Institute. Those present were C. E. Scholz, chairman; Howard Chinn, I. S. Coggeshall, E. D. Cooke, F. W. Cunningham, Coke Flannagan, L. G. Pacent, C. R. Rowe, Bernard Salzberg, and J. D. Crawford, assistant secretary.

NEW YORK PROGRAM COMMITTEE

Austin Bailey, chairman; R. R. Beal, A. B. Chamberlain, Keith Henney, G. T. Royden, J. D. Crawford, assistant secretary; and H. P. Westman, secretary, attended a meeting of the New York Program Committee held in the Institute office on February 9. The meeting was devoted to the preparation of the program for the next few New York meetings.

STANDARDS COMMITTEE

The Standards Committee met in the Institute office on January 28. Those present were L. C. F. Horle, chairman; L. F. Curtis, L. P. Wheeler, William Wilson, and H. P. Westman, secretary. Final action was taken on the report of the Technical Committee on Radio Receivers. This finishes the work of the 1937 Standards Committee.

TECHNICAL COMMITTEE ON ELECTROACOUSTIC DEVICES—ASA

A meeting of the Technical Committee on Electroacoustic Devices, operating under the Sectional Committee on Radio of the American

Standards Association was held in the Institute office on December 17. Those in attendance were Julius Weinberger, chairman; E. D. Cook (representing H. B. Marvin), A. H. Caeser (guest), Frederick Ireland (representing Melville Eastham), J. W. Fulmer, H. S. Knowles, Benjamin Olney, L. J. Sivian, and H. P. Westman, secretary.

On December 20, a meeting of a subcommittee of the above committee was held in the Institute office and attended by Julius Weinberger, chairman; H. S. Knowles, L. J. Sivian, and H. P. Westman, secretary. These meetings were devoted to the preparation of a report on the testing of loud speakers for submission to the American Standards Association.

TECHNICAL COMMITTEE ON TELEVISION

The Technical Committee on Television met on January 26 in the Institute office. Those present were J. V. L. Hogan, chairman; J. L. Callahan, K. B. Eller (representing J. W. Milnor), E. W. Engstrom, P. C. Goldmark (representing, E. K. Cohan), C. W. Horn, D. D. Israel, E. F. Kingsbury, H. M. Lewis, A. F. Murray, B. E. Shackelford (representing C. B. Jolliffe), J. D. Crawford, assistant secretary; and H. P. Westman, secretary. The meeting was devoted to a revision of the annual review report in order to bring the style of presentation into conformance with that employed by the other technical committees in their reports.

Institute Meetings

ATLANTA

C. F. Daugherty, chairman, presided at the February 17 meeting of the Atlanta Section which was held at the Atlanta Athletic Club and attended by twenty-four.

"The Trend in Modern Receiver Design," was the subject of a paper by J. S. Morris of the Morris Radio Service. The general design requirements of receivers intended for various services were first sketched. Receivers for broadcast reception were then considered and it was pointed out that the trend is toward sacrificing some sensitivity and selectivity to attain greater ease in tuning and lessen the possibility of distortion resulting from improper tuning. Automatic tuning systems were then described. The effect of the relatively high output capacitance of metal tubes when used in single-tube tuned-radio-frequency amplifiers, was discussed. There were then considered the problems of all-wave noise-reducing antenna systems and various types of tuning indicators.

BUFFALO-NIAGARA

A meeting of the Buffalo-Niagara Section was held on February 9 at the University of Buffalo. G. C. Crom, Jr., chairman, presided and there were thirty-four present.

H. L. Olesen, assistant general sales manager of the Weston Electrical Instrument Corporation, presented a paper on "Interesting Features Found in Indicating Instruments." The paper was devoted to indicating instruments only and did not consider recording or integrating devices. The first type considered, which is useful for both direct current and low-frequency alternating current, consists of a fixed coil encircling two elements of nonretentive magnetic material. One element is fixed and the other, carrying a pointer, is mounted on a pivot. The shape and position of the elements are so arranged that the like poles of the elements cause movement by repulsion. This type of instrument absorbs a relatively large amount of power. The second type, for direct current only, consists of a pointer mounted on a coil which rotates within the field of a permanent magnet. It is highly sensitive and may be designed to give full-scale deflection on as little as five microamperes. By means of a copper-oxide rectifier it may be applied to the measurement of alternating currents of moderate frequency. In this service its sensitivity is reduced. A third type, known as the dynamometer, consists of a pointer attached to a moving coil the field of which reacts against that of one or two fixed coils. It is useful for both alternating and direct currents. The fourth type, also applicable to direct and alternating currents, is the hot-wire instrument.

It was pointed out that high precision was obtained by the use of extremely small, delicate, and accurately shaped parts. Pointers are made of wire 0.001 inch in diameter. Some are of seamless tubing 0.001 inch thick and 0.012 inch in outside diameter. Some pivots have an end diameter as small as 0.0002 inch. An infinitely small point is, of course, not physically possible. As an interesting contrast, he described the shunt to an ammeter to measure a current of 50,000 amperes. It cost over \$2000 and consumed about $2\frac{1}{2}$ kilowatts of power although it was used with an indicating instrument costing but a few dollars. He then described various features found in voltmeters reading up to a million volts.

Methods of eliminating contact-resistance errors in instruments employing adjustable multiple shunts were described. The application of bridges and rectifiers to meters for special purposes was discussed as well as schemes employing thermocouples and photoelectric cells. A variety of instruments and component parts were displayed.

CHICAGO

On March 4 a meeting of the Chicago Section was held at Fred Harvey's Union Station Restaurant and attended by one hundred and fifty. J. E. Brown, chairman, presided.

"Tube and Circuit News from the Physics Laboratories" was the subject of a paper by J. B. Hoag, professor of physics at the University of Chicago. Dr. Hoag's discussion centered about unique tube and circuit applications as an aid to research in physics. Among these was the use of vacuum tubes in quenching the gaseous discharge in Geiger counter tubes. Another development is the use of electron-beam-deflecting tubes as high-frequency oscillators. Large anode areas are effective for power dissipation and relatively small control elements permit lumped circuit constants at these frequencies. The utility of gaseous or high-vacuum electronic switches was described and included the use of thyratrons and several variations of multivibrator circuits which are free from limitations imposed by deionization time. Recent developments in ionization manometers have resulted in greater dependability of calibration and independence of fluctuations of supply voltages.

CINCINNATI

The February 2 meeting of the Cincinnati Section was held jointly with the local sections of the American Institute of Electrical Engineers and the Illuminating Engineering Society at the Cincinnati Gas and Electric Company auditorium. It was attended by five hundred. Professor Wilson of the department of engineering of the University of Cincinnati introduced Phillips Thomas of the Westinghouse Electric and Manufacturing Company research laboratories who presented a demonstration lecture on "Adventures in Electricity."

Dr. Thomas demonstrated and discussed an electrostatic air filter, uses for polarized light, a model of an atom-smashing device developing 400,000 volts, a card sorter using light-operated relays, an infrared-ray burglar alarm, and other interesting devices.

The February 18 meeting was a joint meeting of all of the societies affiliated with the Cincinnati Technical and Scientific Societies Council. There were seven hundred present and the meeting was held in the Taft auditorium with Thornton Boggart, president of the Engineers Club of Cincinnati, presiding.

"Traffic in the City of Tomorrow," was the subject of a paper by Miller McClintock, director of the Bureau for street-traffic research of Harvard University and of the traffic audit bureau of New York

City. Dr. McClintock gave a brief history of the growth of automobile travel stressing the point that we are still trying to use highways designed for slow-moving traffic. The difficulties of educating the public to use these highways with consideration of their limitations was then discussed. He pointed out that there were four general conditions which result in accidents. The collisions are between vehicles traveling in opposite directions, vehicles driven at right angles to each other, moving vehicles and parked vehicles or other obstructions located along the right of way, and vehicles traveling in the same direction but at different speeds. He estimated that 98 per cent of all accidents could be avoided by the elimination of crossings, the separation of travel in opposite directions by the erection of physical barriers, the elimination of parking and unloading along the highway, and the proper segregation of vehicles traveling in the same direction but at different speeds.

EMPORIUM

The February 10 meeting of the Emporium Section, which was attended by sixty, was held in the American Legion Rooms and presided over by A. W. Keen, chairman.

A paper on "Electrical Measuring Instruments," was presented by H. L. Olesen of the Weston Electrical Instrument Corporation. This paper is summarized in the report of the February 9 meeting of the Buffalo-Niagara Section. The paper was discussed by Messrs. Abbott, Baldwin, Bowie, Campbell, Ratchford, and Stringfellow.

A special dinner-meeting of the Emporium Section was held on February 28 at the Hotel Warner and attended by seventy-five. A. W. Keen, chairman, introduced B. G. Erskine, president of the Hygrade Sylvania Corporation who served as toastmaster. The speaker of the evening was J. W. Van Allen, general counsel of the Radio Manufacturers Association.

Judge Van Allen pointed out the need for more science in government and indicated that constant experimentation which fails would as surely lead to bankruptcy in government as it does in business. He called upon engineers to broaden their interests by reading and studying in other fields. As an example, he recalled that Samuel F. B. Morse, a pioneer in telegraphy, was considered one of the best pictorial artists in America during his time.

MONTREAL

The Montreal Section met on January 26 in the Engineering Institute of Canada auditorium. A. M. Patience, chairman, presided and there were one hundred and fifty present.

"Practical Aircraft Navigation and Communication" was the subject of a paper by W. P. Lear, president of Lear Developments. It dealt with recent developments in radio compasses. The requirements for a successful one were that there be no 180-degree ambiguity, the bearing should be independent of phasing, design should permit interchangeability of tubes and loops, frequency calibration should be accurate and should cover bands from three to six megacycles, from 500 to 1500 kilocycles, and from 195 to 500 kilocycles; it should be carrier-operated and thus independent of modulation, it should provide a constant left or right visual indication as well as an aural null indication, it should be capable of receiving either telephone or continuous-wave signals, an output of from 250 to 300 milliwatts should be provided to permit operation of as many as four to six headsets, remote control should be incorporated, either a fixed or rotatable loop should be usable, and the power consumption should not exceed 35 to 50 watts. The paper was discussed by Messrs. DeNiverville, Lauruk, and Rushbrook.

The first meeting of the Montreal Section in February was held on the 9th at the Engineering Institute of Canada auditorium. There were fifty-eight present and Chairman Patience presided.

W. P. Dobson, chief test engineer of the Ontario Hydro-Electric Power Commission, presented a paper on "Testing Approvals and Interpretation of the Canadian Electrical Code with Special Reference to Radio." He presented first a brief historical outline of the Ontario Hydro-Electric Laboratory. Its functions were indicated as purely that of testing and issuing approvals for appliances based on the specifications incorporated in the Canadian electrical code. The object of such approvals is to minimize the danger of shock and fire. Recently the question of interference to radio reception has become important in view of the Canadian Broadcasting Act. The paper was discussed by Messrs. Beauchamps, Hammond, Hunt, Oxley, Patience, Sillitoe, and Vennes.

The February 24 meeting was attended by two hundred and was held jointly with the Engineering Institute of Canada in the Bell auditorium. C. V. Christie, professor at McGill University, presided. J. O. Perrine, associate editor of the *Bell System Technical Journal*, presented a paper on "Words, Waves, and Wires."

In it, Dr. Perrine discussed the problems of electrical communication. He demonstrated a high-fidelity loud-speaker system, which was used in conjunction with a high-fidelity microphone as a public-address system, for the presentation of the paper. The effect on the reproduc-

tion of speech by the insertion of filters was described and demonstrated. A high-quality program line between Montreal and Toronto was used for demonstration purposes as was an ordinary circuit to Chicago via New York, This line was approximately 3000 miles long and was used to demonstrate effects in the transmission of speech.

NEW YORK

The regular New York meeting of the Institute was held in the Engineering Societies Building on March 2. H. M. Turner, a member of the Board of Directors, presided in the absence of President Pratt.

The first paper was on "A Bearing-Type High-Frequency Electrodynamometer" by H. R. Meahl of the General Electric Company, Schenectady, N.Y. It covered a jewel-bearing oscillating-ring electrodynamic instrument. Its method of operation and calibration was described. Data and calculations were presented to show that it may be employed as a standard for current measurement at high frequencies. Frequency characteristics of three thermocouple ammeters were obtained by comparison with the electrodynamic ammeter.

The second paper by J. B. Sherman of the RCA Manufacturing Company, Radiotron Division, was on "An Audio-Frequency—Response-Curve Tracer." A cathode-ray oscillograph tube having a long-persistence screen was used as the indicating device. The equipment to be measured had its output connected to one pair of deflecting plates. By electrical means, an oscillator, connected to the input of the device under test, is made to traverse the audio-frequency spectrum and the voltage applied to the other deflecting plates is controlled by the frequency of the oscillator. Thus, as the oscillator sweeps through the audio-frequency spectrum, the response-frequency graph of the equipment under test is drawn on the cathode-ray tube screen. The long-persistence screen permits the entire graph to be displayed for many seconds.

The meeting was attended by two hundred fifty.

PITTSBURGH

R. T. Gabler, chairman, presided at the February 15 meeting of the Pittsburgh Section held at the Carnegie Institute of Technology. There were forty present.

"Teledynamic Control by Selective Ionization and the Application to Radio Receivers" was the subject of a paper presented by C. N. Kimball of the license division laboratories of the Radio Corporation of America. A low-power self-rectified oscillator which may be tuned to about 200 or 300 kilocycles is operated from the regular alternating-

current power line. The radio-frequency output is transmitted through the wiring in the room or building to the receiver to be controlled. By means of a gaseous-discharge tube which requires no stand-by power, a relay may be operated to supply power to the receiver. The transmitter operates only when its plate is positive which is half the time. During the remainder of the alternating-current cycle when its plate is negative, it is inoperative. Similarly, by adjusting an alternating-current bias on the gaseous-discharge tube, it can be made to operate only on one half of the alternating-current cycle. Thus by reversing the alternating-current input to the oscillator, two channels are obtained for each transmission frequency. With two transmission frequencies and interlocking relays, ten control functions may be performed. A demonstration setup permitted turning the receiver on or off, increasing or decreasing the volume output, and the selection of any one of six preset channels. The paper was discussed by Messrs. Gabler, Krause, Place, Shreve and others.

SAN FRANCISCO

A joint meeting of the San Francisco Sections of the Institute and the American Institute of Electrical Engineers was held in the Bell Telephone and Telegraph Company auditorium, on February 18. There were ninety-five present and R. O. Brosemer, chairman of the local American Institute of Electrical Engineers section, presided.

A paper on "What Mathematics Has Done for the Communication Engineer" was presented by T. C. Fry, research mathematician of Bell Telephone Laboratories. In it, Dr. Fry stressed the improvements in long-distance telephony resulting from mathematical researches of the past quarter century. Vacuum-tube amplifiers make possible the transmission of useful quantities of electrical energy through great distance and the use of electrical networks, such as equalizers, regulators, and filters, permit the energy to produce intelligible sound. Improvements in electrical networks have been chiefly the result of mathematical research. The development of these networks from the early type of simple low-pass filter to the intricate band-pass filters using piezoelectric crystals as elements was outlined.

SEATTLE

On February 25 a meeting of the Seattle Section was held at the University of Washington with A. R. Taylor, chairman, presiding. There were one hundred fifty present.

"Snow Static" was the subject of a paper by Marcus O'Day, professor of electrical engineering at Reed College. Interference caused by

snow static in aircraft radio reception must be eliminated or greatly reduced to improve the reliability and safety of air travel. This form of interference was described and its effect on radio reception demonstrated by means of a static machine. A detailed description of the research in a "flying laboratory" plane was given and illustrated by motion pictures. The problem appears to consist mainly in discharging the accumulated static charge on the plane without corona. The best solution so far obtained is the use of a trailing wire connected to the plane through a suppressor resistor. Further reduction in noise was obtained by using an electrostatically shielded loop antenna for reception. Such an antenna was demonstrated.

TORONTO

On February 14 the Toronto Section met at the University of Toronto with W. H. Kohl, chairman, presiding. There were seventy-one present.

W. C. Little, regional engineer of the Canadian Broadcasting Corporation, presented a paper on "Technical Operations of the Canadian Broadcasting Corporation Network." He pointed out that the first link between two stations in Canada was established in 1923 between stations in Montreal and Ottawa. In 1928, the first Canadian transcontinental chain came into existence. The Canadian Broadcasting Corporation is now using 7000 miles of wire lines and serves between thirty-five and seventy stations. Wire links are available with the National Broadcasting Company, the Columbia Broadcasting System, the Mutual Broadcasting System, and the Michigan Broadcasting Network in the United States. In addition, a high-frequency receiving station is maintained near Ottawa to pick up programs from the British Broadcasting Corporation for rebroadcasting. This station uses rhombic antennas for reception. Descriptions were given of a number of stations, notably CBR at Vancouver, CBO at Ottawa, CBF at Montreal, and CBL at Toronto. Material was presented on the acoustical treatment of studios, types of antennas used, and the repeaters necessary in the long-wire circuits between stations. Uses are made of facilities supplied by two telegraph companies and a number of telephone systems.

On February 22 a meeting was held jointly with the local section of the American Institute of Electrical Engineers at the University of Toronto. There were thirty-seven present, and Chairman Jones of the American Institute of Electrical Engineers Section presided.

J. O. Perrine, associate editor of the *Bell System Technical Journal*,

presented a paper on "Waves, Words, and Wires." A summary of this paper is given in the report on the February 24 meeting of the Montreal Section.

WASHINGTON

The Washington Section met on February 14 in the Potomac Electric Power Company auditorium. E. H. Rietzke, chairman, presided and there were one hundred and twenty present.

N. P. Case of the Hazeltine Service Corporation presented a paper on "Modern Broadcast Receiver Design." In addition to discussing general design problems, considerable attention was given to various means of tuning receivers by remote control. The advantages and limitations of different methods were given. The paper was discussed by Messrs. Biser, Redington, Rietzke, Wallace and others.

Personal Mention

V. H. Fraenckel, formerly with the Electronic Tube Company, has joined the vacuum-tube engineering department of the General Electric Company at Schenectady, N. Y.

Alex Gorbunoff has joined the staff of Stromberg-Carlson Proprietary, Limited, of Sydney, Australia, having formerly been with Seeburg Radio Corporation of Chicago.

G. J. Maki is now in the engineering department of the National Broadcasting Company at Chicago, Ill.

E. C. Miller of the National Broadcasting Company has been transferred from New York to Hollywood, Calif.

Previously with the Northern Electric Company, G. E. Sarault has become chief engineer of CBF in Vercheres, Quebec.

W. A. Shane has been transferred from CRCT to CBL at Hornby, Ontario, as assistant chief engineer.

R. F. Shea, formerly with Fada Radio and Electric Company is now a member of the radio engineering department of the General Electric Company, in Bridgeport, Conn.

Formerly with the RCA Manufacturing Company at Camden, D. C. Trafton has become a radio engineer for the Army Air Corps, at Washington, D. C.

Previously with Tropical Radio Telegraph Company at New Orleans, L. P. Williams has become district manager for Mackay Radio and Telegraph Company in Boston, Mass.

Correction

Karl G. Jansky, "Minimum Noise Levels Obtained on Short-Wave Radio Receiving Systems," *Proc. I.R.E.*, vol, 25, pp. 1517-1530; December, 1937. Page 1520, footnote 5.

In line 1 of the note

read "eighteen" for "fifteen"

In line 6

read "the 10,000-cycle effective band required for double side-band operation" for "5000-cycle band"

In line 6

read "40.8" for "43.8"

In line 7

read "an 18" for "a 15"

In line 9

read "22.8" for "28.8"

In line 11

read "21.8" for "27.8"



TECHNICAL PAPERS

THE DEVELOPMENTAL PROBLEMS AND OPERATING
CHARACTERISTICS OF TWO NEW ULTRA-HIGH-
FREQUENCY TRIODES*

BY

WINFIELD G. WAGENER

(Research and Engineering Department, RCA Manufacturing Company, Inc., Harrison, New Jersey)

Summary—Large values of power are difficult to obtain in the ultra-high-frequency region. At the limiting frequencies it is increasingly more difficult to find vacuum tubes that will deliver such power and perform efficiently. The principal factors that affect the design and performance of the tubes are those involving the electrical circuit, the size requirements for the power desired, and the transit time of the electrons within the evacuated space of the tube.

The design principles that result from a consideration of these factors have been used in the development of two new ultra-high-frequency triodes. A triode capable of delivering approximately 700 watts at 100 megacycles is described. This tube, which is cooled by water and air, is capable of operation as a neutralized power amplifier up to 200 megacycles with an output of approximately 500 watts. A second triode is described which is a radiation-cooled glass tube with a 300-watt plate-dissipation rating. Normal efficiency is obtained up to 40 megacycles and operation as a neutralized power amplifier is possible up to 100 megacycles. The efficiency at 100 megacycles is approximately 60 per cent.

LARGE output power is obtained only with increased difficulty at the higher frequencies in the region usually described as the ultra-high-frequency portion of the radio spectrum. These difficulties begin to be readily evident above 30 megacycles, approximately, or at wavelengths below 10 meters. In considering these difficulties, it will be more convenient to speak in terms of the wavelength because the wavelength figures can be easily grasped and the values are readily correlated to the possible sizes of electrical circuits and tubes.

The problem of obtaining large power at very short wavelengths exists because the demands of three simple requirements can be made compatible only within limited conditions. In the first place, to generate power at a very short wavelength the electrical circuits should be smaller than one wavelength. It follows that the vacuum tube must be even smaller than the complete electrical circuit, and, hence, should be quite small compared to a wavelength. However, a second require-

* Decimal classification: R330. Original manuscript received by the Institute, August 23, 1937. Presented before Silver Anniversary Convention, New York City, May 11, 1937.

ment follows that in order to generate large power the equipment must be of large size to handle such power. Thus, large clearances are required to avoid voltage breakdown; large conductors are required to carry the currents; large areas are required to dissipate the heat losses; and in the case of stored circulating energy in the resonant circuits, a large volume of space is necessary. The third requirement is that the distance traveled by the electrons must be short in order that the time spent by an electron in flight from filament to grid and plate

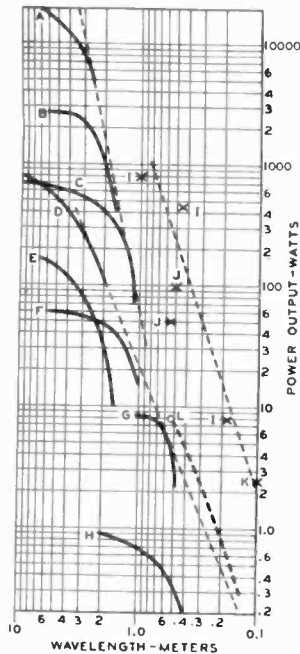

Fig. 1—Power output of vacuum-tube oscillators at short wavelengths.

shall be a small part of the very short time period of a single ultra-high-frequency oscillation. Such close spacings are very difficult to obtain in tubes of any appreciable size. Thus, very short wavelengths require small tubes with close spacings, and large power requires large tubes. The extent to which these opposite demands are met in individual tubes depends on the purpose for which the tube was developed. The emphasis may have been placed on the power aspect, or on the limiting wavelength feature, or it may have been directed to the two simultaneously, in which case the manufacturing difficulties would probably have been considerably augmented.

The degree to which this problem has been met today in commer-

cially available tubes of American manufacture can be seen in Fig. 1. Each solid curve shows the power output that can be obtained from a particular tube type operating as a self-excited oscillator at the limiting wavelengths. In the various power classifications are shown only tubes of the better types and those whose high-frequency performances have been published.

The highest three curves, *A*, *B*, and *C*, represent water-cooled tubes of the negative-grid design. The broken line marking their envelope indicates the present location of the practical limit of such tubes. Curves *D*, *E*, *F*, *G*, and *H* are for air-cooled tubes of the negative-grid design. A second broken line indicates the present location of the practical limit of this class of tubes. The lowest curve *H* is shown for completeness and applies to a receiving tube whose performance would be extended to higher powers and also to lower wavelengths if it were rated as a power tube.

As these curves show only power output as oscillators, several important features are not evident. The curves give no idea of the tube efficiency or relative costs. Most important of all they do not indicate the frequency limit at which it is no longer possible to operate the tube as a power amplifier due to circuit-construction difficulties.

To complete the picture of high-frequency power oscillators, some of the best published experimental results with tubes designed for the Barkhausen-Kurz oscillations and with magnetrons have been included. The broken line beginning with tube *L* is the present limit of the Barkhausen-Kurz type of tube as presented by C. E. Fay and A. L. Samuel.¹ The various best experimental magnetron tubes are shown by crosses with a broken line to indicate their trend. The *I* tubes were described by O. Pfetscher and W. Puhlman,² the *J* tubes by G. R. Kilgore,³ and the *K* tubes by E. G. Linder.⁴

The magnetron and the Barkhausen-Kurz type of oscillation are known to be inherently poor in frequency stability. Even the conventional type of tube is unsatisfactory for most communication purposes when used alone as a self-oscillator. For all types of radio communication it is necessary to vary the power output of the signals or make

¹ C. E. Fay and A. L. Samuel, "Vacuum tubes for generating frequencies above one hundred megacycles," *Proc. I.R.E.*, vol. 23, pp. 199-212; March, (1935).

² O. Pfetscher and W. Puhlmann, "Über Habann-Generatoren Grosser Leistung für Ultrakurzwellen," *Hochfrequenztech. und Electroakustik*, vol. 47, pp. 105-115; April, (1936).

³ G. R. Kilgore, "Magnetron oscillators for the generation of frequencies between 300 and 600 megacycles," *Proc. I.R.E.*, vol. 24, pp. 1140-1157; August, (1936).

⁴ E. G. Linder, "Description and characteristics of the end-plate magnetron," *Proc. I.R.E.*, vol. 24, pp. 633-653; April, (1936).

some change in the signal constancy. It is very difficult to make such variations directly without severe reaction on the generator of the radio-frequency power. If this generator is a self-oscillator, it will react directly on the desired frequency of the oscillations. This fact has resulted in the general use of power amplifiers to obtain the frequency stability needed for radio communication. The need for power amplifiers and frequency control is even greater at the ultra-high frequencies.

As a guide to future developments it is almost a basic fact that for communication purposes radio-frequency power must be generated by means of power amplifiers in which the frequency control is separate from the power stage and the modulating or signaling control. The only practical power amplifier known today is that employing the con-

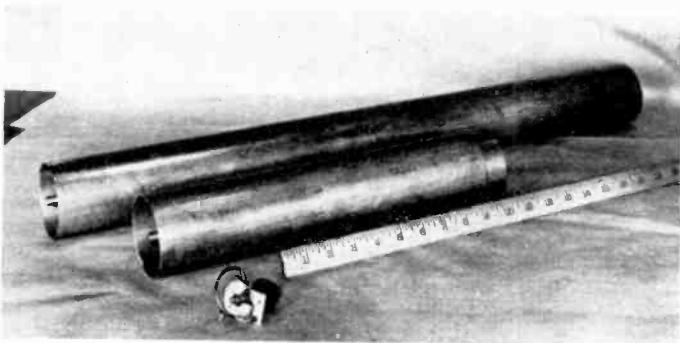

Fig. 2—Electrical circuits resonant at 1.5 meters.

ventional type of tube in which the signal is supplied to the isolated grid circuit and power is taken from the plate circuit. For this reason the present line of attack is to extend the use of conventional power amplifiers to higher and higher frequencies.

As was noted earlier, the extension of the vacuum tube to higher frequencies brings in several considerations: the physical size as required by the limiting wavelength of operation of the tube and its adjacent circuits, the physical size necessary for the power to be controlled, and the problems of electron behavior at such very high frequencies.

The significance of the wavelength requirement with respect to the physical size of circuits can be seen readily by looking at Fig. 2. Three circuits resonant at 1.5 meters are shown. The coil-and-condenser circuit consists of $2\frac{1}{2}$ inches of wire and a quarter of the capacitance of the midget variable condenser. The transmission-line circuits on the other hand can be a half wavelength long, as in the case of the line open at two ends, or a quarter of a wavelength long with one end open

and one end closed. For 1.5 meters the former is 29 inches long and the latter $14\frac{1}{2}$ inches long. Furthermore, the diameter of the line circuits can be varied freely with no effect on the total length. For instance the inner rod might be increased in diameter until the clearance to the outer tubing is the same as between the plates in the midjet condenser, but the lines would still be 29 and $14\frac{1}{2}$ inches long, respectively. It seems wise to avoid lumped-capacitance and lumped-inductance effects and strive to attain distributed constants as in the transmission line.

In tube design this means that the size of the lead and support members and the spacing between them should approach the size of the tube electrodes and the spacing between them. In this manner the tube can approach the ideal of being a section of a transmission line. The simple solution is complicated by the fact that the input and output circuits are not in themselves simple but often require irregularities such as the neutralization circuits or increased clearances to avoid voltage breakdown in air outside the tube. However, if the design of the leads and electrodes within the tube itself is made to approach a transmission line it will greatly assist the problem of building larger portions of the complete electrical circuits outside the tube.

The requirements necessary for handling large electrical power in small physical sizes are well known. The insulation must be excellent, the current losses as low as possible, and the most effective means of cooling must be employed to dissipate the heat developed by the remaining losses. The whole must be rugged with respect to temperature in order to permit the high temperatures necessary to transfer large amounts of heat. In a vacuum tube these general requirements must be met in addition to those peculiar to the basic electronic action of vacuum tubes. The cathode must maintain its emission in spite of the unusually severe ion and electron bombardment that ultra-high-frequency applications cause. The grid must almost touch the cathode and yet it must not emit primary electrons or be permitted to develop surface conditions favoring the emission of a large number of secondary electrons. The space-current electrons must be confined to their proper paths to the plate or damage to the tube will result. Finally, the whole action must not impair the maintenance of the vacuum. In a vacuum tube the parts must be held rigidly in space without support inside the active area of the electrodes. Insulation losses rise rapidly with temperature, increase as the square of the voltage and increase rapidly with the frequency. Thus a structural problem is presented in which the difficulty of applying insulating supports is increasingly greater at the very high frequencies.

A third requirement which is new in tube design is imposed by the time taken by an electron in transit from filament to grid and plate. Although the transit time may be only two thousandths of a millionth of a second it represents $\frac{1}{3}$ of the time period of a 3-meter oscillation. This must be taken into account in the tube design. A considerable amount of work has been done to evaluate the effects of the time of transit of the electron in vacuum tubes,^{5,6,7} Unfortunately most of this work has been directed to the problem of the class A amplifier rather than that of the class C power amplifier. It is of value in indicating the type of effect to be found in the class C amplifier. However, in the latter case it does not give the correct magnitude and importance

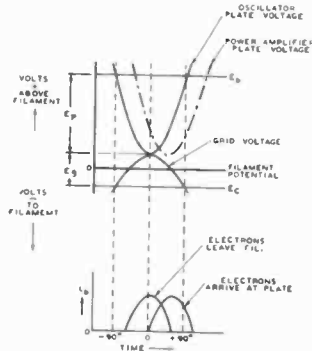

Fig. 3—Typical voltages and plate current in class C oscillators and power amplifiers at ultra-high frequencies.

of the transit-time effects because the electron currents flow in intermittent pulses instead of the relatively steady streams found in the class A amplifier.

The importance of the time of transit of an electron can be appreciated by looking at the curves of instantaneous values of plate voltage, grid voltage, and plate current within a tube during a radio-frequency cycle as shown in Fig. 3. As the grid voltage swings positive, the electrons leave the filament in proportion to the grid voltage in the usual manner. Thus a pulse of electrons is released as indicated, in time phase with the grid voltage. The electrons must then be accelerated under the action of the grid voltage from a standstill at the filament to a finite velocity as they shoot through the grid mesh into

⁵ W. R. Ferris, "Input resistance of vacuum tubes as ultra-high frequency amplifiers," *Proc. I.R.E.*, vol. 24, pp. 82-107; January, (1936).

⁶ D. O. North, "Analysis of the effects of space charge on grid impedance," *Proc. I.R.E.*, vol. 24, pp. 108-136; January, (1936).

⁷ F. B. Llewellyn, "Notes on vacuum tube electronics at ultra-high frequencies," *Proc. I.R.E.*, vol. 23, p. 112; February, (1935).

the field of the plate voltage. The flight across to the plate is made more quickly because of the finite velocity on leaving the grid, and because of the action of the somewhat higher plate voltage in sustaining or increasing this velocity. But, due to the relatively long time necessary to accomplish this acceleration and movement, the electrons arrive at the plate considerably later in the radio-frequency cycle as indicated.

In a conventional oscillator it is practically impossible to shift the phase of the plate voltage with respect to the grid voltage. This follows logically from the fact that the radio-frequency grid and plate voltages are obtained directly from the same resonant circuit. It can be seen easily from Fig. 3 that the electrons do not arrive at the plate when the plate voltage swings down to low values. Actually they arrive later when the plate voltage has risen to large values. The energy given up by the electrons at the plate is the total of the work done on them by the voltages present while they are in flight. In this case it is represented closely by the voltage of the plate at the time of arrival. Thus it can be seen that the electrons strike the plate with high energy and cause excessive losses which result in lower plate-circuit efficiency.

In the power amplifier it is fortunate that due to the separation of the output and input circuits the phase of the plate voltage can be adjusted independently of the applied grid voltage. The down swing of the plate voltage to low values can be shifted so that the electrons in their flight to the plate are acted on by lower voltages and thus strike the plate with much less energy. The plate loss is thus made lower and approaches that of a low-frequency power amplifier. That the plate loss is not as low is due to the presence of the electrons in the grid-to-plate space for a larger fraction of the radio-frequency cycle. Because the plate voltage becomes rapidly higher each side of its minimum down-swing value, the total energy delivered to the electrons is greater. Thus, the action is similar to low-frequency operation in which the current pulse is permitted to flow for a greater portion of the cycle.

This falling off of plate-circuit efficiency with transit time for oscillators or power amplifiers follows a definite generalized curve reproduced in Fig. 4. The index of transit time used is the calculated time expressed as a portion of a radio-frequency cycle that an electron requires to travel from filament to grid under the action of the peak grid voltage. As this time represents by far the greater fraction of the total time of flight to the plate and is something definite and calculable it was chosen for the purpose. The portion of the cycle represented by this transit time can be considered as an angle of θ degrees, where the full period is 360 degrees. Fig. 4 shows that the output of an oscillator

falls to zero when θ becomes 60 degrees, or $\frac{1}{6}$ of the time period of the radio-frequency cycle. The case of the power amplifier is quite interesting, however, and indicates that much better efficiency can be obtained. Haeff of the RCA Radiotron research and engineering department was among the first to point out this difference between power amplifiers and oscillators and he has given the approximate location of the power-amplifier curve. The better efficiency and greater output of tubes acting as power amplifiers gives additional hope of breaking through the oscillator limiting lines of Fig. 1 which seem to form the present practical limit of power obtainable at ultra-short wavelengths.

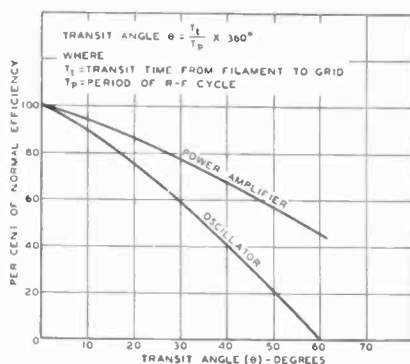

Fig. 4—Changes in plate-circuit efficiency as a result of electron-transit time.

Another cause of low output in transmitting tubes at very high frequencies is the opportunity that some electrons have to stray out of the filament-plate region. These electrons shoot out of the open ends of the plate and take a circuitous path before they arrive back at the plate again. On the way they are very apt to bombard the glass bulb walls and release secondary electrons.⁸ The secondaries return to the plate in their stead. Obviously these paths require long transit times. The effect of such long transit-time electrons and bulb effects is to destroy the desired shape of the plate-current pulse and make it much less efficient. Fig. 5 shows the probable appearance of such a pulse with a tail of long transit-time electrons. For comparison the same pulse is shown as it would appear if such electrons were not allowed to stray off the beaten path. The pulses are drawn to have the same direct-current component. But note that the alternating-current fundamental

⁸ H. C. Thompson, U. S. Patent No. 2,035,003. M. Benjamin, C. W. Cosgrove, and G. W. Warren, "Modern receiving valves: Design and manufacture," *Jour. I.E.E.*, vol. 80, pp. 401-439; April, (1937).

component is much reduced. The output of the tube for the same input will then be reduced to about 75 per cent and the resulting overheating of the tube and bombardment of parts other than the plate may reduce its useful life very considerably.

The realization of the importance of these design requirements has aided greatly in the development of new tubes for ultra-high frequencies. These principles have been incorporated in a new triode, the RCA type 888. It is a small water-cooled triode whose size has been reduced as much as possible consistent with the power desired. The close spacing of the electrodes has been attained to make the performance consistent with the wavelengths at which resonant circuits may be built around the tube^{9,10}. The tube is pictured in Fig. 6 complete with

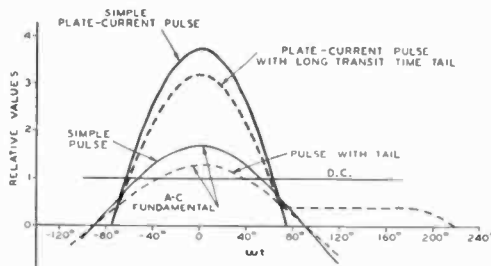

Fig. 5—Probable distortion of a pulse of plate current due to long-transient-time electrons.

water jacket. A sectional cut of the tube shows the internal structure. The tentative ratings for class C telegraphy for the RCA-888 follow:

Filament voltage	11.0 volts
Filament current	24.0 amperes
Amplification factor	30
Direct plate voltage	3000 volts, maximum
Direct grid voltage	-500 volts, maximum
Direct plate current	400 milliamperes, maximum
Direct grid current	100 milliamperes, maximum
Plate input	1200 watts, maximum
Plate dissipation	1000 watts, maximum

A companion tube, the RCA-887, has also been developed which has an amplification factor of 10.

The size and arrangement of the parts of the tube permit the construction of electrical circuits for wavelengths of the order of 1.25 meters. The total length of the grid structure out to a point of external contact is about 1/10 of a meter. The full length from the top of the filament to the outside lead is also about 1/10 of a meter. In each case the leads are essentially a continuation of the electrode itself. The

⁹ I. E. Mourontseff and H. V. Noble, "A new type of ultra-short-wave oscillator," *Proc. I.R.E.*, vol. 20, pp. 1328-1344; August, (1932).

¹⁰ John Liston, "Developments in the electrical industry during 1933," *Gen. Elec. Rev.*, vol. 37, p. 37.

diameter of the enclosing glass cylinders has been kept very small in order that the inductance of the leads will be small due to their proximity to the outside circuit. The contact to the plate may be made di-

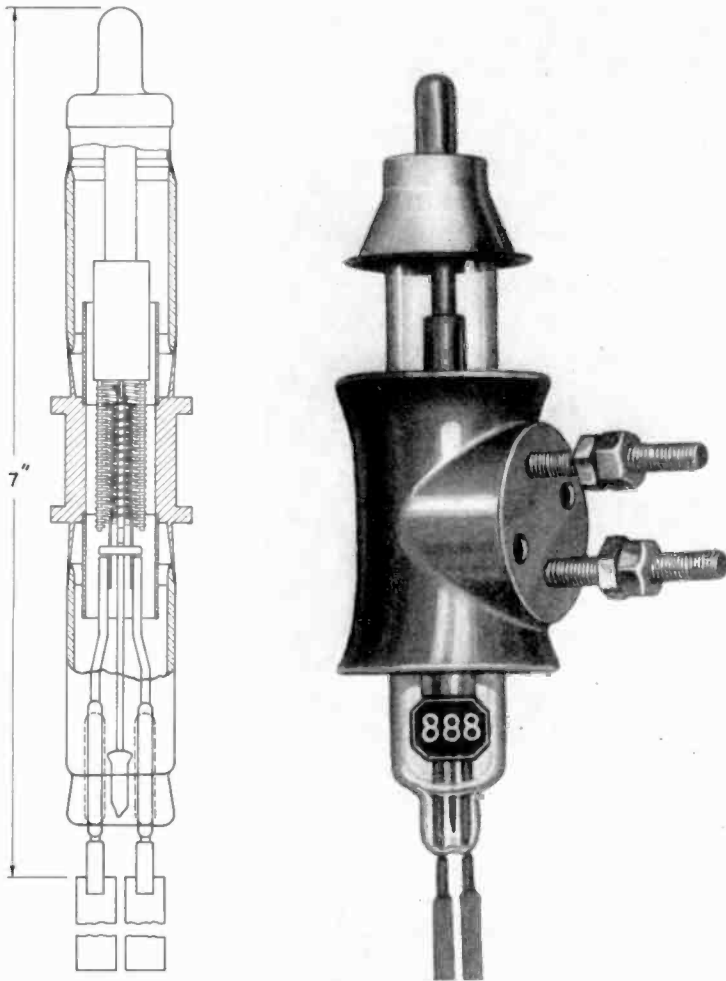

Fig. 6—RCA type 888, complete tube and sectional cut of tube alone.

rectly without considering lead length since it is part of the outside envelope of the tube. The water jacket is soldered solidly to the plate and is an integral part of the tube. Thus, each electrode and its lead are fairly close to the ideal arrangement, a section of a transmission-line circuit.

The copper plate, though it is only one inch long and less than an inch in diameter, will dissipate one kilowatt easily due to the water-cooling. The cathode is a pure tungsten filament, which is the most rugged emitter known, and the grid is of tantalum. No internal supporting insulation is employed and the filament and grid are self-supporting. The glass portion of the envelope thus becomes the only insulation. In order for the tube to withstand continuous operation at full input and full voltage in the neighborhood of 1.25 meters, the glass has to be shielded both internally and externally to avoid the formation of strong voltage gradients. In meeting the requirement of low

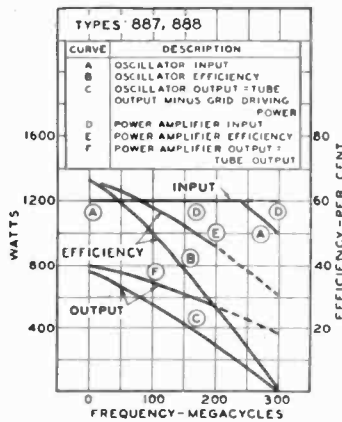

Fig. 7—High-frequency performance and input ratings of RCA type 888.

inductance in the leads, large diameter leads were employed, which also provide sufficient surface area to carry the heavy charging currents.

The electronic requirements with respect to transit time have been met by allowing only 0.060 inch clearance between the grid and the filament and 0.090 inch between grid and plate. No electrons can escape from the filament to plate region because the ends of the anode are essentially closed by means of the low-potential solid ends of the grid and filament. If an electron should slip past the solid ends of the grid or filament, it will meet a strong directing field produced by the extensions of the plate and will be drawn quickly to them.

In Fig. 7 the high-frequency rating and performance curves are shown as a function of frequency. These curves check the general-efficiency-versus-transit-angle curves shown in Fig. 4. The power-amplifier curve has been tested only to 1.5 meters. The design of the circuits becomes the principal problem in this region, and it is felt

that with time and more demand circuits can be built to develop the latent possibilities of this tube as a power amplifier down to one meter and below.

Fig. 8 shows a laboratory push-pull oscillator employing two of these tubes on 3.3 meters. 1100 watts of power is being dissipated in the bank of eight 300-watt lamps.

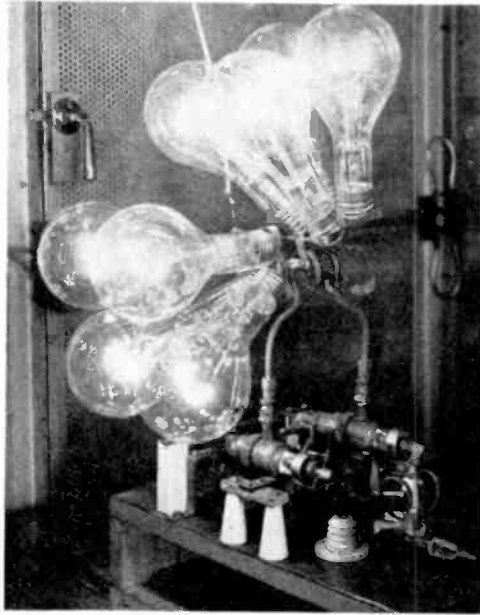

Fig. 8—90-megacycle (3.3-meter) push-pull oscillator employing two RCA-888's.

These same design principles have also been applied to a 300-watt air-cooled triode, the RCA type 833. It demonstrates again the benefit to be derived from proper high-frequency design. Fig. 9 is a photograph of the completed tube, and of the unique filament base and mount assembly¹¹. The mount carrying the filament and grid structures is built directly on the filament lead posts. Those posts are sealed directly into a molded glass dish or flare¹². The plate is of tantalum and is self-supporting from its short and rugged lead post. The only internal supporting insulation is between grid and filament and this is designed to have a sufficiently long leakage path for the low radio-frequency

¹¹ D. K. Wright, "New design of high-wattage incandescent lamps," *Gen. Elec. Rev.*, vol. 35, pp. 532-534.

¹² Howard Scott, "Recent developments in metals sealing into glass," *Jour. Frank. Inst.* vol. 220, pp. 733-754, (1935).

voltage present. The grid lead is brought out the top of the tube after the molded flare is sealed to the bulb. This construction permits the shortest possible electrode leads consistent with permissible temperatures of the glass seals. The over-all length of the tube is $8\frac{5}{8}$ inches.

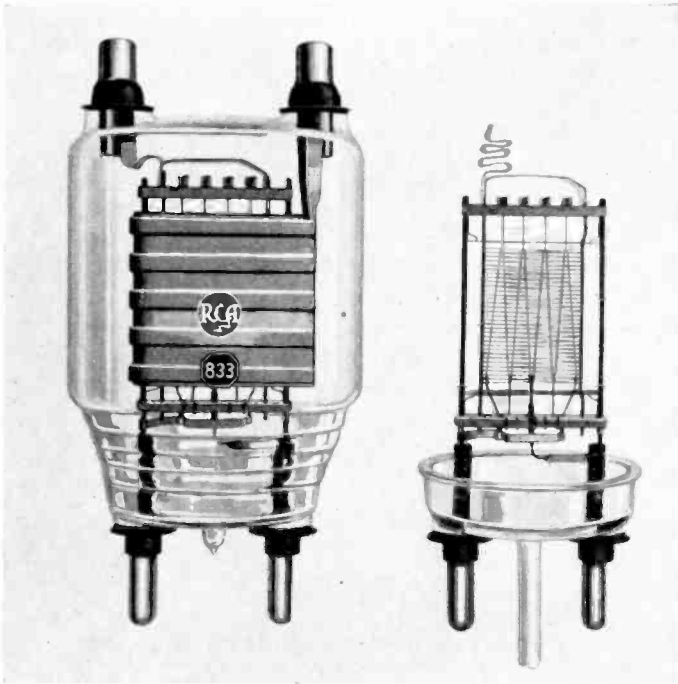

Fig. 9—RCA type 833 and mount assembly before sealing into bulb.

The tentative ratings of the RCA-833 for class C telegraphy are as follows:

Filament voltage	10.0 volts
Filament current	10.0 amperes
Amplification factor	35
Direct plate voltage	3000 volts, maximum
Direct grid voltage	-500 volts, maximum
Direct plate current	500 milliamperes, maximum
Direct grid current	75 milliamperes, maximum
Plate input	1250 watts, maximum
Plate dissipation	300 watts, maximum

Fig. 10 shows the high-frequency performance and rating curves for the RCA-833. Normal efficiency can be maintained easily up to 40 and 50 megacycles. Operation as a neutralized power amplifier at 90 megacycles (3.3 meters) has been obtained. The plate-circuit efficiency obtained at the 90-megacycle test was 60 per cent, a rather high value for an air-cooled tube at such frequencies.

The oscillator output curves of the RCA-887 and RCA-833 are reproduced as curves *C* and *D* of Fig. 1. The water-cooled tube is thus seen to extend the lower portion of this group of tubes into shorter wavelengths, and the tube offers the added advantage of permitting the construction of neutralized power-amplifier circuits in a large region not penetrated by other tubes of comparable or greater size. The air-cooled tube extends its group upward as an oscillator about fourfold. As a power amplifier it offers efficient amplification with proportionally in-

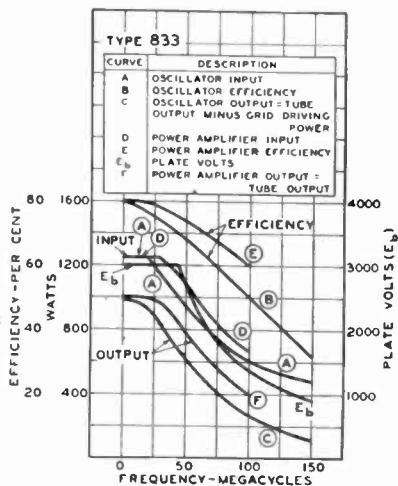

Fig. 10—High-frequency performance and input ratings of RCA type 833.

creased outputs in a very active portion of the ultra-short-wave spectrum. The design of these two new tubes is based to a large degree on the technique of modern large-lamp and vacuum-tube construction. The improvement that these tubes offer lies in the extension of design principles to meet the ultra-high-frequency requirements and in the solution of the constructional difficulties introduced by the need for small size and close spacings.

ACKNOWLEDGMENT

The author wishes to acknowledge the many contributions of those associated with the work, and especially those of Mr. J. B. Fitzpatrick who aided greatly by solving many of the basic problems of manufacture of the water-cooled triode and of Mr. J. C. Hapgood for the fine work he has done on the development of the air-cooled tube.

CONSTANTS OF FIXED ANTENNAS ON AIRCRAFT*

By

GEORGE L. HALLER

(War Department, Aircraft Radio Laboratory, Wright Field, Dayton, Ohio)

Summary—This paper presents the resistance and reactance characteristics of various fixed antennas on two types of modern aircraft, one a two-place low-wing metal military airplane of the attack type and the other a large mid-wing metal military airplane of the bombardment type, whose dimensions are comparable to those of modern commercial transport airplanes. A frequency range of from three to eight megacycles is covered in all cases and in some cases this range is extended. A description of the measuring equipment and method is included.

IN AN investigation concerning the power delivered by various aircraft transmitters into the antennas with which they were to be used it was found necessary to have complete information on the resistive and reactive constants. The available literature had references to measurements on trailing-wire antennas at frequencies under three megacycles,¹ and while some installations still use trailing-wire antennas, the trend is toward higher frequencies and fixed antennas which do not require any manipulation on the part of the crew.

Several methods were employed in trials to determine suitable equipment for rapid and accurate measurements. The bridge method was discarded due to difficulties in obtaining an aural balance in a noisy airplane and due to the inaccuracies of available bridges at the higher radio frequencies. The resistance-substitution method was discarded due to the resistance and frequency range to be covered. The equipment finally selected was a commercially available "Q meter"² with a frequency range adequate for this investigation. This instrument consists basically of a radio-frequency oscillator supplying power to a 0.04-ohm resistor which is in series with a tuned circuit. A self-contained vacuum-tube voltmeter measures the step-up voltage of the circuit. This voltmeter is calibrated directly in Q , (X/R) and by measuring the Q before and after connecting the antenna in parallel with the tuned circuit, the Q of the antenna can be calculated from the following formula:

$$Q_a = \frac{(C_1 - C_2)(Q_1 \times Q_2)}{C_1(Q_1 - Q_2)} \quad (1)$$

* Decimal classification: R525. Original manuscript received by the Institute, November 24, 1937.

¹ L. A. Hyland, "The constants of aircraft trailing antennas," *Proc. I.R.E.*, vol. 17, pp. 2230-2241; December, (1929).

² Boonton Radio Corporation, Q meter, Type 100-A.

where the subscript 1 indicates values at circuit resonance before the unknown antenna is connected and the subscript 2 indicates values at circuit resonance after the antenna has been connected. The reactance of the antenna is obtained directly as capacitance or inductance (negative capacitance) necessary to retune the circuit to resonance as above. In use a tapped coil is convenient for adjusting the inductive values, and hence the capacitive values, to usable magnitudes. From the values of Q and X the resistance can be calculated from the formula

$$R = \frac{X}{Q} \quad (2)$$

When approaching the quarter-wave resonance region of the antenna where the reactance is approaching zero, better readings can be obtained if a small condenser of known capacitance and resistance is inserted in series with the antenna.

The Q meter was mounted with shockproof mountings on a base which contained a dynamotor for furnishing a 110-volt alternating-current supply to the Q meter from the ship's 12-volt direct-current supply. Readings of frequency, resonating capacitance before and after the antenna was connected, and corresponding Q values were recorded during a flight and the characteristics were then calculated later. In this manner one antenna could be measured in from fifteen to twenty minutes of time in the air.

The reactance and resistance curves are plotted on a special log-log graph paper which has a departure from true logarithmic ordinates in that there is a small section which contains a zero line so that the quarter-wave resonance can be shown. There are three logarithmic cycles above and three below this zero line. In the lower three cycles the negative reactance (capacitive) is plotted while in the upper three cycles the positive reactance (inductive) and resistance are plotted.

Fig. 1 shows a rear view of a modern military airplane of the "attack" type. This all-metal low-wing monoplane has a wing spread of 48 feet and is 32 feet long. The lead-in insulator is on the right side of the airplane just forward of the rear cockpit cover and all antennas on this airplane were measured with the lead-in in this position. Figs. 2 to 5 inclusive show characteristics of various antennas installed on this airplane. All antennas were constructed with copper-clad steel wire 0.040 inch in diameter. The measurements were made with the airplane in flight at various altitudes from 2000 to 10,000 feet except as noted in Fig. 5.

Fig. 2 shows the characteristics of an antenna comprising a wire running from the lead-in insulator to the top of the mast (a distance of 6 feet) and thence to the vertical fin in the rear (a distance of 12 feet).



Fig. 1—Three-quarter rear view of "attack" type of airplane.

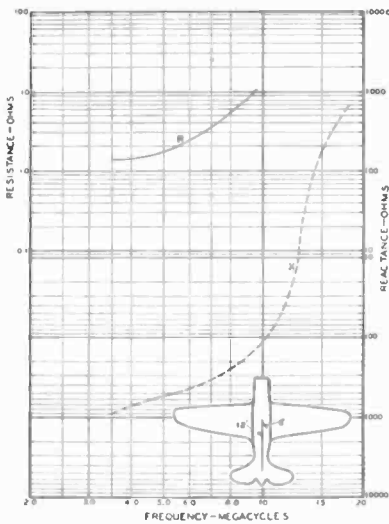

Fig. 2—Characteristics of front-to-rear antenna on "attack" type of airplane.

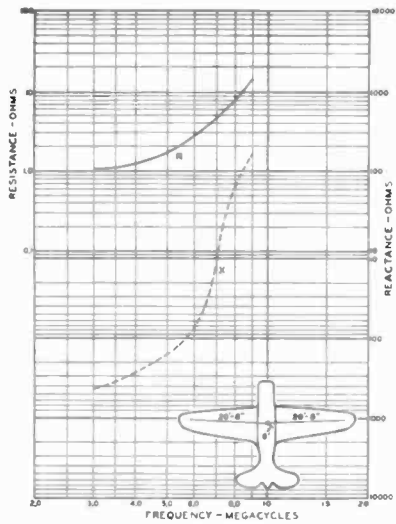

Fig. 3—Characteristics of wing-tip-to-wing-tip antenna on "attack" type of airplane.

Fig. 3 shows the characteristics of an antenna comprising a wire running from an anchor near one wing tip over the mast to an anchor on the other wing tip. The length of this antenna is 41 feet and 4 inches, and the lead-in from the top of the mast to the airplane is 6 feet long.

Fig. 4 shows the characteristics of an antenna comprising a wire running from one wing tip to the rear vertical fin and thence to the other wing tip, with the lead-in near the center of the antenna at the vertical fin. The length of this antenna is 48 feet and that of the lead-in, 11 feet.

Fig. 5 shows the characteristics of an antenna very similar to that of Fig. 4 except that the lead-in is connected to the antenna at a point approximately midway on one side. The length of this lead-in is 9 feet and 5 inches. This figure also shows the difference between meas-

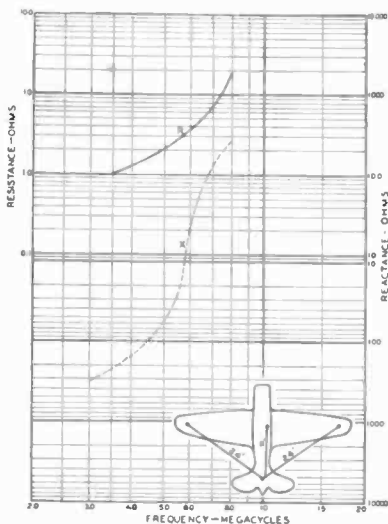

Fig. 4—Characteristics of V antenna with lead-in from rear on "attack" type of airplane.

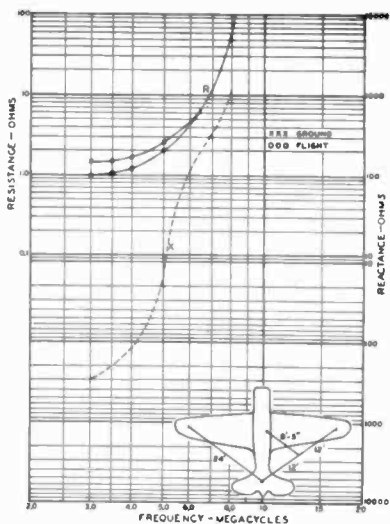

Fig. 5—Characteristics of V antenna with lead-in to center of one side on "attack" type of airplane.

urements of the characteristics on the ground and in flight. It is interesting to note that while the resistance is different in the two cases, especially at the lower frequencies, the reactance curves are coincident. This characteristic helps in that the radio transmitter may be tuned to the antenna on the ground and little if any readjustment will be required when the airplane is in flight.

Fig. 6 shows a front view of a military airplane of the "bombardment" type. This all-metal mid-wing monoplane has a wing spread of 90 feet and is 57 feet long, dimensions which are comparable to the modern commercial transport airplanes. The lead-in insulator is on the roof of the cabin and all antennas were measured from this position. Figs. 7 to 9 inclusive are characteristics of antennas installed on this airplane.

Fig. 7 shows the characteristics of an antenna 26 feet long running from the vertical fin in the rear to a small mast over the cabin with a lead-in from this point 2 feet 6 inches long.



Fig. 6—Three-quarter front view of "bombardment" type of airplane.

Fig. 8 shows the characteristics of an antenna 71 feet long, running from near the tip of one wing over a short mast to a similar point on the other wing. A lead-in 4 feet 9 inches long is fastened to the center of the antenna.

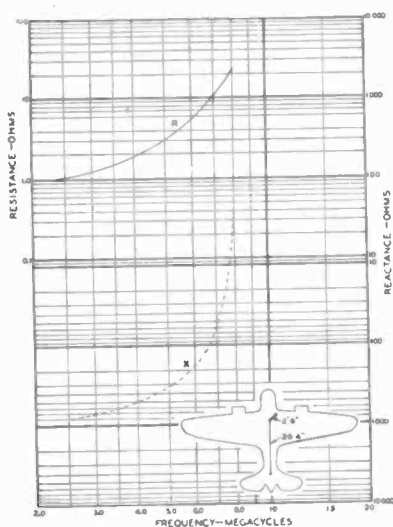

Fig. 7—Characteristics of front-to-rear antenna on "bombardment" type of airplane.

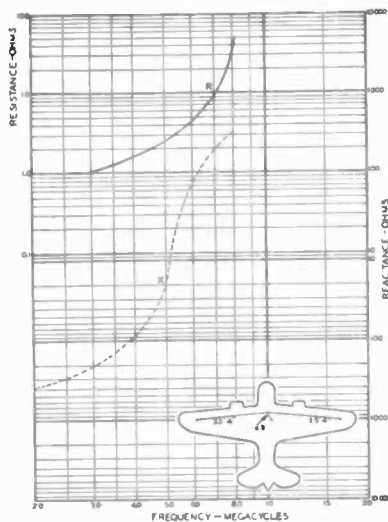

Fig. 8—Characteristics of wing-tip-to-wing-tip antenna on "bombardment" type of airplane.

Fig. 9 shows the characteristics of an antenna which consists of a wire from a small mast near the front of the airplane to the vertical

fin (a distance of 34 feet) and wires from this point to each wing tip. These sections are broken by an insulator so that the antenna length of these wires is 26 feet, 6 inches each. The lead-in is taken off near the front mast, and is 3 feet 5 inches long. This antenna was especially designed to work at 3105 kilocycles, the air alert frequency of the Department of Commerce. The transmitter which was to be used would not work well into an inductive load near a quarter wavelength

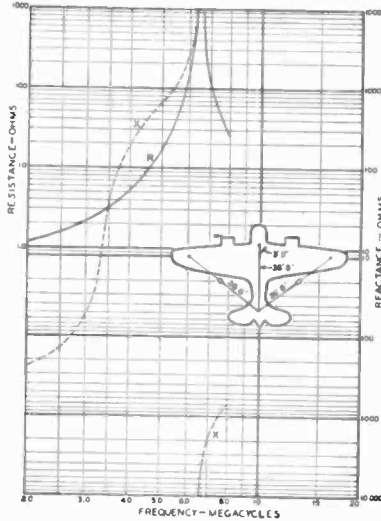

Fig. 9—Characteristics of V antenna with lead-in from rear on "bombardment" type of airplane.

so the length of the antenna was adjusted so that resonance was obtained at 3200 kilocycles. It is interesting to note that at 3105 kilocycles the resistance of this antenna is approximately $2\frac{1}{2}$ ohms as compared to approximately 1 ohm for the other antennas on this airplane.

It will be seen from these curves that antennas for aircraft are a real problem. If a band of frequencies are to be covered as is required in military airplanes, the transmitter must have very flexible antenna-coupling facilities and must be able to work into very low resistances over portions of the band.



DIRECT MEASUREMENT OF THE LOSS CONDUCTANCE OF CONDENSERS AT HIGH FREQUENCIES*

BY

M. BOELLA

(Regio Istituto Elettrotecnico e delle Comunicazioni della Marina, Livorno, Italy)

Summary—A method of measuring the losses of a variable air condenser at high frequencies is described in which the condenser under test and the standard are connected in series as part of a tuned circuit. A radio-frequency voltage of resonant frequency is impressed on this circuit for a stated value of the standard. The unknown is then removed and the standard adjusted to resonance. The voltage across the tuned circuit is readjusted to its initial value by placing a conductance across the standard. The design of the standard condenser requires special considerations which are discussed. A self-biasing valve voltmeter, which is not critical to variations in power-supply voltage, is used. The results of measurements on several specimen condensers are given. A method of extending the measurements to higher frequencies is shown.

I. OBJECT OF THE RESEARCH

FOR THE measurement of the angle of loss of condensers by the normal methods of substitution, it is necessary to prepare a standard condenser having zero or, at least, a known loss. When it is used at a relatively low radio frequency and with condensers having relatively large losses, it is permissible to suppose that an air condenser presents no losses other than those in the insulators supporting the rotor. Therefore, one may imagine an air condenser consisting of a pure variable capacitance across which there is a resistance which is a function of the frequency and not of the capacitance. On the other hand, at higher frequencies and for the measurement of small angles of loss one cannot ignore the losses in the metal parts of variable air condensers, which may conveniently be represented by a resistance placed in series with the condenser¹ and which in general varies with the capacitance because the utilized area of the rotor varies with it. To determine the existence of such losses and to decide between what limits it is permissible to neglect them, a variation of the classical substitution method was studied. It is not necessary in this method to take into account the series resistance which represents the metallic losses

* Decimal classification: R220×R241.3. Original manuscript received by the Institute, August 10, 1937; revised manuscript received by the Institute, November 3, 1937.

¹ R. F. Field and D. B. Sinclair, "A method of determining the residual inductance and resistance of a variable air condenser at radio frequencies," Proc. I.R.E., vol. 24, pp. 255-274; February, (1936).

in the standard condenser, in the same way that, with the ordinary methods, one takes no account of the parallel resistance which represents the loss in the rotor supports.

II. PRINCIPLE OF THE METHOD OF MEASUREMENT

The circuit showing the principle of the method is given in Fig. 1. The condenser under test C_x (with its loss conductance G_x in parallel) and the standard condenser C_0 are placed in series and connected to an oscillatory circuit LC fed by a radio-frequency generator. The condenser C_0 consists of two parallel plane disks, the capacitance being varied by altering the distance between them; in this way the high-frequency resistance R_0 of the plates may be kept constant although the capacitance is varied, since the current distribution in the plates

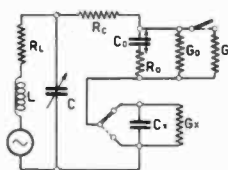

Fig. 1—Schematic diagram of the measuring circuit.

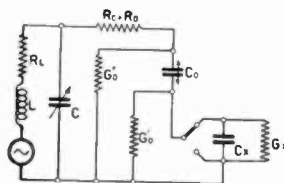

Fig. 2—Equivalent schematic diagram of the effective circuit.

does not change with their spacing. R_c is the resistance of the connections and the conductance G_0 represents the losses in the supporting insulation which is in the electric field of the condenser.

For the measurement, the circuit is tuned by means of the condenser C , for a stated value C_{01} of the condenser C_0 . C_x is then removed, the tuning is readjusted by setting C_0 to a new value C_{02} , and, finally, the potential across the tuned circuit is adjusted to the initial value by placing a suitable value of conductance G across the condenser C_0 . We then have

$$\frac{1}{C_{02}} = \frac{1}{C_{01}} + \frac{1}{C_x} \quad (1)$$

$$G + G_0 = G_0 \left(\frac{C_{02}}{C_{01}} \right)^2 + G_x \left(\frac{C_{02}}{C_x} \right)^2 \quad (2)$$

The second relation is obtained by equalizing the power lost in the circuit in the two conditions (putting $G_x \ll \omega C_x$, $G \ll \omega C_{02}$) and considering that no account is taken of R_L , R_c , or R_0 , because the currents which pass through them remain identical in the two cases.

From (2) we obtain

$$G_x = G \left(\frac{C_x}{C_{02}} \right)^2 + G_0 C_x^2 \left(\frac{1}{C_{02}} + \frac{1}{C_{01}} \right) \left(\frac{1}{C_{02}} - \frac{1}{C_{01}} \right),$$

from which, by reason of (1),

$$G_x = G \left(\frac{C_x}{C_{02}} \right)^2 + G_0 C_x \left(\frac{1}{C_{02}} + \frac{1}{C_{01}} \right),$$

and again, for the same reason,

$$G_x = G \left(\frac{C_x}{C_{02}} \right)^2 + G_0 \left(1 + 2 \frac{C_x}{C_{01}} \right). \quad (3)$$

The correction term in G_0 can assume importance for the higher values of C_x/C_{01} , which is rather unfortunate since the effective value of G_0 is determinable only in a somewhat uncertain manner. There exists a remedy for this in the type of construction successfully adopted for the condenser C_0 ; i.e., by supporting the plates by means of separate insulating supports attached to a grounded metal frame. In this way parts of the insulating material are not directly interposed in the electric field between the plates of the condenser; the equivalent circuit becomes that of Fig. 2, in which the conductances G_0' and G_0'' represent, respectively, the losses in the insulating supports of the two plates. G_0'' does not enter into the calculations, because it becomes a part of the constant losses in the circuit, while G_0' only enters in the first part of the measurement when it is in parallel with G_x , so that (3) must be modified as follows:

$$G_x = G \left(\frac{C_x}{C_{02}} \right)^2 - G_0'. \quad (3')$$

The multiplying term $(1+2 C_x/C_{01})$, which may assume values much greater than 1, having disappeared, G_0' represents a correction which is generally negligible, and moreover is constant. It is of little importance in checking the losses caused by the variation in capacitance since it affects the residual losses only.²

III. THE STANDARD CONDENSER

In Fig. 3 is shown the construction of the standard condenser C_0 . The two plates are 10 centimeters in diameter, made of brass accurately machined and electrically gilded; the lower fixed plate (1) is supported

² The hypothesis, implicitly admitted in the preceding treatment, that air may be considered as a loss-free dielectric, appears to be generally accepted and tests, within the limits of approximation, have confirmed this in the case of dry air.

by three quartz pillars (2) which are themselves supported on three leveling screws mounted on the metal base plate (3); the upper plate, which is movable (4.5-millimeter motion) by means of a screw mechanism (5), is supported from the base plate and rigidly fixed to it by means of three metal pillars (6) and cylindrical ebonite insulators (7) inside bell-shaped screening caps. The fixed plate must be connected to the condenser under test C_x (Fig. 2) while the movable plate is connected to the oscillating circuit. G_0'' represents the losses in the

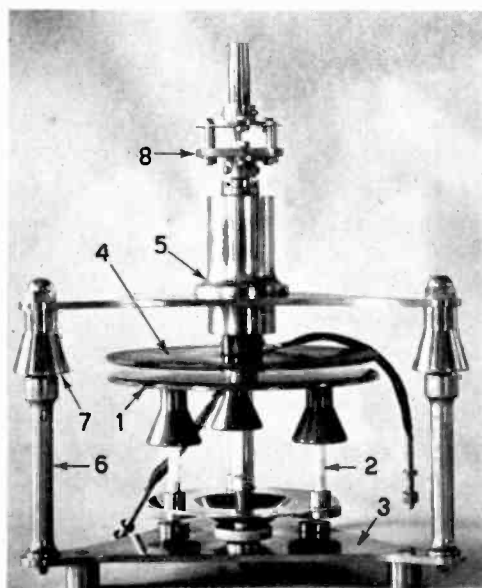

Fig. 3—The standard condenser.

ebonite insulators (7) and G_0' that of the three pillars (2) which are best made long and thin so that the losses in them are a minimum.

Between the dial and the movable plate an insulating piece (8) must be inserted and the dial must be earthed to avoid hand-capacitance effects. The three leveling screws permit the lower plate to be adjusted to be perfectly parallel to the movable one. This adjustment is made easily and very accurately by looking between the plates when they are almost touching. The metallic bell-shaped caps on the tops of the quartz pillars remove them still farther from the electric field between the two plates. It appears however that such a precaution may be superfluous.

The determination of the capacitance of the condenser has been

effected for various values of the distance between the plates by the classical method used for the determination of the interelectrode capacitances of triodes; also in this case there is, in fact, a system of three capacitances: C_0 the direct capacitance between the plates, and C_0' and C_0'' , the capacitances between the fixed and movable plates with respect to the screen. With three measurements, either by substitution or bridge means, there may be determined, by short-circuiting each of the three capacitances in turn, the three values of the sums of

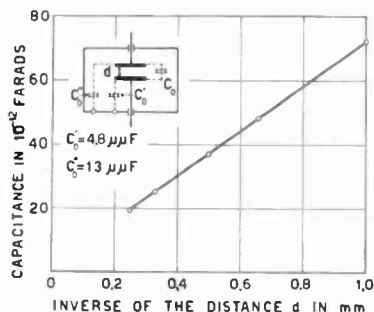

Fig. 4—Calibration curve of the standard condenser.

the remaining two unknowns in each case. Thus we have three equations from which the three capacitances are obtainable.

In Fig. 4 are shown the results of the measurements as an inverse function of the distance between the plates. The graph, for values of d between approximately 1 and 4 millimeters, is practically linear.

The capacitance C_0'' is of no interest since it is always in parallel with the tuning capacitance of the oscillating circuit, while C_0' must be summed in (3') with the capacitance C_x . It should be noted that

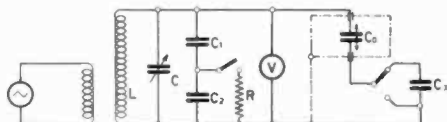

Fig. 5—Simplified schematic diagram of the measuring circuit.

C_0'' remains practically constant in spite of the movement of the upper plate, because of the smallness of the movement and the location of piece (5) which has a partial screening effect between the upper plate and the screen.

IV. MEASURING CIRCUIT SCHEMATIC AND APPARATUS

In Fig. 5 is shown the basic circuit of the measuring arrangement. The radio-frequency generator induces a constant electromotive force in the oscillating circuit and the equality of the losses under the two

measuring conditions, i.e., with and without the condenser C_x under test and with the comparison resistance R of suitable value, is verified by making the potential at the top of the oscillating circuit equal as measured by the valve voltmeter V . The resistance R is connected across the capacitive potential divider C_1C_2 so that a lower value of resistance may be used and thus permit the use of a resistor, the radio-frequency value of which may be equal to its direct-current resistance.³ With the two values of capacitance (about 50 and 500×10^{-12} farads; $[1 + C_2/C_1]^2 = 122.5$) adopted for the actual measurements, Siemens Karbowid 1-watt resistors were used having values between 20,000 and 150,000 ohms. Comparison is effected by interpolation, which is

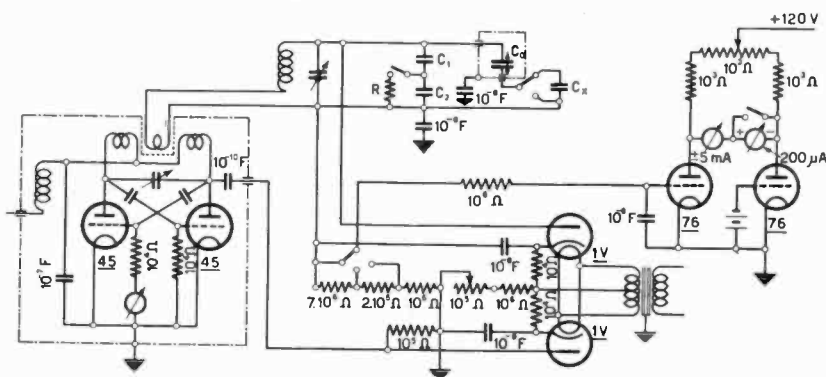

Fig. 6—Detailed schematic diagram of the circuit.

simplified by the linear characteristics of the apparatus, the curve for which should be arranged with voltmeter readings as the abscissas and the corresponding values of conductance as ordinates.

The capacitive potential divider should be arranged as close as possible to the condensers C_0 and C_x , in order to avoid any possibility of the total potential across C_0 and C_x exceeding that across C_1 and C_2 which might result from the inductive reactance of the connecting leads and thus increase the measured losses. The point at which the voltmeter is connected is unimportant.

The valve voltmeter gives the peak value of the voltage and is of the polarized diode type, with direct-current triode amplification following the diode, as shown in Fig. 6, which gives the complete circuit in detail. The polarizing voltage is furnished by the radio-frequency generator itself by means of a diode rectifier. This is an important

³ M. Boella, "Sul comportamento alle alte frequenze di alcuni tipi di resistenze elevate usate nei radiocircuiti" (On the behavior, at high frequencies, of some types of high resistances in use in radio circuits), *Alla Frequenza*, vol. 3, p. 132; April, (1934).

O. S. Puckle, "The behaviour of high resistances at high frequencies," *Wireless Eng.*, vol. 12, p. 303; June, (1935).

feature and avoids instability caused by radio-frequency-voltage variations and reduces the effects of supply-voltage fluctuations.

The radio-frequency generator is a well-screened push-pull oscillator. It is a convenient practice to place an electrostatic shield between the generator circuit and the small coupling coil in the measurement circuit to avoid serious troubles caused by capacitive coupling. Harmonics in the output of the oscillator may cause serious errors and must be guarded against.

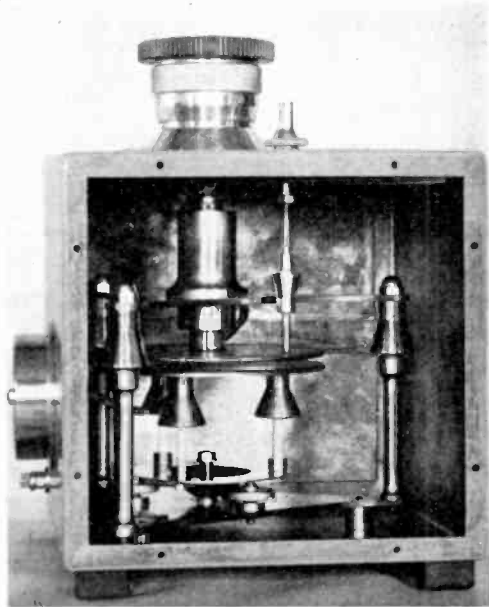

Fig. 7—Standard condenser within the screening box.

Also the two 10,000-ohm resistors between the two diode cathodes of the voltmeter are put there to avoid any capacitive coupling between the generator and the circuit through the interelectrode capacitance of the diodes.

The standard condenser C_0 must be completely screened, since even a small leakage of energy may cause noticeable errors in measurement. The results of measurements of a given condenser with various values of the initial distance between the plates of the standard condenser, i.e., with different values for C_{01} , are not identical under conditions of poor shielding.

The screen used for the condenser is shown in Fig. 7 and consists of a copper box, 16×18×16 centimeters, with two holes in the side for the connections. The insulation of the lead to the lower fixed plate of

the condenser C_x under test, should contribute a minimum of loss and the capacitance of the lead to the screen should also be kept as low as possible. The losses in this insulator which in this case was a thin hipertrolitul disk add to those of the three supports of the fixed plates, the effect of which has already been discussed. The arrangement of the second lead which connects the movable plate to the circuit is of no importance, since the losses cannot influence the results of the measurements but only add to the constant losses in the circuit.

Care must be taken that the parts of the screen make good contact, otherwise even small variations in the losses in the screen will make the

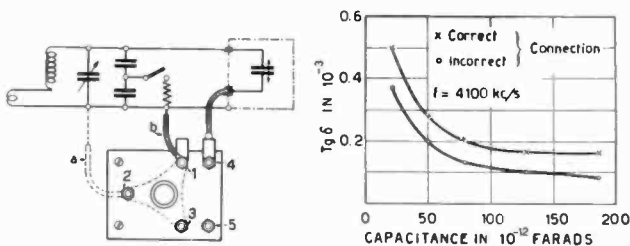

Fig. 8—Illustrating the effect of connections in testing a variable condenser. (a) incorrect connection, (b) correct connection.

voltmeter readings unstable rendering measurement impossible; the use of a well-soldered brass or copper box is recommended.

As a result of the screening of the condenser C_0 it is possible to obtain results constant to within ± 2 per cent no matter how the initial distance d between the plates may vary.

For the switch which connects the condenser under test into the circuit, two mercury-filled copper pots are used. They are connected to the condenser by short leads or directly mounted on it. A small cylinder of copper having a flexible lead a few centimeters long soldered to its end is immersed in the mercury. The pieces should be cleaned occasionally with nitric acid so as to become amalgamated. This system gives a satisfactory contact and is convenient. The connections between a pot and the termination on the condenser must be identical, so that the impedance of the connection will be constant, whether the condenser is in circuit or not. It is, moreover, of the greatest importance that each of the two connections between the condenser under test and the circuit shall leave the condenser at the same point as that to which the pot is connected. In order to give an idea of the effect which these matters have on the success of the measurements it is well to explain more fully the effects obtained with one of the experimental variable air condensers.

In this condenser the plates are supported between rectangular

isolantite plates; at the center of one of these is fixed, by means of three screws 1, 2, and 3, as is shown in Fig. 8, a small triangular metal plate, on which the spindle of the rotor makes contact by friction. The mercury pots were fixed to one of these screws (1) and under one of the nuts, 4 or 5, fastening the supports for the stator of the condenser. The



Fig. 9—Condenser No. 1.

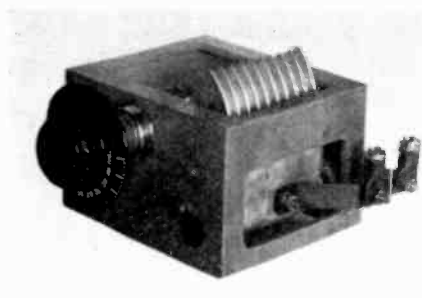

Fig. 10—Condenser No. 2.

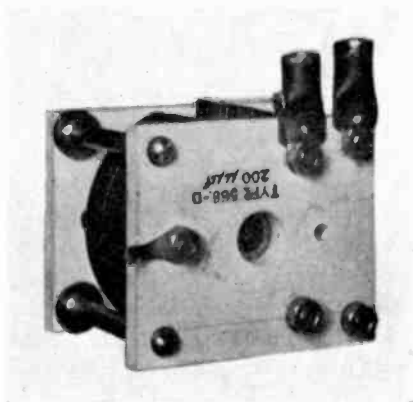

Fig. 11—Condenser No. 3

connection which joins the rotor to the oscillatory circuit was, at first, as shown at *a* and was placed under screw 2. The resulting values of loss angle at 4200 kilocycles were notably smaller (one half for the maximum value of the capacitance) than those obtained afterwards with the correct connection *b*. The error is caused by the resistance between the points 1 and 2 of the metal end plate which remains in the circuit when the condenser is excluded.

V. RESULTS OF MEASUREMENTS ON SOME VARIABLE CONDENSERS

With the above-described method, measurements of loss angles were made at frequencies of 2000 and 4200 kilocycles on three types of variable air condensers (Figs. 9, 10, and 11). Fig. 11 shows the con-

denser that was previously described. The others are of the type having metal frames, and quartz insulation. The electrical connection between the rotor and the frame is made in the first case (Fig. 9) by a copper pigtail about 0.8-square-millimeter cross section and 50 millimeters long; in the second case (Fig. 10) by a mercury contact.

In Fig. 12 are shown the results of the measurements. From these results one sees immediately the poor behavior of condenser No. 1 in comparison with that of the other two, which are almost equivalent.

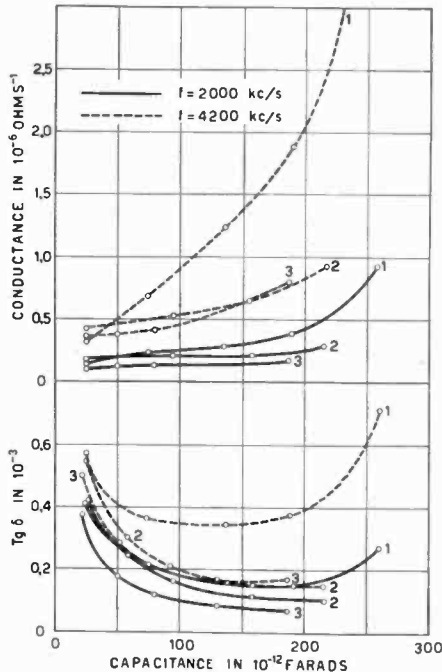

Fig. 12—Results of measurements on condensers 1, 2, and 3.

This difference, which increases with frequency and capacitance is relatively negligible for the zero setting of the condenser, and is attributable to the resistance of the copper pigtail connecting the rotor to the frame.

It is also established that in condensers 2 and 3 the ohmic losses in the metal are certainly not negligible compared with those in the supporting insulators; but, for the larger values of capacitance and at 4200 kilocycles, they are greater. In Fig. 13 are shown for condensers 2 and 3 at 4200 kilocycles, the tangents of the loss angle relative to the variable part of the condensers. The loss angle has been calculated on

the basis of the difference between the effective capacitance and the minimum or residual value, and on the difference between the corresponding values of the loss conductance. For condenser 1 the same calculation gives much higher values, which vary from 0.26 to 0.76×10^{-3} for values of capacitance from minimum to maximum.

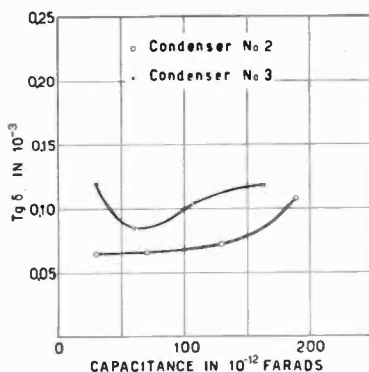

Fig. 13—Loss angle relative to the variable part of the condensers.

VI. VARIATIONS OF THE MEASURING CIRCUIT

To extend the range of the measurements to much higher frequencies and to improve the operation of the circuit, it would be advisable to arrange the circuit as a series one, using small series resistors as standards, instead of large parallel resistors. The circuit diagram is now changed to that shown in Fig. 14 in which C is the condenser which enables the circuit to be tuned when C_0 is altered and the resistance box is arranged to eliminate the effect of the resistance of the plugs and of the bus bars.

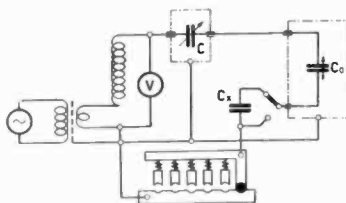

Fig. 14—Improvement of the measuring circuit for higher frequencies.

It is interesting to observe that with this arrangement one measures the value of the series resistance equivalent to the complex losses in the condenser by direct comparison, without any necessity of calibrating the standard condenser C_0 , thus eliminating a possible cause of

error. The resistance box should consist of resistors between 0.01 and 0.2 ohm and its construction should be thoroughly and accurately considered in order to avoid obvious operating difficulties.^{4,5}

VII. CONCLUSIONS

The method of substitution described permits an accurate determination of the loss angle of condensers used in high-frequency circuits, without the necessity of knowing the ohmic loss in the auxiliary condenser. Moreover, in comparison with the ordinary substitution method, it easily eliminates the effects of the resistance of the connections between the condenser under test and the measuring circuit, thus becoming of particular value when it is desired to make tests on condensers or on samples of insulating materials in an enclosed space; e.g., when one wishes to carry out researches on the effect of temperature or humidity on the loss angle.

⁴ J. G. Chaffee, "The determination of dielectric properties at very high frequencies," *Proc. I.R.E.*, vol. 22, pp. 1009-1020; August, (1934).

⁵ L. Rohde and H. Schwarz, "Verlustwinkelmessung bei 10^8 Hz" (Loss angle measurements at 100 megacycles), *Hochfrequenztech. und Elektroakustik*, vol. 43, p. 156; May, (1934).

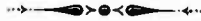

THE VARIATION IN THE HIGH-FREQUENCY RESISTANCE AND PERMEABILITY OF FERROMAGNETIC MATERIALS DUE TO A SUPERIMPOSED MAGNETIC FIELD*

BY

J. S. WEBB

(University of Minnesota, Minneapolis, Minnesota)

Summary—The variation of the high-frequency resistance of ferromagnetic conductors as a function of a superimposed magnetic field is discussed. It is shown that very large changes in high-frequency resistance are obtainable in ferromagnetic conductors having high initial permeabilities. Some important applications of this effect are given. The application of high-frequency incremental permeability to remote tuning of radio circuits is briefly outlined.

INTRODUCTION

THE subject of the variation of the high-frequency resistance of a ferromagnetic conductor due to a superimposed magnetic field seems to have received very little attention. It appears now that with the development of new types of ferromagnetic materials, as well as the increase in uses of high-frequency apparatus, some important applications of the effect are possible. Some of these are its uses in radio receivers in conjunction with automatic expanding systems, automatic tuning, automatic volume control, and remote tuning; in geophysical measurements; in directional flying; and not least, in measuring field intensities where it is impossible to use the ordinary methods, or where the fields are too weak to use the bismuth spiral. It is the purpose of this paper to give a brief account of some investigations that have been made on the variation of the high-frequency resistance, due to a superimposed field, of a few of the common types of ferromagnetic conductors and also to point out some of the possible applications of the effect.

THEORY

The approximate theory of high-frequency resistance of a straight cylindrical conductor has been given by many physicists and electrical engineers; the exact solution however is due to Lord Kelvin.¹ This solution is quite involved and it was in this connection that he introduced his "bei" and "ber" functions. Kelvin gives

* Decimal classification: R282.3. Original manuscript received by the Institute, September 2, 1937.

¹ Kelvin, "Mathematical and Physical Papers," vol. III, p. 291.

$$\frac{R'}{R_0} = \frac{x}{2} \frac{(\text{ber } x \text{ bei}' x - \text{ber}' x \text{ bei } x)}{(\text{ber}' x)^2 + (\text{bei}' x)^2} \quad (1)$$

where,

$$\text{ber } x = 1 - \frac{x^4}{2^2 \cdot 4^2} + \frac{x^8}{2^2 \cdot 4^2 \cdot 6^2 \cdot 8^2} - \dots \quad (2)$$

$$\text{bei } x = \frac{x^2}{2^2} - \frac{x^6}{2^2 \cdot 4^2 \cdot 6^2} + \frac{x^{10}}{2^2 \cdot 4^2 \cdot 6^2 \cdot 8^2 \cdot 10^2} - \dots \quad (3)$$

$$x = \pi d \sqrt{\frac{2\mu f}{\rho}} \quad (4)$$

and where,

R' = high-frequency resistance in ohms

R_0 = direct-current resistance in ohms

d = diameter of the conductor in centimeters

f = frequency in cycles

ρ = resistivity in centimeter-gram-second units

μ = permeability.

$\text{Ber}' x$ and $\text{bei}' x$ are the first derivatives in respect to x .

Tabulations of R'/R_0 in terms of x are to be found in the radio literature.² It is interesting to note that the very complicated expression of (1) reduces to that of an approximately straight line for values of x exceeding 3.0, and can then be expressed as

$$\frac{R'}{R_0} = 0.25 + 0.355x \quad \text{or} \quad 0.25 + 0.355\pi d \sqrt{\frac{2\mu f}{\rho}} \quad (5)$$

The permeability cannot be taken as a constant, since the field strength in a conductor carrying a current varies as we move outward from the axis. It is therefore necessary to consider μ as the average permeability, since it is a function of H , which is not constant over the cross section of the conductor.

A ferromagnetic conductor carrying a current can be considered as having a circular permeability due to the current flowing in the conductor. When this conductor is placed in a magnetic field that is parallel to the axis of the conductor, it will have a longitudinal permeability which is at right angles to the circular permeability. As the strength of the superimposed field is increased, it will tend to orient the "unit magnets" in the direction of the longitudinal field with a gradual re-

² Bureau of Standards Circular No. 74, second edition, p. 309.

duction in the circular permeability, and with a corresponding decrease in the high-frequency resistance of the conductor. Here, however, the demagnetization due to the pole effect is so great that it requires a relatively strong superimposed field to produce much of a change in the high-frequency resistance of the conductor.

The variation of the permeability of ferromagnetic materials, due to superimposed fields, has been studied by Spooner,³ Hanna,⁴ and others, using low or relatively low frequencies. Yensen has termed this "incremental permeability." It has been shown that for a given alter-

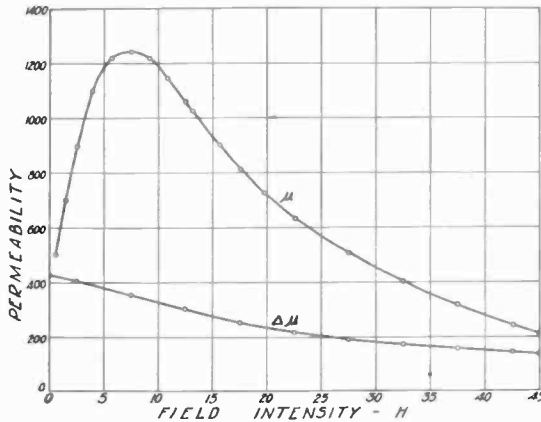

Fig. 1—Curves showing general relationship between static and incremental permeability.

nating field, the initial permeability is the maximum incremental permeability, decreasing in value as the superimposed direct field H_s is increased. This is shown in Fig. 1. It is this form of variation in permeability that is obtained when a ferromagnetic conductor, carrying a current, is placed in a superimposed magnetic field. Since the high-frequency resistance of the conductor is a function of its permeability, it can be seen that a variation in μ , due to a superimposed field, will produce a variation in its high-frequency resistance.

EXPERIMENTAL

In order to measure accurately the change in the high-frequency resistance, as well as to keep the current constant through the test sample, the resistance-substitution method was chosen as being the most desirable. The circuit arrangement is shown in Fig. 2. The source

³ Spooner, *Jour. A.I.E.E.*, vol. 42, p. 42; January, (1923); *Phys. Rev.*, vol. 25, p. 527; April, (1925).

⁴ Hanna, *Jour. A.I.E.E.*, vol. 46, p. 128; February, (1927).

is a conventional Hartley oscillator, R a General Radio decade resistor, C a General Radio precision vernier condenser, and I a Weston thermomilliammeter. The Helmholtz coils shown in the diagram can be replaced by a Weiss electromagnet when a superimposed field of higher value is needed. The test samples are made by winding lengthwise, on thin bakelite strips, the ferromagnetic materials to be investigated. These materials are Nichrome, 193 Alloy, soft iron, steel, and nickel, all of which come in the form of No. 24 or No. 26 B & S gauge wire. Several test samples of each material are made ranging in length from six to eighteen centimeters. The six-centimeter samples are for use in the Weiss electromagnet, where it is unsatisfactory to use pole spacing much in excess of six centimeters.

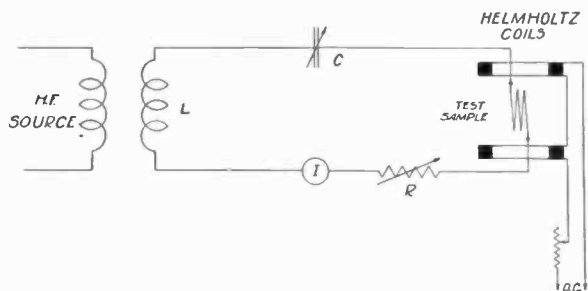

Fig. 2—Circuit for measuring the variation in the high-frequency resistance of ferromagnetic conductors due to a superimposed magnetic field.

In making measurements, R is set at zero and the circuit is tuned to that of the oscillator by means of the variable condenser C . The current is adjusted to the desired value by means of the pickup coil L . As the superimposed field H_s is applied, starting at its lowest value, the change in resistance of the test sample is determined by the amount of resistance R that must be inserted in order to keep the current I constant. A slight retuning of the circuit may be necessary with each change in H_s , since the inductance of the test sample changes slightly with the superimposed field.

Fig. 3 shows the changes in resistance obtained for soft iron, nickel, and 193 Alloy, using the Weiss magnet to produce the superimposed field H_s . Here "longitudinal field" denotes that the winding of the test sample is parallel to the direction of the superimposed field, while "transverse field" denotes that the winding is at right angles to the superimposed field. The fact that the resistance of the test sample changes much more gradually in the transverse field than in the longitudinal, is due to the pole effect which has a tendency to neutralize the superimposed field in the test sample. There is also a small pole

effect noticeable when using short test samples in the longitudinal field. This is shown by the fact that it requires a slightly larger value of H_s to produce a given change of resistance in the six-centimeter

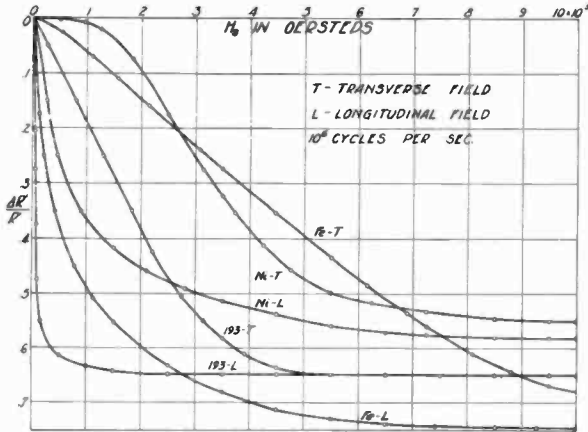

Fig. 3—Variations in the high-frequency resistance of several ferromagnetic conductors, due to a superimposed field.

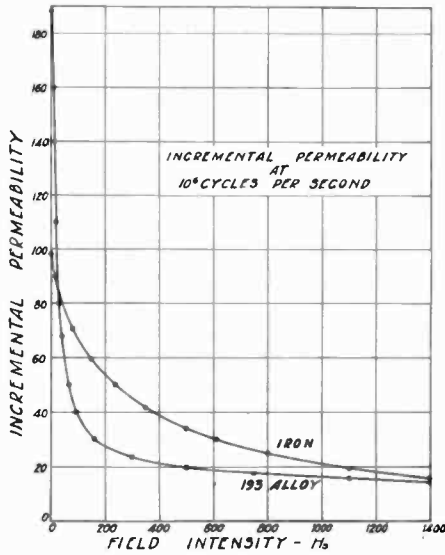

Fig. 4—Variation in the incremental permeability of iron and 193 Alloy.

samples than is required for the longer ones. It appears that no pole effect is detected for samples longer than approximately ten centimeters. As Nichrome and 193 Alloy give very nearly the same changes

in resistance, only data on the latter alloy are shown. Several other alloys were studied, all showing changes in resistance similar to those given in Fig. 3, but varying in degree.

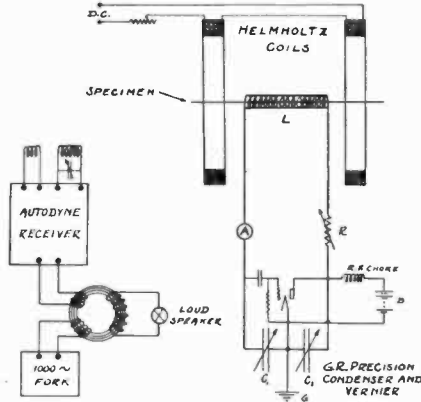

Fig. 5—Circuit arrangement for measuring the longitudinal permeability and core losses at radio frequencies.

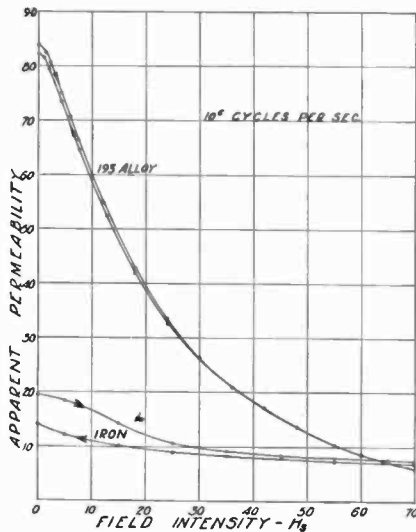

Fig. 6—Incremental longitudinal permeability showing effect of retentivity.

The variation in the incremental permeability of iron and 193 Alloy, as calculated from their high-frequency resistances by (1), is given in Fig. 4. One of the most striking effects found is that there is no evidence of a retentivity in any of the samples, after application of very

high values of H_s . This is evidenced by the fact that the high-frequency resistance of the test sample always returns to its original value after the superimposed field H_s is removed. This is in contrast to what is found when the longitudinal high-frequency permeability is measured directly by the arrangement as shown in Fig. 5. Here, as the superimposed field is applied, the value of R is varied so as to keep the high-frequency current I constant. The permeability is determined from the change in C_2 required to keep the oscillator frequency constant, as determined by the zero beat from the autodyne receiver. Results for two materials are given in Fig. 6, where it is seen that iron exhibits

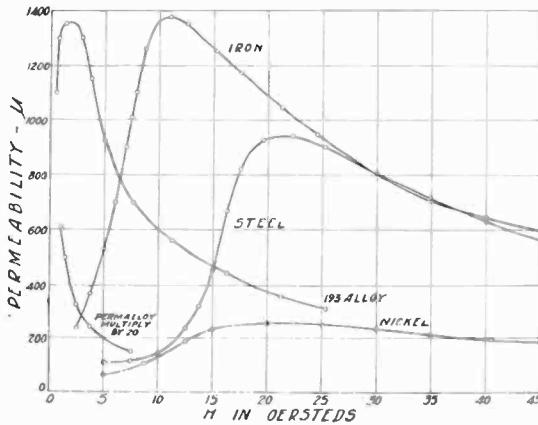

Fig. 7—Static permeability curves of a number of ferromagnetic materials used in this investigation.

a large retentivity compared to that of 193 Alloy. Steel and nickel, not shown in the figure, exhibit considerable retentivity, while none is found in the permalloy strips measured in the same way. This is due to the fact that the high-frequency field of the oscillator coil completely demagnetizes the materials of the permalloy type in which μ_{\max} takes place at a relatively low magnetizing force. See Fig. 7. Using permalloy or other ferromagnetic materials having similar properties, such as hydrogenized iron, it is possible to obtain incremental permeability curves that are the same for increasing and decreasing values of the superimposed field, such as is approached by 193 Alloy, in Fig. 6. This kind of a variation in the incremental permeability of certain ferromagnetic materials, makes possible a desirable method for remote tuning of high-frequency circuits or radio receivers, such as is shown in Fig. 8. The tuning is accomplished by a variation of the current from the high-voltage direct-current supply, to the superim-

posed field winding by means of a variable high resistor. The high resistance of the coil L due to the core losses as well as to the reflected resistance from the circuit producing the superimposed field, can be reduced to any desired value by operating the input tube on the negative-resistance portion of the characteristic curve, together with a variable positive resistor in series with the plate circuit. The high-frequency resistance of this latter resistor can be made to vary automatically in accordance with the change in the resistance of the coil L .

The question of the constancy of the permeability over the range of 200 to 1500 kilocycles arose during the course of this investigation. In order to check this, the high-frequency resistance of long straight ferromagnetic conductors, one meter in length, was measured by the resistance-substitution method. All sources of possible errors were con-

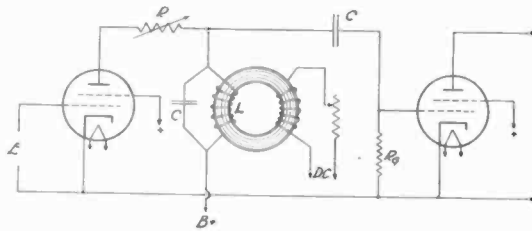

Fig. 8—Circuit arrangement for incremental permeability tuning of a stage of radio-frequency amplification.

sidered, such as radiation resistance and proximity effects. Calculations of the permeabilities from these measurements gave a value for each material that was constant over the range of the frequencies used. This would indicate that the magnetization cycle follows exactly up to at least 1500 kilocycles.

Referring again to Fig. 3, it can be seen that almost any range in the variation of the high-frequency resistance can be obtained by proper choice of the ferromagnetic material and the manner in which it is used. With the increasing number of new magnetic materials having very high initial permeabilities, it is possible to obtain marked changes in the high-frequency resistance by but very small changes in the superimposed field. Thus for hydrogenized iron, an approximate change of from 30 to 3 ohms or a ratio of 10 to 1 can be obtained for a change in H_s of the order of one oersted. Using a neutralizing field in order to utilize the portion of the curve that gives the largest change in the high-frequency resistance for a small change in H_s , it is possible to obtain sensitivities capable of detecting small variations in the earth's magnetic field. This makes it possible to use the effect in de-

vices for geophysical exploration as well as in places where the induction compass is now used.

The writer has found the high-frequency resistance and its changes in a superimposed field a most useful method for investigating the magnetic properties of ferromagnetic materials during heat and chemical treatment. In this way tests can be run simply and continuously, without changing from heat or chemical treating position to that of the magnetic testing apparatus.

The effect of the variation of the high-frequency resistance has many possibilities in a radio receiver where the superimposed field can be made a function of the received signal by using some form of rectifying device. A paper dealing with some of these applications to radio receivers is in preparation.



A METHOD OF NEUTRALIZING HUM AND FEED- BACK CAUSED BY VARIATIONS IN THE PLATE SUPPLY*

BY

K. B. GONSER

(Department of Physics, University of Kansas, Lawrence, Kansas)

Summary—A method is described whereby hum and feedback can be reduced in multistage screen-grid resistance-coupled amplifiers. By the method described it is possible to reduce degenerative and regenerative feedback and hum.

The principle involves using the screen grid of a multigrad tube in such a manner that it produces a variation upon the grid of the following tube substantially equal to and out of phase with the variation appearing at that grid directly through the plate-circuit resistor. The two thus neutralize out.

The theory giving the conditions under which neutralization takes place is described. Experimental data prove that such neutralization does take place. Typical graphs giving the conditions for neutralization using a 6C6 tube are given.

VOLTAGE variations in the plate supply to tubes in amplifiers frequently are the cause of much grief. These variations may appear as unfiltered hum, degenerative or regenerative feedback due to a common power-supply impedance,¹ or as a waviness due to slow variations. These necessitate the use of heavy filtering between stages and frequently multiple power supplies.

Tubes having screen grids, as, for example, types 6C6 or '24 A, can be utilized in proper circuits to neutralize the effect of these plate-supply variations within limits.

Fig. 1 is a diagrammatic representation of the appearance of hum and undesired voltages on the grid of the following tube. Part of this voltage, dE_P , will appear directly through Z_R on the grid as indicated by path 1. This voltage will also make itself apparent on the following grid by appearing partially on the screen grid, and being inverted through the tube, path 2. Should the phase and amplitudes of these two be proper, dE_P will not appear on the grid of the following tube.

It can be seen that Fig. 2 is the type of circuit which will give this type of neutralization. dE_{G1} will be some function of dE_G and the constants of the circuit. Further inspection shows that any change of E_P , which we denote by dE_P , will also appear to some extent in dE_{G1} .

* Decimal classification: R133. Original manuscript received by the Institute, July 11, 1937; revised manuscript received by the Institute, November 10, 1937.

¹ J. E. Anderson, "Influence on the amplification of a common power supply impedance in the plate circuit of amplifiers," Proc. I.R.E., vol. 15, pp. 195-212; March, (1927).

The screen grid of a tube acts much as an ordinary grid except that its controlling action is not as great. Any voltage change in the supply leads dE_P will appear fractionally on the screen dE_{SG} . This voltage change causes a change in current through the tube which produces a change in voltage across R_P . This change of voltage across R_P is

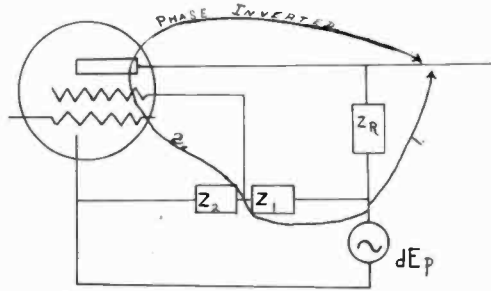

Fig. 1—Diagram to illustrate the appearance of voltage variation due to plate-supply variation dE_P on the grid of a tube following a screen-grid stage. There are two pathways, one of which has its phase inverted by passing through the tube.

out of phase with that appearing directly across R_P . If circuit values are right these two variations in dE_{G1} will be equal in magnitude and 180 degrees out of phase, thus neutralizing.

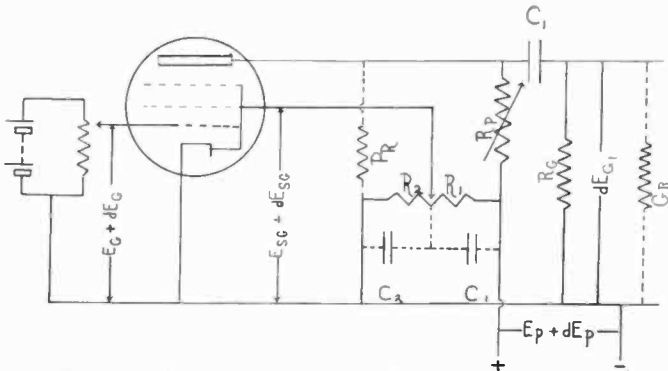

Fig. 2—Diagram showing elements involved in neutralization theory.

It is well to note here that no condenser, or at least only a small one, can be shunted from screen grid to ground, because of the phase difference which would be developed between dE_P and dE_{SG1} . Two condensers could be used, however, one from screen to ground and the other from screen to plate supply. These are dotted in Fig. 2. If these condensers are of such capacitances that dE_P divides across them in the same ratio as it divides across R_1 and R_2 there will be no phase shift introduced at any frequency.

An alternative would be to make the resistances and the condensers large enough so that any frequency of fluctuation in which we might be interested would divide across the condensers in a manner practically independent of the values of R_1 and R_2 . This introduces the possibility of making the steady voltage appear in a different ratio than the varying voltage on the screen. This might be useful in actual practice.

If self-bias is desired, either a small value of resistor with no condenser could be used in the cathode circuit, giving a low grid bias, or a large by-pass condenser could be used with any resistor in order to minimize variation in grid bias.

The equation approximately describing the plate current of a screen-grid tube is²

$$I_P = K(E_G + E_{SG/u})^n \quad (1)$$

where,

I_P = plate current in amperes

K = a constant depending upon type of tube

E_G = control-grid voltage

E_{SG} = screen-grid voltage

u = amplification factor of grid with respect to the screen grid
(ratio of controlling actions)

n = a constant, approximately 1.5 for most tubes.

Differentiating I_P in (1) with respect to E_{SG} to find how I_P changes as E_{SG} changes, we obtain

$$dI_P = nK/u(E_G + E_{SG/u})^{(n-1)}dE_{SG}. \quad (2)$$

It is interesting to note that dI_P is a function of E_{SG} as well as dE_{SG} . This is the factor which puts a limit on the amplitude of plate-voltage variation that can be neutralized.

When we multiply dI_P by the load resistance in the plate circuit R_L and set this equal to dE_{G1} , we have³

$$dI_P \cdot R_L = n \cdot K/u(E_G + E_{SG/u})^{(n-1)}dE_{SG} \cdot R_L = dE_{G1}. \quad (3)$$

Any change of E_P will divide across R_P and the series-parallel combination of R_G , C_1 , and P_R , the internal resistance of the tube, and G_R , the input resistance of the following tube. If we neglect C_1 , then

$$dE_{G1} = dE_P \frac{P_R \cdot R_G \cdot G_R}{R_P \cdot R_G \cdot G_R + R_P \cdot P_R \cdot G_R + R_P \cdot P_R \cdot R_G + P_R \cdot R_G \cdot G_R}. \quad (4)$$

² Modified from an equation as given by H. J. van der Bijl, "The Thermionic Vacuum Tube and Its Applications," first edition, p. 151, 1920.

³ In the treatment given here it will be noticed that the screen-grid tube is assumed to be a constant-current generator shunted by the plate resistance of the tube. If the tube is assumed to be a constant-voltage generator in series with the plate resistance, a different treatment results.

Inspection of Fig. 2 shows that R_L is composed of the combined resistance of P_R , R_P , R_G , and G_R to ground, if C_1 is neglected.

$$R_L = \frac{P_R \cdot R_P \cdot R_G \cdot G_R}{R_P \cdot R_G \cdot G_R + P_R \cdot R_G \cdot G_R + P_R \cdot R_P \cdot G_R + P_R \cdot R_P \cdot R_G} \quad (5)$$

Substituting (4) and (5) into (3) we obtain

$$nK/u(E_G + E_{SG/u})^{(n-1)} dE_{SG} \cdot R_P = \cdot dE_P. \quad (6)$$

It will be noticed that R_G , P_R , and G_R have canceled out. This indicates that their value will have no effect upon neutralization. By a more detailed calculation it can be shown that the impedance C_1 introduces also will cancel out. These values and the value of C_1 will however affect the gain of the stage. This was actually found later by experiment.

E_{SG} and dE_{SG} may be expressed as

$$E_{SG} = F \cdot E_P \quad (7)$$

$$dE_{SG} = Fv \cdot dE_P. \quad (8)$$

Here F and Fv are constants expressing the fractions of E_P appearing as E_{SG} , and of dE_P as dE_{SG} . Should the value of these be desired it can easily be shown that

$$F = \frac{R_{SG} \cdot R_2}{R_{SG} \cdot R_2 + R_1 R_{SG} + R_1 R_2} \quad (9)$$

$$Fv = \frac{R_{SGv} \cdot R_2}{R_{SGv} \cdot R_2 + R_1 R_{SGv} + R_1 R_2} \quad (10)$$

where,

R_{SG} = direct-current resistance of screen grid to ground

R_{SGv} = variational resistance of screen grid to ground.

If we use resistors to supply the steady component and condensers to supply the variable component Fv becomes

$$Fv = \frac{C_2 + C_1}{C_1} \quad (11)$$

Substituting (7) and (8) into (6) we obtain

$$n \cdot K/u(E_G + F \cdot E_{P/u})^{(n-1)} Fv \cdot R_P = 1. \quad (12)$$

The factor dE_P has canceled out which is to be expected since it is the factor we are attempting to eliminate.

The variables in this equation are E_G , F , E_P , R_P , and Fv . The remaining factors are constants depending upon the tube. This seems to

be a formidable array of variables; however, in testing the theory all but two of the variables can be fixed. The number of variables also permits of more freedom in circuit design.

The dashed line in Fig. 3 gives an example of the conditions for neutralization from the theory. The tube constants used were $\mu=18$, $n=1.5$, and $K=0.0008834$.

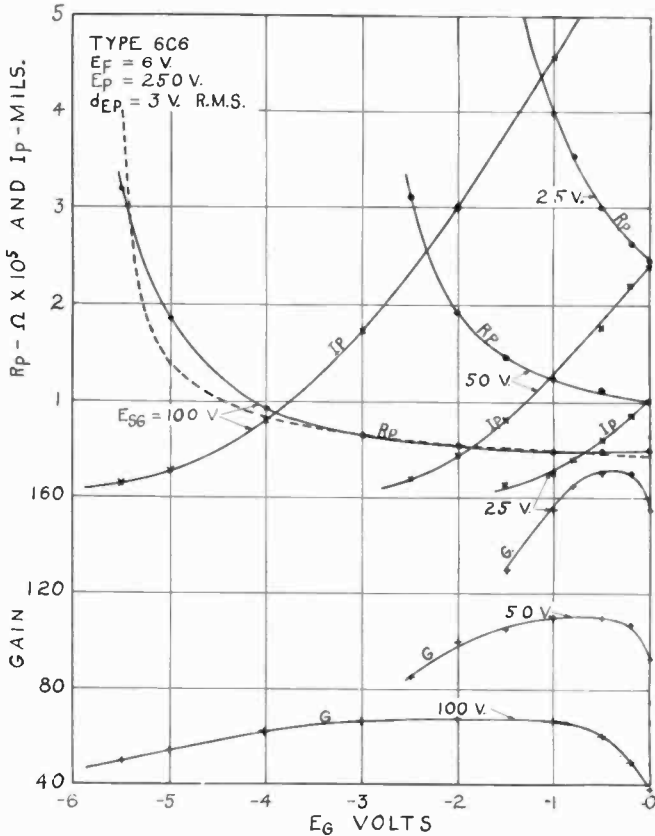

Fig. 3—Graph giving conditions for neutralization. The above was obtained using a grid resistor R_G of one megohm. A different value than this would not change the I_p or R_p curves but would affect the gain. The dashed R_p line was obtained theoretically. The gains of the stage with various values of E_{SG} have been plotted to show the performance. The gain is expressed as the ratio of the output to the input voltage.

The solid lines give characteristics of the circuit as actually measured. This graph was plotted from a setup using both resistors and condensers in the screen-grid circuit. Fv in all cases was made equal to F .

The variation from the corresponding experimental curve is undoubtedly due largely to the failure of (1) to describe accurately the plate current of the tube.

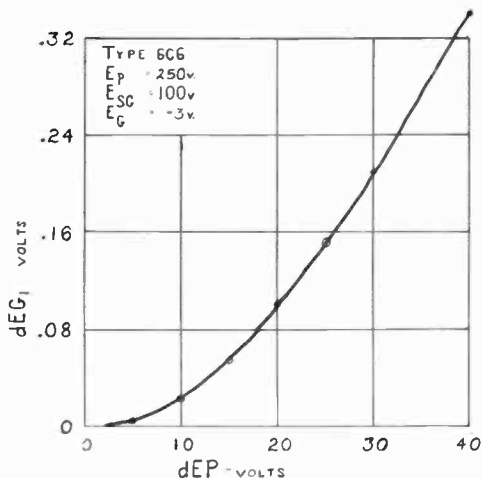

Fig. 4—The reduction of hum to be expected when the circuit is properly adjusted. Under these conditions the residual hum has a form similar to the output of a full-wave rectifier, and has twice the frequency of the hum in dE_p . This is to be expected.

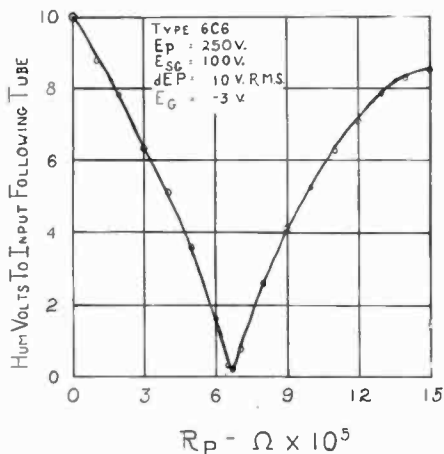

Fig. 5—The amount of hum appearing on the grid of a following tube when the stage is not properly neutralized. The variable chosen was R_p . In all measurements an amplifier feeding into a vacuum-tube voltmeter was used.

Fig. 4 gives an idea of the reduction of hum to be expected from a circuit using this type of hum neutralization if the circuit is in exact balance. It is, of course, impractical to maintain such a balance in actual amplifier circuits. The reduction is quite large as can be seen.

Fig. 5 shows the reductions of hum to be expected when the circuit is not balanced. The plate resistance R_P was chosen as the variable here, although there are many others in the circuit. The rounding-off of the curve toward 150,000 ohms is caused by the plate being operated at too low a potential.

The best resistance value in this setup was 68,000 ohms. It will be noticed that the hum can be reduced to half or less with any value from 40,000 ohms to 100,000 ohms. Should we allow for circuit variations corresponding to this large an amount we may allow hum and feedback voltages in the power supply to this stage of at least twice as much as was formerly permissible.

If large amplitudes are to be handled by a stage and distortion minimized, proper operating conditions must be chosen. This is the case with all screen-grid stages. The plate must not swing too low nor may the grid operate on a curved part of its characteristic. It is interesting to note that a balance can be obtained with the values used to obtain the curve of Fig. 5, with $R_P = 70,000$ ohms. These closely approach values sometimes recommended.

While working with low-frequency biological amplifiers the author has had circuits which would oscillate unless the first stage was neutralized properly.

It is hoped that use of the principle presented in the above theory may prove to be of value in special low-frequency amplifiers where the amount of filtering becomes almost prohibitive and in audio-frequency amplifiers where it is desirable to keep the cost at a minimum.



HARMONIC GENERATION*

BY

HERBERT J. SCOTT AND LEONARD J. BLACK

(University of California, Berkeley, California)

Summary—When plate current in a vacuum-tube amplifier flows for only a portion of the grid-excitation cycle, harmonics appear in the output circuit. The magnitude of any one of these harmonics depends upon the fraction of the fundamental cycle during which plate current flows. In the gradual transition from perfect class A to extreme class C operation, the magnitude of the n th harmonic goes through a series of $n-1$ maxima. To derive the maximum output for any given harmonic, the proper angle of plate-current flow must be chosen.

In the present paper the case wherein the plate load is a large pure resistance to all frequencies is considered first. The results of this analysis are then carried over to the case of the tuned-plate-circuit load by the introduction of a simple function. Experimental verification of the analysis is made for harmonics up to and including the ninth.

INTRODUCTION

WHEN a vacuum tube is operated over the curved portion of its characteristic it is a well-known fact that harmonics of the fundamental frequency are generated. If the operation is restricted to a small section of the characteristic, the magnitudes of the harmonics are small and can be accurately determined from the analytical expression for the characteristic curve. In controlled harmonic generation the excitation voltage is large and plate current flows for only a portion of the excitation-voltage cycle. For this type of harmonic generation, the harmonics result from the relatively abrupt change of the characteristic at cutoff, the curvature before cutoff being of secondary importance in determining the magnitude of the lower-order harmonics. To produce these pulses of plate current, the grid-excitation voltage is allowed to swing over a considerable portion of the operating characteristic about the region of cutoff. The magnitude of any particular harmonic is determined by the amplitude of the plate-current pulse and by the fraction of the cycle over which this current flows. It has been found entirely practicable, by making certain approximations, to predetermine the magnitude of any desired harmonic. The calculation of harmonic-generator performance of screen-grid and similar tubes, in which the plate current is substantially independent of plate voltage and hence of the load impedance, and in which the limiting factor is the maximum permissible positive

* Decimal classification: R132×R357. Original manuscript received by the Institute, November 10, 1936; revised manuscript received by the Institute, October 6, 1937.

grid swing, has been previously treated.¹ In harmonic generators employing tubes having a plate resistance comparable with the plate-load impedance, the effect of the harmonic voltage developed across this load impedance must be considered in the analysis. In practical operation the plate-circuit load impedance is a resonant circuit tuned to the desired harmonic. This condition of operation is analyzed in considerable detail in the present paper. The case wherein the plate-circuit load is a large resistance to all frequencies is considered in Part I. It is then shown (Part II) that the results of the analysis for the resistive load can be carried over to the case of the tuned-plate-circuit load by the introduction of one additional function.

PART I

RESISTANCE LOAD

Theoretical Discussion

In any triode operating with a fixed plate-supply voltage and a given load resistance, the plate current may be expressed as a function of the total grid voltage alone. This immediately reduces the triode circuit to that of the conventional equivalent diode. The plate current of such a circuit is given by the expression

$$i_b = \frac{\mu(E_c + e_g)}{r_p + R_L} \quad (1)$$

where,

- i_b = instantaneous total plate current
- E_c = grid-bias voltage
- e_g = instantaneous grid-exciting voltage
- μ = amplification constant
- r_p = plate resistance
- R_L = plate load resistance.

In this expression both μ and r_p are strictly functions of the total grid voltage e_c . In most tubes, however, μ may be considered constant over the working range. Also, if the load resistance is large, there is nearly a linear relation between the plate current and the grid voltage until cutoff is reached, at and beyond which the plate current is zero. Such an "ideal" straight-line characteristic would be obtained with a tube having a constant μ and having a plate resistance of constant value on one side of cutoff and of infinite value on the other side. For the type of harmonic generation considered here such an ideal char-

¹ F. E. Terman and J. H. Ferns, "The calculation of class C amplifier and harmonic generator performance of screen-grid and similar tubes," Proc. I.R.E., vol. 22, pp. 359-373; March, (1934).

acteristic would be desirable since it exaggerates the abruptness of cutoff and increases the maximum value of any harmonic. In the practical operation of many vacuum-tube circuits, the assumption of a straight-line characteristic is justifiable.² In Appendix C the effect of the curvature near cutoff is considered. For an experimental investigation the "ideal" characteristic can be closely approximated by using the diode elements of a '55-type tube or its equivalent. With such a tube the μ becomes unity and the plate resistance in the region before cutoff is small.

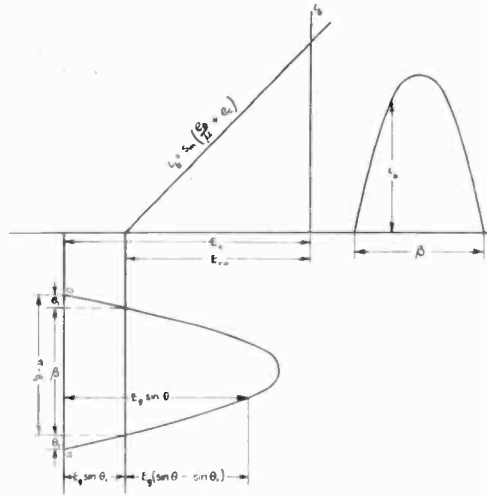

Fig. 1

The voltage and current relationships are assumed as shown in Fig. 1. Current starts to flow at an angle θ_1 and continues to flow for an angle β during which time the grid voltage is above cutoff. This angle β which is designated as the pulse angle is related to the angle θ_1 by the expression

$$\beta = \pi - 2\theta_1. \tag{2}$$

From the diagram it is apparent that

$$\cos \frac{\beta}{2} = - \frac{E_c - E_{c0}}{E_g} \tag{3}$$

where,

E_{c0} = cutoff bias voltage

E_g = peak value of the grid-excitation voltage.

² W. L. Everitt, "Optimum operating conditions for class C amplifiers," Proc. I.R.E., vol. 22, pp. 152-176; February, (1934).

The problem of determining the magnitudes of the respective harmonics is essentially one of a Fourier analysis of partial sine waves. This analysis is given in Appendix A. The voltage components appearing across the resistive load in the plate circuit are

direct-current component

$$E_{0R} = \mu E_g \cdot \frac{R_L}{r_p + R_L} \cdot \frac{1}{\pi} \left[\sin \frac{\beta}{2} - \frac{\beta}{2} \cos \frac{\beta}{2} \right] \quad (4)$$

fundamental component

$$E_{1R} = \mu E_g \cdot \frac{R_L}{r_p + R_L} \cdot \frac{1}{\pi} \left[\frac{\beta}{2} - \frac{1}{2} \sin \beta \right] \quad (5)$$

odd harmonics

$$E_{nR} = \mu E_g \cdot \frac{R_L}{r_p + R_L} \cdot \frac{1}{\pi} \left[- \frac{\cos \frac{(n+1)\pi}{2} \sin \frac{(n+1)\beta}{2}}{n+1} + \frac{\cos \frac{(n-1)\pi}{2} \sin \frac{(n-1)\beta}{2}}{n-1} - \frac{2}{n} \sin \frac{n\pi}{2} \cos \frac{\beta}{2} \sin \frac{n\beta}{2} \right] \quad (6)$$

even harmonics

$$E_{nR} = \mu E_g \cdot \frac{R_L}{r_p + R_L} \cdot \frac{1}{\pi} \left[\frac{\sin \frac{(n+1)\pi}{2} \sin \frac{(n+1)\beta}{2}}{n+1} - \frac{\sin \frac{(n-1)\pi}{2} \sin \frac{(n-1)\beta}{2}}{n-1} - \frac{2}{n} \cos \frac{n\pi}{2} \cos \frac{\beta}{2} \sin \frac{n\beta}{2} \right] \quad (7)$$

in which n is the order of the harmonic and E_{nR} is expressed in the same units as E_g .

Experimental Results

The arrangement of the apparatus used in the experimental investigations is shown in Fig. 2. The General Radio wave analyzer, having an input impedance of 10 megohms, was used to measure the magnitudes of the harmonic voltages developed across the load impedance. An excitation voltage of 20 volts effective value was used. The diode elements of a '55-type tube were used in the experimental work because of the close approach of the resulting voltage-current

characteristic to that of the linear case. It is quite obvious that the results obtained with the diode are equally applicable to any device having a similar volt-ampere characteristic, such, for instance, as the grid-voltage—plate-current characteristic of the multielement tube.

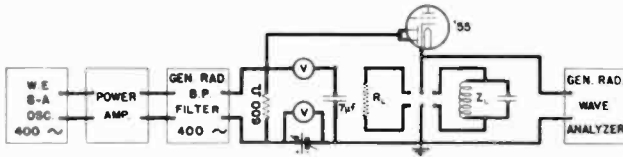

Fig. 2

The theoretical and experimental values for the various component voltages developed in the plate circuit across the load resistance are shown in Figs. 3, 4, and 5. On these curves all values have been

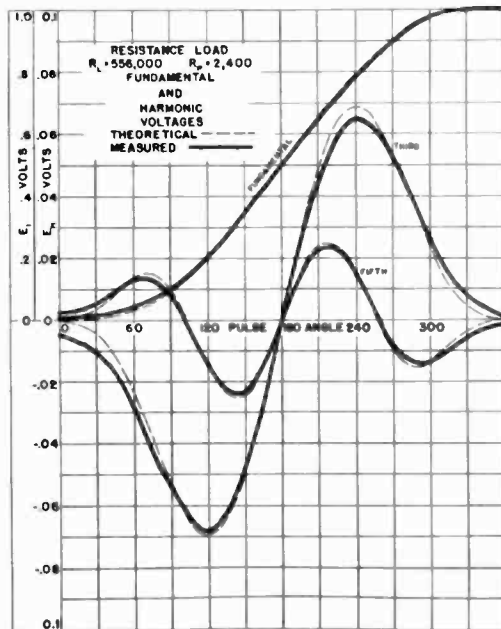

Fig. 3

reduced to unit excitation voltage. For a triode the values as given by these curves would be multiplied by the amplification factor of the tube and by the effective value of the grid-excitation voltage. Since the harmonic output voltage is directly proportional to the excitation, the reduction to unit excitation voltage makes convenient

the determination of the harmonic output if the excitation is varied in some predetermined manner. In the practical operation of a vacuum tube the grid-excitation voltage is often limited by one or more of the following considerations: (1) the amount by which the grid may be

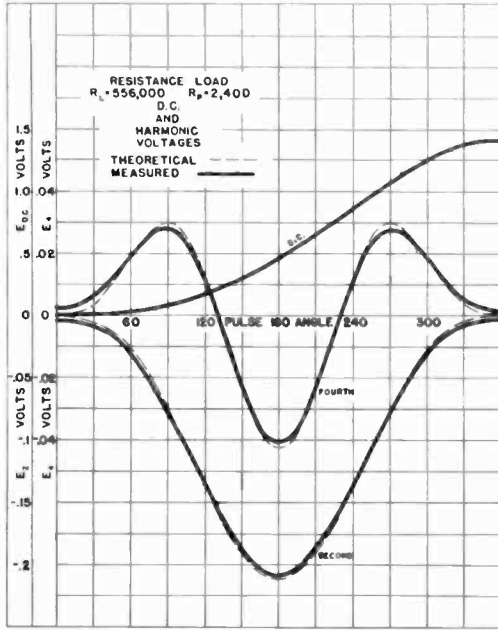

Fig. 4

driven positive, (2) the maximum permissible peak plate current, (3) the maximum allowable plate loss, (4) the maximum possible voltage available from the driving source. Examples wherein the grid excitation is varied so as to meet first, the condition of (1) above, and second, the condition of (4) above are given in Part II.

The small departure of the experimental results from the theoretical is due to the curvature of the tube characteristic near cutoff. The effect of this slight curvature is to extend cutoff over into the theoretically inactive region. As would be expected then, the departure of the experimental from the theoretical is most pronounced in the vicinity of zero angle of current flow. This region, since the magnitudes of the various harmonic components are small, is not one of importance in practical harmonic generation. In addition, this curvature reduces the magnitude of the maximum value of harmonic voltage that could be developed by the ideal characteristic.

The odd harmonics all pass through zero at a pulse angle of 180 degrees, which is the point of symmetry for all of the harmonics. The even harmonics have a maximum value at this same pulse angle. The magnitude of any given harmonic goes through a series of $n-1$ maxima

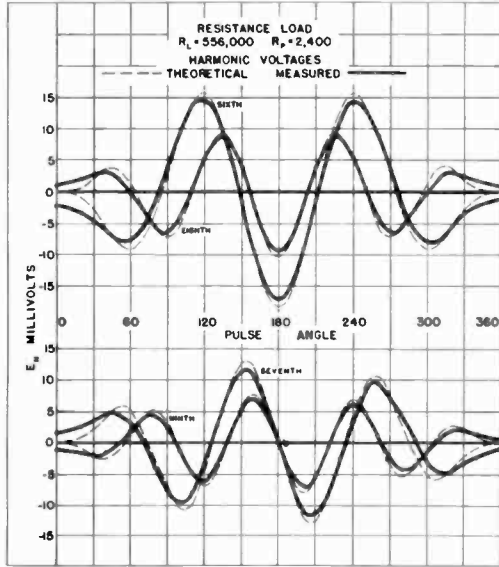

Fig. 5

as the pulse angle is continuously increased from 0 to 360 degrees. The pulse angles at which these maxima occur are defined by

$$\beta' = \frac{n \pm k}{n} \pi \tag{8}$$

where k takes on the values

- 1, 3, 5, 7, . . . for the odd harmonics
- 0, 2, 4, 6, . . . for the even harmonics.

The choice of k in (8) is restricted to such values as will limit β' to the interval

$$0^\circ < \beta' < 360^\circ.$$

The magnitude of any one of these maxima is

$$E_n = \left| \mu E_0 \frac{R_L}{r_p + R_L} \frac{1}{\pi} \left(\frac{2}{n^2 - 1} \right) \sin \frac{\beta}{2} \right| \tag{9}$$

Examination of the curves for any of the harmonics shows the predicted number of maxima. From (9) it will be noted that the en-

velope of these maxima is a sine function of the angle $\beta'/2$. Consequently, the maximum maximum occurs for the pulse angle β' which lies nearest to 180 degrees. Equation (9) indicates that the higher-harmonic voltages vary inversely as the square of the order of the harmonic. It is evident that the available harmonic voltage diminishes rapidly with the order of the harmonic.

PART II TUNED LOAD

Theoretical Discussion

A suitable tuned impedance in the plate circuit, tuned to a particular harmonic, discriminates against all undesired components. It may also increase the value of the desired harmonic voltage over that which would be developed across a pure resistance load. As in the previous case, an "ideal" characteristic will be assumed, i.e., a linear relation between plate current and equivalent grid voltage. It is further assumed that the plate-circuit load presents a pure resistance to the desired harmonic and a negligible impedance to all other components of plate current.

The expression for the harmonic voltage appearing across the tuned circuit is developed in Appendix B. This voltage is

$$E_n = \frac{E_{nR}}{R_L + \frac{r_p}{\pi} \left[\frac{\beta}{2} + \frac{1}{n} \sin \frac{n\beta}{2} \cos \frac{n\beta}{2} \right]} \quad (10)$$

where E_{nR} is the corresponding harmonic voltage that would be developed across a pure resistance of large value (large in comparison with the tube plate resistance) placed in the plate circuit. The expressions for E_{nR} are given by (6) and (7). R_L denotes the antiresonant resistance of the tuned circuit.

It is to be noted from (10) that E_n is related to E_{nR} by a simple factor. This single factor, which is the ratio of E_n/E_{nR} , and is termed in this paper the "step-up effect," makes it possible to apply the results obtained for the case of the resistive load directly to the case of the tuned-circuit load. For the pulse angles which result in maximum values of harmonic voltages the quantity

$$\frac{1}{n} \sin \frac{n\beta}{2} \cos \frac{n\beta}{2}$$

is at, or very near to, zero and for a first approximation may be neglected. The "step-up effect" then becomes

$$\frac{E_n}{E_{nR}} = \frac{1}{\frac{r_p}{R_L} + \frac{\beta'}{2\pi}} \tag{11}$$

where, as before, β' is the particular pulse angle at which a maximum occurs for the harmonic under consideration.

In the case of the resistive load, it was pointed out that the maximum maximum occurred at the pulse angle β' nearest to 180 degrees. For the tuned load, however, the "step-up effect" increases as β' is decreased and hence, one of the other maxima might be the largest, depending upon the value of the ratio of plate-to-load resistance. Experimentally, this is shown to be the case by the curve of Fig.

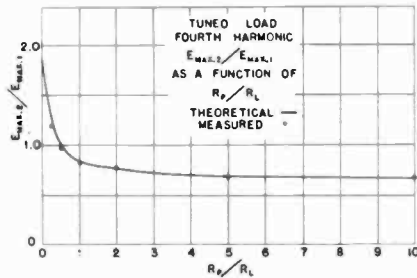

Fig. 6

6, which is a plot of the ratio of the maximum fourth harmonic that occurred for a pulse angle of approximately 90 degrees to that which occurred at 180 degrees. As the ratio of plate-to-load resistance becomes very large the ratio of the two maxima approaches that obtained with a pure resistive load.

The envelope of the maxima followed a sine curve for the pure resistive load (equation (8)). For the tuned circuit, however, the approximate form of the envelope is given by the expression

$$A = \frac{\sin \frac{\beta}{2}}{\frac{r_p}{R_L} + \frac{\beta}{2\pi}} \tag{12}$$

A series of such envelopes with r_p/R_L as a parameter are plotted in Fig. 7. On this same figure in dotted lines is shown the form of the envelope of the maxima for the case of the resistive load. These envelopes indicate the departure from symmetry about the 180-degree

point as the ratio of plate-to-load resistance is decreased in value. From this series of curves, for any given pulse angle β' , the ratio of the particular harmonic voltage obtained with the tuned load to that obtained with a large pure resistive load (large in comparison with the plate resistance of the tube) is given very nearly by the ratio of the ordinates of the solid and dotted curves corresponding to this particular pulse angle and ratio of plate-to-load resistance.

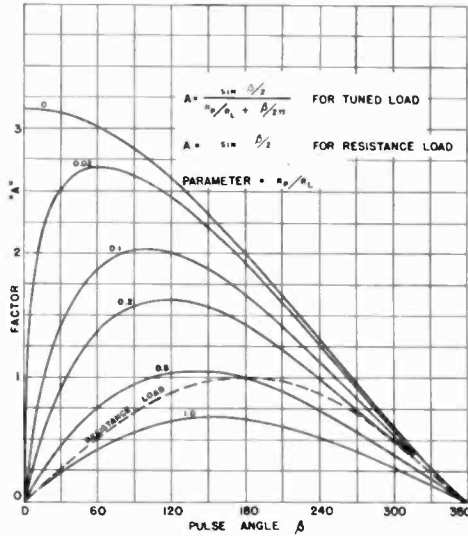

Fig. 7

In Table I are tabulated the pulse angles β' at which the maxima occur, for harmonics up to and including the ninth, for the resistance case. In the case of the tuned circuit, each of these values of β' are shifted slightly towards a smaller pulse angle. For a *first approxima-*

TABLE I

n	VALUES OF β' .							
2	180							
3	120	240						
4	90	180	270					
5	72	144	216	288				
6	60	120	180	240	300			
7	51.4	102.9	154.3	205.7	257.2	308.6		
8	45	90	135	180	225	270	315	
9	40	80	120	160	200	240	280	320

tion, however, this shift may be neglected. From Table I and the curves of Fig. 7, the "step-up effect" for any particular harmonic and ratio of r_p/R_L can be determined. For a given ratio of plate-to-load resistance, this "step-up effect" would be equal to the ratio of the maximum ordinate corresponding to a β' for a particular harmonic and to the maximum ordinate corresponding to a β' for the resistive case. Neglecting the shift of β' introduces an error in the "step-up effect"

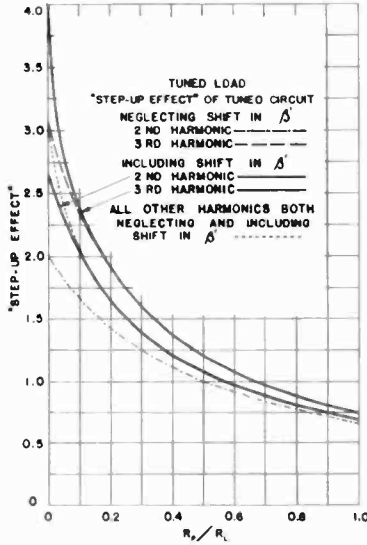

Fig. 8

as determined by this method. The percentage error is greatest for the second and third harmonics and for small ratios of plate-to-load resistance. The curves of Fig. 8 show the "step-up effect" both neglecting and including the shift in β' . For all harmonics above the third the error due to neglecting the shift in β' is negligible.

Experimental Results

The measured magnitudes of the third-harmonic voltage developed across a tuned load are shown for two different ratios of plate-to-load resistance in Fig. 9. The theoretical magnitudes are shown dotted. The lack of complete symmetry about the 180-degree pulse angle is quite apparent. As indicated by the curves of Fig. 7, all the harmonics will have a maximum value for pulse angles less than 180 degrees.

The importance of the ratio of plate-to-load resistance is evident from the curve of Fig. 10. On this same figure are shown the pulse angles at which the maximum harmonic voltage occurs. It will be

noted that for large ratios of plate-to-load resistance that the pulse angle approaches that obtained for the resistive case.

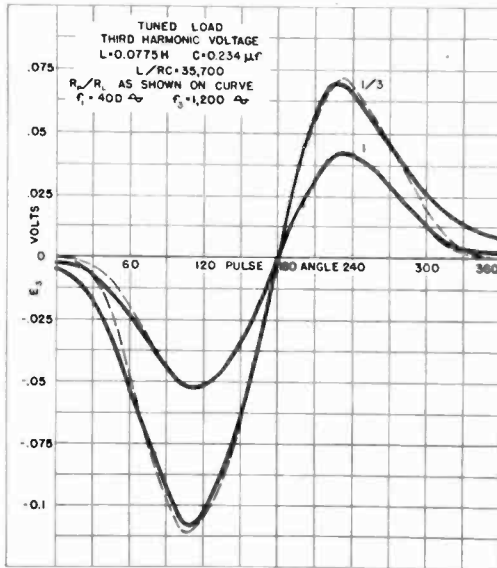

Fig. 9

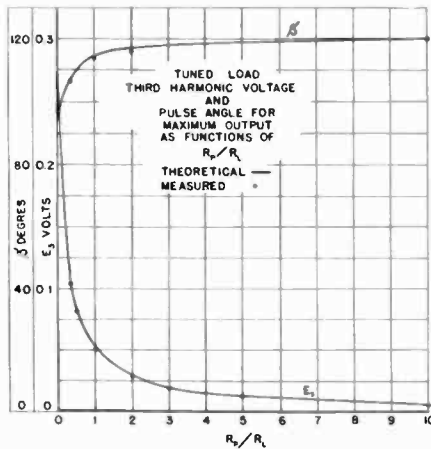

Fig. 10

In the preceding analysis the excitation voltage was considered constant. The results are, therefore, directly applicable when a limited excitation voltage is available. A typical example of this is the lightly loaded low-level crystal oscillator followed by a frequency doubler or

tripler. However, since the harmonic output is directly proportional to the excitation voltage, it is a simple matter to determine the harmonic output if the excitation voltage is varied in some predetermined manner. In the practical operation of class B amplifiers, class C amplifiers, or harmonic generators, the limit of grid excitation is often determined by the maximum permissible positive grid swing. Such limitations are discussed in detail in an article that has appeared previously¹. Denoting by E_+ the permissible amount by which the grid may be allowed to swing positive, the peak grid voltage measured

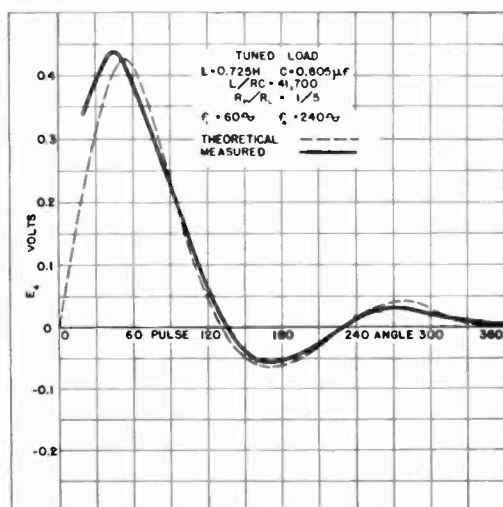

Fig. 11

from cutoff is $E_+ - E_{c0}$. The grid-excitation voltage and angle of current flow are related to the peak grid voltage by the expression

$$E_g \left(1 - \cos \frac{\beta}{2} \right) = E_+ - E_{c0} = \text{constant}. \quad (13)$$

Both the grid excitation and the grid bias must be varied in order to maintain this relation. Substituting the value of excitation voltage, as defined by (13), into the previously derived expressions, gives the harmonic components that can be obtained under these conditions of operation.

The experimental and theoretical results are shown by the curves of Fig. 11, for the fourth harmonic, under the conditions just mentioned. The values of bias and grid-excitation voltage necessary to obtain pulse angles of less than 25 degrees were physically unrealizable.

In plotting these curves, all values were reduced to an excitation voltage of one volt effective for β equal to 180 degrees; i.e., such that $E_+ - E_{c0} = \sqrt{2}$.

Symbols

The following notation has been used throughout the present paper. Where possible, conformity to the recommended symbols has been maintained.³

- μ = amplification factor.
- s_m = grid-plate transconductance.
- r_p = plate resistance.
- R_L = load resistance.
- E_b = quiescent value of plate voltage.
- E_c = grid-bias voltage.
- E_{c0} = cutoff grid-bias voltage.
- E_θ = peak value of varying component of grid voltage.
- E_n = n th harmonic voltage developed across the tuned load.
- E_{nR} = n th harmonic voltage developed across the resistive load.
- e_b = instantaneous total plate voltage.
- e_c = instantaneous total grid voltage.
- e_θ = instantaneous value of varying component of grid voltage.
- I_n, I_n' = peak value of the n th harmonic current.
- i_b = instantaneous total plate current.
- n = order of the harmonic.
- θ_1 = angle at which plate current starts to flow (see Fig. 1).
- β = angle during which plate current flows (see Fig. 1).
- β' = particular values of β for which a maximum voltage, of the n th harmonic, is developed.

In derivations appearing in the following appendixes, the assumption is made that operation is over a linear characteristic.

APPENDIX A

Resistance Load

During that portion of the grid-excitation voltage cycle when plate current flows, the net equivalent voltage acting in the plate circuit is positive and is

$$\mu E_\theta (\sin \omega t - \sin \theta_1).$$

The resulting plate current consists of partial sine waves which can be expressed by the usual Fourier series.

³ "Report of the Standards Committee of the I.R.E.," (1933).

$$i_b = I_0 + I_1 \sin \omega t + I_2 \sin 2\omega t + \dots + I_n \sin n\omega t \\ + I_1' \cos \omega t + I_2' \cos 2\omega t + \dots + I_n' \cos n\omega t$$

where,

$$I_0 = \frac{\mu E_g}{r_p + R_L} \cdot \frac{1}{2\pi} \int_{\theta_1}^{\pi - \theta_1} (\sin \omega t - \sin \theta_1) d(\omega t) \\ = \frac{\mu E_g}{r_p + R_L} \cdot \frac{1}{\pi} \left[\cos \theta_1 - \left(\frac{\pi}{2} - \theta_1 \right) \sin \theta_1 \right] \\ I_n = \frac{\mu E_g}{r_p + R_L} \cdot \frac{1}{\pi} \int_{\theta_1}^{\pi - \theta_1} [\sin \omega t \sin n\omega t - \sin \theta_1 \sin n\omega t] d(\omega t).$$

Since this integral is equal to 0 for even values of n , only odd harmonics are present in the sine terms. Performing the indicated integration there results

fundamental

$$I_1 = \frac{\mu E_g}{r_p + R_L} \cdot \frac{1}{\pi} \left[\left(\frac{\pi}{2} - \theta_1 \right) - \frac{1}{2} \sin 2\theta_1 \right]$$

odd harmonics

$$I_n = \frac{\mu E_g}{r_p + R_L} \cdot \frac{1}{\pi} \left[\frac{\sin (n+1)\theta_1}{n+1} - \frac{\sin (n-1)\theta_1}{n-1} - \frac{2}{n} \sin \theta_1 \cos n\theta_1 \right].$$

For the cosine coefficients

$$I_n' = \frac{\mu E_g}{r_p + R_L} \cdot \frac{1}{\pi} \int_{\theta_1}^{\pi - \theta_1} (\sin \omega t \cos n\omega t - \sin \theta_1 \cos n\omega t) d(\omega t).$$

This integral is 0 for odd values of n , consequently only even harmonics are present in the cosine terms.

even harmonics

$$I_n' = \frac{\mu E_g}{r_p + R_L} \cdot \frac{1}{\pi} \left[\frac{\cos (n+1)\theta_1}{n+1} - \frac{\cos (n-1)\theta_1}{n-1} + \frac{2}{n} \sin \theta_1 \sin n\theta_1 \right].$$

The voltage developed across the load resistance, R_L is $i_b R_L$. Since θ_1 can be expressed in terms of the angle of current flow (equation (2) of the text), the final equations ((4), (5), (6), and (7) of the text) can be obtained by direct substitution.

The grid bias for any desired value of θ_1 is

$$E_c = E_{c0} - E_g \sin \theta_1.$$

The derivatives of I_n and I_n' with respect to θ_1 equated to zero give the values of θ_1 for which the harmonic maxima occur. These maxima occur at values of θ_1 such that $\pm n\theta_1 = \pi/2, 3\pi/2, \dots [(2n-1)\pi]/2$ for the odd harmonics and $\pm n\theta_1 = 0, \pi, 2\pi, \dots n\pi$ for the even harmonics. For these values of $n\theta_1$, both I_n and I_n' are given by the expression

$$\frac{\mu E_g}{r_p + R_L} \cdot \frac{1}{\pi} \left(\frac{2}{n^2 - 1} \right) \cos \theta_1.$$

Expressing θ_1 in terms of β , (8) and (9) of the text are obtained.

APPENDIX B

Tuned Load

It will be assumed that the tuned impedance in the plate circuit is a pure resistance R_L at the desired harmonic frequency and offers a negligible impedance to all other components of current. The total instantaneous plate voltage will then be

odd harmonics

$$e_b = E_b - I_n R_L \sin n\omega t$$

even harmonics

$$e_b = E_b - I_n' R_L \cos n\omega t.$$

The total grid voltage e_c is

$$e_c = E_c + E_g \sin \omega t.$$

Assuming a linear relation, as shown in Fig. 1, the expression for the plate current is

$$i_b = s_m \left(e_c + \frac{e_b}{\mu} \right).$$

This becomes, for the odd harmonics,

$$i_b = s_m \left[E_c + E_g \sin \omega t + \frac{E_b}{\mu} - \frac{I_n R_L}{\mu} \sin n\omega t \right].$$

Plate current starts to flow at an angle θ_1 and the net positive voltage will be such that

$$i_b = s_m \left[E_g (\sin \omega t - \sin \theta_1) - \frac{I_n R_L}{\mu} \sin n\omega t \right].$$

Evaluating the Fourier coefficients

$$\begin{aligned}
 I_n &= \frac{1}{\pi} \int_{\theta_1}^{\pi-\theta_1} i_b \sin n\omega t \, d(\omega t) \\
 &= \frac{s_m}{\pi} \int_{\theta_1}^{\pi-\theta_1} E_v (\sin \omega t - \sin \theta_1) \sin n\omega t \, d(\omega t) \\
 &= \frac{1 + \frac{s_m}{\pi} \int_{\theta_1}^{\pi-\theta_1} \frac{R_L}{\mu} \sin^2 n\omega t \, d(\omega t)}{1 + \frac{s_m}{\pi} \int_{\theta_1}^{\pi-\theta_1} \frac{R_L}{\mu} \sin^2 n\omega t \, d(\omega t)}
 \end{aligned}$$

The voltage developed across the plate load will be $I_n R_L$ and since $s_m = \mu/r_p$, the harmonic voltage becomes

$$E_n = \frac{\mu E_v \frac{1}{\pi} \int_{\theta_1}^{\pi-\theta_1} (\sin \omega t \sin n\omega t - \sin \theta_1 \sin n\omega t) d(\omega t)}{\frac{r_p}{R_L} + \frac{1}{\pi} \int_{\theta_1}^{\pi-\theta_1} \sin^2 n\omega t \, d(\omega t)}$$

The value of the integral in the numerator of this expression has been given in Appendix A. Evaluating the integral in the denominator and substituting the results of Appendix A, the harmonic voltage becomes

odd harmonics

$$E_n = \frac{E_{nR}}{\frac{r_p}{R_L} + \frac{1}{\pi} \left[\left(\frac{\pi}{2} - \theta_1 \right) + \frac{1}{n} \sin n\theta_1 \cos n\theta_1 \right]}$$

where E_{nR} is the corresponding harmonic voltage that would be developed across a pure resistance of large value (large in comparison with the tube plate resistance) placed in the plate circuit. The expression for E_{nR} is given by (6) of the text.

A similar procedure is followed for the even harmonics and results in the expression

even harmonics

$$E_n = \frac{E_{nR}}{\frac{r_p}{R_L} + \frac{1}{\pi} \left[\left(\frac{\pi}{2} - \theta_1 \right) - \frac{1}{n} \sin n\theta_1 \cos n\theta_1 \right]}$$

where E_{nR} is given by (7) of the text.

Expressing θ_1 in terms of the pulse angle β (10) of the text is obtained.

The grid bias necessary for any desired value of θ_1 is
odd harmonics

$$E_c = E_{c0} - E_g \sin \theta_1 + E_n \sin n\theta_1$$

even harmonics

$$E_c = E_{c0} - E_g \sin \theta_1 + E_n \cos n\theta_1.$$

APPENDIX C

The relation between the plate current and the grid voltage of a vacuum tube during the conducting period is in general not linear. The plate current is instead proportional to the n th power of the grid volt-

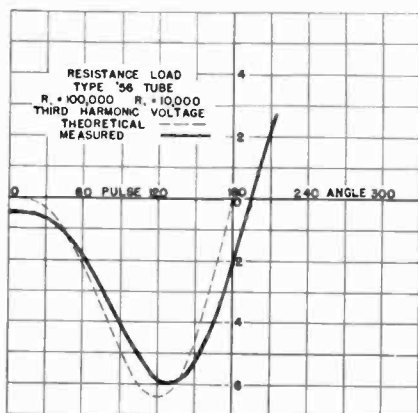

Fig. 12

age. The magnitude of n usually lies between one and two, its value changing with the value of load impedance. A consideration of the linear and of the square-law relations would therefore cover the complete range of possible operation for all tubes and loads. The mathematical treatment for the square-law case by means of the Fourier analysis leads to a quadratic involving integral functions. While this quadratic can be evaluated, the expressions become so involved and unwieldy that they have been considered as impracticable for inclusion in this paper. However, the effect of the curvature near cutoff can be considered without recourse to an involved mathematical treatment.

In practice the operation extends over a large portion of the characteristic, the greater part of which is linear. As previously pointed out in this paper, the curvature near cutoff decreases the maximum value of any particular harmonic below that which could be obtained with a strictly linear characteristic. This curvature also results in a change

of the pulse angle at which a maximum harmonic voltage is obtained. These effects are shown by the curves of Fig. 12. The solid curve shows the measured values of the third-harmonic voltage as measured across the plate load of a '56-type tube. The dashed curve shows the theoretically computed values assuming a linear characteristic.

The departure of the experimental from the theoretical, due to the curvature of the characteristic near cutoff, can be understood from a consideration of the Fourier analysis as illustrated in Fig. 13. In this figure, three different conditions for the analysis of the third harmonic

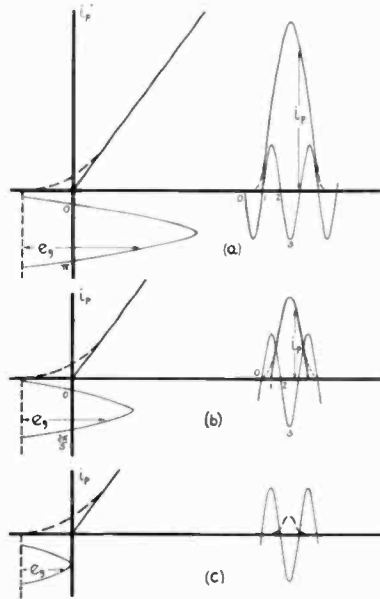

Fig. 13

have been illustrated. Based on the ideal characteristic the three conditions correspond to (A) 180-degree pulse angle, (B) 120-degree pulse angle (the angle of theoretical maximum third harmonic), and (C) 0-degree pulse angle.

The third-harmonic current is given by the expression

$$i_3 = \frac{1}{\pi} \int_0^{2\pi} i_p \sin 3\theta d\theta.$$

Referring to Fig. 13(a) it is seen that for the *ideal* characteristic this integral is equal to 0. This is true since the integral between the points 0 and 1 is 0 ($i_p=0$ over this region) and the integral between points 1 and 2 is equal to the negative value of the integral between

points 2 and 3. The curvature, however, gives the integral between the point 0 and 1 a negative value instead of 0. The result is that i_3 has a negative value for the conditions shown in Fig. 13(a). It is thus apparent why the measured value of third harmonic has a negative value for a pulse angle of 180 degrees as shown by the experimental curve of Fig. 12.

From Fig. 13(b) it can be noted that for the ideal characteristic the integral between the points 0 and 1 is 0, the integral between the points 1 and 2 is positive, and the integral between the points 2 and 3 is negative. Since the integral between points 2 and 3 is greater in magnitude than the integral between points 1 and 2, the resultant magnitude of i_3 is negative. It is apparent that the effect of the curvature is to give a positive value to the integral between the points 0 and 1 and hence decreases the magnitude of the resultant negative value of the third-harmonic current.

The presence of a small pulse of plate current as shown in Fig. 13(c) results in the presence of a small amount of third-harmonic current.

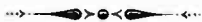

ON SINGLE AND COUPLED TUNED CIRCUITS HAVING CONSTANT RESPONSE-BAND CHARACTERISTICS*

BY

HO-SHOU LOH

(Purdue University, Lafayette, Indiana)

Summary—The gain characteristic of a two-stage amplifier, one stage of which works into coupled tuned circuits while the other works into a single tuned circuit, is discussed. It is shown that this combination is capable of giving a flat response over a satisfactory band of frequencies and that the required circuit constants are easily computed.

A VERY simple means of obtaining a constant response throughout the band of an amplifier may be realized by a cascade arrangement of two stages, with one of them working into a coupled tuned circuit, and the other into a single tuned circuit, as shown in Fig. 1. As is well known, the coupled-circuit stage can be

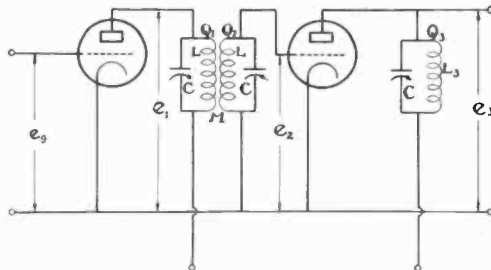

Fig. 1—The general scheme.

made to yield a gain curve having a valley in the center. With proper proportioning, the peak of the single circuit can be made to fill up this valley without material sacrifice of band width.

The analysis of the coupled-circuit stage may be based on Aiken's paper¹ and gives for the gain

$$A_1 = \frac{e_2}{e_3} = \frac{g_{m1} X_c^2 s}{\sqrt{R_1 R_2} \left[(1+s^2)^2 - 2 \left(s^2 - \frac{b}{2} \right) Q_1 Q_2 F^2 + Q_1^2 Q_2^2 F^4 \right]^{1/2}} \quad (1)$$

* Decimal classification: R363.1. Original manuscript received by the Institute, July 26, 1937; revised manuscript received by the Institute, November 1, 1937.

¹ C. B. Aiken, "Two-mesh coupled tuned circuits," Proc. I.R.E., vol. 25, pp. 230-272; February, (1937).

where,

g_{m1} = transconductance of the first tube

$$s = \frac{\omega M}{\sqrt{R_1 R_2}}$$

$$b = \frac{R_2}{R_1} + \frac{R_1}{R_2}$$

$$Q_1 = \frac{X_{0L}}{R_1} \quad Q_2 = \frac{X_{0L}}{R_2}$$

$$F = \frac{2\Delta f}{\omega f}$$

In a similar way analysis of the single-circuit stage gives the gain

$$A_2 = \frac{e_3}{e_2} = \frac{g_{m2} Q_3 X_{L3}}{\sqrt{1 + F^2 Q_3^2}} \quad (2)$$

The over-all gain $A_1 A_2$ is the product of the individual gains and may be written in terms of Q_1

$$y = \frac{2sn\sqrt{m}Q_1^2}{\sqrt{(1+s^2)^2 + \left[(1+s^2)^2 n^2 - 2\left(s^2 - \frac{b}{2}\right)m \right] Q_1^2 F^2 + \left[m - 2\left(s^2 - \frac{b}{2}\right)n^2 \right] m Q_1^4 F^4 + m^2 n^2 Q_1^6 F^6}} \quad (3)$$

where,

$$y = \frac{2A_1 A_2}{g_{m1} g_{m2} X_C X_{L3}}$$

$$m = \frac{Q_2}{Q_1}$$

$$n = \frac{Q_3}{Q_1}$$

The maxima and minima of the gain curve may be found by differentiating (3) with respect to F and setting the result equal to zero. This operation gives for the corresponding frequencies

$$F = 0 \quad (4)$$

and

$$\left[(1 + s^2)^2 n^2 - 2 \left(s^2 - \frac{b}{2} \right) m \right] + 2m \left[m - 2 \left(s^2 - \frac{b}{2} \right) n^2 \right] Q_1^2 F^2 + 3m^2 n^2 Q_1^4 F^4 = 0. \quad (5)$$

The positions of the valleys and peaks in the band is thus seen to be symmetrical with respect to the center, where $F=0$. The gain at the center is, from (3) and (4),

$$y_0 = 2s\sqrt{m} \frac{nQ_1^2}{1 + S^2}. \quad (6)$$

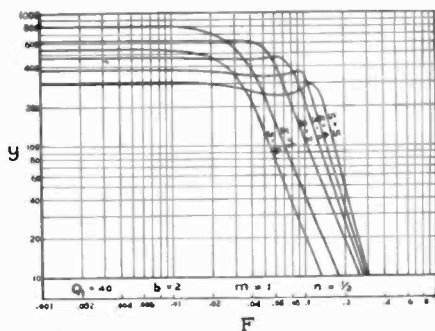

Fig. 2—General resonance curve of the scheme with equal coupled-circuit resistances.

For a broad band, this same gain should be obtained at the frequencies of the peaks. To find the relations needed to accomplish this, substitute (6) for the gain in the general expression (3) and solve simultaneously with (5). The result is

$$n = \frac{m}{m + 1}. \quad (7)$$

General characteristics of the combined tuned circuits are shown in Figs. 2 and 3. In Fig. 2 the resistances in the two coupled circuits are equal while in Fig. 3 they are unequal. As the coupling s increases, the gain goes through a maximum for a value of s equal to unity. For greater couplings the gain decreases, but the band width continues to increase, while the gain remains reasonably flat up to moderately wide bands. The unequal resistance condition of Fig. 3 is seen to be superior to the equal resistance condition of Fig. 2.

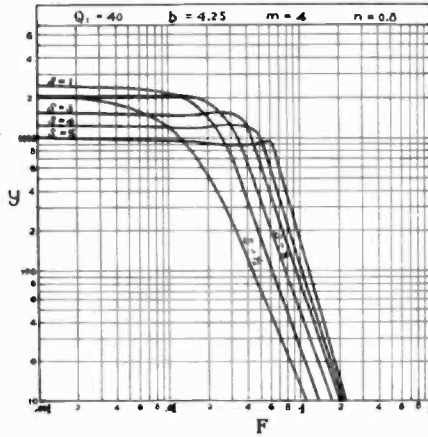

Fig. 3—General resonance curves of the combined scheme with unequal resistances for the coupled circuit.

In Figs. 4 and 5 the effect of the Q 's of the various circuits is illustrated for two values of coupling. When the curves are reduced to a common gain basis by the relation

$$Z = \frac{y}{n\sqrt{m}Q_1^2} \tag{8}$$

the effect on the band width is demonstrated, as may be seen by reference to Fig. 6. The required Q for a given band width may be found

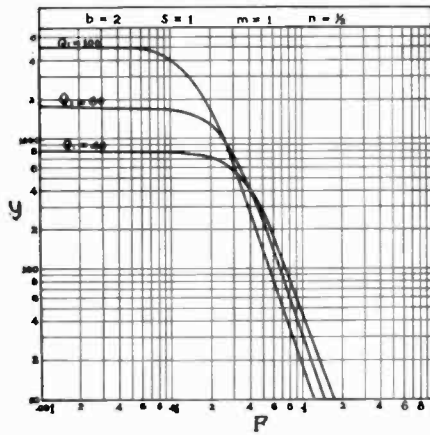

Fig. 4—Comparison of y for different values of Q_1 at the critical coupling.

by differentiating (8) with respect to Q_1 which results in the formula

$$Q_1 = \frac{1}{\sqrt{3F}} \left[2 \left(s^2 - \frac{b}{2} \right) - \frac{m}{n^2} \right] \pm \sqrt{\left[\frac{m}{n^2} - 2 \left(s^2 - \frac{b}{2} \right) \right]^2 - 3 \left[(1 + s^2)^2 - 2 \left(s^2 - \frac{b}{2} \right) \frac{m}{n^2} \right]} \quad (9)$$

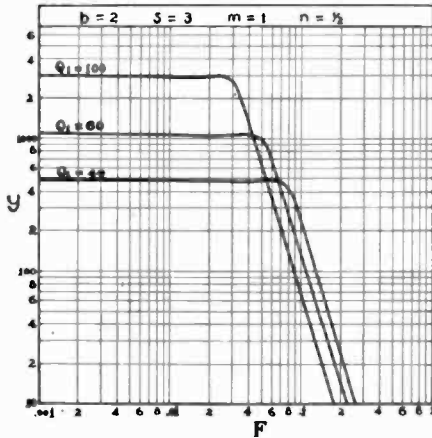

Fig. 5—Comparison of y with different values of Q_1 above critical coupling.

In the use of this relation, m and n may be roughly estimated as the effect on Q is not critical. Final adjustment may be made by altering the coupling.

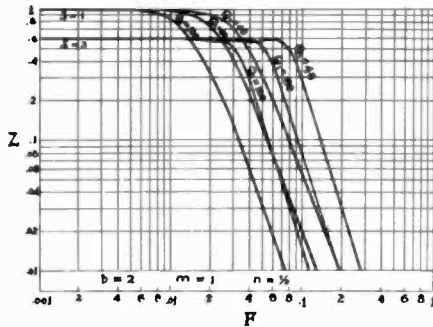

Fig. 6—Effect of Q on band width.

In regard to the coupling, it is interesting to note that the transition from curves with a single peak to those with three peaks does not occur for the value $s=1$ (usually called critical coupling) but for a somewhat larger value. This value may be found from (5) by placing

F' equal to zero. The result, termed as "transmutational coupling," may be written with the aid of (7)

$$s' = \sqrt{b + 1}. \quad (10)$$

When the actual coupling exceeds this value but slightly, the depression in the valleys will naturally be very small.

To sum up, the procedure for circuit design is as follows: Knowing the desired band width, and the resonant frequency, find the required Q from (9), taking into consideration the desired gain (6), the re-

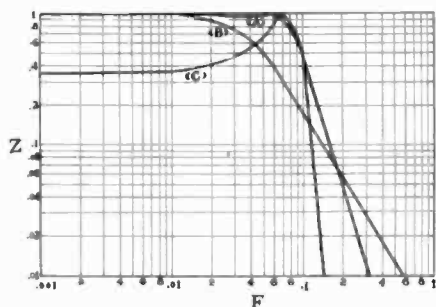

Fig. 7—Comparison of the relative response.

- (A) The combined scheme.
- (B) Two stages of single tuned circuits.
- (C) Two stages of coupled tuned circuits.

quired relation between the Q 's, (7), and the "transmutational coupling" (10). For comparison, Fig. 7 shows the response of the combined-circuit amplifier together with that from two stages of coupled circuits and also from two stages of single circuits. In all three cases the conditions assumed are

$$Q_1 = Q_2 = 40 \quad Q_3 = 20 \quad s = 3 \quad b = 2.$$

ACKNOWLEDGMENT

The author wishes to thank Dr. C. B. Aiken of Purdue University for his kindness in checking the analysis made in this paper.



ARMSTRONG'S FREQUENCY MODULATOR*

BY

D. L. JAFFE

(Marcellus Hartley Laboratory, Department of Electrical Engineering, Columbia University,
New York, N.Y.)

Summary—When the side bands of an amplitude-modulated signal are shifted 90 degrees and then recombined with the carrier, a frequency-modulated carrier results. In this paper the order and magnitudes of the distortion components of such a frequency-modulated carrier are quantitatively determined assuming an idealized receiver. It is found that this type of distortion will be negligibly small after frequency multiplication to obtain the desired carrier frequency.

FUNDAMENTAL CONSIDERATIONS

Consider a voltage

$$e = E \sin \phi \quad (1)$$

where,

e = instantaneous value

E = maximum value

ϕ = instantaneous angle.

Then the instantaneous radian velocity ω is defined as

$$\omega = \frac{d\phi}{dt} \quad (2)$$

whence

$$\phi = \int \omega dt. \quad (3)$$

Thus we may write (1) as

$$e = E \sin \int \omega dt. \quad (4)$$

For a frequency-modulated voltage

$$\omega = \omega_0(1 + k_f \cos \lambda t) \quad (5)$$

where,

$\omega_0/2\pi$ = fixed frequency

k_f = fraction of fixed frequency that $\omega_0/2\pi$ is varied

$\lambda/2\pi$ = audio frequency.

* Decimal classification: R148. Original manuscript received by the Institute, September 13, 1937; revised manuscript received by the Institute, November 15, 1937.

Equation (4) now becomes

$$e = E \sin \int \omega_0(1 + k_f \cos \lambda t) dt \quad (6)$$

$$e = E \sin \left(\omega_0 t + \frac{k_f \omega_0}{\lambda} \sin \lambda t + C \right). \quad (7)$$

If we let $k_f \omega_0 / \lambda = m_f$ and $C = 0$ then we may write

$$e = E \sin (\omega_0 t + m_f \sin \lambda t). \quad (8)$$

Let

$$\phi_f(t) = (\omega_0 t + m_f \sin \lambda t)$$

then

$$e = E \sin \phi_f(t). \quad (9)$$

For systems of demodulation which depend upon the rate of change of $\phi_f(t)$, or the instantaneous frequency, it is necessary that $\phi_f'(t)$ have the same functional form as the modulation signal for amplitude-distortion-free transmission. Equations (8) and (9) are for an ideal case with a sinusoidal modulation signal. Thus

$$\begin{aligned} \phi_f'(t) &= \frac{d\phi_f(t)}{dt} = \frac{d}{dt} (\omega_0 t + m_f \sin \lambda t) \\ &= \omega_0 + m_f \lambda \cos \lambda t \end{aligned}$$

but

$$\begin{aligned} m_f &= k_f \omega_0 / \lambda \\ \therefore \frac{d\phi_f(t)}{dt} &= \omega_0 (1 + k_f \cos \lambda t) \end{aligned}$$

which evidently contains no harmonic terms.

ARMSTRONG'S SYSTEM

An ingenious method of producing a frequency-modulated carrier has been developed by Edwin H. Armstrong of Columbia University. His method involves shifting the side bands or carrier of an amplitude-modulated carrier 90 degrees and then recombining the translated components.

If we have an amplitude-modulated carrier,

$$V_a = E_0(1 + m_a \sin \lambda t) \sin \omega_0 t \tag{10}$$

where m_a is the per cent amplitude modulation. Upon expanding (10)

$$V_a = E_0 \sin \omega_0 t + m_a E_0 \sin \omega_0 \sin \lambda t. \tag{11}$$

Let $m_a E_0 = 2E_s$, where E_s is the amplitude of the two side bands, and suppose the side bands are shifted ± 90 degrees so that

$$V_p = E_0 \sin \omega_0 t \pm 2E_s \sin \lambda t \cos \omega_0 t. \tag{12}$$

We can rewrite (12) as

$$V_p = \sqrt{E_0^2 + (2E_s \sin \lambda t)^2} \sin \left[\omega_0 t \pm \tan^{-1} \left(\frac{2E_s}{E_0} \sin \lambda t \right) \right]. \tag{13}$$

Variations in the amplitude of the carrier can be smoothed out by means of a suitable current limiter.¹ We need therefore concern ourselves with the sinusoidal argument only. Equation (13) represents a phase-modulated carrier, but if E_s is made inversely proportional to the audio frequency, frequency modulation results.

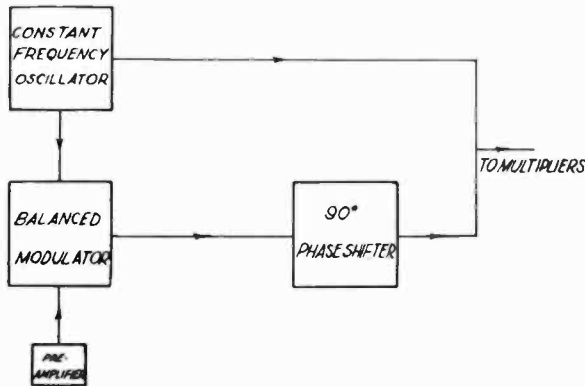

Fig. 1—Armstrong system of frequency modulation.

If the side bands are produced by a balanced modulator then $E_s = A_m E_m$ where E_m is the input voltage to the modulator and the output of some preamplifier. A_m is the absolute gain of the modulation circuit. Suppose $E_m = k/\lambda$ where k is a constant, then $E_s = A_m k/\lambda$. This may be accomplished by connecting across the output of the preamplifier a condenser in series with a suitable resistance and feeding the

¹ Refer to Bibliography.

voltage across the condenser to the balanced modulator. Thus the side-band voltage will be made inversely proportional to the audio frequency. If we write (13) setting

$$E_c = \sqrt{E_0^2 + (2E_s \sin \lambda t)^2}$$

$$E_s = A_m E_m = A_m k / \lambda$$

then

$$V_f = E_c \sin \left[\omega_0 t \pm \tan^{-1} \left(\frac{2A_m k}{E_0 \lambda} \sin \lambda t \right) \right]$$

$$V_f = E_c \sin \left[\omega_0 t \pm \tan^{-1} (p \sin \lambda t) \right] \quad (14)$$

where $p = 2A_m k / E_0 \lambda$.

Let

$$f(t) = \left[\omega_0 t \pm \tan^{-1} (p \sin \lambda t) \right]$$

then

$$V_f = E_c \sin f(t). \quad (15)$$

DISTORTION PRODUCED BY COMBINING SIDE BANDS AND CARRIER

As has been shown above, for distortionless transmission with a sinusoidal modulating signal, $df(t)/dt$ should contain no harmonics. It is here assumed that the carrier is of the form as given by (14); i.e., no distortion has been introduced between the combination of carrier and side bands and the demodulation system. Then

$$\frac{df(t)}{dt} = \omega_0 \pm \frac{p \lambda \cos \lambda t}{1 + p^2 \sin^2 \lambda t} \quad (16)$$

Remembering that

$$p = \frac{2A_m k}{E_0 \lambda}$$

$$\frac{df(t)}{dt} = \omega_0 \pm 2A_m \frac{k}{E_0} \frac{\cos \lambda t}{1 + p^2 \sin^2 \lambda t} \quad (17)$$

Referring to (14) and (16) it will be seen that the maximum angular shift is determined by p . Equation (17) shows that the demodulation products will have amplitude distortion only.

Fourier analysis of the term

$$\frac{\cos \lambda t}{1 + p^2 \sin^2 \lambda t}$$

reveals that there are only odd harmonics whose amplitude may be expressed as follows:

$$A_n = \frac{2}{p^{n+1}} (\sqrt{1 + p^2} - 1)^n \tag{18}$$

where,

- A_n = magnitude of the nth harmonic
- p = arc tangent of the maximum angular shift.

In Fig. 2 the harmonic magnitudes and per cent harmonic in terms of the fundamental have been plotted for values of p between 0 and 1. Fig. 3 gives the per cent harmonic in terms of the fundamental for

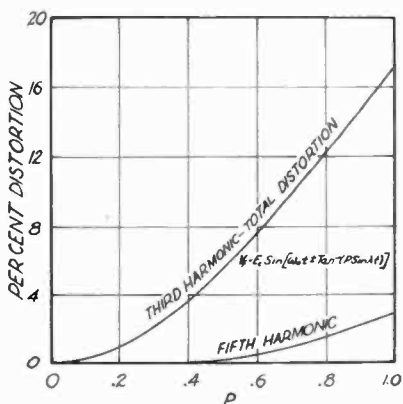

Fig. 2—Per cent distortion versus p .

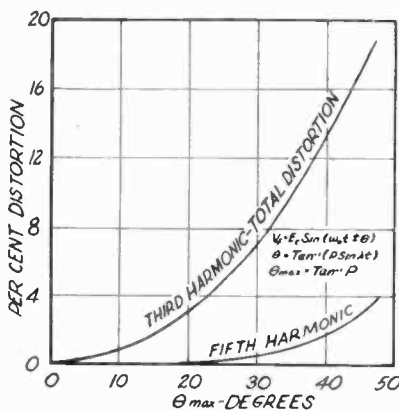

Fig. 3—Per cent distortion versus maximum phase shift in degrees.

values of arc tangent of p up to 45 degrees. Since the 5th harmonic is very small compared to the 3rd, the per cent total distortion is practically equal to the per cent 3rd harmonic.

Equation (17) shows p to be inversely proportional to λ . Thus if we choose λ so that the total distortion at $\lambda/2\pi = 20$ cycles is 5 per cent, from Fig. 2, $p = 0.48$. Fig. 4 shows the variation of the per cent total distortion versus audio frequency for this condition. Fig. 4 further shows that if p is chosen as 0.48 for $\lambda/2\pi = 20$ cycles then for audio frequencies above 100 cycles the distortion will be negligible and for lower frequencies will be 5 per cent at 20 cycles.

In an Armstrong frequency-modulated transmitter the original voltage as defined by (13) is passed through a series of frequency doublers so that after m stages of doubling (13) becomes

$$V_p = \sqrt{E_0^2 + (2E_s \sin \lambda t)^2} \sin 2m \left[\omega_0 t \pm \tan^{-1} \left(\frac{2E_s}{E_0} \sin \lambda t \right) \right]. \quad (13a)$$

It is interesting to note that neither the per cent frequency change nor the per cent harmonic distortion is affected by doubling. Heterodyning in the transmitter will change the per cent frequency change but will not affect the per cent distortion due to the combination of side bands

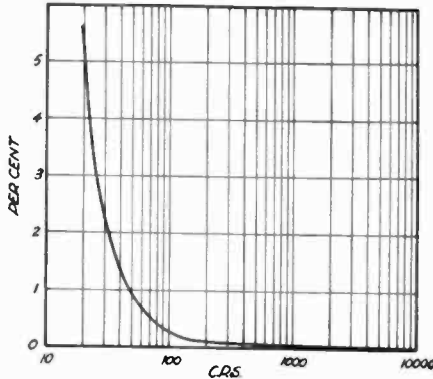

Fig. 4—Per cent total distortion versus audio frequency for $\lambda/2\pi = 20$ cycles.

and carrier. Thus by keeping the modulator phase shift less than 25.5 degrees at 20 cycles and frequency doubling to obtain the desired carrier, the distortion due to the modulator can be made negligibly small.

CONCLUSIONS

Thus it has been shown that the type of distortion in Armstrong's frequency modulator is amplitude distortion and that the distortion components are odd harmonics of the modulating voltage. The total distortion is made up practically of a 3rd harmonic of the modulating voltage. For less than 5 per cent total distortion the phase shift must be less than 25.5 degrees. For a phase shift of 45 degrees the distortion is 17.4 per cent. If the phase shift is adjusted to 25.5 degrees at an audio frequency of 20 cycles the distortion will be 5 per cent at 20 cycles and 0.06 per cent at 400 cycles.

Armstrong¹ has indicated that a maximum phase shift of 30 degrees be used for an audio frequency of 30 cycles. The distortion will then be 7.2 per cent at 30 cycles and less than 0.05 per cent at 400 cycles.

ACKNOWLEDGMENT

The writer wishes to express his appreciation for the helpful assistance of Professor John B. Russell in the preparation of this paper.

Bibliography

- (1) E. H. Armstrong, "A method of reducing disturbances in radio signaling by a system of frequency modulation," *Proc. I.R.E.*, vol. 24, pp. 689-740; May, (1936).
- (2) H. Roder, "Amplitude, phase, and frequency modulation," *Proc. I.R.E.*, vol. 19, pp. 2145-2176; December, (1931).
- (3) B. van der Pol, "Frequency modulation," *Proc. I.R.E.*, vol. 18, pp. 1194-1205; July, (1930).
- (4) Carson, "Notes on the theory of modulation," *Proc. I.R.E.*, vol. 10, pp. 57-82; February, (1922).
- (5) C. H. Smith, "Note on the relationship existing between radio waves modulated in frequency and amplitude," *Exp. Wireless and Wirless Eng.*, vol. 7, p. 609; November 6, (1930).
- (6) Bierens de Haan, "D. Nouvelles Tables d'Intégrales Définies," Leiden, (1867).



CHARACTERISTICS OF THE IONOSPHERE AT WASHINGTON, D. C., FEBRUARY, 1938.*

By

T. R. GILLILAND, S. S. KIRBY, and N. SMITH

(National Bureau of Standards, Washington, D. C.)

DATA on the critical frequencies and virtual heights of the ionosphere layers are given for February, 1938, in Fig. 1. Fig. 2 gives the maximum frequencies which could be used for radio communication in latitudes approximately that of Washington, calculated from the data of Fig. 1.

Figs. 1 and 2 show that the night critical frequencies and maximum usable frequencies for February were considerably greater than those for December and January. These night values are expected to increase somewhat during the spring and remain high until about October. The daytime F_2 -layer critical frequencies and maximum usable frequencies were also slightly greater during February than during December and January. The daytime values for the F_2 layer however are expected to begin decreasing during March and to remain low until the latter part of September. The daytime E-layer critical frequencies are expected to rise to a seasonal maximum near the time of the summer solstice and then decrease again. All of these effects are seasonal and may be estimated approximately in advance from previous seasonal variations already published.

The following critical frequencies for February, 1938, were less than those for the corresponding hours in February, 1937, by approximately the following amounts: noon f_{F_2} , 300 kilocycles; midnight f_F , 200 kilocycles; diurnal minimum (0600 local time), 600 kilocycles; noon f_E , 180 kilocycles. If seasonal effects are eliminated by comparing critical frequencies for a given month with those for the corresponding month of the preceding year, there can be observed a trend toward lower critical frequencies in recent months. This has been found for several months, possibly beginning with November, with the E layer first showing the trend. A similar condition over a like period of time has not been found for several years. Until this decrease began, there

* Decimal classification: R113.61. Original manuscript received by the Institute, March 9, 1938. This is one of a series of reports on the characteristics of the ionosphere at Washington, D. C. For earlier publications see Proc. I.R.E., vol. 25, pp. 823-840; July, (1937), and a series of monthly reports beginning in Proc. I.R.E., vol. 25, pp. 1174-1191; September, (1937). Publication approved by the Director of the National Bureau of Standards of the U. S. Department of Commerce.

had been a considerable year-to-year increase of critical frequencies since 1933 or 1934. This may mean that the maximum of the 11-year cycle of solar activity has been passed.

The ionosphere storms during February were very mild compared to the three severe storms in January. Only one storm, the moderate one of February 14, affected the ionosphere appreciably during the daytime. Ionosphere disturbances were indicated on several other

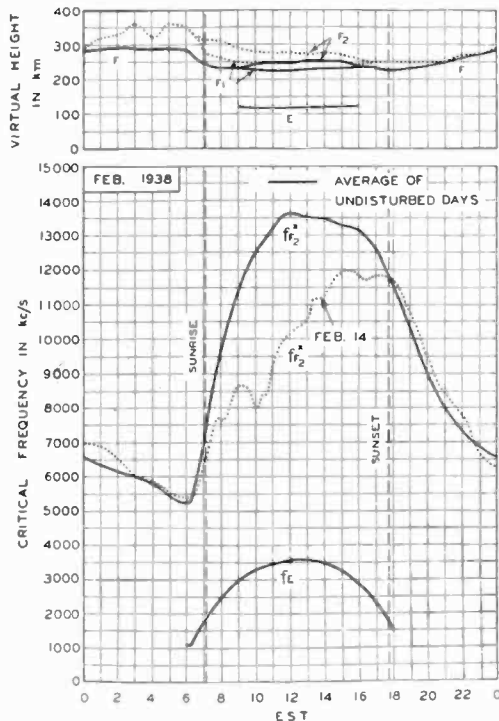

Fig. 1—Virtual heights and critical frequencies of the E, F, and F_2 layers of the ionosphere for February, 1938. The solid-line graph represents the average for undisturbed days. The dotted curve shows values for the ionospherically disturbed day of February 14.

days between about midnight and sunrise. The moderate ionosphere storm of February 14 occurred 28 days after the severe storm of January 17. No ionosphere storms occurred at a like period after the severe storms of January 22 and 25; indeed, the ionosphere was extremely quiet during this period. The most severe ionosphere storms during February, 1938, are shown in Table I approximately in the order of their severity.

Table II shows the number of hours f_p^x differed from the February average of the undisturbed days by more than the given percentages.

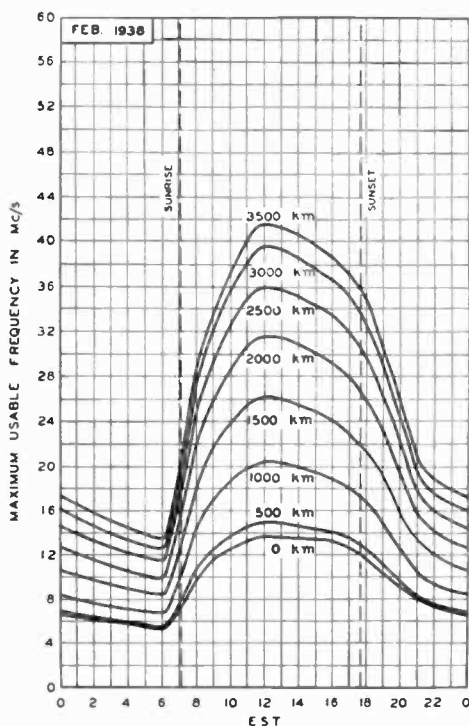

Fig. 2—Maximum usable frequencies for latitude of Washington, average for February. Time to be used is local time where the waves are reflected from the ionosphere layer.

TABLE I

Date and hour E.S.T.	h_p before sunrise km	Min. f_p^x during day (before sunrise) kc	Max. f_p^x during day, kc	Magnetic character ¹	
				0000-1200 G.M.T.	1200-2400 G.M.T.
Feb. 14 0100-1800	344	5400	12,000	1.0	0.9
Feb. 6 0000-0800					
Jan. 31 after 2300	346	2700	near average	1.1	1.1
Feb. 1 to 0700	344	4200	near average	0.9	0.2
Feb. 11 0000-0800					
Average of undisturbed days	288	5220	13,600	0.3	0.3

There were also slight ionosphere disturbances between midnight and sunrise on February 7, 9, and 10.

¹ American character figure, compiled by the Department of Terrestrial Magnetism, Carnegie Institution of Washington, from data supplied by their two observatories and five observatories of the United States Coast and Geodetic Survey.

From 0100 to 0300 E.S.T., February 6, the critical frequencies were so poorly defined that they could not be determined. These hours could not be listed in the percentage variation of Table II but are included in the total of 387 hours of night observations.

TABLE II

For 387 hours of observations between 1900 and 0800 local time.									
Per cent.....	-50	-40	-30	-20	-10	-0	+0	+10	+20
Number of hours.....	2	3	12	21	78	198	186	44	2
Disturbed hours.....	2	3	11	18	33	40	5	0	0
Undisturbed hours.....	0	0	1	3	45	158	181	44	2

For 40 hours of observations on Wednesdays between 0900 and 1800 local time.									
Number of hours (all undisturbed).....	0	0	0	0	0	22	17	1	0

Fade-out activity was rather low during February. The prolonged periods of low-layer daytime absorption continued to be well marked but were not as severe as during January.

Sudden disturbances of the ionosphere at Washington during February were marked by the radio fade-outs listed in Table III.

TABLE III¹

Date 1938	Beginning of fade-out	Beginning of recovery	Recovery complete	Location of transmitter	Min. intensity
Feb. 3	1733	1804	1820	Ohio, Mass., D.C.	0.0
Feb. 19	1704	1724	1730	Ohio	0.01
Feb. 21	1906	1918	1930	Ohio	0.1

¹ All times G.M.T. Minimum intensities given in terms of transmissions from W8XAL, 6060 kilocycles, distance 650 kilometers.

Out of 667 hours of observations during February, sporadic E reflections occurred above 4500 kilocycles during only 1 hour.

Note: The National Bureau of Standards broadcasts current ionosphere data and maximum usable frequencies, each Wednesday, by radiotelephone from its station WWV, in accordance with the following schedule: 1:30 P.M., E.S.T., 10 megacycles; 1:40 P.M., E.S.T., 5 megacycles; and 1:50 P.M., E.S.T., 20 megacycles.



CONTRIBUTORS TO THIS ISSUE

Black, Leonard James: Born July 29, 1905, at Santa Clara, California. Received B.S. degree in electrical engineering, 1928; M.S. degree, 1930, Ph.D. degree, 1935, University of California. Pacific Telephone and Telegraph Company, 1928-1929; instructor in electrical engineering, University of California, 1931 to date. Member, Sigma Xi; Member, Acoustical Society of America. Associate member, Institute of Radio Engineers, 1931.

Boella, Mario: Born January 31, 1905, at Genoa, Italy. Received degree, doctor in electrotechnical engineering, University of Turin, 1927. Laboratory assistant, Naval Electrotechnical and Communications Institute, Leghorn, 1929 to date. Professor's degree in radio communications, 1933. Captain, Technical Corps, Royal Navy reserve. Consulting engineer, Campagna Generale di Elettricità, Milan. Member, Italian Electrotechnical Committee. Member, Board of Editors, *Alta Frequenza*. Associate member, Italian Electrotechnical Association. Nonmember, Institute of Radio Engineers.

Gilliland, T. R.: See PROCEEDINGS for January, 1938.

Gonser, Karl B.: Born July 14, 1914, at Wallulla, Kansas. University of Kansas, 1933 to date. Entered Kansas Medical School, 1935; assistant instructor in anatomy, 1937. Engaged in graduate research on low-frequency amplifiers and recorders for medical purposes. Nonmember, Institute of Radio Engineers.

Haller, George L.: Born May 8, 1907, at Pittsburgh, Pennsylvania. Received B.S. degree in electrical engineering, Pennsylvania State College, 1927; E.E. degree, 1934; M.S. degree in physics, 1935. Radio engineer, KDKA, 1927-1929; engineer, E. A. Myers and Sons, 1929-1933; graduate assistant, Pennsylvania State College, 1933-1935; inspector, War Department, Aircraft Radio Laboratory, 1935; assistant radio engineer, 1935-1937; associate radio engineer, 1937 to date. Member, Tau Beta Pi, Sigma Pi Sigma, Eta Kappa Nu, Pi Mu Epsilon. Associate member, Institute of Radio Engineers, 1928; Member, 1936.

Jaffe, David Lawrence: Born July 6, 1913, at Brooklyn, New York. Received B.S. degree, Engineering College of the City of New York; M.S. degree in electrical engineering, Columbia University, 1936. Laboratory instructor, department of electrical engineering, College of the City of New York, 1935-1937; Bridgham Research Fellow in electrical engineering, Marcellus Hartley Laboratory, Columbia University, 1937 to date. Associate member, American Institute of Electrical Engineers; Member, American Association for the Advancement of Science; Member, Sigma Xi. Associate member, Institute of Radio Engineers, 1937.

Kirby, S. S.: See PROCEEDINGS for January, 1938.

Loh, Ho-Shou: Born August 8, 1913, at Shanghai, China. Received B.S. degree in physics, St. John's University, Shanghai, 1936. Graduate student, Purdue University, 1936 to date. Student member, Institute of Radio Engineers, 1937.

Scott, Herbert Jefferson: Born February 12, 1897, at Baltimore, Maryland. Received B.S. degree in electrical engineering, 1927; E.E. degree, 1933, University of Washington. Ship and shore operator, American Marconi Company and Radio Corporation of America, 1915-1923; engineer, radio research and development, Bell Telephone Laboratories, Inc., 1927-1934; assistant professor of electrical engineering, University of California, 1934 to date. Member, Sigma Xi. Associate member, Institute of Radio Engineers, 1919.

Smith, Newbern: See PROCEEDINGS for January, 1938.

Wagner, Winfield G.: Born July 11, 1906, at San Jose, California. Received B.S. degree, 1928; M.S. degree in electrical engineering, 1929, University of California. Antenna and vacuum-tube development, Federal Telegraph Company, 1929-1933; research and development laboratory, RCA Manufacturing Company, Inc., Radiotron Division, 1933 to date. Associate member, Institute of Radio Engineers, 1929.

Webb, J. S.: Born June 28, 1894, at Valparaiso, Indiana. Received B.S. degree, Valparaiso University, 1917; M.S. degree, University of Chicago, 1926; Ph.D. degree, Cornell University, 1930. Physical and electrical laboratory, Western Electric Company, 1917-1923, except for six months war work, Signal Corps Laboratory, Camp Alfred Vail, New Jersey. Instructor in physics, Lehigh University and Cornell University, 1923-1930; associate professor of radio engineering, University of Minnesota, 1930 to date. Member, Sigma Xi; Member, American Physical Society. Associate member, Institute of Radio Engineers, 1917.



BOOKLETS, CATALOGS, AND PAMPHLETS RECEIVED

The following commercial publications of radio engineering interest have been received by the Institute. You can obtain a copy of any item without charge by addressing the issuing company and mentioning your affiliation with the Institute of Radio Engineers.

MEASURING INSTRUMENTS—LABORATORY APPARATUS

Q, DIELECTRIC CONSTANT, AND CONVERTER-TUBE PERFORMANCE * * * Bulletin A describes instruments for measuring the Q and dielectric constant of components and materials and for checking on the performance of converter tubes. (4 pages + price list, 6 × 9 inches, printed.) *Boonton Radio Corporation Boonton, N. J.*

STANDARD-SIGNAL GENERATOR * * * A new bulletin (Form 489-A) gives specifications on the Type 605-B Standard-Signal Generator. (4 pages, 8½ × 11 inches, printed.) *General Radio Company, 30 State Street, Cambridge, Mass.*

AMPLIFIER FOR MEASUREMENTS * * * This leaflet describes the 7673 thermionic amplifier designed to permit the use of short-period galvanometers with high-resistance glass electrodes in hydrogen-ion-concentration measurements. (2 pages, 7½ × 10½ inches, printed.) *Leeds & Northrup Company, 4908 Stenton Avenue, Philadelphia, Pa.*

RECORDING FIELD STRENGTH * * * Bulletin Number 1037 describes the use of a graphic instrument for recording field-intensity changes in a coverage survey. (8 pages, 8½ × 11 inches, printed.) *The Esterline-Angus Company, Indianapolis, Ind.*

ANTENNA MEASUREMENTS * * * "Broadcast Antenna Measurements with the Radio-Frequency Bridge" appears in *The General Radio Experimenter* for February. (8 pages, 6 × 9½ inches, printed.) *General Radio Company, 30 State Street, Cambridge, Mass.*

PRECISION MEASURING EQUIPMENT * * * A new bulletin with this title describes the 68-A Beat-Frequency Oscillator and the 69-A Distortion and Noise Meter. (8 pages, 8½ × 11 inches, printed.) *RCA Manufacturing Company, Inc., Camden, N. J.*

ULTRA SENSITIVE METER * * * Bulletin TE-1012 describes a multi-range instrument for measuring low values of current (and direct-current voltages or resistance). (1 page, 8½ × 11 inches, lithographed.) *RCA Manufacturing Company, Inc., Camden, N. J.*

RESISTANCE BOXES * * * The Shallcross line of decade resistance boxes and potentiometers (voltage dividers) is described in Bulletin No. 835. (4 pages, 8½ × 11 inches, printed.) *Shallcross Manufacturing Company, Collingdale, Pa.*

PANEL INSTRUMENTS * * * Price list 45-1 on Triplett panel instruments has just been issued. (4 pages, 8½ × 11 inches, printed.) *The Triplett Electrical Instrument Company, Bluffton, Ohio.*

POWER-LEVEL INDICATORS * * * Circular R-100-E describes power-level indicators and gives data on speed and damping characteristics. (12 pages, 8½ × 11 inches, lithographed.) *Weston Electrical Instrument Corporation, 589 Frelinghuysen Avenue, Newark, N. J.*

BROADCAST TRANSMISSION EQUIPMENT

ANTENNA-COUPPLING UNITS * * * Bulletin 816 describes 3 sizes of coupling units for use with shunt-excited radiators. (1 page, $8\frac{1}{2} \times 11$ inches, lithographed.) *Victor J. Andrew, 7221 South Francisco Avenue, Chicago, Ill.*

BRUSH STROKES * * * An article in the January, 1938, issue of *Brush Strokes* describes the design of the Brush PL-12 and PV-12 high-fidelity pickups. (12 pages, $4\frac{1}{2} \times 6$ inches, printed.) *The Brush Development Company, Perkins Avenue, Cleveland, Ohio.*

MICROPHONES * * * The January, 1938, issue of the *Technical Bulletin* discusses the operating principle of a microphone having any of the three basic directional characteristics available at will. (4 pages, $8\frac{1}{2} \times 11$ inches, lithographed.) *Shure Brothers, 225 W. Huron Street, Chicago, Ill.*

RADIO COMMUNICATION EQUIPMENT

AIRCRAFT RECEIVER AND TRANSMITTER * * * Two new bulletins describe, respectively, the Model AVT-7B Aircraft Transmitter and the AVR-7 Aircraft Receiver. (2 pages each, $8\frac{1}{2} \times 11$ inches, printed.) *RCA Manufacturing Company, Inc., Camden, N. J.*

MARINE RADIO TELEPHONE EQUIPMENT * * * A bulletin under this title describes the 224A Radio-Telephone Equipment for installation on small boats. (8 pages, 8×11 inches, printed.) *Western Electric Company, 195 Broadway, New York, N. Y.*

MATERIALS—METALS, INSULATION, DIELECTRICS

A NEW MOLDING MATERIAL * * * Bakelite has developed a new thermoplastic material with good dielectric properties at radio frequencies. Specifications are given in Bulletin XMS-10023. (4 pages, $8\frac{1}{2} \times 11$ inches, printed.) *Bakelite Corporation, 247 Park Avenue, New York, N. Y.*

ULTRA STEATITE * * * Bulletin 10-37 lists the electrical characteristics of Ultra Steatite and the standard shapes in which it is obtainable. (24 pages and cover, 5×9 inches, lithographed.) *General Ceramics Company, 30 Rockefeller Plaza, New York, N. Y.*

FIBRE AND LAMINATED PHENOLIC SHEETS * * * Performance data and information on methods of working vulcanized fibre and laminated phenolic products are given in the "1938 Engineering Data Book." (32 pages + cover, $8\frac{1}{2} \times 11$ inches, printed.)—*Spaulding Fibre Company, Inc., 310 Wheeler Street, Tonawanda, N. Y.*

THERMOSTATIC BIMETAL * * * A supplement to "The Blue Book of Thermometals" has just been issued. (12 pages, $8\frac{1}{2} \times 11$ inches, printed.)—*The H. A. Wilson Company, 105 Chestnut Street, Newark, N. J.*

COMPONENTS

CONDENSER TESTS * * * Part I of an article "Practical Methods of Testing Condensers" appears in the January, 1938, issue of *The Aerovox Research Worker*. (4 pages, $8\frac{1}{2} \times 11$ inches, printed.)—*Aerovox Corporation, 70 Washington Street, Brooklyn, N. Y.*

RADIO-FREQUENCY INDUCTORS * * * Catalog No. 937 gives specifications on Aladdin's line of iron-cored inductors. (12 pages, $8\frac{1}{2} \times 11$ inches, printed.)—*Aladdin Radio Industries, Inc., 466 West Superior Street, Chicago, Ill.*

CONDENSER CALCULATION CHART * * * Cornell-Dubilier has published a calculator chart for quickly determining the capacitance and power factor of an electrolytic condenser from measurements of power and current at 110 volts, 60 cycles.—*Cornell-Dubilier Electric Corporation, South Plainfield, N. J.*

FLEXIBLE SHAFTS * * * Bulletin 1037 gives application specifications (torque characteristics, etc.) on flexible shafts for remote controls. (4 pages, $8\frac{1}{2} \times 11$ inches, printed.)—*The S. S. White Dental Manufacturing Company, 10 East 40th Street, New York, N. Y.*

CONDENSERS WITH CERAMIC DIELECTRIC * * * A recent "Specification" describes the new Erie ceramic-dielectric condensers and discusses their use for compensating frequency drift resulting from temperature changes. (9 pages + cover, $8\frac{1}{2} \times 11$ inches, mimeographed.)—*Erie Resistor Corporation, Erie, Pa.*

EXPERIMENTAL TELEVISION CIRCUITS * * * *Kenyon Engineering News*, Number 20, is devoted to an article with the above title. (4 pages, $8\frac{1}{2} \times 11$ inches, printed.)—*Kenyon Transformer Company, Inc., 840 Barry Street, New York, N. Y.*

TEMPERATURE-RISE IN RESISTORS * * * The March "Ohmite News" gives data for determining the temperature rise to be expected in a given vitreous enameled resistor for different values of watts dissipated. (2 pages, $8\frac{1}{2} \times 11$ inches, lithographed.)—*Ohmite Manufacturing Company, 4835 Flournoy Street, Chicago, Ill.*

VOLTAGE REGULATORS * * * Bulletin DL48-71F gives specifications and discusses applications for Raytheon voltage regulators. (4 pages, $8\frac{1}{2} \times 11$ inches, printed.)—*Raytheon Manufacturing Company, 126 Willow Street, Waltham, Mass.*

TUBES

TRANSMITTING TUBES * * * Amperex transmitting and rectifier tubes are described in a new catalog. (60 pages and cover, $9 \times 11\frac{1}{2}$ inches, printed.)—*Amperex Electronic Products, Inc., 79 Washington Street, Brooklyn, N. Y.*

VACUUM-TUBE NOISE * * * Bulletin #51 is a technical report on "Noise in Vacuum Tubes and Associated Circuits" by J. R. Nelson. (10 pages, $8\frac{1}{2} \times 11$ inches, lithographed.)—*Raytheon Production Corporation, Newton, Mass.*

PHASMAJECTOR * * * The December-January issue of the *Du Mont Oscillographer* describes the phasmajector, a pickup tube for supplying video test signals. (4 pages, $6 \times 9\frac{1}{2}$ inches, printed.)—*Allen B. Du Mont Laboratories, Inc., Upper Montclair, N. J.*

GAMMATRON * * * Application characteristics of the Type HK-54 Gammatron is given in Engineering Data Sheet Number 54-1. (4 pages, $8\frac{1}{2} \times 11$ inches, printed.)—*Heintz and Kaufman, Ltd., South San Francisco, Calif.*

APPLICATION NOTES (RCA) * * * The following application notes have been received: No. 84, On the operation of phototubes, 8 pages; No. 85, On the operation of the 6AC5-G, 3 pages; No. 86, On the operation of the 646-G, 5 pages; No. 87, On the 6K8—A new converter tube, 8 pages. ($8\frac{1}{2} \times 11$ inches, multigraphed and lithographed.)—*RCA Manufacturing Company, Inc., Harrison, N. J.*

TUBE DATA (Raytheon) * * * Tentative data sheets for the Type 6K8 and the Type 6W7G have been received. (2 pages, $8\frac{1}{2} \times 11$ inches, multigraphed.)—*Raytheon Production Corporation, 55 Chapel Street, Newton, Mass.*

ELECTROMETER TUBE * * * Information Bulletin No. 15 describes the RH-507 electrometer tube and the WL-756, a sputtered-carbon resistor mounted in a gas-filled tube envelope. (4 pages, $8\frac{1}{2} \times 11$ inches.)—*Westinghouse Electric & Manufacturing Company, Bloomfield, N. J.*

Here It Is!

THE *Instrument* OF 1000 Uses

HANDY SIZE
COMPLETE
A.C.-D.C.

POCKET VOLT-OHM- MILLIAMMETER

Engineers and experimenters are very enthusiastic about this pocket size instrument, sturdy and precision built. Handy for laboratory, shop or field use.

MODEL
666

DEALER \$15.00
NET . . . \$15.00



MOLDED CASE AND PANEL

Model 666

Has 3" Sq. Triplet Improved Rectifier Type Instrument.

A.C.-D.C. Voltage Scales Read: 10-50-250-500-1000 at 1000 Ohms per Volt.

D.C. Milliampere Scale Reads: 1-10-50-250. Ohms Scales Read: Low 1/2-300; High 250,000.

Size . . . 3-1/16" x 5 7/8" x 2 1/8".

Black Molded Case and Panel

Low Loss Selector Switch.

Complete with Alligator Clips, Battery and Test Leads . . . DEALER PRICE . . . \$15.00.

A complete instrument for all servicing and other needs. Can be used for all A.C.-D.C. voltage, current and resistance analyses. Resistance range can be increased by adding external batteries.

Attractive Heavy Black Leather Carrying Case with Finished Edges and Strap, Model 669, supplied extra. DEALER PRICE . . . \$3.67.

WRITE FOR CATALOG



The Triplet Elec. Instrument Co.
214 Harmon Dr., Bluffton, Ohio.
Please send me more information on
. . . Model 666. . . I am also interested in
Name
Address
City State

When writing to advertisers mention of the PROCEEDINGS will be mutually helpful.



Sleep S O U N D L Y ,
L I T T L E L A D Y . . .

"Mother and Daddy are near and the telephone is always close by. It doesn't go to sleep. All through the night it stands guard over you and millions of other little girls and boys."

Each night about 11,000,000 telephone calls are made over the Bell System. Many are caused by sudden, urgent needs. Great in its every-day values, the telephone becomes priceless in emergencies. The constant aim of the Bell System is to give you, at all times, the best and the most telephone service at the lowest possible cost.



BELL TELEPHONE SYSTEM

When writing to advertisers mention of the PROCEEDINGS will be mutually helpful.

for
HIGH-VOLTAGE
APPLICATIONS

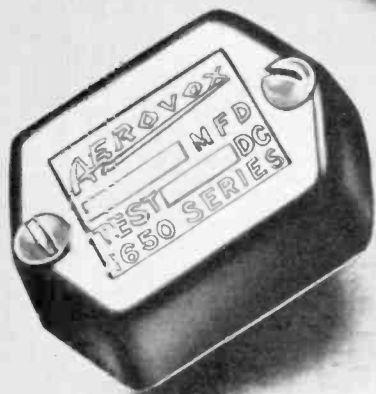

Mass-produced AEROVOX oil capacitors and high-voltage mica capacitors combine quality with low cost.



Likewise the complementary line of AEROVOX essential wire-wound fixed and adjustable resistors.



So in designing that transmitter, heavy-duty power pack or high-power amplifier, simply specify AEROVOX condensers and resistors for lowest first and last cost.

AEROVOX
 CORPORATION

70 Washington St.

Brooklyn, N. Y.

The Institute of Radio Engineers

Incorporated

330 West 42nd Street, New York, N.Y.

APPLICATION FOR ASSOCIATE MEMBERSHIP

(Application forms for other grades of membership are obtainable from the Institute)

To the Board of Directors

Gentlemen:

I hereby make application for Associate membership in the Institute of Radio Engineers on the basis of my training and professional experience given herewith, and refer to the members named below who are personally familiar with my work.

I certify that the statements made in the record of my training and professional experience are correct, and agree if elected, that I will be governed by the constitution of the Institute as long as I continue a member. Furthermore I agree to promote the objects of the Institute so far as shall be in my power, and if my membership shall be discontinued will return my membership badge.

.....
(Sign with pen)

.....
(Address for mail)

.....
Date)

.....
(City and State)

Sponsors:

(Signature of references not required here)

Mr. Mr.

Address Address

City and State City and State

Mr.

Address

City and State

The following extracts from the Constitution govern applications for admission to the Institute in the Associate grade:

ARTICLE II—MEMBERSHIP

Sec. 1: The membership of the Institute shall consist of: * * * (c) Associates, who shall be entitled to all the rights and privileges of the Institute except the right to hold any elective office specified in Article V. * * *

Sec. 4. An Associate shall be not less than twenty-one years of age and shall be a person who is interested in and connected with the study or application of radio science or the radio arts.

ARTICLE III—ADMISSION AND EXPULSIONS

Sec. 2: * * * Applicants shall give references to members of the Institute as follows: * * * for the grade of Associate, to three Fellows, Members, or Associates; * * * Each application for admission * * * shall embody a full record of the general technical education of the applicant and of his professional career.

ARTICLE IV—ENTRANCE FEE AND DUES

Sec. 1: * * * Entrance fee for the Associate grade of membership is \$3.00 and annual dues are \$6.00.

ENTRANCE FEE SHOULD ACCOMPANY APPLICATION

INDEX TO ADVERTISEMENTS

A

Aerovox CorporationXV
 American Telephone & Telegraph
 Co.XIV

C

Cornell-Dubilier Electric Corp.XX

G

General Radio CompanyCover IV

T

Triplett Electric Instrument Co. ...XIII

W

Western Electric Co.XIX

ENGINEERING POSITIONS OPEN

GRADUATE ENGINEER, 27-35 years old, with experience in high-voltage applications and good commercial sense wanted to supervise installation and maintenance of X-ray equipment. The applicant's personal qualities—appearance, intelligence and the ability to handle men—must be of high order. Include a complete list of former employers with positions held, and address Box 183, c/o Institute of Radio Engineers, 330 West 42nd Street, New York, N.Y.

ENGINEERING POSITIONS

Advertisements on this page are accepted from organizations interested in employing Institute members. Information on rates, preparation of material, and closing dates will be mailed on request.

**THE INSTITUTE OF RADIO
ENGINEERS**
 330 West 42nd Street
 NEW YORK, N.Y.

ENGINEERING DIRECTORY

CONSULTANTS AND DESIGNERS

including
 Amplifiers · Antennas · Transmitters
 Receivers · Laboratory Equipment
 Special equipment designed
 and constructed

RADIO DEVELOPMENT & RESEARCH CORP.

145 West 45th Street, New York, N.Y.
 Tel. BRyant 9-6898

**Cathode Ray Tubes
and Associated
Equipment For All
Purposes**

*Write for Complete
Technical Data*

**ALLEN B. DUMONT
LABORATORIES
UPPER MONTCLAIR, N.J.**

PRACTICAL RADIO ENGINEERING

One year Residence Course
 Advanced Home Study Course
 Combined Home Study-Residence
 Course

Write for details

**Capitol Radio Engineering
Institute
Washington, D.C.**

QUARTZ CRYSTALS

for Standard or Special
 Radio Frequency Applications

Write for Catalog

BLILEY ELECTRIC CO.
 230 Union Station Bldg.
 ERIE, PENNA.

When writing to advertisers mention of the PROCEEDINGS will be mutually helpful.

Western Electric's NEW 5KW has the DOHERTY CIRCUIT, too!



A FEW FEATURES OF THE 5KW

Doherty Circuit increases efficiency of final amplifier stage from the usual 30% to over 60%.

Requires less primary power, greatly reduces operating and maintenance costs.

Automatic line voltage regulator.

Improved stabilized feed-back circuit.

Automatic circuit breakers and an automatic reclosing contactor in the power circuit to the rectifier.

Cathode ray oscillograph connections in all important circuits.

Engineered to permit increase in power to 10KW, 50KW and 500 KW by adding selected apparatus.

"ASK YOUR ENGINEER"

In the new 5KW (as in the new 50KW) the famous Doherty Circuit increases power amplifier efficiency by more than 100%—cuts operating and maintenance costs—saves space. One more proof that Bell Telephone Laboratories and Western Electric are continuing to set the pace in better equipment for broadcasters!

Western Electric

RADIO TELEPHONE BROADCASTING EQUIPMENT

When writing to advertisers mention of the PROCEEDINGS will be mutually helpful.

Distributors:
Graybar Electric Co., Graybar Bldg., N.Y.
In Canada and Newfoundland:
Northern Electric Co., Ltd.
In other countries:
International Standard Electric Corp.

THE MOST STABLE CAPACITOR YET DEVELOPED

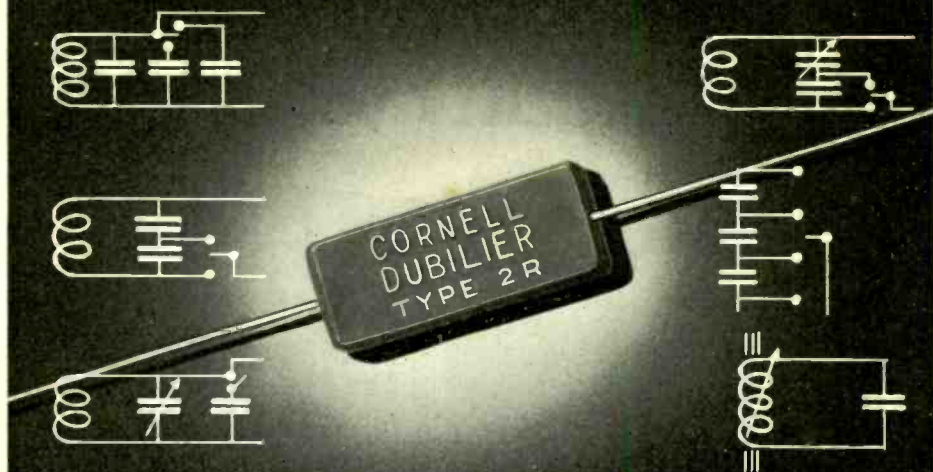

THE C-D "Silver-Mike" THE CONDENSER THAT RESISTS CHANGE

1. Brand NEW molded silver-plated mica construction.
2. Remarkably low temperature coefficient: Plus .003% per degree C.
3. Excellent "retrace" characteristics.
4. Practically no capacity drift with time.
5. Exceptionally high "Q" (3,000 to 5,000).
6. Mechanically protected by low loss Bakelite against physical damage and change in electrical characteristics, due to varying atmospheric conditions.
7. Capacity tolerance well within $\pm 3\%$.
8. Capacitors tested at 1,000 volts, D.C.
Range: 10 mmfd. to 1100 mmfd. (Larger sizes to be made available on specific request).
9. Ideal for use in circuits where the LC product must remain constant under all operating conditions. Specifically designed for use in conjunction with push-button tuning, where accuracy and stability are of paramount importance.
- 10.

CORNELL  **DUBILIER**

SEND FOR LITERATURE TO 1012 HAMILTON BLVD. • CABLE "CORDU"

CORNELL-DUBILIER ELECTRIC CORP., SO. PLAINFIELD, N. J.

I.R.E. CONVENTION AND EXHIBITION

JUNE 1938

SUN.	MON.	TUE.	WED.	THU.	FRI.	SAT.
<small>FIRST ON 4TH</small>	<small>FULL MOON 12TH</small>	<small>LAST ON 20TH</small>	1	2	3	4
5	6	7	8	9	10	11
12	13	14	15	16	17	18
19	20	21	22	23	24	25
26	27	28	29	30	<small>NEW MOON 27TH</small>	<small>1ST 27TH</small>

Courtesy of Cosmo-Sileo Co.

At New York —Hotel Pennsylvania—

No matter where in radio or allied engineering your interests lie, this year's annual convention and exhibition will be worth traveling a long way to attend.

There is no other easier way of keeping abreast of technical developments in our rapidly changing art. And there is no better way of broadening your professional outlook than this 3-day meeting with 1000 other engineers having interests like your own.

The program now in preparation will include

- Reading and discussion of technical papers
- Entertainment for the women guests of members
- The exhibition of new instruments, materials, and components—an important feature of I.R.E. Annual Conventions since 1930

Address suggestions for technical papers and reservations for exhibition space to

Here's a Vacation Suggestion

Why not include a visit to New York and the I.R.E. Convention in your plans?

Make a note of the dates and look for the complete convention program in your June Proceedings.



INSTITUTE OF RADIO ENGINEERS
330 WEST 42ND STREET, NEW YORK, N. Y.



NEW G-R High Frequency Monitor 1,500 kc to 30 Mc

The answer to the high frequency monitoring problem . . . extremely simple to operate . . . easily installed . . . low upkeep . . . moderately priced.

FEATURES

- Visual indication of deviation outside legal allowance
- Warning lamps light if transmitter deviates *above* or *below* allowed tolerance
- Lamps show direction of deviation
- Easier to watch than continuously indicating type of instrument
- Simple to use: lamps out, frequency OK . . . one lamp lighted, frequency off
- Very compact . . . 7 inches of relay rack space
- Can be used on one to four channels
- Easily installed . . . requires only a-c line and simple coupling to transmitter
- No subsequent adjustments needed
- Entirely a-c operated from built-in supply

Type 775-A Frequency-Limit Monitor \$240.00
Type 376-M Quartz Plates \$50.00 each

● Write for bulletin 257 for information

GENERAL RADIO COMPANY
CAMBRIDGE, MASSACHUSETTS

New York

Los Angeles