

PROCEEDINGS OF  
**The Institute of Radio Engineers**

VOLUME 26

February, 1938

NUMBER 2

Board of Editors

ALFRED N. GOLDSMITH, *Chairman*

R. R. BATCHER

P. S. CARTER

F. W. GROVER

J. W. HORTON

G. W. PICKARD

B. E. SHACKELFORD

K. S. VAN DYKE

H. P. WESTMAN, *ex officio*

L. P. WHEELER

L. E. WHITTEMORE

WILLIAM WILSON

CONTENTS

PART I

Institute News and Radio Notes.....	127
Annual Meeting of the Board of Directors.....	127
Joint Meeting of the Institute and the American Section of the Inter- national Scientific Radio Union.....	127
Australian Radio Convention.....	128
Institute Meetings.....	128

Part II

*Technical Papers*

Beam Power Tubes.....	O. H. SCHADE	137
Single-Side-Band Telephony Applied to the Radio Link Between the Netherlands and the Netherlands East Indies.....	N. KOOMANS	182
Frequency Discrimination by Inverse Feedback..	GEORGE H. FRITZINGER	207
A New Type of Selective Circuit and Some Applications....	H. H. SCOTT	226
Characteristics of the Ionosphere at Washington, D. C., December, 1937 .....	T. R. GILLILAND, S. S. KIRBY, N. SMITH, AND S. E. REYMER	236
Discussion on "Ultra-Short-Wave Propagation Along the Curved Earth's Surface," by Paul von Handel and Wolfgang Pfister.....	CHARLES R. BURROWS, PAUL VON HANDEL, AND WOLFGANG PFISTER	240
Contributors to This Issue.....		246

# The Institute of Radio Engineers

---

## GENERAL INFORMATION

**INSTITUTE.** The Institute of Radio Engineers was formed in 1912 through the amalgamation of the Society of Wireless Telegraph Engineers and the Wireless Institute. Its headquarters were established in New York City and the membership has grown from less than fifty members at the start to several thousand.

**AIMS AND OBJECTS.** The Institute functions solely to advance the theory and practice of radio and allied branches of engineering and of the related arts and sciences, their application to human needs, and the maintenance of a high professional standing among its members. Among the methods of accomplishing this is the publication of papers, discussions, and communications of interest to the membership.

**PROCEEDINGS.** The PROCEEDINGS is the official publication of the Institute and in it are published all of the papers, discussions, and communications received from the membership which are accepted for publication by the Board of Editors. Copies are sent without additional charge to all members of the Institute. The subscription price to nonmembers is \$10.00 per year, with an additional charge for postage where such is necessary.

**RESPONSIBILITY.** It is understood that the statements and opinions given in the PROCEEDINGS are views of the individual members to whom they are credited, and are not binding on the membership of the Institute as a whole. Papers submitted to the Institute for publication shall be regarded as no longer confidential.

**REPRINTING PROCEEDINGS MATERIAL.** The right to reprint portions or abstracts of the paper, discussions, or editorial notes in the PROCEEDINGS is granted on the express condition that specific reference shall be made to the source of such material. Diagrams and photographs published in the PROCEEDINGS may not be reproduced without making specific arrangements with the Institute through the Secretary.

**MANUSCRIPTS.** All manuscripts should be addressed to the Institute of Radio Engineers, 330 West 42nd Street, New York City. They will be examined by the Papers Committee and the Board of Editors to determine their suitability for publication in the PROCEEDINGS. Authors are advised as promptly as possible of the action taken, usually within two or three months. Manuscripts and illustrations will be destroyed immediately after publication of the paper unless the author requests their return. Information on the mechanical form in which manuscripts should be prepared may be obtained by addressing the secretary.

**MAILING.** Entered as second-class matter at the post office at Menasha, Wisconsin. Acceptance for mailing at a special rate of postage is provided for in the act of February 28, 1925, embodied in Paragraph 4, Section 412, P. L. and R., and authorization was granted on October 26, 1927.

---

Published monthly by

### **THE INSTITUTE OF RADIO ENGINEERS, INC.**

Publication office, 450-454 Ahnaip St., Menasha, Wis.

**BUSINESS, EDITORIAL, AND ADVERTISING OFFICES**

330 West 42nd Street, New York, N. Y.

Harold P. Westman, *Secretary*

## INSTITUTE SECTIONS

- ATLANTA—Chairman, N. B. Fowler; Secretary, G. S. Turner, Federal Communications Commission, 411 Federal Annex, Atlanta, Ga.
- BOSTON—Chairman, H. W. Lamson; Secretary, E. B. Dallin, 64 Oakland Ave., Arlington, Mass.
- BUFFALO-NIAGARA—Chairman, G. C. Crom, Jr.; Secretary, E. C. Wauch, 235 Huntington Ave., Buffalo, N. Y.
- CHICAGO—Chairman, J. E. Brown; Secretary, E. Kohler, Jr., Ken-Rad Tube and Lamp Corporation, 2400 Sheffield Ave., Chicago, Ill.
- CINCINNATI—Chairman, R. J. Rockwell; Secretary, M. M. Wells, Crosley Radio Corporation, 1329 Arlington St., Cincinnati, Ohio.
- CLEVELAND—Chairman, R. A. Fox; Secretary, R. L. Kline, Winteradio, Inc., 3014 Lorain Ave., Cleveland, Ohio.
- CONNECTICUT VALLEY—Chairman, F. H. Scheer; Secretary, C. E. Keeler, 59 Fairfield St., Springfield, Mass.
- DETROIT—Chairman, E. H. Lee; Secretary, R. J. Schaefer, 9753 N. Martendale, Detroit, Mich.
- EMPORIUM—Chairman, A. W. Keen; Secretary, M. C. Hoffman, Hygrade Syl-  
vania Corporation, Emporium, Pa.
- INDIANAPOLIS—Chairman, V. C. MacNabb; Secretary, I. M. Slater, 6433 E.  
Shelley Ave., Indianapolis, Ind.
- LOS ANGELES—Chairman, R. P. Brooke; Secretary, A. C. Pachard, Station  
KNX, Columbia Broadcasting System, 5939 Sunset Blvd., Hollywood,  
Calif.
- MONTREAL—Chairman, A. M. Patience; Secretary, S. Sillitoe, 1261 Shearer St.,  
Montreal, Que., Canada.
- NEW ORLEANS—Chairman, G. H. Peirce; Secretary, D. W. Bowman, 8327  
Sycamore St., New Orleans, La.
- PHILADELPHIA—Chairman, A. F. Murray; Secretary, R. L. Snyder, 103 Frank-  
lin Rd., Glassboro, N. J.
- PITTSBURGH—Chairman, R. T. Gabler; Secretary, A. F. Shreve, 459 Willow  
Dr., Mt. Lebanon, Pittsburgh, Pa.
- ROCHESTER—Chairman, Lee A. Du Bridge; Secretary, H. A. Brown, 89 East  
Ave., Rochester, N. Y.
- SAN FRANCISCO—Chairman, Noel Eldred; Secretary, L. J. Black, 243-30th St.,  
Oakland, Calif.
- SEATTLE—Chairman, A. R. Taylor; Secretary, R. M. Walker, 2600-26th Ave.,  
S.W., Seattle, Wash.
- TORONTO—Chairman, W. H. Kohl; Secretary, N. Potter, Canadian National  
Carbon Co., Ltd., Davenport Rd., Toronto, Ont., Canada.
- WASHINGTON—Chairman, E. H. Rietzke; Secretary, L. C. Young, 12 Grove  
St., Hyattsville, Md.

## GEOGRAPHICAL LOCATION OF MEMBERS ELECTED JANUARY 5, 1938

### Transferred to the Fellow Grade

New Jersey	Haddonfield, Haddonfield Manor.....	Murray, A. F.
Ohio	Columbus, Dept. of Electrical Engineering, Ohio State Univ.....	Everitt, W. L.

### Transferred to the Member Grade

Connecticut	Stamford, c/o Cinaudagraph Corp.....	Friend, H. H.
District of Columbia	Washington, 3403 Munitions Bldg.....	Perkins, O. D.
England	Willesden Green, London N.W.10, 60 Donnington Rd.....	Montague, D.

### Elected to the Member Grade

District of Columbia	Washington, 1901 Wyoming Ave., N.W.....	Cruse, A. W.
New Jersey	Harrison, RCA Manufacturing Co., Inc.....	Bacher, E. J.
France	Paris VII e, 94 rue de Varenne.....	Beason, P.
India	Allahabad, Dept. of Physics, Univ. of Allahabad.....	Toshniwal, G. R.

### Elected to the Associate Grade

California	Alhambra, 1612 W. Shorb St.....	Foster, A. M.
	Los Angeles, 919 White Knoll Dr.....	Hanson, C. T.
Connecticut	Stamford, c/o Cinaudagraph Corp.....	Bozak, R. T.
District of Columbia	Washington, 3342-18th St., N.W.....	Albanese, R.
	Washington, 3342-18th St., N.W.....	Bell, W. S.
	Washington, 1400-18th Pl., S.E.....	Dwight, S. J.
	Washington, 1375 Penn. Ave., S.E.....	Larkin, G. G.
	Washington, 3020 Channing St., N.E.....	McCue, J. J.
	Washington, 5231 Wisconsin Ave.....	Treubig, K.
	Washington, 123-104th St., N.E.....	Wheeler, J. P.
	Washington, Box 43, Bliss Electrical School.....	Wyatt, N. R.
Illinois	Chicago, 1638 N. Fairfield Ave.....	Palik, F.
Indiana	Gary, 33 E. 8th Ave.....	Lytle, C. W.
Kentucky	Anchorage, Route 1.....	Heick, B. K.
Massachusetts	South Braintree, 57 Holbrook Ave.....	Saxe, R. K.
Michigan	Detroit, 2449 E. Grand Blvd.....	Miller, O. V.
	East Lansing, 229 Division St.....	Blakeslee, J. T.
Missouri	Kansas City, 3607 Pennsylvania Ave.....	Erickson, C. V.
New Jersey	Bound Brook, 97 Hazelwood Ave.....	Housten, H. J.
	Cranford, 27 1/2 Hillcrest Ave.....	Hall, F. T., Jr.
	Orange, 208 S. Center St.....	Hazelhurst, E.
New York	Brooklyn, 109 Carroll St.....	DiFusco, F. J.
	Brooklyn, 55 Hanson Pl.....	Fong, L. B. C.
	New York, 52 Vanderbilt Ave., Rm. 1110.....	Freeman, W. H.
	New York, 420 Lexington Ave., Rm. 2354.....	Hellmann, R. K.
	New York, Shelton Hotel.....	Moffat, W. H.
	New York, 463 West St.....	Showers, E. G.
	New York, 320 E. 158th St.....	Soderquist, W. A.
	New York, 463 West St.....	White, S. D.
	New York, 562 W. 148th St.....	Zvorist, H.
	Schenectady, 69 Elder St.....	Earls, H. G.
	Schenectady, General Electric Co.....	Ramo, S.
Pennsylvania	Drexel Hill, 1032 Belfield Ave.....	Schurich, J. H.
Tennessee	Johnson City, 109 W. Holston Ave.....	Hine, R. T.
Texas	San Antonio, 721 Peck Ave.....	Moseley, T. B.
West Virginia	Charleston, General Delivery.....	Collins, F.
Canada	Lethbridge, Alta., Radio Beacon Station.....	McDougal, D. A.
Chile	Santiago, Casilla 1060.....	Pinto, G.
	Santiago, Casilla 104 D.....	Ried, A.
England	Ashton-on-Mersey, Nr. Manchester, 67 Firs Rd.....	Dummer, G. W.
	Chelmsford, Essex, Marconi School.....	Wang, S. W.
	Finchley, London N.3, 41 Church Crescent.....	Pegrum, A. M.
	Gosforth, Newcastle-on-Tyne, "Langemarck," Bridge Park.....	Grove, S. H.
	Hampstead, London N.W.3, 54 Parliament Hill.....	Myers, L. M.
	Highgate, London N.6, 29 Wood Lane.....	Smith, I. F.
	Iver, Bucks, Thatch End, The Ridings.....	Brecknell, C. J.
	Leigh-on-Sea, Essex, 20 Adalia Crescent.....	Inskip, F. A.
	London N.W.2, 34 Dartmouth Rd.....	Traub, E. H.
	Lostock Hall, Nr. Preston, Lancs., Tardy Gate Hotel.....	Baxter, D.
	Richmond, Surrey, 1 Manor Park.....	Tolliday, K. L.
	South Kensington, London S.W.7, c/o Lloyds Bank Ltd., Onslow Sq.....	Anand, L. S.
	Windsor, Berks., "Fernlea," Montagu Rd., Datchet.....	Brooker, F. C.

### *Geographical Location of Members Elected*

Germany	Berlin-Wilmersdorf, Holsteinische Str. 27	Hagen, G. B.
Holland	Eindhoven, Philips Gloeilampenfabrieken, 2 te Apparatifabriek	Schroter, E.
Italy	Torino, Via Assietta 33	Bertolotti, S.
New Zealand	Auckland, c/o New Zealand Radio College, Winstone Bldgs., Queen St.	Egan, R. A.
Philippine Islands	Manila, 719 Dakota St.	Spier, F. H.
South Africa	Uitenhage, Box 125	Reid, O. W.

#### Elected to the Junior Grade

Connecticut	New London, 42 Summit Ave.	Latham, W. S.
District of Columbia	Washington, 3342-18th St., N.W.	Armand, E. J. A.
	Washington, 1803 Monroe St., N.W.	Cunningham, J. E.
	Washington, 3227-13th St.	Franck, F. O.
	Washington, 11-5th St., N.E.	Manning, D. F.
Pennsylvania	Philadelphia, 622 E. Cornwall St.	Kershaw, W. L.

#### Elected to the Student Grade

California	Berkeley, 2414 Telegraph Ave.	Fenn, W. H.
	San Jose, 1151 University Ave.	Abbott, W.
	Stanford University, Box 1117	Palmer, W.
Georgia	Rome, Radio Station WRGA	Swan, A. G.
Illinois	Champaign, 602 E. Springfield Ave.	Higgins, F. V.
Indiana	West Lafayette, 300 Sylvania St.	Dalrymple, H. C.
	West Lafayette, Electrical Engineering Dept., Purdue Univ.	Hylkema, C. G.
	West Lafayette, 419 W. Stadium Ave.	Thomson, R. E.
Maryland	Baltimore, Box 510, Johns Hopkins Univ.	Larrick, C. V.
Massachusetts	Cambridge, M.I.T. Dormitories	Cohen, M. M.
	Cambridge, M.I.T. Dormitories	Popkin, J. R.
Michigan	Detroit, 808 W. Bethune	Beck, F. E., Jr.
New York	New York, 1230 Sheridan Ave.	Marshall, S. L.
Ohio	Cincinnati, 449 Riddle Rd.	McKenney, H.
	Cincinnati, 2355 Ohio Ave.	Strother, C., Jr.
Washington	Seattle, 6235-4th Ave., N.W.	Newsom, E. G.



APPLICATIONS FOR MEMBERSHIP

Applications for transfer or election to the various grades of membership have been received from the persons listed below and have been approved by the Admissions Committee. Members objecting to transfer or election of any of these applicants should communicate with the Secretary on or before February 28, 1938. These applications will be considered by the Board of Directors at its meeting on March 2, 1938.

For Transfer to the Fellow Grade

Massachusetts	Cambridge, General Radio Co.	Karplus, E.
New Jersey	Harrison, RCA Manufacturing Co., Inc.	Thompson, B. J.
New York	New York, Bell Telephone Labs., Inc., 463 West St.	Carson, J. R.
	New York, Radio Corporation of America, 30 Rockefeller Plaza	Shackelford, B. E.

For Transfer to the Member Grade

Iowa	Des Moines, Radio Station WHO	Loyet, P. A.
New Jersey	Camden, RCA Manufacturing Co., Inc.	Jones, L. F.
	Harrison, RCA Manufacturing Co., Inc.	Hendrick, L. B.
	Summit, 9 Iris Rd.	Schmit, D. F.
New York	Brooklyn, 1845 E. 47th St.	Dreyer, J. F., Jr.
	Riverhead, L. I., Box 626	Braaten, A. M.
	Riverhead, L. I., c/o RCA Communications, Inc.	Moore, J. B.
Tennessee	Nashville, Radio Station WSM	De Witt, J. H., Jr.

For Election to the Associate Grade

California	Los Angeles, 1984 Park Grove Ave.	Anderson, J. S.
	Los Angeles, 1956 S. Figueroa St.	Dooley, P.
	Los Angeles, 6900 McKinley Ave.	Downs, G. W., Jr.
	Los Angeles, 1214 N. Alvarado St.	Fodor, F. H.
	New Haven, 127 Hyde St.	Keyworth, J. G.
Connecticut	Washington, 924 National Press Bldg.	Ports, D. C.
District of Columbia	Chicago, American Airlines	Flynn, J. G., Jr.
Illinois	Chicago, 2652 W. Greenleaf Ave.	Gray, F. D.
	Chicago, 2704 N. Kildare Ave.	O'Brien, E.
	Chicago, 5125 N. Ashland Ave.	Osterlund, S. S. G.
	Rock Island, 1537-39th St.	Sinnett, R. J.
Indiana	Fort Wayne, 3229 Hoagland Ave.	Markwalder, W. B.
Kansas	Kansas City, 2803 Hiawatha	Browder, J. E.
Nebraska	Omaha, 4603 N. 60th St. R 7	McDonald, P. F.
New Jersey	Carteret, Radio Station WOR	Singer, C.
	Hoboken, P.O. Box 905	Rosenblatt, P.
	Lawrenceville, Box 20	Miller, E. S. G.
	Merchantville, 606 W. Maple Ave.	Rhea, H. E.
	Merchantville, 6748 Rogers Ave.	Washburn, E. M.
	Newark, 57 State St.	Drummond, J. J.
	Oaklyn, 112 Woodland Ter.	Martinelli, C. C.
	Oaklyn, 39 E. Collingswood Ave.	McDonald, E. H.
	Passaic, 98 Grant St.	Kihn, H.
	Teaneck, 613 Ramapo Rd.	Friebele, E. J.
New York	Lancaster, 43 Laverack Ave.	Scott, M. C.
	New York, 580 Park Ave.	Churchill, H. B.
	New York, c/o Columbia Broadcasting System, 485 Madison Ave.	Frendlich, M. M.
	New York, Bell Telephone Labs., 463 West St.	Meacham, L. A.
	New York, Bell Telephone Labs., 180 Varick St.	Reichle, W. E.
North Dakota	Minot, 416-2nd St., S.E.	Meyer, M.
Ohio	Sugar Creek, R. 2	Hershberger, W. O., Jr.
Oklahoma	Stillwater, 215 Monroe St.	Fisher, B. A.
Pennsylvania	Emporium, 314 W. 5th St.	Brown, W. G.
	Germantown, 547 Abbottsford Rd.	King, F. W., Jr.
	Philadelphia, 200 W. Sedgewick St.	Schroeder, A. C.
	Philadelphia, 1335 Walnut St.	Schroeder, R. G.
	St. Marys, 334 Brussels St.	Dickinson, W. A.
	St. Marys, Hygrade Sylvania Corp.	Ellesford, B. S.
	St. Marys, 125 State St.	Gessford, R. K.
	St. Marys, 503 Chestnut St.	Will, L. E.
	St. Marys, 225 N. Michael St.	Zelt, W. J.
Texas	Austin, University of Texas, Elec. Eng. Dept.	Schulz, E. H.
Washington	Seattle, 4025-32nd Ave., S.W.	Barry, F. N.
	Spokane, 1118 Pittsburg St.	McCann, F. H.

## Applications for Membership

West Virginia	Charleston, 706 Park Ave.....	Zaharis, G.
Canal Zone	Cristobal, P.O. Box 1734.....	Sanchez, H. E.
Canada	Valois, Que., 123 Valois Ave.....	Bonneville, S.
England	Chelmsford, Essex, Marconi College of Wireless Communication.....	Atal, S. N.
	Ealing, W. 13, London, 16 Bruton Way.....	Kallmann, H. E.
	London, S. E. 25, 3 Howden Rd. South Norwood Hill.....	Tingley, G. R.
	South Farnborough, Hants., 74 Peabody Rd.....	Hay, V. J.
Italy	Wembley, Middx., General Electric Co., Ltd., Research Labs.....	Gavin, M. R.
Japan	Rome, 29 Corso d'Italia.....	Aliotti, N.
	Setagayaku, Tokyo, c/o Sankoso 201, 539, 4-chome, Kitazawa.....	Uetsuki, K.
South Africa	Pretoria, c/o H. Polliack and Co.....	McBride, W. V.

### For Election to the Junior Grade

Idaho	Malad, Box A.....	Horsley, R.
-------	-------------------	-------------

### For Election to the Student Grade

Connecticut	Bridgeport, 492 Atlantic St.....	Lapinski, C. S.
Georgia	Hartwell, 526 Benson St.....	Harrison, A. E.
Indiana	West Lafayette, Cary Hall East, Rm. 239.....	Huffman, M.
Massachusetts	Boston, 1167 Boylston St.....	Rosen, L.
	North Attleboro, 16 Old Post Rd.....	Korman, N. I.
New York	Jackson Heights, L. I., 35-47-80th St.....	Kellogg, D. S.
	New York, 80 Van Cortlandt Park, S.....	Antell, S.
	New York, 1074-3rd Ave.....	Purpura, E.
Pennsylvania	Bethlehem, Taylor Hall-A.....	Brubaker, P. M.
Texas	Houston, 6900 Washington Ave.....	Pfeiffer, P. E.
England	London N. 16, 21 Cranwich Rd.....	Zienau, S.



## OFFICERS AND BOARD OF DIRECTORS

(Terms expire January 1, 1939, except as otherwise noted)

### *President*

HARADEN PRATT

### *Vice President*

E. T. FISK

### *Treasurer*

MELVILLE EASTHAM

### *Secretary*

HAROLD P. WESTMAN

### *Editor*

ALFRED N. GOLDSMITH

### *Directors*

E. H. ARMSTRONG

J. E. BROWN

R. A. HACKBUSCH

L. C. F. HORLE

VIRGIL M. GRAHAM

E. K. JETT

A. F. MURRAY

B. J. THOMPSON

ALAN HAZELTINE, *Past President*

### SERVING UNTIL JANUARY 1, 1940

H. H. BEVERAGE, *Past President*  
RALPH BOWN

ALFRED N. GOLDSMITH  
H. M. TURNER

### SERVING UNTIL JANUARY 1, 1941

F. W. CUNNINGHAM

O. B. HANSON

C. M. JANSKY, JR.



## INSTITUTE NEWS AND RADIO NOTES

### Annual Meeting of the Board of Directors

The annual meeting of the Board of Directors was held in the Institute office on January 5 and attended by Haraden Pratt, president; Melville Eastham, treasurer; E. H. Armstrong, H. H. Beverage, Ralph Bown, F. W. Cunningham, Alfred N. Goldsmith, Virgil M. Graham, O. B. Hanson, C. M. Jansky, Jr., H. M. Turner, and H. P. Westman, secretary.

Messrs. Eastham and Westman were reappointed to serve during 1938 as treasurer and secretary, respectively.

The following directors were appointed to serve for the year 1938: J. E. Brown, R. A. Hackbusch, L. C. F. Horle, E. K. Jett, A. F. Murray, and B. J. Thompson.

W. L. Everitt and A. F. Murray were transferred to Fellow grade. H. H. Friend, D. Montague, and O. D. Perkins were transferred to Member, and there were admitted to that grade E. J. Bacher, P. Besson, A. W. Cruse, and G. R. Toshniwal.

Fifty-eight Associates, six Juniors, and sixteen Students were admitted to membership.

The committees to serve during 1938 were appointed.

The budget under which the Institute will operate during 1938 was approved.

The necessity for paying a new entrance fee, when delinquent members resume active membership, was waived for 1938. This follows policies which were established several years ago. Members whose dues payments are in arrears and who desire to resume active membership, may do so by payment of current dues and at least one-half year's dues extra each year until their accounts are up to date.

The 1938 Convention will be held in New York City with headquarters at the Hotel Pennsylvania, on June 20 to 22, inclusive.

### Joint Meeting of the Institute and the American Section of the International Scientific Radio Union

The annual joint meeting of the Institute of Radio Engineers and the American Section of the International Scientific Radio Union will be held in Washington, D. C., on April 29 and 30, 1938. This will be a two-day meeting instead of the usual one-day meeting held in past years. This meeting is an important feature of the week which attracts to Washington every year an increasingly large number of scientists

and scientific societies. Papers on the more fundamental and scientific aspects of radio will be presented. A program of titles will be published in the April PROCEEDINGS. This will necessitate the submission of titles to the Committee by February 23. It is desirable but not necessary that abstracts be submitted with the titles. A program of abstracts will be printed and mailed to those interested before the meeting. The abstracts will therefore be required by April 1. Correspondence should be addressed to S. S. Kirby, National Bureau of Standards, Washington, D. C.

---

### **Australian Radio Convention**

The Institution of Radio Engineers of Australia has extended a most cordial invitation to the members of the Institute of Radio Engineers to take part in the World Radio Convention which will be held at Sydney, New South Wales, from April 4 to April 14, 1938. Sir Ernest Fisk, president of the Australian group and vice president of our Institute will preside at the meetings.

Twelve technical sessions as well as trips, receptions, and other social activities promise to make this convention one of great interest. Coming as it does towards the end of the celebration of the 150th anniversary of the settling of Australia, it offers an excellent opportunity to learn much about the country.

Those interested may obtain specific program information from the secretary, O. F. Mingay, 30 Carrington Street, Sydney, N.S.W., Australia.

---

### **Thirteenth Annual Convention**

Institute Members and others who are interested in presenting papers at our forthcoming Thirteenth Annual Convention which will be held in New York City, June 20, 21, and 22, 1938, must submit manuscripts not later than April 15, 1938. All manuscripts should be sent to the Secretary with the request that they are for Convention presentation. Otherwise they will be considered as having been submitted for publication only and handled accordingly. Acceptance of papers for presentation will probably be made not later than April 25, 1938.

---

### **Institute Meetings**

#### **ATLANTA**

N. B. Fowler, chairman, presided at the December 15 meeting of the Atlanta Section held at the Atlanta Athletic Club. There were twenty-two present.

"The Right Man for the Job" was the subject of a paper presented by W. V. Gearhart. The speaker covered the primary reasons for using meters, the differences in them, the causes of failures, and the effect of aging on the calibration. A new expanded-scale instrument was described and developments in bearings discussed. It was pointed out that recording meters are finding an increasing field of usefulness in the radio industry.

#### BUFFALO-NIAGARA

The Buffalo-Niagara Section met at the University of Buffalo on December 22, with an attendance of eleven. George C. Crom, Jr., chairman, presided.

The first paper on "High-Fidelity Reception" by Lincoln Walsh, consulting engineer, was presented by the chairman in the absence of the author. It included a demonstration of a receiver capable of passing a band of 16,000 cycles. The width of the band could be adjusted to demonstrate the change in effectiveness of reproduction under these conditions. Features in the design of high-fidelity reproducing devices were incorporated in the paper.

The second paper by L. G. Hector, professor of physics at the University of Buffalo, was on "Silencing of Exhaust Noises of Engines." The acoustic design of various types of mufflers was described and their effectiveness indicated. The analogies connecting the acoustic transmission line and the electrical transmission line were outlined. Test equipment which included a disk recording, amplifier, and special loud-speaker suitably housed to connect to the end fittings of engine mufflers was described and demonstrated. The use of a cathode-ray oscillograph to examine the wave form of acoustic disturbances caused by engines was demonstrated. A mechanical device was used to demonstrate visually the transmission, reflection, interference, superposition, and damping of acoustic waves. The analogous electrical effects of circuit constants on electromagnetic waves could be demonstrated with the device.

#### CHICAGO

Two meetings of the Chicago Section were held in December at Fred Harvey's Union Station Restaurant. The meeting on the third was attended by fifty-seven and presided over by J. K. Johnson, chairman.

"Some Notes on Insulation Research" was presented by H. A. Brown, professor of electrical engineering of the University of Illinois, and covered his research on the rupture of high-voltage cables. Particular stress was placed on the occurrences of discharges in air pockets in or adjacent to the insulation. A slight amount of radio-frequency

emission results from these discharges. The desirability of carrying these measurements into the radio-frequency region was pointed out.

A committee was appointed to represent the section in an organization meeting for the proposed formation of an Illinois Engineering Council.

The meeting on the 17th was presided over by J. E. Brown, vice chairman, and attended by two hundred and ninety. The first paper was on "An Instrument Landing System for Transport Aircraft," by D. S. Basim, development engineer of the Bendix Radio Corporation. The application of ultra-high frequencies for the production of suitable landing beams for aircraft was discussed in detail. The radiation characteristics which result from various antenna designs and locations were outlined. A method of measuring the space-signal output of an experimental transmitter was given. A comprehensive report was then presented on the design problems encountered in the development of a 400-watt, 91-megacycle transmitter. A working model of the transmitter was displayed, together with numerous other aviation radio products. The paper was closed with an explanation of the technique of instrument landing and included the technical and psychological factors involved. Over 2000 blind landings have been made without accident using this system.

The second paper on "Some Recent Aircraft Radio Equipment Developments of the Bendix Radio Corporation" was by W. E. Phillips, L. B. Wilson, and J. W. Hammond of the radio-engineering department of that organization. Among the devices displayed was an aircraft radio compass for use in the standard broadcast frequency band.

#### CINCINNATI

The annual meeting of the Cincinnati Section was held on December 14 at the University of Cincinnati, George F. Platts, chairman, presiding. There were eighteen present.

"Ceramics and Iron-Dust Cores" was the subject of a paper by H. L. Crowley, president of Henry L. Crowley and Company. The paper described modern processes and raw materials used in making low-loss insulating materials. This was followed by a discussion of processes, materials, and characteristics of iron-dust magnetic cores.

In the election of officers, R. J. Rockwell of the Crosley Radio Corporation was named chairman; Jack Yolles, Aviation Radio Laboratory at Wright Field, vice chairman; and M. M. Wells, also of the Crosley Radio Corporation, secretary-treasurer.

**DETROIT**

The Detroit Section met at the University of Michigan on November 19, with fifty in attendance. R. L. Davis, chairman, presided.

W. J. Dow, professor of electrical engineering at the University of Michigan, presented a paper on "Vacuum Tubes as Electrons Know Them." It included presentation of the theory of multielement tubes and those of the beam power variety. A graphical presentation was made of the electric fields and electron flow in vacuum tubes with special reference to the shape of the characteristic curves obtained with multigrad tubes.

**EMPORIUM**

The annual meeting of the Emporium Section was held on December 13 at the Warner Hotel. M. I. Kahl, chairman, presided and there were one hundred and two present.

At the close of the dinner which was attended by all, E. F. Carter introduced L. L. Lathrop who presented greetings and congratulations to the section in the name of the town. M. I. Kahl, retiring chairman, then opened a short business meeting at which A. W. Keen of Hygrade Sylvania Corporation, was elected chairman, H. A. Williams of the Stackpole Carbon Company, vice chairman, and M. C. Hoffman reelected secretary-treasurer. Mr. Kahl made a retiring address and introduced the new chairman. The secretary-treasurer presented the annual report on the activities of the section.

G. C. Connor and C. R. Marshall spoke briefly. They supervised the selection of V. H. Campbell as the section member to receive the award of a monel-metal watch given by the International Nickel Company for service of greatest value to the section during the past year.

A. F. Van Dyck, engineer-in-charge of the RCA License Laboratory presented some "Radio Ramblings." He briefly recalled some of the earlier beginnings of radio and drew the lesson that those pioneers should have taken time to visualize the developments that have since occurred. He pointed out that 30 per cent of those listed in "Who's Who" were engineers or scientific workers and called upon these men to broaden their viewpoints and devote some time to education, statistics, economics, and management problems. This would result in a much more effective utilization of existing knowledge and its application to future problems. He pointed out that in the field of radio two pressing needs are for a committee to develop navigation aids in the realm of aviation radio and the further standardization of tube types to eliminate unnecessary models.

## NEW ORLEANS

The annual meeting of the New Orleans Section was devoted strictly to the business of electing new officers. It was held on November 8 in the Association of Commerce Building, and attended by nine, L. J. N. DuTreil, chairman, presided.

In the election, G. H. Pierce of Station WDSU was named chairman; W. A. Clemmons of the Gulf Radio School, vice chairman; and D. W. Bowman of the U. S. engineering Corps was elected secretary-treasurer.

## NEW YORK

The annual meeting of the Institute was held in the Engineering Societies Building in New York City on January 5 and attended by five hundred and fifty. Retiring President Beverage made a brief statement of Institute activities during 1937 and presented his successor, Haraden Pratt.

Two papers on modulation systems were presented. The first by R. B. Dome of the General Electric Company was entitled "A High-Efficiency Modulation System." In it he presented a description and mathematical treatment of a method of obtaining modulated radio-frequency power with good conversion efficiency. The load line of a saturated radio-frequency amplifier is modified to provide for positive peaks of modulation and the amplifier is grid-modulated to care for the negative peaks. Load modulation is accomplished by a modulation-controlled absorber which returns to the direct-current source of supply the absorbed energy. This reduces the net power drain from the supply source and results in efficiencies of the order of 50 to 60 per cent.

The second paper on "A Unique Method of Modulation for High-Fidelity Television Transmitters" was presented by W. N. Parker of the Philco Radio and Television Corporation who pointed out that present-day high-fidelity television transmission demands modulation frequencies as high as 4 megacycles. Tube capacitance and the fly-wheel effect of resonant circuits make such modulation difficult. In the system described, modulation was effected between the output amplifier and the antenna by means of a variable impedance connected across the transmission line. This impedance consists of a quarter-wave line connected across the antenna transmission line a quarter of a wave length away from the power oscillator. The additional line is terminated by a pair of modulator tubes which absorb energy in accordance with the voltage applied to their grids. At high video frequencies, its plate efficiency and degree of modulation com-

pare favorably with usual systems employed in sound broadcasting. A 1-kilowatt experimental television transmitter employing this system may be modulated up to 5 megacycles at 80 per cent. A 200-megacycle oscillator was demonstrated and modulated at frequencies up to 20 megacycles.

#### PHILADELPHIA

H. J. Schrader, vice chairman, presided at the December 2 meeting of the Philadelphia Section which was held in the Engineers Club and attended by three hundred and eighty.

Five short papers on television developments were presented. The first, by A. V. Bedford of the RCA Manufacturing Company on "The Figure of Merit for Television Performance," traced the evolution of a sectionalized test chart for measuring resolution, half tones, and deformation of television images. Vertical and horizontal resolutions are measured in each of 12 sections of the screen and a formula for converting these readings into an over-all resolution figure of merit was given. This figure indicates the total number of black-and-white dots which may be put into a screen for transmission with random location relative to the position of the scanning lines and which could all be identified separately and located in the received picture.

I. G. Maloff of the RCA Manufacturing Company presented a paper on "Direct-Viewing-Type Cathode-Ray Tube for Large Television Images," which covered the design and construction of a 30-inch-screen continuously pumped cathode-ray tube employing a metal body and heavy glass window.

The third paper by Hans Salinger of Farnsworth Television, Inc., was on "Recent Developments in the Farnsworth Image Dissector." In a dissector tube, Dr. Salinger pointed out, a rather thick bundle of electrons is focussed and magnetically deflected. An idealized structure amenable to mathematical treatment was discussed. Barrel and S distortions can be made negligible. The most serious form of distortion is caused by transverse chromatic aberration which occurs also in image amplifiers. Methods of reducing these defects especially in telecine work were described.

A paper on "Television Transmission Frequencies and Standards" was presented by A. F. Murray of the Philco Radio and Television Corporation. It covered the decisions of the Federal Communications Commission in the assignment of television bands in the ultra-high-frequency region and the work of the Radio Manufacturers Association in the establishment of standards for television.

The final paper on "A Unique Method of Modulation for High-Fi-

delity Television Transmitters" was presented by W. N. Parker of the Philco Radio and Television Corporation. This paper is abstracted in the report of the January New York Meeting.

#### SAN FRANCISCO

The annual meeting of the San Francisco Section was held on December 15 at radio station KYA. V. J. Freiermuth, chairman, presided and there were twenty-eight present. The election of officers resulted in the designation of Noel Eldred, of Heintz and Kaufman, as chairman; Carl Penther, of the Shell Development Company, as vice chairman; and L. J. Black, of the University of California, as secretary-treasurer.

P. A. Schulz, chief engineer of KYA and Jack Frost of the RCA Manufacturing Company presented a paper on "The New KYA 5-Kilowatt Transmitter." Mr. Frost presented a technical discussion of the new transmitter which features attractive housing, high efficiency, and high fidelity. The total input power was given as 32 kilowatts for 5 kilowatts output. The audio-frequency response curve is flat within 1.5 decibels from 30 to 14,000 cycles at 90 per cent modulation. The transmitter is completely alternating-current-operated and with 100 per cent modulation, the hum is only 0.05 per cent.

Mr. Schulz treated the problems encountered in the erection of the station. It is located on one of the hills surrounding San Francisco and the basement of the structure was cut out of solid rock. The grounding system presented a substantial problem and consists of 120 radial cables each one-quarter wave length long. The antenna is 0.6 wave length high and of the unguyed type.

#### SEATTLE

On November 26 the Seattle Section met at the University of Washington with J. W. Wallace, chairman, presiding. There were fifty present.

"Mechanized Tuning Systems and Associated Circuits" was the subject of a paper by N. H. Foster, field engineer for the General Electric Company. It covered the arrangements used in several lines of broadcast receivers. All of them employ automatic-frequency control to overcome the small tuning discrepancies which are found in the mechanical tuning arrangements. Chassis of five different makes of receivers were displayed in order to demonstrate the methods of operation of the various designs. The paper was discussed by Messrs. Libby, Libby, Jr., Mason, Renfro, Tolmie, Walker, and Wallace.

The annual meeting of the Seattle Section was held on December



17 at the University of Washington. Forty-three were present and J. W. Wallace, chairman, presided.

In the election of officers Lieutenant-Commander A. R. Taylor, of the U. S. Naval Radio Station was named chairman; R. O. Bach, Pacific Telephone and Telegraph Company, vice chairman; and R. M. Walker, secretary-treasurer.

P. M. Haiggs, professor of physics at the University of Washington, presented a paper on "Physical Properties of Acoustical Materials." He pointed out that the problem of studying the properties of acoustical materials has been largely one of finding any property which could be expressed definitely. Sabine first presented quantitative relationships between a material and its acoustical properties. His original formula related the sound absorption coefficient of the material and the reverberation time of the chamber in which it was measured. Various modifications have been made in the original formula to bring it more closely into agreement with observed performance. Various methods of determining the coefficient of absorption by measuring reverberation time were explained. Samples of absorbent materials were inspected and the mechanism whereby they absorbed the sound energy was described. Three-dimensional curves were presented of the variation of absorption coefficient with frequency and the angle of incidence of the sound. The paper was concluded with a description of an electrical method for measuring reverberation time.

The paper was discussed by Messrs. Libby, Tolmie, Wallace, Walker, Williams, and others.

#### TORONTO

W. H. Kohl, chairman, presided at the December 13 meeting of the Toronto Section which was held at the University of Toronto and attended by fifty-two. A paper by D. G. Geiger of the Bell Telephone Company of Canada on "Wide-Band Telephone Systems" was presented. He outlined first the history of telephone circuits and the efforts made to increase the number of conversations on a circuit. Phantom and ghost circuits were briefly reviewed as well as composites and the older types of carrier systems. The new coaxial cable was described and its characteristics outlined. Using a transmission band from 60 to 1024 kilocycles wide, 240 two-way simultaneous conversations have been carried by the cable. The modulating, demodulating, and filter systems employed were described. On ordinary cables, carrier transmission employing frequencies as high as 60 kilocycles have been developed. It is useful only between points connected by at least two cables and is essentially the same as that for the coaxial system

except that the frequency band which may be employed is much narrower. Open-wire carrier circuits were discussed and compared with the cable and coaxial lines. It was pointed out that use of three modulators and demodulators were needed to obtain the desired transmission-frequency band.

#### WASHINGTON

W. P. Burgess, chairman, presided at the annual meeting of the Washington Section held in the Potomac Electric Power Company's auditorium on December 13. There were ninety-three present.

E. H. Rietzke, of the Capitol Radio Engineering Institute, was designated chairman; G. C. Gross, of the Federal Communications Commission staff, was named vice chairman; and L. C. Young, of the Naval Research Laboratory, was elected secretary-treasurer.

A paper on "Radio Transmission and the Ionosphere" was presented by N. Smith of the radio section of the National Bureau of Standards. In it Dr. Smith presented considerable data on the several reflective layers of the ionosphere and their effects on the transmission of various high-frequency waves. The relation between the height of the ionosphere layers and critical frequencies were indicated.

A second paper, "Concerning the Influence of the Ionosphere on Broadcast Waves," was presented by H. C. Booker of the department of terrestrial magnetism of the Carnegie Institution. Dr. Booker continued the discussion started by the previous speaker and pointed out the effects of the earth's magnetic field on radio transmission. This effect is particularly notable in the normal broadcast-frequency spectrum.



## TECHNICAL PAPERS

### BEAM POWER TUBES\*

By

O. H. SCHADE

(RCA Manufacturing Company, Inc., RCA Radiotron Division, Harrison, New Jersey.)

**Summary**—*The general characteristics of the ideal output tube for broadcast receivers are discussed briefly with respect to specific electrical and acoustical requirements.*

*Considerations of practical power-tube design indicate that the tube most nearly approaching the ideal characteristics is one having an accelerating grid (screen) and a control grid which does not require power. The limitations of conventional output tetrodes and pentodes with respect to the ideal are treated and are illustrated by means of oscillograms and models showing field-potential distributions. It follows that homogeneous potential fields and directed electron beams having high electron density can be utilized to minimize these limitations. These design features indicate the feasibility of a tube suitable for operation as a class A amplifier having substantially second-harmonic distortion only and capable of high power output, high efficiency, and high power sensitivity.*

*The theoretically proper geometric structure for beam power tubes is developed. The theory is substantiated by performance data obtained from actual tubes.*

#### I. INTRODUCTION

DEVELOPMENTS in the art of transmitting and reproducing sound by electrical means point toward systems of higher fidelity capable of reproducing faithfully the tremendous range of volume of the symphony orchestra without altering the infinite variety in combinations of tones and overtones. In the achievement of this ideal, radio tubes have an important part. A brief résumé of audio-frequency power-amplifier requirements will help in formulating the specifications of an ideal power tube for loud-speaker operation.

#### II. FUNDAMENTAL REQUIREMENTS FOR HIGH-FIDELITY SOUND REPRODUCTION

The audio-frequency amplifier in the receiving unit must cover a *frequency range* of more than eight octaves for true reproduction of music. To accomplish this, it is necessary that the amplifier tubes themselves do not generate tones of substantial magnitude within the desired range.

\* Decimal classification: R330. Original manuscript received by the Institute, September 8, 1937. Presented before New York meeting, April 1, 1936.

The science of music teaches us that pure octaves, i.e., tones of second-, fourth-, and eighth-harmonic order, are always harmonious, and, therefore, are least objectionable when introduced by *harmonic distortion* in amplifiers.

The third harmonic is the octave of the pure musical "fifth." It is harmonious to single tones but causes dissonance as a harmonic of some of the component tones in musical chords of relative purity. Small magnitudes of third harmonic generated in the amplifier can be tolerated but should not exceed a few per cent of the fundamental tones. The fifth harmonic is the pure "second" to the double octave of the fundamental tone. Harmony conditions are somewhat similar to those of the third harmonic. The larger pitch difference, however, reduces masking effects<sup>1</sup> produced by the fundamental tones so that the permissible maximum value is considerably smaller than for the third harmonic. Higher-order harmonics of odd number, seventh, ninth, etc., are disharmonious and thus increasingly objectionable. High-order harmonics in general are so much different in pitch from the fundamental tone that magnitudes much smaller than one per cent may be noticed as a disagreeable sharpness of tone or a hissing sound. They are generated especially in amplifiers having dynamic characteristics with sudden changes of curvature.

In the preamplifier stages it is not difficult to limit harmonic distortion to satisfactory values if the required output power or voltage is substantially less than the obtainable maximum value. The output stage, however, must not only be operated efficiently but must also supply maximum power output at low distortion.

The *peak output power* required for reproduction is at least 10 to 25 times the average power output and still larger for amplifiers with volume expansion. Thus, an average volume level of one watt of electrical power demands the undistorted reproduction of peaks as high as 20 to 30 watts. If this power is to be obtained at reasonable cost, the output tube must have not only a high plate efficiency, but also a good "circuit" efficiency.

The *plate load* of the power stage is not a pure resistance. The motional impedance of commercial dynamic cone loud-speakers for receiving sets varies considerably with frequency due to the low coefficient of electromechanical coupling. Due to the loose coupling, the mechanical circuit reflects its reactance and resistance efficiently only at the resonant frequency as illustrated in Fig. 1, which shows the electrical characteristics of a typical speaker. The increase of the normal<sup>2</sup> resistance to 96.7 ohms indicates an efficiency of close to 90 per

<sup>1</sup> Harvey Fletcher, "Speech and Hearing," D. Van Nostrand Co., (1929).

<sup>2</sup> See 1933 Report of the Standards Committee of the I.R.E., page 36.

cent at the resonant frequency, while only about five per cent of the input power is transferred to the secondary system at other frequencies.

The reactance of the moving coil is responsible for the normal impedance rise at high frequencies. This impedance rise is quite easily corrected over the entire *high-frequency* range by the much-used series-resistance-capacitance shunt on the reflected load. This compensation is absolutely necessary to provide good quality and to avoid high transient voltages when the output tubes have high internal impedance ( $r_p$ ), but it may be omitted with low-impedance tubes.

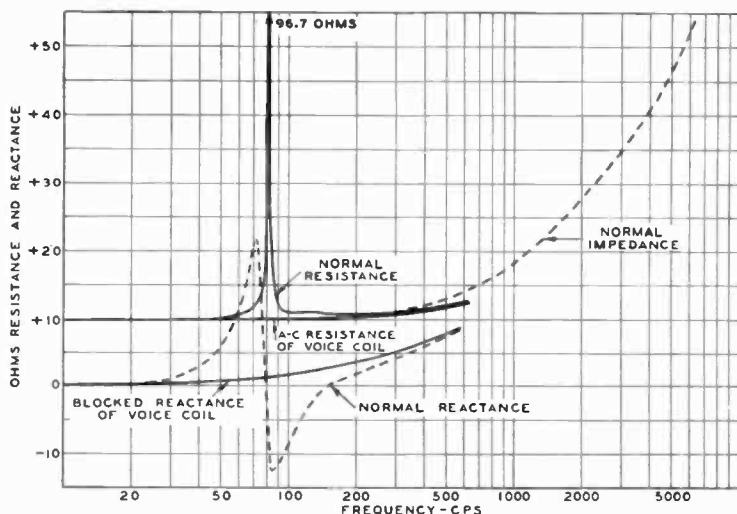

Fig. 1—Electrical characteristics of a dynamic loud-speaker.

### Loud-Speaker Damping

The internal impedance of the power tube shunts the plate load. If the plate load ( $R_p$ ) is high compared to the tube impedance, the  $Q$  ratio of a parallel-tuned plate load is decreased by the tube shunt which acts to prevent a large resonance rise. The mechanical resonance of the dynamic speaker appears over a short frequency range in the primary substantially as a high-impedance parallel-tuned circuit (compare Fig. 1). This circuit is damped by low-impedance tubes but affected little by high-impedance tubes. But even if the reflected electrical circuit resonance is almost completely damped by low tube impedance, the sound output still rises above normal due to the high energy transfer into the mechanically resonant secondary circuit.

If a resonant-voltage rise of 5 on the voice coil is assumed and the equivalent increase in efficiency is considered as from 5 to 81 per cent, a calculation yields the following results: High-impedance sources as

represented by pentodes in class A service with  $r_p = 10R_p$  permit a 16.4-decibel sound-output rise at resonance; triodes with  $r_p = \frac{1}{2}R_p$ , a 7.8-decibel rise. For  $r_p = 0$ , the rise is still 5.1 decibels.

Electrical damping cannot completely eliminate resonance "boom" and prevent overload of the speaker at resonance. This must be done by power-absorbing circuits or in the loud-speaker design.

### III. GENERAL PROBLEM OF POWER-TUBE DESIGN

The design of a desirable tube begins with the formulation of ideal-type characteristics. An analysis of the electrical characteristics of an idealized tube follows in order that the most suitable design principle may be selected on the basis of both tube development and practical operation. The theoretical investigation of the electrical principles involved points out the direction of research, and assists in formulating the specific design problem.

According to the preceding discussion, the general specifications for an ideal power tube are as follows:

#### A. General Specifications for an Ideal Power Tube

1. *Low distortion* mostly of second-harmonic order. A small percentage of third harmonic can be tolerated. Higher-order harmonics must be negligible.

2. *Good power sensitivity* to permit low-level operation of the pre-amplifier stage.

3. *High power output* obtainable with self-bias and supply circuits having the voltage regulation of conventional broadcast receivers. Exceptionally large power output with good quality for limited high-frequency response with supply circuits of moderately good regulation.

4. *Maximum efficiency* in both tube and associated circuits with respect to power dissipation as well as cost.

5. *Effective damping* of resonant loads.

#### B. Analysis of Tube Types and Design Possibilities on the Basis of the Required Electrical Characteristics

##### 1. Triodes

##### (a) The Required Characteristic for Negative-Control-Grid Operation

The distortion from present class A output triodes is low and contains only small magnitudes of higher-order harmonics. The 2A3 is a large power triode for receivers. It is a filament type, having a large effective cathode area which does not require as much heater power as a unipotential cathode of equivalent area. However, it is not feasible at present to construct at reasonable cost a triode having much higher

power sensitivity, higher efficiency, and larger power output than the 2A3 for a 300- or 400-volt plate supply. The necessary large cathode area would be quite expensive and would present difficult constructional and operating problems due to grid emission. The relatively low efficiency of low- $\mu$  class A triodes is a serious objection from the standpoint of tube dissipation, and cost of power supply for increased output power.

A plate efficiency approaching 50 per cent without grid current in class A service is not impossible even for existing triodes, but the power output for medium voltages is very small with respect to the size of the tube. The *hypothetical* triode must have a sharp cutoff, substantially constant  $\mu$  at all plate voltages, and high transconductance,

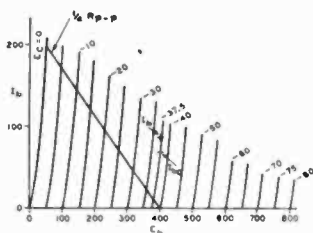

Fig. 2—Plate family of hypothetical triode.

Conditions for push-pull operation

$$E_c = -37.5 \text{ volts fixed}$$

$$E_b = 400 \text{ volts fixed}$$

$$I_{b0} = 71 \text{ milliamperes}$$

$$I_b = 85 \text{ milliamperes}$$

$$\text{Power output} = 35 \text{ watts (two tubes)}$$

$$\text{Efficiency} \approx 51.2 \text{ per cent}$$

$$R_{p-p} = \text{plate-to-plate load}$$

i.e., a very steep rise of current versus applied potential, as shown in Fig. 2. This plate characteristic is ideal on a theoretical basis. The characteristic family is constructed by parallel displacement of the zero-bias characteristic. This constant  $\mu$  (it is shown to be 10) is approached in an actual tube by using a fine-mesh control grid at relatively large distances from cathode and plate. The effective grid potential at  $E_b = +50$  volts and  $E_{c1} = 0$  volts is thus approximately five volts, which must be sufficient to cause an electron current of 200 milliamperes. We know that this is possible only by the use of a *very large cathode area* even for considerably lower  $\mu$  values. Furthermore, this large cathode should radiate little heat to the grid in order to avoid grid emission.

A cathode of large area may be produced with an auxiliary positive grid. The "virtual cathode" of the space-charge-grid tube seems a good solution. The virtual cathode, however, must have an *electron reserve capable of supplying the peak current* demanded from it. The space-

charge-grid tube thus requires a larger cathode current and consequently a larger B power supply in comparison with other tubes to be discussed and, therefore, does not meet the requirements for circuit efficiency.

### (b) Triodes with Positive-Grid Operation

The control grid itself may be permitted to swing positive, in order to accelerate the electrons and obtain a steep current rise at low plate voltages. This method has certain disadvantages. The grid current in conventional triodes is of substantial magnitude and considerably decreases the expected plate-current rise, especially at low plate voltages.

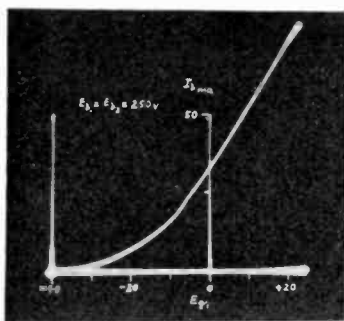

Fig. 3—Transfer characteristic of a positive-operated-grid output tube with conductively coupled driver.

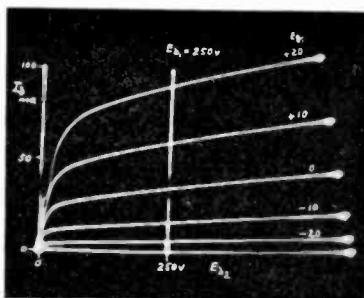

Fig. 4—Resultant plate family of a positive-operated-grid output tube with conductively coupled driver.

This action causes increased distortion. A second complication arises from the fact that there are now two positive electrodes in the tube so that secondary electrons from one electrode may not fall back to the plate but instead may travel to the other positive electrode.

*Secondary emission* occurs whenever electrons hit an obstacle which, aside from transit-time effects, must be at positive potential. The liberation of normal<sup>3</sup> secondaries begins substantially at a positive voltage of about ten volts and thus causes a break in the grid-current curve. The performance of present-day class B triodes shows fairly good success in smoothing out the grid-current “kinks” in their reaction on the plate current, by bettering the ratio of plate current to grid current through the use of specially designed high-impedance triodes. These high-impedance tubes have a plate family very similar to pentodes and thus give a performance similar to a pentode. Unlike the pentode, they require driving power and, therefore, demand care-

<sup>3</sup> H. Barkhausen, “Electronenroehren,” vol. 1.



fully designed low-impedance preamplifiers. Because only drivers with zero internal resistance and ideal coupling devices eliminate grid-circuit distortion, the "kinks" and consequent higher-order harmonics cannot be completely suppressed in practical systems. That this is the case is shown by the transfer characteristic of Fig. 3. The plate load has little effect on the break in the characteristic.

In push-pull operation, tubes with positive grids operate with considerable plate efficiency. They may be designed to require no biasing voltage. The distortion of high-impedance triodes operating with positive grid voltages is naturally higher than that of pentodes operated without control-grid current, because distortion is increased in all

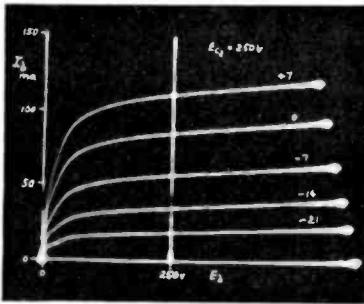

Fig. 5—Plate family of a typical power pentode.

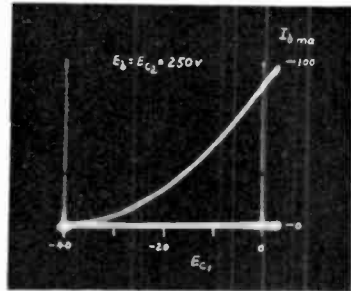

Fig. 6—Transfer characteristic of a typical power pentode.

practical cases by harmonics including those of high orders arising from the irregularities of the grid-current characteristic.

In class A operation, single high-impedance tubes operated with positive control-grid voltages and conductively coupled driver stages present no advantage in output performance over conventional pentodes. The resultant plate family is very similar to that of a pentode and consequently the plate-circuit performance with regard to distortion, efficiency, and load variation is also similar (Figs. 4 and 5). The transfer characteristic of pentodes operated without grid current is inherently a smooth curve (Fig. 6).

## 2. Pentodes

### (a) Characteristics of Conventional Pentodes

Power output and efficiency of commercial pentodes are considerably higher than those of conventional triodes operated without grid power. The screen-grid potential remains fixed and highly positive at all plate-voltage values. This feature eliminates the necessity of a large cathode area for obtaining a steep plate-current rise with low

plate potentials. *Overbiased pentodes* in push-pull operate with an overall efficiency which compares favorably with that of good class B triodes, and in addition have the considerable advantage of operating without grid current. This guarantees negligible high-order harmonics and a simple preamplifier design.

It can be shown that *overbiased operation* of push-pull pentodes is, in fact, *necessary* in order to obtain distortion values of less than three per cent consisting mainly of third-harmonic distortion and having less than one per cent of fifth harmonic. The attainment of a high plate efficiency of 70 per cent and a total B supply power efficiency of approximately 60 per cent are accompanied by considerable increases in the current demand for an applied signal. In order to maintain correct operating conditions for all signal levels, it is necessary to provide a well-regulated bias and B voltage supply. A study of modern receivers shows, however, that the power stage is generally designed to have at most a two-to-one increase in plate current due to a signal and is operated with self-bias or semi-self-bias. In many instances better performance with respect to distortion and efficiency is sacrificed to obtain partial class A performance and with it supply circuits not requiring good regulation.

It has been indicated that the desirable power tube could not be built economically as a triode, because three-electrode tubes with positive signal grids were ruled out for distortion reasons. It will also be shown later that the operation of triodes having high power sensitivity places severe requirements on the circuit. Because of these limitations the solution will be sought in a four- or five-electrode tube having a separate positive accelerating grid.

#### (b) Characteristics of a Desirable Power Pentode or Tetrode

The first requirement in our specifications for an ideal power tube is *low distortion of substantially second-harmonic order*. The practical solution is a square-law curvature of the transfer characteristic and a plate family which is substantially linear over the entire useful plate-current—plate-voltage characteristic.

The second requirement is *good power sensitivity*. This demands fine-mesh grids, and an efficient cathode with close control-grid spacing to obtain high transconductance.

The third and fourth requirements are *high power output and efficiency*. These require the extension of the straight section of the plate family down to very low plate-voltage values and a low percentage of screen-grid current at all plate voltages in the useful range.

The fifth requirement is *low plate impedance*. This is in conflict with the second, third, and fourth requirements. The screen-current rise

with decreasing plate voltage is considerably larger in pentodes or tetrodes of low plate impedance than in pentodes with high plate impedance whether the curves are ideally straight or not, provided good screening of the plate field with resultant good cutoff is maintained. The large increase of screen-grid dissipation with signal in low-impedance pentodes decreases efficiency and power-output capability, while the plate impedance obtainable is hardly low enough to effect a substantial damping of a resonant load.

It is, therefore, reasonable to depart in this one point from the ideal if a power tube can be designed which satisfies all other requirements. It will be shown later that the characteristic of such a tube can be changed into that of a very good low-impedance triode by the use of an inexpensive circuit.

An analysis of screen-grid tubes with respect to potential conditions encountered by electrons in their flight is necessary to recognize limitations in existing tubes. It will be shown that these limitations can be overcome by directed electron beams.

#### IV. ANALYSIS OF SCREEN-GRID TUBES—ESPECIALLY THE ELECTRON CURRENT IN SPACE BETWEEN ACCELERATING GRID AND PLATE

##### A. Effect of Space Charge

###### (1) Space-Charge Effects in Diodes

Let us assume a parallel-plane diode for the purpose of illustrating electron effects in space. Without the presence of electrons, the potential between cathode and plate increases linearly with distance (Fig. 7). This constant gradient is changed if electrons are present. The effect of the negative charge of electrons in space, the "space charge," is to reduce the space potential. Because the density of electrons in a given current is inversely proportional to their velocity, the *potential gradient* is thus zero at the cathode if the initial velocity of the electrons is neglected, and increases cumulatively with distance. An increasing number of *secondary electrons* are liberated at the plate at plate voltages over ten volts approximately. These electrons fly back a short distance towards the cathode but as their volt-velocity is much smaller than that of the primary electrons, they soon come to a stop and return to the plate. The plate current is thus not affected directly. A noticeable decrease in plate current may, however, be caused by an increased space-charge density in the space  $X-P$  (Fig. 7) due to secondary space charge in cases of large secondary emission.

## 2. Space-Charge Effects in Tubes with Accelerating Grid

The potential distribution in a triode with positive grid and plate is shown in Fig. 8 for the theoretical case of uniform electron velocity, uniform path length, and the absence of secondary emission. We as-

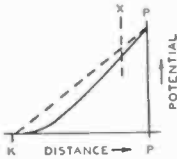

Fig. 7—Effect of space charge on potential distribution in a diode.

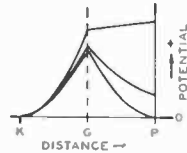

Fig. 8—Potential distribution in a tube with positive grid and plate.

sume again a parallel-plane structure and also low current absorption by the fine-mesh grid in both directions. For a distance  $d_{K-G} = d_{G-P}$  and zero plate voltage, the potential distribution is symmetrical on both sides of the positive grid. The electrons just reach the plate because they are decelerated to zero velocity at zero voltage and zero gradient. More positive plate voltages change potential distribution and gradients as indicated. This will be discussed in more detail later on. All electrons passing the grid reach the positive plate.

The *theoretical tetrode* having a control grid inserted between cathode and screen grid should thus have the desired plate characteristic

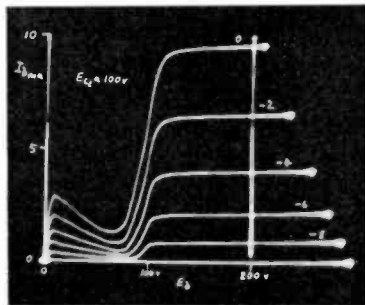

Fig. 9—Plate family of a typical tetrode with low space-charge density.

of parallel straight lines, the plate current rising abruptly at zero plate voltage to a value constant for all positive plate voltages.

In the practical case, however, *secondary electrons* are liberated at the plate and find a positive gradient in the direction of the screen grid at all plate voltages substantially lower than the screen-grid voltage (see Fig. 8). The secondaries thus fly to the screen grid. This action decreases the plate current and increases the screen current.

As the number reaching the plate decreases at very low plate voltages, the well-known plate-current curve shown in Fig. 9 is obtained. Note the plate voltage at which substantial secondary emission begins.

### B. The Suppression of Secondary-Emission Effects and the Suppressor Grid

The tetrode characteristic of Fig. 9 will approach the ideal characteristic if it is possible to prevent secondary emission or to suppress its effects. Most secondary electrons have a relatively low velocity of emission. They are forced to return to the plate if the potential between the positive grid and the plate is decreased at some point ap-

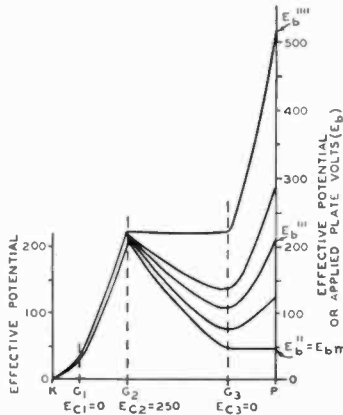

Fig. 10—Calculated effective potentials in a typical power pentode.

proximately ten to twenty volts below the plate voltage. Such a potential “minimum” will prevent the large loss of plate current due to secondary electrons. It can be produced by insertion of a low-potential electrode, the “*suppressor*” grid in pentodes.

As illustrated in Fig. 10, a potential minimum is formed for plate voltages higher than  $E_{bm}$ . This forces secondary electrons back to the plate. The percentage of primary electrons arriving at the plate is found, however, to decrease considerably in actual tubes when the plate potential is decreased to the value  $E_{bm}$ . This plate-current loss is caused partly by the *nonuniform potential* in the plane of the suppressor grid  $G_3$ . The wires of  $G_3$  are always at zero potential while only the space between wires have a positive potential of varying magnitude caused by the penetrating positive screen-grid and plate fields. This “bumpy” field causes the value  $E_{bm}$  to represent a range of voltages instead of a single value and thus rounds off the theoretical sharp knee at  $E_{bm}$ .

The plate-current loss at low voltages is caused by *velocity differences of electrons in the normal direction* produced mainly by distortion of the potential field due to grid wires, side rods, and nonuniform distances of electrodes. Such velocity differences between screen and plate result in oversuppression in some sections in the plate-current path, while secondaries are just sufficiently suppressed in other sections.

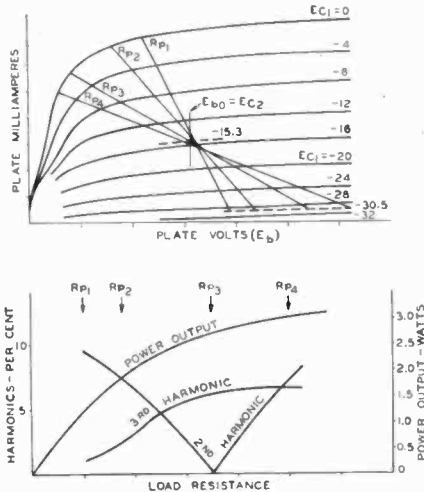

Fig. 11—Performance characteristics of a typical power pentode.

### C. Pentode Performance Resulting from Nonuniform Potential Distribution

The round "knee" of the plate-current characteristic of conventional pentodes produces in class A operation the distortion-versus-load characteristic shown in Fig. 11. With low loads ( $R_{p1}$  and  $R_{p2}$ ) the distortion is mainly of second-harmonic order but the plate efficiency is low. Higher loads give better efficiency but cause a relatively large third-harmonic distortion. Components of higher order are small for reasons discussed later.

From the standpoint of distortion, operation with a low plate load is much preferred. Although the percentage of the second harmonic is large in single-tube operation, it is much less objectionable than a considerably smaller percentage of third-harmonic distortion. It is difficult by comparison with speech or music to detect a difference in quality of sound output between tubes having five and ten per cent second-harmonic distortion.

In push-pull operation, even harmonics generated in each power

tube cancel; odd harmonics do not cancel. Odd harmonics may be reduced by the loading conditions made possible in class AB operation.

#### D. Current Distribution as a Function of the Potential Field Between Screen and Plate

##### 1. The Potential Field

We now investigate the causes of the plate-current loss in pentodes at plate voltages lower than the screen-grid voltage. The field between

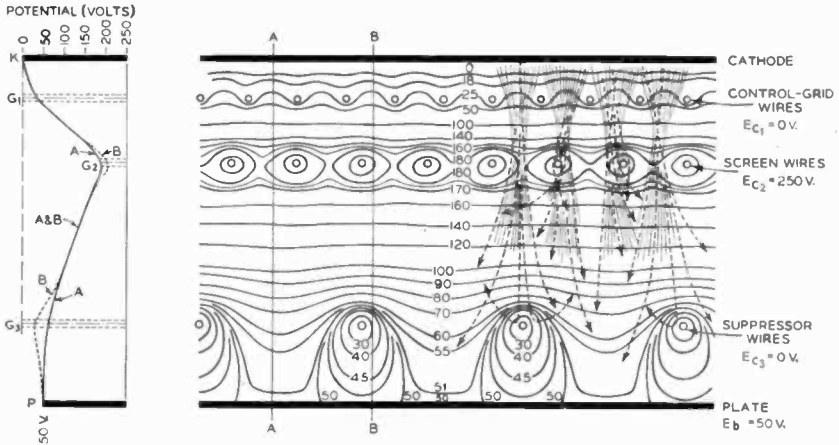

Fig. 12—Plot of potential distribution in a typical power pentode.

screen grid and plate is a decelerating field at medium and low plate voltages. The *percentages of electrons arriving at the plate* out of the total number which leave the cathode is a *function of the shape of the potential field* in the tube which determines the electron path and velocity component in the direction of the plate. According to Fig. 10, the entire electron current passing the screen-grid wires should reach the plate for the condition when  $E_b > E_{bm}$ , but this is only true if the potential field is homogeneous and only for electrons having a normal direction and equal velocities. The actual potential field of a pentode at  $E_b = E_{bm} = 50$  volts is shown in Fig. 12. The field is obviously not uniform. The wires of the grids in the tube disturb the homogeneity of the field.

The action of electrons in this field can be mechanically illustrated by means of the topographic model shown in Fig. 13. In this model, the electrostatic force is replaced by a component of gravitational force depending on the slope of the model at any particular point. The slope is analogous to the potential gradient of the electrostatic field (see left side of Fig. 12). Each lamination represents a potential

step of ten volts, the lower levels corresponding to more positive potentials. The No. 1 and No. 3 grid wires are thus mountain peaks. The electrons may be compared to frictionless balls rolling down from the elevation of the cathode (zero volts) into the valley of the screen grid (+200 to +250 volts). A certain percentage missing the wires of  $G_2$  (the holes) are carried by their momentum up the incline to the plate. Those that pass near the center between screen-grid wires follow a fairly straight path toward the plate. Some of them, are, however, diverted by the curved contour of the suppressor-grid hills, lose velocity and return in an arc toward the screen-grid valley; others traverse the gap between the suppressor hills and reach the plate on the other side.

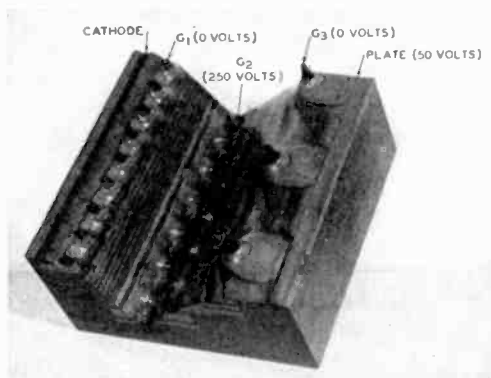

Fig. 13—Topographic model of potential distribution shown in Fig. 12.

A number of the balls coming from the cathode pass close to the screen-grid "holes," and thus are deflected from a straight path because they obtain a tangential-velocity component in the conical field near the screen-grid wires. Their chances of reaching the plate are less than for balls rolling in a straight path toward the suppressor-grid hills. A certain percentage of electrons is headed directly toward the screen-grid holes and does not get through at all. Neglecting this percentage at present, it is easily understood from the analogy that the number of electrons reaching the plate increases when the "gap" between the suppressor-grid hills is deepened by lowering the elevation of the plate because fewer electrons are turned back to the screen grid. Electrically, the gap between the suppressor wires is deepened by an increase of plate potential. The steepness of the current rise with plate voltage thus depends on the manner in which the gap width, i.e., the shape and gradient of the decelerating potential field, affects the tan-



gential component of electrons. As pointed out later, the actual potential distribution may be altered considerably by space charge which is neglected in this model.

The plate current is thus a function of the potential distribution between screen grid and plate within the range of decelerating potentials. Fig. 14(a) shows the plate current of a pentode plotted against the square root of the plate voltage. The curve has several linear sections and shows four significant plate-voltage values at which the factor of proportionality for current increments changes. Calculation of resultant potentials in the planes of the various electrodes disclosed that *significant potential-field or gradient changes* occur between screen grid and plate at the values  $E_b = E''$ ,  $E'''$ , and  $E''''$ , indicated in Fig. 10.

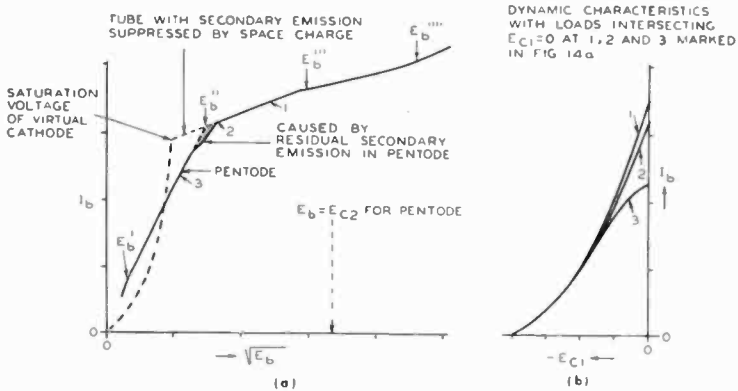

Fig. 14

- (a)—Proportionality of current increments to the square root of plate voltage between successive group-saturation values in a typical power pentode.  
 (b)—Dynamic characteristics of a typical power pentode with loads intersecting  $E_{c1} = 0$  at points 1, 2, and 3 marked in (a).

We term these specific values "group-saturation" voltages, as certain groups of electrons have then arrived at the plate.

## 2. Group-Saturation Potentials

At  $E_b = E_b^I$  only the electrons following a normal path have reached the plate.

At  $E_b = E_b^{II}$  the potential line of plate-voltage value has just penetrated completely between the suppressor wires, and has touched the plate. This occurs quite suddenly as observed in the electrolytic tank (compare Fig. 12). The average field gradient between  $G_3$  and plate has become zero. At plate voltages  $E_b > E_b^{II}$ , the field between plate and  $G_3$  becomes accelerating.

At  $E_b = E_b'''$ , the acceleration in the plate field has become equal in magnitude to the deceleration in the screen-grid field.<sup>4</sup>

The fourth and less distinct group-saturation value occurs when the penetrating plate-potential line extends as far as the screen grid. This is the case at  $E_b = E_b''''$ ; the entire field between  $G_2$  and plate has become accelerating so that no electrons are returning to the screen. The partial saturation voltages are easily expressed in terms of electrode potentials and forward- and reverse- $\mu$  values.

The apparent *one-half-power proportionality of current increments* to the plate voltage observed in three sections of the  $I_b - E_b$  characteristic is of particular interest. The electron "spray" in the decelerating suppressor field is caused by tangential-velocity components (compare Fig. 12). The deflecting force on electrons of given velocity having a tangential component decreases proportionately to the decelerating gradient.

The effective area enclosed by a penetrating potential line in and close to the plane of grids increases over a considerable voltage range substantially proportional to the one-half power of the voltage applied to the source or sources of the potential line. In the considered case the applied voltages  $E_{c1}$ ,  $E_{c2}$ , and  $E_{c3}$  are constant and the decelerating field is controlled by the plate voltage. Thus,  $\Delta i_p = KE_b^{1/2}$ . The factor  $K$  changes its magnitude at every partial saturation point.

Under *dynamic conditions*, the potential fields on each side of the screen grid are controlled by two respective voltages. Grid voltage and plate voltage vary with opposite signs. The plate-current increases with the three-halves or four-halves power of the grid voltage and approximately with the minus one-half power of the plate voltage (decreasing). As the plate-load value governs the plate-voltage change, it is possible to obtain sections with three-halves-, two-halves-, or one-half-power increments of current in the decreasing plate-voltage range as shown by the dynamic curves in Fig. 14(b). Due to this fact, pentodes are substantially free from high-order harmonic distortion when loaded properly.

#### E. Effects of Space Charge Between Screen and Plate of Power Pentodes

If the mesh of the suppressor grid  $G_3$  is made very fine (oversuppression), the plate current is decreased considerably at lower plate

<sup>4</sup> The value of  $E_b'''$  was found to be approximately equal to the effective screen-grid potential in a number of pentodes. In tetrodes the minimum occurs in the center of the space between the screen grid and plate at  $E_b = P_{c2}$ . In pentodes, it does not necessarily occur in the plane of  $G_3$  due to space-charge effects which thus affect the value of  $E_b'''$ .

voltages due to the low effective positive potential and its area in the plane of  $G_3$  (a high  $\mu$ -factor of the suppressor in both directions causes low plate impedance in the decelerating potential range). With a suppressor of coarser mesh, the effective positive potential area is increased and, consequently, the plate current and plate impedance are increased at low plate voltages. At the same time, however, the range  $E_p'$  to  $E_p''$  in which secondary-emission effects occur is moved to higher plate voltages and the potential minimum is reduced. The mesh of  $G_3$  is adjusted in practice so as just to eliminate secondary-emission effects under normal cathode-operating conditions (Fig. 5). The same tube, however, shows larger secondary-emission effects (under suppression) if operated with a temperature-limited (underheated) cathode as shown in Fig. 15. This points out that *the electron*

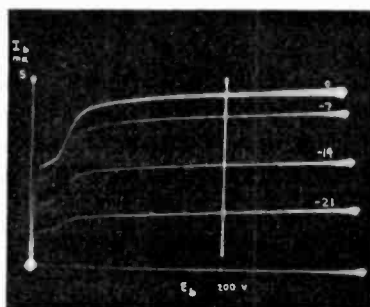

Fig. 15—Plate characteristics of typical power pentode operated with temperature-limited cathode ( $E_f = 0.4$  normal volt).

*space charge* near and between the grid wires of  $G_3$  under normal conditions reduces the space potential and *contributes to the suppression of secondary-emission effects*.

If the electron density is further increased, it does by itself become sufficiently large to produce a minimum potential in space between plate and screen, and thus suppresses secondary-emission effects without the help of a physical low potential source.

When the suppressor grid is replaced by space charge, the potential gradient at and in the direction of the plate never becomes negative in correctly designed tubes; thus, the curved section between  $E_b'$  and  $E_b''$  is eliminated as indicated by dashed lines in Fig. 14(a).<sup>5</sup>

<sup>5</sup> Some development work on replacement of the suppressor grid by space charge has been done in Europe, especially by Electric and Musical Industries, Ltd., in England. They have worked on tubes in which the suppression of secondary-emission effects is accomplished by space charge.

## V. THEORY AND DESIGN OF BEAM POWER TUBES WITH SPACE-CHARGE SUPPRESSION OF SECONDARY-EMISSION EFFECTS

### A. Plate-Current Characteristics of Tetrodes with Potential Minimum

Potential conditions in a decelerating field have been treated in a paper by Fritz Below.<sup>6</sup> The theory applies with modifications to the screen-plate section in tetrodes and pentodes, where we are interested especially in a definite and low saturation potential. Space-charge conditions at higher plate voltages are of equal importance in the design of power tubes. We shall thus examine the potential distribution in space with this specific purpose in mind.

#### 1. The Potential Minimum in Space

The space-charge density in a given electron current depends on the cross section of the electron path and the electron velocity. The potential distribution in space between positive grid and plate varies with distance as shown in Fig. 16(a). There are assumed constant cross section, constant current, and fixed electrode potentials as shown. The transit time of each electron is increased with greater distance between electrodes; hence, the number of electrons in the space between grid and plate is also increased and, consequently, the total negative electron charge which reduces the space potential. In the illustrated case the potential gradient at the plate becomes zero for  $d = d_2$ . For distances greater than  $d_2$ , a potential minimum is formed near the plate; the potential gradient at the plate has reversed sign and the field at the plate accelerates primary electrons. For the still larger plate distance  $d_4$  the potential value at the minimum  $M$  has decreased to zero.

The theoretical minimum distance  $d_{G-P}$  for the existence of a potential minimum at zero value in the ideal parallel-plane triode is equal to the cathode-grid distance, as illustrated in Fig. 8. It is seen that the minimum of zero value occurs at zero plate voltage and that no potential minimum is formed at low positive plate voltages. Hence, this distance is too short for suppression of secondary-electron effects.

The potential distribution with greater plate distances for a given current is shown versus plate voltage in Figs. 16(b) and 16(c). The minimum of zero value forms at  $E_b = E_m$ . Sufficient potential minima of positive value for suppressor purposes are produced with plate potentials having values between  $E_m$  and  $E_{b1}$ . For the shorter distance (Fig. 16(b)), the value  $E_{b1}$  is lower in potential than the accelerating-grid potential. The potential difference between plate and minimum is insufficient to repel secondary electrons from the plate for voltages be-

<sup>6</sup> "The theory of space-charge grid tubes," *Zeit. für Fernmeldetechn.*, vol. 9, pp. 113-118; August 29, (1928).

tween<sup>7</sup>  $E_{b1}$  and  $E_{b2}$ . Secondary-electron effects are thus to be expected in this plate-voltage range, and are indicated in the corresponding plate characteristic. For the larger distance (Fig. 16(c)) a larger minimum of positive value is formed up to plate potentials higher than the accelerating-grid potential. The minimum potential in this case remains sufficiently lower with respect to the plate voltage to repel secondary electrons liberated at the plate.

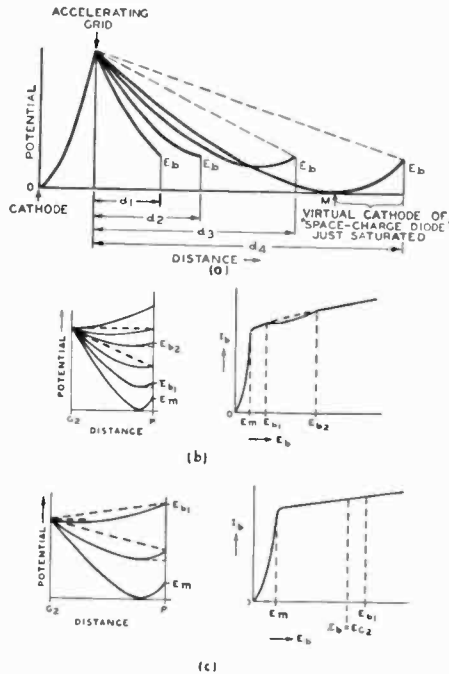

Fig. 16

- (a)—Potential distribution in space between accelerating grid and plate as a function of the distance between them (constant current to accelerating grid).  
 (b)—Plate current and space potential between accelerating grid and plate as a function of plate voltage for conditions where insufficient minima are formed.  
 (c)—Same as for (b), but for conditions where sufficient minima are formed.

Hence, the minimum plate distance for good suppressor action by the space charge is the distance for which the potential minimum remains at least ten to twenty volts lower than the plate potential. The minimum ratio of screen-plate distance to screen-cathode distance is  $\rho m = d_{g-p}/d_{g-k}$ . This ratio is considerably larger than unity for struc-

<sup>7</sup> B. Salzberg and A. V. Haeff, "Effects of space charge in the grid-anode region of vacuum tubes," *RCA Rev.*, vol. 2, pp. 336-374; January, (1938).

tures with parallel or divergent electron beams, i.e., constant or increasing electron-path cross section in the direction of the plate. The actual value of  $\rho m$  depends on the electron density; hence,  $\rho m$  is larger for a larger angle of divergence and also larger for smaller values of plate current. In the equivalent triode, the ratio of  $\rho m$ , therefore, does not have one fixed value because it is a function of potentials and current. In the beam power tube, the *optimum* distance ratio has the value 2.9.

## 2. The Virtual Cathode

Assume that a constant supply of electrons having uniform velocity and perpendicular direction is maintained through a fine-mesh accelerating grid. All of these electrons reach the plate for voltages  $E_b > E_m$ : the primary electron plate current is constant. The plate saturation current may be decreased by a secondary-electron current in cases of insufficient potential minimum in space (Fig. 16(b)). In practical cases the electron supply to the screen increases with plate voltage, and causes a characteristic of finite impedance value for  $E_b > E_{bm}$ .

At  $E_b = E_{bm}$ , the electrons are just decelerated to zero velocity at zero potential. The condition in space at  $M$  (Fig. 16(a)) is termed "virtual cathode" as it has the criteria of a real cathode, i.e., zero potential and zero electron velocity. The virtual cathode is saturated and disappears at  $E_{bm}$  because the positive value of  $M$  for  $E_b > E_m$  indicates a finite velocity of all electrons which are able, therefore, to reach the plate.

A decrease in plate voltage to  $E_b < E_m$  seems to require a potential minimum of negative value. For zero electron velocity of emission at the real cathode, a minimum of negative value would stop the entire electron current to the plate; but electrons of zero initial velocity cannot form a space charge of negative potential value. The condition  $M=0$  at  $E_b < E_m$  can exist, however, for a lower plate current. The excess electrons at the virtual cathode are forced to return to the accelerating grid and increase the space charge between  $M$  and the screen grid. The consequent decrease in space potential causes the virtual cathode to recede from the plate. The plate current is space-charge limited in the voltage range  $E_b < E_m$ .

We are justified in treating the section consisting of virtual cathode and plate as a diode and in drawing the following conclusions:

- i. The steepness of the diode-current (plate-current) rise with plate voltage depends on the area of the virtual cathode and its distance from the plate. Close spacing or a large area of the virtual

diode causes high conductance with consequent low saturation potential, i.e., a "knee" of the plate-current curve at a low plate voltage.

ii. If a sharp knee is desired, the virtual cathode must saturate at a single plate-voltage value over its entire area. This requires uniform distance from the plate, as well as uniform density and velocity of all electrons forming the virtual cathode.

iii. The plate current is space-charge limited for plate voltages lower than the value necessary to saturate the virtual cathode and thus cause its disappearance.

(a) Virtual-Diode Spacing and Saturation Voltage  $E_m$ —Functions of Electrode Voltages

The electron supply to the virtual cathode can be varied in tetrodes by the control-grid voltage  $E_{c1}$  without altering the voltage on the

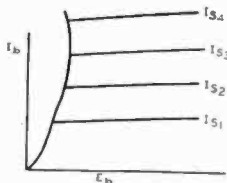

Fig. 17—Generalized "virtual-diode" characteristic.

positive grid  $G_2$ , or on the plate. The virtual-diode spacing is increased with larger currents (due to the higher space charge) and is decreased with smaller currents with corresponding changes of the saturation potential  $E_m$ . This change in perveance of the virtual diode as a function of the real cathode current explains the possible *crossover of the plate characteristics* at low  $E_b$  values for different values of the control-grid voltage at fixed screen potential (Fig. 20) and for different values of screen voltage with fixed control-grid voltage.

(b) The General Virtual-Diode Characteristic in Tetrodes

Although space-charge limited, the current does not increase in the range below  $E_m$  with the three-halves power of the plate voltage as in diodes with a real cathode, but follows a more complicated relationship as shown by the curve in Fig. 17. The conductance of the characteristic increases at some point to infinity and then becomes negative. Depending on the electron reserve and spacing, the virtual diode may saturate at any current value of the generalized curve. The peculiar relation of current and voltage is produced by the fact that the virtual-diode spacing is not fixed as in diodes with real cathodes. These conditions are analyzed in Figs. 18(a), (b), and (c).

The space-potential depression  $E_v$  is a function of the electron density. The density varies not only with the total electron supply but also with the amount of electrons leaving the virtual cathode in both directions.

If the plate voltage is zero or slightly negative, a current towards the virtual cathode only is impossible, as it cannot disappear in space. Because the total current is zero, the same number of electrons must fly back from the virtual cathode to the screen as arrive at the virtual cathode from the screen. This brings about the condition that the virtual cathode cannot approach the positive grid beyond a certain minimum distance  $V_0$ . The space potential between virtual cathode

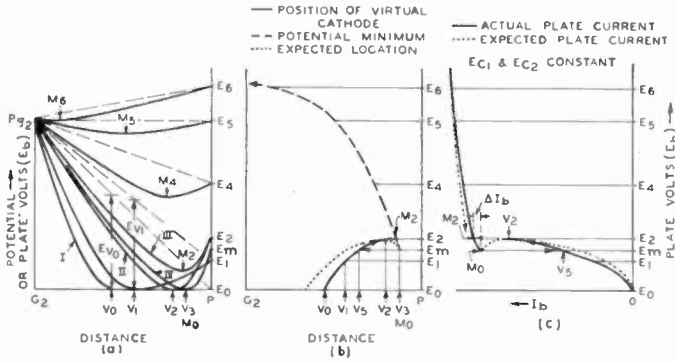

Fig. 18

- (a)—Potential distribution in a tetrode with high space-charge density between screen and plate.  
 (b)—Location of virtual cathode and potential minimum in tetrode with high space-charge density.  
 (c)—Plate characteristic of a tetrode with high space-charge density.

and positive grid is greatly affected by the magnitude of electron absorption at the positive grid wires, which is different for electrons of opposite direction due to beam formation by the grid wires.

A certain percentage of the electrons returning from the virtual cathode passes the screen grid and flies towards the cathode, comes to a stop, and flies again towards the screen. At negative and very low plate voltages, the number of returning primary electrons is very great. The electrons flying back towards the cathode reduce the space potential between screen and cathode and the effective potential near the cathode. Hence, the cathode current decreases. These circling electrons are responsible for the deviation of plate current and virtual-cathode position from the expected curves (dotted in Figs. 18(b) and 18(c)).

For the positive plate voltage  $E_1$ , the virtual-cathode space charge



and potential depression in the grid-plate space is decreased by the plate current and the equivalent decrease in reverse current due to fewer returning electrons. Hence the virtual cathode moves toward a position satisfying the decreased potential depression  $E_{v1}$ , which is a position closer to the plate. As the virtual-diode spacing is decreased, the plate current increases simultaneously and causes a further decrease of distance until a stable position is reached, shown as  $V_1$  in Figs. 18(a) and 18(b). If the electron reserve is not as large as shown, the virtual cathode will eventually saturate in such a stable position ( $I_{s1}$  and  $I_{s2}$  in Fig. 17). The case of a large saturation current is considered in the following, because it occurs with positive values of  $E_{c1}$  in the beam power tube (see Fig. 35).

The potential distribution (curve II in Fig. 18(a)) at  $E_b = E_2$  is critical.  $V_2$  has approached the plate sufficiently, so that the slightest increase in current starts a cumulative effect.  $V$  moves from position  $V_2$  towards the plate, an action which increases the perveance and, hence, the plate current until saturation occurs somewhat before reaching the position  $V_3$  (Figs. 18(a) and 18(b);  $E_2$  is higher than  $E_m$ ). Inasmuch as a stable minimum of zero value cannot be maintained by the plate voltage  $E_2$  (only by the lower voltage  $E_m$ ), the potential distribution changes to the stable curve III with a minimum  $M_2$  of positive value. The jump of the minimum from zero to  $M_2$  causes a plate-current increase  $\Delta I_b$  (Fig. 18(c)), which is not the case under ideal conditions, but always true in practical tubes. Some electrons have lower velocities than others, due to differences in initial velocity at the real cathode, and especially due to tangential components obtained during their flight through the structure. These slower electrons are unable to pass a minimum of low absolute potential but gradually reach the plate as the plate voltage is increased. A further cause is the finite value of the amplification factor  $\mu = -\partial e_p / \partial e_g$ .

With further increased plate voltage, the minimum recedes from the plate (see Figs. 18(a) and 18(b)). It occurs near the center (exactly at the center in ideal parallel-plane tubes) for  $E_b = P_{G2}$  and then disappears for voltages higher than  $E_6$ .

When the plate voltage is decreased, the plate current remains at saturation value and is stable until the minimum potential reaches zero value ( $M_0$ ). This occurs with  $E_b = E_m$ , and is shown by curve IV in Fig. 18(a). A virtual cathode forms; the slightest decrease of plate current forces  $V$  to move away from the plate. This action becomes cumulative until the stable position  $V_5$  (Fig. 18(b)) of high space-charge density is reached. The plate current drops suddenly to the value marked  $V_5$  in Fig. 18(c).

## (c) Optimum Plate Distance in Power Tetrodes

The control-grid voltage in power tetrodes varies the saturation current. It is best to saturate the virtual cathode at the value  $I_{s3}$  of Fig. 17 for zero control-grid voltage because the potential minimum  $M_0$  is then stable and occurs close to the plate. The saturation potential  $E_m$  of the virtual diode in power tetrodes is the plate-voltage value at which the "knee" occurs. At plate voltages  $E_b > E_m$  but  $< E_{c2}$ , a potential minimum of a least ten to fifteen volts less than plate potential must be formed between screen and plate in order to suppress secondary-emission effects. The virtual cathode is not a necessity for suppressor action but is formed eventually in all cases where a potential minimum is obtained at higher voltages.

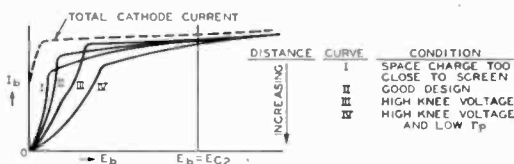

Fig. 19—Effects of plate-to-screen-distance variation on the plate characteristic in tetrodes having electrons with tangential components.

High plate currents at low plate potentials with respect to the screen potential require that the distance from virtual cathode to plate be short and uniform in order to obtain saturation at *one low plate-voltage value*. The plate distance can be made longer, if the area of the virtual cathode is increased which would indicate the use of a divergent electron path (wide beam angle) and circular structures. The potential *minimum after saturation should occur, however, closer to the plate* than to the screen and *should not be of large cross-sectional area*, to prevent a steep decelerating field. The latter undesirable condition is obtained either with very short plate distances and extreme electron densities or in circular structures with wide-angle electron beam and moderate electron densities. It causes high screen current and low plate impedance similar to high forward- $\mu$  suppressor grids located in pentodes too close to the screen grid. For these reasons circular structures with larger plate distances have been found unsatisfactory. The design of the structure for the saturation current  $I_{s3}$  in Fig. 17 results in a low saturation potential with high current due to the high diode conductance and causes the formation of a potential minimum sufficient for suppression of secondary-emission effects. The optimum distance ratio for the beam power tube (see page 156) is  $\rho_{opt} = 2.9$ . The beam angle is approximately 60 degrees. The curves I to IV in Fig. 19 illustrate the effects of plate-to-screen-distance varia-

tion in tubes having electrons with tangential components. The curves are understood from the aforesaid. Oscillogram checks for plate diameter changes in the beam power tube are shown in Fig. 20.

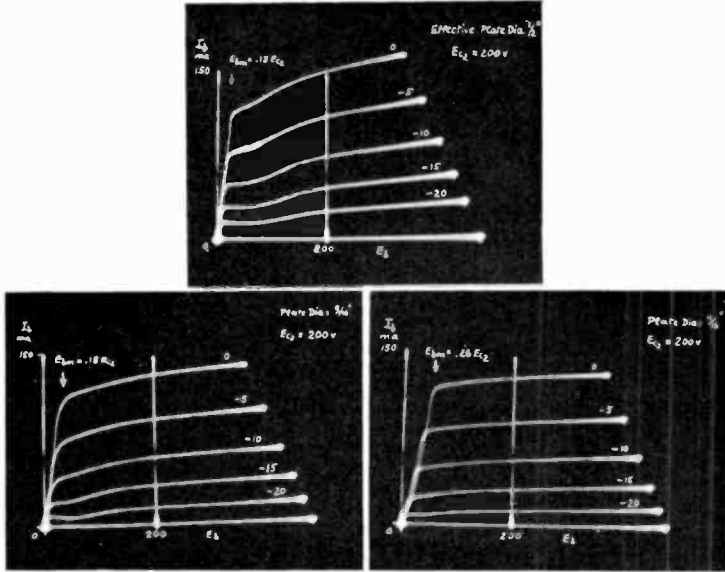

Fig. 20—Oscillograms showing plate characteristics for beam power tubes having different plate diameters.

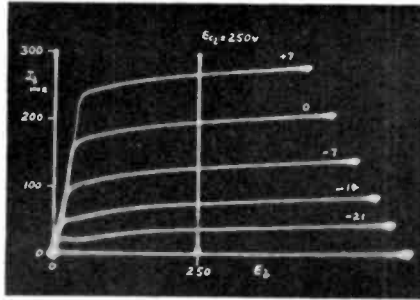

Fig. 21—Plate family of type 6L6 beam power tube.

## B. Beam Formation and Structure of the Beam Power Tetrode

### 1. The Electron Beam in a Radial Plane

#### (a) The Beam between Accelerating Grid and Plate

It is essential to maintain electron direction and *density perfectly uniform* in any cross section of the electron path at any distance from

cathode or plate to approach the theoretical performance discussed in the preceding section. The electron current is thus formed into a beam with definite properties.

The beam density at saturation current for the condition  $I_{s3}$  in Fig. 17 was found to be 28 milliamperes per square centimeter at the plate for  $E_{c2}=250$  volts and  $E_{c1}=0$  volts. The restriction of the electron beam to a section of a cylindrical structure with large radius is necessary to obtain high plate impedance and low screen current.

A series of tests has shown that the desirable relatively short plate distance will invariably cause a serious loss of plate current, a badly rounded "knee," or give rise to secondary-emission effects, unless the *utmost care is taken* in the design of the entire electrode structure to produce and maintain at low plate voltages a uniform electron beam that neither spreads nor compresses and has the required density and

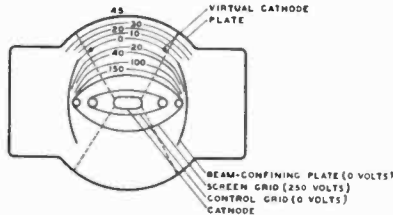

Fig. 22—Cross section and potential plot of beam power tube.

cross section when decelerated. The horizontal-beam cross section and location of the virtual cathode at saturation voltage in the beam power tube are indicated in the sectional view of the beam power-tube structure in Fig. 22.

In the screen-plate space, the electron beam in a radial plane is confined to a sector by two "beam-confining" plates at cathode potential. Virtual cathode and potential minimum stop secondary electrons from the plate. The beam-confining plates continue this potential barrier outside of the electron stream and prevent the return of secondary electrons along the sides of the beam. Ideal beam-confining plates should terminate all potential lines abruptly without distorting their uniformity. Shape and spacing of the actual plates is thus adjusted for best termination of the potential lines on the beam borders at low plate-voltage conditions. The edges of the plates point to the zero-potential plane of the virtual cathode at saturation potential. A mechanical analogy for explaining the shape of the radial field would be a tapered chute with bent-up sides and a curved bottom. The model in Fig. 25(b) shows the smooth bottom of this "chute."

## (b) The Beam between Cathode and Screen Grid

Having provided a suitable radial path for the electrons beyond the screen, we must further supply an electron stream of uniform density and velocity to the plane of the screen. Starting at the cathode, we must maintain the electron-beam density at any distance from the cathode substantially constant over the sector width by adjusting the *radius of curvature of the grids*. The sectional view in Fig. 22 shows that the radius of curvature of the electrodes is *decreasing* with distance. This is because a radius correction is necessary to compensate for

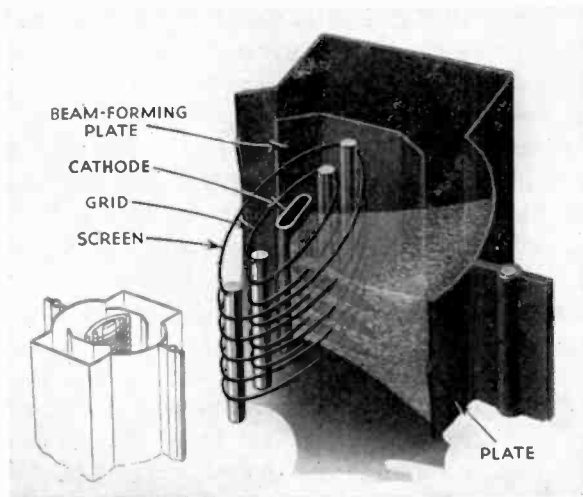

Fig. 23—Beam formation in type 6L6 beam power tube.

side-rod effects. The *flattened cathode* gives a more uniform and larger effective area than a round cathode with consequent gain in transconductance and power sensitivity. Spacing and cross section of the *grid side rods*, especially of the control grid, determine the beam angle and thus are fixed for a given current density in the decelerating field. With negative control-grid voltages, the beam angle is reduced by the control-grid side-rod field and thus some secondary electrons from the plate travel to the screen grid along the edges of the beam. This can be prevented but is unnecessary in a power tube.

## 2. The Beam Formation in a Longitudinal Plane

### (a) Subdivision of Cathode Current by Grid Wires into Directed Beams of Disk-Sector Shape

If the resultant field in the control-grid plane is positive, electrons leave the space-charge cloud at the cathode and travel with increasing

velocity in a path which approaches the position of a flux line. In tubes with negative control-grid voltage, the entire electron stream is divided into definite beams. In conventional tubes, no attempt is made to direct these beams, with the result that the electron streams have varying density and direction (see Fig. 12). These undirected beams of emission are responsible for a considerable absorption of electrons at the screen and a large variation of electron direction in the decelerating field beyond the screen, which causes gradual saturation no matter how uniform the electrostatic field is made in the space between screen and plate.

The misalignment of grid wires (see Fig. 12) in conventional pentodes permits electrons to pass at any point between the screen wires; the potential in the plane of  $G_2$  varies more than 50 volts. In the case shown, four beams are formed within one period of grid-wire alignment. The main beam area is shaded. Two of the main beams pass between the wires of  $G_2$  and only stray electrons are intercepted directly. The other two beams, however, hit the wires of  $G_2$  which intercept approximately 25 per cent of the beam current. The screen current intercepted directly is thus approximately 12.5 per cent of the cathode current. This value is obtained only at high plate voltages where all electrons passing the screen are collected by the plate. At lower plate voltages, electrons with tangential components fall back into the screen grid. For the particular tube and voltage shown, they amount to 20 per cent of the cathode current. Thus, the screen collects approximately one third of the total cathode current for the condition shown. To prevent serious overheating of the bombarded screen wires, the grids are wound with opposite thread so that the bombarded length of wire per turn is reduced and so that the total bombarded length is distributed over more turns.

*Directed electron beams are formed* when the entire length of all screen wires in the electron current is positioned in the electrical shadow of the control-grid wires. Certain distance relations are necessary to maintain a narrow beam width between the wires of  $G_2$  within the range of the variable control-grid voltage of power tubes in order to minimize screen current, and prevent serious divergence of electron paths at low plate voltages in the decelerating field beyond the screen.

The control-grid voltage governs the focal length of the beams, and thus their divergence for given electrode and grid-wire distances. Simultaneous adjustments must be made when designing the tube structure because control-grid voltage, plate current, and beam focus depend on the same physical space relations between grid wires, grids, and cathode.

## (b) Advantages of Directed Beam Formation

- i. Substantially uniform current density and electron direction at the virtual cathode in a direction parallel to the cathode axis is obtained. (The beams meet. See Fig. 24.)
- ii. The low screen dissipation increases the efficiency of the tube.
- iii. The low screen current gives an unusual flexibility of operating conditions, as the screen voltage can be stabilized with bleeders of low power dissipation.

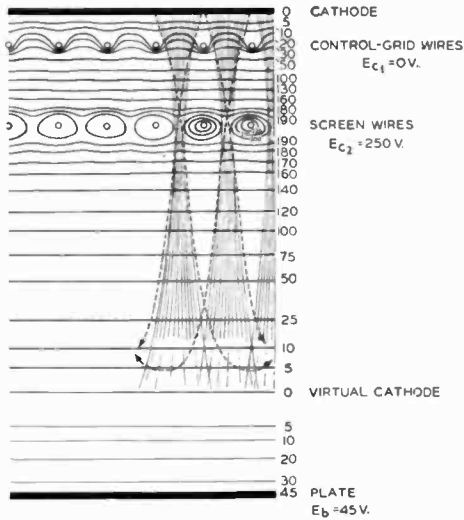

Fig. 24—Potential field of type 6L6 beam power tube for the condition of virtual-cathode saturation.

- iv. Higher screen-voltage ratings are permitted with consequent increase in power output.
- v. The power sensitivity can be increased without danger of grid emission, because the screen temperature is low.
- vi. The field distribution parallel to the axis of the cathode is more uniform at the cathode than in tubes with grids of different pitch and periodic misalignment of grid wires. This uniformity permits obtaining higher transconductance values with good plate-current cutoff.

## (c) The Beam Formation in the Beam Power Tube

Developmental power tubes have been constructed with individual beams of long focal length formed by negative grid wires and sharply focused between the positive screen wires. The screen-grid current at the operating point was reduced to less than two per cent of the plate-

current value. The spacing requirement is, however, not suitable for high power sensitivity.

The distance between control grid and cathode is determined by the power sensitivity, and the control-grid pitch and wire size by the cutoff characteristic, as explained later. *The formation of directed beams requires equal pitch of control and screen grid.* Hence, for a given set of the above conditions, the distance ratio of  $d_{G_1-G_2}$  to the pitch distance is the main variable. It determines the focal length of the beams and also plate-current, screen-current, and control-grid voltage. In order to satisfy also the requirements for grid side-rod spacing, radius of curvature, power-dissipation capability of the plate, and low grid emission, a balance of the various tube properties is necessary to result in a generally desirable structure.

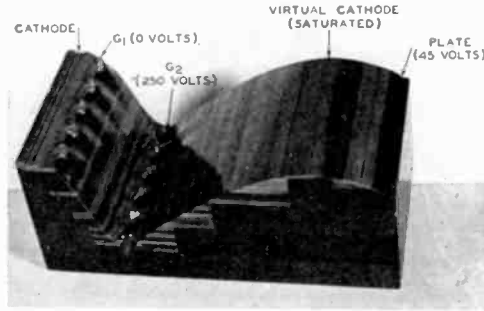

Fig. 25—Topographic model of potential field shown in Fig. 24.

An artist's sketch of the total beam formation in the beam power tube at a low plate voltage is shown in Fig. 23. The control-grid beams have the form of sheets. The dense area near the plate indicates the location of the virtual cathode also shown in Fig. 22. The cathode current is split up into two groups of 43 narrow beams. The ratio of the grid distance ( $d_{G_1-G_2}$ ) to the grid-wire spacing is 1.4.

The potential field of the beam power tube and a topographic model are shown in Figs. 24 and 25. The uniformity of the field between screen grid and plate is apparent. The plate voltage shown is the saturating potential (45 volts) of the virtual cathode (knee), and thus the hill in front of the plate has an elevation just equal to that of the cathode. The control-grid mountain peaks (shown for zero grid voltage) direct the electron "balls" towards the narrow ridge between the screen-grid holes. Less than nine per cent of the electrons at the sides of the beams is deflected from a linear path by the conical holes, loses radial velocity,



and turns back from the virtual-cathode hill to the screen. About three per cent of stray electrons is intercepted directly. All others have just sufficient momentum to roll over the virtual-cathode hill to the plate. With increased plate voltage ( $E_b > 45$  volts), the elevation of the plate decreases (in the model) as does also that of the potential minimum in front of the plate. The electrons including those with tangential components pass easily over the lower hill in front of the plate but hit the plate with considerably more impact. The hill in front of the plate, however, prevents them from bounding back and rolling back to the screen valley. In an actual tube, however, the primary electrons stay bound at the plate, but secondary electrons are knocked off and are the ones which are prevented from reaching the screen valley.

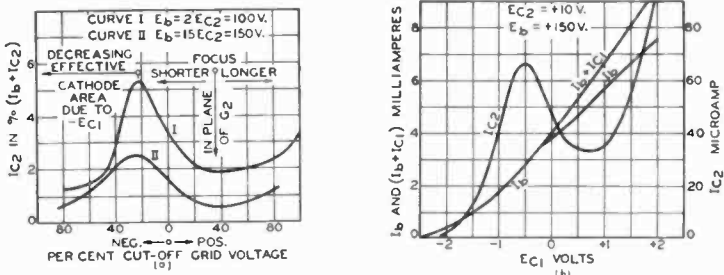

Fig. 26

- (a)—Changes of beam focus and current intercepted by the screen as a function of control-grid voltage in a beam power tube.  
 (b)—Current distribution in a beam power tube as a function of control-grid voltage.

The beams come to a focus in the plane of the screen grid with a positive control-grid voltage, and cause a screen-current minimum (see Figs. 26(a) and 26(b)). The focal length is decreased with increased negative control voltages. Consequently, the beam width in the plane of  $G_2$  is increased. The increase of  $I_{c2}$  is, however, checked by the decrease in effective cathode area opposite the grid-wire space due to cutoff conditions. This narrows the convergent angle so that the divergence and beam width beyond the focus actually reduce for high bias values with consequent low current absorption. A low screen voltage and high plate voltage were used in obtaining the curves of Figs. 26(a) and 26(b) to minimize secondary-emission effects from the screen.<sup>8</sup>

<sup>8</sup> I am indebted to Mr. H. C. Thompson, who has studied beam principles for many years in our laboratory, for his explanation of beam theory. His paper, "Electron beams and their applications in low voltage devices," appeared in the Proc. I.R.E., vol. 24, pp. 1276-1297; October, (1936).

The transfer characteristic of the tube follows the square law in order to reduce third-harmonic distortion. The control-grid-wire distance from the cathode was made shorter than the grid-wire spacing (ratio 2 to 3) so as to cause the effective area of the control potential to vary substantially with the one-half power of the applied control-grid voltage as pointed out in the discussion of the pentode plate char-

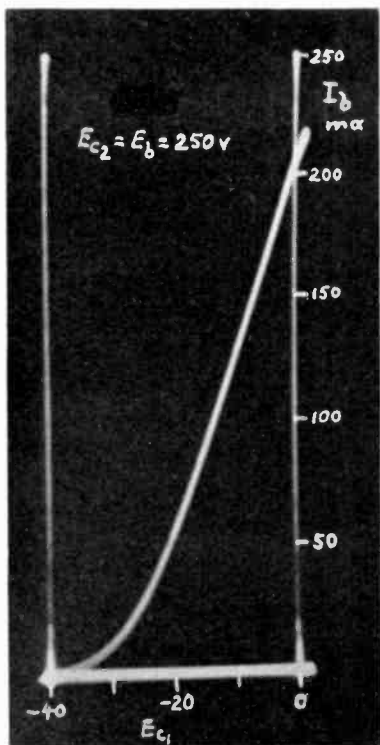

Fig. 27—Transfer characteristic of type 6L6 beam power tube.

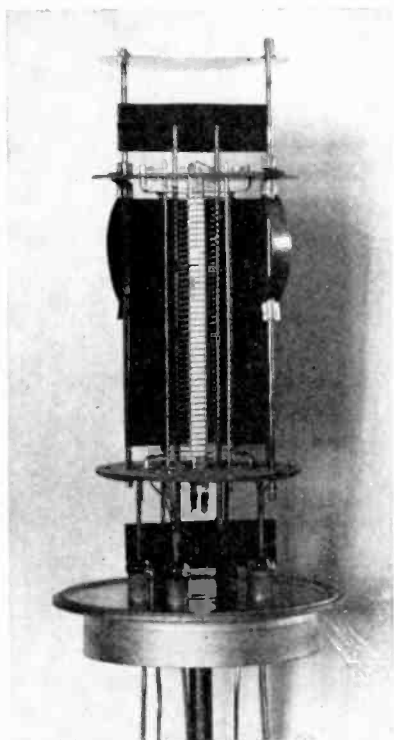

Fig. 28—Type 6L6 with cutaway plate to show grid-wire alignment.

acteristic. The desired result is obtained because the positive potential source (the screen) remains at a fixed potential and because side-rod effects are compensated for by electrode shape adjustment. An oscillogram of the transfer characteristic is shown in Fig. 27.

The *plate characteristics* of the beam power tube are shown in the oscillogram in Fig. 21. Insufficient minimum potentials are indicated at highly negative grid voltages by the presence of secondary-emission effects but they have no harmful consequences inasmuch as this section of the plate characteristics is not utilized in practical operating

conditions. Although the beam power tube was designed for operation with screen voltages between 250 and 300 volts, it may be operated within a wide screen-voltage range without substantial performance loss.

The beam power tube is the first tube in large quantity production to utilize grids in register. The alignment is held at present within 0.004 inch for all grid wires. This corresponds to a screen-current variation of from four to ten per cent of the plate current at the normal operating point. In the side view with cutaway plate in Fig. 28, the tube appears to have only a single grid on account of the exact alignment of the two grids. This precision is obtained by means of a high degree of accuracy in maintaining a constant pitch angle in the manufacture of both grids. The grids are aligned mechanically and all side rods are anchored to weld lugs clamped in a "terminal board" mica which positions and supports the electrodes rigidly. Two heat radiators maintain the control-grid temperature at a low value to minimize grid emission under all operating conditions within the rating of the tube.

It is thus found that directed electron beams obtained by electrical focusing with properly chosen grid wires, grid side rods, beam-confining plates, and electrode shapes will produce an electron stream of nearly ideal properties with respect to uniformity of electron direction and velocity, and that substantially theoretical performance may be obtained with tubes in which these beams are used. In the beam power tube, slow electrons and those having large tangential components are substantially prevented by beam formation; hence, large plate spacings are not required, wasteful screen current is avoided, and improved plate efficiency is obtained. In this beam power tube it was found practical to suppress secondary-emission effects by space charge.

Tubes which do not utilize carefully directed electron beams, but use the space-charge type of secondary-emission suppression, require long distances between screen grid and plate for satisfactory results and have been found to show little improvement over existing commercial pentodes. Such tubes with a large screen-to-anode distance, may be made to have a characteristic with a fairly defined knee occurring at somewhat higher voltages than in a beam tube, but the magnitude of the screen current at lower plate voltages prevents highly efficient tube operation. Tubes of this type with long distance between screen grid and anode have been discussed by J. H. O. Harries<sup>9</sup> of London, England, in recent articles.

<sup>9</sup> "Critical distance tubes," *Electronics*, vol. 9, p. 33; May, (1936).

## VI. THE PERFORMANCE OF THE BEAM POWER TUBE

## A. Single-Tube Operation

## 1. Distortion, Efficiency, and Ratings

The harmonic distortion of a single tube is of substantially second-harmonic order, and decreases linearly with signal according to theory. Higher orders than the third are negligible (see Figs. 29(a) and 29(b)). The percentage of second harmonic is comparatively large if the grid

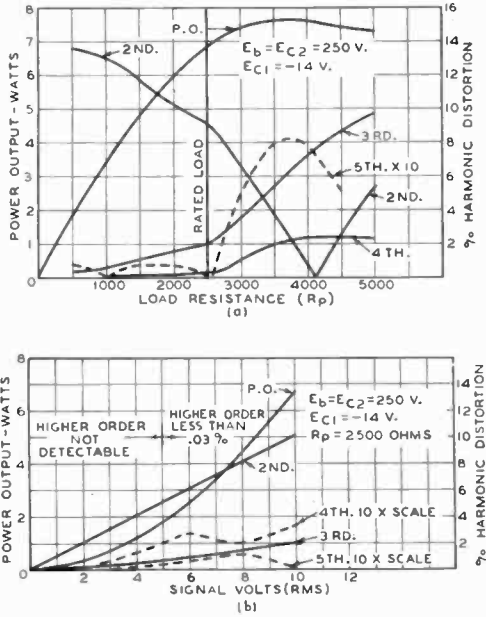

Fig. 29

- (a)—Harmonic distortion and power output as a function of load resistance for type 6L6 at peak input signal volts equal to the grid-bias voltage.  
 (b)—Harmonic distortion and power output as a function of input signal voltage for type 6L6 with 2500-ohm load.

bias is selected for high efficiency as shown in Fig. 30(a) by the values calculated from the ideal characteristic of parallel straight lines with square-law spacing. A comparison of actual tube performance (Fig. 30(b)) with these values shows better efficiency at the same values of second-harmonic distortion because a small value of third-harmonic distortion has been intentionally allowed by designing the plate characteristic as shown by curve II in Fig. 19.

Various measurements have proved that it is always possible to reduce the total distortion to six per cent or less with resistance-coupled

preamplifiers (triodes or pentodes) by generating in these amplifiers operated with reduced plate loads a canceling second harmonic of sufficient magnitude. A third harmonic produced in preamplifiers is usually additive to the third harmonic in the output stage except in special operation of push-pull preamplifiers.

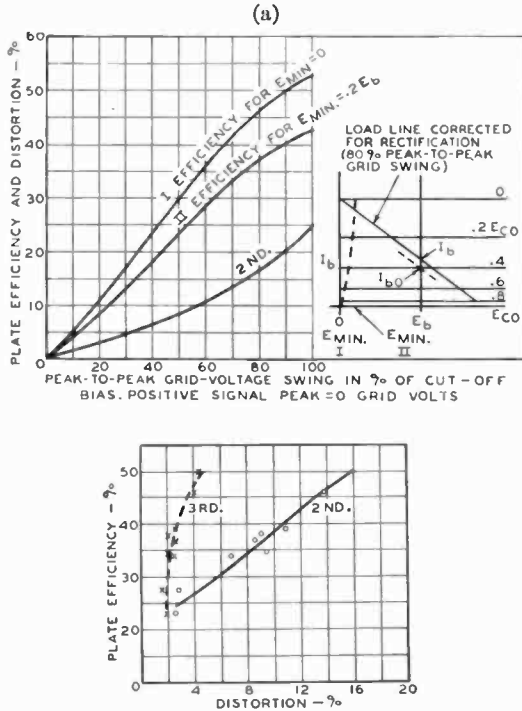

Fig. 30

- (a)—Performance of hypothetical screen-grid tube with linear characteristics and square-law transfer characteristic.  
 (b)—Performance of beam power tube for various operating conditions at maximum signal input without grid current.

The flexibility of screen-voltage values permitted by the low screen current results in large power-output ratings as well as high power sensitivity as tabulated in Table I.

In contrast to standard practice for pentodes, the plate load is not selected for minimum total distortion (Fig. 29(a)), but for a minimum of higher-order distortion in accordance with the previous discussions, because the design of the tube allows nearly maximum power output to be obtained with such loads.

TABLE I

Static and Dynamic Characteristics							
Heater voltage.....	6.3 volts						
Plate voltage.....	250 volts						
Screen voltage.....	250 volts						
Grid voltage.....	-14 volts						
Amplification factor.....	135						
Plate resistance.....	22500 ohms						
Transconductance.....	6000 micromhos						
Plate current.....	72 milliamperes						
Screen current.....	5 milliamperes						
Single-Tube Class A1 Amplifier*							
Plate voltage.....	375 max. volts						
Screen voltage.....	250 max. volts						
Plate and screen dissipation (total).....	24 max. watts						
Screen dissipation.....	3.5 max. watts						
Typical operation:							
Heater voltage.....	6.3		6.3		6.3		6.3 volts
Plate voltage.....	375		250		300		375 volts
Screen voltage.....	125		250		200		250 volts
	<i>Fixed Bias</i>	<i>Self-Bias</i>	<i>Fixed Bias</i>	<i>Self-Bias</i>	<i>Fixed Bias</i>	<i>Self-Bias</i>	<i>Fixed Bias</i>
Direct grid voltage.....	-9	—	-14	—	-12.5	—	-17.5 volts
Self-biasing resistor.....	—	365	—	170	—	220	ohms
Peak audio-frequency grid voltage.....	8	8.5	14	14	12.5	12.5	17.5 volts
Zero-signal direct plate current.....	24	24	72	75	48	51	57 milliamperes
Max.-signal direct plate current.....	26	24.3	79	78	55	54.5	67 milliamperes
Zero-signal direct screen current.....	0.7	0.7	5	5.4	2.5	3	2.5 milliamperes
Max.-signal direct screen current.....	2	1.8	7.3	7.2	4.7	4.6	6 milliamperes
Load resistance.....	14000		2500		4500		4000 ohms
Distortion:							
Total harmonic.....	9		10		11		14.5 per cent
2nd harmonic.....	8		9.7		10.7		11.5 per cent
3rd harmonic.....	4		2.5		2.5		4.2 per cent
Max.-signal power output.....	4.2		6.5		6.5		11.5 watts
Plate and screen efficiency (total).....	42		43		30		37.2
							43 per cent

\* Suffix 1 indicates that grid current does not flow during any part of the input cycle.

## 2. Overload Characteristics

In all ideal audio-frequency amplifier tubes, whether triodes or pentodes, the efficiency has reached the maximum value of 50 per cent with normal operating conditions and zero peak grid volts. A so-called "smooth overload" characteristic as obtained in tubes having low efficiency at the rated output value is thus not obtainable in class A operation for audio-frequency purposes. An analysis of the ideal triode characteristic shown in Fig. 2 shows that distortion at the grid-current point is very small and rises steeply for further increases in signal voltages because the plate voltage at the current maximum can only increase 50 volts at most. This fact is not altered by the assumption of a control grid which draws no current even with high positive grid voltages.

The plate-current knees in the beam power tube occur at a low plate voltage. A high plate load intersects a knee of a negative-control-grid-voltage line. The corresponding peak swings of voltage and current do

not increase any further with larger grid signals, although these may be negative. Power output and efficiency are increased but at the expense of higher distortion because plate-efficiency values over 50 per cent require that the wave approach a "flat-topped" or square form.

## B. Push-Pull Operation

### 1. General Discussion of Push-Pull Amplifiers Having High Power Sensitivity.

Push-pull amplifiers are used in radio receivers not only for balancing out various current components in transformers and load, but also to obtain low distortion and increased efficiency of tube and circuit operation. It is highly important to analyze the performance of hypothetical tubes with high power sensitivity in amplifier circuits having commercially obtainable power supply regulation.

#### (a) Triodes

The dynamic characteristic of triodes having a constant  $\mu$  and a plate impedance much lower than the plate load (as, for instance, the ideal tube shown in Fig. 2) is substantially linear. The resultant characteristic of two tubes in a push-pull circuit is thus represented by the geometric addition of two straight lines. Fig. 31 shows the joined characteristics for five distinct operating points. Dotted lines mark the grid-current point. Conditions 1 and 2 show class A1 operation; condition 2 is for class A1 operation with minimum plate current. Both conditions give zero distortion. The power output and efficiency of condition 1 is naturally less than for condition 2 which is limited to 50 per cent efficiency. Class AB1 operation, as shown in condition 3, has still higher efficiency because  $I_{b0}$  is lower than  $\frac{1}{2} I_{max}$ . The breaks in the curve, however, cause distortion including high orders. Condition 4 shows the very critical class B1 operation having zero distortion and a maximum theoretical efficiency for ideal audio amplifiers of 78.6 per cent.

In practical amplifiers the supply voltages vary with current increments because of imperfect regulation. The operation of ideal triode amplifiers is thus limited to class A conditions. A pair of hypothetical triodes (Fig. 2) operated as push-pull class A1 amplifiers at maximum efficiency as in Fig. 31, condition 2, requires a direct grid voltage ( $E_c$ ) of -37.5 volts and a plate voltage ( $E_b$ ) of 400 volts for 35 watts output with 51 per cent plate efficiency and negligible distortion. The characteristic (Fig. 2) of these hypothetical tubes was constructed to obtain a performance approximately equal to the beam power tube. Because of the high triode conductance, the plate-current increment due to signal is sufficient to shift the operating point to zero plate

current (Fig. 31, condition 4), if the plate-voltage regulation is 6.25 per cent.

It can be shown that self-biased operation of these tubes requires a minimum plate current of 85 milliamperes per tube in order to prevent complete cutoff (condition 5) at full signal. The rectification in actual tubes would be larger and the obtainable efficiency would be reduced

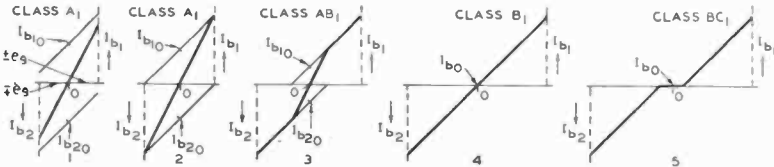

Fig. 31—Push-pull characteristics for triodes having linear dynamic characteristics.

to the order of 35 per cent because the required operating condition would necessitate a higher plate current and cause higher plate dissipation.

(b) Pentodes and Beam Power Tubes

For equal power sensitivity the stability of the operating point is considerably better in tubes with accelerating grid. The screen prevents the control of the plate voltage over the plate current and thus the required transconductance for equally good efficiency and power sensitivity is considerably lower than in triodes.

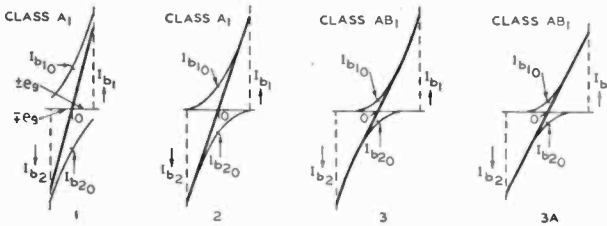

Fig. 32—Push-pull characteristics for ideal pentodes having square-law dynamic characteristics (sketches 1, 2, and 3); push-pull characteristic of beam power tube (sketch 3A).

The dynamic transconductance obtained with two of the new beam power tubes in push-pull is 4000 micromhos per tube while that of the equivalent hypothetical triode would have to be 56,000 micromhos.<sup>10</sup>

<sup>10</sup> It can be shown that for a triode power tube to equal the performance of a pentode power tube the following ratio holds:

$$\frac{g_m \text{ (triode)}}{g_m \text{ (pentode)}} = \frac{2(E_{b0} - E_{bm})}{E_{bm}}$$

For  $E_{b0} = 400$  volts and  $E_{bm} = 50$  volts, we obtain  $g_m \text{ (triode)} = 14 g_m \text{ (pentode)}$ .



The curvature of a high-impedance plate characteristic is *not* straightened out by the plate load. This permits operation with smaller quiescent plate currents and thus higher efficiency, as illustrated in Fig. 32. The resultant characteristic from two square-law curves is linear for the class A1 operating conditions 1 and 2. The overbiased operation in condition 3 does not cause high-order distortion because the curve does not have sharp breaks.

In the design of the beam power tube the plate characteristics in the low plate-voltage range are so adjusted that the distortion minimum (0.8 per cent) is obtained in push-pull class AB1 operation with a quiescent plate current of 28 milliamperes per tube, i.e.,  $I_{b0} = 0.14 I_{max}$  at  $E_{c1} = 0.625 {}_{c0}E_c$ . The high-current end of each individual dynamic characteristic is straightened out by the plate load so that only the square-law sections of the individual characteristics have to be overlapped (3A in Fig. 32). Class A1 operation of these tubes causes an increase in distortion to two per cent which, due to the absence of higher orders, is not objectionable. Plate-current increments above the knee are substantially proportional to the one-half power of the plate voltage over the range in which a potential depression is caused by space charge between  $G_2$  and the plate.

## 2. Performance of Beam Power Tubes in Conventional Push-Pull Service

The new all-metal beam power tube is designed for class A1 and class AB1 operation.<sup>11</sup> Two self-biased tubes in push-pull class AB1 are capable of delivering without grid current a power of 32 watts with 58 per cent plate-plus-screen-power efficiency, and 54 per cent direct-current-power efficiency including self-biasing power. Including heater power, the total circuit efficiency is 45 per cent. Distortion has the small value of one to two per cent and is of substantially third-harmonic order. Other harmonics are small fractions of one per cent, no larger or of higher order than found in the output of push-pull low-impedance triodes.

With only 350 milliwatts peak grid power, a power output of 60 watts with two per cent plate distortion and with efficiency similar to that just given is obtained in class AB2 operation for use in large sound systems. Operation with grid current is not recommended for high quality reproduction due to the generation of higher harmonics in the grid circuit. The small grid power permits a driver design of low distortion.

The cathode is of the indirectly heated type operating with 6.3 volts alternating or direct current and 0.9 ampere, i.e., 5.7 watts.

<sup>11</sup> The tube has been made available under the type number 6L6.

Correct self-bias operation is highly efficient and does not require good supply-voltage regulation, as may be seen from the table comparing fixed-bias and self-bias operation in Table II. The self-bias

TABLE II

Push-Pull Class AB1 Amplifier					
Plate voltage.....					400 max. volts
Screen voltage.....					300 max. volts
Plate and screen dissipation (total).....					24 max. watts
Screen dissipation.....					3.5 max. watts
Typical operation—2 tubes:					
<i>Values are for 2 tubes</i>					
Heater voltage.....	6.3	6.3	6.3	6.3	6.3 volts
Plate voltage.....	400	400	400	400	400 volts
Screen voltage.....	250	250	300	300	300 volts
	<i>Fixed</i>	<i>Fixed</i>	<i>Self-</i>	<i>Self-</i>	<i>Fixed</i>
	<i>Bias*</i>	<i>Bias</i>	<i>Bias</i>	<i>Bias</i>	<i>Bias*</i>
Direct grid voltage.....	-20	—	-25	—	-25 volts
Self-biasing resistor.....	—	190	—	200	— ohms
Peak audio-frequency grid-to-grid voltage.....	40	40	43.8	50	57
Zero-signal direct plate current.....	88	88	96	102	112
Max.-signal direct plate current.....	126	124	110	152	128
Zero-signal direct screen current.....	4	4	4.6	6	7
Max.-signal direct screen current.....	9	12	10.8	17	16
Load resistance (plate to plate).....	6000	8500	—	6600	—
Distortion:					3800 ohms
Total harmonic.....	1	2	—	2	0.6 per cent
3rd harmonic.....	1	2	—	2	0.6 per cent
Max.-signal power output.....	20	26.5	24	34	32
Plate and screen efficiency (total).....	38	50.5	52	51.5	58
					23 watts
					35 per cent

\* Plate load decreased to permit operation with grid current.

resistor is selected such that the plate and the screen rectification at full signal do not shift the bias beyond the value of minimum distortion and highest efficiency. Because of the high power sensitivity, the voltage changes are small causing but a slight decrease in power output. The amplitude distortion of  $-0.8$  decibel in input voltage due to the self-bias shift is not detectable by the ear.

The advantages offered by push-pull amplifiers utilizing tubes with accelerating screen grids are augmented by the use of beam power tubes. Owing to their characteristics and their precision of manufacture, it is possible to obtain substantially the same performance in the practical use of beam power tubes as is obtained under ideal conditions. No matching of beam power tubes is required.

### C. Circuits with Inverse-Voltage Feedback for Adjustment of Tube Impedance

#### 1. Theory

Low plate impedance has been shown to be inconsistent with regard to design and operation of practical highly efficient power tubes. As low plate impedance is, however, one of the specified properties of an ideal power tube, circuit means for changing the effective plate impedance of tubes were investigated.

The plate impedance of a vacuum tube is defined as  $r_p = d e_p / d i_p$  and measured by the ratio  $\Delta e_p / \Delta i_p$ . If the increment  $\Delta e_p$  or a percentage of  $\Delta e_p$  in the plate circuit is coupled back into the grid circuit, it will increase or decrease the plate-current change  $\Delta i_p$  depending on the phase of the feedback. If, furthermore, the phase of the feed-back voltage is in opposition, i.e., "inverse," to the grid-voltage change which causes the plate-voltage change  $\Delta e_p$ , stable operation is obtained; the circuit is not regenerative.

The circuit in Fig. 33(a) has 100 per cent inverse-voltage feedback. If a voltage increment  $+\Delta e_p$  is produced in the circuit branch normally containing the load resistance, the plate-current increment without

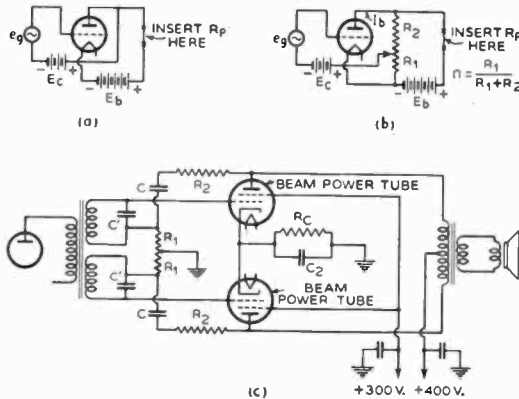

Fig. 33

- (a)—Circuit for 100 per cent conductive feedback ( $n = 1$ ).  
 (b)—Circuit with adjustable conductive inverse feedback ( $n < 1$ ).  
 (c)—Practical inverse-feedback circuit utilizing push-pull beam power tubes.

$$\left. \begin{array}{l} R_1 = 10,000 \\ R_2 = 90,000 \end{array} \right\} \text{ or } \left. \begin{array}{l} 5000 \\ 45,000 \end{array} \right\} \text{ for 10 per cent feedback}$$

$R_C$  = self-bias resistor

$C = 0.1$  microfarad or larger

$C'$  = value depends on secondary impedance of transformer and should be determined by test. Large values require a series resistor to prevent transients.

$C = 35$ -volt electrolytic condenser (50 microfarads).

feedback is  $+\Delta i_{p1} = +\Delta e_p / r_p$ . Due to the feed-back connection, however, the grid voltage is changed simultaneously by the increment  $+\Delta e_g = +\Delta e_p$ . This causes a further plate-current change  $+\Delta i_{p2} = \Delta e_g \times g_m$ , and thus

$$\Delta i_p = \Delta i_{p1} + \Delta i_{p2} = \Delta e_p (1/r_p + g_m).$$

The resultant value of plate resistance is thus

$$r_{p(r)} = \frac{1}{1/r_p + g_m} = \frac{r_p \times 1/g_m}{1/g_m + r_p} = r_p \parallel 1/g_m.$$

The feedback causes an effective shunt  $r_p' = 1/g_m$  across the actual plate impedance. The new resultant value  $r_{p(r)}$  in this circuit requires a change in magnitude of amplification factor in order to satisfy the tube equation  $\mu = g_m \times r_p$ . Because the plate and grid circuit do not contain any common resistances,  $g_m$  remains constant and thus the resultant amplification factor ( $\mu_r$ ) is

$$\mu_{(r)} = g_m \times r_{p(r)}$$

which can be written

$$\mu_{(r)} = \mu / (1 + \mu).$$

The feedback  $n$  in this circuit is unity. Less feedback ( $n < 1$ ) results in smaller changes of  $r_p$  and  $\mu$ , because in general

$$r_{p(r)} = r_p \parallel \frac{1}{n \times g_m}$$

where  $n$  = feed-back factor, and

$$\mu_{(r)} = \frac{\mu}{1 + n\mu}.$$

The distortion in circuits with 100 per cent inverse feedback has been investigated by F. H. Shepard, Jr., of the RCA Radiotron Division. He found it to be extremely low, because it is reduced approximately by the same factor by which the required grid signal must be increased. Circuits with unity feedback ( $n = 1$ ) require a grid signal equal to the sum of plate and grid-signal voltage and thus have very low power sensitivity.

A modification of the circuit for obtaining fractional feed-back values ( $n < 1$ ) is shown in Fig. 33(b), in which the feed-back value  $n = r_1(r_1 + r_2)$  may be adjusted at will. The circuit shown has a conductive feed-back connection, which permits the plotting of the resultant plate characteristic of the tube with feedback by any conventional method.

Oscillograms of feed-back characteristics of the beam power tube taken with a cathode-ray curve tracer for 10, 20, and 30 per cent inverse feedback are shown in Fig. 34. Because the oscillograms require a flat frequency characteristic with zero phase distortion from 10 to approximately 10,000 cycles, they prove the frequency stability of the circuit. The decrease of  $r_{p(r)}$  and  $\mu_{(r)}$  with increased feedback is obvious.

## 2. Graphic Construction of Feed-Back Characteristic

The construction of the characteristic with feedback from the original characteristic is not difficult. As illustrated in Fig. 35, it is obtained by simply adding  $-n E_b$  to all grid-voltage values and draw-

ing curves through all points  $-(E_{c1} + nE_b) = -E_{v1(r)}$  of equal voltage.

The construction furnishes the correct resultant values of  $\mu_{(r)}$  and  $r_{p(r)}$  ( $g_m$  is unchanged) at any point of the feed-back characteristic. The original

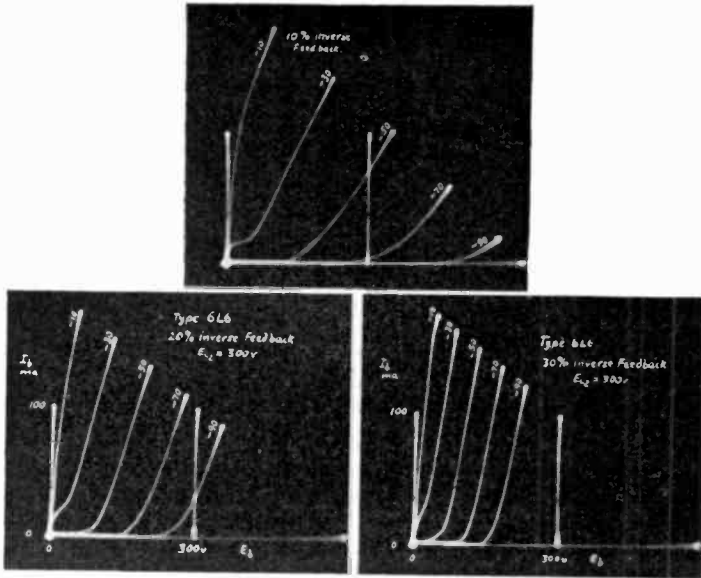

Fig. 34—Oscillograms showing effects of inverse feedback on plate characteristics of a beam power tube. Oscillograms taken with the curve tracer using circuit of Fig. 33(b).

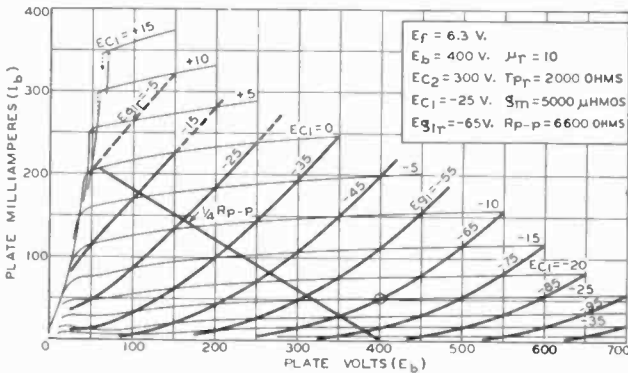

Fig. 35—Inverse feed-back plate characteristics for  $n=0.1$  constructed from the static plate family of the 6L6 beam power tube.

zero-bias line is the envelope of all values without grid current. It is further seen that the position of the optimum plate load and the power output, as determined for all normal operating conditions, remains

unchanged. Distortion analysis, however, will show a reduction of distortion in approximate proportion to the required signal increase.

### 3. Performance of Beam Power Tubes in Practical Circuits with Inverse-Voltage Feedback

Conductive feedback is unnecessary in audio-frequency amplifiers. The correct phase relation is least disturbed by a resistance-capacitance coupling as shown in the practical circuit of Fig. 33(c). The blocking condensers  $C$  eliminate direct-current feedback and thus make it unnecessary to change the original grid-biasing voltage. *This measure avoids at the same time possible plate-current cutoff due to rectification*, because the direct-current plate conductance is not increased to the high value of a real triode.

The high power sensitivity of the beam power tube requires the value of only 10 per cent feedback to effect a *loud-speaker damping equal to that obtained with class A1-operated low-impedance triodes*. The required grid signal as obtained from the push-pull operating condition illustrated in the feed-back characteristics of Fig. 35 is 60 peak volts at the grid-current point. The operating bias ( $E_{g1}$ ) is  $-65$  volts which would be the direct-current bias value for the conductive feed-back connection. Since the practical feed-back connection contains a blocking condenser, the direct-current bias on the tube is  $-25$  volts. The power output remains 32 watts, a small percentage of which is dissipated in the potential divider. The distortion is reduced to approximately 0.6 per cent. The high circuit efficiency is substantially unaltered.

A possible phase reversal due to leakage-reactance tuning of the input transformer is prevented by connecting small condensers across each secondary winding. Plate-load compensation is unnecessary due to the low effective plate impedance of the tubes. The low  $r_{p(e)}$  of the tubes will give less trouble from hum than triodes, due to better stability of the operating point, but naturally requires a better filtered B supply voltage as compared to pentode operation.

*Circuits with un-by-passed cathode resistor* are also inverse-feed-back circuits. In single-tube operation such circuits will reduce the distortion of the beam power tube to approximately one half of its normal value while the required grid signal will be doubled and the output power reduced approximately 10 per cent by the loss in the cathode resistor. It can be shown that this feed-back method *increases the effective plate impedance of the tube with respect to a separate plate-circuit load and decreases the tube impedance with respect to the cathode resistor*. For damping purposes, therefore, this method is efficient only for 100 per cent inverse feedback, i.e., if  $R_p$  is located in the cathode lead.

## CONCLUSION

By the use of new principles in design and application of power tubes, we have in the beam power tube closely approached ideal power-tube characteristics and performance. The development of this tube has been made possible by the splendid co-operation and specific knowledge of many fellow engineers, to whom I want to express my sincere appreciation.



## SINGLE-SIDE-BAND TELEPHONY APPLIED TO THE RADIO LINK BETWEEN THE NETHERLANDS AND THE NETHERLANDS EAST INDIES\*

By

N. KOOMANS

(Radio Laboratory, Netherlands Telegraph Administration, 's Gravenhage, The Netherlands)

**Summary**—An historical introduction reviews the initial long-wave telegraph circuit with the East Indies in 1923, the first short-wave telegraph circuit in 1925, and the inauguration of short-wave telephony in 1928, this being accomplished by means of the usual double-side-band and carrier system. The principal limitations attending this method of operation are discussed; viz., the phenomena of fading, susceptibility to frequency and phase modulation, and the fact that it does not lend itself to multiplexing, because of the presence of the high-powered carrier.

The features which characterize the present system are, first, that of single-side-band as applied to high-frequency transmission, and, second, that of multiplexing, whereby a plurality of channels are enabled to be transmitted by means of a single power amplifier and directive antenna system.

In the transmitter the group of channels which is to be transmitted, representing one telegraph and two telephone messages, is assembled at low power and low carrier frequency and is then stepped up in power and in frequency in a succession of stages. The spectrum transmitted comprises (1) the two telephone channels located in frequency as single bands on opposite sides of the suppressed carrier; (2) the telegraph channel superimposed thereon as two tone frequencies, one for spacing and one for marking, and transmitted on a double-side-band basis to obtain the advantage of frequency diversity; and (3) the pilot channel transmitted at a frequency 5000 cycles removed from the carrier position.

At the receiver this spectrum is amplified and stepped down in frequency by two heterodyne detections, first to 470 kilocycles and then to a position at which 10 kilocycles corresponds to the suppressed carrier. At this 10-kilocycle position the spectrum is resolved into the individual channels by filters and the carrier is resupplied to each channel for individual detection. The 2 superheterodyne oscillators are automatically maintained at the correct frequency by means of a control exercised by the 5-kilocycle superimposed pilot channel.

Preliminary trials of this type of system were begun on a one-way basis in 1933 and extended to two-way operation in 1934. The results to date have justified every expectation, giving considerable saving in power, economy in the use of the ether, and an almost complete absence of fading, with consequent improvement in quality and serviceability.

### INTRODUCTION AND HISTORICAL SURVEY

SINCE the single-side-band system has now been in use for a considerable time in the short-wave radiotelephone link between the Netherlands and the Netherlands East Indies, and since this apparatus has been subject to numerous alterations in accordance with the experience gained in the course of time, it now seems opportune

\* Decimal classification: R410. Original manuscript received by the Institute, August 9, 1937, after translation from the original Dutch. Presented by Lloyd Espenschied in behalf of the author before New York Meeting, November 3, 1937.



to describe the final form of the transmitters and receivers and to account for their development, both from the historical and experimental point of view.

The Netherlands—Netherlands East Indies short-wave radiotelephone circuit is a part of the radio sending and receiving network operated by the Netherlands P.T.T. service. The operating center is located at Amsterdam, the receiving equipment at Noordwijk-Radio, and the transmitting station at Radio-Kootwijk.

Of all the radio links serving the various European countries, North and South America, Japan, and the colonies in the West and East Indies, next to the traffic of the United States that with the Netherlands East Indies is the most important, not only on account of its volume but also on account of the strong bonds between the people of the mother country and those over there who are served by it. The East Indies traffic has therefore always been of major concern, and upon it the utmost care has been bestowed.

Having begun with the long-wave telegraph circuit, which was opened in 1923, soon afterwards short waves were taken up in order to be able to expand the service by means of a cheaper method of operation. Although the long-wave machine-transmitter which was used at the start was built by Telefunken, later alterations and extensions in the main were designed and executed by the Netherlands P.T.T. service under its own supervision.

The first short-wave telegraph circuit with a single-stage transmitter of small power was put into commercial use in July, 1925. Since that time the short-wave telegraph service has greatly developed both in extent and in the perfection of the equipment used for sending and receiving, while in 1927 the first two-way radiotelephone conversation with the Netherlands East Indies was carried on by means of short waves. The first transmitter used for this purpose at the Netherlands end was a three-stage, noncrystal-controlled transmitter of 15-kilowatt carrier capacity.

The inauguration of the radiotelephone link with the Indies for the use of the public took place on the 28th of February, 1928. For several years this circuit was maintained by means of five-stage crystal-controlled transmitters on various wave lengths between 16 and 40 meters, four 20-kilowatt water-cooled valves being used in the final stage. Modulation was effected in this stage according to the anode-modulation method, for which purpose six water-cooled 15-kilowatt modulator valves were employed. By the use of these transmitters, and thanks to the low tariff (33 florins for 3 minutes<sup>1</sup>), traffic has

<sup>1</sup> Since October 1, 1936, the tariff has been reduced to 15 florins for 3 minutes.

greatly increased and has become almost indispensable for business and social communication.

From the outset beam antennas have been used for telephony in order to increase radiation in the desired direction.

These transmitters have been of great service, not only from the traffic standpoint but also on account of the experimental knowledge and conclusions derived from their use. Their good properties demonstrated the great importance of a radiotelephone service, while their imperfections stimulated the desire for an ideal solution.

In picturing this historical background, which contributes to a better understanding of the later single-side-band system, it should be remarked that these transmitters worked entirely on alternating current. For the heating current of the valves 50-cycle alternating current was used while the anode potential was obtained by rectification of multiphase alternating current, with the aid of smoothing filters. Owing to this practical and simple arrangement, which involved no rotating parts, four of these comparatively large transmitters, together with their complete current supply, were installed in an 8- by 34-meter room.

This all-alternating-current supply was possible for the reason that anode modulation in the last stage enables this stage to be overloaded with respect to the high-frequency input from the earlier stages. On this account the alternating-current ripple was automatically reduced by limiting, while at the same time the purity of the anode modulation was improved, because the high-frequency amplitude can increase quite linearly with anode potential increase.

Since these transmitters, together with the associated receivers, have given service for a number of years, and particularly in the development period of short-wave communication, all the bad features of this method of short-wave operation have come to light. Some mention may be made of the most important of these:

(1) One of the troubles encountered was that due to fading phenomena, which may be attributed to various causes, such as change of polarization of the arriving wave, or change in the angle of arrival, but which in practice has proved to be predominately the result of the multiplicity of paths that the waves may take. Accordingly there was applied to the receiver automatic volume control, which regulates the output in accordance with the strength of the incoming carrier. The result of this was twofold:

(a) Such benefit as was obtained was marred by varying strength of the disturbing noise, the effect being dependent upon

the varying ratio of noise to signal. Fading correction by volume control was able to hold the low-frequency signal strength constant, but, as it were, transferred the fading effect from the signal to the noise. It is on account of this circumstance that conversation by short-wave radio has always been characterized by a disturbing background effect, being typically different from a wire conversation.

(b) In so far as automatic volume control gave unsatisfactory results, this was because fading due to multiple paths is naturally dependent on frequency. This selectivity, which in practice is very sharp, brings about deep fading of the carrier, causing more than 100 per cent modulation, thus resulting in distortion such as is connected with the overmodulation effect. This distortion, which leads to poor intelligibility, or to unintelligibility, is therefore not to be remedied by means of automatic volume control. This condition has always marred telephone communication for shorter or longer periods.

It has been learned from experience that these bad periods, in so far as they are periodic and not fortuitous (freaks), are more serious at certain seasons of the year and hours of the day. They have a connection, therefore, with the yearly and daily periods of the sun's radiation, hence with the state of the ionosphere. The above-mentioned multiple-path condition applies entirely to the ionosphere, since, for the distances involved, the ground wave is soon damped out and of no importance.

(2) A second difficulty which made itself apparent was the susceptibility to frequency and phase modulation, which, in the case at hand, was promoted by the all-alternating-current supply of the transmitters. This trouble manifested itself as rattle-noises of a frequency corresponding to the rectified frequency of the 50-cycle supply current to the valves. The residual ripple occurring in the high tension was without effect on account of the multiphase rectification and the smoothing action applied.

Since the carrier frequency in the crystal stage was proved by examination not to be influenced by the alternating-current supply of the indirectly heated generator valve, the frequency modulation arose in the later stages, apparently from the magnetron effect due to the large supply currents in the final stages. The mutual coupling of these stages being accomplished by means of tuned circuits, at the resonant point a great tendency toward phase shift is present, and under the influence of the magnetron effect there is a risk of

phase modulation, which because of the mathematical relation between phase change and angular rotation, is naturally inherent in frequency modulation. Experience has proved

- (a) that this phase modulation remained within limits when the grids of all the stages were considerably overloaded;
- (b) that the transformation of phase modulation into amplitude modulation, caused by phase shift of the modulation components concerned, only seldom takes place as it depends on the condition of the ionosphere. It is only during special periods of the year that the risk of this transformation is great, but the attending rattle-noise, though of infrequent occurrence, is troublesome to the service; and
- (c) that inexpert operators can cause unnecessary risk of phase modulation by improper adjustment of the transmitter.

It may be remarked that the above-mentioned phase shift of the modulation components can also occur in amplitude-modulated speech, in which case amplitude modulation changes over to phase modulation, which is inaudible in the receiver. Since this shift is naturally dependent on frequency, amplitude-modulated double-side-band telephony can suffer this distortion. So considered, two side bands are not only superfluous, but also harmful.

(3) A third drawback lies in the difficulties of effecting multiple links.

It is a fact that large beam antennas improve the reliability and the quality of a telephone circuit. These, however, take up much room. The making of an economically managed concentrated service with many radio links, with small supervising staff, is difficult of realization on account of the space which the beams require, while the cost problem also plays a rôle.

Another way is in the direction of multiple circuits on a single wave length, so that a single directive antenna can suffice for all. The number of beams required is thereby diminished and the possibility exists of making these beams large and hence effective.

Experience has demonstrated that multiple circuits, viewed from a business standpoint, are for many reasons desirable. However, the danger of cross talk is an important obstacle.

Moreover, it is an experimental fact, but also theoretically obvious, that the carrier has a deleterious effect with respect to cross talk, because the carrier is always present and is strong in comparison with the modulation components. Especially in the

case of multiple operation does each of the modulation components become reduced in strength with respect to the carrier wave.

Cross talk between the various channels can arise in the transmitter because of incomplete linearity of amplification, or in the receiver for the same reason and also because of incomplete linearity of detection, assuming that the modulation itself is properly effected. In both cases a rôle is played by higher-power terms of the modulated high-frequency complex, which consist of a number of modulation components, viz., the side-band frequencies which belong to the multiple channels and the carrier wave. There arises a great number of combination products, with the result that at reception one channel is audible in the other. Of the combination products, naturally those wherein the carrier is present are of a stronger order and hence more disturbing than those wherein merely the weaker side bands appear.

If, therefore, the carrier is not present, the cross-talk problem becomes easier. Moreover, there enter odd derivatives of the valve characteristics, which cannot be corrected with push-pull circuits, while in detection also not all components which in practice are harmful in producing cross talk can be suppressed by means of balanced circuits.

The absence of the carrier wave is also desirable for the reason that this very strong component if present can readily result in operation on the curved portion of the valve characteristic.

Finally, it may be remarked that with multiple operation, when it is assumed that overmodulation must be avoided, so that the sum of the side-band amplitudes in a measure is limited, the energy is still more preponderatingly concentrated in the carrier, if this is present, than is the case with single operation; this in consequence of the fact that the energy of the various components is determined by the square of the amplitude. The fact that nearly all the energy, especially in a multiple channel, is concentrated in the carrier is particularly uneconomical if it is remembered that this carrier wave is a troublesome superfluity.

Furthermore, in telephonic communication, as is well known, the periods of actually modulated speech are small, since in a conversation only one subscriber speaks at a time; thus on the average only half of the time is there speech, without mentioning the pauses which occur between words.

All these problems led to the decision to experiment with the single-side-band system without carrier, which theoretically offered the pros-

pect of overcoming all the above-discussed difficulties. By means of one side band and a pilot frequency the modulation is unequivocally defined. The other side band and the carrier wave are superfluous and even harmful, as already set forth.

#### SINGLE-SIDE-BAND TRANSMITTERS

The transmitters in use at present will be described by means of a block diagram. In accounting for their ultimate form the experience gained during the period of their development and the requirements as finally determined by circumstances will be leading factors.

It may be stated beforehand that the single-side-band transmitters are of a much more complicated design than the double-side-band transmitters which they replaced.

The single-side-band modulation product, consisting of one side band without carrier, is obtained at low power, the high power wanted for radiation being reached by four stages of high-frequency amplification. Accordingly, the required modulation apparatus, consisting of modulators and filter equipment, may be smaller, less expensive, and consequently more practical. A large amplification must be effected in the four stages.

The final stage consists of four 20-kilowatt water-cooled valves, connected in pairs in push-pull, so that the peak capacity may amount to 80 kilowatts, whereas the modulator preceding the four stages delivers to these stages a power of the order of only ten watts. Hence these straight amplification stages, which must function linearly, should satisfy the highest demands of stability.

The requirement of straight amplification cannot be escaped, since frequency doubling of a single-side-band modulation is not possible. In a double-side-band transmitter, even if modulation takes place in an initial stage, one can always apply frequency doubling, and stability against oscillation is served by this measure. With a single-side-band transmitter, by doubling the frequency the modulated frequency would also be doubled, while that is not the case in a double-side-band transmitter with carrier wave, since through the presence of both side bands frequency modulation is absent; i.e., the successive passages of the high-frequency current through the zero value always take place with the same time intervals independently of the modulation.

The desired stability of the stages can only be obtained by a neutralization independent of frequency. The latter, moreover, has the advantage that the transmitters can be arranged for more than one wave length without the necessity of altering the neutralization for the change-over from one wave length to another, which is an indispensable requirement for easy operation.

In view of limitations in filter design and balanced modulators, the modulation is effected in successive frequency stages; i.e., the low-frequency tone spectrum is brought in several stages successively to a higher frequency level. These levels are respectively 10 kilocycles, 100 kilocycles, 500 kilocycles, and finally the transmitting frequency. Originally these levels were 25 kilocycles, 500 kilocycles, and finally the transmitting frequency, the number thus being smaller. The following facts have given rise to this change:

(1) The transmitters in question serve not merely for ordinary commercial telephony. This kind of telephony, in conformity with what is permitted in the ordinary telephone lines, can suffice with a speech band of 300 to 2750 cycles. The transmitters must at the same time be able to serve for single-side-band broadcasting, which in the Netherlands East Indies is received and repeated, in the same way as ordinary radio broadcasting with two side bands and a carrier wave. A wider frequency band of 100 to 6000 cycles needs, therefore, to be aimed at, wherein the extension of the lower frequency limit causes trouble.

(2) The carrier wave must be rigorously suppressed, because even its slightest presence endangers secrecy through reception on ordinary broadcast receivers equipped for short-wave operation. When the modulation is weak a small amount of carrier present can bring about intelligibility.

This suppression of the carrier cannot merely be left to the balanced modulators, not only because the adjustment of these is critical, but also because it appears that the modulation itself, especially where this is strong, easily disturbs the balance, so that even when by adjustment the carrier is well suppressed, under the modulating condition, it can appear in a certain measure along with the modulation. If it is remembered in this connection that laborious adjustment of the balanced modulators by attendants must be provided, then it is seen to be useful to supplement the operation of the balanced modulators effectually, with respect to the suppression of the carrier, with the aid of the filters which eliminate the second side band, by taking care that these filters at the same time strongly suppress the carrier.

In view of the above-mentioned facts the first modulation level was chosen to be low. For similar reasons, in order that the correct carrier frequency may be delivered for the control of the receiver, there is transmitted not a reduced carrier wave along with one side band but a separate pilot frequency of 5000 cycles, as will appear from the block diagram. Originally the carrier wave at one to two per cent of its normal strength was transmitted, which was amply sufficient to stabil-

ize the receiver at its resupplied frequency. For the above-mentioned reasons this was altered.

Moreover, from the standpoint of receiver technique it is preferable to work with a pilot frequency of 5000 cycles instead of the reduced carrier itself, especially if, to obtain broadcast quality, including the transmission of music, low tones down to about 100 cycles are transmitted. These low tones, which lie close to the carrier and can considerably surpass the same in strength, involve the danger that the receiver may mistake them for the carrier, resulting in a wrong adjustment of the resupplied carrier frequency. The only remedy for this is to separate the fractional carrier wave with a very sharp filter in the receiver, which may be accompanied by some disadvantages, as will be discussed in connection with the receiver.

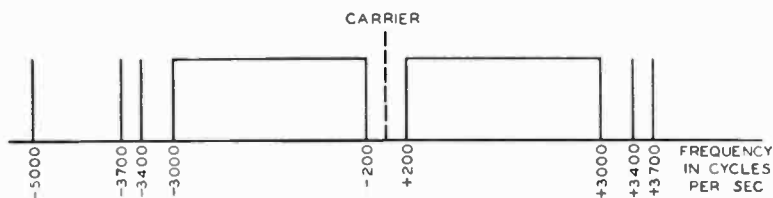

Fig. 1.—The transmitted frequency spectrum.

The transmitters, as shown in the block diagram, are multiple transmitters containing two telephone channels and one telegraph channel. The telephone channels lie on both sides of the suppressed carrier. One side band is one channel and the other side band is the other channel. The telegraph channel is formed by a double tone of 3400 and 3700 cycles, as spacing and marking waves, respectively. This double tone is sent out, as it were, with two side bands and is found thus on both sides of the suppressed carrier. As will be explained later in the description of the receiver, both of these bands are combined into a single result to overcome fading.

The transmitted spectrum is illustrated in Fig. 1.

For broadcast purposes a broader band is transmitted, as a single transmission and not multiplex; the multiple telegraph channel is omitted in order to provide for the broader frequency band required. The block diagram of the transmitter is given in Fig. 2.

Channels I and II carry the two telephone conversations to be transmitted, and III the direct-current signals of telegraphy. Conversation I is supplied through an adjustable low-frequency amplifier and a low-pass filter to a modulator, where the speech band is modulated at 10 kilocycles. This modulator, shown in Fig. 3, consists of four



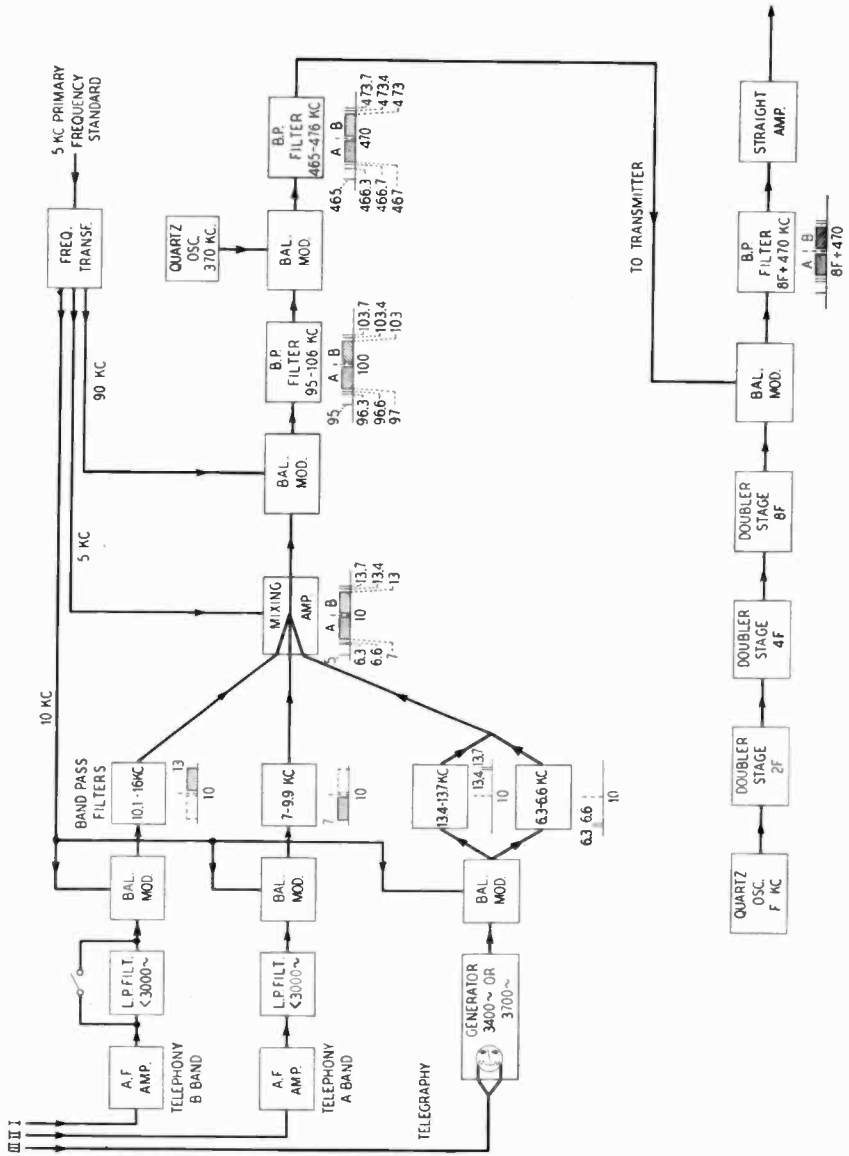

Fig. 2—Diagram of single-side-band multiplex transmitter.

cuprox rectifiers which, in the well-known manner, are arranged to suppress the low-frequency telephone products and its harmonics as well as the carrier.

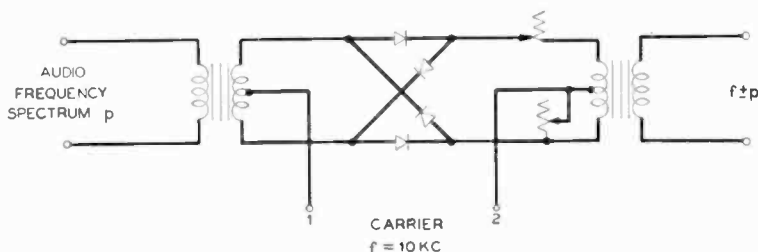

Fig. 3—Modulator, using copper-oxide rectifiers.

Since, in consequence of the inequality between the elements, the level of the carrier in the output is too high with respect to that of the side bands, the suppression is increased through improvement of the balance by the use of a system of resistances, which are shown in Fig. 3. By this means a suppression of 90 to 100 decibels is obtained with respect to the level of the unsuppressed carrier.

For previously mentioned reasons, however, the suppression in practice is less perfect. Therefore the carrier is suppressed additionally, in that to the filter following the modulator, which serves to suppress one of the two side bands, a considerable attenuation is given for 10 kilocycles. This filter, which has a pass band from 10.1 to 16 kilocycles, passes only the upper band of the modulated spectrum. This band will be referred to in the following as the *B* band.

Since the low-pass filter limits to 3000 cycles the low-frequency spectrum, this band will extend from 10.1 to 13 kilocycles. When a music spectrum must be sent out the low-pass filter can be cut out of the circuit, whereby the modulated spectrum can be extended to 16 kilocycles.

Speech coming in at II is likewise modulated at 10 kilocycles. By means of the filter following the modulator the lower band, 7 to 9.9 kilocycles, is passed and the upper band suppressed. In the case of this band, which in the following is designated the *A* band, the 3000-cycle low-pass filter is not made disconnectable, so that in this band no spectrum can be modulated that is wider than 3000 cycles.

The direct-current signals coming in at III actuate a relay, whereby an oscillator is detuned from 3400 cycles to 3700 cycles. Both these tones similarly modulate a 10-kilocycle wave, while two parallel-connected filters take care that of this double-tone telegraphy both side bands are let through while the carrier wave is effectually suppressed.

The three above-mentioned frequency spectrums are combined in

a common amplifier, to which also the frequency of 5000 cycles for the synchronization of the receiver is supplied. Thereupon the spectrum is modulated at 90 kilocycles in a second modulator, after which there is a band filter which passes the upper band, 95 to 106 kilocycles.

After the second modulator there follows a third, wherein the spectrum is modulated at 370 kilocycles. Of the two side bands arising, the upper band is passed through a filter which extends from 465 to 476 kilocycles. Then this last-named frequency spectrum is supplied to the modulator stage of the transmitter.

The transmitter consists of a crystal stage followed by three doubling stages and a modulator stage. The modulator consists of two valves connected in push-pull, in the plate circuits of which is found a band filter which passes the upper band. A straight amplifier brings the power in four stages to the desired final value. The frequencies 5, 10, and 90 kilocycles are derived from a tone of 5 kilocycles obtained from a primary frequency standard.

#### SINGLE-SIDE-BAND RECEIVERS

The single-side-band receivers serve to reproduce the low-frequency transmitter modulation and must deliver each of the telephone and telegraph channels separately, to which end the receivers should effect the separation in the received high-frequency band.

To accomplish this, the received frequency band is reduced to a frequency level sufficiently low to enable filter equipment to effect the desired separation. A frequency of 10 kilocycles is chosen for this level; i.e., the suppressed carrier frequency is transformed down to 10 kilocycles by the application of heterodyne reception. Because of image frequencies this transformation cannot be effected in one stage, since the high-frequency selectivity cannot be made sharp enough. The frequency in question is reduced by means of the first heterodyne to 470 kilocycles, and in the second, which resupplies a 460-kilocycle frequency, to 10 kilocycles. Care is taken that the high-frequency selectivity suffices to suppress the image frequency lying at  $2 \times 470$  kilocycles from the wanted frequency. The value of 470 kilocycles was chosen more or less arbitrarily. It is made to differ from the round number 500 because this frequency might interfere with the well-known marine service wave.

Further, the receiver contains a third heterodyne, which resupplies a 10-kilocycle carrier for the detection of the reception which has been put on the 10-kilocycle level.

The first heterodyne is adjustable in order to enable tuning to various stations, while the third is nonadjustable, functioning at a fixed frequency of 10 kilocycles.

It would also be possible to make the second heterodyne function at a fixed frequency of 460 kilocycles, if

- (1) the transmitter had an absolutely constant frequency;
- (2) no Doppler effect appeared in the ether;
- (3) various circumstances did not affect the frequency of the first heterodyne after such an adjustment of the latter that the incoming transmitting frequency is brought to the 470-kilocycle level.

In reality none of the three conditions is satisfied. A short-wave transmitter is not so constant during many hours at a stretch that the frequency will not vary some tens of cycles during that period.

It is to be borne in mind that the frequency of the resupplied carrier, in order to secure a proper quality of reception of an ordinary conversation, must not deviate more than 20 cycles from its assigned value, which difference may not exceed 5 cycles in case of music, at least in our opinion. These narrow limits are necessitated by the circumstance that the shift of the carrier frequency causes a similar frequency shift of all the tones, which is accompanied by a disturbance of the mutual ratio of vibrations, so that harmonics become inharmonic.

Further, the Doppler effect actually does occur in the ether under certain conditions.

Finally, the following reasons make it difficult to operate the first heterodyne at a fixed frequency:

- (1) The first heterodyne must be able to embrace a range of wave lengths from 14 to 70 meters. It might be possible to make the frequency sufficiently independent of the applied electrode voltages if only a small adjustment of the heterodyne in question would be sufficient.

- (2) Since the use of alternating-current valves is a practical requisite, the great heat development in these valves causes frequency shift,

- (a) because of heating of the internal valve elements, which alters the internal valve characteristics. Choosing a suitable valve may partly remedy this evil;

- (b) because of heating of the coils and the condensers which form a part of the oscillatory circuit. This influence may for the greater part be nullified by installing these parts in a separate space isolated thermally from the valves, provision being made for air circulation.

Since none of the three conditions is satisfied, the second heterodyne must be automatically adjustable in such a way that all incon-  
stancies due to the above-mentioned conditions are compensated to  
the utmost at any moment, so that reception is brought as near to the  
desired frequency level as possible, a maximum difference of 20 cycles  
for a conversation and a maximum difference of 5 cycles for broadcast  
quality, especially for music, being deemed allowable. The adjustment  
of the second heterodyne is accomplished electrically.

The question whether it might be desirable to make the third  
heterodyne adjustable must be answered in the negative, since the  
third heterodyne local carrier should be resupplied only after the  
channels have been separated. In that case the very narrow band filter  
would have to operate on nonstabilized frequencies, which may vary  
too much.

The receivers are so equipped that it is not only possible to adjust  
to the 5-kilocycle pilot signal, as is done in the East Indies link, but  
also to a pilot signal of the frequency of the carrier wave. This latter  
may be used when telephone stations working in the ordinary manner  
with double side band plus carrier are to be received. Then the carrier  
is used as pilot signal, only one of the two side bands being chosen to be  
detected with the locally obtained carrier. Hence the advantages of  
single-side-band reception are obtained with ordinary amplitude-modu-  
lated transmitters.

It may be pointed out that the presence of the high-powered car-  
rier, which is subject to fading, owing to its varying strength gives rise  
to overloading and alteration of the working point of the valves. There-  
fore the reception of a single-side-band transmission without carrier is  
always superior.

The adjustment of the second heterodyne is so accomplished that  
a regulating voltage arises if the transformed carrier differs from 10  
kilocycles, or if the transformed pilot differs from 5 kilocycles, accord-  
ing to the synchronizing method adopted.

The regulating voltage, which may be positive or negative accord-  
ing to the sign of the above-mentioned difference, is supplied to the  
grid of a regulating valve which accomplishes the frequency adjust-  
ment of the second heterodyne. As is known, this frequency stabiliza-  
tion may be effected in various ways. The method applied will be  
briefly described when discussing the block diagram.

The following values may demonstrate the degree of control ob-  
tained in the apparatus: a frequency deviation of 5 cycles gives 1 volt  
of regulating voltage, which causes a 3000-cycle detuning of the second  
heterodyne. If, for example, the transmitter frequency changes 10

cycles, then the second heterodyne readjustment will require a regulating voltage of  $10/3000 = 1/300$  volt. The difference that remains is therefore  $5 \times 1/300 = 1/60$  cycle.

It may be remarked that a constant small frequency difference is less detrimental to reception quality than a variation of this difference. If the difference varies only a few cycles within a short period of time, the received signals will be out of pitch, especially when receiving music; speech can tolerate a much greater variation. Too rapid variations must therefore be avoided.

For this reason the regulating voltage produced must be applied through a smoothing network to the regulating valve, and the degree of smoothing must be chosen in accordance with the quality desired. This smoothing must not be made too small, however, for there exists a close relation between the band width of the filter which selects the carrier or the pilot frequency and the minimum smoothing needed; viz., a narrower filter requires a greater smoothing. The time constant of the circuit in question is 70 seconds.

If the time constant is chosen too small, then the control system has a tendency to hunt or "sing," because of overregulation. The filter which selects the carrier must be narrow in order to avoid operation of the adjustment on low tones present in the modulation, and requires on this account a suitably large time constant. The filter which selects the 5-kilocycle pilot frequency, since this frequency is farther removed from the modulation frequencies, permits a smaller time constant to be used.

The second heterodyne is bound to rather narrow limits with respect to allowable adjustment. These limits embrace about 7 kilocycles, which is amply sufficient to compensate for frequency variations of the transmitter and Doppler effects. However, according to the above, the first heterodyne varies considerably over long periods. On this account the second heterodyne, which has also to correct for the variations of the first heterodyne, may eventually receive a regulating voltage which has constantly followed the same trend and continuously increased in strength. For the second heterodyne this involves the danger of reaching the limit of its adjusting range. If, moreover, the pilot signal under this voltage condition momentarily disappears through fading, the heterodyne frequency will vary more than would be the case if this frequency lay nearer to the equilibrium frequency. Frequency differences connected with fading will thus be greater because the first heterodyne must be readjusted every time the regulating voltage returns. The undesirable effect of fading on the regulating voltage is unavoidable in the existing system, though this drawback

may be partly nullified by keeping the regulating voltage as small as possible.

This circumstance led to the automatic readjustment of the first heterodyne by means of the same regulating voltage that controls the second heterodyne, care being taken that the time constant of the circuit through which this voltage operates on the first heterodyne is a good deal greater than that between the regulating voltage and the second heterodyne. Consequently the more rapid variations are exclusively applied to the second heterodyne, the variations of longer duration being applied to the first. The slow frequency changes of the first heterodyne caused by its heating are thus self-corrected by this heterodyne.

The frequency control of the first heterodyne is effected mechanically, which prevents its going off frequency in case fading should affect the pilot signal. On the contrary, the heterodyne will remain in the same condition if the pilot signal should disappear. That the mechanical regulation is much slower than the electrical is here no drawback, since a considerable degree of sluggishness is exactly what is wanted in the regulation of this heterodyne.

For the regular daily connection between the Netherlands and the Netherlands East Indies a limited number of transmitters are used on fixed wave lengths. Practically constant crystal generators are used as first heterodynes, so that the electrical adjustment of the second heterodyne amply suffices for the frequency control.

These receivers lack automatic volume control and the fading correction connected with it, the resupplied carrier in itself performing the most effective fading correction in the single-side-band system.

The block diagram of the receiver is shown in Fig. 4. The received signals are amplified in a three-stage high-frequency amplifier, and then, together with the first heterodyne frequency, applied to a push-pull detector. For reasons explained before, a mechanically controlled heterodyne or a crystal generator may be used as the first heterodyne.

The frequency spectrum, the carrier of which, after this first detection lies at 470 kilocycles, is in its entirety amplified in the first intermediate-frequency amplifier and then applied to the second detector, also connected in push-pull. In this second detector the signal is demodulated by the 460-kilocycle adjusted heterodyne frequency, so that after the second detection the carrier will lie at 10 kilocycles.

After this the frequency spectrum is divided by means of five filters.

First, there is a filter to select the pilot signal. In the case of carrier

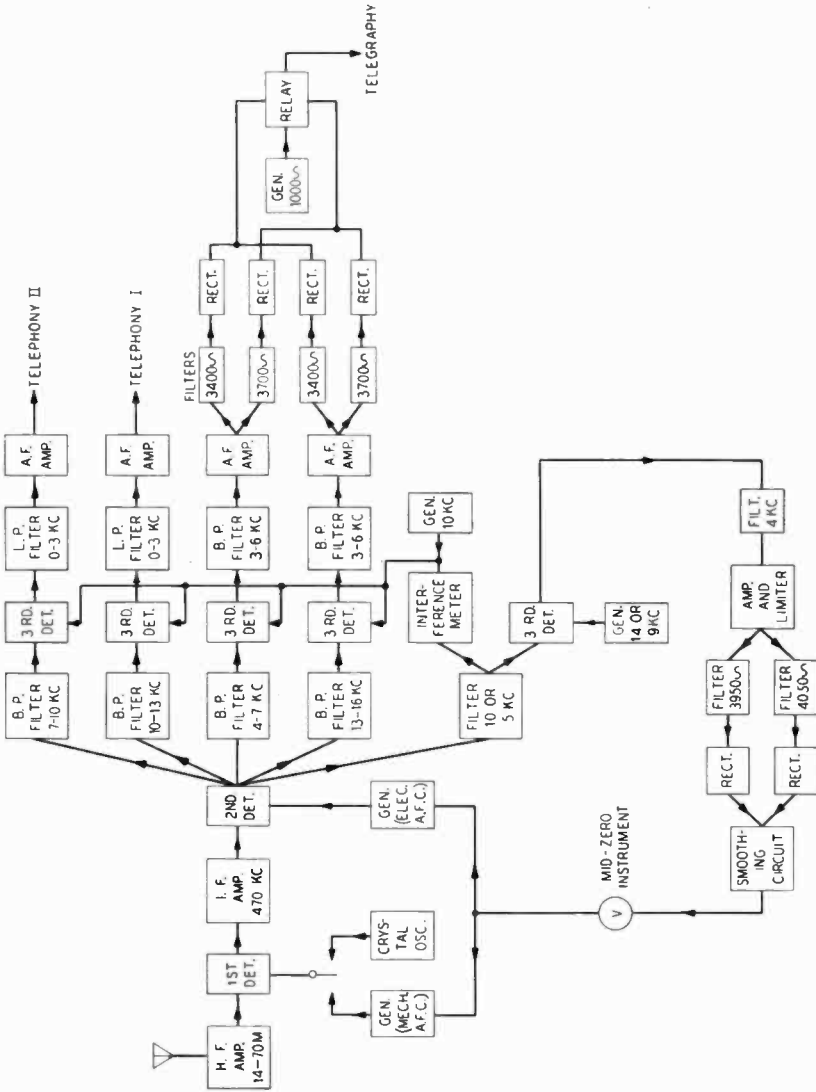

Fig. 4—Diagram of receiver.





Fig. 5—Radio-Kootwijk. General view of the four single-side-band transmitters.



Fig. 6—Radio-Kootwijk. First modulation stages.

suppression the transformed pilot signal lies at 5 kilocycles; if, however, the carrier itself is used as pilot signal, it lies at 10 kilocycles. In order to be able to receive both kinds of transmission this filter is equipped with a change-over switch.

Next are two band filters, respectively of 7 to 10 kilocycles and 10 to 13 kilocycles, for the two telephone channels, and then two other band filters, respectively of 4 to 7 kilocycles and 13 to 16 kilocycles, which serve to select the double tones of the telegraph channel when working with double-side-band modulation. Each of the four last-mentioned filters is followed by a detector, which also is supplied with the locally produced 10-kilocycle carrier frequency.



Fig. 7—Radio-Koorwijk. Second modulation stages and distributing panel to transmitters.

After this third detection the telephone channels produce the two audio-frequency conversations, which are supplied to the telephone cable via a low-pass filter and an amplifier, while the telegraph channels give the double-tone telegraphy, the spacing and marking frequencies of which lie respectively at 3400 and 3700 cycles.

Since the two spacing and the two marking signals can only be combined as direct current, in each channel the 3400- and 3700-cycle

frequencies are first separated. After being limited and rectified the four resulting outputs are combined in pairs. These combined direct currents actuate a relay, which delivers a 1000-cycle tone to the line.

In order to keep open the opportunity of equipping more channels in the future, an ample width of 3 to 6 kilocycles was chosen for the filters following the third detector in the telegraph channels.

The transformed pilot signal coming from the 5- or 10-kilocycle filter is applied to a third detector, together with a locally produced voltage, the frequency of which is so chosen in accordance with the

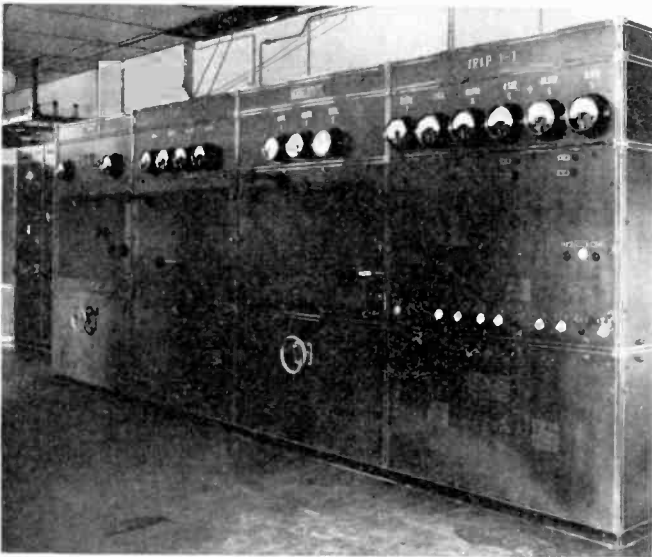

Fig. 8—Radio-Kootwijk. The single-side-band transmitter PCV.

filter before the third detector that the pilot signal after having been detected amounts to 4 kilocycles.

This 4-kilocycle frequency is amplified and limited in order to remove as far as possible the above-mentioned objections attending the electrical frequency readjustment. Then the amplitude-limited pilot signal is applied to two circuits tuned to 3950 and 4050 cycles, respectively. The resonance curves of these circuits meet at 4 kilocycles, so that both the circuits contain the same amplitude of alternating voltage, provided that the supplied frequency is exactly 4 kilocycles. Should the supplied frequency deviate from 4 kilocycles, then the alternating voltages of the circuits differ in magnitude. The voltage of each circuit is rectified after amplification and the difference of the obtained direct voltages is applied through a smoothing circuit as

regulating voltage to the generators. On account of a threshold and a limiting effect, the regulating voltage depends principally on frequency and only to a small extent on the pilot-signal amplitude.

The magnitude of the regulating voltage, which may be positive, zero, or negative, is registered by the voltmeter *V*, which thus indicates whether the apparatus is tuned correctly and, if not, in which

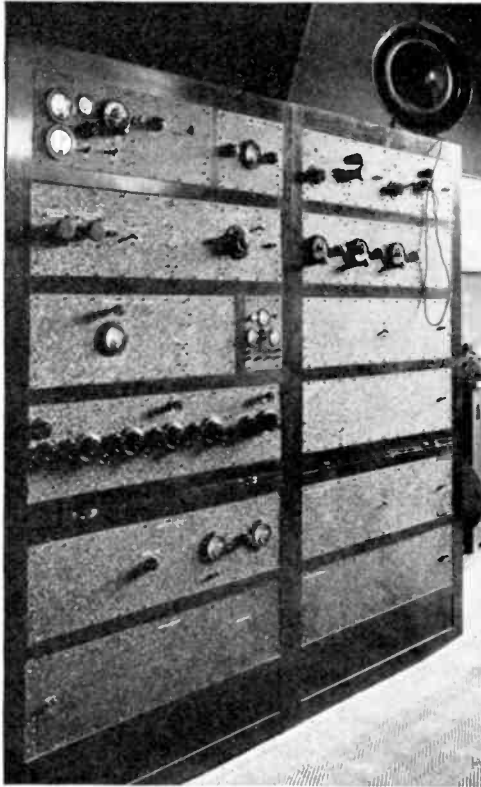

Fig. 9—Radio-Kootwijk. The single-side-band check receiver.

direction it is detuned. This voltmeter is an important requisite for operation.

The electrical frequency readjustment is effected in the well-known manner by altering the active inductance of the oscillator circuit. For that purpose the regulating voltage is applied to the grid of a valve, the plate circuit of which is coupled directly to the coil of the oscillator circuit.

‡ The mechanical frequency adjustment of the first heterodyne is effected by varying the generator circuit capacitance. For this pur-

pose a small variable condenser is provided in parallel with the fixed capacitance, which condenser may be turned by means of a Ferraris motor (watt-hour meter). This motor contains two coils, one of which is supplied directly from the 50-cycle mains, the other being placed as a diagonal in a bridge duplex connection, the mains voltage being on the other diagonal. Three arms of the bridge consist of resistances, the fourth consisting of the internal resistance of a valve to the grid of which the regulating voltage is supplied. The bridge is so adjusted that the current in the diagonal containing the motor coil is zero in the absence of regulating voltage. When the regulating voltage be-

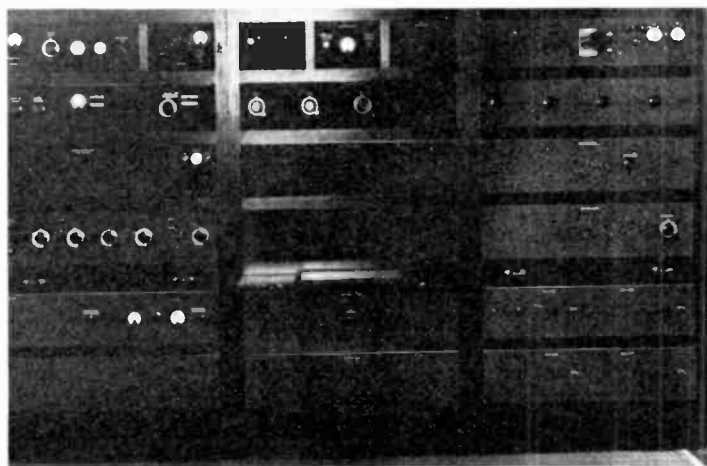

Fig. 10—Radio-Noordwijk. The single side-band receiver for three telephone channels and one telegraph channel.

comes positive or negative, the motor begins to turn in one direction or the other until equilibrium is regained.

In order to be able to keep a proper control on correct receiver adjustment, the transformed pilot signal after the second detector is compared with the frequency of the locally generated carrier. If this transformed pilot signal is 10 kilocycles, it is applied directly to a detector together with the 10-kilocycle local carrier frequency. Then the number of oscillations of the milliammeter in the detector plate circuit indicates the frequency difference. If the transformed pilot is 5 kilocycles, its second harmonic is applied to the interference meter.

#### POSTSCRIPT

A trial transmitter in experimental form was ready in May, 1933, while in the Netherlands East Indies a suitable receiver was provided, so that a start could be made with experimental traffic.

The results were immediately complete and convincing. Between the time when it was decided to abandon the old system and the time when the new system could be tried a considerable period elapsed, during which so much work had to be done that doubt was raised whether the result would justify the cost. In the working out of new methods, too often the outcome is half positive and half negative, so that radical improvements are necessary. The single-side-band system, however, gave an impressively perfect result, all theoretical expectations being borne out in actuality. The system proved to be one of those technical conceptions wherein the creative idea has foreseen logically and clearly the future reality.

(1) There is a striking saving of energy. When a conversation is started the antenna ammeter and the plate-current meters of the final stage rise in jerks. When there is no speech almost no anode energy is used, the final stage operating almost completely in class B adjustment. Practically speaking, the expenditure of energy is of minor importance in comparison with that formerly required, the transmitter expense arising largely from the valve costs.

The final-stage valves on the average deliver little energy, but must be amply dimensioned with respect to saturation current in order to be able to carry the peak currents. For this purpose a special type of valve is being developed, which is characterized by a cathode with great emission and comparatively small dissipating capacity. It appears that in this way the valve expense may be reduced.

With regard to utilizing the valve capacity, it may be considered that only one fourth of the available amplitude is utilized by one side band in case of 100 per cent modulation of one tone in a double-side-band transmitter. If the same valve capacity is used in working with only one side band, the amplitude of the latter may be 4 times and the energy 16 times as great. Considering that the carrier power is useless in ordinary double-side-band telephony, while, moreover, one of the two side bands owing to its possible detrimental effect may be looked upon likewise as useless, a single-side-band transmitter may be called 16 times as powerful for a single-tone modulation as a double-side-band transmitter, when using the same valve capacity.

(2) Fading is practically absent. No background noise is present. One is impressed by the reception, radio conversation in its quality coming up to wire conversation.

(3) It is remarkable that all the valves, though adjusted linearly, may be supplied with alternating current without an alternating-current hum being audible at reception. This amazing result must be put down to the absence of the carrier. Nevertheless the transmitters are equipped so as to allow direct-current supply for the valves, in order to permit double-side-band plus carrier operation for broadcast purposes. On the occasion of a national celebration these transmitters are used for broadcasting, and of course listeners must be able to receive by means of their ordinary receiving sets.

The transmission of double-side-band telephony with alternating current on the valves is accompanied by an amplitude hum of about 10 per cent, rather powerful hum side bands thus being produced alongside the carrier. It may be assumed that a similar amplitude hum can be expected in case of single-side-band operation of the transmitter, since all the valves are adjusted in the same way. The carrier being absent, the hum side bands can only arise around each of the side-band frequencies. These side bands of side bands are therefore not only weakened, but in case of detection with the strong resupplied carrier, there arise principally various higher intermodulation tones which apparently are not detrimental. For similar reasons phase and frequency modulation are also inoffensive.

(4) Multiple operation with two telephone channels and one telegraph channel greatly contributes to a better exploitation of the service. In the near future the number of channels will be extended. Recently a third telephone channel has been added by the P.T.T. service in the Netherlands East Indies.

The final reconstruction of the four existing receivers was completed in December, 1934. The transmitters and receivers are shown in the accompanying photographs.

It is worth mentioning that the single-side-band receivers have been of great use for radio relaying purposes in the Netherlands as well as in the Netherlands East Indies, especially on account of their favorable properties as regards fading. In this respect double-side-band operation is greatly at a disadvantage.

Only selective fading of the side band remains. This, however, is less troublesome than the carrier fading with two side bands. It may be remedied by diversity reception on various antennas if care is taken to resupply the same local carrier. By this means short-wave broadcast relaying may be greatly improved in future, especially for those directions over the globe which are less favorable.

Preliminary observations seem to point to the appearance of another apparently irremediable distortion, especially when great distances have to be bridged, the seriousness of which depends on the condition of the ionosphere. When the electric waves follow several paths in the ionosphere, the superposition of mutually shifted (delayed) modulation products will be received. Considering that different frequencies tend to follow different paths, difference in frequency will promote this shift.

This phenomenon may to a certain extent be compared with distortion on a long line on account of the different propagation time of the different frequencies. It is this circumstance which also bears on the failure of picture telegraphy at great signaling speed on short waves, this failure being due to the time difference of successive points and the time difference of the several incoming rays being of the same order of magnitude.

In the light of the above, the general use of the double-side-band method must be considered as obsolete, too much frequency space being occupied and the energy of the carrier and the superfluous side band being wasted, not only needlessly but even detrimentally.

This report, which does not lend itself to the citation of literature, intends to contribute to the development of this field as opened up by the pioneering conception and the labor of the scientific staffs of the American Telephone and Telegraph Company and of the International Standard Electric Company.

In the course of years many employees of the East Indies P.T.T. service and the radio laboratory of the Netherlands P.T.T. service have done their best to overcome construction difficulties and to adapt the apparatus of the transmitting and the receiving station to the demands and teachings of practice. In this connection I may mention the names of Mr. Einthoven, Mr. de Haas, Mr. Lels, Mr. Leunis, Mr. de Cock Buning, Mr. van Dijn, Mr. Ennen, Mr. Stöver, Mr. Ver-ton, Mr. Vormer, Mr. Vos de Wael and Mr. Jhr. van der Wyck. It has been a satisfaction to them to be able to realize in and through their work how surprisingly correct the Bell System conception has proved to be and what a rôle the single-side-band system may be able to play in the service of long-distance traffic.





## FREQUENCY DISCRIMINATION BY INVERSE FEEDBACK\*

BY GEORGE H. FRITZINGER

(Telediphone Department, Thomas A. Edison, Inc., West Orange, New Jersey)

**Summary**—This paper deals with the application of feedback to amplifiers for the sole purpose of obtaining a frequency discrimination in the gain-frequency characteristic of the amplifier. The theory of the feed-back amplifier is given and the general form of the vector envelope  $\mu\beta$  representing the over-all propagation factor of the amplifier and feed-back circuit is described for a feed-back amplifier which is to have a predetermined gain-frequency characteristic. A basis of feed-back amplifier design is indicated in which the desired over-all  $\mu\beta$ -vector envelope is formed by choosing and synthesizing the propagation factors of the component circuits in the amplifier and feed-back circuits. The analysis of the amplifier and feed-back circuits into component circuits which have either fixed- or variable-frequency propagation factors is indicated. Various common resistance-capacitance circuit configurations useful in feed-back amplifier design are shown and simple graphical means for determining the propagation-factor—vector envelopes for these circuits are illustrated. The allocation of the frequency scale on these vector envelopes is also done by graphical means. Two specific cases in feed-back amplifier design are then illustrated for obtaining respectively a high-pass and low-pass gain-frequency characteristic to resistance-capacitance-coupled amplifiers utilizing only resistive and capacitive elements in the feed-back circuit. The amplifier circuit arrangements, the  $\mu\beta$ -vector envelopes, and the gain-frequency characteristics of the feed-back amplifiers are given in these illustrated cases.

The analytical proof for the graphical determination of the behavior of the propagation factor for one of the resistance-capacitance circuits illustrated is submitted in the Appendix.

### INTRODUCTION

THE many publications on feed-back amplifiers since<sup>1,2,3,4,5</sup> H. S. Black's original paper<sup>6</sup> bear record of the widespread interest and fundamental importance of this new tool in amplifier design. The feed-back amplifier has many improved operating characteristics over the ordinary amplifier, but the very practical aspect of feedback lies in the fact that the feed-back feature can be realized by a relatively simple circuit, and its effect accurately ascertained by equally simple

\* Decimal classification. R363. Original manuscript received by the Institute, July 30, 1937. Presented before New York meeting, October 6, 1937.

<sup>1</sup> "Feedback amplifiers," *Electronics*, vol. 9, p. 30; July, (1936).

<sup>2</sup> F. E. Terman, "Feedback amplifiers," *Electronics*, vol. 10, p. 12; January, (1937).

<sup>3</sup> A. R. Rumble, "Audio feedback," *Communication and Broadcast Engineering*, vol. 4, p. 14; April, (1937).

<sup>4</sup> J. R. Day and J. B. Russell, "Feedback amplifiers," *Electronics*, vol. 10, p. 16; April, (1937).

<sup>5</sup> Louis Martin, "Characteristics of inverse feedback circuits," *Radio Eng.*, vol. 17, p. 13; May, (1937).

<sup>6</sup> H. S. Black, "Stabilized feedback amplifiers," *Elec. Eng.*, vol. 53, p. 114; January, (1934).

theory. Briefly, in the feed-back amplifier the amplifier proper is designed to have an excess voltage gain; a portion of the output voltage is then fed back to the input through a suitable feed-back circuit with due regard to its magnitude and phase relationship to annul the excess gain. The amplifier thus acquires many improved operating characteristics some of which are:

1. Great constancy of operating characteristics with respect to tube variations and supply voltage variations.
2. Improved gain-frequency characteristics.
3. Reduced amplitude and phase distortion.
4. A reduction of noise as created from within the amplifier.

In the afore-mentioned application of feedback the output voltage is fed back to the input with as little frequency discrimination as is possible but in such phase and magnitude relationship as to decrease the amplifier gain generally. In so doing, the amount of gain reduction at any one frequency becomes nearly proportional to the original gain of the amplifier at that frequency, with the result that a very flat gain-frequency characteristic is obtained for the feed-back amplifier.

This paper deals with the application of feedback to an amplifier for obtaining the directly opposite effect. Instead of applying feedback in a manner to secure a flat gain-frequency characteristic for the amplifier, the feed-back circuit is intentionally designed with frequency discrimination in phase and magnitude so as to secure a gain-frequency characteristic for the amplifier that discriminates sharply between bands of frequencies. There are many applications in which electric wave filters are operated in conjunction with amplifiers to secure an over-all gain-frequency characteristic that discriminates sharply in transmission efficiency between bands of frequencies. Such filters, particularly if operated in the output circuit, must have a low insertion loss in order to preserve the power-handling ability of the amplifier. In order that a wave filter shall have a sharp frequency-discrimination characteristic and have a low insertion loss in the transmitting band, essentially pure reactive elements must be used. The cost, weight, bulk, and shielding requirements of coils often preclude their use in practical applications with the result that a sacrifice in circuit performance is sometimes tolerated.

The economy of obtaining the frequency-discriminating action within the amplifier itself as a means of eliminating the wave filter is self-evident. In amplifiers employing interstage transformer couplings it is possible to obtain within the amplifier some discrimination in the gain-frequency characteristic. However, since the advent of the high- $\mu$  tube, interstage transformer couplings have been superseded

generally by resistance-capacitance couplings. The latter type of inter-stage coupling, while offering the advantages of compactness and low cost, does not lend itself to sharp discrimination in transmission efficiency for any given frequency band. However, by properly controlled inverse feedback, sharply discriminating low-pass, band-pass, high-pass, and band-elimination frequency characteristics can be secured through resistance-capacitance-coupled amplifiers with the use of only resistive and capacitive elements in the feed-back circuit.

### THEORY OF THE FEED-BACK AMPLIFIER

In the feed-back amplifier a feed-back circuit, or network, is connected from the amplifier output terminals back to its input terminals in order to feed back a portion of the output voltage to the input. The magnitude and phase relationship which the "fed-back voltage" bears to the signal input voltage determines the feed-back effect. Thus the performance of the feed-back amplifier is fully characterized by the behavior of the propagation factors of the amplifier and of the feed-back circuit. By the propagation factor of a unit is meant the term which expresses the ratio of its output voltage to its input voltage. The voltage outputs of an amplifier, and of the feed-back circuit, differ from the input voltages in both magnitude and phase, and are functions of frequency. The propagation factor thus may be expressed as a complex quantity or vector in which both real and imaginary components are functions of frequency. A plot of the extremities of this vector on polar co-ordinate paper for all frequencies is the vector envelope.

The propagation factor for the amplifier is represented by  $\mu$  and that of the feed-back circuit by  $\beta$  where both are complex quantities. For an input signal of value  $e$ , an output is obtained from the amplifier proper of value  $E$  such that

$$E = \mu e. \quad (1)$$

With feedback, the input is to a first approximation ( $e + \mu\beta e$ ) and the output is accordingly  $\mu$  times this value, or  $\mu(e + \mu\beta e)$ . Likewise, to a second approximation, the input is  $e + \mu\beta(e + \mu\beta e)$  and the output is  $\mu[e + \mu\beta(e + \mu\beta e)]$ . Obtaining the succeeding higher-order approximations in a similar manner, and rearranging the terms, the output is seen to be a geometric series of  $\mu\beta$  such that

$$E = \mu e(1 + \mu\beta + \mu^2\beta^2 + \dots). \quad (2)$$

For certain values of  $\mu\beta$ , (2) reduces to the following form:

$$E = \frac{\mu e}{1 - \mu\beta}. \quad (3)$$

Nyquist<sup>7</sup> has shown that (3) is applicable in all cases for which the system is stable. Equation (3) represents the amplifier output voltage with feedback. Without feedback (where  $\beta=0$ ) the amplifier output voltage is given by (1). By (3), the feed-back factor is

$$\frac{1}{1 - \mu\beta} \quad (4)$$

This factor is the ratio of the amplifier output voltage with feedback to that without feedback. It is a complex quantity expressing the feedback effect both in phase and gain change. Referring to the polar diagram of the  $\mu\beta$ -vector envelope shown in Fig. 1, it is seen that the factor,  $(1 - \mu\beta)$ , has a magnitude equal to the distance between the extremity of the vector  $\mu\beta$  and the point  $P$  located at  $1 + j0$ . Since we are primarily interested in magnitude of gain change and not so much in phase-angle change, this graphical method of ascertaining the gain change may be used. It thus follows that all  $\mu\beta$  vectors whose extremities are at unity distance from the point  $P$  will effect zero change in gain even though there are phase changes. If the  $\mu\beta$  plot is on polar co-ordinate paper of linear scale the locus of the extremities of all  $\mu\beta$  vectors which cause zero change in gain is a circle of unity radius at center  $1 + j0$ . (If the  $\mu\beta$  plot is to a logarithmic scale this locus is no longer circular, as is shown in Figs. 13 and 16.) If the  $\mu\beta$  vector falls within this circle then the magnitude of  $(1 - \mu\beta)$  is less than unity, and by (4) there is an increase in gain. If  $\mu\beta$  falls beyond this circle then the magnitude of  $(1 - \mu\beta)$  is greater than unity, and by (4) the gain factor is less than unity to effect a decrease in gain. Likewise, it is evident that should the  $\mu\beta$  vector be in the second or third quadrant, the magnitude of  $(1 - \mu\beta)$  is greater than should the same vector fall in the first or fourth quadrant. If  $\mu\beta$  has unity magnitude and zero phase angle,  $(1 - \mu\beta)$  is zero in magnitude and the gain rise would be theoretically infinite—which is an unstable condition. The general and exact criterion for instability has been established by Nyquist<sup>7</sup> to be that the  $\mu\beta$ -vector envelope and its conjugate for all frequencies shall not intersect or enclose the point  $P$  which is at  $1 + j0$ . With these facts in mind we are in a position to set down the vector envelope and the approximate frequency allocation on it for any feed-back amplifier that is to have a predetermined gain-frequency characteristic. The basic problem in designing the feed-back amplifier is one of choosing and synthesizing the propagation factors of the interstage coupling circuits of the amplifier and of the component circuits of the feed-back

<sup>7</sup> H. Nyquist, "Regeneration theory," *Bell Sys. Tech. Jour.*, vol. 11, pp. 126-147; July, (1932).

circuit to form the desired composite  $\mu\beta$ -vector envelope. This problem is most readily and simply done by the use of graphical methods.

### SIMPLIFYING LIMITATIONS AND APPROXIMATIONS

In this paper only resistance-capacitance-coupled amplifiers and feed-back circuits comprised only of resistive and capacitive elements are considered. This, of course, is not a necessary restriction, but from

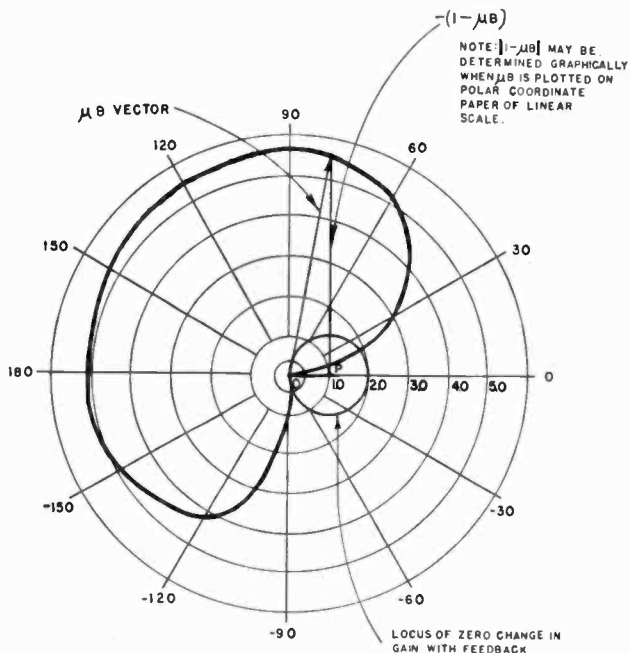

Fig. 1— $\mu\beta$ -vector envelope on a linear scale.

a practical standpoint it is a desirable one. The feed-back circuit may be employed over all, or a portion, of the amplifier. Its exact configuration is determined by the kind of frequency discrimination desired for the amplifier and by the requirements for the maintenance of stability. It may be comprised of one or more meshes connected in tandem of which each mesh is of some common configuration of resistance-capacitance elements.

In analyzing a feed-back circuit comprised of a multiplicity of meshes it is desirable to make approximations which make possible a simple and direct attack since a rigorous analysis of multiple-mesh circuits is generally so complex and cumbersome that its practical value is largely lost to the engineer. Care, however, must be taken that due

regard be given to such approximations. An approximation that greatly facilitates the analysis is one in which the mutual effect between tanded meshes is neglected. By proper design the mutual effect can be made quite small over wide frequency ranges. The mutual effect is small whenever each mesh is fed from a voltage source of relatively low impedance and is made to work into a relatively high impedance. On this basis the propagation factor for each type of resistance-capacitance circuit that might be used in the separate meshes is easily determined, as is shown subsequently. Of course, no mutual effect does exist between the interstage coupling circuits as these are isolated by the tubes. Likewise, each interstage coupling circuit is fed from a voltage source of relatively low impedance, such as from the tube plate, and is made to work into a relatively high impedance, such as the tube grid. A simplifying assumption is here made in neglecting the internal capacitances of the tubes. This is justifiable for audio-frequency feed-back amplifiers, except that in some cases its effect may have to be annulled to avoid high-frequency instability.

#### COMPONENT PROPAGATION FACTORS OF AMPLIFIER AND FEED-BACK CIRCUITS

Each interstage coupling circuit and each mesh of the feed-back circuit is considered as a component circuit of the feed-back amplifier. Each component of the amplifier and of the feed-back circuit has its propagation factor. The product of these component propagation factors is the over-all propagation factor for the unit. Some of these factors, or vectors, are fixed in magnitude and phase angle; others are variable, the magnitude and phase angle of which are functions of frequency. The fixed amplifying ratio of each of the amplifier stages determines the magnitude of the component fixed vectors whereas the phase angle of each of these vectors would be 180 degrees representing the phase shift of the tube. Transformers likewise introduce fixed propagation factors the magnitudes of which depend upon the turns ratio, and the phase angle is zero or 180 degrees depending upon the phasing. The component variable vectors which vary in magnitude and phase with frequency arise from the frequency-discriminating circuits, such as from interstage coupling circuits, and from the separate meshes of the feed-back circuit.

If the feed-back circuit is a passive network its propagation factor will, in general, not be comprised of fixed component vectors, but will be comprised wholly of frequency-variable vectors which will vary in magnitude and phase as a function of frequency. In the general sense, the feed-back circuit need not be a passive network, and thus for

general terminology,  $\mu_0$  and  $\beta_0$  are used to designate the product of the absolute magnitudes of all fixed propagation factors within the amplifier and feed-back circuit respectively; likewise,  $\alpha_0$  and  $\theta_0$  are used to designate the sum of the phase angles of the fixed propagation factors within the amplifier and feed-back circuits respectively. The frequency-variable vectors within the amplifier are designated as  $\mu_1, \mu_2, \text{etc.}$ , while those in the feed-back circuit are  $\beta_1, \beta_2, \text{etc.}$  The absolute magnitudes of these vectors are accordingly

$$|\mu_1|, |\mu_2|, \dots, |\beta_1|, |\beta_2|, \dots$$

and their respective phase angles

$$\alpha_1, \alpha_2, \dots, \theta_1, \theta_2, \dots$$

Therefore, the  $\mu\beta$  propagation vector has an absolute magnitude of  $|\mu\beta|$  and a phase angle  $\theta$ , wherein

$$|\mu\beta| = [\mu_0\beta_0][|\mu_1||\mu_2|\dots|\beta_1||\beta_2|\dots]$$

$$\theta = [\alpha_0 + \theta_0] + [\alpha_1 + \alpha_2 + \dots + \theta_1 + \theta_2 + \dots]$$

In order to maintain a systematic procedure of analysis in the feed-back amplifier wherein are involved both fixed- and variable-frequency propagation factors, it is desirable to assign such magnitude to the fixed factors as will permit the determination of the variable-frequency propagation factors from their respective circuits as fed by a voltage of unity magnitude. Each component propagation factor will thus be an expression of the manner by which a unit voltage is changed in magnitude and phase by the respective component circuits. This is illustrated in the following case. Fig. 2 represents an amplifying stage

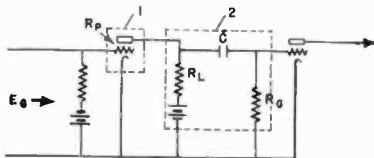

Fig. 2

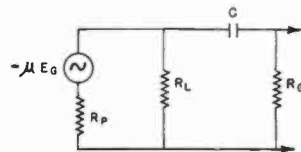

Fig. 3

comprised of amplifier tube 1 and coupling circuit 2. Its equivalent circuit is shown in Fig. 3. Tube 1 has an internal resistance  $R_p$  and an amplifying factor,  $\mu_p$ . The over-all propagation factor involves a fixed factor  $\mu_0$  and a variable-frequency factor  $\mu_1$ . The  $\mu_1$ , according to our former specification, is determined from the coupling circuit fed by unity voltage. This coupling circuit will be comprised of condenser  $C$  and a resistance having the value  $R_G$  in series with the parallel arrangement of  $R_L$  and  $R_p$ . The  $\mu_0$  factor thus represents the effective gain of the

stage at high frequencies wherein the frequency-discriminating effect of the coupling circuit is negligible. Its value is determined by shorting the coupling condenser  $C$ . The magnitude of  $\mu_0$  is thus

$$\mu_p E_0 \left[ \frac{R_G}{R_G + \frac{R_p R_L}{R_p + R_L}} \frac{R_L}{R_p + R_L} \right],$$

and its phase shift is 180 degrees as obtained from the tube. The product  $\mu_0 \mu_1$  is the over-all propagation factor for the amplifying stage.

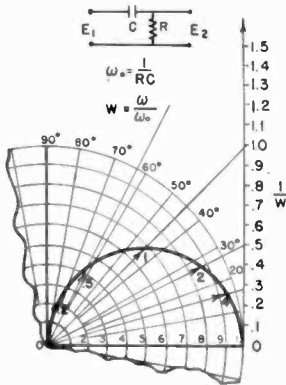

Fig. 4—Vector envelope of  $E_2/E_1$ .

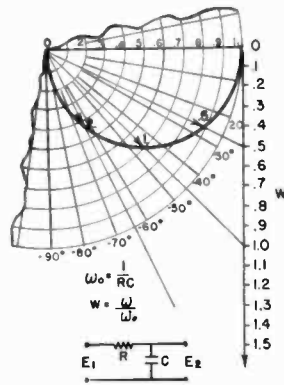

Fig. 5—Vector envelope of  $E_2/E_1$ .

**DETERMINATION BY GRAPHICAL MEANS OF THE PROPAGATION-  
FACTOR—VECTOR ENVELOPES FOR VARIOUS COMMON  
RESISTANCE-CAPACITANCE CIRCUIT  
CONFIGURATIONS**

There are various common resistance-capacitance configurations which may be employed in the feed-back amplifier either as interstage coupling circuits, as filters or as the separate meshes of the feed-back circuit. These various types are shown in Figs. 4, 5, and 6. Fortunately, the vector envelope of the propagation factor for each type of resistance-capacitance circuit shown is circular in form as plotted on polar co-ordinate paper of linear scale. The radii and the location of the center for each of these circular envelopes are determined by very simple relationships which are noted on the respective figures. Likewise, the allocation of the frequency scale on the vector envelope is done very simply by graphical means. The numbers designating the frequency allocation on the vector envelopes represent the ratio of  $\omega/\omega_0$  where  $\omega$  is the angular velocity of the applied voltage and  $\omega_0$



is the so-called reciprocal time constant of the circuit,  $1/RC$ . By this manner of designation each vector envelope is expressed in general form. It is to be noted here that these results are based upon the condition that the voltage feeding the network has low internal resistance or impedance and that the output voltage is obtained across a relatively high impedance. These are the conditions, as formerly noted, by which a negligibly small mutual effect is obtained between tandem meshes. The analyses proving the circular characteristic of the

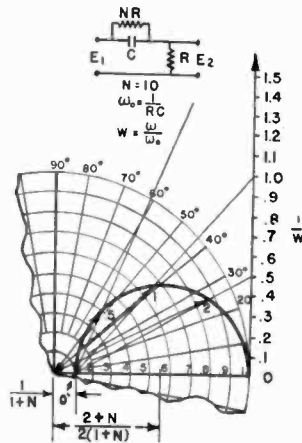

Fig. 6—Vector envelope of  $E_2/E_1$ .

vector envelope and the manner of allocating the frequencies for the case of Fig. 6 is given in the Appendix. The proof for the other cases may be carried out by a similar procedure.

It is seen that the propagation factor for the circular vector envelope of Fig. 4 begins at a leading phase angle of 90 degrees at zero magnitude and ends at unity value and zero phase angle at infinite frequency. The inverse circuit of Fig. 5 begins at unity magnitude of zero phase angle and ends at zero magnitude at 90 degrees lagging phase angle at infinite frequency. However, in the circuit of Fig. 6 the propagation factor has a magnitude at zero frequency but has zero phase angle at this frequency. As the frequency increases it takes a leading phase angle and an increasing magnitude such that at infinite frequency the magnitude becomes unity and the phase angle has returned to zero.

Note that since in all cases the magnitude of the propagation factor at zero frequency and at infinite frequency is determined by very simple algebraic expressions, the circuit elements are readily determined. Consequently, since the general form of the over-all vector

envelope for any given form of frequency discrimination can be set down easily with fair accuracy, the type of component envelopes needed for obtaining the composite vector envelopes can be ascertained graphically, and the determination of the magnitude of the circuit elements remains only a routine procedure.

#### ILLUSTRATION OF SPECIFIC HIGH-PASS CASE

A specific case is now illustrated for obtaining a high-pass gain-frequency characteristic to a four-stage resistance-capacitance-coupled amplifier as shown in Fig. 7. Feedback is applied over the first three stages to which is assigned a voltage gain of sixty decibels. A reciprocal time constant of 100 is assigned to the interstage coupling circuits

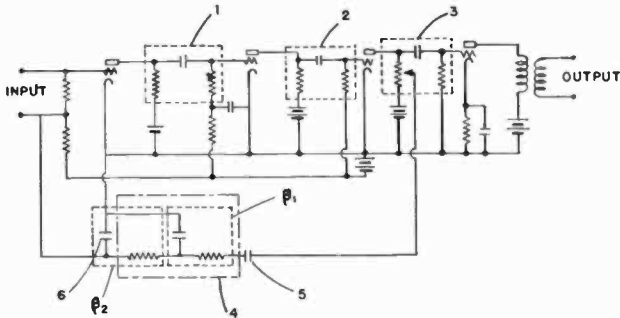

Fig. 7—Amplifier feed-back circuit for high-pass case.

Nos. 1 and 2. This would be obtained with a coupling condenser of 0.01 microfarad and a resistance of one megohm such as would be obtained by the series connection of the grid-leak resistance and the parallel connection of the plate load and internal tube resistance. The gain-frequency characteristic for the first three stages, as determined graphically from Fig. 4, is curve 1 of Fig. 9. The gradual decrease in this characteristic at low frequencies is caused by the interstage coupling circuits Nos. 1 and 2 of Fig. 7.

The feed-back circuit is comprised of a two-mesh resistance-capacitance circuit,  $\beta_1$  and  $\beta_2$  of Fig. 7 having respective reciprocal time constants of 25 and 100. The vector envelope for the feed-back amplifier must now be determined in order to ascertain the feed-back effect. To the  $\mu_0$  vector, the fixed propagation factor of the amplifier, is assigned a magnitude of 1000 representing the sixty-decibel voltage gain for the first three stages of the amplifier. This vector has a phase shift of 180 degrees because of the odd number of tubes traversed. This is  $\alpha_0$  by our former designation. The variable-frequency propagation factors of the amplifier,  $\mu_1$  and  $\mu_2$ , are determined from Fig. 4. The

variable-frequency-component propagation factors of the feed-back circuit,  $\beta_1$  with a reciprocal time constant of 25 and  $\beta_2$  with a reciprocal time constant of 100, are determined from Fig. 5. The product of the fixed propagation vector  $\mu_0$ , and the four variable-frequency-component propagation factors,  $\mu_1, \mu_2, \beta_1, \beta_2$ , is the over-all propagation factor for the feed-back amplifier whose vector envelope becomes that of Fig. 8. This shows graphically the manner by which a unit voltage is modified in phase and magnitude in traversing the amplifier and feed-

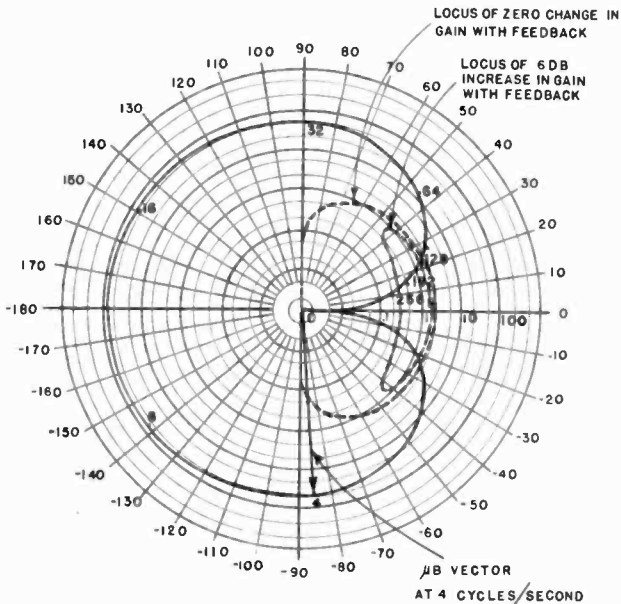

Fig. 8— $\mu\beta$ -vector envelope for high-pass case.

back circuit at all frequencies. Note that this vector envelope traverses four quadrants due to the fact that each of the four component resistance-capacitance circuits involved in the feed-back amplifier has a vector envelope which traverses the whole of one quadrant. Due to the 180-degree phase shift in the amplifier, the  $\mu\beta$ -vector envelope starts from zero in the fourth quadrant. With increasing frequency the  $\mu\beta$ -vector envelope increases in magnitude as it traverses the fourth and third quadrants. Its magnitude then decreases as it traverses the second and first quadrants. At the so-called "cutoff" frequency it passes through a portion of the gain-regenerating region; however, the point *P* is not enclosed to insure stability for the system.

The vector envelope of Fig. 8 is plotted to logarithmic scale. Upon plotting this on polar co-ordinate paper of linear scale the feed-back

effect may be determined graphically by measuring the value  $(1 - \mu\beta)$  at the various frequencies. Otherwise the feed-back effect,  $1/(1 - \mu\beta)$ , may be computed by taking the values of  $\mu\beta$  from the vector envelope of Fig. 8. Upon determining the feed-back effect and subtracting it from curve 1, the amplifier gain-frequency characteristic without feedback, curve 2 of Fig. 9 is obtained. Since the vector envelope of the feed-back amplifier traverses the gain-regenerative region a considerable regenerative peak is obtained at 250 cycles. By assigning a reciprocal time constant of 4000 to the interstage coupling circuit 3 of Fig. 7 the regenerative peak can be annulled to obtain a

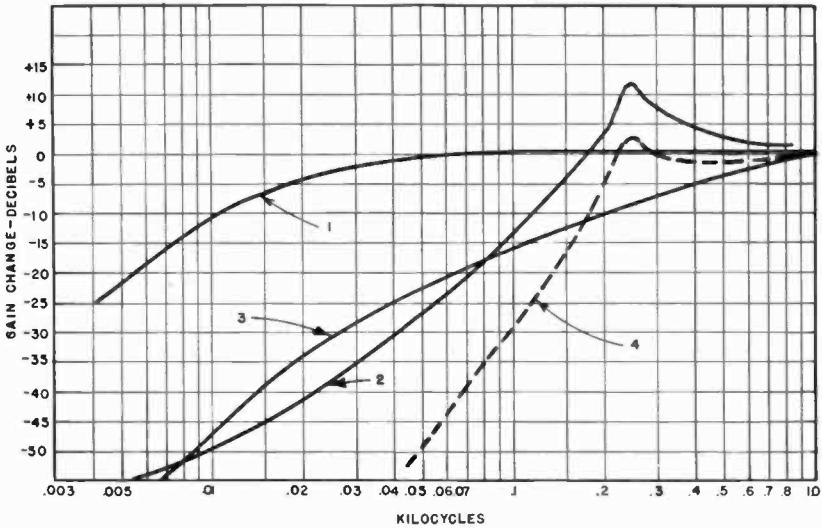

Fig. 9

much sharper cutoff for the over-all amplifier. A reciprocal time constant of 4000 would be obtained from a coupling condenser having a value of 0.00025 microfarad in series with the grid-leak resistance of one megohm. The frequency characteristic of this coupling circuit is shown by curve 3. As a result, the shape of the over-all gain-frequency characteristic for the amplifier is that of curve 4. This is the gain-frequency characteristic of the voltage feeding the grid of the output stage. These theoretical results have been checked experimentally and found to be surprisingly accurate. Note that this sharp cutoff in the gain-frequency characteristic of the amplifier is obtained with the use of only two additional resistors and two condensers which are condenser 5 and those of the feed-back circuit of Fig. 7. Condenser 6 is not included since it is required for grid filtering to the first stage. Condenser

5 is a blocking condenser which is made large relative to the condenser value of the  $\beta_1$  mesh of the feed-back circuit so that it has relatively little effect on the feed-back characteristic. It should be noted that care must be exercised to avoid extraneous phase shifts such as would occur from self-biasing systems that are not by-passed sufficiently to avoid appreciable degeneration in frequency ranges wherein feed-back control is desired. Similarly, phase shifts may arise from decoupling condensers in the B filter, and from screen-grid by-pass condensers in pentode amplifying tubes. Although these phase shifts may not be appreciable at high frequencies, they may become great at extremely low frequencies.

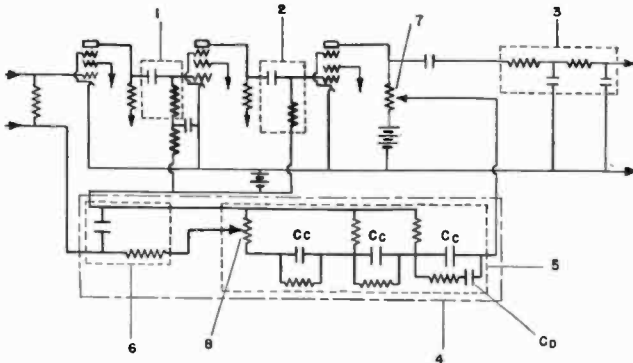

Fig. 10—Amplifier feed-back circuit for low-pass case.

#### ILLUSTRATION OF SPECIFIC LOW-PASS CASE

A specific case of low-pass frequency discrimination in a resistance-capacitance-coupled amplifier is now illustrated. In Fig. 10 is shown a three-stage voltage amplifier having roughly fifty decibels or more voltage gain. In order for this amplifier to have a fairly good low-frequency response the interstage coupling circuits 1 and 2 must have a relatively low reciprocal time constant; for which a typical value would be 400. At higher frequencies the interstage coupling circuits have no longer any appreciable effect on the propagation factor of the amplifier. Therefore, all of the active resistance-capacitance meshes for obtaining the low-pass feed-back characteristic will be contained in the feed-back circuit, which is group 4 of Fig. 10.

Fundamentally, the type of vector envelope desired is one in which all  $\mu\beta$  vectors remain at a negligibly small value for all frequencies below the so-called cutoff frequency. At the cutoff frequency the  $\mu\beta$ -vector envelope should extend into the gain-regenerating region to provide a gain rise that may be annulled by filter means in a later part

of the amplifier circuit. Beyond the cutoff frequency, it is of course desired to have the  $\mu\beta$  vectors pass into the gain-degenerating region as quickly as possible with the greatest possible increase in magnitude. In order to do this it is necessary to use as many sections in the feedback circuit as possible. Care must be exercised that the stray capacitances and inductances introduced by these additional meshes do not produce undesirable effects. To avoid enclosure of the point  $P$  careful selection of the type of section is necessary when a number of sections

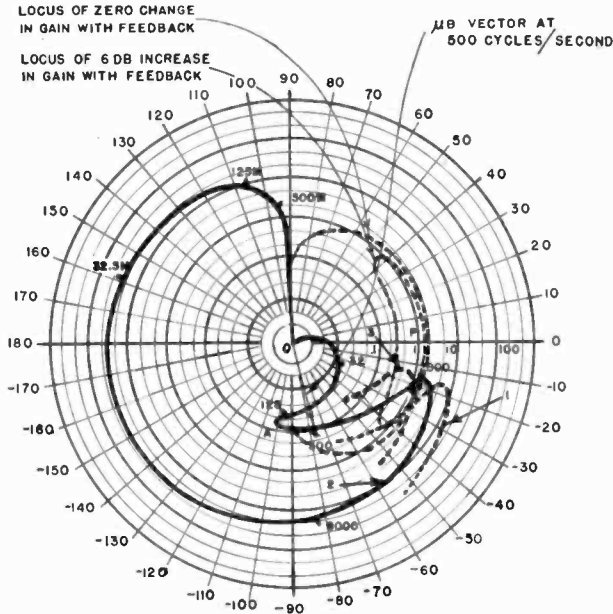

Fig. 11— $\mu\beta$ -vector envelope for low-pass case.

are placed in tandem. Obviously, at ultra-high frequencies it is necessary that the  $\mu\beta$  vector decrease in magnitude to zero in order to insure amplifier stability. At least one section of the type of Fig. 5, or its equivalent, is necessary to meet this requirement. This is section 6 of the feed-back circuit shown in Fig. 10. It should preferably have a very small time constant so that it would not appreciably decrease the amount of voltage fed back throughout the useful frequency spectrum. It is found that with three additional sections of the type shown in Fig. 6, which sections comprise group 5 of the feed-back circuit, the desired vector envelope can be secured. By assigning a reciprocal time constant of 100,000 to the resistance-capacitance mesh of section 6, and a reciprocal constant of 50,000, with  $N = 10$ , to the three meshes of group 5, the vector envelope of Fig. 11 is obtained.

Note that a blocking condenser  $C_d$  is required for the first mesh of group 5 of the feed-back circuit. By choosing a value for  $C_d$  that is many times that of  $C_c$ , which is the condenser in the series arm of this mesh, its effect on the propagation factor will be appreciable only at very low frequencies. In this case  $C_d$  is made fifty times that of  $C_c$ . At very low frequencies where  $C_d$  shows its effect, the interstage coupling circuits are also introducing phase and magnitude variations. These effects account for the peculiar shape of the  $\mu\beta$  characteristic

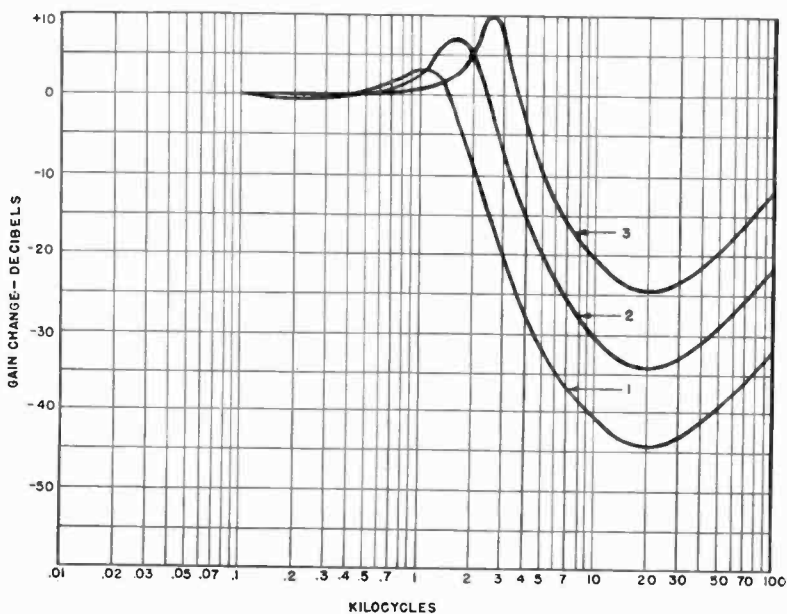

Fig. 12

at low frequencies such as from  $O$  to point  $A$  of the vector envelope of Fig. 11. Note that the magnitude of  $\mu\beta$  at these frequencies is so small that no feed-back effect is obtained.

The complete vector envelope for this case for a  $\mu_0\beta_0$  value of 95 is shown in Fig. 11. Portions of the envelope, 3 and 1, as repositioned by changing the value of  $\mu_0\beta_0$  to 30 and 300, respectively, are also shown in Fig. 11. The gain-change effect through feedback may be determined graphically by plotting the vector envelope on polar coordinate paper on linear scale, or else algebraically by (4). It is found that the gain-frequency characteristic for the feed-back amplifier is as shown by curves 1, 2, and 3 of Fig. 12 for respective  $\mu_0\beta_0$  values of 300, 95, and 30. These gain-frequency characteristics, 1, 2, and 3, are obtained, respectively, from the vector envelopes 1, 2, and 3 of Fig. 11.

Due to the "finger" of the vector envelope extending into the gain-regenerating region there are regenerative peaks on each of the gain-frequency characteristics of Fig. 12. The regenerative peaks may be annulled with conventional filter means by inserting a filter in the amplifier following the feed-back portion of the circuit. This filter will also serve to obtain a sharper cutoff characteristic. The two resistance-capacitance sections comprising group 3 of Fig. 10, each having a time constant of 12,500, have a frequency characteristic as shown by curve 4 of Fig. 13. The superposition of curve 4 on curves

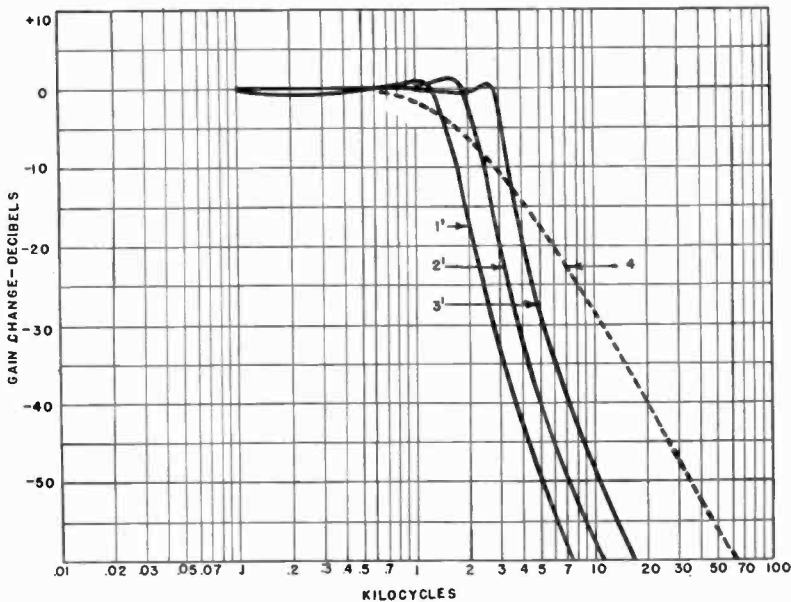

Fig. 13

1, 2, and 3 of Fig. 12, obtains respectively curves 1', 2', and 3' of Fig. 13. These over-all gain-frequency characteristics show the sharp cutoff producible by this combination. It, moreover, illustrates a means for obtaining a variable frequency cutoff characteristic to an amplifier through the control of the value of  $\mu_0\beta_0$  for the feed-back amplifier. The value of  $\mu_0$  may be changed at will by the potentiometer 7 of Fig. 10 or the value of  $\beta_0$  may be changed by potentiometer 8 of the feed-back circuit 4 of Fig. 10. The setting of these potentiometers will have no appreciable effect upon the variable-frequency propagation factors for the system.

The two afore-mentioned specific cases illustrate the design procedure employed in obtaining a feed-back amplifier which is to have a



predetermined gain-frequency characteristic. By similar design procedure, band-elimination and band-pass characteristics may be secured. In fact, the low-pass case illustrated is basically a band-elimination case wherein a regenerative peak is obtained at the lower cutoff frequency, but not at the higher cutoff frequency. By careful design, regenerative peaks may be secured at each cutoff frequency. To obtain band-pass characteristics, separate feed-back circuits over the same or over different portions of the amplifier may be employed. One of these feed-back circuits would be of the high-pass type, and the other would be of the low-pass type, as has been illustrated by the two specific cases in this paper.

#### ACKNOWLEDGMENT

The author wishes to express his appreciation to Mr. O. M. Dunning, manager of his department, for his many helpful suggestions and encouraging attitude toward this work and the preparation of this paper. He also is deeply indebted to Mr. Charles T. Jacobs for his invaluable contribution to the design of the low-pass case illustrated in this paper.

#### APPENDIX

##### 1. Envelope derivation for circuit of Fig. 6

$$\frac{E_2}{E_1} = \frac{R}{R + \frac{NR}{NR + \frac{1}{\frac{JC\omega}{NR + 1}}}} \quad (1)$$

$$\begin{aligned} &= \frac{NR + \frac{1}{JC\omega}}{NR + \frac{1+N}{JC\omega}} \\ &= \frac{1 + JNRC\omega}{1 + N + JNRC\omega} \end{aligned} \quad (2)$$

Let,

$$\omega_0 = \frac{1}{RC}; \quad W = \frac{\omega}{\omega_0}$$

Then,

$$\frac{E_2}{E_1} = \frac{1 + JNW}{1 + N + JNW} \quad (3)$$

Let,

$x$  = real part of (3), and  $y$  = imaginary part of (3).

Then,

$$\left. \begin{aligned} x &= \frac{N^2W^2 + 1 + N}{(1 + N)^2 + N^2W^2} & \text{(a)} \\ y &= \frac{N^2W}{(1 + N)^2 + N^2W^2} & \text{(b)} \end{aligned} \right\} \quad (4)$$

Solving (4a) for  $W^2$

$$W^2 = \frac{(1 - X - XN)(1 + N)}{N^2(X - 1)} \quad (5)$$

Substituting (5) in (4b)

$$y = \frac{N^2 \sqrt{\frac{(1 - X - XN)(1 + N)}{N^2(X - 1)}}}{(1 + N)^2 + N^2 \frac{(1 - X - XN)(1 + N)}{N^2(X - 1)}} \quad (6)$$

Simplifying (6)

$$y^2 + x^2 - x \left( \frac{2 + N}{1 + N} \right) = - \frac{1}{1 + N} \quad (7)$$

Completing the square

$$y^2 + \left( x - \frac{2 + N}{2(1 + N)} \right)^2 = \frac{N^2}{4(1 + N)^2} \quad (8)$$

Equation (8) represents a circle of radius  $N/2(1+N)$ , having its center displaced along the  $x$  axis a distance of  $(2+N)/2(1+N)$  as is shown in Fig. 6.

## 2. Frequency Allocation

Let,

$$x' = x - \frac{1}{1 + N} \quad (9)$$

(This moves the  $y$  axis to the right to become tangent to the vector envelope, as expressed by (8).)

By (4a) and (9)

$$x' = \frac{\frac{N^3 W^2}{1 + N}}{(1 + N)^2 + N^2 W^2} \quad (10)$$

(The numerator of  $x'$  now involves  $W$  only as a factor.)

By (10) and (4b)

$$\frac{y}{x'} = \frac{\frac{1}{W}}{\frac{N}{1 + N}} \quad (11)$$

Equation (11) signifies in simple form as a function of  $W$  and  $N$ , the slope of all vectors from the origin  $O'$ .



## A NEW TYPE OF SELECTIVE CIRCUIT AND SOME APPLICATIONS\*

By

H. H. SCOTT

(General Radio Company, Cambridge, Massachusetts)

**Summary**—This paper describes the use of the inverse feed-back principle to obtain sharply selective circuits. Important advantages of such circuits are (1) inductances are not necessary, (2) "tuning" may be changed by merely varying resistances, (3) ready adaptability for use at very low frequencies, (4) "tuning" may be varied over wide ranges of frequency while maintaining a selectivity curve which is a constant percentage function of the tuned frequency, (5) the possibility of using a single set of frequency-determining elements for "tuning" several amplifying stages, and (6) the general simplicity of construction and operation when compared with many other types of equipment designed to produce equivalent results.

Many uses for a circuit of this type immediately suggest themselves. Two important applications are described, including a novel type of analyzer and an oscillator having extremely good wave form.

### I. INTRODUCTION

**S**ELECTIVE circuits in common use today consist generally of combinations of inductance and capacitance or their mechanical equivalents. Illustrations are the many tuned circuits used in radio receivers, transmitters, and other types of communication equipment. Among the selective mechanical or electromechanical devices may be included crystals (quartz, Rochelle salt, etc.) and various types of magnetostriction and mechanical filters.

In the interests of simplified design and low construction cost it has become general practice to adjust the tuning of electrical circuits, so far as possible, by varying the condensers and allowing the inductances to remain fixed. This is generally satisfactory at higher frequencies, but at lower frequencies the condensers used are sufficiently large so that conventional types of variable condensers cannot be used. Another serious objection to circuits of this type is the difficulty of obtaining satisfactory inductances for use at lower frequencies.

The electromechanical types of selective circuits, such as crystals, magnetostriction devices, and mechanical filters, are even more restricted so far as changing the resonant frequency is concerned, since in such devices the frequency is determined mainly by the mechanical dimensions and other characteristics which are not variable. Also, several important factors such as size and expense limit the use of such devices to relatively high frequencies.

\* Decimal classification: R141.2. Original manuscript received by the Institute, October 6, 1937.

Some circuits have been developed in which the change of tuning can be accomplished by adjusting variable resistances, but have not attained wide acceptance due, perhaps, to the complicated nature of the circuits involved or the general unavailability of satisfactory necessary circuit elements such as, for instance, dynatrons. The "resistance tuning" of Cabot<sup>1</sup> is an illustration of this general type of circuit. An obvious advantage of being able to adjust the tuning of a circuit by varying resistances only is the fact that, at low frequencies, suitable variable inductances or capacitances are not available, with the result that in most conventional types of circuits low-frequency tuning is adjustable only in steps.

One of the most important uses for tuned circuits at low frequencies is in the analysis of electrical wave forms, and, in particular, in recent years the analysis of noise wave forms as obtained from a microphone and amplifier. In order to meet this demand for analyzers, various instruments have been developed. Types involving merely tuned circuits consisting of inductances and capacitances have generally been abandoned due to the elaborate switching arrangements necessary for complete coverage of the low-frequency ranges, the difficulties in obtaining satisfactory selectivity at the lower frequencies, and to the susceptibility of this type of circuit to magnetic pickup and interference, particularly from power lines. Analyzers of the heterodyne type have, accordingly, gained wide acceptance.<sup>2</sup> In these devices the wave form to be analyzed is heterodyned against a practically sinusoidal wave form obtained from a local oscillator, and the resulting beat note is passed through a sharply selective filter, generally of some electromechanical type consisting of crystals, magnetostriction rods, or similar devices. An outstanding characteristic of an analyzer of this type is that the band width in cycles is practically constant, regardless of the frequency to which the analyzer is tuned. Changes in band width can only be accomplished by changes in the electromechanical resonant circuits or by the more common method of switching other resonant circuits into the system.

For many types of work such arrangements are quite satisfactory, but for noise analysis they are, in general, a compromise. It is generally agreed among users of sound-measuring equipment that the most satisfactory analyzer for noise analysis should have a band width or

<sup>1</sup> Sewall Cabot, "Resistance tuning," *Proc. I.R.E.*, vol. 22, pp. 709-731; June, (1934).

<sup>2</sup> For information on conventional types of analyzers see L. B. Arguimbau, "Wave analysis," *Gen. Rad. Exp.*, vol. 8, pp. 12-14; June-July, (1933); M. S. Mead and T. M. Berry, "A portable frequency analyzer," *Gen. Elec. Rev.*, vol. 37, pp. 378-383; August, (1934); and H. H. Scott, "The analysis of complex sounds of constant pitch," *Gen. Rad. Exp.*, vol. 9, pp. 5-8; May, (1935).

selectivity curve which is a constant percentage of the frequency to which the device is selective.<sup>3</sup> Obviously, such an analyzer constructed along conventional heterodyne principles would be extremely elaborate and expensive.

The principle of inverse feedback or degeneration has been employed for several years in circuits where approximately equal response, low harmonic distortion, and stability over a wide range of frequencies are desirable. The method of operation of such circuits has been described quite completely by Black,<sup>4</sup> and circuits using the inverse feedback principle to obtain wide-range frequency response and low harmonic distortion are in quite general use. A general characteristic of such circuits is that the over-all amplification is reduced by the addition of degeneration, so that the improvements in frequency response and the reduction of harmonic distortion are accompanied by an unavoidable decrease in sensitivity. Variations of the feed-back principle have also been used to form a "tone control" or to modify the amplifier frequency characteristics somewhat from a straight line in order to compensate for opposite variations in the associated equipment or for the changes in sensitivity of the human ear at low levels.

## II. PRINCIPLE OF OPERATION

In developing a new type of selective circuit with particular regard to its use as a noise or wave analyzer, a different use of the inverse feedback or degeneration principle has been used. In this system the degeneration is used, not to obtain wide-range frequency response, but rather to obtain a sharply selective circuit. An important characteristic of this circuit as contrasted to other degenerative circuits is that the sensitivity of the amplifier itself is not reduced at the selective frequency, that is, the gain of the system at the frequency to which it is tuned is the same as the gain of the amplifier at that frequency without the degeneration.

In its simplest form the system consists essentially of an amplifier and a feed-back network, which may be a bridge or similar type of circuit which balances to a null at a predetermined frequency. At this frequency, accordingly, no voltage is fed back from the amplifier output to the input, and normal gain of the amplifier is obtained. At frequencies above and below this null point, however, the circuit is arranged so that the voltage fed back through the degenerative network is applied to the amplifier input with such a phase relationship with

E. J. Abbott, "The rôle of acoustical measurements in machinery quieting," *Jour. Acous. Soc. Amer.*, vol. 8, pp. 133-142; October, (1936).

<sup>4</sup> H. S. Black, "Stabilized feedback amplifiers," *Elec. Eng.*, vol. 53, pp. 114-120; January, (1934); or *Bell Sys. Tech. Jour.*, vol. 13, pp. 1-18, January, (1934).

respect to the original input voltage that a reduction of gain is produced. This system is outlined in Fig. 1. Naturally, the amount of this

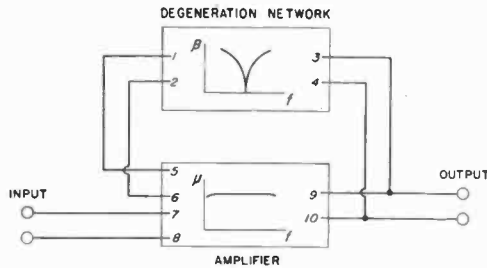

Fig. 1—Diagram showing general type of circuit for obtaining selectivity through the use of inverse feedback.

reduction will depend upon the propagation constants of the amplifier and degeneration circuits ( $\mu$  and  $\beta$ , respectively), but it will readily be seen that, if the degenerative network balances to a sharp null, a sharply selective response can be obtained.

### III. SUITABLE CIRCUITS

There are many practical types of circuits which balance sufficiently sharply for use in the degenerative circuit, and such circuits may, of course, include resistances, capacitances, inductances, as well as amplifying stages or other devices in many possible combinations. For the purposes of simplicity, however, and because of their ready adaptability to existing problems, only two of the simpler networks are shown in Fig. 2.

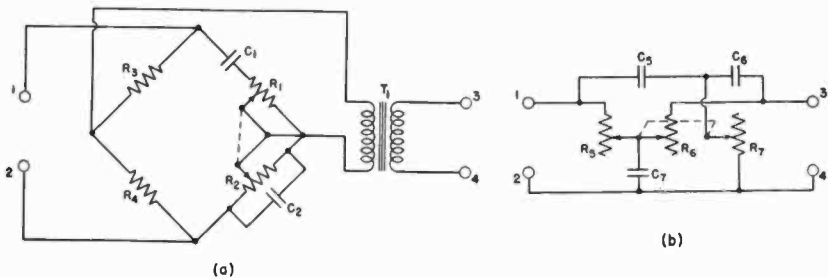

Fig. 2—Two of the many possible degenerative networks which may be used as shown in Fig. 1.

The first of these circuits is the well-known Wien bridge, which balances sharply to a frequency determined by its circuit elements, which consist only of resistances and condensers. Fig. 2(a) shows a

circuit of this type, which may be inserted directly as the "degenerative network" in Fig. 1. The conditions for balance of this bridge are

$$f = \frac{1}{2\pi\sqrt{R_1R_2C_1C_2}} \quad (1)$$

and,

$$\frac{C_2}{C_1} = \frac{R_3}{R_4} - \frac{R_1}{R_2} \quad (2)$$

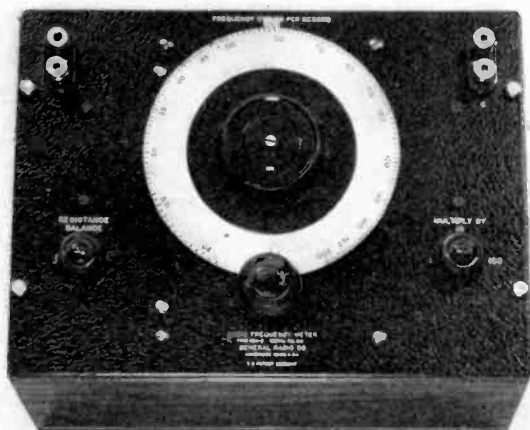

Fig. 3—Audio-frequency meter designed for commercial use.

A convenient arrangement is to make

$$\frac{R_1}{R_2} = \frac{C_2}{C_1} = 1 \quad \text{and} \quad \frac{R_3}{R_4} = 2. \quad (3)$$

Thus (2) is always fulfilled and (1) becomes

$$f = \frac{1}{2\pi R_1 C_1} \quad (4)$$

In its commercial form as the General Radio Company's type 434-B audio-frequency meter, which is shown in Fig. 3, continuous variation of the Wien bridge is obtained by merely turning a single dial which controls two variable resistances ( $R_1$  and  $R_2$ ) mounted upon a common shaft. In order to extend the range of the instrument, the capacitances ( $C_1$  and  $C_2$ ) are adjustable by means of a multipole switch, so that various frequency ranges are available. Since changing the capacitances by a given factor always produces a corresponding but inverse change in frequency, the various frequency ranges over which the instrument is



used may be made to track with a single-dial calibration which need merely be multiplied or divided by constant factors for the additional frequency ranges. In the commercial form of the instrument the multiplying factors are ten or multiples thereof, so that operation of the frequency meter is extremely simple.<sup>5</sup>

We have, therefore, in the Wien bridge a type of circuit which is unusually well suited for use in a selective system working on the inverse feed-back principle. When a circuit of this sort is operated from a relatively low impedance, such as the output circuit of an amplifier, into a relatively high impedance, such as the input circuit of an amplifier, the frequency may be varied over wide ranges while maintaining a practically constant transmission at any point a given percentage in frequency away from the null point. The result is, therefore, a constant percentage selectivity curve or band width in the selective system. Furthermore, continuous variation of frequency is secured at even very low frequencies by merely adjusting variable resistances, and no inductances are employed excepting a suitable transformer for providing the proper balance-to-ground conditions for operation of the bridge.

For many circuit applications, however, it is an advantage if the degenerative network consists of a three-terminal network, one terminal of which may be grounded. A practical equivalent of the Wien bridge in a three-terminal network is provided by the so-called parallel-T network, as shown in Fig. 2(b). In this type of network the number of frequency-determining resistances and condensers is increased from two to three each over the Wien bridge, but this is not a serious disadvantage, and the elimination of the transformer simplifies many other design and manufacturing problems. Referring to Fig. 2(b), a balance is obtained for the network when

$$C_5 = C_6 = \frac{1}{2}C_7 \quad (5)$$

$$R_5 = R_6 = 2R_7 \quad (6)$$

and,

$$R_5 = \frac{1}{2\pi f C_5} \quad (7)$$

Thus,

$$f = \frac{1}{2\pi R_5 C_5} \quad (8)$$

which is similar in form to (4).

<sup>5</sup> R. F. Field, "A bridge-type frequency meter," *Gen. Rad. Exp.*, vol. 6, pp. 1-3, November, (1931). For further information on the Wien bridge see J. G. Ferguson and B. W. Bartlett, "The measurement of capacitance in terms of resistance and frequency," *Bell Sys. Tech. Jour.*, vol. 7, pp. 420-437; July, (1928), and B. Hague, "Alternating-Current Bridge Methods," second edition, pp. 233-237, published by Pitman and Son's Ltd., London and New York (1930).

It will be noted that the values are in convenient ratios and, since a high-impedance circuit is desirable, result in mechanical sizes which are not too large, even at extremely low frequencies. By using three variable resistances ganged together on a common shaft continuous adjustment of the frequency may be obtained, while larger changes of frequency may be obtained by switching condensers. At higher frequencies, ganged variable condensers can be used.

#### IV. PRECAUTIONS

When the amplifier used in a selective system of this type has a relatively low amount of gain satisfactory operation can be obtained without any particular difficulties. Since, however, the selectivity increases almost directly with the gain, it is frequently desirable to use a relatively high degree of amplification. Obviously, the net propagation characteristic ( $\mu\beta$ ) of the amplifying and degenerative systems combined must be such that regeneration and consequent oscillation are not produced. With the simpler networks and amplifier circuits the most common source of trouble is regeneration either at the high or at the low end of the amplifier frequency range due to phase shifts taking place within the amplifier circuits themselves. For this reason the amplifier should be designed to have a minimum of phase shift over a range exceeding somewhat the range of frequencies over which the system will be used, or means should be taken to correct the phase shift. For low-frequency work in particular, direct-coupled amplifiers have proved very satisfactory. Amplifier circuits having a sharp cut-off beyond the usable frequency range and with a minimum of phase shift are generally desirable. For many purposes suitably sharp cutoffs can be obtained at the low-frequency end by means of a single series capacitance or a shunt inductance and at the high-frequency end by a single series inductance or shunt capacitance. Of course, more elaborate filter circuits may also be used, or phase-correcting elements may be inserted in either the amplifier or the feed-back circuits. The main objective is to provide a total phase shift (due to the propagation constant  $\mu\beta$ ) through the amplifier and feed-back networks of approximately 180 degrees at those frequencies which the system as a whole should suppress. In actual practice it has been found that considerable deviation from this ideal may be tolerated, but, obviously, the phase shift should never be such as to produce serious regeneration.

#### V. AN ANALYZER

An experimental analyzer for use on sound or other wave forms has been constructed along the principles outlined in this paper. The

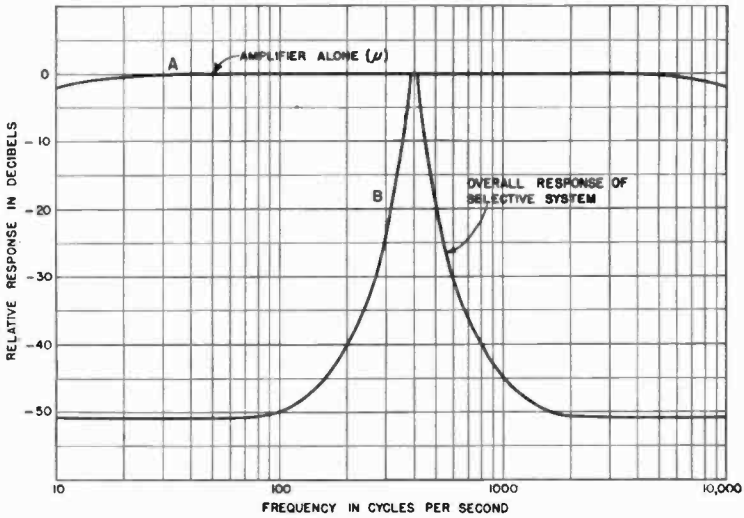

Fig. 4—Characteristics of typical selective circuit based upon degeneration.

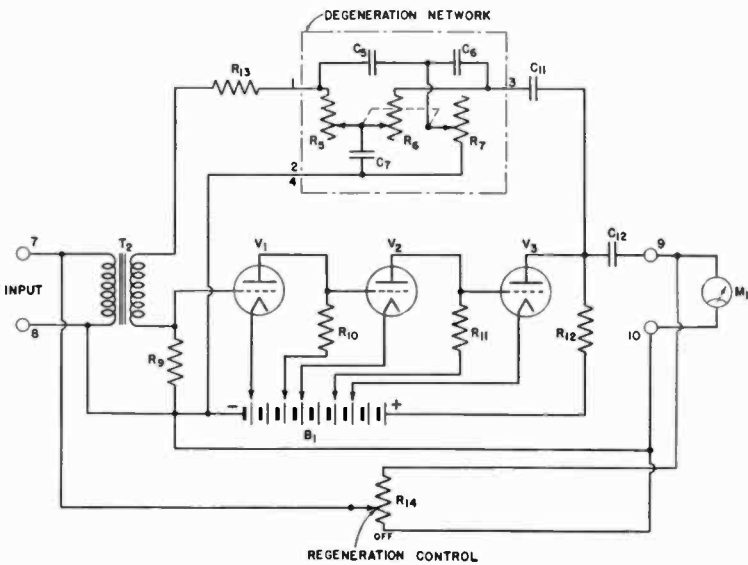

Fig. 5—One of the many possible circuit arrangements in which sharp selectivity is achieved by the use of inverse feedback. The circuit shown can function either as an oscillator, or when  $R_{14}$  is omitted, as an analyzer.

general characteristics of such a device are shown in Fig. 4, in which curve A represents the characteristic of the amplifier circuit alone, while curve B represents the typical selectivity curve obtained. In

actual operation practically this same selectivity curve with only minor deviations may be obtained throughout the range of the instrument.

Fig. 5 shows a simple circuit which has been found satisfactory for an analyzer of this type. It consists essentially of three direct-coupled amplifying stages, a parallel-T degenerative network, and suitable auxiliary equipment. The transformer  $T_2$  merely provides a convenient means for coupling both the input voltage and the voltage obtained from the degenerative network to the grid of the first tube. The meter  $M_1$  may be a rectifier type of vacuum-tube voltmeter or a cathode-ray oscillograph and is used for indicating the output of the system at the frequency to which it is selective. The regeneration control  $R_{14}$  should be left out of the circuit for analyzer use. The reason for this control will be discussed later.

## VI. AN OSCILLATOR

A sharply selective amplifier can be made to oscillate at a frequency determined mainly by its selectivity curve, providing a suitable amount of regeneration is introduced between the output and the input circuits. The inverse feed-back method of obtaining selectivity has also been applied to an experimental oscillator with gratifying results. The amount of regenerative feedback is small compared to the degenerative feedback, except in the neighborhood of the oscillation frequency. Accordingly, the degenerative action of the circuit provides an unusually pure sinusoidal wave form. After experimenting with a circuit of this type and using various commercially available vacuum tubes, it has been found that there is little difficulty in obtaining a total harmonic distortion of only a few tenths of one per cent while operating the output tube at a large percentage of its maximum rating. Generally, practically all of the distortion in the output wave form consists of the second harmonic, all other harmonics being so low as to be comparatively negligible.

The regeneration control  $R_{14}$ , shown in Fig. 5, provides the necessary means for transforming the analyzer circuit into an oscillator. Best results are generally obtained when this control is only turned up sufficiently far to provide reliable oscillation.

## VII. CONCLUSIONS

As a result of the experiments briefly described in this paper, it has been concluded that there is an important type of inverse feed-back or degenerative circuit which hitherto has been seemingly overlooked. The selectivity curves obtained with these new circuits compare most favorably with other types of tuned circuits and appreciably surpass

results obtained with other practical systems at low frequencies. It is probable that further work along these lines will result in improved circuits which will be of considerable value for use in various frequency ranges. It would appear as if this new use of degeneration not only offers possibilities of hitherto unattainable results in low-frequency apparatus, but also provides a type of circuit which could be used to advantage to replace or complement existing types of selective circuits in many other applications and frequency ranges.

#### ACKNOWLEDGMENT

The assistance and advice of Dr. W. N. Tuttle regarding suitable three-terminal networks for use as described in this paper is gratefully acknowledged.



**CHARACTERISTICS OF THE IONOSPHERE AT WASHINGTON, D. C., DECEMBER, 1937\***

By

T. R. GILLILAND, S. S. KIRBY, N. SMITH, AND S. E. REYMER

(National Bureau of Standards, Washington, D. C.)

**D**ATA ON the critical frequencies and virtual heights of the ionosphere layers are given for December, 1937, in Fig. 1. Fig. 2 gives the maximum frequencies which can be used for radio communication in latitudes approximately that of Washington, based on the data of Fig. 1.

The average noon value of the  $F_2$  critical frequency in December,

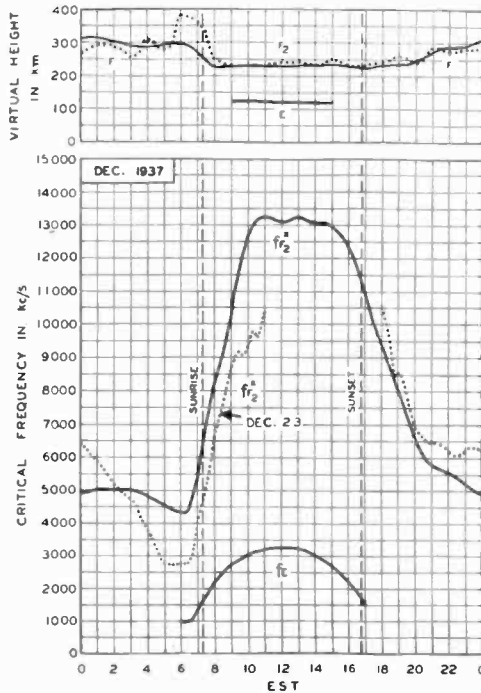

Fig. 1—Virtual heights and critical frequencies of the E, F, and  $F_2$  layers of the ionosphere for December 1937. The solid-line graph represents for undisturbed days. Dotted curve shows values for ionospherically disturbed day of December 23.

\* Decimal classification: R113.61. Original manuscript received by the Institute, January 8, 1938. This is one of a series of reports on the characteristics of the ionosphere at Washington, D.C. For earlier publications see Proc. I.R.E., 25, pp. 823-840; July, (1937), and a series of monthly reports beginning in Proc. I.R.E., vol. 25, pp. 1174-1191; September, (1937). Publication approved by the Director of the National Bureau of Standards of the U. S. Department of Commerce.

1937, exceeded that for December, 1936, by about 500 kilocycles. The following critical frequencies for December, 1937, were less than those for the corresponding hours in December, 1936, by approximately the following amounts: midnight  $f_F$ , 200 kilocycles; diurnal minimum (0630 local time), 250 kilocycles; noon  $f_E$ , 100 kilocycles.

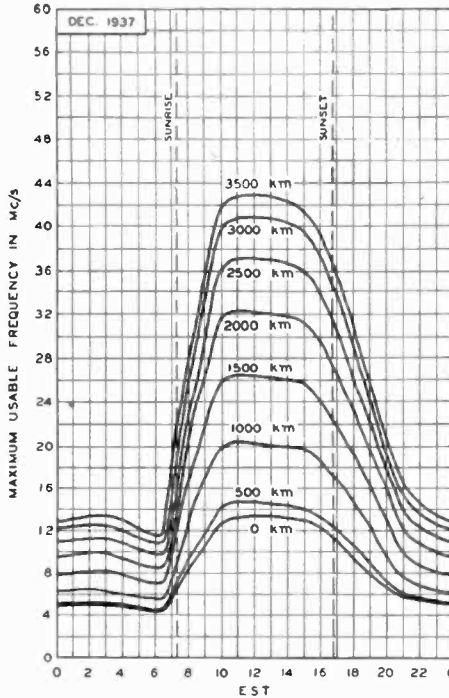

Fig. 2—Maximum usable frequencies for latitude of Washington; average for December. Time to be used is local time where the waves are reflected from the ionosphere layer.

The ionosphere storms during December were very mild as in November. This condition has been typical of the past three winters, November to February. The most severe ionosphere storm during December, 1937, is shown in Table I.

TABLE I

Date	$h_F$ before sunrise km	Min. $f^z F_2$ during day (before sunrise) kc	Max. $f^z F_2$ during day (near noon) kc	Magnetic Character <sup>1</sup>	
				0000-1200 G.M.T.	1200-2400 G.M.T.
Dec. 23	304	2800	between 10,000 and 13,700	0.5	1.1
Average of undisturbed days	293	4350	13,260	0.3	0.3

<sup>1</sup> American character figure, compiled by the Department of Terrestrial Magnetism, Carnegie Institution of Washington, from data supplied by their two observatories and five observatories of the United States Coast and Geodetic Survey.

Table II shows the number of hours  $f^z_F$  differed from the December average of the undisturbed days by more than the given percentages.

TABLE II

For 513 hours of observations between 1700 and 0900 E.S.T.										
Per cent . . . . .	-30	-20	-10	-0	+0	+10	+20	+30	+40	+50
Number of hours . . . . .	2	28	113	282	231	100	39	9	3	1
Hours on disturbed day . . . . .	2	5	6	7	10	9	5	0	0	0
Hours on undisturbed days . . . . .	0	23	107	275	221	91	34	9	3	1

For 35 hours of observations on Wednesdays between 1000 and 1600 E.S.T.										
Number of hours . . . . .	0	0	3	17	18	3	0	0	0	0

A sudden disturbance of the ionosphere was marked by a radio fade-out from 1418 to 1439 G.M.T., December 14. The effect was a minor one at Washington.

A type of high daytime absorption which resembles fade-outs and which has been observed by us for about two years occurred frequently during the latter half of December. This absorption does not have the sudden beginning, which usually characterizes fade-outs, and it continues for several hours during the middle of the day. It results in very low field intensities at the medium-high frequencies such as the W8XAL transmissions at a frequency of 6060 kilocycles and distance of 650 kilometers. This absorption has occurred intermittently at all seasons of the year, during both the occurrence and absence of ionosphere storms and fade-out activity. No similar day-to-day variation of the absorption of daytime sky-wave transmissions over similar distances has been observed at broadcast frequencies. The absorption appears to be produced in a part of the ionosphere in the lower part of, or below the E layer but at a level above that from which broadcast transmissions are reflected in the daytime.

TABLE III  
Midnight to Noon  
Total Hours of Observation 360.

Date . . . . .	Hour E.S.T.											
	00	01	02	03	04	05	06	07	08	09	10	11
Dec. 7 . . . . .			4.5						6.0	6.0	6.0	
Dec. 9 . . . . .		6.0	4.5			6.0						
Dec. 10 . . . . .	8.0	8.0				8.0	8.0	8.0	8.0			
Dec. 16 . . . . .				4.5		8.0	8.0	8.0	8.0			

Noon to Midnight  
Total Hours of Observation 359

Date . . . . .	Hour E.S.T.											
	12	13	14	15	16	17	18	19	20	21	22	23
Dec. 7 . . . . .	4.5	4.5	6.0	8.0		8.0	8.0	8.0	8.0	8.0	8.0	8.0
Dec. 9 . . . . .							4.5	8.0	8.0	8.0	8.0	8.0
Dec. 24 . . . . .											8.0	8.0



Table III shows the days of December, 1937, during which strong sporadic-E reflections were most prevalent. In this table the figures indicate approximately the frequency in megacycles up to which strong sporadic-E reflections were observed.

*Note*—The National Bureau of Standards broadcasts ionosphere data and also maximum usable frequencies, on each Wednesday by radiotelephone from its station WWV, in accordance with the following schedule: 1:30 P.M. E.S.T., 10 megacycles, 1:40 P.M. E.S.T., 5 megacycles, 1:50 P.M. E.S.T., 20 megacycles.



## DISCUSSION ON "ULTRA-SHORT-WAVE PROPAGATION ALONG THE CURVED EARTH'S SURFACE"\*

PAUL VON HANDEL AND WOLFGANG PFISTER

Charles R. Burrows:<sup>1</sup> In this paper von Handel and Pfister have presented some valuable experimental results and some interesting theoretical suggestions. By making field-strength measurements over an extended range of distances they have experimentally shown that with elevated antennas the field decreases exponentially at the longer distances. The fact that their theoretical formulation is not convincing reflects the difficulty of the subject. Their theory does not advance from a fundamental basis which can be traced to Maxwell's equations, but proceeds by the use of analogy to simpler phenomena. To mention two criticisms, first it is not a sound procedure to use the ray method in diffraction problems; second, the analogy to optical diffraction led to the erroneous conclusion that the earth's surface may be treated as a perfect conductor. Theoretical papers by van der Pol<sup>2</sup> and by Wwedensky<sup>3</sup> show that electrical properties of the earth's surface affect the results. Even for the conditions so far treated by Wwedensky, which more nearly resemble a perfectly conducting earth than real earth does, the numerical factor in the exponent differs by as much as a factor of two from that for a perfectly conducting earth.

In the work by Burrows, Decino, and Hunt<sup>4</sup> criticized by von Handel and Pfister, a formula was obtained on the accepted wave theory and it was based on a physical picture in which the earth's surface was replaced by two tangent planes. Admittedly the earth does not have such a shape and the results should not be carried too far. They are therefore correct in assuming that the formula does not apply to antennas at heights attained by airplanes.

Their modification of this formula, however, does not improve the agreement but makes it actually worse. The original takes the form

\* Proc. I.R.E., vol. 25, pp. 346-368; March, (1937).

<sup>1</sup> Bell Telephone Laboratories, Deal, New Jersey.

<sup>2</sup> Balth. van der Pol, "Radio propagation over finitely conducting spherical earth," presented before New York meeting of the I.R.E., November 12, 1936. For propagation on a wave length of seven meters Dr. van der Pol found that at short distances the field strength over ocean water was the same as that over a perfectly conducting earth but at longer distances it was increasingly less being about one seventh at 100 kilometers. The field strength over land on this wave length was found to be very much less. Since this discussion was written "The diffraction of electromagnetic waves from an electrical point source round a finitely conducting sphere, with applications to radiotelegraphy and the theory of the rainbow" by Balth. van der Pol and H. Bremmer has been published in *Phil. Mag.*, ser. 7, pp. 141-176 and 825-864; July and supplement to November, (1937). This treatment of the idealized case of homogeneous atmosphere and spherical earth leaves nothing to be desired from the theoretical point of view. They find that in general the effects of height and distance cannot be separated but for long distances and not too high antennas these effects can be separated.

<sup>3</sup> B. Wwedensky, "The diffractive propagation of radio waves," *Tech. Phys.* (U.S.S.R.), vol. 2, no. 6, pp. 624-639, (1935), and vol. 3, no. 2, pp. 915-925, 1936. These papers give the attenuation of radio waves for propagation over a spherical earth of small  $Q$  for arbitrary antenna heights. Since this discussion was written Part III of Wwedensky's paper has appeared in *Tech. Phys.* (U.S.S.R.), vol. 4, no. 8, pp. 579-591.

<sup>4</sup> Charles R. Burrows, Alfred Decino, and Loyd E. Hunt, "Ultra-short-wave propagation over land," *Proc. I.R.E.*, vol. 23, pp. 1507-1535; December, (1935).

$$E = \left\{ \frac{3\sqrt{5}\sqrt{P_t}}{d} \right\} \left\{ 2 \sin 2\pi h_1 h_2 / \lambda d \right\} F. \quad (1)$$

In their modification they replace the sine term by its argument, a procedure not justified by the statement that maxima and minima are not formed beyond the line of sight.

Even though it is incorrect to attempt to apply (1) to the conditions of the von Handel and Pfister data it gives values that do not differ from the experimental data as greatly as one would be led to believe by reading their paper. This can be seen from Fig. 1 which is a copy of their Fig. 5 with some additional curves. Curve 1 is calculated by the method described by Schelleng, Burrows, and Ferrell.<sup>5</sup> The effect of refraction in the lower atmosphere is taken into account by assuming the effective radius of the earth to be equal to four thirds the actual

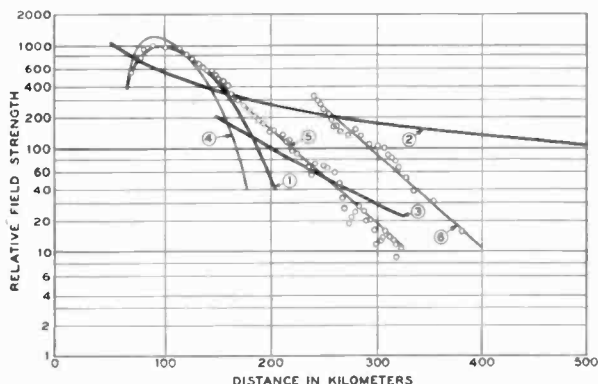

Fig. 1—Replot of von Handel and Pfister's Fig. 5 together with additional curves. Wavelength, 7 meters; transmitting antenna, 135 meters high. Receiving antenna 2000, and 5000 meters high.

- Curve 1. Theoretical curve calculated on the basis of geometrical reflection with refraction.
  - Curve 2. Free-space field.
  - Curve 3. Plot of equation (1).
  - Curve 4. Theoretical curve calculated on the basis of geometrical reflection neglecting refraction.
  - Curve 5. Exponential curve through 2000-meter data.
  - Curve 6. Exponential curve through 5000-meter data.
- The first three curves were calculated by the writer, the remaining three are due to von Handel and Pfister.

radius. This spherical surface was replaced by the plane tangent at the point of geometric reflection. The reflection coefficient was assumed to be equal to  $-1$ . The absolute value of the field strength so calculated was adjusted so as to obtain the best fit with the experimental data. This curve fits the experimental data appreciably better than curve 4 calculated by von Handel and Pfister by a similar method but neglecting atmospheric refraction. By locating curve 1, the other calculated curves are fixed. Curve 2 gives the free-space field. Curve 3 is a plot of (1). The effect of refraction was assumed to be the same as in curve 1. This formula was developed for low antennas and was not expected to apply to airplane

<sup>5</sup> "Ultra-short-wave propagation," *Proc. I.R.E.*, vol. 21, pp. 427-463; March, (1933), and *Bell Sys. Tech. Jour.*, vol. 12, pp. 125-161; April, (1933).

data. For conditions under which the received field strength calculated by the first method<sup>6</sup> gives values greater than the free-space field this method is to be preferred. Under these conditions (1) can only give correct results when it is in agreement with the first method. This is the case if the antennas are low. It is interesting to note that (1) gives the right order of magnitude for the received field strength from 200 to 300 kilometers with one antenna 2000 meters high. At the shorter distances it gives a pessimistic value for the received field strength as should be expected because it neglects the effect of antenna height on the shadow effect and hence predicts an appreciable reduction due to the earth's shadow even under conditions where the phase relations between the direct and reflected wave of method 1 are optimum. Curves 5 and 6 are exponential curves drawn through the two sets of data.

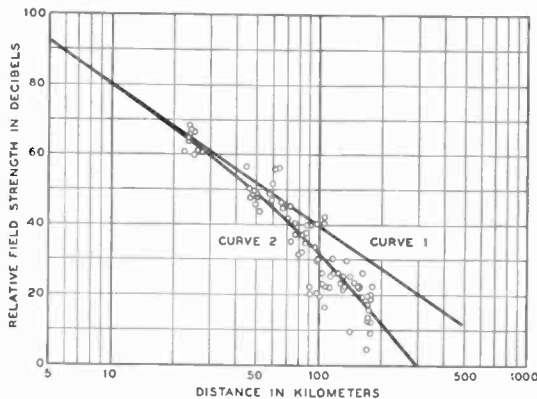

Fig. 2—Replot of data published by Beverage.

$\lambda = 7.4$  meters,  $h_1 = 296$  meters,  $h_2 = 5.37$  meters.

Curve 1. Theoretical formula for propagation over plane earth 5.3 decibels below stated power.

Curve 2. Plot of equation (1).

Until recently (1) has not had a crucial test. Data presented by Beverage,<sup>6</sup> however, show that the shadow factor  $F$  is at least of the right order of magnitude for distances up to several times the shadow distance. Figs. 2, 3, and 4 are replots of his Figs. 1, 2, and 3 together with plots of the theoretical formula<sup>7</sup> for propagation over plane earth and (1). While it is gratifying to obtain this confirmation of our level-land formula, caution should still be exercised in applying it to different conditions of refraction, types of terrain, and ranges of the variables, height, wave length, and distance.

<sup>6</sup> Harold H. Beverage, "Some notes on ultra-high-frequency propagation," *RCA Rev.*, vol. 1, pp. 76-87; January, (1937).

<sup>7</sup> Even for near distances the data published by Beverage lie below the theoretical curve for the stated power. Without attempting to evaluate the possible reasons for this, the theoretical curves have been drawn for the "effective" radiated power that gives the best agreement with the experimental data. The value of the parameter  $k$  which is a measure of the difference in curvature of the path of the wave and that of the earth has also been adjusted to fit the data. While the value of  $k = 0.92$  was used for all three curves the agreement would be almost as good for a value of  $k = 4/3$ .

Added in proof: In transcribing the curve of Fig. 10 of reference 3 for publication, the curve was shifted to the right. To correct for this multiply the labeling of the abscissa by 0.8. This has a maximum effect of reducing the shadow factor by 3 decibels. Accordingly, curve 3 of Fig. 1 could be lowered about 3 decibels. When this correction is made, the curves of Figs. 2, 3, and 4 correspond to values of  $k = 1.3$ .

Even for constant conditions of refraction in the lower atmosphere the phenomenon of ultra-short-wave propagation over a spherical earth is very complicated. In general it will probably not be possible to separate the effect of antenna height and distance into two separate factors. At one end of the range of variables the relationship between distance and antenna height is simple as shown by (1);  $F$  is a function of wave length, distance, and amount of refraction. At the

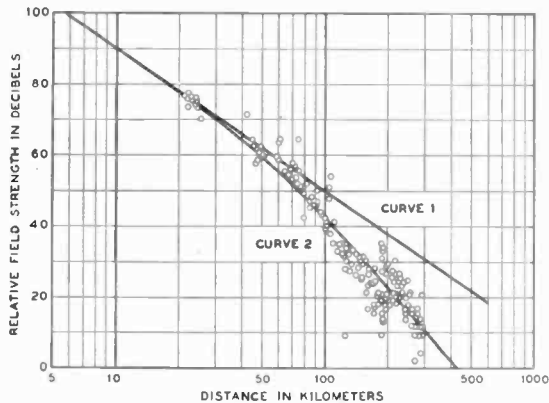

Fig. 3—Replot of data published by Beverage.

$\lambda = 7.32$  meters,  $h_1 = 396$  meters,  $h_2 = 5.37$  meters.

Curve 1. Theoretical formula for propagation over plane earth 8.2 decibels below stated power.

Curve 2. Plot of equation (1).

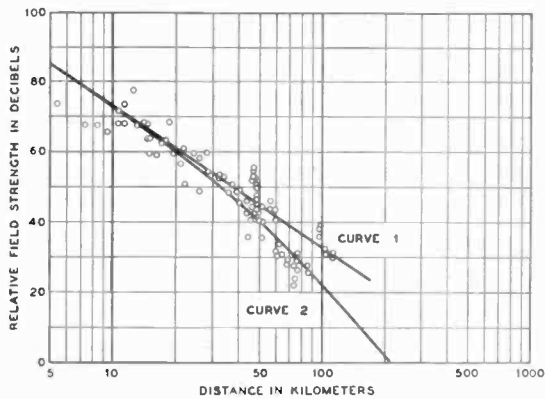

Fig. 4—Replot of data published by Beverage.

$\lambda = 3.27$  meters,  $h_1 = 183$  meters,  $h_2 = 3.05$  meters.

Curve 1. Theoretical formula for propagation over plane earth 8.5 decibels below stated power.

Curve 2. Plot of equation (1).

other end, in the region of the von Handel and Pfister experiment, it may also be possible to separate the effect of antenna height and distance. In between these extremes there has been a wealth of data published by Trevor and Carter<sup>8</sup> but to date it has been impossible to fit it into a consistent simple formula.

<sup>8</sup> Bertram Trevor and P. S. Carter, "Notes on propagation of waves below ten meters in length," Proc. I.R.E., vol. 21, pp. 387-426; March, (1933).

Paul von Handel and Wolfgang Pfister:<sup>9</sup> Mr. Burrows is quite correct in pointing out that an exact calculation of the diffraction problem taking into account the actual conductivity of the ground yields a numerical factor in the exponent of the  $\epsilon$  function which is twice as large as that with ideal conductivity, on which our calculation is based, following the approach of Watson and Laporte. We have used this expression because at the time we concluded our work (February 21, 1936) the works of van der Pol and T. L. Eckersley<sup>10</sup> had not yet appeared. The mathematical derivations are not yet contained in the paper referred to and, according to a private communication from Mr. Eckersley, are first to appear shortly in the *Proceedings of the Royal Society*. Van der Pol's paper also has heretofore not been available to us. Nevertheless it can be clearly seen from Eckersley's paper that the character of his curves agrees in all details with that of our curves, the variation of the field strength with height also corresponds to our results, only the slope of the curves is twice as great throughout, corresponding to the doubled exponent. From this it follows that Eckersley's and van der Pol's methods of calculation lead to the same results as ours, with the difference that both of them have introduced the actual value of the conductivity instead of ideal conductivity. Through this agreement of the results we are confirmed in the view that the method of a ray treatment of the diffraction problem is quite permissible and would like to submit for consideration that indeed all methods of reflection calculation (including that of Burrows according to Fig. 1 and Fig. 9 of his paper)<sup>4</sup> are based on a ray treatment with good results. A physically clear method on the other hand must proceed from the currents (or field strengths) induced in the ground.<sup>11</sup> Beyond this, however, the treatment of the diffraction problem by Burrows according to Epstein's method also postulates a ray treatment, as follows from Fig. 9 of Burrows paper. True, Burrows speaks of four components, but since according to Epstein only the excitation in the immediate vicinity of the diffracting edge enters into the calculation, these components have the significance of rays; a direct ray ( $T-R$ ), two singly reflected rays ( $T'-R$ ,  $T-R'$ ), and a doubly reflected ray ( $T'-R'$ ). Such an assumption of the ray path is only permissible for very low heights of transmitter and receiver, as Burrows himself mentions in his discussion. For greater heights the reflected rays should no longer be introduced with the same amplitude and we necessarily arrive at a representation of the ray distribution corresponding to our paper, Fig. 2. Such a ray distribution gives no maxima and minima beyond the horizon, which would be in contradiction to all experience obtained in flight experiments. It thus is not correct to use a formula for the field strength beyond the line of sight which, like (12) in the paper of Burrows referred to, contains the sine function.

But Burrows' method even gives far too great values of field strength for quite low receiver heights far below the first maximum, at greater distances; namely, whenever the screening already plays a considerable part.\* An example may serve to illustrate this:

$\lambda = 7$  meters; transmitter height, 30 meters; transmitter power, 7 kilowatts: let there be a directional antenna at the transmitter measuring  $25 \times 25$

<sup>9</sup> Berlin-Adlershof, Germany.

<sup>10</sup> *Jour. I.E.E.* (London), vol. 80, March, (1937).

<sup>11</sup> Cf. Wise, *Bell Sys. Tech. Jour.*, vol. 8, p. 662, (1929), and Niessen, *Ann. der Phys.*, vol. 18, p. 893, (1933).

\* Paper under discussion, p. 359.

meters, provided with a reflector. Height of receiver, only 30 meters; distance, 500 kilometers.

Then from our equation (5) we find the field strength raised by the factor 100 by the directional antenna and we deduce from Fig. 10 and Fig. 17 a field strength

$$\mathcal{E} = 1.1 \mu\text{v}/\text{m}$$

while Burrows' equation (12) gives

$$\mathcal{E} = 16.1 \mu\text{v}/\text{m}.$$

This value appears to be too large by an order of magnitude and is *still* further removed from the values obtained according to Eckersley and van der Pol.

Finally permit us to make one more remark regarding the difference between our curves and the steeper curves of Eckersley and van der Pol. We do not doubt that these two authors, whose method of procedure is different, but whose results agree, have calculated the diffraction relations exactly and correctly. But there exists the remarkable fact that our curves, which agree exactly with the character of Eckersley's curves, despite the lower slope agree very well with the measured values. We believe that this can be explained by the fact that through the effect of refraction in the lower layers of the atmosphere the influence of the finite conductivity of the ground in our idealized calculation is in general just compensated. Thus in the exact diffraction calculation of Eckersley and van der Pol we must yet introduce in suitable fashion a wave-dependent refraction effect in order to depict correctly the actual relationships, and must then arrive at curves which are about the same as those of our approximate method.

In Burrows' last remark that it apparently is not permissible to separate into two factors the contribution of the radiation diagram (effect of antenna height) and the contribution of diffraction (effect of distance), may we counter with the following: It is undoubtedly the more desirable and more elegant solution to find a formula which contains both factors implicitly. We have not found this formula and have therefore resolved on the simpler way of handling the problems separately, and later fitting them together diagrammatically in what seems to us to be a physically clear manner. It is interesting then to find subsequently that Eckersley and van der Pol, who apparently have found an implicit solution, also here again arrive at the same results as we, which is best seen perhaps from a comparison of our Fig. 5 with Eckersley's Fig. 29.



**CONTRIBUTORS TO THIS ISSUE**

**Fritzing, George H.:** Born February 10, 1909, at Bryant, Indiana. Received B. A. degree, Wittenberg College, 1930; B. S. degree in electrical engineering, Purdue University, 1931; M. S. degree in electrical engineering, Massachusetts Institute of Technology, 1932; E. E. degree, Purdue University, 1936. Recipient of Charles A. Coffin Award and Tau Beta Pi Scholarship, 1931. Development engineer, Telediphone department, Thomas A. Edison, Inc., 1933-1937; member of patent department, 1937 to date. Associate member, Sigma Xi, 1931. Nonmember, Institute of Radio Engineers.

**Koomans, N.:** Born December 18, 1879, at Delft, Holland. Engineer Technical Service, Netherlands P.T.T., 1903. Received D.Sc. degree, 1908. Extraordinary member, Dutch States Patent Office, 1918; chief of radio laboratory, Dutch States Telegraph, 1926; engineer-in-chief, 1928; extraordinary professor of electrotechnics, Technische Hoogeschool, Delft; adviser in radio matters, League of Nations; Member of Board, Nederlandsch Radiogenootschap. Nonmember, Institute of Radio Engineers.

**Schade, Otto H.:** Born April 27, 1903, at Schmalkalden, Germany. Graduated, Reform-Real-Gymnasium Halle, Germany, 1922. Telephonfabrik A. G. vorm. J. Berliner, Berlin and Düsseldorf, Germany, 1922-1924; in charge of laboratory in radio manufacturing company "Ratag," Berlin, 1924-1925; engineering department, Atwater Kent Manufacturing Company, 1926-1931; research and engineering department, RCA Manufacturing Company, Inc., RCA Radiotron Division, 1931 to date. Nonmember, Institute of Radio Engineers.

**Scott, H. H.:** Born March 28, 1909, at Somerville, Massachusetts. Received S. B. degree, 1930; S. M. degree, 1931, Massachusetts Institute of Technology. M.I.T.-Bell System co-operative course included terms with Western Electric Company, 1938, New York Telephone Company, 1929, and Bell Telephone Laboratories, 1929-1930. Engineer, General Radio Company, 1931 to date. Associate member, American Institute of Electrical Engineers and Society of Motion Picture Engineers; Member, Acoustical Society of America. Member, Institute of Radio Engineers, 1935.





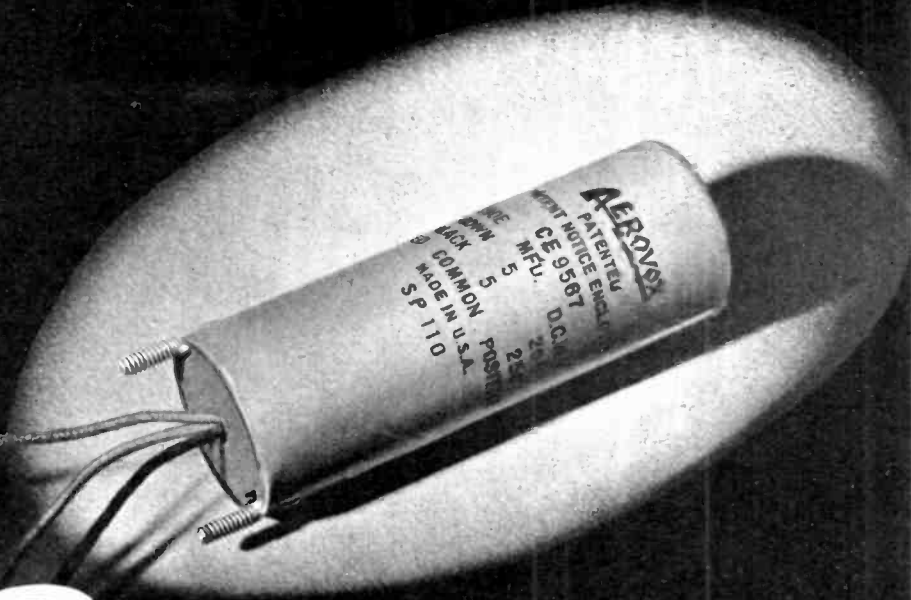

# Submit

## Your Condenser Problem

• A. A. E.—AEROVOX APPLICATION ENGINEERING—costs you nothing. Yet in addition to insuring the RIGHT condenser for your job, it frequently means marked savings in other components for your assembly. • Case histories indicate tens of thousands of dollars saved for manufacturers large and small alike. • So just submit that problem. Our engineers will provide the specifications, samples, quotations.



**AEROVOX CORPORATION**

70 WASHINGTON STREET, BROOKLYN, N. Y.



Sales Offices in All Principal Cities

**“MY TELEPHONE CONNECTS  
WITH 19,000,000\* OTHERS...  
and so does yours”**



You buy contacts with many people when you buy Bell Telephone service. Your own particular telephone can be connected to practically any other telephone in the United States and to 93% of all the telephones in the whole world. You can use as much or as little of this service as you want, any time and at low cost.

## **BELL TELEPHONE SYSTEM**

\*The figure 19,000,000 is for the United States only. The total becomes 35,000,000 when you add Bell System overseas telephone connections.



*When writing to advertisers mention of the PROCEEDINGS will be mutually helpful.*

# TURN TUBE IN ANY DIRECTION FOR DIRECT WORKING VIEW

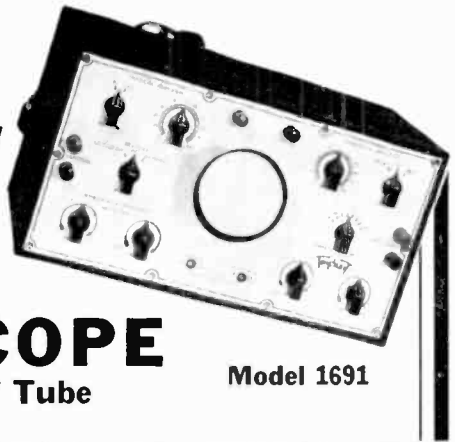

## WITH THIS **OSCILLOSCOPE** Now Available with 3" Tube

Model 1691

- Exclusive Turret Type Tube Mounting for Adjusting Screen to Any Angle for Direct View . . .
- Extremely Brilliant Pattern
- Linear Sweep 15 to 20,000 Cycles
- 2" or 3" Cathode Ray Tube

*Model 1690, with 2"  
Cathode Ray Tube—  
Dealer Price . . . . . \$47.00*

*Model 1691, with 3"  
Cathode Ray Tube—  
Dealer Price . . . . . \$62.50  
(In Metal Case)*

***Meets Every Requirement of Servicing Engineers For  
Visual Study and Adjustment of Radio Receiver Cir-  
cuit Problems***

### ADVANTAGES

This new Triplet Oscilloscope is complete. In addition to radio servicing, it has invaluable applications in radio transmitter, sound equipment, industrial and educational fields.

The cathode ray tube with exclusive Triplet turret type mounting can be moved up or down or to either side for adjustment of the screen to an angle always in direct alignment with the user's line of vision. Adjustable shield can be pulled out to project beyond the screen for easy reading in brightest daylight on Model 1690. (Model 1691 has snap-on shield.)

The Oscilloscope incorporates separately controlled resistance coupled vertical and horizontal amplifiers. Vertical and horizontal plates can be either direct coupled with amplitude control, or through amplifiers with amplitude control. Can be used with any type frequency modulated Signal Generator. 60 Cycle A.C. operated.

Linear sweep from 15 to 20,000 cycles. Sweep (either internal, external or 60 cycle) may be used through amplifier or direct with amplitude control. Positive lock. All controls on panel. No interactional controls.

Model 1690 also is available in black leatherette carrying case with removable cover. Dealer net price—\$51.00.

### A TRIPLETT DELUXE MODEL

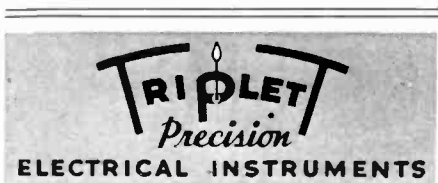

The Triplet Elec. Instrument Co.  
212 Harmon Dr., Bluffton, Ohio

Please send me Catalog New Triplet DeLuxo Line.

Name .....

Address .....

City ..... State .....

*When writing to advertisers mention of the PROCEEDINGS will be mutually helpful.*

# Resistance

to heat . . . cold . . . and the ceaseless humidity of the tropics . . . these are the problems that confront set builders. In its particular field CENTRALAB answers this problem of resistance with a Fixed Resistor whose characteristics are so constant that they oft times form the standard by which all others are judged.

Which is why so many set builders and service men turn to CENTRALAB for the satisfactory answer.



Centralab Resistors are a solid rod, hard as stone throughout, and not just a delicate resistor placed in a tube. That is why Centralab resistors will carry loads of many times their rating without damage.



By the patented Centralab process only the central portion of the ceramic is conducting. Externally the resistors are fully insulated.



- TYPE 510 rating  $\frac{1}{2}$  watt  
size  $\frac{1}{8}$  x  $\frac{5}{8}$
- TYPE 514 rating 1 watt  
size  $\frac{1}{4}$  x 1"
- TYPE 516 rating  $1\frac{1}{2}$  watt  
size  $\frac{1}{4}$  x  $1\frac{1}{4}$
- TYPE 710 rating  $\frac{1}{2}$  watt  
size  $\frac{1}{8}$  x  $\frac{5}{8}$

DIVISION OF GLOBE UNION, INC.  
MILWAUKEE, WISCONSIN

# Centralab

*When writing to advertisers mention of the PROCEEDINGS will be mutually helpful.*

# The Institute of Radio Engineers

Incorporated

330 West 42nd Street, New York, N.Y.

## APPLICATION FOR ASSOCIATE MEMBERSHIP

(Application forms for other grades of membership are obtainable from the Institute)

To the Board of Directors

Gentlemen:

I hereby make application for Associate membership in the Institute of Radio Engineers on the basis of my training and professional experience given herewith, and refer to the members named below who are personally familiar with my work.

I certify that the statements made in the record of my training and professional experience are correct, and agree if elected, that I will be governed by the constitution of the Institute as long as I continue a member. Furthermore I agree to promote the objects of the Institute so far as shall be in my power, and if my membership shall be discontinued will return my membership badge.

.....  
(Sign with pen)

.....  
(Address for mail)

.....  
(Date)

.....  
(City and State)

### Sponsors:

(Signature of references not required here)

Mr. .... Mr. ....

Address ..... Address .....

City and State ..... City and State .....

Mr. ....

Address .....

City and State .....

The following extracts from the Constitution govern applications for admission to the Institute in the Associate grade:

#### ARTICLE II—MEMBERSHIP

Sec. 1: The membership of the Institute shall consist of: \* \* \* (c) Associates, who shall be entitled to all the rights and privileges of the Institute except the right to hold any elective office specified in Article V. \* \* \*

Sec. 4. An Associate shall be not less than twenty-one years of age and shall be a person who is interested in and connected with the study or application of radio science or the radio arts.

#### ARTICLE III—ADMISSION AND EXPULSIONS

Sec. 2: \* \* \* Applicants shall give references to members of the Institute as follows: \* \* \* for the grade of Associate, to three Fellows, Members, or Associates; \* \* \* Each application for admission \* \* \* shall embody a full record of the general technical education of the applicant and of his professional career.

#### ARTICLE IV—ENTRANCE FEE AND DUES

Sec. 1: \* \* \* Entrance fee for the Associate grade of membership is \$3.00 and annual dues are \$6.00.

**ENTRANCE FEE SHOULD ACCOMPANY APPLICATION**



# MEASURE DISTORTION ... FIDELITY

**THIS FAST ... EASY WAY !**

Now you can make measurements faster, easier and more accurately! New RCA measuring equipment makes it possible.

This equipment consists of the two instruments shown on this page. With it, complete operating characteristics of amplifiers or transmitters can be accurately determined. Direct measurements of distortion percentage, noise level and frequency characteristics of equipment at frequencies in audible range can also

be made swiftly and easily. Routine fidelity checks are made in short order. Broadcast stations can maintain consistent high fidelity performance.

Proof of the quality and usefulness RCA has built into this equipment is shown by these fine features: AC operated...small, compact...rack or cabinet mounting...covers entire audio frequency band...easy adjustment, direct indication, calculations and critical adjustments unnecessary. Full technical data on request.

RCA type 68A Beat Frequency Oscillator. Specifications: Frequency Response: Is flat within plus or minus 1 db. over the range between 20 and 17,000 cycles. Instrument may be operated down to 5 cycles per second with good wave form. Output power: Maximum 120 mw. Output Impedances: 5,000, 500 and 250 ohms. Distortion: Total arithmetic sum below 100 cycles, 0.3%—Above 100 cycles, 0.2% at 12½ mw. output. Hum (zero level output): Minus 60 db. Power supply: 110-120 volts. 25-60 cycles, 70 watts.



RCA type 69A Noise and Distortion Meter. Specifications: Frequency Range for Distortion Measurements: 50 to 7,000 cycles. Distortion Measurement Range: Full scale, 1% to 100%. Minimum reading .3 of 1%. Minimum Hum Measurements: 88 db. below a 12.5 mw. level on a 500 ohm line or below 100% modulation. Includes R.F. rectifier for transmitter measurements. Audio Input Impedance: 20,000 ohms bridging input balanced to ground and 250,000 ohms unbalanced to ground.



*Broadcast Equipment*

RCA Mfg. Co., Inc., Camden, N. J. • A Service of the Radio Corporation of America

New York: 1270 Sixth Ave.  
Dallas: 2211 Commerce St.

Chicago: 589 E. Illinois St.  
San Francisco: 170 Ninth St.

Atlanta: 490 Peachtree St., N.E.  
1016 N. Sycamore Ave., Hollywood

*When writing to advertisers mention of the PROCEEDINGS will be mutually helpful.*

# INSTITUTE SUPPLIES

## EMBLEMS



Three styles of emblems are available to members of the Institute only. They are all of 14K gold with gold lettering on an enameled background, the color of which indicates the grade of membership. The approximate size of each emblem is as illustrated.



The lapel button is supplied with a screw back having jaws which fasten it securely to the coat. The price is \$2.75, postpaid, for any grade.

The pin which is provided with a safety catch may be obtained for any grade for \$3.00, postpaid.



The watch charm is handsomely finished on both sides and is equipped with a suspension ring for attaching to a watch chain or fob. Price for any grade, \$5.00, postpaid.

## BINDERS

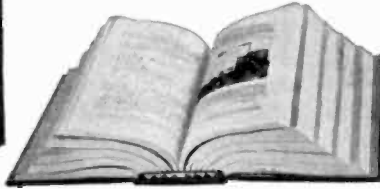

Binders are available for those who desire to protect their copies of the PROCEEDINGS with stiff covers. Each binder will accommodate the twelve monthly issues published during the year. These binders are of blue Spanish Grain Fabricoid with gold

lettering, and will serve either as temporary transfers or as permanent binders. They are so constructed that each individual copy of the

PROCEEDINGS will lie flat when the pages are turned. Copies can be removed from the binder in a few seconds and are not damaged by their insertion. They are priced at \$1.50 each, and the member's name or PROCEEDINGS Volume Number will be stamped upon the binder in gold for \$0.50 additional.

## BACK ISSUES OF THE PROCEEDINGS

Complete volumes of back issues of the PROCEEDINGS are available in unbound form for the years 1918, 1921, 1922, 1923, and 1926 at \$6.75 per year (six issues) to members. Also complete unbound for 1931, 1932, 1933, 1934, and 1935 at \$7.50 per year to members. A list of the available miscellaneous copies published from 1913 on may be obtained from the Secretary. Single copies published prior to 1927 are sold to members at \$1.13 each, and those issued during and after 1927 are \$0.75 each. Foreign postage on single copies is \$0.10 per copy, making \$0.60 on unbound volumes before 1927.

Issues bound in blue buckram for 1922 (six numbers) are available at \$8.75 to members. For 1930 and 1931 they are priced at \$9.50 each to members. Foreign postage is \$1.00 additional per volume. Volumes for 1922 and 1926 bound in Morocco leather are available at \$10.25 each to members.

## TWENTY-EIGHT-YEAR INDEX

An Index of the PROCEEDINGS for the years 1909-1936, inclusive, is available at \$1.00 per copy. It is extensively cross indexed. The earlier references are to the PROCEEDINGS of the Wireless Institute; the PROCEEDINGS of the Institute of Radio Engineers has been published since 1913.

When ordering any of the above, send remittance with order to the Secretary, Institute of Radio Engineers, 330 West 42nd Street, New York City.

*When writing to advertisers mention of the PROCEEDINGS will be mutually helpful.*



# L-R-C COMPONENTS THAT SQUARE WITH YOUR MOST EXACTING DESIGN REQUIREMENTS

—MORRILL—



• H-F IRON CORES—Circuit Q of 360 at 1000 kc  
Available in a variety of standard shapes for R-F transformers.

SHELL-TYPE CORE  
for shell-type R-F transformers.  
Semi-closed type also available.



TRIMMING PIN

CROSS-TYPE CORE  
with partitioned coil  
form for 1- or 3-section  
windings.



## PRECISION CARBONIZED RESISTORS OF HIGHEST STABILITY IN STANDARD AND ULTRASHORT-WAVE TYPES

The conducting element is a machined film of chemically pure carbon on a ceramic base. Unexcelled for use in television, high-grade audio amplifiers, meter multipliers and other calibrated and precision circuits. Capacitance less than 1  $\mu\mu\text{f}$ . Minimum inductance. Available in ultra-high-resistance values—up to 10,000 megohms. Moisture proof.



For frequencies greater than 10 Mc ask for our Special H-F Resistors.

### • PAPER CONDENSERS

Widely used where small size and absolute reliability are essential. Exceptionally high insulation resistance.

Also available in Cased, Un-cased, and Tropical types.



GLASS TUBULAR

ENGINEERS—Write for technical data and specifications

## MORRILL AND MORRILL

30 Church Street, New York, N.Y.

Used Where Quality Counts



*When writing to advertisers mention of the PROCEEDINGS will be mutually helpful.*

## ENGINEERING DIRECTORY

### QUARTZ CRYSTALS

for Standard or Special  
Radio Frequency Applications

*Write for Catalog*

**BLILEY ELECTRIC CO.**  
230 Union Station Bldg.  
ERIE, PENNA.

### Cathode Ray Tubes and Associated Equipment For All Purposes

*Write for Complete  
Technical Data*

**ALLEN B. DUMONT  
LABORATORIES**  
UPPER MONTCLAIR, N.J.

### PRACTICAL RADIO ENGINEERING

One year Residence Course  
Advanced Home Study Course  
Combined Home Study-Residence  
Course

*Write for details*

**Capitol Radio Engineering  
Institute**  
Washington, D.C.

### "Q"—Measurements

We specialize in equipment for  
the radio frequency measurement  
of "Q" (X/R) of coils, condens-  
ers and other radio components.

*Write for Circular*

**BOONTON RADIO CORPORATION**  
BOONTON, NEW JERSEY

## ALPHABETICAL INDEX TO ADVERTISEMENTS

A	
Aerovox Corporation .....	IX
American Telephone & Telegraph Co. ....	X
C	
Central Radio Laboratories .....	XII
Cornell-Dubilier Electric Corp. ....	XX
G	
General Radio Company .....	Cover IV
M	
Morrill and Morrill .....	XVII
R	
RCA Manufacturing Company, Inc. ....	XV
T	
Triplett Electrical Instrument Co. ....	XI

*When writing to advertisers mention of the PROCEEDINGS will be mutually helpful.*

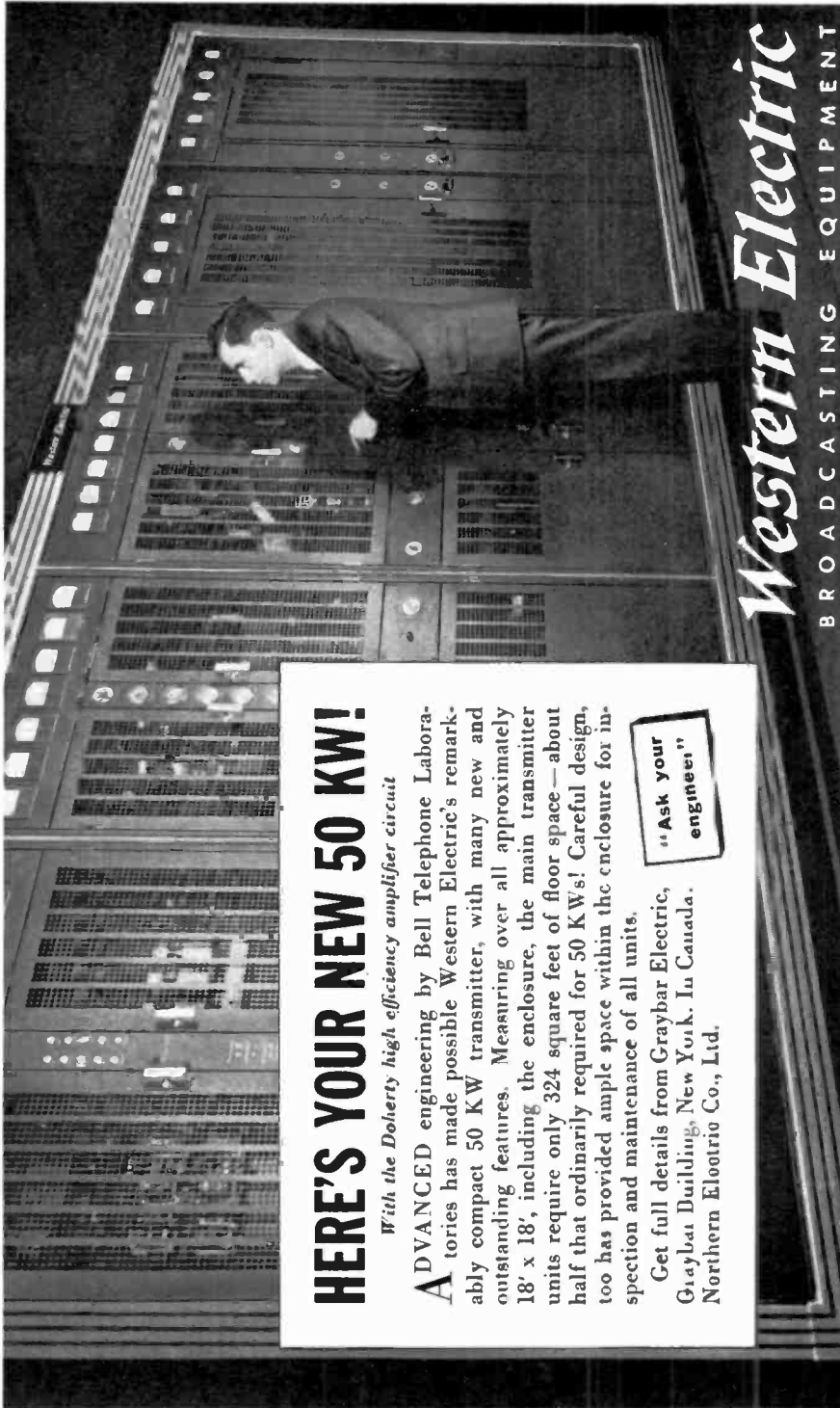

## HERE'S YOUR NEW 50 KW!

*With the Doherty high efficiency amplifier circuit*

**A**DVANCED engineering by Bell Telephone Laboratories has made possible Western Electric's remarkably compact 50 KW transmitter, with many new and outstanding features. Measuring over all approximately 18' x 18', including the enclosure, the main transmitter units require only 324 square feet of floor space—about half that ordinarily required for 50 KW's! Careful design, too has provided ample space within the enclosure for inspection and maintenance of all units.

Get full details from Graybar Electric, Gaybat Building, New York, In Canada, Northern Electric Co., Ltd.

**"Ask your engineers!"**

# Western Electric

BROADCASTING EQUIPMENT

*When writing to advertisers mention of the PROCEEDINGS will be mutually helpful.*

# 26 YEARS AGO THIS APRIL



**Wireless Equipment Revolutionised.**

Over a year ago we began supplying our Condensers for Wireless Work. We have now supplied a large number for voltages up to 30,000. They have been tested to very severe tests, and we are receiving repeat orders from British, American, French, German, and from other large users in all parts of the world.

We claim, and tests have proved, that this class of condensers are more efficient than any others, that they take up not more than **one-tenth of the space** and are about **one-tenth the weight** of other condensers. This is arranged for portability, and they are practically unbreakable. They are also able to stand the discharge or leakage that is necessary in a wireless set, and are so constructed as to prevent the possibility of arcing. The capacity of our condensers is increased by the introduction of a special dielectric material.

**The Sending Radius is Greatly Increased.**

SEND YOUR ENQUIRIES. All Condensers Guaranteed and are returnable if they do not give entire satisfaction.

**THE DUBILIER ELECTRIC CORPORATION**

New York World - 1912

**A**s long ago as the year the Titanic went down, the name of Dubilier was known over land and sea to the corners of the earth. 'Dubilier' meant good condensers in 1912, dependable, guaranteed.

Great new ships have replaced the lost Titanic and luxury liners fly over the waters. New names, new records. Yet in all this forward surge of progress, Cornell-Dubilier keeps step. In 1938 as in 1912, engineers rely on C-D's—the name for good condensers.

Complete Catalog on Request

**WORLD'S LARGEST AND OLDEST EXCLUSIVE MANUFACTURER OF CAPACITORS**

**CORNELL  DUBILIER ELECTRIC CORPORATION**

1012 Hamilton Blvd., So. Plainfield, N. J.

Cable Address: CORDU



TODAY IT IS TYPE TJ-U  
DYKANOL FILTER CAPACITORS FOR MODERN TRANSMITTING

# I·R·E CONVENTION AND EXHIBITION



Courtesy of Cosmo-Billeo Co.

JUNE 1938

SUN.	MON.	TUE.	WED.	THU.	FRI.	SAT.
FIRST OR 4TH	FULL MOON 12TH	LAST OR 20TH	1	2	3	4
5	6	7	8	9	10	11
12	13	14	15	16	17	18
19	20	21	22	23	24	25
26	27	28	29	30	NEW MOON 27TH	..

## New York

This is the first call to the 1938 Convention. If you are one of the 1000 engineers who attended last year, you know the value of the 3-day technical program, the industrial-radio trips, and the display of new materials, components, and instruments put on by 35 leading manufacturers. No matter where in radio or allied engineering your vital interests lie, the 1938 Convention will be valuable to you. Plan now to attend.

Address correspondence about technical papers and exhibition space to

See the June  
**PRE-CONVENTION  
ISSUE**

of the Proceedings  
for all details . . .

Your June Proceedings, in the mails June 5, will carry the complete convention story: Technical Program and summaries of papers, Trips, Ladies Program, and the Exhibition Directory.



**INSTITUTE OF RADIO ENGINEERS**  
330 WEST 42ND STREET, NEW YORK, N. Y.



## HERE'S HOW

### The Studio and the Transmitter Can Agree

WITH the new G-R Type 686-A Volume Indicator the studio control engineer and the engineer at the transmitter see the same thing . . . *how much the transmitter is being modulated.*

The Volume Indicator and the modulation monitor at the transmitter indicate the same levels. Peaks can be checked between the studio and the transmitter with great accuracy.

With this newest G-R broadcast instrument you are *sure* that the program output of the studio agrees with the program put on the air at the output of the transmitter.

These are a few of the many reasons why the new G-R Volume Indicator is one of the most useful pieces of broadcast station equipment General Radio has manufactured.

Price: \$195.00

*Write for Bulletin 232 for information*

**GENERAL RADIO COMPANY**  
**CAMBRIDGE, MASSACHUSETTS**

**Los Angeles**

**New York**