

TOTM ✓

VOLUME 25, NUMBER 3
IN TWO PARTS

MARCH, 1937
PART 1

286 - Electron Music

340 - IF Transformer Design

PROCEEDINGS
of
**The Institute of Radio
Engineers**



**Silver
Anniversary Convention**
May 10, 11, and 12, 1937
New York, N. Y.

Application Blank for Associate Membership on Page XI

Institute of Radio Engineers Forthcoming Meetings

SILVER ANNIVERSARY CONVENTION

May 10, 11, and 12, 1937
New York, N. Y.

JOINT MEETING

American Section, International Scientific Radio Union
and Institute of Radio Engineers

Washington, D. C.
April 30, 1937

CLEVELAND SECTION

March 25, 1937

DETROIT SECTION

March 19, 1937

LOS ANGELES SECTION

March 16, 1937

NEW YORK MEETING

March 3, 1937
April 7, 1937

PHILADELPHIA SECTION

March 4, 1937
April 1, 1937

WASHINGTON SECTION

March 8, 1937

PROCEEDINGS OF

The Institute of Radio Engineers

VOLUME 25

March, 1937

NUMBER 3, PART 1

Board of Editors

ALFRED N. GOLDSMITH, *Chairman*

R. R. BATCHER

K. S. VAN DYKE

H. H. BEVERAGE

H. P. WESTMAN, *ex officio*

F. W. GROVER

L. P. WHEELER

J. W. HORTON

L. E. WHITEMORE

G. W. PICKARD

WILLIAM WILSON

CONTENTS

PART I

Institute News and Radio Notes.....	275
February Meeting of the Board of Directors.....	275
Joint Meeting of the U.R.S.I. and I.R.E.....	275
Radio Emissions of Standard Frequency.....	276
Institute Meetings.....	276
Personal Mention.....	288

PART II

Technical Papers

Automatic Tuning, Simplified Circuits, and Design Practice.....	
..... D. E. FOSTER AND S. W. SEELEY	289
Simultaneous Radio Range and Telephone Transmission.....	
..... W. E. JACKSON AND D. M. STUART	314
Frequency Errors in Radio-Frequency Ammeters.....	
..... J. D. WALLACE AND A. H. MOORE	327
A Graphical Design of an Intermediate-Frequency Transformer with Variable Selectivity.....	
..... CYRIL BARANOVSKY AND ARTHUR JENKINS	340
Ultra-Short-Wave Propagation Along the Curved Earth's Surface.....	
..... PAUL VON HANDEL AND WOLFGANG PFISTER	346
Book Reviews: "Electronics and Electron Tubes," by E. D. McArthur	
..... B. E. SHACKELFORD	364
"Handbook of Engineering Fundamentals," by Ovid W. Eshbach...	
..... H. M. TURNER	364
"An Hour a Day with Rider on Automatic Volume Control," by John F. Rider.....	
..... ALBERT R. HODGES	365
Booklets, Catalogs, and Pamphlets Received.....	366
Contributors to This Issue.....	368

The Institute of Radio Engineers

GENERAL INFORMATION

INSTITUTE. The Institute of Radio Engineers was formed in 1912 through the amalgamation of the Society of Wireless Telegraph Engineers and the Wireless Institute. Its headquarters were established in New York City and the membership has grown from less than fifty members at the start to several thousand.

AIMS AND OBJECTS. The Institute functions solely to advance the theory and practice of radio and allied branches of engineering and of the related arts and sciences, their application to human needs, and the maintenance of a high professional standing among its members. Among the methods of accomplishing this is the publication of papers, discussions, and communications of interest to the membership.

PROCEEDINGS. The PROCEEDINGS is the official publication of the Institute and in it are published all of the papers, discussions, and communications received from the membership which are accepted for publication by the Board of Editors. Copies are sent without additional charge to all members of the Institute. The subscription price to nonmembers is \$10.00 per year, with an additional charge for postage where such is necessary.

RESPONSIBILITY. It is understood that the statements and opinions given in the PROCEEDINGS are views of the individual members to whom they are credited, and are not binding on the membership of the Institute as a whole. Papers submitted to the Institute for publication shall be regarded as no longer confidential.

REPRINTING PROCEEDINGS MATERIAL. The right to reprint portions or abstracts of the papers, discussions, or editorial notes in the PROCEEDINGS is granted on the express condition that specific reference shall be made to the source of such material. Diagrams and photographs published in the PROCEEDINGS may not be reproduced without making specific arrangements with the Institute through the Secretary.

MANUSCRIPTS. All manuscripts should be addressed to the Institute of Radio Engineers, 330 West 42nd Street, New York City. They will be examined by the Papers Committee and the Board of Editors to determine their suitability for publication in the PROCEEDINGS. Authors are advised as promptly as possible of the action taken, usually within two or three months. Manuscripts and illustrations will be destroyed immediately after publication of the paper unless the author requests their return. Information on the mechanical form in which manuscripts should be prepared may be obtained by addressing the secretary.

MAILING. Entered as second-class matter at the post office at Menasha, Wisconsin. Acceptance for mailing at special rate of postage is provided for in the act of February 23, 1925, embodied in Paragraph 4, Section 412, P. L. and R., and authorization was granted on October 26, 1927.

Published monthly by

THE INSTITUTE OF RADIO ENGINEERS, INC.

Publication office, 450-454 Ahnaip St., Menasha, Wis.

BUSINESS, EDITORIAL, AND ADVERTISING OFFICES

Harold P. Westman, *Secretary*

330 West 42nd Street, New York, N. Y.

INSTITUTE SECTIONS

- ATLANTA—Chairman, N. B. Fowler; Secretary, G. S. Turner, Federal Communications Commission, 411 Federal Annex, Atlanta, Ga.
- BOSTON—Chairman, E. L. Bowles; Secretary, Roland G. Porter, Northeastern University, Boston, Mass.
- BUFFALO-NIAGARA—Chairman, George C. Crom; Secretary, E. C. Waud, 235 Huntington Ave., Buffalo, N. Y.
- CHICAGO—Chairman, J. K. Johnson; Secretary, V. J. Andrew, 7221 San Francisco Ave., Chicago, Ill.
- CINCINNATI—Chairman, G. F. Platts; Secretary, A. P. Richards, Crosley Radio Corporation, 1329 Arlington St., Cincinnati, Ohio.
- CLEVELAND—Chairman, R. A. Fox; Secretary, R. L. Kline, 132 Normal Ave., Kent, Ohio.
- CONNECTICUT VALLEY—Chairman, F. H. Scheer; Secretary, R. H. Freck, 39 Eldridge St., Springfield, Mass.
- DETROIT—Chairman, R. L. Davis; Secretary, Howard S. Gould, 214 Tuxedo Ave., Detroit, Mich.
- EMPORIUM—Chairman, M. I. Kahl; Secretary, R. N. Palmer, Hygrade Sylvania Corporation, Emporium, Pa.
- INDIANAPOLIS—Temporary Secretary-Treasurer, I. M. Slater, P. R. Mallory and Company, 3029 E. Washington St., Indianapolis, Ind.
- LOS ANGELES—Chairman, Douglas Kennedy; Secretary, F. G. Albin, United Artists Studios, 1041 N. Formosa Ave., Los Angeles, Calif.
- MONTREAL—Chairman, A. M. Patience; W. R. Wilson, Canadian Marconi Company, Mount Royal, Que., Canada.
- NEW ORLEANS—Chairman, L. J. N. Du Treil; Secretary, G. H. Peirce, Electrical Research Products, Inc., 1631 Canal Band Bldg., New Orleans, La.
- PHILADELPHIA—Chairman, Irving V. Hoff; Secretary, R. L. Snyder, 103 Franklin Rd., Glassboro, N. J.
- PITTSBURGH—Chairman, Branko Lazich; Secretary, W. P. Place, Curtis St., R.D. 1, Wilksburg, Pa.
- ROCHESTER—Chairman, Lee A. Du Bridge; Secretary, H. A. Brown, 89 East Ave., Rochester, N. Y.
- SAN FRANCISCO—Chairman, V. J. Freiermuth; Secretary, C. J. Penther, 1000 Aileen St., Oakland, Calif.
- SEATTLE—Chairman, J. W. Wallace; Secretary, R. O. Bach, Pacific Telephone and Telegraph Company, 820 Fairview Ave., N., Seattle, Wash.
- TORONTO—Chairman, B. de F. Bayly; Secretary, H. P. Knap, Stromberg-Carlson Tel. Mfg. Company, 211 Geary St., Toronto, Ont., Canada.
- WASHINGTON—Chairman, W. B. Burgess; Secretary, E. H. Rietzke, 3308 14th Ave., N. W., Washington, D. C.

GEOGRAPHICAL LOCATION OF MEMBERS ELECTED
FEBRUARY 3, 1937

Elected to the Associate Grade

Arizona	Tempe, 16 E. 8th St.....	Hoisington, D. W.
District of Columbia	Washington, 2906 Nichols Ave. S.E.....	Fricks, R. E.
Illinois	Chicago, 1637 Balmoral Ave.....	Jorgensen, C. M.
	Palatine, 36 E. Wilson St.....	Anderson, A. A.
Indiana	Indianapolis, 1402 N. Alabama.....	Hylton, W. M.
	Indianapolis, 3239 Boulevard Pl.....	Johnson, S. E.
	Indianapolis, 3036 Boulevard Pl.....	Kiser, J. L.
	Indianapolis, 401 E. 37th St.....	Lawrence, L. E.
	Indianapolis, 2446 N. New Jersey St.....	Thompson, R. T.
	Indianapolis, 3715 E. Walnut St.....	Vollmer, A. C.
	Indianapolis, 54 N. Gladstone Ave.....	Wilson, G. G.
Kentucky	Covington, 620 Madison Ave.....	Lee, W. M.
Massachusetts	Cambridge, Mass. Inst. of Technology.....	Nottingham, W. B.
	Cheshire, Richmond St.....	Leonard, S. C.
Michigan	Lansing, 600 S. Walnut St.....	Kachelski, C. W.
New Mexico	State College.....	Wolfe, C. M.
New York	Astoria, 3235-30th St.....	Puntin, E. J.
	Beechhurst, 166-41-17th Ave.....	Hergenrother, R. C.
	Jamaica, 8520 Parsons Blvd.....	Goldan, T. J.
	New York, 510 W. 124th St.....	Bradley, R. A.
	New York, 604 E. 141st St.....	Fesnick, J. H.
	Watervliet, 1523-3rd Ave.....	Edinger, J. R.
Ohio	Cleveland, USS Tahoma, CG.....	Hartnett, J. L.
Pennsylvania	Emporium, 235 E. 5th St.....	Zwald, J. J.
Virginia	Quantico, First Signal Co., U.S.M.C.....	Bogert, C. E.
Brazil	Sao Paulo Ave., Turmalina 51.....	Barbosa, H.
Canada	Montreal, P. Q., 1261 Shearer St.....	Acton, H. J.
	Montreal, P. Q., 4661 Park Ave.....	Burman, I.
	Montreal, P. Q., 20 Grenville Ave.....	Clerk, R. D.
	Montreal, P. Q., 1455 Drummond St.....	Dale, M.
	Montreal, P. Q., 2272 Bercy St.....	Dunski, F.
	Montreal, P. Q., 4644 St. Urbain St.....	Garon, J. C.
	Montreal, P. Q., 2006 Marlowe Ave.....	George, F. W.
	Montreal, P. Q., 2001 Marlowe Ave.....	Johnson, R. E. L.
	Montreal, P. Q., 4609 City Hall Ave.....	Kahne, L.
	Montreal, P. Q., Macdonald Physics Lab., McGill Univ.....	Keys, D. A.
	Montreal, P. Q., 5139 St. Urbain St.....	Klein, H.
	Montreal, P. Q., 418 Claremont Ave.....	McMurray, J. L.
	Montreal, P. Q., 87 Ontario St. W.....	McNeil, B. T.
	Montreal, P. Q., 2622 Rozel St.....	Poeschl, F.
	Montreal, P. Q., 1261 Shearer St.....	Punchard, J. C. R.
	Montreal, P. Q., 1261 Shearer St.....	Robinson, H. A.
	Montreal, P. Q., 4632 Esplanade Ave.....	Rolbin, M.
	Montreal, P. Q., 336 Grosvenor.....	Rosengarten, G. J.
	Montreal, P. Q., 1261 Shearer St.....	Sarault, G. E.
	Montreal, P. Q., 4982 Queen Mary Rd.....	Smyth, H. R.
	Montreal, P. Q., 2376 Melrose Ave.....	Stephenson, W. H.
	Montreal, P. Q., 1261 Shearer St.....	Tiedemann, D. P.
	Montreal, P. Q., 5876 Somerled Ave.....	Wright, N. N.
	Pointe Claire, P. Q., 15 Julien Ave.....	Stewart, D.
	Quebec, P. Q., 174 Aberdeen St.....	Lariviere, A.
	St. Lambert, P. Q., 276 Sanford Ave.....	Roach, C. L.
	Verdun, P. Q., 358 Egan Ave.....	Lawruk, A.
	Verdun, P. Q., 823 Godin Ave.....	Mitchell, J. C. E.
	Westmount, P. Q., 465 Lansdowne Ave.....	Carlisle, J.
	Westmount, P. Q., 367 Metcalfe Ave.....	Ross, W. B.
	Westmount, P. Q., 4334 Westmount Ave.....	Stadler, J. C.
Canal Zone	France Field, Box 87.....	Reed, R. G.
China	Hong Kong, P. O. Box 1312.....	Lau, J.
England	London N.W.6, 37 Calcott Rd.....	Smith, B. W.
	London N.19, 22 St. Johns Park.....	Smith, C.
	Portishead, Bristol, 2 Hope Bldgs., High St.....	Middleton, K. M.
	Surbiton, Surrey, Weston Elec. Instrument Co. Ltd., Kingston By-Pass.....	Story, F. G.
	Wilmslow, Man., "Ramble," Cambridge Ave.....	Davies, E. W.
France	Boulogne-sur-Seine, (Seine), 120 rue du Chateau.....	Langlois, A. H.
Ireland	Dundalk, Co. Louth, 8 Wynne's Terrace.....	Mulhern, G. M.
Italy	Milano, Via G. Cimabue No. 11.....	Pinciroli, A.
Japan	Osaka-fu, Senri-Hososhio JOBK, Senri-mura, Mishima-gun.....	Sawamura, E.
South Africa	Johannesburg, 6 Walmer Ct., Bok St.....	Myers, C.
Venezuela	Maracaibo, Aptdo. 234.....	Whitmore, J. A.

Geographical Location of Members Elected

Elected to the Student Grade

California	Berkeley, 2315 College Ave.....	Gill, G. H.
	Berkeley, 161 York Ave.....	McCoy, M. H.
Indiana	Berkeley, 2634 Haste St.....	Sachs, H.
	Fort Wayne, 319 E. Jefferson St.....	Trimble, C. B.
	West Lafayette, 40 N. Salisbury St.....	Giffin, K. A.
	West Lafayette, 222 Marsteller St.....	Levy, G. F.
Kansas	Manhattan, 1026 Kearney St.....	Morgan, A. H.
Massachusetts	Cambridge, 360 Harvard St.....	Natapoff, G.
Michigan	Detroit, 9345 Richter St.....	Lundstedt, C. V.
Minnesota	Minneapolis, 3917 Bryant Ave. S.....	Neuman, R. E.
Nebraska	Lincoln, 1823 N. 32nd St.....	Pentico, G. W. A.
New York	Troy, 197 Hoosick St.....	Harris, H.
	Cincinnati, Memorial Dormitory, Univ. of Cincinnati.....	Baumzweiger, B.
Ohio	New Washington, R.F.D. 1.....	Schimpf, L. G.
	Philadelphia, 1320 S. 5th St.....	Bennon, S.
Pennsylvania	London S.E.13, 355 Hither Green Lane, Lewisham.....	Parsons, L. W.
England		



APPLICATIONS FOR MEMBERSHIP

Applications for transfer or election to the various grades of membership have been received from the persons listed below, and have been approved by the Admissions Committee. Members objecting to transfer or election of any of these applicants should communicate with the Secretary on or before March 31, 1937. These applications will be considered by the Board of Directors at its meeting on April 7, 1937.

For Election to the Associate Grade

Delaware	Wilmington, National Vulcanized Fibre Co.....	Otis, J. O.
District of Columbia	Bellevue, U. S. Naval Research Lab.....	Williams, C. L.
	Washington, 621 Alabama Ave., S.E.....	Bolen, F.
Illinois	Chicago, 309 S. Clark St.....	Gootee, T. E.
	Chicago, Northmere Hotel, 4943 Kenmore Ave.....	Haubrich, A. M.
Minnesota	Redwood Falls.....	Winter, H.
New Jersey	Arlington, 61 Clinton Ave.....	Richardson, H. M.
	East Orange, 96 N. Walnut St.....	Barnes, G. W.
	Fort Monmouth, 15th Signal Service Co.....	Lyon, A. C.
	Jersey City, 260 Jewett Ave.....	Dalton, J. L.
	Linden, 1200 Roselle St.....	Wilner, J. T.
	Newark, 27 Pomona Ave.....	Finklestein, S. B.
	Princeton, Palmer Physics Labs.....	Harnwell, G. P.
New York	Brooklyn, 55 Hanson Pl.....	Rettenmeyer, R. D.
	New York, 74 Trinity Pl.....	Ellis, F. C.
	New York, Sonotone Corp., 19 W. 44th St.....	Pearson, H. A.
Ohio	Stapleton, S. I., U.S.S. Champlain C.G., Pier 18.....	Little, W. A.
	Cincinnati, 1410 Yarmouth Ave.....	Etter, C. W.
	Cincinnati, 5630 Ridge Ave.....	Hackman, E.
Oklahoma	Enid, Box 298.....	Clopton, A. B.
Pennsylvania	Edgewood, 207 Elm St.....	Pickels, G. W.
	Emporium, 7 E. 4th St.....	Kiser, N. L.
	Emporium, 210 W. Allegany Ave.....	Sassaman, P. H.
	Williamsport, 340 W. 4th St.....	Phipps, G. A.
Belgium	Liege, 3 Rue de Chaudfontaine.....	Bielefeldt, H.
Canada	Montreal, P.Q., 377 Fairmount Ave. W.....	Hammond, J. W.
	Montreal, P.Q., 3837 St. Denis St.....	Henry, M.
	Montreal, P.Q., Engineering Bldg., McGill Univ.....	Howes, F. S.
	Montreal, P.Q., 1261 Shearer St.....	Hunt, A. B.
	Nipigon, Ont.....	Slater, E. W.
	Prince George, B. C.....	McLean, L. D.
Canal Zone	Pedro Miguel, Box 236.....	Shaw, N. N.
Colombia	Bogota, Apartado 1266.....	Amore, I.
	Bogota, c/o Ministerio De Correos y Telegrafos.....	Zapata, E. S.
Cuba	Havana, 3a Avenida y Calle 34, Miramar.....	Mendoza, N. G.
England	London, N. 11, 42 Brookdale, New Southgate.....	Chiang, C. R.
	London, S.W. 1, c/o Egyptian Education Office, 4 Central Bldgs.....	Mahmoud, H. M.
	Portishead, Somerset, "Solheim," Down Rd.....	Shorten, G. J.
	South Kensington, S.W. 7, c/o Lloyds Bank Ltd.....	Puri, K. L.
Poland	Warszawa, Wspolna 35 m. 18.....	Gurtzman, J.
Venezuela	Caracas, Sur 5-157.....	Gil-Borges, J.
	Caracas, Oeste 7, No. 76.....	Jimenez, L. G.

For Election to the Junior Grade

California	Los Angeles, 927 Beacon Ave.....	Grumbein, P., Jr.
Canada	Toronto, Ont., 34 Broadway Ave.....	Simmonds, L. C.

For Election to the Student Grade

California	Berkeley, 2498 Piedmont Ave.....	Jones, D. E.
	Oakland, 5927 Chaboly Ter.....	Organ, W. H.
	Pasadena, Blacker House, California Inst. of Tech.....	Miller, C. N.
	Stanford University, Box 1182.....	Barnes, F. P.
Illinois	Urbana, 1205 W. Clark St.....	Kempf, R. A.
Iowa	Iowa City, 521 E. College St.....	Safra, J.
Massachusetts	Cambridge, M.I.T. Dormitories.....	Gilman, M. A.
	Cambridge, M.I.T. Dormitories.....	Winans, R. C.
Michigan	Ann Arbor, 1142 E. Catherine St.....	Vadhana, S. T.
	Detroit, 5221 Crane Ave.....	Berg, C. N.
Minnesota	Minneapolis, 2852-44th Ave. S.....	Prestholdt, O.
New York	Forest Hills, L.I., 7727 Kew Forest Lane.....	Robinson, J. T.
	Syracuse, 809 Madison St.....	Peckham, M. A.
Pennsylvania	Philadelphia, 3300 Richmond St.....	Rubin, H.
Washington	Seattle, 6817-19th Ave. N.E.....	Cole, R. J., Jr.
West Virginia	Wheeling, 100 Maple Tree Lane.....	McLain, W. W.
Canada	Montreal, P.Q., 3483 Peel St.....	Dean, W., W. H.
	Toronto 6, Ont., 182 Fulton Ave.....	Anthes, R. G.

OFFICERS AND BOARD OF DIRECTORS

(Terms expire January 1, 1938, except as otherwise noted)

President

H. H. BEVERAGE

Vice President

P. P. ECKERSLEY

Treasurer

MELVILLE EASTHAM

Secretary

HAROLD P. WESTMAN

Editor

ALFRED N. GOLDSMITH

Directors

STUART BALLANTINE, *Past President*

T. A. M. CRAVEN

L. C. F. HORLE

C. M. JANSKY, JR.,

C. B. JOLLIFFE

A. F. MURRAY

E. L. NELSON

HARADEN PRATT

B. J. THOMPSON

L. E. WHITEMORE

SERVING UNTIL JANUARY 1, 1939

E. H. ARMSTRONG

VIRGIL M. GRAHAM

ALAN HAZELTINE, *Past President*

SERVING UNTIL JANUARY 1, 1940

RALPH BOWN

H. M. TURNER

100

100

100

INSTITUTE NEWS AND RADIO NOTES

February Meeting of the Board of Directors

The regular monthly meeting of the Board of Directors was held on February 3 in the Institute office and those present were H. H. Beverage, president; Melville Eastham, treasurer; E. H. Armstrong, Ralph Bown, Alfred N. Goldsmith, Virgil M. Graham, L. C. F. Horle, C. B. Jolliffe, A. F. Murray, E. L. Nelson, Haraden Pratt, B. J. Thompson, H. M. Turner, and H. P. Westman, secretary.

Seventy-five applications for Associate membership, two for Junior, and ten for Student grade were approved.

The personnel of the committee to have charge of the preparations for our Silver Anniversary Convention was approved.

Some additional committee appointments were made to complete the personnel of all standing committees.

The secretary was instructed to have included in the Year Book an alphabetical list of the names of all Fellows of the Institute and another list of all Members. This should be of convenience in locating the names of suitable sponsors for applications for higher grades of membership.

The Secretary's Report for 1936 was approved and excerpts of it ordered included in the 1937 Year Book for the information of the membership.

The Auditor's Report for 1936 was accepted.

A committee composed of Messrs. Thompson, Goldsmith, and Wilson was appointed to prepare suggestions for rules to govern an annual award for the best paper published in the PROCEEDINGS.

The possibility of a joint meeting being held with the American Institute of Electrical Engineers during their convention in Spokane, Washington, late this summer to be participated in by our three Pacific Coast Sections was favorably considered.

It was agreed that in the future the annual reviews of radio which during the past three years have been presented before New York meetings of the Institute would be restricted to publication in the PROCEEDINGS only.

Joint Meeting of the Institute and the American Section of the International Scientific Radio Union

The annual joint meeting of the Institute of Radio Engineers and the American Section of the International Scientific Radio Union will be held in Washington, D. C., on April 30, 1937. This all-day meeting is an important feature of the week which attracts to Washington every year an increasingly large number of scientists and scientific societies.

Papers on the more fundamental and scientific aspects of radio will be presented. Titles of papers offered for this program should be submitted immediately. It is desirable but not necessary that abstracts be submitted with the titles. An abstract will be required by March 20. The program, with abstracts, will be mailed to those interested before the meeting. Correspondence should be addressed to Mr. S. S. Kirby, National Bureau of Standards, Washington, D. C.

Radio Emissions of Standard Frequency

The National Bureau of Standards provides standard frequency emissions from its station WWV at Beltsville, Md. On each Tuesday and Friday the emissions are continuous unmodulated waves and on each Wednesday they are modulated by an audio frequency, generally 1000 cycles. There are no emissions on legal holidays.

On all schedules three radio carrier frequencies are transmitted as follows: noon to 1 p.m., Eastern Standard Time, 15,000 kilocycles; 1:15 to 2:15 p.m., 10,000 kilocycles; and 2:30 to 3:30 p.m., 5000 kilocycles. The accuracy of these frequencies will at all times be better than one part in five million.

During the first five minutes of each transmission announcements are given of the station call letters, the frequency of transmission, and the frequency of modulation, if any. For the CW emissions, the announcements are in telegraphic code and are repeated at ten-minute intervals. For the modulated emissions, the announcements are given by voice only at the beginning of each carrier frequency transmission, the remainder of the hour being an uninterrupted audio frequency. The CW emissions are from a twenty-kilowatt transmitter and the modulated transmissions are from a one-kilowatt set.

Information on how to utilize these signals is given in a pamphlet obtainable on request from the National Bureau of Standards, Washington, D. C. Reports from those using this service will be welcomed by the Bureau. As the modulated emissions are somewhat experimental it is particularly desired that users report their experiences outlining methods of utilization, information on relative fading intensity, etc., on the three carrier frequencies and preferences as to the audio frequency to be furnished.

Institute Meetings

ATLANTA SECTION

The following four meetings of the Atlanta Section were held at the Atlanta Athletic Club. The September 17 meeting at which I. H. Gerks, chairman, presided was attended by nineteen.

A paper by H. L. Wills, consulting engineer, was presented on "An Experimental Laboratory for Electrical Instruments." The various standards and instruments used in the laboratory were discussed as were the testing, repairing, and calibrating of various types of alternating- and direct-current instruments. Detailed information was given on the design and calibration of a beat-frequency oscillator. The paper was closed with a brief résumé of the author's experiences in machine and electrical shops and in his consulting engineering practice. The paper was discussed by Messrs. Bangs, Gerks, Owens, and Shropshire.

The October 15 meeting of the section was held jointly with the Atlanta Section of the American Institute of Electrical Engineers and was presided over by J. H. Persons, chairman of that section. There were forty present.

S. R. Durand of the rectifier division of the Allis-Chalmers Manufacturing Company presented a paper on "Steel Tank Grid-Controlled Mercury-Arc Power Tubes." The rectifiers described are used for converting alternating current to direct current for various industrial, transportation, and radio purposes. A general description was given of the rectifier, vacuum pumps, ignition excitation equipment, vacuum seals, methods of construction, cooling, and circuit connections. The function of the control grid was discussed and in radio service it is useful for clearing flashovers in the transmitter or antenna and permits restoring service in a few cycles. The paper was discussed by various members present.

The November 19 meeting was attended by fourteen and presided over by Chairman Gerks. "Teletypewriter Exchange Service" was the subject of a paper by N. B. Fowler of the American Telephone and Telegraph Company. It included an outline of the nation-wide system with a description of the switchboards, the equipment and signaling functions, and the transmission network interconnecting the switching points. The engineering considerations involved in designing switchboards and interconnecting trunk circuits were discussed. The transmission theory of start-stop teletypewriter telegraph circuits was developed and the various sources of distortion enumerated. Their effects on transmission were outlined. The paper was discussed by Messrs. Bangs, Gerks, Owens, and Reid.

On December 17, Chairman Gerks presided over a meeting of the section which was attended by sixteen.

A. W. Shropshire, transmitter engineer of WSB, presented a paper on the "Design of a Thirty-Seven-Megacycle Mobile Transmitter." The equipment was designed for broadcast pickup work and the power

supply was the limiting factor on its portability. A six-volt dynamotor supplies the power. A crystal oscillator operating near six megacycles is followed by a tripler and a doubler to multiply the frequency to the desired value. The push-pull final amplifier delivers about ten watts through a special coupling circuit into a coaxial transmission line which feeds a quarter-wave vertical antenna mounted on the bumper of an automobile. Combination plate- and screen-grid modulation is employed. The speech amplifier gives a ninety-decibel gain and is used with a dynamic or velocity microphone. Between eighty-five and ninety per cent modulation is obtained. The usable coverage range was found to be between five and six miles. The paper was closed with a description of some experiments with directive antennas. The transmitter was available for inspection, and operated into a dummy antenna.

BOSTON SECTION

The October 23 meeting of the Boston Section was held at Harvard University and was presided over by E. L. Bowles, chairman. There were fifty in attendance.

"A Report on Ionosphere Measurements During the Total Eclipse of June 19, 1936" was presented by H. R. Mimno, P. B. King, Jr., H. Selvidge, J. A. Pierce, E. P. York, and J. C. Cook, all of Cruft Laboratory, Harvard University. It concerned the activities of the radio section of the Harvard University-Massachusetts Institute of Technology Eclipse Expedition to Ak-Bulak, U.S.S.R. Professor Mimno introduced the subject by outlining the general problem, and recalling the work done at the eclipse of 1932. It was pointed out that the differences in path between any hypothetical corpuscular eclipses in 1932 and 1936 made the measurements of 1936 particularly useful in determining the possibility of corpuscular activity. Mr. King then described the records obtained by the two fixed frequency transmitters. The original records were shown and a comparison made with similar records made in 1932. Mr. Pierce then discussed the records made by the variable frequency transmitter. A three-dimensional model was displayed, showing the combined data of the fixed and variable frequency runs superimposed on the data for a normal day. The data clearly showed the effect of the eclipse and the conclusion was drawn from a preliminary analysis that there was no evidence of any important contribution of corpuscular activity to the ionization in the F region, the eclipse effect being due to a decrease in the ultraviolet light from the sun. The effect of the world-wide magnetic disturbance of June 19 and 20 was shown on the data, but it was pointed out that this did not seriously affect the value of the results. It was stated that

a more complete analysis of the records would probably yield additional information of considerable value as the material presented was in the form of a preliminary report. Mr. Selvidge discussed some of the experiences of the expedition and showed numerous colored slides taken during the expedition's stay in Russia.

The November 20 meeting held at Harvard University and presided over by H. W. Lamson, vice chairman, was attended by fifty.

"The Use of Radio in Geographical Exploration in Foreign Lands" was the subject of a paper by T. S. McCaleb, a member of the faculty of the Institute of Geographical Exploration of Harvard University. It was concluded with a demonstration of standing wave patterns from a high-frequency transmitter. Messrs. Hunt and O'Neill discussed it.

Professor Bowles presided at the December 18 meeting of the section held at the Massachusetts Institute of Technology and attended by 100.

"Engineering Activities of a Large Broadcast System" was the subject of a paper by H. A. Chinn, assistant to the director of engineering of the Columbia Broadcasting System. The author outlined the organization of the engineering department of the Columbia Broadcasting System with specific reference to the functions, the duties, and the problems that are encountered by the various engineering divisions. The presentation covered the activities of the groups that are responsible for daily technical obligations and those groups that design, assemble, install, and test the radio, audio and experimental facilities. A general discussion of the paper was participated in by Messrs. Chaffee, Lamson, and Mimno.

BUFFALO-NIAGARA SECTION

A meeting of the Buffalo-Niagara Section was held on January 27 at the University of Buffalo with K. B. Hoffman, vice chairman, presiding. There were sixty-one present.

R. F. Field of the General Radio Company presented a paper on "The Development of Direct Reading Methods." It concerned the development of various instruments to permit direct reading of the units desired without reference to calibration curves or charts. This is desirable as it reduces the time required for experiments and potential errors in them. There was introduced complicated forms and shapes of stationary and movable instruments. Numerous views of measuring instruments and their parts, were shown and described.

Scales are much improved to avoid crowding of marker lines and ingenious multipliers designed to simplify and to eliminate confusion or complication in use. A general discussion followed.

CHICAGO SECTION

On January 22 a meeting of the Chicago Section was held in the LaSalle Hotel with J. K. Johnson, chairman, presiding. The meeting was attended by ninety-one.

H. H. Beverage, chief research engineer of the RCA Communications, Inc., and president of the Institute presented a paper on "Some Notes on the Propagation of Ultra-High Frequencies." Many data on field strength versus height were given. They were obtained by measuring in an airplane the transmissions from the Empire State building. It was pointed out that the signal reflected from the ground was 180 degrees out of phase with the direct signal and therefore nearly cancels it when both transmitter and antenna are on the ground. As height increases, the signal increases to a maximum and then passes through successive maxima and minima values. The reversal of phase at reflection occurs at ultra-high frequencies with either vertical or horizontal antennas because of the dielectric characteristics of the earth or water. The propagation characteristics with vertical or horizontal antennas are quite similar. Propagation in this range is classified into direct waves, reflected waves, and sky waves. Sky waves usually absent, occasionally appear for a few hours. More data on this subject are needed for theoretical purposes. The sky waves are of doubtful commercial value. The paper was discussed by Messrs. Andrew, Crossley, Harper, Kohler, and Million.

CINCINNATI SECTION

Forty-four attended the January 19 meeting at the University of Cincinnati of the Cincinnati Section. G. F. Platts, chairman, presided.

A paper on "Patent Law for the Radio Engineer" was presented by Marston Allen of Allen and Allen. He described first the meaning of a patent as interpreted by our government. The relationship of the patentee and the government was outlined and the importance of claims emphasized. Infringement of patent rights, its seriousness and complications were discussed. The differences in patent law practice in the past and present were disclosed. In the early days the claims of an application described the patent and a working model was also necessary. Now, practice is based on rules, exceptions to the rules, and exceptions to the exceptions. He clearly differentiated between invention and mere scientific or engineering application. In the radio field he indicated the necessity of confining an application to a particular phase of

the art and how the breadth of invention is becoming more and more narrow. Various points were illustrated and he related numerous interesting experiences. The paper was discussed by a large number of those present.

CLEVELAND SECTION

R. A. Fox, chairman, presided at the January 29 meeting of the Cleveland Section which was held in the Case School of Applied Science and attended by sixteen.

J. F. Byrne, associate professor of communication engineering at the Ohio State University presented a paper on "Nighttime Propagation at Broadcast Frequencies." This paper was presented before the engineering hearings of the Federal Communications Commission which started on October 5.

Of 100,000 questionnaires sent to rural listeners to obtain the order of preference of their favorite stations, between thirty and forty thousands were usable and in conjunction with the reports of the Federal Radio Census Takers formed the basis of a cleared channel survey. The field intensities of forty cleared channel stations were measured and interpolated with the results of the above survey in an effort to place nighttime transmission on a quantitative basis. It was pointed out that the practical service limits of 50-kilowatt cleared channel stations were eight hundred miles and of a 500-kilowatt station, nine hundred miles. The practical service limits of low-frequency broadcast band regional stations were twenty-eight miles, of middle-band regionals, twenty miles, and of high-frequency regionals fourteen miles. It was emphasized that methods of improving program delivery should not concern so much their legality as an economic feasibility. It suggested that better conditions might exist if the station power was controlled by the field strength at a mile from the antenna rather than by actual power ratings.

CONNECTICUT VALLEY SECTION

P. D. Zottu of the RCA Radiotron Company presented a paper on "Radio Technique at One Meter" at the January 21 meeting of the Connecticut Valley Section which was held at the Wesleyan University in Middletown, Connecticut. F. H. Scheer, chairman, presided and there were sixty present.

The author discussed some of the difficulties encountered in obtaining oscillation and measuring the power and wave length of circuits operating at one meter and below. A major difficulty in oscillators was in obtaining sufficiently high impedance circuits. Quarter-wave coaxial lines appeared to answer this problem. The frequency of oscillation is

determined by the length of the line and may be changed by the addition of capacitance to the end of the line as well as by use of a spiral or inductive center wire. Radiation from this type of circuit is negligible. Increased power could be obtained by coupling several tubes to the line. Power measurement encounters difficulties because at these high frequencies spurious reactions are met when employing conventional equipment. Frequency measurement is not as difficult and reasonably satisfactory results are obtainable by using an adjustable transmission line and a diode rectifier. A receiver consisting of a coaxial line coupled to acorn type tubes was shown. Three lines for coupling in a conventional tuned-radio-frequency circuit were employed. No field tests have been made of the equipment to determine its usefulness in communication work.

DETROIT SECTION

The January 21 meeting of the Detroit Section was held jointly with the local section of the American Society of Mechanical Engineers at the studios of WWJ. It was presided over by R. L. Davis, chairman, and attended by 280.

"Some Mechanical Applications of Piezoelectrical Devices" was the subject of a paper by A. L. Williams, president of the Brush Development Company. He gave first a short explanation of piezoelectricity followed by a description and demonstration of several devices using these crystals. One device demonstrated was for measuring and analyzing mechanical vibration. Another permitted automatic testing of small parts such as ball and roller bearings and small motors. The third device permitted automatic testing of small metal parts for flaws and faults by means of a minute unidirectional microphone. A new smoothness gauge employs a crystal pickup and crystal pen for comparing finished surfaces. The paper was closed with a description of the analysis of low-frequency vibrations of machinery, ships, and other large bodies by means of a new displacement type piezoelectric pickup.

EMPORIUM SECTION

It was recently indicated in the report on the December 10 meeting of the Emporium Section that the newly elected vice chairman, H. W. Abbott was associated with the Hygrade Sylvania Corporation. He is a member of the staff of the Spear Carbon Company, also M. I. Kahl who was presented with an Institute membership emblem in appreciation of his activities in the Emporium Section was not a member of the Executive Committee.

Two meetings of the Emporium Section were held during January,

the first on the 14th was attended by fifty. It was held in the American Legion Rooms and presided over by M. I. Kahl, chairman.

A paper on "Some Notes on the Propagation of Ultra-High Frequencies" was presented by H. H. Beverage, chief research engineer of R.C.A. Communications and president of the Institute. This has already been summarized in the report of the Chicago Section. It was discussed by a number of those present.

The meeting was closed with a short talk by C. F. Miller of the Hygrade Sylvania Corporation on his experiences during a recent trip to Germany.

The second meeting in January was held on the 29th in the American Legion Rooms and presided over by M. I. Kahl, chairman. There were sixty present.

F. E. Terman associate professor of electrical engineering at Stanford University, presented a paper on "Feed-Back Amplifiers." The development of the feed-back amplifier by the Bell Telephone Laboratories was first described. Equations were then developed showing the feedback of an amplifier. The precautions to prevent oscillation were discussed and it was shown that although the single stage amplifier was easy to stabilize, there were numerous advantages in employing multistage amplifiers. The feed-back amplifier will eliminate certain types of noise and the frequency response is broadened. In the summary it was pointed out that feed-back amplifiers give improved stability and frequency response, and reduce distortion, cross talk, certain types of internal noise, and phase shift. It is a more complicated circuit and amplification is lost. Various applications of feed-back amplifiers were discussed. The paper was discussed by Messrs. Brand, Clark, Connors, Jones, Marshall, Oman, and West.

NEW ORLEANS SECTION

A meeting of the New Orleans Section was held in the studios of WBNO in the St. Charles Hotel on January 22 and attended by fourteen. The meeting which was presided over by G. H. Peirce, secretary-treasurer, was held during the annual meeting of the convention of the Louisiana Engineering Society. It was devoted chiefly to a round-table discussion of several radio subjects and was closed in time to permit those present to participate in the subsequent events on the convention program.

NEW YORK MEETING

The regular meeting of the Institute was held in New York on February 3 in the Engineering Societies Building and presided over by President Beverage. There were 450 present.

A paper on "Automatic Tuning, Simplified Circuits, and Design Practice" was presented by D. E. Foster and S. W. Seeley of the RCA License Laboratory. This paper appears elsewhere in this issue.

PHILADELPHIA SECTION

The January 7 meeting of the Philadelphia Section was held in the Engineers Club and presided over by Irving Wolff, chairman. There were 280 present.

E. I. Green of the Bell Telephone Laboratories presented a paper on "High-Frequency Broad Band Transmitters." He pointed out that in the telephone art new developments and inventions are providing an ever-increasing number of communication channels imposed upon a single pair of conductors. The development of high-frequency carrier systems now in use and the proposed new broad band systems were reviewed. The development of the vacuum tube and the refinement of the wave filter made possible in 1918 the application of the first carrier system which provided four channels over a single pair of open wires. Systems now under development will make it possible to obtain twelve one-way channels over a single cable circuit or twelve two-way channels on a single open-wire circuit, while the coaxial system provides 240 one-way channels over a single coaxial circuit.

The difficulties of overcoming noise, cross talk, time of wave propagation, attenuation, and phase distortion were explained. The greatest gain that can be used in an amplifier at any one point is approximately 70 decibels. Consequently, amplifiers have to be used along a circuit at frequent intervals.

With the coaxial cable system 240 channels spaced at 4000-cycle intervals can be carried over a single circuit with repeater amplifiers placed ten miles apart. The coaxial cable as installed between New York and Philadelphia is made up of a single copper wire with rubber spacers to center it and surrounded by a copper tube made of interlocking z tapes surrounded by a steel tape to hold it firmly in shape. Two of these structures together with two quads of 19-gauge conductors are placed together under one lead sheath, seven eighths of an inch outside diameter. The coaxial cable can be used to transmit television pictures. A band 1,000,000 cycles wide has been transmitted successfully over the New York-Philadelphia cable approximately ninety miles long. It is expected that from 2,000,000- to 4,000,000-cycle bands eventually can be transmitted. The talking circuits have been set up through this cable by connecting channels back and forth making a circuit equivalent to a line 3800 miles long in which the carrier frequency changed seventy times and the conversation passed twenty times through the same repeater.

The talk was illustrated with lantern slides and one showed how the band filter has been perfected. A curve for this filter showed how a net band of approximately 3000 cycles could be derived from a total frequency interval of 4000 cycles, with unwanted frequencies attenuated approximately seventy decibels. These filters are of a new type, very small and include quartz crystal elements. Another new feature is the negative feed-back repeater arranged for neutralizing distortion. The paper was discussed by Messrs. Benning, Forstall, Hayes, Luck, Saling, and others.

SAN FRANCISCO SECTION

A meeting of the San Francisco Section was held on January 6 in the auditorium of the San Francisco Telephone Building. Noel Eldred, vice chairman, presided and there were thirty present.

The meeting was devoted to a discussion of four papers which were published in recent issues of the PROCEEDINGS. The papers on "Electrical Measurements at Wave Lengths Less than Two Meters" by L. S. Nergaard, and "A High Power Amplifier for Ultra-High Frequencies" by A. L. Samuel and N. E. Sowers were reviewed by John Donahue of Stanford University. Two additional papers, "Thermocouple Ammeters for Ultra High Frequencies" by J. H. Miller and "The Measurement of Radio-Frequency Power" by A. H. Taylor, were reviewed by Clark Spahr of Heintz and Kaufman.

On January 20 the San Francisco Section met in the Piedmont City Hall. V. J. Freiermuth, chairman, presided and there were ninety-six present.

The first paper on "The Utilization of Two-Way Communication with Patrol Cars in Police Work" was presented by Fred Heere, Chief of Police of the City of Piedmont. He pointed out the many advantages of two-way communication in police work, emphasizing the saving of time and the assurance to the station operator that his call has been received. Two-way radio systems have been found to be extremely useful not only in their police work but in conjunction with fire-fighting equipment and ambulances.

A second paper on "Problems in Developing, Establishing, Maintaining, and Operating a Radio Communication System with Mobile Units" was presented by C. B. McMurphy, chief engineer of the City of Piedmont Police Radio System. He described the early work and equipment. As faults are disclosed they are gradually eliminated and the present system gives entirely satisfactory performance. The equipment now used was described in detail. Unlike much contemporary equipment both the transmitter and receiver in all portable units are crystal controlled. The receivers are equipped with a particularly effec-

tive "quiet" control so that it is silent unless the carrier from the transmitter is on the air. Substantial distances are now being covered by the police frequencies and daily reception of Atlantic and Midwestern transmissions occur. In many cases, signals after traveling three thousand miles are practically as loud as from a local transmitter. A display of portable equipment was available and a tour of the central station was made where both the transmitting and receiving equipment were inspected and demonstrated by remote control from the police station.

SEATTLE SECTION

On January 8 the annual meeting of the Seattle Section was held at the University of Washington with E. D. Scott, chairman, presiding. There were forty present.

"Methods of Determining Performance of Radiotelephone Transmitters" was the subject of a paper by Robert Walker, resident engineer of KOMO-KJR. It covered methods of determining antenna input power, power radiated from an antenna, antenna efficiency, and quality of the radiated signal as to carrier noise level, distortion, and frequency maintenance. The paper was discussed by Messrs. Libby, Wallace, and others.

In the election of officers, J. W. Wallace of the Puget Sound Broadcasting Company was named chairman; H. C. Hurlbut of the Lighting Department of the City of Seattle, vice chairman; and R. O. Bach of the Pacific Telephone and Telegraph Company, secretary-treasurer.

Chairman Wallace presided at the January 29 meeting held at the University of Washington and attended by seventy-five.

R. C. Fisher, research engineer, presented a paper on "Electronic Music—Past, Present, and Potential Development." He first reviewed the physical principles underlying musical instruments and then described the basic processes of tone generation, selection of tone, control of tone quality, and translation into sound which are employed in electronic instruments. The application of these processes in both early and present designs were described. The paper was closed with a demonstration of the performance and technical features of the Hammond electrical organ. It was discussed by Messrs. Hurlbut, Libby, and Wallace.

WASHINGTON SECTION

The Washington Section met on January 11 in the auditorium of the Potomac Electric Power Company and W. B. Burgess, chairman, presided. There were 180 members and guests in attendance.

A paper on "RCA Television Field Test System" was presented by R. R. Beal of the RCA Manufacturing Company and the questions which followed the presentation of the paper were answered by R. D. Kell of the RCA Manufacturing Company and R. E. Shelby of the National Broadcasting Company.

The paper discussed the experimental high definition television system of the RCA which is now being tested in New York City. The transmitting equipment in the Empire State building was described as were the studios and installation equipment of the National Broadcasting Company in the RCA Building. The paper was closed with a short sound film showing the actual production of the television program.

The February 8 meeting of the Section was held in the Potomac Electric Power Company auditorium and attended by seventy-six. Chairman Burgess presided.

"Radio Methods for Investigation of Upper-Air Phenomena with Unmanned Balloons" was the subject of a paper by H. Diamond, W. S. Hinman, Jr., and F. W. Dunmore of the National Bureau of Standards. The general methods and their application to the study of a large class of phenomena were first described. A description of a radiometeorograph based on these principles which was developed for meteorological service in the U. S. Navy Department for the collection of upper-air weather data was given. A miniature transmitter is sent aloft on a small balloon and employs an ultra-high-frequency oscillator operating between 50 and 200 megacycles. A relaxation oscillator provides a varying audio-frequency modulating current of from 20 to 200 cycles. The frequency of the relaxation oscillator is controlled by resistors connected in its grid circuit. These resistors are varied mechanically by instruments responding to the phenomena being investigated or they may be special devices the electrical resistance of which vary proportionally with the phenomena. The modulation frequency is thus a measure of the phenomenon studied. Several phenomena may be measured successively, the corresponding resistors being switched into the circuit by an air-pressure-driven switching unit which serves also for indicating the balloon altitude. At the ground receiving station a graphical frequency recorder connected in the receiving set output provides an automatic chart of the variation of the phenomena with altitude. Special ground direction finding methods were described to determine the azimuthal direction of the balloon and its distance from the receiving point. These data are required in measuring upper-air conditions. The paper was discussed by a number of those present.

Personal Mention

J. E. Brown formerly with the Federal Communications Commission has joined the staff of Zenith Radio Corporation, Chicago, Ill.

Formerly with Targan Electric Company, K. H. Chittock has joined Airzone, Ltd., of Camperdown, Sydney, Australia.

[Previously with Stewart Warner Corporation, C. W. Dymond is now in the Detroit office of the Radio Corporation of America.

H. G. Beer has been transferred from the Engineer-in-Chief's office to the General Post Office Research Station at Dollis Hill, England.

Frederick Wheeler formerly with WREN has joined the staff of WKY at Oklahoma City, Okla.

Ching-Huan Wu formerly at Cheeloo University is now a member of the Physics Department of the National University of Shangtung, Tsingtao, China.



TECHNICAL PAPERS

AUTOMATIC TUNING, SIMPLIFIED CIRCUITS,
AND DESIGN PRACTICE*

BY

D. E. FOSTER AND S. W. SEELEY
(RCA License Laboratory, New York, N. Y.)

Summary—The principles underlying automatic frequency control of the oscillator in superheterodyne receivers have been outlined in previous papers given before the Institute of Radio Engineers. This paper deals with simplification and improvements in operation of frequency control circuits and their application to automatic (electronic) tuning control.

A new type of "discriminator" which differentiates between mis-tuned signals on the high-frequency side of resonance and those on the low-frequency side is described and its operation demonstrated by means of a visual frequency indicator.

The operation of the discriminator is such that it may be used to supply audio-frequency components corresponding to the amplitude modulations of the received carrier wave and automatic volume control potentials as well as the control voltage for the frequency control circuits. This multifunction is described and illustrated.

Alternative circuit connections to improve the compromise between discriminator sensitivity, audio fidelity, and selectivity are explained and illustrated.

The use of vacuum tubes in such manner that they act as reactive components and the manner in which their apparent reactive impedance may be controlled by varying the tube parameters is demonstrated.

The action of a complete receiver embodying automatic (electronic) tuning control in overcoming mis-tuning and oscillator frequency drift will be demonstrated.

I. FOREWORD

A HIGHLY abridged description of the automatic frequency control method is the simple statement that the basic requirements are: (a) a direct-current detector operated through an intermediate-frequency discriminator network, and (b) an oscillator frequency control circuit. This functional combination has been described by Travis.¹ The progress to be disclosed lies in means of realizing (a) and (b); i.e., a circuit arrangement to avoid the use of any off-tuned LC circuits in the frequency discriminator, and further refinement of oscillator control practice.

The discriminator-detector network (a), as the name implies, dis-

* Decimal classification: R140. Original manuscript received by the Institute, October 19, 1936. Presented before Eleventh Annual Convention, Cleveland, Ohio, May 12, 1936; presented before New York meeting February 3, 1937.

¹ Charles Travis, "Automatic frequency control," Proc. I.R.E., vol. 23, pp. 1125-1141; October, (1935).

criminate between applied intermediate frequencies which are too low and those which are too high, and produces a corresponding direct current or voltage whose polarity depends upon the direction of frequency departure from a prescribed intermediate frequency. This direct voltage is applied to a control element which in turn causes a shift in frequency of the local oscillator such as to bring the intermediate-frequency signal to very nearly the correct intermediate frequency. Since production of the direct voltage is due to departure from the resonant or "center" frequency of the intermediate-frequency system, obviously the correction cannot be strictly complete: but in the system to be described a correction ratio of more than 100 to 1 is feasible. In other words, when the dial of the receiver is mistuned ten kilocycles for the received signal, the automatic correction may be made to bring the actual intermediate signal frequency to only 100 cycles off resonance in the intermediate-frequency system. Of course that is easily sufficient.

II. FREQUENCY DISCRIMINATOR FOR DIRECT-CURRENT DETECTOR OPERATION

This section is a description of a method for obtaining differential direct-current potentials (or currents) whose magnitude and polarity are determined by the amount and the sign, respectively, of the difference between an applied frequency and a certain fictitious frequency. "Side circuits" tuned above and below the "center frequency" are not used.

The action depends upon the fact that a 90-degree phase difference exists between the primary and secondary potentials of a double tuned, loosely coupled transformer when the resonant frequency is applied, and that this phase angle varies as the applied frequency varies. Thus if the primary and secondary voltages are added vectorially, the absolute magnitude of the resultant vector will be greater on one side of resonance than on the other.

The vector sum of the primary and secondary voltages may be physically realized by connecting the two parallel tuned, coupled circuits in tandem, applying the input potentials to one circuit and taking the output across both circuits in series. In this manner, an action similar to that of a side circuit is produced even though the primary and secondary are both tuned to the center frequency. (See Fig. 1.) Notice that the only difference between *A* and *B* is the sign of the coupling between primary and secondary of the intermediate-frequency transformer. The potentials at either end of a secondary winding with respect to a center tap on that winding are 180 degrees out of phase. Therefore if the center tap, rather than one end, of the secondary is

connected to the primary, two potentials may be realized, one maximizing above and one maximizing below the center frequency. (See Fig. 2.)

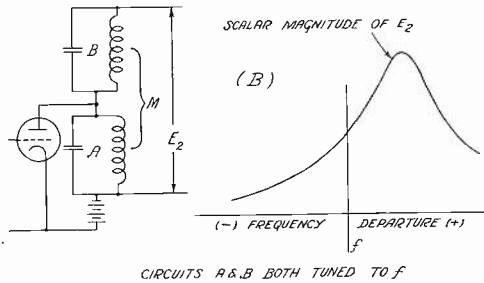
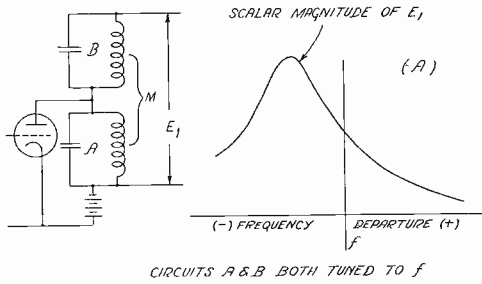

Fig. 1

If a transformer is connected in this manner and the resonant frequency is applied to the primary the two resulting output potentials will be equal in magnitude. If these are then applied to two separate,

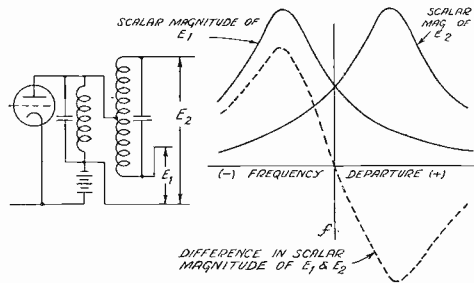

Fig. 2

like, detectors and the resulting direct voltages (or currents) are added in opposition, the sum will be equal to zero. If, however, the applied frequency departs from resonance, the sum of their outputs will be some real value whose polarity will depend upon the sign of the frequency departure.

The rate of change in scalar magnitude of a given resultant of two vectors at 90 degrees, with small changes in the angle between those vectors, is greatest when the scalar value of one vector is equal to the scalar value of the resultant divided by $\sqrt{3}$, or when the ratio of vector lengths is equal to $\sqrt{2}$. If a double tuned transformer has a secondary of twice the inductance of the primary, the Q of the primary being equal to that of the secondary (when in circuit) and the coupling between circuits being critical, the primary voltage will be related to one half the secondary voltage on resonance in such manner as to fulfill the above conditions.

This does not mean that a larger secondary with the same primary, or a different value of coupling, would not give a greater number of volts per cycle change in the primary plus half the secondary sum, but in such event the resultant itself would be greater. Circuit or other requirements might necessitate an exceedingly low tuned primary impedance in which case a much higher ratio would be in order.

A measure of the sensitivity of this device may be the developed direct voltage (or amperes) per cycle of frequency deviation, per volt applied to the grid of the tube whose plate circuit contains the primary of the transformer. Regardless of the type of detectors employed this quantity will be a function of the rate of change, with frequency, of the difference between magnitudes of the input potentials to the two detectors. If these magnitudes are plotted against frequency difference (both positive and negative) the curves will intersect on the zero abscissa ordinate with slopes equal but opposite in sign. (See Fig. 2.) The slope of the curve representing their difference is, therefore, equal to twice the slope (at the center frequency) of the curve of input potentials to one of the detectors. This establishes the significance of a factor which will be termed S , which equals twice the first derivative, with respect to frequency, at resonance, of an expression for absolute magnitude of input potential to one of the detectors. It must be borne in mind that the value of the ordinate at the point of intersection of the two curves becomes significant only when detectors other than those with a linear characteristic are used.

To simplify the derivation given below the apparent Q values of both primary and secondary (when in circuit) have been assumed to be equal.

Symbols Employed:

S = slope, at resonance, of the expression representing the difference between magnitudes of the potentials applied to the two detectors.

f = a frequency at which the total internal reactance of the tuned circuits is equal to zero.

f' = a frequency removed from f by a discrete increment.

r = apparent primary series resistance. This includes the effect of the plate impedance of the tube, the natural primary series resistance, and any other resistive load other than the secondary.

r_2 = apparent secondary series resistance.

A = the ratio of total secondary inductance to primary inductance.

Since $Q_1 = Q_2$ (by assumption) $r_2 = Ar$.

L = primary inductance. Thus $L_2 = AL$.

$Q = 2\pi fL/r$.

x = sum of the internal series reactances of the primary.

$x_2 = Ax$ = sum of the internal series reactances of the secondary.

n = the ratio of reactance to resistance (internal) of either primary or secondary at any frequency. At f' this equals $2(f' - f)Q/f$.

K = the ratio between actual and critical couplings between primary and secondary. $2\pi fM = K\sqrt{r}\sqrt{r_2} = K\sqrt{Ar}$.

G_m = mutual conductance of the amplifier tube preceding the transformer.

$j = \sqrt{-1}$.

With one volt applied to the grid of the amplifier tube the vector primary voltage takes the form

$$E_p = 2\pi fLQG_m \frac{1 + jn}{(1 + jn)^2 + K^2} \quad (1)$$

(Note that by taking the effect of the plate impedance into r the primary voltage is equal to $G_m \times$ apparent impedance across the primary.)

The primary current may then be written:

$$I_p = \frac{E_p}{j2\pi fL} \quad *$$

and the induced voltage in the secondary = $\frac{E_p K \sqrt{A} r}{2\pi fL}$.

From which the secondary current becomes:

$$I_s = \pm \frac{E_p K}{2\pi fL(1 + jn)\sqrt{A}}$$

* To a very close approximation.

and the secondary voltage may be written:

$$E_s = \pm \frac{jE_p K \sqrt{A}}{1 + jn}$$

Replacing E_p with its equivalent from (1):

$$E_s = \pm 2\pi f L Q G_m \frac{jK \sqrt{A}}{(1 + jn)^2 + K^2} \quad (2)$$

which is the expression for the vector voltage across the entire secondary with one volt applied to the grid of the amplifier tube.

Adding the primary voltage to one half the secondary voltage vectorially gives the vector expression for the resultant voltage applied to either detector.

$$E_{\text{det}} = 2\pi f L Q G_m \frac{(1 + jn) \pm jK \sqrt{A/2}}{(1 + jn)^2 + K^2} \quad (3)$$

or,

$$E_1 = 2\pi f L Q G_m \frac{(1 + jn) + jK \sqrt{A/2}}{(1 + jn)^2 + K^2}$$

and,

$$E_2 = 2\pi f L Q G_m \frac{(1 + jn) - jK \sqrt{A/2}}{(1 + jn)^2 + K^2}$$

The scalar magnitude of E_1

$$Y = 2\pi f L Q G_m \frac{(1 + n^2 + \sqrt{AK}n + AK^2/4)^{1/2}}{(1 + K^2 + n^2 + 2K^2 + 2n^2 - 2K^2n^2)^{1/2}} \quad (4)$$

As stated above the sensitivity of the device to changes in frequency will be a function of S which is two times the rate of change of the above expression, with respect to frequency. Or $S = 2(dy)/df$. From the definitions above it can be seen that, at resonance, $dn/df = 2Qf$.

Thus $(4Qdy)/(fdn) = S$. Differentiating Y with respect to n and then setting n equal to 0 to get the slope at resonance gives

$$\frac{dY}{dn} = 2\pi f L Q G_m \frac{(AK)^{1/2}}{(1 + K^2) \left(1 + \frac{AK^2}{4}\right)^{1/2}}$$

from which

$$S = 8\pi L Q^2 G_m \frac{(AK)^{1/2}}{(1 + K^2) \left(1 + \frac{AK^2}{4}\right)^{1/2}} \quad (5)$$

From this expression it can be seen that S is independent of frequency and is proportional to L , Q^2 , and G_m and also that it is a function of A (the secondary to primary inductance ratio) and of K (per cent critical coupling)/100.

If the right-hand side of the expression is maximized by differentiating with respect to K , setting the differential equal to 0 and solving for K in terms of A , we have

$$K = \frac{(\sqrt{1 + 2A} - 1)^{1/2}}{A} \quad (6)$$

from which it can be seen that the optimum value of coupling will be less than critical for any ratio of secondary to primary inductance. K is plotted against A in Fig. 3.

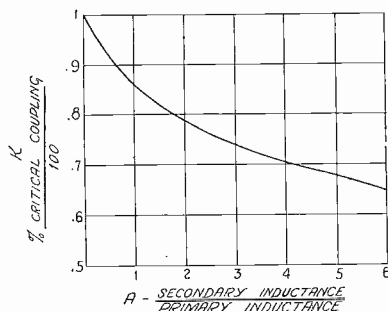

Fig. 3—Optimum coupling if linear detectors are used.

If the expression for S is maximized with respect to A , we arrive at a ratio equal to infinity with zero coupling. This merely confirms the fact that the sensitivity can be increased by increasing the secondary inductance. It must, of course, be borne in mind that if conductive input detectors are used, their effect on the apparent Q of the tuned circuits will be greater, the greater the inductance.

As an example of the use of (5), possible values for the parameters may be taken as follows: $L = 0.5 \times 10^{-3}$, $Q = 100$, $G_m = 1500 \times 10^{-6}$, $A = 2$. Then from (6), $K = 0.785$. Substituting these values in (5) and solving for S we have: $S = 0.113$ root-mean-square volt difference, per cycle, in the potentials applied to the two detectors when one volt root-mean-square is applied to the grid of the preceding amplifier tube. Thus if the frequency departs from resonance by ten cycles an unbalance of 1.13 volts will exist at the detector input points. A sensitivity of this order may not, in general, be necessary or desirable. However, the above example illustrates the order of sensitivities which

may be obtained should the need arise. The calculated value for S has been verified experimentally.

So far we have calculated the slope at resonance only. If the scalar magnitudes of E_1 and E_2 are calculated for positive and negative values of n , subtracted and plotted against n it is apparent that the slope becomes equal to zero at two points. These correspond to two frequencies, one above and one below the resonant frequency, and at these points the difference between applied potentials to the two detectors is maximum. With various circuit constants and with the coupling adjusted to give a maximum slope at resonance, these maxima will normally appear at positive and negative values of n ranging between 0.5 and 0.95. The frequencies corresponding to these values are sufficiently well separated to give adequate operating range for most applications. This is particularly true if the range of frequencies applied to the device is limited by the selectivity of preceding circuits. It must also be remembered that the differential direct output voltage will bear the same sign after passing a maximum point, and if it is used for frequency control it may still have sufficient magnitude to swing the controlled frequency into the so-called operating range.

However, if it becomes necessary to increase the frequency separation of the two maxima, it may be done either by increasing the value of coupling above the optimum as determined by (6), or by decreasing the Q of the circuits. Either method will decrease S at the center frequency, although an increase in coupling will cause the least change in sensitivity for a given increase in separation.

If square-law detectors are used their outputs will be proportional to the square of the scalar magnitudes of the applied potentials. From (4):

$$Y^2 = 4(\pi f L Q G_m)^2 \frac{1 + n^2 + \sqrt{AK}n + AK^2/4}{1 + K^4 + n^4 + 2K^2 - 2K^2n^2} \quad (7)$$

The over-all sensitivity will then be equal to two times the first derivative (of this expression) with respect to n , (at $n=0$) multiplied by the applicable detection constant. This gives

$$S' = 4(\pi f L Q G_m)^2 \frac{\sqrt{AK}}{(1 + K^2)^2} \times (\text{det. const.}) \quad (8)$$

Maximizing with respect to K and solving for K as before, we have

$$K = \frac{1}{\sqrt{3}} \quad (9)$$

Therefore if square-law detectors are used the optimum coupling is independent of the ratio between secondary and primary inductance and is equal to $0.578 \times$ critical coupling.

III. CIRCUIT APPLICATION

So far, no mention has been made of methods for combining the direct-current output potentials (or currents) of the detectors to produce the differential effect. A simple voltage connection will be described in detail.

Referring to Fig. 4, circuits *I* and *II*, both tuned to the same frequency, are mutually coupled and connected together as described above. The reactance of the condenser C_3 between points *C* and *D* is

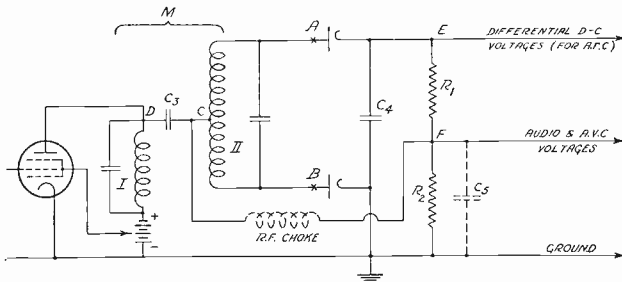

Fig. 4—If the radio-frequency choke and the condenser C_3 are not used a radio-frequency choke must be included in any external connection to the audio and automatic volume control point.

small at the frequency of operation and merely serves to isolate the direct-current plate potential of the primary. The diodes connected with their plates at points *A* and *B* are conventional except for the fact that for this circuit they must have separate cathodes. The two diodes in a type 6H6 tube fulfill this condition. The diode cathodes are connected together by means of the condenser C_4 , and one of them is also connected to ground. The condenser C_4 must have low impedance at the operating frequency and in general it will be desirable that it be low at useful modulating frequencies. Two resistors R_1 and R_2 are also connected, in series, between cathodes. Their resistances are equal and will usually be between 0.5 and 1.0 megohm. The center point *F* between them is connected to the center tap *C* on the secondary. The use of a radio-frequency choke in this connection is optional but if it is used the condenser C_3 (shown dotted in the diagram) must also be included and the two together will serve to decrease the effect of the resistors on the Q value of the primary.

The action is as follows. If the resonant or "center" frequency is

applied to the grid of the amplifier tube, equal amplified voltages will exist between the point A and ground and between the point B and ground. These are rectified by the diodes and direct currents will flow in the resistors R_1 and R_2 in opposite directions with respect to ground. Thus, the net direct-current potential produced by the two IR drops between E and ground is equal to zero. If, however, the applied frequency departs from resonance the potentials across the diodes will be unequal in magnitude, unequal IR drops will be produced in the two resistors and direct-current potential will exist between E and ground, the polarity of which will depend upon the sign of the frequency departure.

As has been indicated on the diagram, audio-frequency and automatic volume control voltages also may be derived from the rectified output of this circuit, as well as differential direct-current potentials. This is undoubtedly desirable in some cases of automatic frequency application in receivers, in order to avoid the use of additional tubes and tuned circuits.

If a carrier at the resonant frequency with normal "intensity" modulation but without frequency modulation, is applied to the system, the audio-frequency as well as the direct voltages across R_1 and R_2 will be equal and opposed. Therefore at resonance there will be no audio-frequency potentials between E and ground, and as far as audio components are concerned the system acts exactly as though point E were grounded with the outputs of the two diodes acting in parallel. Actually if C_4 is sufficiently large to have negligible reactance at the lowest modulating frequency, this is the case. Then the point F becomes a potent source of audio voltages to supply the audio-frequency amplifier system and no other audio detector is necessary. If automatic volume control voltages are also taken from the point F and it is necessary to maximize the alternating- and direct-current impedance ratio, it can be seen that the direct-current impedance is equal to one half the resistance of one of the resistors, even though R_1 and R_2 are not in parallel as far as direct current is concerned. The use of a normally active control element in an automatically controlled intermediate-frequency system will not allow the carrier to depart sufficiently far from resonance to hazard the above facts.

It can be seen that the direct-current potential between ground and the point F will have the proper polarity to be used for automatic volume control action, and that this potential will bear the same ratio to the developed audio voltages as is found in the conventional diode detector automatic volume control system. The fact that it minimizes at one side of resonance is of small significance if automatic frequency

control is used. When the automatic frequency control is cut out of circuit (manually) it is assumed that the point E will be grounded. This will cause the direct-current potential at F to maximize on resonance.

The only factor which determines the polarity of the automatic frequency control differential voltage developed at point E in Fig. 4 is the sign of the coupling between the two coupled tuned circuits. An examination of the circuit shows that any unbalance in the capacitances from either diode plate to ground takes on the nature of capacitive coupling between the tuned circuits. Likewise an unbalance in capacitances from either side of the secondary tuning condenser to ground has the same effect. Because of the mechanical construction of the average intermediate-frequency transformer, this unbalance will usually be sufficiently large to account for the major portions of the coupling when it is connected in circuit as in Fig. 4. For this reason it is best to phase the inductive coupling to oppose this external capacitive coupling (regardless of the direct-current polarity requirements) and to correct the over-all coupling by the addition of a small capacitance from the proper diode plate to ground so as either to increase or decrease the existing capacitance unbalance as the need may be. The direct-current polarity of the automatic frequency control voltage may be reversed, if necessary, by removing the ground from the one diode cathode and grounding the opposite one.

It should be noted that the "translation" gain (audio output/modulated intermediate-frequency input) of the system in Fig. 4 will be greater than with conventional circuits since the primary and half the secondary voltages are added (vectorially), and that the selectivity will approximate that of the primary alone.

An extension of the analysis in Section II reveals (as would be guessed) that modulation envelope distortion arises from the asymmetrical frequency discrimination. As expected, measurement shows that this distortion is not appreciable at low audio-frequency modulating frequencies, but that when S is desirably great, I and II being coupled to a desirable degree, this distortion is appreciable when the carrier is deeply modulated (say 80 per cent) at a frequency higher than (say) 3500 cycles. Of course deep modulation does not normally occur at high audio frequencies, but as the frequency is increased a lesser percentage modulation gives rise to distortion which is not unquestionably negligible. Consequently, it cannot be safely recommended that the audio-frequency output be taken across R_2 (Fig. 4) in a strictly high fidelity receiver.

Accordingly, note Fig. 5(a) which shows the audio-frequency de-

tector (diodes) driven by the primary (circuit 1). Of course this is the preferred method of audio-frequency detection when applying the automatic frequency control portion of Fig. 4 to a high fidelity receiver.

As shown in Fig. 5(b), both automatic volume control detection and audio-frequency detection may be applied at the primary (circuit 1), and of course the same or separate diode(s) may be used.

Fig. 5(c) shows another modification of Fig. 4. The automatic volume control point is "tapped down" on R_2 . As best determined by

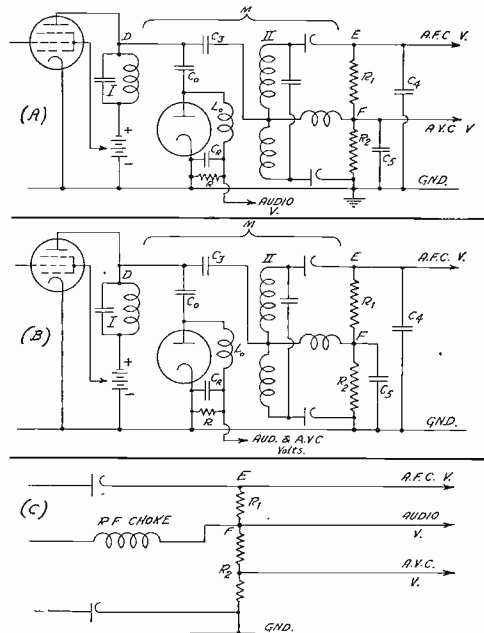

Fig. 5

experimental development, performance may in some cases be definitely improved by the "tapped R_2 " arrangement in Fig. 5(c). In Fig. 4 the automatic frequency control to automatic volume control direct voltage ratio does not exceed unity. In Fig. 5(c), unity may be exceeded when desirable.

In Figs. 5(a) and (b), of course C_0 should be small, and the ordinarily high Q choke L_0 must be large enough for $\omega L_0 > 1/\omega C_0$; e.g., the frequency of series resonance of C_0 and L_0 should be of the order of intermediate frequency/10. Also, L_0 should be so chosen that it does not establish parallel resonance with the diode plate: cathode capacitance (and circuit capacitance) at or near the intermediate frequency. To a first approximation, C_0 and C_R are the capacitances across R at audio frequency, from the standpoint of modulation envelope detection.

IV. THREE WINDING DISCRIMINATOR TRANSFORMERS

The selectivity of the audio-frequency output of the preceding circuits is low in comparison with that of the usual intermediate-frequency transformer. By the use of a third winding on the discriminator

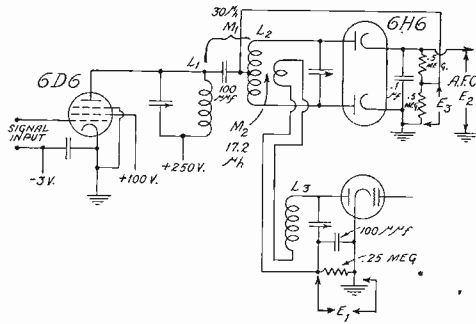

Fig. 6

transformer to supply the audio-frequency detector, the selectivity is much improved. One means, using a triple tuned circuit, is shown in Fig. 6.

The coupling is arranged so that L_3 is coupled only to L_2 and not to L_1 . This may be done, as shown schematically in Fig. 6 by using a few coupling turns close to L_2 . These turns are shown at the center of L_2 ,

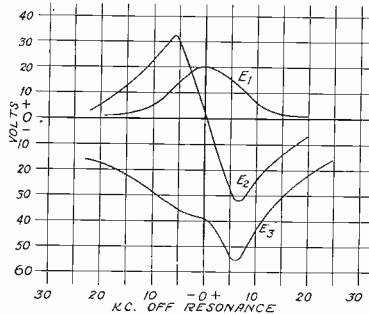

Fig. 7

and this arrangement should be followed physically also, in order to keep the capacitive coupling of L_3 symmetrical with respect to both sides of L_2 . In order to keep the capacitive coupling small and symmetrical, it is desirable to keep L_3 , and the leads thereto, well separated from L_2 , possibly to the extent of putting L_3 in a separate shield. The manner in which the rectified diode potentials vary with frequency is shown in Fig. 7.

Capacitive coupling dissymmetry produces departure from symmetry of both signal and automatic frequency control selectivity. The discriminator has little selectivity when the audio signal is taken from the center tap of the diode resistors, since the discriminator is primarily a phase responsive system. However, the discriminator acts as any tuned circuit, of the same Q and coupling, to a third circuit coupled to it, and the selectivity of the third circuit therefore is excellent.

Selectivity is only one of the characteristics of a discriminator circuit which are of interest in consideration of automatic frequency control action. In addition to audio selectivity, audio gain, automatic frequency control peak gain, automatic frequency control slope, and frequency separation of the automatic frequency control peaks are important.

The audio or signal gain may be expressed as the ratio of peak value of signal input on the grid of the intermediate-frequency stage driving the discriminator, to the direct voltage in the audio diode.

The automatic frequency control voltage reaches a maximum in the positive sense at some frequency off the resonant or center frequency, and a maximum in the negative sense on the opposite side of the resonant frequency. The magnitude and separation of these two automatic frequency control peaks and the slope of the characteristic passing through the center frequency, all are important in discriminator action. The automatic frequency control peak gain is the ratio of maximum direct voltage, in either positive or negative direction, to the peak value of carrier applied to the intermediate-frequency driver tube.

The slope varies in value dependent upon the frequency points between which it is evaluated. In the data below, the slope is that between points one kilocycle each side of the resonant frequency. The slope is expressed in volts per kilocycle for one volt peak carrier on the intermediate-frequency driver grid.

The frequency separation between the positive and negative automatic frequency control peaks is of importance not only because of its effect on the slope, but also in determination of the effective automatic frequency control selectivity. If the peaks are too widely separated the slope will be small, and if they are too close together signal modulation may be heard before the automatic frequency control acts as the frequency is varied.

TRIPLE TUNED CIRCUITS

Tertiary Coupled to Secondary

$$M_1 = 30\mu\text{h} \quad M_2 = 17.2\mu\text{h}$$

(1). Signal gain at resonance 34

(2). Signal selectivity

Δf	Voltage Ratio
+10 kc	4.7
-10 kc	3.3
+20 kc	45
-20 kc	30.5

(3). Automatic frequency control gain 59

(4). Automatic frequency control peak separation 13 kc

(5). Automatic frequency control slope 8.8. volts per kc per peak volt input

$$L_1 = L_2 = L_3 = 0.7 \text{ mh}$$

$$Q_1 = Q_2 = Q_3 = 110$$

$$f_0 = 460 \text{ kc}$$

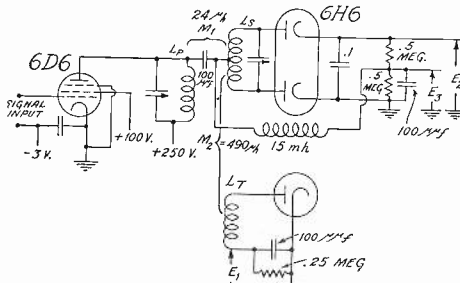

Fig. 8

The tertiary, in Fig. 6, acts to decrease the automatic frequency control slope and separate automatic frequency control peaks, since it acts as a resonant absorption circuit. Reduction of tertiary coupling

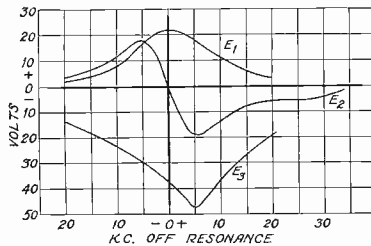

Fig. 9

decreases this effect, but also acts to decrease signal circuit gain. The automatic frequency control gain is good, but as pointed out above, the slope is somewhat decreased. The selectivity is better than that of a conventional diode stage using two tuned circuits.

Where selectivity less than that of the previous system can be tolerated, the tertiary tuning may be omitted as shown in Fig. 8.

The curves of Fig. 9 show that this system has less automatic frequency control gain, but steeper automatic frequency control slope, than the system of Fig. 6.

UNTUNED TERTIARY

$$M_1 = 24\mu\text{h} \quad M_2 = 490\mu\text{h}$$

(1). Signal gain at resonance 38.5

(2). Signal selectivity

Δf	Voltage Ratio
-10 kc	2.26
+10 kc	2.87
-20 kc	7.1
+20 kc	12.5

(3). Automatic frequency control gain 32

(4). Automatic frequency control peak separation 11 kc

(5). Automatic frequency control slope 12.8 volts per kc per peak volt input.

In this system, as in the ones discussed previously, it is important to keep capacitive coupling low and symmetrical with respect to the discriminator.

V. DERIVATION OF AUTOMATIC VOLUME CONTROL

The circuits shown in Figs. 6 and 8 use separate diodes for automatic frequency control and signal purposes. The use of separate diodes imposes additional power output requirements on the intermediate-frequency tube driving the diodes. Voltage for automatic volume control purposes may be derived either from the center tap of the discriminator or from the signal circuit. As shown in Figs. 7 and 9, voltage E_2 derived from the discriminator is not symmetrical with respect to resonance, so that if this voltage be used for automatic volume control purposes, the gain of the receiver will be higher on one side of the intermediate-frequency resonant frequency than on the other, producing asymmetry of automatic frequency control action.

By using voltage E_1 , derived from the signal circuit, for automatic volume control purposes, it will be symmetrical about resonance. At normal bias the intermediate-frequency stage will drive the diodes satisfactorily, but at high bias, such as would be produced by full automatic volume control on the intermediate-frequency stage, curvature of the characteristic may occur. This is shown in Fig. 10 where the

direct voltage, E_1 , in the signal circuit is plotted as a function of root-mean-square signal on the intermediate-frequency grid. These curves were taken with the circuit arrangement of Fig. 6. Somewhere in the neighborhood of 20 volts will be required for automatic volume control action in order to secure adequate control of large signals, assuming three tubes controlled. In order that the audio output of the signal diode shall be free from distortion, the characteristic should be straight.

The range of signal inputs over which the characteristic is straight determines the modulation percentage which may be handled without distortion. For 100 per cent modulation the peak signal must swing from zero to twice the carrier level. We may use the root-mean-square volts of Fig. 6 similarly, since they are proportional to peak volts.

With 20 volts intermediate-frequency bias, to derive 20 volts automatic volume control is seen to require 5.36 volts carrier. For 100 per

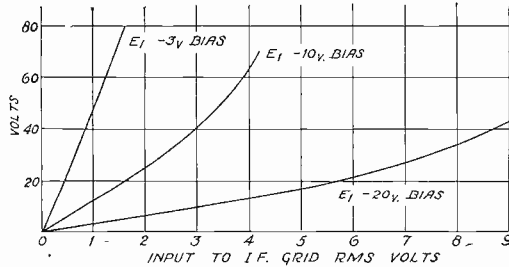

Fig. 10

cent modulation, twice this input is instantaneously applied and for such applied signal the characteristic is seen to depart appreciably from a straight line. However, if we use only half of the developed automatic volume control voltage on the intermediate-frequency tube, or ten volts, when the total developed automatic volume control is twenty volts, 1.6 volts of signal is required.

The characteristic is seen to be very nearly a straight line up to the 8.2-volt input required for 100 per cent modulation, under these conditions.

Thus it results, by applying half automatic volume control to the intermediate frequency driving the diodes, and full automatic volume control to the other tubes, that large signals can be handled without appreciable distortion, using the discriminator systems described above.

VI. CONTROL CIRCUITS

The fundamental operating conditions and requirements for the control circuit, whereby direct voltage differences developed by the discriminator are converted into reactance variations, have been set

forth in the paper by Travis.¹ Additional data are given below which is believed, will be helpful in application of these principles to radio receivers.

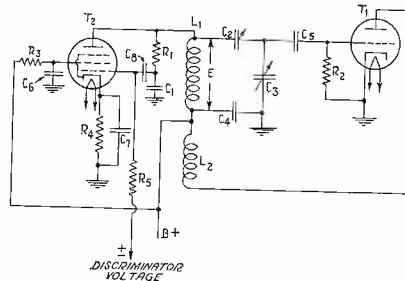

Fig. 11

Let us consider the circuit of Fig. 11 shown in simplified form in Fig. 12.

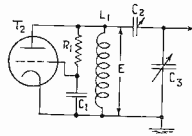

Fig. 12

Here,

- E is tank circuit voltage
- i_1 is current in circuit R_1C_1
- G_m is mutual conductance of control tube T_2
- i_p is plate alternating current of T_2
- e_g is grid alternating voltage of T_1
- Z_0 is effective impedance of T_3 .

A high impedance radio-frequency pentode will ordinarily be used for the control tube so we can neglect r_p . We can also neglect the resistance of L_1 . Then,

$$i_1 = \frac{E}{R_1}$$

since in practice

$$R_1 \gg \frac{1}{j\omega C_1}$$

$$e_g = \frac{i_1}{j\omega C_1} = \frac{E}{j\omega C_1 R_1}$$

$$i_p = e_g G_m = \frac{E G_m}{j\omega C_1 R_1}$$

$$Z_0 = \frac{E}{i_p} = \frac{j\omega C_1 R_1}{G_m}$$

Since Z_0 varies directly as frequency it has the nature of inductance. If we call the virtual inductance due to the control tube L_0 ,

$$L_0 = \frac{C_1 R_1}{G_m}. \quad (10)$$

If R_1 is not large compared to $\frac{1}{j\omega C_1}$, then $Z_0 = \frac{j\omega C_1 R_1 + 1}{G_m}$.

If an inductance L_A were used in place of C_1 ,

$$Z_0 = \frac{R_1}{j\omega L_A G_m}.$$

In this case Z_0 is effectively a capacitance since it varies inversely as the frequency.

The use of capacitance in the grid of the control tube has several advantages:

1. The Q of condensers is generally higher than that of inductances so that the control tube acts as a more nearly pure reactance.
2. The distributed capacitance frequently resonates an inductance within the frequency band used, so that the control action disappears at that frequency.
3. A capacitance appears as an inductance in parallel with the tank circuit inductance, so that the frequency shift is a constant percentage of the resonant frequency throughout the tuning range.

In the circuit of Fig. 11 the padding condenser, C_2 , is placed at the high potential side of the circuit so that the control tube may be connected directly across L_1 . If the control tube is placed in parallel with L_1 and C_2 in series, a certain amount of control is lost at the low-frequency end of the band. The combination of L_1 and C_2 is resonant below the band, and at such frequency the control tube would have no effect. The circuit of Fig. 11 shows a blocking condenser C_4 connecting the low side of the tank inductance to ground, so that plate voltage may be applied to the control tube through L_1 .

Another means of connecting the control tube is shown in the simplified circuit Fig. 13. In this case the control tube is coupled to the tank circuit inductively.

Here again,

E is tank circuit voltage

e_g is alternating-current grid potential of control tube

T

G_m is mutual conductance of T

e' is equivalent series voltage in tank circuit

i_p is plate alternating current of T_2

Z' is equivalent control reactance.

Then assuming that r_p of control tube is large compared with $j\omega L_2$ and $\omega^2 M^2 / r_L$,

$$e_g = \frac{E}{j\omega C_1 R_1}$$

$$i_p = e_g G_m = \frac{E G_m}{j\omega C_1 R_1}$$

$$e' = \pm j\omega M i_p = \frac{\pm j\omega M G_m E}{j\omega C_1 R_1} = \frac{M G_m}{C_1 R_1} E.$$

Let,

$$\frac{M G_m}{C_1 R_1} = A.$$

Then,

$$e' = \pm A E.$$

Let i_1 be current in L_1

$$E = i_1 j\omega L_1 + i_1 Z'$$

$$e' = -i_1 Z'$$

$$E = i_1 j\omega L_1 \pm A E$$

$$i_1 = \frac{E \mp A E}{j\omega L_1}$$

$$e' = -\frac{E \pm A E}{j\omega L_1} Z = \mp A E$$

$$Z' = j\omega L'.$$

Where L' is equivalent control inductance

$$L' = L_1 \frac{\mp A E}{E \pm A E} = L_1 \frac{\mp A}{1 \pm A}, \quad \text{but } A = \frac{M G_m}{C_1 R_1}$$

$$L' = \frac{L_1}{\frac{C_1 R_1}{\pm M G_m} - 1} \quad (11)$$

L' then may be either positive or negative depending upon whether M is positive or negative. Note that in this case L' is the equivalent in-

ductance in series with the tuned circuit, whereas in Figs. 11 and 12 the equivalent inductance is in parallel. The equivalent inductance in the case of Figs. 11 and 12 is positive so that an increase in G_m of the control tube decreases L_0 thus causing the oscillator frequency to increase.

In the circuit of Fig. 13 increase in G_m of the control tube can cause either an increase or a decrease in oscillatory frequency dependent upon the sense of the mutual inductance. In general the circuit of Fig. 11 is to be preferred to that of Fig. 13, since, for the same control

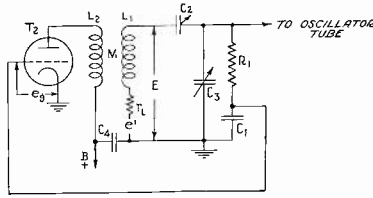

Fig. 13

effect more capacitance is added by Fig. 13, reducing the available tuning range. This additional capacitance is due to capacitance between L_2 and L_1 .

Another possible control circuit is shown in Fig. 14. Here T_1 is a radio-frequency pentode, such as a 6J7 with the screen acting as the anode for the oscillatory circuit and with control voltage taken off

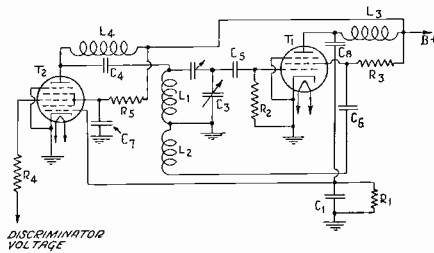

Fig. 14

across condenser C_1 in the plate circuit. Here the control tube T_2 is a 6L7 with radio-frequency control voltage applied to grid No. 1 and the direct voltage from the discriminator applied to grid No. 3. The radio-frequency voltage also develops the bias for grid No. 1 across R . L_3 and L_4 are chokes for supplying direct current to plates of the oscillator and control tubes, respectively. This type of control circuit produces an equivalent negative inductance across L_1 so that increasing mutual conductance of the control tube lowers the frequency of the oscillator.

The use of the 6L7 control tube as shown permits of somewhat

greater control range than other systems, but care must be taken to operate the tube, by reducing screen voltage or otherwise, so that the maximum safe cathode current is not exceeded when the discriminator voltage swings positive. If spurious oscillation or blocking occurs, reduction of value of R_1 will be found helpful in eliminating this effect.

VII. OSCILLATOR CONSIDERATIONS

In the broadcast band as the signal frequency varies from 540 to 1600 kilocycles, the oscillator frequency will vary from 1000 to 2060 kilocycles with an intermediate frequency of 460 kilocycles. Equation (10) shows that the oscillatory voltage, E , does not directly affect the amount of control. However, voltage E with a given R_1 and C_1 does determine the potential e_g appearing at the grid of the control tube. When the peak radio-frequency voltage e_g exceeds the bias on the control tube, no further control can take place and therefore the voltage E determines the value of R_1 and C_1 which can be used without exceeding the bias.

From this standpoint, the lower the value of E the more control which can be obtained. However, the voltage must be high enough to give adequate translation, and such that there is no likelihood of the oscillator ceasing to function on low line voltage. The impedance of C_1 varies inversely with frequency, so that for uniformity of control voltage E should vary directly with frequency. Fortunately, most oscillators with simple mutual inductance coupling have such a characteristic. If the voltage E is too great at the low-frequency end, a resistor in series with L_3 will decrease oscillation strength more at this end of the band than at the high frequency end. Conversely, a parallel resistor will affect the oscillation more at the high-frequency end than at the low-frequency end. The control limitation with bias on the control tube is governed by cutoff with negative potential from the discriminator, and by control tube grid current with positive discriminator potentials. Cutoff is not affected by the oscillatory voltage whereas the grid current point is, so if the oscillator voltage does not vary inversely with the impedance across which the control tube is connected, the amount of frequency shift will not be uniform about the axis of zero discriminator potential.

VIII. CONTROL TUBE

As we have seen from (10) the amount of control is proportional to G_m , but is also affected by the control grid voltage for this G_m , since a high value of bias permits R_1 or C_1 to be smaller for a given oscillatory voltage. Consequently maximum control is proportional to

the product of G_m and E_c . Sensitivity of control is however another important requirement, since we wish the frequency change to be as large as possible for a given change in bias. This means the tube should be of the short cutoff type. Further requirements are high r_p , linear change of G_m with bias, and for economy, low plate and screen currents. All of these requirements are best met by the short cutoff, radio-frequency pentodes such as 57, 77, 6C6, and 6J7. Except for plate impedance requirement the 53 and 6A6 are excellent, and these tubes might be used in the coupled type of control circuit shown in Fig. 8 where M could be chosen so that plate impedance would not have as great an effect on the oscillatory circuit. As pointed out in connection with Fig. 9 the 6L7 may be used with radio-frequency voltage on No. 1 grid and direct current on No. 3 grid. The variation of G_m with No. 3 grid bias is substantially linear but the cutoff is slightly more remote than the 6C6 or 6J7, so more discriminator voltage is required. Operation at reduced screen voltages is required to prevent excessive cathode current.

The 6C6 or 6J7 will in general be used so that we shall consider them in greater detail.

By proper choice of R_1 and C_1 the maximum amount of frequency shift can be adjusted to suit required conditions. An example will illustrate this fact. The oscillatory voltage E is primarily affected by R_1 , and but little by C_1 , so R_1 should be adjusted first for proper E over the range and then C_1 to govern the amount of control. Assume $E = 25$ volts peak, $R = 50,000$ ohms.

Then if $X_c = 1000$ ohms, cutoff in positive direction will be at 0.5 volt. If $X_c = 4000$ ohms, cutoff in positive direction will be at 2 volts. G_m at 0.5-volt bias on a 6J7 is 1760 micromhos. G_m at 2.0-volt bias on a 6J7 at 1500 micromhos so as the value of C_1 is changed to vary L_0 4 to 1, the value of G_m changes L_0 only 17 per cent in the opposite direction.

The table below illustrates variation of control possibility with bias for a 6J7 at 250 volts plate and 100 volts screen.

E_c volt	G_m micromhos	$G_m \times E_c$
0.2	1800	360
0.5	1760	880
1	1700	1700
2	1500	3000
3	1250	3750
4	900	3600
5	450	2250
6	140	840
7	40	280

We see then that circuit values chosen to give three volts peak oscillator on the control tube will give maximum control for a 6J7.

The normal operating bias will be halfway between this value and the value of bias for cutoff in the negative direction. Since cutoff is approximately 7.5 volts the initial bias with zero discriminator potential should be 5.25 volts. A typical control curve is shown in Fig. 15.

IX. CONCLUSION

In an experimental receiver using the system described above it has been found that a discriminator sensitivity of 20 volts per kilocycle and a control sensitivity of 7 kilocycles per volt can be easily obtained, so

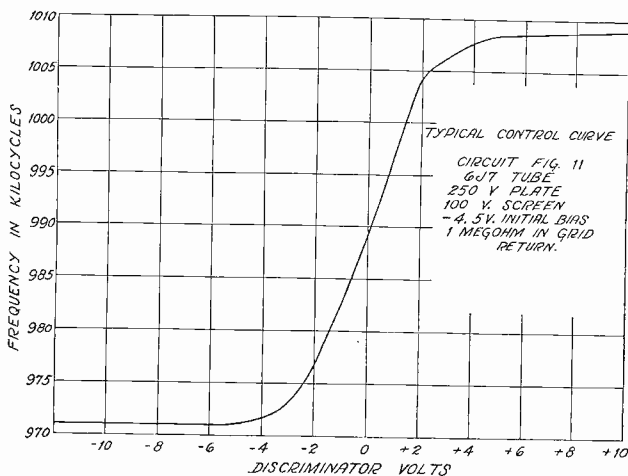

Fig. 15

that an over-all control ratio of 140 to 1 results. A tuning misadjustment of 7 kilocycles will result in only a 50-cycle shift of the intermediate frequency.

The use of alternating frequency control on the short-wave bands has the very much needed advantage of making the tuning operation easier. The tuning control has to be moved only until the frequency is close enough to resonance that the discriminator will develop sufficient voltage to bias the control tube the amount required for the departure from resonance. Short-wave stations are thus "spread out" on the dial, making them easier to locate and easier to hold.

In the broadcast band this characteristic would have the disadvantage that the receiver would appear to laymen to be broad in tuning in comparison with receivers without automatic frequency control. This apparent disadvantage can be eliminated by combining the alternating frequency control switch with the tuning mechanism

so that the automatic frequency control automatically becomes inoperative during the tuning operation.

The above-mentioned characteristic of automatic frequency control makes possible the use of mechanisms to provide the user with simplified tuning and many types of mechanism will suggest themselves to the development engineer. Some of these devices have been attempted in the past, but the extreme mechanical precision necessary for accurate tuning, and changes of electrical constants of various parts in service, made them impractical. Automatic frequency control removes these limitations, and its use opens up the possibility of new and novel tuning arrangements which provide the broadcast receiver with additional attractiveness, and the user with easier and better operation.



SIMULTANEOUS RADIO RANGE AND TELEPHONE TRANSMISSION*

BY

W. E. JACKSON AND D. M. STUART

(Bureau of Air Commerce, Washington, D. C.)

Summary—*Simultaneous radio range and telephone service has been in demand on the airways of the United States for several years. A simple method of obtaining this service has been developed and is now being gradually applied to the airways.*

Various methods of obtaining simultaneous service are discussed. The effect of linear and square-law detection used with single side-band and double side-band transmission of the range tone have been analyzed. The single side-band method appears to offer the most practical solution to the problem when used with a linear detector.

RADIO ranges and radiotelephones which have been installed by the Department of Commerce have contributed a great deal toward the safety of air navigation; however, it has become evident that there are definite limitations in the method of operation of this equipment which greatly restrict its usefulness in practical application. Fundamentally the major limitation is that neither range nor broadcast service is continuous due to the fact that the range has to be shut down while the broadcast is made and vice versa. This means that a pilot who may require continuous range service is forced to stand by during the weather broadcasts by circling at the point where the range service was removed or in the event that continuous range service is being furnished to another pilot, he must continue his flight without the aid of the weather broadcasts. In 1927 and 1928 when radio ranges and telephone stations were first installed in the United States, it was the policy to broadcast weather on one radio frequency and give radio range service on another radio frequency removed by approximately thirty kilocycles. This method of operation had the advantage of being continuously available to the pilot, but had the disadvantages of being wasteful of radio-frequency channels, necessity of pilot having to retune the receiver to the telephone frequency at specific times, and difficulty involved in notifying pilot listening to the range that a special broadcast was being made. In 1929 numerous requests for the alternate use of radio range and broadcasts on the same frequency were made. This together with the fact that there were relatively few radio frequencies available brought the change in policy

* Decimal classification R526.1. Original manuscript received by the Institute, October 5, 1936.

which established both services on the same radio frequency. This method of operation was in effect from 1929 to 1934. In 1934, it became necessary to give continuous range operation upon request except for broadcasting local conditions which required approximately ten seconds. Also, a number of stations each operated on 236 kilocycles were installed at busy terminals so that other than local weather broadcasts could be made on this frequency at the regular broadcast periods when continuous range service was requested. In 1935, at the request of the air lines, continuous range service was inaugurated at six terminal stations on the regular radio-frequency channel with all broadcasts on 236 kilocycles. At other stations continuous range service was made available on specific request, the weather broadcasts being entirely omitted. The 236-kilocycle broadcast schedules were staggered in order to eliminate heterodyne interference. This method of operation could be successfully applied to a few stations, but could not be applied to the entire airways system employing over a hundred stations because of excessive interference which would occur due to overlapping schedules.

From the foregoing, it is apparent that continuous radio range operation is at times of greater importance to the pilot than the weather broadcasts. The rapidly increasing air traffic condition and the need for instantaneous communication between air traffic control ground stations and all aircraft, will cause the weather broadcast stations to take over a more valuable function than ever before. It is with these factors in mind that the Bureau of Air Commerce has been endeavoring to develop a system which would provide for continuous range and broadcast service.

The general method of attack has been to transmit weather broadcasts and radio range signals simultaneously on the same radio-frequency channel and separate them by means of audio-frequency filters in the receiver output. In order to accomplish this, two separate antenna systems are used at the transmitting station. A single tower radiates a circular carrier frequency (f_c) field pattern which is modulated by speech during weather broadcasts and which at all times heterodynes with a fixed frequency single side band ($f_c + 1020$) radiated directionally from four towers, symmetrically disposed about the broadcast tower, and keyed in the conventional A-N manner to produce the range courses. (See Figs. 1 and 2.)

The audio frequency selected for the range is 1020 cycles which appears to be best from several considerations such as, minimum masking effect due to engine noises and static, easily readable, and may be produced readily by means of synchronous machines, if required. The

1020-cycle audio-frequency difference between carrier and single side band may be obtained either from a single side-band generator modulated by a synchronous alternator or a tuning fork or by means of two matched A-cut quartz plates which excite two separate radio-frequency channels. Both methods have been used although the latter method

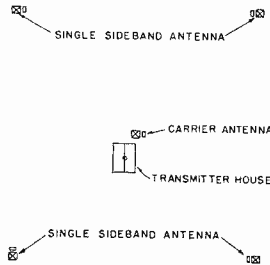

Fig. 1—Layout of radio range plot and antenna system.

has proved to be simpler and more reliable. In order to avoid interference between the 1020-cycle heterodyne, and the speech frequencies during weather broadcasts, a filter which eliminates the band of frequencies between 830 and 1252 cycles is inserted in the line which carries the speech input to the modulator of the carrier transmitter. A similar filter is used in the output of the aircraft receiver to pass the

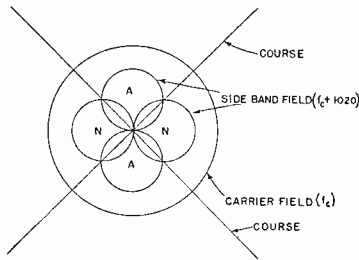
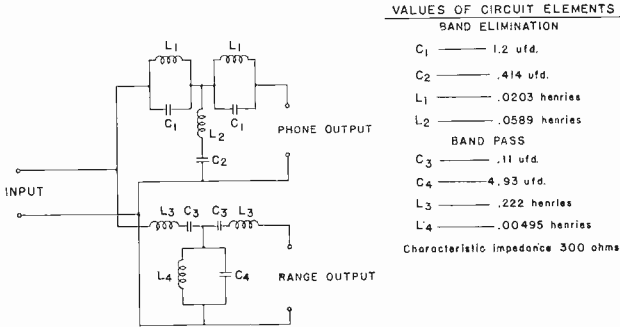

Fig. 2—Field pattern of simultaneous radio range and broadcast station.

voice frequencies and eliminate the range signal, in conjunction with a band-pass filter which passes only the range signal and eliminates the voice frequencies. This combination permits optional reception of either range or weather broadcasts or the simultaneous reception of both if one pilot flies the range while the other receives the weather. Fairly satisfactory simultaneous reception of both services is also possible without the use of a filter, as the pilot may concentrate on either service desired; however, the use of a filter is highly desirable in order to realize the full advantages of the simultaneous system.

The filter unit which has been developed consists of a single section band-pass and a single section band-elimination filter connected with parallel inputs. This unit is very compact, weighs only three and a



VALUES OF CIRCUIT ELEMENTS

BAND ELIMINATION	
C ₁	1.2 ufd.
C ₂	.414 ufd.
L ₁	.0203 henries
L ₂	.0589 henries
BAND PASS	
C ₃	.11 ufd.
C ₄	4.93 ufd.
L ₃	.222 henries
L ₄	.00495 henries

Characteristic impedance 300 ohms

Fig. 3—Schematic diagram of aircraft filter unit.

quarter pounds and is relatively inexpensive. The band-pass section is designed for minimum attenuation at 1020 cycles with cutoff frequencies at 919 and 1132 cycles. The characteristic impedance is 300 ohms at the frequency of minimum attenuation. The band-elimination

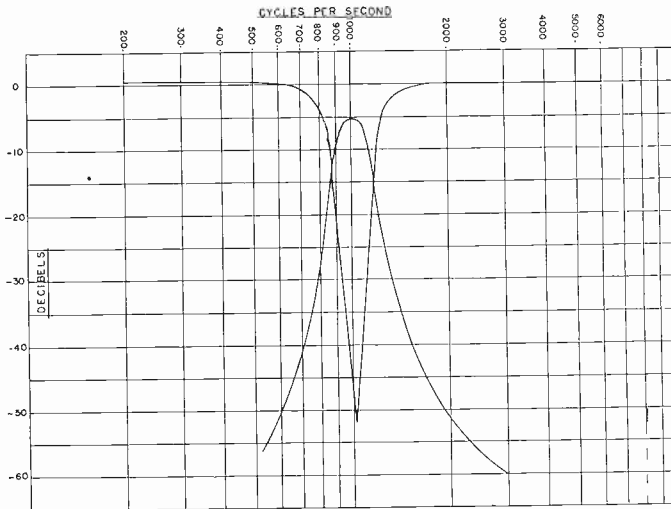

Fig. 4—Characteristic curves of aircraft filter unit.

section is designed for maximum attenuation at 1020 cycles with cutoff frequencies of 830 and 1252 cycles. The characteristic impedance is 300 ohms at 2000 cycles, and remains substantially constant over the non-attenuating range.

In Figs. 3 and 4 are shown a schematic diagram and characteristic curves of the complete aircraft filter. Mechanically the entire unit is constructed in a case $2\frac{1}{2}'' \times 3\frac{1}{4}'' \times 5''$.

The band-elimination filter which is used in the microphone circuit at the transmitter consists of two sections of the same type as are used in the aircraft. The cutoff frequencies are 830 and 1252 cycles with maximum attenuation at 1020 cycles and the characteristic impedance is made 600 ohms at 2000 cycles to match the impedance of the line and line amplifier equipment. The characteristic curve of this filter is shown in Fig. 5.

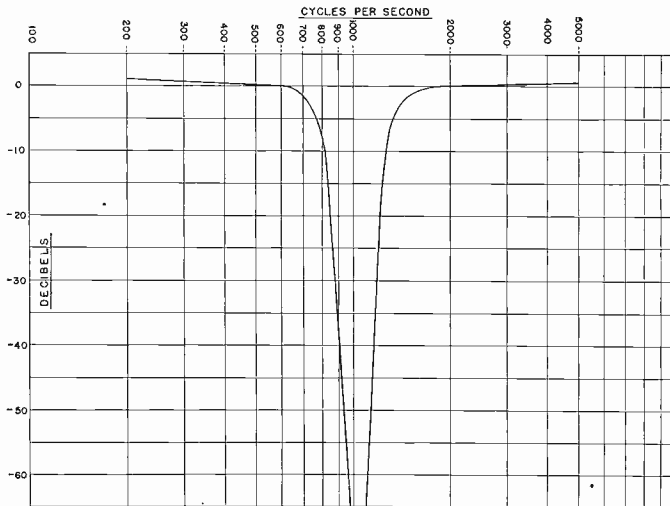

Fig. 5—Characteristic curve of the band-elimination filter used at the transmitting station to eliminate frequencies in the neighborhood of 1020 cycles from the speech during broadcasts.

The filter which has been adopted is probably the best compromise under the prevailing circumstances. While it would be highly desirable to reduce the minimum attenuation of the aircraft band-pass section below the 6.0 decibels which is obtained, it is necessary to consider the increased weight and bulk which would result if this was done. If a sharper band-pass characteristic is used, difficulty is encountered in the form of high insertion loss and ringing following static crashes or any form of transient noise, and no particular advantage is gained from the standpoint of voice interference with the range signals. This latter is governed chiefly by the distortion present in the receiver detector rather than by direct interference between speech and range signals through the filter.

The method of detection used in the reception of simultaneous range and telephone transmission is an important phase of the development. An analysis of the detection of the type of signal under

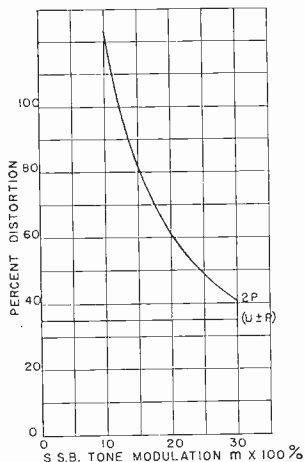

Fig. 6—Square-law detection of a single side-band tone for a fixed superimposed speech modulation of $M = 0.70$. Distortion expressed as per cent single side-band tone fundamental.

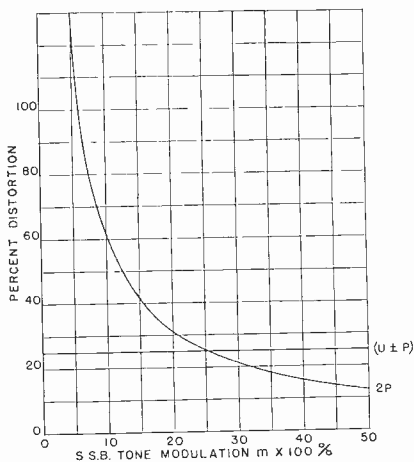

Fig. 7—Square-law detection of a single side-band tone for a fixed superimposed speech modulation of $M = 0.50$. Distortion expressed as per cent single side-band tone fundamental.

consideration by means of a square-law or parabolic rectifier shows that the distortion is so great as to render its use impractical in the present application. (See Figs. 6 and 7.) However, if a linear detector is used, the distortion is not excessive provided the single side-band

modulation does not exceed thirty per cent and the speech modulation does not exceed seventy per cent. The most serious type of distortion

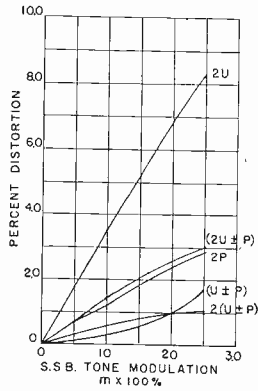

Fig. 8—Linear detection of a single side-band tone for a fixed superimposed speech modulation of $M=0.70$. Distortion expressed as per cent of single side-band tone fundamental.

is that which gives rise to frequencies of $(P \pm U)/2\pi$, $(P \pm 2U)/2\pi$, $(2P \pm U)/2\pi$, $(2P \pm 2U)/2\pi$, etc.,¹ all of which may be of such a value as to pass through the aircraft band-pass filter, and cause interference

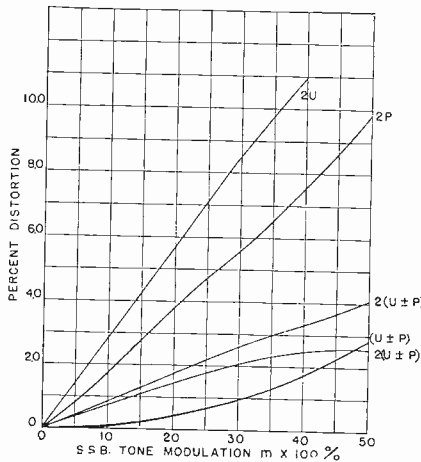

Fig. 9—Linear detection of a single side-band tone for a fixed superimposed speech modulation of $M=0.50$. Distortion expressed as per cent of single side-band tone fundamental.

with the range signals in addition to their deleterious effect on the quality of the voice. Also harmonic distortion of the range signals

¹ Refer to Appendix for definitions of P and U .

passes through the band-elimination filter and interferes with the speech during broadcasts; however, this type of interference is much less serious than the former. From the curves of Fig. 8, it may be seen that no serious distortion of any kind occurs if the percentage of single side-band modulation does not exceed thirty. In Fig. 9, it may be seen that the distortion increases if the voice modulation is decreased to fifty per cent and the single side-band modulation is increased to fifty per cent.

The chief advantages of the single side-band system, as employed here lies in the simplicity of the equipment required and the fact that variation in phase between the carrier and single side band has no effect. Two transmitters, one of which can be modulated by speech,

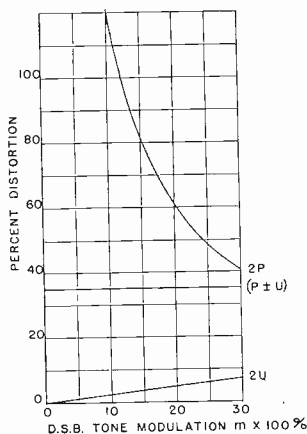

Fig. 10—Square-law detection of a double side-band tone for a fixed superimposed speech modulation of $M = 0.70$. Distortion expressed as per cent of tone fundamental.

together with the antenna and coupling apparatus which is used at all ranges is all of the radio-frequency equipment that is necessary for simultaneous transmission. Perhaps the most objectionable feature of the single side-band system is the necessity for operating the single side band at moderate percentages of modulation in order to avoid high detector distortion when the voice and range signals are transmitted simultaneously.

It is possible to obtain distortionless reception at considerably higher levels of modulation if two side-band frequencies, symmetrical with respect to the carrier, are transmitted from the corner towers, and the receiver detector characteristic is essentially linear. Square-law detection of this type of transmission will cause excessive distortion which will render the range and telephone signals unsatisfactory. (See Figs. 10 and 11.) In order to provide for double side-band transmission,

it is necessary that both transmitters be excited from a common radio-frequency source, and that the side-band transmitter be of the balanced modulator suppressed carrier type. Also means must be provided

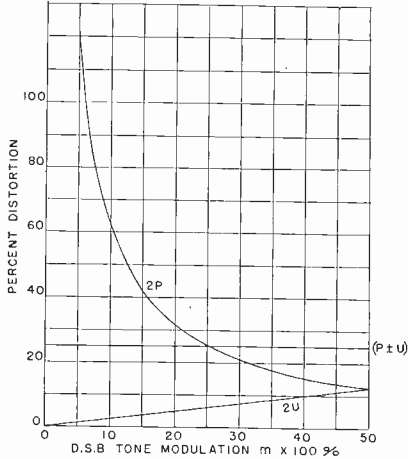

Fig. 11—Square-law detection of a double side-band tone for a fixed superimposed speech modulation of $M = 0.50$. Distortion expressed as per cent of tone fundamental.

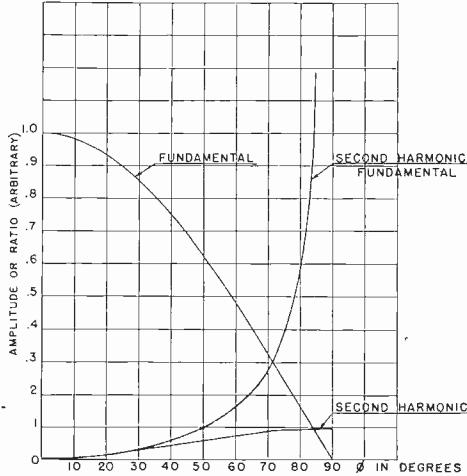

Fig. 12—Curves showing the relationship between fundamental and second harmonic output from linear detection of double side-band transmission as the carrier phase is varied.

for adjusting and maintaining the phase of the carrier so that it is of the proper value to combine with the side bands in the receiver detector. While the carrier phase is not very critical, some distortion will be

present unless it is maintained within approximately plus or minus thirty degrees of the correct value. (See Fig. 12.) The most objectionable feature of the double side-band system is the necessary use of a balanced modulator with matched tubes in the modulated radio-frequency amplifier. Little experience has been had with the operation of this type of equipment, but it is anticipated that considerable maintenance would be necessary to insure satisfactory operation at all times.

On the other hand, the double side-band system has the advantage that this is much freer of distortion than the single side-band system and permits the use of higher modulation percentages with a consequent economy of power. A discussion of detector distortion of single and double side-band transmission as it relates to the problem of providing simultaneous radio range and telephone transmission appears in the appendix.

APPENDIX

Detector Distortion for Cases of Single and Double Side-Band Transmission

Inasmuch as a brief analysis of square-law detection of the single and double side-band transmission under consideration discloses the fact that in each case the resulting distortion is of sufficient magnitude as to render its use impracticable in the present application (see Figs. 6, 7, 10, and 11) we shall confine ourselves to consideration of the linear type of detector.

Double Side-Band Case

If a speech modulated carrier is radiated from the center tower and two symmetrical side bands from the corner towers, the voltage input to a receiver at some remote point will be given by

$$E_o = E \left((1 + M \cos Pt) \cos (Wt + \phi) + \frac{m}{2} \cos (W + U)t + \frac{m}{2} \cos (W - U)t \right) \tag{1}$$

where,

- $W/2\pi$ = radio carrier frequency
- $P/2\pi$ = speech modulation frequency
- $U/2\pi$ = side-band modulation frequency
- ϕ = arbitrary phase angle assigned to the carrier
- E = carrier voltage
- $M \times 100$ = per cent modulation of the carrier by speech frequency $(P)/(2\pi)$
- $m \times 100$ = per cent modulation of the carrier by side-band modulation frequency $(U)/(2\pi)$.

We may rewrite (1) in the form

$$E_0 = E \left((1 + M \cos Pt)^2 + 2m \cos \phi \cos Ut (1 + M \cos Pt) + m^2 \cos^2 Ut \right)^{1/2} \cos (Wt - \delta) \quad (2)$$

where $\delta = f(U, t)$ may be neglected without affecting the calculation of the audio frequencies.² If a voltage of the form (2) is applied to a linear detector, the detector output will be directly proportional to the coefficient of $\cos (Wt + \delta)$. If we put $\phi = 0$, the detected signal will be

$$E_0' = E'((1 + M \cos Pt) + m \cos Ut) \quad (3)$$

and no distortion will occur provided

$$m + M < 1. \quad (4)$$

If ϕ has a value other than zero the detected signal will be given by

$$E_0' = E' \left((1 + M \cos Pt)^2 + 2m \cos \phi \cos Ut (1 + M \cos Pt) + m^2 \cos^2 Ut \right)^{1/2} \quad (5)$$

from which the frequency components must be obtained by expansion.

We may rewrite (5) as

$$E_0' = E'(1 + M \cos Pt)(1 + 2Z \cos \phi + Z^2)^{1/2} \quad (6)$$

or,

$$E_0' = E'(1 + M \cos Pt)(1 + 2Z \cos \phi + Z^2)(1 + 2Z \cos \phi + Z^2)^{-1/2} \quad (7)$$

where,

$$Z = \frac{m \cos Ut}{1 + M \cos Pt} < 1.$$

The function $(1 + 2Z \cos \phi + Z^2)^{-1/2}$ may be expanded in a power series in Z , the coefficients of which are Legendrian polynomials in $\cos \phi$; i. e.,

$$(1 + 2Z \cos \phi + Z^2)^{-1/2} = \sum_{n=0}^{n=\infty} P_n(\cos \phi) Z^n.$$

The terms $(1 + M \cos Pt)^{-a}$ which occur may in turn be expanded by the binomial theorem and the frequency components determined. Carrying out this process we obtain

² C. B. Aiken, Proc. I.R.E., vol. 21, pp. 601-630; April, (1933).

$$\begin{aligned}
E_0' = E' & \left(\left(1 + \frac{m^2 \sin^2 \phi}{4} + \frac{3m^4 \sin^2 \phi}{64} \right) (5 \cos^2 \phi - 1) \right. & (8) \\
& + m^8 \sin^2 \phi (35 \cos^4 \phi - 14 \cos^2 \phi + 1) + \dots \\
& \left. + m^2 M^2 \sin^2 \phi + \frac{9}{64} m^4 M^2 \sin^2 \phi (5 \cos^2 \phi - 1) + \dots \right) \\
& + M \left(1 - \frac{m^2 \sin^2 \phi}{4} - \frac{9m^4}{64} \sin^2 \phi (5 \cos^2 \phi - 1) - \dots \right) \cos Pt \\
& + M^2 \left(\frac{m^2 \sin^2 \phi}{8} + \frac{9m^4}{64} \sin^2 \phi (5 \cos^2 \phi - 1) + \dots \right) \cos 2Pt \\
& - M^3 \left(\frac{m^2 \sin^2 \phi}{4} + \dots \right) \cos 3Pt \\
& + M \left(\frac{3m^3}{8} \cos \phi \sin^2 \phi + \frac{5m^5}{32} \sin^2 \phi (3 \cos \phi - 7 \cos^3 \phi) + \dots \right) \cos (U \pm P)t \\
& - M \left(\frac{m^2 \sin^2 \phi}{8} + \frac{3m^4}{32} \sin^2 \phi (5 \cos^2 \phi - 1) + \dots \right) \cos (2U \pm P)t \\
& + M \left(\frac{m^3}{8} \cos \phi \sin^2 \phi - \frac{5m^5}{64} \sin^2 \phi (3 \cos \phi - 7 \cos^3 \phi) + \dots \right) \cos (3U \pm P)t \\
& - M \left(\frac{3m^4}{128} \sin^2 \phi (5 \cos^2 \phi - 1) + \dots \right) \cos (4U \pm P)t \\
& + M^2 \left(\frac{m^2 \sin^2 \phi}{16} + \frac{3m^4}{32} \sin^2 \phi (5 \cos^2 \phi - 1) + \dots \right) \cos 2(U \pm P)t \\
& - M^2 \left(\frac{9m^3 \cos \phi}{32} \sin^2 \phi - \frac{25m^5}{128} \sin^2 \phi (3 \cos \phi - 7 \cos^3 \phi) + \dots \right) \cos (U \pm 2P)t \\
& - M^3 \left(\frac{9m^3 \cos \phi}{16} \sin^2 \phi + \dots \right) \cos (U \pm 3P)t \\
& - M^2 \left(\frac{3m^3 \cos \phi}{32} \sin^2 \phi - \frac{25m^5}{256} \sin^2 \phi (3 \cos \phi - 7 \cos^3 \phi) + \dots \right) \cos (3U \pm 2P) \\
& + \dots \\
& + m \cos \phi \left(1 - \frac{3m^2 \sin^2 \phi}{8} + \frac{5m^4}{64} \sin^2 \phi (3 - 7 \cos^2 \phi) + \dots \right. \\
& \left. - \frac{9}{16} m^2 M^2 \sin^2 \phi + \frac{25}{64} m^4 M^2 \sin^2 \phi (3 - 7 \cos^2 \phi) + \dots \right) \cos Ut \\
& + \frac{m^2 \sin^2 \phi}{4} \left(1 + \frac{m^2}{4} (5 \cos^2 \phi - 1) + \frac{3m^4}{32} (35 \cos^4 \phi - 14 \cos^2 \phi + 1) + \dots \right. \\
& \left. + \frac{M^2}{2} + 3m^2 M^2 (5 \cos^2 \phi - 1) + \dots \right) \cos 2Ut \\
& - \frac{m^3 \sin^2 \phi}{8} \left(\cos \phi - \frac{5m^2}{16} (3 \cos \phi - 7 \cos^3 \phi) + \dots \right. \\
& \left. + \frac{3}{2} M^2 \cos \phi - 25m^2 M^2 (3 \cos \phi - 7 \cos^3 \phi) + \dots \right) \cos 3Ut.
\end{aligned}$$

It may be seen by inspection of (8) that all of the distortion terms, with the exception of the even harmonics of U , are very small for values of ϕ even up to forty-five degrees, provided that m and M are each less than 0.50. It would thus appear, therefore, that in a practical application the phase angle ϕ could easily be maintained within limits which would render detection of this type of transmission essentially distortionless. In Fig. 12, curves of double side-band fundamental, and second harmonic against ϕ are shown for $M=0$ and $m=0.4$. It is seen that the effect of increasing ϕ from zero to ninety degrees is to reduce the fundamental output to zero and at the same time increase the even harmonic distortion.

Single Side-Band Case

When only a single side band is radiated from the corner towers to heterodyne with the speech modulated carrier the phase angle ϕ loses its significance, and the expression from which the detector output frequencies are to be calculated becomes

$$E_0' = E' \left((1 + M \cos Pt)^2 + 2m \cos Ut(1 + M \cos Pt) + m^2 \right)^{1/2}. \quad (9)$$

The frequency components obtained by expansion of (9) have already been calculated by Aiken.² In his notation this case is covered by putting his $m=0$ and our $m=k$. The curves of Figs. 8 and 9 shows the variation of distortion with percentage single side-band modulation for a fixed value of M . From an examination of these curves it is seen that the distortion is not great if the single side-band modulation is kept at a comparatively low level.

ACKNOWLEDGMENT

The authors wish to express their appreciation to R. P. Battle, A. E. Harrison, and S. D. Lavoie for their hearty co-operation in assisting in this development.

Bibliography

- (1) F. G. Kear and G. H. Wintermute, "Simultaneous radiotelephone and visual range beacon for the airways," *Proc. I.R.E.*, vol. 20, pp. 478-515; March, (1932); *Bur. Stand. Jour. Res.*, vol. 7, pp. 261-289; August, (1931), (RP 341).

² Aiken, *loc. cit.*, p. 620.



FREQUENCY ERRORS IN RADIO-FREQUENCY AMMETERS*

BY

J. D. WALLACE AND A. H. MOORE

(Naval Research Laboratory, Bellevue, Anacostia, D. C.)

Summary—This paper discusses from a theoretical standpoint the various types of frequency errors in thermal ammeters, describes methods of calibration of current measuring instruments at radio frequencies, and furnishes some data as to the accuracy of certain commonly used instruments at frequencies up to 100 megacycles. Frequency errors are determined in the low range instruments and in the high range instruments (ten amperes full scale or larger) at the lower radio frequencies (below thirty megacycles) by means of specially constructed tungsten filament lamps, a photoelectric cell, and a direct-current instrument for measuring the output of the cell, this equipment being used as a transfer device in comparing two currents, one at sixty cycles and the other at the applied radio frequency. Frequency errors in the high range instruments above thirty megacycles are determined by a substitution method. By this means, the reading of an ammeter under test may be compared with that of another instrument in which the frequency error has already been determined (with calibrating lamps, etc.), using an additional instrument in the circuit to insure that no change in circuit current has occurred. The following facts were established by this investigation: Frequency errors in many of the commonly used instruments are considerable at frequencies up to one hundred megacycles; the direction of these errors is such as to cause the instrument to indicate too great a current; the error becomes greater as the full scale current range of the instrument increases, in any particular design of instrument except in the case of the sensitive instruments (0.5 ampere full scale or less); frequency errors in a well-designed instrument of three amperes full scale or larger are due principally to "skin effect" in the instrument heater.

FOR many years the radio art has been in need of means of accurately measuring current—one of the fundamental electrical quantities—at high radio frequencies, and until recently, little investigation has been conducted upon this subject.

The two methods of high-frequency calibration of thermocouple ammeters described herein have been employed by other investigators, but as there are little published data available, this article has been prepared both to indicate the magnitude of frequency errors commonly encountered in ordinary thermal instruments and to furnish sufficient information concerning the design of apparatus and the testing procedure to enable others to calibrate instruments for any particular use.

All methods of determining the magnitude of an alternating current are based upon one of three of its effects, the magnetic effect, the

* Decimal classification: R242.12. Original manuscript received by the Institute, October 21, 1936. The views expressed herein are the personal ones of the authors, and are not to be interpreted as the expression of an official opinion of the Naval Research Laboratory or the Navy Department.

heating effect, or the voltage drop resulting from passing the current through a known impedance. Current measuring devices whose operation depends upon the force of a magnetic field produced by the current, while very satisfactory at commercial power frequencies and at those falling in the lower portion of the audio-frequency band, are in most instances, unsuitable even at lowest commonly used radio frequency, for their impedance is usually fairly high, and their characteristics depend considerably upon the applied frequency. Methods of current determination dependent upon measurement of voltage drop produced across an impedance by passage of the unknown current become unsuitable at the high frequencies since it is difficult to measure both the voltage drop and impedance accurately. High-frequency current measuring equipment of the type which relies upon the heating effect of the current has in most cases been preferable to all others. The most widely used device of this nature, the thermocouple ammeter, while more satisfactory than any of the other types, in certain applications can hardly be considered as a current measuring instrument, but more nearly as a current indicator. Thermal ammeters commercially available are usually calibrated with sixty-cycle alternating current, and it is obvious that radio-frequency current measurements made with such an instrument are in error if the applied frequency is high enough to cause a change in the operating characteristics of the instrument.

One characteristic of thermal ammeters which is dependent upon the operating frequency, and will therefore cause a frequency error, will be discussed. From a consideration of the electrical properties and physical size of heaters customarily employed in thermocouple ammeters, an increase in heater resistance with frequency is to be expected because of the "skin effect." When the high-frequency resistance of the heater of an instrument is greater than its low-frequency value, the instrument readings obtained from passing currents of the same value but differing considerably in frequency would not be the same, and the apparent current indicated at the high frequency would be greater. Consequently, this effect would cause an instrument calibrated at a low frequency to indicate more current than was actually flowing at a high frequency, the discrepancy increasing with frequency, as the change in resistance resulting from "skin effect" increases with frequency. Since the required cross-sectional area of the heater of an instrument increases as the full scale current range increases, and since the increase in resistance of a conductor due to "skin effect" increases with cross-sectional area, a greater frequency error would be expected in a high current range instrument than in one of lower range at any

particular frequency. This type of frequency error may be referred to as the "skin effect error," and its effect is to cause an instrument to indicate more current than is actually flowing in the circuit.

There are several other causes of frequency errors in thermal instruments, as the following discussion will indicate. One type of error occurs at operating frequencies sufficiently great to allow impedances of the heater and the capacitive path in shunt with the heater (introduced principally by the dielectric path through the insulating material on which the instrument terminals are mounted) to become comparable, thereby causing some of the current to be diverted from the heater. Another source of frequency error may be introduced by the induction of eddy currents in the thermocouple by current passing through the heater, the induced currents usually being greater at radio frequencies than at the calibrating frequency. An additional type of frequency error may occur in "bridge type" thermocouple instruments, if the two radio-frequency current paths have unequal impedances, which causes the high-frequency current distribution to differ from that at the calibrating frequency. These sources of frequency errors are mentioned; however, a theoretical analysis indicates that in all except the sensitive instruments, a much greater inaccuracy from "skin effect error" would be expected than from any of the others.

From the foregoing discussion, it is evident that considerable inaccuracies may be expected in thermal ammeters at radio frequencies. It would be difficult to compute a correction factor for an instrument, as it would not, in all instances, be possible to obtain the necessary data on which to base a calculation. In addition, a correction factor based upon computation alone should not be relied upon without experimental verification. Obviously, there is need of some practical method of determination of the accuracy of instruments at radio frequencies. This may be accomplished by use of some auxiliary device whose action and operation are such that no appreciable frequency errors are present, or whose errors are small and of such a nature that suitable frequency corrections may be readily applied.

In order to determine the frequency error in a thermal ammeter at radio frequencies, a suitable calibrating device may be placed in series with the instrument which will conform to requirements stated in the previous paragraph. In addition this device should be compact and capable of being associated with the instrument in such a manner to assure that the current through each is as nearly the same as possible. From a consideration of the three methods of determination of the magnitude of an alternating current discussed previously, it appears that the most suitable radio-frequency calibrating device would be

one whose operation relied upon the heating effect of the current. A specially constructed, straight wire, evacuated, tungsten filament lamp would be well adapted for this purpose, as it may be constructed small in physical dimensions and could be inserted in a circuit very close to the instrument under test, thereby assuring that approximately the same radio-frequency current passes through both. By means of such a lamp, two currents, one at a radio frequency, and the other at a very low frequency (sixty cycles, for example) may be compared by the relative intensity of the luminous output of the lamp filament. If one of the currents is varied until the luminous outputs are equal then the two currents are equal when the lamp filament resistance is the same at the two frequencies. A photoelectric cell and suitable galvanometer may be used as an indicator of equal luminous outputs. By means of such equipment, a current at a frequency of sixty cycles may be adjusted until it is the equal of a radio-frequency current, and by determining the value of current at the lower frequency with a suitable instrument, the radio-frequency current may be evaluated.

Lamps employed in the calibration of radio-frequency instruments are subject to certain of the frequency errors which affect instruments. It is usually possible to design a lamp having much less frequency error than an instrument of comparable current range. For the same values of current, a tungsten filament may be employed which is considerably smaller in diameter than that required in a material suitable to serve as an instrument heater, the reduction in diameter being approximately thirty-five per cent. Obviously the change in resistance due to "skin effect" would be less in the lamp filament, other factors being equal. It is also possible to construct a lamp of smaller shunt capacitance than is possible in an instrument, the reduction thereof being of the order of ten to one. Single filament lamps would not be suitable for use in calibrating the high current range instruments (four amperes full scale or larger), as changes in the filament resistance from "skin effect" would become excessive. Suitable lamps for the high-frequency calibration of such instruments may be constructed with a number of small size filaments in parallel, arranged in such a manner that the impedance of each of the paths is equal or as nearly so as possible. The size of the filaments may be so chosen that, in most instances, the change in resistance with frequency is inappreciable; and in other cases, so that the increase is small. The effect of these changes in resistance, when appreciable, may be eliminated by the application of a suitable correction factor, which may be applied by means of the computed increase in lamp filament resistance as determined by any of the for-

mulas suitable for this purpose. Since tungsten has a considerable temperature coefficient of resistance per unit volume, and since the increase in resistance is a function of this quantity, it may appear that an individual frequency correction would be necessary at each operating temperature, or that the radio-frequency resistance of a lamp filament would be a function of both frequency and operating current. If the operating conditions were so chosen that the increase in resistance were large, this would be the case, but if they are selected so that the increase is small (eight per cent or less) at the average operating temperatures, the change in the "increase in resistance" resulting from operation at other temperatures (or currents) becomes a second order effect, and "skin effect" corrections may be applied on the basis that the increase in resistance is a constant at any operating current without introducing serious error. A considerable error may be tolerated in a correction which is no greater than eight per cent. It will subsequently be shown that the ratio of high-frequency resistance to that at a low-frequency is not a governing factor in "skin effect" corrections, but that the square root of this ratio is the factor, which further reduces any error introduced by the assumption that the resistance ratio, when the increase is small, is not a function of operating current. Multiple filament lamps may be placed with respect to the photocell in such a manner that light from all of the filaments actuates the cell, and if the radio-frequency current distribution between the filaments differed slightly from that at the calibrating frequency, errors thereby introduced would be partially compensated for, as the effect of additional illumination in filaments conducting too much of the radio-frequency current would be somewhat offset by the reduction in illumination afforded by those conducting less than their portion of the current. Lamps used as calibrating devices have one disadvantage, as their operating current range is somewhat limited. The useful operating range of a lamp is from its maximum current carrying capacity to approximately sixty-five per cent of that value, smaller currents producing insufficient illumination to actuate a photocell. In order to calibrate an instrument completely it will therefore be necessary to employ two or more lamps.

The method of applying "skin effect" corrections to results obtained in calibrating instruments by means of lamps will be described. When a current of radio frequency and that of low frequency produce the same intensity of illumination in a lamp filament, the powers dissipated under both conditions are equal, and the terms which express this power are equal, and are shown by the following equation:

$$I_o^2 R_o = I^2 R \quad (1)$$

where,

I_o = low-frequency current in amperes

R_o = low-frequency resistance of lamp filament in ohms

I = radio-frequency current in amperes

R = radio-frequency resistance of lamp filament in ohms.

Equation (1) may be rearranged as follows:

$$I = \frac{I_o}{\sqrt{R/R_o}} \quad (2)$$

By means of (2) the radio-frequency current through a lamp may be found from the measured value of current at sixty cycles required to produce the same degree of illumination. It is by no means necessary to apply such a correction to all results, as in many cases there is no appreciable increase in resistance. The value of R/R_o may be computed with the following formula:¹

$$R/R_o = 0.25 + \sqrt[6]{(0.75)^6 + (V^2)^3} \quad (3)$$

where,

$$V^2 = \frac{\pi^2 d^2 \mu f}{4r \cdot 10^9}$$

and,

d = diameter of filament in centimeters

μ = permeability of filament material

f = frequency in cycles per second

r = resistance per unit volume of the filament in ohms-centimeters.

It may be noted that the value of resistance per unit volume of the material is a factor in (3), which in the case of tungsten at the average operating temperature (2000 degrees centigrade) is 65×10^{-6} ohms-centimeters. "Skin effect" corrections in multiple filament lamps are made on the basis of that in one of the filaments. In multiple filament lamps the spacing between filaments was fifty times the filament diameter or greater. Therefore, it may be assumed that the resistance change with frequency (in percentage) in a multiple filament lamp is approximately the same as that for one of the filaments.

A substitution method may be also employed in the calibration of instruments at high frequencies. By this means the reading of the instrument to be calibrated is compared with one which has been previously calibrated by means of tungsten lamps. It might appear that the instruments could be placed in series and their readings compared in that manner. However, it is difficult to be certain that the

¹ M. Mathieu, *L'Onde Electrique*, vol. 9, p. 139; March, (1930).

same current passes through both instruments, when their physical size, capacitance to ground, etc., are considered. Instruments may be compared by means of a circuit provided with positions for two instruments, as described in the discussion to follow. One instrument, in which the frequency error has already been determined, hereafter designated as the "standard," is placed in one position; and another one, which may be termed a "reference instrument," is placed in the other. The readings of these two instruments may be compared simultaneously, and the true current in the circuit at the position occupied by the "standard" may be determined in terms of the reading of the "reference instrument." After this relationship has been established, any other instrument whose accuracy is to be checked may be placed in the position occupied by the "standard," and thereby calibrated. This method is particularly convenient for calibrating high range instruments, as some difficulty is encountered in calibrating them at high frequencies with lamps, as it is difficult to obtain sufficient calibrating circuit current with the resistance of the lamp imparted to the circuit. Tests by the substitution method can be conducted much more rapidly than with lamps. The substitution method has one other advantage, as the "skin effect" error in instruments makes it possible to compare the reading of a low range instrument, previously calibrated with a lamp, with an instrument of higher range, which is to be calibrated. For example, a 7.5-ampere instrument may be used as a "standard" and a ten-ampere instrument as a "reference instrument." At a frequency of thirty megacycles, both instruments will indicate somewhere in the region of full scale deflection simultaneously, the discrepancy in current reading being produced by the greater "skin effect" error in the ten-ampere instrument. After the relationship between the reading of the "reference instrument" and the true radio-frequency current at the position occupied by the standard has been established, the "standard" may be replaced with a fifteen-ampere instrument; and in this condition the ten-ampere "reference instrument" will indicate full scale when the fifteen-ampere instrument indicates somewhere near full scale reading. It is not always possible to calibrate the instrument completely up to full scale deflection; however, it is usually possible to make a calibration up to a point great enough to determine the performance of the instrument.

In calibrating an ammeter at radio frequency, it would be necessary to use a radio-frequency current as free from harmonics and spurious oscillations as possible, as currents of any frequency other than at the calibrating frequency may affect the lamp and instrument differently, thereby introducing calibration errors. The instrument and lamp may

be placed in a tuned circuit and loosely coupled, either inductively or through a suitable transmission line, to a source of radio-frequency power, thereby reducing to a very small value currents of any extraneous frequency.

[Fig. 1 illustrates diagrammatically the arrangement of the apparatus used in instrument calibration by means of lamps, and Fig. 2

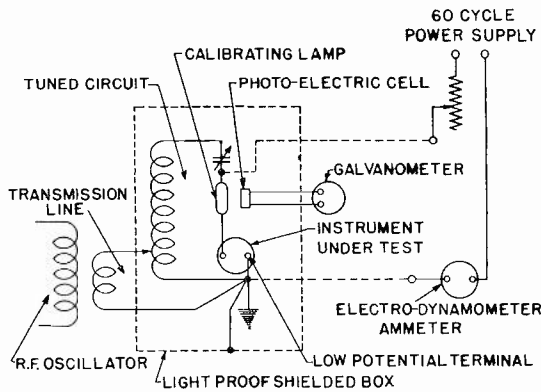

Fig. 1—Circuit and apparatus used in thermal ammeter calibration by means of lamps.

indicates the circuits used in the substitution method. No description of the testing procedure will be furnished, for it is obvious from the foregoing discussion. The question may arise as to which of the instrument terminals is grounded during the test, as indicated in Figs. 1

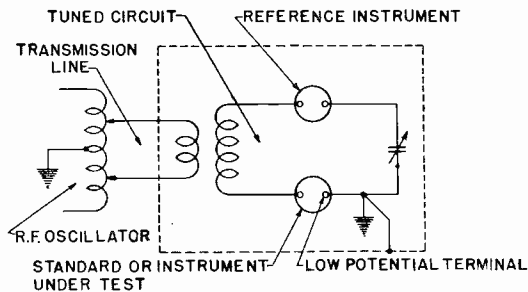

Fig. 2—Circuit and apparatus used in thermal ammeter calibration by the substitution method.

and 2. It is conventional practice in thermal instrument manufacture to connect electrically the permanent magnet, bezel ring, scale (if of metallic construction), moving coil, etc., of the instrument to one of the instrument terminals, thereby from a structural viewpoint making it the low potential terminal. This terminal was the one connected to ground during test.

By means of fifteen specially designed straight wire filament calibrating lamps, a current range from fifty milliamperes to twenty am-

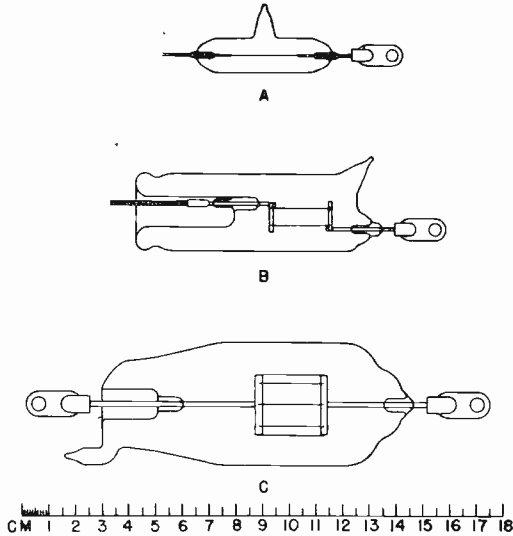

Fig. 3—Calibrating lamp design.

peres may be attained. The design and characteristics of these lamps are shown in Fig. 3 and Table I. Single filament lamps are used in instrument calibration below three amperes, and lamps of the multiple

TABLE I
CALIBRATING LAMP DESIGN DATA

NOTE: Length of all lamp filaments approximately 2.5 centimeters.

Lamp No.	Current Range (amps.)	Resistance (ohms)	Fil. Diam. (cm)	For Design Note	No. of Fils.	Diam. Fil. Assembly (cm)
A	0.05-0.07	125 -168	0.0013	Fig. 3A	—	—
B	0.08-0.12	56 - 75	0.0018	Fig. 3A	1	—
C	0.11-0.2	25 - 37	0.0025	Fig. 3A	1	—
D	0.2-0.34	10 - 13.4	0.0038	Fig. 3A	1	—
E	0.34-0.5	5.5 - 7.3	0.0051	Fig. 3A	1	—
F	0.63-0.9	2.1 - 3.0	0.0076	Fig. 3A	1	—
G	1.0-1.4	1.2 - 1.6	0.010	Fig. 3A	1	—
H	1.5-2.2	0.8 - 1.1	0.0127	Fig. 3A	1	—
I	2.0-2.8	0.5 - 0.8	0.0152	Fig. 3A	1	—
J*	3.0-4.4	0.4 - 0.6	0.0127	Fig. 3B	2	—
K**	4.4-6.6	0.35-0.5	0.0127	Fig. 3C	3	1.3
L**	6.0-9.0	0.27-0.38	0.0127	Fig. 3C	4	2.0
M**	7.4-10.5	0.23-0.35	0.0127	Fig. 3C	5	2.3
N**	10.3-14.7	0.14-0.21	0.0127	Fig. 3C	7	2.6
O**	14.0-20.0	0.07-0.11	0.0152	Fig. 3C	7	2.6

* Inverted "L" type of filament mounting used. Spacing between filaments 0.6 centimeter.

** "Squirrel-cage" assembly of filaments used.

filament type are used for greater currents. The increase in lamp resistance with frequency due to "skin effect," when appreciable, is shown in Table II.

Of approximately one hundred instrument calibration curves obtained by means of lamps, several typical ones which are illustrative of the nature of such data are furnished in Fig. 4. The excellent agreement between various lamps when used to calibrate different portions of the scale of an instrument is shown, particularly in the case of the

TABLE II
RATIO OF RADIO-FREQUENCY RESISTANCE TO LOW-FREQUENCY RESISTANCE
OF CALIBRATING LAMP FILAMENTS AT VARIOUS FREQUENCIES

NOTE: Computations based on the average filament operating temperature, 2000 degrees centigrade, at which the resistance per unit volume of tungsten is $65 \cdot 10^{-6}$ ohms-centimeters. The increase in resistance of lamp nos. A to F, inclusive, is inappreciable at frequencies up to 100 megacycles. Equation (3) used in computation.

Lamp No.	Fil. Diam. (cm.)	Ratio of High-Frequency to Low-Frequency Resistance				
		30 mc.	45 mc.	60 mc.	80 mc.	100 mc.
G	0.010	1.000	1.000	1.01	1.02	1.04
H, J, K, L, M, and N	0.0127	1.00	1.01	1.03	1.07	*
I and O	0.0152	1.01	1.04	1.08	*	*

* Lamp not used at these frequencies.

calibration of a twenty-ampere instrument (No. 22) where five multiple filament lamps were employed. No calibration curves obtained by the substitution method will be furnished in this paper as they would impart little additional information. In all cases it was noted that the true radio-frequency current was proportional to the instru-

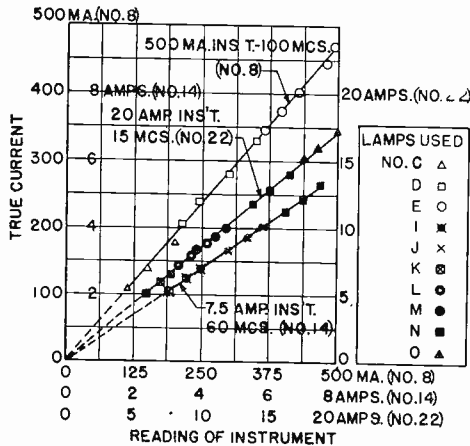

Fig. 4—Radio-frequency calibration curves of thermal ammeters obtained by means of lamps.

ment reading. Therefore, it is unnecessary to have an actual radio-frequency calibration curve for use with an instrument, as the true current may be computed from its reading when their ratio has been established experimentally. This ratio may be termed a "multiplying factor," which is defined as the ratio of the true radio-frequency cur-

rent to the reading of the instrument produced by this current. Thus the true radio-frequency current indicated by an instrument is the product of the instrument reading and the multiplying factor. In Table III, the multiplying factors of a number of instruments are shown, all of these instruments being of the three and a half-inch, self-contained, switchboard type.

TABLE III
MULTIPLYING FACTORS OF INSTRUMENTS AT VARIOUS FREQUENCIES

NOTE: *Multiplying factor is defined as the ratio of the true radio-frequency current through the instrument to the instrument reading obtained thereby. The values shown below were obtained both by means of calibrating lamps and by the substitution method, the method used being indicated below. The values of multiplying factor differing somewhat from 100 per cent at sixty cycles indicate slight basic errors in the calibration of the instrument.*

Inst. No.	Range	Multiplying Factor—Per Cent						
		60 cycles	15 mc	30 mc	45 mc	60 mc	80 mc	100 mc
1	125 ma	101	—	101	—	97	91	87
2	125 ma	101	—	85	—	81	61	55
3	150 ma	101	—	99	—	96	87	82
4	250 ma	101	—	100	—	98	88	79
5	250 ma	102	—	100	—	99	95	94
6	250 ma	103	—	94	—	87	75	68
7	500 ma	102	—	101	—	97	95	94
8	500 ma	101	—	100	—	98	95	94
9	500 ma	100	—	96	—	89	74	65
10	1 amp	100	—	100	—	97	93	91
11	1 amp	100	—	99	—	84	79	66
12	1.5 amp	105	—	100	—	95	93	87
13	3 amp	100	97	91	85	79	72	69
14	7.5 amp	100	92	83	75	70	—	—
15	10 amp	102	94	87	83*	81*	—	—
16	10 amp	101	91	84	78*	76*	—	—
17	15 amp	100	83	68	61*	57*	—	—
18	15 amp	100	81	68	60*	55*	—	—
19	15 amp	101	88	79	74*	70*	—	—
20	15 amp	102	90	83	79*	77*	—	—
21	20 amp	102	90	86	81*	75*	—	—
22	20 amp	101	86	81	76*	70*	—	—

* These results obtained by the substitution method, all others by means of calibrating lamps.

It may be noted that many of the commonly used ranges of instruments have considerable frequency error at frequencies customarily employed.

An estimate of probable error in data submitted in this paper is furnished. The largest source of error in instrument calibrations is introduced by the possibility that the radio-frequency current through the instrument and lamp may not be exactly the same because of the by-passing effect of stray capacitances. The discrepancy between the currents in the two parts will likely increase with frequency, thereby causing the error to depend upon the frequency. Results obtained in instrument calibrations can be reproduced to within three per cent at the highest test frequency, and to within one per cent at the lower frequencies. The accuracy of calibrations is probably within five per cent at fifteen megacycles and within twelve per cent at one hundred megacycles, the accuracy at intermediate frequencies falling between these estimated percentages.

It has previously been stated that a theoretical analysis indicates the frequency error in the higher current ranges of radio-frequency ammeters is principally due to "skin effect" in the instrument heater, and the following information will indicate that this fact has been shown experimentally. Upon the assumption that the above statement is true, it is possible to compute the radio-frequency multiplying factor for any particular range of instrument from the diameter and electrical properties of its heater. If the computed and experimentally measured values of multiplying factor are substantially the same, this would be indicative that this assumption is correct. The means by which the multiplying factor of an instrument may be computed will first be described. Referring to the discussion of "skin effect errors" in calibrating lamps, it is not difficult to realize that a similar effect occurs in an instrument heater. Equation (1) may therefore be rewritten to express the effect of the applied frequency upon the indication of an instrument as follows:

$$\frac{I''}{I'} = \sqrt{\frac{R'}{R''}} \cdot 100 = M \quad (4)$$

where,

I'' = radio-frequency current through instrument

I' = instrument reading produced by the current I'' , assuming the instrument calibrated at a low frequency (sixty cycles)

R'' = radio-frequency resistance of instrument heater

R' = low-frequency resistance of instrument heater

M = multiplying factor of instrument expressed in per cent.

The term R'/R'' is a function of frequency, and may be computed from the diameter and specific resistance of the heater at various frequencies by means of (3). The multiplying factors of three of the instruments listed in Table III were computed, and the values of these factors both by calculation and by experimental determination are illustrated graphically in Fig. 5. Agreement between computed and observed values is as close as could have been expected. It is thereby illustrated that the frequency error in the higher current ranges of instruments at commonly used frequencies is due principally to "skin effect" in the instrument heater.

It would not be difficult for manufacturers to supply with their instruments frequency correction data over the commonly used frequency bands. It is not suggested that every instrument be individually calibrated, but that composite correction data be furnished with a statement as to what degree the information may be relied upon in the individual instrument. From a consideration of the degree of fre-

quency errors encountered, and since an error in an instrument produces an error more than twice as great (in percentage) in power determinations, the need for information of this nature is readily appreciated.

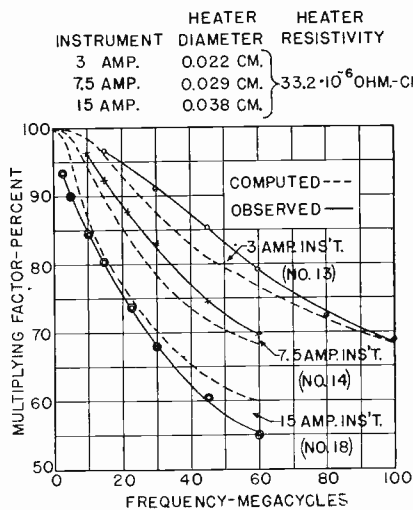

Fig. 5—Computed and observed values of multiplying factors of instruments.

Summarizing the results of this investigation, it may be stated that:

- (1). It is possible to calibrate any of the commonly used ranges of thermal ammeters over the frequency ranges customarily employed in various types of radio activities.
- (2). Frequency errors in commonly used ranges of instruments are considerable over the customarily employed frequency bands.
- (3). The direction of frequency errors is such as to cause an instrument to indicate more current than is actually passing through the instrument.
- (4). Frequency errors in thermal instruments increase with frequency.
- (5). Frequency errors (except in the case of sensitive instruments—0.5 ampere full scale or less) are usually greater in high current range instruments than in those of a lower range at any particular frequency, in instruments which are otherwise identical in design.
- (6). Frequency errors in well-designed instruments of full scale current ranges of three amperes or greater are due principally to "skin effect" in the instrument heater.

A GRAPHICAL DESIGN OF AN INTERMEDIATE-FREQUENCY TRANSFORMER WITH VARIABLE SELECTIVITY*

BY

CYRIL BARANOVSKY AND ARTHUR JENKINS

(University of Minnesota, Minneapolis, Minnesota)

Summary—The following discussion deals with a graphical method for designing an intermediate-frequency transformer for variable selectivity using the method of varying the coupling. A brief theory of the graphs precedes the application of the graphs to an actual problem.

INTRODUCTION

RECENTLY there have appeared several devices for varying the selectivity of an intermediate-frequency transformer. One method has been to vary the coupling between primary and secondary; it is the simplest of the various schemes. The following discussion deals with the design of such a transformer by a graphical method which comes from treating usual equations in a slightly different way.

THEORY

The constants of the two circuits forming the intermediate-frequency transformer are similar, so that the analysis is simplified. Suppose it is required to design a transformer whose band width is say

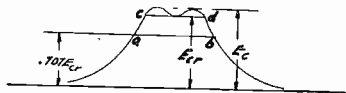

Fig. 1

Δf_m taken between any two points such as ab or cd on the selectivity curve, Fig. 1, and then to contract this band width to its smallest possible value Δf_c ; the dip in the selectivity curve at resonance must not exceed a certain amount n , from the maxima on each side of resonance.

The full schematic sketch of an intermediate-frequency transformer is shown in Fig. 2a. For purposes of analysis we may consider a certain effective electromotive force (E), as acting in series with the tuning condenser, C_1 , and as far as the transformer is concerned, forget the circuit to the left of terminals 1-2. This assumption can be rigorously

* Decimal classification: R382. Original manuscript received by the Institute, April 6, 1936. Revised manuscript received by the Institute, October 15, 1936.

proved by Thevenin's theorem. The circuit can be reduced, for design purposes, to the form shown in Fig. 2b.

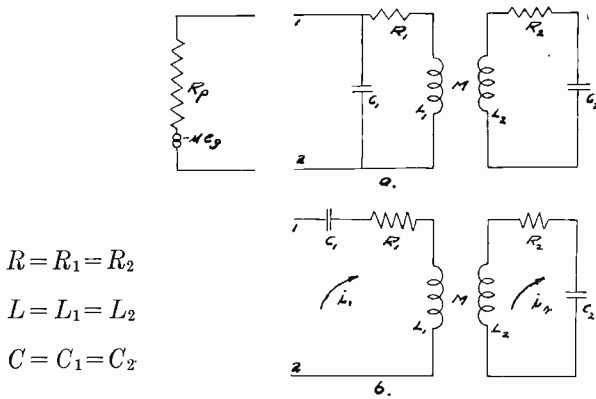

Fig. 2

The following equations may be written describing the conditions existing in the intermediate-frequency transformer; reference is made to Fig. 2b.

$$E = \left(R + j\omega L + \frac{1}{j\omega C} \right) i_1 - j\omega M i_2$$

$$0 = (-j\omega M) i_1 + \left(R + j\omega L + \frac{1}{j\omega C} \right) i_2.$$

Solving for the ratio E_c/E_{cr} , where E_c is the output voltage across condenser C_2 at any frequency off resonance, we get (if the analysis is taken between the points where $E_c/E_{cr}=0.707$, or points $a-b$ in Fig. 1)

$$R^4 + 2R^2M^2(2\omega_0^2 - \omega^2) + M^4(2\omega_0^4 - \omega^4) - 2R^2X^2 + 2\omega^2X^2M^2 - X^4 = 0 \quad (1)$$

upon substituting

$$\frac{R}{\omega_0 L} = \frac{1}{Q} = p$$

$$\frac{M}{L} = k$$

$$2(\omega_0 - \omega)L = X$$

$$\frac{k}{p} = s$$

$$\frac{R}{L} = t$$

equation (1) becomes

$$t^4 \left[1 + 2s^2 \left(\frac{2\omega_0^2 - \omega^2}{\omega_0^2} \right) + s^4 \left(\frac{2\omega_0^4 - \omega^4}{\omega_0^4} \right) \right] - t^2 \left[8(\omega_0 - \omega)^2 - 8\omega^2 s^2 \left(\frac{\omega_0 - \omega}{\omega_0} \right)^2 \right] - 16(\omega_0 - \omega)^4 = 0.$$

When the above equation is solved for t , we get the following as a very good approximation

$$\frac{R}{2\pi L} = \frac{t}{2\pi} = (f_0 - f) \sqrt{\frac{8(1 - s^2) + 8\sqrt{2 + 2s^4}}{2(1 + 2s^2 + s^4)}} \tag{2}$$

This is the equation of a straight line having a slope,

$$m = \sqrt{\frac{8(1 - s^2) + 8\sqrt{2 + 2s^4}}{2(1 + 2s^2 + s^4)}}, \tag{3}$$

and passing through the origin.

Table I shows a set of calculated values of m for Fig. 3 using (2).

Before showing Table I, it may not be amiss to mention the fact that at the optimum coupling of two similar coils, $\omega^2 M^2 = R^2$ so that at overcoupling $\omega^2 M^2 = s^2 R^2$ where s is a constant for a particular degree of overcoupling, it can be shown that

$$\frac{2s}{1 + s^2} = n = \frac{E_{cr}}{E_c} \text{ (see Fig. 1).} \tag{4}$$

TABLE I

Per cent dip (n)	s	m	Per cent dip (n)	s	m
0.0	1.0	1.414	0.0	1.0	1.414
0.5	1.1	1.281	- 0.5	0.9	1.569
1.6	1.2	1.170	- 2.5	0.8	1.740
3.3	1.3	1.073	- 6.0	0.7	1.940
5.4	1.4	0.993	-18.0	0.6	2.150
7.7	1.5	0.915			
10.0	1.6	0.858			

To use Fig. 3, suppose we choose the maximum permissible band width from resonance ($f_0 - f$); i.e., the total band width would be twice this, and the permissible dip at resonance (the corresponding s) we at once find $R/2\pi L$ which when divided by the intermediate frequency gives the value of p ; upon inversion it becomes Q . Therefrom, we find all the other quantities such as the coefficient of coupling, the resistance R and the others. It is necessary, however, to make a choice of the tuning condenser C before this can be done. To illustrate, sup-

pose the maximum upper modulating frequency is 10,000 cycles and we permit a ten per cent dip at resonance, $s=1.6$, then from Fig. 3 $R/2\pi L=8.6$ dividing by the intermediate frequency of 465 kilocycles gives $p=1.85 \times 10^{-2}$ and $Q=54$. This is the Q of each coil. By choosing a tuning condenser of $C=70$ micromicrofarads, then $L=1/\omega_0^2 C=1.66$

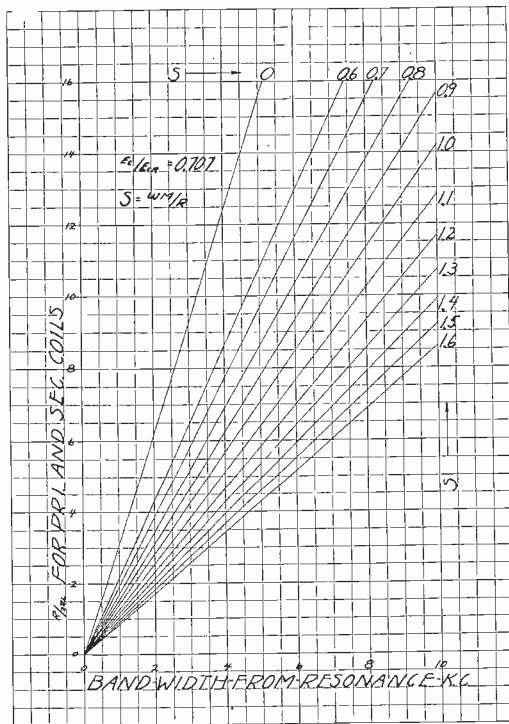

Fig. 3

millihenrys. Since Q is known we calculate $R=90$ ohms. The mutual inductance M is found from $\omega_0^2 M^2 = s^2 R^2$ and in this case $M=4.97 \times 10^{-5}$ henrys. The coefficient of coupling $k=M/L=2.97 \times 10^{-2}$. The minimum upper modulating frequency to which we can contract can be found by simply projecting over to the line where $s=0$ (Fig. 3). Thus when $s=1.6$ and $(f_0-f)=10,000$ cycles we find the minimum upper modulating frequency to be 2875 cycles. The amplification at this frequency is zero. Thus it is obvious that with the circuit constants used here, it is possible to vary the band width between 5750 and 20,000 cycles. This, of course, is accomplished by varying the coupling between the coils.

A similar analysis was carried through for points *c* and *d* (Fig. 1). This analysis yields

$$\frac{R}{L} = t = (\omega_0 - \omega) \sqrt{\frac{2}{s^2 - 1}} \tag{5}$$

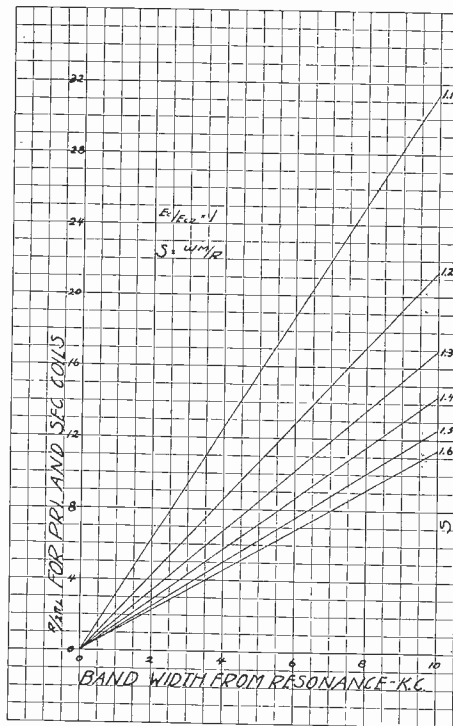

Fig. 4

This equation is plotted in Fig. 4. The graph can be used in the same manner as Fig. 4 with the exception that *s* must obviously be greater than one if it is to be defined in the same way as it was in the first case. Table II shows the values calculated from (5).

TABLE II

Per cent dip (<i>n</i>)	<i>s</i>	<i>m</i>
0	1.0	
0.5	1.1	
1.6	1.2	3.15
3.3	1.3	2.13
5.4	1.4	1.70
7.7	1.5	1.44
10.0	1.6	1.26
		1.13

CONCLUSION

The results obtained from the graphical method shown are within the limits of engineering accuracy and the laborious mathematics of the more precise solutions is minimized. The approximate method outlined here does not involve a knowledge of the intermediate frequency for a solution of L/R .

ACKNOWLEDGMENT

The authors wish to express their indebtedness to Dr. James S. Webb of the electrical engineering department of the University of Minnesota for his presentation of this problem.



ULTRA-SHORT-WAVE PROPAGATION ALONG THE CURVED EARTH'S SURFACE*

BY

PAUL VON HANDEL AND WOLFGANG PFISTER

Summary—The penetration of ultra-short-wave radiation beyond the range of optical sight is dependent on the diffraction and refraction of the rays. Proceeding from an analogy to optics the diffraction is calculated by various methods. It is found that calculation of the ray distribution beyond the line of sight yields the best agreement with measurement. The practical application of the results of calculation is represented by curves which give the decrease of field intensity with distance for various elevations in the whole range of wave lengths at present of interest. The curves are substantiated by airplane measurements. Measurements of the influence of refraction are appended.

I. INTRODUCTION

IN AN earlier paper¹ an investigation was made of the radiation characteristics of ultra-short-wave antennas including effects of ground constants. Several curves of propagation of ultra-short waves over great distances obtained by airplane measurements were given. The penetration of the rays beyond the line of sight was shown to be caused by two agencies: refraction of the rays in the atmosphere and diffraction at the earth's surface. The influence of diffraction is independent of diurnal and seasonal times. The calculation of diffraction together with measured values of field intensity gives information as to the relative field intensities produced by diffraction and refraction.

II. CALCULATION OF DIFFRACTION

1. Calculations in Optics

An analogy to the present problem of the diffraction of ultra-short waves along the earth's surface is found in optics in the problem of the diffraction at a sharp straight edge. Two methods of solving this problem are known. Fresnel's method is based on Huyghens' principle; in it the diffracting screen is treated as if it completely absorbed the electromagnetic waves. An exact calculation for an ideal reflecting screen was carried through by Sommerfeld. For the case where the

* Decimal classification: R113. Report of the Deutschen Versuchsanstalt für Luftfahrt, E. V., Berlin-Adlershof, Germany. Translated from *Hochfrequenztechnik und Elektroakustik*, vol. 47, no. 6, pp. 182-190, June, (1936), by Martin Katzin. Translation received by the Institute, September 24, 1936.

¹ P. von Handel and W. Pfister, "Investigations of the radiation field of ultra-short-wave antennas," *Hochfrequenz. und Elektroak.*, vol. 46, pp. 8-15, (1935).

screen is approximately perpendicular to the line joining the source of light and the point of observation both methods lead to the same result. This good agreement holds for a point of observation behind the screen which is sufficiently far away from it, but not in the immediate vicinity of the screen.²

2. Calculation by Huyghens' Principle for Ultra-Short Waves

A treatment of the diffraction problem for ultra-short waves by Huyghens' principle was carried out by P. S. Epstein³ under the assumption of completely absorbing earth. He replaced the earth in

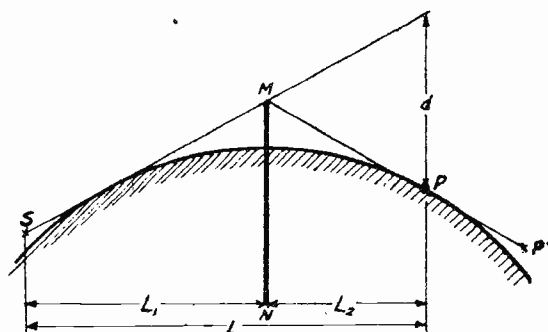

Fig. 1—Equivalence of the earth's surface to an absorbing screen $M-N$, due to Epstein.

first approximation by an absorbing screen whose position is determined by the tangents from the transmitter and from the receiver, as shown in Fig. 1. If we replace the radiating surface of the transmitting antenna arrangement which Epstein introduces, by a single radiator of length $\lambda/2$, then the field intensity at the point P is determined from the formula

$$\mathcal{E} = \frac{60J}{2\pi d} \sqrt{\frac{\lambda L_2}{L_1 L}} \quad \text{v/m} \quad (1)$$

where J is the transmitting antenna current, and the lengths d , L_1 , L_2 , and L in meters are to be taken from Fig. 1. Since in this no account is taken of reflection at the earth's surface, incorrect results are obtained when the transmitter and receiver are too close to the ground (P). For greater heights of transmitter and receiver we can assume as in the above analogous example in optics, that the properties of the

² For detailed treatment see M. Born, "Optics," Chap. IV. Julius Springer, Berlin, 1933.

³ P. S. Epstein, "On the bending of electromagnetic microwaves below the horizon," *Proc. Nat. Acad. Sci.*, vol. 21, pp. 62-68, (1935).

ground no longer enter, so that then correct results are to be expected (P').

For low heights it must be remembered that the radiation diagram for shallow vertical angles approaches zero. Correspondingly, Burrows, Decino, and Hunt⁴ have inserted negative images for transmitter and receiver in their calculations. The result for low heights below the first maximum of radiation can be written in the following form for a $\lambda/2$ antenna:

$$\mathcal{E} = \frac{60J}{R} \cdot \frac{4\pi h_1 h_2}{R\lambda} \cdot F \quad \text{v/m} \quad (2)$$

where R is the distance, h_1 and h_2 the heights of transmitter and receiver, respectively, in meters. In the original formula the factor

$$\frac{\sin 2\pi h_1 h_2 / \lambda R}{2\pi h_1 h_2 / \lambda R},$$

which represents the formation of maxima and minima, is also included. But since maxima and minima in this form are not found below the line of sight, this factor is deleted from (2). The first two factors give the field intensity for plane earth; the factor F takes into account the additional attenuation due to diffraction. In the paper referred to it is calculated by Epstein's method. It will be shown later that by this method much too large values are obtained at great distances.

3. Calculation of the Decrease of Field Intensity From the Distribution of Rays Beyond the Line of Sight

Since a deviation from rectilinear propagation of electromagnetic radiation (homogeneous atmosphere assumed) can take place only in the immediate vicinity of the earth's surface, we get for diffraction around the earth fundamentally the radiation distribution shown in Fig. 2. The height H above the earth, up to which a curved ray distribution can be assumed, decreases with the wave length. The decrease of field intensity along the rectilinear portion of a ray shown in Fig. 2 can be shown to follow the following law:

$$\mathcal{E} = \frac{\text{const.}}{\sqrt{R} \cdot \sqrt{R - ix}}$$

For in the horizontal plane the rays diverge from the transmitter, so that the field decreases as the square root of the distance R . On the

⁴ C. R. Burrows, A. Decino, and L. E. Hunt, "Ultra-short-wave propagation over land," Proc. I.R.E., vol. 23, pp. 1507-1535; December, (1935).

other hand, the rays diverge in the vertical plane, as is shown in Fig. 2, from the point S' . The distance of this point from the emitter is designated by x and is different for each ray. The decrease of field intensity in the vertical plane is thus as $1/\sqrt{R-X}$. To calculate the field intensity at greater altitudes h we can neglect H and figure as

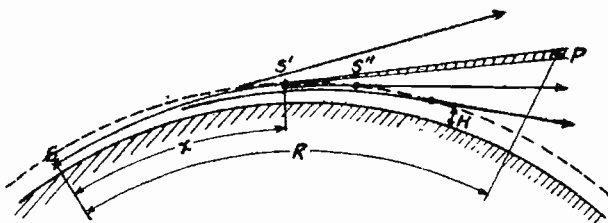

Fig. 2—Schematic representation of the course of the diffracted rays.

though the rays beyond optical sight leave the earth tangentially. We then obtain the relation

$$R - x = \sqrt{2ah} = 3.55\sqrt{h}, \quad R \text{ and } x \text{ in km, } h \text{ in m,}$$

radius of the earth $a = 6380$ km.

The decrease of field intensity with distance x has been calculated for perfectly conducting earth by Poincaré, Watson, and Laporte, the screening factor in their formula being

$$\delta = e^{-0.0376\lambda^{-1/3}x}$$

λ in m; x in km.

A clear description of the formula is to be found in a paper by Burrows.⁵

In Section II, Part 1 it was shown in an optical example that the electrical constants of a diffracting screen do not affect the result if the point of observation lies sufficiently far from the screen. Analogous to this we can here also treat the earth's surface as a perfect conductor for greater elevations. If we then also introduce into the expression for the decrease of field intensity along a single ray the screening factor, which gives the decrease of ray density with distance x , we obtain

$$\mathcal{E} = \frac{A \cdot e^{-0.0376\lambda^{-1/3} \cdot (R-3.55\sqrt{h})}}{\sqrt{R} \cdot \sqrt{3.55\sqrt{h}}} \quad (3)$$

The field intensity is thus determined within the amplitude A .

⁵ C. R. Burrows, "Radio propagation over spherical earth," Proc. I.R.E., vol. 23, pp. 470-480; May, (1935).

4. Calculation of the Field Intensity Within the Line of Sight

The amplitude A includes those factors (antenna current, directivity, and antenna height) which also affect the field intensity within the line of sight. The determination of A is based on the evaluation of the radiation characteristic of the transmitter, which results from the superposition of the direct ray and the ray reflected at the curved earth's surface (Fig. 3). For shallow elevation angles the reflection coefficient can be set equal to -1 and the effective value of the field intensity for a $\lambda/2$ antenna becomes

$$|\mathcal{E}| = \frac{60J}{R} \cdot 2 \sin \left[\frac{2\pi(b + c - R)}{\lambda \cdot 2} \right] \cdot 10^{-3} \quad \text{v/m.} \quad 4)$$

R , b , c , in kilometers are as in Fig. 3, where as ordinates are plotted the heights to a greatly expanded scale.

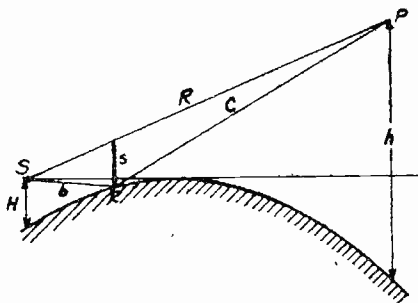

Fig. 3—Reflection of the rays at the curved earth.

For low heights s we can write

$$b + c - R = \frac{s^2}{2b} + \frac{s^2}{2(R - b)}$$

s is composed of a portion below and a portion above the tangent from the emitter to the earth's surface

$$\begin{aligned} s &= \left(\frac{b - 3.55\sqrt{H}}{3.55} \right)^2 + \frac{b}{R} \left[h - \left(\frac{R}{3.55} - \sqrt{H} \right)^2 \right] \\ &= H \frac{R - b}{R} - \frac{b(R - b)}{3.55^2} + h \frac{b}{R} \end{aligned}$$

The distance b of the reflection point from the emitter is determined from the condition that the path difference between the direct and reflected rays must be a minimum. The equation for this is

$$\frac{h}{R - b} - \frac{H}{b} + \frac{2b - R}{3.55^2} = 0.$$

Fig. 4 shows the variation of the field intensity of the radiation of a $\lambda/2$ dipole thirty meters high for an altitude of 6000 meters calculated in this manner. Calculations were made for waves from ten centimeters to ten meters. The abscissas are distances from the transmitter, up to the line of sight, the ordinates give the field intensity in $\mu\text{V}/\text{m}$ for one-ampere antenna current.

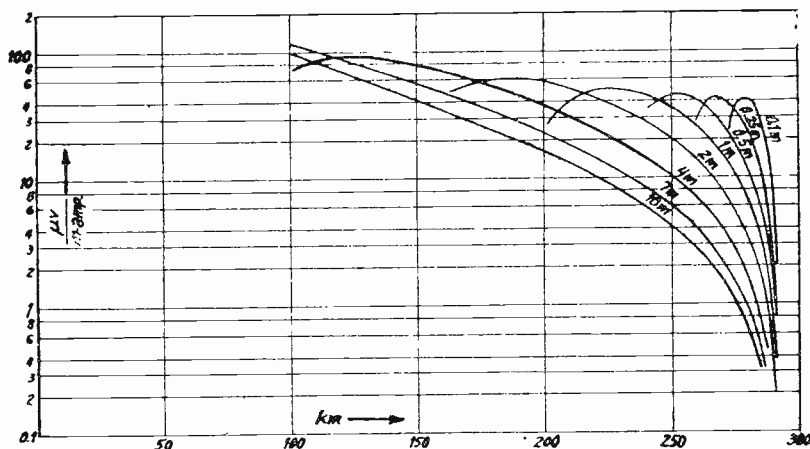

Fig. 4—Field intensity vs. distance within the line of sight. Transmitting antenna 30 meters high. Received at 6000 meters altitude.

5. Determination of the Field Intensity for the Region Beyond the Line of Sight

In Section III the decrease of field intensity in the region beyond the line of sight was calculated. The amplitude factor A was at first left undetermined. Since we can assume that within the line of sight the influence of diffraction in the maximum of the radiation is negligible and furthermore the transition at the line of sight must be continuous, we arrive at a picture of the field strength variation as shown in Fig. 5. The points entered are measurements of the Witzleben television transmitter made at two altitudes in an airplane. The curve calculated from (4) for a height of 2000 meters is drawn in. The decrease of field intensity in the region beyond optical sight is determined from (3). This curve is drawn in the figure so as to form a continuous transition from the first curve. The calculated fields agree well with the measured values. The error in the amplitude A which can be made in matching the two curves together is relatively small. Also the error

which results from the fact that actually the radiation maximum at the limit of optical sight is somewhat displaced by diffraction is not appreciable.

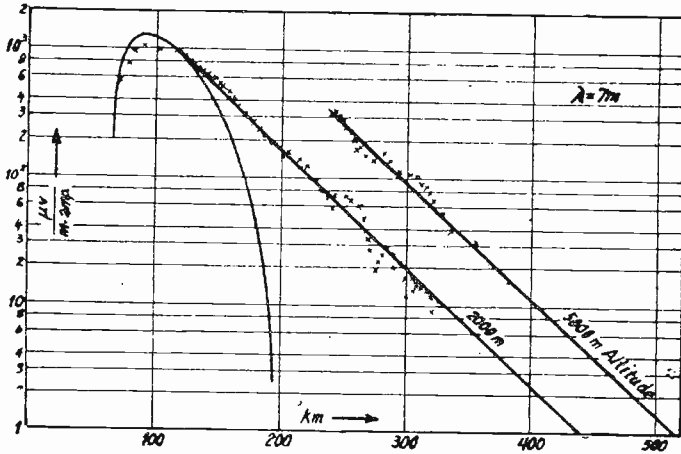

Fig. 5—Field intensity vs. distance. Transmitting antenna 135 meters high. $\lambda = 7$ meters.

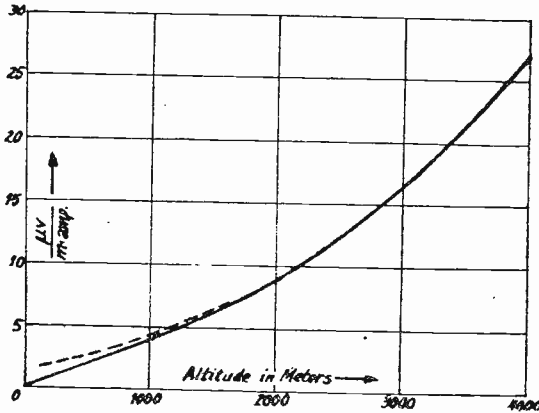

Fig. 6—Field intensity vs. altitude. Distance 335 kilometers. $\lambda = 7$ meters.

6. Extension to Arbitrary Altitudes

The derivation of (3) assumes rectilinear ray distribution and holds, therefore, as pointed out in Section III, only for greater altitudes. The variation of the field intensity with height for a constant distance can be calculated from (3) and is plotted in Fig. 6. For moderate altitudes below the range of validity this curve is drawn in dotted.

At moderate altitudes the field intensity must increase linearly with the height [equation (2)]. This linear variation is plotted in Fig. 6 in a manner such that it joins the other smoothly.

The variation of field intensity with altitude drawn in Fig. 6 can be coupled with the variation of field intensity for the two rather great

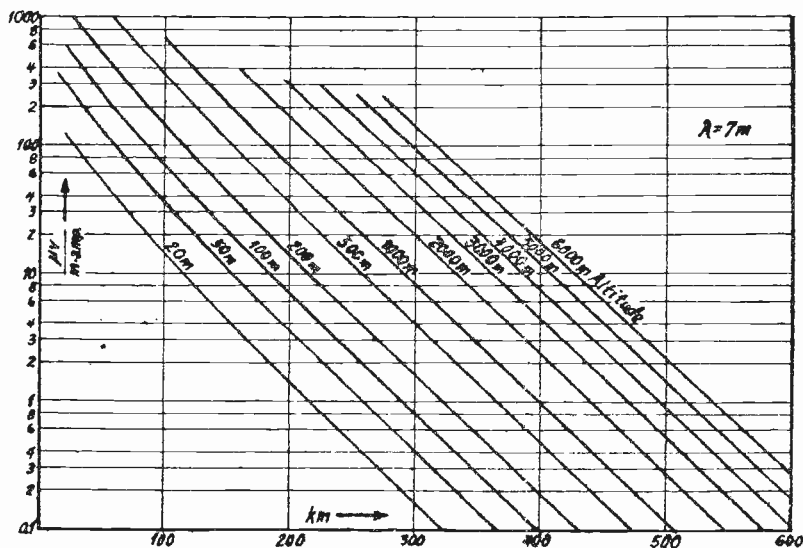

Fig. 7—Field intensity vs. distance for various altitudes. Transmitting antenna 135 meters high. $\lambda = 7$ meters.

altitudes (2000 and 5000 meters) drawn in Fig. 5 to yield variations for other altitudes. Such a plot is shown in Fig. 7. For many purposes it appears clearer to show the variation of altitude with distance for a

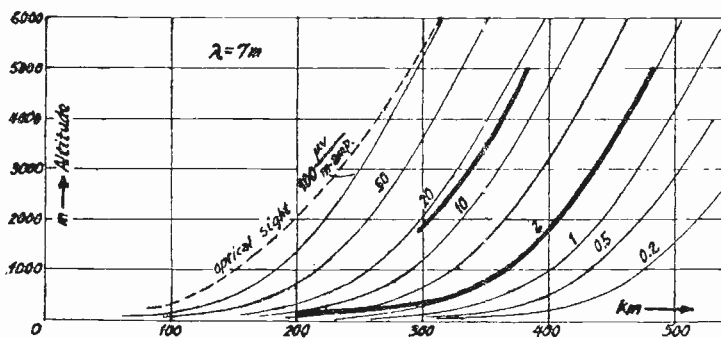

Fig. 8—Curves of constant field intensity. Height of transmitting antenna 135 meters. $\lambda = 7$ meters.

constant field intensity. Such a family of curves is immediately derivable from Fig. 7 by plotting the heights associated with a constant field intensity, as in Fig. 8. The units on the calculated curves give the

field intensity in $\mu\text{v}/\text{m} \cdot \text{amp}$. The heavy curves are measured in flight, their variation being in good agreement with calculation. Only for very low altitudes does calculation give somewhat greater field intensity than measurement. This can be explained by the fact that calculation is carried out for a flat spherical earth's surface, while wavy and built-up terrain distorts the radiation distribution in the vicinity of the ground.

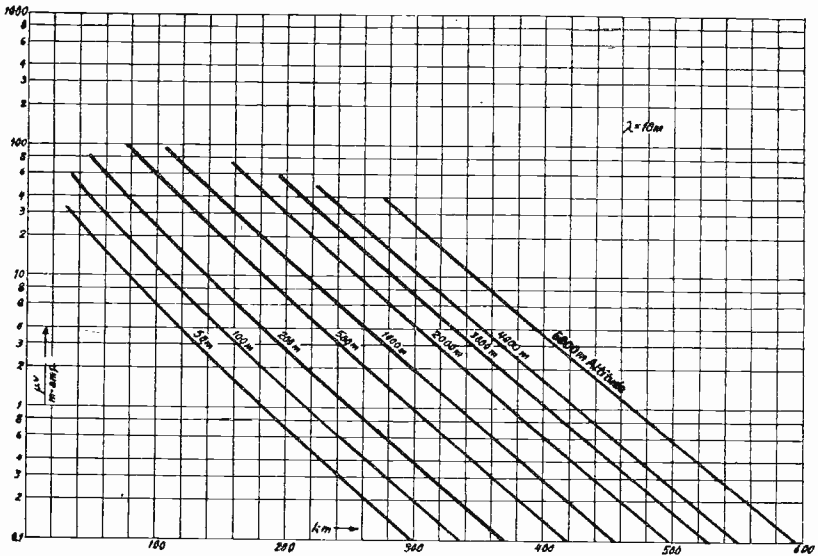

Fig. 9—Field intensity vs. distance for various altitudes. Transmitting antenna 30 meters high. $\lambda = 10$ meters.

III. PRACTICAL EVALUATION OF THE RESULTS OF CALCULATION

Figs. 9 to 16 show the variation of field intensity with distance for the whole wave range from ten centimeters to ten meters, which is at present of interest. The curves are calculated corresponding to the example of Fig. 7, for a transmitting antenna height of thirty meters above the ground. The ordinates are $\mu\text{v}/\text{m} \cdot \text{amp}$., giving the field intensity relative to the current in a $\lambda/2$ antenna. In Fig. 14, six measured points are entered for comparison with the calculated curves, being the field intensity decrease in relative values for $\lambda = 73$ centimeters measured by Trevor and George.⁶

The relative values for the curves of Figs. 9 to 16, which are drawn for a transmitting antenna height of thirty meters, are given by (3).

⁶ B. Trevor and R. W. George. "Notes on propagation at a wavelength of seventy-three centimeters," Proc. I.R.E., vol. 23, pp. 461-469; May, (1935).

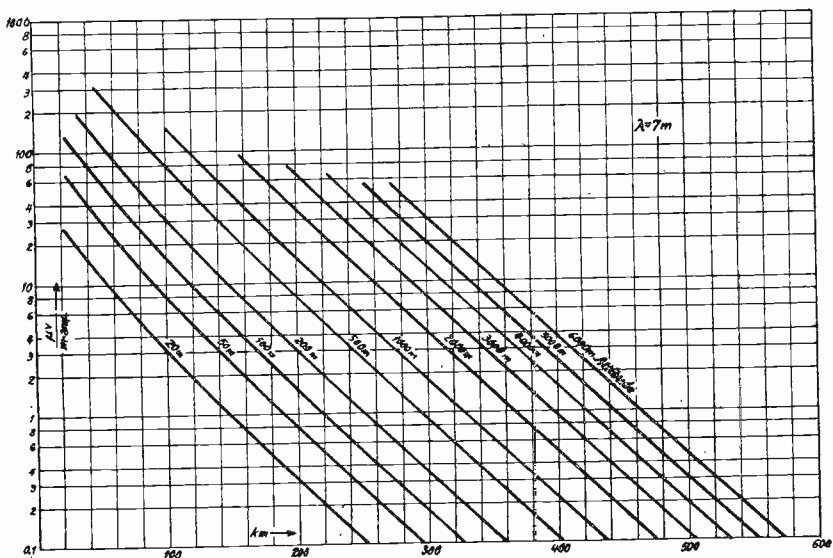

Fig. 10—Field intensity vs. distance for various altitudes. Transmitting antenna 30 meters high. $\lambda = 7$ meters.

From this equation it is evident that the variation is independent of the transmitting antenna height. The effect of the height of the transmitting antenna appears only in the amplitude factor A . The conver-

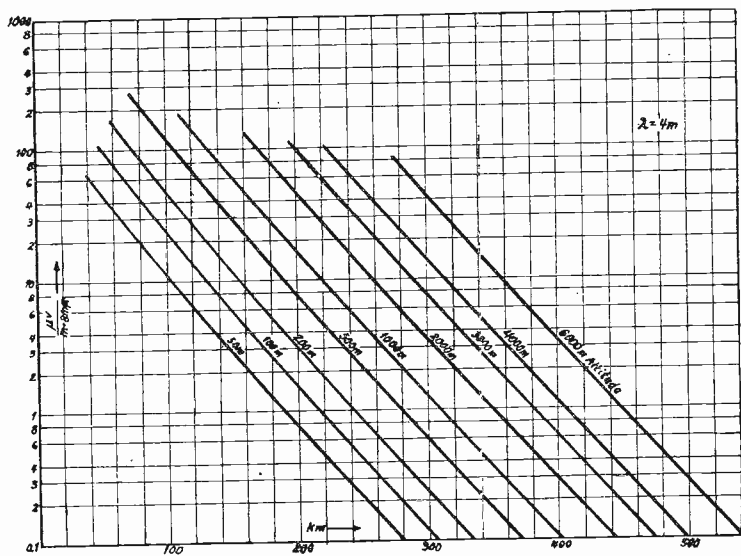

Fig. 11—Field intensity vs. distance for various altitudes. Transmitting antenna 30 meters high. $\lambda = 4$ meters.

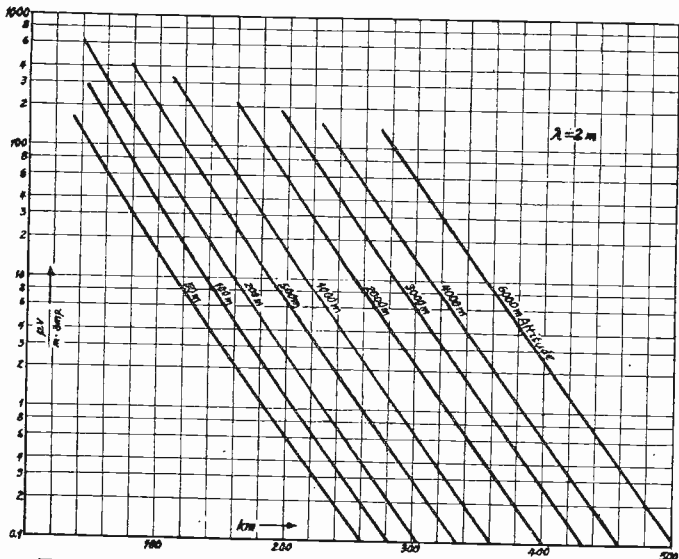

Fig. 12—Field intensity vs. distance for various altitudes. Transmitting antenna 30 meters high. $\lambda = 2$ meters.

sion factor by which the field intensity as a function of transmitting antenna height must be multiplied is shown in Fig. 17, again for the whole wave range. This family of curves was calculated from the

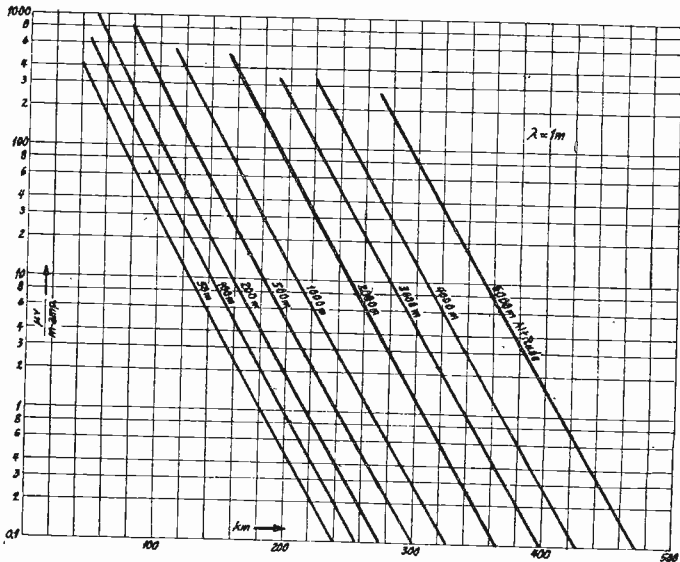

Fig. 13—Field intensity vs. distance for various altitudes. Transmitting antenna 30 meters high. $\lambda = 1$ meter.

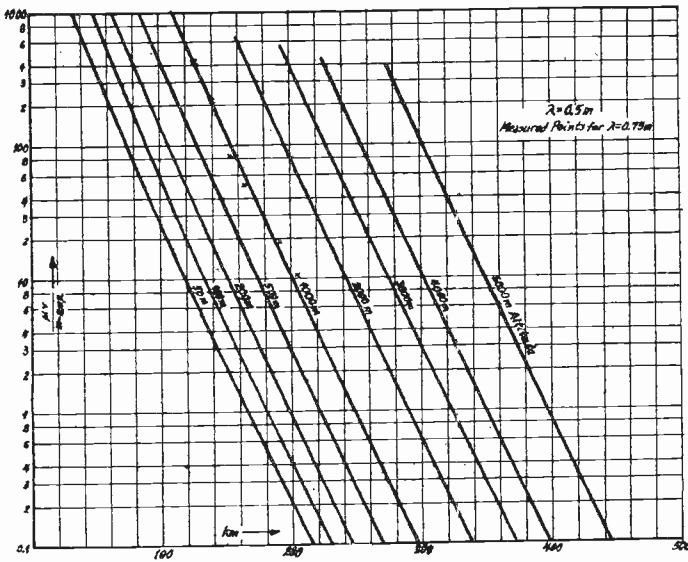

Fig. 14—Field intensity vs. distance for various altitudes. Transmitting antenna 30 meters high. $\lambda = 50$ centimeters.

variation of field intensity with altitude shown in Fig. 6 by application of the reciprocity theorem.

Directive systems increase the field intensity by the square root of

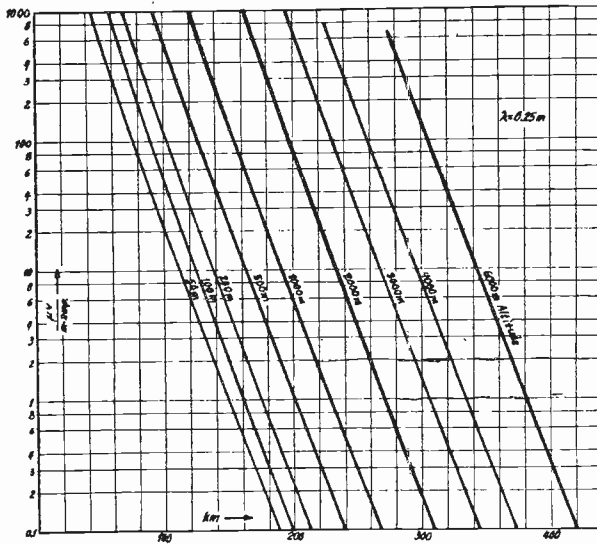

Fig. 15—Field intensity vs. distance for various altitudes. Transmitting antenna 30 meters high. $\lambda = 25$ centimeters.

the area of the antenna system expressed in wave lengths. For a directive system with reflector the increase of field intensity can therefore be taken into account by the factor

$$\sqrt{\frac{F}{\lambda^2/4} \cdot \frac{2N}{R_s}} = \frac{0.335}{\lambda} \sqrt{F \cdot N}, \quad (5)$$

where F is the area of the directive antenna in m^2 , N the antenna power in W and R_s the radiation resistance of a $\lambda/2$ dipole.

The use of the curves will be illustrated in the following by means of some examples:

1. $\lambda = 7$ m.; emitter height 1000 m.; emitter power 7 kw.; altitude 5000 m.; distance 500 km. From Fig. 10 we find for an emitter current $J = \sqrt{7000/70} = 10$ amp. a field intensity of $3.1 \mu V/m$. The conversion factor from 30 m. antenna height from Fig. 17 is 33.5. We thus obtain a field intensity of $E = 104 \mu V/m$.

If we figure the same example by Epstein's method [equation (1)] we get

$$E = \frac{60 \cdot 10}{2\pi \cdot 7000} \cdot \sqrt{\frac{7 \cdot 320}{180 \cdot 500 \cdot 10^3}} \cdot 10^6 = 68 \mu V/m.$$

Burrows' method [equation (2)] gives for this example

$$E = \frac{60 \cdot 10 \cdot 4\pi \cdot 1000 \cdot 5000}{500 \cdot 500 \cdot 7} \cdot \frac{1}{22} = 980 \mu V/m.$$

2. $\lambda = 7$; emitter height 30 m.; emitter power 7 kw.; altitude 200 m.; distance 300 km.

From Figs. 10 and 17 we find, as above,

$$E = 3.5 \mu V/m.$$

Epstein's method [equation (1)] gives for this case

$$E = \frac{60 \cdot 10}{2\pi \cdot 6000} \cdot \sqrt{\frac{7 \cdot 165}{135 \cdot 300 \cdot 10^3}} \cdot 10^6 = 85 \mu V/m.$$

By Burrows' method [equation (2)] we find

$$E = \frac{60 \cdot 10}{300 \cdot 10^3} \cdot \frac{4\pi \cdot 30 \cdot 200}{300 \cdot 10^3 \cdot 7} \cdot 0.1 \cdot 10^6 = 7.2 \mu V/m.$$

3. $\lambda = 7$; emitter height 1000 m.; emitter power 7 kw.; altitude 500 m.; distance 500 km.

From Figs. 10 and 17 we find

$$\mathcal{E} = 3.8\mu\text{v/m.}$$

Epstein's method [equation (1)] gives

$$\mathcal{E} = \frac{60 \cdot 10}{2\pi \cdot 11500} \cdot \sqrt{\frac{7 \cdot 234}{266 \cdot 500 \cdot 10^3}} \cdot 10^6 = 29\mu\text{v/m.}$$

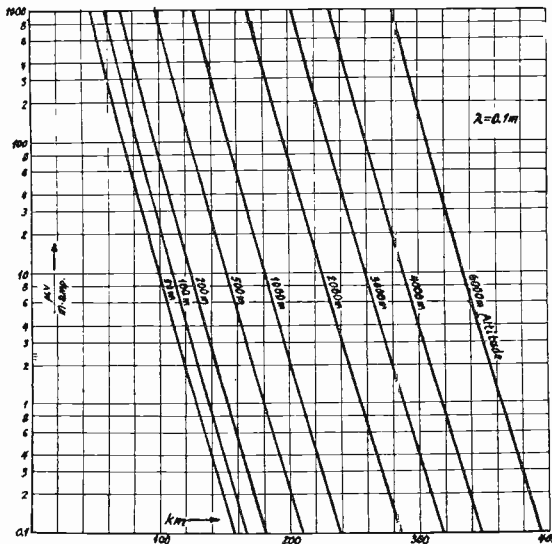

Fig. 16—Field intensity vs. distance for various altitudes. Transmitting antenna 30 meters high. $\lambda = 10$ centimeters.

By Burrows' method [equation (2)] we find

$$\mathcal{E} = \frac{60 \cdot 10 \cdot 4\pi \cdot 1000 \cdot 500}{500 \cdot 500 \cdot 7} \cdot \frac{1}{22} = 97\mu\text{v/m.}$$

Comparison of the results by the various methods shows a satisfactory agreement between the calculations by our method and Epstein's for large heights (example 1). On the other hand, as already pointed out in Section II, Part 2, Epstein's method gives much too high values for small heights (examples 2 and 3).

Burrows' method gives much too high field strength values for great distances (examples 1 and 3), while for smaller distances for which the screening has not as yet too great an effect, the results must become more correct (example 2).

4. $\lambda = 50$ cm., $N = 20$ w.; emitter height 50 m.; directive antenna with reflector 2×2 m.; altitude 5000 m.; distance 400 km. From (5) we find the factor 6. From Fig. 17 we get for 50-meter emitter height the factor 1.67. The value for 400 meters taken from Fig. 14 multiplied by these two factors yields a field intensity of

$$\mathcal{E} = 2.9 \mu\text{v}/\text{m}.$$

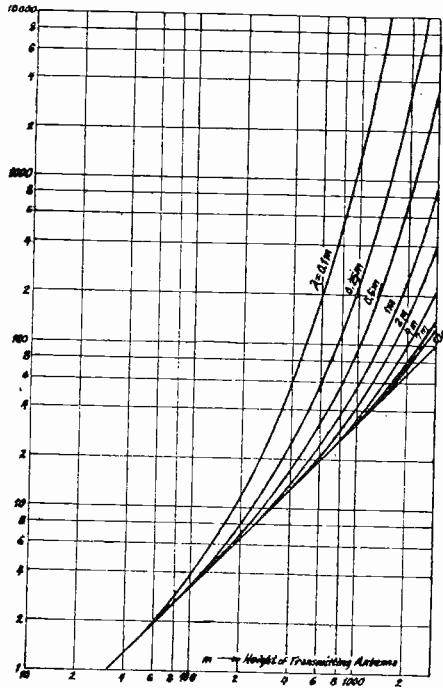

Fig. 17—Increase of field intensity with height of transmitting antenna. $\lambda = 0.1 \dots 10$ meters.

IV. REFRACTION PHENOMENA

All the calculations and curves treated so far took into account only diffraction. But occasionally ranges were observed which appreciably exceeded those normally attainable. Fig. 18 shows the results of measurements of two flights on two days in August, 1935. While the measured curve at an altitude of 1000 meters agrees well with the calculated curve, which is drawn in dotted, on another day at an altitude of 4000 meters considerably higher field intensities than calculated were measured at distances from 460 kilometers on. From among many observations this flight gave by far the greatest ranges. The reason for this abnormal behavior lies in a refraction of the waves

apparently within the troposphere. The appearance of this refraction phenomenon changes for the most part through very strong variations

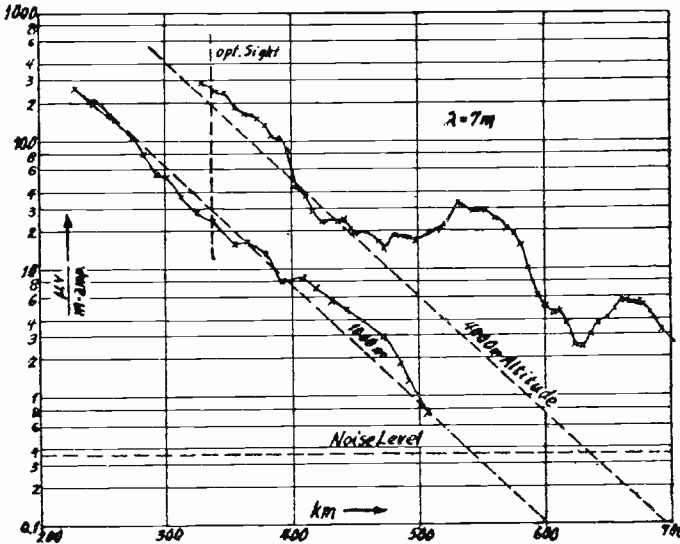

Fig. 18—Example of refraction. Calculated and measured field intensity curves. Transmitter elevation 1000 meters. Power = 7 kilowatts. $\lambda = 7$ meters.

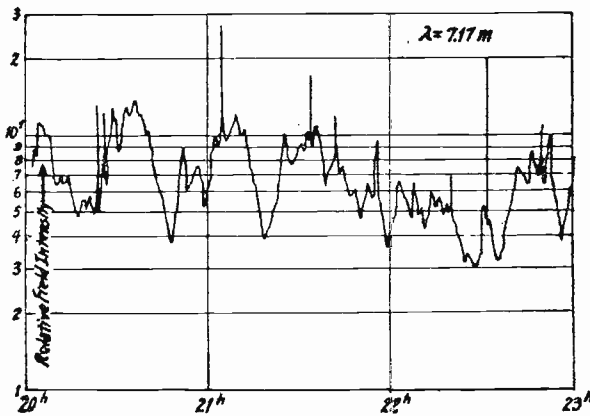

Fig. 19—Example of temporal field intensity fluctuations. Section of a recorder record. $\lambda = 7$ meters.

of the received intensity, similar to fading in short-wave reception, while within the diffraction zone the field intensities are very stable. The form of these temporal variations is shown by Fig. 19, which is taken from the record of a recorder placed on a mountain 3000 meters

high. The fluctuations of field intensity here, aside from peaks of a few seconds duration, amount to about 1:5. On some days practically no reception was possible. A law connecting reception by day and by night could not be determined. Similar observations were also made in other countries. Fig. 20 is taken from a paper by Englund, Crawford, and Mumford⁷ and shows the refraction on different days for a 4.6-meter wave. The curve measured on November 20 corresponds to field intensity decrease caused by diffraction. On November 1 refraction entered from about 100 kilometers on and on September 27 from about

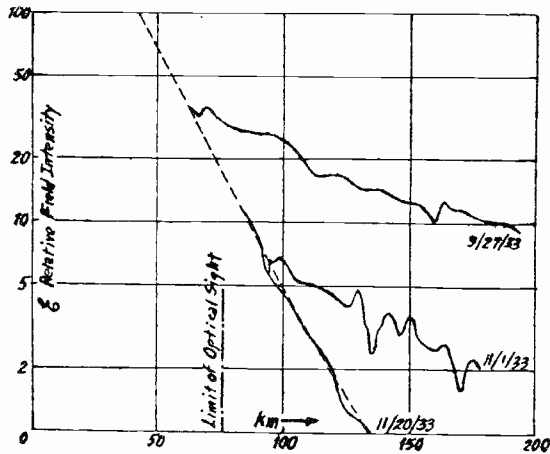

Fig. 20—Example of refraction on different days. $\lambda = 4.6$ meters. Taken from Englund, Crawford, and Mumford.⁷

65 kilometers on. This result coincides with our own observations that in summer refraction seems to appear more frequently and strongly than in winter. Moreover it was observed that, in agreement with the measured curve from Fig. 20, refraction over sea is stronger than over land.

With the aid of impulses of duration $3 \cdot 10^{-6}$ second we have attempted to separate the refracted ray from the diffracted ray and to measure the difference in time of travel. The distance from the transmitter was about 120 kilometers. With this arrangement a reflecting layer at 3000 meters height would be detectable at least as a splitting up of the impulse on a cathode-ray tube. However, only amplitude fluctuations of the impulse were observed. From this it can be con-

⁷ C. R. Englund, A. B. Crawford, and W. W. Mumford. "Further results of a study of ultra-short-wave transmission phenomena," *Bell Sys. Tech. Jour.*, vol. 14, pp. 369-387; March, (1935).

cluded that only a diffracted ray is present, which at times is more strongly bent by refraction in the lower atmospheric layers.*

Nevertheless it must be assumed that at very great distances the occasional appearance of short-time high field intensities is to be attributed to reflection at a sharply defined layer. Sufficient observational material is not available at present to clarify these phenomena.

* *Translator's Note:* The last two paragraphs contain material which was added after the publication of the original paper in German. This supplementary material was received by the translator September 19, 1936.



BOOK REVIEWS

Electronics and Electron Tubes, by E. D. McArthur. Published by John Wiley and Sons, Inc., New York, N. Y. 173 pages. Price \$2.50.

This is not a radio book; it deals with electron tubes broadly. The author states that he has tried to meet a part of the demand for information by describing "the fundamental principles which govern the action of all electron tubes." The book is descriptive rather than mathematical and is illustrated with 89 figures. One third is devoted to gas- or vapor-filled tubes; this section forms perhaps the most useful part of the book.

Bibliographies are given at the ends of nine of the ten chapters. These refer largely to work of the General Electric Company, possibly because the book was originally published in serial form in the *General Electric Review*.

The treatment of the problems involved, although simple, is not for beginners, inasmuch as in many cases general statements are made without the inclusion of the special conditions making valid the discussion.

*B. E. SHACKELFORD

Handbook of Engineering Fundamentals, by Ovid W. Eshbach. Published by John Wiley and Sons, Inc., New York, N. Y. 1081 pages. Price \$5.00.

The title "Handbook of Engineering Fundamentals" makes a special appeal, although one is conscious of a contradiction of terms—handbook suggesting a collection of facts, fundamentals, basic laws or principles. The expression "engineering fundamentals" conveys the idea of a development of formulas from basic principles rather than a collection of these formulas. The editor's preface says "This handbook has been prepared for the purpose of embodying in a single volume those fundamental laws and theories of science which are basic to engineering practice," and the publisher speaks of it as including "fundamental material underlying all engineering." One in sympathy with these objectives is surprised to find the first 200 pages devoted to mathematical tables, properties of materials, tables of conversion factors, structural sizes, and interest tables such as one would expect to find in any handbook. True, the greater part of this material is useful to most engineers but it is factual rather than fundamental. Material related to the various specialized branches of engineering such as Communication and Electronics, and Electric Power are published as separate volumes. This will necessarily increase the number of handbooks required by the individual and the number of places to look for information, but the publishers feel that engineering science and practice has developed to the point where this is necessary. Off-setting these disadvantages will be the fuller treatment of the various specialized topics. A certain amount of duplication appears to be unavoidable. Obviously the book under review is intended to furnish only a limited amount of information on the specialized subjects, possibly enough for those in other fields.

For those who experience trouble in changing from one system of units to

* RCA Manufacturing Company, Inc., RCA Radiotron Division, Harrison, New Jersey.

another, the conversion tables will be much appreciated. The process is purely mechanical and it is almost impossible to make an error. However, it does not help one to understand the transformation, nor is it intended to. Of special value to the radio engineer is the table of the three-halves power of numbers from 10 to 1000 by units and below 10 by fractional steps. The addition of condensed tables of trigonometric functions and logarithms would be helpful. A good table of integrals is included. In view of the limited space devoted to Heaviside operational calculus it is questioned whether the Laplacian transformation will be of much assistance to the average engineer. Likewise the treatment of determinants is too short to be of much value. Both of these sections could be expanded with advantage. There is nothing on the convection of heat, friction between rubber and concrete, etc. In view of the increasing importance of air-conditioning this subject should be expanded unless it is taken up in greater detail in some other handbook. For radio engineers the sections on the theory of mechanics, mechanics of materials, and nonmetallic materials are adequate. The sections on electricity and magnetism, radiation of light, acoustics, meteorology, and chemistry are of interest.

The publishers deserve the highest praise for adopting an enlarged format, good paper, and readable type. For the most part the mechanical make-up is excellent. Two improvements are suggested: a thumb-notch index by subject; a continuous page numbering system. It is realized that from the publishers' point of view the section numbering system has definite advantages in getting out future editions but the publishers do not use the book.

*H. M. TURNER

An Hour a Day with Rider on Automatic Volume Control, by John F. Rider; John F. Rider, Publisher, 1440 Broadway, New York, N. Y. 94 pages. Price \$.60

This book is intended as an elementary text for servicemen and experimenters, and as such it should serve satisfactorily. The explanations of terms like "time constant" and "delay voltage" are lucid, but wordy and repetitious in a manner which characterizes the author's style throughout the book. The use of illustrative examples taken from standard circuit diagrams is commendable.

Although the title suggests a reasonably complete treatment of the subject of automatic volume control, the book does not mention the occasional practice of controlling the audio-frequency amplification to obtain a more nearly horizontal automatic volume control characteristic curve. Several relatively complicated systems for obtaining delayed automatic volume control are discussed in detail, but nothing appears regarding the very common practice of providing the controlled tubes with self-biasing resistors in order to realize an effective voltage delay in the operation of the automatic control system. On the contrary, it is stated several times that the voltage developed across the cathode resistor of a controlled tube provides a "fixed minimum bias" for the tube. This statement is not only incorrect but very likely to be misleading to a serviceman attempting to analyze a series of voltage readings made under operating conditions.

This small volume should be helpful to the novice, but will be of little value to the engineer or advanced experimenter.

†ALBERT R. HODGES

* Yale University, New Haven, Connecticut.

† Associate, Ralph H. Langley, Consulting Engineer, New York, N. Y.

BOOKLETS, CATALOGS, AND PAMPHLETS RECEIVED

The following commercial publications of radio engineering interest have been received by the Institute. You can obtain a copy of any item without charge by addressing the issuing company and mentioning your affiliation with the Institute of Radio Engineers.

COAXIAL CABLE . . . Specifications for a new line of radio-frequency power-transmission cable, gas filled. (2 pages, $8\frac{1}{2} \times 11$ inches, printed.) *Communication Products, Inc., 245 Custer Avenue, Jersey City, N. J.*

COMPONENTS . . . A wide variety of variable air condensers, coil forms, intermediate-frequency transformers, etc. are described in "The Hammarlund '37' Catalog." (16 pages, $8\frac{1}{2} \times 10\frac{1}{2}$ inches, printed.)—*Hammarlund Manufacturing Company, Inc., 424-438 West 33rd Street, New York, N. Y.*

INSTRUMENTS . . . A new loose-leaf catalog describes some 25 "Measuring and Testing Instruments for the Electrical and Allied Industries." (52 pages + cover, $8\frac{1}{2} \times 11$ inches, printed.)—*Marconi-Ekco Instruments Ltd., Electra House, Victoria Embankment, London, W.C.2, England.*

INTERFERENCE ELIMINATION . . . Article under this title in "The Aerovox Research Worker" describes filter circuits. (4 pages, $8\frac{1}{2} \times 11$ inches, printed.)—*Aerovox Corporation, 70 Washington Street, Brooklyn, N. Y.*

LOUDSPEAKER . . . Catalog page describes two new 15-inch heavy-duty speakers. (2 pages, $8\frac{1}{2} \times 11$ inches, printed.)—*The Magnavox Company, 2131 Bueter Road, Fort Wayne, Ind.*

MICROPHONES . . . Data Sheet No. 125 gives specifications on three "ultra wide-range crystal microphones." (2 pages, $8\frac{1}{2} \times 11$ inches, lithographed.)—*Shure Brothers, 225 West Huron Street, Chicago, Ill.*

NICKEL ALLOYS . . . Booklet describes engineering applications of the "Monel" alloys. (48 pages + cover, 9×12 inches, printed.)—*The International Nickel Company, Inc., 67 Wall Street, New York, N. Y.*

NICKEL ALLOYS . . . Physical characteristics and uses of nickel and Monel Metal in several radio manufacturing applications. (5 pages, $8\frac{1}{2} \times 11$ inches, printed.)—*Somers Brass Company, Inc., 350 Madison Avenue, New York, N. Y.*

MUTUAL INDUCTANCE . . . Instruments and methods for measuring mutual inductance are discussed in the January issue of "The General Radio Experimenter." (8 pages, 6×9 inches, printed.)—*General Radio Company, 30 State Street, Cambridge, Mass.*

PARTS . . . "Cat. No. 190" lists a variety of supplies for the experimental laboratory. (36 pages + cover, $8\frac{3}{8} \times 10\frac{3}{4}$, printed.)—*Insuline Corporation of America, 23-25 Park Place, New York, N. Y.*

PARTS . . . The coil forms, coil sockets, and other insulated parts used in the Q-Meter are now available for general sale. (1 page, $8\frac{1}{2} \times 11$ inches, lithographed.)—*Boonton Radio Corporation, Boonton, N. J.*

PARTS . . . Condensers, control resistors and vibrators are listed in this Mallory-Yaxley catalog. (44 pages, $8\frac{1}{2} \times 11$ inches, printed).—*P. R. Mallory & Company, Inc., Indianapolis, Ind.*

PICKUPS . . . A bulletin "Pick-up Facts" contains specifications for 10 Audak pickups. (6 pages, $8\frac{1}{2} \times 11$ inches, printed).—*Audak Company, 500 Fifth Avenue, New York, N. Y.*

PICKUPS . . . Description of a new "Crystal record reproducer." (4 pages, $8\frac{1}{2} \times 11$ inches).—*Shure Brothers, 225 West Huron Street, Chicago, Ill.*

POWER PLANTS . . . Bulletin describes electric power plants driven by gas engines. For continuous-duty or stand-by service. Outputs up to 60 kilowatts. (12 pages, 9×12 inches, printed).—*Lycoming Manufacturing Company, Williamsport, Pa.*

RESISTORS . . . Catalog Number 15 describes a line of vitreous enameled rheostats and fixed resistors, tap switches, chokes, and attenuators capable of dissipating up to 50 watts. (12 pages, $8\frac{1}{2} \times 11$ inches, printed).—*Ohmite Manufacturing Company, 4835 Flournoy Street, Chicago, Ill.*

ROCHELLE SALT . . . "Some Fundamental Characteristics of Rochelle Salt" is the title of an article beginning in the January issue of "Brush Strokes." (12 pages, $4\frac{3}{8} \times 6$ inches, printed).—*Brush Development Company, East 4th and Perkins, Cleveland, Ohio.*

TEST INSTRUMENTS . . . "A design manual of tube and radio testing instruments" illustrates and describes the technical design of meters and circuits employed in Supreme instruments. (64 pages, $5\frac{1}{2} \times 8\frac{3}{8}$ inches, printed).—*Supreme Instruments Corp., Greenwood, Miss.*

TUBE DATA (NATIONAL UNION) . . . Specifications and characteristics on Twin diode pentodes 6B7, 6B8, and 6B8G; power output tube, 6V6G; medium mu voltage amplifier 6C5, 6C5G and 6J5G. (12 pages, $8\frac{1}{2} \times 11$ inches, printed).—*National Union Laboratories, 1181 McCarter Highway, Newark, N. J.*

TUBE DATA (RCA) . . . Application Note No. 67 discusses operation of triodes and pentodes as resistance-coupled radio-frequency amplifiers. (7 pages, $8\frac{1}{2} \times 11$ inches, multigraph and lithograph).—Application Note No. 68 gives design and operating data on a 55-watt amplifier using two type 6L6 tubes. (11 pages, $8\frac{1}{2} \times 11$ inches, multigraph and lithograph).—*RCA Manufacturing Company, Inc., Harrison, N. J.*

TUBE DATA (SYLVANIA) . . . Third edition of "Technical Manual" gives characteristics and circuit applications for receiving tubes. (184 pages + cover, $4\frac{3}{8} \times 9\frac{1}{4}$ inches, printed).—*Hygrade Sylvania Corporation, Emporium, Pa.*

TUBE DATA (SYLVANIA) . . . Tabular listing of "Average Characteristics" of receiving tubes and tube and base diagrams. (5 pages, $8\frac{1}{2} \times 11$ inches, lithographed).—*Hygrade Sylvania Corporation, Emporium, Pa.*

TUBE DATA (WESTINGHOUSE) . . . Twelve light-sensitive phototubes of both vacuum and gas-filled types are described in Information Bulletin No. 8. (4 pages, $8\frac{1}{2} \times 11$ inches, lithographed).—*Westinghouse Lamp Division, Special Products Sales Department, Bloomfield, N. J.*

CONTRIBUTORS TO THIS ISSUE

Baranovsky, Cyril: Born February, 1914, at St. Petersburg, Russia. Attended school in England and Canada. C.N.R. surveys, summers, 1930, and 1931. Received B.E.E. degree, University of Minnesota, 1936. Assistant, J. R. Longstaffe, Ltd., 1936 to date. Member, American Association for the Advancement of Science, Student member, American Institute of Electrical Engineers. Student member, Institute of Radio Engineers, 1935.

Foster, Dudley E.: Born December 12, 1900, at Newark, New Jersey. Received E.E. degree, Cornell University, 1922. Commercial radio operator, Marconi Company, 1917; electrical engineer, Electrical Alloy Company and Driver-Harris Company, 1922-1925; production engineer, Malone-Lemmon Products Company, 1925-1926; chief engineer, Case Electric Company, 1926-1928; assistant chief engineer, United States Radio and Television Company, 1928-1931; chief radio engineer, General Household Utilities Company, 1933-1934; engineer, RCA License Laboratory, 1934 to date. Associate member, Institute of Radio Engineers, 1926; Member, 1937.

Jackson, William E.: Born May 8, 1904, at Bridgewater, Massachusetts. Received B.S. degree in electrical engineering, Brown University, 1925. Westinghouse Electric and Manufacturing Company, 1923; New England Telephone and Telegraph Company, 1925-1927; radio engineer, Department of Commerce, Airways Division, 1927-1932; chief, Radio Development Section, Air Navigation Division, Bureau of Air Commerce, 1932 to date. Associate member, Institute of Radio Engineers, 1929; Member, 1934.

Jenkins, Arthur: Born November 23, 1914, at Ironwood, Michigan. Received E.E. degree, University of Minnesota, 1936. Oliver Iron Mining Company, summer, 1936; engineer, Electrux Sound Systems, Inc., fall, 1936; engineer, Wright De Coster, Inc., November, 1936, to date. Student member, Institute of Radio Engineers, 1936.

Moore, A. H.: Born January 14, 1906, at Silverdale, Tennessee. Received B.S. degree University of Chattanooga, 1928. Radio Division, Naval Research Laboratory, 1929 to date. Associate member, Institute of Radio Engineers, 1929.

Pfister, Wolfgang: Born August 16, 1906, at Munich. Studied electrical technology Munich Technical High School 1925-1929. Grafelfing Experimental Station for wireless telegraphy and static electricity, under Professor Dieckmann, 1930-1934. Received doctor's degree, 1934. German Experimental Station for Aviation, Institute for Electrophysics, 1934 to date. Nonmember, Institute of Radio Engineers.

Seeley, Stuart William: Born June 23, 1901, at Chicago, Illinois. Received B.Sc. degree in electrical engineering, Michigan State College, 1925. Amateur experimenter and commercial operator, 1915-1924. General Electric Company, 1925-1926; engineer, experimental research department, Sparks Withington Company, 1926-1935; chief radio engineer, 1928-1935; engineer, RCA License Laboratory, 1935 to date. Nonmember, Institute of Radio Engineers.

Stuart, Donald M.: Received B.S. degree, University of Minnesota, 1928. Research laboratory, Northwest Paper Company, 1928-1929; Radio Section, National Bureau of Standards, 1929-1934; Radio Development Section, Air Navigation Division, Bureau of Air Commerce, 1934 to date. Nonmember, Institute of Radio Engineers.

von Handel, Paul F.: Born January 30, 1901, at Bisenz, Austria. Studied at Technical High School, Munich, 1919-1923; became graduate engineer, 1923. Worked as leader of Siemens Elektrowaerme G.m.b.H., Sornewitz, near Dresden, 1925-1926; experimental laboratory for development of sending apparatus, Telefunkengesellschaft für drahtlose Telegraphie, Berlin. Division for radio-telegraphy and electrotechnics under the direction of Prof. H. Fassbender, Deutsche Versuchsanstalt für Luftfahrt E. V., Berlin-Adlershof, Germany, 1928-1936; division head, 1936 to date. Nonmember, Institute of Radio Engineers.

Wallace, J. D.: Born March 6, 1904, at Gloster, Mississippi. Received B.A. degree, University of Mississippi, 1925; M.A. degree, 1927. Radio Division, Naval Research Laboratory, 1926 to date. Associate member, Institute of Radio Engineers, 1929.







• INCONSPICUOUS but important is the name "Western Electric" on your telephone.

You may never have noticed it, yet it has been there for years. And it has a great deal to do with the quality and low cost of telephone service.

Western Electric has been making Bell System equipment for over half a century. Its specialized production and purchasing enable the operating

companies in the Bell System to buy equipment and supplies of the highest quality at reasonable prices.

Western Electric also maintains a nation-wide system for the rapid delivery of material and apparatus. This is an important factor in providing good telephone service from day to day and speeding its restoration in time of fire, flood or other emergency.



BELL TELEPHONE SYSTEM

When writing to advertisers mention of the PROCEEDINGS will be mutually helpful.

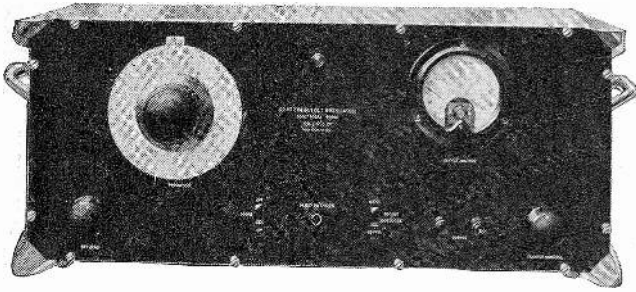

BEAT FREQUENCY OSCILLATOR

TYPE TF. 195

DISTORTION FACTOR METER

TYPE TF. 142

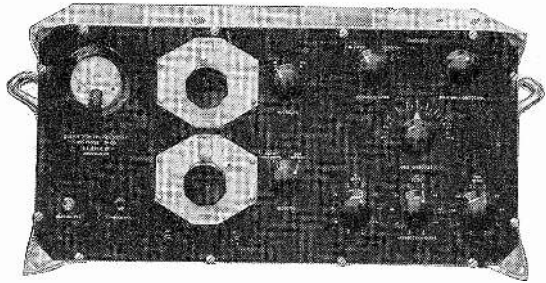

Type TF. 195

A Mains operated low frequency Source continuously variable from 10 to 12000 cycles per second. The harmonic content is less than 1% over the greater part of the frequency range and the Output voltage is within plus or minus 0.5 db. from 50-12000 cycles per second.

Type TF. 142

A portable instrument measuring directly the total harmonic content in the output of audio frequency oscillators and amplifiers.

Range 0.1% to 50% distortion on frequencies between 100-5000 cycles per second.

Prices and further particulars of these and other instruments will be gladly forwarded on request.

MARCONI-EKCO INSTRUMENTS, LTD.
Electra House, Victoria Embankment, London, W.C.2, England

When writing to advertisers mention of the PROCEEDINGS will be mutually helpful.

The Institute of Radio Engineers

Incorporated

330 West 42nd Street, New York, N.Y.

APPLICATION FOR ASSOCIATE MEMBERSHIP

(Application forms for other grades of membership are obtainable from the Institute)

To the Board of Directors

Gentlemen:

I hereby make application for Associate membership in the Institute of Radio Engineers on the basis of my training and professional experience given herewith, and refer to the members named below who are personally familiar with my work.

I certify that the statements made in the record of my training and professional experience are correct, and agree if elected, that I will be governed by the constitution of the Institute as long as I continue a member. Furthermore I agree to promote the objects of the Institute so far as shall be in my power, and if my membership shall be discontinued will return my membership badge.

(Sign with pen)

(Address for mail)

(Date)

(City and State)

Sponsors:

(Signature of references not required here)

Mr. _____ Mr. _____

Address _____ Address _____

City and State _____ City and State _____

Mr. _____

Address _____

City and State _____

The following extracts from the Constitution govern applications for admission to the Institute in the Associate grade:

ARTICLE II—MEMBERSHIP

Sec. 1: The membership of the Institute shall consist of: * * * (c) Associates, who shall be entitled to all the rights and privileges of the Institute except the right to hold any elective office specified in Article V. * * *

Sec. 4: An Associate shall be not less than twenty-one years of age and shall be a person who is interested in and connected with the study or application of radio science or the radio arts.

ARTICLE III—ADMISSION AND EXPULSIONS

Sec. 2: * * * Applicants shall give references to members of the Institute as follows: * * * for the grade of Associate, to three Fellows, Members, or Associates; * * * Each application for admission * * * shall embody a full record of the general technical education of the applicant and of his professional career.

ARTICLE IV—ENTRANCE FEE AND DUES

Sec. 1: * * * Entrance fee for the Associate grade of membership is \$3.00 and annual dues are \$6.00.

ENTRANCE FEE SHOULD ACCOMPANY APPLICATION

Handy... and for 1000 Uses

**Completely
Insulated**



Model 666

Accurate Within 2%

**Pocket
Volt-Ohm-
Milliammeter**

For laboratory, shop or field use. Handy pocket size yet sturdy and precision built.

DEALERS PRICE \$15⁰⁰

Model 666

3" Sq. Triplet Instrument is moving coil rectifier type. A.C.-D.C. Voltage Scales Read: 10-50-250-500-1000 at 1000 ohms per volt.
D.C. Milliampere Scale Reads: 1-10-50-250.
Ohms Scale Reads: Low 1/2-300; High 250,000.
Black Molded Case and Panel.
Size 3 1/16 x 5 7/8 x 2 1/8 in.

Low Loss Selector Switch.
Complete with Alligator Clips, Battery and Test Leads.
DEALER PRICE\$15.00
A complete instrument for all servicing and other needs. Can be used for all A.C.-D.C. voltage, current and resistance analyses.
Leather Carrying Case, Model 669, supplied extra. Dealer Price\$3.00
Very attractive. Of black, heavy leather with finished edges and strap.

WRITE FOR CATALOG



The Triplet Electrical Instrument Co.
213 Harmon Ave., Bluffton, Ohio

Without obligation please send me
 More information on Model 666.
 I am also interested in

Name

Address

City State

When writing to advertisers mention of the PROCEEDINGS will be mutually helpful.

AEROVOX

Wet Electrolytics



AEROVOX offers two general types of wet electrolytics: (1) Standard Condensers and (2) Regulating Condensers. These two types differ from one another by their characteristics in the region above their normal operating voltage rating.



Standard Wet Electrolytics increase in leakage gradually until the scintillating voltage of the electrolyte is reached. Regulating Wet Electrolytics cut off rather sharply at the regulating voltage, so that no further increase of voltage across the condenser is possible and only the current through the condenser is capable of increase.



Regardless of your wet electrolytic requirements, AEROVOX either has a standard type ready or can design a special type for you. Meanwhile, a vast wet electrolytic department is prepared to meet any release schedule.



Consult Us . . .

Place your capacitance problems before us. Our engineers will gladly cooperate in their solution. Quotations cheerfully submitted.



AEROVOX CORPORATION

71 WASHINGTON STREET, BROOKLYN, N. Y.

Sales Offices in All Principal Cities



When writing to advertisers mention of the PROCEEDINGS will be mutually helpful.

ENGINEERING DIRECTORY

QUARTZ CRYSTALS

for Standard or Special
Radio Frequency Applications

Write for Catalog

BLILEY ELECTRIC CO.
230 Union Station Bldg.
ERIE, PENNA.

Cathode Ray Tubes
and Associated
Equipment For All
Purposes

*Write for Complete
Technical Data*

**ALLEN B. DUMONT
LABORATORIES**
UPPER MONTCLAIR, N.J.

COIL APPLICATIONS

Our coil specialists will engineer and design to your specific requirements coils for original installation or replacement purposes. Write for catalog or send specifications for quotations.

**EDWIN I. GUTHMAN and
CO., INC.**
400 S. Peoria St.
Chicago, Ill.

PRACTICAL RADIO ENGINEERING

One year Residence Course
Advanced Home Study Course
Combined Home Study-Residence
Course

Write for details

**Capitol Radio Engineering
Institute**
Washington, D.C.

MICROPHONE APPLICATIONS

Our engineering department will cooperate, without obligation, in the selection of suitable microphones for standard or special applications.

SHURE BROTHERS

"Microphone Headquarters"
225 WEST HURON ST. CHICAGO, U.S.A.

"Q"—Measurements

We specialize in equipment for the radio frequency measurement of "Q" (X/R) of coils, condensers and other radio components.

Write for Circular

BOONTON RADIO CORPORATION
BOONTON, NEW JERSEY

For the Engineering Consultant

who can handle a little extra business this year

For the Designer

who can manage some additional work

we suggest the Engineering Directory of the I.R.E. PROCEEDINGS. Manufacturers who need services such as yours and organizations with special problems come to our Engineering Directory for information. Your name and special service announced here will put you in line for their business. For further information and special rates for I.R.E. members write to the Institute of Radio Engineers.

When writing to advertisers mention of the PROCEEDINGS will be mutually helpful.

Change in Mailing Address or Business Title

Members of the Institute should use this form to notify the Institute office of a change in their mailing address or the listing of their company affiliation or title.

The Secretary
THE INSTITUTE OF RADIO ENGINEERS
330 West 42nd Street
New York City

New Affiliation or Title

Name _____
(Print or type)

Title _____

Company Name _____

Company Address _____

Home Address

Street _____
(Print or type)

City and State _____

Old Mailing Address

Street _____
(Print or type)

City and State _____

Please indicate whether you wish your mail to be sent to your home
or business address.

Signature _____

Date _____

Alphabetical Index to Advertisements

A	
Aerovox Corporation	XV
American Telephone & Telegraph Company	IX
C	
Central Radio Laboratories	XX
Cornell-Dubilier Corporation	XIII
E	
Engineering Directory	XVI
Erie Resistor Corporation	XIX
G	
General Radio Company	Cover IV
I	
Institute of Radio Engineers	XI, XII, XVII, Cover III
M	
Marconi-Ekco Instruments	X
T	
Triplett Electrical Instrument Company	XIV

PROCEEDINGS BOUND VOLUMES

VOLUME 24 (1936) of the Proceedings is now available in bound form to members of the Institute. It may be obtained in Buckram or Morocco leather for \$9.50 and \$12.00 respectively. Foreign postage is \$1.00 additional per volume.

Buckram bound copies of Volumes 18 and 19 (1930 and 1931) are also available for \$9.50. Foreign postage is \$1.00 additional per volume.

When writing to advertisers mention of the PROCEEDINGS will be mutually helpful.

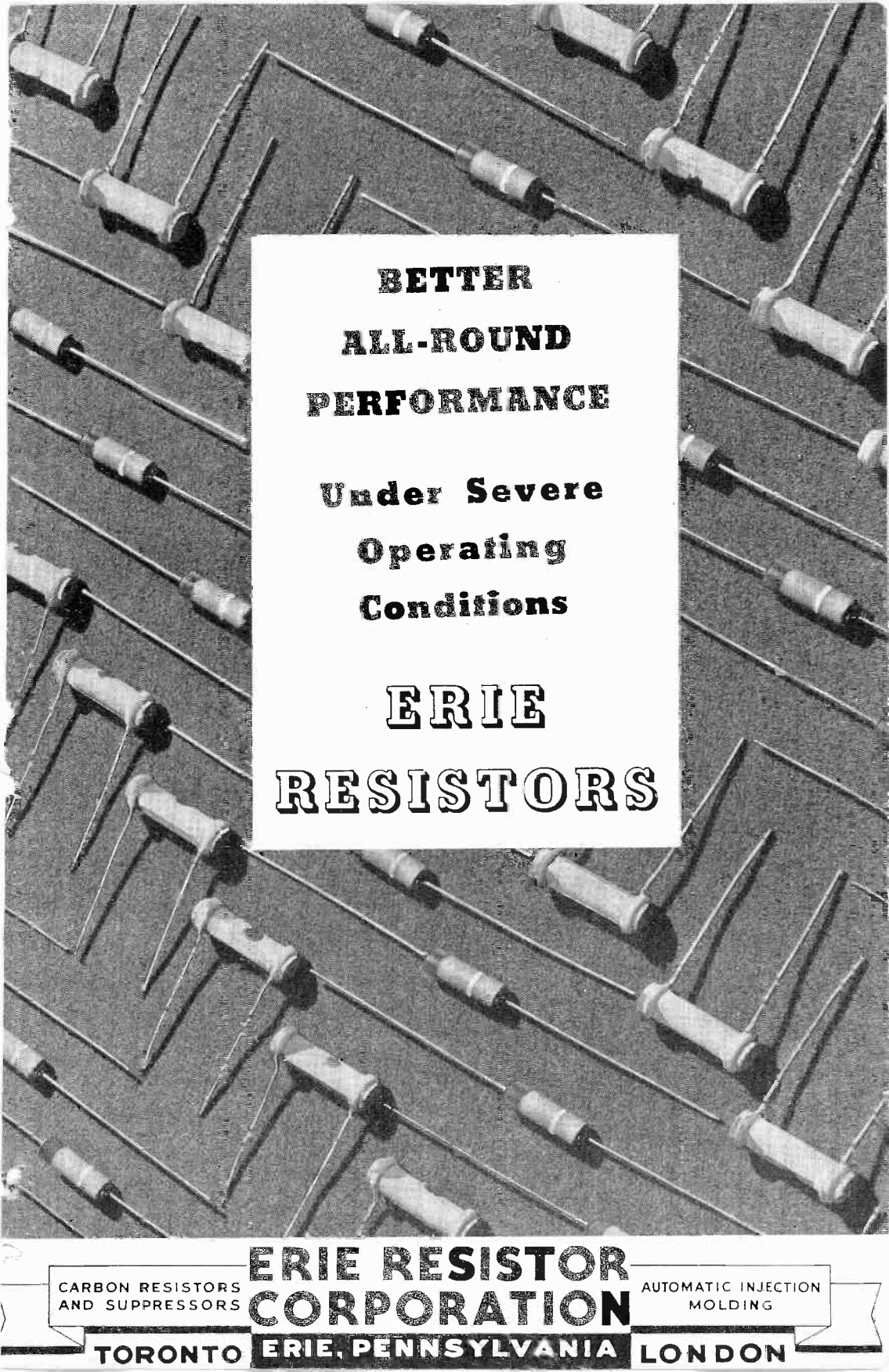

**BETTER
ALL-ROUND
PERFORMANCE**

**Under Severe
Operating
Conditions**

**ERIE
RESISTORS**

CARBON RESISTORS
AND SUPPRESSORS

**ERIE RESISTOR
CORPORATION**

AUTOMATIC INJECTION
MOLDING

TORONTO

ERIE, PENNSYLVANIA

LONDON

Since 1927



THE INSTITUTE OF RADIO ENGINEERS
INCORPORATED
330 WEST 42ND STREET
NEW YORK

January 4, 1937

Mr. H. E. Osmun, Vice-Pres.
Centralab
Milwaukee, Wis

My dear Mr. Osmun:--

This will acknowledge with thanks your contract for space in the twelve issues of the Proceedings for the coming year

Our records show, incidentally, that you started advertising with us in the February 1927 issue. This will make the eleventh year that we have carried a full Centralab schedule in the Proceedings.

We sincerely hope that you will be with us for many years to come.

Yours very truly,

John D. Crawford
John D. Crawford,
Advertising Manager

JDC:LOL

Since 1927, Centralab announcements have been telling the story of dependable, quality products . . . and through the years "Centralab" has become a synonym for quality. For original equipment or replacements specify "Centralab."

CENTRALAB
Division of GLOBE-UNION Inc.
MILWAUKEE, WISCONSIN

Centralab
GRL

When writing to advertisers mention of the PROCEEDINGS will be mutually helpful.

INSTITUTE SUPPLIES

EMBLEMS



Three styles of emblems are available to members of the Institute only. They are all of 14k gold with gold lettering on an enameled background, the color of which indicates the grade of membership. The approximate size of each emblem is as illustrated.



The lapel button is supplied with a screw back having jaws which fasten it securely to the coat. The price is \$2.75, postpaid, for any grade.



The pin which is provided with a safety catch may be obtained for any grade for \$3.00, postpaid.

The watch charm is handsomely finished on both sides and is equipped with a suspension ring for attaching to a watch chain or fob. Price for any grade, \$5.00, postpaid.

BINDERS



Binders are available for those who desire to protect their copies of the PROCEEDINGS with stiff covers. Each binder will accommodate the twelve monthly issues published during the year. These binders are of blue Spanish Grain Fabricoid with

gold lettering, and will serve either as temporary transfers or as permanent binders. They are so constructed that each individual

copy of the PROCEEDINGS will lie flat when the pages are turned. Copies can be removed from the binder in a few seconds and are not damaged by their insertion. They are priced at \$1.50 each, and the member's name or PROCEEDINGS Volume Number will be stamped upon the binder in gold for \$0.50 additional.

BACK ISSUES OF THE PROCEEDINGS

Complete volumes of back issues of the PROCEEDINGS are available in unbound form for the years 1918, 1921, 1922, 1923, and 1926 at \$6.75 per year (six issues) to members. Also complete unbound for 1931, 1933, 1934, and 1935 at \$7.50 per year to members. A list of the available miscellaneous copies published from 1913 on may be obtained from the Secretary. Single copies published prior to 1927 are sold to members at \$1.13 each, and those issued during and after 1927 are \$0.75 each. Foreign postage on single copies is \$0.10 per copy, making \$0.60 on unbound volumes before 1927.

Issues bound in blue buckram for 1922 (six numbers) are available at \$8.75 to members. For 1930 and 1931, they are priced at \$9.50 each to members. Foreign postage is \$1.00 additional per volume. Volumes for 1922 and 1926 bound in Morocco leather are available at \$10.25 each to members.

TWENTY-EIGHT-YEAR INDEX

An Index of the PROCEEDINGS for the years 1909-1936, inclusive, is available at \$1.00 per copy. It is extensively cross indexed. The earlier references are to the PROCEEDINGS of the Wireless Institute; the PROCEEDINGS of the Institute of Radio Engineers has been published since 1913.

When ordering any of the above, send remittance with order to the Secretary, Institute of Radio Engineers, 330 West 42nd Street, New York City.

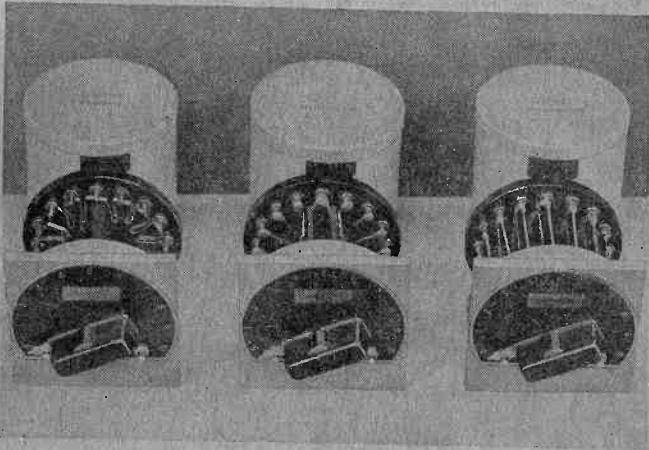

COMPACT DECADE-RESISTANCE UNITS

MANY electrical circuits require the use of one or more decade-resistance units of the panel mounting type where use of the usual decade-resistance box is not possible.

To meet this demand General Radio supplies individual decade units identical with those used in the G-R Type 602 Decade-Resistance Boxes. These Type 510 Units have found wide application in experimental equipment and in composite assemblies of special laboratory apparatus.

The Type 510 Units feature:

- **EXCELLENT FREQUENCY CHARACTERISTIC**—no appreciable error up to 50 kc.
 - **THOROUGH AGING**—to relieve mechanical strains and stresses which might subsequently alter their electrical characteristics.
 - **LOW AND CONSTANT CONTACT RESISTANCE**—quadruple-leaf switches bear on contacts $\frac{3}{8}$ inch in diameter. Switch resistance is approximately 0.002 ohm.
 - **LOW TEMPERATURE COEFFICIENT**—less than $\pm 0.002\%$ per deg. C.
- at normal operating temperatures.
- **COMPACTNESS**—each unit is self-contained and is assembled around a one-piece moulded bakelite frame. The switch and contacts are at the rear of the assembly. A positive-action cam-type detent mechanism is used.

The Type 510 Decade-Resistance Units are supplied with aluminum shield, knob and etched-metal dial plates in maximum resistances (with 10 steps for each unit) from 1 ohm to 100,000 ohms. Prices range between \$8.50 and \$14.00.

Write for Bulletin 113-R for complete information

GENERAL RADIO COMPANY
30 STATE STREET CAMBRIDGE, MASSACHUSETTS