

BRUCE

VOLUME 24

JUNE, 1936

NUMBER 6

PROCEEDINGS
of
**The Institute of Radio
Engineers**



Application Blank for Associate Membership on Page XI

Institute of Radio Engineers Forthcoming Meetings

CLEVELAND SECTION
September 24, 1936

DETROIT SECTION
June 19, 1936

EMPORIUM SECTION
June 26, 1936

LOS ANGELES SECTION
June 16, 1936

NEW YORK MEETING
October 7, 1936

PHILADELPHIA SECTION
June 4, 1936

PITTSBURGH SECTION
June 16, 1936

WASHINGTON SECTION
June 8, 1936

The Institute of Radio Engineers

Board of Editors

ALFRED N. GOLDSMITH, *Chairman*

R. R. BATCHER

H. H. BEVERAGE

F. W. GROVER

J. W. HORTON

G. W. PICKARD

K. S. VAN DYKE

H. P. WESTMAN, *ex officio*

L. P. WHEELER

L. E. WHITTEMORE

WILLIAM WILSON

CONTENTS

PART I

Institute News and Radio Notes.....	815
April Meeting of the Board of Directors.....	815
May Meeting of the Board of Directors.....	815
Nominations and Election of Officers.....	816
Radio Emissions of Standard Frequency.....	817
Institute Meetings.....	817
Erratum.....	834
Personal Mention.....	835

PART II

Technical Papers

A Unicontrol Radio Receiver for Ultra-High Frequencies Using Concentric Lines as Interstage Couplers.....	FRANCIS W. DUNMORE	837
The Design of Radio-Frequency Choke Coils.....	HAROLD A. WHEELER	850
Radio Field Intensity and Distance Characteristics of a High Vertical Broadcast Antenna.....	SAMUEL S. KIRBY	859
A Cathode-Ray Time Axis for High Frequency....	LAURANCE M. LEEDS	872
Notes on the Theory of the Single Stage Amplifier... ..	BERNARD SALZBERG	879
Frequency Modulation Propagation Characteristics.....	MURRAY G. CROSBY	898
Unsymmetrical Self-Excited Oscillations in Certain Simple Nonlinear Systems.....	J. G. BRAINERD AND C. N. WEYGANDT	914
Electromagnetic Shielding Effect of an Infinite Plane Conducting Sheet Placed Between Circular Coaxial Coils.....	SAMUEL LEVY	923
Book Reviews: "Phenomena in High-Frequency Systems," by August Hund.....	LYNDE P. WHEELER	942
"Einführung in die Angewandte Akustik," by H. J. von Braunmühl and Walter Weber.....	IRVING WOLFF	943
Booklets, Catalogs, and Pamphlets Received.....		944
Contributors to This Issue.....		945

The Institute of Radio Engineers

GENERAL INFORMATION

INSTITUTE. The Institute of Radio Engineers was formed in 1912 through the amalgamation of the Society of Wireless Telegraph Engineers and the Wireless Institute. Its headquarters were established in New York City and the membership has grown from less than fifty members at the start to several thousand.

AIMS AND OBJECTS. The Institute functions solely to advance the theory and practice of radio and allied branches of engineering and of the related arts and sciences, their application to human needs, and the maintenance of a high professional standing among its members. Among the methods of accomplishing this is the publication of papers, discussions, and communications of interest to the membership.

PROCEEDINGS. The PROCEEDINGS is the official publication of the Institute and in it are published all of the papers, discussions, and communications received from the membership which are accepted for publication by the Board of Editors. Copies are sent without additional charge to all members of the Institute. The subscription price to nonmembers is \$10.00 per year, with an additional charge for postage where such is necessary.

RESPONSIBILITY. It is understood that the statements and opinions given in the PROCEEDINGS are views of the individual members to whom they are credited, and are not binding on the membership of the Institute as a whole. Papers submitted to the Institute for publication shall be regarded as no longer confidential.

REPRINTING PROCEEDINGS MATERIAL. The right to reprint portions or abstracts of the papers, discussions, or editorial notes in the PROCEEDINGS is granted on the express condition that specific reference shall be made to the source of such material. Diagrams and photographs published in the PROCEEDINGS may not be reproduced without making specific arrangements with the Institute through the Secretary.

MANUSCRIPTS. All manuscripts should be addressed to the Institute of Radio Engineers, 330 West 42nd Street, New York City. They will be examined by the Papers Committee and the Board of Editors to determine their suitability for publication in the PROCEEDINGS. Authors are advised as promptly as possible of the action taken, usually within two or three months. Manuscripts and illustrations will be destroyed immediately after publication of the paper unless the author requests their return. Information on the mechanical form in which manuscripts should be prepared may be obtained by addressing the secretary.

MAILING. Entered as second-class matter at the post office at Menasha, Wisconsin. Acceptance for mailing at special rate of postage is provided for in the act of February 28, 1925, embodied in Paragraph 4, Section 412, P. L. and R., and authorization was granted on October 26, 1927.

Published monthly by

THE INSTITUTE OF RADIO ENGINEERS, INC.

Publication office, 450-454 Ahnaip St., Menasha, Wis.

BUSINESS, EDITORIAL, AND ADVERTISING OFFICES

Harold P. Westman, *Secretary*

330 West 42nd Street, New York, N. Y.

INSTITUTE SECTIONS

- ATLANTA—Chairman, I. H. Gerks; Secretary, N. B. Fowler, 1048 Woodland Ave., S.E., Atlanta, Ga.
- BOSTON—Chairman, E. L. Bowles; Secretary, Roland G. Porter, Northeastern University, Boston, Mass.
- BUFFALO-NIAGARA—Chairman, L. E. Hayslett; Secretary, E. C. Waud, 235 Huntington Ave., Buffalo, N. Y.
- CHICAGO—Chairman, H. C. Vance; Secretary, J. E. Brown, 2022 Engineering Building, Chicago, Ill.
- CINCINNATI—Chairman, C. D. Barbulesco; Secretary, R. L. Freeman, Crosley Radio Corporation, Cincinnati, Ohio.
- CLEVELAND—Chairman, R. Morris Pierce; Secretary, J. S. Hill, 3325 Beechwood Ave., Cleveland Heights, Ohio.
- CONNECTICUT VALLEY—Chairman, M. E. Bond; Secretary, E. E. Schwarzenbach, 42 Northwood St., Chicopee Falls, Mass.
- DETROIT—Chairman, E. C. Denstaedt; Secretary, Howard S. Gould, 214 Tuxedo Ave., Detroit, Mich.
- EMPORIUM—Chairman, Raymond R. Hoffman; Secretary, L. E. West, Hygrade Sylvania Corporation, Emporium, Pa.
- LOS ANGELES—Chairman, C. R. Daily; Secretary, L. W. Howard, 525 West Central St., Anaheim, Calif.
- NEW ORLEANS—Chairman, L. J. M. Du. Treil; Secretary, C. B. Reynolds, Radiomarine Corporation of America, 512 St. Peter St., New Orleans, La.
- PHILADELPHIA—Chairman, Knox McIlwain; Secretary, R. L. Snyder, 103 Franklin Rd., Glassboro, N. J.
- PITTSBURGH—Chairman, Lee Sutherlin; Secretary, Branko Lazich, Union Switch and Signal Company, Swissvale, Pa.
- ROCHESTER—Chairman, Lee C. DuBridge; Secretary, H. A. Brown, 89 East Ave., Rochester, N. Y.
- SAN FRANCISCO—Chairman, Robert Kirkland; Secretary, Henry Tanck, RCA Communications, Inc., Bolinas, Calif.
- SEATTLE—Chairman, Earl D. Scott; Secretary, Harold C. Hurlbut, 2633-11th Ave. N., Seattle, Wash.
- TORONTO—Chairman, L. M. Price; Secretary, R. Klingelhoefter, International Resistance Company, 187 Duchess St., Toronto, Ont., Canada.
- WASHINGTON—Chairman, Chester L. Davis; Secretary, Gerald C. Gross, Federal Communications Commission, Washington, D. C.

GEOGRAPHICAL LOCATION OF MEMBERS
ELECTED MAY 6, 1936

Elected to the Associate Grade

California	Bolinas, Box 144	Macono, F. J.
	Inverness	Oates, T. L.
	Long Beach, 835 E. Hill St.	Hall, F. W.
	Los Angeles, 1533 Wilshire Blvd.	Eastman, F. F.
	San Pedro, USS Pennsylvania	Tucker, D. P.
	Coscob, c/o R. D. Dykema, Cognewaugh Rd.	De Waard, R.
Connecticut		
District of		
Columbia	Washington, 3109-24th St. N.E.	Linger, R. A.
	Washington, 922 National Press Bldg.	Poast, L. M.
Florida	Tallahassee, Radio Dept., Florida A. and M. College	Orr, H. R.
Georgia	Atlanta, 995 Delaware Ave. S.E.	Stephens, H. W.
	Atlanta, 774 Sherwood Rd. N.E.	Trammell, R. D.
	Quitman, Box 367	Underwood, F. C., Jr.
Illinois	Chicago, 3629 Pine Grove Ave.	Argento, H. F.
	Chicago, Radio Lab., United Air Lines, Municipal Airport	Buckthal, E. P.
	Chicago, RCA Communications, 114 W. Adams St.	Hutchens, R. D.
	Chicago, c/o Jackson Distributing Co., 1122 W. Jackson Blvd.	Marks, M.
	Chicago, 1122 W. Jackson Blvd.	Wells, W. J.
	Fort Sheridan	Benfer, E. L.
Indiana	Columbus, 1628 Cottage Ave.	Crouch, J.
Kansas	Concordia, 707 W. 7th St.	Young, K. A.
Louisiana	Shreveport, Box 17	Antony, W. E.
	Shreveport, Box 248, Queensboro Station	Garrett, E. D.
Maine	Bangor, c/o Radio Station WABI	Hodgkins, R. W.
Massachusetts	Holyoke, 151 Dartmouth St.	Webber, F. G.
	Malden, 51 Concord St.	Rich, G. C.
	Salem, 35 Dearborn St.	Ellithorn, H. E.
Michigan	Ann Arbor, 929 Olivia	Morton, J. A.
New Jersey	Bayonne, 1084 Boulevard	Brady, J. S.
	East Orange, 48 Amherst St.	Peet, E. C.
	Merchantville, 1800-48th St., Delaware Gardens	Wentworth, C.
	Nutley, 331 Park Ave.	Curtis, L. B.
	Summit, Box 1	Lamb, J. M.
	Whippany, P.O. Box E.	Goss, F. A.
New York	Brooklyn, Clarostat Mfg. Co., Inc., 285 N. 6th St.	Hall, R. E.
	Brooklyn, Clarostat Mfg. Co., Inc., 285 N. 6th St.	Mucher, G. J.
	New York, 463 West St.	Keller, A. C.
	New York, 560 W. 113th St.	Klinck, H. O.
	New York, Bell Tel. Labs., 180 Varick St.	Lenigan, T. E.
	New York, 295 Madison Ave.	Pfeffer, N.
	New York, c/o Weston Electrical Instrument Corp., 50 Church St.	Sievers, E. S.
	New York, 147 E. 61st St.	Talmey, P.
	Troy, 1834 Highland Ave.	Stoker, W. C.
North Carolina	Raleigh, 124 Groveland Ave.	Hulick, H., Jr.
Pennsylvania	Emporium, 120 E. 4th St.	Campbell, V. H.
	Philadelphia, 1613 N. 16th St.	Marble, F. G.
	Philadelphia, 3817 Elsinore St.	Marshall, B. T.
	Pittsburgh, 1940 W. Homestead St., N.S.	Vogt, L. E.
Texas	Del Rio, Box 25	Cammack, W. R.
	Laredo, Box 410	Meza, J. O.
Australia	Sydney, N.S.W., 221 Gale Rd., Marsbra	Stirk, F. J.
Canada	Schumacher, Ont., Box 440	Parsons, A. B.
	Toronto, Ont., 187 Duchess St.	Longstaffe, J. R.
England	East Molesey, Surrey, 6 Summer Ave.	Moon, J. L.
	Flixton, Lanes., 5 Ashley Ave.	Veevers, J. F.
	Hadley Wood, Herts., Barngate, Waggon Rd.	Taylor, W.
	London S.E. 20, 130 Anerley Rd.	Goodchild, F. D.
	London Wall, London E.C. 2, 426 Salesbury House	Johnson, D. H.
	Sheffield, 429 Staniforth Rd.	Kitching, F. O.
	Wirral, Ches., 12 Castle Close, Leeds Lane, Moreton	Parry, R. C.
Germany	Berlin-Britz, Parchimer-Allee 73c	Passarge, G.
Japan	Tokyo, Shingo-hosoyjo, Shingo-Mura, Kitaadachi-gun, Saitama-ken	Sakai, N.
New Zealand	Feilding, c/o Radio Sales and Service Co.	McEwen, K. D.
Poland	Warsaw, Targowa 32 m.8.	Rabecki, W.
South Africa	Johannesburg, 43 Olivia Rd., Berea	Wendrow, R.
	Kensington, Transvaal, 28 Cumberland Rd.	Hutchinson, M.
Sumatra	Palembang, N. K. P. M. Soenggi Garden	Lytle, T. M.

Elected to the Junior Grade

Florida	Miami, 283 N.W. 59th Terrace	Haeger, J. R.
New Jersey	Salem, P.O. Box 237	McCloskey, J. D.
Mexico	Nuevo Laredo, Tamps., Belden 1001	Loyo Gomez, F.

Geographical Location of Members Elected

Elected to the Student Grade

California	Berkeley, 2632 Channing Way.....	Kramer, F. S.
	Oakland, 3847 Randolph Ave.....	Mole, J.
Indiana	Fort Wayne, 533 E. Wayne St.....	Palguta, E. M.
Massachusetts	Cambridge, Box 115, Mass. Inst. of Tech.....	Adams, J. C.
	Cambridge, 76 Grozier Rd.....	Mooney, V. J.
Michigan	Ann Arbor, 802 Oakland Ave.....	Evans, H. W.
	Detroit, 11790 Ilenc Ave.....	Hart, A. D.
	Detroit, 9418 Manor Ave.....	Shimkus, A.
Nevada	Reno, 792 West St.....	Greulich, R. A.
New York	New York, 704 Livingston Hall, Columbia Univ.....	Marshall, R. W.
Ohio	Cincinnati, 125 W. McMillan St.....	Grinstead, C. E.
	Columbus, 207 W. 11th Ave.....	Prehn, L. D.
Oklahoma	Norman, 800 Chataugua.....	Waller, J. L., Jr.
Washington	Seattle, 3879-44th Ave. N.E.....	Alvensleben, G. V.
	Seattle, 3631-43rd Ave. N.E.....	Guptill, H.

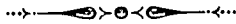

APPLICATIONS FOR MEMBERSHIP

Applications for transfer or election to the various grades of membership have been received from the persons listed below, and have been approved by the Admissions Committee. Members objecting to transfer or election of any of these applicants should communicate with the Secretary on or before June 30, 1936. Final action will be taken on these applications July 1, 1936.

For Transfer to the Fellow Grade

Connecticut	West Hartford, 282 Fern St.	Warner, K. B.
New Jersey	Haddonfield, 424 Hawthorne Ave.	Diehl, W. F.

For Transfer to the Member Grade

District of Columbia	Washington, 924 National Press Bldg.	Bailey, S. L.
	Washington, 1420 New York Ave. N.W.	Girard, E. J.
	Washington, 5241 Broad Branch Rd. N.W.	Wells, H. W.
Indiana	Columbus, 1121 Sycamore St.	Wolcott, C. F.
New York	New York, Hudson View Gardens	Robbins, L. R.
	New York, Bell Tel. Labs., 180 Varick St.	Woodworth, F. B.

For Election to the Member Grade

Illinois	Chicago, 1154 Merchandise Mart Bldg.	Martin, G. I.
Utah	Salt Lake City, 277 "N" St.	Pack, E. G.

For Election to the Associate Grade

California	Los Banos, P.O. Box 708	Greulich, A. L.
	San Francisco, 146 A Noe St.	Kerkhof, L. M.
Connecticut	Bridgeport, 1151 Central Ave.	Tietzworth, F. W.
	Stratford, 426 Woodstock Ave.	Shofstall, N. F.
District of Columbia	Washington, Washington Missionary College, Takoma Park	Jones, G. E.
Georgia	Atlanta, 69 Linden Ave. N.W.	Baker, R. W.
	Atlanta, 1314 Northview Ave. N.E.	Coleman, G. A.
	Jonesboro	Heely, O. H.
Illinois	Berwyn, 1838 S. Euclid Ave.	Novy, J. F.
	Chicago, 3852 Addison St.	Skinner, C. F.
	Chicago, 2012 Jackson Blvd.	Trout, E. D.
	Glenview, 8 Park Dr.	Burnham, E.
Indiana	Valparaiso, 551 College Ave.	Elder, R. K.
Maryland	Fallston, c/o C. H. Durham	Haynes, J. M.
Massachusetts	Brookline, 260 Fisher Ave.	Porter, N. C.
	Wollaston, 627 Quincy Shore Dr.	Peterson, C. U.
Michigan	Detroit, 15-210 General Motors Bldg.	Archer, S. W.
Minnesota	Minneapolis, 1435 W. 31st St.	McKnew, W. H.
Missouri	St. Louis, 4568 Manchester Ave.	Forst, J. A.
New Jersey	East Orange, 209 Prospect St.	Truell, R.
	Harrison, RCA Radiotron Div., RCA Mfg. Co.	Gibbons, D. R.
	Harrison, RCA Radiotron Div., RCA Mfg. Co.	Headrick, L. B.
	Irvington, 493 Stuyvesant Ave.	Knochel, W. J.
	Jersey City, 138 Van Nostrand Ave.	Graves, A. C.
	North Arlington, 30 Hedden Ter.	Johnson, H. C.
	Upper Montclair, 14 Bruce Rd.	Judd, F. V. H.
New York	Brooklyn, 19-A Garden Pl.	Goldmark, P. C.
	Buffalo, 206 Locust St.	Schmidt, F. W., Jr.
	Flushing, L.I., 153-14-32nd Ave.	Hopkins, E. J.
	Freeport, L.I., P.O. Box 12	Wardlow, C. A.
	Jackson Heights, L.I., 37-52-74th St.	Mead, P. R.
	Mount Vernon, 12 Hartley Ave.	Dorschug, H. A.
	New York, N. Y. Evening Journal, 210 South St.	Brooks, T. A.
	New York, c/o Varick House, 11 Dominick St.	Geluch, A.
	Schenectady, General Elec. Co.	Mayer, H. F.
	Woodhaven, L.I., 9525-75th St.	Culmone, F. T.
Ohio	Dayton, Aircraft Radio Lab., Wright Field	Gallay, H.
Pennsylvania	Emporium, 239 W. Allegheny Ave.	Campbell, R. E.
	Haverford, 339 W. Lancaster Ave.	Bruning, J. M.
	Philadelphia, Germantown YMCA, 5722 Greene St.	Crowley, J. F.
	Philadelphia, 3616 Chestnut St.	Latsha, M. P.
	Philadelphia, 4512 "D" St.	Marsh, W. E.
	Philadelphia, 127 E. Mermaid Lane.	Sleeper, G. E., Jr.
Texas	Fort Worth, Box 1317	Tinsley, A. B.
Canada	Brandon, Manit., 2425 McDonald Ave.	Burneski, A. D.

Applications for Membership

China	Tsinan, Radio Eng. Dept., Cheeloo Univ.	Chang, T. Y.
England	Bradford, Yorks., 90 Leeds Old Rd.	Pennessy, F. H.
	East Putney, London S.W. 15, 61 Galveston Rd.	Young, A. J.
	Liverpool, Lanes., 68 Sandhurst St.	Wells, W. E.
	London N.W. 3, 8 Hampstead Hill Gardens.	D'Arcy, N. W.
	London S.W. 19, 186 Morden Rd.	Duran, J.
	South Shields, Durham, 34 Mount Ter.	Roberts, G. N.
	Wallington, Surrey, 52 Cowper Gardens.	Smith, M. C.
	Watford, Herts., 53 Cassio Rd.	Richardson, W. D.
	Woking, Surrey, Coxhill, Chobham.	Gabriel, R. P.
	France	Rueil, Seine et Oise, 108 Avenue Albert Ier
Holland	Hilversum, Leeuwenhoekstraat 8.	Rens, H.
Ireland	Dublin, Army Signal Corps, Officers Mess, McKee Barracks.	Murphy, P. J.
	Dublin, 31 St. Helens' Rd., Booterstown.	Neligan, S.
New Zealand	Auckland, W. 1, 30 Ponsonby Ter., Ponsonby.	Hansen, I. C.
Uruguay	Montevideo, Vilardebo 2065.	Garcia, L. A.

For Election to the Junior Grade

Illinois	Glenview, Box 375.	Pond, R. F.
Kansas	Sabetha, 1533 Main St.	Dillaplain, V
Montana	Miles City, 1218 N. Montana Ave.	Bunn, C.

For Election to the Student Grade

Arkansas	Fayetteville, Box 453.	Davis, J. W.	
California	Berkeley, 2010 Parker St.	Peterson, N. J.	
	Beverly Hills, 434 S. Bedford Dr.	Elmendorf, O.	
Indiana	Oakland, 3936 Rhoda Ave.	Bollaert, R.	
	Oakland, 5897 Claremont Ave.	Clark, O.	
	Piedmont, 46 Craig Ave.	Chick, A. J.	
	Angola, 302 E. Gale St.	English, R. R.	
	Louisiana	New Orleans, 4708 Banks St.	Cronvich, J. A.
	Massachusetts	Arlington Heights, 36 Kenilworth Rd.	Gregson, R. L.
		Boston, 53 Grampan Way, Dorchester.	Dufourd, A. J.
	Michigan	Cambridge, M.I.T. Dormitories.	Altman, F. J.
		Cambridge, 39 Hammond St.	Darwin, F. A.
		Cambridge, 6½ Acacia St.	Taylor, M.
Ann Arbor, 1346 Geddes Ave.		Huang, S.	
Minnesota		Minneapolis, 2848-44th Ave. S.	Sigford, J. V.
Minneapolis, 1012 Essex St. S.E.		Silliman, R. M.	
New Jersey		Chatham, 13 Chestnut St.	Tyson, B. F.
New York		Schenectady, 1716 Rugby Rd.	Plummer, W. B.
		Ohio	Cincinnati, 2640 Burnet Ave.
Pennsylvania		Cleveland, 1247 E. 101st St.	La Marsh, J. E.
	Cuyahoga Falls, 1733 Chestnut Blvd.	Farrington, R. A.	
	Lakewood, 1470 Wyandotte Ave.	Sibila, K. F.	
West Virginia	Altoona, 2406-2nd Ave.	Findley, J. D., Jr.	
Austria	Bluefield, 1208 Princeton Ave.	Henderson, W. D.	
Japan	Vienna, XIV Storchengasse 12.	Filipowsky, R.	
	Osaka, c/o Physics Dept., Faculty of Science, Osaka Imperial University, Nakanosima, Kitaku.	Akazawa, K	



OFFICERS AND BOARD OF DIRECTORS

(Terms expire January 1, 1937, except as otherwise noted)

President

ALAN HAZELTINE

Vice President

VALDEMAR POULSEN

Treasurer

MELVILLE EASTHAM

Secretary

HAROLD P. WESTMAN

Editor

ALFRED N. GOLDSMITH

Directors

ARTHUR BATCHELLER

J. V. L. HOGAN

L. C. F. HORLE

C. M. JANSKY, JR., *Junior Past President*

C. B. JOLLIFFE

A. F. MURRAY

H. M. TURNER

WILLIAM WILSON

SERVING UNTIL JANUARY 1, 1938

STUART BALLANTINE, *Senior Past President*

E. L. NELSON

HARADEN PRATT

L. E. WHITTEMORE

SERVING UNTIL JANUARY 1, 1939

E. H. ARMSTRONG

VIRGIL M. GRAHAM

H. H. BEVERAGE

INSTITUTE NEWS AND RADIO NOTES

April Meeting of the Board of Directors

The regular monthly meeting of the Board of Directors was held on April 1, in the Institute office. Those present were Alan Hazeltine, president; Melville Eastham, treasurer; E. H. Armstrong, Arthur Batcheller, H. H. Beverage, Alfred N. Goldsmith, Virgil M. Graham, L. C. F. Horle, C. M. Jansky, Jr., C. B. Jolliffe, A. F. Murray, E. L. Nelson, Haraden Pratt, H. M. Turner, William Wilson, and H. P. Westman, secretary.

Sixty-four applications for Associate membership, three for Junior, and seventeen for Student grade were approved.

On the recommendation of the Awards Committee, the Institute Medal of Honor for 1936 was voted to G. A. Campbell, for his contributions to the theory of electrical networks.

An invitation to the Institute to participate as a sponsor of the First National Conference on Education and Broadcasting to be held in Washington, D. C., this December was accepted.

May Meeting of the Board of Directors

A meeting of the Board of Directors was held on May 6 and was attended by Alan Hazeltine, president; Melville Eastham, treasurer; Stuart Ballantine, H. H. Beverage, Virgil M. Graham, J. V. L. Hogan, L. C. F. Horle, C. N. Jansky, Jr., A. F. Murray, E. L. Nelson, L. E. Whittemore, William Wilson, and H. P. Westman, secretary.

A committee comprised of C. M. Jansky, Jr., chairman; C. B. Jolliffe, and E. L. Nelson was appointed to prepare a program to be given in Washington, D. C., in December as part of the first International Conference on Educational Broadcasting.

An invitation for the Institute to submit a testimonial commemorating the centennial of the death of the French scientist Andre Marie Ampere was accepted.

Nominations for officers to be voted on this fall were prepared and are given at the end of this report.

It was agreed that a year book would be published early in 1937 to contain the membership list as of December 31, 1936.

The Awards Committee announced that the Morris Liebmann Memorial Prize would be given to B. J. Thompson for his contributions to the vacuum tube art in the field of very high frequencies.

Nominations and Election of Officers

In accordance with the requirements of the Institute Constitution, Article VII of that document is reprinted herewith and is followed by a list of nominations submitted to the membership by the Board of Directors.

ARTICLE VII

NOMINATION AND ELECTION OF PRESIDENT, VICE PRESIDENT, AND THREE DIRECTORS AND APPOINTMENT OF SECRETARY, TREASURER, AND FIVE DIRECTORS

SEC. 1—On or before July 1st of each year the Board of Directors shall call for nominations by petition and shall at the same time submit to qualified voters a list of the Board's nominations containing at least two names for each elective office, together with a copy of this article.

Nomination by petition shall be made by letter to the Board of Directors setting forth the name of the proposed candidate and the office for which it is desired he be nominated. For acceptance a letter of petition must reach the executive office before August 15th of any year, and shall be signed by at least thirty-five Fellows, Members, or Associates.

Each proposed nominee shall be consulted and if he so requests his name shall be withdrawn. The names of proposed nominees who are not eligible under the Constitution, as to grade of membership or otherwise, shall be withdrawn by the Board.

On or before September 15th, the Board of Directors shall submit to the Fellows, Members, and Associates in good standing as of September 1st, a list, of nominees for the offices of President, Vice President, and three Directors. This list shall comprise at least two names for each office, the names being arranged in alphabetical order and shall be without indication as to whether the nominees were proposed by the Board or by petition. The ballot, shall carry a statement to the effect that the order of the names is alphabetical for convenience only and indicates no preference.

Fellows, Members, and Associates shall vote for the officers whose names appear on the list of nominees, by written ballots in plain sealed envelopes, enclosed within mailing envelopes marked "Ballot" and bearing the member's written signature. No ballots within unsigned outer envelopes shall be counted. No votes by proxy shall be counted. Only ballots arriving at the executive office prior to October 25th shall be counted. Ballots shall be checked, opened, and counted under the supervision of a Committee of Tellers, between October 25th and the first Wednesday of November. The result of the count shall be reported to the Board of Directors at its first meeting in November and the nominees for President and Vice President and the three nominees for Directors receiving the greatest number of votes shall be declared elected. In the event of a tie vote the Board shall choose by lot between the nominees involved.

SEC. 2—The Treasurer, Secretary, and five appointive Directors shall be appointed by the Board of Directors at its annual meeting for a term of one year or until their successors be appointed.

FOR PRESIDENT

H. H. Beverage

L. C. F. Horle

FOR VICE PRESIDENT

P. P. Eckersley

Heinrich Fassbender

FOR DIRECTORS

Ralph Bown

C. B. Jolliffe

A. F. Murray

Alfred N. Goldsmith

George Lewis

H. M. Turner

Radio Emissions of Standard Frequency

The National Bureau of Standards provides standard frequency emissions from its station WWV at Beltsville, Md. On each Tuesday and Friday the emissions are continuous unmodulated waves and on each Wednesday they are modulated by an audio frequency, generally 1000 cycles. There are no emissions on legal holidays.

On all schedules three radio carrier frequencies are transmitted as follows: noon to 1 P.M., Eastern Standard Time, 15,000 kilocycles; 1:15 to 2:15 P.M., 10,000 kilocycles; and 2:30 to 3:30 P.M., 5000 kilocycles. The accuracy of these frequencies will at all time be better than a part in five million.

During the first five minutes of each transmission announcements are given of the station call letters, the frequency of transmission, and the frequency of modulation, if any. For the CW emissions, the announcements are in telegraphic code and are repeated at ten-minute intervals. For the modulated emissions, the announcements are given by voice only at the beginning of each carrier frequency transmission, the remainder of the hour being an uninterrupted audio frequency. The CW emissions are from a twenty-kilowatt transmitter and the modulated transmissions are from a one-kilowatt set.

Information on how to utilize these signals is given in a pamphlet obtainable on request from the National Bureau of Standards, Washington, D. C. Reports from those using this service will be welcomed by the Bureau. As the modulated emissions are somewhat experimental it is particularly desired that users report their experiences outlining methods of utilization, information on relative fading, intensity, etc., on the three carrier frequencies and preferences as to the audio frequency to be furnished.

Institute Meetings

ATLANTA SECTION

A meeting of the Atlanta Section was held on February 20 at Georgia Institute of Technology with I. H. Gerks, chairman, presiding.

A paper on "Radio-Frequency Measurements as Applied to Modern Broadcast Transmitters" was presented by W. J. Holey, a radio consultant. The importance of accurate antenna resistance measurements to permit computation of antenna power was pointed out. These measurements may be made either by resistance substitution, resistance variation, or direct bridge measurement methods. Measurements of audio-frequency distortion with the transmitter fully loaded should be followed by transmission versus frequency measurements to show

the fidelity of transmission. Several typical curves of broadcast transmitter performance were presented and analyzed to indicate the corrections needed in the adjustment of equipment to permit a high degree of performance to be obtained. Some of the measuring methods were demonstrated by equipment set up in the lecture hall. Nineteen members and guests attended the meeting.

The March meeting of the section was held on the 19th at the Atlanta Athletic Club. There were sixteen present and Chairman Gerks presided.

A paper on "New Radio Receiver Circuits for 1936" was presented by D. Mathewson of the Dixie Radio Distributors, Inc. He reviewed briefly the changes which occurred in 1935, and outlined the trends for 1936 designs. Graphs were shown to illustrate the power levels, amplifier characteristics, and the evolution of microphones together with sound equipment, fidelity, and performance characteristics. Improved types of speakers were described and relative efficiencies compared, the maximum reaching about twenty-five per cent. Trends in metal tubes were noted and high fidelity receiver characteristics outlined together with volume expander circuits which have been introduced in some receivers.

BOSTON SECTION

The Boston Section met on January 17 at Massachusetts Institute of Technology. E. L. Bowles, chairman, presided and there were eighty members and guests present. Twenty attended the informal dinner which preceded the meeting.

D. H. Bacon, chief engineer of the National Company presented a paper on "Short-Wave Receiver Design Problems." Practical methods of obtaining high signal-to-noise ratio were discussed and a new system of interstage coupling particularly applicable to frequencies above fifteen megacycles was described. This system in its simplest form consists of a tuned circuit inductively coupled to both the antenna or plate circuit and the grid of the following tube. Characteristics may be made such that stage gain is uniform over a wide frequency range and the effects of electronic loading greatly reduced. The subject of variable selectivity was considered with particular regard to quartz crystal filters. A filter was described in which the equivalent band width was continuously variable over a fourteen-to-one range.

The paper was discussed by Messrs. Bowles, Clapp, Hall, and Hunt.

Professor Bowles presided at the February 28 meeting held at the Harvard University and attended by seventy. Twenty were present at the dinner which preceded the meeting.

"A Report on Diffraction Measurements at Ultra-High Frequencies" was presented by Harner Selvidge, an instructor at Harvard University and J. A. Pierce, a research assistant at Harvard. Experimental work on the diffraction behind a knife-edge-shaped hill was done at Bar Harbor, Maine. The measurement method permitted diffraction effects to be separated from reflection and refraction phenomena. The observed diffraction was compared with computations based on simple optical theory. Tentative results seem to indicate that horizontal polarized ultra-high-frequency signals are diffracted more than highly polarized waves. When diffracted around sharp angles, horizontally polarized signals are frequently stronger than vertically polarized waves of equal radiated power. The observations checked fairly well with the optical theory computations.

Plans for a solar eclipse expedition being sent by Cruft Laboratory to Russia this spring were described. Ionosphere measurements with two fixed and one variable frequency transmitter will be made. The variable frequency transmitter covers completely the range from two to seven megacycles in about three minutes. Automatic recording will be used throughout.

The paper was discussed by Messrs. Bowles, Chaffee, Mimno, and Hunt.

The March meeting was held on the 27th at Massachusetts Institute of Technology. There were twenty-two at the dinner which preceded the meeting and seventy attended the meeting which was presided over by Chairman Bowles.

A. L. Samuel of Bell Telephone Laboratories presented a paper on "The Design of Vacuum Tubes for Use at Ultra-High Frequencies." The subject was introduced with a brief reference to the probable value of the frequency range above one hundred megacycles. Factors which limit the usefulness of conventional tubes at these frequencies were examined. In designing special tubes for this range, attention may be given to the high-frequency requirements of ordinary tubes or use may be made of radically different operating mechanisms not subject to the same restrictions. Advantages and limitations of both procedures were discussed and illustrated by reference to specific tubes. It was concluded that the first procedure is more promising as it permits use of usual circuits and operating techniques already highly developed. The alternate mechanisms are chiefly of value at frequencies and power levels not yet covered by tubes of the first type.

The paper was discussed by Messrs. Bowles, Eastham, Hunt, and Karplus.

BUFFALO-NIAGARA SECTION

The Buffalo-Niagara Section met on March 25 at the University of Buffalo. There were forty-six present and R. J. Kingsley, vice chairman, presided.

A paper on "Construction and Operation of WHAM Fifty-Kilowatt Transmitter" was presented by J. J. Long, Jr., its technical supervisor. A description of the fifty-kilowatt transmitter was given and the problems in the expansion of the station from the previous five-kilowatt rating outlined. The original five-kilowatt equipment has been retained for stand-by operation. Difficulty was encountered in obtaining cooling water free from sediment. Following the meeting, Dr. Hector opened the Science Hall of the university for inspection. A device for measuring permeability of slightly magnetic materials was examined. It is capable of detecting permeability differences from unity by one part in a hundred thousand. Symmetrically arranged balanced coils are unbalanced by the insertion of the test sample and alternating currents induced by the unbalance are amplified and read on a suitable meter. Another apparatus for measuring the absorption of various acoustic materials employed standard samples calibrated by the National Bureau of Standards in comparative tests.

The April meeting of the section was held on the 15th at the Hotel Statler in Buffalo. L. E. Hayslett, chairman, presided and there were 173 members and guests present. This meeting was held jointly with the Buffalo Engineering Society and the local sections of the American Institute of Electrical Engineers and the American Society of Mechanical Engineers.

A paper on "Acoustics and Sound Control" was presented by W. J. Hodge of the Johns-Manville Corporation who introduced the subject with a short description of the characteristics of the human ear. He pointed out that the ear is on continuous duty throughout the lifetime of the individual as noise of some kind is always present. An individual alone in a soundproof room can hear his own heart beats and breathing. Sound motion pictures were then shown of typical sound sources, their transmission and reception, and details of the operation of the human ear. The speaker then described and demonstrated the uses of sound isolating and absorbing materials, their efficiency and the effect of different configurations. It was shown that the absorbing effectiveness of materials was altered but slightly by coating exposed surfaces with perforated sheet metal. The limits of audible frequencies were described and the range of sound intensities discussed. Faulty auditorium design and some of the corrective measures employed were explained.

Plans and sectional models of an auditorium were used with analogous light effects substituted to demonstrate the behavior of sound.

CHICAGO SECTION

A meeting of the Chicago Section was held on March 20 in the RCA Institutes auditorium. H. C. Vance, chairman, presided and the attendance totaled 100. There were twelve at the dinner which preceded the meeting.

A paper on "Transmutation of the Elements" was presented by H. B. Hoag, professor of physics at the University of Chicago. In it Dr. Hoag reviewed the efforts of past workers in determining the fundamental nature of matter and its composition. Developments employing spectroscopy were covered with special reference to the equipment used. The work of several scientists was outlined to show its application to the developments and theories now in force. Methods of producing transmutation were then considered. Among these were accelerating methods which covered the obtaining of high voltage supplies and the description of the cyclotron which has recently become prominent. The theory of operation, limitations, and equipment for the evaluation of results obtained were discussed. Specific citations of transmutation were given and analyzed.

The April meeting of the section was held on the 17th at the RCA Institutes auditorium with Chairman Vance presiding. Twenty-five attended the dinner and there were 115 at the meeting.

G. E. West, radio engineer for the Bureau of Police of the State of Illinois, presented a paper on "Illinois State Police Radio System." He introduced the subject with a short history of the present system. A field survey of the state with a portable one-kilowatt transmitter was made and seven transmitters of the same power finally installed with vertical self-supporting 300-foot radiators of uniform cross section. A minimum signal strength of fifty microvolts per meter is expected to be attained. Over three hundred automobile and motorcycle receivers are to be installed.

CINCINNATI SECTION

The Cincinnati Section met on March 17 at the University of Cincinnati and there were twenty-two members and guests present. G. F. Platts, vice chairman, presided.

W. S. Franklin, chief engineer of The John E. Fast Company, presented a paper on "Paper-Insulated Electrical Condensers." The properties of foils of pure aluminum and an alloy of lead, tin, and antimony were discussed. The development of kraft and linen paper was credited

for a considerable increase in reliability of paper condensers. Methods of determining soluble salts and conducting particles in paper samples were described. The advantages of natural oils and waxes as impregnators over mineral and synthetic oils were enumerated. Automatic winding machines have eliminated defects caused by perspiration contamination. Elaborate drying and impregnating processes have greatly increased breakdown voltages. Data on the variation of insulation of resistance with time, temperature, and voltage were presented. Factors determining ultimate breakdown were area of foil, thickness, rate of voltage rise, temperature, and frequency. Graphs on breakdown voltage as related to these factors were given. Other characteristics considered were losses, life, capacitance, and proper utilization of paper condensers. The paper was discussed by Messrs. Bussard, Hultberg, and Osterbrock.

C. D. Barbulesco, chairman, presided at the April 7 meeting which was held in the Engineers Club at Dayton. There were 150 members and guests present and ninety-five attended the dinner which preceded the meeting.

A paper on "Radio in Military Aviation" was presented by L. B. Bender, lieutenant colonel, United States Army, Signal Corps, Wright Field. He described various uses of radio in aviation. He pointed out that stability in service, small size and weight, and low power consumption are the primary factors in the design of equipment. Direction finders and blind flying radio aids were described. A complete station was placed in operation on the speaker's platform and two-way contact made with a plane flying over Dayton. A direction finding receiver was demonstrated and described.

The second paper on "Electric Power Equipment in Military Aviation" was presented by C. L. Munroe, lieutenant, United States Army Air Corps. In it he stressed the need of greater power supply capacity in aircraft. As a twelve-volt storage battery supply requires heavy conductors and has other disadvantages, the use of higher alternating voltages with frequencies between twenty-five and five hundred cycles are being considered. The maintenance of reasonably constant generator speed and the advantages and disadvantages of single and poly-phase systems are being discussed.

During the afternoon an inspection trip was made through the Wright Field radio laboratories, airplane hangars, shops, and museum.

CLEVELAND SECTION

A meeting of the Cleveland Section was held on February 27 at Case School of Applied Science. There were fifty present and R. M.

Pierce, chairman, presided. The meeting was held jointly with the Institute of Radio Servicemen.

A paper on "The Development and Manufacture of Condensers" was presented by Mr. Whitby of The Sprague Products Company. His talk covered briefly the history of condensers up to the early twenties when they began to play an important part in receivers and power supply. Advancement since then has been much more rapid and increased demands have required more careful design and manufacture. Developments discussed included the use of oil as an impregnating medium and wet and dry electrolytic condensers.

The March meeting was held on the 26th at Case School of Applied Science with J. Aitkenhead, Jr., vice chairman, presiding. There were forty-four in attendance.

"The Importance of Low Angle Radiation in Broadcasting" was the subject of a paper given by E. L. Gove, technical supervisor of radio of the Radio Air Service Corporation. He traced briefly developments in antenna design and its effect on the radiation pattern. Antennas giving predominantly low angle radiation assist greatly in reducing interference and increasing primary surface areas of shared channel stations. A description was given of a quarter-wave vertical radiator installed in 1930 at WHK.

Another paper on "The Control of Antenna Radiation" was given by C. E. Smith of the same organization. In it he covered the preliminary theory of wave propagation and radiation and analyzed simple antennas. Various types of arrays and loaded antennas which gave increased ground wave were then developed and graphs given of their vertical radiation patterns. For a field test of antennas, a portable field strength measuring set was designed and built together with a continuous recording measuring set. Their design was discussed and some of the results obtained with them. The paper was concluded with a demonstration of the operation of both pieces of equipment.

CONNECTICUT VALLEY SECTION

The annual meeting of the Connecticut Valley Section was held on December 20 at Springfield, Mass. J. A. Hutcheson, chairman, presided and there were twenty present.

A paper on "Police Radio Systems" was presented by C. J. Burnside, manager of the engineering department of Westinghouse Electric and Manufacturing Company at Chicopee Falls, Mass. It covered a description of modern police radio equipment and its operation.

In the election of officers, M. E. Bond of United American Bosch Corporation was named chairman; F. H. Scheer of F. W. Sickles and

Company, vice chairman; and E. E. Schwarzenbach of United American Bosch Corporation was designated secretary-treasurer.

DETROIT SECTION

E. C. Denstaedt, chairman, presided at the March 27 meeting of the Detroit Section which was held in the Detroit News Conference Room. There were eighty present, twenty of whom attended the informal dinner which preceded the meeting.

J. C. Haber of the Bell Telephone Laboratories presented a paper on "Description of New Transmitter for WWJ." The equipment is designed for power output of five kilowatts and consists of five main units. A buffer stage is modulated and followed by two linear amplifiers of one kilowatt and five kilowatts, respectively. The daytime power output of five kilowatts is reduced to the nighttime power of one kilowatt by switching the transmission line to the penultimate stage, and turning off the final stage. Methods of employing reversed feedback to reduce audio-frequency distortion were discussed.

The wires supplying power for the antenna tower illumination are carried through a copper tube which forms the inner conductor of a concentric transmission line. This inner conductor is connected to the outer conductor at a quarter-wave length from the antenna tower. It forms a short circuited one-quarter-wave transmission line offering a high impedance at the fundamental frequency of the transmitter and avoids use of large chokes in the lighting lines or carrying them through the antenna tuning inductance. The combination also provides a low impedance path to ground for even-order harmonics.

The April 17 meeting was held in the same auditorium with Chairman Denstaedt presiding. Fifty were present and there were ten at the dinner.

A paper on "Class C Amplifiers" was presented by H. A. Moench of the University of Michigan. The author demonstrated analogies with a pendulum of the energy relations in a parallel tuned circuit. He demonstrated a similarity of the change in form of energy storage throughout the cycle, the effective damping, and the constant period of oscillation with diminishing amplitude. The maintenance of oscillation by the addition of energy of short impulses of proper phase was demonstrated. Oscillograms showed the similarity of a parallel circuit tuned to sixty cycles driven by a vacuum tube operating as a class C amplifier and when driven by a motor-operated switch. The current voltage relations for open angle operation of a class C amplifier and their use to determine operating characteristics were described. It was pointed out

that a large operating angle on amplifiers used as frequency doublers increases the plate current but does not increase the radio-frequency output at the double frequency and thus lowers the efficiency of the system. Harmonic distortion was shown to increase with a reduction in operating angle. The effect of the L/C ratio of the tank circuit on its impedance and the energy source in it was considered. The class C amplifier should be viewed not as a power amplifier but as a converter of direct-current energy and the use of a tube having an amplification factor of unity or less was briefly discussed. For high efficiency operation, the tube should have a low internal resistance, small operating angle, and the ratio of energy source in the tank circuit per cycle should be two or greater.

EMPORIUM SECTION

A meeting of the Emporium Section was held on March 20 at the American Legion Club Rooms. R. R. Hoffman, chairman, presided and forty were present.

H. W. Parker, chief engineer of Rogers Radio Tubes, Ltd., of Toronto presented a paper on "The Mechanics of the Work Function of Metals." He presented a brief historical sketch of the classical background of statistical mechanics as propounded by Maxwell, Boltzman, and Gibbs. He then discussed Planck's concept of distribution of radiation in thermodynamic equilibrium in which the quantum of action was first introduced. He then presented changes of the last decade made by Fermi and Sommerfeld in statistical mechanics to adapt it to the more modern concept of wave mechanics. Thermionic emission was discussed from the solution of the Schroedinger equation which is given by the product of five terms representing the energies of translation, vibration, rotation, speed of the free electrons, and the nucleus. It was shown that the vibrational energy is the only one of sufficient magnitude to allow electrons to pierce the potential barrier at the surface of the metal. The following forms of electron emission were discussed: thermionic, photoelectric, field current, electron bombardment, and ion bombardment. These were discussed in the light of the De Broglie wave equation and the Einstein photoelectric equation. Recent experimental work on electron diffraction and optics was discussed. By means of slides he demonstrated the corroboration of the present concepts, heretofore only speculative, made possible by electron optics. The high lights of these demonstrations were: the comparison of the diffraction patterns of a gold foil obtained by X-rays and electrons of the same wave length; changing of the work function of metals; avoiding distortion in an electron optical image of a thin wire by application

of negative voltage behind the wire; and the differences of the work function at different crystal surfaces of the same material. The paper was discussed by Messrs. Acheson, Esperson, and Hoffman.

The April meeting was held on the 8th in the American Legion Club Rooms with fifty-one in attendance. Chairman Hoffman presided.

A paper on "Notes on Radio Design" was given by L. C. F. Horle, consultant of New York City. He discussed first the input impedance of vacuum tubes in design and operation considerations and sketched first a brief history of its early recognition by radio engineers and its increased importance as the scope of application of vacuum tubes expands. Graphs and vectors were used to show the relationships between voltages and currents in various circuit elements in the adaptation of vacuum tubes to radio circuits and demonstrated the significance of those quantities from the input impedance viewpoints, recording load and voltage conditions as parameters. Particular attention was drawn to their use in applying vacuum tubes to ultra-high-frequency work.

Mr. Horle then discussed ultra-high-frequency antennas. Mechanical and electrical design problems were discussed first in regard to their characteristics and then with consideration of their cost. The comparison was then made between ultra-high-frequency and lower frequency radiation systems. In concluding, problems of man-made interference were considered and there was demonstrated a recent development of the author of an instrument for the measurement of ignition and other man-made electrical disturbances. The paper was discussed by Messrs. Carter, Fraenckel, West and Wise.

The section had as its guest, James Walker, the owner and operator of amateur station W2FSM of Highland Park, N. J., who assisted greatly in handling traffic out of the Emporium area during the recent flood.

A second meeting in April was held on the 24th at the American Legion Club Rooms with Chairman Hoffman presiding. There were fifty-five present.

"Mechanical Measurement by Optical Methods" was the subject of a paper presented by H. F. Kurtz, a research and development engineer of the Bausch and Lomb Optical Company. He traced briefly the science of optics and its uncommonly recognized "keystone" relationships to advancements in many other arts and sciences. Optical systems have been used extensively in astronomy, surveying, civil engineering, navigating, and military engineering. The author deprecated

the existing opinion that optical measurements are unsuitable for ordinary mechanical problems and inspection purposes and showed numerous possibilities for the profitable use of optical apparatus in everyday work and engineering. A number of shop and laboratory measurement and inspection equipments were described and demonstrated. The paper was discussed by Messrs. Bachman, Bowie, and Fraenkle.

LOS ANGELES SECTION

A meeting of the Los Angeles Section was held on February 18 at the Los Angeles Junior College with C. R. Daily, chairman, presiding. There were thirty-three present and seven at the dinner.

A paper on "Transformer Design Procedure" was presented by G. W. Weaver, chief engineer of Metal Products Company. In it he discussed the use of silicon steel and transformer core material. Data were given on core losses, permeability, mechanical properties, resistance to aging, and methods of testing. Design procedure in connection with power transformers, filter chokes, and audio transformers were outlined. The paper was discussed by Messrs. Daily, Nikirk, and Shultz.

The March meeting was held on the 17th with Chairman Daily presiding and the attendance was thirty.

A paper on "Intermediate-Frequency Transformer Design Considerations" by A. P. O'Connor, chief engineer of J. W. Miller Company was read by John Blackburn due to the illness of the author. The theory of coupled circuits was reviewed and an elaboration applied to band-pass circuits. Current manufacturing technique in intermediate-frequency transformer production was discussed and included comparisons of air-core and iron-core coils as well as air and mica compression trimmers. Methods for obtaining uniform response over wide bands were explained. The paper was discussed by Messrs. Anderson, Daily, and Silent.

On April 21 a meeting of the section was attended by thirty and presided over by Chairman Daily. There were ten at the dinner which preceded it.

The first paper was on the "Development of Artificial Hearing Aids" by N. Watson and L. Settnyer of the University of California. The development of these devices from the Fletcher and Weaver-Brey experiments on the response of the ear was given. Poor frequency response which is characteristic of some commercially available aids and which may actually decrease the intelligibility in certain types of deafness were described. It was the opinion of the authors that best results

can only be obtained by analyzing the hearing characteristics of the deaf person and prescribing an equipment to correct for the particular deficiencies of the ear.

The second paper of the evening on "Absolute Measurement of Sound Intensity" was by Leo Delsasso of the University of California. He discussed the development of a device for determining altitude by the analysis of echoes. It required the development of equipment for the measurement of sound intensity and experimental results permitted the determination of altitude over a three-hundred-foot range with an accuracy of within four feet.

NEW YORK MEETING

The regular monthly meeting of the Institute was held in New York in the Engineering Societies Building on April 1. It was presided over by President Hazeltine and there were 400 present.

A paper on "Beam Power Tubes" was presented by O. H. Schade of the RCA Manufacturing Company Radiotron Division. The general characteristics of the ideal output tube for broadcast receivers were discussed briefly with respect to specific electrical and acoustical requirements.

Considerations of practical power tube design indicate that the tube most nearly approaching the ideal characteristics is one having an accelerating grid (screen) and a control grid which does not require power. The limitations of conventional output tetrodes and pentodes with respect to the ideal are tested and were illustrated by means of oscillograms and models showing field potential distribution. It follows that homogeneous potential fields and directed electron beams having high electron density can be utilized to minimize these limitations. These design features indicate the feasibility of a tube suitable for operation as a class A amplifier having substantially second harmonic distortion only and capable of high power output, high efficiency, and high power sensitivity.

The theoretically proper geometric structure for beam power tubes was developed. The theory was substantiated by performance data obtained from actual tubes.

The May meeting of the Institute was held on the sixth at the Engineering Societies Building. Four hundred and fifty members and guests attended the meeting and President Hazeltine presided.

A paper on "Electronic Music and Instruments" was presented by B. F. Miessner of Miessner Inventions, Inc. Electronic music, with a history covering over forty years of research, invention, and develop-

ment, is now at last commanding popular attention through rapidly advancing commercial activities during the past year. It is estimated that retail sales of these new instruments have already aggregated about two million dollars in the United States.

The object of this paper was to present, for the first time in this country, a technical-historical review of this art of electronic music, based chiefly on the methods and apparatus for producing it. These methods and instruments encompass wide variations in principle and form. While technical literature in this country is very meager, there exists a wealth of patent literature in about four hundred United States patents relating altogether or very closely to this new art. The general methods, as well as representative examples, were described and illustrated by lantern slides; a bibliography of pertinent literature, both technical and patent, was appended; and a number of instruments were demonstrated.

PHILADELPHIA SECTION

The Philadelphia Section met on March 5 at the Engineers Club. Knox McIlwain, chairman, presided and the attendance was 300 of whom twenty-three attended the informal dinner which preceded the meeting.

Professor Hazeltine, president of the Institute, presented a paper on "Radio Vacuum Tubes Having Deflection Control." He pointed out that present-day tubes operate by control of electron emission while cathode-ray tubes operate by the deflection of electron streams. By a special mechanical arrangement of the grids and plates in a tube it is possible to change the anode current greatly by deflecting the stream through a small angle which requires only a small change in control potential. The plate current change is directly proportional to the control potential change. The tube is constructed with two interleaved helical grids outside of which are two interleaved helical anodes having the same pitch and alignment. A metal shield surrounds the whole. The tube is used in a push-pull circuit. Various forms and arrangements of the element were shown and it was pointed out that a screen grid was not required as the arrangement of the grids and plates provides a shielding effect. The tube may be used as an oscillator and also for automatic volume control. Deflection control may also be used for frequency doubling. The paper was discussed by Messrs. Thompson and Wolffe.

A. E. Thiessen of the General Radio Company presented an exhibition of measuring equipment which he described. The instruments were designed for routine measurements of broadcast transmitting station

characteristics. It permits the measurement of distortion and residual noise. A new type of direct reading modulation indicator permits continuous readings to be made. It includes also an overmodulation alarm whereby a lamp flashes every time a preset value is exceeded. The circuit design and operational principles were described. The paper was discussed by Messrs. Cook and Wolffe.

"Some Recent Advances in Applied Piezoelectricity" was the subject of a paper by A. L. Williams, president of the Brush Development Company which was given at the April 2 meeting of the section. There were 260 present and nineteen attended the dinner.

Rochelle-salt crystals of sodium potassium tartrate are the best generators of piezoelectricity being about a thousand times more effective than quartz. Large crystals are grown and one four inches wide and twenty inches long was displayed. These are sawed into thick strips along a certain axis and then machined like pieces of metal. Electrodes are applied to active surfaces and two of these cemented together to form a bimorph unit. For torsional generators the strips are cut along the B axis of the crystal while for bending they are cut at a forty-five degree angle to this axis.

A large torque bimorph unit about ten inches long generated sufficient power to light a neon lamp and to operate a relay. Construction of phonograph pickup units was described and demonstrated. Microphone units reproducing audible frequencies up to ten thousand cycles with variations not exceeding two decibels and smaller units capable of operating up to twenty thousand cycles were described. Special connections of sound cells to provide directional microphone characteristics were outlined. It is possible also to make microphones insensitive to sound propagated in air but responsive to sound conducted through materials. Crystal-operated telephone receivers were exhibited. A phonograph record cut by a rochelle-salt crystal recorder was played with a crystal pickup. This output was used to modify a light beam by means of a crystal oscilloscope and the light beam made to actuate a photoelectric cell. The output of the photoelectric cell was amplified to permit the operation of a loud speaker for reproduction of the music.

A high speed pen recorder or oscillograph was demonstrated in addition to small oscilloscopes capable of reproducing frequencies up to ten thousand cycles. What is believed to be the first direct acting piezoelectric rotary motor and generator was shown. The motor when supplied with one milliampere direct current was self-starting and turned its four-inch flywheel between 200 and 300 revolutions per minute.

PITTSBURGH SECTION

The January meeting of the Pittsburgh Section was held on the 21st at the Fort Pitt Hotel with Lee Sutherlin, chairman, presiding. Thirty-three members and guests attended.

A paper on "High-Frequency Radiators" was presented by T. A. Graul, telephone engineer of the Bell Telephone Company of Pennsylvania. He covered the subject of antennas from simple single vertical wires to the various types of arrays. The characteristics of the particular types of antennas under discussion were described.

Messrs. Griffith, Lazich, Magg, Place, Sutherlin, and Upp participated in the discussion which followed.

The February meeting was held on the 18th at the Fort Pitt Hotel and was attended by twenty-eight. Chairman Sutherlin presided.

A paper on "Ionic Diodes and Triodes" was presented by W. E. Bahls of the Westinghouse Electric and Manufacturing Company. A theoretical discussion of tube characteristics and design was given and it was pointed out that ionization spaced between the anode and cathode has the effect of bringing these elements together resulting in tube operation similar to that obtained in high vacuum tubes with elements placed much closer than would be practicable from mechanical considerations. This condition accounts for the low voltage drop in gaseous tubes following breakdown. Characteristic curves of gas-filled diodes and triodes were presented.

The paper was discussed by Messrs. Lazich, Place, Stark, Sutherlin, and Ulrey.

ROCHESTER SECTION

A meeting of the Rochester Section was held on March 12 at the Sagamore Hotel and was attended by 157. E. K. Huntington presided.

A paper on "Developments in Toll Transmission" was presented by B. K. Boyce, chief engineer of the New York Telephone Company in which he outlined the major developments which have made possible high grade transmission service over telephone lines between widely separated points. Circuit equalizing and loading were discussed. Actual cable circuits and apparatus were used to demonstrate the effect of loading on the quality and volume of the transmitted speech, time delay, and echo effects on a 1800-mile circuit, and its corrective apparatus. The quality of transmission as affected by the bands of frequencies transmitted was demonstrated.

The April meeting was held on the 16th with E. C. Karker, chair-

man, presiding. The attendance was ninety-six and ten were at the dinner. The meeting was held at the Sagamore Hotel.

W. R. Jones of Hygrade Sylvania Corporation presented a paper on "Circuit Considerations for Metal Tubes." He presented an outline of metal tube developments showing the speed at which they were perfected to permit their use by the public with as good performance as existing glass tubes. Difficulties in manufacturing processes were described and the cures for them given. The paper was concluded with a discussion of radio receiver circuit refinements required to permit the use of metal tubes in automatic volume control circuits handling one hundred per cent modulated signal circuits. In some instances metal tubes had one-half microampere of gas or grid emission which in some automatic volume control resistance circuits reduced the modulation that could be handled. The paper was discussed by Messrs. Karker and Manson.

SAN FRANCISCO SECTION

The San Francisco Section met on February 19 at the KFRX Transmitter Station. R. D. Kirkland, chairman, presided and 140 members and guests were present. There were ten at the dinner which preceded the meeting.

A. N. Cormack, operating engineer of KFRC presented a paper on "The New KFRC Transmitter." After the presentation of a description of the circuits and the transmitter, the audience was divided into groups for an inspection trip. After this, they were assembled to hear the conclusion of the paper and discuss it.

The March meeting of the section was held at the Bellevue Hotel on the 18th with Chairman Kirkland presiding. There were sixty present of whom fourteen attended the dinner.

D. K. Lippincott, patent attorney, presented a paper on "The Farnsworth Multipactor Tube." He outlined the development of the modern cold cathode tube used to obtain high amplification with low input and negligible background noise. Circuits, theory of operation, tube sizes, output, and efficiency were discussed. The tube having a rated output of 600 watts was available for inspection.

Another meeting of the section was held on April 15 at the Bellevue Hotel with Chairman Kirkland presiding. There were thirty-eight present of whom twenty-one attended the dinner.

The first paper on "A System of Grid Modulation having High Plate Efficiency" by F. A. Everest, a student at Stanford University, was presented by a fellow student, L. M. Hollingsworth, in the absence of the author. The system varies both the plate and grid-bias supply

voltages simultaneously. It is applicable only to class C amplifiers and the efficiency was estimated at fifty per cent.

A second paper on "A Circuit to Produce a Standard Time Interval" was presented by A. E. Harrison, a student at the University of California. It discussed circuits and experiments used to obtain square-wave electrical pulses of precise duration and interval by means of three-element thyratrons. This was the first "student" meeting of the San Francisco Section and was considered to be quite successful.

F. E. Terman was awarded the annual section prize for the best paper published by a member of the Section in the PROCEEDINGS during 1935.

SEATTLE SECTION

A meeting of the Seattle Section was held at the University of Washington on March 27 and was attended by eighty-five. There were thirty at the dinner which preceded the meeting. E. D. Scott, chairman, presided.

"Broadcast Coverage and Broadcast Antenna Systems" was the subject of a paper by F. E. Terman, professor of electrical engineering at Stanford University. In it Professor Terman reviewed antenna theory and the Sommerfeld ground-wave equation. He described the radiation characteristics of vertical antennas of various heights and also those of broadside arrays of spaced horizontal antennas. He pointed out the economical limits of increasing transmitter power considering the increased coverage obtained; also the importance of wave length and ground conductivity in wave propagation and the effect on coverage of the angle of radiation.

Messrs. Libby, Wallace, and Woodyard participated in the discussion.

The April meeting was held on the 24th at the University of Washington and J. W. Wallace, vice chairman, presided. The attendance was fifty-eight.

E. B. Hansen, application engineer for the Pacific Telephone and Telegraph Company, presented a paper on "Ship-to-Shore Radiotelephone Service in the Puget Sound Area." A land station now provides a link between radiotelephone equipment aboard boats in Puget Sound waters and the land telephone line system. The preliminary work to determine the most suitable location for this land station was described. It is located at Point Edwards about five miles north of the city limits. A vertical antenna is used for transmission and the receiving antenna which is 200 feet away, is connected to the station through a concentric transmission line. A 400-watt transmitter is employed and the receiver

in a superheterodyne. A four-wire two-way circuit connects the transmitting station and the Seattle Telephone Exchange. The transmitter and receiver are operated remotely from the exchange. A general explanation of the functioning of the system was given and the discussion of the paper was participated in by Messrs. Hurlbut, Johnson, Libby, Wallace, and Wilson.

WASHINGTON SECTION

L. B. Arguimbau of the General Radio Company presented a paper on "Wave Analysis" at the March 9 meeting of the Washington Section which was held in the Potomac Electric Power Company auditorium. There were seventy members and guests present and twenty-five attended the dinner.

The author discussed three methods of analyzing waves; the distortion factor meter, the tuned circuit wave analyzer, and the heterodyne type wave analyzer. The distortion factor meter which depends on a band elimination filter is intended primarily for rapid distortion measurements in the center of the audio band where iron distortion and unbalanced high-frequency effects may be neglected. The tuned circuit analyzer is complicated but flexible. Application of it to the heterodyne measurement of relative radio-frequency amplitudes was described; absolute values were obtained by comparison with a high-frequency voltage standard. The discussion of the heterodyne wave analyzer was primarily concerned with the operation of the balanced modulator and the piezoelectric filter. An equivalent electrical diagram was given for the three-electrode crystal used. The crystal presents a series resonant impedance of 10,000 ohms on the input side and a parallel resonant impedance of six megohms on the secondary side. The voltage gain is approximately seventeen.

Erratum

It has been brought to the attention of the editors that in the paper, "Some Engineering and Economic Aspects of Radio Broadcast Coverage," by Glenn D. Gillett and Marcy Eager, which appeared in the February, 1936, issue of the PROCEEDINGS, pages 192-206, the abbreviation mv/m was misinterpreted throughout the text as microvolts per meter. This should read millivolts per meter in both the text and captions.

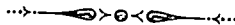

Personal Mention

M. P. Wilder, formerly of Electron Research Laboratories, has joined the engineering staff of the Kenrad Corporation, Owensboro, Ky.

R. B. Ayer, previously with the General Electric Company, is now employed by the RCA Manufacturing Company, Harrison, N. J.

E. Fagnomi, formerly with Standard Elettrica Italiana, has now joined the F.I.M. Marelli, Milan.

E. H. Felix, broadcast consultant, has moved his office from New York City to 32 Rockland Place, New Rochelle, N. Y.

Previously with L'Tatro Products Corporation, C. A. Hultberg has become a radio engineer for Crosley Radio Corporation, Cincinnati, Ohio.

J. M. Ide has left Harvard University to become a research physicist for Shell Petroleum Corporation at Houston, Texas.

D. D. Israel, formerly with Crosley Radio Corporation, has become chief engineer of Emerson Radio and Phonograph Company, New York City.

Arthur Jackson has left the Northern Electric Company and is now associated with Dominion Sound Equipment, Ltd., of Vancouver, B. C.

E. E. Karpus has become chief engineer of H. W. Peabody and Company of Buenos Aires, Argentina, having formerly been with Ditlevsen Company Ltd.

Previously with National Union Radio Corporation, C. N. Kimball, Jr., is now connected with the RCA License Laboratories, New York City.

H. H. Knubbe has left Detroit Radio Corporation to become assistant chief engineer of the radio division of Sparks Withington Corporation at Jackson, Mich.

I. L. Lindow of RCA Communications has been transferred from Morca, La., to Riverhead, N. Y.

A. V. Loughren is now with the Hazeltine Service Corporation in New York City having formerly been with the General Electric Company at Bridgeport, Conn.

P. J. Neimo, lieutenant, U.S.N., has been transferred from Seattle, Wash., to Cavite, P. I.

Formerly with Sparks Withington Corporation, Fred Pacholke joined the engineering staff of Colonial Radio Corporation at Buffalo, N. Y.

L. J. Peters has left the Gulf Research Laboratory to join the Gypsy Oil Company at Tulsa, Okla.

R. G. Piety has left Yale University to join the United Research Corporation of Burbank, Calif., as a research engineer.

E. S. Rogers is now with Rogers Majestic Corporation, Toronto, Ont., having formerly been with Standard Radio Manufacturing Corporation.

P. C. Schulz is now chief engineer of KYA having formerly been with KGDM.

Formerly with RCA License Laboratories, C. O. Siegelin has joined the staff of Bell Telephone Laboratories, New York City.

Harry Wilkie has been transferred from San Antonio, Texas, to the Aircraft Radio Laboratories, U. S. Army Signal Corps, Dayton, Ohio.

L. J. Wolf, formerly with the Westinghouse X-Ray Company, is now in the engineering department of the RCA Manufacturing Company at Camden, N. J.

Jack Yolles, previously with the Sonora Company, Paris, France, is now a member of Aviation Radio Laboratories of the United States Army Signal Corps, Dayton, Ohio.

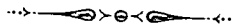

TECHNICAL PAPERS

A UNICONTROL RADIO RECEIVER FOR ULTRA-HIGH FREQUENCIES USING CONCENTRIC LINES AS INTERSTAGE COUPLERS*

BY

FRANCIS W. DUNMORE

(National Bureau of Standards, Washington, D. C.)

Summary—A new type of radio receiver for frequencies between 100 and 300 megacycles per second is described. This receiver differs from conventional designs in that it utilizes quarter-wave concentric transmission lines as coupling impedances between amplifier stages. A method of using a single line per stage and means for varying the effective line length for unicontrol tuning is shown. The deviation of the line length from the actual full quarter-wave length over the frequency range of the receiver is given. Measurements showed an amplification of the order of two per stage at 300 megacycles, six per stage at 200 megacycles, and nine per stage at 175 megacycles. With four stages of radio-frequency amplification and a detector, an effective over-all amplification of the order of 100,000 may be expected at 200 megacycles.

The paper gives the circuit arrangement for a receiver consisting of four stages of radio-frequency amplification and a detector. This receiver uses four concentric lines with ganged tuning plungers for varying the effective line lengths in unison. The lines are arranged with their major axes about a common center.

I. INTRODUCTION

THE ultra-high radio frequencies (above thirty megacycles) are daily finding new applications. There is therefore increasing need for receivers designed to function at these frequencies. This paper describes the development of a radio receiver for these frequencies which differs from conventional designs in that it utilizes quarter-wave concentric transmission lines grounded at one end as coupling impedances between amplifier stages. The theory and possibilities of concentric lines for such purposes were treated in an article by F. E. Terman.¹ This paper will therefore deal only with the special features and operating characteristics of this receiver.

* Decimal classification: R361.1×R583. Original manuscript received by the Institute, November 6, 1935. Published in *Bur. Stand. Jour. Res.*, vol. 15, pp. 609-618; December, (1935). RP856. Publication approved by the Director of the National Bureau of Standards of the United States Department of Commerce.

¹ F. E. Terman, "Resonant lines in radio circuits," *Elec. Eng.*, vol. 53, pp. 1046-1053; July, (1934).

II. PRINCIPLE OF OPERATION

The use of quarter-wave lines as interstage coupling impedances is shown in Fig. 1a. *A* is a quarter-wave concentric line made up of an outer tubing *B* and an inner tubing *C*. *B* is grounded. *C* is connected to the plate of the electron tube *G* and is insulated from ground for direct current but its lower end is grounded for radio frequency by means of plunger *P* which is in metallic contact with *C* and capacitively connected to *B*. When the transmission line *A* is adjusted by moving plunger *P* to be some length less than a quarter of the wave length of the voltage impressed on the grid of tube *G* (the length is always

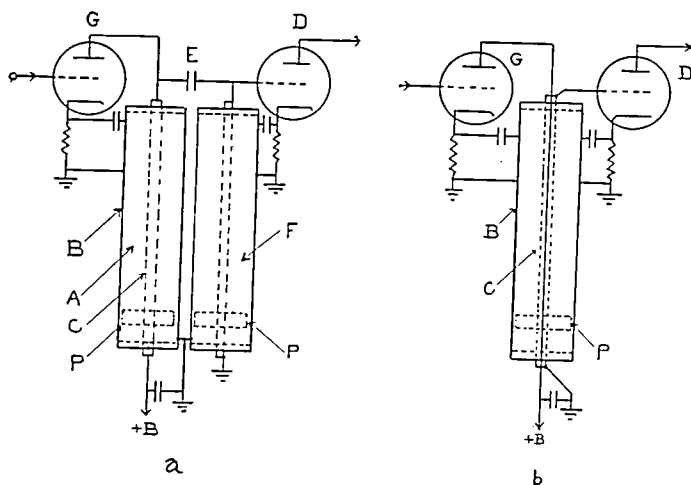

Fig. 1—Concentric transmission line as an interstage coupling impedance.

shorter than $\lambda/4$ because of the capacitance of the plate in tube *G*, connecting leads, and circuit elements), a maximum voltage is built up in the plate circuit of tube *G* and passed on through coupling condenser *E* to the grid of the second electron tube *D*. The grid of this tube is grounded for direct current but is held at the radio-frequency voltage delivered to it by means of a second concentric line *F* similarly tuned to nearly a quarter wave length. With this type of coupling it is possible more nearly to match tube impedances and thereby obtain greater amplification per stage at ultra-high radio frequencies than by other means.

Instead of a transmission line both in the output and in the input of each electron tube as shown in Fig. 1a, it is possible to reduce the number of lines by one half by using a single line for both output and input circuits. This is made possible as shown in Fig. 1b by running the insulated direct-current plate supply lead down through the center of the inner concentric line. In this way the plate of electron tube *G*

is supplied with its proper direct voltage without grounding it with respect to the radio frequency. The capacitance of this plate lead to the central concentric line, *C*, takes the place of condenser *E* (Fig. 1a) and provides unity coupling at the ultra-high radio frequencies used, so that the radio-frequency voltage in the plate circuit of tube *G* is readily transferred to the central concentric line and thence to the control grid of tube *D*. The grid of electron tube *D* is grounded as before for direct current but held at the radio-frequency voltage delivered to it from electron tube *G* due to the high impedance built up when the line is tuned with plunger *P*.

III. DETAILS OF DESIGN

In order to obtain maximum efficiency, between frequencies of 100 and 300 megacycles, from an amplifier using concentric lines as inter-stage coupling impedances, the concentric lines should be arranged so that all high-frequency connecting leads are as short as possible and arranged to have a minimum of capacitance to ground. This arrangement of lines should also be such as to facilitate their ganging for unicontrol operation. Each line should terminate in a separate shielding compartment. A convenient method of varying the effective line length is essential. This should be accomplished without introducing noise due to variable contacts or undue resistance in the line. The concentric lines should be made of copper or copper plated. The concentric line on the input should be provided with means for a proper impedance match to the antenna and associated transmission line. The receiver should, of course, be designed so that all wiring and parts are accessible and easily replaced.

IV. CIRCUIT ARRANGEMENT

The circuit arrangement of a receiver designed with the above facts in mind and incorporating a number of new features is shown in Fig. 2.

This receiver consists of four stages of radio-frequency amplification and a detector. A single concentric line per stage is used with the direct-current plate supply lead running down through the center line. The electrical length of each line is varied by means of a metallic plunger *P*, in contact with the central line but capacitively connected to the outer line in order to avoid noise due to variations in a friction contact. The plungers for a number of stages may all be controlled by insulated rods extending through the rear of the line and suitably ganged to give unicontrol of tuning.

The transmission line tuning the grid of the input electron tube

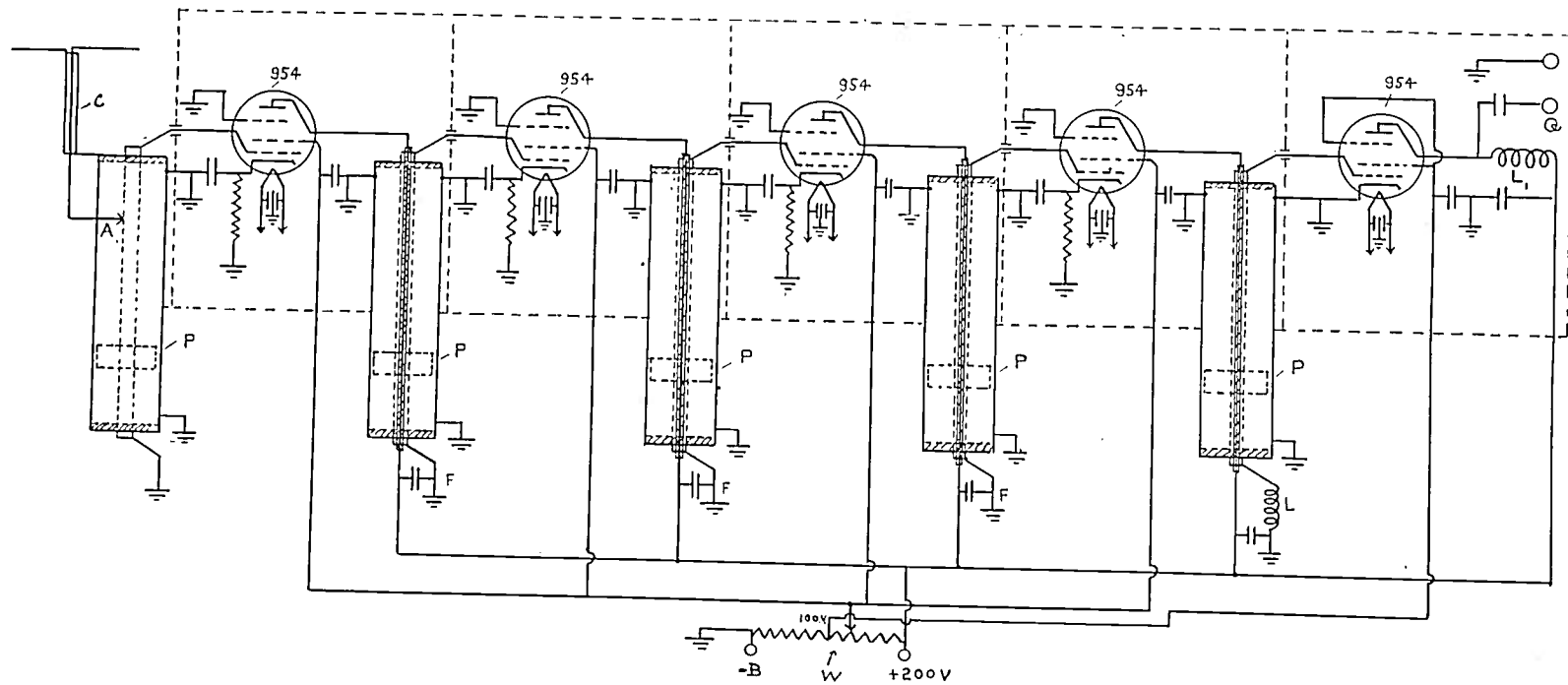

Fig. 2—Circuit arrangement for a multistage ultra-high radio-frequency amplifier using concentric line tuning.

has a sliding contact *A* on the central line which connects to one side of the transmission line *C* coming from the antenna. In this way a better input impedance match may be realized.

The grid of each electron tube is grounded for direct current by connecting its low radio-frequency voltage end to ground. Grid bias is obtained with the usual cathode resistor properly by-passed.

The high voltage end of each transmission line terminates in a separate shielding compartment containing a type 954 electron tube with associated wiring.

The detector circuit in this receiver was designed for detection at modulation frequencies in the broadcast radio-frequency band. The output terminal is therefore connected to the antenna terminal of a broadcast receiver and the resulting added amplification realized.

The grid of the detector tube is held at the voltage of the modulated signal impressed on it by means of choke *L* in the low voltage end of the transmission line. A similar choke *L*₁ in the plate circuit serves to deliver the modulation frequency to the output terminal. These chokes may be replaced by inductors tuned to the modulation frequency if desired, in which case the capacitance of the central line and plunger *P* to ground serve as part of the tuning capacitance for inductor *L*.

If the ultra-high radio-frequency carrier has several radio-frequency modulations impressed upon it, these may all be obtained at terminal *Q* and received simultaneously on separate broadcast receivers connected to this terminal; or with a properly designed detector circuit and concentric lines designed to pass a band width of 2000 kilocycles, terminal *Q* may deliver a television signal if such a signal has been impressed on the ultra-high radio-frequency carrier.

V. RECEIVER CONSTRUCTION

Figs. 3 and 4 show a receiver using the circuit arrangement shown in Fig. 2 and constructed in accordance with the design details mentioned in a previous paragraph. This receiver covers a useful frequency range of from 170 to 300 megacycles (1.76 to 1.0 meters). The lower frequency limit is restricted only by the length of the transmission lines used. With but slight modifications longer lines may be inserted and the lower frequency limit thereby extended.²

Fig. 3 shows the receiver completely assembled. The five transmission lines are shown terminating at their lower ends in the circular shielding housing containing the separate shielded compartments for

² This range may be further extended to a limited degree by connecting small variable condensers from the plate of each radio-frequency electron tube, to ground. These condensers are removed from circuit when operating the receiver at the upper frequency limits.

each line termination. The radio-frequency input terminals are shown at *A* and *B*. *A* makes contact through a slider operating on the central line of the input concentric line. (This is shown in detail in Fig. 5.) *Q* is the output terminal which with its neighboring ground terminal is connected to the input of a standard broadcast receiver. The central cylinder *D* is merely a shield covering the voltage divider *W* (Fig. 2) and associated wiring or it could also inclose a power pack if desired.



Fig. 3—A four-stage concentric-line tuned radio receiver for 175 megacycles (1.71 meters) to 300 megacycles (one meter).

Each line contains a tuning plunger *P* attached to two bakelite rods extending through the upper ends of the lines. These rods are all attached to a common tuning control handle through a disk by means of setscrews. By loosening the setscrew on a given control rod that line may be tuned independently when desired. A suitable frequency scale (not shown) is attached to the disk. The third rod in the input transmission line is for operating the sliding contact attached to terminal *A*. The cap covering the upper end of cylinder *D* contains a terminal block where the *B* supply voltage is supplied to the upper end of each transmission line. The shielding cover on the top end of each transmission line covers the by-pass condenser *F* shown in Fig. 2, and in the case of the last transmission line it contains the radio-frequency choke *L* in the detector grid-to-ground circuit.

Fig. 4 shows the receiver in a knockdown condition. This photograph shows how, with this type of assembly, the grid and plate leads to the electron tubes may be kept very short. These leads with tube clips attached may be seen on the left end of the transmission lines.

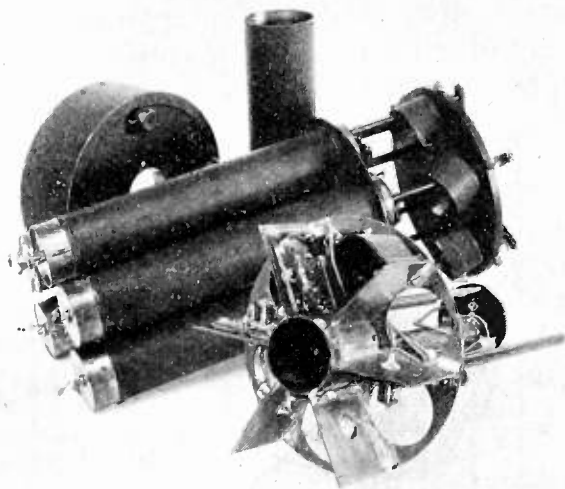

Fig. 4—The concentric line receiver showing method of assembly.

One lead is fastened to an insulated wire running down through the hole in the central line (the plate lead) and the other (the grid lead) is attached to the central line.

The insulating disks holding the central line in position at the high voltage end should have as little insulating material in them as possible, and this should be of high grade.



Fig. 5—One of the concentric lines showing tuning plunger and sliding antenna input terminal.

By loosening a few screws and taking the grid and plate clips from the electron tubes the receiver may be easily taken apart as shown.

In Fig. 5 is shown the type of transmission line used in the receiver. The one shown in this figure is used in the input circuit. It differs from

the other four lines only in that it contains the sliding contact carrying the binding post *A*, (see *A* in Fig. 3) and in that it does not contain the plate lead through the center line. The white pieces of paper held in slots in the tuning plunger are for insulating it from the outer line so as to prevent a direct metallic contact with resulting friction and noise. They are about 0.008 of an inch (0.02 centimeter) thick. This capacitance contact, so to speak, has an approximate capacity of 156 micromicrofarads and an impedance of ten ohms at 100 megacycles per second and 3.3 ohms at 300 megacycles.

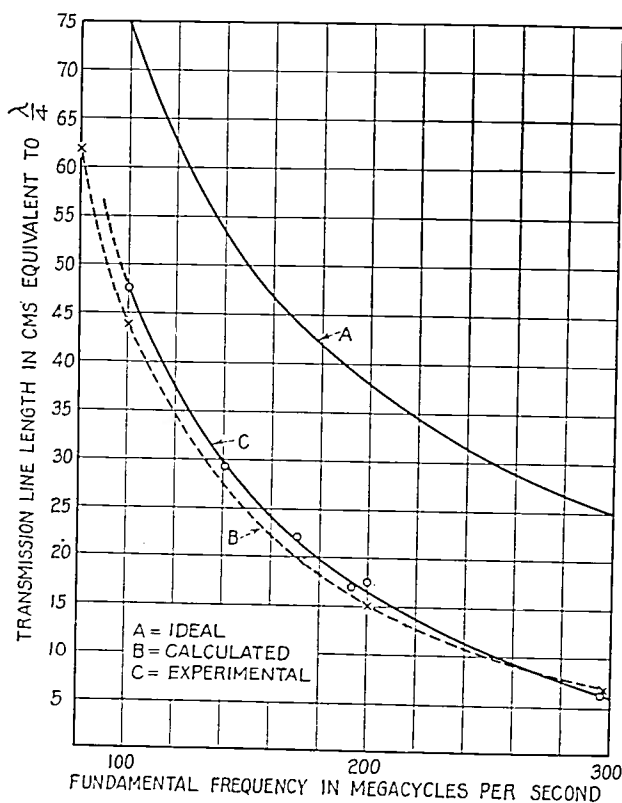

Fig. 6—Transmission line length with and without capacitance of electron tubes and associated leads.

The outer conductor of each transmission line has an inside diameter of 4.6 centimeters and the inner conductor has an outside diameter of 0.49 centimeters. This ratio of 9.2 is the correct one according to Terman¹ to give maximum impedance.

Both inner and outer lines and plungers are of brass, copper plated.

VI. OPERATING CHARACTERISTICS

A. Transmission Line Lengths

In Fig. 6 *A* shows the length of a quarter-wave line at different frequencies without external capacitance shunting the free end of the line.

When used as an interstage coupling impedance, however, each line has shunting it the capacitance of the plate of one type 954 electron tube and the grid of the following tube with associated leads. The total capacitance due to the electron tube elements is six micromicrofarads. The leads probably introduce an additional three micromicrofarads. The line length at resonance is therefore reduced accordingly, the line behaving as an inductance of such value as to form a parallel resonant circuit with the total shunting capacitance.

Curve *B* shows the calculated line lengths for different frequencies assuming the above shunting capacitance and a line surge impedance of 120 ohms.

Curve *C* shows the lengths as determined experimentally by tuning the receiver to each of the frequencies.

It will be seen from these curves that the electron tube and lead capacitance on the end of the transmission line has a marked effect in reducing the line length from a full quarter wave. In fact this reduction is some 73 per cent at 300 megacycles per second and 50 per cent at 171.5 megacycles, this percentage becoming progressively less as the frequency is lowered.

The 100- and 140-megacycle points were obtained experimentally for curve *C* by temporarily replacing the line in the detector input circuit with one fifty centimeters long.

All concentric lines except the input (which has only a grid element on its end) were found to be about the same length when the receiver was tuned to a given frequency. Variations in tube and lead capacitances made differences in length not over 1.0 centimeter. The input line is some two to four centimeters longer than the others depending upon the position of contact *A* (Fig. 2).

B. Amplification per Stage

The amplification per stage as measured at different frequencies is shown in Fig. 7.³ From this graph and from the lengths of the concentric lines required for tuning to the different frequencies, the equivalent series resistance of the parallel resonant circuit formed by the shunting capacitances and the concentric line used as an inductance, may be computed. Assuming a tube amplification factor of 1500 and a plate resistance of 1.5 megohms, the series resistance is 1.5 ohms at 300 megacycles, 0.9 at 200 megacycles, and 0.85 ohm at 171 megacycles. From these values it may be assumed that the equivalent series resistance at 150 megacycles is, say, 0.8 ohm. Computing backwards, on

³ Since first writing this paper it has been found possible to increase the amplification per stage at 300 megacycles from two to three by increasing the screen-grid voltage on the radio-frequency tubes by means of a sliding connection on voltage divider *W*, Fig. 2.

the basis of the same assumptions of amplification factor and plate resistance, the amplification per stage at 150 megacycles is 13.2. This reasoning forms the justification for the extrapolation shown by the dotted portion in the graph in Fig. 7. The over-all amplification for a four-stage amplifier of this type is approximately the fourth power of the amplification per stage as shown in Fig. 7. The step-up in the antenna coupling impedance is approximately 1.5 to 1. The effective amplification is further increased by the nonlinear operation of the detector. By actual measurement the over-all effective amplification of the amplifier and detector at 300 megacycles is 125 (approximately 42 decibels), at 200 it is 93,000 (approximately 100 decibels), and at

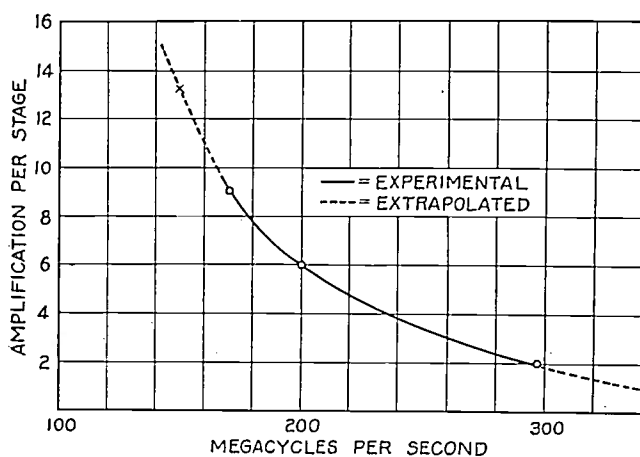

Fig. 7—Amplification per stage for the concentric line tuned receiver at frequencies from 150 to 300 megacycles.

170 megacycles it is 1,060,000 (approximately 120 decibels). This overall gain should be multiplied by the detector conversion efficiency and for the amplification on the intermediate modulating frequency in the first detector and in the broadcast receiver in order to determine the over-all amplification of the complete receiving setup.

Measurements were made on a line with a ratio of inner and outer line diameters of 3.60 instead of 9.20. While this ratio should have given more gain due to a greater Q , measurements did not show this effect at 300 megacycles. This was probably due to the predominance of lead and electron tube resistance over the concentric line equivalent series resistance. The smaller ratio of diameters tuned to resonance with the line 3.5 centimeters longer than for the 9.2-ratio line. This was to be expected according to theory.

C. Third Harmonic Response

A transmission line tuned to a certain fundamental frequency will also respond to a frequency near the third harmonic of this fundamen-

tal, as well as to other odd harmonics. This is due to the fact that the half-wave length section of a three-quarter-wave length line remains fixed at its full half-wave value, the variations due to the shunting capacitance occurring in the initial quarter-wave section. Thus for example the length of line for tuning to 300 megacycles, as actually obtained by measurement, is 6.5 centimeters as shown by curve *B*, Fig. 6. A half-wave length line for 300 megacycles per second is fifty centimeters, therefore the length of line tuned to some fundamental frequency for which 300 megacycles is an interfering third harmonic

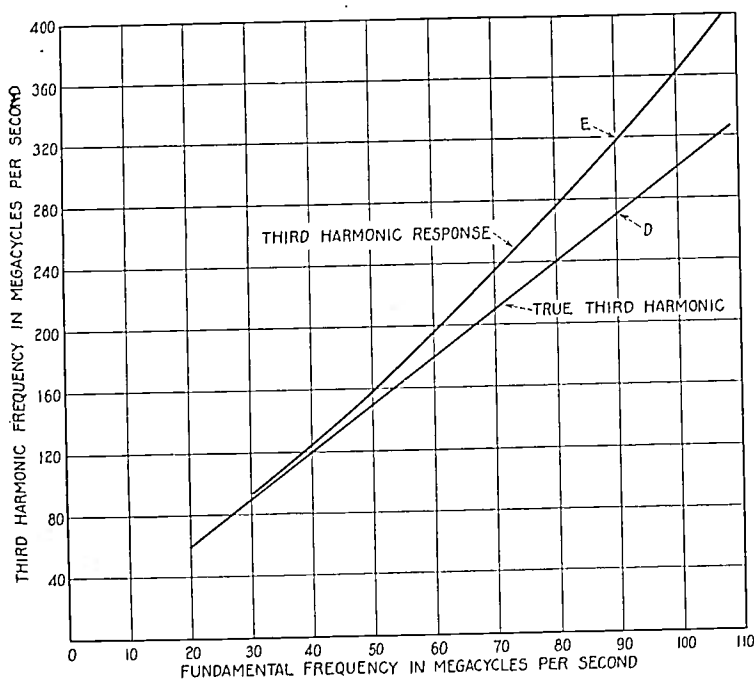

Fig. 8—Deviation between the third harmonic response frequencies and the true third harmonic frequencies.

frequency is $50 + 6.5$ or 56.5 centimeters. From graph *B* (Fig. 6) the fundamental frequency to which the line (56.5 centimeters long) is tuned is 86 megacycles. In other words, when tuned to a fundamental of 86 megacycles, a frequency of 300 megacycles would be received (if present) and not 258 megacycles per second, the actual third harmonic frequency.

In Fig. 8 curve *E* shows how this third harmonic response frequency differs from the true third harmonic for various fundamental frequencies. The question of interference which may be caused by this third harmonic response effect when using transmission lines as interstage coupling impedances is not as serious as one might expect due to the rapid decrease in amplification per stage at the higher (third harmonic) frequencies.

Thus, for example, from Fig. 7 the amplification per stage at 100 megacycles per second is probably well over sixteen. From curve *E*, Fig. 8, the third harmonic response frequency for this fundamental is 360 kilocycles. The amplification per stage at this frequency as shown from Fig. 7 is probably less than one, a considerable difference when the over-all gain is considered. For fundamental frequencies higher than 100 megacycles the receiver becomes even less responsive to the third harmonics. A receiver of this type for use above 100 megacycles should require a very strong third harmonic interfering signal as compared to the fundamental before any interference would be noted. Furthermore the gain for a three-quarter-wave length line would be considerably less than for a $\lambda/4$ -wave line due to increased attenuation along the longer line.

D. Sharpness of Resonance

In the design of this receiver, a ratio of diameters corresponding to maximum coupling impedance rather than to maximum selectivity, was chosen, since extreme selectivity was not desired. Actually, as was determined later, the selectivity is determined more by other circuit constants than by the ratio of line diameters. For television the receiver should pass a band width of 2000 kilocycles. Measurements indicate that the present experimental receiver responds to over twice this band width. By proper design the sharpness of resonance of a receiver for television use may be brought to the television requirements.

Since in most applications, ultra-high frequencies may be modulated by low radio frequencies, probably between 550 and 3000 kilocycles, an ultra-high radio-frequency receiver must pass a band width at least equal to that of the highest modulating frequencies used. For this service ultra-high radio-frequency receivers with high selectivity would be of little use.

VII. SUMMARY OF RESULTS

Tests on a four-stage amplifier in which quarter-wave concentric transmission lines are used as interstage coupling impedances show that an amplification of two per stage may be obtained at 300 megacycles, six per stage at 200 megacycles, and over sixteen per stage at 100 megacycles.

It is possible to tune over the above range of frequencies by using lines fifty centimeters long with a movable metallic plunger in each for varying its effective length. These plungers may be ganged for unicontrol operation. When tuned to resonance the lines are not a full quar-

ter-wave long but 27 per cent of this amount at 300 megacycles, 50 per cent at 171 megacycles, and 58.7 per cent at 100 megacycles. By running the direct-current plate supply lead down through the center of the inner concentric line it is possible to use one in place of two concentric lines between each stage and the next.

The possibility of interference in this receiver due to third harmonic response is probably negligible as the receiver is insensitive above 360 megacycles.

VIII. ACKNOWLEDGMENT

I am indebted to Mr. H. Diamond for advice during the progress of this work and for the theoretical analysis of much of the data obtained.

Acknowledgment is also due Mr. L. L. Hughes for the construction of the receiver and for valuable suggestions on the mechanical design.



THE DESIGN OF RADIO-FREQUENCY CHOKE COILS*

BY

HAROLD A. WHEELER

(Hazeltine Corporation, Jersey City, New Jersey)

Summary—The selection of a choke coil without regard for overtones is likely to permit kinks in the curve of apparent capacitance. These kinks represent overtones, at whose frequencies the choke coil has maximum values of excess shunt conductance, and therefore is unsuited for connection across a sharply selective tuned circuit. These overtones occur near even multiples of the fundamental frequency, in the absence of an iron core.

Choke coils of two equal or unequal sections are proposed, and rules are given for proportioning the dimensions to suppress the first and second overtones. Examples are described, in which the remaining effect of the third overtone is small and that of higher overtones is negligible. Iron cores for choke coils have some advantages, in reducing the excess conductance, as indicated by the performance of an example described.

I. INTRODUCTION

THE behavior of radio-frequency choke coils is complicated by the presence of overtones, or natural frequencies higher than the fundamental frequency. There is, in general, a family of overtones which are identified by kinks or irregularities in the curve of apparent capacitance versus frequency, and by corresponding sharp peaks in the curve of apparent shunt conductance versus frequency. As the apparent capacitance is easily measured, the kinks in the capacitance curve are easily employed to identify the overtone frequencies.

It is generally desirable that choke coils behave simply as parallel inductance and capacitance. Some apparent shunt conductance is unavoidable, caused by dissipation in the coil. Any excess of shunt conductance, such as found at the overtone frequencies, is objectionable, and may be much greater than the unavoidable value. The excess conductance is most detrimental when the choke coil is connected across a sharply tuned circuit whose own apparent shunt conductance is small, and when the circuit is tuned to the overtone frequency. In small multilayer choke coils for use at broadcast frequencies, the excess conductance may be of the order of thirty micromhos, as compared with values of five to fifteen micromhos for tuned circuits. Such a choke coil is connected effectively in parallel with such a tuned circuit when the choke coil and a condenser are used to isolate the direct-current circuit from the alternating-current circuit of the input

* Decimal classification: R382. Original manuscript received by the Institute, December 26, 1935.

or output electrodes of a vacuum tube. Many other similar applications are found in filter circuits where low-frequency and high-frequency circuits are connected in parallel.

The cause of overtone effects in choke coils of one or more sections involves the distribution of inductance and capacitance among the sections and also within each section. For example, a simple multi-layer coil of many layers has less capacitance across the inner half of the inductance than across the outer half. Such nonuniformity of distribution causes a maximum of excess conductance at a frequency identified as the first overtone frequency. In general, choke coils designed for less distributed capacitance are less compact and therefore are more susceptible to such nonuniformity of distribution and the resulting overtone effects.

This paper describes various expedients for reducing or even balancing out the effects of the more prominent overtones in radio-frequency choke coils. The methods of design are simple and appear to be generally applicable to the problem. Theoretical explanations and examples are given to illustrate the principles involved. The use of iron cores in choke coils is considered and an example is described.

The measurement of apparent capacitance is facilitated by the use of the so-called "reactance meter" which was devised by the writer in 1929, and which is now commercially available.¹ This is an arrangement for the measurement of susceptance in terms of frequency and apparent capacitance. Two independent tunable oscillators are employed, with means for indicating when their frequencies are equal. One is calibrated as to frequency and the other as to differential capacitance. The latter oscillator is tuned to the former at any given frequency, successively with and without the unknown susceptance connected across the tuned circuit of the latter. The observed differential capacitance is equal and opposite to the apparent capacitance whose value is desired, and the observation is substantially independent of the effective shunt conductance associated therewith.

II. SYMMETRICAL CHOKE COIL

Fig. 1 shows a cross-sectional diagram and schematic electrical diagrams of a choke coil having two like sections disposed symmetrically with respect to a "plane of symmetry." The inner terminals of the sections are joined, and the directions of winding are such that the mutual inductance aids the self-inductance. Each section is considered as having two parts (L_1 and L_2) for the purpose of indicating the location of

¹ H. H. Scott, *General Radio Experimenter*, vol. 8, no. 11, pp. 1-4; April, (1934).

inherent capacitance within each section (C_1 and C_2) and between the sections (C_3 and C_4). Further subdivision of the sections is unnecessary for the purpose of simple analysis.

In the electrical diagram of Fig. 1, it is desired that no current flow in the leads a and b , since the coil would then behave simply as parallel inductance and capacitance. The symmetry of the coil balances out the current in a and therefore constitutes the first condition for this design.

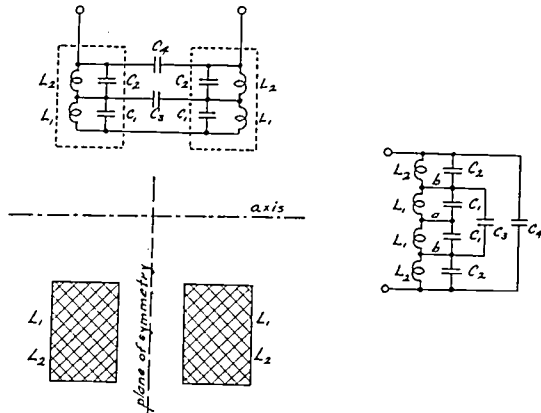

Fig. 1—Analysis of symmetrical choke coil of two sections.

The current in each of the leads b is balanced out if the resonant frequency of L_1, L_1, C_1, C_1, C_3 is the same as that of L_2, C_2 . Therefore the second condition is

$$L_1(C_1 + 2C_3) = L_2C_2.$$

Since L_1C_1 is ordinarily less than L_2C_2 , this condition is readily satisfied by adjusting the separation between sections, which determines C_3 . There are no critical restrictions on the value of C_4 . It is noted that (for simplicity) the mutual inductance between parts has been neglected, but the same principles are found applicable in the presence of mutual inductance.

Symmetrical choke coils are most applicable to symmetrical or balanced circuits such as push-pull amplifiers. Ordinary circuits are more often unsymmetrical, and it is found possible to obtain even further advantages in unsymmetrical choke coils having one terminal grounded. Modification of the first condition is necessary, but the second condition is still applicable in principle.

III. UNSYMMETRICAL CHOKE COILS

Fig. 2 shows a cross-sectional diagram and schematic electrical diagrams of a choke coil having two unlike sections located in a shield can. The inner terminals of the section are joined and the outer terminal of the smaller section is connected to the shield. The directions of winding

are such that the mutual inductance aids the self-inductance. Each section is considered as a whole (L_1 or L_2) for the purpose of indicating the location of inherent capacitance within each section (C_1 or C_2) and among the sections and shield (C_3 , C_4 , and C_5). Further subdivision is unnecessary for the purpose of revising the first condition stated above.

In the electrical diagram of Fig. 2, it is desired that no current flow in the lead a . This current is balanced out if the resonant frequency of

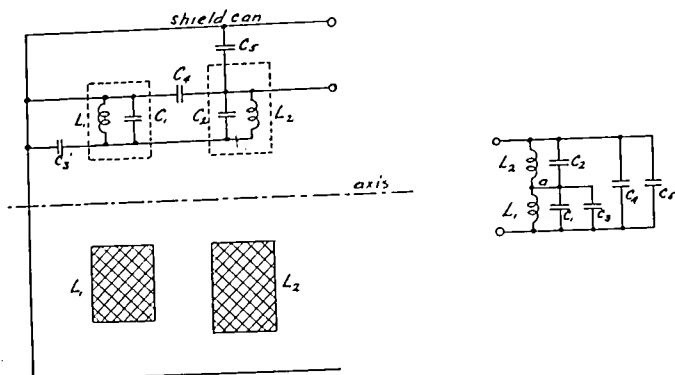

Fig. 2—Analysis of unsymmetrical choke coil of two sections in a shield can.

L_1 , C_1 , C_3 is the same as that of L_2 , C_2 . Therefore, the revised first condition is

$$L_1(C_1 + C_3) = L_2C_2.$$

The number of turns of the smaller section determines L_1C_1 , and is easily adjusted to satisfy this condition. There are no critical restrictions on C_4 and C_2 . The mutual inductance between parts has been neglected, but the same principles are found applicable in the presence of mutual inductance.

At this point, it is well to note the effect of failure to satisfy this condition. The resonant frequencies of L_1 , C_1 , C_3 and L_2 , C_2 being different, there will be an intermediate frequency at which these two sections will present equal and opposite apparent reactances connected in series between the terminals of the choke coil. At this frequency, these sections present maximum apparent shunt conductance across the terminals. The same phenomenon is manifested as a kink in the curve of apparent capacitance. Both effects disappear when the above conditions are satisfied at least in principle.

Fig. 3 shows an unsymmetrical choke coil of thirty millihenrys, designed according to the above principles. The coil sections have an inside diameter of one-half inch. The separations of the coils was not critical in this case, because of the characteristics of the coil sections used. The dotted curve a' shows the kink of two like sections, caused

by capacitance to the shield (C_3 in Fig. 2), which capacitance is unsymmetrically associated with the coil sections. This kink represents the first overtone of this choke coil. The number of turns on the section connected to the shield was reduced until this kink disappeared, with the result shown by the smooth curve *a*. This choke coil in its shield has a natural frequency of 420 kilocycles, and behaves substantially as thirty millihenrys and 4.8 micromicrofarads in parallel.

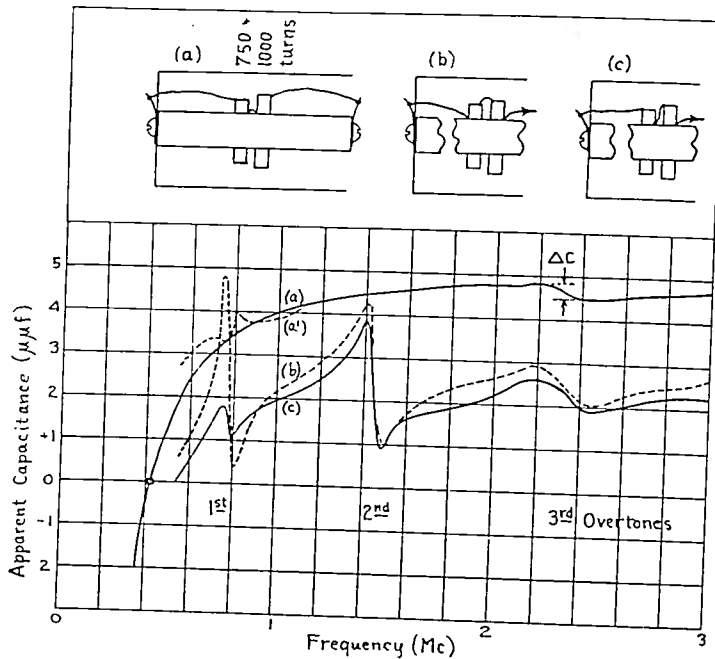

Fig. 3—Apparent capacitance of an unsymmetrical choke coil, showing the effects of changing the connections between the coil sections.

The detrimental effect of a relatively small kink in the capacitance curve can be evaluated in terms of ΔC , the height of the kink. This dimension is indicated on the remaining minor kink at 2300 kilocycles, in curve *a* of Fig. 3. The excess shunt conductance at the kink frequency is $\omega\Delta C$. When the choke coil is connected across a tuned circuit whose capacitance is C , the resulting excess power factor appearing in the tuned circuit is $\Delta C/C$. For curve *a* at 2300 kilocycles, where $\Delta C = 0.35$ micromicrofarad, the excess conductance is only five micromhos, and the excess power factor is 0.35 per cent when connected across a tuned circuit of $C = 100$ micromicrofarads.

Curves *b* and *c* of Fig. 3 show the performance of the same two sections connected differently, the directions of winding in each case being such that the mutual inductance aids the self-inductance. The contrast between these curves and curve *a* is apparent. Curves *b*

and c both show the second overtone, which did not even appear in curve a . Its absence there is caused by the manner of connecting the sections, so that the capacitance between sections tends to satisfy the second condition stated with reference to Fig. 1. This condition can be satisfied only when the inner terminals of the two sections are joined.

The third overtone may be explained by considering the choke coil as comprising six parts, each section as comprising three parts. The corresponding kink in the curve is the composite effect of the second overtones of the two individual sections. The unsymmetrical choke coil has an advantage over the symmetrical, in that these second overtones of two unlike sections are separated in frequency. The resultant ΔC is therefore less than that of two like sections.

It is noted that the first three overtones are approximately at even multiples of the fundamental frequency. The fourth and higher overtones are likely to be negligible in concentrated coils having considerable dissipation in the inductance at the overtone frequencies. This is true of the choke coils described herein. Such dissipation at overtone frequencies in the inductance of a choke coil tends to suppress the overtones. It is not necessarily detrimental to the performance, because the capacitance of the choke coil is the main factor at overtone frequencies. Therefore capacitive dissipation should be minimized, while a limited amount of inductive dissipation at overtone frequencies is an advantage.

Fig. 4 shows a larger unsymmetrical choke coil of ninety-three millihenrys, designed according to the above principles. The main curve shows the performance of the final design. The partial curves are displaced vertically to avoid confusion, and show some effects of varying the separation between sections. The upper group of curves was observed first with two like sections, and lead to the choice of one-eighth inch separation to suppress the second-overtone kink, while minimizing the first-overtone kink. The number of turns on the section connected to the shield was then reduced until the first-overtone kink disappeared. The lower group of curves was observed after this change, and indicates that one-eighth inch separation is still optimum. The latter curve for one-sixteenth inch separation is equally smooth, but the corresponding capacitance is greater, which is a disadvantage. This choke coil in its shield has a natural frequency of 255 kilocycles, and behaves substantially as ninety-three millihenrys and 4.2 micro-microfarads in parallel.

The minor double kink remaining in Fig. 4 represents the third overtone, actually the resultant effect of the staggered second overtones of the two individual sections. Comparing this part of the upper

and lower groups of curves indicates that ΔC was reduced to half by changing from like to unlike sections. The final $\Delta C = 0.4$ micromicrofarad at 1400 kilocycles indicates an excess conductance of only 3.5 micromhos, or an excess power factor of 0.4 per cent when connected across a tuned circuit of $C = 100$ micromicrofarads.

It seems to be generally possible to design choke coils on the order of those described, whose overtones are all negligible except the third. Therefore it is logical to locate the third at such a frequency that its detrimental effect is minimized. A choke coil for use in a receiver to

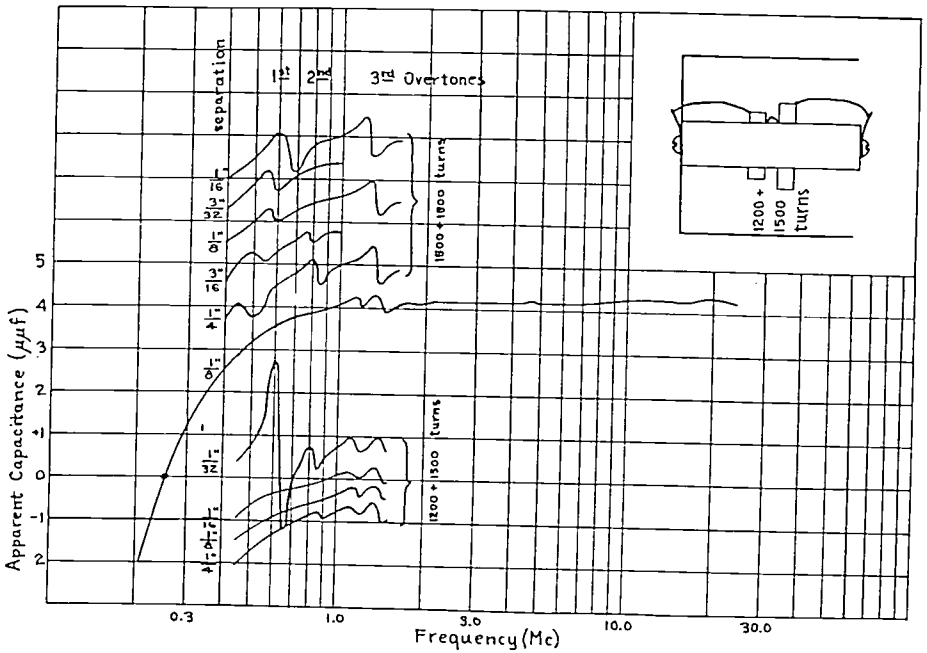

Fig. 4—Apparent capacitance of another unsymmetrical choke coil, showing the effects of varying the separation between the coil sections.

cover the bands of 150 to 400, 540 to 1600, and 1500 to 4000 kilocycles, for example, should have the third overtone placed at about 1800 to 2000 kilocycles. This points to a design similar to Fig. 3, but having two sections of 900 and 1200 turns, respectively. In a receiver to cover the bands of 540 to 1600 and 1500 to 4000 kilocycles, the third overtone may alternatively be placed at about 4500 to 5000 kilocycles. This points to a design along the lines of Fig. 3, but having only about half as many turns on the respective sections of the coil. In each of these suggested designs, the fundamental frequency of the choke coil is somewhat higher than the lowest operating frequency, which is according to accepted practice in apparatus operating over a wide range of frequency.

The general rule is to locate the remaining kink in the curve at a frequency where the tuning circuits have nearly maximum capacitance. The inductance of a choke coil should be about ten to thirty times the maximum inductance of a tuning circuit connected in parallel therewith. These rules are less essential where the choke coil is not connected across the entire impedance of a tuning circuit.

IV. IRON-CORE CHOKER COILS

Iron-core choke coils are adequate where the excess shunt conductance is of secondary importance. Fig. 5 shows the apparent capacitance of a 1000-turn multilayer coil, with and without an open iron

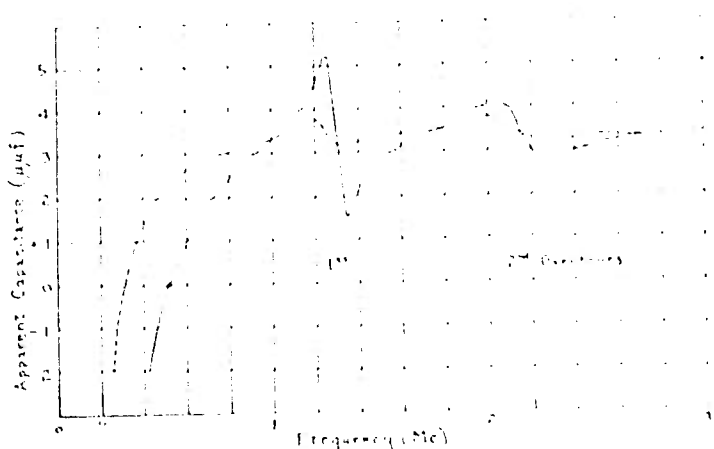

Fig. 5—Apparent capacitance of a simple choke coil of one section, showing the effect of adding an open core of thinly laminated iron.

core of thin laminations. The core increases the inductance and also increases the damping of overtones, which damping reduces the height of the kinks in the curve. Both inductance and damping would be less with iron-dust cores than with laminated cores, so that the latter is preferable. A closed core would yield further advantage, and would greatly reduce the external field, so that the coil could be contained in a small shield can. The iron lowers the fundamental frequency much more than the overtone frequencies, so that the even-multiple relation is not even approximately satisfied.

The choke coils of Figs. 3 and 4 might benefit by even a short laminated core, to increase the damping and thereby to reduce the effect of the third overtones.

V. CONCLUSION

By following the principles outlined, it is possible to design a choke coil whose apparent shunt conductance is minimized over a wide

range of frequency. The improvement over ordinary choke coils is obtained by completely suppressing or at least reducing the excess conductance at the lower overtone frequencies, which otherwise would be most detrimental. The benefit of such improvement is greatest when the choke coil is to be connected across a sharply selective circuit tunable over a wide range of frequency.

ACKNOWLEDGMENT

The described experiments on this subject were performed by Mr. W. O. Swinyard, whose valuable assistance is gratefully acknowledged.

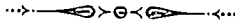

RADIO FIELD INTENSITY AND DISTANCE CHARACTERISTICS OF A HIGH VERTICAL BROADCAST ANTENNA*

BY

SAMUEL S. KIRBY

(National Bureau of Standards, Washington, D.C.)

Summary—During December, 1934, field intensity records of emissions from radio station WBT, Charlotte, North Carolina, were made at seven different distances from the transmitting station before and after the construction and use of a high mast antenna. In addition, field intensity measurements were made at eight points on a circle at a distance of one mile from the transmitting station. The results showed that the substitution of the mast antenna for the older T and L antennas produced much greater ground-wave field intensities near the transmitter and somewhat greater total field intensities at greater distances. At the same time the amplitude of the fading was reduced at the first three recording stations at distances sixty-nine to 142 kilometers. The fading at these first three stations was of a more rapid type than at the more distant stations. The antenna change did not appreciably affect the frequency of the fading. Wires were added to the mast antenna to increase its top capacity and thus make the current distribution in this antenna more nearly sinusoidal. This change seemed to reduce the fading amplitude at the first three recording stations by the suppression of certain high angle radiation rather than by an increase of the intensity of the ground wave.

With all conditions of the transmitting antennas used greater values of the averages of the ten-minute peak field intensities were recorded at the receiving station at Meadows, Maryland, 552 kilometers, than at any other station from sixty-nine to 879 kilometers.

INTRODUCTION

IN December, 1934, the antenna system of station WBT, 1080 kilocycles at Charlotte, North Carolina, was changed from a T antenna with a height of about 175 feet and a flat top with a length of 200 feet, to a vertical guyed cantilever mast 429 feet or 0.47 wave length high. A short time before this, plans for a co-operative investigation of the effects of such a change were made by the Columbia Broadcasting System and the National Bureau of Standards. In accordance with these plans seven automatic field intensity recorders¹ were set up

* Decimal classification: R270. Original manuscript received by the Institute, March 19, 1936. Presented before Tenth Annual Convention, Detroit, Mich., July 3, 1935. Published in *Bur. Stand. Jour. Res.*, vol. 16, pp. 289-300; April, (1935). Publication approved by the Director of the National Bureau of Standards of the U. S. Department of Commerce.

¹ K. A. Norton and S. E. Reymers, "A continuous recorder of radio field intensities," *Bur. Stand. Jour. Res.*, vol. 11, p. 373; September, (1933); (abstract), *Proc. I.R.E.*, vol. 22, p. 266; February, (1934).

at various distances from the transmitting station as shown by Fig. 1. These recorder locations were Salisbury, Lexington, Greensboro, and Durham, North Carolina; Charlottesville, Virginia; Meadows, Maryland; and Boonton, New Jersey. It was intended to have the recording stations as nearly as possible on the same great-circle path. This condition was approximately satisfied although Durham, North Carolina, was somewhat out of line. The recorders were set up during the latter part of November, 1934, and ran for about six weeks with calibrations about twice per week.



Fig. 1—Locations of radio station WBT and seven recording stations.

Unfortunately the T antenna was in the way of the mast construction and had to be taken down about the middle of November. An unsatisfactory temporary antenna was used until December 4, after which time an inverted L antenna 110 feet high with a flat top 200 feet long, was used. With this antenna the field intensity at one mile was about 0.88 that of the T. Otherwise it was believed that the characteristics of the L antenna were similar to those of the T.

Until December 17 the sloping down lead of the L was between fifty and 100 feet from the mast, the construction of which was completed about December 13. On December 17 after the L antenna and the old towers supporting it were removed, a decrease of fading of the

emissions from the mast was observed at Salisbury and Lexington. This was an indication that the proximity of the L affected the mast so it might be expected that the proximity of the mast affected the L. The effect of any coupling between these two antennas, however, should have reduced the differences between their performances. In other words, the differences found would have been greater if each an-

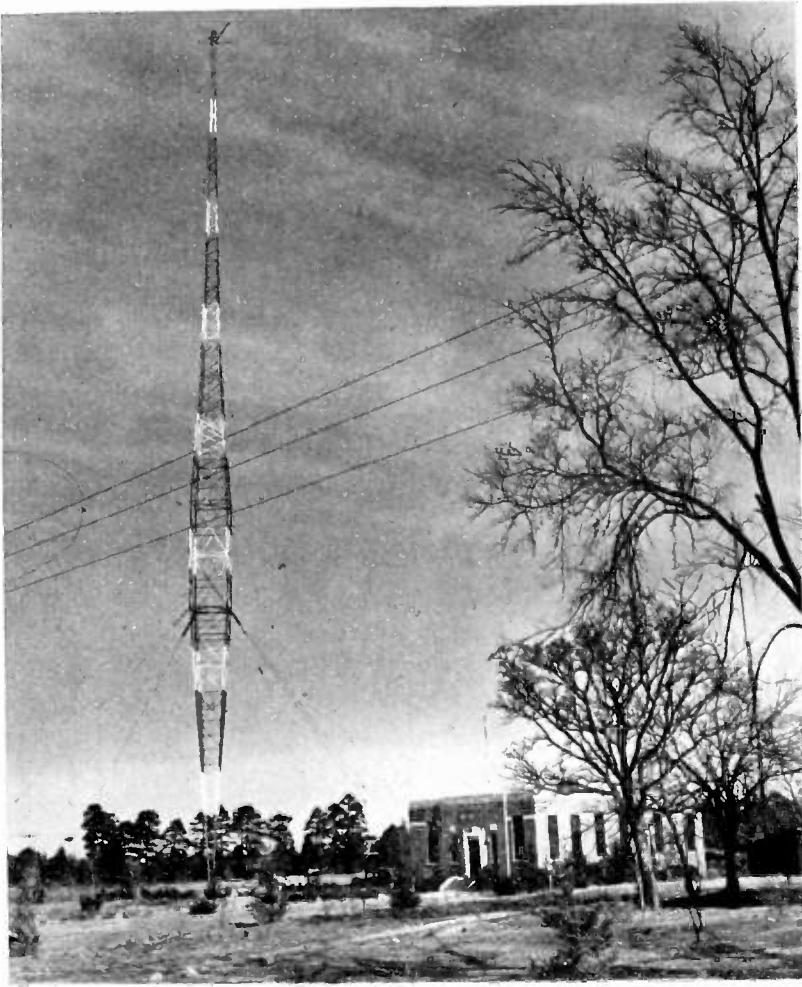

Fig. 2—WBT mast antenna.

tenna had been operated without the presence of the other. Emissions from the mast were recorded only two days before the L was removed.

EXPERIMENTAL DATA

The WBT mast antenna is shown in Fig. 2. The ground system consisted of 120 radials of No. 10 hard-drawn copper wire, each radial being 300 feet in length. The remote end of each radial was attached to a one-half-inch ground rod driven to a depth of four feet.

Records of emissions from the L antenna were made from about December 5 to 15, and from the mast from about December 16 to 31. The mast was used both alone and with four wires added to increase its top capacity. These wires were stretched from cross arms at the top downward to the waist of the tower below the center and later nearly to the ground.

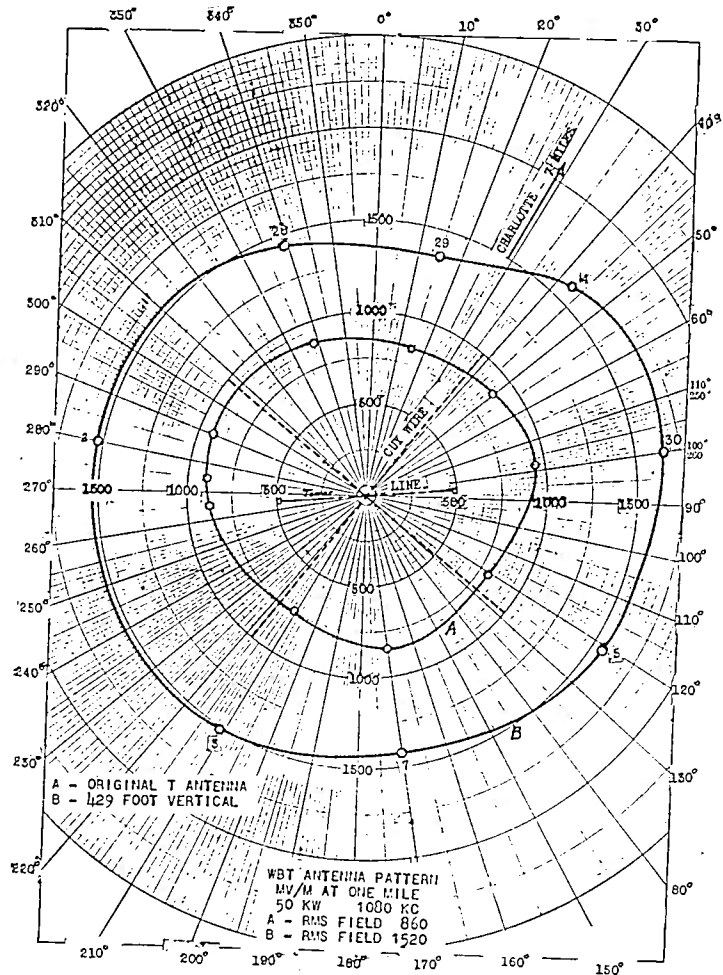

Fig. 3—Field intensities at a distance of one mile. (T antenna, A; and mast antenna, B).

The field intensities at a distance of one mile are shown for the old T and the new mast in Fig. 3. These measurements were made by W. B. Lodge of the Columbia Broadcasting System. They show that the ground wave was increased about 1.75 times by the use of the mast instead of the T. The average field intensity at one mile from the L antenna was 760 millivolts per meter, this being one half the field intensity at one mile from the mast.

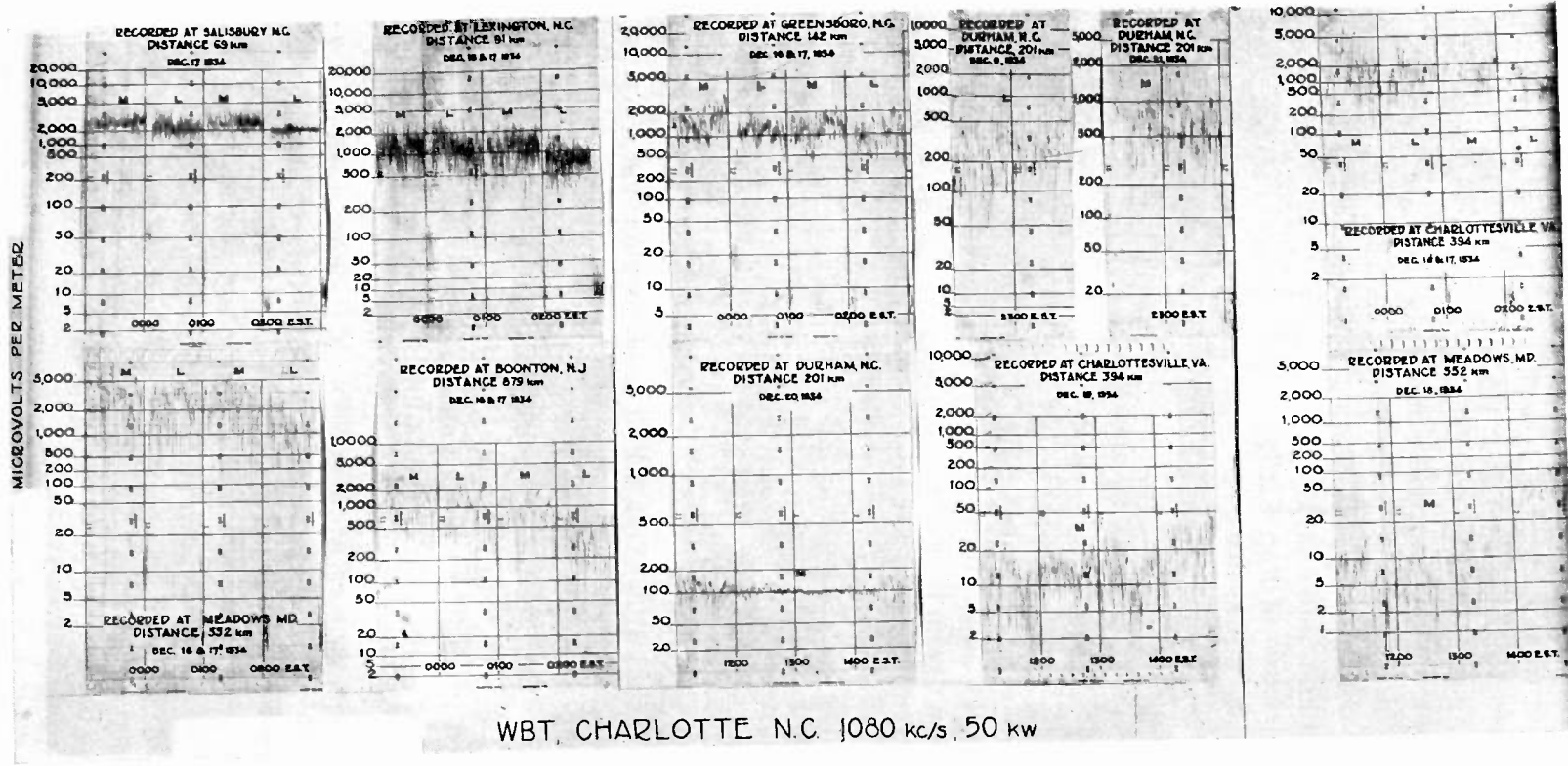

Fig. 4—Field intensity records of emissions from the L and mast (M) at night, and from the mast during the day.

Fig. 4 shows some night records from each of the seven recording stations and from each of the two antennas. The power input to the antenna in each case was fifty kilowatts. The only changes at the transmitting station were the changes of antenna indicated in Fig. 4. At all of the receiving stations, excepting Durham, the night records shown in this figure were made simultaneously. Day records of emissions from the mast are also shown in this figure, *M* and *L* representing the mast and *L* antenna, respectively.

An inspection of Fig. 4 will indicate the general characteristics of fading and field intensity as the distance from the transmitting station was increased. However this inspection will also indicate that it is difficult and unsafe to judge the respective merits of the two antennas from a few short records taken with successive antenna changes.

Consider the records taken at Salisbury. The first three one-hour records of transmissions from the mast, the *L*, and the mast in turn indicate that the field intensity was increased and the fading decreased by the substitution of the mast for the *L*. This is the conclusion which will be drawn later from a consideration of all of the records from December 5 to 30. The last hour's record of transmissions from the *L* taken between 0210 and 0300 E.S.T., however, would indicate that there was less fading of emissions from the *L*. It is believed that this change was brought about by a change of the ionosphere and that the first three hours' records indicated the relative performance of the mast and the *L* antennas as observed at Salisbury. Whatever the change in the ionosphere after 0200 E.S.T. may have been, its effect did not depend critically on the angle of incidence of the wave on the ionosphere as the same effect was indicated at nearly all of the recording stations simultaneously.

The records from 2300 December 16 to 0200 December 17 present qualitatively very well the relative performance of the two antennas as observed from different distances. Points to be noted are the field intensity, the amplitude of the fading, and the rapidity of the fading. It might be pointed out that on this night the peak values of field intensity were greater at Meadows, Maryland, than at any other recording station. Although the amplitude of the fading increased with the distance for some distance from the transmitting station, the fading at moderate distances was much more rapid and therefore more destructive. The fading at Lexington was an example of this.

Some day records are included in this figure to show the distances at which sky wave became appreciable during the daytime. Considerable sky wave was found at Durham during most of the day and at the more distant receiving points sky wave was predominant during

the day as well as the night. By comparing the peak values of the day and night field intensities it will be seen that the night field intensities were about 250 and 350 times the day field intensities at Charlottesville and Meadows, respectively. This indicates that even when the daytime sky wave at this frequency is strongest, as it is in midwinter, that it is even then very highly absorbed in the ionosphere. Waves of this frequency could not pass through the E region of the ionosphere during the day.

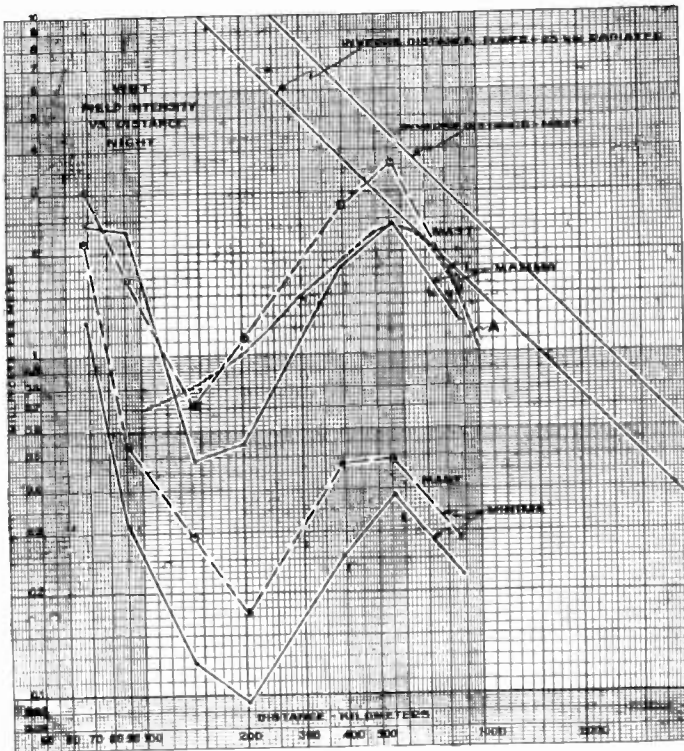

Fig. 5—Average of ten-minute maximum and minimum night field intensities of emissions from L and mast antennas.

ANALYSIS OF RECORDS

From the records given here, it may be seen that it is difficult to draw satisfactory conclusions by simple inspection of the records or from records taken over short periods. These records have been analyzed by measuring the maxima and minima for each ten-minute period and averaging the day values and the night values separately for daily averages. The hours from 0800 to 1600 E.S.T. were arbitrarily used as day hours and 1800 to 0000 E.S.T. as night hours. The daily averages were again averaged over the period during which a particular antenna was used.

Fig. 5 shows the averaged night field intensities for both the L and

the mast plotted together for comparison. It should be noted that with the exception of the Lexington records that the ten-minute maximum field intensities at all distances were greater in the case of the mast than in the case of the L. Part of this increase of field intensity was caused by an increase in the ratio of low angle to high angle radiation and part probably was caused by the increased radiation efficiency of the high mast antenna. Similarly the minimum values in the case of the mast were greater than those in the case of the L at all recording stations. In this figure the graph labeled "inverse distance power 25 kw radiated" indicates the inverse distance values of field intensity as given for the ground wave, with no absorption, by the formula for a vertical infinitesimal doublet; i.e., $F = C\sqrt{P_r/D}$ where F is the field intensity in microvolts per meter, C is the velocity of light in kilometers per second, P_r is the power radiated in kilowatts, and D is the distance in kilometers. The use of twenty-five kilowatts for the radiated power in this case is based on the assumption that the radiation efficiency of the antenna was fifty per cent and the distribution of energy the same as for the vertical infinitesimal doublet, which were the conditions assumed by Norton, Kirby, and Lester² for a large number of miscellaneous antennas. The graph labeled "inverse distance mast" was based on the average value of field intensity at one mile from the mast antenna. Similar graphs based on the average field intensity at one mile for the old T and L antennas are not shown but would have fallen below both of those plotted. The average values of the ten-minute peak field intensities from the L antenna did not reach the inverse distance graph for twenty-five kilowatts radiated at any of the receiving stations. However, many of the individual peaks did exceed the inverse distance values. In a similar manner the average ten-minute peak field intensities from the mast did not exceed the inverse distance values as calculated from the field intensities at one mile, but many of the individual peak values did exceed the inverse distance values. The smooth dashed curve shown in this figure represents the empirical formula for twenty-five kilowatts radiated, for sky-wave field intensities as given by Norton, Kirby and Lester.² The sky-wave field intensities received at Meadows, 552 kilometers, exceeded those recorded at any other station. The latter result corroborates the result found by Norton, Kirby, and Lester² that for a large number of miscellaneous broadcast stations, the maximum sky-wave field intensities were produced at a distance of about 600 kilometers.

² K. A. Norton, S. S. Kirby, and G. H. Lester, "An analysis of continuous records of field intensity at broadcast frequencies," *Bur. Stand. Jour. Res.*, vol. 13, pp. 897-910; December, (1934); *Proc. I.R.E.*, vol. 23, pp. 1183-1200; October, (1935).

Fig. 6 shows the ratios of the amplitudes of night fading from the mast and the L antennas. The mast had a decided advantage over the three shortest paths and this result may reasonably be ascribed to an increase of ground-wave to sky-wave ratio. The decrease of the amplitude of night fading over the three shortest paths by the use of the mast was a very great improvement. At Lexington the fading ratio for the mast as shown by an analysis of all the records obtained was only 0.4 that for the L and at Greensboro 0.6. Fig. 4 does not show this clearly. These stations were in regions where night reception from the L was poor because of bad fading. It would be reasonable to conclude from these

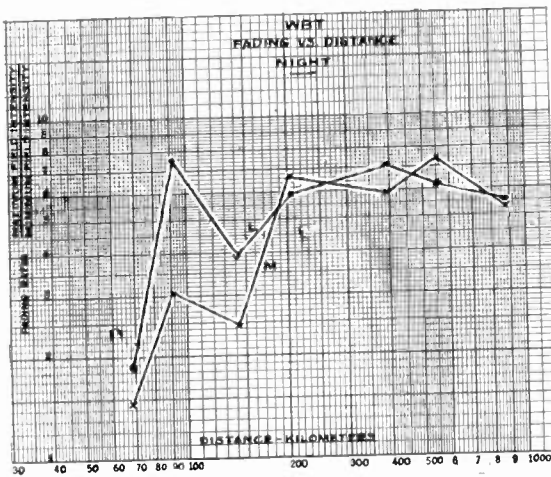

Fig. 6—Amplitude ratios of night fading of emissions from L and mast antennas.

results that the night service area was considerably increased by the use of the mast. At the more distant receiving stations the amplitudes of the fading ratios from the mast and the L were approximately equal. These latter fields were composed almost entirely of sky waves for both antennas. At the shorter distances the fields were composed of both sky waves and ground waves.

In addition to the amplitude of the fading ratios the rapidity of the fading is very important. It may be seen from Fig. 4 that fading at the closer receiving stations was much more rapid than at the more distant stations. This was especially noticeable at Lexington where the amplitude of the fading was great enough to be serious and the fading period was very short.

Fading may be produced in several ways such as by phase interference between ground wave and sky wave or between two or more sky waves, by changing intensity of sky wave or rotation of the components of the field of sky waves. Ground waves are stable and sky waves unstable. By a comparison of Fig. 7, which shows the day field intensities

at various distances, with Fig. 5 it may be estimated that the ground wave and sky wave were of approximately the same amplitude at Lexington. It seems reasonable to conclude that this rapid type of fading was due in a large measure to interference between the ground wave and sky wave whose relative phase relations were continuously

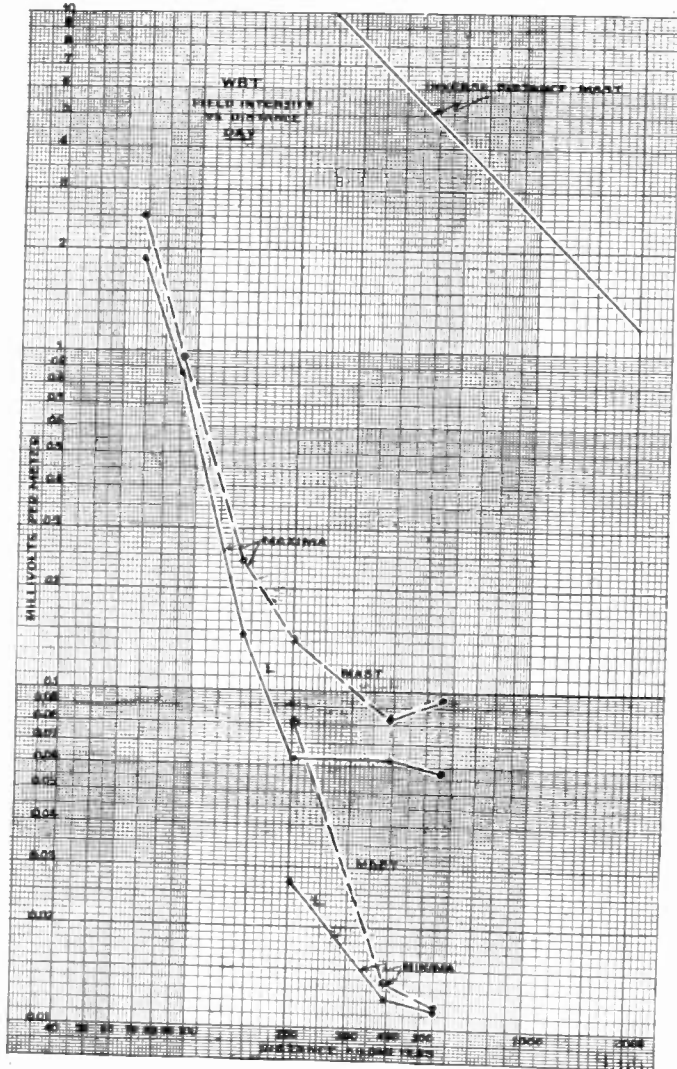

Fig. 7—Average of ten-minute maximum and minimum day field intensities of emissions from L and mast antennas.

changing. If all of the fading were due to this cause the field intensity would oscillate between fixed upper and lower limits. This condition does not exist because the intensity and polarization of the sky wave also changed. At Greensboro the sky wave was considerably stronger than the ground wave and at the more distant points the ground wave is almost negligible at night.

From an analysis of all of the records obtained it may be concluded that over distances at which the ground wave and sky wave were of appreciably equal intensities a rapid destructive type of fading was produced mainly by interference between ground wave and sky wave, and that the amplitude but not the frequency of this fading was reduced by increasing the ratio of ground wave to sky wave by the use of the high mast antenna. Over greater distances at which the sky wave was predominant, the fading was produced by variations of the inten-

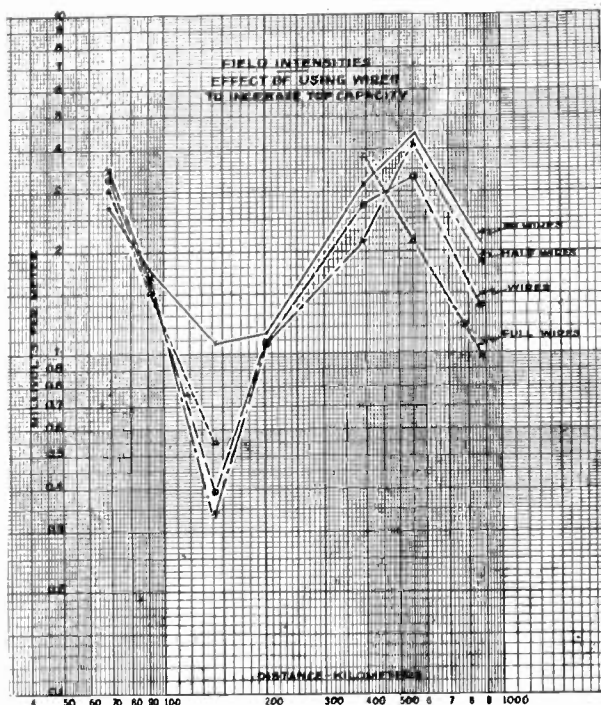

Fig. 8—Field intensities of emissions from mast antenna with and without wires used to increase top capacity.

sity and polarization of the sky wave and neither the amplitude nor frequency of the fading was altered appreciably by the substitution of the mast antenna for the L. In the WBT investigation receiving points out as far as Greensboro (142 kilometers) were affected by the former type of fading although it was much more pronounced at Lexington (ninety-one kilometers). With a lower frequency or a ground of higher conductivity this type of fading would be found farther from the transmitting station. It seems that the frequency of the fading would be lower for a lower frequency.

Fig. 7 shows the day field intensities from the mast and the L. The mast produced greater field intensities than the L at all recorder stations. The Boonton values are not shown on this graph.

As previously mentioned, the mast was used under several different conditions; i.e., with wires added to increase the top capacity and without the wires. The wires were used under two different conditions; i.e., half wires or wires from the top down to the waist of the tower and full wires or wires from the top nearly to the ground. In each case four wires were used and they were supported at the top by steel arms extending out horizontally. In studying the effect of the wires, records were available only for rather short periods for each condition so that some of the variations are more likely to be accidental than in the previous discussion. This is especially true for the Greensboro data because some of the late December records at this station were spoiled by receiving set trouble.

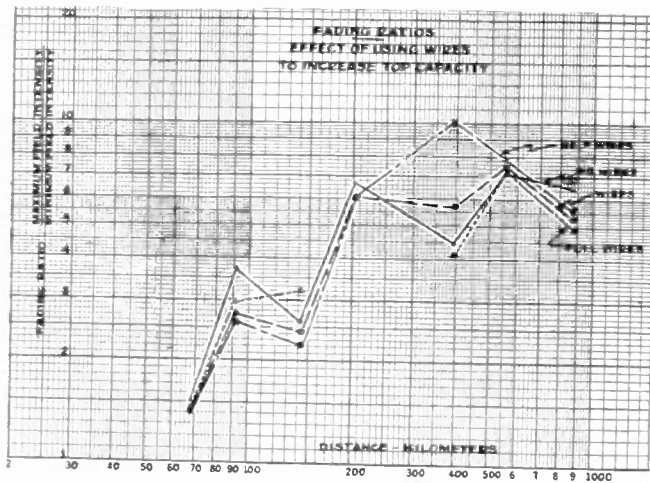

Fig. 9—Amplitude ratios of night fading of emissions from mast antenna with and without wires to increase top capacity.

In Fig. 8 are shown the field intensities with the mast antenna used under the different conditions described. The graph labeled "wires" includes the data for the days when both half wires and full wires were used. In general these results favor the use of the mast without the wires.

In Fig. 9 are shown the fading ratios with the mast used under the different conditions. For the important near-by points the wires, especially the half wires, seem to have an advantage in reducing the fading. This problem should have further study. It should not be absolutely necessary to study the effect of antenna changes on the fading over a wide range of distances as was done in the WBT experiment as much can be learned from a careful study at one well-located station, Lexington, in the case at hand.

CONCLUSIONS

The 429-foot mast antenna produced a ground-wave field intensity 1.75 times that produced by the old T, and twice that produced by the L.

The night field intensity at considerable distances was increased by a factor of about 1.5 by the substitution of the mast for the L.

The night fading amplitude was decreased appreciably out to 150 kilometers by the use of the mast. The fading amplitude was not appreciably decreased at distances over 200 kilometers where sky wave was predominant from both antennas.

Fading was much more rapid and destructive within a distance of 150 kilometers than for greater distances. The change of antennas did not appreciably affect the frequency of the fading but only the amplitude.

The maximum sky-wave field intensity recorded was at Meadows, at a distance of 552 kilometers from the transmitting station.

The use of wires to increase the top capacity and make the antenna current more nearly sinusoidal did not increase the field intensity but there was some evidence that the fading was decreased over the first 150 kilometers. The half wires were more effective than the full wires.

ACKNOWLEDGMENT

This investigation was made possible through the co-operation of the Columbia Broadcasting System, by arrangement with Mr. E. K. Cohan, director of engineering for that company. Messrs. A. B. Chamberlin and W. B. Lodge, engineers for the Columbia Broadcasting System; assisted in the work.

Mr. S. E. Reymer of the National Bureau of Standards assisted in installing the recorders. Facilities for the installation of receiving equipment and recorders were furnished by Mr. T. M. Casey, Salisbury, N. C.; Mr. Fred Hunnicut and the firm Conrad, Linville, and Martin, Lexington, N. C.; Women's College, University of North Carolina, Greensboro, N. C.; Duke University, Durham, N. C.; University of Virginia, Charlottesville, Va; and Ballantine Laboratories Inc., Boonton, N. J.; Mr. S. Ballantine also operated the equipment installed in his laboratory.

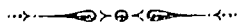

A CATHODE-RAY TIME AXIS FOR HIGH FREQUENCY*

BY

LAURANCE M. LEEDS

(General Electric Company, Schenectady, N. Y.)

Summary—A periodically recurrent high-frequency time axis generator with return trace removal is described. The theoretical nonlinearity is less than one per cent. The apparatus is capable of tracing out one cycle of a thirty-megacycle wave. The wave form of a conventional high-frequency oscillator is altered by means of a high vacuum rectifier circuit to obtain the required sweep voltage wave. Return trace removal is accomplished by biasing the control grid of the cathode-ray tube to cutoff over the return trace portion of the sweep cycle.

THE solution of problems incident to the adjustment of high-frequency transmitters, such as the location and elimination of parasitic oscillations and elimination of carrier distortion, can be greatly facilitated by the use of a cathode-ray oscilloscope capable of reproducing a stationary image of the carrier frequency. Such an instrument is also useful in the realm of fundamental research; for example, in the study of vacuum tube circuits a knowledge of the wave form change coincident with a parameter adjustment may assist in the formulation of a theory of operation. The time axis generator described below is capable of operation at frequencies of the order of thirty megacycles, and it is believed that operation at even higher frequencies may be attained by the use of more elaborate shielding. The complete removal of the return trace is unusual in cathode-ray oscillography and results in an unobscured and readily interpretable image.

In the discussion to follow it has been found convenient to introduce several terms which are defined as follows.

Unknown Voltage: This term refers to the voltage wave being analyzed.

Fundamental Sweep Frequency: The sweep circuit frequency which will cause the unknown voltage to trace out one cycle.

Maximum Three-Cycle Frequency: The frequency of the unknown voltage which will trace out *three cycles* when the particular sweep circuit is adjusted for its fastest operation. This was chosen, with some justification, as the optimum image trace and is useful in rating the upper limit of a sweep circuit.

* Decimal classification: R388. Original manuscript received by the Institute, February 13, 1936. Presented before Eleventh Annual Convention, Cleveland, Ohio, May 13, 1936.

REVIEW OF PREVIOUS TIME AXIS DEVELOPMENTS¹

For low audio frequencies the motor-driven potentiometer has found considerable usefulness in the production testing and adjustment of intermediate-frequency transformers.² The fundamental sweep frequency is limited, of course, by mechanical considerations. The condenser method has been used extensively in the medium and high audio-frequency range.^{3,4,5} In this method a pentode tube is used to limit the condenser charging current to a constant value, the voltage across the condenser then being a linear function with respect to time. Rapid condenser discharge is accomplished by means of a gaseous discharge tube which becomes conductive when the condenser voltage reaches a predetermined value. Because of the deionization time of the gas (usually mercury vapor) the maximum three-cycle frequency is limited to about 45,000 cycles, (maximum fundamental sweep frequency of 15,000 cycles).

Because the deionization time of the gaseous discharge tubes placed an unreasonably low limit to the fundamental sweep frequency, high vacuum discharge tubes were resorted to. Thus Hoover and Kennedy used a relaxation oscillator to control the grid of a high vacuum discharge tube.^{6,7} One of their devices used the linear condenser charge scheme, similar to those used in the low-frequency devices, while the other utilized the initial portion of the exponential condenser voltage charge characteristic when the condenser is charged from a high voltage source. This characteristic is reasonably linear with respect to time during the initial (say thirty per cent) voltage rise, at which time the condenser is discharged by the high vacuum tube and the cycle repeated.

Another method was described by W. Osbon,^{8,9} wherein the condenser is charged rapidly and discharged through a constant current tube. The control of the condenser is accomplished by means of a dis-

¹ No attempt is made at completeness; only the more important developments are recorded.

² Thiessen, "Cathode-ray oscillographs and their applications," *Gen. Radio Exp.*, vol. 8, pp. 1-4; November, (1933).

³ Bedell and Reich, "The oscilloscope; a stabilized cathode-ray oscillograph with linear time axis," *Jour. A.I.E.E.*, vol. 46, pp. 563-567; June, (1927).

⁴ Haller, "A linear timing axis for cathode-ray oscillographs," *Rev. Sci. Instr.*, vol. 4, pp. 385-386; July, (1933).

⁵ Meier and Richards, "Power supply and linear time axis for cathode-ray oscillographs," *Electronics*, vol. 7, pp. 110-112; April, (1934).

⁶ Hoover and Kennedy, See Master's Thesis of E. Kennedy, Rutgers University, (1933).

⁷ Hoover and Kennedy, U. S. Patent No. 1,978,461.

⁸ Osbon, "A new cathode-ray oscilloscope." *Elec. Jour.*, vol. 28, pp. 322-324; May, (1931).

⁹ W. V. Osbon, U.S. Patent No. 1,934,322.

symmetrical multivibrator circuit in which a pentode tube, in shunt with a fixed resistor, takes the place of one of the grid leaks.

The control of the grid of a high vacuum discharge tube, which is biased past cutoff except for short intervals when the grid is driven positive by a source of alternating current, has been used by Zworykin¹⁰ as well as Nakajima and Takayanagi.¹¹ More recently, Goldsmith and Richards,¹² using the same principle of pulse excitation of the grid of the discharge tube, extended the speed of the condenser method by using four '58 type tubes in parallel to obtain a greater constant charging current but at the expense of greater distributed capacity. Since the period of the forward trace of the sweep circuit cycle is directly proportional to the capacity and inversely proportional to the constant charging current, no improvement can be obtained by increasing the charging current if the capacity is increased in the same ratio. The limits of the constant charging rate available with the present types of vacuum tubes, together with the unavoidable distributed capacity introduced, places a limitation upon the maximum economical fundamental sweep frequency available with the condenser method. Thus if a three-cycle image of a thirty-megacycle wave were desired with a screen spread corresponding to a 400-volt condenser charge with an available constant charging current of fifty milliamperes, the capacity must be $C = It/E = 50 \times 10^{-3} \times 10^{-7} / 400 = 12.5$ micromicrofarads. This capacity is much less than the stray capacity which can be obtained in practice. Considerations such as this led to an investigation to discover other methods, independent of condenser charge, to obtain a linear variation of voltage with respect to time.

THE TIME AXIS GENERATOR

The analysis of an ordinary sine wave $y = E \sin x$ between $x = -\pi/6$ and $x = +\pi/6$ shows that the maximum ordinate difference between the sine wave and a straight line joining the two points $(-\pi/6, -E/2)$ and $(+\pi/6, +E/2)$ is 0.904 per cent of E . This nonlinearity factor of 0.904 per cent is of such a value that if this portion of the sine wave is used for a time axis, the resultant fluorescent trace will be linear to within the thickness of the trace line. Thus the useful portion of the sine wave for this application is that which occurs between $x = -\pi/6$ and $x = +\pi/6$; the remainder of the wave is superfluous and should be removed from the screen for intelligibility.

¹⁰ Zworykin, "Description of an experimental television system and the kinescope," *Proc. I.R.E.*, vol. 21, pp. 1655-1673; December, (1933).

¹¹ T. Nakajima, and K. Takayanagi, (Japan), U.S. Patent No. 1,933,219.

¹² Goldsmith and Richards, "A high-frequency sweep circuit," *Proc. I.R.E.*, vol. 23, pp. 653-657; June, (1935).

In Fig. 1 is shown the schematic circuit arrangement of a sine wave distortion device whose output voltage wave form has desirable time axis features. E_{61} is a source of alternating current of variable frequency whose wave form is, in general, sinusoidal. VT_1 and VT_2 are high vacuum rectifiers, R and R_1 noninductive resistors, and C by-pass condensers. The operation is as follows: In the steady state, resistors R_1 and associated condensers assume a potential E_1 with polarities as shown. As

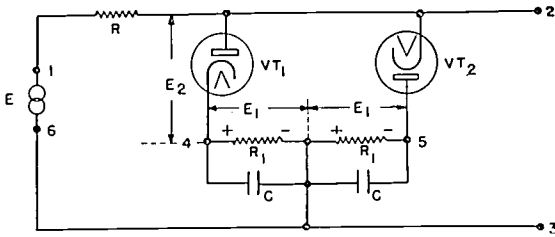

Fig. 1—Sine wave distortion device.

long as E_{61} is less than E_1 , the potential E_{32} will be identical with E_{61} . As soon as E_{61} becomes greater than E_1 , current will flow through VT_1 (or VT_2) causing a voltage drop across R equal to $E_{61} - E_1 - E_2$. The rectifier drop E_2 is small compared with E_{61} or E_1 . A plot of the voltages is shown in Fig. 2. Of course, in practice, instantaneous change in slope of the voltage curve E_{32} will not be obtained due to the inertia of the circuit, but sufficiently rapid change is obtained to make the appara-

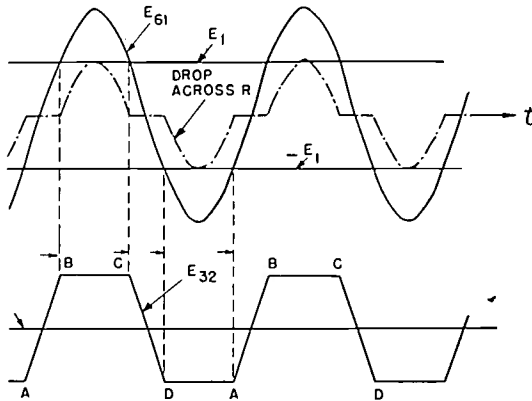

Fig. 2—Voltage relative.

tus readily usable. It has been possible to proportion R and R_1 so that $E_1 = 1/2 E_{61}$ thus fulfilling the conditions imposed in the previous discussion.

The portion of the wave E_{32} (Fig. 2) occurring between A and B (or between C and D) is used for the practically linear variation of voltage with respect to time; linear to within the thickness of the trace line. If the section $A - B$ is used then section $C - D$ should be suppressed

(or vice versa). This suppression is necessary to avoid an obscuring of the image trace because the section $A - B$ would sweep out the image going, say, from left to right while section $C - D$ would sweep out an image on the return. In general, these two images would not be superposed, hence suppression of one of them is necessary. A simple method of accomplishing this will be described below. The resulting sweep voltage, applied to the deflection plates during the luminous portion of the sweep cycle, will be as shown in Fig. 3. Note that the sweep voltage amplitude is equal to the peak amplitude of the driving voltage E_{G1} .

FREQUENCY RELATIONS

Reference to Fig. 3 shows that, as far as the sweep voltage is concerned, the cathode beam will hold at each end for one sixth of a cycle (of frequency of E_{G1}), will sweep for one sixth of a cycle, and be sup-

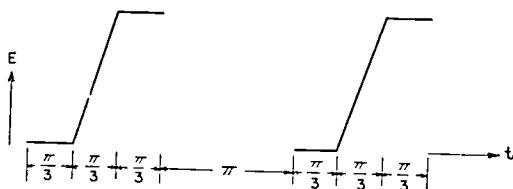

Fig. 3—Sweep voltage during luminous portion of sweep cycle.

pressed for one half of a cycle. The entire cycle is then repeated. It is immediately apparent that the frequency of the driving source E_{G1} will be one sixth of the unknown voltage frequency when one cycle of the unknown is traced on the screen. Thus the driving source is operated at a much lower frequency than that which is being observed and analyzed. It may be thought that an arrangement such as this, wherein the average time of image appearance is only one sixth of the total time, would have poor luminosity. Such was not found to be the case with the type FP53 cathode-ray tube (six-inch screen diameter) which was used in this apparatus. A sufficiently luminous image trace was obtained at all times.

SUPPRESSION OF RETURN TRACE IMAGE

Biasing the control grid of the cathode-ray tube past cutoff during the return trace portion of the sweep cycle has been found to be an entirely satisfactory method of suppressing the return trace image. The control grid voltage required to cut off the cathode beam of the FP53 tube is -70 volts. This voltage is obtained from the sweep circuit driving voltage, rectified to half sine waves by a high vacuum diode, and introduced into the control grid circuit of the cathode-ray tube. Reference to Fig. 4, the complete circuit diagram, will show how this is ac-

completed. The sweep circuit driving voltage is obtained from an ordinary Hartley variable frequency oscillator. Coil L_2 is a single turn around L_1 . The voltage induced in L_2 is of sufficient amplitude, after rectification, to effect the suppression of the return trace. A study of Fig. 2 will reveal that the time axis voltage should be ninety degrees out of phase with the return image trace suppression voltage impressed across R_2 (of Fig. 4). In the developmental apparatus no phase shifting other than that inherently present in the circuit and wiring is required. However, the suppression voltage may be shifted in phase by a simple network if found necessary.

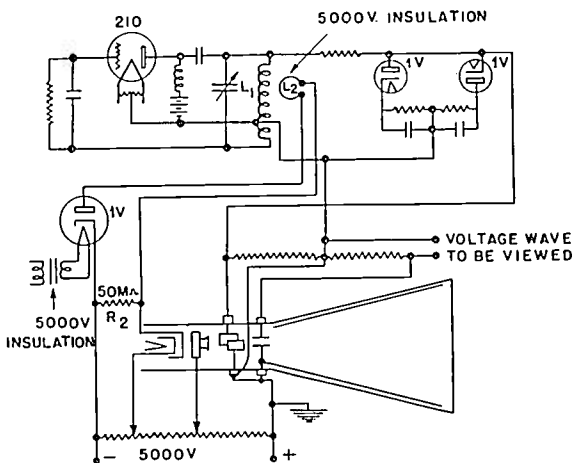

Fig. 4—Circuit diagram, high-frequency sweep circuit.

SYNCHRONIZATION

In order to obtain a stable image trace it is essential that the frequency of the time axis voltage be a submultiple of the unknown voltage frequency. In the experimental unit, which was totally unshielded, synchronization was accomplished by careful orientation of the apparatus involved. No difficulty was experienced in obtaining stable synchronization even when the frequency difference was as great as eighteen to one. In a carefully shielded design of this apparatus a wire connecting to the unknown voltage deflecting plate with the other end placed in the shielded oscillator compartment should be sufficient to effect synchronization. Care must be exercised that none of the unknown gets into the sine wave distortion circuits as this would produce serious distortion in the image trace. This type of distortion can be readily detected as follows. With the sweep circuit apparatus connected to the lower deflecting plates and the unknown voltage connected to the upper deflecting plates, and with the oscillator plate volt-

age disconnected, the trace should be a thin line of thickness somewhat less than the spot diameter when no deflecting voltages are applied, and should remain stationary and unaltered when the lower deflecting plates are short circuited at the cathode-ray tube terminals. The high anode voltages used on cathode-ray tubes (5000 volts on the FP53) call for extreme care in making the above test.

SHIELDING

Adequate and effective shielding is of primary importance in a high-frequency cathode-ray oscilloscope. Any stray fields which induce a voltage into the deflection plate circuits will produce distortion in the image trace. The sweep circuit apparatus must be totally shielded from the sixty-cycle fields prevalent in the cathode-ray tube control circuits and power supplies. In addition, the unknown voltage must be fed to the deflecting plates by a means which introduces the least possible capacity to ground in order to prevent a capacity load on the unknown source which might alter its characteristics. This requires that the unknown voltage connections be unshielded and hence that the other apparatus be very effectively shielded.

The above requirements may be met by building the entire assembly in an iron case. A section, closed off by an iron shield except for a hole to pass the stem of the cathode-ray tube, should contain the tube socket, control circuits, and power supplies. The sweep circuit apparatus should be made in two sections, one the oscillator, and the other the sine wave distortion apparatus, and each totally enclosed in an aluminum box. These should be located adjacent to the sweep circuit deflection plates. The unknown voltage should be fed to the proper deflection plates through studs, set in insulating inserts in the outer case, and wired directly to the plates. To prevent a difference of radio-frequency potential on the shields from inducing a voltage into the deflecting plate circuits all radio-frequency ground returns should be made to a central point, the grounded deflection plates.

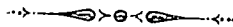

NOTES ON THE THEORY OF THE SINGLE STAGE AMPLIFIER*

By

BERNARD SALZBERG

(RCA Radiotron Division, RCA Manufacturing Company, Inc., Harrison, New Jersey)

Summary—The theory of the single stage vacuum tube amplifier is generalized and also extended to include phenomena of interest in vacuum tube and receiver design at high frequencies. General expressions are derived for the increase in the input admittance due to feedback, for the conditions for stability, and for the gain, as functions of the various parameters of the tube and the associated circuits. These expressions are then examined in some detail. Two specific results of especial interest are given: the case of feedback through a parallel path of susceptance and conductance, and the conditions which result when the transfer admittance consists not only of a real part but also of an imaginary part.

I. INTRODUCTION

THE theory of the single stage amplifier is of practical importance to vacuum tube and receiver design engineers because it expresses the operation of such a stage quantitatively, and so permits the calculation of such pertinent matters as the gain of the amplifier, the stability of the amplifier, and the increase in the input admittance of the amplifier due to feedback. It is also of importance because it forms the basis of an extended theory for the more general case of the n -stage amplifier.

The theory of the amplifier has been rather extensively studied, at least as regards the operation of radio-frequency amplifiers at medium frequencies and for the case in which the feedback path is of an elementary nature.^{1,2,3,4,5,6,7,8} Recent studies of the behavior of tubes

* Decimal classification: R132. Original manuscript received by the Institute, February 11, 1936.

¹ H. W. Nichols, "The audion as a circuit element," *Phys. Rev.*, vol. 13, p. 404, (1919).

² J. M. Miller, "Dependence of the input impedance of a three-electrode vacuum tube upon the load in the plate circuit," *Sci. Pap. Bur. Stand.*, vol. 15, no. 351, p. 367, (1919).

³ Stuart Ballantine, "Input impedance of the thermionic amplifier," *Phys. Rev.*, vol. 15, p. 409, (1920).

⁴ R. T. Beatty, "The stability of the tuned-grid, tuned-plate high-frequency amplifier," *Exp. Wireless and Wireless Eng.*, vol. 5, p. 3; January, (1928).

⁵ R. T. Beatty, "The stability of a valve amplifier with tuned circuits and internal reaction," *Proc. Phys. Soc. (London)*, vol. 40, p. 261, (1928).

⁶ J. R. Nelson, "Circuit analysis applied to the screen-grid tube," *Proc. I.R.E.*, vol. 17, pp. 320-338; February, (1929).

⁷ B. J. Thompson, "Oscillation in tuned radio-frequency amplifiers," *Proc. I.R.E.*, vol. 19, pp. 421-437; March (1931).

⁸ M. O'Connor Horgan, "The grid-anode capacity of valves," *Wireless Eng. and Exp. Wireless*, vol. 11, p. 464; September, (1934).

at high frequencies indicate that the operation of the amplifier tube is modified in such a way as to make the existing amplifier theory somewhat inadequate. Specifically, the influence of the time of passage of the electrons between the various electrodes of the tube is such as to introduce a phase shift in the grid-plate transconductance and to alter the various tube admittances.^{9,10,11,12} The effect of the alteration of the input and output admittances may be accounted for by a proper interpretation of the existing theory, but the introduction of a phase shift in the transconductance necessitates some alterations of the theory. In addition, it is of further interest to generalize the existing theory in a manner which will permit the explanation of the operation of the amplifier when more complex admittances than have hitherto been considered are connected across the tube terminals.

In the following study, the existing theory of the single stage vacuum tube amplifier is somewhat generalized and also extended to include the case in which the electron transit time modifies the behavior of the tube.¹³ First, general expressions are derived for the increase in the input admittance of the amplifier due to feedback, for the conditions for stability, and for the gain of the amplifier, as functions of the various parameters of the tube and the associated circuits. Several special cases of interest, for which suitable simplifying assumptions may be made, are then treated in detail.

II. GENERAL ANALYSIS

The amplifier under consideration consists of a vacuum tube having circuits of a general nature attached to its terminals, as shown in Fig. 1. A sinusoidal voltage of frequency $\omega/2\pi$ is introduced into the input circuit. The amplitude of this voltage is taken so small that the differential parameters of the tube may be considered constant; i.e., a linear problem is stipulated.

For the purpose of analysis, the tube and its associated circuits are replaced by the equivalent circuit shown in Fig. 2a. This equivalent circuit is a generalization of the well-known first order equivalent circuit of an amplifier working at moderate frequencies, where the transit angles are exceedingly small.¹ It differs from the usual representation

⁹ F. B. Llewellyn, "Vacuum tube electronics at ultra-high frequencies," Proc. I.R.E., vol. 21, pp. 1532-1573; November, (1933).

¹⁰ F. B. Llewellyn, "Note on vacuum tube electronics at ultra-high frequencies," Proc. I.R.E., vol. 23, pp. 112-127; February, (1935).

¹¹ D. O. North, "Analysis of the effects of space charge on grid impedance," Proc. I.R.E., vol. 24, pp. 108-136; January, (1936).

¹² W. R. Ferris, "Input resistance of vacuum tubes as ultra-high-frequency amplifiers," Proc. I.R.E., vol. 24, pp. 82-104; January, (1936).

¹³ The author intends to present at some later date an extension of this work to the case of the n -stage amplifier.

in that the first-order effects of the transit angles, which are now assumed as small but significant, on the tube input, output, coupling, and transfer admittances are included. It is supposed that the characteristics of the tube—its input, output, coupling, and transfer admit-

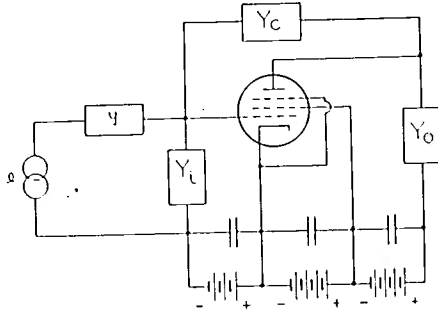

Fig. 1—The circuit diagram of the type of amplifier stage under consideration. Admittances are known and measurable functions of the frequency and electrode voltages,^{12,14,15} so that for any given operating conditions the values of these tube parameters can be used for further circuit calculations. In Fig. 2a the control-grid-to-plate path is represented by the general

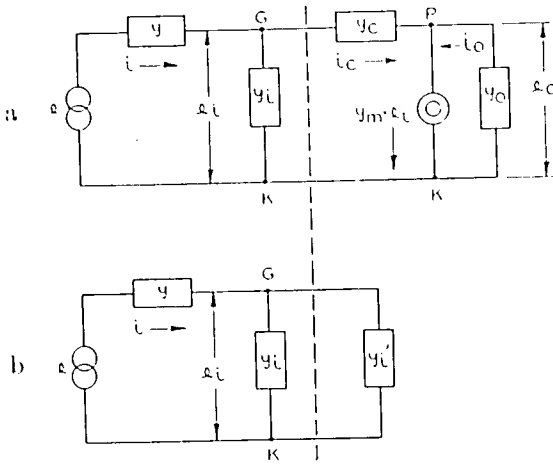

Fig. 2

a—The schematic first-order equivalent circuit representation of the amplifier stage shown in Fig. 1.

b—A simplification of Fig. 2a. In this diagram y_i' represents the equivalent admittance, across the grid-cathode terminals, of the circuit to the right of the dotted line.

admittance y_c . The effect, in the output circuit, of the voltage e_i applied to the control grid of the tube is represented by a generator of constant current $y_m e_i$ shunted by an admittance. The input, output, and cou-

¹⁴ Bernard Salzberg and D. G. Burnside, "Recent developments in miniature tubes," Proc. I.R.E., vol. 23, pp. 1142-1157; October, (1935).

¹⁵ F. B. Llewellyn, "Phase angle of vacuum tube transconductance at very high frequencies," Proc. I.R.E., vol. 22, pp. 947-956; August, (1934).

pling admittances of the tube are included in the corresponding admittances of the attached circuits, and the combined admittances are then denoted by y_i , y_0 , and y_c , respectively. The general admittance y , in series with the source of voltage e , includes the generator admittance. The additional input admittance of the tube due to feedback through the coupling admittance is designated separately as y_i' , and is equal to i_c/e_i (see Fig. 2b).

By applying Kirchoff's laws to this equivalent circuit, we are enabled to write:

For the voltage across the input terminals

$$e_i = \frac{i_c}{y_c} - \frac{i_0}{y_0}. \quad (1)$$

For the current through the output admittance

$$i_0 = y_m \cdot e_i - i_c. \quad (2)$$

For the generator current

$$i = \frac{e}{\frac{1}{y} + \frac{1}{y_i + y_i'}}. \quad (3)$$

For the voltage across the input terminals, in terms of the generator current, or in terms of the generator voltage and the general admittance y ,

$$e_i = \frac{i}{y_i + y_i'} = \frac{e \cdot y}{y + y_i + y_i'}. \quad (4)$$

For the voltage drop through the load admittance

$$e_0 = -\frac{i_0}{y_0} = -e_i \left(\frac{y_m - y_i'}{y_0} \right). \quad (5)$$

By making use of (1) to (5) we may derive expressions for various quantities pertinent to the expression of the behavior of the amplifier.

The additional input admittance of the tube due to feedback through the coupling admittance is, from (1) and (2),

$$y_i' = \frac{i_c}{e_i} = y_c \left(\frac{y_0 + y_m}{y_0 + y_c} \right). \quad (6)$$

The voltage step-up, or gain, from control grid to output terminals is, from (5) and (6),

$$A_0 = \frac{e_0}{e_i} = \frac{y_c - y_m}{y_c + y_0}. \quad (7)$$

The voltage step-up, or gain, in the input circuit is, from (4) and (6),

$$A_i = \frac{e_i}{e} = \frac{y}{y + y_i + y_i'} = \frac{y}{y + y_i + y_c \left(\frac{y_0 + y_m}{y_0 + y_c} \right)}. \quad (8)$$

The over-all voltage amplification is, from (7) and (8),

$$A = \frac{e_0}{e} = \frac{e_0}{e_i} \cdot \frac{e_i}{e} = A_0 \cdot A_i. \quad (9)$$

It should be emphasized that the foregoing equations are expressed in terms of complex quantities. That is, $y = g + jb$, $A = A' + jA''$, etc., where g , A' , etc., represent the magnitudes of the real parts, or inphase components, of the corresponding complex quantities, and b , A'' , etc., represent the magnitudes of the imaginary parts, or out-of-phase components, of the corresponding complex quantities. In the discussion which follows it is assumed that the complex variables involved are analytic. As far as ordinary circuit theory is concerned, this condition will generally be fulfilled.

1. The Additional Input Admittance

The addition to the input admittance of the tube due to feedback through the coupling admittance is given by (6). (This expression does not, of course, include the input admittance of the tube itself, since the latter has been included in the admittance y_i .) This quantity is of importance because it represents the extent of the reaction of the output circuit upon the input circuit; i.e., it is a measure of the loading and detuning of the input circuit caused by the output circuit. In addition, this quantity may be used to determine the conditions for the stability of the amplifier.

Expression (6) may be written as

$$\begin{aligned} y_i' &= \frac{y_c y_0}{y_c + y_0} + \frac{y_m}{y_0} \left(\frac{y_c y_0}{y_c + y_0} \right) \\ &= y_i''(1 + a) \end{aligned} \quad (6a)$$

and in this form may be used to provide a physical representation for the additional input admittance. This quantity may be regarded, according to (6a), as being made up of a two-branch parallel circuit, one arm of which consists of the admittance y_c and y_0 in series, and the other of which consists of the same series combination of admittances multiplied by a complex operator which may be termed the intrinsic gain of the amplifier. In an efficient, well-screened amplifier the second

term predominates and, in fact, the relations between the various admittances are such that (6) may be simplified to

$$y_i' = y_c \left(\frac{y_m}{y_0} \right). \quad (6b)$$

Returning to (6a), we may deduce some important properties of this admittance. First, we see that y_i' vanishes when $a = -1 + j0$; i.e., the output circuit has neither loading nor detuning effects on the input circuit only when the absolute value of the intrinsic gain is unity and its phase with respect to the grid voltage is 180 degrees.

Second, the conductance component of y_i' is zero when the angle, or argument, of y_i' is plus or minus ninety degrees. Thus, the output circuit reflects no conductance across the input circuit when $\arg y_i' = \pm \pi/2$. By using (6a), we can write this condition as

$$\arg \left(\frac{y_c y_0}{y_c + y_0} \right) = \pm \frac{\pi}{2} - \arg \left(1 + \frac{y_m}{y_0} \right). \quad (10)$$

In the important practical case of an efficient, well-screened amplifier, $|y_c y_0| \ll 1$ and $|y_m y_0| \gg 1$, so that (10) becomes

$$\arg y_0 = \arg y_m + \arg y_c \mp \frac{\pi}{2}. \quad (10a)$$

Third, the susceptance component of y_i' is zero when the angle of y_i' is zero or 180 degrees. Thus, the output circuit reflects no detuning component across the input circuit when $\arg y_i' = 0$ or π , and from (6a), this is

$$\arg \left(\frac{y_c y_0}{y_c + y_0} \right) = (0 \text{ or } \pi) - \arg \left(1 + \frac{y_m}{y_0} \right). \quad (11)$$

For the case of the efficient, well-screened amplifier, (11) becomes

$$\arg y_0 = \arg y_m + \arg y_c \pm (0 \text{ or } \pi). \quad (11a)$$

It is also pertinent to determine the values of the output admittance y_0 , which will result in maximum and minimum values of the conductance and susceptance components of y_i' , under the assumption that y_m and y_c are fixed in value, as they would be for a given amplifier. The particular values of y_0 which lead to these properties will now be derived.

Fourth, the conductance component of y_i' is a maximum or a minimum when¹⁶

¹⁶ Walter Van B. Roberts, "Maximization methods for functions of a complex variable," Proc. I.R.E., vol. 15, pp. 519-524; June, (1927).

$$\operatorname{Re}\left(\frac{dy_i'}{dy_0} \cdot dy_0\right) = 0. \quad (12)$$

Now in the usual type of output circuit, y_0 is changed by tuning only in its imaginary component, so that $\operatorname{Re}(dy_0) = 0$, and (12) may be written as

$$\arg\left(\frac{dy_i'}{dy_0}\right) = (0 \text{ or } \pi). \quad (12a)$$

In the general case, where both the real and imaginary components of y_0 are changed as y_0 is varied, it would be necessary to write

$$\cot \arg\left(\frac{dy_i'}{dy_0}\right) = \tan \arg(dy_0). \quad (12b)$$

Proceeding, however, with the more usual case, since this is of greatest practical interest, and performing the differentiation of (6) indicated in (12a), there results

$$2 \arg(y_0 + y_c) = \pm [\arg y_c + \arg(y_c - y_m) - (0 \text{ or } \pi)]. \quad (13)$$

For the case of a good amplifier using a well-screened tube, (13) becomes

$$2 \arg y_0 = \pm [\arg y_c + \arg y_m + (0 \text{ or } \pi)]. \quad (13a)$$

Fifth, the condition which gives the maximum and minimum values of the susceptance component of y_i' is¹⁶

$$\operatorname{Im}\left(\frac{dy_i'}{dy_0} \cdot dy_0\right) = 0. \quad (14)$$

Again, since with the usual type of circuit only the imaginary part of y_0 is affected by tuning, we have that $\operatorname{Re}(dy_0) = 0$, and (14) may then be expressed as

$$\arg\left(\frac{dy_i'}{dy_0}\right) = \frac{\pi}{2} \text{ or } \frac{3\pi}{2}. \quad (14a)$$

In the general case, where both the real and imaginary components of y_0 are changed as y_0 is varied, it would be necessary to write

$$\tan \arg\left(\frac{dy_i'}{dy_0}\right) = - \tan \arg(dy_0). \quad (14b)$$

Proceeding, once more, only with the more usual case, there results

¹⁷ The meaning of the particular notation used here is perhaps best illustrated as follows: Consider a complex quantity, A , such that $A = A' + jA'' = |A| \cdot e^{j\phi}$. Then $A' = \operatorname{Re}(A)$, $A'' = \operatorname{Im}(A)$, $|A| = \operatorname{Mod}(A)$, $\phi = \arg(A)$.

$$2 \arg (y_0 + y_c) = \pm \left[\arg y_c + \arg (y_c - y_m) - \left(\frac{\pi}{2} \text{ or } \frac{3\pi}{2} \right) \right]. \quad (15)$$

For the important case of an efficient, well-screened amplifier, (15) becomes

$$2 \arg y_0 = \pm \left(\arg y_c + \arg y_m \pm \frac{\pi}{2} \right). \quad (15a)$$

2. Conditions for Stability

The conditions for stability of the amplifier stage, which are of primary importance to the design engineer, may be obtained by making use of the results of the preceding section.

When the amplifier is at the critical point, i.e., on the verge of oscillation, the total effective conductance and the total effective susceptance of the circuit as a whole are each equal to zero. Thus, if the amplifier is to remain stable at any particular frequency, the circuit must be adjusted to satisfy the conditions

$$g + g_i + g_i' > 0 \quad (16)$$

$$b + b_i + b_i' > 0. \quad (17)$$

Now, if (16) is not satisfied over a given frequency range, but (17) is satisfied for a frequency within that range, the circuit will not oscillate at the particular frequency in question; it may, however, oscillate at some other frequency within the range for which (17) may not be satisfied. However, if condition (16) is always fulfilled, the circuit will not oscillate even at some tuning adjustment which violates (17). Thus, if the amplifier is arranged so that condition (16) is always maintained, the amplifier will be stable. Now, if (16) is satisfied for the tuning adjustment of y_0 which results in a maximum negative additional input conductance g_i' , the amplifier will be stable for all other tuning adjustments. The particular adjustment of y_0 which results in this maximum negative additional input conductance is given by (13). Thus, to determine the conditions for stability of the amplifier stage, it is merely necessary to substitute the value of y_0 given by (13) in the real part of (6) and make use of the inequality (16). This procedure will be illustrated in Part III, where several practical cases of interest are examined in detail.

3. Gain

The over-all voltage amplification of the stage is

$$A = \frac{e_i}{e} \cdot \frac{e_0}{e_i} = A_i \cdot A_o. \quad (9)$$

The first factor of (9) represents the gain of the input circuit, and the second factor represents the gain from control grid to output circuit. These factors are not independent, however, because any tuning adjustment of y_0 which changes the output voltage simultaneously affects the additional input admittance, and thus causes a change in the voltage across the grid-cathode terminals. As a matter of fact, we shall see from an examination of (7) and (8) that the adjustment of y_0 which makes $|A_0|$ a maximum does not, in general, correspond to the adjustment of y_0 which makes the over-all gain a maximum. Consequently, the practical utility of the determination of the adjustment of y_0 which makes $|A_0|$ a maximum is confined to the case of an amplifier having a constant voltage impressed across its grid-cathode terminals, or to the case of an amplifier having no feed-back path.

From (7) we see that $|A_0|$ cannot be infinite so long as the real parts of y_c and y_0 are positive. The condition which gives the maximum value of $|A_0|$ is¹⁶

$$\operatorname{Re}\left(\frac{1}{A_0} \cdot \frac{dA_0}{dy_0} \cdot dy_0\right) = 0. \quad (18)$$

If y_0 is changed by tuning only in its imaginary part, (18) may be written as

$$\arg\left(\frac{1}{A_0} \cdot \frac{dA_0}{dy_0}\right) = 0 \text{ or } \pi \quad (18a)$$

which requires that

$$\arg(y_0 + y_c) = 0 \text{ or } \pi. \quad (19)$$

The second solution of (19) is not realizable if g_c and g_0 are positive. Also, if $|y_c/y_0| \ll 1$, which is usually the case, (19) becomes

$$\arg y_0 = 0. \quad (19a)$$

From (8) we see that A_i and, therefore, A will be infinite (provided $A_0 \neq 0$) when the input and output circuits are adjusted so that

$$y + y_i + y_i' = 0. \quad (20)$$

This corresponds to the unstable state, which is represented by the extreme values of the inequalities (16) and (17).

A matter of paramount importance to the engineer is the value of the maximum absolute over-all gain and the adjustment of y_0 and y_i , which give this maximum $|A|$, for given values of y_m , y_c , and y in the

range extending between the point of no feedback and the point of instability. The necessary adjustments can be determined by maximizing $|A|$ with respect to y_i and y_0 separately, and combining the separate maximization conditions. The maximization relations are

$$\operatorname{Re}\left(\frac{1}{A} \cdot \frac{dA}{dy_i} \cdot dy_i\right) = 0 \quad (21)$$

and

$$\operatorname{Re}\left(\frac{1}{A} \cdot \frac{dA}{dy_0} \cdot dy_0\right) = 0. \quad (22)$$

If we assume, as before, that in the variation of y_i and y_0 only the imaginary parts undergo a change, then (21) and (22) become

$$\arg\left(\frac{1}{A} \cdot \frac{dA}{dy_i}\right) = 0 \text{ or } \pi \quad (21a)$$

and,

$$\arg\left(\frac{1}{A} \cdot \frac{dA}{dy_0}\right) = 0 \text{ or } \pi. \quad (22a)$$

By making use of (6), (7), (8), and (9), and performing the indicated differentiations, we have

$$\arg(Y + y_i') = (0 \text{ or } \pi) \quad (21b)$$

and,

$$\arg y_0 \cdot \left(1 + \frac{y_c}{y_0}\right) = (0 \text{ or } \pi) + \arg \left[\frac{1 + \frac{y_c}{y_0} + \frac{y_c}{Y} + \frac{y_c}{y_0} \cdot \frac{y_c}{Y}}{1 + \frac{y_c}{y_0} + \frac{y_c}{Y} + \frac{1}{Y} \cdot \frac{y_c y_m}{y_0}} \right] \quad (22b)$$

in which for brevity $Y = y + y_i$.

Now, for an efficient, well-screened amplifier, we may assume that $|y_m/y_0| \gg 1$, $|y_c/Y| \ll 1$, $|y_c/y_0| \ll 1$, and $y_i' = y_m y_c / y_0$. Furthermore, in most practical cases, the real parts of y_0 and Y will be positive. Then (21b) and (22b) become

$$\arg(Y + y_i') = 0 \quad (21c)$$

$$\arg \frac{y_0}{Y} + \arg(Y + y_i') = 0. \quad (22c)$$

Combining (21c) with (22c), we see that the first condition for maximum $|A|$ is

$$\arg y_0 = \arg Y. \tag{23}$$

Equation (23) tells us that for maximum $|A|$ the tuning adjustments of the output circuit and the combined input circuit must be similar. The actual value of this adjustment, in terms of the circuit parameters, may be determined by combining (21c), (6b), and (23). This manipulation gives

$$\tan \phi_0 = \frac{|y_c| \cdot |y_m| \cdot \sin(\phi_c + \phi_m)}{|y_c| \cdot |y_m| \cdot \cos(\phi_c + \phi_m) - |Y| \cdot |y_0|}$$

or,

$$t_0^3 + \left[1 + \frac{b_c b_m - g_c g_m}{g_0 G} \right] t_0 + \left[\frac{b_c g_m + g_c b_m}{g_0 G} \right] = 0 \tag{24}$$

where,

$$t_0 = \frac{b_0}{g_0}, \text{ and } G = \text{Re}(Y).$$

The second condition, which is given by the solution of (24), provides the value of the angle to which the output circuit and the combined input circuit must be tuned in order that maximum $|A|$ be achieved. The substitution of this solution in the absolute value of (9) gives the maximum value of $|A|$ for any particular value of y_c and y_m . This procedure will be carried out in Part III for several special cases of particular interest.

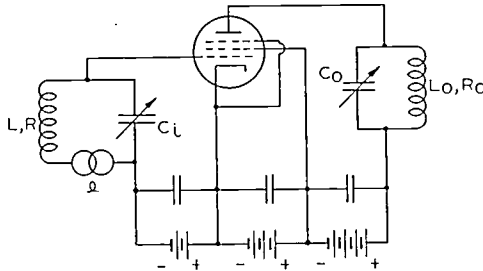

Fig. 3—The particular circuit used in the illustrative cases.

III. SPECIAL CASES

The results of the general analysis contained in Part II will now be applied to several cases of particular interest. Expressions will be developed for the additional input admittance, for the conditions for stability, and for the gain as functions of the various particular parameters of the tube and the associated circuits. For all of these special cases the assumed circuit is shown in Fig. 3. It is also assumed that the amplifier in all cases is efficient and well screened.

1. *Medium Frequencies.* $b_m = 0$, $g_c = 0$, $b_c = \omega C_c$.

This case has been extensively studied and, therefore, will be useful as a check of the results of the foregoing analysis; it will serve, furthermore, as an interesting basis of comparison for the cases which follow.

The additional input admittance for this case is

$$y_{i'} = \left(\frac{g_m b_c}{g_0} \cdot \frac{t_0}{1 + t_0^2} \right) + j \left(\frac{g_m b_c}{g_0} \cdot \frac{1}{1 + t_0^2} \right) \quad (25)$$

where $t_0 = \tan \phi_0 = b_0/g_0$. It is clear from (10a) and (25) that $g_{i'}$ will

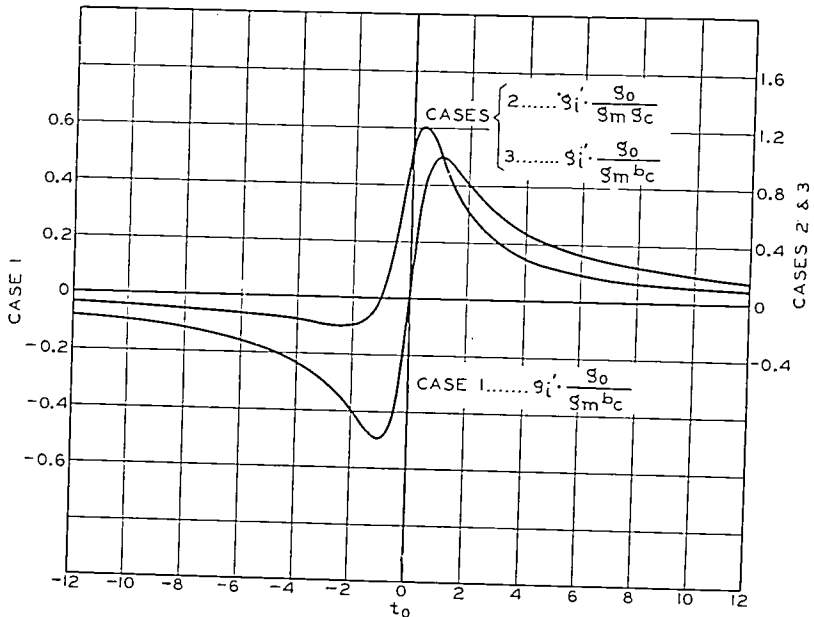

Fig. 4—The variation of the additional input conductance due to feedback, as a function of the tangent of the phase angle of the output circuit. Case 1 represents the usual conditions at medium frequencies where feedback occurs only through a capacitance. Case 2 represents conditions at medium frequencies when feedback takes place through equal parallel paths of conductance and capacitive susceptance. Case 3 represents conditions at high frequencies when feedback takes place through a capacitance, and the phase angle retardation of the transfer admittance is forty-five degrees.

be zero when $\arg y_0 = 0$ (i.e., $t_0 = 0$). This condition is obtained when the output admittance is adjusted so that its susceptance is zero. Equations (13a) and (25) indicates that $g_{i'}$ will exhibit maxima, of absolute value $g_m b_c / 2g_0$, when $\arg y_0 = \pm \pi/4$ (i.e., $t_0 = \pm 1$). Incidentally, these adjustments will result in maximum capacitive and inductive reactance, respectively, for the assumed circuit. The exact form of variation of $g_{i'}$ with t_0 is shown in Fig. 4.

Equations (15a) and (25) indicate that $b_{i'}$ will be a maximum, of absolute value $g_m b_c / g_0$, when $\arg y_0 = 0$ (i.e., $t_0 = 0$), and will decrease

symmetrically about $t_0=0$ to zero as $t_0 \rightarrow \pm \infty$. The exact variation of b_i' with t_0 is shown in Fig. 5. It is of interest to note that when $\arg y_0 = \pm \pi/4$, the absolute values of the conductance and the susceptance are equal; i.e., $\arg y_i' = \pm \pi/4$.

To determine the conditions for the stability of the amplifier, we follow the procedure outlined in Part II, section 2. As we have just seen, the maximum negative additional input conductance is $g_m b_c / 2g_0$ and is obtained when the output admittance is adjusted so that \arg

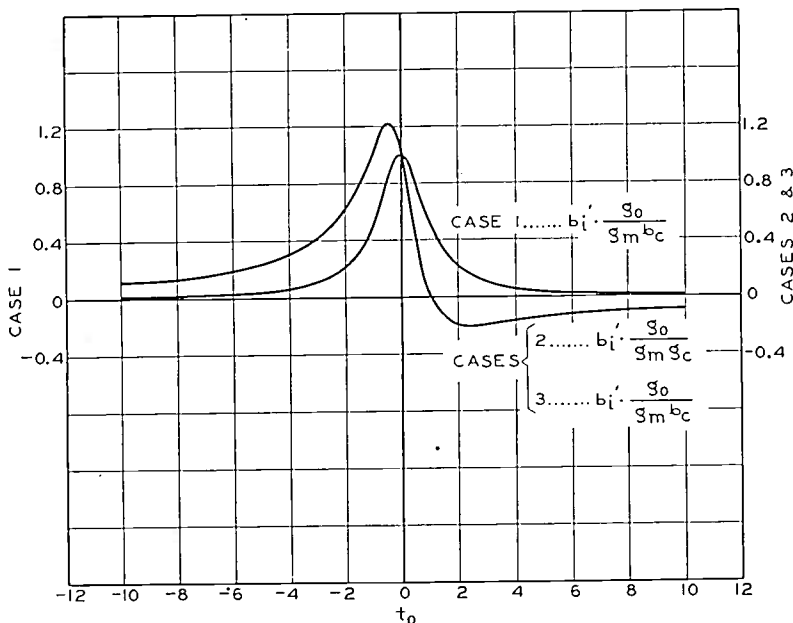

Fig. 5—The variation of the additional input susceptance due to feedback, as a function of the tangent of the phase angle of the output circuit. The cases are the same as those given in Fig. 4.

$y_0 = -\pi/4$. Making use of this fact in (16) and writing the condition for stability as the maximum permissible value of the grid-plate capacitance, we get

$$C_c < \frac{2g_0 G}{\omega g_m} \tag{26}$$

where $G = g + g_i$, and is the conductance of the combined input circuit.

Usually we are interested in the maximum over-all gain of the stage, without regard to the relative phases of the input and output voltages, and in the adjustments of the input and output circuits which give this maximum gain. It is also of interest to determine the portion of this gain which is due to feedback. These matters may be determined by following the procedure indicated in Part II, Section 3. To be-

gin with, we know that the tuning adjustments of the output circuit and the combined input circuit must be similar. The actual value of this adjustment is then given, in terms of the circuit parameters, by the solution of the equation

$$t_0^3 + t_0 + H = 0 \quad (27)$$

where $H = b_c g_m / g_0 G$. From (26), we see that the maximum value of H is 2, so that the solution of (27) has but one real root; this root gives

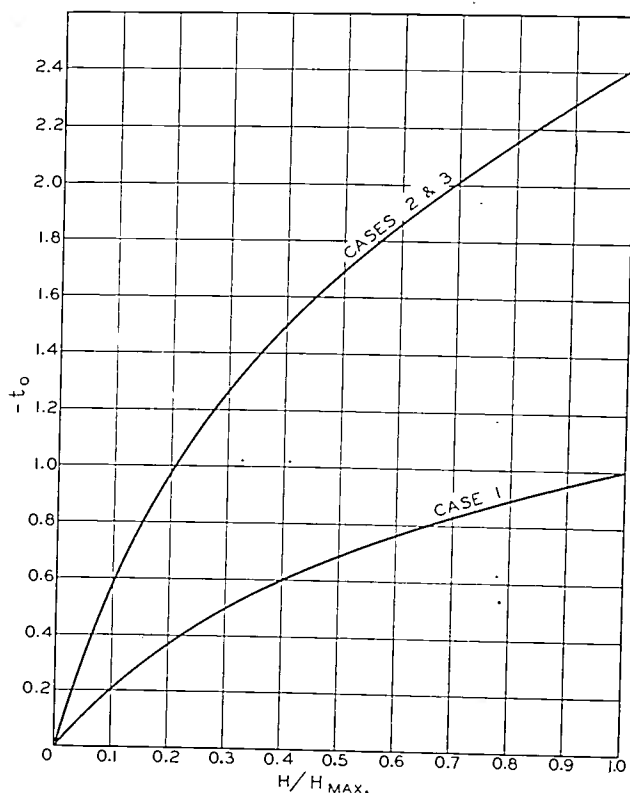

Fig. 6—The variation of the adjustment of the input and output circuits which result in maximum over-all gain, as a function of the feed-back parameter. The cases are the same as those given in Fig. 4.

us the required tuning adjustment for any particular value of H over the range extending from zero feedback to instability. The variation of this optimum value of t_0 with the stage parameter H is shown in Fig. 6.¹⁸ The substitution of this optimum value in the following expression, which represents the absolute value of (9), gives the maximum over-all gain as a function of the stage parameter H .

$$A = \frac{|y| g_m}{g_0 G} \cdot \frac{1}{\sqrt{(1 + t_0^2)^2 + 4t_0 H + H^2}} \quad (28)$$

¹⁸ This curve is similar to one given in footnote 8.

The variation with H of the maximum over-all gain is shown in Fig. 7, where for convenience $1/|A|$ instead of $|A|$ is used as the ordinate.¹⁸ The gain for the zero-feed-back case is given by $H=0$ in (28); the difference between the actual gain and the zero-feed-back gain is the incremental gain contributed by regeneration. In passing, it may be pointed out that even this linear theory indicates that it is commercially impracticable to replace a stage of efficient, cascaded amplification by regeneration.

2. Medium Frequencies. $b_m=0, g_c=1/r_c, b_c=\omega C_c$.

This case is similar to the preceding one, except that the feed-back path now consists of conductance as well as susceptance. This situation

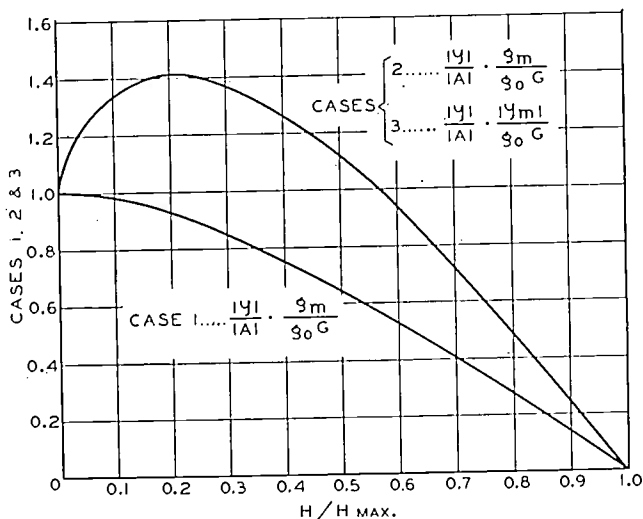

Fig. 7—The variation of the inverse of the maximum over-all gain with the feedback parameter. The adjustment of the input and output circuits is given by Fig. 6.

can arise when leakage, either intentional or otherwise, is present in the tube or the receiver proper.

The additional input admittance becomes

$$y_i' = \left(\frac{g_m g_c}{g_0} \cdot \frac{1 + t_c t_0}{1 + t_0^2} \right) + j \cdot \left(\frac{g_m g_c}{g_0} \cdot \frac{t_c - t_0}{1 + t_0^2} \right) \tag{29}$$

where $t_c = \tan \phi_c = b_c/g_c$. It is clear from (10a) and (29) that g_i' will be zero when $\arg y_0 = \arg y_c + 3\pi/2$; i.e., $t_0 = -1/t_c$. Furthermore, by making use of (13a) or by maximizing the real part of (29), it will be seen that g_i' will exhibit maxima and minima when $\arg y_0 = \pm 1/2 \arg y_c$. This is equivalent to the statement that the output admittance must be adjusted so that $t_0 = -1/t_c \pm \sqrt{1 \pm 1/t_c^2}$, the positive sign indicating a maximum and the negative sign indicating a minimum. The corresponding values of g_i' are

$$(g_i')_{\max} = \frac{g_m g_c}{2g_0} \cdot \frac{\pm \sqrt{1 + t_c^2}}{1 + \frac{1}{t_c^2} \mp \frac{1}{t_c^2} \sqrt{1 + t_c^2}} \quad (30)$$

The detailed variation of g_i' with t_0 , for the particular value of $\phi_c = \pi/4$, is shown in Fig. 4.

According to (11a) or (29), the additional input susceptance will be zero when $\arg y_0 = \arg y_c$; i.e., $t_0 = t_c$. By making use of (15a), or by maximizing the imaginary part of (29), we find that b_i' exhibits maxima and minima when $\arg y_0 = \pm 1/2$ ($\arg y_c \pm \pi/2$) or when $t_0 = t_c \pm \sqrt{1 + t_c^2}$, the positive sign indicating a minimum and the negative sign a maximum. The values of these maxima are

$$(b_i')_{\max} = \frac{g_m g_c}{2g_0} \cdot \frac{\mp \sqrt{1 + t_c^2}}{1 + t_c^2 \pm t_c \sqrt{1 + t_c^2}} \quad (31)$$

The detailed variation of b_i' with t_0 , for the particular value of $\phi_c = \pi/4$, is shown in Fig. 5. It will be observed that whereas b_i' for the preceding case is always capacitive, it may be for this case either capacitive or inductive, depending on the value of t_0 .

To obtain the conditions for the stability of the amplifier, it is merely necessary to combine (30) and (16). In doing so, we have, for the maximum permissible value of the grid-plate capacitance,

$$C_c < \frac{2g_0 G}{\omega g_m} \sqrt{1 + \frac{2g_c}{\omega} \frac{\omega g_m}{2g_0 G}} \quad (32)$$

If we define C_{c_0} as the maximum permissible coupling capacitance when $g_c = 0$, i.e., $C_{c_0} = 2g_0 G / \omega g_m$, and write $r_c = 1/g_c$, (32) may be written

$$C_c < C_{c_0} \sqrt{1 + \frac{2}{\omega C_{c_0} r_c}} \quad (32a)$$

This tells us that when the capacitive-feed-back path of the preceding case is shunted by a resistance r_c , the permissible coupling capacitance is increased by the factor under the radical.

The determination of the absolute value of the maximum over-all gain, and the adjustments of the input and output circuits which give this maximum gain, can be determined in the manner outlined previously. The required circuit adjustments are given by the solution of the equation

$$t_0^3 + \left[1 - \frac{H}{t_c}\right] t_0 + H = 0. \quad (33)$$

From (32), we find that the maximum value of H is $2(1/t_c + \sqrt{1/t_c^2 + 1})$, so that the optimum adjustment of the circuits is a function of t_c as well as H . The variation of the optimum value of t_0 with H for the particular value $t_c = 1$, i.e., $\phi_c = \pi/4$, is shown in Fig. 6. The substitution of this optimum value in the following expression, which represents the

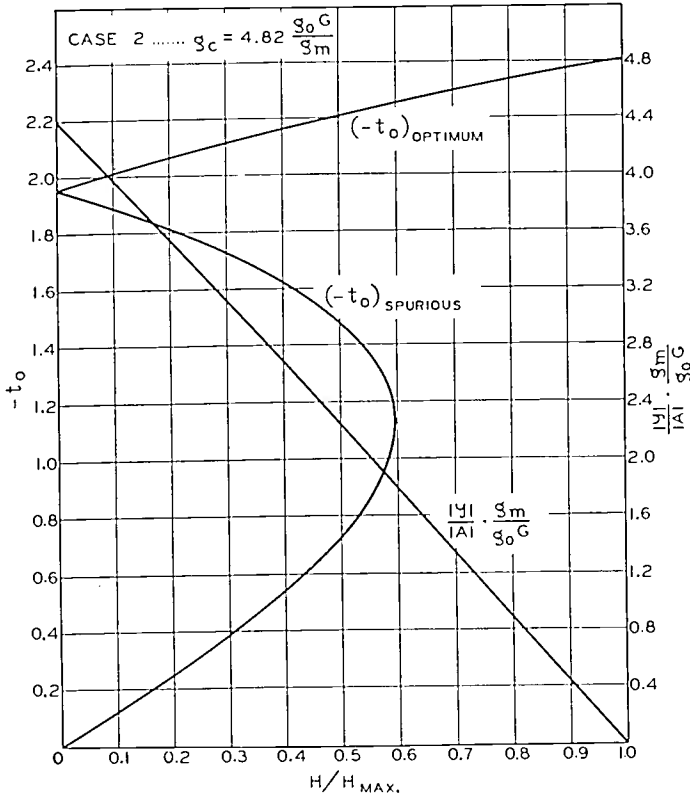

Fig. 8—The variation of the inverse of the maximum over-all gain and the adjustment of the input and output circuits which result in this maximum over-all gain, as functions of the feedback parameter. In this case, the feedback path consists of a constant conductance and a varying capacitive susceptance.

absolute value of (9), gives the maximum over-all gain as a function of the stage parameters H and t_c .

$$|A| = \frac{|y| g_m}{g_0G} \cdot \frac{1}{\sqrt{(1+t_0^2)^2 + H^2 \left(1 + \frac{1}{t_c^2}\right) + 4t_0H + \frac{2H}{t_c} (1-t_0^2)}} \quad (34)$$

The variation with H , for the particular value $t_c = 1$, of the maximum over-all gain is shown in Fig. 7. It should be noted that since these curves are plotted against H for a constant value of $t_c = 1$, they implicitly require that g_c vary with H , as $g_c = H(g_0G/g_m)$. In Fig. 8, on the other hand, there is plotted the variation with H of the optimum t_0 and

the maximum over-all gain, for the particular value of $g_c = 4.82 g_0 G/g_m$, a value which makes $t_c = 1$ at the point of instability, where $H = 4.82$. It will be observed that for $H/H_{\max} < 0.595$, the solution of (33) provides three real roots. Two of these roots correspond to minor maxima of $|A|$, as can be verified by their substitution in (34). In Fig. 8, the inverse of the maximum over-all gain, which is plotted as a function of H/H_{\max} , is obtained by using the values of the optimum t_0 which provides a grand maxima. These results indicated that while the stability of the amplifier is increased by the addition of a shunt resistance to the coupling path, the over-all gain is decreased at the same time.

3. *High Frequencies.* $g_c = 0$, $b_c = \omega C_c$, $y_m = g_m + jb_m$.

This case is similar to the first one, except that the amplifier is now supposed to be working at frequencies high enough so that the transit angles, while small, are significant. Under these conditions (6a) may be written as

$$y_i' = \left(\frac{g_m b_c}{g_0} \cdot \frac{t_0 - t_m}{1 + t_0^2} \right) + j \left(\frac{g_m b_c}{g_0} \cdot \frac{1 + t_m t_0}{1 + t_0^2} \right) \quad (35)$$

where $t_m = \tan \phi_m = b_m/g_m$. From (10a) and (35), we find that g_i' will be zero when $\arg y_0 = \arg y_m + \pi$; i.e., $t_0 = t_m$. Also, by making use of (13a) or by maximizing the real part of (35), it will be seen that g_i' will exhibit maxima and minima when $\arg y_0 = \pm 1/2$ ($\arg y_m \pm \pi/2$); i.e., $t_0 = t_m \pm \sqrt{1 + t_m^2}$. The values of these maxima are

$$(g_i')_{\max} = \frac{g_m b_c}{2g_0} \cdot \frac{\pm 1}{\sqrt{1 + t_m^2} \pm t_m} \quad (36)$$

The detailed variation of g_i' with t_0 , for the particular value of $\phi_m = 3\pi/4$, is shown in Fig. 4. It will be observed that the variation of g_i' for this case is similar to that of the preceding case; this is tied up with the form of (6a).

From (11a) or (35), we find that b_i' will be zero when $\arg y_0 = \arg y_m \pm \pi/2$; i.e., $t_0 = -1/t_m$. From (15a), or by maximizing the imaginary part of (35), we find that b_i' exhibits maxima when $\arg y_0 = \pm 1/2$ ($\arg y_m + \pi$); i.e., $t_0 = -1/t_m \pm \sqrt{1/t_m^2 + 1}$. These maxima are

$$(b_i')_{\max} = \frac{g_m b_c}{2g_0} \cdot \frac{\pm t_m^2}{\sqrt{1 + t_m^2} \pm 1} \quad (37)$$

The variation of b_i' with t_0 , for the particular value of $\phi_m = 3\pi/4$, is shown in Fig. 5.

The conditions for stability may be obtained from (36) and (16). The maximum permissible coupling capacitance is given by

$$C_c < \frac{2g_0G}{\omega|y_m|} \cdot \frac{1}{1 + \sin \phi_m} \quad (38)$$

Thus, the effect of small phase retardations in the transfer admittance is to increase the maximum permissible value of the coupling capacitance.

The circuit adjustments of the output circuit and the combined input circuit for maximum absolute over-all gain are, as before, similar. The actual adjustments are given by the solution of the equation

$$t_0^3 + (1 + t_m H)t_0 + H = 0. \quad (39)$$

From (38), we find that the maximum value of H is $2(\sqrt{1+t_m^2}-t_m)$ so that the optimum adjustment of the circuits is now a function of t_m as well as H . The variation of the optimum value of t_0 with H for the particular value $t_m = -1$, i.e., $\phi_m = 3\pi/4$, is shown in Fig. 6. The substitution of this optimum value in the following expression which represents the absolute value of (9) gives the maximum over-all gain as a function of the parameters H and t_m .

$$|A| = \frac{|y||y_m|}{g_0G} \cdot \frac{1}{\sqrt{(1+t_0^2)^2 + H^2(1+t_m^2) + 4t_0H + 2Ht_m(t_0^2-1)}} \quad (40)$$

The variation with H , for the particular value $t_m = -1$, of the maximum over-all gain is shown in Fig. 7. The foregoing results indicate that while the stability of the amplifier can be increased by the phase shift in the transfer admittance, this must be accompanied by a decrease in the over-all gain. It may be well to point out here that in ordinary tubes the effect of the increasing transit angles at high frequencies is, at least initially, more serious in its increase of the input conductance of the tube than in its reduction of the transfer admittance, so that the amplifier gain at high frequencies is reduced more by an increase of G than by a decrease of $|y_m|$.

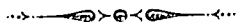

FREQUENCY MODULATION PROPAGATION CHARACTERISTICS*

BY

MURRAY G. CROSBY

(R. C. A. Communications, Inc., Riverhead, N. Y.)

Summary—Early work on frequency modulation is described wherein the propagation characteristics of frequency modulation were determined for frequencies between 9000 and 18,000 kilocycles. Oscilloscopic wave form and aural program observations, taken on a circuit between California and New York, showed that frequency modulation is much more distorted by the effects of multipath transmission than is amplitude modulation. The distortion is greatest at the lower modulation frequencies and higher depths of modulation where the side frequencies are most numerous.

Oscilloscopic observations of the Lissajou figures formed by placing the outputs of receivers connected to spaced antennas on opposite oscilloscope plates showed that the diversity characteristics of frequency modulation are similar to those of amplitude modulation. That is, the detected outputs of the receivers tend to remain in phase for the lower modulation frequencies and become more phase random as the modulation frequency is increased. However, this tendency is almost obliterated on the lower modulation frequencies of frequency modulation by the presence of unequal harmonic distortion in the two receiver outputs.

Theory is given analyzing the distortion encountered in a two-path transmission medium under various path amplitude and phase relation conditions. The theory explains phenomena observed in the tests and points out the extreme distortion that can be encountered.

INTRODUCTION

IN THE annals of radio, most of the work done on frequency modulation has been of a theoretical nature^{1,2,3} and very little has been offered as a result of any experimental development.

Considerable theory has also been presented in the consideration of this type of modulation as a defect of amplitude modulation.^{3,4,5,6,7} A

* Decimal classification: R148. Original manuscript received by the Institute, November 4, 1935. Presented as part of a paper on "Propagation and characteristics of frequency modulated waves," before New York meeting, January 8, 1936.

¹ John R. Carson, "Notes on the theory of modulation," Proc. I.R.E., vol. 10, pp. 57-64; February, (1922).

² Balth van der Pol, "Frequency modulation," Proc. I.R.E., vol. 18, pp. 1194-1205; July, (1930).

³ Hans Roder, "Amplitude, phase, and frequency modulation," Proc. I.R.E., vol. 19, pp. 2145-2176; December, (1931).

⁴ R. Bown, D. K. Martin, and R. K. Potter, "Some studies in radio broadcast transmission," Proc. I.R.E., vol. 14, pp. 57-131; February, (1926).

⁵ R. K. Potter, "Transmission characteristics of a short-wave telephone circuit," Proc. I.R.E., vol. 18, pp. 633-648; April, (1930).

⁶ J. C. Schelleng, "Some problems in short-wave telephone transmission," Proc. I.R.E., vol. 18, pp. 933-937; June, (1930).

⁷ T. L. Eckersley, "Frequency modulation and distortion," *Experimental Wireless and The Wireless Engineer*, vol. 7, pp. 482-484; September, (1930).

more recent contribution⁸ includes an experimental investigation checking theory on the detection products produced in a frequency modulation receiver. It is the purpose of this paper to report on development work undertaken by the engineering department of R.C.A. Communications, Inc., wherein the propagation characteristics of frequency modulation were determined for a circuit between California and New York.

Early work done on frequency modulation within the Radio Corporation was that of H. O. Peterson⁹ in which a laboratory frequency modulation circuit was set up. Later, in an attempt to reduce fading by frequency diversity, one of the telegraph transmitters on the Argentina and Brazil circuits was frequency modulated. Finally a definite development program was undertaken consisting of the development of a frequency modulation transmitter at the Rocky Point transmitting research and design laboratories and the development of a suitable receiver at the Riverhead receiving research and design laboratories.

After the transmitter and receiver were developed to a sufficient stage to permit a long-distance test to determine the propagation characteristics of frequency modulation, the transmitter was shipped to Bolinas, California, where it was operated by J. W. Conklin who had assisted in its development. The transmissions were observed at the Riverhead station on the receivers developed by the author. The tests were carried out in 1931 during the months from March to June, inclusive.

PROPAGATION TESTS

In the tests carried on between Bolinas and Riverhead, two major problems presented themselves for solution. First, how would frequency modulation withstand the ravages of fading. Second, could the detected outputs of two frequency-modulation receivers, fed by spaced antennas, be added directly¹⁰ in a diversity¹¹ receiving system; that is, would the detected audio outputs remain in phase so that they could be combined directly, or would some kind of diversity antenna choosing device, as is in present use, be necessary.

It is interesting to note that in this article Eckersley makes the following prediction from his theory which agrees with the results obtained in the work described in this paper: "It will easily be seen that this results in most appalling distortion, and renders futile any attempt to use even pure frequency modulation in any transmission where appreciable echo delays (of the order of two or three milliseconds) are present."

⁸ J. G. Chaffee, "The detection of frequency modulated waves," Proc. I.R.E., vol. 23, pp. 517-540; May, (1935).

⁹ H. O. Peterson, U.S. Patent No. 1,789,371.

¹⁰ C. W. Hansell, U.S. Patent No. 1,803,504.

¹¹ H. O. Peterson, H. H. Beverage, and J. B. Moore, "Diversity telephone receiving system of R.C.A. Communications, Inc.," Proc. I.R.E., vol. 19, pp. 562-584; April, (1931).

In order to solve the problem of the effect of fading on frequency modulation, oscilloscopic wave form and aural program observations were made on the tone and program modulation after it had traversed the radio circuit from California to New York. In this manner the instantaneous harmonic distortion could be observed.

The diversity problem was answered by applying the outputs of two receivers, fed by spaced antennas, to opposite oscilloscope plates. Hence, by proper interpretation of the Lissajous figures obtained, the relative phases and amplitudes of the two outputs could be determined.

The Transmitter

To obtain the frequency modulation, a circuit of the type shown in Fig. 1 was employed. This type of modulator was used as the master

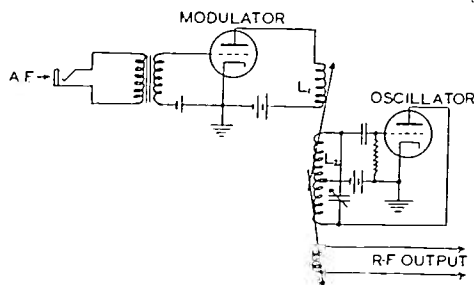

Fig. 1—Circuit diagram of frequency modulated master oscillator.

oscillator to replace the crystal oscillator normally used in a standard R.C.A. Communications telegraph transmitter. Special precautions were taken to insure constant element voltages for mean frequency stability. For the same reason, a one-hour warm-up period was observed before each transmission to allow the tube temperatures to settle and prevent drifting. By modulating at master oscillator frequency a frequency multiplication of from eight to sixteen was employed depending upon the radiated frequency. Hence, the frequency deviation, with modulation, was multiplied by a factor of from eight to sixteen and the frequency deviation applied to the oscillator tube was therefore, one eighth to one sixteenth of that radiated.

The operation of the modulator of Fig. 1 depends upon the variation of the effective inductance of the oscillator tuned circuit inductance, L_2 , by virtue of the variation of the modulator tube plate resistance connected across coil L_1 which is coupled to the oscillator inductance, L_2 . The modulator tube is biased at such a point that as the modulation is applied at its grid, its plate resistance will vary in accordance with the modulation. By a proper choice of the modulator bias and the inductance of L_1 , together with proper adjustment of the

coupling between L_1 and L_2 , a linear frequency modulation may be obtained.

During the frequency modulation transmission the transmitter amplifiers and frequency doublers were operated class C throughout so as to limit off any amplitude modulation introduced in the modulator or otherwise.

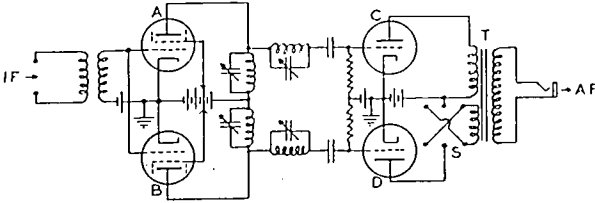

Fig. 2—Circuit diagram of frequency modulation receiver showing the conversion filters and detectors.

An amplitude modulating stage was included in the transmitter so that the transmitter could be adjusted for amplitude modulation and direct comparison could be made between frequency modulation and amplitude modulation.

The Receiver

A schematic diagram of the frequency modulation receiver is shown in Fig. 2. Energy at the superheterodyne intermediate frequency is fed to the two coupling tubes, A and B, having the conversion filters for converting the frequency modulation into amplitude modulation in

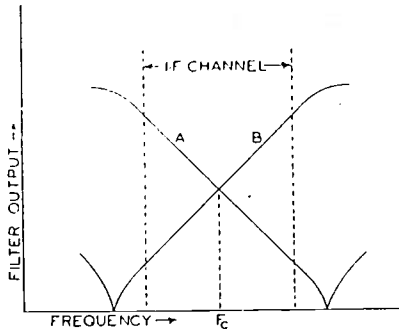

Fig. 3—Characteristics of the conversion filters used to convert frequency modulation into amplitude modulation for detection.

their plate circuits. The characteristics of these two filters are given by the curves A and B in Fig. 3. The carrier frequency F_c , is tuned to the middle of the linear portion of the sloping characteristic formed by the two tuned circuits connected as shown. By adjusting the tuned circuits so that the points of maximum and minimum output fall outside of the intermediate-frequency channel, only the linear portion of the characteristics are utilized. The outputs of these filters are fed to the detectors

C and *D* of Fig. 2 whose audio outputs are combined by the transformer *T* in push-pull or parallel combination, depending upon the switch *S*. With the switch in the push-pull position, frequency modulation may be received and amplitude modulation balanced out. The balance obtainable on amplitude modulation, however, is complete only for the condition of no frequency modulation present. As soon as the carrier is frequency deviated from its unmodulated position, the carriers fed to the detectors are no longer balanced due to the fact that the sloping filters have opposite slopes. Hence the balance is thrown off by an amount proportional to the frequency deviation from the unmodulated carrier position, and the resultant balance is an average between the balanced and unbalanced conditions. With the switch in the push-pull position, second harmonic square-law detector distortion is completely

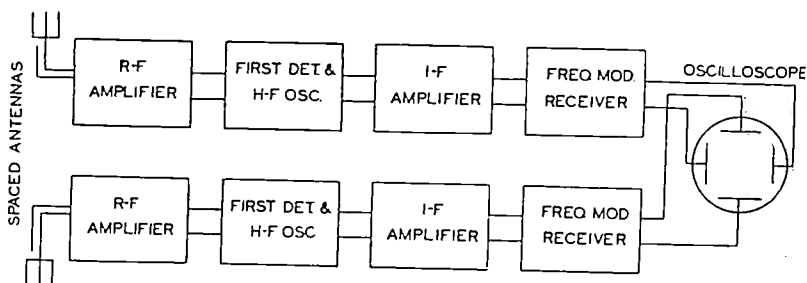

Fig. 4—Block diagram of receiver arrangement used in determining the phase relation between the detected outputs from receivers connected to spaced antennas.

balanced out. With the switch in the parallel position amplitude modulation may be received and frequency modulation balanced out.

The intermediate-frequency amplifier of the receiver was adapted from broadcast components and had a twelve-kilocycle pass band. Consequently the maximum frequency deviation was limited to one half of this intermediate frequency channel or six kilocycles. An experimental harmonic analysis of the receiver showed that it was capable of this amount of deviation without serious distortion.

An amplitude limiter was arranged so that it could be switched in and out of the intermediate-frequency circuits. This limiter consisted of a separate multistage intermediate-frequency amplifier feeding a tube with lowered element voltages so that the tube would be heavily overloaded and its output would be constant regardless of the changes of the input. Thus amplitude modulation could be removed. This method of removing amplitude modulation has an advantage over the balance obtained with the opposite sloping conversion filters in that the amplitude modulation is completely removed in the presence of frequency modulation as well as in the unmodulated condition.

For the diversity experiments, an arrangement as shown in Fig. 4 was used. Two complete frequency modulation receivers were fed by two harmonic wire antennas spaced 450 feet apart. The detected outputs of the tone modulation were fed to the opposite oscilloscope plates. Hence, by noting whether the oscilloscope diagram was a line in the second and fourth quadrants, a circle, or a line in the first and third quadrants, the relative phase relation of the two detected outputs could be determined as being in phase, ninety degrees out of phase, or 180 degrees out of phase, respectively. (See Fig. 5a, b, c, d, and e.)

For the wave form observations, the output of a single receiver was applied to one set of oscilloscope plates and a timing voltage to the other. Quality distortion was also checked by the aural observation of music which was transmitted by the frequency and amplitude modulation transmitters.

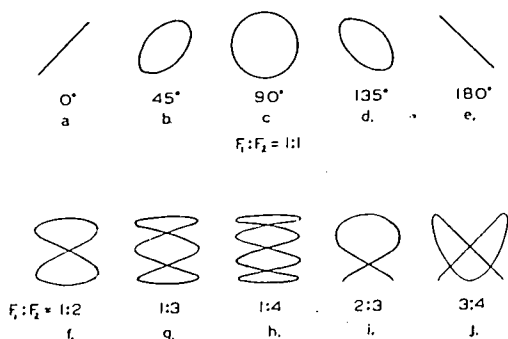

Fig. 5—Lissajou figures obtained with various phase relations and frequency ratios between voltages applied to opposite oscilloscope plates.

Wave Form Data

Day and night observations were made using music and tone modulation on frequencies of 18,020, 13,690, and 9010 kilocycles. The general conclusions derived were that frequency modulation is far more susceptible to the effects of selective fading than amplitude modulation. On music, the bass and lower notes were distorted and jumbled together while the violin and the other higher solo instruments came through fairly well. The intelligibility of speech was very low; in some cases a signal which gave fair intelligibility on amplitude modulation was practically unintelligible on frequency modulation. The distortion seemed to be proportional to the depth of modulation, since a sort of blasting effect was observed on the modulation peaks, and transmissions with lowered deviation came through better than those with higher deviation. The distortion also seemed to be greatest during fading minimums at which time "bursts" of distortion would appear; this condition was also present to a lesser extent on amplitude modulation.

The effect due to limiting seemed to be the indication that the distortion was caused by a change in the instantaneous frequency deviation of the wave and not due to an added amplitude modulation. This was evidenced by the fact that the limiter effectively removed all amplitude modulation introduced by fading, but the extreme distortion remained with little or no perceptible difference attributable to the limiter.

The general result of the use of different radiation frequencies over the circuit was to indicate that the quality of modulation was most impaired on the frequencies where the selective fading was most marked. Of the three frequencies observed, 18,020 kilocycles showed the least amount of selective fading, 9010 the greatest, and 13,690 a mean between the other two. Consequently, the quality of frequency modulation on 18,020 kilocycles was only occasionally inferior to that on amplitude modulation. On 9010 kilocycles there was scarcely an interval of good quality on the frequency modulation, and the amplitude modulation was also considerably distorted. 13,690 kilocycles was considered a representative frequency for the observations, since it presented periods of extremely poor quality along with periods of fairly good quality. Consequently, the oscillograms were taken on the 13,680-kilocycle radiations.

Fig. 6 gives the oscillograms showing the effects of distortion fading on wave form. From a comparison of the 300- and 1000-cycle oscillograms taken on frequency modulation, it is apparent that the amount of distortion on 300 cycles is much greater than that on 1000 cycles. At the lower modulation frequencies on frequency modulation, the harmonics were comparable to and stronger than the fundamental for a large percentage of the time. As the modulation frequency was increased, the amount of distortion decreased until at modulation frequencies above about 3000 cycles, little or no harmonic distortion was encountered. One of the reasons for this absence of harmonic distortion on the higher frequencies is probably the fact that the pass band of the receiver intermediate-frequency amplifier was twelve kilocycles and that of the audio amplifier six kilocycles. Hence, for modulation frequencies above 3000, the side bands above the first were eliminated by the intermediate-frequency filter and the harmonics were eliminated by the audio system. The reason for the excessive distortion at the lower modulation frequencies of frequency modulation is no doubt due to the effects of multipath transmission in disturbing the phase relations between the many side frequencies produced by these lower modulation frequencies.

Fig. 6J shows a wave form taken on amplitude modulation when

aural observations indicated that the carrier and not the side bands had faded. The presence of second harmonic is very evident. It has been conjectured that frequency modulation might be less susceptible to the effects of carrier fading because of the fact that the modulated energy is distributed among the side bands to a greater extent; consequently, the detected output is not as dependent for its value upon a single frequency in the transmission medium as is amplitude modulation. The observations did indicate that with frequency modulation,

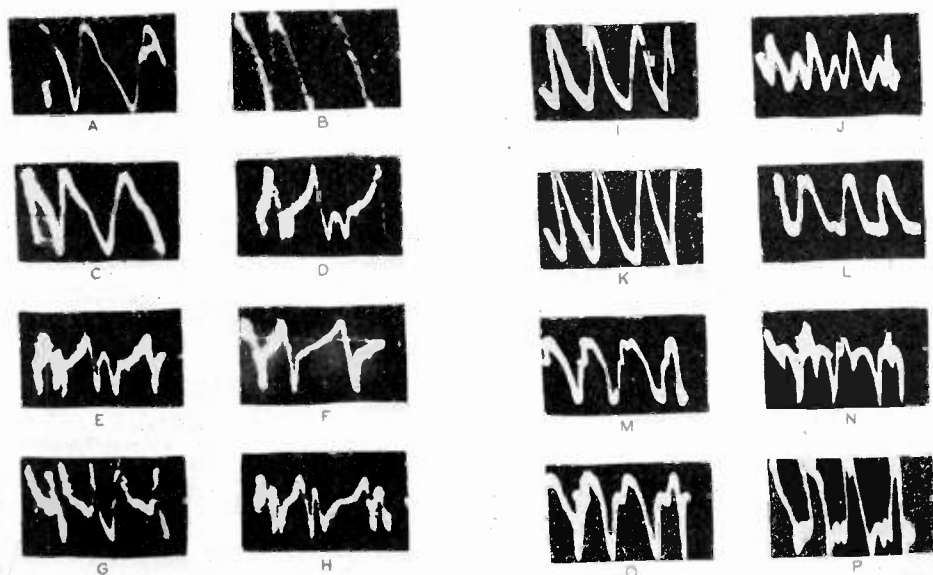

Fig. 6—Frequency and amplitude modulation wave form oscillograms showing the distortion due to fading.

A, B, and C. Amplitude modulation, 300 cycles.
 D, E, F, G, and H. Frequency modulation, 300 cycles.
 I, J, and K. Amplitude modulation, 1000 cycles.
 L, M, N, O, and P. Frequency modulation, 1000 cycles.

the output was more constant; the quality of this output, however, prevented its constancy from being of any value for the purpose for which it was intended. This observation tends to indicate the advantage of systems wherein telegraph transmitters are frequency modulated to effect a frequency diversity to reduce fading.

Diversity Data

In general the diversity experiments indicated that on both frequency and amplitude modulation the lower modulation frequencies produced outputs from the two receivers which remained in phase. As the modulation frequency was increased, the tendency toward phase

differences became very marked until at a 5000-cycle modulation frequency the phase relation was usually random, varying occasionally a full 360 degrees.

The effect of radiation frequency on the phase relations between the two receiver outputs proved to be similar to the effect on wave form. That is, the phase distortion became less as the radiated frequency was increased. Thus on the 18,020-kilocycle radiations there were frequent periods when no phase distortion could be observed in

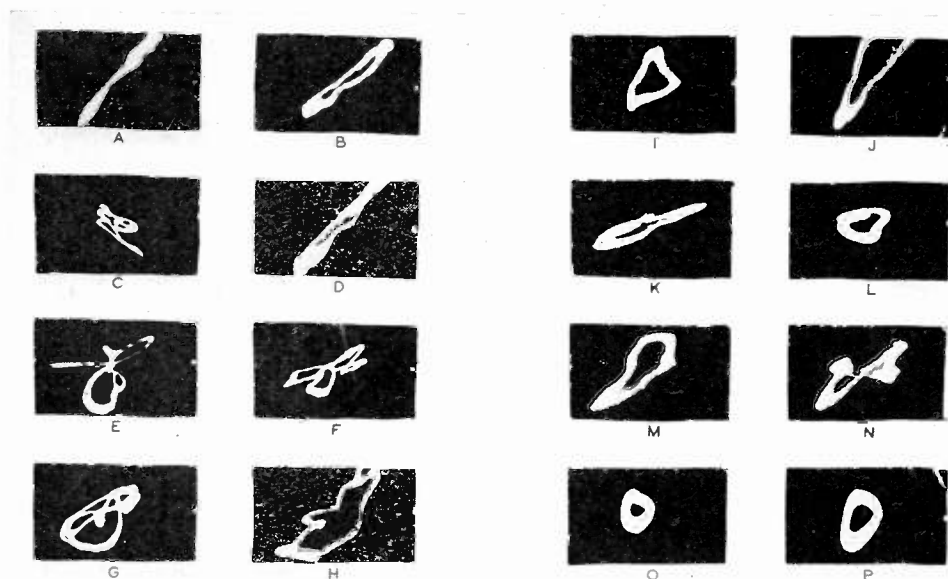

Fig. 7—Oscillograms showing the phase characteristics obtained on frequency and amplitude modulation using the arrangement of Fig. 4.

- A, B, and D. Amplitude modulation, 300 cycles.
- C, E, F, G, and H. Frequency modulation, 300 cycles.
- I and J. Amplitude modulation, 1000 cycles.
- K, L, M, and N. Frequency modulation, 1000 cycles.
- O and P. Frequency modulation, 5000 cycles.

the audio range. On the 13,690-kilocycle radiations the distortion was usually less than ninety degrees for modulation frequencies below 1000 cycles, while for modulation frequencies from 1000 to 5000 cycles marked distortions were apparent. On the 9010-kilocycle radiations, the figures showed random phase variations on all modulation frequencies most of the time. The oscillograms were taken on 13,690 kilocycles with a frequency deviation of about 2000 cycles.

Fig. 7 shows the Lissajou figures obtained in the diversity setup. The diagrams for amplitude modulation given in Fig. 7A, B, and D for a modulation frequency of 300 cycles show how the two receiver outputs remain in phase on a low-frequency tone. The diagrams ob-

tained on frequency modulation with a 300-cycle modulation frequency, given in Fig. 7C, E, F, G, and H, obtain their grotesque distortions from the presence of different harmonic distortions in the two receiver outputs. Thus one receiver might be receiving a signal producing a pure fundamental tone only, whereas the other receiver might be receiving a signal rich in harmonics; consequently, the diagram is distorted according to the difference in the amounts of harmonic content present at the instant of exposure. The effect produced by this unequal harmonic content on the two sets of oscilloscope plates can be seen from a study of the Lissajou figures given in Fig. 5 f, g, h, i, and j. Thus the diagram of Fig. 5 f might be formed by the condition of fundamental tone from one receiver and second harmonic from the other, or the diagram of Fig. 5i by second harmonic from one receiver and third harmonic from the other. The rapid shift from one harmonic relation to another together with the presence of complex instead of simple wave forms on the two sets of plates makes possible erratic and grotesque patterns.¹² This effect was apparent to such a degree on frequency modulation that difficulty was experienced in determining the phase tendency of the fundamental tones. The effect was only occasionally noticeable on amplitude modulation.

The diagrams given in Fig. 7 I and J for a modulation frequency of 1000 cycles, show how the higher modulation frequencies on amplitude modulation are marked by phase differences which are not present on the lower tones. The higher tones on frequency modulation given in Fig. 7 K, L, M, and N for a modulation frequency of 1000 cycles, and in Fig. 7 O and P for a modulation frequency of 5000 cycles, also indicate marked phase differences and only a slight indication of different harmonic distortions. Amplitude and frequency modulation showed about the same amount of phase distortion on the higher modulation frequencies.

THEORY

It is well known that the cause of fading distortion, taking place in the range of frequencies used in these tests, is due to multipath transmission in which the signal is conveyed to the receiving antenna by means of more than one path. These paths consist of refractions or reflections from the conducting layers of the ionosphere. Since these conducting layers vary in height and since the signal may follow a course consisting of various numbers of ricochets between the ionosphere and the earth, the signal traveling over the longer path is given

¹² A more complete set of these Lissajou figures may be found in the book, "High-Frequency Measurements," by A. Hund, pp. 71-75; McGraw-Hill, (1933).

a time lag with respect to that traveling over the shorter path. Hence the frequency modulated signal traveling over an earlier path may be expressed by

$$e = E_0 \sin \left(\omega t + \frac{F_d}{F_m} \cos pt \right) \quad (1)$$

where $\omega = 2\pi \times F_c$, F_c = carrier frequency, F_d = peak frequency deviation due to modulation, F_m = modulation frequency, and $p = 2\pi \times F_m$. The signal traveling over a later path may be expressed by

$$e = E_1 \sin \left\{ \omega t + \beta + \frac{F_d}{F_m} \cos (pt + \alpha) \right\} \quad (2)$$

where β and α take into account the time delay imparted to the carrier wave and the modulation, respectively.

Considering only a two-path case first, the two waves given by (1) and (2) may be combined into a single resultant wave by means of the cosine law resulting in

$$e = \sqrt{E_0^2 + E_1^2 + 2E_0E_1 \cos \left\{ \frac{F_d}{F_m} \cos (pt + \alpha) + \beta - \frac{F_d}{F_m} \cos pt \right\}} \sin \left[\omega t + \frac{F_d}{F_m} \cos pt + \tan^{-1} \frac{\sin \left\{ \frac{F_d}{F_m} \cos (pt + \alpha) + \beta - \frac{F_d}{F_m} \cos pt \right\}}{\frac{E_0}{E_1} + \cos \left\{ \frac{F_d}{F_m} \cos (pt + \alpha) + \beta - \frac{F_d}{F_m} \cos pt \right\}} \right] \quad (3)$$

Applying the sum and difference formula for the cosine, calling $E_0/E_1 = R$, and $2F_d/F_m \sin \alpha/2 = Z$, gives

$$e = \sqrt{E_0^2 + E_1^2 + 2E_0E_1 \cos \left\{ z \sin \left(pt + \frac{\alpha}{2} \right) - \beta \right\}} \sin \left[\omega t + \frac{F_d}{F_m} \cos pt - \tan^{-1} \frac{\sin \left\{ z \sin \left(pt + \frac{\alpha}{2} \right) - \beta \right\}}{R + \cos \left\{ z \sin \left(pt + \frac{\alpha}{2} \right) - \beta \right\}} \right] \quad (4)$$

Since the receiver either limits off or balances out the amplitude modulation on the signal, the amplitude term of (4) is reduced to a constant voltage and the only part requiring investigation is the angle or phase of the wave. To obtain the effective frequency deviation, the instantaneous frequency, or the rate of change of phase of (4) must be determined. This is given by

$$d \left[\omega t + \frac{F_d}{F_m} \cos pt - \tan^{-1} \frac{\sin \left\{ z \sin \left(pt + \frac{\alpha}{2} \right) - \beta \right\}}{R + \cos \left\{ z \sin \left(pt + \frac{\alpha}{2} \right) - \beta \right\}} \right] = f(\text{cycles})$$

$$\frac{2\pi}{dt}$$

$$= F_c + F_d \left[\cos pt - \frac{2 \sin \frac{\alpha}{2} \cos \left(pt + \frac{\alpha}{2} \right)}{R + \cos \left\{ z \sin \left(pt + \frac{\alpha}{2} \right) - \beta \right\}} \right. \\ \left. \frac{1}{\frac{1}{R} + \cos \left\{ z \sin \left(pt + \frac{\alpha}{2} \right) - \beta \right\}} + 1 \right] \quad (5)$$

When $R=1$, (5) reduces to:

$$f = F_c + F_d \left[\cos pt - \sin \frac{\alpha}{2} \cos \left(pt + \frac{\alpha}{2} \right) \right] \quad (6)$$

which, by application of the cosine law gives

$$f = F_c + F_d \sqrt{1 + \sin^2 \frac{\alpha}{2} - \sin \alpha \cos \left[pt - \tan^{-1} \frac{\sin^2 \frac{\alpha}{2}}{1 - \frac{\sin \alpha}{2}} \right]} \quad (7)$$

However when $R=1$, the amplitude term of (4) must be considered since there is a possibility of the wave being 100 per cent amplitude modulated so that the limiter would be unable to hold its output constant and a signal modulated by noise would result. For the case where the amplitude does not go to zero, that is, for conditions in which the quantity $(2 F_d/F_m \sin \alpha/2 - \beta)$ does not pass through the points π , 3π , 5π , etc., the instantaneous frequency of the wave applied to the frequency modulation sloping filters is given by (7). From this equation it can be seen that the resultant distortion under these conditions is merely a change in the effective frequency deviation of the modulation by a factor depending on α , and the addition of a phase angle depending upon α to the modulation frequency. Thus, provided the amplitude does not go to zero, no harmonic distortion is encountered.

When R is large compared to one, (5) becomes:

$$f = F_c + F_d \cos pt - \frac{2 \sin \frac{\alpha}{2} F_d}{R} \cos \left(pt + \frac{\alpha}{2} \right) \cos \left\{ z \sin \left(pt + \frac{\alpha}{2} \right) - \beta \right\}. \quad (8)$$

By an application of the addition formulas for the sine and cosine, together with the Bessel function expansions for $\cos(x \sin \phi)$ and $\sin(x \sin \phi)$ and the recurrence formulas for $J_n(x)$, (8) may be transformed into the following:

$$f = F_c + F_d \cos pt - \frac{2F_m \cos \frac{\alpha}{2}}{R} \left[\cos \beta \left\{ \sum_{n=0}^{\infty} (2n+1) J_{2n+1}(z) \cos (2n+1) \left(pt + \frac{\alpha}{2} \right) \right\} + \sin \beta \left\{ \sum_{n=1}^{\infty} 2n J_{2n} \sin 2n \left(pt + \frac{\alpha}{2} \right) \right\} \right]. \quad (9)$$

Thus when β is zero, a distortion consisting of fundamental and odd harmonics is added to the frequency deviation originally present. These harmonics are proportional to the ratio between the weaker and the stronger of the signals from the two paths, the modulation frequency, and $nJ_n(2F_d/F_m \sin \alpha/2)$ where n is the order of the harmonic. When β is ninety degrees, the distortion consists of even harmonics proportional to the same factors.

By far the most destructive distortion occurs when R is not large compared to unity, or is not equal to unity, but is slightly greater than unity. Fig. 8 shows wave forms calculated from the part of (5) in the square brackets. These wave forms are for a two-path case in which the ratio between the amplitudes arriving over the two paths is 1.2:1. Figs. 8(A), (B), and (C) show the effect of various phase differences between the two radio-frequency carriers with a constant phase difference of ninety degrees between the modulation frequencies modulating the two carriers and a constant ratio of F_d/F_m of ten. It is quite apparent that the distortion is greatest when the radio-frequency carriers are 180 degrees out of phase. This checks the observations that the distortion seemed to be greatest during the fading minimums. With the two radio-frequency carriers out of phase, the resultant unmodulated amplitude would be at a minimum, producing a fade in the signal. Figs. 8(C) and (D) show the effect of the value of F_d/F_m on the

wave form. The increase of the distortion with increase in F_a/F_m agrees with the observations that the lower modulation frequencies were the most distorted and that the distortion seemed to be proportional to the depth of modulation. Thus for modulation frequencies greater than one half the maximum modulation frequency where F_a/F_m can not be greater than two, a wave form similar to Fig. 8(D) would be

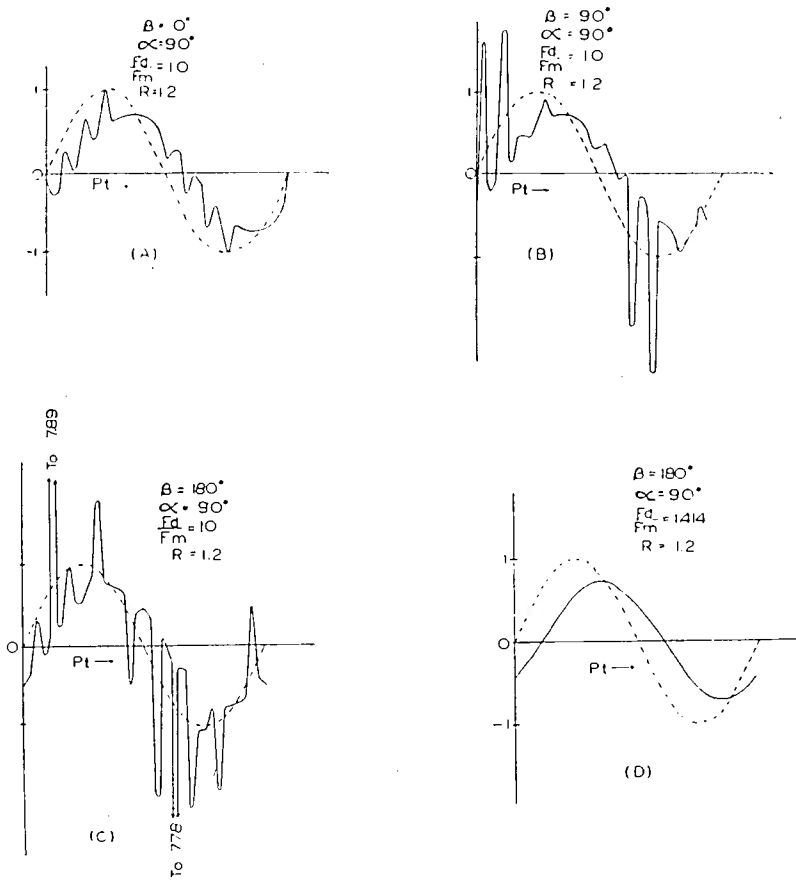

Fig. 8—Calculated wave forms for frequency modulation transmitted over a two-path medium plotted from (6). Ratio between path amplitudes, $R=1.2$. F_a =frequency deviation. F_m =modulation frequency. α =phase difference between modulation frequencies. β =phase difference between carrier frequencies. The dotted line curve is a pure sine wave (representing no distortion) for comparison purposes.

obtained. For the lower modulation frequencies, for instance, 200 cycles, the wave form of Fig. 8(D) would exist for a deviation of 282.4 cycles and that of Fig. 8(C) for a deviation of 2000 cycles; hence the distortion increases with increase in depth of modulation.

From a study of (5), it can be seen that the effect of a change in the value of the phase difference, α , between the modulation frequencies on the two paths is approximately the same as a change in the value of

F_d/F_m since $\sin \alpha/2$ enters in the quantity Z in the same manner as does the quantity F_d/F_m . However it can also be seen that the distortion is zero when α is equal to 0, 2π , 4π , etc. Thus the most severe distortion occurs when $\alpha = \pi$ radians or 180 degrees. Since $\alpha = 2\pi DF_m$, where D = time delay between the two paths, for a given time delay $\sin \alpha/2$ will go through maximums and minimums as the modulation frequency is varied. Hence bands of maximum and minimum distortion would be expected throughout the modulation frequency band.

By an application of the same theoretical method, the distortion due to three or more paths could be determined. The addition of a wave arriving over the third path to the resultant given by (4) would add another arc-tangent term to the phase of the resultant in which R would be equal to the ratio between the resultant amplitude of the first two paths and the amplitude of the third. This would add distortion which would result in a wave form undoubtedly more distorted than the two-path case. However, the degree of distortion would be proportional to the same parameters as the two-path case since the distortion term added by each path is similar to that produced by the first two paths.

The distortion encountered by amplitude modulation in multipath transmission has been theoretically considered in previous literature.¹³ The general results of this theory are that the distortion consists of a change of the amplitude of the fundamental modulation frequency together with the introduction of second harmonic distortion. However, the higher order harmonic distortion so prone to appear in frequency modulation, and depending upon the ratio F_d/F_m , is not present. It is this extreme high order harmonic distortion which makes the reception of frequency modulation over a multipath medium far more distorted than the reception of amplitude modulation over the same medium.

CONCLUSIONS

The general conclusion derived from the tests and theory is that on circuits where multipath transmission is encountered, frequency modulation is impracticable. This, of course, precluded the use of frequency modulation on frequencies which are transmitted by refraction from the Kennelly-Heaviside layer. For the frequencies in the immediate vicinity of eighteen megacycles, where transmission is largely by a

¹³ Charles B. Aiken, "Theory of the detection of two modulated waves by a linear rectifier," Proc. I.R.E., vol. 21, pp. 601-629; April, (1933). The "Case of Identical Modulating Frequencies" considered on page 616 covers exactly the same situation as the two-path multipath transmission case.

single path, and where echo is small when it is present,¹⁴ fair success would be possible with a frequency modulation circuit where the modulation frequencies were not higher than about 5000 cycles. However, the logical place for frequency modulation is on the ultra-high frequencies where the only multipath transmission that exists¹⁵ is that due to the direct ray and the ray reflected from the ground and other near-by objects. On the other hand, even this multipath transmission on ultra-short waves will introduce appreciable distortion to modulation frequencies of the order used in television. This distortion would be particularly severe in the case where the transmitter and receiver are both at rather high elevations, but would have the possibility of elimination by the use of directivity to discriminate against one of the rays.

The specific conclusions of the tests may be summarized as follows: The distortion is most severe on the lower modulation frequencies and on the lower radiation frequencies. The distortion was equally severe with or without limiting. The diversity tests showed a tendency for the two receivers to stay in phase at the lower modulation frequencies, but this tendency was almost obliterated by unequal harmonic distortion on the two receivers. The higher modulation frequencies and the lower radiation frequencies showed the most random phase characteristics.

The specific conclusions of the theory concerning the two-path case may be summarized as follows: When the two paths are exactly equal in amplitude, provided conditions are such that the resultant amplitude does not go to zero, the effect is a change in the effective frequency deviation with no harmonic distortion. When the strength of one path is great compared to the other, odd harmonics are introduced when the phase difference between the carriers is zero and even harmonics are introduced when the phase difference is ninety degrees. The most destructive distortion occurs when the amplitudes of the paths are not quite equal. Under this condition the distortion is greatest for the higher values of F_d/F_m and for phase relations such that the phase differences between the modulation frequencies and between the carrier frequencies are both 180 degrees.

ACKNOWLEDGMENT

The author is indebted to Messrs. H. H. Beverage and H. O. Peterson under whose guidance the work of this paper was carried out.

¹⁴ T. L. Eekersley, "Multiple signals in short-wave transmission," Proc. I.R.E., vol. 18, pp. 106-122; January, (1930).

¹⁵ Bertram Trevor and P. S. Carter, "Notes on propagation of waves below ten meters in length," Proc. I.R.E., vol. 21, pp. 387-426; March, (1933).

UNSYMMETRICAL SELF-EXCITED OSCILLATIONS IN CERTAIN SIMPLE NONLINEAR SYSTEMS*

BY

J. G. BRAINERD AND C. N. WEYGANDT

(Moore School of Electrical Engineering, University of Pennsylvania, Philadelphia, Pennsylvania)

Summary—The solution of the equation governing oscillations in simple nonlinear systems is obtained by use of the differential analyzer, a mechanical means for solving differential equations. Solutions are given in the form of curves plotted for various values of the two parameters of the equation. The curves show in particular the behavior of a system which is not operating on an inflection point of the characteristic of the nonlinear device, so that the oscillations are not symmetrical.

IN THIS paper are given the wave forms and other pertinent data concerning certain unsymmetrical oscillations arising in simple, nonlinear systems in which there is no external driving force.

To relate the present material to other published work and to define terms, a brief introductory résumé is desirable. A *simple* system is one in which the displacement, velocity, current, charge or other quantity is governed by an equation of the form

$$m \frac{d^2y}{dt^2} + b \frac{dy}{dt} + cy = e$$

or in the notation used hereafter in this paper

$$my'' + by' + cy = e. \quad (1)$$

Here y is the quantity under consideration, m , b , and c are parameters of the circuit, which may be electrical, mechanical or anything else, and e is the externally applied force. If m , b , and c are constants or functions of t only, the system is *linear*. If one or more of them depends on y or any of its derivatives, the system is *nonlinear*.

A simple system is not necessarily one of simple construction. In the electrical case a circuit containing resistance, inductance, and capacitance in series is a simple system, but a two-mesh network containing resistance, capacitance, self- and mutual inductance, and an electron tube may also be a simple system.

The term *oscillation* will be used to denote a *periodic* disturbance. "*Self-excited*" is used to indicate the absence of an externally applied force ($e = 0$). The simplest case in which (1) yields a self-excited oscillation is when $b = 0$ and m and c are positive constants:

* Decimal classification: R140. Original manuscript received by the Institute, December 27, 1935.

$$my'' + cy = 0. \quad (2)$$

If b is positive and not zero,

$$my'' + by' + cy = 0 \quad (3)$$

which does not yield an oscillation according to the definition given above, since a constantly damped sine wave is not periodic.

Turning now to simple self-excited nonlinear systems, the one case which has been studied to any extent is that in which b varies with y or a derivative of y , and m and c are constants. To produce oscillations, it is necessary that b be negative during part of each cycle, that is, that there be in the system some device (e.g., an electron tube in an electrical system) producing the equivalent of a negative resistance during part of each cycle. Assuming that this device has an operation characteristic of the form $-\alpha y + \beta y^2 + \gamma y^3$, the oscillation may be shown in certain important cases to be governed by

$$y'' - \epsilon(1 - 2ay - y^2)y' + y = 0. \quad (4)$$

In obtaining (4) a transformation of co-ordinates has been introduced, so that y and t of (4) are proportional to, but not equal to, the corresponding quantities of (3). In particular, it should be noted that neither the coefficient of y' nor the integral of the y' term in (4) is the operating characteristic $-\alpha y + \beta y^2 + \gamma y^3$ of the nonlinear device, but is easily derivable from the characteristic. The results of this derivation in the case of a simple triode oscillator are given in the Appendix.

Equation (4) (with right-hand side not necessarily zero) has been derived so often that a repetition is not justified here.¹ Suffice it to say that it has many important applications, and that some two hundred papers have been written discussing it or circuits governed by it. However, following the early example of van der Pol, the parameter a has nearly always been considered equal zero. There are good pragmatic reasons for this which need not be reviewed here. This assumption is equivalent to assuming $\beta = 0$ in the characteristic of the curve, which implies that the operating point on the characteristic is an inflection point.

The parameter ϵ depends on the parameters of the circuit and those of the characteristic of the nonlinear device. For $\epsilon \ll 1$, (4) reduces to $y'' + y = 0$, which is equivalent to (2). This is the so-called "interchange" case where wave form is practically sinusoidal and the period very close to 2π in the units of (4). For $\epsilon \gg 1$, relaxation oscillations are obtained. These have been studied extensively. Systems for which

¹ Balth van der Pol, "Nonlinear theory of electric oscillations," Proc. I.R.E., vol. 22, p. 1051, September, (1934), and appended bibliography.

ϵ is neither very much less than or very much greater than unity are called mixed systems. They have been studied very little.

In this paper are given the results of an investigation of the effect of the parameter a on wave form, maximum values, and period of the

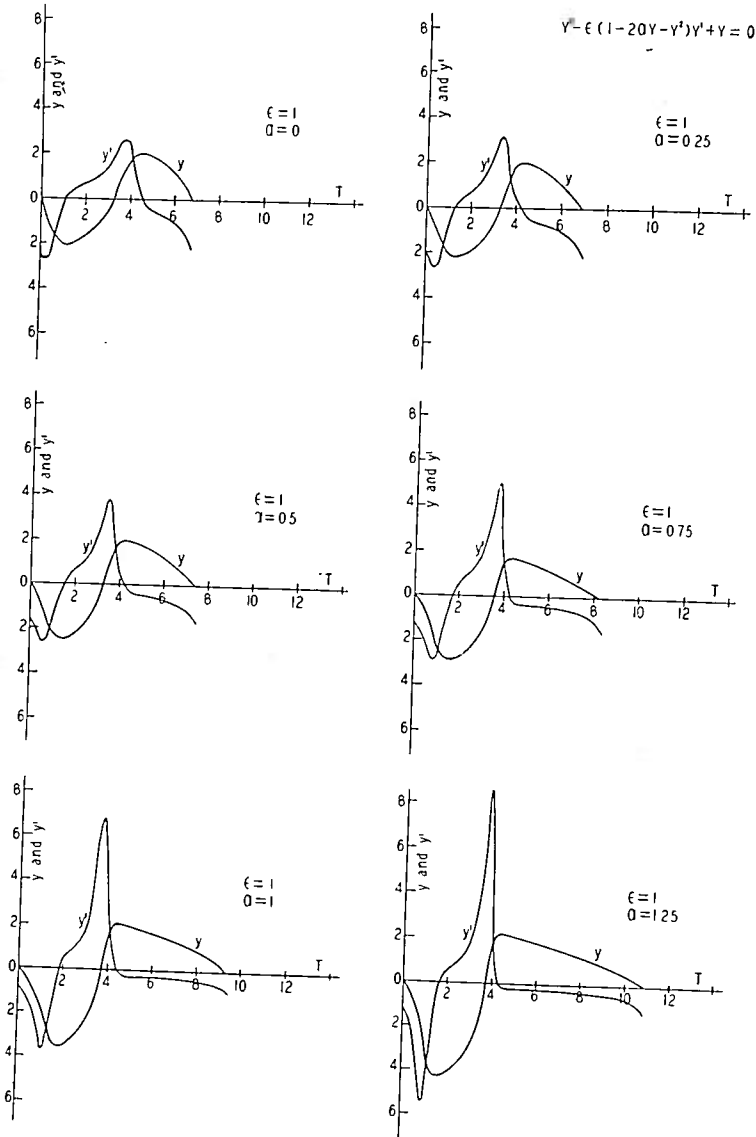

Fig. 1—Variation of y and y' with t for various values of a for $\epsilon = 1$.

oscillations in a mixed system. Physically, the assumption $a \neq 0$ is equivalent to assuming that the operating point is not an inflection point on the characteristic. This is a condition easily obtained physically and appears to be of far more importance than a review of the literature would indicate. Likewise values of ϵ of the order of unity are easily obtained.

Succinctly then, the problem is to determine the oscillations in a system governed by

$$y'' - \epsilon(1 - 2ay - y^2)y' + y = 0 \tag{4}$$

when ϵ ranges from 0 to 2 and a from 0 to 1.25. Since (4) applies to numerous systems, it seems better to consider the problem in the more abstruse form given than to tie it to any one particular application, such as an electric oscillator.

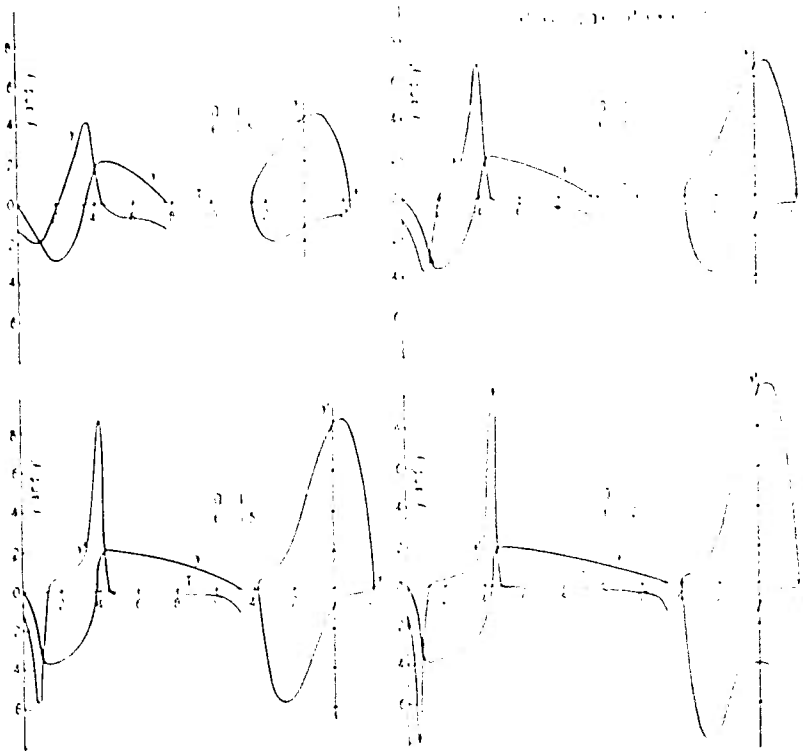

Fig. 2 Variation of y and y' with t and y with y' for various values of ϵ for $a = 1$.

The curves here given were obtained by the use of the Moore School differential analyzer.^{2,3} There are two types of curves given in Figs. 1 and 2, one showing the variation of y with t and the other y' with t . The first needs no comment; the second is desirable because it is proportional to a physically significant quantity and because with it the first changes in the terms of the equation can be visualized.

In Fig. 2 a third type of curve obtained by plotting y' against y is

² V. Bush, "A differential analyzer, a new machine for solving differential equations," *Jour. Frank. Inst.*, vol. 212, p. 447; October, (1931).

³ Irven Travis, "Differential analyzer eliminates brain fog," *Machine Design*, p. 15; July, (1935).

also shown. Figs. 3 and 5 show the variation with the parameters a and ϵ of the maximum values of the function y and its derivative y' . Figs. 4 and 6 show the variation of the period with the parameters.

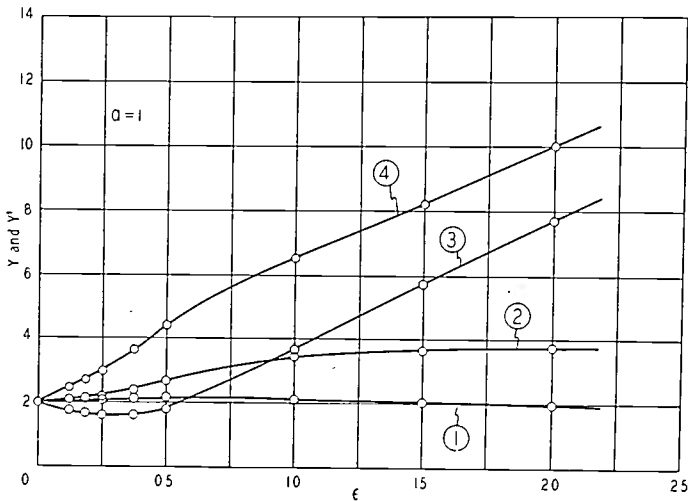

Fig. 3—Variation with ϵ when $a=1$ of:
 1. Small maximum of y .
 2. Large maximum of y .
 3. Small maximum of y' .
 4. Large maximum of y' .

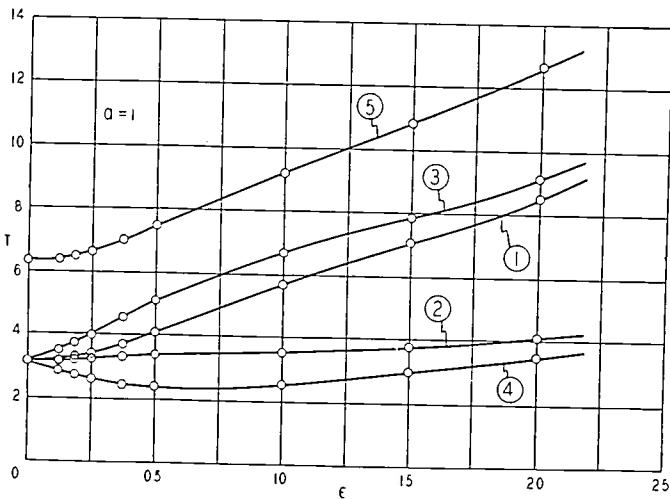

Fig. 4—Variation with ϵ when $a=1$ of:
 1. Part period including small maximum of y .
 2. Part period including large maximum of y .
 3. Part period including small maximum of y' .
 4. Part period including large maximum of y' .
 5. Period.

Since when a is not equal zero the parts of the period between zeros including the small and large maximums are not equal, their several variations are also shown.

Figs. 3 and 4 correspond to Fig. 2 and show the variation of periods and maximum values of the variables with the parameter a when ϵ is constant. Similarly Figs. 5 and 6 show the variation of the periods and

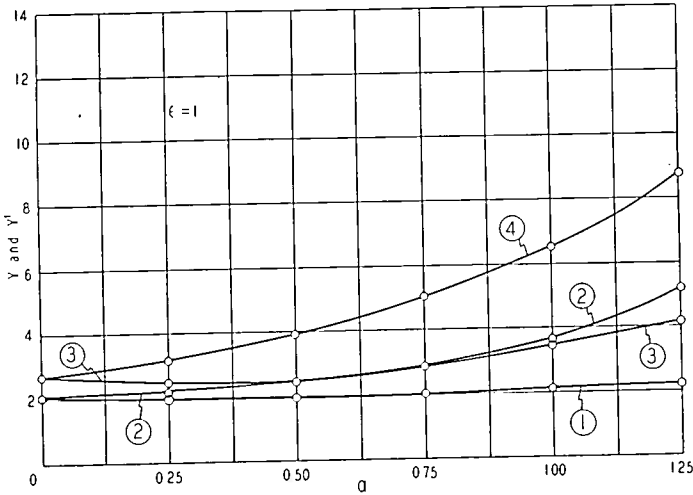

Fig. 5—Variation with a when $\epsilon=1$ of:
 1. Small maximum of y .
 2. Large maximum of y .
 3. Small maximum of y' .
 4. Large maximum of y' .

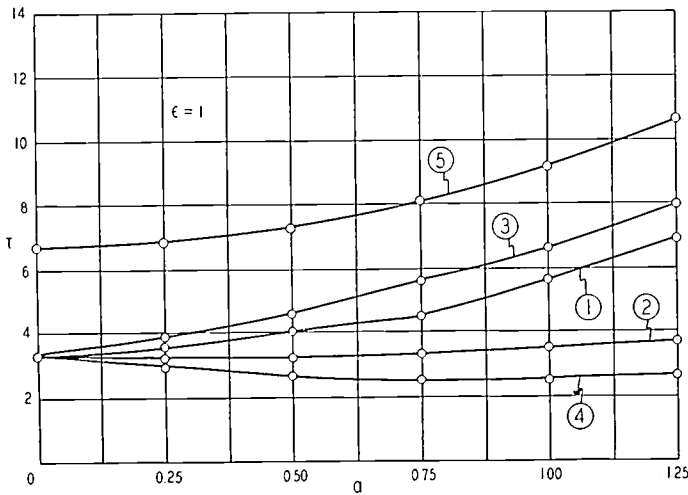

Fig. 6—Variation with a when $\epsilon=1$ of:
 1. Part period including small maximum of y .
 2. Part period including large maximum of y .
 3. Part period including small maximum of y' .
 4. Part period including large maximum of y' .
 5. Period.

maximum values of the variables with ϵ when a is constant, corresponding to Fig. 1.

The heavy curve of Fig. 7 corresponds to the curves of Fig. 1, where

$\epsilon = 1$ and $a = 0$ except that y is plotted against y' instead of each being plotted against t . The light curves represent transient portions of the oscillation starting from two different initial conditions, one within and one without the heavy curve, which has been called the limiting cycle. This type of curve is of importance because of the compact manner in which it shows energy changes as well as co-ordinates y' and y . Poincaré⁴ studied curves of this type extensively, and they have begun to appear rather frequently in the French and Russian literature⁵ in connection with problems of nonlinear systems. It appears that they are to play an increasingly important part in the future.

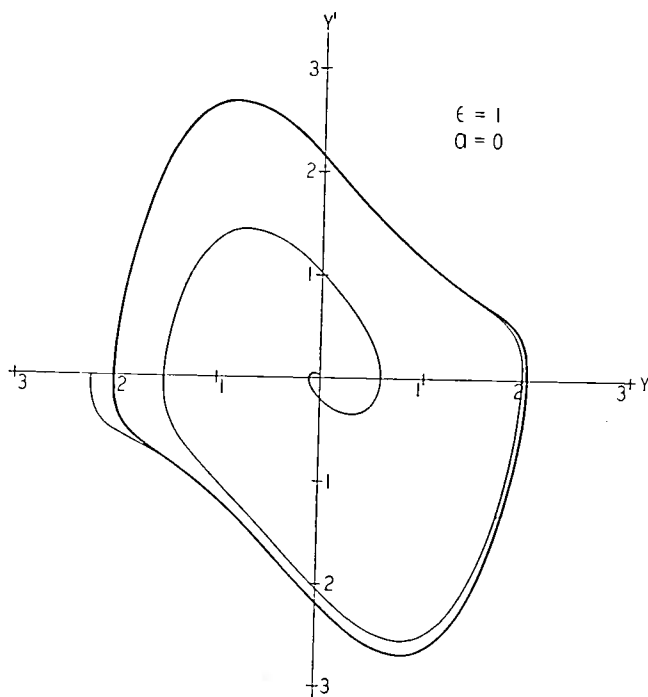

Fig. 7—Variation of y with y' for $\epsilon = 1$, $a = 0$.

It is interesting to note that any radius vector from the origin to a point on Fig. 7 is a measure of the instantaneous kinetic plus potential energy at the point. For $\rho^2 = y'^2 + y^2$ and in the units used in (4), the instantaneous kinetic energy is $1/2y'^2$ and the instantaneous potential energy is y^2 . Thus energy changes may be easily traced on the $y' - y$ cycles.

In conclusion it may be pointed out that the curves shown in this paper should be of value not only in furthering the theoretical analysis

⁴ H. Poincaré, "Mémoire sur courbes définies par une équation différentielle," *Science Hypothèse*, Tome I, p. 7.

⁵ F. Dawes and J. Frenkel, "L'équation des phénomènes oscillatoires," *Bull. de l'Assn. des Ing. Sortis de l'Institut Montefisore*, December, (1934).

of certain simple nonlinear systems, but also in the design of such systems.

ACKNOWLEDGMENT

The authors are indebted to the Faculty Research Committee of the University for aiding in the preparation of these and other results by a grant and to Mr. Jacob Neufeld for his assistance.

APPENDIX

It has been shown by van der Pol¹ that for a triode oscillator where the plate current can be expressed in the form

$$i_a = v_a + \mu v_g$$

where v_a is the plate voltage and v_g is the grid voltage and μ the amplifying factor, an equation of the following form will hold:

$$\frac{dy^2}{dt^2} - \epsilon(1 - 2ay - y^2) \frac{dy}{dt} + y = 0. \tag{4}$$

To derive this it is necessary to assume that the triode has an operating characteristic of the form

$$i = -\alpha v + \beta v^2 + \gamma v^3$$

where i is the variable part of the plate current and v the variable part of the plate voltage. α , β , and γ are constants. If R is the resistance across the tuned circuit, L the inductance, and C the capacitance of the tuned circuit then the following relationships define the quantities of (4):

$$y = \sqrt{\frac{3\gamma}{\alpha - \frac{1}{R}}} v$$

$$t = \frac{1}{\sqrt{LC}} t' \quad t' \text{ is time}$$

$$a = \frac{\beta}{\sqrt{\gamma \left(\alpha - \frac{1}{R} \right)}}$$

$$= \frac{1}{\sqrt{LC} \left(\alpha - \frac{1}{R} \right)}$$

Equation (4) can be transformed in several interesting ways. First let $y_1 = -y$

$$y_1'' - \epsilon(1 + 2ay_1 - y_1^2)y_1' + y_1 = 0 \tag{5}$$

showing that the equation and hence the oscillations are not symmetrical in y . Equation (5) also shows that only positive values of a need be taken in (4).

If $y_2 = y_1 - a$

$$y_2'' - \epsilon(1 + a^2 - y_2^2)y_2' + y_2 = -a. \tag{6}$$

Now let $y_3 = -(\sqrt{1+a^2})y_2$

$$y_3'' - \epsilon_1(1 - y_3^2)y_3' + y_3 = A \tag{7}$$

where,

$$\epsilon_1 = (1 + a^2)\epsilon$$

$$A = \frac{a}{\sqrt{1 + a^2}}$$

This form shows that (4) describes the equivalent of operating at an inflection point on the characteristic of the nonlinear device but with a steady force applied.

Finally let

$$x = \frac{dy}{dt} = y'$$

then,

$$\frac{dx}{dy} - \epsilon(1 - 2ay - y^2) + \frac{y}{x} = 0. \tag{8}$$

This is the equation of the cycles in which y' is plotted against y . When $y = 0$, $dx/dy = \epsilon$; when $1 - 2ay - y^2 = 0$, $x^2 + y^2 = \text{constant}$ or the curve in the immediate vicinity is an arc of a circle with its center at the origin.

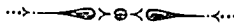

ELECTROMAGNETIC SHIELDING EFFECT OF AN INFINITE PLANE CONDUCTING SHEET PLACED BETWEEN CIRCULAR COAXIAL COILS*

BY

SAMUEL LEVY
(St. Paul, Minnesota)

INTRODUCTION

IN apparatus employing amplification it is frequently necessary to isolate certain circuit elements from electromagnetic disturbances. In many practical cases the amount of shielding action required is very great. This is by reason of the fact that the amplification provided between certain circuit elements may be extremely high. If these elements are not shielded from the disturbing electromagnetic forces, these disturbances greatly amplified will appear in the output of the apparatus. Frequently this lack of proper isolation is responsible for disturbances so great as either to impair the usefulness of the device greatly, or even to make it entirely inoperative.

In a great many practical cases the electromagnetic disturbance is predominantly of either the magnetic or of the electric type. The latter of these is relatively easy to shield against by reason of the fact that metallic conductors have very high conductivity and for that reason will not support large differences of potential. On the other hand magnetic disturbances are very annoying and difficult to eliminate because no material is known which has relatively as high a degree of magnetic permeability as metallic conductors have electric conductivity. A great deal of work, both theoretical and experimental, has already been done on this phase of the shielding problem. A bibliography of articles treating the problem is given at the end of this article.

Lenz's law is of particular interest in connection with the shielding of varying magnetic fields. This law states that wherever electrical conductors are present in an alternating magnetic field, electric currents will be induced in them in such a direction as to diminish the strength of the alternating magnetic field passing through the conductor. Therefore the strength of the magnetic field in a region surrounded by a conducting medium will be smaller than it would be were the conducting medium absent. In many practical cases conductors designed on this principle are used to shield from magnetic fields and result in quite effective shielding.

* Decimal classification: R387.1. Original manuscript received by the Institute, December 3, 1935.

It will be the purpose of this article to investigate shielding depending on Lenz's law for the particular case of a plane shield placed perpendicularly to the axis of two similar coaxial circular coils. The method, however, is equally applicable to other types of coil and other methods of location for which the required mutual inductances have been determined.

It will be shown, among other things, that placing a plane conducting sheet of thickness T centimeters and per cent conductivity γ between and perpendicular to the common axis of two circular coils of radius A centimeters will cause a drop in the cross talk between them of $10 \log [(AT\gamma f/78.8)^2 + 1]$ decibels at a frequency of f cycles per second.

THEORY

The problem is pictured in Fig. 1 where coil 1 represents the source of electromagnetic disturbance and coil 2 the coil which is to be isolated

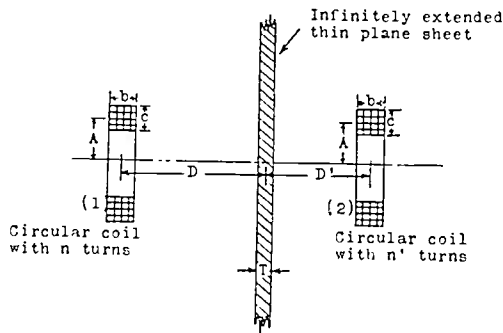

by the infinitely extended thin plane sheet of conducting material placed between the two coils. The insertion of the plane sheet of conducting material between the two coils as shown in Fig. 1 will have two effects. First, it will change the equivalent series resistance and inductance of coil (1), and second, it will lower the disturbing voltage in coil (2) which is induced by the currents flowing in coil (1). The magnitude of these two effects depends on the electrical frequency of the exciting currents, on the geometry of the system, and on the specific conductivity of the material from which the shielding plane is made. The solution for the numerical value of these effects can best be obtained by the method of moving images developed by J. C. Maxwell.¹

This method when applied to a circular exciting coil such as we have leads to a very useful simplification. Let (see Fig. 2) the point at which the axis of coil (1) pierces the shielding plane be the origin of co-ordinates with the positive z axis extending along the coil axis in

¹ Numbers refer to Bibliography.

direction from the shield to the coil. Through the origin and in the plane of the shield draw the co-ordinate axes x and y and also any line C starting at the origin and extending to infinity. Denote the distance from the origin along the line C by the letter s . Now as a result of the circular symmetry of both the coil and shield about the coil axis, the currents induced in the shield will flow in circles about the origin as a center. Let the total current crossing line C in a counterclockwise sense between the point L and infinity be denoted by ϕ . The current ϕ will be a function of time and of the distance s from the point L to the origin; that is, $\phi = \phi(s, t)$.

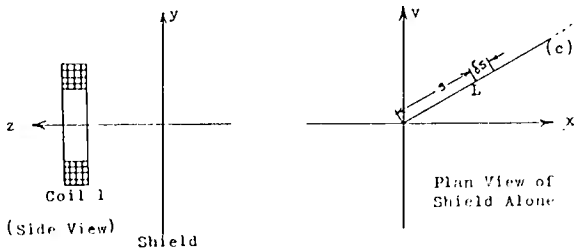

Fig. 2

Consider the annular portion of the sheet included between the circles about the origin of radius s and $s + \delta s$. When δs is very small the current flowing in this portion of the sheet will be, within errors of the second order with respect to δs ,

$$\delta i = \frac{\partial \phi}{\partial s} \delta s.$$

The magnetic effect of this current will, when δs is very small, be equivalent to that of a uniform magnetic shell of strength δi lying in the plane of the shield and having the circle of radius s as its edge. This shell would consist of two parallel plane sheets of magnetic matter at a very small distance c apart, one sheet on the positive side of the shielding plane and the other on the negative side of the shielding plane. The surface density of magnetic charge on the positive sheet would be $\delta i/c$ and would be uniformly distributed within the circle of radius s . Also the surface density of magnetic charge on the negative sheet would be $-\delta i/c$ and would be uniformly distributed. Similarly if we considered the current flowing in the annular portion of the sheet lying between s' and $s' + \delta s'$ we could represent its magnetic effect by a corresponding magnetic shell lying parallel to the shielding plane and having the circle of radius s' as its edge.

Now the whole system of currents in the shielding plane can be considered as flowing in such elementary rings. Associated with each of these rings will be a magnetic shell of radius depending on the

radius of the ring and of strength corresponding to the current flowing in the ring. The magnetic effect of the currents flowing in all these elementary rings will be equivalent to the summed up magnetic effect of all of the corresponding magnetic shells. But a moment's reflection shows us that the magnetic shells acting at a point, say s centimeters from the origin, are those due to currents flowing in rings of radius larger than s . Also the summation of the strengths of the magnetic shells equals the summation of the corresponding currents, which are those currents flowing in rings of larger radius than s . This by previous definition is $\phi(s, t)$. Therefore the strength of the summed up magnetic shells at any point a distance s from the origin is $\phi(s, t)$ and these shells can, similarly to a single shell, be considered as two parallel plane sheets of magnetic matter at a very small distance c apart, the surface density of magnetic charge on the positive sheet being $\phi(s, t)/c$ and the surface density of magnetic charge on the negative sheet being $-\phi(s, t)/c$.

In order to find the magnetic potential due to this composite shell we shall digress for a moment and introduce a magnetic potential function P defined in terms of a fictitious distribution of magnetic charge over the shielding plane of density equal to $\phi(s, t)$, where ϕ is given in electromagnetic units. Let (ξ, η, ζ) be the co-ordinates of a point at which it is desired to determine the value of P . Then summing up the strength of the magnetic charge divided by the distance through which it must act,

$$P = \int_{-\infty}^{\infty} \int_{-\infty}^{\infty} \frac{dx dy \phi(s, t)}{\sqrt{(\xi - x)^2 + (\eta - y)^2 + \zeta^2}} = P(\xi, \eta, \zeta) \quad (1)$$

where,

$$\phi(s, t) = \phi(\sqrt{x^2 + y^2}, t).$$

Returning to our problem, we find that the distribution of charge on the positive surface of the composite magnetic shell is exactly $1/c$ times that used in calculating P . Also the distance from (ξ, η, ζ) to this positive surface is only $\zeta - c/2$ instead of ζ . Therefore the magnetic potential at (ξ, η, ζ) due to the positive surface is,

$$(1/c)P(\xi, \eta, \zeta - c/2).$$

Similarly the magnetic potential due to the negative surface with charge distribution $-\phi/c$ is,

$$-(1/c)P(\xi, \eta, \zeta + c/2).$$

Therefore, the total magnetic potential at (ξ, η, ζ) due to the com-

posite magnetic shell is,

$$Q = \frac{1}{c} P\left(\xi, \eta, \zeta - \frac{c}{2}\right) - \frac{1}{c} P\left(\xi, \eta, \zeta + \frac{c}{2}\right). \tag{2}$$

If we expand P in (2) into a Taylor series about the point (ξ, η, ζ) ,

$$Q = \frac{1}{c} \left\{ P + \frac{\partial P}{\partial \zeta} \left(-\frac{c}{2}\right) + \frac{\partial^2 P}{\partial \zeta^2} \left(\frac{c^2}{8}\right) + \frac{\partial^3 P}{\partial \zeta^3} \left(-\frac{c^3}{48}\right) + \dots \right\} \\ - \frac{1}{c} \left\{ P + \frac{\partial P}{\partial \zeta} \left(\frac{c}{2}\right) + \frac{\partial^2 P}{\partial \zeta^2} \left(\frac{c^2}{8}\right) + \frac{\partial^3 P}{\partial \zeta^3} \left(\frac{c^3}{48}\right) + \dots \right\}$$

or,

$$Q = -\frac{\partial P}{\partial \zeta} - \frac{\partial^3 P}{\partial \zeta^3} \left(\frac{c^3}{24}\right) - \dots$$

And when c becomes very small we have within errors of higher order with respect to c ,

$$Q = -\frac{\partial P}{\partial \zeta}. \tag{3}$$

But P is given by (1) and under the conditions of its definition it is permissible to differentiate under the integral sign, or (3) becomes,

$$Q = \int_{-\infty}^{\infty} \int_{-\infty}^{\infty} \frac{+ \zeta dx dy \phi(s, t)}{[\sqrt{(\xi - x)^2 + (\eta - y)^2 + (\zeta^2)}]^3}. \tag{4}$$

Consider for a moment the integral for Q in (4). The value of such an integral depends almost entirely on the integration over the relatively small region where $\sqrt{(\xi - x)^2 + (\eta - y)^2}$ is of the same order of magnitude as ζ . Now due to the inclusion of $\phi(s, t) = \phi(\sqrt{x^2 + y^2}, t)$ under the integral sign, the evaluation of Q is difficult. In one case however, when ζ is extremely small, the evaluation becomes simple for the value of the integral only depends then on those values of x and y which make $\sqrt{(\xi - x)^2 + (\eta - y)^2}$ of the same relative magnitude as ζ , that is, for x and y very nearly equal to ξ and η respectively. Since $\phi(\sqrt{x^2 + y^2}, t)$ is a continuous function of $\sqrt{x^2 + y^2}$ we can, within errors of the second order with respect to ζ , allow $\phi(\sqrt{x^2 + y^2}, t) = \phi(\sqrt{\xi^2 + \eta^2}, t)$ during the integration, in which case,

$$Q = \zeta \phi(\sqrt{\xi^2 + \eta^2}, t) \int_{-\infty}^{\infty} \int_{-\infty}^{\infty} \frac{dx dy}{[(\xi - x)^2 + (\eta - y)^2 + \zeta^2]^{3/2}}$$

which is equivalent to

$$\begin{aligned}
 Q &= \zeta \phi(\sqrt{\xi^2 + \eta^2}, t) \int_0^\infty \frac{2\pi r dr}{(r^2 + \zeta^2)^{3/2}} \\
 &= 2\pi \phi(\sqrt{\xi^2 + \eta^2}, t) \frac{\zeta}{(\zeta^2)^{1/2}}
 \end{aligned} \tag{5}$$

and when $\zeta = c/2$,

$$Q = 2\pi \phi(\sqrt{\xi^2 + \eta^2}, t) = -\frac{\partial P}{\partial \zeta} = -\frac{\partial P}{\partial z}. \tag{6, 3}$$

We are now in a position to find the relations between the magnetic potential Q due to the shielding currents alone and the magnetic potential denoted by Q_0 due to the exciting coil alone. Let the magnetic potential Q_0 , due to the exciting coil, be represented by

$$Q_0 = -\frac{\partial P_0}{\partial z}.$$

Then the total magnetic potential Q' , produced by both the coil and the shield, will be the sum of the separate potentials, or,

$$\begin{aligned}
 Q' &= Q + Q_0 \\
 &= -\frac{\partial P}{\partial z} - \frac{\partial P_0}{\partial z} = -\frac{\partial(P + P_0)}{\partial z}.
 \end{aligned} \tag{7}$$

Maxwell has shown in his well-known development of electromagnetic theory that the voltage due to the variations of the magnetic potential Q' may be described in terms of a so-called vector potential. Let F , G , and H be the components of this vector potential along the x , y , and z axes, respectively. Then applying Maxwell's theory they must satisfy the general equations,

$$\begin{aligned}
 \frac{\partial H}{\partial y} - \frac{\partial G}{\partial z} &= -\frac{\partial Q'}{\partial x} \\
 \frac{\partial F}{\partial z} - \frac{\partial H}{\partial x} &= -\frac{\partial Q'}{\partial y} \\
 \frac{\partial G}{\partial x} - \frac{\partial F}{\partial y} &= -\frac{\partial Q'}{\partial z}.
 \end{aligned}$$

And equations (8) are satisfied when,

$$F = \frac{\partial(P + P_0)}{\partial y}, \quad G = -\frac{\partial(P + P_0)}{\partial x}, \quad H = 0. \quad (9)$$

Let X and Y be the components of the electric voltage intensity in the shielding plane parallel to the x and y axes, respectively. Then if ψ is used to denote the electric potential at the point $(x, y, 0)$ in the shield,

$$X = -\frac{\partial F}{\partial t} - \frac{\partial \psi}{\partial x}, \quad Y = -\frac{\partial G}{\partial t} - \frac{\partial \psi}{\partial y}. \quad (10)$$

If the resistance of a square centimeter of the shielding conductor, of thickness T , measured between two parallel edges be denoted by σ , then we also can write the equations,

$$X = \sigma \frac{\partial \phi}{\partial y}, \quad Y = -\sigma \frac{\partial \phi}{\partial x}. \quad (11)$$

But (6) states that on the positive surface of the shielding plane

$$2\pi\phi = -\frac{\partial P}{\partial z}. \quad (11')$$

or substituting from (6) into (11),

$$X = -\frac{\sigma}{2\pi} \frac{\partial^2 P}{\partial y \partial z}, \quad Y = \frac{\sigma}{2\pi} \frac{\partial^2 P}{\partial x \partial z}. \quad (12)$$

Substituting from (9) and (12) into (10) and eliminating X , Y , F and G , we obtain, corresponding to the positive surface of the sheet the equations,

$$\begin{aligned} \frac{\sigma}{2\pi} \frac{\partial^2 P}{\partial y \partial z} &= +\frac{\partial^2(P + P_0)}{\partial y \partial t} + \frac{\partial \psi}{\partial x}, \\ -\frac{\sigma}{2\pi} \frac{\partial^2 P}{\partial x \partial z} &= -\frac{\partial^2(P + P_0)}{\partial x \partial t} + \frac{\partial \psi}{\partial y}. \end{aligned} \quad (13)$$

If we differentiate the first part of (13) with respect to x and the second with respect to y and add we obtain,

$$\frac{\partial^2 \psi}{\partial x^2} + \frac{\partial^2 \psi}{\partial y^2} = 0. \quad (14)$$

The only value of ψ which satisfies (14) and is finite and continuous at

every point of the shielding plane and vanishes at an infinite distance is,

$$\psi = 0. \quad (15)$$

Substituting this value of ψ in (13) and integrating we obtain for the positive surface of the sheet,

$$\frac{\sigma}{2\pi} \frac{\partial P}{\partial z} - \frac{\partial P}{\partial t} - \frac{\partial P_0}{\partial t} - f(z, t) = 0. \quad (16)$$

Since the values of the currents in the shield are found by differentiating with respect to x or y , omitting the arbitrary function $f(z, t)$ introduced by the operation of integration will have no effect on the subsequent determination of the shield currents. If we let the constant $(\sigma/2\pi)$ be denoted by V and omit $f(z, t)$, (16) becomes

$$V \frac{\partial P}{\partial z} = \frac{\partial P}{\partial t} + \frac{\partial P_0}{\partial t}. \quad (17)$$

Let us consider the implications of (17). First, let us suppose that there are no external electromagnetic effects disturbing the shield. The case then becomes that of a system of electric currents in the shield left to themselves, but acting on one another by their mutual induction, and at the same time losing their energy on account of the resistance of the shield material. The result is expressed by setting $P_0 = 0$ in (17). Then for the positive surface of the shield,

$$V \frac{\partial P}{\partial z} = \frac{\partial P}{\partial t}. \quad (18)$$

The solution of this equation for the function P in describing the magnetic potential due to the currents in the shield is

$$P(x, y, z, t) = P'(x, y, z) + Vt, 0). \quad (19)$$

This solution satisfies the boundary condition at the positive surface of the sheet and also satisfies the differential equation. Therefore (19) is not only the correct solution for the positive surface of the shield, but also holds throughout the region on the positive side of the shield.

Expressed in words, (19) says that the magnetic potential at any point A , Fig. 3, is equal to the potential which existed at time t_1 earlier at B , where A is any distance Z_1 in front of the positive surface of the shield plane and where B is displaced from A by a distance Vt_1 . That is, the currents in the shield plane in general vary with time; however they vary in such a manner that the potential at A due to the current distribution then existing is equal to the potential at B due to the

current distribution which existed in the shielding plane at a time t_1 earlier.

The dependence on the time of the function P involved in (19) may then be described as follows. In Fig. 4 is shown at (1) the shield plane and the current distribution in the plane at time t . At (2) is shown a fictitious shield plane displaced from (1) a distance Vt and having the current distribution which existed in (1) at zero time. Now we may think of the potential, P , at A in either of two ways: first, as the potential due to the varying currents actually flowing in the shield at

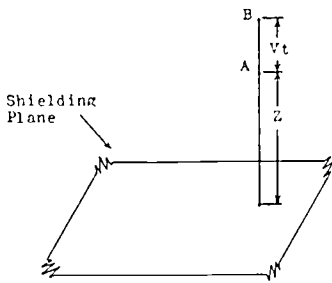

Fig. 3

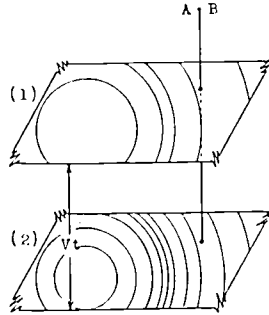

Fig. 4

(1) at any time t ; and second, as the potential due to the constant current flowing in a fictitious shield plane (2) which moves with velocity V away from the actual shield plane. The constant currents flowing in (2) are those which flowed in (1) when $t = 0$, that is, when (1) and (2) coincided. The diminution of the potential which arises from the decay of the currents in the actual case is accurately represented by the diminution of the potential due to the increasing distance in the fictitious case. This equivalence will later allow a great simplification of the solution.

Returning to (17), which refers to points on the positive surface of the shield,

$$V \frac{\partial P}{\partial z} = \frac{\partial P}{\partial t} + \frac{\partial P_0}{\partial t} \tag{17}$$

Let us integrate partially with respect to time. Then,

$$P + P_0 = \int V \frac{\partial P}{\partial z} dt + f(x, y, z), \tag{20}$$

and if the currents in the shield and in the exciting coil were zero at all times before the initial instant from which time is being reckoned, $(P + P_0)_{t < 0} = 0$, and (20) reduces to,

$$P + P_0 = \int_0^t V \frac{\partial P}{\partial z} dt. \quad (21)$$

But when t is very small, that is, at the initial instant after t is zero, the right-hand side of (21) is still relatively zero or,

$$P = -P_0 \text{ (when } t = 0\text{)}. \quad (22)$$

That is at the initial instant the magnetic field set up by the currents flowing in the shield in response to the external forces is, at the positive surface of the shield, equal and opposite to the magnetic field set up by the external forces themselves. This fact will also allow a simplification of our problem.

Returning to the real problem in hand, that is, the coil and shield pictured in Fig. 2, suppose we apply (19) and (22) to a simple case. Let the current in the coil be zero up to the time $t = 0$, and let it have the constant value i_a afterward. Then by (22), the flux crossing the shielding plane at the initial instant will be zero. That is, the system of currents excited in the shield by the sudden introduction of current into the windings of the primary coil is such that at the surface of the shield it exactly neutralizes the magnetic effect of the coil. This is in agreement with Lenz's law. We may also express this by saying that the shield currents on the region to the positive side of the shield plane at the initial instant is the same as though a coil with current $-i_a$ had been placed at the image point on the negative side of the shield.

Now since the image coil mentioned above satisfies the flux conditions on the boundary of the positive region, that is, on the positive side of the shield plane, it also gives the flux distribution throughout the positive region caused by the shield currents at the initial instant. This fact places us in a position to apply (19). As has already been explained (Figs. 3 and 4) this equation relates the flux existing at any point A at a time t with the flux that existed at a point B , Vt further from the shield, at the initial instant of time. But we have just shown that at the initial instant of time the flux caused by the shield currents is represented by a fictitious image coil placed at the image point and having a current $-i_a$ flowing through it. Therefore, at a time t after the initial instant, the flux in the positive region due to the shield currents is represented by a fictitious image coil placed a distance Vt behind the image point and having a current $-i_a$ in it.

Furthermore, by repeated applications of (19), (see Fig. 5) it becomes apparent that if we allow the fictitious image coil to move away from the shield with a constant velocity V , it can at all times be used to represent the flux due to the actual currents flowing in the shield plane.

Therefore the solution of the problem of a coil in front of the shield with a current i started in it is, for the positive region, the appearance of a fictitious coil at the image point carrying current $-i$, which coil immediately starts moving away from the shield with a velocity $V = c/2\pi$; and for the negative region, the appearance of a fictitious coil carrying current $+i$, superposed on the actual coil, which fictitious coil immediately starts moving away from the shield with a velocity $V = c/2\pi$.

In a more elaborate problem, that is, one in which the coil current varies with time, the amplitude i just noted can be generalized. Suppose that for every successive increment of time Δt the current should change

$$i \rightarrow i + \Delta i$$

$$i \rightarrow i + \frac{\Delta i}{\Delta t} \Delta t$$

$$i \rightarrow i + \frac{\Delta i}{\Delta t} \Delta t + \frac{\Delta i}{\Delta t} \Delta t$$

$$i \rightarrow i + \frac{\Delta i}{\Delta t} \Delta t + \frac{\Delta i}{\Delta t} \Delta t + \frac{\Delta i}{\Delta t} \Delta t$$

$$\dots$$

$$i \rightarrow i + \frac{\Delta i}{\Delta t} \Delta t + \frac{\Delta i}{\Delta t} \Delta t + \frac{\Delta i}{\Delta t} \Delta t + \dots$$

Fig. 5

by the amount Δi . Then each of the n changes of current in coil gives rise to a new fictitious image coil which would have a current $\pm \Delta i$ (with Δi corresponding to the current change of the next interval, Fig. 4). The fictitious image coil, due to all the n increments of i up to now, would be moving away from the shield plane in a body with the constant velocity V , and would be uniformly spaced along the z -axis at intervals of $V \Delta t$ apart. As the time increment Δt is decreased the number of coils spaced $V \Delta t$ close together. In the limit, as $\Delta t \rightarrow 0$, the motion picture of fictitious coils will exactly represent the shield currents in their respective effect on the positive side of the shield plane.

The theory developed above may be extended to include the region on the negative side of the shield plane also. If in developing (6) we had let $\zeta = -z/2$ we would in our final results have obtained equations corresponding to the negative side of the shield plane. These equations would show that that part of the magnetic flux due to the shield currents is symmetrical with respect to the shield plane and continuous over the boundary between the positive and negative sides of the shield plane.

We are now in a position to perform the solution of a frequently occurring problem in electromagnetic shielding, that is, the special problem of solving for the change in series inductance and resistance of coil (D), Figs. 1 and 6, when the shield plane is brought in its proximity. Let $i(t)$ be the current flowing in coil (1). Then following the example given above, the constant current flowing in the image coil

which at time t is x centimeters from the primary coil is,

$$- \frac{di}{dt} \left(\text{at time } t - \frac{x - 2D}{V} \right) \delta t.$$

Let the mutual inductance between the image coil under consideration and coil 1 be denoted by $M(x)$, where x is the distance in centimeters between them. Now $M(x)$ has a value corresponding to the amount of flux from the image coil which links coil (1). Therefore if $M(x)$ is varied by the motion of the image coil, a voltage will be induced in

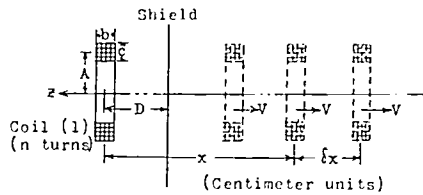

Fig. 6

coil (1) corresponding to the rate at which $M(x)$ is changing. Hence the voltage induced in coil (1) by the motion of the image coil located between x and $x + \delta x$ will equal the current flowing in the image coil times $-dM(x)/dt$, or,

$$\delta E = - \frac{di}{dt} \left(\text{at time } t - \frac{x - 2D}{V} \right) \delta t \left(\frac{-dM(x)}{dt} \right). \quad (23)$$

But for any particular image coil, x and t are related by the fact that

$$x - 2D = V(t - t_0) \quad (24)$$

where t_0 is the instant at which the image coil was formed. Using (24), (23) reduces to,

$$\delta E = \frac{dM(x)}{dx} \left(\frac{di}{dt} \right) \left(\text{at time } t - \frac{x - 2D}{V} \right) \delta x. \quad (25)$$

The current flowing in coil (1) will in general have a complex wave form. For purposes of analysis, however, since we are dealing with linear impedances, it is convenient to think of this complex wave as the sum of a series of simple sine waves of different frequency. Consider the term corresponding to the frequency $\omega/2\pi$. Then,

$$i = I \sin \omega t. \quad (26)$$

Then by differentiation,

$$\frac{di}{dt} = I \omega \cos \omega t, \quad (27)$$

and at a time $t - (x - 2D/V)$,

$$\frac{di}{dt} = I\omega \cos \omega \left(t - \frac{x - 2D}{V} \right). \tag{28}$$

Or substituting from (28) into (25),

$$\delta E = \frac{dM(x)}{dx} (\delta x) I\omega \cos \omega \left(t - \frac{x - 2D}{V} \right). \tag{29}$$

Also the voltage induced in coil 1 by the sudden appearance of the images at the point $x = 2D$ is,

$$- M(2D) \left[\frac{- di}{dt} \right] = M(2D) I\omega \cos \omega t. \tag{30}$$

Hence the total voltage induced in coil (1) by the image coils located in each element, δx , of the $-z$ axis, plus that due to the sudden appearance of the image coils at $x = 2D$ is,

$$E' = M(2D) I\omega \cos \omega t + \int_{2D}^{\infty} \frac{dM(x)}{dx} I\omega \cos \omega \left(t - \frac{x - 2D}{V} \right) dx. \tag{31}$$

Now the value of $M(x)$ involved in (31) depends on the geometry of coil (1) and on the value of x . An exact algebraic expression with a

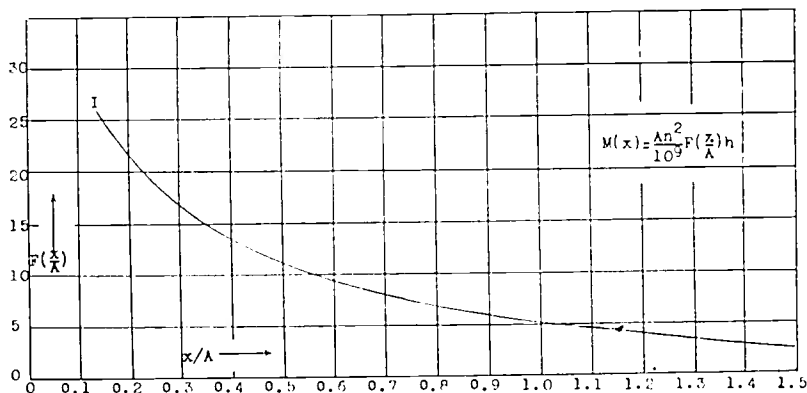

Fig. 7

finite number of terms cannot be found for this function since an elliptic integral is involved. The Bureau of Standards⁷ has published tables by the aid of which it is possible to calculate the numerical magnitude of $M(x)$ for any value of x and for any circular coil. An excerpt from this paper is given in curve 1, Fig. 7. In the original article data are given from which $M(x)$ may be determined with an error of less than 0.1 per cent.

$$P + P_0 = \int_0^t V \frac{\partial P}{\partial z} dt. \quad (21)$$

But when t is very small, that is, at the initial instant after t is zero, the right-hand side of (21) is still relatively zero or,

$$P = -P_0 \text{ (when } t = 0\text{)}. \quad (22)$$

That is at the initial instant the magnetic field set up by the currents flowing in the shield in response to the external forces is, at the positive surface of the shield, equal and opposite to the magnetic field set up by the external forces themselves. This fact will also allow a simplification of our problem.

Returning to the real problem in hand, that is, the coil and shield pictured in Fig. 2, suppose we apply (19) and (22) to a simple case. Let the current in the coil be zero up to the time $t=0$, and let it have the constant value i_a afterward. Then by (22), the flux crossing the shielding plane at the initial instant will be zero. That is, the system of currents excited in the shield by the sudden introduction of current into the windings of the primary coil is such that at the surface of the shield it exactly neutralizes the magnetic effect of the coil. This is in agreement with Lenz's law. We may also express this by saying that the shield currents on the region to the positive side of the shield plane at the initial instant is the same as though a coil with current $-i_a$ had been placed at the image point on the negative side of the shield.

Now since the image coil mentioned above satisfies the flux conditions on the boundary of the positive region, that is, on the positive side of the shield plane, it also gives the flux distribution throughout the positive region caused by the shield currents at the initial instant. This fact places us in a position to apply (19). As has already been explained (Figs. 3 and 4) this equation relates the flux existing at any point A at a time t with the flux that existed at a point B , Vt further from the shield, at the initial instant of time. But we have just shown that at the initial instant of time the flux caused by the shield currents is represented by a fictitious image coil placed at the image point and having a current $-i_a$ flowing through it. Therefore, at a time t after the initial instant, the flux in the positive region due to the shield currents is represented by a fictitious image coil placed a distance Vt behind the image point and having a current $-i_a$ in it.

Furthermore, by repeated applications of (19), (see Fig. 5) it becomes apparent that if we allow the fictitious image coil to move away from the shield with a constant velocity V , it can at all times be used to represent the flux due to the actual currents flowing in the shield plane.

Therefore the solution of the problem of a coil in front of the shield with a current i_a started in it is, for the positive region, the appearance of a fictitious coil at the image point carrying current $-i_a$, which coil immediately starts moving away from the shield with a velocity $V = \sigma/2\pi$; and for the negative region, the appearance of a fictitious coil carrying current $-i_a$ superposed on the actual coil, which fictitious coil immediately starts moving away from the shield with a velocity $V = \sigma/2\pi$.

In a more elaborate problem, that is, one in which the coil current varies with time, the simple case just cited can be generalized. Suppose that for every successive increment of time δt the current should change

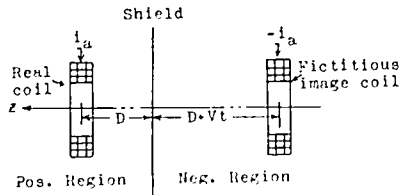

Fig. 5

by the amount δi . Then each of these changes of current would give rise to a new fictitious image coil which would have a current strength corresponding to the current change at the instant it was formed. The fictitious image coils due to all these current changes would be moving away from the shield plane in a body with the constant velocity V and would be uniformly spaced along the $-z$ axis at a distance $V\delta t$ apart. As the time increment δt is decreased the image coils are spaced closer together. In the limit, as $\delta t \rightarrow 0$, this moving train of fictitious coils will exactly represent the shield currents in their magnetic effects on the positive side of the shield plane.

The theory developed above may be expanded to include the region on the negative side of the shield plane also. If in developing (6) we had let $\zeta = -c/2$ we would in our final results have obtained equations corresponding to the negative side of the shield plane. These equations would show that that part of the magnetic flux due to the shield currents is symmetrical with respect to the shield plane and continuous over the boundary between the positive and negative sides of the shield plane.

We are now in a position to perform the solution of a frequently occurring problem in electromagnetic shielding, that is, the special problem of solving for the change in series inductance and resistance of coil (1), Figs. 1 and 6, when the shield plane is brought in its proximity. Let $i(t)$ be the current flowing in coil (1). Then following the example given above, the constant current flowing in the image coil

which at time t is x centimeters from the primary coil is,

$$- \frac{di}{dt} \left(\text{at time } t - \frac{x - 2D}{V} \right) \delta t.$$

Let the mutual inductance between the image coil under consideration and coil 1 be denoted by $M(x)$, where x is the distance in centimeters between them. Now $M(x)$ has a value corresponding to the amount of flux from the image coil which links coil (1). Therefore if $M(x)$ is varied by the motion of the image coil, a voltage will be induced in

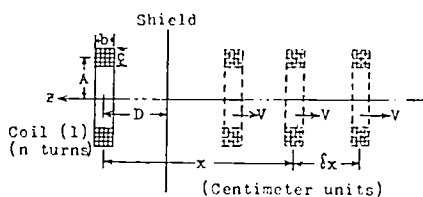

Fig. 6

coil (1) corresponding to the rate at which $M(x)$ is changing. Hence the voltage induced in coil (1) by the motion of the image coil located between x and $x + \delta x$ will equal the current flowing in the image coil times $-dM(x)/dt$, or,

$$\delta E = - \frac{di}{dt} \left(\text{at time } t - \frac{x - 2D}{V} \right) \delta t \left(\frac{-dM(x)}{dt} \right). \quad (23)$$

But for any particular image coil, x and t are related by the fact that

$$x - 2D = V(t - t_0) \quad (24)$$

where t_0 is the instant at which the image coil was formed. Using (24), (23) reduces to,

$$\delta E = \frac{dM(x)}{dx} \left(\frac{di}{dt} \right) \left(\text{at time } t - \frac{x - 2D}{V} \right) \delta x. \quad (25)$$

The current flowing in coil (1) will in general have a complex wave form. For purposes of analysis, however, since we are dealing with linear impedances, it is convenient to think of this complex wave as the sum of a series of simple sine waves of different frequency. Consider the term corresponding to the frequency $\omega/2\pi$. Then,

$$i = I \sin \omega t. \quad (26)$$

Then by differentiation,

$$\frac{di}{dt} = I \omega \cos \omega t, \quad (27)$$

and at a time $t - (x - 2D/V)$,

$$\frac{di}{dt} = I\omega \cos \omega \left(t - \frac{x - 2D}{V} \right). \tag{28}$$

Or substituting from (28) into (25),

$$\delta E = \frac{dM(x)}{dt} (\delta x) I\omega \cos \omega \left(t - \frac{x - 2D}{V} \right). \tag{29}$$

Also the voltage induced in coil 1 by the sudden appearance of the images at the point $x = 2D$ is,

$$- M(2D) \left[\frac{- di}{dt} \right] = M(2D) I\omega \cos \omega t. \tag{30}$$

Hence the total voltage induced in coil (1) by the image coils located in each element, δx , of the $-z$ axis, plus that due to the sudden appearance of the image coils at $x = 2D$ is,

$$E' = M(2D) I\omega \cos \omega t + \int_{2D}^{\infty} \frac{dM(x)}{dx} I\omega \cos \omega \left(t - \frac{x - 2D}{V} \right) dx. \tag{31}$$

Now the value of $M(x)$ involved in (31) depends on the geometry of coil (1) and on the value of x . An exact algebraic expression with a

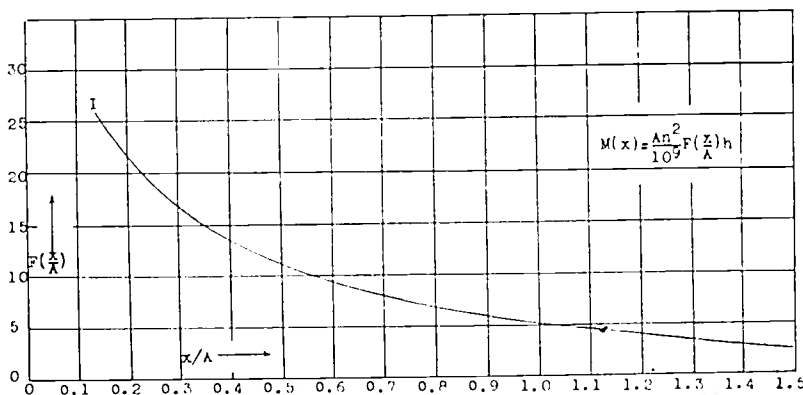

Fig. 7

finite number of terms cannot be found for this function since an elliptic integral is involved. The Bureau of Standards⁷ has published tables by the aid of which it is possible to calculate the numerical magnitude of $M(x)$ for any value of x and for any circular coil. An excerpt from this paper is given in curve 1, Fig. 7. In the original article data are given from which $M(x)$ may be determined with an error of less than 0.1 per cent.

Where great accuracy is desired, the integral in (31) may be evaluated by use of numerical integration. When such great accuracy is not necessary it is much simpler to use an approximate equation for $M(x)$. Many such equations can be formed; however for our purpose it is desirable to obtain an easily integrable expression. One such equation is,

$$M(x) = 28.6An^2e^{-1.8x/A}10^{-9} \text{ henrys.} \quad (32)$$

This equation is accurate within seven per cent when b and c (Fig. 6) are less than A and when $0.3A < x < 1.5A$.

Substituting the value of $M(x)$ given in (32) into (31) and performing the indicated integration,

$$E' = -R'I \sin \omega t - L'I\omega \cos \omega t, \quad (33)$$

where,

$$R' = \frac{51.5Vn^210^{-9}e^{-3.6(D/A)}}{1 + (1.8V/A\omega)^2} \text{ ohms}$$

$$L' = -\frac{28.6An^210^{-9}e^{-3.6(D/A)}}{1 + (1.8V/A\omega)^2} \text{ henrys.} \quad (34)$$

That is, the apparent series resistance of coil (1) has been changed by an amount R' and the apparent series inductance by an amount L' due to the presence of the shield plane as shown in Figs. 1 and 6.

Now in order to simplify the notation we shall let γ be the per cent conductivity of the shield material with standard annealed copper taken as 100 per cent. Referring to (17), we see that

$$V = \sigma_c(2\pi) = \rho_c'(2\pi T) = \rho_{cu}'(2\pi T\gamma). \quad (35)$$

But,

$$\rho_{cu} = 1.724 \times 10^3 \text{ abohms/cm}^2, \text{ or}$$

$$V = 275(\gamma T) \text{ centimeters/second.} \quad (36)$$

Furthermore,

$$\omega = 2\pi f. \quad (37)$$

Therefore, if we substitute for V and ω in (34),

$$R' = \frac{1.42n^210^{-5}(1/\gamma T)e^{-3.6(D/A)}}{1 + (78.8AT\gamma f)^2} \text{ ohms} \quad (38)$$

$$L' = -\frac{28.6An^210^{-9}e^{-3.6(D/A)}}{1 + (78.8AT\gamma f)^2} \text{ henrys} \quad (39)$$

where,

R' is the apparent change in resistance of coil (1)

L' is the apparent change in inductance of coil (1)

n is the number of turns in coil (1)

γ is the per cent conductivity of the shield material

T is the shield thickness in centimeters

D is the distance in centimeters from the center of coil 1 to the center of the shield

A is the distance in centimeters from the axis of coil (1) to the center of its wire channel.

The above equations are accurate within plus or minus ten per cent so long as,

1. The shield area is greater than $8A^2$

2. $0.15A < D < 0.9A$

3. $b < A, c < A, T < 0.2A$.

When the value of $AT\gamma f$ increases, the accuracy becomes much better by reason of the fact that the errors tend to compensate in the integration involved in (31). Since, in practical cases, one is interested in studying shielding for cases where the resistance is very low in the shield and the thickness as large as possible, the value of $AT\gamma f$ is ordinarily quite large. This fact gives much better accuracy to (38) and (39) in the useful range.

The development leading up to (19) and (22) also places us in a position to determine the effect of placing a shield between coils (1) and (2), Fig. 1. Since we are here only considering the effects due to the current flowing in coil (1) we shall assume that the current flowing in coil (2) is zero, that is, that it is open-circuited. In cases where this assumption is incorrect, the only added difficulty would be to consider each coil separately and then add the separate effects as the solution for the combined problem.

The current flowing in coil (1) will induce in the shielding plane the same eddy currents previously discussed in connection with obtaining the change in series resistance and inductance of coil (1). Furthermore these eddy currents will induce in coil (2), which is on the negative side of the shield (see Fig. 6), the same voltage as they would in a similar coil placed an equal distance on the positive side of the shield. The equations needed in obtaining the voltage induced in coil (2) by the shield eddy currents will therefore be exactly similar in form to those leading up to (33) for the voltage induced in the primary coil itself. The difference will be that we must now use $D+D'$ where we used $2D$ before and nn' where we used n^2 before.

If we express this voltage by means of the familiar vector notation for alternating currents, we have, where \dot{I}_1 is the current flowing in coil (1) and where \dot{E}_2' is the voltage in coil 2 due to the shield currents,

$$\dot{E}_2' = - \frac{1.42(1/\gamma T)10^4 - j28.6\omega}{1 + (78.8/AT\gamma f)^2} nn'10^{-9}e^{-1.8} \frac{D + D'}{A} \dot{I}_1. \quad (40)$$

Note that \dot{E}_2' depends only on the sum $D+D'$ and is independent of either of them taken separately. The voltage in coil (2) with the shield absent is $-j\omega M_{12}\dot{I}_1$. If we represent this by \dot{E}_2'' we have, using (32) to get M_{12} ,

$$\dot{E}_2'' = -j\omega 28.6Ann'10^{-9}\dot{I}_1e^{-1.8} \frac{D + D'}{A}. \quad (41)$$

The total voltage induced in coil (2) will be the sum of that due to the shield currents alone and that due to the current in coil 1 alone, or if we denote it by \dot{E}_2 ,

$$\dot{E}_2 = \dot{E}_2' + \dot{E}_2''. \quad (42)$$

However, we are not so much interested in the vector value of the voltages in coil (2) with and without the shield as we are in the ratio between the effective values of these voltages. Forming this ratio, we have

$$\left| \frac{\dot{E}_2}{\dot{E}_2''} \right| = \left| \frac{-1.42(1/\gamma T)10^4 - j(78.8/AT\gamma f)^2\omega 28.6A}{28.6\omega A \{1 + (78.8/AT\gamma f)^2\}} \right| \quad (43)$$

which reduces to

$$\left| \dot{E}_2/\dot{E}_2'' \right| = [(AT\gamma f/78.8)^2 + 1]^{-1/2}. \quad (44)$$

Therefore the drop in decibels caused by inserting the shield between the two coils is,

$$\text{drop (db)} = 10 \log [(AT\gamma f/78.8)^2 + 1] \quad (45)$$

where A is the coil radius in centimeters, T the shield thickness in centimeters, γ the specific conductivity with standard annealed copper taken as 100 per cent, and f the frequency in cycles per second.

Note that within the degree of approximation indicated in (38) and (39) the ratio in (44) depends on the coils and shield used but not on their relative positions with respect to each other.

Applying (45), to obtain a drop in the cross-talk voltage of forty decibels, the value of $AT\gamma f$ would have to be 7880. For a sixty-decibel drop, the value of $AT\gamma f$ would have to be 78,800.

Thus if coils (1) and (2) had a mean radius of ten centimeters and one desired the shielding between them to produce a forty-decibel drop in cross talk, one would need to use a copper shield 0.08 centimeter thick at 10,000 cycles, whereas at 100,000 cycles a copper shield 0.008 centimeter thick would suffice, and at 1000 cycles 0.8 centimeter would be necessary.

Likewise, to obtain a forty-decibel drop in cross talk at 10,000 cycles between coils of one-centimeter radius would require a shield of copper 0.8 centimeter thick, while between coils of ten-centimeter radius a shield thickness of only 0.08 centimeter would be required, and between coils of 100-centimeter radius only 0.008 centimeter of thickness would be necessary.

The results which can be obtained by use of the integral equation (31) are highly accurate but require a lengthy numerical integration. For ordinary purposes and for use in making rough estimates, the results obtained in (38), (39), and (45), through use of the approximate (32), though not so accurate, are nevertheless more useful by reason of their readily calculable form.

Check experiments were run to measure both R' and L' and also the effectiveness of the shielding. The shields used were at least three times the size of the coils and had a thickness variation from place to place of not over ten per cent. The coils used in making the tests were scatter-wound in a wooden frame. No screws or other metallic parts were used in the construction. The spacing of the coils and shield was accomplished by inserting between the coil and the shield a sufficient number of pieces of flat composition board. In making the measurements the coils were placed opposite the center of the shield and the shields used were large enough so that a movement of a centimeter or two from this central position gave no perceptible change in the readings. Corrections were made in taking the readings for the internal capacity of the coils.

Case 1: A circular coil was used in front of a plane shield satisfying the conditions set forth with (38) and (39). The experimental arrangement was that shown in Fig. 1 with the exception that coil (2) was absent. The geometry was, (see Fig. 1) $A = 4.6$ cm., $b = 2.5$ cm., $c = 2.5$ cm., $n = 1374$ turns, $D = 1.63$ cm., $T = 0.16$ cm., $f = 1200$ cycles. The shielding material was standard annealed copper. The experimental values were,

$$R' = 46 \text{ ohms, and } L' = -0.066 \text{ henry.}$$

By calculation from (38) and (39) we get for the same set of conditions,

$$R' = 46 \text{ ohms and } L' = -0.069 \text{ henry,}$$

which checks very well for R' and within the limits of approximation in (38) and (39) for L' .

Case 2: Using the same coil as in Case 1 for the primary coil and using a similar coil with 1939 turns for coil (2), measurements were made of the drop in cross talk where, $D = D' = 1.84$ cm., $T = 0.16$ cm., and $f = 1333$ cycles. The shield used was No. 14 sheet copper. Experimentally, the drop in cross talk was found to be 22 decibels. The theoretical value obtained by using (45) is 22.1 decibels.

Other experimental tests made checked the theoretical equations to about the same degree of accuracy. Use was made of both copper and brass shielding plates. Care had to be taken not to bend the plates in any way as small bends had an appreciable effect on the readings. The worst readings obtained were in error by as much as fifteen per cent; however this was a relatively rare occurrence and in general the error was within five per cent for R' and L' and under one decibel in the cross-talk voltage.

THEOREMS GENERALLY APPLICABLE TO ELECTRO- MAGNETIC SHIELDING

In the literature,⁵ occasional reference is made to two very useful theorems. When they are applied to electromagnetic shielding and capacity effects are neglected they may be stated as follows:

Theorem I: Consider two geometrically identical shields of any shape whatsoever placed alternately in a given position with respect to a primary coil (1) of arbitrary shape. Let the per cent conductivity of the material of the first shield be k times the per cent conductivity of the material of the second shield. Then if at a frequency f and using the first shield the voltage induced in a neighboring coil by the eddy currents flowing in the shield due to \dot{I}_1 is $(R + jX)\dot{I}_1$, it follows that at a frequency kf and using the second shield, the voltage in the same neighboring coil induced by the eddy currents flowing in the shield due to \dot{I}_1 will be $k(R + jX)\dot{I}_1$.

Proof: Under the conditions assumed, the current flowing in each current path in the second shield will be exactly equal both in magnitude and in phase to the current flowing in the corresponding path in the first shield. But, due to the increase in frequency in the second case, the mutual impedance between the neighboring coil and each shield current path is k times as great as it was in the first case. Therefore the induced voltage is also increased by the factor k .

Theorem II: Consider any arrangement of coils with respect to a shield. Also consider another similar arrangement in which *all* the linear dimensions have been multiplied by a factor K . If at a frequency

f , using the first arrangement, the voltage induced in a neighboring coil by the shield eddy currents caused by the current \dot{I}_1 flowing in coil 1 is $(R+jX)\dot{I}_1$; then, it follows that at a frequency f/K^2 and using the second arrangement, the voltage induced in the corresponding neighboring coil by the shield eddy currents caused by \dot{I}_1 will be $1/K(R+jX)\dot{I}_1$.

Proof: In making the change in dimensions, the self-inductance of and the mutual inductance to each current path in the shield will be multiplied by the factor K . If the resistance of each of the current paths had also been multiplied by the factor K the voltage induced in the neighboring coil by the currents flowing in the shield at a frequency f would have been $K(R+jX)\dot{I}_1$. But the resistance of each current path has actually been divided by K . This is the equivalent of saying our per cent conductivity is K^2 times what we have used above. Using Theorem I to make this correction, we get at a frequency f/K^2 as the voltage induced in the neighboring coil, $(1/K)(R+jX)\dot{I}_1$.

These theorems are useful in correlating experimental data. By use of the first it is possible to determine the shielding effect of a brass shield by making measurements on a copper shield, and by use of the second it is possible to determine the shielding effect of any large shield by making measurements on a small-scale model. It must be carefully remembered however that in deriving these theorems capacity effects are neglected and their use should be governed accordingly.

ACKNOWLEDGMENT

Acknowledgment is gratefully made to Dr. H. E. Hartig of the University of Minnesota under whose direction these formulas were developed as a Master's Thesis in 1933, and to Mr. Greenspan who read the work in proof and made many valuable suggestions and criticisms.

Bibliography

- ¹ J. C. Maxwell, "On the induction of electric currents in an infinite plane sheet of uniform conductivity," *Proc. Royal Soc.*, vol. 20, p. 160; (1872).
- ² Morecroft and Turner, "The shielding of electric and magnetic fields," *Proc. I.R.E.*, vol. 13, pp. 477-506; August, (1925).
- ³ King, "Electromagnetic shielding at radio frequencies," *Phil. Mag.*, vol. 15, p. 201; (1933).
- ⁴ Lyons, "Experiments on electromagnetic shielding at frequencies between one and thirty kilocycles," *Proc. I.R.E.*, vol. 21, pp. 574-590; April, (1933).
- ⁵ Dwight and Slepian, "A discussion on skin effect in tubular and flat conductors," *Trans. A.I.E.E.*, vol. 37, p. 1403; (1918).
- ⁶ Curtis and Sparks, "Formulas, tables, and curves for computing the mutual inductance of two coaxial circles," *Bur. Stand. Sci. Paper No. 492*, (1924).
- ⁷ Grover, "Tables for the calculation of the mutual inductance of circuits with circular symmetry about a common axis," *Bur. Stand. Sci. Paper No. 498*, (1924).

BOOK REVIEWS

"Phenomena in High-Frequency Systems," by August Hund. McGraw-Hill Book Co., Inc., New York and London. 642 pages. Price \$6.00.

This book must be classified as a reference work, although in some respects it has the characteristics of a textbook and in others those of a "handbook." The subject matter treated covers a wide variety of topics some of which are covered in quite ambitious detail and others in very brief descriptive manner. The attempt to cover such a large mass of diverse material in one volume leads occasionally to an abruptness or breathlessness of style which is not conducive to clarity and to the inclusion of some topics which are discussed so cursorily as to raise the question of the wisdom of their introduction at all. However it must be conceded that on the whole the author has succeeded in giving a very fair picture of the present status of the theoretical basis of the phenomena considered.

The book is divided into thirteen chapters and an appendix of useful relations and tables. Numerous references to the literature are given in footnotes and an adequate combined subject and author index is included. A rather rapid reading has revealed relatively few typographical errors and none of misleading importance.

Chapters III, IV, and V on voltage, current, phase, and frequency changers are very brief and purely descriptive in nature, although the theory of some of the devices described is discussed elsewhere in the text. The remaining ten chapters cover the ground in much more detail. Of these chapters I, II, VI, and VII cover the usual topics in thermionics, gaseous discharge and photoelectricity together with their applications to devices for rectification, amplification, and the production of oscillations. In connection with the more recent developments in these matters it seems to the reviewer that the author's presentation leaves something to be desired. Thus although he devotes several paragraphs to the subject of high-frequency thermionics, he does not mention the very fundamental work of Benham in this field. A more obvious criticism of the first chapter however lies in its inclusiveness rather than in its omissions. The attempt to put within a space of fifty-five pages the theory of conduction as complicated by secondary emission, frequency, and illumination and to include a smattering of electron optics, quantum theory, and wave mechanics has resulted not altogether happily. Chapters II, VI, and VII while not suffering from the extreme compression of Chapter I seem to the reviewer to be deficient in the matter of orderly continuity of development. Although the ground is for the most part adequately covered, the reader has the sensation of being jerked instead of smoothly drawn along.

The chapters mentioned above constitute roughly one half of the book. The remaining chapters deal with the piezoelectricity of quartz (static and dynamic), electromagnetic wave propagation in general, propagation through an ionized medium, propagation along smooth conducting lines, directive antenna systems, and recurrent networks (filters). This portion of the book reads on the whole more smoothly, and gives an adequate if sometimes naïve and not very critical presentation of the theories involved. The treatment is in general carried out to the development of design formulas.

In spite of its defects the reviewer believes that this book will be found to be of value to the radio engineer. Many a busy practical engineer will find it convenient to have in one volume a book which summarizes both the older and the newer work over such a wide range of topics.

*LYNDE P. WHEELER

"Einführung in die Angewandte Akustik." (Introduction to Applied Acoustics), by H. J. von Braunmühl and Walter Weber. Published by S. Hirzel, Leipzig, Germany, 216 pages, 154 illustrations. Price Rm 9.20 unbound, Rm 10.70 bound.

The two authors are engineers of the Reichsrundfunk-Gesellschaft. In general the book is well written. The German style is less involved than that used by many German authors and the reading is therefore not difficult for an American who has a fair knowledge of German.

Chapters are included on fundamentals, microphones, and loud-speakers, sound measurements, sound recording, auditorium acoustics, and the reproduction of sound. With the exception of the chapter on sound recording, the reader will find that the subject has been covered in at least as satisfactory a manner in books which are available in English. The reader who is interested in developing acoustical apparatus will particularly miss the explanation of the performance of the different types of apparatus in terms of fundamental concepts in any but the most general terms. The authors have also for the most part omitted the electrical analogues which have been of great help in development of acoustic apparatus.

The chapter on recording contains sections on disk, film, and wire methods and treats the latest development of these systems in greater detail than is available in books in English.

The chapter on the reproduction of sound discusses various methods which are available to obtain a true transport of the listener to the place where the sound is being picked up. Volume compression-expansion, binaural, and auditory perspective systems are described.

This book makes a good addition to the library of one who is interested in having a fairly complete library of the better books on applied acoustics or who is particularly interested in a general discussion of the newest sound recording methods.

†IRVING WOLFF

* Washington, D. C.

† RCA Manufacturing Co., Inc., Camden, New Jersey.



BOOKLETS, CATALOGS, AND PAMPHLETS RECEIVED

Copies of the publications listed on this page may be obtained without charge by addressing the publishers.

Hygrade Sylvania Corporation of Emporium, Pa., has issued technical data sheets for the following tubes: 5W4, full-wave high vacuum rectifier; 5Y3, full-wave rectifier; 6A8G, pentagrid converter; 6C5G, Triode amplifier; 6F5G, high-mu triode; 6F6G, power amplifier; 6H6G, double diode; 6J7G, triple grid amplifier and detector; 6K7G, triple grid supercontrol amplifier; 6L7G, pentagrid mixer amplifier; 6N6G, direct-coupled power amplifier; 6Q7G, double diode high-mu triode; 6X5G, full-wave high vacuum rectifier; 25A6G, power amplifier pentode; 25Z6G, high vacuum rectifier and voltage doubling tube. An additional sheet gives data on a series of 2 volt "G" tubes. Engineering News Letter Number 22 covers audio output systems for automobile receivers and Number 23 is on the characteristics of resistance coupled amplifiers.

The RCA Manufacturing Company, Radiotron Division, Harrison, N. J., has issued technical data sheets on the following tubes: 1A4 and 1B4, supercontrol radio-frequency amplifier tetrode; 6Q7, duplex-diode high-mu triode; 6R7, duplex-diode triode; 6X5, fullwave rectifier; 25A6, power amplifier pentode; 25Z6, rectifier doubler; 804, radio-frequency power amplifier pentode; 805, radio-frequency power amplifier, oscillator, class B modulator; 830-B, class B modulator, radio-frequency power amplifier, oscillator; 834, radio-frequency power amplifier and oscillator; 868, gaseous type phototube; 909, high vacuum electrostatic type cathode-ray tube with long-persistence screen; 910, high vacuum electrostatic type cathode-ray tube with long-persistence screen; 911, high-vacuum electrostatic type cathode-ray tube with gun unusually free from magnetization effects; 917, vacuum type phototube; 918, gaseous type phototube; 919, vacuum type phototube. Application Note No. 58 is on receiver design and No. 59 is on the operation of the 6Q7.

An extensive line of fixed and adjustable resistors is covered in the 1936 catalog issued by Electrad, Inc., of 175 Varick St., New York City.

The Operadio Manufacturing Company of St. Charles, Ill. has issued catalog 10 covering public address equipment and radio receiving set replacement speakers.

Their 30FXC 200-watt high-frequency transmitter is described in a leaflet issued by the Collins Radio Company of Cedar Rapids, Iowa. Additional catalogs cover their 45A 125-watt high-frequency transmitter, broadcast transmitters, and speech input equipment.

Catalog No. 63, issued by the Wholesale Radio Service Company of 100-6th Ave., New York City, covers an extensive line of receivers and components.

Police radio transmitting equipment No. 309B is covered in a catalog issued by the Western Electric Company of 195 Broadway, New York City.

Federated Purchaser of 25 Park Pl., New York City, has issued catalog No. 19 on radio receivers and components.

RCA Manufacturing Company of Camden, N. J., has issued leaflets describing AVT-7 and 7A aircraft radio transmitters and models AVT-12 and 12-A aircraft transmitters.

CONTRIBUTORS TO THIS ISSUE

Brainerd, John Grist: Born 1904. Police reporter. *Philadelphia North American*, 1923-1925. Instructor and assistant professor, Moore School of Electrical Engineering, University of Pennsylvania, 1925 to date. Received B.S. degree, University of Pennsylvania, 1925; Sc.D. degree, 1934. Associate member, Institute of Radio Engineers, 1933.

Crosby, Murray G.: Born September 17, 1903, at Elroy, Wisconsin. University of Wisconsin, 1921-1925. Radio Corporation of America, 1925-1927. Received B.S. degree in electrical engineering, University of Wisconsin, 1927. RCA Communications, Inc., 1927 to date. Associate member, American Institute of Electrical Engineers. Associate member, Institute of Radio Engineers, 1925.

Dunmore, F. W.: Born January 24, 1891, at Haverhill, Massachusetts. Commercial radio operator, summers, 1911-1913. Received B.S. degree, Pennsylvania State College, 1915. Student engineering course, General Electric Company, 1915-1917; research department, American Radio and Research Corporation, 1918; radio physicist, Radio Section, National Bureau of Standards, 1936; member Bureau radio staff, specializing in research work on direction finders, directional transmission, ultra-high-radio-frequency transmitters and receivers, and radio aids to air navigation, 1918 to date. Nonmember, Institute of Radio Engineers.

Kirby, S. S.: Born October 27, 1893, at Gandy, Nebraska. Received A.B. degree, College of Emporia, 1917; M.A. degree, University of Kansas, 1921. Signal Corps, U. S. Army, A.E.F., 1918-1919. High school teacher, 1919-1921; professor of physics, Friends University, Wichita, Kansas, 1921-1926; assistant physicist, Bureau of Standards, 1926-1930; associate physicist, 1930 to date. Associate member, Institute of Radio Engineers, 1927.

Leeds, Laurance M.: Born October 10, 1906, at Tulsa, Oklahoma. Received B.S. degree in electrical engineering, Rutgers University, 1934. Amateur, 1917; Manhattan Electrical Supply Company, 1922; Peck Radio Corporation, 1922; Marine Inspector, RCA, 1922; Westinghouse Electric and Manufacturing Company, broadcast station WBZ, 1923; marine operator, 1923-1926; Tropical Radio Telegraph Company, 1926-1927, New Jersey Bell Telephone Company, 1927-1929; American Telephone and Telegraph Company, 1929-1930; General Electric Company, 1934 to date. Associate member, Institute of Radio Engineers, 1930.

Levy, S.: Born June 28, 1912, at St. Paul, Minnesota. Received B.S. degree in electrical engineering, University of Minnesota, 1933, M.S. degree, 1934. Research, University of Minnesota, 1934-1935. National Bureau of Standards, 1935 to date. Nonmember, Institute of Radio Engineers.

Salzberg, Bernard: Born July 22, 1907. Received E. E. degree, Polytechnic Institute of Brooklyn, 1929; M.E.E. degree, 1933. Brooklyn Edison Company, Inc., 1923-1925, summers, 1926-1927. Fada Radio Company, Inc., summer,

1928. RCA Communications, Inc., 1929-1931; research and development laboratory, RCA Radiotron Company, Inc., 1931-1935; Radiotron Division, RCA Manufacturing Company, Inc., 1935 to date. Junior member, Institute of Radio Engineers, 1925; associate, 1930.

Wheeler, Harold Alden: Born May 10, 1903, at St. Paul, Minnesota. Received B.S. degree in physics, George Washington University, 1925. Postgraduate studies, physics department, Johns Hopkins University, 1925-1928; lecturer, 1926-1927. Assistant, Radio Section, Bureau of Standards, 1921-1922; assistant to Professor Hazeltine, 1923; engineer, Hazeltine Corporation, 1924 to date. Member, Sigma Xi. Associate member, Institute of Radio Engineers, 1927; Member, 1928; Fellow, 1935.

Weygandt, Cornelius N.: Born 1904 at Germantown, Pennsylvania. Received B.S. degree, University of Pennsylvania, 1928. General Electric Company, 1928-1932. Received M.S. degree, Massachusetts Institute of Technology, 1933. Brooke Engineering Company, Philadelphia, 1934-1935. Instructor, Moore School of Electrical Engineering, University of Pennsylvania, 1935 to date. Non-member, Institute of Radio Engineers.

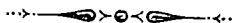

*The Service Representative
in the telephone business
office greets a young
couple who want to have
a telephone installed.*



The Bell System serves the whole country, yet it remains close to the people. The people use it. Their savings built it. "It belongs to Main Street."

The 270,000 employees of the Bell System live and work in your neighborhood and in similar neighborhoods in every section of the country. They are good neighbors. Thousands of times each day and

night their activities bring friendly aid to those in need.

To every one—to the newlyweds, to the man in the grand house on the hill or the little lady with the shawl—the Bell System offers the same full measure of service.

And seeks to do it always with courtesy and sympathetic understanding—in the manner of a friend.



BELL TELEPHONE SYSTEM

When writing to advertisers mention of the PROCEEDINGS will be mutually helpful.



SYMBOLS OF SCIENCE AND SERVICE TO THE RADIO MAN

IN EVERY field of endeavor, there is always one company that takes the lead . . . one label that stands for leadership in quality and service. In this industry, radio men specify and use Cornell-Dubilier condensers. The smallest "ham" rig, and the world's largest transmitting station, alike, boast capacitors bearing the C-D trademark.

Throughout the industry, C-D labels, representing twenty-six years of manufacturing experience, research and development, are symbols of unflinching dependability. Their widespread acceptance is your assurance that you may, with safety, specify Cornell-Dubilier capacitors—"Proven by the Past, Improved for the Future."



Catalogs No. 127 and 128 giving complete technical data on the complete C-D Line of Industrial and Transmitting Condensers are available for Radio Engineers. Send for your copies today.

THE WORLD'S MOST COMPLETE CONDENSER LINE. DYKANOL • MICA • PAPER • WET & DRY ELECTROLYTIC

CORNELL-DUBILIER

CORPORATION

4379 BRONX BOULEVARD • NEW YORK

When writing to advertisers mention of the PROCEEDINGS will be mutually helpful.

The Institute of Radio Engineers

Incorporated

330 West 42nd Street, New York, N.Y.

APPLICATION FOR ASSOCIATE MEMBERSHIP

(Application forms for other grades of membership are obtainable from the Institute)

To the Board of Directors
Gentlemen:

I hereby make application for Associate membership in the Institute of Radio Engineers on the basis of my training and professional experience given herewith, and refer to the members named below who are personally familiar with my work.

I certify that the statements made in the record of my training and professional experience are correct, and agree if elected, that I will be governed by the constitution of the Institute as long as I continue a member. Furthermore I agree to promote the objects of the Institute so far as shall be in my power, and if my membership shall be discontinued will return my membership badge.

.....
(Sign with pen)

.....
(Address for mail)

.....
(Date)

.....
(City and State)

Sponsors:

(Signature of references not required here)

Mr. Mr.

Address Address

City and State City and State

Mr.

Address

City and State

The following extracts from the Constitution govern applications for admission to the Institute in the Associate grade:

ARTICLE II—MEMBERSHIP

Sec. 1: The membership of the Institute shall consist of: * * * (c) Associates, who shall be entitled to all the rights and privileges of the Institute except the right to hold any elective office specified in Article V. * * *

Sec. 4: An Associate shall be not less than twenty-one years of age and shall be a person who is interested in and connected with the study or application of radio science or the radio arts.

ARTICLE III—ADMISSION AND EXPULSIONS

Sec. 2: * * * Applicants shall give references to members of the Institute as follows: * * * for the grade of Associate, to three Fellows, Members, or Associates; * * * Each application for admission * * * shall embody a full record of the general technical education of the applicant and of his professional career.

ARTICLE IV—ENTRANCE FEE AND DUES

Sec. 1: * * * Entrance fee for the Associate grade of membership is \$3.00 and annual dues are \$6.00.

ENTRANCE FEE SHOULD ACCOMPANY APPLICATION

NEW RCA MODULATION MONITORS

*Tested and approved
by the FCC*

THIS new RCA Modulation Monitor meets every requirement of the FCC—as to response, accuracy and stability. In addition, you are offered four RCA Features of unusual value.

- 1 Added range, useful in taking amplitude characteristics.
- 2 High impedance r-f Input Circuit, easily excited.
- 3 Flasher as well as meter operates on either positive or negative peak of modulation.
- 4 Low power excitation.



RCA Type 66-B Modulation Monitor for standard rack mounting. Price \$150, less tubes, f. o. b. Camden. Metal cabinet for desk or table mounting at slight additional cost.

In addition to RCA Type 66-B Modulation Monitor (illustrated), there is also a new Type 66-A which offers oversize meters, and high speed relay in flash circuit. RCA Type 66-A priced at \$185, less tubes.



Get in touch with one of these offices:
New York, 1270 Sixth Avenue; Chicago,
111 North Canal St.; San Francisco, 170
Ninth St.; Dallas, 2211 Commerce St.;
Atlanta, 492 Peachtree St., N. E.

Transmitter Section

RCA MANUFACTURING COMPANY, INC.
Camden, New Jersey — A Service of the Radio Corporation of America

When writing to advertisers mention of the PROCEEDINGS will be mutually helpful.

RESONANCE TUNING METERS FOR SUPERIOR TUNING

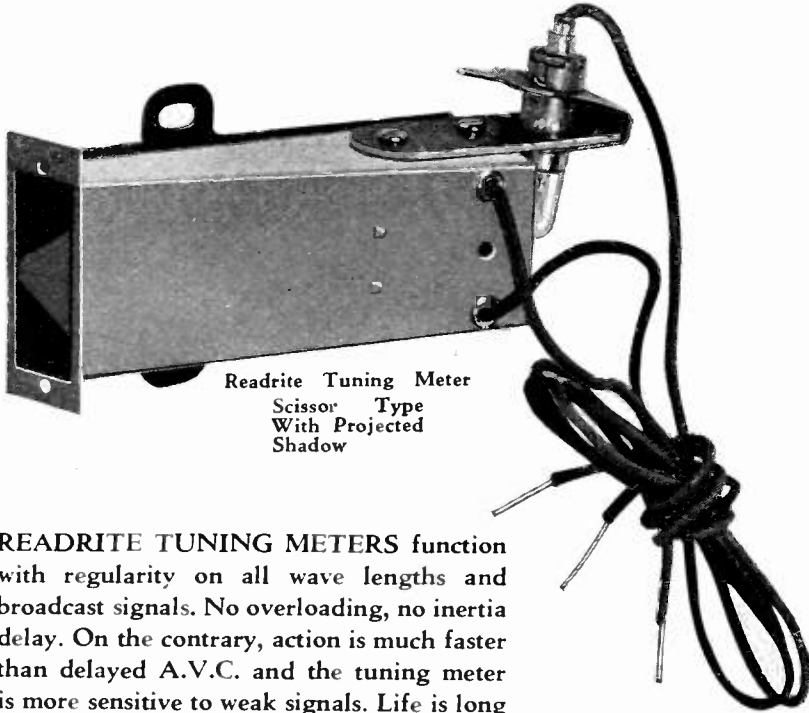

Readrite Tuning Meter
Scissor Type
With Projected
Shadow

READRITE TUNING METERS function with regularity on all wave lengths and broadcast signals. No overloading, no inertia delay. On the contrary, action is much faster than delayed A.V.C. and the tuning meter is more sensitive to weak signals. Life is long and unchanging.

A wide selection of standard models is available. Special designs can be obtained also to meet individual requirements. Tuning meters thus offer an opportunity to have a radio panel that is both attractive and distinctive as well as to meet the demand of the critical buyer.

Readrite Tuning Meters are surprisingly low in cost.

Write for more details: our engineers are at your service.

MAIL THIS COUPON

Readrite

TESTERS AND METERS

Readrite Meter Works,
621 College St., Bluffton, Ohio.
Please send me more information on tuning meters.

Engineer's Name
Company
Address
City State

When writing to advertisers mention of the PROCEEDINGS will be mutually helpful.

Another Contribution

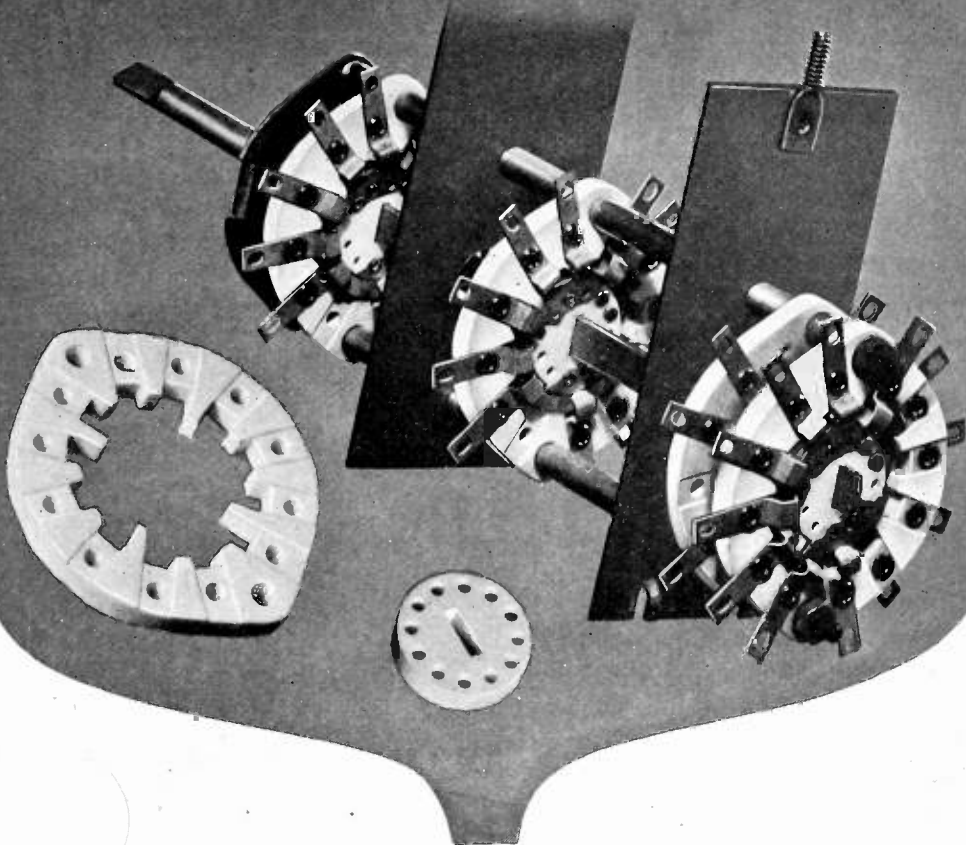

ISOLANTITE has helped to improve many pieces of equipment and now makes another contribution to this CENTRALAB wave change switch.

ISOLANTITE may also be the means of helping to improve your product.

ISOLANTITE INC. 233 Broadway, N. Y. C.
Factory at Belleville, N. J.

Visit our exhibit at the I. R. E. Convention at Cleveland



Isolantite
CERAMIC INSULATORS

When writing to advertisers mention of the PROCEEDINGS will be mutually helpful.

Change in Mailing Address or Business Title

Members of the Institute are asked to use this form to notify the Institute office of a change in their mailing address or the listing of their company affiliation or title.

The Secretary
THE INSTITUTE OF RADIO ENGINEERS
330 West 42nd Street
New York City

Old Mailing Address

Name _____
(Print or type)

Street _____

City and State _____

New Mailing Address

Street _____
(Print or type)

City and State _____

New Affiliation or Title

Title _____
(Print or type)

Company Name _____

Company Address _____

Signature _____

Date _____

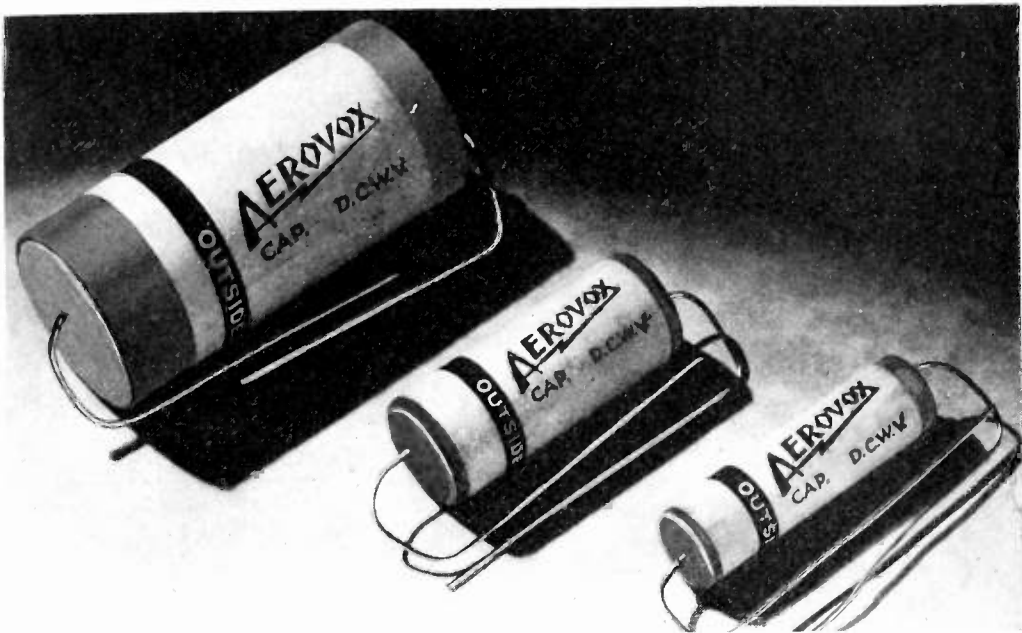

Better Tubulars

DEVELOPED originally to withstand trying salt air and humidity of ocean shipment to buyers half-way round the world. Now standard production. • Triple sealed, providing maximum protection against humidity. In comparative humidity tests these tubulars indicate negligible drop in insulation resistance when conventional units drop to zero resistance, and $4\frac{1}{2}$ times longer life. • Why not check these facts for yourself?

Write for general catalog covering the complete line of condensers and resistors. And do not hesitate to submit condenser and resistor problems for engineering aid and quotations.

AEROVOX

CORPORATION

71 Washington St.,

Brooklyn, N. Y.

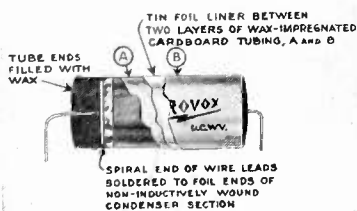

First Seal: Non-inductively wound section of selected paper and foil, oil impregnated and wax coated.

Second Seal: Heavy wax-impregnated tubing with special imbedded liner serving as armor against moisture.

Third Seal: Liberal wax-sealed ends in place of usual spun-over ends.

These three seals, plus conservative ratings, as well as pigtails that will not work loose, provide better units at no added cost.



When writing to advertisers mention of the PROCEEDINGS will be mutually helpful.

ENGINEERING DIRECTORY

QUARTZ CRYSTALS

for Standard or Special
Radio Frequency Applications

Write for Catalog

BLILEY ELECTRIC CO.

230 Union Station Bldg.
ERIE, PENNA.

**Cathode Ray Tubes
and Associated
Equipment For All
Purposes**

*Write for Complete
Technical Data*

**ALLEN B. DUMONT
LABORATORIES
UPPER MONTCLAIR, N.J.**

PRACTICAL RADIO ENGINEERING

One year Residence Course
Advanced Home Study Course
Combined Home Study-Residence
Course

Write for details

**Capitol Radio Engineering
Institute
Washington, D.C.**

MICROPHONE APPLICATIONS

Our engineering department will co-
operate, without obligation, in the
selection of suitable microphones for
standard or special applications.

SHURE BROTHERS

"Microphone Headquarters"
215 WEST HURON ST. CHICAGO, U.S.A.

Alphabetical Index to Advertisements

A

Aerovox CorporationXVII
American Tel. & Tel. CompanyIX

C

Central Radio LaboratoriesXX
Cornell-Dubilier CorporationX

E

Employment PageCover III
Engineering DirectoryXVIII
Erie Resistor CorporationXIX

G

General Radio CompanyCover IV

I

Institute of Radio EngineersXI, XII, XVI, Cover III
Isolantite, Inc.XV

R

RCA Manufacturing Company, Inc.XIII
Readrite Meter WorksXIV

When writing to advertisers mention of the PROCEEDINGS will be mutually helpful.

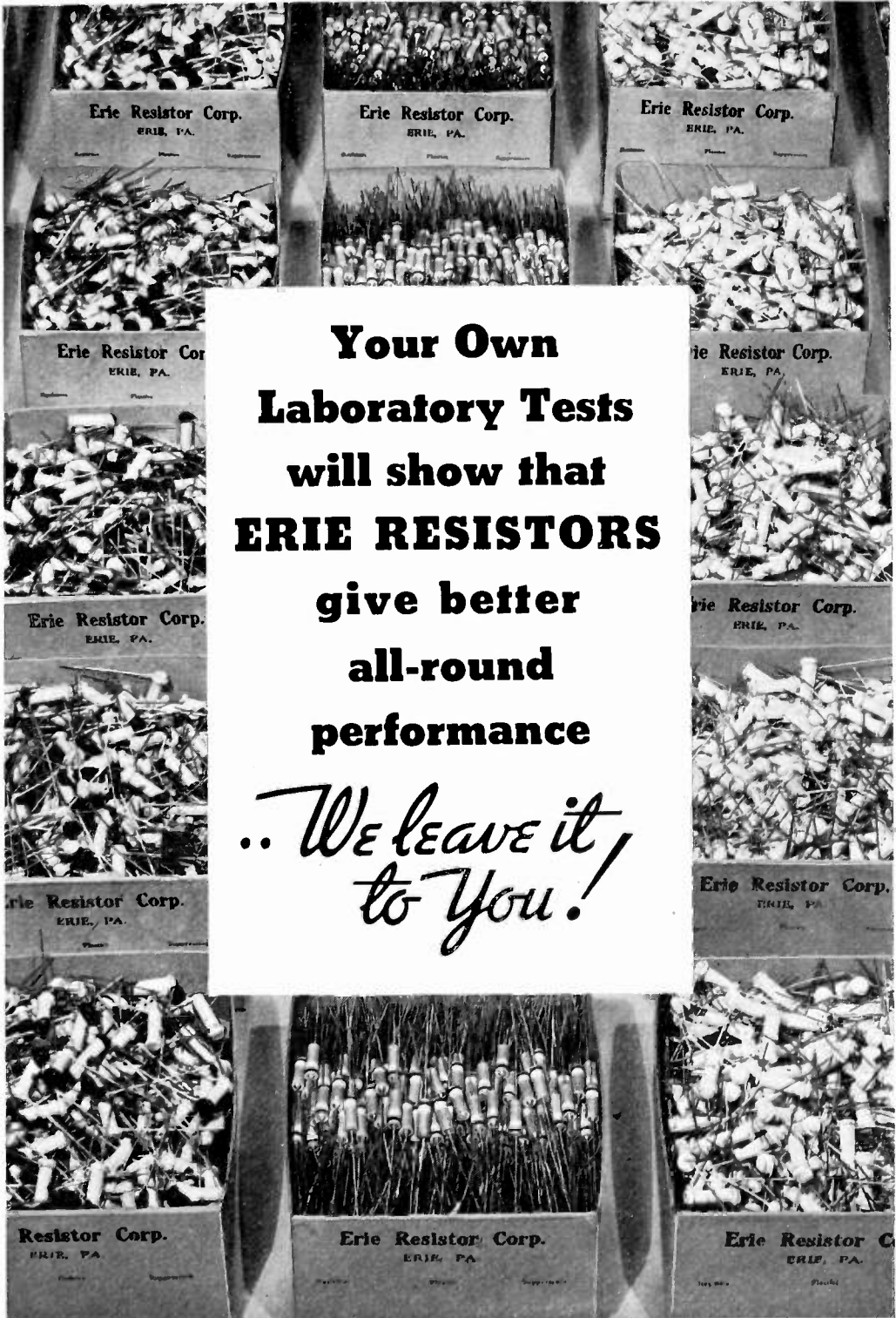

**Your Own
Laboratory Tests
will show that
ERIE RESISTORS
give better
all-round
performance**

*.. We leave it,
to You!*

CARBON RESISTORS
AND SUPPRESSORS

**ERIE RESISTOR
CORPORATION**

AUTOMATIC INJECTION
MOLDING

TORONTO

ERIE, PENNSYLVANIA

LONDON

When writing to advertisers mention of the PROCEEDINGS will be mutually helpful.

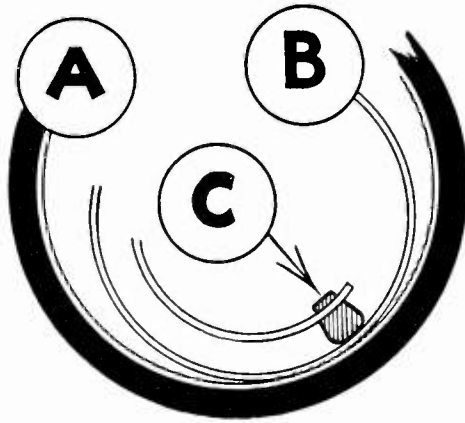

The A B C of Good Volume Control

- A** Resistor strip on inner circumference of Bakelite case has longest possible length to insure smooth volume control and low noise level.
- B** Highly polished non-rotating metal band contacts the resistor over a large area. Result, low contact resistance with light pressure, low noise level, no resistance change or wear.

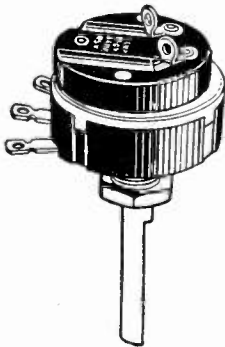

- C** Oilless wood bearing provides the contact pressure and glides over the polished metal band when control is rotated. Permanently quiet and smooth turning.

British Centralab, Ltd.
Canterbury Rd., Kilburn
London, N.W. 6, England

Centralab
68-70 Rue Amelot
Paris, France

Centralab

MILWAUKEE, WISCONSIN

Radiohms : Suppressors : Fixed Resistors : Wave change Switches

When writing to advertisers mention of the PROCEEDINGS will be mutually helpful.

EMPLOYMENT PAGE

GRADUATE Pratt Institute with two years experience on measurement and construction of test equipment and testing of broadcast receivers desires placement in these fields. 30 years old and unmarried. Box No. 157, care of The Institute of Radio Engineers.

PROMINENT TUBE MFR. WANTS ENGINEER, thoroughly experienced in the design, development and manufacturing of radio receiving tubes. Good knowledge of present type tubes and actual factory and laboratory experience essential. Desirable opportunity for the right man. Location: New England. Reply Box No. 158, care of The Institute of Radio Engineers, stating experience, and salary expected.

ENGINEERING POSITIONS

Advertisements on this page are accepted from Institute members who desire new positions and organizations which are interested in employing Institute members. A nominal charge of \$2.00 is made for each insertion. Information on the preparation of material and closing dates for its acceptance will be mailed on request.

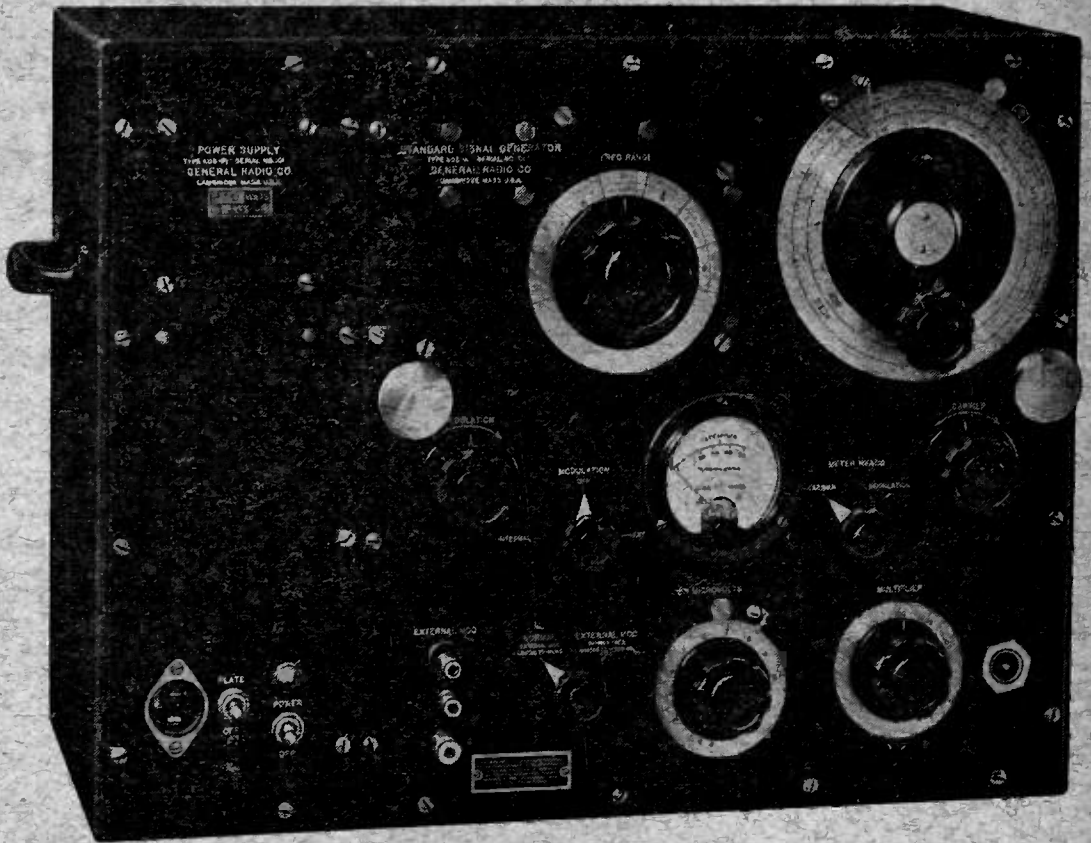

A NEW Standard-Signal Generator

NOW announced after several years of development, the new G-R Type 605-A Standard Signal Generator with its many novel mechanical and electrical developments has *all* the features you have wanted.

Check these characteristics against your ideal:

- Direct Reading in Frequency
- No Plug-In Coils
- Continuous Range 10 kc to 30 Mc
- A-C Operated with Built-in Voltage Regulator
- 400-cycle Internal and 30 to 15,000 cycle External Modulation
- No Frequency Modulation
- No Reaction of Attenuator or Frequency
- V. T. Voltmeter Indicates Carrier Amplitude

Available in four models for either 42, 50 or 60 cycle a-c or battery operation.

Type 605-A Standard Signal Generator: \$415.00

Write for Bulletin 14-R for complete data

GENERAL RADIO COMPANY
CAMBRIDGE MASSACHUSETTS