

VOLUME 22

APRIL, 1934

NUMBER 4

PROCEEDINGS  
*of*  
**The Institute of Radio  
Engineers**



**Ninth  
Annual Convention  
Philadelphia, Pennsylvania  
May 28, 29, 30, 1934**

**Form for Change of Mailing Address or Business Title on Page XVII**

---

# Institute of Radio Engineers Forthcoming Meetings

---

## NINTH ANNUAL CONVENTION

Philadelphia, Pennsylvania

May 28, 29, and 30, 1934

---

## LOS ANGELES SECTION

April 16, 1934

---

## NEW YORK MEETING

April 4, 1934

---

## PHILADELPHIA SECTION

April 5, 1934

May 3, 1934

---

## WASHINGTON SECTION

April 9, 1934

---

PROCEEDINGS OF  
**The Institute of Radio Engineers**

Volume 22

April, 1934

Number 4

Board of Editors

ALFRED N. GOLDSMITH, *Chairman*

R. R. BATCHER

H. H. BEVERAGE

F. W. GROVER

G. W. PICKARD

K. S. VAN DYKE

L. P. WHEELER

L. E. WHITTEMORE

WILLIAM WILSON

CONTENTS

PART I

|  |     |
|--|-----|
| Institute News and Radio Notes.....              | 411 |
| March Meeting of the Board of Directors.....     | 411 |
| Joint Meeting of I. R. E. and U. R. S. I.....    | 411 |
| Radio Transmissions of Standard Frequencies..... | 412 |
| Committee Work.....                              | 414 |
| Institute Meetings.....                          | 416 |
| Personal Mention.....                            | 421 |

PART II

*Technical Papers*

|   |  |     |
|---|--|-----|
| A New Method of Removing Distortions Due to the Space Charge in Gas-Filled Cathode Ray Oscillograph Tubes.... | MANFRED VON ARDENNE                          | 423 |
| League of Nations Wireless Station.....   | G. F. VAN DISSEL                             | 430 |
| The Testing of Frequency Monitors for the Federal Radio Commission.....                                       | W. D. GEORGE                                 | 449 |
| High-Frequency Models in Antenna Investigations.....  | G. H. BROWN AND RONALD KING                  | 457 |
| Studies of the Ionosphere and Their Application to Radio Transmission.....                                    | S. S. KIRBY, L. V. BERKNER, AND D. M. STUART | 481 |
| Propagation of High-Frequency Currents in Ground Return Circuits....  | W. H. WISE                                   | 522 |
| Booklets, Catalogs, and Pamphlets Received.....   |  | 528 |
| Contributors to This Issue.....   |  | 529 |

# The Institute of Radio Engineers

---

## GENERAL INFORMATION

**INSTITUTE.** The Institute of Radio Engineers was formed in 1912 through the amalgamation of the Society of Wireless Telegraph Engineers and the Wireless Institute. Its headquarters were established in New York City and the membership has grown from less than fifty members at the start to several thousand.

**AIMS AND OBJECTS.** The Institute functions solely to advance the theory and practice of radio and allied branches of engineering and of the related arts and sciences, their application to human needs, and the maintenance of a high professional standing among its members. Among the methods of accomplishing this is the publication of papers, discussions, and communications of interest to the membership.

**PROCEEDINGS.** The PROCEEDINGS is the official publication of the Institute and in it are published all of the papers, discussions, and communications received from the membership which are accepted for publication by the Board of Editors. Copies are sent without additional charge to all members of the Institute. The subscription price to nonmembers is \$10.00 per year, with an additional charge for postage where such is necessary.

**RESPONSIBILITY.** It is understood that the statements and opinions given in the PROCEEDINGS are views of the individual members to whom they are credited, and are not binding on the membership of the Institute as a whole. Papers submitted to the Institute for publication shall be regarded as no longer confidential.

**REPRINTING PROCEEDINGS MATERIAL.** The right to reprint portions or abstracts of the papers, discussions, or editorial notes in the PROCEEDINGS is granted on the express condition that specific reference shall be made to the source of such material. Diagrams and photographs published in the PROCEEDINGS may not be reproduced without making specific arrangements with the Institute through the Secretary.

**MANUSCRIPTS.** All manuscripts should be addressed to the Institute of Radio Engineers, 33 West 39th Street, New York City. They will be examined by the Papers Committee and the Board of Editors to determine their suitability for publication in the PROCEEDINGS. Authors are advised as promptly as possible of the action taken, usually within two or three months. Manuscripts and illustrations will be destroyed immediately after publication of the paper unless the author requests their return. Information on the mechanical form in which manuscripts should be prepared may be obtained by addressing the secretary.

**MAILING.** Entered as second-class matter at the post office at Menasha, Wisconsin. Acceptance for mailing at special rate of postage is provided for in the act of February 28, 1925, embodied in Paragraph 4, Section 412, P. L. and R., and authorization was granted on October 26, 1927.

---

Published monthly by

**THE INSTITUTE OF RADIO ENGINEERS, INC.**

Publication office, 450-454 Ahnaip St., Menasha, Wis.

BUSINESS, EDITORIAL, AND ADVERTISING OFFICES

Harold P. Westman, *Secretary*

33 West 39th Street, New York, N. Y.



## INSTITUTE SECTIONS

- ATLANTA—Chairman, Henry L. Reid; Secretary, Philip C. Bangs, 23 Kensington Road, Avondale Estates, Ga.
- BOSTON—Chairman, E. L. Chaffee; Secretary, G. W. Kenrick, Tufts College, Mass.
- BUFFALO-NIAGARA—Chairman, L. Grant Hector; Secretary, E. C. Waud, 235 Huntington Avenue, Buffalo, N. Y.
- CHICAGO—Chairman, Hugh S. Knowles; Secretary, John S. Meck, The Fensholt Company, 549 W. Washington St., Chicago, Ill.
- CINCINNATI—Chairman, W. C. Osterbrock; Secretary, Helen Hymans, Crosley Radio Corporation, Cincinnati, Ohio.
- CLEVELAND—Chairman, F. G. Bowditch; Secretary, C. H. Shipman, 14805 Ardenall Ave., East Cleveland, Ohio.
- CONNECTICUT VALLEY—Chairman, K. S. Van Dyke; Secretary, C. B. De Soto American Radio Relay League, 38 La Salle Rd., W. Hartford, Conn.
- DETROIT—Chairman, Samuel Firestone; Secretary, E. C. Denstaedt, Detroit Police Department, Detroit, Mich.
- LOS ANGELES—Chairman, H. C. Silent; Secretary, N. B. Neely, 1569 Munson Ave., Los Angeles, Calif.
- NEW ORLEANS—Chairman, J. A. Courtenay; Secretary, C. B. Reynolds, Radiomarine Corporation, 512 St. Peter St., New Orleans, La.
- PHILADELPHIA—Chairman, W. F. Diehl; Secretary, R. L. Snyder, Bell Telephone Company of Pennsylvania, 1835 Arch St., Philadelphia, Pa.
- PITTSBURGH—Chairman, Lee Sutherlin; Secretary, A. P. Sunnergren, West Penn Power Company, 14 Wood St., Pittsburgh, Pa.
- ROCHESTER—Chairman, Arthur L. Schoen; Secretary, Earl C. Karker, Mechanics Institute, 55 Plymouth Ave., Rochester, N. Y.
- SAN FRANCISCO—Chairman, G. T. Royden; Secretary, R. C. Shermund, 2300-16th Ave., San Francisco, Calif.
- SEATTLE—Chairman, Howard Mason; Secretary, Raymond C. Fisher, 602 N. C. St., Tacoma, Wash.
- TORONTO—Chairman, W. F. Choat; Secretary, G. E. Pipe, Rogers-Majestic Corporation, Toronto, Ont., Canada.
- WASHINGTON—Chairman, T. McL. Davis; Secretary, C. L. Davis, Washington Building, 15th and G Sts. N. W., Washington, D. C.

**GEOGRAPHICAL LOCATION OF MEMBERS ELECTED  
MARCH 7, 1934**

Elected to the Associate Grade

|               |   |                  |
|---------------|---|------------------|
| California    | Alhambra, 700 N. Monterey St.                   | Gould, L. K.     |
| Massachusetts | Belmont, 40 Upland Rd.                          | Norton, G. A.    |
|               | Beverly, 362 Cabot St.                          | Biggs, O. H.     |
|               | Beverly, 15 Ives St.                            | Carnahan, C. W.  |
|               | Cambridge, 26 Conant Hall                       | Kohler, H. W.    |
|               | Danvers, 45 B—Chase St.                         | Cox, J. L.       |
|               | Danvers, 45 A—Chase St.                         | McCarthy, H. J.  |
|               | Danvers, 43 Central Ave.                        | Swan, R. A., Jr. |
|               | Everett, 59 Glendale St.                        | Kimball, C. N.   |
|               | Marblehead, 3 Pickwick Rd.                      | Haller, C. W.    |
|               | Salem, 31 Nursery St.                           | Henderson, F. C. |
|               | Somerville, 8 Leon St.                          | Rockwell, S. A.  |
| New Jersey    | Great Notch, Box 6                              | Budelman, F. T.  |
| New York      | Brooklyn, 281 Carlton Ave.                      | Mercer, J. S.    |
|               | New York, 140 W. 77th St.                       | Chipp, R. D.     |
|               | New York, Rm. 212, 1 Madison Ave.               | Ohno, S.         |
|               | Orangeburg, R.F.D.                              | Stafford, L. A.  |
|               | Rochester, 5 Wendell St.                        | Braman, P. U.    |
| Ohio          | Cincinnati, 1268 Michigan Ave.                  | Osmond, A. S.    |
|               | Columbus, 71 E. Lane Ave.                       | Spangenberg, K.  |
| Pennsylvania  | Media, 507 S. Orange St.                        | Richardson, F.   |
|               | Philadelphia, 5903 Wayne Ave.                   | Pearson, E. E.   |
| Tennessee     | Knoxville, P.O. Box 972                         | Epperson, J. B.  |
| Australia     | Dubbo, N.S.W., 263 Brisbane St.                 | Everett, F.      |
| British India | Lahore, Punjab, D-96 Model Town                 | Handa, G. C.     |
| Canada        | Calgary, Alta, Suite 9, 1040 8th St. E.         | Nielsen, K. D.   |
|               | Halifax, Nova Scotia, 4 Brenton Pl.             | Egan, E. J.      |
|               | Halifax, Nova Scotia, T. Eaton Co.              | Evans, J. W.     |
|               | London, Ont., Linwood St.                       | Little, R. W.    |
|               | Toronto, Ont., 50 Gloucester St., Apt. 209      | Cuthbert, G.     |
| England       | Bradford, Yorkshire, 460 Harewood St.           | Smith, F.        |
|               | Chelmsford, Essex, Russets Vicarage Rd.         | O'Donovan, D. E. |
|               | Coulsdon, Surrey, 466 Chipstead Valley Rd.      | Hall, D. L.      |
|               | Guilford, Surrey, "Malvernia," Shepherds Lane   | Perkins, A. C.   |
|               | Hounslow, Middlesex, 17 Kingsley Ave.           | Hobbs, J. G.     |
|               | London, S.W. 15, 5 Clarendon Rd.                | Whitehead, C. C. |
|               | Sheffield 10, Yorkshire, 6 Clarkehouse Rd.      | Walker, T. H.    |
|               | Tolworth, Surrey, 412 Ewell Rd.                 | Woods, G.        |
|               | Whiteley Bay, Northumberland, 70 The Broadway   | Thew, C. L. A.   |
| India         | Cherat, N.W.F.P., Wireless Experimental Section | Peacock, J. W.   |
| Japan         | Aichi-ken, Nihon Musen Yosami-Mura, Hekikai-gun | Taki, I.         |
|               | Arimatsucho, JOCK, Okehazawa Hosojo             | Keiji, S.        |
|               | Hiroshima, JOFK, Hiroshima Sending Station      | Fujimoto, T.     |
| New Zealand   | Rotorua, 17 Amohau St.                          | Tapp, D. W. M.   |
| West Africa   | Monrovia, Liberia                               | Cooper, J. L.    |

Elected to the Junior Grade

|          |  |                |
|----------|--|----------------|
| New York | Bayside, L. I., 40-19 219th St.  | Roberts, R. H. |
| Turkey   | Istanbul, Osmaniye Telsiz Telegraf Istasyonu, Telsiz Muamelat Merkezi, Vasisatiyle | Kerim, A.      |

Elected to the Student Grade

|            |                                   |                |
|------------|-----------------------------------|----------------|
| California | Berkeley, 1443 Josephine St.      | Randall, R. D. |
| Maryland   | Linthicum Heights East Hiltop Rd. | Brian, J. M.   |
| New York   | Troy, Clement Dormitory, Ave. B.  | Baluta, R. E.  |



## APPLICATIONS FOR MEMBERSHIP

Applications for transfer or election to the various grades of membership have been received from the persons listed below, and have been approved by the Admissions Committee. Members objecting to transfer or election of any of these applicants should communicate with the Secretary on or before April 30, 1934. These applicants will be considered by the Board of Directors at its meeting on May 2, 1934.

### For Election to the Associate Grade

|               |   |                       |
|---------------|---|-----------------------|
| California    | Coronado, Fleet Air, VS-14M, Naval Air Station          | Brandis, L. J.        |
|               | Los Angeles, 108 S. Harper Ave.                         | Scoville, R. R.       |
|               | Sacramento, 2533 Castro Way                             | Bowman, C. S.         |
| Colorado      | Pueblo, 824 W. 11th St.                                 | Cassler, H. R.        |
| Connecticut   | Meriden, c/o Conn. Radio Co., 248 Pratt St.             | Theobald, N. C.       |
| Idaho         | Shelley, P.O. Box 382                                   | Pace, J. T.           |
| Illinois      | Chicago, 7712 St. Lawrence Ave.                         | Hill, D. S.           |
|               | Peoria, Galena Rd.                                      | Karl, R. J.           |
| Indiana       | Richmond, 411 Kinsey St.                                | Timmons, F. E.        |
| Massachusetts | Cambridge, Rm. 1-131, Mass. Inst. of Tech.              | King, H. F.           |
| Minnesota     | St. Paul, 1946 Portland Ave.                            | Milnowski, A. S., Jr. |
| New York      | Clarendon   | Allis, B. A.          |
|               | New York City, 27 Commerce St.                          | Engelhardt, G. B.     |
|               | New York City, c/o Miss C. L. Chow, 106 Morningside Dr. | Wang, P. H.           |
| Pennsylvania  | Carrolltown   | Sharbaugh, C. R.      |
|               | Philadelphia, 3502 Tudor St.                            | Head, G., Jr.         |
|               | Philadelphia, 4932 Walton Ave.                          | Parks, W. H.          |
|               | West Chester, 202 N. Penn St.                           | Comfort, H. F.        |
| Wisconsin     | Milwaukee, 626 N. Jackson St.                           | Hanson, C. H.         |
| Brazil        | Rio de Janeiro, Avenida Paulo de Frontin 395            | Garcia, M.            |
| Canada        | Edmonton, Alta., 400 C.P.R. Bldg.                       | Mitchell, A. M.       |
|               | St. Hyacinthe, P.Q., Radio Station CKAC                 | Beaulieu, W. R.       |
| Ceylon        | Colombo, 6 Blake Rd.                                    | DeMel, C. H. J.       |
| China         | Shanghai, Chinese Government Radio Administration       | Hu, M. S.             |
| Egypt         | Cairo, Radio House, P. O. Box 795                       | Mathias, E. L. A.     |
| England       | Cambridge, 13 Albion Row                                | Walton, E. T. S.      |
|               | Cobham, Surrey, "The Firs," Sandy Lane                  | Lewis, H. A.          |
|               | Harold Wood, Essex, 63 Rosslyn Ave.                     | Bryant, T. C.         |
|               | London, c/o Thomas Cook & Sons, Berkley St.             | Pai, M. V.            |
|               | Swindon, Wilts., 86 Medgbury Rd.                        | Gassner, J. W.        |
| South Africa  | Ladysmith, Natal, 168 Murchison St.                     | Beard, R. G.          |

### For Election to the Junior Grade

|            |                     |             |
|------------|---------------------|-------------|
| California | Avalon, P.O. Box X1 | Wick, O. F. |
|------------|---------------------|-------------|

### For Election to the Student Grade

|              |   |                 |
|--------------|---|-----------------|
| California   | Pasadena, Blacker House, Calif. Inst. of Tech.                | Krantz, C. H.   |
|              | Stanford University, Box 908                                  | Reynolds, D. G. |
| Kansas       | Lawrence, 700 Alabama   | Erickson, L. H. |
| New Jersey   | Leonia, 396 Allaire Ave.                                      | Hoth, D. F.     |
| New Mexico   | Albuquerque, 114 S. Maple St.                                 | Remley, H.      |
| Ohio         | Cleveland Heights, 3325 Beechwood Ave.                        | Hill, J. S.     |
| Pennsylvania | Bethlehem, 514 Delaware Ave.                                  | Porter, R. S.   |
| China        | Shanghai, c/o Shanghai Radio Central Station, 565 Min Kou Rd. | Hsu, A. L.      |
| Germany      | Baden, Studenthau, Karlsruhe                                  | Keinonen, A. F. |
| Puerto Rico  | Guayanilla, c/o Central Refina                                | Valls, R. P.    |



## OFFICERS AND BOARD OF DIRECTORS, 1934

(Terms expire January 1, 1935, except as otherwise noted)

### *President*

C. M. JANSKY, JR.

### *Vice President*

BALTH. VAN DER POL, JR.

### *Treasurer*

MELVILLE EASTHAM

### *Secretary*

HAROLD P. WESTMAN

### *Editor*

ALFRED N. GOLDSMITH

### *Directors*

W. G. CADY, *Junior Past President*

O. H. CALDWELL

J. V. L. HOGAN

L. C. F. HORLE

C. W. HORN

E. L. NELSON

E. R. SHUTE

A. F. VAN DYCK

H. A. WHEELER

### Serving until January 1, 1936

R. A. HEISING.

L. M. HULL, *Junior Past President*

F. A. KOLSTER

H. M. TURNER

### Serving until January 1, 1937

ARTHUR BATCHELLER

WILLIAM WILSON



# COMMITTEES OF THE INSTITUTE OF RADIO ENGINEERS, 1934

## Admissions Committee

E. R. SHUTE, *Chairman*  
L. C. F. HORLE  
C. W. HORN  
A. G. LEE  
J. S. SMITH  
A. F. VAN DYCK

AUSTIN BAILEY  
ARTHUR BATCHELLER  
I. S. COGGESHALL  
C. P. EDWARDS

## Awards Committee

H. M. TURNER, *Chairman*  
A. F. VAN DYCK  
WILLIAM WILSON

J. H. DELLINGER  
R. H. LANGLEY

## Board of Editors

ALFRED N. GOLDSMITH, *Editor*  
G. W. PICKARD  
K. S. VAN DYKE  
L. P. WHEELER  
L. E. WHITTEMORE  
WILLIAM WILSON

R. R. BATCHER  
H. H. BEVERAGE  
F. W. GROVER  
G. W. KENRICK

## Broadcast Committee

E. L. NELSON, *Chairman*  
J. V. L. HOGAN  
C. W. HORN  
L. F. JONES  
J. C. McNARY

S. L. BAILEY  
E. K. COHAN  
T. A. M. CRAVAN  
E. L. GOVE

## Constitution and Laws Committee

J. V. L. HOGAN, *Chairman*  
E. R. SHUTE  
A. F. VAN DYCK  
H. P. WESTMAN, *ex officio*  
H. A. ZEAMANS

ARTHUR BATCHELLER  
AUSTIN BAILEY  
R. A. HEISING  
C. M. JANSKY, JR., *ex officio*

## Membership Committee

I. S. COGGESHALL, *Chairman*  
H. C. HUMPHREY  
A. V. LOUGHREN  
T. A. McCANN  
A. F. MURRAY  
L. G. PACENT  
D. E. REPLOGLE  
C. R. ROWE  
E. W. SCHAFER  
C. E. SCHOLZ  
J. E. SMITH

L. A. BRIGGS  
W. W. BROWN  
C. J. BURNSIDE  
H. A. CHINN  
W. F. COTTER  
F. W. CUNNINGHAM  
H. C. GAWLER  
S. A. GOLDHAMER  
DAVID GRIMES  
L. C. F. HORLE

*(Chairman of Membership Committees of Sections, ex officio)*

## New York Program Committee

A. F. VAN DYCK, *Chairman*  
W. G. H. FINCH  
J. K. HENNEY  
L. C. F. HORLE  
C. W. HORN  
R. H. LANGLEY

AUSTIN BAILEY  
H. H. BEVERAGE  
E. K. COHAN  
O. E. DUNLAP

### Nominations Committee

W. G. CADY  
O. H. CALDWELL

L. M. HULL, *Chairman*  
L. C. F. HORLE  
R. H. MANSON

### Papers Committee

H. A. AFFEL  
J. K. CLAPP  
E. K. COHAN  
T. A. M. CRAVEN  
P. O. FARNHAM  
E. B. FERRELL  
T. R. GILLILAND  
E. L. HALL  
L. F. JONES  
F. B. LLEWELLYN  
R. M. MORRIS  
A. F. MURRAY

WILLIAM WILSON, *Chairman*  
BENJAMIN OLNEY  
H. O. PETERSON  
R. K. POTTER  
R. R. RAMSEY  
F. M. RYAN  
B. E. SHACKELFORD  
G. C. SOUTHWORTH  
G. G. THOMAS  
H. M. TURNER  
H. A. WHEELER  
W. C. WHITE  
IRVING WOLFF

### Publicity Committee

C. E. BUTTERFIELD  
L. M. COCKADAY  
O. E. DUNLAP

O. H. CALDWELL, *Chairman*  
W. G. H. FINCH  
DONALD MCNICOL  
R. C. POULTER  
K. B. WARNER

### Sections Committee

I. S. COGGESHALL  
H. B. COXHEAD  
V. M. GRAHAM

DAVID GRIMES, *Chairman*  
H. C. GAWLER  
J. H. MILLER  
B. E. SHACKELFORD  
(*Chairman of Sections, ex officio*)

### Standards Committee

H. H. BEVERAGE  
J. K. CLAPP  
J. H. DELLINGER  
ALFRED N. GOLDSMITH  
F. G. KEAR  
R. H. LANGLEY

HARADEN PRATT, *Chairman*  
E. L. NELSON  
F. E. TERMAN  
H. M. TURNER  
A. F. VAN DYCK  
L. E. WHITTEMORE  
WILLIAM WILSON

### Tellers Committee

DAVID GRIMES  
WALTER MILTON-KING

ARTHUR BATCHELLER, *Chairman*  
L. E. WHITTEMORE  
H. P. WESTMAN, *Secretary*

## INSTITUTE NEWS AND RADIO NOTES

### March Meeting of the Board of Directors

The regular meeting of the Board of Directors was held on March 7 at the Institute office. Those in attendance were Alfred N. Goldsmith, acting chairman; Melville Eastham, Arthur Batcheller, O. H. Caldwell, F. A. Kolster, E. L. Nelson, E. R. Shute, H. M. Turner, A. F. Van Dyck, H. A. Wheeler, and H. P. Westman, secretary.

Forty-five applications for Associate, two for Junior, and three for Student membership were approved.

Additional committee appointments were made and the complete list of committees appears elsewhere in this issue.

An invitation for the Institute to be represented on the Electrical Standards Committee of the American Standards Association was accepted, and the representative will be designated at the next meeting.

The secretary was instructed to lease space in the building at 330 West 42nd Street for the Institute headquarters office. This will result in a substantial saving in rental and the obtaining of quarters more suitably arranged for carrying on Institute business. The removal of the Institute office will be effected late in May.

The Emergency Employment Service reported the placing of nineteen men during the month of February.

---

### PRELIMINARY PROGRAM OF JOINT MEETING, APRIL 27, 1934

Institute of Radio Engineers  
and

American Section, International Scientific Radio Union

There will be two sessions at the National Academy of Sciences Building, 2101 Constitution Avenue, Washington, D.C., beginning at 10 A.M. and 2 P.M. Papers will be limited to twelve minutes each, to allow time for discussion. The following papers are listed at the time of going to press. While there may be some changes in the final program, the general scope will not be altered.

"The Development and Characteristics of 9-centimeter Radiation," by C. R. Kilgore, Westinghouse Electric and Manufacturing Company.

"Vacuum Tubes for Generating Frequencies Above one Hundred

Megacycles," by C. E. Fay and A. L. Samuel, Bell Telephone Laboratories.

"Facsimile Radio Observations During the 1932 Eclipse," by E. F. W. Alexanderson, General Electric Company.

"Notes on Propagation at a Wavelength of 73 Centimeters," by B. Trevor and R. W. George, Radio Corporation of America.

"Some Recent Work on the Ionosphere in Canada," by J. T. Henderson, Canadian National Research Council.

"Studies of the Ionosphere by Multifrequency Automatic Recording," by T. R. Gilliland, Bureau of Standards.

"Ionosphere Measurements at Low Latitudes," by L. V. Berkner and H. W. Wells, Carnegie Institution of Washington.

"High-Frequency Ammeter," by H. M. Turner, Yale University.

"The Thermal Method of Measuring the Losses in a Vacuum Tube," by F. P. Cowan, Harvard University.

"Frequency Standard and Monitor Stations of Canadian Radio Commissions," by W. A. Steel, Canadian National Research Council.

"A Method of Measuring Noise Levels on Short-Wave Telegraph Circuits," by H. O. Peterson, Radio Corporation of America.

"Relative Daytime Intensities of Atmospherics," by K. A. Norton, Bureau of Standards.

"Developments in Automatic Sensitivity Control," by G. E. Pray, Signal Corps Laboratories.

"Phase Angle of Vacuum Tube Transconductance at Very High Frequencies," by F. B. Llewellyn, Bell Telephone Laboratories.

"A New Method of Obtaining the Operating Characteristics of Power Oscillators," by E. L. Chaffee and C. N. Kimball, Harvard University.

"A Short-Cut Method for Calculation of Harmonic Distortion of Modulated Radio Waves," by I. E. Mouromtseff and H. N. Kozanowski, Westinghouse Electric and Manufacturing Company.

"Space-Charge Effects in Piezo-Electric Resonators," by W. G. Cady, Wesleyan University.

---

### Radio Transmissions of Standard Frequencies

The Bureau of Standards transmits standard frequencies from its station WWV, Beltsville, Md., every Tuesday except legal holidays. The transmissions are on 5000 kilocycles per second. The transmissions are given continuously from 12 noon to 2 P.M., and from 10:00 P.M. to midnight, Eastern Standard Time. The service may be used by transmitting stations in adjusting their transmitters to exact frequency, and



by the public in calibrating frequency standards, and transmitting and receiving apparatus. The transmissions can be heard and utilized by stations equipped for continuous-wave reception through the United States, although not with certainty in some places. The accuracy of the frequency is at all times better than one cycle per second (one in five million).

From the 5000 kilocycles any frequency may be checked by the method of harmonics. Information on how to receive and utilize the signals is given in a pamphlet obtainable on request addressed to the Bureau of Standards, Washington, D.C.

The transmissions consist mainly of continuous, unkeyed carrier frequency, giving a continuous whistle in the phones when received with an oscillating receiving set. For the first five minutes the general call (CQ de WWV) and announcement of the frequency are transmitted. The frequency and the call letters of the station (WWV) are given every ten minutes thereafter.

Supplementary experimental transmissions are made at other times. Some of these are made at higher frequencies and some with modulated waves, probably modulated at 10 kilocycles. Information regarding proposed supplementary transmissions is given by radio during the regular transmissions.

The Bureau desires to receive reports on the transmissions, especially because radio transmission phenomena change with the season of the year. The data desired are approximate field intensity, fading characteristics, and the suitability of the transmissions for frequency measurements. It is suggested that in reporting on intensities, the following designations be used where field intensity measurement apparatus is not used: (1) hardly perceptible, unreadable; (2) weak, readable now and then; (3) fairly good, readable with difficulty; (4) good, readable; (5) very good, perfectly readable. A statement as to whether fading is present or not is desired, and if so, its characteristics, such as time between peaks of signal intensity. Statements as to type of receiving set and type of antenna used are also desired. The Bureau would also appreciate reports on the use of the transmissions for purposes of frequency measurement or control.

All reports and letters regarding the transmissions should be addressed to the Bureau of Standards, Washington, D.C.

---

## Committee Work

### ADMISSIONS COMMITTEE

The Admissions Committee met at the Institute office on Tuesday, January 30, and those in attendance were E. R. Shute, chairman; Austin Bailey, A. F. Van Dyck, and H. P. Westman, secretary.

An application for transfer to the Fellow grade was approved. Four applications for transfer to Member were accepted, and two tabled pending the obtaining of further information. Two applications for admission to Member were approved, two were rejected, and one was tabled pending further action.

### BROADCAST COMMITTEE

The Broadcast Committee met on the evening of January 30 at the Institute office, and those in attendance were E. L. Nelson, chairman; Wilson Aull (representing J. V. L. Hogan), S. L. Bailey, E. K. Cohan, T. A. M. Craven, E. L. Gove, C. W. Horn, C. M. Jansky, Jr., C. B. Jolliffe, W. L. Lyndon (representing L. F. Jones), J. C. McNary, and H. P. Westman, secretary.

The meeting was devoted to a general discussion of the problems facing the committee and preparation of a general program of operation for the year.

The March meeting of the Committee was held on the evening of the 6th at the Bell Telephone Laboratories and was attended by E. L. Nelson, chairman; Wilson Aull, A. W. Barber, S. L. Bailey, G. L. Beers, H. A. Chinn, A. B. Chamberlain, J. A. Chambers, Alfred N. Goldsmith, J. V. L. Hogan, C. W. Horn, L. F. Jones, J. C. McNary, and H. P. Westman, secretary.

Messrs. Aiken, Black, Clark, Collins, Cunningham, Henning, Kember, Porter, and Rettenmeyer of the Bell System assisted in the demonstrations presented. These demonstrations included a number of tests indicating the value and possibilities of higher fidelity reception of broadcast transmissions than is at the present afforded by standard broadcast receivers. It assisted the committee materially in obtaining first-hand information as to the effects of widening the range of reception and some of the engineering difficulties encountered.

### MEMBERSHIP COMMITTEE

The Membership Committee held its first meeting of the year on March 7. I. S. Coggeshall, chairman, H. A. Chinn, W. F. Cotter, F. W. Cunningham, H. C. Gawler, H. C. Humphrey, A. V. Loughren, T. A. McCann, L. G. Pacent, D. E. Replogle, C. R. Rowe, E. W. Schafer,

C. E. Scholz, and I. R. Weir (representing W. W. Brown), were present. Plans were formulated for the organization and operation of the committee and its activities during the year.

#### NEW YORK PROGRAM COMMITTEE

New York Program Committee meetings were held on January 24 and February 21 at the Institute office to complete plans for the Institute meetings to be held in New York.

The first meeting was attended by A. F. Van Dyck, chairman; Austin Bailey, H. H. Beverage, H. A. Chinn (representing E. K. Cohan), O. E. Dunlap, J. K. Henney, L. C. F. Horle, C. W. Horn, and H. P. Westman, secretary.

The latter meeting was attended by A. F. Van Dyck, chairman; Austin Bailey, H. A. Chinn (representing E. K. Cohan), L. C. F. Horle, and the secretary, H. P. Westman.

#### SECTIONAL COMMITTEE ON RADIO

The Sectional Committee on Radio, operating under the American Standards Association procedure, met on January 24 at the Institute office. Those in attendance were Alfred N. Goldsmith, chairman; C. H. Sharp, vice chairman, Wilson Aull (representing J. V. L. Hogan), A. R. Belmont, L. W. Chubb, J. A. Eipter (representing J. A. Code), Lloyd Espenschied, K. W. Keene (representing R. B. Shepard), J. W. MacNair, H. W. Wahlquist (representing J. O'R. Coleman), L. E. Whittemore, William Wilson, and H. P. Westman, secretary.

The committee accepted the resignation of Mr. Dudley whose location does not permit the continuing of his work as secretary, and appointed H. P. Westman to that position.

The personnel of the committee and the list of organizations represented on it were examined, and the secretary instructed to correspond with a number of these to ascertain their present interest and the names of their representatives. Two additional organizations were invited to cooperate in the work.

The chairman was empowered to appoint technical committees to review existing standards and pass upon their suitability for submission to the American Standards Association for approval as American standards. In addition, these committees will consider a substantial amount of material which has been proposed for international standardization by several European countries through the International Electrotechnical Commission.

---

## Institute Meetings

### ATLANTA SECTION

The annual meeting of the Atlanta Section was held at the Atlanta Athletic Club on January 11. H. L. Wills, chairman, presided and seventeen members and guests were in attendance. Eleven were present at the informal dinner which preceded it.

"Public Address Systems and Equipment" was the subject of a paper by Ben Adler of the Transmitter Department of the RCA Victor Company. In it the construction and operation of velocity microphones were discussed in detail and one of these devices together with a portable public address amplifier was demonstrated. Messrs. Bangs Gardberg, and Wills participated in the discussion.

An informal discussion on harmonic analyzers was then given by I. H. Gerks, Professor of Electrical Engineering of the Georgia School of Technology. Additional comments were made by H. L. Wills.

As a result of the election of officers for the following year H. L. Reid was named chairman, I. H. Gerks, vice chairman, and P. C. Bangs was reelected secretary-treasurer.

### BOSTON SECTION

A meeting of the Boston Section was held on December 15 at Massachusetts Institute of Technology and was presided over by G. W. Kenrick, secretary.

A paper by C. B. Aiken of the Bell Telephone Laboratories on "Synchronized and Shared Channel Broadcasting" was presented. In it the products derivable from frequency and phase modulation of two carriers operating on the same frequency or on proximate frequencies were discussed for the cases of linear and quadratic detection. The distortion produced by energy return from the Kennelly-Heaviside layer was also considered. Applications of the theoretical conclusions derivable from the analytical investigations to "booster" and interlocking systems for synchronization were pointed out and examples of apparatus developed in connection with these problems were shown. Messrs. Bowles, Kenrick and others of the seventy-five members and guests participated in the discussion. Twenty were present at the informal dinner which preceded the meeting.

An extensive program of papers was presented at a special meeting of the Boston Section held on December 28, during the winter meeting of the American Association for the Advancement of Science. E. L. Chaffee, chairman, presided at the meeting which was held at Harvard University and attended by sixty members and guests. The papers presented are listed below:



"Measurement of High-Intensity Sound Fields," by W. M. Hall, Massachusetts Institute of Technology.

"Measurement of Temperatures in Sound Waves," by E. A. Johnson, Massachusetts Institute of Technology.

"Supersonic Determination of Directional Characteristics of Horns," by S. Goldman.

"The Design of Smoothing Circuits for Rectified Alternating Currents," by F. S. Dellenbaugh, Raytheon Production Corporation.

"A Method of Determinating the Operating Characteristics of Power Oscillators," by E. L. Chaffee and C. N. Kimball, Harvard University.

"Classification of Vacuum Tubes," by H. R. Mimno, Harvard University.

"On the Oscillations of a Circuit Having a Periodically Varying Capacitance," by W. L. Barrow, Massachusetts Institute of Technology.

"Antennas," by R. M. Hammon, Westinghouse Electric and Manufacturing Company.

"Thermal Agitation Voltages in Resistances," by C. Neitzert, Massachusetts Institute of Technology.

"Demonstration of Fluctuation Phenomena," by F. V. Hunt, Harvard University.

"Ultra-High-Frequency Development," by C. J. Madsen, Westinghouse Electric and Manufacturing Company.

"Radio Aids to Air Navigation," by F. S. Mabry, Westinghouse Electric and Manufacturing Company.

"Operation of Broadcast Stations," by J. E. Bandino, Westinghouse Electric and Manufacturing Company.

"Commercial Developments in Frequency Standards and Measuring Equipment," by J. K. Clapp, General Radio Company.

"A Three-Electrode Quartz Crystal," by L. B. Arguimbau, General Radio Company.

"Variable Resistors Having Constant Inductance," by R. F. Field, General Radio Company.

On the evening of the day of the above meeting an informal dinner was held at the Hotel Commander, and T. S. McCaleb, Instructor in Exploration Radio at the School of Geographical Exploration, Harvard University, presented an informal talk on his radio experiences in different parts of the world. An impromptu discussion of ball lightning was introduced by Professor Jensen of the University of Nebraska who showed interesting photographs of examples of ball lightning taken by him in the course of his studies.

The January meeting of the Boston Section was held at Harvard University and was attended by 125. E. L. Chaffee, chairman, presided. "Ultra-High-Frequency Transmission Over Indirect Paths" was the title of a paper presented by G. W. Pickard of the General Radio Company. In it, the results of observations of transmission on frequencies of the order of 60 megacycles over numerous indirect paths including the Mount Washington to Blue Hill circuit were discussed. Large diurnal changes of the order of 60 decibels were shown to exist and to possess seasonal trend. The probable existence of meteorological correlations associated with surface temperature gradients and inversions was also discussed. Field intensity observations over water paths from Seabrook Beach, N. H., to Cape Neddick were covered.

A general discussion was participated in by Messrs. Karplus, MacKenzie and others.

#### BUFFALO-NIAGARA SECTION

L. Grant Hector presided at the February 14 meeting of the Buffalo-Niagara Section held at the University of Buffalo.

A paper on "Speech Input Circuits for Broadcast Transmitters" was presented by K. C. Hoffman, chief engineer, Buffalo Broadcasting Corporation. The relation of the microphone to the acoustics of the studio was first discussed. Typical studio construction was described with such factors as size, material for walls, location of windows, air conditioning, and sound traps in air ducts commented on. The placement and various types of microphones including carbon, condensers, moving-coil, ribbon, and crystal-cell varieties were covered. Difficulties encountered in microphone operation were enumerated and remedies suggested. Typical wire diagrams of speech input were shown and the construction and operation of associated apparatus described. A general discussion followed and the attendance was twenty-six.

#### CINCINNATI SECTION

A meeting of the Cincinnati Section was held on February 13 at the University of Cincinnati. Chairman R. E. Kolo presided and the attendance was forty.

W. S. Barden of the RCA License Laboratory presented a paper on "Superregeneration." He discussed the subject chiefly as a means of securing high amplification in the wavelength range around five to ten meters. The essential circuits were described and their method of operation outlined. It was shown that the selectivity possible with this type of circuit does not permit the operation of stations separated by but small differences in frequency. The difficulties encountered in using

a buffer stage to prevent radiation was discussed. He stated that two audio stages of high amplification were necessary because of the low power available from the demodulator circuit. The possibility of using superregeneration in combination with superheterodyne circuits was regarded as valueless. As a general conclusion it was stated that superregeneration was useful only in the very high frequency portion of the radio spectrum and then only with wide cleared channels.

#### DETROIT SECTION

The February 27 meeting of the Detroit Section was held jointly with the local section of the American Institute of Electrical Engineers and the attendance was 400. Fifty were present at the informal dinner which preceded the meeting.

R. Foulkrod, chairman of the American Institute of Electrical Engineers' section, presided and introduced A. W. Hull, Assistant Director of the Research Laboratories of the General Electric Company who presented a paper on "Fundamental Phenomena in Mercury Vapor Tubes." In opening his paper, Dr. Hull discussed the possibilities in the use of Thyatron tubes pointing out that while electrical machinery is at present in a high state of development, control devices need considerable improvement.

By means of slides, he showed the relative electron densities of copper wire, a high vacuum tube, and a gas-filled tube, and explained the similarity between conduction in a wire and in a gas-filled tube. Due to the gas atoms, the current carrying capacity of a gas-filled tube was found to be one thousand times that of a high vacuum tube of similar size. The comparative sizes of high vacuum and Thyatron tubes of various ratings were shown. The efficiency of the hard tube has about 50 per cent while that of the Thyatron is near 95 per cent.

After discussing cathode construction for Thyatrons the speaker completed his paper with some tables showing the effect of frequency and inductance upon the Thyatron tube life. It was pointed out that low-frequency circuits with sine wave voltages permit the greatest life as high frequencies and distorted wave shapes effect a reduction.

#### NEW YORK MEETING

A meeting of the Institute was held in New York on March 7 in the Engineering Societies Building. In the absence of President Jansky, William Wilson presided and introduced F. A. Kolster of International Communications, Inc., who presented a paper on "Generation and Utilization of Ultra-Short Waves in Radio Communication."

The author devoted his discussion to that range of waves which are

shorter than ten meters in length. He described an oscillator in which a "tank" or "flywheel" circuit of novel design was used to obtain a high degree of frequency stabilization without resorting to frequency multiplication or piezo-electric control. The characteristics of this circuit were outlined. He then discussed the feasibility of utilizing these very short waves as carriers of signal channels for communication between a remote receiving station and the city operating room of a communications organization. Some preliminary experiments in this field were described. A very lively discussion resulted. The attendance totaled 650.

#### TORONTO SECTION

On February 23 a meeting of the Toronto Section was held jointly with the Toronto Section of the American Institute of Electrical Engineers at the University of Toronto. It was presided over by W. F. Choat, chairman of the Institute section and the attendance totaled 275.

A. B. Clark of the Bell Telephone Laboratories presented a paper on "Developments in Long-Distance Communications." The speaker first outlined the type telephone circuits used up to about twenty-five years ago, and pointed out the tremendous effect of bad weather on the quality of transmission. The evolution of the telephone was traced from that time through the period when the loading of lines was first resorted to. Mechanical repeaters which had been tried were also discussed. The advent of the vacuum tube amplifier made all the mechanical repeating systems obsolete and they were replaced.

A demonstration of an eight-stage band-pass filter by means of a mechanical model having eight pendulums actuated by springs was then given. Various conditions of short-circuited and open-end lines were mechanically demonstrated in addition to the various types of transients. Transmission time constants also were discussed and it was stated that due to the loading of lines the transmission constant is approximately 20,000 miles per second or about one ninth of the accepted speed of propagation. The transmission constant of the carrier system was approximately 110,000 miles per second and the speaker indicated that these systems operating with carriers between 40 and 40,000 cycles would most likely replace present long-distance circuits.

Another meeting of the Toronto Section was held on February 26 at the University of Toronto. The attendance was sixty and W. F. Choat, chairman, presided.

"Present Trend of Radio Service Equipment" was the subject of a paper by H. L. Olesen of the Weston Instrument Company. In it the speaker traced the evolution of broadcast receiving set analyzers from



the single direct-current meter type used some ten or eleven years ago up to the more complex analyzers of recent date which are complicated to the point of requiring over 150 switching operations to utilize all the functions the instrument is capable of performing. Methods of rating the accuracy of meters were discussed and it was pointed out that any stated accuracy in terms of full scale deflection may result in substantial errors at low scale readings. Consequently, meters should be used in the range from half to full scale, an important factor in multirange meters. Range extension methods for various types of meters and arrangements to obtain greatest accuracy were explained.

Rectifier type instruments were discussed. With accuracies of approximately 3 per cent at one thousand cycles it was stated that a further loss in accuracy of one half of 1 per cent for every increase in frequency of one thousand cycles resulted. Ohmmeters were described and errors due to correction for zero point pointed out. The advantages of shunt type correction were indicated.

Capacity meters and their design were covered. The latest types of set analyzers were described and employ in principle an alternating- and direct-current volt-ohm meter for point-to-point examination of the receiving set circuits. Methods of measuring the transconductance of vacuum tubes were then illustrated. The discussion which followed the presentation of the paper was participated in by almost everyone in attendance.

#### WASHINGTON SECTION

A meeting of the Washington Section was held on February 8 at the Kennedy-Warren Apartments. T. McL. Davis, chairman, presided and the attendance was thirty-four. Of these, thirteen were present at the informal dinner which preceded the meeting.

C. B. Jolliffe, chief engineer of the Federal Radio Commission, presented a paper on "Engineering Aspects of Radio Regulation." In it Dr. Jolliffe discussed the organization of the Engineering Department of the Federal Radio Commission, the classification of stations according to service rendered, and the regulatory problems relating to each particular class of service. A number of those present participated in the general discussion which followed.

---

#### Personal Mention

A. O. Austin formerly with the Ohio Insulator Company has established a consulting practice at Barberton, Ohio.

Previously with U. S. Radio and Television Corporation, R. C.

Ballard has joined the Television Engineering Staff of General Household Utilities, Chicago.

R. M. Beusman has left the staff of Belmont Radio Corporation to become chief radio engineer for the Reliance Dye and Stamping Company of Chicago.

J. T. Brothers has left the RCA License Laboratories to become a member of the research laboratory of the Philco Radio and Television Corporation in Philadelphia.

E. H. Cooley is now an engineer for the Philco Radio and Television Corporation having previously been chief engineer of Shallcross Manufacturing Company.

Formerly with Wellmade, Ltd., M. A. Davies has joined the radio engineering staff of the Universal Radio Company of Auckland, N. Z.

K. H. Emerson previously with the U. S. Radio and Television Corporation is now a member of the staff of General Household Utilities Company, Chicago.

F. B. Folknor has been made central division engineer of the Columbia Broadcasting System with headquarters in Chicago.

A. H. Hart of Mackay Radio and Telegraph Company has been transferred from San Francisco to Kent, Wash.

Zenith Radio Corporation of Chicago is the present location of M. J. Jelen previously with the Stewart Warner Speedometer Corporation.

A. W. Peterson, Lieutenant, U.S.N., has been transferred from the U.S.S. West Virginia to the U.S.S. Dahlgren basing at San Diego, Calif.

Formerly with Doolittle and Falknor, H. M. Smith has joined the Engineering Department of the Canadian Radio Broadcast Commission, Ottawa, Ont., Canada.

H. K. A. Sterky has left Svenska Rarioaktiebolaget to join the staff of the Telefonaktiebolaget L. M. Ericsson, Stockholm, Sweden.

H. T. Stetson formerly of Perkins Observatory is now associated with the Institute of Geographical Exploration, Harvard University, Cambridge, Mass.

## TECHNICAL PAPERS

A NEW METHOD OF REMOVING DISTORTIONS  
DUE TO THE SPACE CHARGE IN GAS-FILLED  
CATHODE RAY OSCILLOGRAPH TUBES\*

By

MANFRED VON ARDENNE

(Berlin-Lichterfelde-Ost, Germany)

*Summary*—In gas-filled cathode ray oscillograph tubes, errors occur with electrostatic beam deflection in that there is a great drop in sensitivity near the undeflected position of the beam zero position. This nonlinear deflection causes distortion of the image in television and some error when the tube is used in making measurements. Because its action depends on the frequency,<sup>1</sup> it does not exert a constant influence on the configuration of fluorescent screen images. Consequently it causes an error in measurement that cannot be easily controlled.

## KNOWN METHODS FOR CORRECTING ABNORMAL ZERO POINTS

A NUMBER of methods have been proposed for reducing or removing the origin distortion. The effect is explained as a variation in the internal field structure of the condenser deflecting field caused by the presence of the gas. The intensity of the field acting on the beam in the vicinity of the zero position is less than that calculated theoretically for vacuum. An explanation of this abnormality is based on the idea that positive ions formed by the electron beam travel slowly to the negative deflecting plate, whereas the electrons generated move quickly to the positive plate. Consequently there is a cathode or anode drop in front of the corresponding plate, so that the field is weakened in the central region between the plates. The difference between the migration velocities causes a field distribution in which the minimum field intensity is not exactly in the middle of the space between the plates. The difference between the gas and vacuum field intensities depends on the ratio of the field intensity resulting from the applied voltage to the field intensity caused by the space charge. The difference becomes less as the field intensity produced by the applied voltage becomes greater in relation to the field intensity resulting from

\* Decimal classification: R388. Original manuscript received by the Institute, August 3, 1933; translation received by the Institute, October 17, 1933.

<sup>1</sup> W. Heimann, "Ueber die Empfindlichkeit der Braunschen Röhre mit Gaskonzentration bei verschiedener Frequenz," *Zeit. für Hochfrequenz.*, vol. 40, no. 4, p. 127, (1932).

the space charge. In regions of high deflecting field intensities, such as are produced by potentials of more than approximately twenty-five volts in deflecting systems of ordinary dimensions, the corresponding difference can be disregarded entirely.

A reduction of the origin distortion can be obtained by the common negative biasing of all deflecting plates in relation to the beam<sup>2</sup> (anode). This method cannot be worked out in a practical manner because of the complications that arise in the wiring. Bedell and Kuhn<sup>3</sup> give a method for complete correction of the origin distortion. According to this method a higher negative potential is applied to one plate of each pair. This is for the purpose of displacing the electron beam from the abnormal central portion of the field to the less affected outer region. The beam is brought back to the center of the screen by an auxiliary magnetic field so that the fluorescent spot will be in the center of the screen. Hudec<sup>4</sup> recently proposed the use of one or two supplementary pairs of plates instead of the magnetic return action. Both the magnetic and the electric methods of restoring the spot to a zero position have the disadvantage that the intensity and direction of the restoring field must be adapted to the biases that are used. With electric restoration we find that if the restoration potentials have approximately the same magnitude as the biases, it is not possible to avoid deflection systems whose maximum beam deflection angle is much smaller than with a normal plate system of the same sensitivity. In order to obtain the same angle of deflection it becomes necessary to double the distance between the plates, so that the sensitivity necessarily is reduced to half. If beam restoration is not used, it is necessary to fit the tube to the deflected position, and it becomes necessary to have an unsymmetrical tube that is hard for the glass blower to make, and in which it is necessary to proportion the tube bias for both pairs of plates in order to bring a fluorescent screen image to the center of the fluorescent screen.

In addition to the methods described, it also is possible to develop methods in which the deflecting field intensity is superposed on a condenser field whose intensity along the path between the plates varies continuously from high positive to high negative values, or the reverse. This proposal is possible of realization because there is a poten-

<sup>2</sup> In this connection see M. von Ardenne, "Untersuchungen an Braunschen Röhren mit Gasfüllung," *Zeit. für Hochfrequenz.*, vol. 39, no. 1, p. 24, (1932); also, "Die Kathodenstrahlröhre und ihre Anwendung in der Schwachstromtechnik," p. 45, (1933); verlag Julius Springer.

<sup>3</sup> F. Bedell and J. Kuhn, "Linear correction for cathode ray oscillograph," *Phys. Rev.*, ser. 2, vol. 36, no. 5, p. 993, (1930).

<sup>4</sup> E. Hudec, "Die Verzerrungen durch Raumladungen in der Braunschen Röhre," *E. N. T.* vol. 10, no. 5, p. 219, (1933).

tial drop along the deflecting plates which are made of resistant material. This method gives absolutely uniform distribution of the space-charge effect over the screen area as long as the potential drop along the deflecting plates is greater than the amplitude of the deflection voltage. This method also necessitates a complicated tube and wiring, and therefore seems of little practical importance.

### A METHOD FOR ZERO POSITION CORRECTION MAINTAINING SYMMETRY OF THE TUBE

The diagram in Fig. 1 shows the basic idea of a similar but much simpler solution. It consists in dividing one of the plates of the deflect-

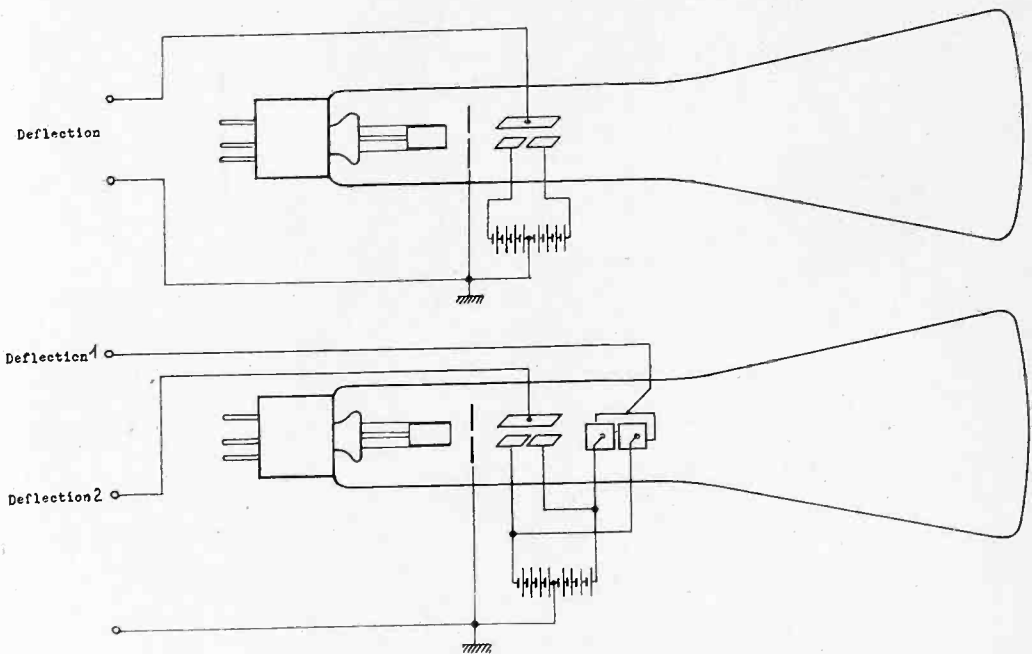

Fig. 1—Connections to eliminate origin distortion.

ing field, preferably the grounded deflecting plates, and in applying a biasing potential between both halves of the plate. It is possible, in principle, to divide both plates in this manner but there is no advantage in doing so and it causes great complication both of the tube and the connections. In the wiring in Fig. 1 two equally strong but opposing fields act on the deflecting field. By selecting a sufficiently high voltage for the auxiliary battery, to keep the longitudinal bias always greater than the deflecting voltage, the deflecting field strength of one of the two components at no time drops to zero, and the zero position abnormality lies outside the edge of the fluorescent screen. This is in contrast with the method mentioned above, in which the abnormality is almost always on one side only. The resultant beam path in this system may

be explained by the diagrams in Fig. 2. If we first consider only one part of the deflecting plate system, we get a deflection equal to the angle  $a'$ , corresponding to the direction and intensity of the deflecting field. The beam would continue along the broken lines. If we now consider only the second part of the deflecting system, there is a deflection equal to angle  $a''$ , but in the opposite direction. Both angles have the

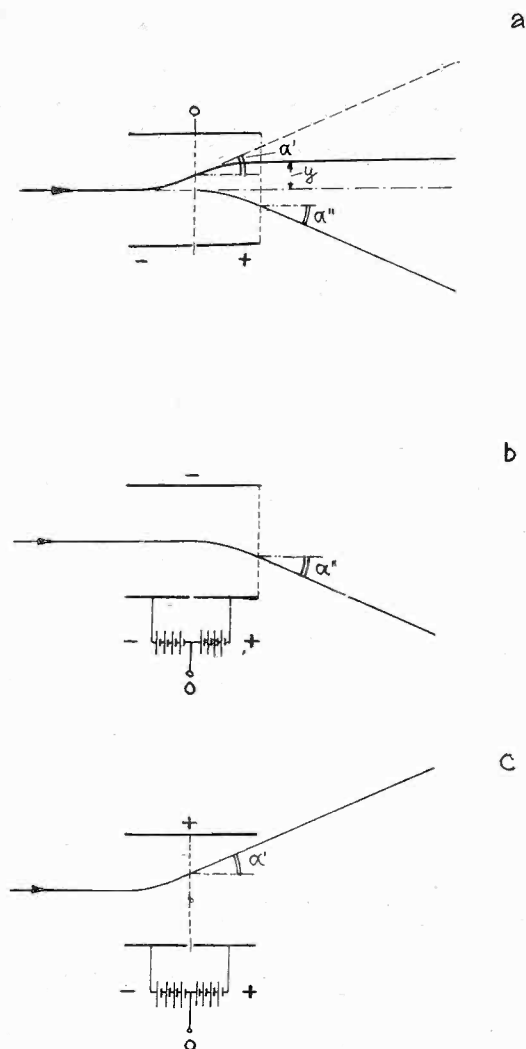

Fig. 2—Beam path at different deflection voltages.

same magnitude if the lengths of the divided pair of plates are the same. If the beam passes through the two fields one after the other, the path indicated by the full line will be followed, and it is seen that the beam again travels in its original direction. The resultant parallel displacement by the amount  $y$  can be entirely disregarded in comparison with the deflection on the screen. In order that the parallel displacement will not cause a reduction in the maximum beam deflection, it is recommended that the beam be adjusted so that its position of rest is some-

what nearer one side of the plate, in order that the beam, after parallel displacement, will lie exactly in the axis of the deflecting system. In Fig. 2a the path of the beam is shown for the case in which the superposed effective deflecting field is zero. In Fig. 2b the beam path is shown for the case in which the effective field strength is exactly equal to the value of the first part of the deflecting system but exactly opposed to it, and in Fig. 2c the value of the second part of the deflecting system is reached. In the two cases shown the deflecting fields in one part of the system counteract each other, and in the second part of

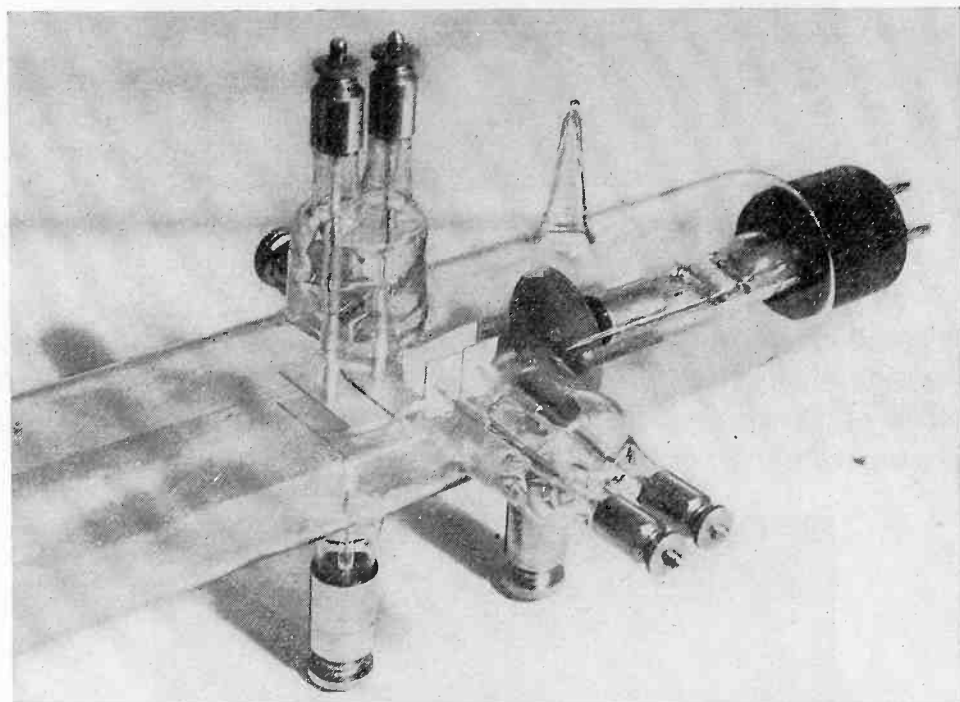

Fig. 3—View of the deflecting system of the tube without space-charge distortion.

the system they augment each other. If the voltage of the auxiliary battery is made higher, as indicated above, unnecessarily large parallel displacement is produced. On the other hand, if the voltage is too low, the origin distortion moves from the two marginal regions on the outside of the screen in toward the center of the screen. But as long as the auxiliary voltage retains a magnitude sufficient to prevent the distorted zones from coinciding or overlapping, it is not nearly as disturbing as with the normal method of operation. The explanation of this is found in the fact that at least one of the two parts of the system always works without distortion under this condition.



## PRACTICAL CONSTRUCTIONS AND RESULTS

In the practical construction of the tube for deflections along both axes as shown in Fig. 1, each two of the plate halves at the same potential are connected together. The number of leads to the outside then

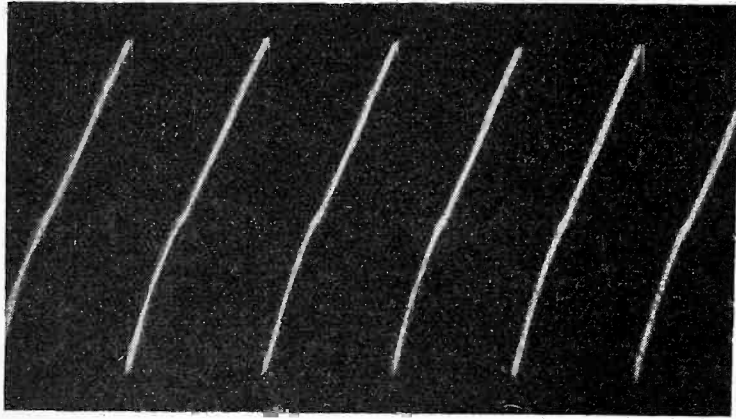

Fig. 4—Sweeping voltage with a linear rise, taken with a normal gas-filled cathode ray oscillograph tube.

is no greater than in a cathode ray tube of the usual type. The interior connection seems advisable in cases in which the tube is used only for specified purposes, as for television. It is better to bring out the plate halves separately for universal use.

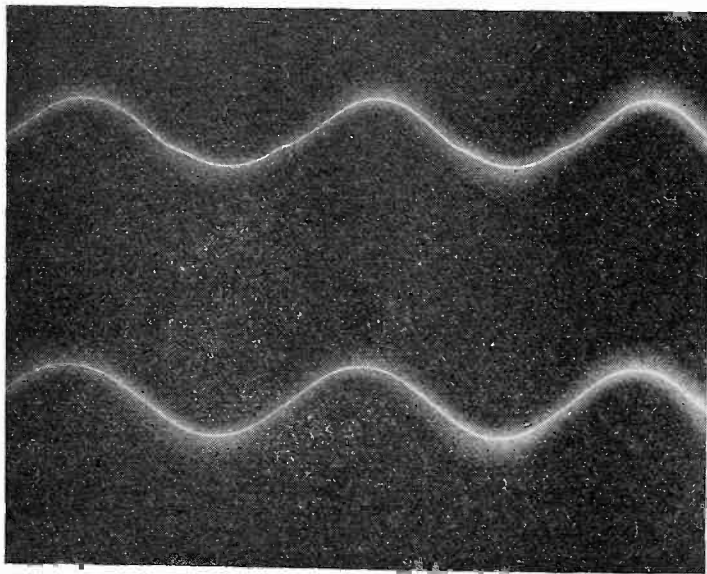

Fig. 5—Oscillogram of a sinusoidal voltage with (upper) and without (lower) space-charge distortion.

Fig. 3 shows a picture of the deflecting system of a tube made in the author's laboratory in accordance with the above plan. If origin

distortion is permissible, this tube can be used in the normal manner with the plate halves connected together outside.

The oscillogram in Fig. 4 shows the distortion with an absolutely linear voltage rise due to the space charge in a normal gas-filled tube. The origin distortion and also the differing steepness of the rise in both directions should be noted. The relation of the deflection sensitivity to the space charge shown here is especially important to note, as because of it there is a light control error with changed beam intensity, that is, changed space charge, which may lead to considerable distortion in television. An absolutely linear rise was produced in the new tube with the same sweeping voltage. The difference is shown even more clearly in the curves in the oscillogram in Fig. 5. Both curves were drawn with the same sinusoidal voltage and using the same tube. The upper curve, which seems to indicate the presence of harmonics, was obtained by connecting together the two plate halves of a tube as shown in Fig. 3, and the lower undistorted curve was obtained after application of the auxiliary potential using the wiring diagram shown in Fig. 1. By this proposed simple change in the deflecting system it is possible to eliminate distortion due to the space charge in gas-filled tubes without the loss of symmetry and consequent ease of inspection of the arrangement.



## LEAGUE OF NATIONS WIRELESS STATION\*

BY

G. F. VAN DISSEL

(Wireless Expert of the League of Nations, Geneva, Switzerland)

*Summary*—This paper gives an account of the League of Nations radio station, a statement of its purpose, the procedure for its administrative control, and a description of the equipment employed.

### I. GENERAL OBSERVATIONS

IN September, 1929, the Assembly of the League of Nations decided to construct a wireless station for the purpose of procuring independent and direct communications between the League and the greatest possible number of its Members. Various possibilities were discussed, among others:

1. A wireless station belonging exclusively to the League and operated by it at all times;

2. A wireless station belonging exclusively to the Swiss Confederation, operated by the latter in time of peace, and transferred to the League in time of emergency;

3. A combined solution, whereby the League would be responsible for the construction of two short-wave transmitters with aerials and of the short-wave receivers, all intended for extra-European traffic. In addition, the Société Radio-Suisse would construct a medium-wave wireless station for European traffic. All these installations would be situated in the buildings and on ground belonging to the Société Radio-Suisse. The Société Radio-Suisse is a private company operating in Switzerland, three quarters of its shares belonging to the Swiss Government and the other quarter to a number of Swiss banks and to the Marconi Company, which had previously constructed the different stations belonging to the Société Radio-Suisse in Switzerland.

Before the Assembly's decision was taken, the Société Radio-Suisse, in order to facilitate the adoption of the third solution by the Assembly of the League, constructed in the neighborhood of Geneva a station for European traffic like that contemplated in this third solution, consisting of a Marconi transmitter with a power of 50 kilowatts in the aerial, and a receiving station. This solution was chosen chiefly for political reasons, the first and second solutions not being satisfactory to the Swiss Confederation and to the League, respectively.

\* Decimal classification: R600. Original manuscript received by the Institute, July 5, 1933.

The Secretary-General of the League therefore concluded with the Swiss Government and with Radio-Suisse an agreement and a convention with a view to the establishment and operation of the joint station. The latter is operated in ordinary times by the Société Radio-Suisse, and in times of emergency by the League, which then has the right to replace the Swiss staff by an international staff. The Swiss Confederation, on the other hand, has the right, in time of emergency, to attach an observer to the station to safeguard its political interests.

## II. OPERATION IN NORMAL TIMES

In normal times the short-wave station provides for the exchange, direct or by relays, of telegraphic correspondence between the League Secretariat and the delegations at Geneva on the one hand, and the greatest possible number of Governments outside Europe on the other.

The Société Radio-Suisse may also utilize it for commercial traffic, when it is not engaged in handling the official traffic of the League. In this way, the station is operated jointly in such a way as to make it to a certain extent remunerative.

## III. OPERATION IN TIME OF EMERGENCY

In time of emergency, the first of the tasks which the station has to fulfill is to place the League Secretariat in immediate and constant touch, without the intervention of an intermediary, with the countries threatened with a conflict. The League thus enjoys, for its telegraphic traffic, an independence equal to that which national stations give to the Governments of the countries to which they belong.

The station bears the name "Radio-Nations." It cost approximately 4,400,000 francs, of which 2,400,000 francs were defrayed by the League (two transmitters, directional receiving and transmitting aerials, and receivers) and 2,000,000 francs by the Société Radio-Suisse (buildings, land and European station).

On February 2, 1932, the station was opened for traffic with the following areas:

1. Far East (Shanghai, Tokio);
2. South America (Rio de Janeiro, Buenos Aires);
3. North America (New York).

The last-named connection was only temporary, for it had been agreed with the Société Radio-Suisse that the traffic with North America would be effected by that company itself on completion of its short-wave station under construction near Berne. This took place in July, 1932. The official traffic with the Far East is, of course, of considerable importance, both in present circumstances and in those which

prevailed at the beginning of 1932. After the opening of the station, direct touch was established with the League's Commission of Enquiry on the Sino-Japanese conflict at Shanghai and in Manchuria; that Commission's reports were transmitted very rapidly by Radio-Nations. In this way the station proved its direct utility from the outset.

During the Assembly's debates at Geneva, which dealt, among other matters, with the Sino-Japanese conflict and the dispute between Bolivia and Paraguay, nearly all the official telegrams were despatched by Radio-Nations.

In the second half of 1932, radiotelephony also began to develop considerably. During the two sessions of the Disarmament Conference, several broadcasts had already been made specially for North America. The well-known American broadcaster, William Hard, regularly issued reports during these sessions on events at Geneva, the Disarmament Conference, and the above-mentioned conflicts. These reports were very well received in America, and were retransmitted on the system of the National Broadcasting Company. The Columbia Broadcasting system has also utilized the Radio-Nations station from time to time for reports, and has even broadcast several speeches direct from the Assembly Hall—including Dr. Yen's speech at the plenary assembly, which created a great impression in the United States.

In the second half of 1932, it was decided to give each Sunday a regular bulletin on the League, on two wavelengths, in three languages (French, English, and Spanish). Prominent personalities like Mr. de Valera, Lord Lytton, M. Politis, M. Matsuoka, Dr. Yen and others contributed to these Sunday evening talks, and hundreds of letters proved that these broadcasts were enthusiastically and successfully received in all parts of the globe. The Japanese delegation made very extensive use of the station during November for broadcasting to Japan. Speeches delivered at Geneva were retransmitted to Japan with great success; it even proved possible to make gramophone records of them, with a view to their retransmission later. A number of duplex telephone tests with Tokio gave satisfactory results, and these tests are still being carried on.

The League has also utilized its station in another way. During its 69th session, the Council dealt with the dispute between Bolivia and Paraguay, and more particularly with the telegrams in which the Commission of Neutrals at New York requested the Council to support its proposals. The Council agreed, and the same evening the Secretary-General broadcast the news of this agreement from the wireless station. In this way the League's station helped to support international action undertaken for the maintenance of world peace.

In February, 1933, the station was utilized a second time for the official transmission by wireless telegraph of the report of the Committee of Nineteen set up by the League Assembly for the Sino-Japanese conflict. This report contained a history of the conflict and the Committee's proposals to the Assembly.

After having been circulated to the press, the report was broadcast in full (15,000 words). The different Governments concerned had been notified in advance. This broadcast was received simultaneously at

|                     | <i>Distance from Geneva</i> |
|---------------------|-----------------------------|
| Washington.....     | 6,500 km                    |
| Rio de Janeiro..... | 8,750 "                     |
| Shanghai.....       | 9,250 "                     |
| Tokio.....          | 9,500 "                     |
| Buenos Aires.....   | 11,000 "                    |
| Sydney.....         | 16,600 "                    |

During the whole period of transmission, permanent touch was maintained with these various stations. In this way it was possible to regulate the speed in such a way that the station receiving most slowly could still obtain the message. Thanks to this method, there was very little repetition, but the speed did not exceed 35 words a minute. The text was broadcast only once; New York and Shanghai received the full text without any error; Tokio, Buenos Aires, and Rio de Janeiro only asked for a few trifling repetitions. Australia, however, failed to receive part of the text owing to fading. This text was repeated next day at its request at a speed of 120 words a minute (6000 words).

This experiment proved that the station is perfectly able to perform the work for which it was constructed. The result of this broadcast may be regarded as not merely very satisfactory, but quite extraordinary.

#### IV. DESCRIPTION OF TECHNICAL EQUIPMENT

The Radio-Nations Station consists of four parts, namely:

1. Transmitting station situated at Prangins, near Nyon, at about 30 kilometers from Geneva;
2. Receiving station situated at Colovrex, 8 kilometers from Geneva;
3. Central office at Geneva in the Federal Telegraph and Telephones building, Rue du Stand;
4. Central control office combined with a wireless telephony studio in the League Secretariat building.

#### Specifications

The technical conditions of the station were laid down in the specifications; the most important are given below:

*Transmitter*

(a) Transmitting power 20 kilowatts in the primary oscillating circuit. This power must be at least 20 kilowatts when the station is operating as a telegraphic transmitter unmodulated when transmitting a long dash; 8 kilowatts when the station is working as a telephonic transmitter with not less than 90 per cent modulation; or 12 kilowatts when the station is operating as a telephonic transmitter with not less than 60 per cent modulation.

Each transmitter must transmit this high-frequency power over three different frequencies of about 20,000, 12,000, and 8500 kilocycles.

(b) The first transmitting set must be capable of working on any frequency between 21,000 and 7500 kilocycles and the second on any frequency between 21,000 and 3000 kilocycles.

In the band required, three or four frequencies must be fixed as operating waves, i.e.; a daylight wave of about 20,000 kilocycles, a night wave of about 8500 kilocycles, a twilight wave of about 16,000 kilocycles, and a European traffic wave between 7500 and 3000 kilocycles.

It must be possible to switch from any one of these frequencies to another with the greatest possible speed. The operation of changing over to a frequency in the band specified other than the prescribed frequencies should be as simple as possible. It must be possible to modify every frequency in the band by decreasing or increasing it by, say, 2000 cycles per second.

(c) Each transmitting set must be capable of being worked as a high speed telegraph transmitter at a minimum speed of 10 words per minute and a maximum speed of 200 words per minute.

(d) Each transmitter, when worked as a telegraph transmitter, must radiate continuous sinusoidal waves during the marking signal and all radiation must be suppressed during the spacing signal (the power radiated during the spacing signal must not be more than 0.1 per cent of the power radiated by the marking signal). Means are to be provided whereby the marking signal may, if desired, be modulated by a pure sinusoidal frequency not greater than 1000 cycles per second and not less than 300 cycles per second. It should be possible to modulate the carrier wave under these conditions by not less than 60 per cent, and the modulation should remain linear throughout the various stages.

(e) Each transmitter, when working as a telephone transmitter, is to be of the double side band radiated carrier type, without suppression of the carrier wave or one of the side bands. In the various stages



modulation must be linear and the acoustic frequencies between 200 and 3000 cycles per second must be reproduced without distortion; i.e., the total amplitude of the harmonics produced by the nonrectilinear part of the operating characteristic must be at least 2.3 nepers or 20 decibels less for each frequency of the specified band than the amplitude of the carrier wave.

During modulation the frequency of the carrier wave must remain absolutely constant.

It should be possible to produce maximum final linear modulation with 0.1 milliwatt  $\pm$  20 per cent power at the input circuit of the primary amplifier.

(f) The carrier wave, whether modulated or not, must not produce harmonics. With the transmitter operating so as to give full telephony output without distortion but with the input modulation circuit disconnected, the level of audio-frequency noise on the carrier must be at least 50 decibels below the level of the tone produced by a musical frequency which fully modulates the transmitter.

(g) The transmitting frequency of the station must remain constant at about 1/100,000. The deviation should not be more than 0.01 per cent (Recommendation No. 14 of the C.C.I.R.).

#### *Receiver*

(a) The receiving apparatus must be capable of efficient and adequate reception of telegraph and telephone signals in the band 2750 kilocycles (109 meters) to 23,000 kilocycles (13.1 meters).

(b) This apparatus must be fitted with automatic high speed recording apparatus permitting reception up to 200 words per minute.

(c) The full efficiency of the receivers should be such as to enable them when operating on a vertical aerial of half wavelength to receive a signal of 0.1 microvolt per meter and to produce output:

(1) In the case of telephone signals a 40-milliwatt audio-frequency free from distortion, with an output impedance of 600 ohms.

(2) In the case of telegraph signals they must be capable of a recording speed of 200 words a minute.

(d) When the receiver is used for telephony in the above circumstance, the noise from the receiver itself should not, with a disconnected aerial, exceed 4 milliwatts measured at the output of the receiver.

(e) The construction of the receiver should be such as to secure a constant output on a band of 6000 cycles per second for telephony and telegraphy. At a frequency more than 18,000 cycles on either side

of the mid-band frequency, the sensitivity of the receiver should be at least 40 decibels less than the sensitivity at the mid-band frequency.

(f) By means of manual control it should be possible to produce from 0 to 60 decibels variation on the intermediate-frequency amplifier and from 0 to 30 decibels variation on the low-frequency amplifier.

(g) The receiver should be fitted with an automatic control device maintaining the audio-frequency output of the receiver practically constant for an increase of signal voltage input of up to 30 times a specified datum value of received signal voltage.

#### *Antennas*

As regards the antennas, greater freedom was left to the constructors, and it was simply indicated that the antenna should be directional, with the exception of a few nondirectional antennas of which special mention was made.

All these conditions were strictly fulfilled as regards the transmitting station. In the case of the receiving station another solution was chosen whereby a special receiver for telephony was placed beside two high speed receivers for telegraphy. In May, 1932, various tests were carried out in the presence of the Technical Committee. These tests gave full satisfaction to the Committee, and the material was accepted with the proviso that for a period of twelve months the station should work in normal conditions with no serious defect.

The necessary tests for the receivers and for the machinery and various other parts of the transmitter have already been completed at the factory under the supervision of a member of the Committee and of the present writer. These tests were unanimously regarded as satisfactory and gave rise to no difference of opinion.

### V. EQUIPMENT AT PRANGINS TRANSMITTING STATION

#### *Transmitter A*

The master oscillator is of the Franklin type without temperature regulation (see Fig. 1). This master oscillator acts on the principle of a multivibrator producing a very large quantity of harmonics. Temperature compensation is effected by the choice of the material of the induction coil. For the latter a material has been chosen in which the expansion caused by an increase of temperature produces a reduction of the capacity which exactly compensates the change of frequency caused by the expansion of the induction coil.

The multivibrator produces a quantity of harmonics; among the latter, the one nearest to the required frequency or to a multiple of that frequency is chosen. By varying the capacity of the multivibrator

it is possible to obtain exactly the required wavelength or a multiple thereof. This frequency is then doubled if necessary. Amplification takes place in the succeeding stages.

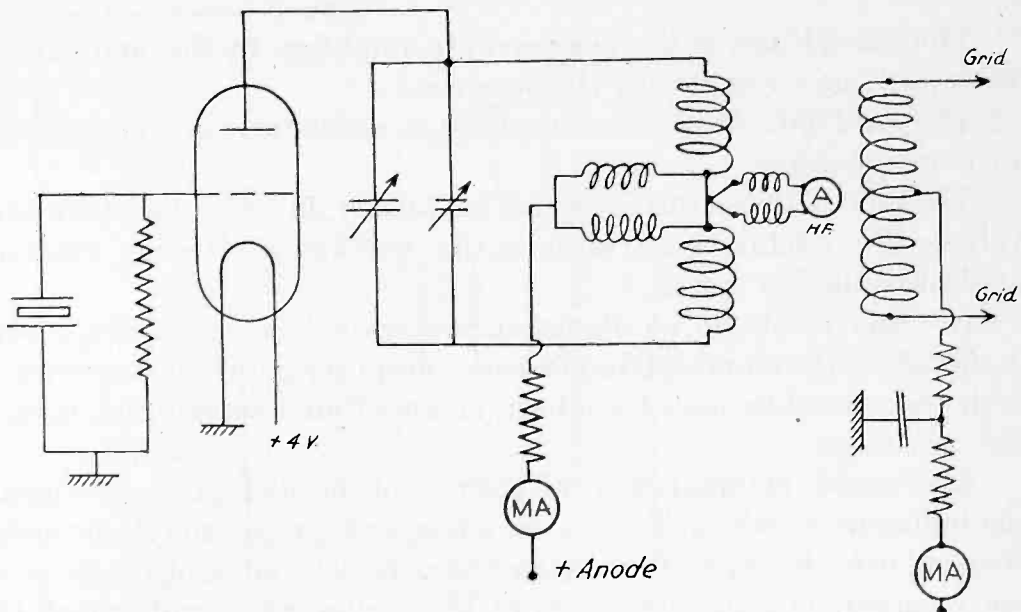

Fig. 1—Master oscillator, Franklin type used in transmitter A (Marconi Company).

The transmitter as a whole is divided into four distinct units (see Fig. 2).



Fig. 2—High-frequency transmitter A.

The first comprises the master oscillator with the appliances for doubling and amplifying the frequency (low power stages). It also comprises four multivibrators for the four fixed wavelengths and for four fixed frequency bands as follows:

1. For a frequency of 22,200 up to 15,500 kilocycles
2. For a frequency of 21,300 up to 10,600 kilocycles
3. For a frequency of 12,500 up to 6600 kilocycles
4. For a frequency of 7500 up to 2990 kilocycles

The second unit is the intermediate amplifier. In this amplifier a valve without water cooling has been used.

The third unit is the power amplifier, in which there are four valves, with water cooling.

The fourth unit is the telephone modulator, in which there are five valves. The modulation system is the well-known Heising system, applied to the last stage.

In order to obtain an almost instantaneous change of frequency in the case of the four fixed frequencies, the appropriate inductance coils with their coupling coils have been mounted on a copper disk in the last two stages.

By a simple manipulation the position of this disk can be changed, the inductance coils and their coupling coils being simultaneously changed in both stages. At the same time, the neutrodyning condensers are changed, but the capacities of the oscillating circuits must be regulated by hand. In this way the fixed frequencies can be changed very rapidly and adjustments are reduced to a minimum. In this transmitter the well-known Marconi circuit resembling the circuit of a Wheatstone bridge has been used.

The total number of amplification and multiplication stages varies from 7 to 8 according to the frequency.

| <i>Approx. Frequency,<br/>Kilocycles</i> | <i>Amplification</i> | <i>Multiplication</i> |
|--|----------------------|-----------------------|
| 20,000                                   | 6                    | 2                     |
| 15,000                                   | 6                    | 2                     |
| 8,000                                    | 7                    | 1                     |

#### *Transmitter B*

A quartz crystal producing an exact submultiple of the frequency has been utilized as the master oscillator (see Fig. 3). This frequency is doubled and amplified, in the first place, by means of several stages with air-cooled valves; the necessary power is obtained by means of the last two stages with water-cooled valves. Thus, the transmitter is divided into three parts.

The first part includes only the low power stages.

The second part consists of the medium power amplifier.

The third part comprises the high power amplifier. This high power amplifier has two water-cooled valves.

The quartz master oscillator has thermostatic temperature regulation, which provides the necessary constancy. The medium power amplifier and the high power amplifier are constructed on similar lines.

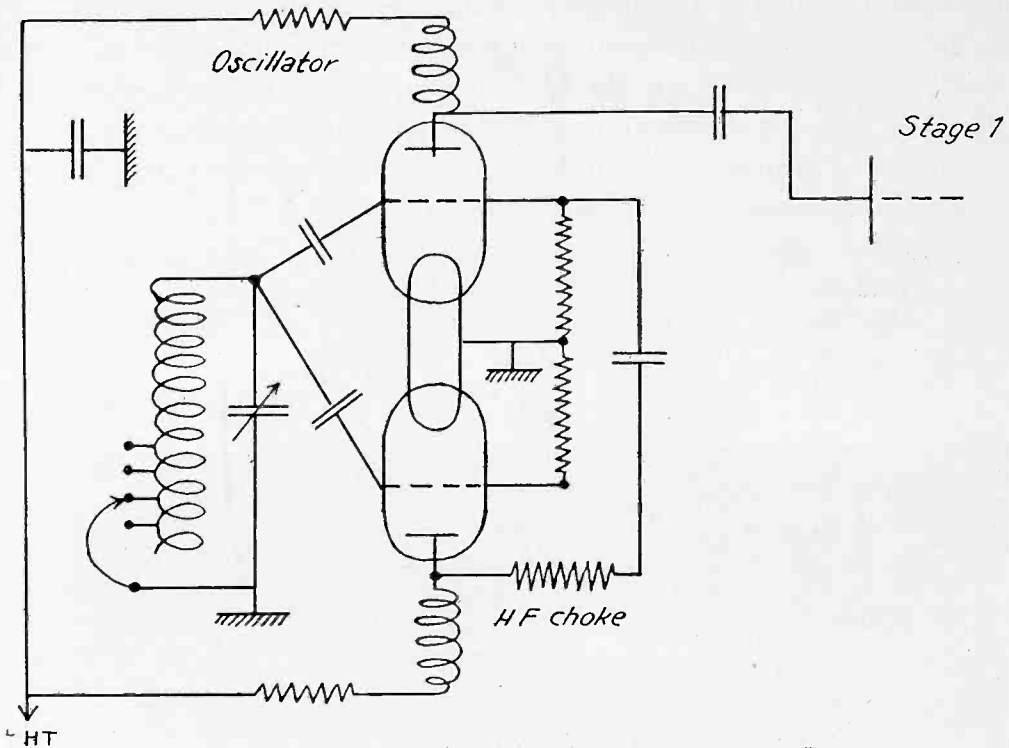

Fig. 3—Quartz oscillator used in transmitter B (Société Française Radio-Électrique).

The modulator consists of four water-cooled valves. The modulation system is also the Heising system in the last stage.

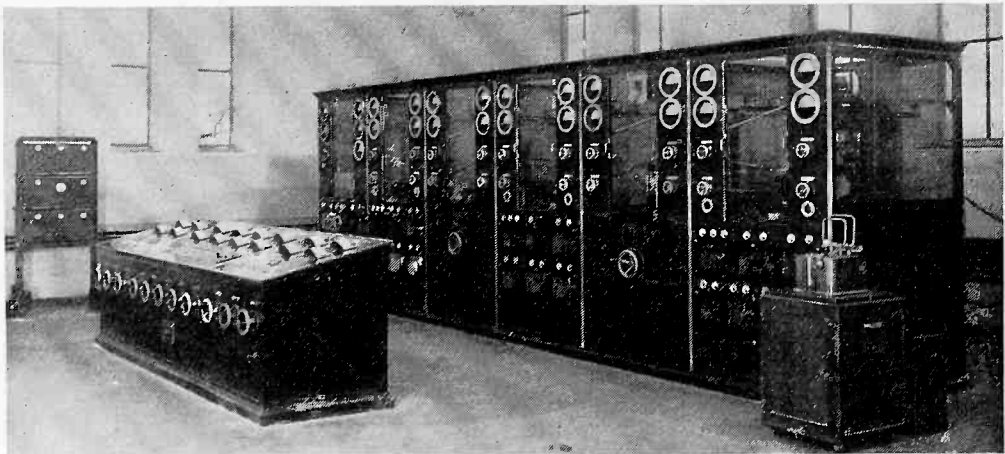

Fig. 4—High-frequency transmitter B.

The transmitter as a whole comprises two high power amplifiers, two intermediate power amplifiers, and three quartz groups combined with low power amplifiers (see Fig. 4). These last three groups (one for

each fixed wave) can produce frequency bands of 30,000–10,700, 15,000–10,000, and 10,000–7500 kilocycles, respectively.

One of the low power amplifiers and one of the high power amplifiers is designed to produce two fixed frequencies below 15,000 kilocycles. The second intermediate power amplifier and the high power amplifier are designed for the highest frequency. A change in the frequency is effected by disconnecting and connecting certain parts.

The total number of amplification and multiplication stages varies from 6 to 7 according to the frequency.

| <i>Approx. Frequency,<br/>Kilocycles</i> | <i>Amplification</i> | <i>Multiplication</i> |
|--|----------------------|-----------------------|
| 20,000                                   | 4                    | 3                     |
| 15,000                                   | 4                    | 2                     |
| 8,000                                    | 4                    | 2                     |

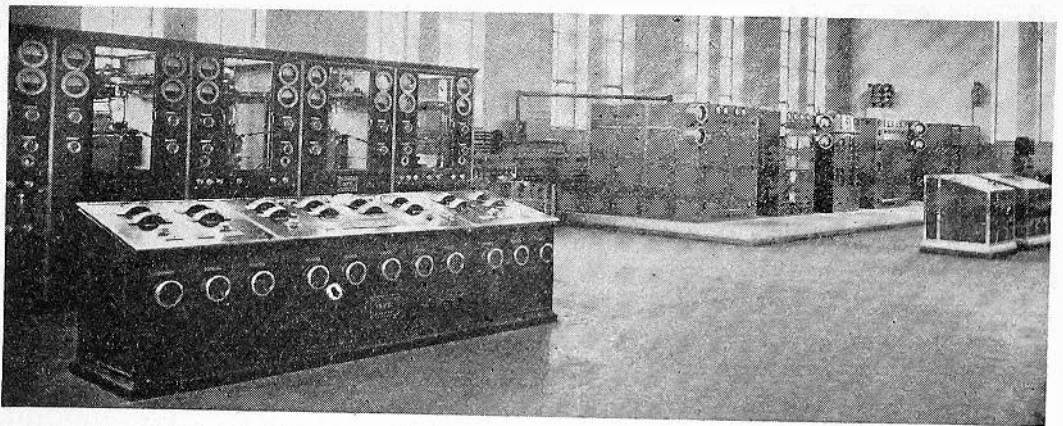

Fig. 5—View of transmitters A and B showing control tables.

The two transmitters are connected to an antenna distributor which enables any transmitter to be connected to any antenna. The feeders terminate in the broadcast hall in a series of vertical tubes which may be connected with another series of horizontal tubes by means of a telescopic connection. With this instrument the antenna can be changed in a few minutes and several antennas can be placed in parallel, if necessary.

The two transmitters may be started by means of two control tables situated in front of the transmitters (see Fig. 5). The generators are situated directly below the transmitters in the cellar (see Fig. 6). Starting has been rendered automatic, as far as possible. The generators have been placed directly below the transmitters in order to shorten the connections as much as possible. Thanks to this method, it is possible to suspend the cables to the ceiling of the cellar by means of hooks instead of running them in ducts, so that they are



easy to reach and repair. By the use of automatic appliances the work can be done by only three engineers. The high tension installation has

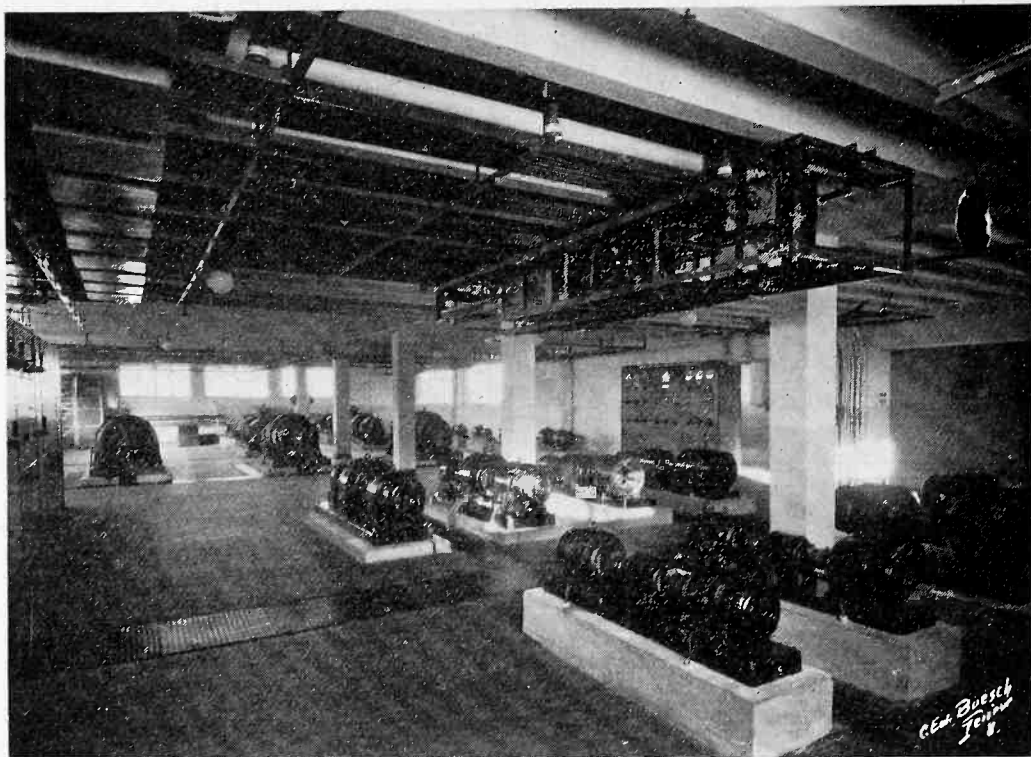

Fig. 6—View of generator room.

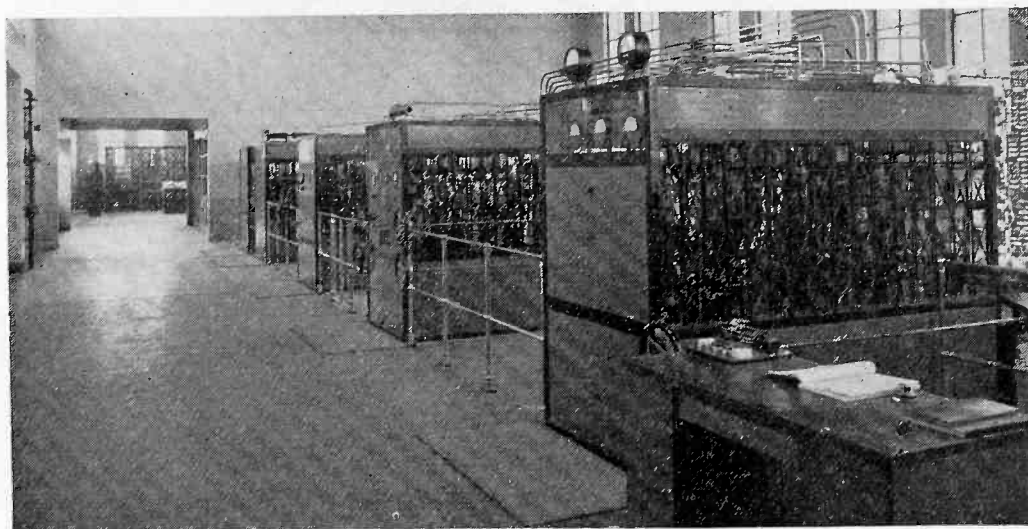

Fig. 7—Medium-wave transmitter—60 to 100 kilocycles.

a transformer of 350 kilovolt-amperes. This transformer serves to step down the high voltage of 13,500 volts, 50 cycles of the Vaud system to the working voltage of 500 volts, 50 cycles.



*Medium-wave Transmitter*

The master oscillator of the medium-wave transmitter consists of an electrically stabilized valve (see Fig. 7). A power of 50 kilowatts can be supplied to the antenna over a frequency band of 60 to 100 kilocycles. Tests made with this transmitter have shown that it can reach all the countries of Europe.

*Antennas*

Located on the grounds of the transmitting station are:

1. A Marconi antenna of the double Franklin type with vertical dipoles. One half is directed towards South America and the other half towards the Far East, each of them having a night wavelength and a day wavelength (of about 20,000 and 7500 kilocycles, respectively) (see Figs. 9 and 10).

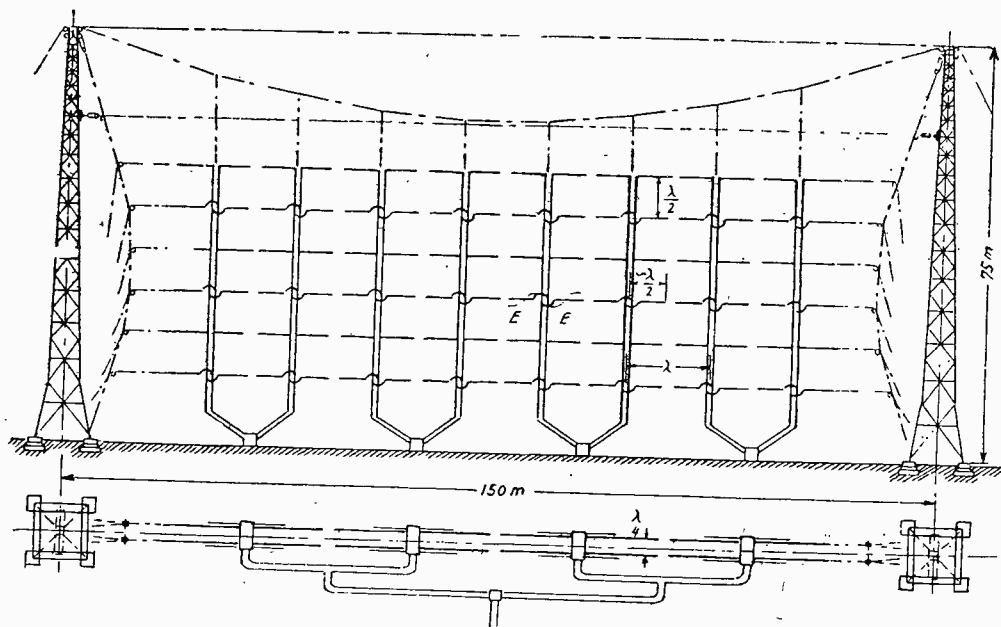

Fig. 8—Telefunken aerial.

2. A first group of Telefunken antennas (Tannenbaum type Fig. 8), with horizontal dipoles directed towards Central America, each having a night frequency and a day frequency (of about 20,000 and 7500 kilocycles, respectively). These antennas are reversible, and may be directed towards Australia and the Netherlands Indies.

3. A second group of Telefunken antennas (Tannenbaum type) are directed towards North America with a single frequency of about 15,000 kilocycles. These two groups are suspended between five masts about 48 meters high (see Fig. 11).

4. A group of three omnidirectional antennas (vertical dipoles), Marconi and Telefunken types.

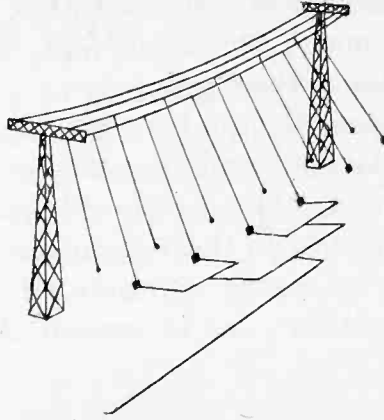

Fig. 9—Suspension of Marconi aerial.

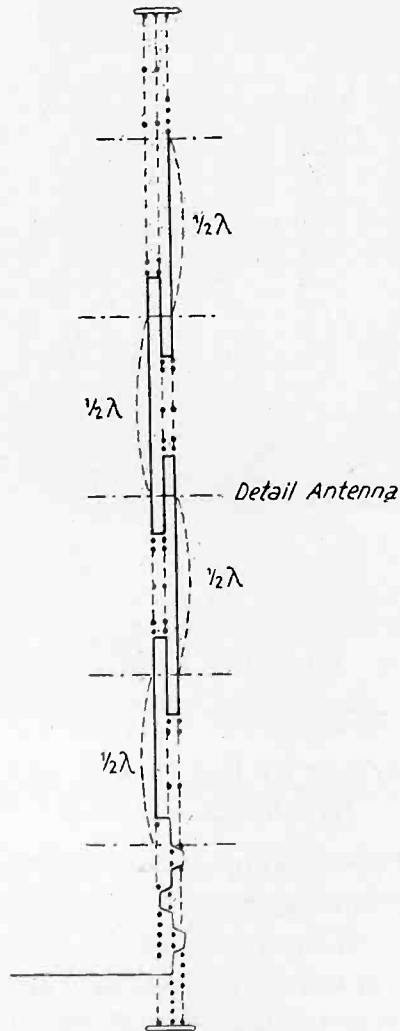

Fig. 10—Detail of Marconi aerial.

5. A flat-topped aerial for medium waves of about 83 kilocycles, suspended between two masts 125 meters high. The photographs and diagrams give a clear idea of these groups.

The Telefunken antennas are fed from high-frequency transformers, supplying the antenna and the reflector. These transformers have been constructed with great care (see Fig. 12).

Another interesting feature of the Telefunken antennas is the feeding of the transformers by means of feeder cables of modern design which, owing to their flexibility, can be treated like ordinary cables.

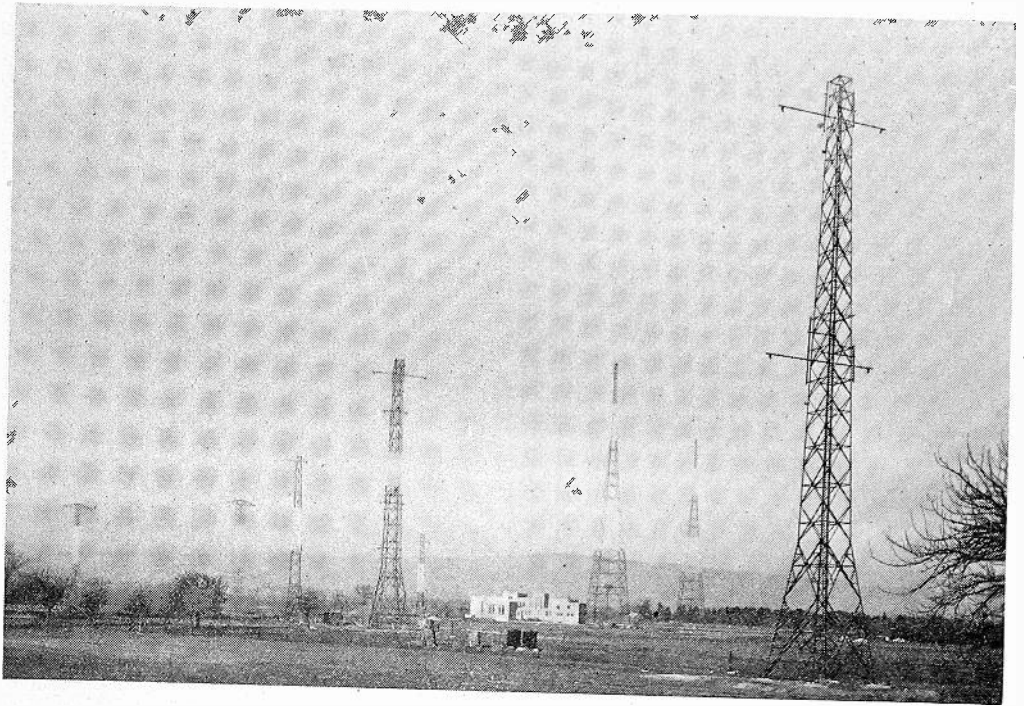

Fig. 11—Antenna masts.

The two feeder tubes are separated by an insulation of steatite. The external diameter of the inner tube is 15 millimeters, and the internal diameter of the outer tube is 45 millimeters.

#### VI. DESCRIPTION OF EQUIPMENT AT COLOVREX RECEIVING STATION

Colovrex, where the receiving station is situated, is at a distance of about 8 kilometers from Geneva.

The station contains the following:

1. Two high speed receivers (200 words a minute).
2. One special receiver for telephonic reception.
3. Seven ordinary receivers for the reception of frequencies of 30,000 to 10 kilocycles.

This last series is for the purpose of listening in at times of emergency.

It is not necessary to give a more detailed description of the receivers, these being all of an ordinary commercial type. In a room next to the main reception hall there is a duplex telephone installation permitting of the use of the ordinary telephone system (see Fig. 13). For each transmitter there is a complete installation enabling the two transmitters to be used simultaneously for duplex telephony.

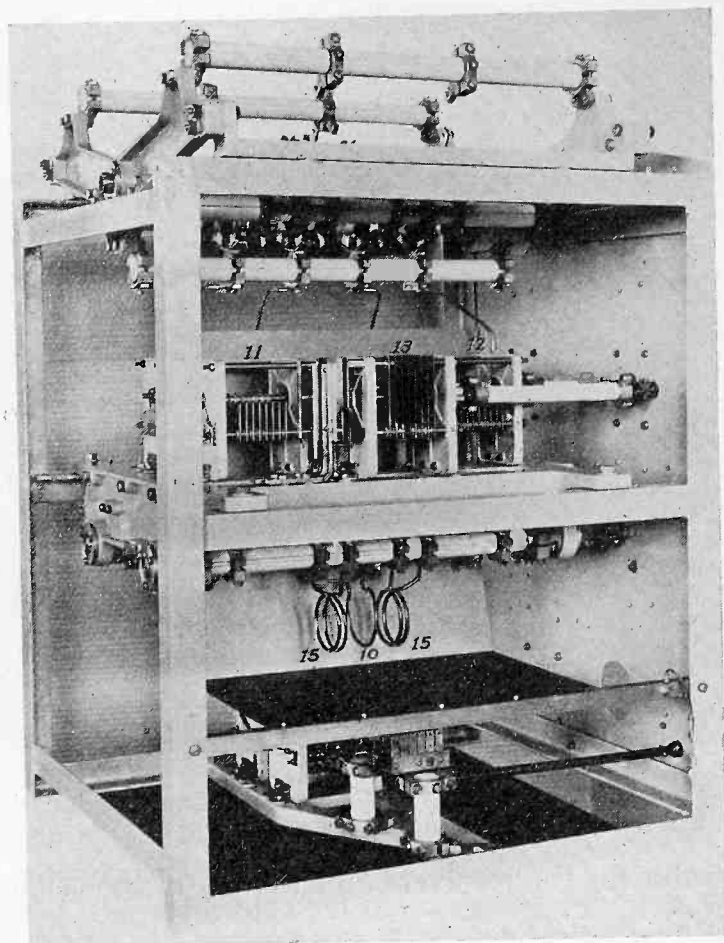

Fig. 12—High-frequency antenna coupling transformers.

For the receiving antennas the Telefunken (Tannenbaum) type has been chosen, divided into two groups, the first directed towards Japan or South America (reversible), and the second towards Central America and Australia, or Netherlands Indies (reversible). These two groups each have a day wave and a night wave.

Two small antennas are intended for reception from North America and on twilight waves of about 16,000–12,000 kilocycles (omnidirectional).

Another group of small aerials around the building is intended for listening in between 30,000 and 10 kilocycles.

The Telefunken groups are connected to the building by means of high-frequency transformers and feeder cables terminating at an antenna distributor, whereby any receiver can be connected to any antenna. The diameter of this cable is about 33 millimeters, and it is constructed like that of Prangins.

The accumulators with their groups of chargers and the anode

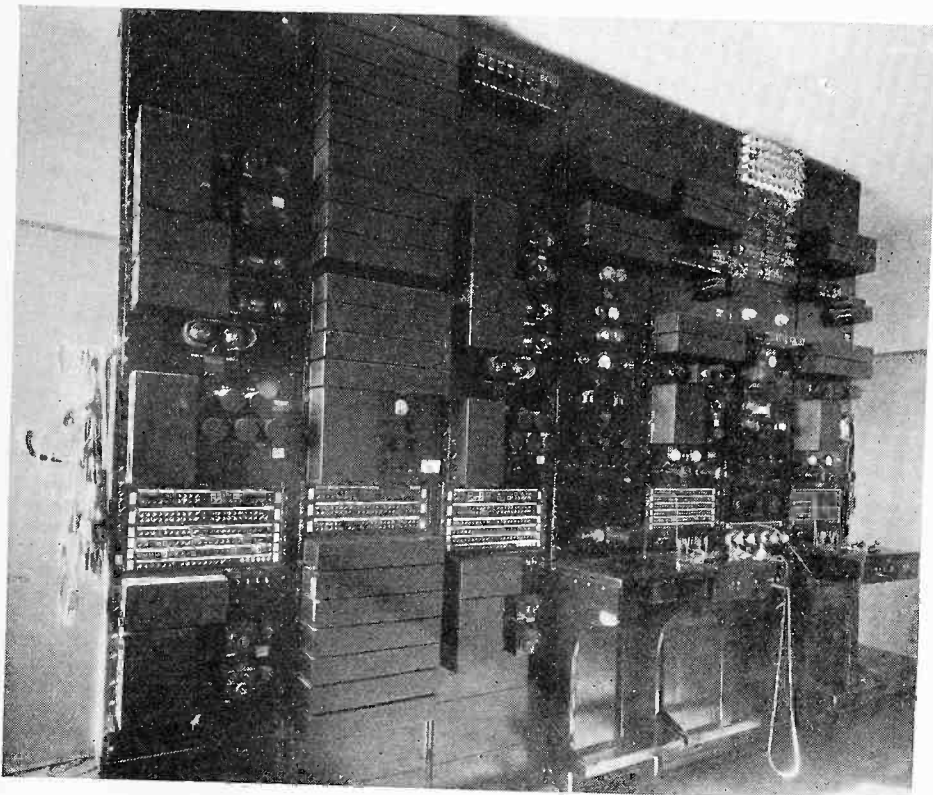

Fig.13—Switchboard for providing connections with landline telephone system.

voltage generator for the receivers are situated in the cellars beneath the main hall.

The emergency power house is at a distance of 50 meters from the main building. It consists of a Diesel engine of 50 horse power directly coupled to a dynamo of 54 kilovolt-amperes. This installation makes it possible to work independently of the local system. There is a heavy oil tank containing a supply of fuel for about two months. In the main hall there are also a number of medium-wave receivers.

#### VII. GENEVA CENTRAL OFFICE IN THE RUE DU STAND

This office is in the main building of the Federal Telegraph and Telephone Service in the Rue du Stand. It is directly connected by

cable with the transmitting and receiving station. In ordinary times the operating service is carried on at this office.

In order to avoid loss of time, an auxiliary office is installed during important conferences at the League of Nations Secretariat in the Disarmament Conference Building.

#### VIII. EMERGENCY OFFICE AND STUDIO

The cables connecting the Central Office with the transmitting and receiving station pass through the building of the League Secretariat, where they terminate at a control table in the emergency office, which would enable the service to be effected in that office at times of emergency.

Next to this office there is the wireless-telephone studio, separated from the office by a soundproof wall. In the studio there is a microphone with amplifier, which is used for the broadcasts organized by the League Secretariat of the Société Radio-Suisse.

#### IX. OPERATING RESULTS

As mentioned above, thorough tests have already proved that the station amply performs all the functions required by the contracts; the station has already demonstrated its great utility as a radiotelegraphic and radiotelephonic instrument by reaching practically every point of the globe, and by rapidly transmitting radiotelegraphic and radiotelephonic news and information.

The financial results of the first year are most striking. The operating expenses (excluding sinking fund) will probably be covered by the revenue, thanks to the system of combined operation. Commercial traffic is continually increasing.

For Switzerland, the maximum has not yet been reached, but as the result of intensive propaganda in commercial and industrial circles this traffic is capable of still further development.

The official traffic during 1933 has been considerable, owing to the conferences held at Geneva under the auspices of the League. Press traffic has also been very heavy. It is difficult to foresee what the volume of this traffic will be in the future.

The revenue from the radiotelephone service was also considerable, and in this direction too, an increase may be anticipated.

While taking these various factors into consideration, it must be remembered that the station was not created for a commercial purpose and that the possibility of covering the operating costs was not even contemplated. In fact, it was anticipated that the operation of the station would cost about 200,000 Swiss francs annually.

Commercial traffic with several countries has declined to a great extent owing to the economic crisis; in Switzerland in particular it has fallen by over 25 per cent.

The tariffs for official and press traffic have also been reduced by 50 per cent. Under these circumstances the financial results of the station for 1932 must be regarded as most satisfactory.

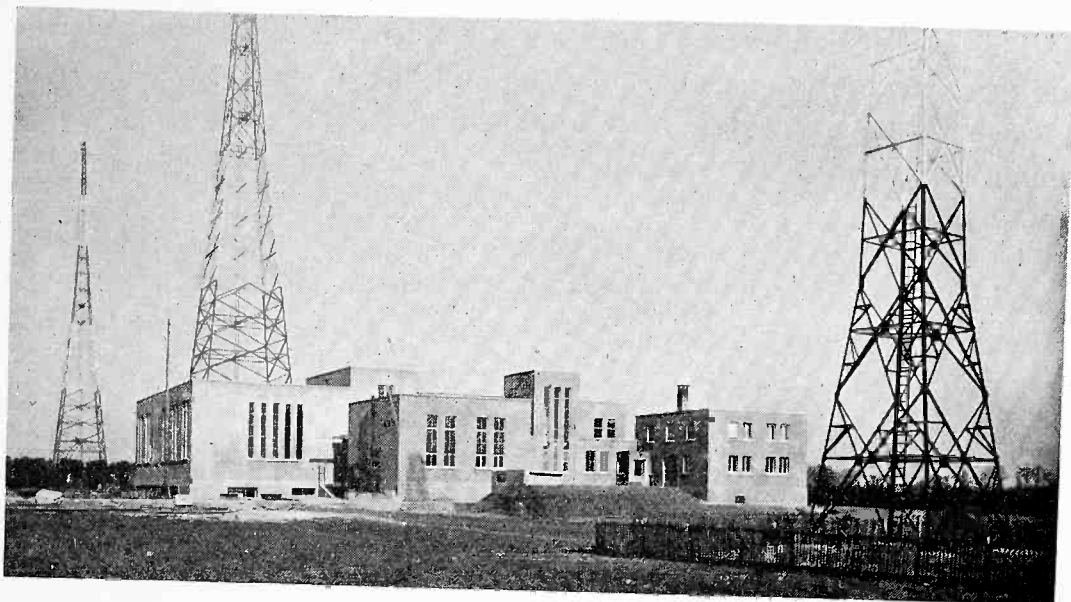

Fig. 14—General view of League of Nations radio station, Prangins, Switzerland.

The station is so managed that the operating services and the special services can ordinarily be carried on with a staff reduced to a strict minimum.

In any case, the tests to which the League wireless station has been subjected have abundantly proved that it is fully capable of performing all the special services for which it was designed, without seriously hampering the combined form of operation described above.





## THE TESTING OF FREQUENCY MONITORS FOR THE FEDERAL RADIO COMMISSION\*

W. D. GEORGE

(Bureau of Standards, Washington, D. C.)

*Summary*—Rule 144 of the Federal Radio Commission of the United States of America requires broadcast stations to maintain their carrier frequencies within fifty cycles per second of the assigned values. To meet this requirement a new and more accurate frequency checking instrument (known as a frequency monitor) was required by each broadcast station. A type test of the different kinds of frequency monitors manufactured was made by the Bureau of Standards. This paper gives a general description of the monitors tested and of the test procedure. Results of the tests are given for ten monitors approved by the Federal Radio Commission.

### I. INTRODUCTION

SINCE June, 1932, broadcast stations have been required by Rule 144 of the Federal Radio Commission to maintain their carrier frequencies within fifty cycles per second of the assigned values. This requires an accuracy of approximately five parts in a hundred thousand. To meet the requirement, new apparatus and checking equipment were necessary. The need has been filled by installation in each station of a device known as a frequency monitor. The Commission has required that the monitor be of a specifically approved type.

It thus became necessary to determine which of the frequency monitors manufactured would be satisfactory for broadcast station use and worthy of the approval of the Federal Radio Commission. To be certain of the qualities of the apparatus, the Commission requested the Bureau of Standards to test a sample of each frequency monitor which any manufacturer wished to submit. A preliminary outline of the tests to be made was prepared at a meeting of representatives of radio manufacturers, the Federal Radio Commission, and the Bureau of Standards.

No specifications were drawn up by the Radio Commission; the design of monitors was left to the choice of the manufacturer. The most important part of the device had to be a standard, or self-contained source of constant frequency. Other equipment to give a comparison of the broadcast transmitter's frequency and the monitor standard was of course necessary. Simplicity and reliability of operation were essential.

\* Decimal classification: R214. Original manuscript received by the Institute, December 22, 1933. Publication Approved by the Director of the Bureau of Standards of the U. S. Department of Commerce.

## II. DESCRIPTION OF MONITORS TESTED

General information is given here on the type of apparatus included in the majority of monitors tested. It is not the purpose of this paper to describe the individual monitors.

For the frequency standard, or self-contained source of constant frequency, a standard capable of maintaining a high degree of accuracy over a long period of time, requiring little attention and having a moderate cost, was necessary. For long-time constancy of frequency, the piezo oscillator provides an almost ideal source of standard frequency, and by observing certain precautions its constancy can be made far in excess of that required. All of the frequency monitors tested use piezo oscillators as the monitor standard.

The frequency of the monitor's piezo oscillator is in most cases of a value not far from the broadcast transmitter's assigned frequency. The difference between the piezo-oscillator frequency and the transmitter's frequency then produces a beat note of audio frequency. The audio frequency is obtained with a detector and amplified to sufficient power to operate indicating or measuring equipment. The detector is supplied with a plate-current meter so that its operation is known and undue distortion is not introduced. The coupling circuits supplying voltage to the detector are so designed that there is no danger of their resonating at or near the second or third harmonic of the radio frequency being monitored. If such resonance occurred, it would cause the resulting wave form to be distorted or, in extreme cases, the audio frequency would be double or triple the actual radio-frequency difference. An audio-frequency amplifier having fairly constant amplification over the frequency range of the frequency difference measuring instrument is used. The amplifier has an output voltmeter and some means of controlling its gain.

To avoid a more or less indefinite warming-up period, during which the monitor's frequency would be inaccurate, the monitors are designed for continuous operation, giving a continuous indication of the radio transmitter's frequency, and enabling the radio station operator to tell at a glance whether the transmitter is within the assigned limits. The frequency-indicating instrument is calibrated in cycles per second, and shows whether the radio transmitter's frequency is high or low. This instrument is operated by the audio-frequency power from the detector-amplifier within the monitor. Its audio-frequency range determines the radio frequency to which the monitor piezo oscillator is adjusted. For example, an audio-frequency meter with a range of 900 to 1100 cycles having its scale marked in cycles, high and low from its 1000-cycle indication, would be used with a monitor piezo oscillator having a

frequency 1000 cycles different from the transmitter's assigned frequency. The heterodyne note between the monitor piezo oscillator and the radio transmitter's frequency would then vary between 950 and 1050 cycles as the transmitter's frequency drifted within its allowable limits. It is, of course, assumed that the monitor's frequency remained constant. With certain types of frequency indicators the monitor piezo-oscillator frequency is adjusted to the transmitter's assigned frequency. With this arrangement the heterodyne note in cycles is the amount in cycles that the transmitter is off the assigned frequency. Such an audio-frequency meter has a range of from a few to 75 or 100 cycles. Meters of this type have been previously described in detail.<sup>1</sup> Audio-frequency meters having ranges of 450 to 550 and 900 to 1100 cycles are usually of the type used for power work. They are advantageous in that they are sturdy and have been used as frequency indicators for many years. When used on a monitor they show at a glance whether the transmitter frequency is high or low.

A monitor can be designed to operate with a standard of almost any frequency, but if the frequency of the standard is not an even multiple of the frequency to be monitored the instrument would be complicated and impractical. However, by choosing a standard frequency of 10 kilocycles, monitors are built which are universal in application. Such monitors may be used to check the frequency of any broadcast station in the United States. In one of the monitors tested, the 10-kilocycle output was obtained from a 100-kilocycle piezo oscillator by means of a multivibrator. The desired harmonic of the 10-kilocycle output is amplified sufficiently to give a beat note at the broadcast transmitter's fundamental frequency. It has the advantage of adaptability and ease with which its piezo oscillator can be checked against standard frequency transmissions. On the other hand, it is not as simple as the other types.

### III. TEST PROCEDURE

Type tests were made of fifteen monitors, ten of which were subsequently approved by the Federal Radio Commission. Each monitor tested had been adjusted by the manufacturer to indicate correctly the frequency of a 1500-kilocycle radio transmitter. Thus all monitors were tested under the same conditions and considerable convenience in testing resulted. Another reason for the 1500-kilocycle adjustment

<sup>1</sup> N. P. Case, "A precise and rapid method of measuring frequencies from 5 to 200 cycles per second," *B.S.J.R.*, vol. 5, p. 237; August, (1930); *Proc. I.R.E.*, vol. 18, p. 1586; September, (1930).

F. Guarnaschelli and F. Vecchiacchi, "Direct-reading frequency meter," *Proc. I.R.E.*, vol. 19, p. 659; April, (1931).

was to have as the test monitor the one most difficult to build. The accuracy requirement was more severe at 1500 kilocycles than at any other broadcast frequency.

The methods used in testing the monitors were basically similar to those used by the Bureau in testing piezo oscillators,<sup>2</sup> except that the test was extended over a greater period of time and was considerably more detailed. Test conditions simulated those in a radio station in that a powerful 1500-kilocycle generator was operated near the monitor. The 1500-kilocycle generator was directly controlled by one of the piezo oscillators of the primary standard of frequency.

When a frequency monitor was received for test, it was examined carefully to see that it had not been damaged in shipment. The monitor was then set up in a temperature-controlled room, connected to a power supply, and left running continuously until the tests were completed.

The tests made upon the monitors were as follows:

- (1) Measurement of constancy of monitor's piezo-oscillator frequency and deviation indicator.
- (2) Measurement of frequency change caused by tilting, tipping, and jarring monitor.
- (3) Measurement of frequency range of frequency adjusting device.
- (4) Determination of the effect of changing the piezo-oscillator tube.
- (5) Measurement of the frequency change with supply voltage change.
- (6) Calibration of the frequency deviation indicator.
- (7) Tests of frequency indicating instruments for sensitivity and effects of starting and stopping.
- (8) Determination of the effect of coupling on frequency.
- (9) Measurement of frequency change caused by room temperature change between 15 and 35 degrees centigrade.
- (10) Examination of quartz plate and mounting.

#### IV. RESULTS

The results which follow are averages for the ten piezo oscillators which received the approval of the Federal Radio Commission. The average time required for all tests of a monitor was 40 days.

##### 1. *Constancy of Oscillator and Frequency Deviation Indicator.*

<sup>2</sup> E. L. Hall, "Method and apparatus used in testing piezo oscillators for broadcasting stations," *B.S.J.R.*, vol. 4, p. 115, (1930); *Proc. I.R.E.*, vol. 18, p. 490, March, (1930).

Twenty-four hours or more after turning the monitor on the tests were started. To determine the constancy of frequency of the unit as a whole and any frequency drift caused by an aging of the parts of a gradual change in the piezo-oscillator temperature or from other causes the piezo-oscillator frequency was measured every other day over a period of about thirty days. The room temperature was maintained at 25 degrees centigrade during that time. The method of measuring the piezo-oscillator frequency was to measure the audio-frequency heterodyne note between it and a radio-frequency generator controlled by the Bureau's primary frequency standard at a frequency of 1,500,000.0 cycles. The heterodyne note was obtained with an ordinary broadcast receiver, tuned to 1500 kilocycles, located in the vicinity of the monitor and the 1500-kilocycle generator. With a monitor that was well shielded a small pick-up coil was placed near the monitor and connected to the antenna circuit of the broadcast receiver; this expedient increased the volume of the audio-frequency note obtained. A very low audio frequency, below forty cycles, would not pass through the amplifier of the radio receiver. For such a case, an additional radio-frequency voltage having a frequency of about 1501 kilocycles was introduced into the radio receiver which caused the low frequency to pass through superimposed upon the higher audio-frequency note. The audio-frequency beat note obtained was measured on a direct-reading frequency meter or it was determined by matching it with a frequency from a calibrated audio-frequency oscillator.<sup>3</sup>

During the average time required for all tests of a monitor, forty days, the average frequency drift of the monitor's piezo oscillator was 13 cycles. The frequency deviation indicator indicated an average drift of 14 cycles. The minimum drift was 6 cycles and the maximum, 30 cycles. These results are cycles deviation in 1500 kilocycles.

2. *Effect of Tilting, Tipping, and Jarring.* Tilting or tipping a monitor usually causes the quartz plate to be differently located in its holder when the monitor is set back into position. Such a change can cause the quartz plate to oscillate at a considerably different frequency. In this test the monitors were tipped and jarred sufficiently to move the quartz plate in its holder. Of course such is not the case when the quartz plate and its electrodes are clamped into one position. One monitor had such a quartz plate mounting and showed no frequency change when tipped. For the remaining nine monitors approved, tilting or tipping a monitor caused an average frequency change of 6 cycles. The minimum change was 1 cycle, the maximum 14 cycles.

<sup>3</sup> E. G. Lapham, "An improved audio-frequency generator," *B.S.J.R.*, vol. 7, p. 691; (1931); *Proc. I.R.E.*, vol. 20, p. 272; February, (1932).

3. *Frequency Range of Frequency Adjusting Device.* The radio station operator requires some simple means of adjusting the frequency of the radio station's frequency monitor to take care of the frequency drift in the piezo oscillator. A manufacturer can make a considerable saving in cost of the monitor if small frequency adjustments can be made without changing the size of the quartz plate. There are two convenient methods of making small frequency changes in a piezo oscillator. One is to change the capacitance across the quartz plate electrodes. The other is to change the inductance or capacitance at some other point in the piezo oscillator. Four of the monitors had a small variable air condenser in parallel with the quartz plate holder. Five had a small variable air condenser in the plate circuit of the piezo oscillator. One had no external means of frequency adjustment. The average range of the frequency adjusting devices was 159 cycles at 1500 kilocycles. The maximum was 675 cycles, and the minimum 28 cycles.

4. *Effect of Changing the Oscillator Tube.* Four vacuum tubes of the same type were tested in the piezo oscillator of each monitor. The average maximum frequency change was 6 cycles, while frequency changes from zero to 15 cycles were noted.

5. *Frequency Change with Supply Voltage Change.* The power supply voltage was changed plus and minus 15 per cent and the piezo-oscillator frequency measured. The average plate voltage change was 55 volts which caused an average frequency change of 1.5 cycles. With the individual monitors, the effect was from zero to 4 cycles.

6. *Calibration of Frequency Deviation Indicator.* Seven of the monitors approved had frequency deviation indicators of the type used in power frequency work. They operated from 450 to 550 cycles and their scales read from  $-50$  to  $+50$  cycles. One monitor had a specially designed meter that operated from 900 to 1000 cycles. Its scale read from  $-100$  to  $+100$  cycles. One monitor was equipped with a mechanical relay. Its meter range was a few to 75 cycles. Another monitor had a vacuum tube relay type of frequency meter with a scale reading from 0 to 100 cycles.

The frequency indicators were tested at three temperatures, 15, 25, and 35 degrees centigrade. The average error noted in the readings was  $-2$  cycles at 15 degrees centigrade and  $+1$  cycle at 25 and 35 degrees centigrade. The maximum error was  $-11$  cycles at 15 and 25 degrees centigrade and  $-10$  cycles at 35 degrees centigrade. The temperature change of 20 degrees centigrade caused a change in the frequency meter readings an average amount of 2 cycles and a maximum amount of 5 cycles for readings near the center of the scale.

7. *Tests of Indicating Instruments.* The frequency indicating instruments were tested for sensitivity, and were checked to see that they gave the same indication after starting and stopping the monitor several times.

8. *Effect of Coupling on Frequency.* If two oscillators are operating at nearly the same frequency, one may appreciably change the frequency of the other or there is a tendency to synchronize when sufficiently coupled. All but one monitor were carefully designed to eliminate such effects. A large change in coupling to the generator operating at 1500 kilocycles caused that monitor to change frequency an average of 5 cycles.

9. *Effect of Variation in Room Temperature between 15 and 35 Degrees Centigrade.* Of the ten monitors approved by the Federal Radio Commission, three had double temperature control on the quartz plate of the piezo oscillator. The three showed a change in frequency of 0.1, 0.45, and 0.68 cycle per degree change in room temperature. The other seven monitors each had a single temperature control. The average change in frequency was 0.59 cycle per degree centigrade change in room temperature, the maximum was 1.3 cycles, the minimum 0.10 cycle per degree centigrade room temperature change.

10. *Examination of Quartz Plate and Mounting.* The mounting tested, or a similar one supplied for the purpose, was disassembled and examined. Seven of the monitors used plate holders with an adjustable air gap. In two, the top electrode rested on the quartz plate. One had a clamped quartz plate.

## V. CONCLUSION

The principal results of the tests of the ten monitors are summarized in the following table.

|   | Frequency change in cycles at 1500 kilocycles |         |         |
|---|---|---------|---------|
|   | Maximum                                       | Minimum | Average |
| Drift in 40 days, continuous operation        | 30  | 6       | 14      |
| Tipping or tilting unit                       | 14  | 0       | 6       |
| Changing the oscillator tube                  | 15  | 0       | 6       |
| Supply voltage change                         | 4   | 0       | 1       |
| Error in frequency indicator                  | 11  | 1       | 2       |
| 20 degrees centigrade room temperature change | 26  | 2       | 12      |
| Total   | 100   | 9       | 41      |

No one monitor had the maximum variation of 100 cycles, likewise no one monitor had a constancy in all respects as good as that shown under the minimum column. Frequency changes shown were not at all in the same direction. The average monitor showed a constancy somewhat better than 41 cycles, during the period of the tests.



In actual service the frequency of the piezo oscillator of the monitor must be periodically checked and adjusted.

All the monitors which were approved by the Federal Radio Commission were thoroughly satisfactory for the exacting service which they have to render. They represent a great advance over the frequency meters and the piezo oscillators without temperature control which were previously used as frequency-checking equipment. A standard with an accuracy of the order of 5 parts in 100,000 was required. For ordinary operation and care, the units tested and approved by the Commission were at least 5 times as accurate, i.e., reliable to 1 part in 100,000.



## HIGH-FREQUENCY MODELS IN ANTENNA INVESTIGATIONS\*

BY

G. H. BROWN and RONOLD KING

(Department of Electrical Engineering, University of Wisconsin, Madison, Wisconsin)

*Summary*—The feasibility of a small scale analogy to study radio transmission problems is briefly discussed as an introduction to the description of model apparatus developed for this purpose. This consists of a model transmitter operating near 75 megacycles and a receiver of the screen-grid voltmeter type. Use is made of these devices to study the effect of the separation of resonant and nonresonant towers on the field patterns of the transmitter. Experimental patterns are shown and compared with corresponding ones computed from formulas derived in the included theoretical study of the problem. It is concluded that a further development of the method of models in conjunction with a study of an actual transmitting system should prove of value as a means of discovery and generalization.

### I. INTRODUCTION

THE antenna system of the modern broadcast station consists of the antenna proper, the supporting towers, and the ground network and surrounding earth. While the true purpose of the towers is to support the antenna, conditions may arise under which they become an important factor in determining the shape of the field pattern of the radiating system as a whole.

The expenditure of energy in the entire system may be expressed in terms of various resistances to which descriptive names have been applied. The quantities here called resistances are not necessarily the actual ohmic resistances of specific portions of the antenna system. They are fictitious resistances computed from the power expenditure in a certain branch of the circuit and the current at the reference point.

The major resistances of an antenna system are:

1. Radiation resistance
2. Conductor resistance
3. Earth resistance from surface to buried wires (earth entering resistance)<sup>1</sup>
4. Extraperipheral resistance<sup>1</sup>
5. Tower resistance
6. Resistance of dielectrics.<sup>2</sup>

\* Decimal classification: R120×R320. Original manuscript received by the Institute, February 15, 1933; revised manuscript received by the Institute, September 15, 1933.

<sup>1</sup> For a detailed discussion, see E. Bennett, "Feasibility of the low antenna in radio telegraphy," Proc. I.R.E., vol. 6, p. 237; October, (1918).

<sup>2</sup> T. L. Eckersley, "An investigation of transmitting aerial resistance," Jour. I.E.E., vol. 60, p. 581, (1922).

## II. SOME CONSIDERATIONS ON THE USE OF MODELS

This paper summarizes some of the results of an experimental and theoretical study the object of which was to minimize losses in antenna systems. In this investigation three methods of attack may be distinguished. The first of these is mathematical; it is limited by the complexity of the problems to simple cases for which it is necessary to make rather broad approximations. It is desirable to justify these experimentally. The second mode of attack is the experimental study of existing antenna arrays. Since these are generally erected for commercial purposes, they offer little opportunity for extensive experimentation. For example, on a given actual antenna array, it is difficult to obtain data of general significance since even the field pattern reveals little or nothing of what to expect were changes to be made in the antenna system. Thus, in the search for a method which will allow more complete flexibility, one is led to the use of a small scale model excited by means of a high-frequency source. In order to justify such a method one must examine the effect of a change in scale on the relations existing between the important quantities involved. Tykociner<sup>3</sup> has described these relations and has given a rather complete discussion of the use of model antennas.

In comparing large and small scale antenna systems, it is easily verified that if the impressed wavelength is decreased in the same ratio as the linear dimensions of the antenna, the radiation resistance remains unchanged. This fact leads to the conclusion that it would be desirable to hold the other major resistances constant. To accomplish this, it would be necessary to increase the conductivity of the earth below the antenna in the ratio of the two wavelengths concerned. If  $m$  is the ratio of the linear dimensions of a small antenna to a large one, the following relations are true.

| Quantity   | Large antenna | Small antenna |
|--|---------------|---------------|
| Capacitance per unit length  | $C$           | $C$           |
| Inductance per unit length   | $L$           | $L$           |
| Wavelength of the impressed voltage  | $\lambda$     | $m\lambda$    |
| Radiation resistance   | $R_r$         | $R_r$         |
| Resistivity of earth (for constant earth entering resistance and extraperipheral resistance) | $\rho$        | $m\rho$       |
| Dielectric loss  | $R_d$         | $R_d$         |

<sup>3</sup> J. Tykocinski-Tykociner, "Investigation of antennae by means of models," *Univ. of Ill. Exp. Station Bull.*, number 147, May 25, (1925).

## III. THE EXPERIMENTAL INVESTIGATION

A discussion of the experimental work may be conveniently subdivided into three parts as follows: A, a description of the apparatus and a brief summary of its underlying theory; B, the characteristics of the apparatus; C, the technique of field measurements and a description of experimentally observed effects of the towers on the field patterns.

## A. Description of Apparatus

(1) *The Transmitter*

The transmitting system consisted of a high-frequency oscillator operating at 75 megacycles coupled to an antenna-ground system. The oscillator used has been described in detail in earlier papers.<sup>4,5</sup> In the present case, the secondary consists of an inductively coupled antenna system. The complete circuit is shown in Fig. 1.

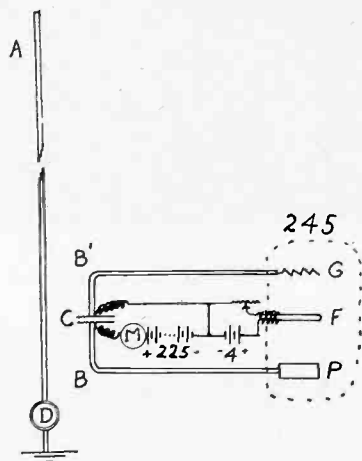

Fig. 1—Circuit diagram of the transmitter

A, antenna; D, milliammeter in antenna base; C, blocking condenser; M, plate-current milliammeter

The antenna proper was made of telescoping brass tubing, to provide vertical, T, or inverted L antennas. A thermal milliammeter was connected permanently in the base, and a grid-leak mounting was arranged near this meter in such a way that conveniently mounted resistances or small inductances could be inserted in order to vary the magnitude of the antenna current or to permit the use of a "short" antenna.

For present purpose of obtaining horizontal polar diagrams, it

<sup>4</sup> R. King, "Eine Untersuchung ueber elek. Drahtwellen," *Ann. der Phys.*, vol. 7, p. 805, (1930).

<sup>5</sup> R. King, "Wavelength characteristics of coupled circuits having distributed constants," *Proc. I.R.E.*, vol. 20, p. 1368, August, (1932).

was necessary that the ground system have no directional effect. A circular copper disk of 21-centimeter radius, placed flat on the ground, proved convenient and satisfactory.

To summarize, the transmitter consisted of a vertical, T, or inverted L antenna with a thermal milliammeter in its base and a circular copper ground plate. To this was coupled a variable high-frequency oscillator. Fig. 2 shows a photograph of the complete set-up.

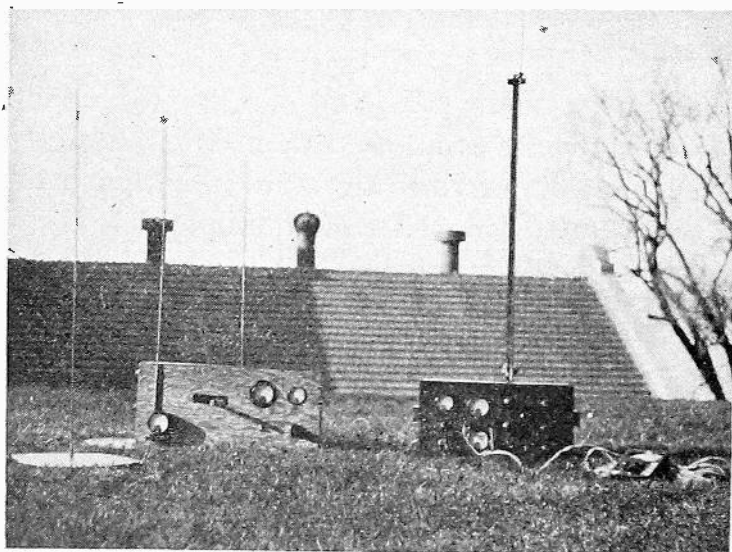

Fig. 2—The apparatus set-up. The receiver is on the right.

## (2) *The Receiver*

The design of a receiver capable of detecting the relatively weak field set up by the transmitter was not simple in view of the high frequencies involved. Here a device developed for an entirely different, although related, purpose proved useful. The screen-grid voltmeter,<sup>6</sup> originally designed as a resonance indicator in wavelength standardization using Lecher wires, is essentially a device for detecting high-frequency fields. It required no wide stretch of the imagination to substitute a variable length vertical antenna for one of the parallel Lecher wires, and a ground plate for the other. After preliminary tests, a modified form of the device was built into a compact box as shown in Figs. 2, 3, and 4. A complete circuit diagram is given in Fig. 5.

The manipulation of the screen-grid voltmeter as a high-frequency receiver is essentially the same as its use as a resonance detector described in reference 6. Instead of a ground plate, it was found convenient to use the shielding of the set itself. The antenna consisted of a

<sup>6</sup> R. King, "A screen-grid voltmeter," *Proc. I.R.E.*, vol. 18, p. 1388; August, (1930).

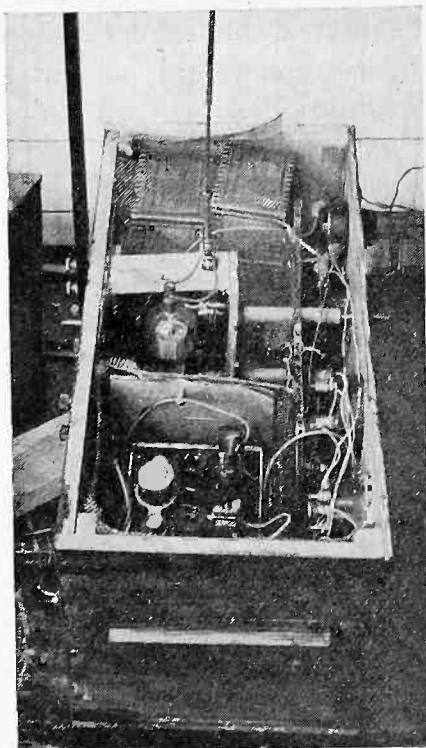

Fig. 3—Interior view of the receiver.

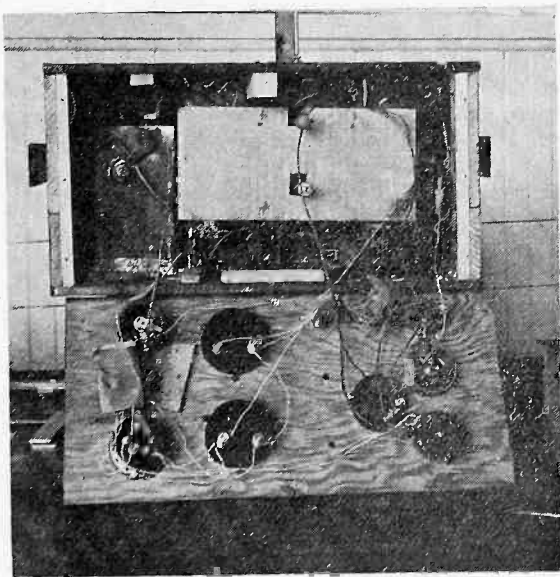

Fig. 4—Interior view of the receiver.





complicated by means of a correctly adjusted parallel wire system using the screen-grid receiver as a resonance indicator.

(2) The Receiver

The transrectification characteristics of the screen-grid voltmeter are independent of frequency at least up to and including the 75 megacycles here involved. Field measurements indicated that the deflections of the receiver meter would range between 0.2 and 4.0 milliamperes; over this range the transrectification characteristics of the

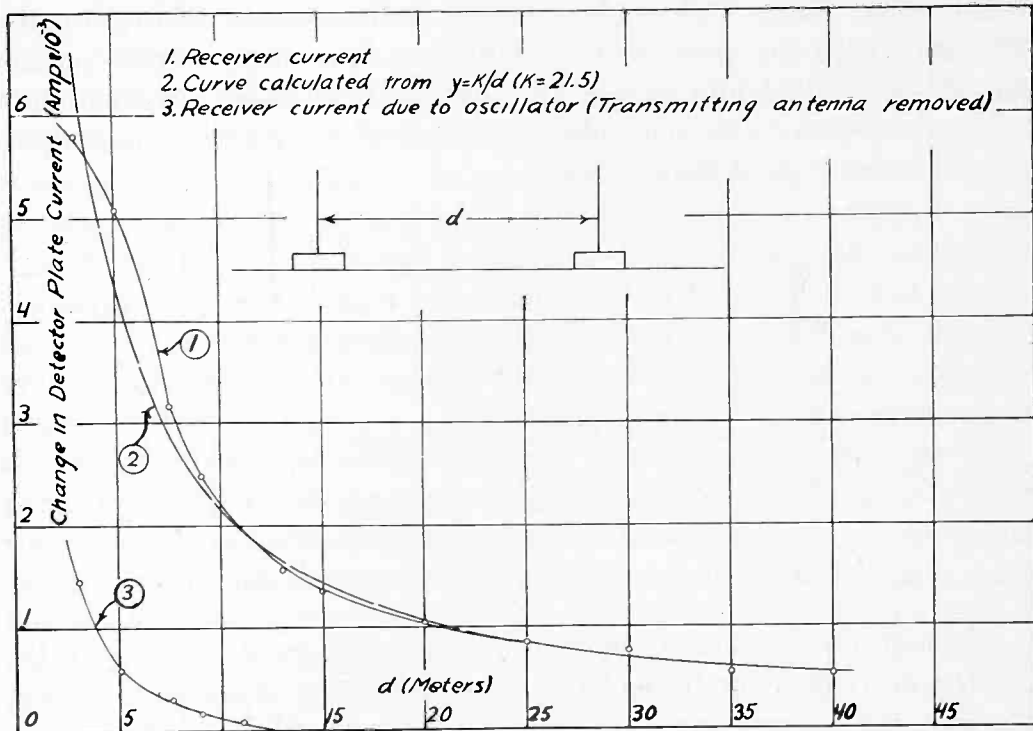

Fig. 6—The 1/r test; receiver deflections as a function of the distance between receiver and transmitter.

single tube detector here used is essentially linear. Hence it may be concluded that the deflection vs. vertical electric intensity characteristic of the device is linear. This conclusion was further verified experimentally by noting that the receiver deflection was inversely proportional to the distance of the receiver from the transmitter in the wave zone as predicted by the Hertzian theory. Fig. 6 shows a calculated 1/r curve and the experimental curve corrected to a definite current in the base of the antenna; it includes the field set up by the oscillator alone which, in the immediate neighborhood of the transmitter, is not insignificant.

Theory also requires that the electric intensity due to a radiating antenna shall be proportional to the current amplitude in the base of

the antenna. This requirement was subject to experimental verification. With the transmitter and receiver several wavelengths apart, suitable resistances made of extremely high resistance nichrome wire (26.25 ohms per inch) and mounted in the form of grid leaks were successively inserted in the mounting provided for this purpose at the base of the antenna. For each resistance, the current in the antenna base was recorded and a reading was taken of the deflection of the receiving meter. Fig. 7 shows the curve so obtained by plotting antenna current against receiver deflection. It is seen that within the accuracy of the observations and of the antenna milliammeter calibration (at low frequency) the curve is a straight line. This test, therefore, indicates that straight-line results are obtained using the low-frequency calibration of the antenna milliammeter and accepting the straight-line characteristics of the receiver.

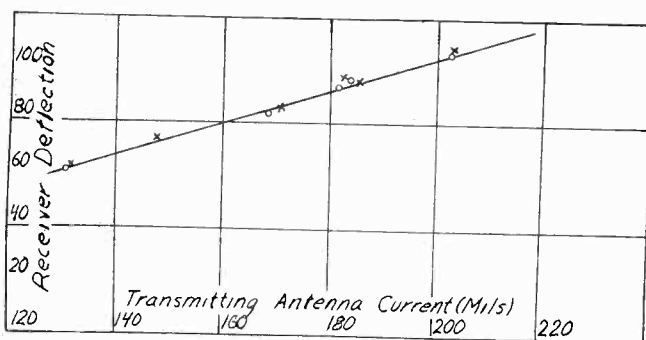

Fig. 7—The receiver deflection vs. transmitter antenna current.

To summarize, the frequency of the carrier wave of the transmitter and the current in the base of the antenna may be considered known. The straight-line response of the receiver is presumed established.

### C. Field Measurements

In describing the experimental tests made to determine the characteristics of the transmitter and receiver, no mention was made of the method employed or of the precautions which had to be taken. In order to avoid extraneous effects and distortions due to buildings and trees in the vicinity of the apparatus, measurements were taken well out on the frozen surface of Lake Mendota. The very serious and inconvenient distortion due to the observers themselves was eliminated as far as the transmitter was concerned by reading the current in the base of the antenna with a telescope. But even the maximum distance from the receiver at which deflections could be read satisfactorily with a telescope proved still too near to avoid distortion effects due to the presence of the observer. For these readings, an auxiliary meter (3 in

Fig. 5) connected in series with the receiver microammeter was placed radially outward on the transmitter-receiver line at the full extension of a pair of 50-foot twisted leads. With this arrangement, neither the observer nor the leads were found to have a noticeable effect on the field.

With the problem of observing deflections thus successfully solved, an equally important difficulty had to be met in taking zero readings. Although on the whole very stable, the plate current as well as the balancing current of the receiver fluctuated somewhat, especially when the receiver was moved about and jarred more or less in consequence. Such variations were extremely small compared with the actual plate current, but since the deflections represented a difference effect, even small fluctuations in plate or balancing current were important. A small but steady drift of plate current or balancing current due to prolonged use of the small size B batteries, subjected as they were to a relatively heavy drain, was found also to affect the zero reading. It is clear, in any case, that a convenient and rapid method of obtaining zero readings was essential. A highly successful and at the same time very simple mechanism for this purpose was the antenna switch already referred to. This was a long string attached to the lower end of the receiving antenna which was hung on a pivot from its upper support. A counterweight on the back of the receiver case normally held the antenna in firm contact with a small suitably grooved surface connected to the control grid of the tetrode. In order to obtain a zero reading, the long string reaching out to the distant meter could be pulled, thus drawing the antenna base out a sufficient and uniform distance to avoid capacitive coupling with the small contact surface. Using this device, a double check on deflections and zero could be obtained in a very short time.

The data for determining the effect of towers on the field patterns were taken as follows. With the transmitter equipped with a quarter wavelength vertical antenna arbitrarily placed on the ice, a great quadrant of a circle having a twenty-meter radius was described with the transmitter antenna as a center. Ten-degree arcs were then struck off along the quadrant. As a first determination, the symmetry of the field was tested by taking readings around the quadrant with no towers. This gave the unit circle of Fig. 8. Now a word about the model towers. Each of these consisted of telescoping brass tubes mounted on a circular copper disk similar to the antenna ground plate. One tower was adjusted to resonance with the antenna by bringing it near this latter and varying its length until it produced a maximum increase in the antenna current as observed from a distance by means of a tele-

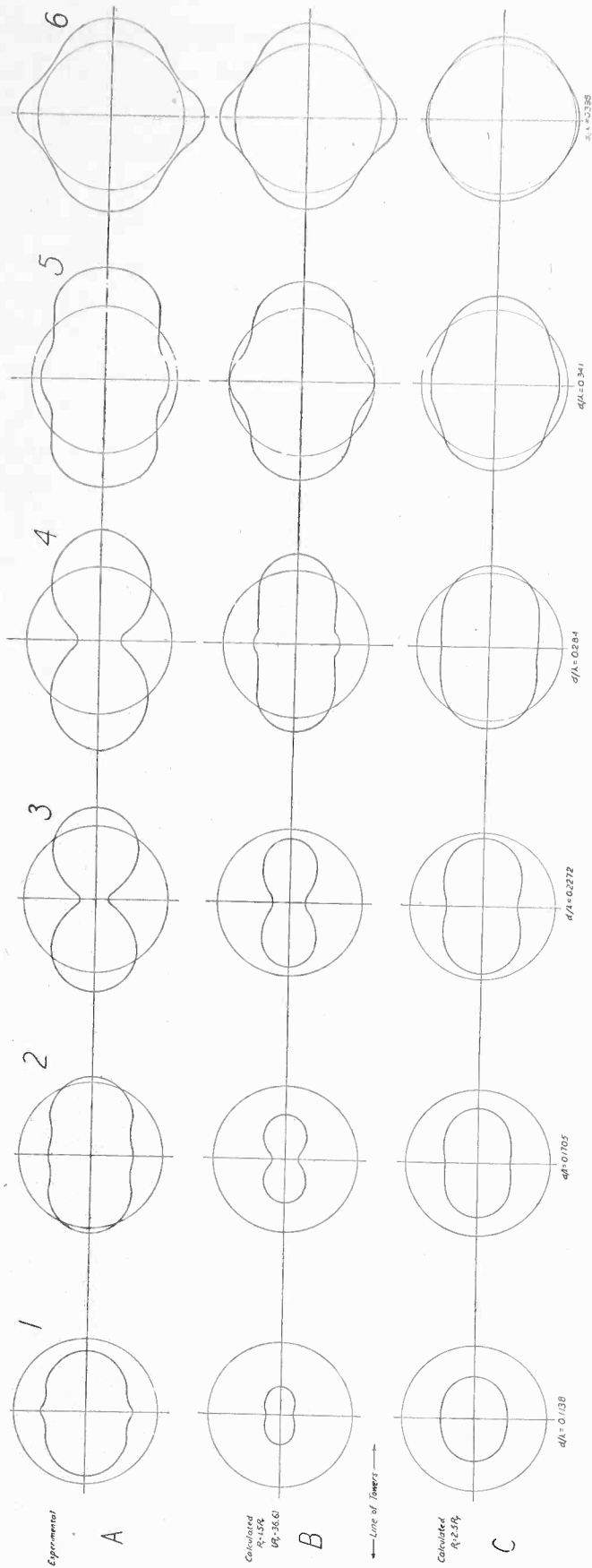

Fig. 8

A. Experimental field patterns showing the effect of tower separation with resonant towers.  
 B. Calculated field patterns showing the effect of tower separation with resonant towers.  $R_t = 1.5R_r$ . ( $R_r = 36.6$  ohms.)  
 C. Calculated field patterns showing the effect of tower separation with resonant towers.  $R_t = 2.5R_r$ .

Column 1— $d/\lambda = 0.1136$   
 Column 2— $d/\lambda = 0.1705$   
 Column 3— $d/\lambda = 0.2272$   
 Column 4— $d/\lambda = 0.2882$   
 Column 5— $d/\lambda = 0.341$   
 Column 6— $d/\lambda = 0.398$

scope. The second tower was set at the same height and the two were placed on a line with the transmitter antenna halfway between them. The line of towers was chosen for the zero line of the angle,  $\phi$ , so that the quadrant of a circle drawn on the ice represented the first quadrant with  $\phi$  ranging from 0 to 90 degrees. For each of a series of separations of the towers (the distance from antenna to a tower is denoted

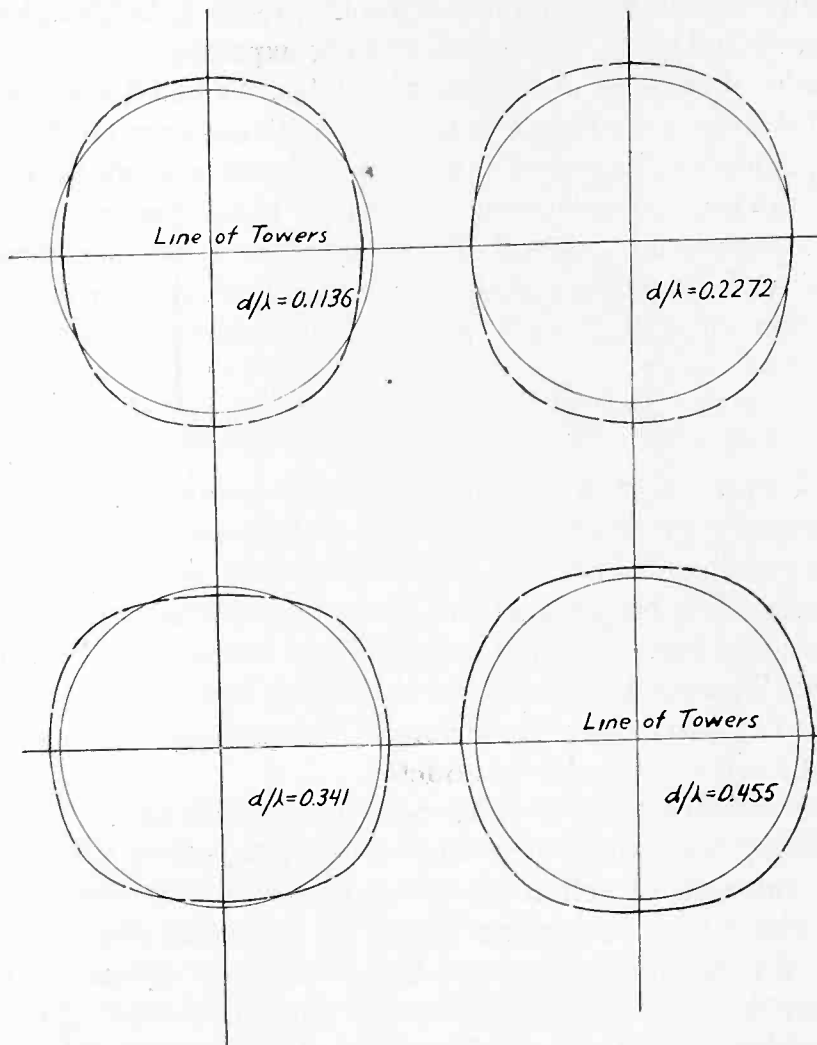

Fig. 9—Experimental field patterns showing the effect of tower separation with nonresonant towers.

by  $d$ ) readings were taken with the receiver placed successively at the ten-degree intervals along the quadrant. The antenna current was read by means of a telescope before taking the reading at  $\phi = 0$  degrees and after taking that at  $\phi = 90$  degrees for each separation  $2d$  of the towers. It was found to remain quite constant for each tower separation. Fig. 8A shows the field patterns obtained. The individual polar diagrams each correspond to one tower separation as noted; the intensity given

by the deflections has been reduced to the same corrected antenna current. The diagrams represent, therefore, the field patterns for constant antenna current.

The curves of Fig. 9 were obtained in precisely the same way as those of Fig. 8A. In this case, however, the towers were shortened to be out of tune, and a T antenna was used instead of a vertical one. Experiments with the T antenna without towers indicated that this had no directional effect, as was indeed to be expected.

A detailed discussion of the curves of Figs. 8A and 9 is superfluous at this point since they fairly speak for themselves. As might have been predicted, towers at or near resonance may exert a powerful effect in distorting the circular symmetry of the field of the transmitter. Towers, on the other hand, that are of such length or construction as to be well out of tune have only a slight distorting influence. The interesting effect of tower separation can be progressively followed in the curves of Fig. 8A.

#### IV. THEORETICAL INVESTIGATION

It is the purpose of this mathematical discussion to determine the relation between the resultant field of the towers and antenna and the conditions existing in the region of the transmitter, such as the spacing of the towers, their height, and the dimensions of the antenna. These factors influence the phase and magnitude of the induced currents in the towers. Expressions will be derived for the vertical electric intensity at distant points along the surface of the earth under the assumption that the earth is a perfect conductor.

In order to find the tower currents in terms of the antenna current, we must know the mutual impedances between towers and between tower and antenna, as well as the self-impedances of the structures in question. These impedances are found by extending the method of Pistol Kors<sup>7</sup> for computing the mutual resistances of antenna systems. P. S. Carter<sup>8</sup> has made this extension for antennas whose lengths are exact multiples of the half wavelength by making use of the generalized reciprocity theorem. J. Labus<sup>9</sup> has advanced another viewpoint in computing the self-impedance of a vertical radiator of length less than or equal to a half wavelength. This is the method which will be briefly presented here.

<sup>7</sup> A. A. Pistol Kors, "The radiation resistance of beam antennas," Proc. I.R.E., vol. 17, p. 562; March, (1929).

<sup>8</sup> P. S. Carter, "Circuit relations in radiating systems and applications to antenna problems," Proc. I.R.E., vol. 20, p. 1004; June, (1932).

<sup>9</sup> J. Labus, "Recherische Ermittlung der Impedanz von Antennen," *Hochfrequenz und Elektroakustik*, p. 17, January, (1933).

Let us consider a rod or wire of radius,  $s$ , and length,  $a$ , placed vertically over a perfectly conducting plane with the lower end of the conductor very close to the conducting plane. (Fig. 10.) A voltage,  $V_0$ , is applied between the lower end and the conducting plane. Then the current at the base is  $\sqrt{2}I_0 \sin \omega t$ . The current in the antenna at any point a distance,  $x$ , from the bottom is

$$i_x = \frac{\sqrt{2}I_0 \sin (G - kx) \sin \omega t}{\sin G} \quad (1)$$

where,

$$G = 2\pi a/\lambda = ka$$

$$k = 2\pi/\lambda$$

and,

$\lambda$  = the wavelength of the impressed voltage.

The vertically downward component of electric intensity at a point,  $M$ , in space is found for the current distribution of (1) and the image. The point  $M$ , is then moved to the surface of the conducting rod. Use

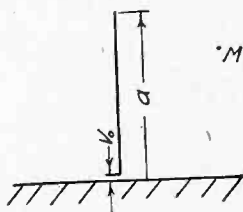

Fig. 10

is then made of Poynting's vector theorem to give the expression for instantaneous flow of power outward through the surface of the rod. If this expression for instantaneous power flow through the surface of the rod is equated to  $2 I_0^2 R_r \sin^2 \omega t + 2 I_0^2 X_r \sin \omega t \cos \omega t$ ,  $R_r$  and  $X_r$  are readily found. Here  $R_r$  and  $X_r$  are the radiation resistance and the reactance of the antenna referred to the current at the base of the antenna. For the rod of Fig. 10,

$$R_r = 15 \left[ \left\{ 1 - \cot^2 G \right\} \left\{ C + \log_e 4G - Ci4G \right\} + 4 \cot^2 G \left\{ C + \log_e 2G - Ci2G \right\} + 2 \cot G \left\{ Si4G - 2Si2G \right\} \right] \quad (\text{ohms}) \quad (2)$$

and,

$$X_r = 15 \left[ 2 \left\{ C - \log_e \frac{a}{ks^2} + Ci4G - 2Ci2G \right\} \cot G - \left\{ Si4G - 2Si2G \right\} \left\{ \cot^2 G - 1 \right\} + \frac{2Si2G}{\sin^2 G} \right] \quad (\text{ohms}) \quad (3)$$



where  $C = 0.5772 +$ , Euler's constant, and  $Ci(x)$  and  $Si(x)$  are respectively the cosine-integral and sine-integral functions given in Jahnke and Emde, "Funktionentafeln mit Formeln und Kurven."

We see that when  $G = 90$  degrees,  $R_r \doteq 15 [C + \log(2\pi) - Ci(2\pi)] = 36.6$  ohms and  $X_r = 15 Si(2\pi) = 21.25$  ohms. Then  $\bar{Z}_r = R_r + jX_r = 36.6 + j21.25 = 42.25 \angle +30.15$  degrees which checks with the results of Carter for the case of a half-wave radiator in space.

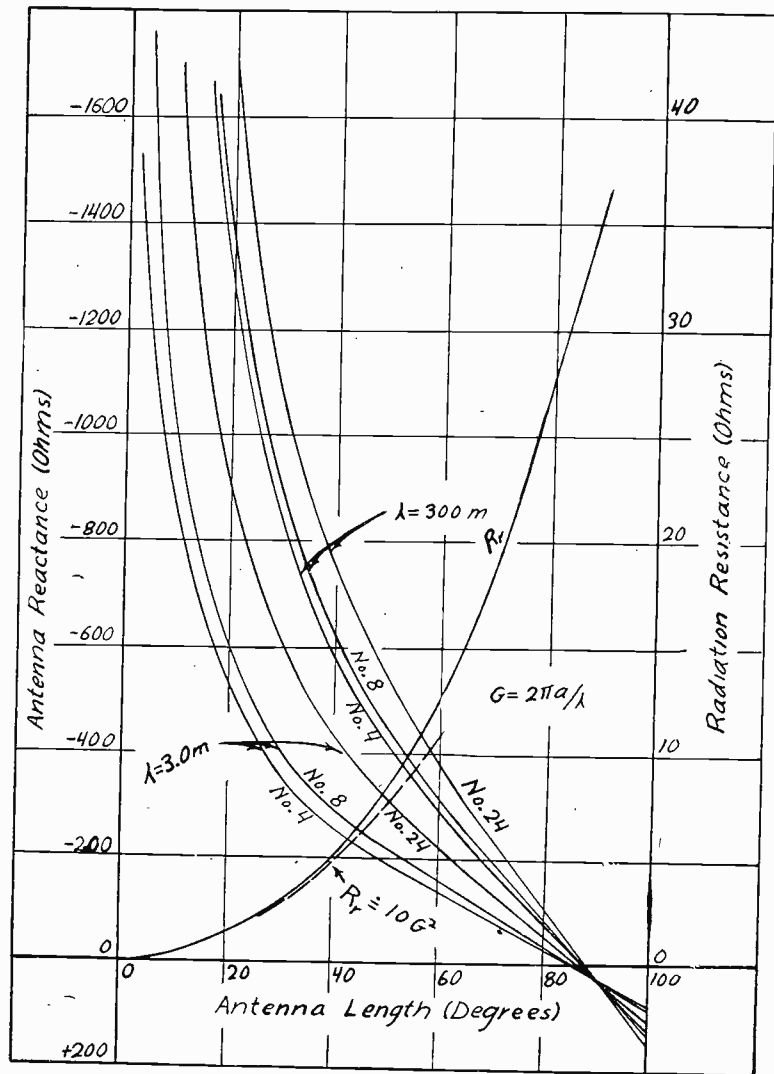

Fig. 11—Resistance and reactance of straight vertical antennas.

When  $G$  is small, ( $\sin G \doteq G$ )

$$R_r \doteq 10G^2 = 10(2\pi a/\lambda)^2 \tag{4}$$

$$X_r \doteq -60 \{ \log_e a/s - 1 \} \cot(G). \tag{5}$$

Fig. 11 shows  $R_r$  and  $X_r$  as functions of antenna length measured in terms of  $G$  in degrees, for different wire sizes and wavelengths. It is to be noted that  $X_r$  passes through zero at a point below  $G = 90$  degrees.

The mutual impedances between two antennas are found in a similar fashion. These impedances are all referred to the base of the antennas. For two vertical antennas of equal length,  $a$ , and separated a distance,  $d$ , as shown in Fig. 12, the mutual impedance is

$$\bar{Z}_m = R_m + jX_m = Z_m \angle \theta \quad (6)$$

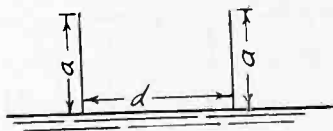

Fig. 12

where,

$$\begin{aligned} R_m = \frac{15}{\sin^2 G} [ & 2\{2 + \cos 2G\}Cikd - 4 \cos^2 G \{Cik(\sqrt{d^2 + a^2} - a) \\ & + Cik(\sqrt{d^2 + a^2} + a)\} + \cos 2G \{Cik(\sqrt{d^2 + (2a)^2} - 2a) \\ & + Cik(\sqrt{d^2 + (2a)^2} + 2a)\} + \sin 2G \{Sik(\sqrt{d^2 + (2a)^2} + 2a) \\ & - Sik(\sqrt{d^2 + (2a)^2} - 2a) - 2Sik(\sqrt{d^2 + a^2} + a) \\ & + 2Sik(\sqrt{d^2 + a^2} - a)\} ] \quad (7) \end{aligned}$$

and,

$$\begin{aligned} X_m = \frac{15}{\sin^2 G} [ & -2\{2 + \cos 2G\}Sikd + 4 \cos^2 G \{Sik(\sqrt{d^2 + a^2} - a) \\ & + Sik(\sqrt{d^2 + a^2} + a)\} - \cos 2G \{Sik(\sqrt{d^2 + (2a)^2} - 2a) \\ & + Sik(\sqrt{d^2 + (2a)^2} + 2a)\} + \sin 2G \{Cik(\sqrt{d^2 + (2a)^2} + 2a) \\ & - Cik(\sqrt{d^2 + (2a)^2} - 2a) - 2Cik(\sqrt{d^2 + a^2} + a) \\ & + 2Cik(\sqrt{d^2 + a^2} - a)\} ]. \quad (8) \end{aligned}$$

Fig. 13 shows the magnitude and phase angle of (6) as a function of spacing,  $d/\lambda$ . The expressions for mutual impedances of two antennas of different heights and for antennas with flat tops are very long and unwieldy, but have the same general form as (7) and (8).

We are now ready to find tower currents and the electric intensity at remote points due to these tower currents. Three configurations will be considered:

A. The case of an antenna and a single vertical tower which is resonant to the frequency of the station.

B. The case of an antenna and two resonant towers.

C. The case of an antenna and two towers of such a height that the induced currents lead the induced voltages by nearly 90 degrees.

The first case is here considered primarily as an introductory and simple illustration of the mode of attack. The second case will show the effects encountered when the towers are allowed to approach the quarter wavelength. The third case corresponds to the conditions usually met in broadcast transmitters in which the towers are shorter than the quarter wavelength.

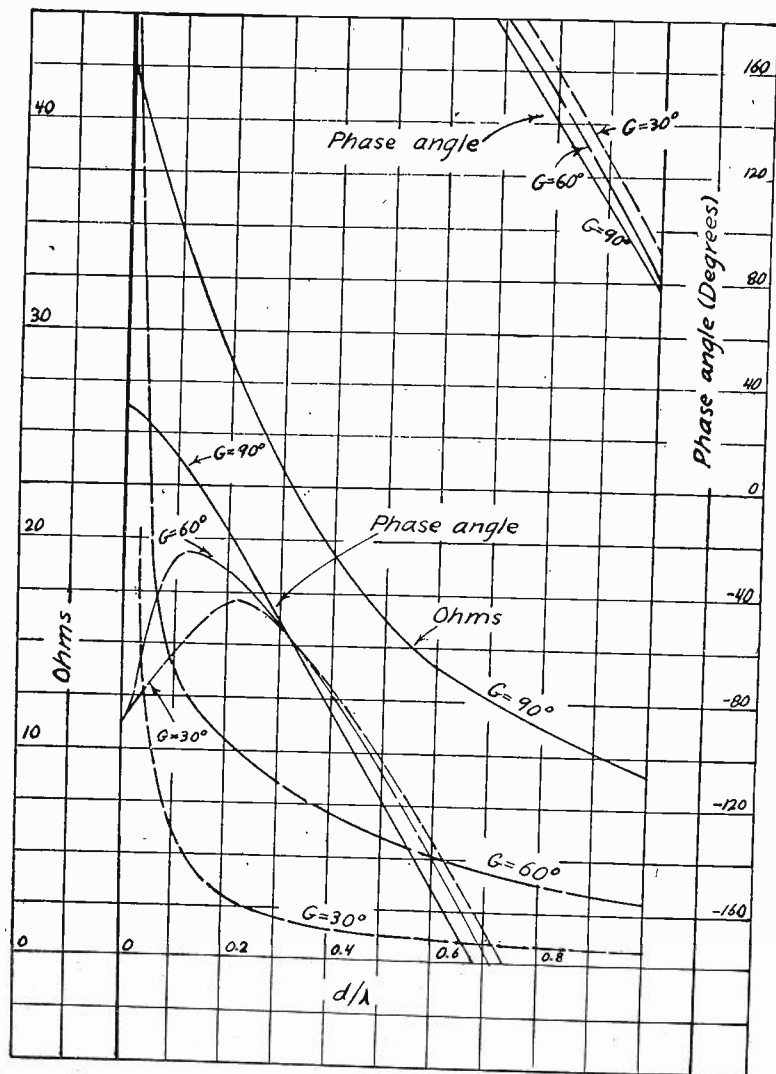

Fig. 13—Mutual impedance between two similar vertical antennas as a function of separation,  $d$ .

#### A. AN ANTENNA AND A TUNED TOWER

For simplicity, the antenna and tower will each be considered to have a length equal to one-quarter wavelength, and are separated a distance,  $d$ . (Fig. 14.) A voltage,  $\bar{V}_0$ , is applied at the base of the antenna and the tower is grounded. The current at the antenna base is  $\bar{I}_0$  and at the tower base is  $\bar{I}_1$ .

Writing Kirchhoff's law for the two circuits involved,

$$\bar{V}_0 = I_0 \bar{Z}_{00} + I_1 \bar{Z}_{01} \quad (9)$$

and,

$$0 = I_0 \bar{Z}_{01} + I_1 \bar{Z}_{11}. \quad (10)$$

To obtain the tower current, we use only (10) thus,

$$\bar{I}_1 = -I_0 \bar{Z}_{10} / \bar{Z}_{11}.$$

The tower current is thus determined by referring to Figs. 11 and 13. It is assumed that the reactance component of  $\bar{Z}_{11}$  is zero, so that  $Z_{11} = R_t$  (tower resistance).

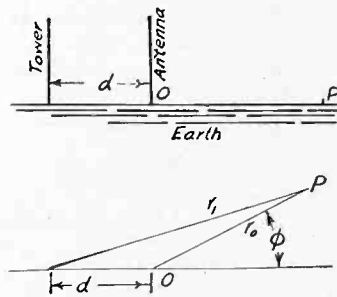

Fig. 14

The upward electric intensity at a point,  $P$ , (Fig. 14) distant  $r_0$  from the antenna, due to the antenna alone is

$$\bar{F}_0 = -j \frac{60I_0}{r_0} \angle - \frac{2\pi r_0}{\lambda} \quad (12)$$

while the upward electric intensity at the same point due to the tower current is

$$\bar{F}_1 = -j \frac{60I_1}{r_1} \angle - \frac{2\pi r_1}{\lambda}. \quad (13)$$

Where  $P$  is far from the antenna,

$$\frac{1}{r_1} \doteq \frac{1}{r_0}, \quad r_1 \doteq r_0 + d \cos \phi \quad (14)$$

and,

$$\bar{F}_1 \doteq -j \frac{60I_1}{r_0} \angle - \frac{2\pi r_0}{\lambda} \cdot \angle - \frac{2\pi d \cos \phi}{\lambda}. \quad (15)$$

Then the total intensity is

$$\bar{F}_T = \bar{F}_0 + \bar{F}_1 = -j \frac{60I_0}{r_0} \left[ 1 - \frac{\bar{Z}_{10}}{R_t} \angle - \frac{2\pi d}{\lambda} \cos \phi \right] \angle - \frac{2\pi r_0}{\lambda} \quad (16)$$

or,

$$\bar{F}_T = \bar{F}_0 \left[ 1 - \frac{\bar{Z}_{10}}{R_t} \angle - \frac{2\pi d}{\lambda} \cos \phi \right]. \quad (17)$$

Thus (17) yields the vertical electric intensity at a distant point  $P$ , on the earth's surface due to an antenna and a single resonant tower a

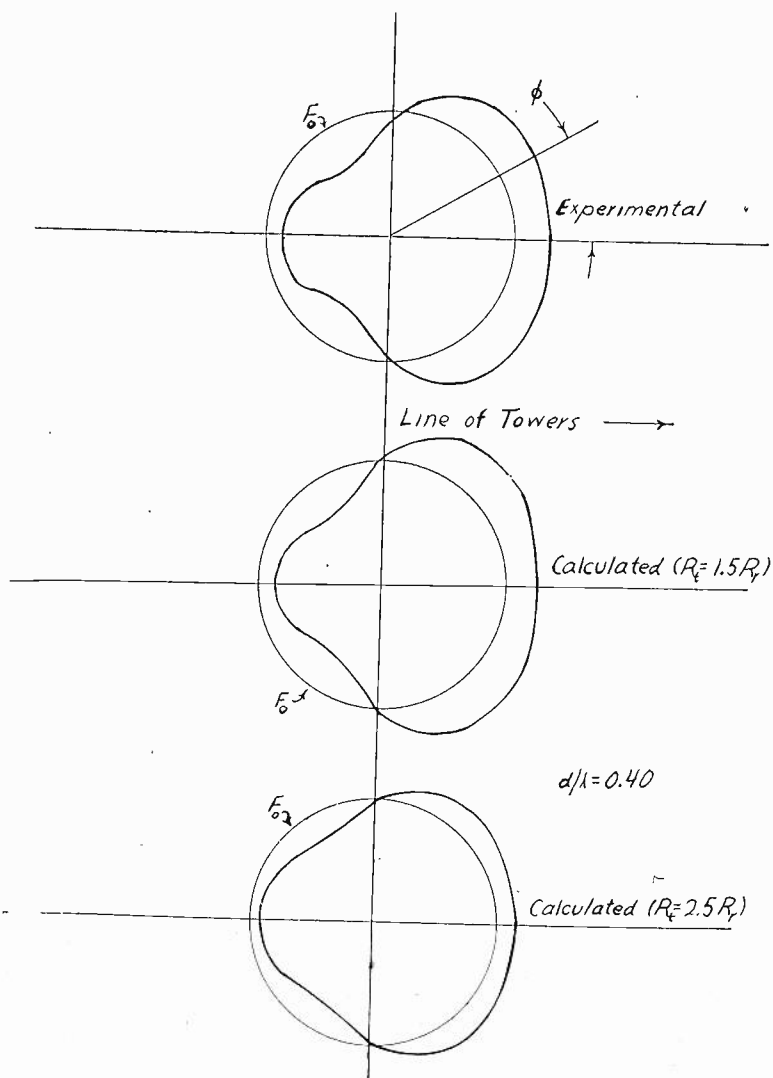

Fig. 15—Field pattern showing the effect of a single resonant tower.

distance,  $d$ , from this antenna, when both antenna and tower are one quarter of the wavelength.

Using the apparatus already described under II and III, and following a similar procedure, the electric intensity on a great circle about the model antenna and a single resonant tower was experimentally determined over ice. The results of this test together with values computed from (17) are shown in Fig. 15. The computations were made to

correspond to the experimental value  $d/\lambda = 0.40$ ; tower resistance values of  $R_t = 1.5R_r$  and  $R_t = 2.5R_r$  were used. Here  $R_r = 36.6$  ohms is the radiation resistance.

A second experimental test was made, this time with the receiver kept in line with the tower and the antenna ( $\phi = 0^\circ$ ) while the distance,  $d$ , was varied. The result of this test and the corresponding computed values are shown in Fig. 16.

In this analysis, the earth has been considered to be a perfect conductor, while the experimental data were obtained over ice. One might easily conclude that there would be little agreement between the results of the analysis and the experiment. However, large enough grounding disks at the base of the antenna and the towers were used

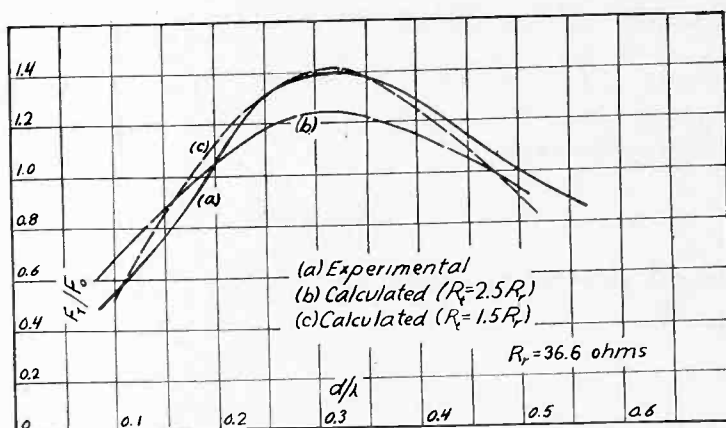

Fig. 16—The effect of location of a single resonant tower.

so that the resonant frequencies were the same as when a good conducting ground was provided. Since the disks were large, the distribution of the electric intensity in the region of the antenna and towers is changed but little. This means that the mutual impedances have nearly the same value that they have when the earth is a perfect conductor. The field at a remote point along the horizon is, no doubt, attenuated greatly. This attenuation does not invalidate our results since the ratio of the field from the tower to the field from the antenna remains the same. Apparently, the greatest effect of the ice is to add resistance to the tower. We see from Figs. 15 and 16 that the total tower resistance must be in the neighborhood of  $1.5R_r = 54.9$  ohms. If the earth were a perfect conductor, the tower resistance would be  $R_r = 36.6$  ohms.

#### B. AN ANTENNA AND TWO TUNED TOWERS

The problem of the two tuned towers will be handled in precisely the same way as the preceding case of a single tower. As before, the

earth will be assumed to be a perfect conductor, the antenna and towers to be a quarter wavelength, and the towers to be resonant. The voltage is impressed at the base of the antenna where the current is  $\bar{I}_0$ . The current at the base of Tower No. 1 is  $\bar{I}_1$  and at the base of Tower No. 2 is  $\bar{I}_2$ . Since the towers are identical and the same distance from the antenna, we may conclude that  $\bar{I}_1$  equals  $\bar{I}_2$ . Writing equations similar to (9) and (10), we have

$$\bar{V}_0 = \bar{I}_0 \bar{Z}_{00} + \bar{I}_1 \bar{Z}_{01} + \bar{I}_2 \bar{Z}_{02} \quad (18)$$

$$0 = \bar{I}_0 \bar{Z}_{10} + \bar{I}_1 \bar{Z}_{11} + \bar{I}_2 \bar{Z}_{12} \quad (19)$$

$$0 = \bar{I}_0 \bar{Z}_{20} + \bar{I}_1 \bar{Z}_{21} + \bar{I}_2 \bar{Z}_{22}. \quad (20)$$

Since  $\bar{I}_1 = \bar{I}_2$ , and  $\bar{Z}_{11} = \bar{Z}_{22}$ , (19) or (20) give

$$\bar{I}_1 = \bar{I}_2 = -\bar{I}_0 \bar{Z}_{10} / (\bar{Z}_{11} + \bar{Z}_{12}). \quad (21)$$

If the towers are resonant,

$$\bar{I}_1 = \bar{I}_2 = -\bar{I}_0 \bar{Z}_{10} / (R_t + Z_{12}). \quad (22)$$

The upward electric intensity at a point,  $P$ , (Fig. 17) due to the antenna alone is

$$\bar{F}_0 = -j \frac{60\bar{I}_0}{r_0} \angle -\frac{2\pi r_0}{\lambda}. \quad (23)$$

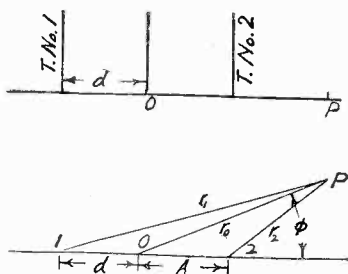

Fig. 17

The intensity at the same point due to the current in Tower No. 1 is

$$\bar{F}_1 = -j \frac{60\bar{I}_1}{r_0} \angle -\frac{2\pi r_0}{\lambda} \angle -\frac{2\pi d}{\lambda} \cos \phi \quad (24)$$

while Tower No. 2 contributes

$$\bar{F}_2 = -j \frac{60\bar{I}_2}{r_0} \angle -\frac{2\pi r_0}{\lambda} \angle +\frac{2\pi d}{\lambda} \cos \phi. \quad (25)$$



Then the total intensity is

$$\bar{F}_T = \bar{F}_0 + \bar{F}_1 + \bar{F}_2 = -j \frac{60\bar{I}_0}{r_0} \left[ 1 - \frac{2\bar{Z}_{10} \cos\left(\frac{2\pi d \cos \phi}{\lambda}\right)}{(R_t + \bar{Z}_{12})} \right] \angle -\frac{2\pi r_0}{\lambda} \quad (26)$$

or

$$\bar{F}_T = \bar{F}_0 \left[ 1 - \frac{2\bar{Z}_{10} \cos\left(\frac{2\pi d \cos \phi}{\lambda}\right)}{(R_t + \bar{Z}_{12})} \right]. \quad (27)$$

Values computed from (27) are shown in Figs. 8B and 8C.

### C. AN ANTENNA AND TWO UNTUNED TOWERS

The problem of an antenna and two untuned towers represents the situation usually encountered in present broadcast systems. The

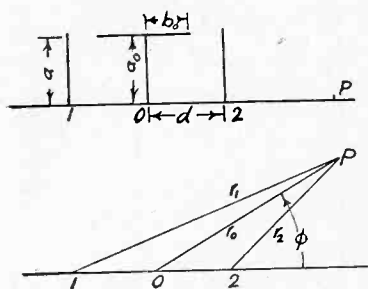

Fig. 18

towers, when grounded towers are used, are usually much shorter than a quarter wavelength, and the antenna, instead of being a single vertical wire, is generally of the T type.

The antenna is taken to have the dimensions shown in Fig. 18. The current in the towers at any distance,  $x$ , from the ground is

$$\bar{I}_1 \frac{\sin(G - kx)}{\sin G} = \bar{I}_2 \frac{\sin(G - kx)}{\sin G}$$

where the notation is the same as is used in (1). The current in the antenna is

$$\bar{I}_0 \frac{\sin(G_0' - kx)}{\sin G_0'}$$

where,  $G_0' = A_0 + B_0'$ ,  $A_0 = 2\pi a_0/\lambda$ ,  $B_0 = 2\pi b_0/\lambda$ , and  $\cot(B_0') = \frac{1}{2} \cot(B_0)$ . The relation between tower and antenna current is given by (21).

The field at point  $P$ , due to the antenna alone, is

$$\bar{F}_0 = -j \frac{60}{r_0} \bar{I}_0 \frac{(\cos B_0' - \cos G_0')}{\sin G_0'} \angle - \frac{2\pi r_0}{\lambda} \quad (28)$$

The field at the same point due to Tower No. 1 is

$$\bar{F}_1 = -j \frac{60}{r_0} \bar{I}_1 \frac{(1 - \cos G)}{\sin G} \angle - \frac{2\pi r_0}{\lambda} \angle - \frac{2\pi d}{\lambda} \cos \phi \quad (29)$$

while Tower No. 2 contributes

$$\bar{F}_2 = -j \frac{60}{r_0} \bar{I}_2 \frac{(1 - \cos G)}{\sin G} \angle - \frac{2\pi r_0}{\lambda} \angle + \frac{2\pi d}{\lambda} \cos \phi. \quad (30)$$

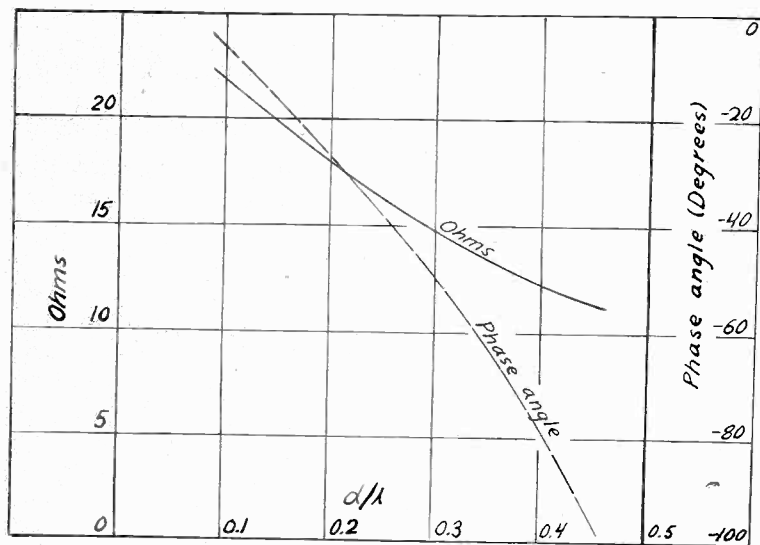

Fig. 19—Mutual impedance between a tower and a T antenna as a function of separation.

Then the total intensity is

$$\bar{F}_T = \bar{F}_0 + \bar{F}_1 + \bar{F}_2 = -j \frac{60}{r_0} \bar{I}_0 \left[ \frac{(\cos B_0' - \cos G_0')}{\sin G_0'} - \frac{2\bar{Z}_{10}(1 - \cos G) \cos\left(\frac{2\pi d}{\lambda} \cos \phi\right)}{(\bar{Z}_{11} + \bar{Z}_{12}) \sin G} \right] \angle - \frac{2\pi r_0}{\lambda} \quad (31)$$

or,

$$\bar{F}_T = \bar{F}_0 \left[ 1 - \frac{2\bar{Z}_{10}(1 - \cos G) \sin G_0' \cos\left(\frac{2\pi d}{\lambda} \cos \phi\right)}{(\bar{Z}_{11} + \bar{Z}_{12})(\cos B_0' - \cos G_0') \sin G} \right] \quad (32)$$

The tower self-impedance,  $\bar{Z}_{11}$ , can be found from Fig. 11. The mutual impedance between towers,  $\bar{Z}_{12}$ , is obtained from Fig. 13. Fig. 19 shows

the mutual impedance between a tower and a T antenna as a function of distance when the dimensions are as follows:

$$\begin{aligned} a/\lambda &= 0.1955, & G &= 2\pi a/\lambda = 1.228 \text{ radians} = 70.4^\circ \\ a_0/\lambda &= 0.1728, & A_0 &= 2\pi a_0/\lambda = 1.085 \text{ radians} = 62.2^\circ \\ b_0/\lambda &= 0.0408, & B_0 &= 2\pi b_0/\lambda = 0.2565 \text{ radians} = 14.73^\circ \\ & & B_0' &= \cot^{-1}(\frac{1}{2} \cot B) = 27.8^\circ \\ & & G_0' &= A_0 + B_0' = 90^\circ \end{aligned}$$

These are the dimensions of the antenna and tower models used to obtain the experimental curves of Fig. 9. Corresponding values computed from (32) are shown in Fig. 20.

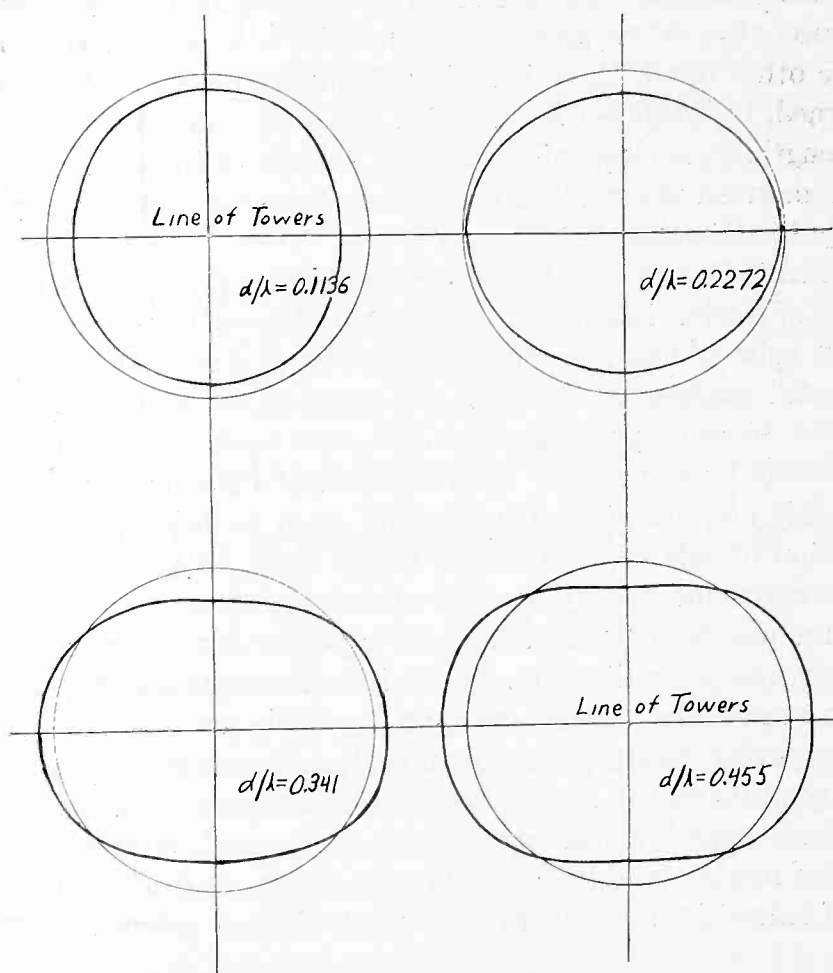

Fig. 20—Calculated field patterns showing the effect of tower separation with nonresonant towers and a T antenna.

## V. CONCLUSION

The purpose of this paper has been threefold. In the first instance, it was desired to describe and justify the use of small scale apparatus to investigate large scale transmission problems. In the second place,

and as a first application of the small scale method, the question of the effect of the supporting towers on the field pattern of a transmitting antenna was to be answered. Third, and finally, it was hoped to demonstrate the significance of the method as a means of experimentally verifying theoretical calculations necessarily involving numerous assumptions and approximations, and thereby justifying these for further mathematical investigation.

As a practical conclusion to the study of both tuned and untuned towers, it seems well to emphasize the necessity of keeping the towers of a transmitting station well away from a resonant length if a symmetrical field is desired, as is usually the case. Thus, towers which are near resonance when grounded should be insulated from the earth. On the other hand, there is little point in so far as field symmetry is concerned, to insulate towers which are well removed from the resonant length. This clearly follows from a study of the patterns of Fig. 9 for the detuned towers. The distortion of the field by the towers is extremely small in this case.

Returning to a general summary of the significance of the use of the method of models in studying antenna problems, the following may be said. In spite of the theoretical simplicity of this method and the experimental success of the devices developed, it would be premature optimism to anticipate significant results from the exclusive use of this mode of investigation. The real value of a further extension of the small scale method of approach would seem to depend upon a proper correlation of this method with a direct study of actual transmitting systems supplemented by theoretical analysis wherever possible. Thus, the prime utility of the models is their potential service as a means of discovery and generalization. General results obtained on a small scale may be verified in particular on an available large scale array; conversely, special results obtained on a given transmitter may be generalized by utilizing the flexible small scale analogy. As an approach to convenient experimental study and a general interpretation, the method of models, and in particular the apparatus described, may well prove of value in the study of radio transmission problems.

#### ACKNOWLEDGMENT

The above described investigation was carried out under the direction of Professor Edward Bennett to whom the writers are indebted for valuable suggestions and encouragement.



## STUDIES OF THE IONOSPHERE AND THEIR APPLICATION TO RADIO TRANSMISSION\*

BY

S. S. KIRBY, L. V. BERKNER, AND D. M. STUART

(Bureau of Standards, Washington, D.C.)

*Summary*—An historical summary is presented which outlines the principal published reports of studies of the ionosphere applied to radio wave propagation. Observations of the virtual height of the ionosphere and its variations carried out at the Bureau of Standards during the period of September, 1930, to April, 1933, are reported and discussed. The pulse method of Breit and Tuve was used with a visual recording technique developed by the Bureau of Standards.

In general, a number of layers were discernible, the major daytime layers being the lower or E layer at about 100 to 120 kilometers virtual height, an  $F_1$  layer at about 180 kilometers virtual height, and an  $F_2$  layer at about 240 kilometers virtual height. The relative electron densities of these layers were determined by measuring the critical penetration frequencies where possible. The E and  $F_1$  layer critical frequencies were highest at summer noon and fell off both diurnally and seasonally as the angle of the sun's rays with the vertical increased. Abnormally strong E layer ionization occurred occasionally at irregular intervals. The  $F_1$  layer showed magneto-ionic splitting during the day. There was some correlation between  $F_1$  layer ionization and magnetic storms.

The  $F_2$  critical frequency was greatest on a summer evening, and greater on a winter noon than on a summer noon. From this evidence it is believed that the  $F_2$  critical frequency may be determined by some other factor than penetration, such as absorption.

Scattered reflections of long retardation were observed on frequencies considerably higher than the  $F_2$  critical frequency.

### I. HISTORICAL SUMMARY

MARCONI'S first successful transatlantic radio transmission in 1901 aroused a great deal of discussion regarding the propagation of radio waves around the curvature of the earth's surface. Theoretical reasoning showed that the phenomena could not be due to diffraction alone. In 1902 A. E. Kennelly<sup>1</sup> published the first suggestion of an ionized upper region in the atmosphere in connection with radio wave propagation. He showed that this region, for the lower limit of which he calculated provisionally a height of 80 kilometers,

\* Decimal classification: R113.61. Original manuscript received by the Institute, October 13, 1933.

Publication approved by the Director of the Bureau of Standards of the U. S. Department of Commerce. Presented before meeting of American Section, International Scientific Radio Union, Washington, April 27, 1933; presented before Eight Annual Convention, Institute of Radio Engineers, Chicago, Illinois, June 27, 1933.

<sup>1</sup> A. E. Kennelly, *Electrical World & Engineer*, vol. 39, p. 473; March 15, (1902).

would be conducting. It is interesting to note that Kennelly used the expression "electrically conducting strata" indicating that he had in mind several layers. If we may quote one sentence from Kennelly's 1902 paper his ideas on this subject will be indicated clearly. He wrote: "It seems reasonable to infer that electromagnetic disturbances emitted from a wireless sending antenna spread horizontally outwards, and also upwards, until the conducting strata of the atmosphere are encountered, after which the waves will move horizontally outwards in a 50-mile layer between the electrically-reflecting surface of the ocean beneath, and an electrically-reflecting surface, or successive series of surfaces, in the rarified air above." A few months later Oliver Heaviside<sup>2</sup> independently set forth the idea that a conducting layer in the upper atmosphere might guide radio waves.

The theory of propagation of light waves through a system of molecules was given by H. A. Lorentz<sup>3</sup> in 1909. This theory was applied to radio wave propagation in the ionosphere by Eccles<sup>4</sup> and Larmor.<sup>5</sup> Eccles assumed an upper layer so intensely ionized as to reflect the waves without penetration and an ionization of the middle atmosphere which bent the waves. He considered only the motions of the heavy ions. He showed that the action of free ions was to increase the phase velocity of the waves in the medium so that the index of refraction was decreased to a value less than unity. Thus the waves were bent by refraction rather than reflection. Larmor emphasized the importance of considering free electrons of such a long free path that absorption was negligible and sketched a theory of refraction based upon these ideas. Being lighter than the ions, comparatively few electrons were necessary to produce sufficient bending of the rays. The foundations for a theoretical discussion of the action of the ionosphere on radio wave propagation are to be found in these two papers.

In his 1912 paper and again in 1924, Eccles<sup>6</sup> stated that two layers, one a high permanently ionized layer, and the other a lower layer ionized daily by sunlight, were required to explain the phenomena then observed.

Appleton and Barnett,<sup>7</sup> in 1925, reported direct evidence of the existence of a reflecting layer. They employed both the frequency change method and the angle of incidence method using a frequency of

<sup>2</sup> Oliver Heaviside, "Encyclopedia Britannica," Tenth Edition, vol. 33, p. 215; December 19, (1902).

<sup>3</sup> Lorentz, "Theory of Electrons," Leipsig, (1909).

<sup>4</sup> Eccles, *Proc. Roy. Soc.*, 87A, p. 79, (1912).

<sup>5</sup> Larmor, *Phil. Mag.*, vol. 48, p. 1025, (1924).

<sup>6</sup> Eccles, *Proc. Phys. Soc.*, vol. 37, pp. 3D and 48D; November, (1924).

<sup>7</sup> Appleton & Barnett, *Nature* (London), vol. 115; March 7, (1925).

about 750 kilocycles. They estimated the virtual height to be about 80 kilometers. A few months later Breit and Tuve<sup>8</sup> independently reported similar evidence using the pulse or group retardation method developed by them, and employing a frequency of about 4200 kilocycles. At this time they reported virtual heights of 80 and 160 kilometers. A comprehensive paper was published by each of these groups of workers a few months later.<sup>9,10</sup> In the latter paper Breit and Tuve reported virtual heights from about 90 to 225 kilometers. In the light of later developments, it is evident that they were getting reflections from both E and F regions. Breit and Tuve at this time also used other frequencies such as 7500 kilocycles, at which they sometimes received reflections but not always. They observed that reflections varied rapidly both in amplitude and position.

At about the same time, studies of the ionosphere were being made by Taylor and Hulburt<sup>11</sup> using the skip-distance method. They calculated daytime virtual heights of from 155 to 240 kilometers.

In 1927 Appleton,<sup>12</sup> working at 750 kilocycles, detected a sudden change in the virtual height of the layer during some early morning measurements, and concluded that there were two layers at night, one at a virtual height of about 100 kilometers and the other at a virtual height of about 240 kilometers.

In 1928 Breit, Tuve, and Dahl<sup>13</sup> reported daytime virtual heights from about 100 to 225 kilometers with multiples of the 225-kilometer values.

In 1929 and 1930 Appleton and Green,<sup>14,15</sup> working at about 3000 kilocycles, reported evidence of sudden jumps of the virtual height of the layer in the daytime and concluded that the two layers, E and F, existed both day and night. They also pointed out that this interpretation fitted in with the earlier results of Breit, Tuve, and Dahl.

In 1931 Schafer and Goodall,<sup>16</sup> working at 1604 and 3088 kilocycles simultaneously, found abrupt increases in virtual height during the late afternoon and corresponding decreases in the early morning. However, the afternoon increase in virtual height occurred about two hours earlier for 3088 kilocycles than for 1604 kilocycles and in the morning

<sup>8</sup> Breit and Tuve, *Nature* (London), vol. 116, p. 357; September 5, (1925).

<sup>9</sup> Appleton and Barnett, *Proc. Roy. Soc. A*, vol. 109, p. 621; December (1925).

<sup>10</sup> Breit and Tuve, *Phys. Rev.*, vol. 28, p. 554; September, (1926).

<sup>11</sup> Taylor and Hulburt, *Phys. Rev.*, vol. 27, p. 189; February, (1926).

<sup>12</sup> Appleton, *Nature*, p. 330; September 3, 1927.

<sup>13</sup> Breit, Tuve, and Dahl, *Proc. I.R.E.*, vol. 16, p. 1236; September, (1928).

<sup>14</sup> Appleton and Green, *Nature* (London), vol. 123, p. 445; March 23, (1929).

<sup>15</sup> Appleton and Green, *Proc. Roy. Soc. A*, vol. 128, p. 159; July, (1930).

<sup>16</sup> Schafer and Goodall, *Proc. I.R.E.*, vol. 19, p. 1434; August, (1931).



the virtual height for 1604 kilocycles decreased before that for 3088 kilocycles. These results were interpreted as evidence of two layers.

In 1931 Gilliland, Kenrick, and Norton<sup>17</sup> varied the frequency from 1600 to 8650 kilocycles and found evidence that the two layers existed simultaneously during the day for frequencies between 3000 and 5000 kilocycles. They also discussed the effect of the E layer on the retardation of pulses going to the F layer and showed that for the critical penetration frequency long retardations should be expected.

Evidence that there are two or more layers has been found in practically all subsequent work of this type regardless of the method used. The frequency change method and the angle of incidence method were developed in England, and the pulse method by Breit and Tuve in the United States. The British school has used the frequency change method for normal incidence experiments almost exclusively until the last three years. Since then, it has taken up the pulse method of Breit and Tuve, probably because the complex phenomena observed at the higher frequencies could not be interpreted by the frequency change method. The American school has used the pulse method of Breit and Tuve exclusively for vertical incidence experiments from the beginning of this work in 1925, and has developed a technique for rapid and continuous measurements which facilitates detailed studies of layer changes. The German<sup>18,19</sup> school also has used the pulse method of Breit and Tuve.

Hafstad and Tuve<sup>20</sup> extended the pulse method to measure the rate of change of the virtual height of a layer by the determination of the rate of change of radio-frequency phase of separate downcoming echoes.

T. L. Eckersley<sup>21</sup> has developed and used a valuable method for long-distance studies of the ionosphere by means of facsimile transmissions.

In 1925 Appleton,<sup>22</sup> and Nichols and Schelleng,<sup>23</sup> independently, pointed out that radio wave refraction and absorption in the ionosphere should be considerably modified by the earth's magnetic field. Nichols and Schelleng showed that, in the simple cases in which a radio wave is propagated parallel or perpendicular to the earth's magnetic field, it would be split into two components by magnetic double refraction

<sup>17</sup> Gilliland, Kenrick, and Norton, *Bureau of Standards Journal of Research*, vol. 7, p. 1083, (1931); *Proc. I.R.E.*, vol. 20, p. 286; February, (1932).

<sup>18</sup> Goubau and Zenneck, *Zeit. für Hochfrequenz.*, vol. 37, p. 207, (1931).

<sup>19</sup> Rukop and Wolf, *Zeit. für tech. Physik*, vol. 3, p. 132, (1932).

<sup>20</sup> Hafstad and Tuve, *Proc. I.R.E.*, vol. 17, p. 1786; October, (1929).

<sup>21</sup> T. L. Eckersley, *Jour. I. E. E.* (London), vol. 71, p. 405, (1932).

<sup>22</sup> Appleton, *Proc. Phys. Soc.*, vol. 37, part 2, p. 16D; February 15, (1925).

<sup>23</sup> Nichols and Schelleng, *Bell Sys. Tech. Jour.*, vol. 4, p. 215; April, (1925)

and, in general, one of these components would be more highly absorbed than the other. They also showed that there should be a critical absorption frequency at about 1400 kilocycles.

In 1927 Breit<sup>24</sup> showed quantitatively the effect of the earth's magnetic field on a ray propagated in any direction with respect to the terrestrial magnetic field. A few months later Appleton<sup>25,26,27</sup> independently solved the same problem and gave an equation for the index of refraction which we shall use later on.

In 1928 Appleton and Ratcliffe<sup>28</sup> found that downcoming waves of 750 kilocycles in England were circularly polarized with a left-handed rotation due to the absorption of the other component and predicted that under similar circumstances in the southern hemisphere the waves would be circularly polarized with a right-handed rotation. In 1932 Green,<sup>29</sup> working in Australia, reported experiments verifying this prediction.

In this brief historical review an attempt has been made to sketch the order of development of some of the principal phases of studies of the ionosphere. No attempt has been made to write a comprehensive review covering all the literature to date. Much of the more recent literature will be referred to during the discussion of our own work later on in this paper.

With regard to the nomenclature, we have adopted the general term "ionosphere" suggested by Dr. Watson Watt, to designate all the ionized region of the earth's atmosphere. We have previously called this region the Kennelly-Heaviside layer in honor of the men who contributed the original suggestions for this method of radio wave propagation.

Although we speak of several layers as if they existed separately with nonionized regions between them, it is not believed that such is the case but rather that there exists one ionized region whose ionization varies with the height in such a manner that the retardations of radio waves fall into fairly definite groups. These retardations which determine the virtual height are due, first, to the actual height of the reflecting layer and, second, to the reduction in group velocity of the pulse caused by passing through lower ionized regions. The resultant virtual heights fall into fairly definite groups, but the real height of the layers and the ionization between them is not known. The ionization between layers need not be less than that of the lower layer.

<sup>24</sup> Breit, *Proc. I.R.E.*, vol. 15, p. 709; August, (1927).

<sup>25</sup> Appleton, *Proc. U. R. S. I.*, part 1, p. 2; October, (1927).

<sup>26</sup> Appleton, *Jour. I. E. E.* (London), vol. 71, p. 642, (1932).

<sup>27</sup> Appleton and Naismith, *Proc. Roy. Soc. A*, vol. 137, (1932).

<sup>28</sup> Appleton and Ratcliffe, *Proc. Roy. Soc. A*, vol. 117, p. 576, (1928).

<sup>29</sup> Green, Radio Research Board Report No. 2, Melbourne, (1932).

## II. EXPERIMENTAL METHOD

The observations reported in this paper were carried out during the period of September, 1930, to April, 1933, as one part of a program to obtain more complete information than has been heretofore available about the ionosphere and its variations, and their relation to radio transmission.

The method used was the "pulse" or group retardation method of Breit and Tuve.<sup>8,10,30</sup> This consists of the transmission of a short pulse of about  $2 \times 10^{-4}$  seconds duration. Part of this pulse travels along the ground to the receiving set and is called the "ground" or reference pulse. Part of the pulse also travels from the ground to any reflecting or refracting medium and back to the ground one or more times. From the measurable difference in time between the arrival of the ground wave and the reflected waves, a virtual height can be computed for the source of each reflection. The virtual height in kilometers as determined by these time differences is indicated directly by means of suitable apparatus at the receiving station.

It has been shown that the existence of free ions in space causes a reduction in the refractive index<sup>3,4,5,31,32</sup> which, when sufficient, results in the complete bending of an electromagnetic wave back to the earth. When the angle of incidence is nearly normal, and the frequency is known, the refractive index can be computed, and the ion content at the virtual height indicated can be estimated. In this discussion this reduction in refractive index is stated in all cases in terms of an equivalent electron density. The effect of a heavy ion will be proportional to the square of its charge and inversely proportional to its mass. A plane wave solution of Maxwell's equations shows that, for a wave propagated in a medium of dielectric constant  $\epsilon$  and conductivity  $\sigma$ , the index of refraction is given by

$$n = \sqrt{\frac{\epsilon}{2} + \sqrt{\frac{\epsilon^2}{4} + \left(\frac{2\pi\sigma c^2}{\omega}\right)^2}} \quad (1)$$

where  $\sigma$  is in electromagnetic units,  $\epsilon$  is in electrostatic units,  $c$  = velocity of light, and  $\omega = 2\pi$  times the frequency. It is shown by Epstein<sup>33</sup> that unless the conductivity  $\sigma$  is negligible, total refraction cannot occur. When  $\sigma$  is neglected, the refractive index becomes

$$n = \sqrt{\epsilon} = \sqrt{1 - \Delta\epsilon} \quad (2)$$

<sup>30</sup> Breit and Tuve, *Terr. Mag.*, vol. 30, p. 15; March, (1925).

<sup>31</sup> Baker and Rice, *Jour. A. I. E. E.*, vol. 45, p. 535, (1926).

<sup>32</sup> Pedersen, "Propagation of Radio Waves," ch. 6, Copenhagen, (1927).

<sup>33</sup> P. S. Epstein, *Proc. Nat. Acad. Sci.*, vol. 16, pp. 37 and 627, (1930).

where  $\Delta\epsilon$  = reduction in dielectric constant due to free electrons. From Snell's law  $n \sin \phi_r = \sin \phi$  where  $\phi_r$  = angle of refraction and  $\phi$  = angle of incidence. Then at the apex of the ray path  $\sin \phi_r = 1$  and

$$n = \sin \phi = \sqrt{1 - \Delta\epsilon}$$

From the work of Lorentz it has been shown that the index of refraction of a frictionless electron gas is given by

$$n^2 = 1 - \frac{4\pi Ne^2}{\omega^2 m + a(4\pi Ne^2)} \quad (3)$$

where,

$N$  = number of electrons per  $\text{cm}^3$

$\omega$  = angular frequency

$e$  = electronic charge in electrostatic units.

The value of the constant "a" has been the subject of considerable discussion in recent literature. Lorentz put

$$a = 1/3 + S$$

and stated that the value of the constant  $S$  would in general be difficult to determine. He has, however, shown that  $S \equiv 0$  for a medium, the scattering elements of which have a regular cubical arrangement.

The earlier writers<sup>4,5,6,31,32</sup> on the theory of the Kennelly-Heaviside layer put  $a \equiv 0$  in their equations. This resulted in a value of

$$\Delta\epsilon = \frac{4\pi Ne^2}{\omega^2 m} \quad (3a)$$

More recently, however, Appleton<sup>26</sup> has called attention to the fact that "a" probably has a value different from zero. Hartree<sup>34</sup> has advanced reasons for believing that, in a medium such as the ionosphere, the value of "a" is very nearly equal to 1/3.

Because of the uncertainty concerning the value of "a," we have used both the value of 0 and 1/3 for numerical calculations.

From (3)

$$n = \sin \phi = \sqrt{1 - \frac{4\pi Ne^2}{\omega^2 m + a(4\pi Ne^2)}} \quad (4)$$

When  $\phi$  is made small by locating the transmitter and receiver near together,  $\sin^2 \phi = 0$  very nearly, and selecting  $f_c$  as the lowest frequency at which the wave passes through the layer (the critical frequency) we have

$$\text{putting } a = 1/3 \text{ in (3)} \quad N = 1.86 \times 10^{-8} f_c^2 \quad (5)$$

<sup>34</sup> Hartree, *Proc. Cambridge Phil. Soc.*, vol. 27, p. 143.

or,

$$\text{putting } a = 0 \text{ in (3)} \quad N = 1.24 \times 10^{-8} f_c^2. \quad (5a)$$

The value of  $N$  is taken as a measure of the maximum ionization of the layer.

It has been shown<sup>11,22,23,24</sup> that the refractive index is modified by the earth's magnetic field. In general, two refractive indexes are possible depending upon the direction of the wave normal with respect to that of the magnetic field.

Following Appleton,<sup>25,26,27</sup> if we assume that friction is small, the index of refraction is given as a function of the frequency by

$$n^2 = 1 + \frac{2}{2\alpha - \frac{\gamma_T^2}{1+\alpha} \pm \sqrt{\frac{\gamma_T^4}{(1+\alpha)^2} + 4\gamma_L^2}} \quad (6)$$

where,

$$\alpha = -\frac{m\omega^2}{4\pi Ne^2} - a$$

$$\gamma_L = \frac{m\omega \left( \frac{H_L e}{mc} \right)}{4\pi Ne^2}$$

$$\gamma_T = \frac{m\omega \left( \frac{H_T e}{mc} \right)}{4\pi Ne^2}.$$

$H_L$  and  $H_T$  are respectively the components of the earth's magnetic field along and at right angles to the wave normal for any direction of propagation with respect to the terrestrial magnetic field.

From this it is deduced that  $n = 0$  when

$$1 + \alpha = 0$$

$$1 + \alpha = \pm \sqrt{\gamma_L^2 + \gamma_T^2} = \pm \gamma.$$

From the equation  $1 + \alpha = 0$  we have

$$f_c'' = \sqrt{\frac{N_{\max} e^2}{\pi m}} \quad \text{putting } a \text{ of (3)} = 0$$

$$\text{or } f_c'' = \sqrt{\frac{2 N_{\max} e^2}{3 \pi m}} \quad \text{putting } a \text{ of (3)} = 1/3$$

when this ray just penetrates the layer. This is seen to be the critical frequency of the ordinary ray denoted by  $f_c''$ . Estimates of electron

density on the basis of this critical frequency are seen to be independent of the earth's magnetic field.

From the roots involving  $\gamma$  we have

$$f_1' = \frac{-\frac{He}{2\pi mc} + \sqrt{\left(\frac{He}{2\omega mc}\right)^2 + 4 \cdot \frac{2N_{\max}e^2}{3\pi m}}}{2}$$

$$f_2' = \frac{\frac{He}{2\pi mc} + \sqrt{\left(\frac{He}{2\pi mc}\right)^2 + 4 \cdot \frac{2N_{\max}e^2}{3\pi m}}}{2}$$

or  $f_2' - f_1' = He/2\pi mc = 1455$  kilocycles, assuming a value of  $H$ , the total terrestrial magnetic field, of 0.52 gauss for 180-kilometer height at Washington.

It appears that there are two possible critical frequencies for the extraordinary ray. It will be seen, however, that the ray will ordinarily travel only until  $N$  is sufficiently large to return it, and it cannot therefore reach such an electron density as to cause  $f_1'$  to exist.

Then,

$$f_2' = + \frac{\frac{He}{2\pi mc} + \sqrt{\left(\frac{He}{2\pi mc}\right)^2 + 4f_c^2}}{2}$$

The critical frequencies of the  $F_1$  layer corresponding to  $f_2'$  and  $f_c'$  are denoted by  $f_{F_1}'$  and  $f_{F_1}''$ . The relation between these critical frequencies is shown in Fig. 1. It can be seen that the critical frequencies for the two rays will also have the above relation. The difference between values of  $f_c''$  and  $f_2'$  is seen to approach a constant value of  $1/2(He/2\pi mc) = 728$  kilocycles at very high frequencies. It has also been shown that the two rays have different polarizations and are attenuated differently.<sup>35</sup>

From the foregoing, two methods of study of the ionosphere are suggested: (1) To observe the variations in virtual height and amplitude at constant frequency as ionization or recombination occurs with changing time, and (2) to observe the variations in virtual height and amplitude as the frequency is changed so rapidly that variations with time can be neglected. This paper relates chiefly to results obtained by the second method.

<sup>35</sup> Appleton and Builder, *Proc. Phys. Soc.*, vol. 45, part 2, no. 247, p. 208 (1933).

For the successful application of this method, a large number of observations at various frequencies throughout the range in which reflections are returned must be made during a period so short that changes due to ionization or recombination are not very appreciable. Each transmission must be so selected, and be made so short that the probability of creating interference is negligible. It is possible to make sufficiently rapid measurements except during periods when violent changes are taking place in the layers.

In practice, the transmissions were limited to a minute or less, and

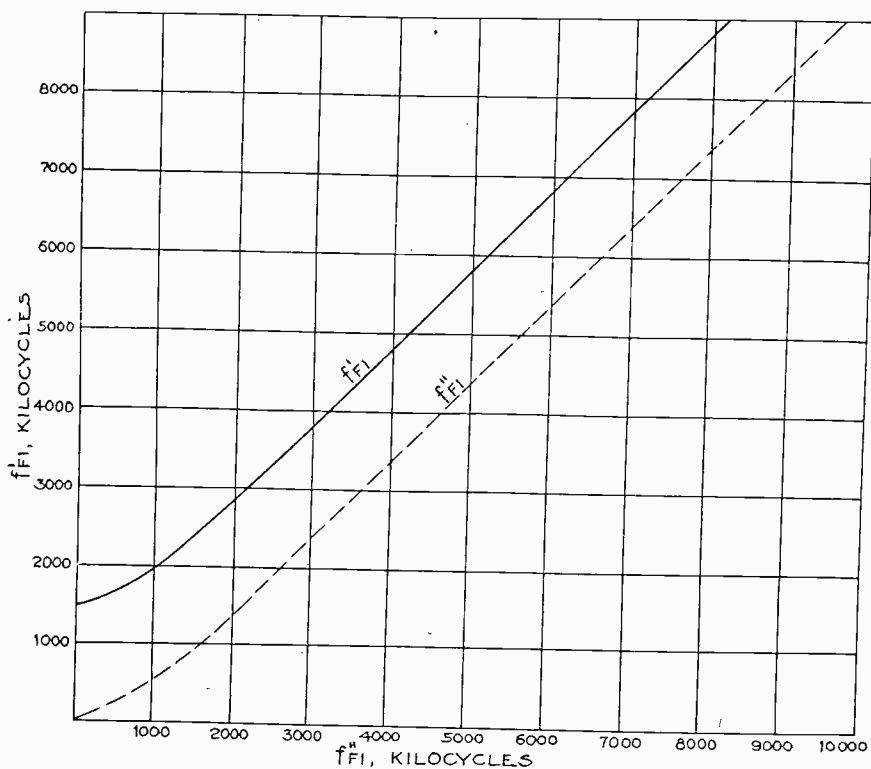

Fig. 1—Graphs showing the frequency separation of the critical frequencies of the ordinary and extraordinary rays due to magnetic double refraction at 180-kilometer height at Washington, D.C.

the run through the portion of the spectrum in which reflections were returned required from thirty to sixty minutes. In order to avoid missing any of the critical ranges, frequency changes must be made in steps of not more than 200 kilocycles. Generally, the changes were made in steps of 100 kilocycles or even less.

Because of the narrow frequency bands within which the critical frequencies occur, the transmitter used had a low power oscillator of good frequency stability followed by a multistage amplifier which was keyed. Sufficient power is necessary to show small reflections occurring

at critical frequencies through high atmospheric noise. The power was increased from time to time during the study until, at the last, somewhat more than one kilowatt was in use. Single-wire horizontal high angle radiators were employed.

A double-detection receiver having linear detector characteristics and operating a direct-current amplifier of the bridge type was used to furnish the energy to an oscillograph galvanometer. The galvanometer was placed at the center of the bridge and had an electrical bias at all times, so that high resolution was possible. A light beam, reflected from the galvanometer, was projected from a three-sided rotating mirror and thence to a translucent celluloid screen. The triple-contact chopper at the transmitter and the rotating mirror at the receiver were rotated by means of synchronous motors operating from the same power supply. As the pulsing frequency was  $3/2$  times the line frequency, spurious noises, synchronous with line frequency, did not break the base line established by the galvanometer, and could be separated from pulses originating at the transmitter which do break this base line. Measurements of virtual height were made by bringing the beginning of each reflected pulse to a reference line. This was accomplished by rotating the motor frame through a known angle with a micrometer screw calibrated directly in kilometers. The ground, or reference pulse, was brought to a second reference line located ahead of the first to correct for the time of travel of the ground pulse.

Large variations in the amplitude of various reflections (frequently in the order of 1000:1 in field intensity) were found. No attempt was made to observe the relative amplitudes directly on the oscillograph screen. Instead, a calibrated attenuator in the intermediate-frequency amplifier was used to reduce the amplitude of the pulse to a standard value for measurement, and the actual amplitude was determined from the attenuator setting. This method served several purposes: (1) It eliminated the effect of the second detector characteristic on comparisons of amplitude; (2) it corrected for the error due to the appreciable (though very small) time required for the transmitted pulse to rise from zero to full amplitude; and (3) it made possible the measurement of very small reflections.

As it was necessary to move the equipment during the period of these experiments, the transmissions were made over three different paths. The transmitting station was finally located at Beltsville, Md., with the receiving station directly south at Meadows, Md., 25 kilometers distant. The ground path of the earlier transmissions was 20 kilometers.



## III. INVESTIGATIONS OF THE E LAYER

At the lower frequencies, reflections are returned from the E layer. The virtual height ranges consistently from about 100 kilometers at frequencies in the broadcast band (550–1500 kilocycles) to about 120 kilometers at frequencies near the critical frequency. These heights do not vary much between day and night conditions. In the daytime, the reflections at upper broadcast frequencies are very small or entirely missing, and are larger in winter than in summer. As the frequency is increased, these reflections become very large in amplitude. In the neighborhood of the critical frequency, a number of phenomena usually are observed in the following order as the frequency is increased:

- (1) The virtual height increases rapidly to large values.

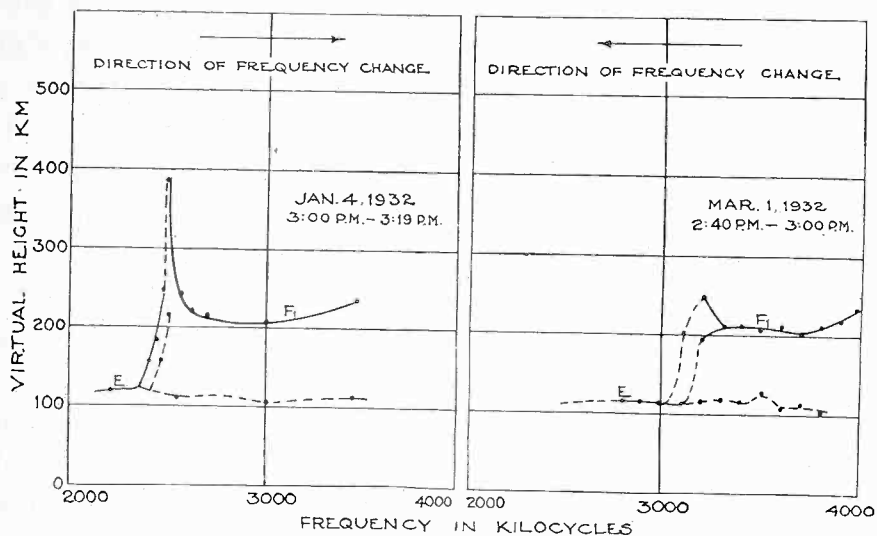

Fig. 2—Typical cases of E layer critical frequency.

- (2) The amplitudes decrease rapidly, all reflections frequently disappearing entirely.

- (3) Further increases in frequency cause a decrease in virtual height to F-layer values.

Some variations of the character of these phenomena are observed from time to time, especially during periods when the absorption increases sufficiently to cause reflections to disappear.

This critical frequency is the lowest frequency which can pass through the E layer and is taken as a measure of the maximum ionization of the layer. It is termed the E critical frequency and is here represented by the symbol  $f_E$ .

Typical cases of E-layer critical frequency are shown in Fig. 2. This phenomenon appears to be identical with that observed by Schafer

and Goodall<sup>16</sup> and others, who held the frequency constant during a decrease in critical frequency due to recombination. The long retardation at critical frequency has been discussed by a number of writers,<sup>36,17,27</sup> and occurs when the frequency is just high enough to permit the pulse to pass through the layer.

Determinations of critical frequency are made by varying the frequency through the range in which these phenomena are observed. The results of a large number of determinations throughout the two and one-half year period show that (with certain exceptions discussed later) the variation of  $f_E$  has certain quite regular characteristics during the

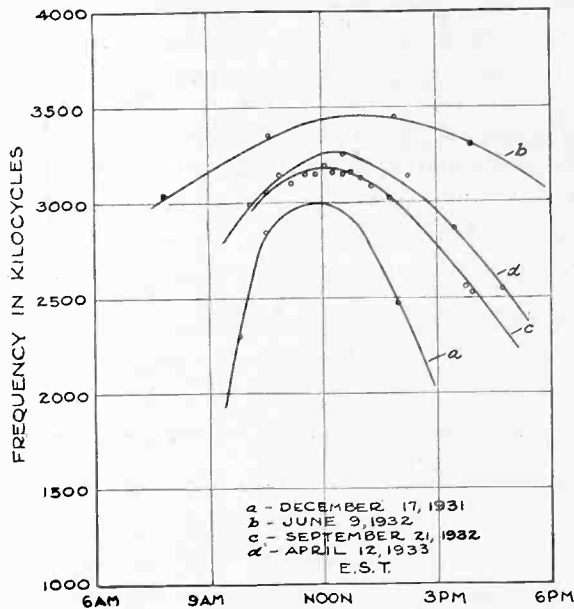

Fig. 3—Typical diurnal variations of  $f_E$  selected for days during the various seasons.

daytime: (1) There is a regular diurnal variation, quite smooth,  $f_E$  rising in the morning and falling in the afternoon; (2) the maximum occurs near local apparent noon, and the characteristic is quite flat during this period; (3) these noon maximum values have a seasonal variation, but very little day-to-day variation.

Fig. 3 shows typical diurnal variations of  $f_E$  during selected days in each of the four seasons. Fig. 4 shows a plot of a large number of values of  $f_E$  taken in the early afternoon, grouped around the dates indicated. These figures show the seasonal change in diurnal variation of  $f_E$ . Fig. 5 shows the annual variation of the maximum values of  $f_E$  over an extended period. A few observations taken shortly after noon but corrected to noon by interpolation from Fig. 4, are included.

<sup>36</sup> Appleton, *Proc. Phys. Soc.*, vol. 42, p. 321, (1930).

From the regularity of the daytime diurnal and seasonal characteristics, it appears that the sun is the chief ionizing agency during the day. From these figures it can be estimated that the annual variation in

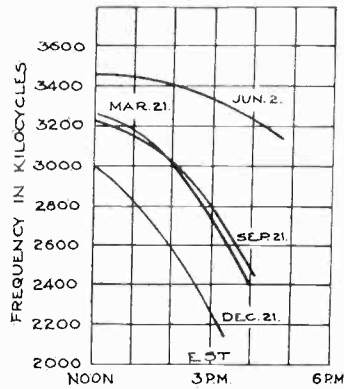

Fig. 4—This figure shows graphs of a large number of E critical frequencies taken in the early afternoon and grouped around the dates indicated.

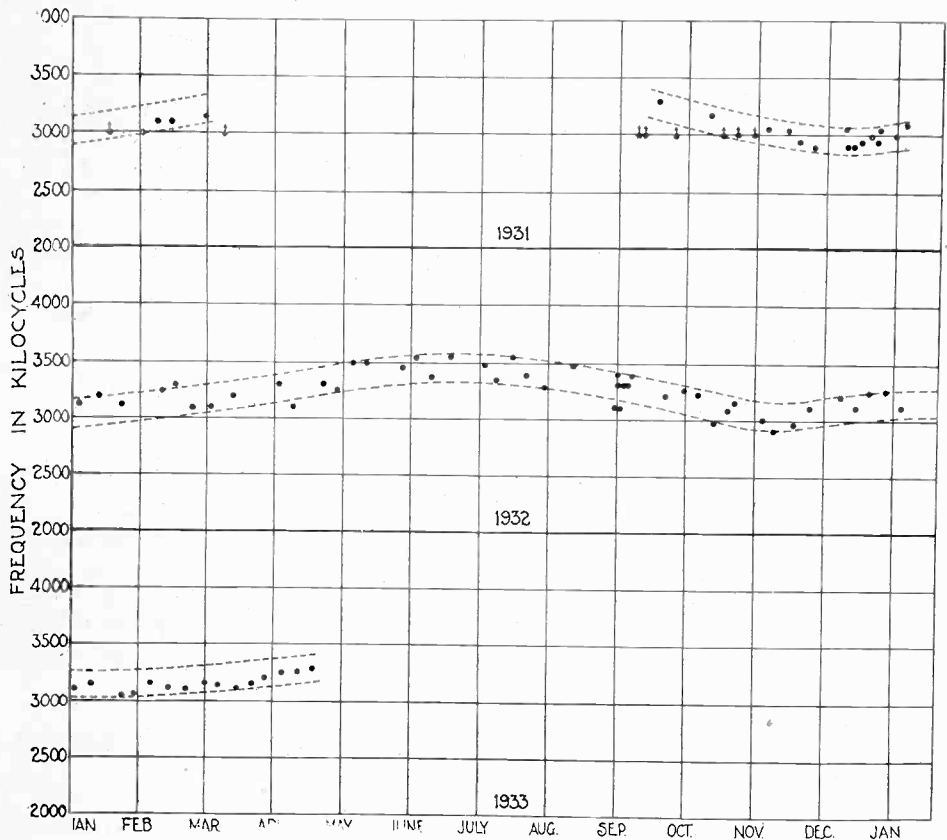

Fig. 5—Noon maximum values of  $f_E$  for 1931, 1932, and 1933. These values do not include occasional random high values of ionization discussed in text.

noon maximum of  $f_E$  during this period was from about 3000 kilocycles in December to 3400 kilocycles in June. This estimate is subject to certain limitations, in that daily observations were not made. There may also be slight differences in the opinions of various observers in

the assignment of an exact frequency to be called "critical" for a phenomenon actually occurring through a narrow band of frequencies.

Taking the ionization as proportional to  $(f_E)^2$  the ratio of maximum ionization from summer to winter values is seen to be about 1.3 to 1.

As the frequency is increased above  $f_E$ , and large reflections are returned from the F layer, E-layer reflections continue to appear but with very diminished amplitudes. (See Fig. 2.) It has been suggested by some writers that this is due to a small amount of energy reflected from the comparatively sharp boundary of the lower region. Gilliland, Kenrick, and Norton<sup>17</sup> show that the reflection coefficients are of approximately the correct magnitude. Magneto-ionic effects might also account for such reflections within certain frequency ranges. By a further study of these reflections it may be possible to obtain a more perfect understanding than now exists of the structure of this layer.

Occasionally reflections of great magnitude, sufficient to return a number of multiples, are returned from the E layer at frequencies considerably higher than the usual values. Such phenomena have been observed when regular  $f_E$  determinations were being made and are illustrated in Fig. 6. It has been suggested<sup>37</sup> that this phenomenon may be due either to a focusing effect from the E layer, or to a sudden abnormal increase in E-layer ionization.

Because of the unexpected appearance of this phenomenon and the rapidity with which it takes place, it has been impossible up to the present time to make determinations of  $f_E$  during its appearance. It has not been possible, therefore, to determine the manner in which  $f_E$  varies. In view of the fact that the upper layers are frequently completely blanketed out for all frequencies, it appears that an increase in ionization may be the cause, and it is believed that  $f_E$  is increased to abnormally high values. Determinations of critical frequencies for the upper layers during this phenomenon have indicated that these layers were not affected. (See Fig. 6.) An examination of the magnetic character of days on which such phenomena are observed shows that they occur on both magnetically quiet and disturbed days.<sup>27</sup> The phenomena have been observed most frequently in the evening or at night. It has been suggested<sup>38</sup> that the high charges in a thunderstorm might account for abnormal E-layer ionization, but such occurrences have been observed during perfectly clear as well as overcast weather. Ranzi<sup>39</sup> finds that some connection may exist between these high ionizations of

<sup>37</sup> Schafer and Goodall, *Proc. I.R.E.*, vol. 20, p. 1131, (1932).

<sup>38</sup> C. T. R. Wilson, *Proc. Phys. Soc.*, vol. 37, part 2, p. 32D; February 15, (1925).

<sup>39</sup> Ranzi, *Nature* (London), vol. 130, p. 369; September 3, (1932).

the E layer and low barometric pressures. As yet no comparison has been made with such meteorological data.

The variations of  $f_E$  are found to be much less regular at night than during the daytime. The critical frequencies range from the lower part

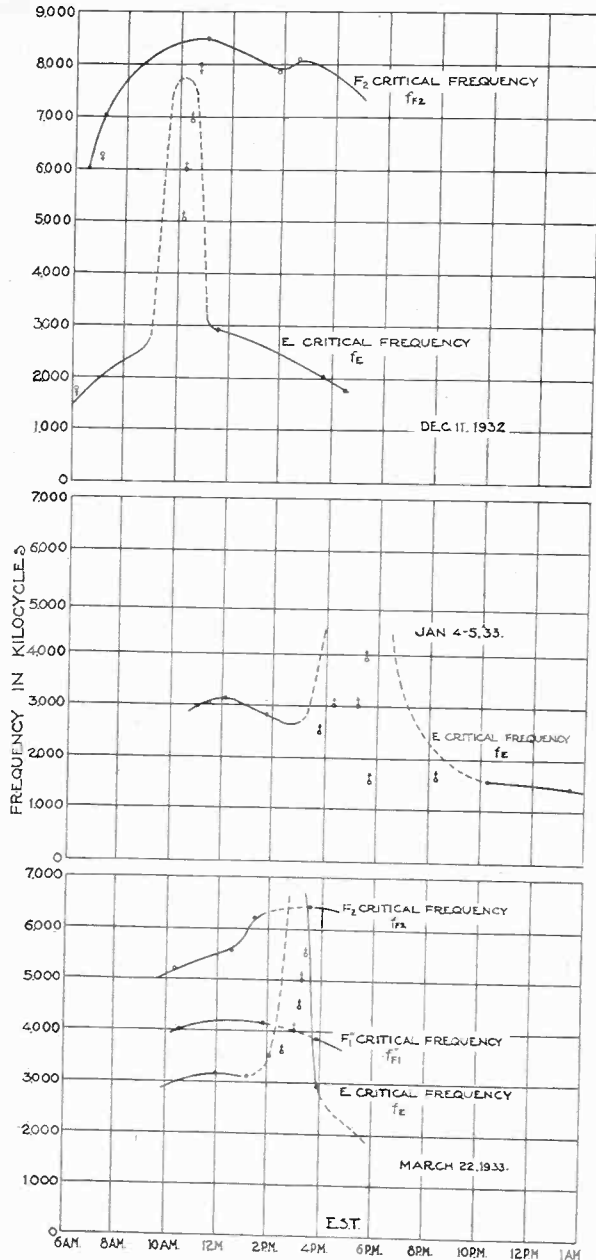

Fig. 6—Examples of occasional random high values of  $f_E$ .  $\circ$  indicates observations.  $\delta$  indicates critical frequency greater than observed frequency.  $\phi$  indicates critical frequency is less than observed frequency.

of the broadcast band (550–1500 kilocycles) to values somewhat above the broadcast band at about 2 A.M. from night to night. The frequent appearance during the late afternoon and evening of the phenomenon of abnormally large E-layer reflections, which blanket out the upper

layers on frequencies higher than normal, is usually followed by night values of  $f_E$  which are higher than those found on other nights. This fact supports the view that the occasional strong E-layer reflections occurring at the higher frequencies are due to high ionization. It is possible that the normal process of recombination may be delayed under these circumstances, thus causing a considerable variability in ion content of the E layer, from night to night. It appears that this ionizing force acts independently of the direct radiations of the sun.

#### IV. INVESTIGATIONS OF THE $F_1$ LAYER

As the frequency is increased above  $f_E$  during the daytime in summer, the virtual heights fall to values between 185 and 250 kilometers,

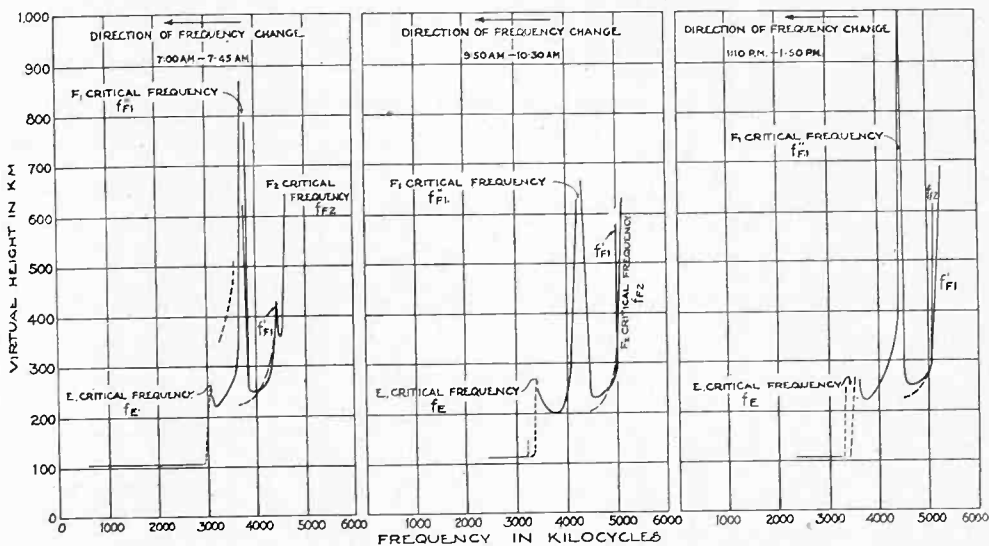

Fig. 7—Typical graphs of virtual height vs. frequency showing the variation of  $f_{F1}''$  and  $f_{F1}'$  during the day.

and then again increase and indicate a second critical frequency with phenomena somewhat similar to those observed for the E critical frequency. Figs. 7, 8, and 9 illustrate typically this phenomenon for the various times of the day during the spring and summer seasons. During the early morning and the late afternoon the phenomenon is much less distinct, and seem to disappear entirely during the night. Likewise, during the winter season, it becomes less distinct than during the summer. Fig. 10 illustrates this seasonal change during the afternoon.

Because of the regular occurrence of this effect and its similarity to that occurring at the maximum ionization of the E layer, it is believed that it indicates a critical frequency representing a maximum ionization of a quite distinct layer<sup>21</sup> in the F region during the daytime. We therefore refer to this layer as the  $F_1$  layer because of its apparent

merging into a general F layer under the conditions outlined. This layer has a maximum ionization indicated by the  $F_1''$  critical frequency denoted here as  $f_{F_1''}$ . We refer to the layer found above the  $F_1$  layer as the  $F_2$  layer.

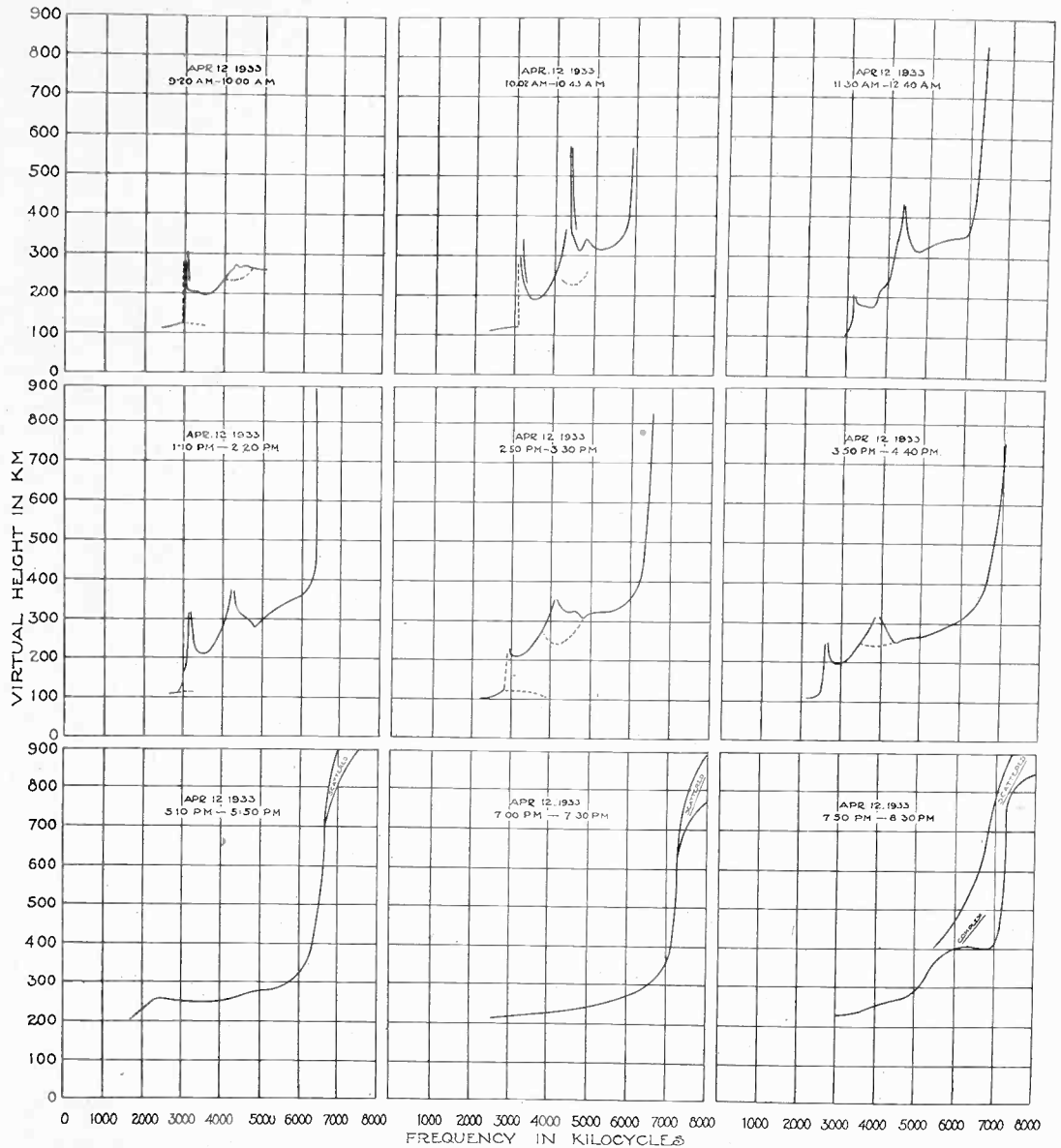

Fig. 8—Typical graphs of virtual height vs. frequency showing diurnal changes of retardations at  $f_{F_1''}$ . Dated curves indicate small reflections from  $F_1'$  (April 12, 1933).

In support of the view of the stratification of the F region during the daytime is the fact that while the virtual heights for frequencies less than  $f_{F_1''}$  show no direct relation to the variation of the virtual heights of the  $F_2$  layer, the virtual heights for these same frequencies take on a direct relation to  $F_2$  layer heights when  $f_{F_1''}$  has fallen below

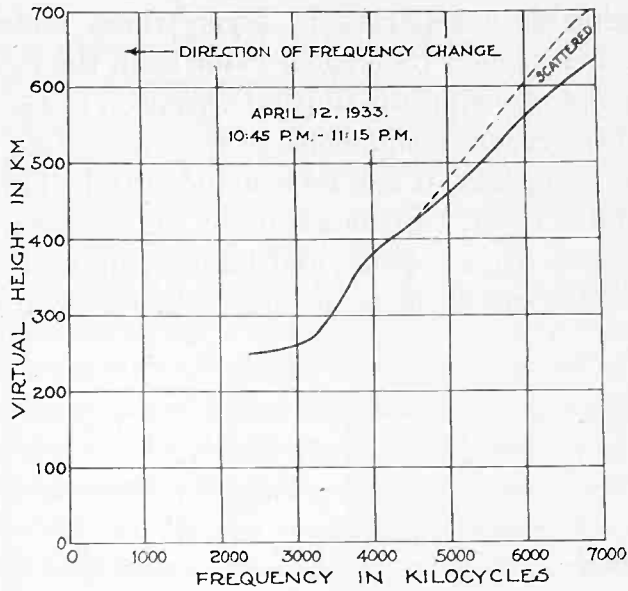

Fig. 9—Evening values of virtual height for April 12, 1933.

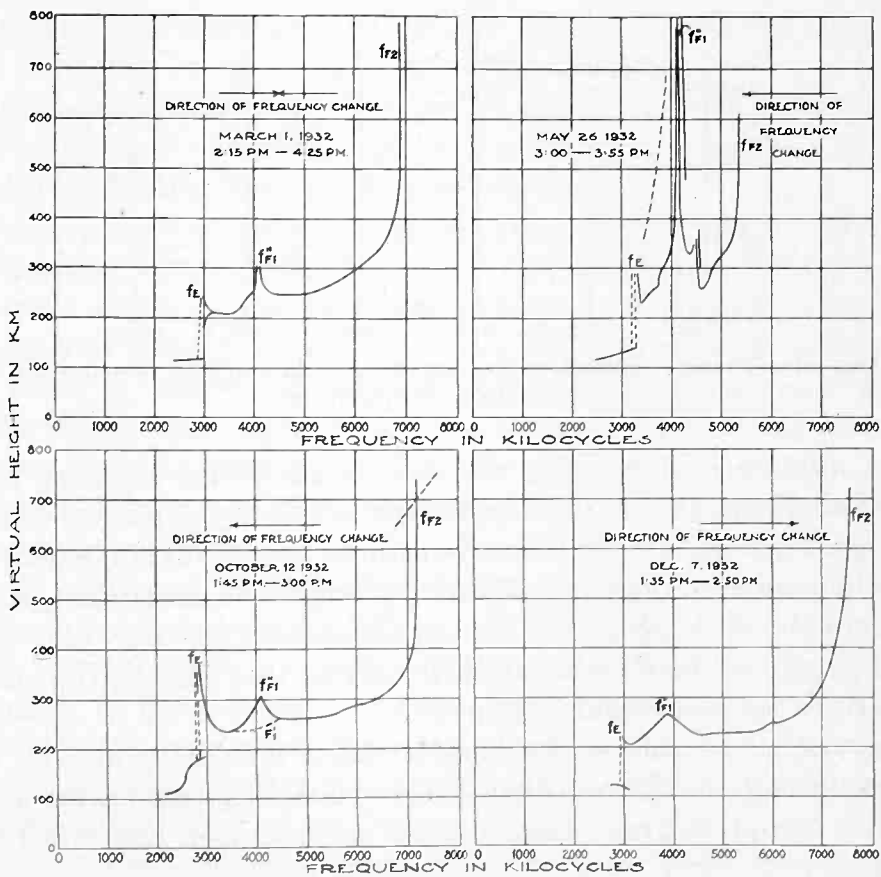

Fig. 10—Typical graphs of virtual height vs. frequency showing seasonal changes in retardations at  $f_{F1}''$  during the afternoon.



them. This indicates a separate  $F_1$  layer whose ionization screens waves of frequencies below its critical value from the  $F_2$  layer.

A typical graph showing the diurnal variation of  $f_{F_1}''$  and its relation to the other critical frequencies is shown in Fig. 11. From the nature of these variations, it can be concluded that, like the ordinary ionization of the E layer, the ionization of the  $F_1$  layer is apparently caused by radiation from the sun, and largely follows the diurnal and annual phases of the sun in the same manner as the ordinary variations of the E layer.

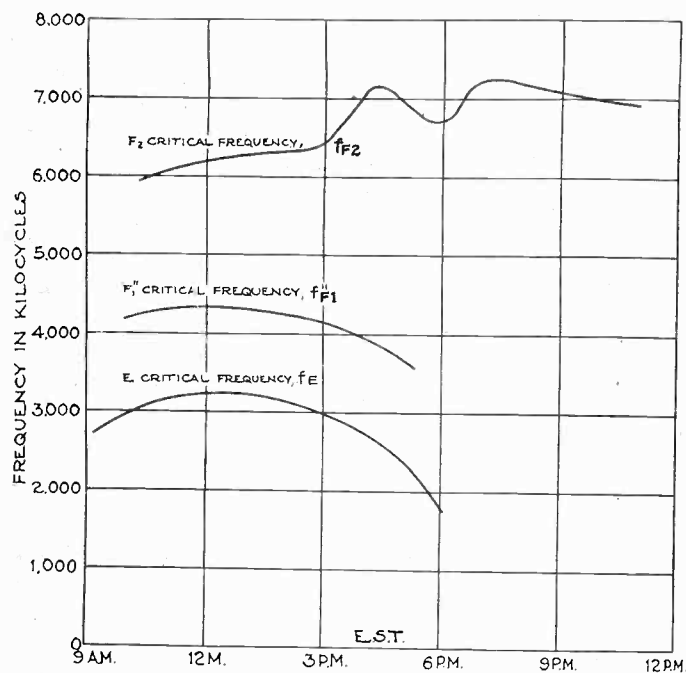

Fig. 11—Typical diurnal variations of  $f_{F_1}''$  showing its relation to other critical frequencies.

The difference between  $f_E$  and  $f_{F_1}''$  is such that the retardation effects found near the critical frequencies ordinarily appear to overlap. (See Figs. 7 and 8.) Under these conditions, the virtual heights would always be very much in excess of the real height. At some times, virtual heights of the  $E_1$  layer as low as 185 kilometers are observed. If the virtual height of the  $F_1$  layer is at all stable, this may be the nearest approach to the real height obtained.

The virtual heights of the long retarded reflections at  $f_{F_1}''$  vary rapidly through small frequency ranges, but may remain for a considerable period at great values, often in excess of 1200–1500 kilometers.

As the frequency is increased through  $f_{F_1}''$ , in addition to the main reflections of large amplitude and increasing retardation, small reflec-

tions sometimes in the order of 1/1000 of the amplitude of the main reflections are returned from virtual heights corresponding to  $F_1$  or  $F_2$  layers. These are shown as the dotted curves in Figs. 7 and 8. Such reflections might be attributed either to magneto-ionic double refraction in which this reflection represents the extraordinary ray, or to the effect of a comparatively sharp boundary.

It is seen from Figs. 12 and 13 that this small reflection increases in amplitude as the frequency is increased, and appears to go through a second critical frequency about 800 kilocycles above  $f_{F_1''}$ . From Fig. 1 it is seen that this separation is about that to be expected for the two critical frequencies for the magnetically doubly-refracted rays. Because the curves for these two reflections maintain a fixed relation, it seems probable that they are due to magnetic double refraction in the  $F_1$  layer, and that the second component is the extraordinary ray  $F_1'$ , having a critical frequency of  $f_{F_1'}$ . The smaller amplitude of the extraordinary ray is probably due to the difference in the absorption of the rays having two different polarizations. This effect has been discussed by Appleton and Ratcliffe.<sup>28</sup> In addition to these effects, splitting of the main reflection at the critical frequencies through very narrow frequency bands is frequently observed. It appears that all of these effects must be studied<sup>40</sup> by some means of continuous frequency variation in order to identify their cause more positively.

Few data are available for estimating the variation in the diurnal and seasonal values of the  $f_{F_1''}$  at vertical incidence. From the available data, however, the variation appears to range from about 3800 kilocycles at noon in winter to about 4500 kilocycles at noon in summer. From (4) this would represent a ratio of maximum electron density for the  $F_1$  layer ranging from 1 to 1.4 from winter to summer. This variation is of the same order as that for the E layer.

Frequently one or more additional critical frequency phenomena such as shown in Fig. 13 are found near  $f_{F_1''}$ , indicating the appearance of additional ionized strata in this region. These have not been observed to appear regularly from day to day as is the case with the layers just discussed. It is seen that the disappearance of the  $F_1$  critical frequency in the evening cannot be easily explained on the basis of recombination because of the relatively slow decrease in critical frequency. It seems possible that the  $F_1$  and  $F_2$  layers may drift together to form a single layer under these conditions.

Some correspondence appears to exist between phenomena at

<sup>40</sup> See the paper, "Note on a multi-frequency automatic record of ionosphere heights," by T. R. Gilliland, *Bureau of Standards Journal of Research*, October, (1933), describing a practical method of making such observations.

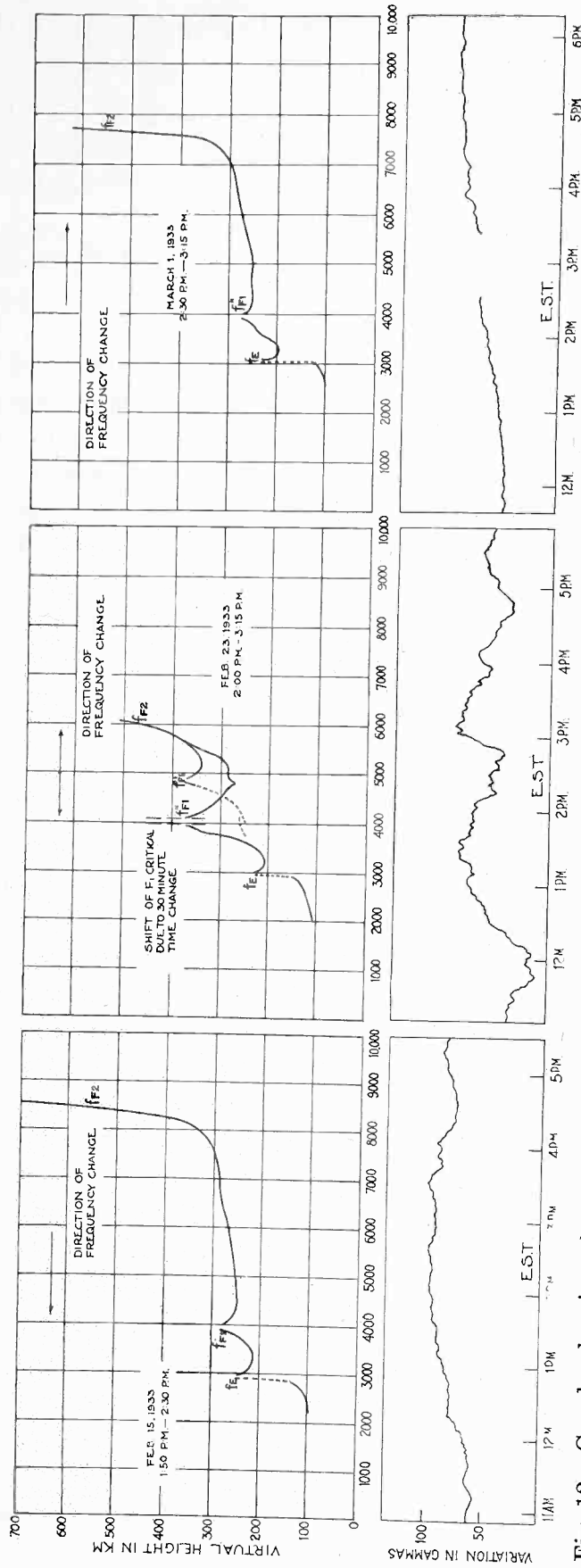

Fig. 12—Graphs showing virtual height vs. frequency for magnetically quiet and disturbed days. Magnetograms for corresponding times are shown at bottom of figure. Center figure shows the two magnetically double-refracted rays.

$f_{F_1}''$  and terrestrial magnetic disturbances. Comparisons of the pulse retardation at  $f_{F_1}''$  with disturbances in the horizontal component of the terrestrial magnetic field indicate that during disturbed periods retardations are often longer and subject to greater absorption than during undisturbed periods. Such phenomena are most easily recognized during the afternoon in summer or at midday in winter when  $f_{F_1}''$  is not ordinarily sharply defined. Fig. 12 shows a typical example of such a case. A study of the long retardations of  $f_{F_1}''$  shows that the virtual height is usually greatest about noon. If the frequency is held constant at the value of the noon  $f_{F_1}''$ , the virtual height of the

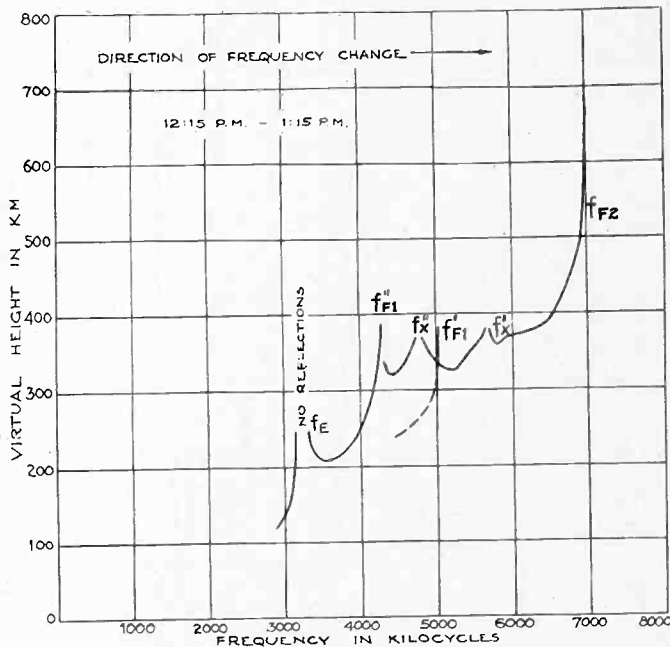

Fig. 13—Graph of virtual height vs. frequency showing a number of critical frequencies due to existence of additional irregular layers and their critical frequencies for both magnetically double-refracted rays.

ordinary ray just passing through the  $F_1$  and reflected from the  $F_2$  layer is found to decrease nearly uniformly throughout the afternoon, with the main reflections joining with the  $F_1'$  reflections late in the afternoon. (See Figs. 14 and 15.) This decrease in virtual height appears to occur for two reasons: (1) reduction in  $f_{F_1}''$  during the afternoon (see Fig. 10); (2) reduction in the retardation of pulses at  $f_{F_1}''$  (see Fig. 8). Both causes tend to decrease the effect of the  $F_1$  layer on the virtual heights of the  $F_2$  layer as the afternoon progresses. The long retardations accompanying  $f_{F_1}'$  disappear as the afternoon progresses. This effect appears to be independent of the decrease of critical frequency during the afternoon. Information regarding this point is

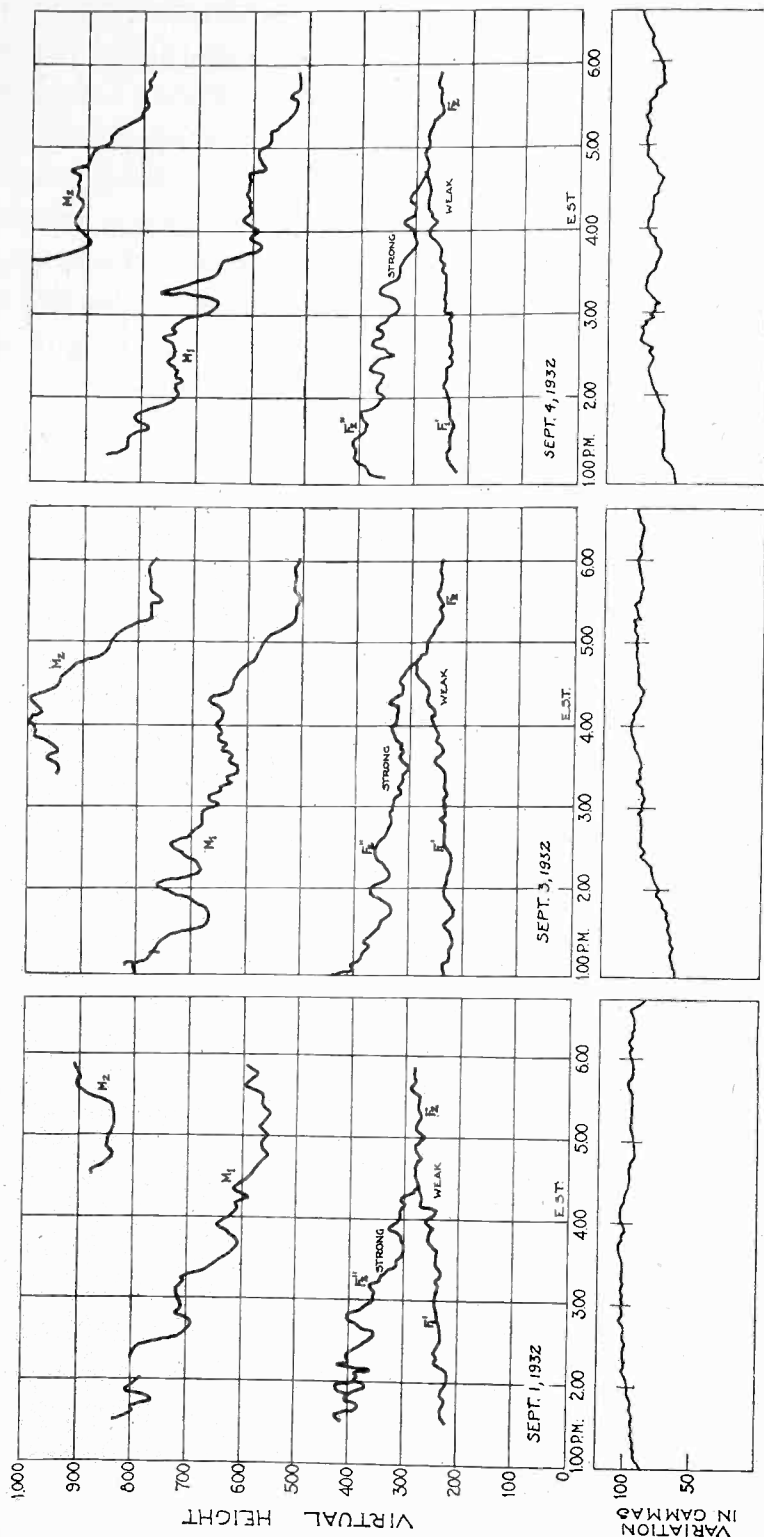

Fig. 14—Graphs showing decrease in retardation of F<sub>2</sub> reflections on 4200 kilocycles as afternoon progresses. The retardation is produced by passing through the F<sub>1</sub> layer at a frequency just above  $f_{F_1}$ . M<sub>1</sub> + M<sub>2</sub> are multiple reflections from the F<sub>2</sub> layer. The magnetograms of horizontal intensity of earth's field are also shown.

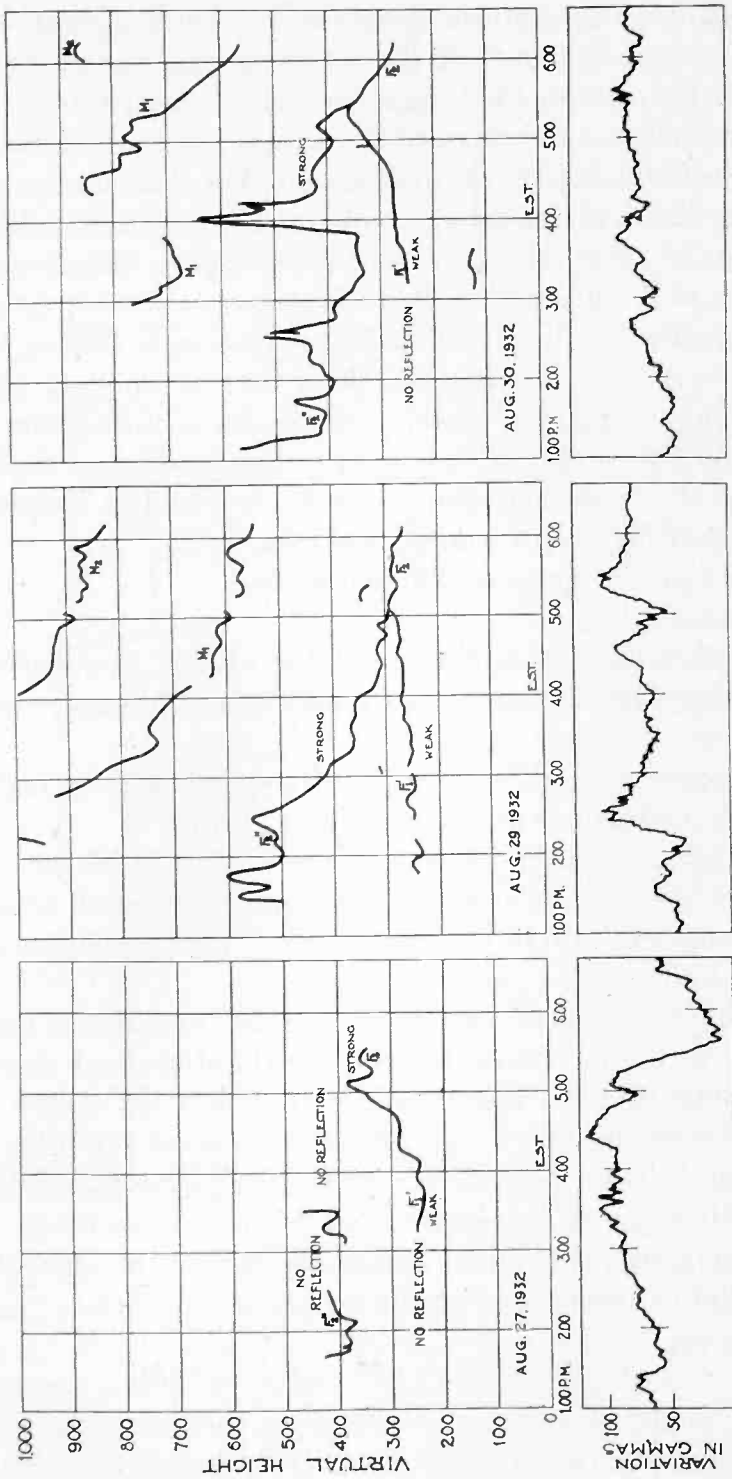

Fig. 15—Same as Fig. 15 taken on magnetically disturbed days.

given in a discussion of results obtained during the solar eclipse of August 31, 1932.<sup>41</sup>

Fig. 14 shows the uniform decrease in virtual height which occurred during the afternoons of the magnetically undisturbed periods of September 1, 3, and 4, 1932, together with the magnetograms of the horizontal intensity of the terrestrial magnetic field taken by the U. S. Coast and Geodetic Survey at Cheltenham, Md. The change of virtual height during the disturbed periods of August 27, 29, and 30, 1932, is shown in Fig. 15, together with the corresponding magnetograms. It appears from such curves that there is some relationship between the magnetic changes and the virtual height phenomena. During the major disturbance on August 27, the reflections were completely absent for long periods, apparently on account of abnormal absorption. During the periods of great retardation on the other disturbed days, reflections were small. Such increases in virtual height at a frequency just above  $f_{F_1}''$  might be due to a number of causes:

- (1) An increase in the virtual height at  $f_{F_1}''$ .
- (2) An increase in  $f_{F_1}''$ .
- (3) The existence of one or more higher critical frequencies in the  $F_2$  region which pass through this frequency as they decrease due to recombination.
- (4) The appearance of a new critical frequency slightly higher than  $f_{F_1}''$  due to changing ionic gradient in the  $F_2$  layer.

An increase in  $f_{F_1}''$  would represent an increase in ionization of the  $F_1$  layer under these conditions. (1), (3), and (4) might all occur as the result of a change in the ionic gradient of the  $F_1$  layer or of unusual ionic strata between the usual  $F_1$  and  $F_2$  layers.

Fig. 16 shows the envelopes of the virtual heights for the undisturbed days, with the virtual heights for the disturbed days superimposed, to illustrate the magnitude of the variation shown in Figs. 14 and 15. It must be noted that in all cases shown in Figs. 14 and 15, the normal virtual heights of the  $F_2$  layer were observed simultaneously with separate equipment on higher frequencies. This is typically demonstrated in Figs. 22 and 23, where the 4000- to 4300-kilocycle contours cross those for the higher frequencies.

## V. INVESTIGATIONS OF THE $F_2$ LAYER

As the frequency is increased above  $f_{F_1}''$ , the virtual height of the ordinary ray falls to values which are usually somewhat higher than those of the  $F_1$  layer. With further increase in frequency, the virtual

<sup>41</sup> Kirby, Berkner, Gilliland, and Norton. *Bureau of Standards Journal Research*, October, (1933).

height is found to increase rapidly to very great values. This is illustrated in Figs. 7, 8, and 10 for various diurnal and seasonal variations. We have arbitrarily termed the frequency at which the maximum slope of this sudden increase in height takes place as the  $F_2$  critical frequency, and denoted this frequency as  $f_{F_2}$ .

As the frequency is increased through  $f_{F_2}$ , the reflections become rapidly smaller in magnitude as the virtual height increases, finally disappearing entirely. Above this frequency either no reflections at all

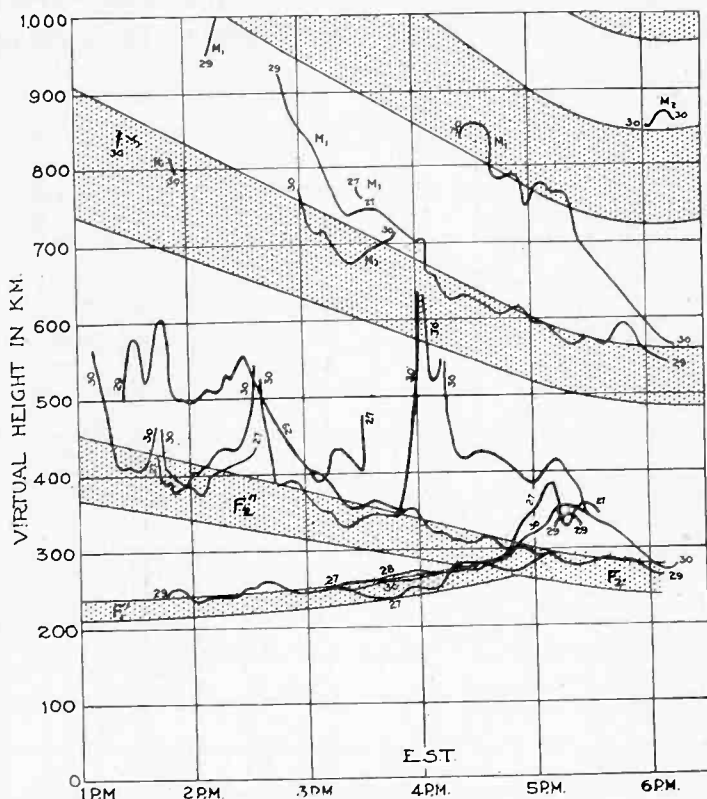

Fig. 16—Envelopes of the virtual heights for 4200 kilocycles for undisturbed days, with the virtual heights of the disturbed days superimposed for the days shown in Fig. 14.

are returned, or the reflections are greatly retarded and extremely small, and variable in magnitude and virtual height. These "scattered reflections" are discussed in a later section. The  $F_2$  critical frequency therefore represents, at vertical incidence, the highest frequency which returns reflections of any appreciable magnitude.

The  $F_2$  critical frequency is subject to certain diurnal and seasonal variations, but these variations do not occur in phase with, or in the same manner as,  $f_E$  and  $f_{F_1''}$ . Furthermore, the day-to-day variations are large compared with the small day-to-day variations observed for  $f_E$  and  $f_{F_1''}$ . The diurnal characteristic is found to vary quite differ-



ently for different seasons. Fig. 17 shows this seasonal variation in diurnal characteristic. The winter values of  $f_{F_2}$  are seen to have a diurnal characteristic reaching a maximum about noon. This is somewhat similar to variations in  $f_E$  and  $f_{F_1}''$ , but much more irregular and variable. The springtime values of  $f_{F_2}$  show a flatter diurnal characteristic, falling after sunset; while the summer values of  $f_{F_2}$  are generally found to rise in the afternoon, reaching a maximum after sunset. The retardations at  $f_{F_2}$  for all seasons are of the same order of magnitude. (See Fig. 10.) Fig. 18 shows the seasonal and day-to-day variation in noon and 2 P.M. values of  $f_{F_2}$ . Fig. 19 shows the average variation

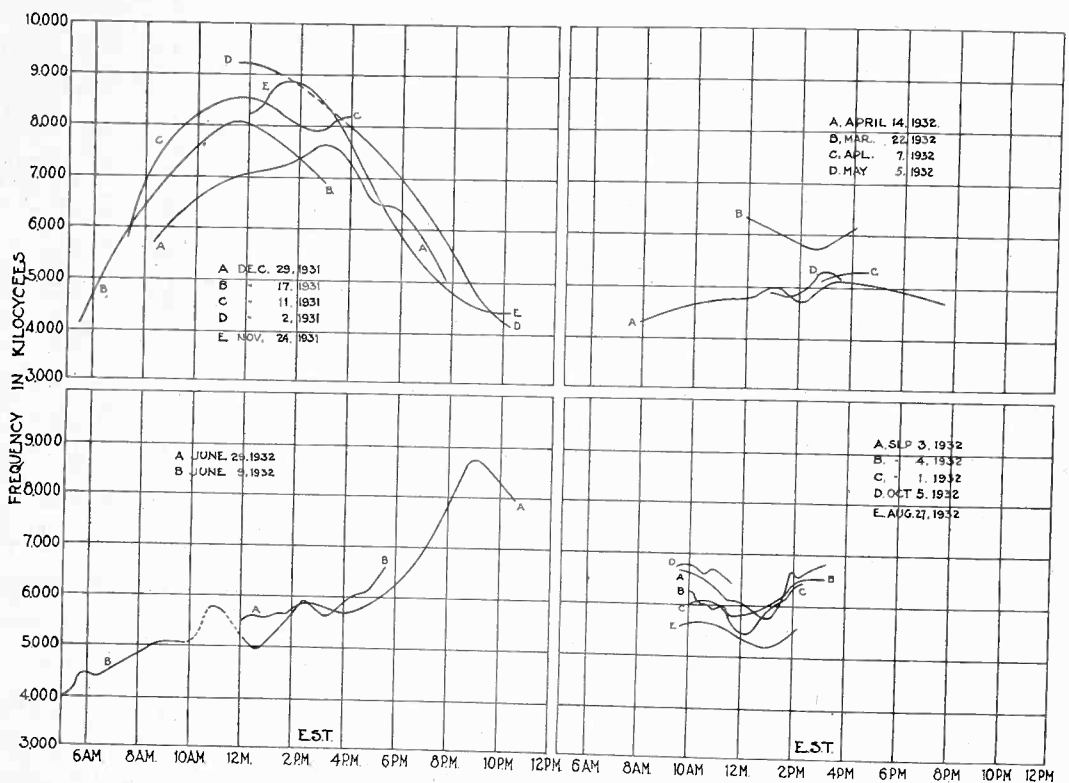

Fig. 17—Seasonal variation of diurnal characteristic of  $f_{F_2}$ .

during the four years in which the observations were made. Fig. 20 shows the diurnal characteristic for a winter day on which  $f_{F_2}$  was high.

Several important experimental facts are to be obtained from these data:

(1) the values of  $f_{F_2}$  are higher at midday in winter than at midday during summer by the large factor. This is distinctly the reverse of the trend of  $f_E$  and  $f_{F_1}''$ .

(2) The values of  $f_{F_2}$  reach a maximum some time near noon in the winter, but usually somewhat after sunset in the summer, while the values of  $f_E$  and  $f_{F_1}''$  regularly reach a peak at noon throughout the year.

(3) The values of  $f_{F_2}$  vary widely from hour to hour and from day to day, while values of  $f_E$  and  $f_{F_1}''$  for the same time vary only slightly.

(4) The values of  $f_{F_2}$  do not show a symmetry of diurnal characteristic about noon for all seasons as do those of  $f_E$  and  $f_{F_1}''$ .

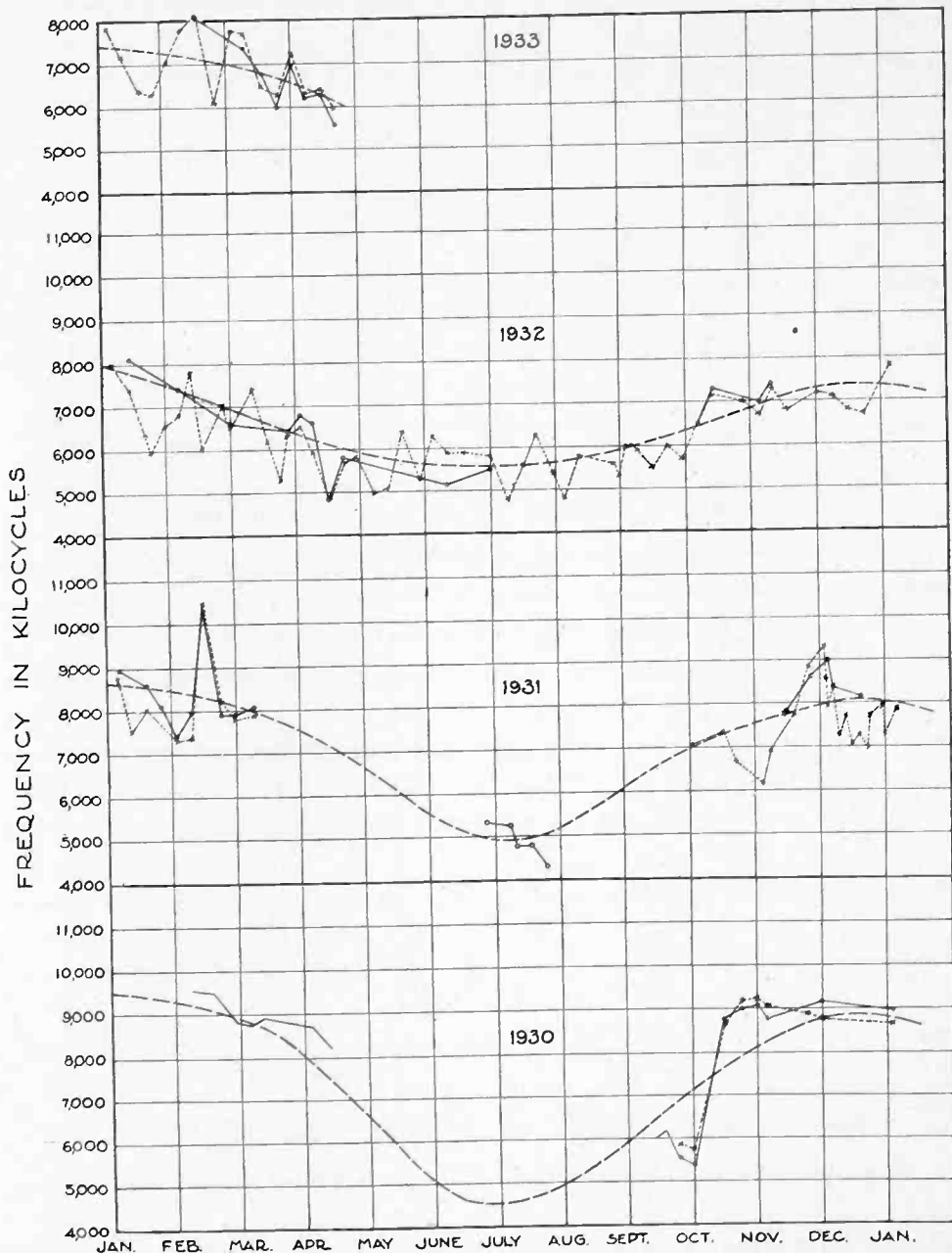

Fig. 18—Seasonal and day-to-day variation in noon and 2 P.M. values of  $f_{F_2}$ . ————noon ————2 P.M.

The characteristic diurnal changes in virtual heights are shown in Fig. 21 for December 21, 1932, and in Figs. 22 and 23 for April 5 and 12, respectively. (See Fig. 8 for additional data on Fig. 23.) These

figures are "virtual height contour maps" plotted against time and frequency. It is seen that the highest critical frequency in December which occurs in the afternoon is accompanied by the lowest virtual heights of the  $F_2$  layer. A marked dip in this contour occurs at about

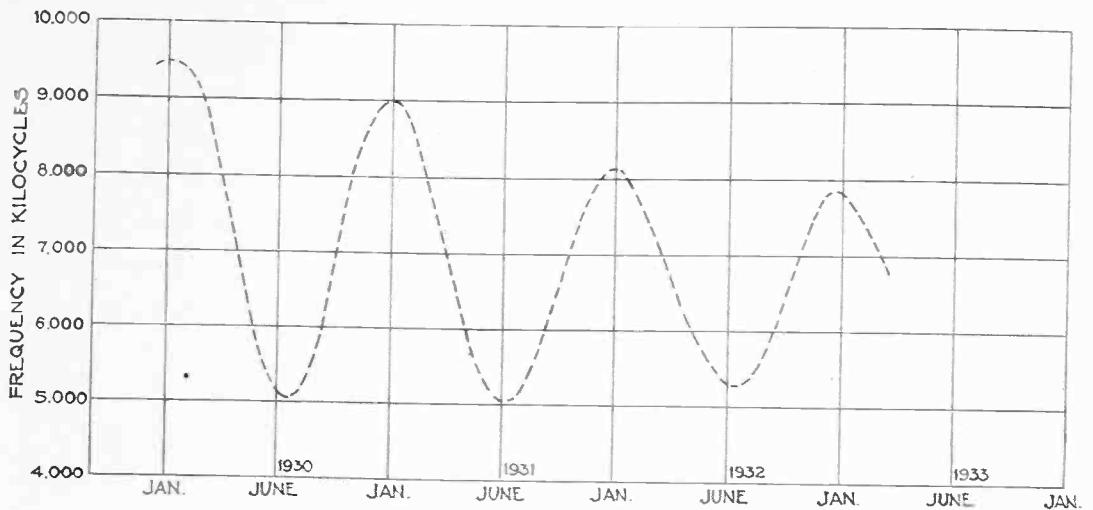

Fig. 19—Average variation as shown in Fig. 18, plotted to indicate change in average values from year to year.

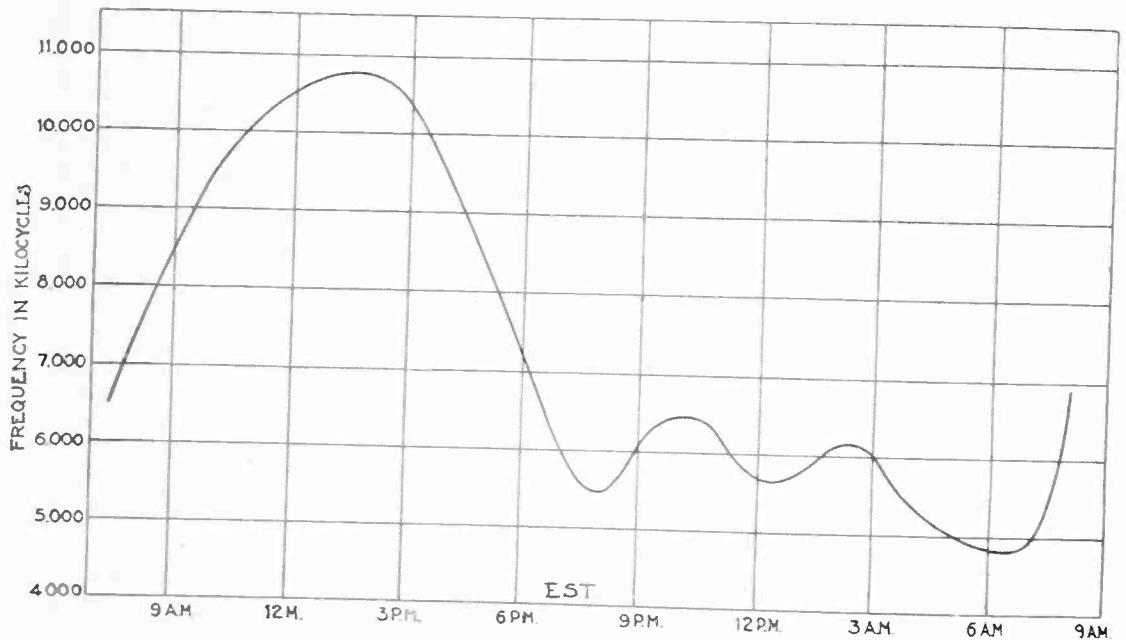

Fig. 20—Diurnal characteristic of  $f_{F_2}$  for a winter day of high  $f_{F_2}$ .

1:30 P.M. The diurnal characteristic of  $f_{F_2}$  for this period is shown in Fig. 17. This situation is entirely changed as summer approaches, as is seen from Figs. 22 and 23. Here  $f_{F_2}$  (shown in Fig. 8 for Fig. 23) has a peak in the evening at about 7:30 P.M. during April, and the contours show a definite dip in the virtual height at this time. In addition, the irregular hour-to-hour variations of  $f_{F_2}$  appear in the contours.

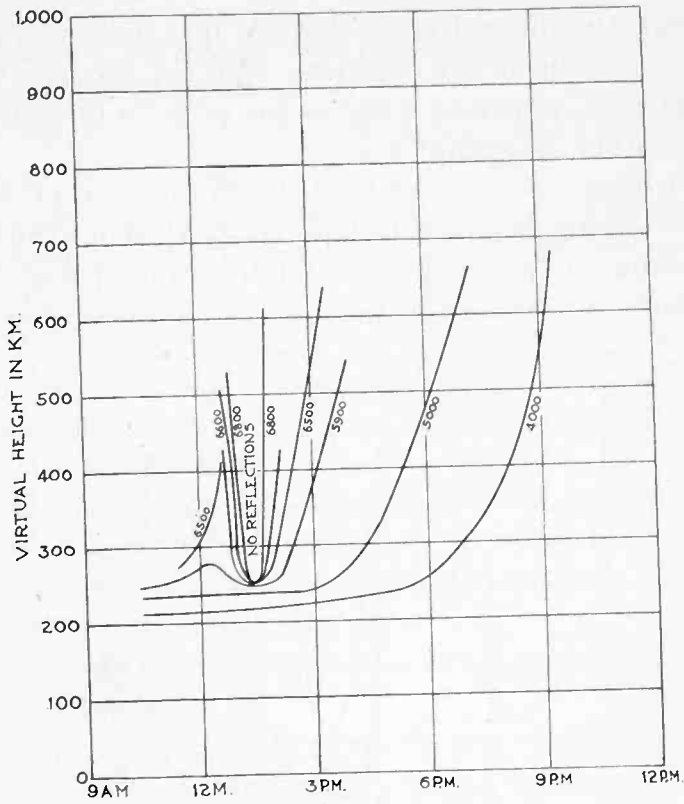

Fig. 21—Virtual height contours for December 21, 1932.

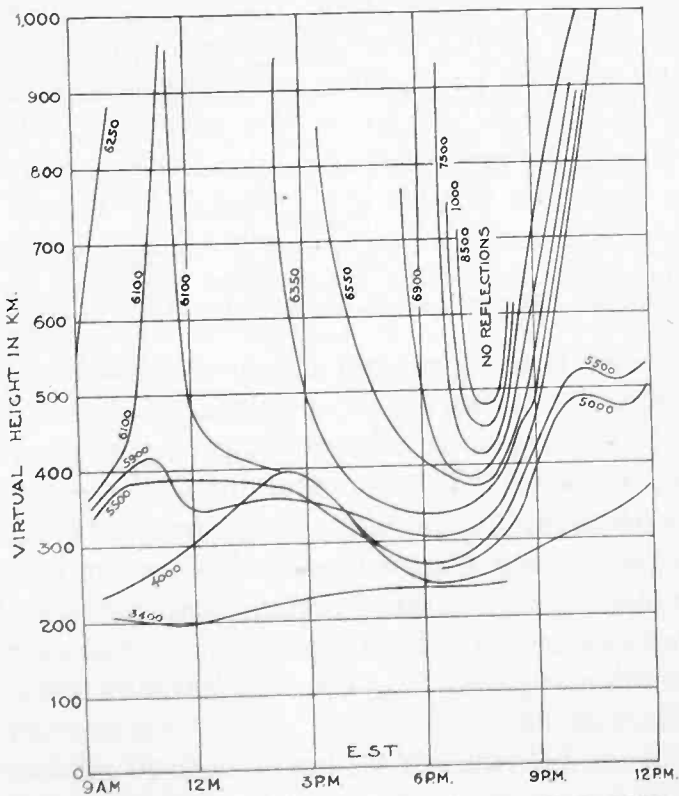

Fig. 22—Virtual height contours for April 5, 1933.

In general, the diurnal characteristic just discussed changes with season, the major dip in the contours, with the accompanying highest critical frequency, occurring latest in the evening in midsummer. This brings out another important fact:

(5) The lowest virtual heights of the  $F_2$  layer for all frequencies at which reflections are returned usually occur at about the same time as does the maximum  $f_{F2}$ , irrespective of the time of day at which this occurs. A study of Figs. 12 to 21 also serves to illustrate this fact.

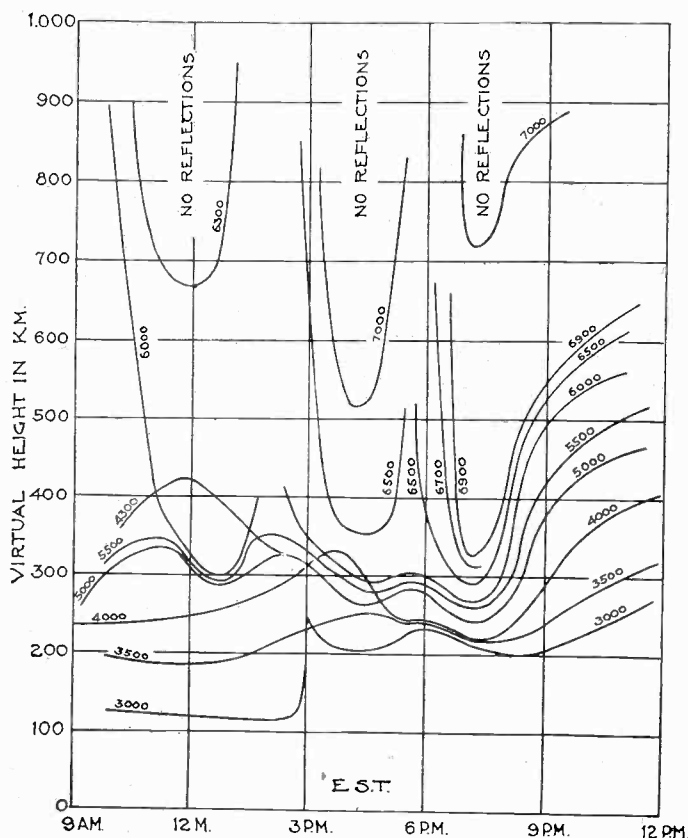

Fig. 23—Virtual height contours for April 12, 1933.

It is observed that, during midsummer, reflections from the  $F_2$  layer often entirely disappear for a period of several hours around noon. This disappearance is preceded by a very marked reduction in intensity, and it seems that the reflections finally disappear entirely without a decrease in  $f_{F2}$  through the frequency range in which reflections were previously returned from the  $F_2$  layer.

It will be seen that while the maximum ionizations for the E and  $F_1$  layers generally follow the seasonal and diurnal variations of the sun,  $f_{F2}$  shows the following major deviations from this form of variation. From our observations,

(1) The maximum value of  $f_{F2}$  bears no fixed relation to the altitude of the sun during any season.

(2) The maximum noon value of  $f_{F_2}$  occurs when the south declination of the sun is the greatest.

(3) When the north declination of the sun is the greatest, the maximum  $f_{F_2}$  occurs after sunset.

It is apparent that  $f_{F_2}$  is subject to effects not evident in the case of the lower layers. Several possible causes of such effects will be considered and discussed:

(1) That the ionization of the  $F_2$  layer is due, in part at least, to external ionizing forces not directly associated with the sun.

(2) That ionization of the  $F_2$  layer is due, in part, to drift of electrons from other ionized regions.

(3) That the variations of  $f_{F_2}$  depend upon absorption and not upon ionization, at least during those parts of the day in which the deviations occur, when the ionization is associated with the sun in the same manner as that of the lower layers.

We shall discuss the reasonableness of these possible causes in the light of the data at hand.

The fact that the ionization of the  $F_2$  layer has a diurnal variation which is associated with the solar day would seem to indicate that the origin of the ionization is solar rather than cosmic.

A possible drifting together of the  $F_1$  and  $F_2$  layers so as to form a single layer has been mentioned. Such a drift would appear to be a comparatively slow process, but it might be possible to obtain a concentration of ions in this manner. Rapid changes in  $f_{F_2}$  might be explained on the basis of a nonuniform and changing horizontal distribution of ions in the  $F_2$  layer. It is difficult, however, to account for the lower ionization in the summer day than in the winter day on such a basis unless there are rather large and complex changes in atmospheric distribution with season.

If we assume that the chief source of ion concentration in the  $F_2$  layer is direct radiation from the sun, as seems to be the case with the lower layers, our conception and definition of  $f_{F_2}$  cannot be the same as that given for the critical frequencies of the lower layers.

Critical frequency has been defined for the E and  $F_1$  layers as the lowest frequency at which waves penetrate these layers, and it therefore serves as a measure of the maximum ionization of these layers. If, as might be expected, the maximum ionization for the  $F_2$  layer takes place about midday throughout the year, we must consider, during the summer daytime at least, that  $f_{F_2}$  depends upon absorption rather than upon penetration. We shall therefore discuss this possibility.

As has been previously mentioned, a number of authors have

shown that the group, or signal, velocity in an ionized medium may be subject to great retardation. It has been shown that

$$u = \frac{c}{n + \omega \frac{dn}{d\omega}} \quad (7)$$

where  $u$  is the group or signal velocity.

For a dispersive medium containing free electrons, this becomes

$$u = \frac{c}{n + \omega \frac{d}{d\omega} \left( 1 - \frac{4\pi N e^2}{n\omega^2 + a(4\pi N e^2)} \right)^{1/2}} \quad (8)$$

$$= \frac{cn}{1 - a(1 - n^2)^2} \quad (9)$$

According to this relation, large reductions in group velocity occur only when  $n$  approaches zero. The actual time retardation experienced in the layer is seen to depend upon the ionic gradient for the medium just described near the density at which  $n$  becomes zero.

Breit<sup>42</sup> has shown that for decreasing ionic gradients, very great retardations may be expected, and has computed possible retardations for a number of postulated distributions. For very high ionic gradients the wave travels only a short distance in a region of low group velocity before being returned, while for decreasing gradients the wave must travel for some distance in a region of reduced group velocity, where  $n$  is very nearly but not quite zero, and is therefore subject to great retardation. This might be true over a wide frequency range for a thick, highly-ionized layer of decreasing gradient. It appears, therefore, that the retardations found at  $f_{F2}$  might be explained on the basis of increasing ionization of decreasing gradient as well as of penetration due to low ionization. It has been shown by Pedersen<sup>43</sup> that when such layer conditions cause long retardation, complete absorption should occur.

Because of difficulty in making valid assumptions regarding conductivity and resulting absorption under these conditions, we shall refer to experimental data to determine the possibility of complete absorption due to such electron distribution. A case of this sort of complete absorption which can be positively identified in the presence of a higher reflecting stratum is shown in Fig. 14 for August 27, 1932. Here the reflections at 4200 kilocycles were completely absent for an ex-

<sup>42</sup> Breit, *Proc. I.R.E.*, vol. 17, p. 1508; September, (1929).

<sup>43</sup> P. O. Pedersen, *Proc. I.R.E.*, vol. 17, p. 1750; October, (1929).

tended period due to conditions in the  $F_1$  layer while at frequencies as much as 1500 kilocycles higher good reflections were returned. The value of  $f_{F_2}$  for this period is shown in Fig. 17. Such cases are frequently observed at critical frequencies and occasionally throughout bands of several hundred kilocycles no reflections are returned. A study of the data shows that when the virtual height of a layer changes only slowly with frequency, the reflection strength and the number of multiples is the greatest. The reflections become small and the multiples disappear when the virtual height changes rapidly with frequency. Great virtual heights occurring at critical frequencies are usually associated with high absorption.

From this it seems possible that above  $f_{F_2}$  there may be complete absorption as well as long retardation, the ionization increasing continuously but with a decreasing gradient. If some mechanism of this sort is assumed to limit the maximum frequency at which reflections are returned,  $f_{F_2}$  then indicates a boundary above which the ionization gradient decreases sufficiently rapidly to cause long retardation and large absorption, rather than the maximum ionization in the  $F_2$  layer.

It is believed that the observed data can be qualitatively explained in a satisfactory manner on this basis. During the winter day there may be comparatively high ionic gradients due to the low incidence of the ionizing radiation on this layer. During the summer, this radiation at a more nearly normal incidence may create a more diffuse layer due to its greater penetration, thus causing long retardation and high absorption over a wider band of frequencies until such time as recombination or ion drift at the bottom of the layer cause higher gradients to appear. At such a time the critical frequency may be expected to rise and the virtual heights decrease as shown in Figs. 21 to 23.

Observations at night frequently show one or more secondary increases in  $f_{F_2}$  after the main increase, with corresponding decreases in virtual height. These secondary increases might be due either to small increases in ionization or to increased ionic gradients caused by recombination or changes of distribution of the ions in the layer. So far, it has not been possible to determine with certainty whether the phenomena associated with  $f_{F_2}$  are due to penetration or absorption but the evidence leads to the belief that both factors may be involved. If this is true,  $f_{F_2}$  frequently is not a measure of the maximum ionization of the  $F_2$  layer.

From the foregoing discussion, it appears that the midday values of the  $F_2$  ionization might exceed the values corresponding to the maximum value of  $f_{F_2}$  by a considerable amount. On this basis it can be estimated from (4) with  $a=0$  that this maximum ionization reaches



$1.5 \times 10^6$  electrons per  $\text{cm}^3$  frequently, and is known to be at least  $2.5 \times 10^6$  electrons per  $\text{cm}^3$  in the evening on certain occasions. With  $a=1/3$  the corresponding electron densities are  $2.25 \times 10^6$  and  $3.75 \times 10^6$ .

A study of the figures indicates that the heights of the  $F_2$  layer may be estimated to be below 250 kilometers. This estimate is based upon the same approximations as were mentioned in connection with the  $F_1$  layer.

Compared with the fairly stable values of  $f_E$  and  $f_{F1}$  during the day,  $f_{F2}$  is subject to small rapid fluctuations superimposed upon its

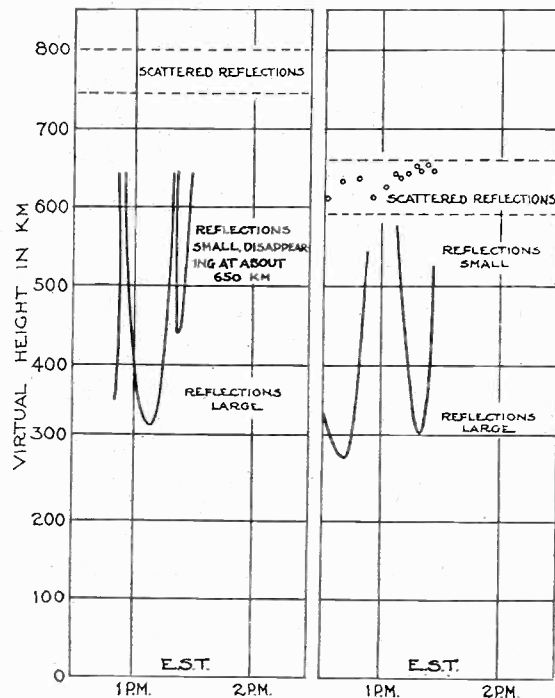

Fig. 24—Characteristic variations in virtual height near  $f_{F2}$ . This shows rapid variation of  $f_{F2}$ .

general diurnal characteristic. This results in rapid changes in virtual height such as shown in Fig. 24.

Because of the rapidity of these fluctuations, it is not valid to assume that time changes are negligible while working near  $f_{F2}$  with a single equipment. For this reason we hesitate to comment on such critical frequency phenomena as are shown in Fig. 25: It is possible that such irregular changes occur with time more rapidly than the frequency can be changed. It is possible at least in the case of Fig. 25d, however, that the two critical frequencies shown were both real effects, and that a temporary double stratification appeared in the  $F_2$  layer during the first run, the higher stratum disappearing by the time of the second run thus leaving only the first critical frequency. Such

phenomena have thus far been observed only during the summertime. Further evidence as to the possible variable stratification of the  $F_2$  layer could be obtained by making simultaneous experiments with several equipments operating at different frequencies.

No obvious relation between magnetic disturbances and values of  $f_{F_2}$  is apparent. Very high and very low values of  $f_{F_2}$  are often observed during magnetic disturbances and seem to occur less frequently during undisturbed periods. Normal values of  $f_{F_2}$  have also been observed during disturbed periods. If the values of  $f_{F_2}$  are largely determined

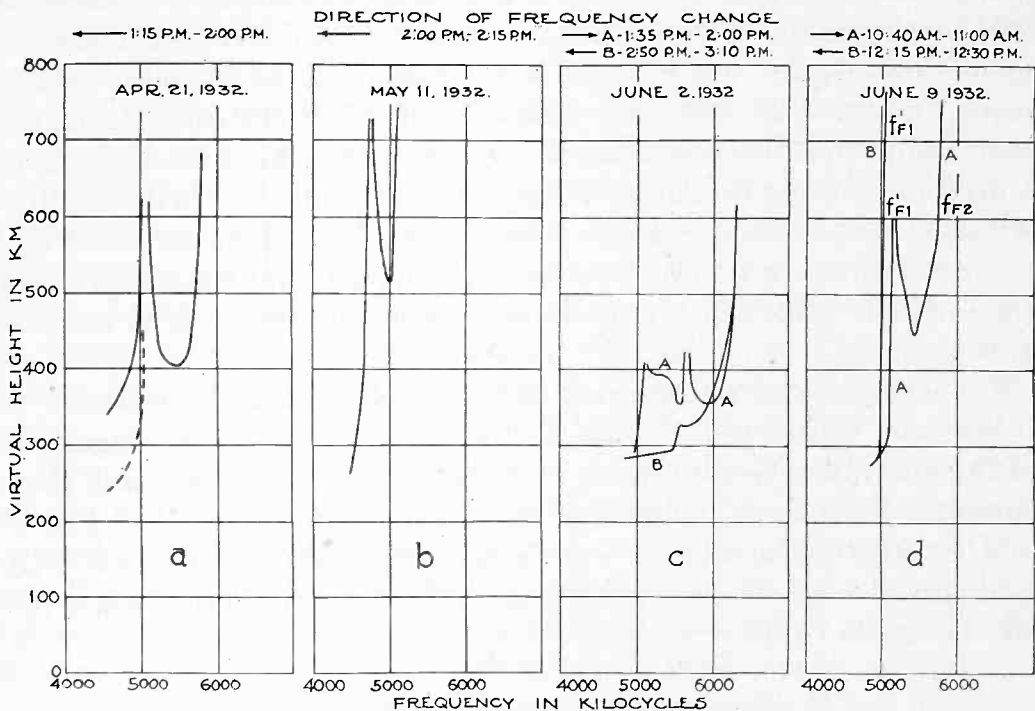

Fig. 25—Examples of rapid changes in  $f_{F_2}$ .

by ionic gradient and absorption, it is reasonable to expect that magnetic disturbances might produce effects not easy to interpret.

### VI. SCATTERED REFLECTIONS

The "scattered reflections" mentioned as occurring above  $f_{F_2}$ , appear to be of a nature quite distinct from the reflections previously discussed. These reflections are found to appear first at a frequency somewhat below  $f_{F_2}$  and at a virtual height generally above 600 kilometers. Their virtual height appears to be independent of changes in the virtual height of the  $F_2$  layer as shown in Fig. 24. The average virtual height increases slowly with frequency, often extending to above 1000 to 1500 kilometers at frequencies well above  $f_{F_2}$ . These are characterized by a small and variable amplitude, and a rapid variation,

through a small range, of virtual height, best described as "rapidly popping in and out at various heights."

During  $F_2$  critical frequency runs, as the virtual height of the  $F_2$  layer was observed to increase rapidly, the  $F_2$  reflection was usually completely absorbed before reaching the virtual heights of these scattered reflections, which were practically unchanged by small frequency variations in the winter. Scattered reflections have been observed on the highest frequencies so far used in these measurements (that is, about 12,000 kilocycles). It is possible that this is the same phenomenon as that described by Taylor and Young<sup>44</sup> and others in connection with experiments at very high frequencies. No directional measurements have so far been made of their source. During the observations made on March 22, 1933, shown in Fig. 6, reflections from the higher layers appeared to be completely blanketed out by a heavy E-layer ionization. During this time, reflections which appeared to be identical with the usual "scattered reflections" continued to appear at virtual heights well above that of the last E multiple, and at frequencies near the previous value of  $f_{F_2}$ , even though the reflections from  $F_2$  had disappeared.

It is possible that these scattered reflections may be returned at frequencies considerably below  $f_{F_2}$ , but the relatively great magnitude of the multiple reflections from the lower layers is likely to mask them completely. During the night, when  $f_{F_2}$  is not well defined (see Fig. 9) and complex reflections of large magnitudes occur above relatively low virtual heights, it is frequently difficult to determine when this effect begins to appear.

## VII. SOME CORRELATIONS WITH RESULTS OF RADIO TRANSMISSION

It is of interest to observe that, using horizontal dipoles as transmitting and receiving aerials, directional toward each other, and over the 25-kilometer land path between stations, the magnitude of the daytime reflections between a frequency somewhat below the E critical frequency and the  $F_2$  critical frequency, ordinarily greatly exceeds the magnitude of the ground wave. The ratio of field intensities of the sky wave to those of the ground wave often exceeds 100:1. At night, the magnitude of the reflections becomes very much greater, particularly at the lower frequencies. The use of lower angle radiators, such as vertical antennas, of course, greatly reduces this ratio. Because of the effectiveness of the ionosphere as a reflector of waves of low frequency

<sup>44</sup> Taylor and Young, *Proc. I.R.E.*, vol. 16, p. 561; May, (1928); vol. 17 p. 1491; September, (1929).

at night, the sky wave and ground wave may be of equal magnitude in an antenna only a very short distance from the transmitting station, even though only a very small amount of energy is radiated upward. This is particularly noticeable if the receiving antenna has a somewhat high angle characteristic. The introduction of vertical antennas at the receiver serves to discriminate greatly against the high angle sky wave energy.

It is of interest to investigate the relation of the highest critical frequency of the  $F_2$  layer at vertical incidence to the frequencies of waves received at great distances. The maximum frequency at which waves are reflected from the  $F_2$  layer is very much less in summer than in winter. The values obtained are believed to be in fair agreement with the results obtained by a number of observers. Burrows<sup>45</sup> has pointed out that during 1928–1929 for transatlantic transmissions, the highest summertime frequency at which waves could be transmitted across the Atlantic was 22,000 kilocycles, while the highest wintertime frequency was 28,000 kilocycles. The times of best transatlantic high-frequency transmission shown in Burrows' figures for the various seasons correspond closely with the times of dip in the "virtual height contour maps" for the  $F_2$  layer when consideration is given to the differences in time existing between the ends of the path.

This agreement might be expected in view of the  $F_2$  layer results by which it was shown that the absorption was the lowest when the frequency-height curves had the least slope, a condition occurring at the time of highest critical frequency. It can be seen that waves of the highest frequencies are returned over long paths when the highest ( $F_2$ ) layer appears to be in the most favorable condition for reflection, and in general the diurnal and seasonal variations of such frequencies seem to follow changes in the condition of this layer. At the same time lower frequencies follow the somewhat different diurnal and seasonal variations of the lower layers.

In a previous section, the possibility that the disappearance of reflections might be due to absorption rather than to low ionization was discussed. Burrows suggests that the return of reflections at lower maximum frequencies during the summer than during the winter may be due to absorption. On the basis of this hypothesis, an ion density considerably in excess of that indicated by the maximum critical frequency should be expected. It would be difficult to make even approximate estimates, however, because of the lack of data on the physical structure of the atmosphere in this layer. A suitable distribution of such high densities might account for the apparent occasional reflec-

<sup>45</sup> Burrows, *Proc. I.R.E.*, vol. 19, p. 1634; September, (1931).

tion from the ionosphere of waves at very high frequencies, such as have been frequently observed. It might be presumed that approximately north-south paths would be most uniform for such maximum-frequency transmissions. Such paths in the northern hemisphere would vary from a path running about north-northwest—south-southeast during winter noon to about north-northeast—south-southwest during summer evenings. Such paths extending between northern and southern hemispheres, however, would be subject to different seasonal effects as shown. More uniform conditions would probably exist during the afternoon. A detailed knowledge of these effects at different latitudes would make it possible to work out more definitely the conditions to be expected for various paths. It may also be possible that higher layers exist which on account of absorption are not evident at the frequencies so far employed, but which might reflect waves of much higher frequencies at smaller angles under favorable conditions.

It is believed that the disappearance of large reflections for frequencies greater than  $f_{F2}$  represents the skip distance effect. It is of interest to examine the development of a "skip distance" if the limitation of  $f_{F2}$  is due to absorption rather than penetration due to low ionization. This possibility has been suggested by T. L. Eckersley<sup>21</sup> on the basis of experiments carried out over a more extended base line.

From equation (4) at the apex of the ray path

$$n^2 = \sin^2 \phi = 1 - \frac{4\pi Ne^2}{4\pi^2 m f^2 + 4a\pi Ne^2}.$$

Then with  $a = 0$

$$N = \frac{\pi m f^2}{e^2} (\cos^2 \phi) \quad (12)$$

with  $a = 1/3$

$$N = \frac{\pi m f^2}{e^2} (\cos^2 \phi) \left( \frac{3}{2 + \sin^2 \phi} \right). \quad (12a)$$

This shows that for small angles of incidence (nearly vertical incidence) where  $(\cos^2 \phi)$  is nearly unity, the number of ions per  $\text{cm}^3$  required to return reflections is not much reduced below that required at vertical incidence, and for boundaries of decreasing ionic gradient, the wave will be subject to the same high retardation and absorption observed at vertical incidence under these conditions. At the same time, the length of path subject to this increased absorption is ex-

tended horizontally as the angle of incidence,  $\phi$ , is increased. When the value of  $\phi$  becomes large enough to cause the factor  $(\cos^2 \phi)$  to depart appreciably from unity, the number of electrons per  $\text{cm}^3$  required for refraction, and therefore the depth of penetration into the region of decreasing ionic gradient, decreases rapidly, and the length of path in which there is large absorption decreases. From this it might be expected that reflections at frequencies somewhat below  $f_{F_2}$ , but penetrating deeply into the  $F_2$  layer as determined by the curvature of the frequency—virtual-height curves, may be subject to a considerable decrease in intensity as the distance from the transmitter is increased, followed by an increase as the reflections are returned from a region of higher ionic gradient. It would also seem that absorption would prevent that portion of the layer represented by the steep slope of the frequency-height curves from returning reflections over any considerable distance. On this basis, it can be seen from the figures that a considerable variation in skip distance might be expected from day to day and from year to year. If this picture of the skip distance phenomenon is correct, it may be expected that the portion of the  $F_2$  layer, represented by the steep slope of the frequency—virtual-height curves will cause absorption of waves reaching this region.



## PROPAGATION OF HIGH-FREQUENCY CURRENTS IN GROUND RETURN CIRCUITS\*

BY

W. H. WISE

(American Telephone and Telegraph Company, New York City)

*Summary*—The electric field parallel to a ground return circuit is calculated without assuming that the frequency is so low that polarization currents in the ground may be neglected. It is found that the polarization currents may be included by replacing the  $r$  in Carson's well-known formulas by  $r\sqrt{1+i(\epsilon-1)2c\lambda\sigma}$ .

### INTRODUCTION

THE problem to be solved is that of calculating the electric field parallel to an alternating current flowing in a straight, infinitely long wire placed above and parallel to a plane homogeneous earth. Carson's derivation of this field<sup>1</sup> is based on three restricting assumptions: (1) The ground permeability is unity; (2) the wave is propagated with the velocity of light and without attenuation; (3) the frequency is so low that polarization currents may be neglected. The first of these restrictions is usually of no consequence and the formula would be quite complicated if the permeability were not made unity.<sup>2</sup> As pointed out in a later paper by Carson<sup>3</sup> the second restriction amounts merely to assuming reasonably efficient transmission. The effect of the third restriction begins to be noticeable at about 60 kilocycles. The object of the present paper is the removal of the third restriction.

### DERIVATION OF THE MUTUAL IMPEDANCE FORMULA

The electric and magnetic fields of any current may be obtained by differentiating the current's wave function. The wave function for a horizontal current-element dipole has been formulated as an infinite integral by H. von Hoerschelmann.<sup>4</sup>

\* Decimal classification: R110. Original manuscript received by the Institute, October 16, 1933.

<sup>1</sup> John R. Carson, "Wave propagation in overhead wires with ground return," *Bell Sys. Tech. Jour.*, vol. 5, pp. 539-554; October, (1926). It is stated in this paper that the propagation constant is assumed to be a very small quantity in c.g.s. units. Since this follows from the second and third restrictions it cannot be classed as a separate restriction. The second restriction is not explicitly stated in this paper but is implicit in equations (4) and (5) and the preceding explanatory remark.

<sup>2</sup> W. Howard Wise, "Effect of ground permeability on ground return circuits," *Bell Sys. Tech. Jour.*, vol. 10, pages 472-484; July, (1931).

<sup>3</sup> John R. Carson, "Rigorous and approximate theories of electrical transmission along wires," *Bell Sys. Tech. Jour.*, vol. 7, p. 11; January, (1928).

<sup>4</sup> H. von Hoerschelmann, *Jahrb. der draht. Teleg.*, Bd. 5, pp. 14-188, (1912).

The wave-function of the current in the wire will be obtained by integrating the wave-functions of the current-element dipoles along the wire from minus infinity to plus infinity. It will be assumed at the start that the current in the wire is exponentially attenuated. The wave-function of the current is thus found to be

$$\begin{aligned} \Pi = & a \times e^{-\gamma x} \int_{-\infty}^{\infty} I e^{-\gamma x} \left( \frac{e^{-ikR_1}}{R_1} - \frac{e^{-ikR_2}}{R_2} \right. \\ & \left. + \int_0^{\infty} \frac{2J_0(\nu\rho)}{l+m} e^{-w\nu} \cdot d\nu \right) dx + b \times 0 \\ & - c \times 2e^{-\gamma x} \int_{-\infty}^{\infty} I e^{-\gamma x} \frac{\partial}{\partial x} \int_0^{\infty} \frac{(1-\tau^2)J_0(\nu\rho)\nu^l}{(l+m)(l+\tau^2m)} e^{-w\nu} d\nu \cdot dx. \end{aligned}$$

$a$ ,  $b$ , and  $c$  are unit vectors pointing in the  $x$ ,  $y$ , and  $z$  directions. The time factor is  $e^{i\omega t}$ .

$$R_1 = \sqrt{x^2 + y^2 + (h-z)^2}$$

$$R_2 = \sqrt{x^2 + y^2 + (h+z)^2}$$

$$\rho = \sqrt{x^2 + y^2}$$

$$k = 2\pi/\lambda; \quad k_2^2 = k_1^2(\epsilon - i2c\lambda\sigma) = \epsilon\mu\omega^2 - i4\pi\sigma\mu\omega, \quad \mu = 1$$

$$l = \sqrt{\nu^2 - k^2}; \quad m = \sqrt{\nu^2 - k_2^2}; \quad w = h + z; \quad \tau^2 = k^2/k_2^2$$

$$\gamma = \alpha + i\beta$$

$$\begin{aligned} -E_x = & i\omega \left[ \Pi_x + \frac{1}{k^2} \frac{\partial}{\partial x} \left( \frac{\partial \Pi_x}{\partial x} + \frac{\partial \Pi_y}{\partial y} + \frac{\partial \Pi_z}{\partial z} \right) \right] = i\omega\pi_x + \frac{\partial V^*}{\partial x} \\ = & i\omega e^{-\gamma x} \int_{-\infty}^{\infty} I e^{-\gamma x} \left( \frac{e^{-ikR_1}}{R_1} - \frac{e^{-ikR_2}}{R_2} + \int_0^{\infty} \frac{2J_0(\rho\nu)}{l+m} e^{-w\nu} d\nu \right) dx \\ & + \frac{\partial V}{\partial x}. \end{aligned}$$

Carson's formula (24) for  $Z_{12}$ , the mutual impedance between two parallel lines, is readily obtained by writing  $\gamma = k = 0$ . This, in effect, is Polloczek's<sup>5</sup> fundamental assumption. It results from the supposition

\* The reader should note that  $V = \int_y^{\infty} E_y dy$  and that this scalar potential is not quite the same as the potential to ground which Carson finally denotes by  $V$ .

<sup>5</sup> F. Polloczek, "Über das Feld einer unendlich langen wechselstromdurchflossenen Einfachleitung," *E.N.T.*, vol. 3, p. 339, (1926); "Gegenseitige Induktion zwischen Wechselstromfreileitungen von endlicher Länge," *Annalen der Physik*, Folge IV, Bd. 87, (1928).



that  $2\pi D/\lambda$ , where  $D$  is the largest dimension of our physical system, is negligible in comparison with unity so that we can ignore all phase effects due to finite velocity of propagation. But we must be consistent in our approximations and blot out the dielectric constants of both ground and air at the same time that we throw away the phase effects; otherwise we end up with a formula which is neither like Carson's nor correct in the way it contains the dielectric constants.

The problem, then, is that of evaluating the integral

$$Z_{12} = i\omega \int_{-\infty}^{\infty} \left( \frac{e^{-ikR_1}}{R_1} - \frac{e^{-ikR_2}}{R_2} + \int_0^{\infty} \frac{2J_0(\rho\nu)}{l+m} e^{-wlv} d\nu \right) e^{-\gamma x} dx$$

without assuming that  $k$  and  $\gamma$  are extremely small. The dipole wave-function used in getting this formula is only valid if  $\mu = 1$ .

We shall write  $\gamma = ik$ . This is an ideal value for  $\gamma$  but the following considerations make it an imperative choice; (1) to assume that the current is propagated down the line with a velocity less than that of

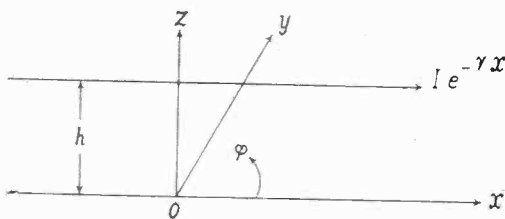

Fig. 1

light makes the integral very hard to evaluate, and (2) to assume that the attenuation is not zero on an infinite line amounts to assuming an infinite source of energy and makes  $Z_{12}$  infinite.

It should not be inferred from this that the resulting formulas are necessarily poor if the physical system does not closely approximate these ideal properties. The procedure being followed is analogous to the successive approximation method for solving differential equations.  $ik$  is a convenient first approximation to the propagation constant. The resulting expression for  $Z_{12}$  is used to compute a second approximation to the propagation constant.  $\gamma^2 = (z + Z_{12})(G + i\omega C)$  where  $z$  is the impedance of the wire per unit length and  $Z_{12}$  is computed at the surface of the wire. Practical experience with the second approximation so obtained shows that  $ik$  is a satisfactory first approximation. Since  $Z_{12}$  is infinite if the attenuation is not zero and the second approximation to  $\gamma$  is not a pure imaginary it is not possible to get a third approximation by repeating the analysis with  $ik$  replaced by the second approximation. So, the use of an infinite line formula presupposes reasonably efficient transmission.

It should be remarked here that the capacity  $C$  is not entirely independent of the ground constants. The characteristic impedance of the line is

$$\sqrt{(z + Z_{12})/(G + i\omega C)} = - \int_0^h E_z dz / I e^{-\gamma z},$$

and, starting with the infinite integral formulation of  $\Pi$ , it is easy enough to set up an infinite integral for  $\int_0^h E_z dz$ , but the evaluation of this integral is not a simple matter.

With  $\gamma = ik$  the first two terms of  $Z_{12}$  reduce to  $i\omega 2 \log \rho''/\rho'$ . They are, omitting the factor  $i\omega$ ,

$$\begin{aligned} & \int_{-\infty}^{\infty} \left( \frac{e^{-ik\sqrt{x^2+\rho'^2}}}{\sqrt{x^2+\rho'^2}} - \frac{e^{-ik\sqrt{x^2+\rho''^2}}}{\sqrt{x^2+\rho''^2}} \right) e^{-ikx} dx \\ &= \lim_{a \& b \rightarrow \infty} \int_{x=-a}^{x=b} \left( \frac{e^{-ik(\sqrt{x^2+\rho'^2}+x)}}{\sqrt{x^2+\rho'^2}+x} d(\sqrt{x^2+\rho'^2}+x) \right. \\ & \quad \left. - \frac{e^{-ik(\sqrt{x^2+\rho''^2}+x)}}{\sqrt{x^2+\rho''^2}+x} d(\sqrt{x^2+\rho''^2}+x) \right) \\ &= \lim_{a \& b \rightarrow \infty} \int_{\nu_1}^{\nu_2} \frac{e^{-it}}{t} dt - \int_{\nu_3}^{\nu_4} \frac{e^{-it}}{t} dt, \end{aligned}$$

where,

$$\begin{aligned} g_1 &= k(\sqrt{a^2 + \rho'^2} - a), & g_2 &= k(\sqrt{b^2 + \rho'^2} + b), \\ g_3 &= k(\sqrt{a^2 + \rho''^2} - a), & g_4 &= k(\sqrt{b^2 + \rho''^2} + b), \\ &= \lim_{a \& b \rightarrow \infty} -Cig_1 + Cig_2 + Cig_3 - Cig_4 \\ & \quad - i(-Sig_1 + Sig_2 + Sig_3 - Sig_4) \\ &= \lim_{a \rightarrow \infty} -Cig_1 + Cig_3 = \lim_{a \rightarrow \infty} \log g_3/g_1 = 2 \log \rho''/\rho'. \end{aligned}$$

So, with  $\gamma = ik$ , we have

$$Z_{12} = i2\omega \log \frac{\rho''}{\rho'} + i2\omega \int_0^{\infty} \frac{\nu e^{-\omega t}}{l+m} \left( \int_{-\infty}^{\infty} J_0(\nu\sqrt{x^2+y^2}) e^{-ikx} dx \right) d\nu.$$

Since  $J_0(\nu\sqrt{x^2+y^2})$  and  $\cos kx$  are even functions of  $x$  and  $\sin kx$  is an odd function of  $x$

$$\int_{-\infty}^{\infty} J_0(\nu\sqrt{x^2+y^2}) e^{-ikx} dx = 2 \int_0^{\infty} J_0(\nu\sqrt{x^2+y^2}) \cos kx \cdot dx$$

$$\begin{aligned}
 &= 0 \quad \text{if } \nu < k \\
 &= 2 \frac{\cos y \sqrt{\nu^2 - k^2}}{\sqrt{\nu^2 - k^2}} \quad \text{if } k \leq \nu^* \\
 \therefore Z_{12} &= i2\omega \log \frac{\rho''}{\rho'} + i4\omega \int_k^\infty \frac{e^{-wl}}{l+m} \frac{\cos yl}{l} \nu d\nu \\
 &= i2\omega \log \frac{\rho''}{\rho'} + \frac{i4\omega}{-k_2^2 + k^2} \int_k^\infty (m-l)e^{-wl} \cos yl \frac{\nu d\nu}{l} \\
 &= i2\omega \log \frac{\rho''}{\rho'} \\
 &\quad + \frac{4\omega}{i(k_2^2 - k^2)} \int_0^\infty (\sqrt{l^2 + ii(k_2^2 - k^2)} - l)e^{-wl} \cos yl \cdot dl \\
 &= i2\omega \log \frac{\rho''}{\rho'} + 4\omega (P + iQ).
 \end{aligned}$$

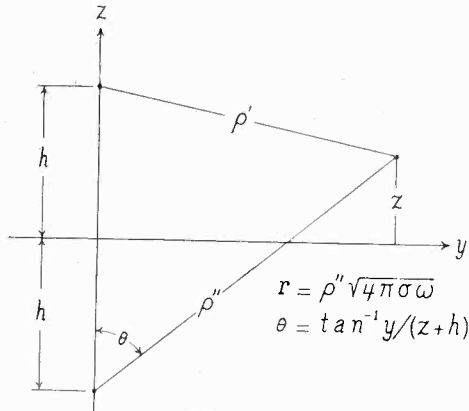

Fig. 2

Writing  $i(k_2^2 - k^2) = 4\pi\sigma\omega + i(\epsilon - 1)k^2 = 4\pi\sigma\omega(1 + i(\epsilon - 1)/2c\lambda\sigma) = \alpha s^2$ ,  $w\sqrt{4\pi\sigma\omega} = w\sqrt{\alpha} = w'$ ,  $y\sqrt{\alpha} = y'$  and making the change of variable  $l = \nu\sqrt{\alpha}$  we have

$$\begin{aligned}
 P + iQ &= \frac{1}{s^2} \int_0^\infty (\sqrt{\nu^2 + is^2} - \nu)e^{-w'\nu} \cos y'\nu \cdot d\nu \\
 &= \frac{1}{s^2} R_j \left( \frac{\zeta s}{\beta} \{ K_1(\zeta s \beta) + G(\zeta s \beta) \} - \frac{1}{\beta^2} \right)^\dagger,
 \end{aligned}$$

where  $\zeta = \sqrt{i}$ ,  $\beta = (w' + jy') = re^{j\theta}$ , and  $R_j$  indicates that the real part is to be taken with  $\zeta$  and  $s$  regarded as real parameters and  $j$  the only imaginary.

\* To get this put  $\sigma = 0$  and  $\nu = -1/2$  in formula (13) on page 255 in Nielsen's "Handbuch der Cylinderfunktionen."

†  $K_1(x)$  is the Bessel function of the second kind and first order as defined by Jahnke and Emde, "Funktionentafeln," p. 93, and

$$G(x) = \frac{x^2}{3} - \frac{x^4}{3^2 \cdot 5} + \frac{x^6}{3^2 \cdot 5^2 \cdot 7} - + \dots$$

Carson's formula for  $P+iQ$  differs from this one only in that he has  $\beta$  where we have  $s\beta$ . It follows that, to get the new series expansions for  $P$  and  $Q$  we have only to replace the  $r$  in Carson's series by  $r\sqrt{1+i(\epsilon-1)/2 c\lambda\sigma}$ .

#### THE HIGH-FREQUENCY SERIES FOR $P$ AND $Q$

Writing  $s = \sqrt{1+i(\epsilon-1)/2 c\lambda\sigma} = \zeta e^{i\eta}$ , where  $\epsilon$  is the dielectric constant of the ground referred to air as unity,  $c$  is the velocity of light in centimeters per second,  $\lambda$  is the wavelength in centimeters and  $\sigma$  is the conductivity of the ground in electromagnetic units, Carson's asymptotic series for  $P$  and  $Q$  are replaced by

$$P \sim \frac{\cos \theta}{\sqrt{2}r\zeta} (\cos \eta + \sin \eta) - \frac{\cos 2\theta}{r^2\zeta^2} \cos 2\eta$$

$$+ \frac{\cos 3\theta}{\sqrt{2}r^3\zeta^3} (\cos 3\eta - \sin 3\eta) + \dots$$

$$Q \sim \frac{\cos \theta}{\sqrt{2}r\zeta} (\cos \eta - \sin \eta) + \frac{\cos 2\theta}{r^2\zeta^2} \sin 2\eta$$

$$- \frac{\cos 3\theta}{\sqrt{2}r^3\zeta^3} (\cos 3\eta + \sin 3\eta) + \dots$$

and Carson's series for use when  $r < 1/4$  are replaced by

$$P = \frac{\pi}{8} - \frac{r\zeta}{3\sqrt{2}} \cos \theta (\cos \eta + \sin \eta) + \frac{\pi r^2 \zeta^2}{64} \cos 2\theta \sin 2\eta$$

$$+ \frac{r^2 \zeta^2}{16} \cos 2\theta \left[ \cos 2\eta \left( 0.6728 + \log \frac{2}{r\zeta} \right) + \eta \sin 2\eta \right]$$

$$+ \frac{\eta}{2} + \frac{r^2 \zeta^2}{16} \theta \sin 2\theta \cos 2\eta + \dots$$

$$Q = -0.03861 + \frac{1}{2} \log \frac{2}{r\zeta} + \frac{r\zeta}{3\sqrt{2}} \cos \theta (\cos \eta - \sin \eta)$$

$$+ \frac{r^2 \zeta^2}{16} \cos 2\theta \left[ \sin 2\eta \left( 0.6728 + \log \frac{2}{r\zeta} \right) - \eta \cos 2\eta \right]$$

$$+ \frac{r^2 \zeta^2}{16} \theta \sin 2\theta \sin 2\eta - \frac{\pi r^2 \zeta^2}{64} \cos 2\theta \cos 2\eta + \dots$$



**BOOKLETS, CATALOGS, AND PAMPHLETS RECEIVED**

Copies of the publications listed on this page may be obtained gratis by addressing a request to the publisher or manufacturer.

The General Radio Experimenter devoted to electrical communications technique and its applications in allied fields is issued regularly by the General Radio Company of 30 State Street, Cambridge A, Mass.

The Ohmite news devoted chiefly to resistors and the problems they present is published regularly by the Ohmite Manufacturing Company, 636 N. Albany Avenue, Chicago.

The Shure Technical Bulletin is issued regularly by Shure Brothers Company of 215 W. Huron Street, Chicago and is devoted to the advancement of microphone technique.

Cenco News Chats is the title of a general bulletin published for regular distribution by the Central Scientific Company, manufacturers of laboratory supplies and located in Chicago, Ill.

Bulletin 100 of the E. F. Johnson Company, Waseca, Minn., describes their horizontal doublet antenna with quarter-wave impedance matching structure.

The Bliley Piezo Electric Company of Erie, Pa., has issued a leaflet describing their products.

A technical data leaflet has been issued on Raytheon vacuum tubes and may be obtained from the Raytheon Production Corporation, 30 East 42nd Street, New York City.

The Ward Leonard Electric Company of Mount Vernon, N. Y., has issued Bulletin 251 on sensitive relays, circular 507A on adjustable resistors, and bulletin 8001 covering their sliding contact rheostats for laboratory and general use.

The RCA Victor Company of Camden, N. J. describes an airport receiver in Bulletin AVB-1, an aircraft radio beacon receiver in Bulletin AVB-2, and a second model airport receiver in Bulletin AVB-3.

Carter Genemotor Power Plants are described in a leaflet published by the Carter Motor Company of Chicago, Ill.

Physical and electrical data on a gammatron power tube is given in a leaflet issued by Heintz and Kaufman of 311 California Street, San Francisco.

The Ignitron Welding Timer for spot welding is described in a leaflet by the manufacturer, the Westinghouse Electric and Manufacturing Company, East Pittsburgh, Pa.

Colloidal graphite as a retardant of secondary emission in vacuum tubes is covered in Technical Bulletin 31.5 issued by the Acheson Oildag Company of Port Huron, Mich.

General Manufacturing Company, 8066 S. Chicago Avenue, Chicago has issued circuit diagrams for a five-tube 456 kc super; a six tube, 175 kc super; and a five tube, 175 kc automobile superheterodyne circuit.

The RCA Radiotron Company and E. T. Cunningham, Inc., of 415 S. Fifth Street, Harrison, N. J., have issued the following application notes: No. 29, audio systems employing 2A3 power amplifier triodes; No. 30, characteristics of the 6F7 tube; No. 31, operating considerations of cathode ray tubes 905 and 906 for oscillographic purposes; No. 32, revision of characteristics of the type 48 tube; No. 33, RCA-800 and Class B audio amplifier; No. 34, 868 photo tube; and No. 35, triode operation of type 42 and 2A5 pentodes.

CONTRIBUTORS TO THIS ISSUE

Berkner, L. V.: See PROCEEDINGS for February, 1934.

Brown, George H.: Born October 14, 1908, at North Milwaukee, Wisconsin. Received B.S. degree, 1930; M.S. degree, 1931; Ph.D. degree, 1933, University of Wisconsin. Research Fellow, electrical engineering department, University of Wisconsin, 1930-1933. Research division, RCA Victor Company, Inc., 1933 to date. Member, Sigma Xi. Associate member, Institute of Radio Engineers, 1930.

George, W. D.: Born March 30, 1907, at Spartanburg, South Carolina. Received B.S. degree, Georgia School of Technology, 1929. Junior engineer, U. S. Bureau of Standards, 1929 to date. Associate member, Institute of Radio Engineers, 1933.

King, Ronold: Born September 19, 1905, at Williamstown, Massachusetts. Received A.B. degree, University of Rochester, 1927; M.S. degree, 1929; Ph.D. degree, University of Wisconsin, 1932. American-German Exchange Student, Munich, 1928-1929; White Fellow in physics, Cornell University, 1929-1930; University Fellow in electrical engineering, University of Wisconsin, 1930-1932; research assistant, University of Wisconsin, 1932 to date. Associate member, Institute of Radio Engineers, 1930.

Kirby, S. S.: See PROCEEDINGS for February, 1934.

Stuart, D. M.: Received B.S. degree, University of Minnesota, 1928. Research laboratory, Northwest Paper Company, 1928-1929. Radio Section, U. S. Bureau of Standards, 1929 to date. Nonmember, Institute of Radio Engineers.

Van Dissel, Gysbert Frans: Born October 27, 1887, at The Hague, Holland. Received degree of Civil Engineer, 1911, Technical University, Delft. Railway engineer, Dutch East Indies and later in Governmental Irrigation Service; section engineer, Java and Celebes, 1913-1919. Studied at Superior School of Electricity and Radio University under General Ferrié, 1920-1921; received degree. Constructing engineer, radio factory, Hilversum, 1921-1922; instructor, Radio Technical University, Bandoeng, 1923; chief of Malabar station, 1926-1929. Represented Dutch East Indies at Conference of Prague and Conférence consultative internationale de Radio at The Hague, 1929. Entered service of League of Nations, 1930, as wireless and electrical expert; planned League of Nations wireless station, director of construction and operation. Represented League of Nations at Conférence consultative internationale de Radio at Copenhagen, 1931 and 1932, and at different World Power Conferences. Secretary of Special Electrical Commission for the study of a European electrical network. Member, Royal Institute of Engineers in Holland; Member, Dutch Society of Radio Engineers. Nonmember, Institute of Radio Engineers.

**Von Ardenne, Manfred:** Born January 20, 1907, at Hamburg, Germany. Studied physics, Berlin University, 1925-1926. Research work on resistance amplifiers, multiple tubes, end stage amplifiers, high-frequency measurements, cathode ray tubes and television with cathode ray tubes in his own laboratory in Lichterfelde, 1928 to date. Junior member, Institute of Radio Engineers, 1927; Associate, 1929.

**Wise, W. Howard:** Born February 18, 1898, near La Bette, Kansas. Received B.S. degree, Montana State College, 1921; M.A. degree, University of Oregon, 1923; Ph.D. degree, California Institute of Technology, 1926. Department of development and research, American Telephone and Telegraph Company, 1926-1934; Bell Telephone Laboratories, March, 1934 to date. Member, Institute of Radio Engineers, 1932.



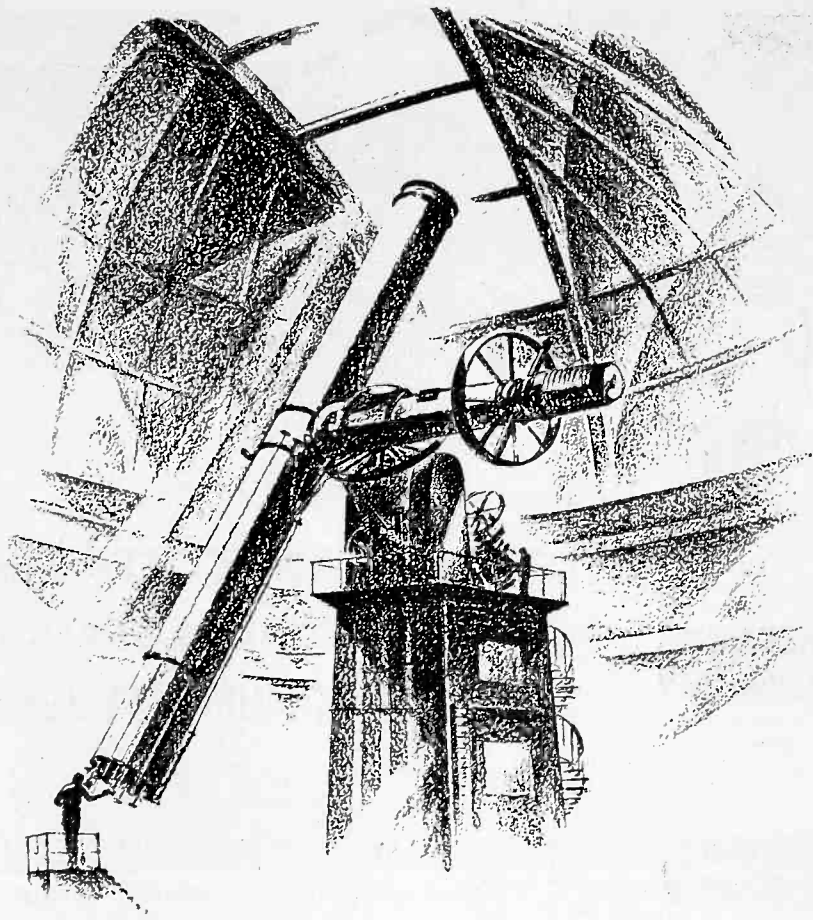

# V I S I O N

For centuries, man looked upward to the stars for new worlds of knowledge. Today radio science offers a realm of research equally broad and rich!

Engineers of the Hygrade Sylvania Corporation hold a leading position in the exploration of this new field. Hygrade Sylvania first pioneered in the development of the more efficient 6.3 volt tubes. And recently, this com-

pany established a complete new plant for similar development in the fields of broadcasting and electronics.

Set manufacturers are invited to write for engineering consultation on circuit and design problems. The facilities of Hygrade Sylvania are placed at your disposal without cost or obligation. Hygrade Sylvania Corporation, Emporium, Pa.

# Sylvania

(Reg. U S. Pat. Off.)



THE SET-TESTED RADIO TUBE

© 1931, H. S. C.

*When writing to advertisers mention of the PROCEEDINGS will be mutually helpful.*



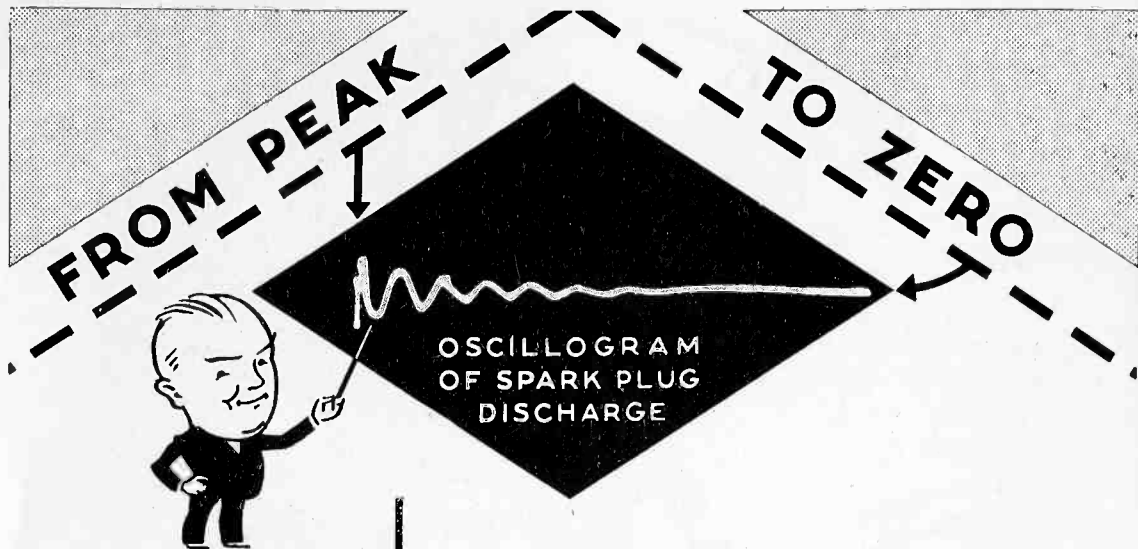

## LOW VOLTAGE COEFFICIENT OF ERIE SUPPRESSORS ASSURES MAXIMUM EFFICIENCY



1. With Proper Value  
Erie Suppressor.



2. With Inadequate  
Suppressor.



3. With no Suppressor.

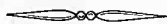

Have you seen this new Erie Suppressor for distributor heads? Increased efficiency because no exposed metal when installed.

**B**ECAUSE of the low voltage coefficient of Erie Suppressors, their resistance is not appreciably changed at the peak voltage of the spark discharge. That this results in more efficient suppression of "motor noise" in auto radios is evident in the accompanying oscillograms.

Note the damped discharge in No. 1 when an Erie Suppressor is used. Compare this with No. 2, which represents conditions present when a suppressor with poor voltage coefficient is used and with No. 3, when no suppressor is used.

Investigate the efficiency of Erie Suppressors. A letter to us will bring you technical data and samples to test in your own laboratory.

# ERIE RESISTOR CORPORATION

ERIE, PA.

Factories in ERIE, PA. - TORONTO, CANADA - LONDON, ENG.

*When writing to advertisers mention of the PROCEEDINGS will be mutually helpful.*

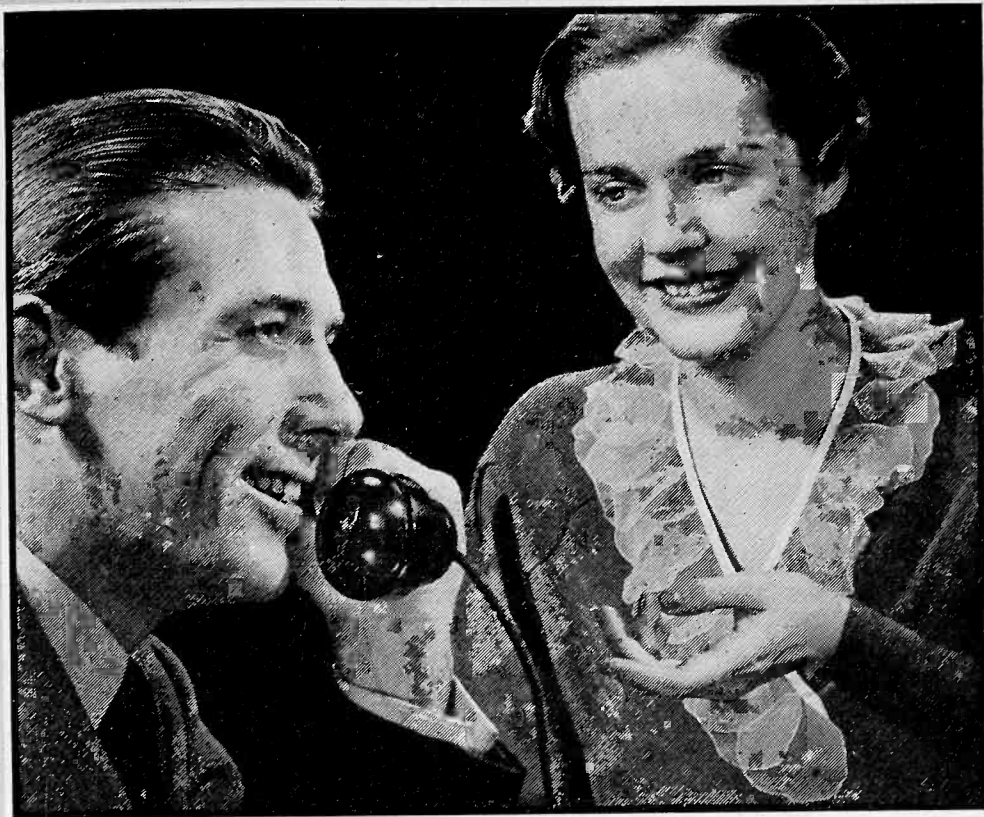

**"YES, MOTHER.** *She's right here"*

AT THE close of the day, at the end of the week, at the turn of the year, when your mind ranges back to sum it up, what counts for most?

Is it not the people you spoke to and what you said to them and what they said to you? The ideas born in conversation, the new slant given to your thoughts by a word or two, the greetings and farewells, the advice and the admonitions, the hopes confessed and questions answered—these and a thousand other vocal expressions of human contact make up the story of our lives.

Think of this the next time you use the telephone. With no greater effort than the calling of a number or the turning of a dial, you can speak to almost anyone, anywhere. No place or person is far away when you can say—"I'll call you up."

---

*Is this somebody's birthday? Is someone in another town being married or celebrating an anniversary? The sound of your voice and your good wishes will brighten the day. The rates are low. You can make a daytime station-to-station call to most places 75 miles away for about 50c. During the evening and night periods many rates are 15% to 40% lower than in the daytime.*

**BELL TELEPHONE SYSTEM**



*When writing to advertisers mention of the PROCEEDINGS will be mutually helpful.*

# Now

## SIMPLIFIED and IMPROVED

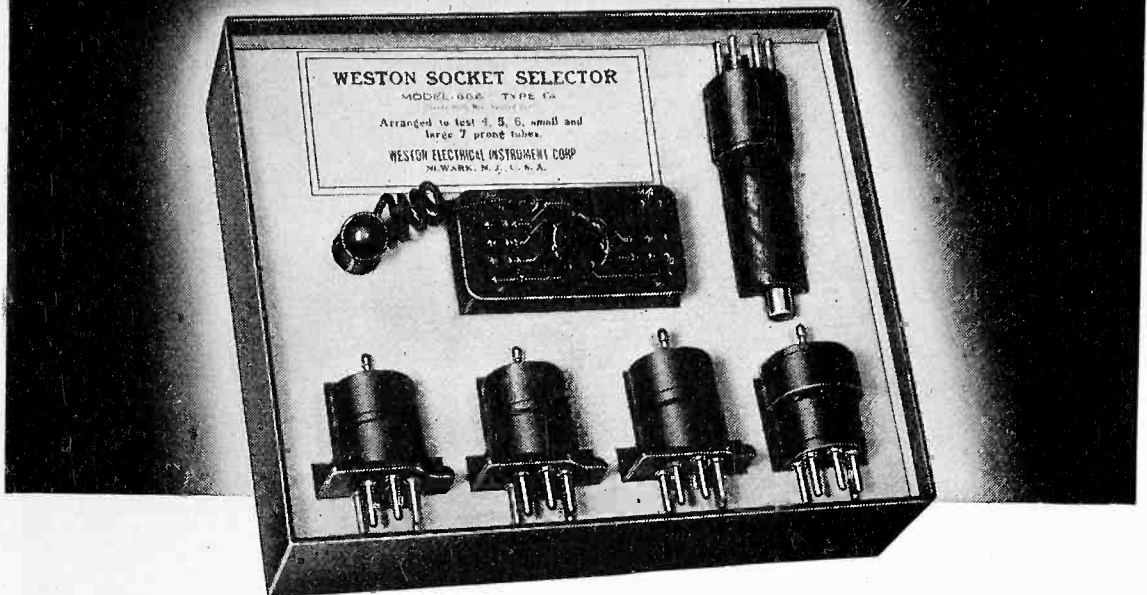

## WESTON SOCKET SELECTOR

MODEL 666 TYPE 1A

The method of Selective Analysis, introduced by Weston, has been further improved and simplified. *Now . . .* only one socket selector cord and plug is necessary—colored special adapter combinations provide for 6, 5, 4 and large 7-prong tubes.

Model 666 makes *any* analyzer truly universal in its capacity to analyze radio

receivers. Combined with the Weston Model 665 Volt-Ohm-Milliammeter it provides a method of analysis which banishes obsolescence. You will want full data on Model 666, type 1A. Return the coupon today for complete information . . . Weston Electrical Instrument Corporation, 589 Frelinghuysen Avenue, Newark, New Jersey.

# WESTON

## *Radio Instruments*



Send Bulletin  
on Weston Radio  
Instruments.

WESTON ELECTRICAL INSTRUMENT CORPORATION, 589 Frelinghuysen Ave., Newark, N. J.

Name .....

Address .....

City and State .....

*When writing to advertisers mention of the PROCEEDINGS will be mutually helpful.*

# The Institute of Radio Engineers

Incorporated

33 West 39th Street, New York, N. Y.

## APPLICATION FOR ASSOCIATE MEMBERSHIP

(Application forms for other grades of membership are obtainable from the Institute)

To the Board of Directors  
Gentlemen:

I hereby make application for Associate membership in the Institute of Radio Engineers on the basis of my training and professional experience given herewith, and refer to the members named below who are personally familiar with my work.

I certify that the statements made in the record of my training and professional experience are correct, and agree if elected, that I will be governed by the constitution of the Institute as long as I continue a member. Furthermore I agree to promote the objects of the Institute so far as shall be in my power, and if my membership shall be discontinued will return my membership badge.

.....  
(Sign with pen)

.....  
(Address for mail)

.....  
(Date)

.....  
(City and State)

### Sponsors:

(Signature of references not required here)

Mr. .... Mr. ....

Address ..... Address .....

City and State ..... City and State .....

Mr. ....

Address .....

City and State .....

The following extracts from the Constitution govern applications for admission to the Institute in the Associate grade:

#### ARTICLE II—MEMBERSHIP

Sec. 1: The membership of the Institute shall consist of: \* \* \* (c) Associates, who shall be entitled to all the rights and privileges of the Institute except the right to hold any elective office specified in Article V. \* \* \*

Sec. 4. An Associate shall be not less than twenty-one years of age and shall be a person who is interested in and connected with the study or application of radio science or the radio arts.

#### ARTICLE III—ADMISSION AND EXPULSIONS

Sec. 2: \* \* \* Applicants shall give references to members of the Institute as follows: \* \* \* for the grade of Associate, to three Fellows, Members, or Associates; \* \* \* Each application for admission \* \* \* shall embody a full record of the general technical education of the applicant and of his professional career.

#### ARTICLE IV—ENTRANCE FEE AND DUES

Sec. 1: \* \* \* Entrante fee for the Associate grade of membership is \$3.00 and annual dues are \$6.00.

**ENTRANCE FEE SHOULD ACCOMPANY APPLICATION**



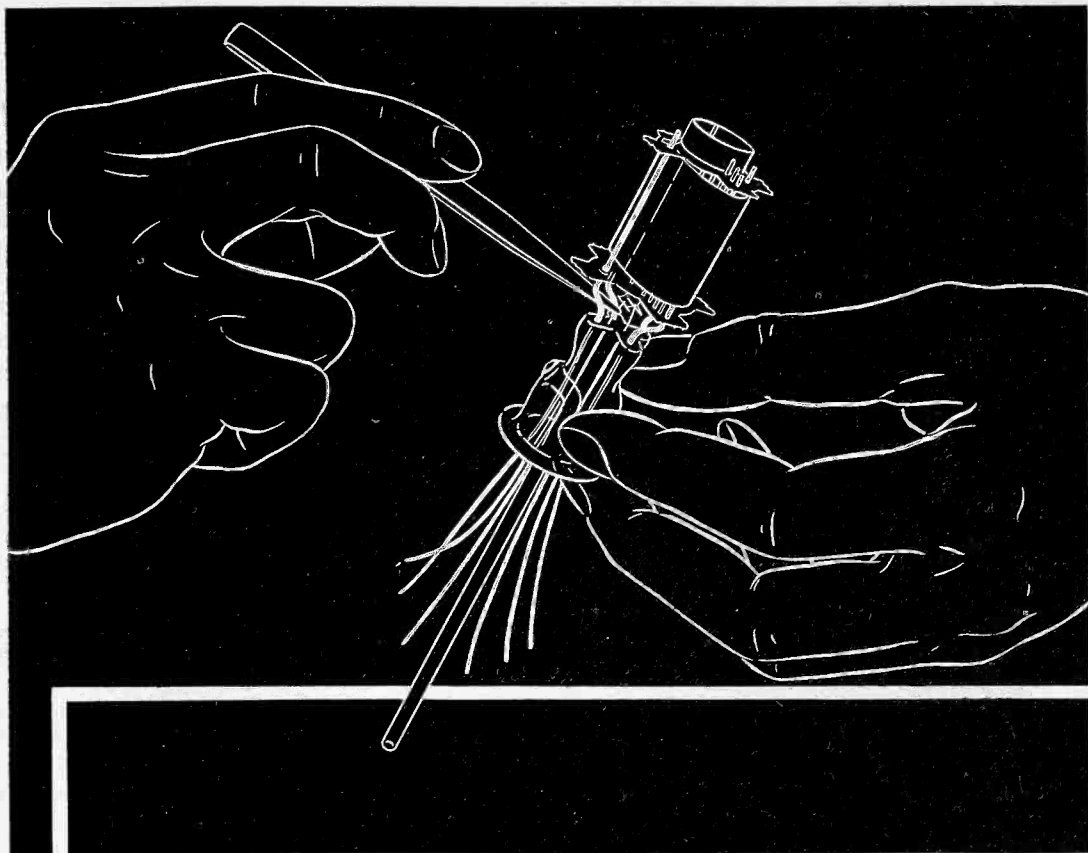

## BEHIND THE FINGERS, THE PURPOSE

FINGERS can be skilful and yet fashion nothing of practical importance. They must be guided by a purpose — a vision of perfection, the desire to create something better.

It is such a purpose that guides the many manual operations in the assembling of Raytheon 4-pillar Radio Tubes. For these tubes are made by workers steeped in the watchmaker's tradition of precision. Even the machines, employed in several stages of their manufacture, are fashioned for an express purpose—the construction of the 4-pillar principle of support which holds the

vital elements in a Raytheon secure against vibration.

Every operation through which the raw materials for these tubes pass, reflects that guiding purpose. The result is a tube that performs to perfection under the most rigorous circumstances. That is why police departments, air transportation companies, polar expeditions and millions of set owners everywhere, use Raytheon 4-pillar Tubes and nothing else. That is why you will find in Raytheon, a tube you can rely on to operate with un-failing clarity under the most severe conditions.

## RAYTHEON 4-PILLAR RADIO TUBES

RAYTHEON PRODUCTION CORPORATION

30 E. 42nd St., New York City  
445 Lake Shore Drive, Chicago



55 Chapel St., Newton, Mass.  
555 Howard St., San Francisco

*When writing to advertisers mention of the PROCEEDINGS will be mutually helpful.*

# Why Pyranol Capacitors?

Striking compactness, higher dielectric strength and dielectric constant, with marked economy account for the use of the new pyranol impregnator in C-D High-Voltage Transmitting Capacitors. More specifically, this impregnator is used

## Because:

- Higher dielectric strength and dielectric constant make possible more compact units without sacrificing performance and long life.
- Units of this type can be operated continuously at voltages and ambient temperatures destructive to units using ordinary impregnators.
- Impregnator is non-inflammable, eliminating fire hazard present in other types.
- Leakage resistance and power factor change far less at high temperatures than in other types in current use.
- Hermetically sealed. Cannot be affected by high humidity.

Available in two series: Type TC (upper unit shown) designed to fill most of average demands of transmitters calling for from 1 mfd. at 6000 to 15 mfd. at 1000 D.C. working volts. Type TB (lower unit shown) designed for high-voltage rectifying systems of commercial radio telegraph and telephone transmitters, incorporating safety factors not found in any other high-voltage filter capacitor.

### For Every Purpose—C-D Capacitors

No matter what your capacitor requirements—receiving or transmitting; paper, mica, electrolytic or ultra-high-frequency; small or large; low or high voltage—there's a standard C-D unit for your particular job.

**Write** for your copy of the new C-D 1934 catalog, covering the *complete* line of condensers built in the largest factory devoted exclusively to condensers, in the world.

## CORNELL-DUBILIER CORPORATION

4377 Bronx Boulevard - - - New York City



*When writing to advertisers mention of the PROCEEDINGS will be mutually helpful.*



# CHANGE IN MAILING ADDRESS OR BUSINESS TITLE

Members of the Institute are asked to use this form for notifying the Institute office of a change in their mailing address or the listing of their company affiliation or title in the Year Book.

The Secretary,  
THE INSTITUTE OF RADIO ENGINEERS,  
33 West 39th Street,  
New York, N.Y.

Dear Sir:

Effective ..... please note change in my address  
(date)  
for mail as follows:

FROM

.....  
(Name)

.....  
(Street Address)

.....  
(City and State)

TO NEW ADDRESS

.....  
(Street Address)

.....  
(City and State)

Please note following change in my Year Book listing.

.....  
(Title)

.....  
(Company Name)

.....  
(Company Address)



# RCA VICTOR

## PRECISION LABORATORY EQUIPMENT

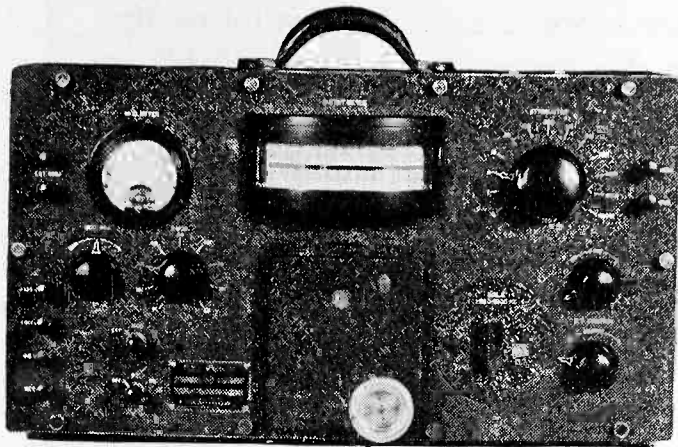

← STANDARD SIGNAL GENERATOR  
TYPE TMV-18-D

Standard range 100 kc to 10,000 kc. Extra coils for 25 kc to 25,000 kc. R-F voltage output 0.25 microvolts to 2 volts. Internal 400 cycle modulator. Accurate frequency calibration. Improved precision dial with worm driven vernier. Minimum stray field.

FIELD INTENSITY METER TYPE TMV-75-B →

Frequency range 500 kc to 20,000 kc. Field intensity range 20 microvolts/meter to 6 volts/meter.

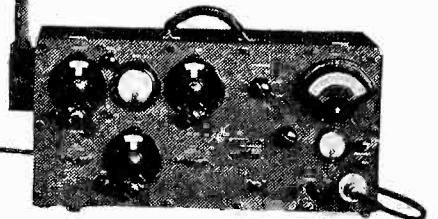
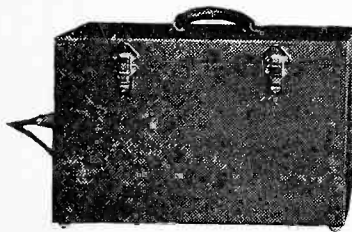

← BEAT FREQUENCY OSCILLATOR TYPE TMV-52-E  
Range 20 to 17,000 cycles. Constant output. Low harmonic content. Open circuit output 25 volts. Vibrating reed calibration indicator.

← UNIVERSAL CURVE RECORDER TMV-36-B  
Semi-automatic. Provides rapid and easy means of recording characteristic curves. (Instrument shown attached to Beat Frequency Oscillator.)

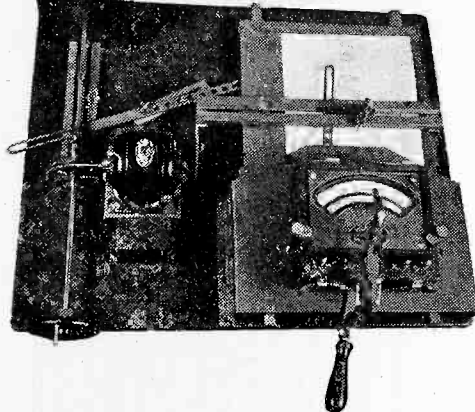

← ALSO HIGH FREQUENCY MULTI-SIGNAL SYSTEM TMV-107-A

For generating, transmitting, selecting and attenuating modulated or unmodulated signals in range of 2,000 kc to 20,000 kc. Employs single transmission line free from leakage. May be mounted on rack with crystal controlled temperature regulated Master Oscillator Amplifier units and power supply.

*Bulletins and prices on application*



Industrial  
Products  
Section

# RCA VICTOR CO., INC.

CAMDEN, NEW JERSEY

"RADIO HEADQUARTERS"

*When writing to advertisers mention of the PROCEEDINGS will be mutually helpful.*

# HIGH QUALITY

## Broadcast Studio Equipment



No. 1

1. TYPE 44-AP VELOCITY MICROPHONE  
—uniform frequency response—uniform directivity  
—the microphone without a diaphragm  
—the choice of the leaders

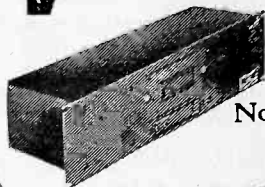

No. 2

2. TYPE 41-B PRE-AMPLIFIER  
—designed to insure full realization of the improved fidelity and greater artistry made possible by the use of velocity microphones

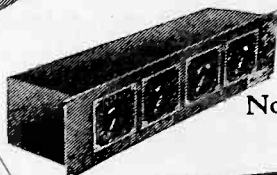

No. 3

3. TYPE 46-A FOUR POSITION MIXER PANEL  
—for use with high quality microphones balanced variable ladder network—positive contact  
—absolute minimum of noise

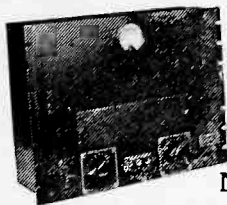

No. 4

4. TYPE 40-C PROGRAM AMPLIFIER  
—complete a-c operation  
—self-contained volume indicator  
—supplies power for pre-amplifiers and auxiliary microphone  
—an all purpose amplifier

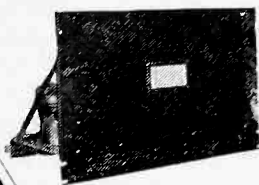

No. 5

5. TYPE AA-4194-B MONITORING AMPLIFIER  
—another completely a-c operated amplifier designed especially for use with high quality monitoring speakers

6. REMOTE CONTROL STATION  
Supplied with AA-4194-B monitoring amplifier



No. 6

The demand for this new line of broadcast studio and control equipment is adequate assurance that it fulfills definitely the requirements set by the ever advancing standards of broadcasting. Write the nearest office for bulletins and price.



RCA VICTOR COMPANY, Inc.

CAMDEN, N.J., U.S.A.

"Radio Headquarters"

New York: 153 E. 24th St.

Chicago: 111 N. Canal St.

San Francisco: 235 Montgomery St.

Dallas: Santa Fe Bldg.

Atlanta: 144 Walton St. N.W.



When writing to advertisers mention of the PROCEEDINGS will be mutually helpful.

## PROFESSIONAL ENGINEERING DIRECTORY

**BLILEY  
PIEZO-ELECTRIC CO.**

*Designers and Manufacturers  
of*

**QUARTZ CRYSTALS**

*for*

*Standard or Special Requirements*

226A Union Station Bldg.  
ERIE, PENNA.

**Cathode Ray Tubes  
and Associated  
Equipment For All  
Purposes**

*Write for Complete  
Technical Data*

**ALLEN B. DUMONT  
LABORATORIES  
UPPER MONTCLAIR, N.J.**

**PRACTICAL RADIO  
ENGINEERING**

One year Residence Course  
Advanced Home Study Course  
Combined Home Study-Residence  
Course

*Write for details*

**Capitol Radio Engineering  
Institute  
Washington, D.C.**

**FOR MANY YEARS**

the Professional Engineering Directory  
has helped consulting engineers, design-  
ers, and laboratory men make the right  
contacts in the radio industry. Perhaps we  
can help you with your problems too. For  
further information write to

*Advertising Department*

**INSTITUTE OF RADIO  
ENGINEERS**

33 West 39th St.  
NEW YORK CITY, N.Y.

### *Alphabetical Index to Advertisements*

|                                   |   |                                    |
|-----------------------------------|---|------------------------------------|
| American Tel. & Tel. Co. ....     | A | XI                                 |
| Central Radio Laboratories .....  | C | XXII                               |
| Cornell-Dubilier Corp. ....       |   | XVI                                |
| Erie Resistor Corp. ....          | E | X                                  |
| General Radio Co. ....            | G | Outside Back Cover                 |
| Hygrade Sylvania Corp. ....       | H | IX                                 |
| I.R.E. ....                       | I | XIII, XIV, XVII, Inside Back Cover |
| Professional Eng. Directory ..... | P | XX                                 |
| Raytheon Production Corp .....    | R | XV                                 |
| RCA Victor Company, Inc. ....     |   | XVIII, XIX                         |
| Triplett Elec. Inst. Co. ....     | T | XXI                                |
| Weston Elec. Inst. Corp. ....     | W | XII                                |



Check  
Your

Experiments With Advanced  
**TRIPLET** INSTRUMENTS!

**I**F YOU want the most precise, easy-to-read equipment, select Triplet Portable Instruments. A sturdy hinged arrangement makes it easy to raise or lower the meter until the desired reading angle is secured. In this way, the scale is always in direct alignment with the line of vision. This feature facilitates the making of curves and the carrying out of laboratory experiments.

The exacting engineer prefers a Triplet Portable Instrument because it serves a double purpose. It can be used either as a regular portable instrument, or, as the new adjustable type. Before starting a chart, he can adjust the meter until he can readily see the dial

... regardless of where he places it! A single glance at the upraised easy-to-read dial gives him the information he desires... and enables him to continue with his experiment without moving from his position and without loss of time.

Triplet Portable Instruments are advanced in design, precision built, compactly constructed, and absolutely dependable. Widely regarded for their superiority, they are extensively used in many leading laboratories, schools and universities. Single range meters are equipped with binding posts or jacks. Tipped cable leads are supplied with a pin jack at one end and spade terminals on the other.

Your Jobber Can Supply You!

See these Triplet Instruments *before* you make up your mind. They pay for themselves many times in service and complete satisfaction.

**THE TRIPLET ELECTRICAL INSTRUMENT COMPANY**  
57 Main Street Bluffton, Ohio 

**SEND COUPON FOR QUICK FACTS!**

The Triplet Electrical Instrument Co.  
57 Main Street, Bluffton, Ohio.  
Gentlemen: Send me catalog on Triplet Portable Instruments... and complete line of radio servicing instruments.

Name .....  
Street Address .....  
City ..... State .....

*When writing to advertisers mention of the PROCEEDINGS will be mutually helpful.*

# THE LONG & SHORT OF IT

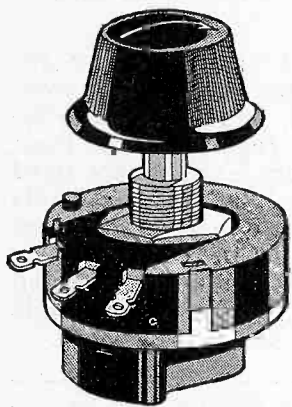
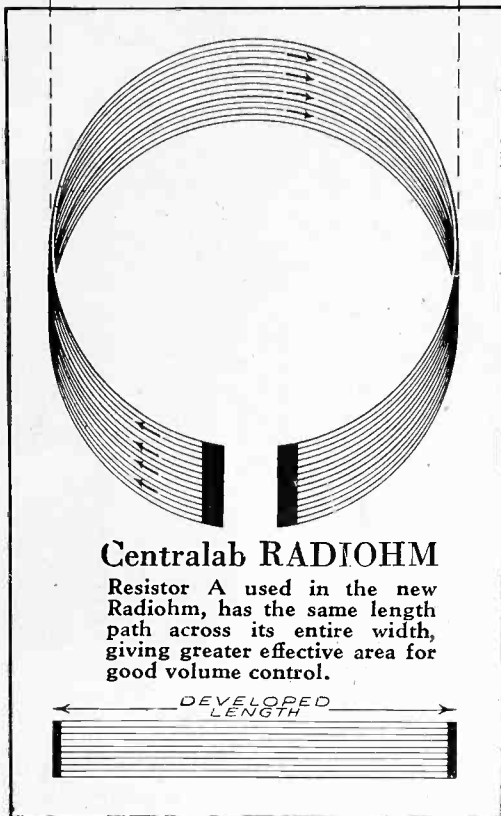

Here's graphic "eye proof" of the superiority of the new **CENTRALAB RADIOHM**

The useful length of the new Radiohm is its maximum circumference. This length is twice that of an old style control of equal outside diameter and represents the relative volume control efficiency.

Here's double efficiency for you!

Central Radio Laboratories - Milwaukee

# Centralab

**CRL**

## RADIOHM

*When writing to advertisers mention of the PROCEEDINGS will be mutually helpful.*



THE  
NINTH  
ANNUAL CONVENTION  
AND  
EXHIBITION  
OF  
THE INSTITUTE OF RADIO ENGINEERS  
WILL BE HELD ON  
MAY 28, 29 AND 30, 1934  
IN THE  
BENJAMIN FRANKLIN HOTEL  
AT  
PHILADELPHIA, PA.

# A FRONTIER PASSED

Type 516-C  
Radio-Frequency Bridge  
Range extends to 5,000,000 cycles  
Measures Inductance, Resistance,  
Capacitance, Dielectric Losses,  
of Lumped or Distributed  
Circuits

First commercial equipment  
available for these measure-  
ments at high frequencies

Price: \$225.00



## Antennas, coils, condensers measured at radio frequency on a bridge!

Bridge methods have not been dependable beyond a vaguely defined limit of about fifty kilocycles, where volt-ammeter and resonance methods have yielded ambiguous results.

Years of effort directed at the improvement of technique and compensation of residual impedances in the measuring circuits have produced a commercial type of impedance bridge extending the use of bridge methods to five megacycles, an important accomplishment in the development of measuring methods.

### RANGES

*Capacitance* - 0.1 mmf. - 1150 mmf. *direct reading*. Can be extended.

*Resistance* - 0.1 ohm - 111 ohms *direct reading*. Can be extended.

*Accuracy* - As a direct-reading bridge 1% to 5% up to two megacycles. Higher accuracy with substitution methods.

For further information ask for Bulletin EX-3312-R from  
General Radio Company, Cambridge A, Massachusetts

# GENERAL RADIO