

VOLUME 21

OCTOBER, 1933

NUMBER 10

PROCEEDINGS  
*of*  
The Institute of Radio  
Engineers



Form for Change of Mailing or Business Title on Page XII

---

# Institute of Radio Engineers Forthcoming Meetings

---

## DETROIT SECTION

October 20, 1933

---

## NEW YORK MEETING

November 1, 1933

December 6, 1933

---

## ROCHESTER FALL MEETING

November 13, 14, and 15, 1933

---

## WASHINGTON SECTION

October 12, 1933

---

# The Institute of Radio Engineers

Board of Editors

ALFRED N. GOLDSMITH, *Chairman*

R. R. BATCHER

H. H. BEVERAGE

F. W. GROVER

G. W. PICKARD

L. P. WHEELER

L. E. WHITTEMORE

WILLIAM WILSON

K. S. VAN DYKE

## CONTENTS

### PART I

Institute News and Radio Notes.....	1383
September Meeting of the Board of Directors.....	1383
Radio Transmission of Standard Frequencies.....	1384
Committee Work.....	1385
Personal Mention.....	1386

### Part II

#### *Technical Papers*

Electrical Disturbances Apparently of Extraterrestrial Origin.....	KARL G. JANSKY	1387
A Piezo-Electric Loud Speaker for the Higher Audio Frequencies.....	STUART BALLANTINE	1399
A Compact, Alternating-Current Operated Speech Input Equipment...	W. L. BLACK	1409
Report of Committee on Radio Propagation Data.....		1419
The Calculation of Harmonic Production in Thermionic Valves with Resistive Loads.....	D. C. ESPLEY	1439
Attenuation of Overland Radio Transmission in the Frequency Range 1.5 to 3.5 Megacycles per Second.....	C. N. ANDERSON	1447
Continuous Measurements of the Virtual Heights of the Ionosphere....	T. R. GILLILAND	1463
Audio-Frequency Atmospherics... E. T. BURTON AND E. M. BOARDMAN		1476
Note on New Methods to Modulate Light.....	G. WATAGHIN AND R. DEAGLIO	1495
Discussion on "Supervisory and Control Equipment for Audio-Frequency Amplifiers," by Harry Sohon.....	A. F. ROSE AND H. SOHON	1497
Book Reviews: "Network Synthesis," by Charles M: Son Gewertz.....	F. W. GROVER	1498
"Télévision et Transmission des Images," by René Mesny.....	MADISON CAWEIN	1498
Radio Abstracts and References.....		1500
Contributors to this Issue.....		1511

---

# Institute of Radio Engineers Forthcoming Meetings

---

**DETROIT SECTION**

October 20, 1933

---

**NEW YORK MEETING**

November 1, 1933

December 6, 1933

---

**ROCHESTER FALL MEETING**

November 13, 14, and 15, 1933

---

**WASHINGTON SECTION**

October 12, 1933

---

# The Institute of Radio Engineers

Board of Editors

ALFRED N. GOLDSMITH, *Chairman*

R. R. BATCHER

H. H. BEVERAGE

F. W. GROVER

G. W. PICKARD

L. P. WHEELER

L. E. WHITTEMORE

WILLIAM WILSON

K. S. VAN DYKE

## CONTENTS

### PART I

Institute News and Radio Notes.....	1383
September Meeting of the Board of Directors.....	1383
Radio Transmission of Standard Frequencies.....	1384
Committee Work.....	1385
Personal Mention.....	1386

### Part II

#### *Technical Papers*

Electrical Disturbances Apparently of Extraterrestrial Origin.....	KARL G. JANSKY	1387
A Piezo-Electric Loud Speaker for the Higher Audio Frequencies.....	STUART BALLANTINE	1399
A Compact, Alternating-Current Operated Speech Input Equipment... ..	W. L. BLACK	1409
Report of Committee on Radio Propagation Data.....		1419
The Calculation of Harmonic Production in Thermionic Valves with Resistive Loads.....	D. C. ESPLEY	1439
Attenuation of Overland Radio Transmission in the Frequency Range 1.5 to 3.5 Megacycles per Second.....	C. N. ANDERSON	1447
Continuous Measurements of the Virtual Heights of the Ionosphere... ..	T. R. GILLILAND	1463
Audio-Frequency Atmospherics... ..	E. T. BURTON AND E. M. BOARDMAN	1476
Note on New Methods to Modulate Light.....	G. WATAGHIN AND R. DEAGLIO	1495
Discussion on "Supervisory and Control Equipment for Audio-Frequency Amplifiers," by Harry Sohon.....	A. F. ROSE AND H. SOHON	1497
Book Reviews: "Network Synthesis," by Charles M. Son Gewertz.....	F. W. GROVER	1498
"Télévision et Transmission des Images," by René Mesny.....	MADISON CAWEIN	1498
Radio Abstracts and References.....		1500
Contributors to this Issue.....		1511

# The Institute of Radio Engineers

---

## GENERAL INFORMATION

**INSTITUTE.** The Institute of Radio Engineers was formed in 1912 through the amalgamation of the Society of Wireless Telegraph Engineers and the Wireless Institute. Its headquarters were established in New York City and the membership has grown from less than fifty members at the start to almost six thousand by the end of 1932.

**AIMS AND OBJECTS.** The Institute functions solely to advance the theory and practice of radio and allied branches of engineering and of the related arts and sciences, their application to human needs, and the maintenance of a high professional standing among its members. Among the methods of accomplishing this need is the publication of papers, discussions, and communications of interest to the membership.

**PROCEEDINGS.** The PROCEEDINGS is the official publication of the Institute and in it are published all of the papers, discussions, and communications received from the membership which are accepted for publication by the Board of Editors. Copies are sent without additional charge to all members of the Institute. The subscription price to nonmembers is \$10.00 per year, with an additional charge for postage where such is necessary.

**RESPONSIBILITY.** It is understood that the statements and opinions given in the PROCEEDINGS are views of the individual members to whom they are credited, and are not binding on the membership of the Institute as a whole. Papers submitted to the Institute for publication shall be regarded as no longer confidential.

**REPRINTING PROCEEDINGS MATERIAL.** The right to reprint portions or abstracts of the papers, discussions, or editorial notes in the PROCEEDINGS is granted on the express condition that specific reference shall be made to the source of such material. Diagrams and photographs published in the PROCEEDINGS may not be reproduced without making specific arrangements with the Institute through the Secretary.

**MANUSCRIPTS.** All manuscripts should be addressed to the Institute of Radio Engineers, 33 West 39th Street, New York City. They will be examined by the Papers Committee and the Board of Editors to determine their suitability for publication in the PROCEEDINGS. Authors are advised as promptly as possible of the action taken, usually within two or three months. Manuscripts and illustrations will be destroyed immediately after publication of the paper unless the author requests their return. Information on the mechanical form in which manuscripts should be prepared may be obtained by addressing the secretary.

**MAILING.** Entered as second-class matter at the post office at Menasha, Wisconsin. Acceptance for mailing at special rate of postage is provided for in the act of February 28, 1925, embodied in Paragraph 4, Section 412, P. L. and R., and authorization was granted on October 26, 1927.

---

Published monthly by

**THE INSTITUTE OF RADIO ENGINEERS, INC.**

Publication office, 450-454 Ahnaip St., Menasha, Wis.

BUSINESS, EDITORIAL, AND ADVERTISING OFFICES

Harold P. Westman, *Secretary*

33 West 39th Street, New York, N. Y.

## INSTITUTE SECTIONS

- ATLANTA—Chairman, H. L. Wills; Secretary, Philip C. Bangs, 23 Kensington Road, Avondale Estates, Ga.
- BOSTON—Chairman, E. L. Chaffee; Secretary, G. W. Kenrick, Tufts College, Mass.
- BUFFALO-NIAGARA—Chairman, L. Grant Hector; Secretary, E. C. Waud, 235 Huntington Avenue, Buffalo, N. Y.
- CHICAGO—Chairman, R. M. Arnold; Secretary, Donald H. Miller, McGraw-Hill Publishing Company, 520 N. Michigan Ave., Chicago, Ill.
- CINCINNATI—Chairman, W. C. Osterbrock; Secretary, Helen Klein, Crosley Radio Corporation, Cincinnati, Ohio.
- CLEVELAND—Chairman, P. A. Marsal; Secretary, R. P. Worden, 1629 Cordova Ave., Cleveland, Ohio.
- CONNECTICUT VALLEY—Chairman, H. W. Holt; Secretary, C. B. De Soto American Radio Relay League, 38 La Salle Rd., W. Hartford, Conn.
- DETROIT—Chairman, G. W. Carter; Secretary, E. C. Denstaedt, Detroit Police Department, Detroit, Mich.
- LOS ANGELES—Chairman, J. K. Hilliard; Secretary, N. B. Neely, 1569 Munson Ave., Los Angeles, Calif.
- NEW ORLEANS—Chairman, J. A. Courtenay; Secretary, C. B. Reynolds, Radiomarine Corporation, 512 St. Peter St., New Orleans, La.
- PHILADELPHIA—Chairman, W. F. Diehl; Secretary, G. C. Blackwood, 243 E. Upsal St., Mt. Airy, Philadelphia, Pa.
- PITTSBURGH—Chairman, Lee Sutherlin; Secretary, A. P. Sunnergren, West Penn Power Company, 14 Wood St., Pittsburgh, Pa.
- ROCHESTER—Chairman, A. E. Soderholm; Secretary, John J. Long, Radio Station WHAM, Sagamore Hotel, Rochester, N. Y.
- SAN FRANCISCO—Chairman, G. T. Royden; Secretary, R. C. Shermund, 2300-16th Ave., San Francisco, Calif.
- SEATTLE—Chairman, H. H. Bouson; Secretary, Howard Mason, 2709-4th West, Seattle, Wash.
- TORONTO—Chairman, W. F. Choat; Secretary, G. E. Pipe, Rogers-Majestic Corporation, Toronto, Ont., Canada.
- WASHINGTON—Chairman, H. G. Dorsey; Secretary, C. L. Davis, Washington Building, 15th and G Sts., Washington, D. C.

**GEOGRAPHICAL LOCATIONS OF MEMBERS ELECTED  
SEPTEMBER 12, 1933**

**Elected to the Associate Grade**

California	Altadena, 809 Sacramento St.....	Axtell, H. B.
	San Francisco, 1547 Jackson St.....	Colson, T.
	San Francisco, 112—7th St.....	Hussey, W. J.
Illinois	Chicago, 526 Surf St.....	Bowen, J. L.
	Glencoe, 602 Dundee Rd.....	Rockey, G. V.
Michigan	Detroit, Detrola Radio Corp., 401 Salliotte St.....	Wood, H. M.
Minnesota	Minneapolis, 3603 Harriet Ave., S.....	Roehl, T. J.
New York	Brooklyn, 55 Hanson Pl.....	Weyh, E. G.
Argentine	Buenos Aires, Mendez de Andes 154.—Dep. 2.....	Meier, J. G.
	Buenos Aires, J. Bonifacio 2764.....	Suarez, C. S.
Australia	Strathfield, N.S.W., 23 Redmyre Rd.....	Priestley, H. T.
Canada	London, Ont., 495 Dundas St.....	Minshall, B.
	Montreal, P.Q., 3360 Troie Ave., Cote des Neiges.....	Quinton, W. F.
	Winnipeg, Man., 593 Victor St.....	Weakley, J. J.
China	Nanking, 2 Say Yuan Hong.....	King, Y. C.
Czechoslovakia	Prague, Myslikova UL 28.....	Pazderka, R.
England	Iver., Bucks, "Joyral" Sykeings.....	Lett, F. T.
	Ponders End, Middlesex, 96 High St.....	Osmond, C. E.
Germany	Berlin-Halensee, Joachim-Friedrichstr. 18, III-1.....	Wang, T. F.
Japan	Tobata, Meidi College of Technology.....	Ataka, H.
	Tokyo, 1140 Nakanobumachi, Ebara-ku.....	Yonezawa, S.
Northern Rhodesia	Broken Hill, Post Office Engineering Dept.....	Stephens, R. W.
South Africa	Johannesburg, 33 Astor Mansions, Jeppe St.....	Filmer, N. L.

**Elected to the Student Grade**

California	Huntington Park, 6730 Marbrisa Ave.....	Cunningham, E. W.
Michigan	Ann Arbor, 1019 Baldwin Ave.....	Bailey, B. F., Jr.
Pennsylvania	Gettysburg, 24 Barlow St.....	Schantz, J. D.





## APPLICATIONS FOR MEMBERSHIP

Applications for transfer or election to the various grades of membership have been received from the persons listed below, and have been approved by the Committee on Admissions. Members objecting to transfer or election of any of these applicants should communicate with the Secretary on or before October 31, 1933. These applications will be considered by the Board of Directors at its meeting on November 1, 1933.

### For Transfer to the Fellow Grade

California San Francisco, c/o Mackay Radio & Telegraph Co., 22 Battery St. . . . . Royden, G. T.

### For Transfer to the Member Grade

New York New York City, c/o Bell Telephone Labs., 180 Varick St. . . . . Mcintosh, F. H.  
New York City, Radio Inventions, Inc., 41 Park Row . . . . . Miller, H. G.  
Australia Sydney, N.S.W., Box 3765, G.P.O. . . . . Mingay, O. F.

### For Election to the Member Grade

Dist. of Columbia Washington, 4817-36 St. N.W., Apt. 210 . . . . . Davies, G. L.  
Washington, McLachlen Bldg. . . . . Orton, W. H.  
England Liverpool, 18, 52 Brodie Ave., Mossley Hill . . . . . Taylor, R. H.  
Paddox, Rugby, "Kelvin," Shenstone Ave. . . . . Hulme, F. H.

### For Election to the Associate Grade

Alabama	Escatawpa	Sporna, J.
California	Altadena, 2185 Mar Vista Ave.	Hull, R. W.
	Half Moon Bay	Triplett, W. R.
	Los Angeles, 1475 Alvira St.	Hidy, J. H.
	Los Angeles, 1474 S. Canfield	Sunde, H. R.
	Los Angeles, 2033 Victoria Ave.	Wamil, P. L.
	San Diego, 3443 Richmond St.	McBride, A. C., Jr.
	San Francisco, 311 California St., Rm. 606	Spiegel, L.
	San Jose, 371 Florence Ave.	Gordon, R. H.
Illinois	Wheaton, 225 W. Wesley St.	Reber, G.
Massachusetts	Springfield, 174 Northampton Ave.	Benson, S. E.
Michigan	Ann Arbor, Lawyers Club	Albertson, F. W.
New Jersey	Haddonfield, 110 Avondale Ave.	Fernster, G. L.
New York	Brooklyn, 741-57th St.	Birkeland, O.
	Brooklyn, 616 Nostrand Ave.	Schreiber, R. G.
	New York City, 3031 N. Holland Ave.	Smith, A.
	New York City, 413 City Island Ave.	Switzer, R. C.
Ohio	Toledo, 116 Boody St.	Heaton, R. W.
Rhode Island	Providence, 433 Friendship St.	Provost, G. O.
Texas	Laredo, Cherokee Hotel	Melloh, A. W.
Washington	Bremerton, U.S.S. Lexington, Navy Yard	Bowers, R. W.
Australia	Casino, N.S.W., P. O. Box 27	Cradick, S. T.
	Melbourne, C.1, Victoria, P.M.G.'s Research Labs., 59 Lt. Collins St.	Badenach, R. M.
Brazil	S. Paulo, Rua Augusta 89	Jones, E. Y., Jr.
Canada	Toronto, Ont., 1590 Bathurst St.	Isserstedt, S. G.
	Montreal, P.Q., 2353 St. Antoine St.	Truesdell, E.
England	Cheltenham, Gloucester, "Whitefield," Harp Hill	Webb, C. B. N.
	Crumpsall, Manchester, 56 Kearsley Rd.	Simpson, G.
	Leeds, Yorkshire, 29 Cliff Mount, Hyde Park	Booth, A. E.
	Norwich, Norfolk, 132 Trafford Rd.	Rudd, G. A.
France	Nanterre (Seine), 49 Rue du Chemin de Fer	Maget, R.
Holland	Rotterdam, 91 Kralingscheplaslaan	Blom, P.
Norway	Oslo, Prinsensgate 2	Hjelm, J. A.
Philippine Islands	Manila, 418 Santa Mesa St.	Palenzuela, V. V.

### For Election to the Junior Grade

California Huntington Park, 3113 Broadway St. . . . . Von Werner, W. K.

### For Election to the Student Grade

California Berkeley, Bowles Hall, University of Calif. Campus. Thorne, B. W., Jr.  
San Francisco, 4141-24th St. . . . . Kusich, E. A.

## OFFICERS AND BOARD OF DIRECTORS, 1933

(Terms expire January 1, 1934, except as otherwise noted)

### *President*

L. M. HULL

### *Vice President*

JONATHAN ZENNECK

### *Treasurer*

MELVILLE EASTHAM

### *Secretary*

HAROLD P. WESTMAN

### *Editor*

ALFRED N. GOLDSMITH

### *Directors*

M. C. BATSEL

J. V. L. HOGAN

C. M. JANSKY, JR.

R. H. MANSON, *Junior Past President*

E. R. SHUTE

A. F. VAN DYCK

WILLIAM WILSON

### Serving until January 1, 1935

W. G. CADY, *Junior Past President*

O. H. CALDWELL

C. W. HORN

E. L. NELSON

### Serving until January 1, 1936

R. A. HEISING

H. M. TURNER

F. A. KOLSTER

COMMITTEES OF THE INSTITUTE OF RADIO ENGINEERS, 1933

Admissions Committee

A. F. VAN DYCK, *Chairman*  
C. W. HORN  
C. M. JANSKY, JR.  
A. G. LEE  
A. V. LOUGHREN  
E. R. SHUTE  
J. S. SMITH

ARTHUR BATCHELLER  
O. H. CALDWELL  
C. P. EDWARDS  
H. C. GAWLER  
R. A. HEISING

Awards Committee

WILLIAM WILSON, *Chairman*  
A. N. GOLDSMITH  
J. V. L. HOGAN

STUART BALLANTINE  
W. G. CADY

Board of Editors

ALFRED N. GOLDSMITH, *Chairman*  
L. P. WHEELER  
K. S. VAN DYKE  
L. E. WHITTEMORE  
WILLIAM WILSON

R. R. BATCHER  
H. H. BEVERAGE  
F. W. GROVER  
G. W. PICKARD

Broadcast Committee

E. L. NELSON, *Chairman*  
J. V. L. HOGAN  
C. W. HORN  
C. M. JANSKY, JR.  
R. H. MARRIOTT  
L. E. WHITTEMORE

ARTHUR BATCHELLER  
E. K. COHAN  
J. B. COLEMAN  
R. L. DAVIS

Constitution and Laws Committee

J. V. L. HOGAN, *Chairman*  
R. A. HEISING  
C. M. JANSKY, JR.  
E. R. SHUTE  
A. F. VAN DYCK  
H. A. ZEAMANS

STUART BALLANTINE  
ARTHUR BATCHELLER  
O. H. CALDWELL  
AUSTIN BAILEY  
MELVILLE EASTHAM

Membership Committee

H. C. GAWLER, *Chairman*  
C. R. ROWE  
E. W. SCHAFFER  
J. E. SMITH  
J. C. STROEBEL, JR.  
A. M. TROGNER  
(*Chairmen of Membership Committees  
of Sections, ex officio*)

W. W. BROWN  
J. M. CLAYTON  
W. F. COTTER  
DAVID GRIMES  
S. R. MONTCALM  
A. F. MURRAY  
M. E. PACKMAN

New York Program Committee

C. W. HORN, *Chairman*  
R. A. HEISING  
L. C. F. HORLE  
HARADEN PRATT  
E. R. SHUTE  
R. M. WILMOTTE

AUSTIN BAILEY  
M. C. BATSEL  
H. H. BEVERAGE  
H. C. GAWLER

### Nominations Committee

W. G. CADY, *Chairman*

H. F. DART  
R. A. HEISING  
F. A. KOLSTER

DONALD McNICOL  
G. W. PICKARD  
W. C. WHITE

### Papers Committee

WILLIAM WILSON, *Chairman*

H. A. AFFEL  
J. K. CLAPP  
E. K. COHAN  
T. A. M. CRAVEN  
F. H. DRAKE  
R. D. DUNCAN  
P. O. FARNHAM  
E. B. FERRELL  
E. L. HALL  
G. W. KENRICK  
S. S. KIRBY  
L. F. JONES  
F. B. LLEWELLYN  
R. H. MARRIOTT  
R. M. MORRIS

BENJAMIN OLNEY  
R. K. POTTER  
R. R. RAMSEY  
R. H. RANGER  
D. E. REPLOGLE  
F. M. RYAN  
B. E. SHACKELFORD  
G. C. SOUTHWORTH  
G. G. THOMAS  
H. M. TURNER  
K. S. VAN DYKE  
H. A. WHEELER  
W. C. WHITE  
R. M. WILMOTTE  
IRVING WOLFF

### Publicity Committee

C. E. BUTTERFIELD, *Chairman*

O. H. CALDWELL  
O. E. DUNLAP  
FRED EHLERT  
W. G. H. FINCH

A. H. HALLORAN  
LLOYD JACQUET  
J. F. MAHER  
DONALD McNICOL

K. B. WARNER

### Sections Committee

B. E. SHACKELFORD, *Chairman*

AUSTIN BAILEY  
I. S. COGGESHALL  
H. B. COXHEAD  
D. H. GAGE  
H. C. GAWLER

V. M. GRAHAM  
C. W. HORN  
F. A. KOLSTER  
R. H. LANGLEY  
W. D. LOUGHLIN

J. H. MILLER

(*Chairmen of Sections, ex officio*)

### Standards Committee

WILLIAM WILSON, *Chairman*

A. N. GOLDSMITH  
H. M. TURNER

A. F. VAN DYCK  
L. E. WHITTEMORE

### Tellers Committee

STUART BALLANTINE, *Chairman*

C. N. ANDERSON  
O. H. CALDWELL

R. H. MANSON  
H. P. WESTMAN, *Secretary*



## INSTITUTE NEWS AND RADIO NOTES

### September Meeting of the Board of Directors

The September meeting of the Board of Directors was held at 1:00 P.M. on the 12th in the Institute office. Those in attendance were President Hull, Treasurer Eastham, M. C. Batsel, O. H. Caldwell, Alfred N. Goldsmith, R. A. Heising, J. V. L. Hogan, C. W. Horn, C. M. Jansky, Jr., E. R. Shute, H. M. Turner, A. F. Van Dyck, William Wilson and H. P. Westman, Secretary. Twenty-three applications for the Associate grade and three for the Student grade of membership were approved.

Upon invitation, B. E. Shackelford of RCA Radiotron Company was appointed the Institute's representative on the newly formed Sectional Committee on Vacuum Tubes for Industrial Purposes which will operate under the sponsorship of the Electrical Standards Committee of the American Standards Association. The scope of the Committee's activity was given as: "Definitions, classification, methods of rating and testing, dimensions, and interchangeability of vacuum tubes for power and industrial application."

The Board expressed gratification of the effectiveness with which the Eighth Annual Convention of the Institute had been conducted.

An invitation from the Philadelphia Section for the Institute to hold its 1934 Convention in Philadelphia was accepted. The date of the convention was not decided upon. It will be considered at a future meeting of the Board of Directors.

Members of the Board of Directors present at the convention in Chicago held two meetings to discuss plans looking toward the improving of conditions of engineers in the radio industry under the National Industrial Recovery Act. A number of suggestions were made and a committee comprising President Hull as chairman, O. H. Caldwell and C. M. Jansky, Jr. was named to keep in touch with the situation and take such action as they considered desirable. Subsequently, the committee made certain recommendations to the Radio Manufacturers Association while that body was preparing its code for submission to the National Recovery Administration. However, that code was later withdrawn, and the radio industry is now operating under the code for the electrical manufacturing industry prepared by the National Electrical Manufacturers Association.

Interpretations of the provisions of the code for the electrical manufacturing industry indicate that engineers are included under it, and unless under seasonal or peak demands or cases of emergency, shall

work not more than forty hours per week. Copies are available through the National Electrical Manufacturers Association, 155 East 44th Street, New York City.

The committee appointed in Chicago will be expanded and be known as the Industrial Relations Committee. Its duties shall be to study and report to the Board of Directors on matters concerning the industrial relations of engineers with particular attention to the amelioration of the conditions under which they are working.

Petitions signed by the required number of active Institute members and naming R. H. Marriott for president and Arthur Batcheller and H. W. Houck for directors were received and accepted. The secretary was instructed to include these names in the ballots to be mailed to the membership on September 15.

The secretary was instructed to convert into cash approximately \$6000 worth of securities held by the Institute in order to permit a satisfactory cash balance to be maintained.

---

### Radio Transmission of Standard Frequencies

The Bureau of Standards transmits standard frequencies from its station WWV, Beltsville, Md., every Tuesday except legal holidays. The transmissions are on 5000 kilocycles per second. The transmissions are given continuously from 12 noon to 2 P.M., and from 10:00 P.M. to midnight, Eastern Standard Time. The service may be used by transmitting stations in adjusting their transmitters to exact frequency, and by the public in calibrating frequency standards, and transmitting and receiving apparatus. The transmissions can be heard and utilized by stations equipped for continuous-wave reception through the United States, although not with certainty in some places. The accuracy of the frequency is at all times better than one cycle per second (one in five million).

From the 5000 kilocycles any frequency may be checked by the method of harmonics. Information on how to receive and utilize the signals is given in a pamphlet obtainable on request addressed to the Bureau of Standards, Washington, D. C.

The transmissions consist mainly of continuous, unkeyed carrier frequency, giving a continuous whistle in the phones when received with an oscillating receiving set. For the first five minutes the general call (CQ de WWV) and announcement of the frequency are transmitted. The frequency and the call letters of the station (WWV) are given every ten minutes thereafter.

Supplementary experimental transmissions are made at other

times. Some of these are made at higher frequencies and some with modulated waves, probably modulated at 10 kilocycles. Information regarding proposed supplementary transmissions is given by radio during the regular transmissions.

The Bureau desires to receive reports on the transmissions, especially because radio transmission phenomena change with the season of the year. The data desired are approximate field intensity, fading characteristics, and the suitability of the transmissions for frequency measurements. It is suggested that in reporting on intensities, the following designations be used where field intensity measurement apparatus is not used: (1) hardly perceptible, unreadable; (2) weak, readable now and then; (3) fairly good, readable with difficulty; (4) good, readable; (5) very good, perfectly readable. A statement as to whether fading is present or not is desired, and if so, its characteristics, such as time between peaks of signal intensity. Statements as to type of receiving set and type of antenna used are also desired. The Bureau would also appreciate reports on the use of the transmissions for purposes of frequency measurement or control.

All reports and letters regarding the transmissions should be addressed to the Bureau of Standards, Washington, D. C.

---

### Committee Work

#### ADMISSIONS COMMITTEE

On August 2 a meeting of the Admissions Committee was held at which A. F. Van Dyck, chairman; R. A. Heising and H. P. Westman, secretary, were present. Two applications for the Fellow grade, three applications for transfer to Member, and three for admission to Member were approved.

The September meeting of the Admissions Committee was held on the 12th with A. F. Van Dyck, Arthur Batcheller, O. H. Caldwell, H. C. Gawler, C. W. Horn, E. R. Shute and H. P. Westman in attendance. One application for transfer to the grade of Member was acted upon and approved, three of eight applications for transfer to Member were approved, and four of the five applications for admission to Member were approved.

#### NEW YORK PROGRAM COMMITTEE

The New York Program Committee met on June 14, and those present were C. W. Horn, chairman; Austin Baily, H. C. Gawler, L. F. C. Horle, F. B. Llewellyn (representing R. A. Heising), Haraden Pratt, and H. P. Westman, secretary. Preparations were made for the arranging of programs for the early fall meetings.

### Personal Mention

R. M. Blair who was formerly with the Crosley Radio Corporation is now connected with the Zenith Radio Corporation.

H. S. Bueche is now head of the Department of Electrical Engineering of Villanova College at Villanova, Pa., having previously been on the staff of Kansas State College.

E. F. Carter has joined the engineering staff of Hygrade Sylvania Corporation at Emporium, Pa.

K. G. Clark of the Division of Field Operations of the Federal Radio Commission has been transferred from San Francisco to Portland, Ore.

R. C. Giese of the American Telephone and Telegraph Company has been transferred from Denver, Colo., to Chicago, Ill.

Formerly with the Naval Research Laboratory, Harold Granger joined the engineering staff of Radio Research Company of Washington, D.C.

F. G. Kear formerly with the Aeronautics Research Division of the U.S. Department of Commerce has joined the Research Department of the Washington Institute of Technology.

E. A. Laport formerly with the Westinghouse Electric and Manufacturing Company has become associated with Paul Godley of Montclair, N.J., as a consulting radio engineer.

Louis Martin formerly managing editor of Radio-Craft is now technical director and president of Short Wave Radio.

A. F. Murray formerly in the Research Division of RCA Victor Company is now with the Research Department of Philco Radio and Television Corporation, Philadelphia.

C. E. Pfautz has been made manager of the RCA Central Frequency Bureau in Washington, D.C.

E. H. Pierce, Lieutenant U.S.N., has been transferred from the U.S.S. Argonne to the Naval Research Laboratory of Bellevue, Anacostia, D.C.

V. G. Rowe inspector for the Federal Radio Commission has been transferred from San Francisco to Los Angeles.

R. F. Shea has become chief engineer of Freed Television and Radio Corporation of Long Island City, N.Y.

W. H. West formerly with KMOX has become general manager of KSD, St. Louis, Mo.





TECHNICAL PAPERS

ELECTRICAL DISTURBANCES APPARENTLY OF  
EXTRATERRESTRIAL ORIGIN\*

BY

KARL G. JANSKY

(Bell Telephone Laboratories, Inc., New York City)

*Summary*—*Electromagnetic waves of an unknown origin were detected during a series of experiments on atmospherics at high frequencies. Directional records have been taken of these waves for a period of over a year. The data obtained from these records show that the horizontal component of the direction of arrival changes approximately 360 degrees in about 24 hours in a manner that is accounted for by the daily rotation of the earth. Furthermore the time at which these waves are a maximum and the direction from which they come at that time changes gradually throughout the year in a way that is accounted for by the rotation of the earth about the sun. These facts lead to the conclusion that the direction of arrival of these waves is fixed in space; i.e., that the waves come from some source outside the solar system. Although the right ascension of this source can be determined from the data with considerable accuracy, the error not being greater than  $\pm 7.5$  degrees, the limitations of the apparatus and the errors that might be caused by the ionized layers of the earth's atmosphere and by attenuation of the waves in passing over the surface of the earth are such that the declination of the source can be determined only approximately. Thus the value obtained might be in error by as much as  $\pm 30$  degrees.*

*The data give for the coordinates of the region from which the waves seem to come a right ascension of 18 hours and a declination of  $-10$  degrees.*

INTRODUCTION

DURING the progress of a series of studies that were being made at Holmdel, N. J., on the direction of arrival of atmospherics at high frequencies,<sup>1</sup> records were obtained that showed the presence of very weak but steady electromagnetic waves of an unknown origin. The first indications of these waves were obtained on records taken during the summer and fall of 1931. However, a comprehensive study of them was not begun until January, 1932. The first complete records obtained showed the surprising fact that the hori-

\* Decimal classification: R114. Original manuscript received by the Institute, June 22, 1933. Presented under a different title at the meeting of the American Section of the U.R.S.I., Washington, D. C., April 27, 1933. Revised for publication and presented before Eighth Annual Convention, Chicago, Illinois, June 27, 1933.

<sup>1</sup> Karl G. Jansky, "Directional studies of atmospherics at high frequencies," *Proc. I.R.E.*, vol. 20, p. 1920; December, (1932). The waves referred to are those of group three in the above paper.

zontal component of the direction of arrival of these waves changed nearly 360 degrees in 24 hours, and at that time this horizontal component was approximately the same as the azimuth of the sun. These facts led to the assumption that the source of these waves was somehow associated with the sun.

Records of these waves have now been taken at frequent intervals for a period of more than a year. The data obtained from these records, contrary to the first indications, are not consistent with the suppositions made above relative to the source of the waves, but indicate that

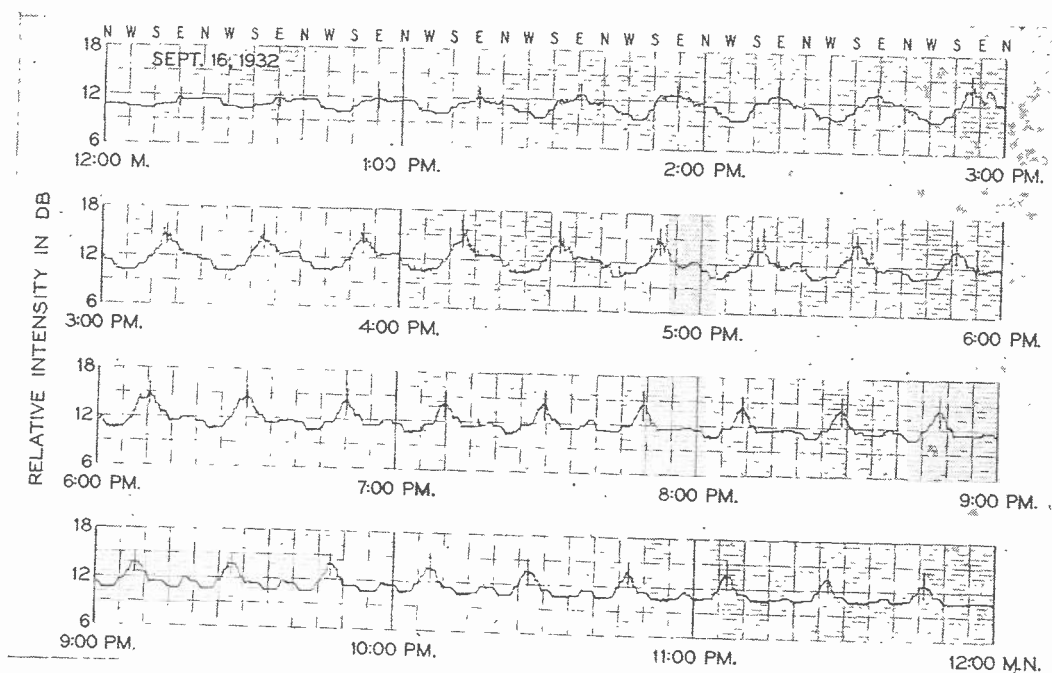

Fig. 1—Sample record of waves of extraterrestrial origin

the direction of the phenomenon remains fixed in space, that is to say, its right ascension and declination remain constant.

#### APPARATUS

The apparatus used and the type of records obtained were described in detail in a former paper.<sup>1</sup> Briefly, however, the apparatus consists of a rotating antenna array, a short-wave measuring set, and an automatic intensity recorder. The array is highly directive in the horizontal plane and is rotated about a vertical axis so that data obtained with the system, like that obtained with a loop rotating on a vertical axis, give the horizontal component of the direction of arrival of signals, but tell nothing directly about the angle the direction of arrival makes with the horizontal plane. The operation of the recorder is synchronized with that of the rotating array so that the records show directly the

horizontal component of the direction of arrival of signals as well as their intensity. The apparatus was tuned to a wavelength of 14.6 meters during all the experiments.

RESULTS

Fig. 1 shows a sample record of the waves of unknown origin obtained with this apparatus. The time at which the array was pointed in the direction from which the unknown waves come is clearly indicated on the record by the humps in the curve. The direction of the waves at those times can be determined from the scale along the top of the record.

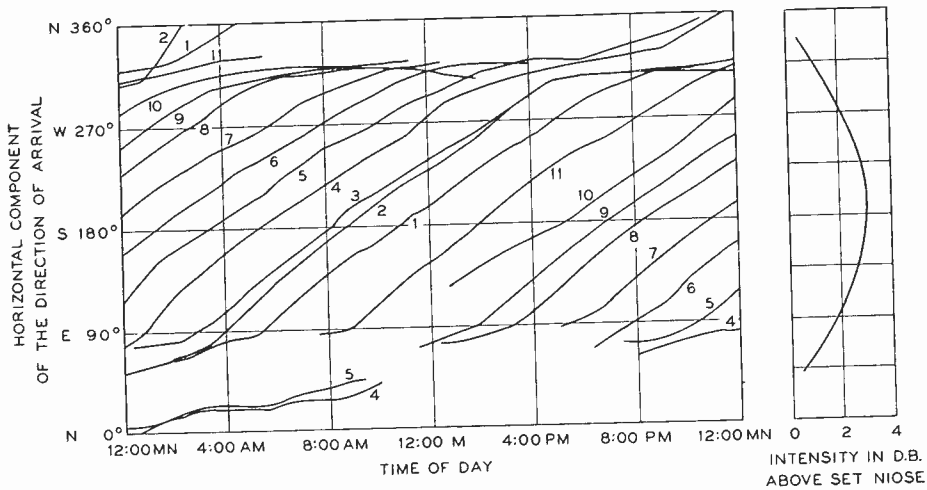

Fig. 2—Direction of arrival of waves of extraterrestrial origin.

- |                  |                  |                   |
|------------------|------------------|-------------------|
| 1. Jan. 21, 1932 | 5. May 8, 1932   | 8. Aug. 21, 1932  |
| 2. Feb. 24, 1932 | 6. June 11, 1932 | 9. Sept. 17, 1932 |
| 3. March 4, 1932 | 7. July 15, 1932 | 10. Oct. 8, 1932  |
| 4. April 9, 1932 |                  | 11. Dec. 4, 1932  |

If, now, the horizontal component of the direction of arrival is plotted against the time of day a curve similar to one of those of Fig. 2 is obtained. Thus, data from the record just mentioned constituted part of that from which curve 9 of this figure was obtained. The figure shows curves for eleven different days spaced approximately one month apart during the year 1932. There is no curve for the month of November. These curves were obtained by averaging the data taken over several consecutive days so as to eliminate the errors made in measuring the records. The day assigned to a given curve is the middle day of the group over which the data for that curve were obtained. The curve at the right in the figure shows the variation in intensity of the waves plotted against the direction of arrival.

This figure shows: first, that the horizontal component of the direction of arrival changes nearly 360 degrees in 24 hours, and, then that

there is a uniformly progressive shift of the curves to the left from month to month which at the end of one sidereal year brings the curve back to its initial position. These facts show that the waves come, not from the sun, but from a direction which remains constant throughout the year.

### DISCUSSION

To show that this is the necessary conclusion it will be necessary to digress a little from the subject and discuss the celestial sphere and celestial coördinates.

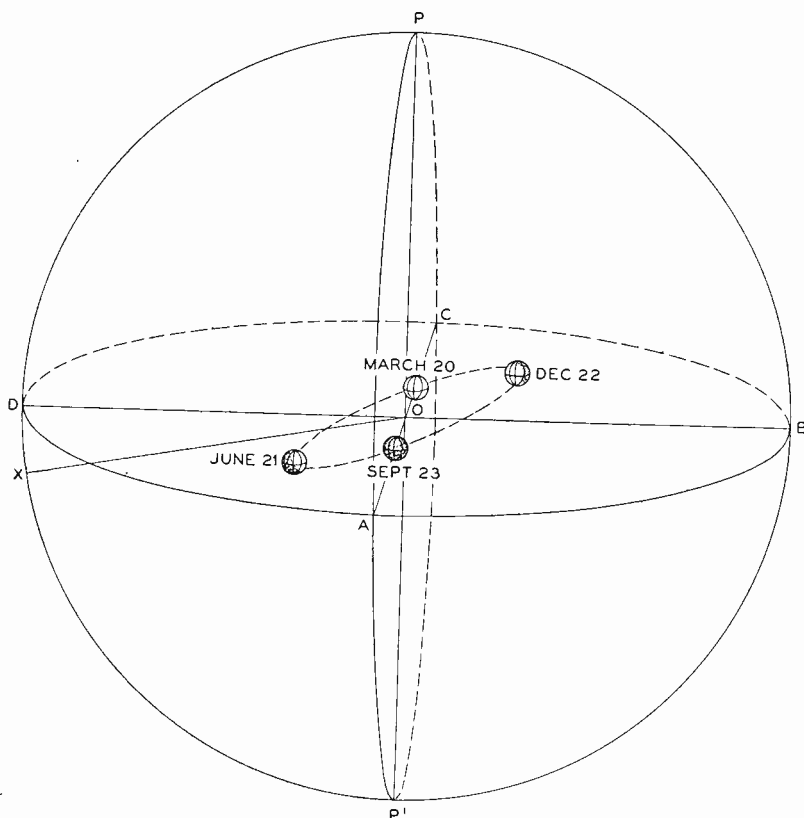

Fig. 3—Graphical representation of the celestial sphere.

The celestial sphere is that hypothetical sphere surrounding the earth upon which all the stars, whatever their distances, appear to be located. The direction of a star, then, is described by giving its apparent position on the celestial sphere, and its position on the sphere is given in terms of a pair of angles called the right ascension and declination of the star. Fig. 3 shows a graphical representation of the celestial sphere with the earth in its orbit around the sun at the center. The plane  $ABCD$  represents the plane of the celestial equator and  $POP'$  the axis of the celestial sphere.<sup>2</sup> Right ascension is measured in hours

<sup>2</sup> For a more complete explanation of the system of coördinates used in this discussion see Russell-Dugan-Stewart, "Astronomy," vol. 1, chap. 1 or the opening chapters of any textbook on astronomy.

around the circle *ABCD* eastward from the line *OA* as reference. The line *OA* is determined by the direction of the sun from the earth at the time it crosses the equator on the first day of spring. Thus the line *OA* lies at 0 hours, *OB* at 6 hours, *OC* at 12 hours, and *OD* at 18 hours; 24 hours of right ascension being equal to 360 degrees. Declination is measured in degrees above or below the equatorial plane, plus, if it is above the plane and minus, if below. The positions of the earth with

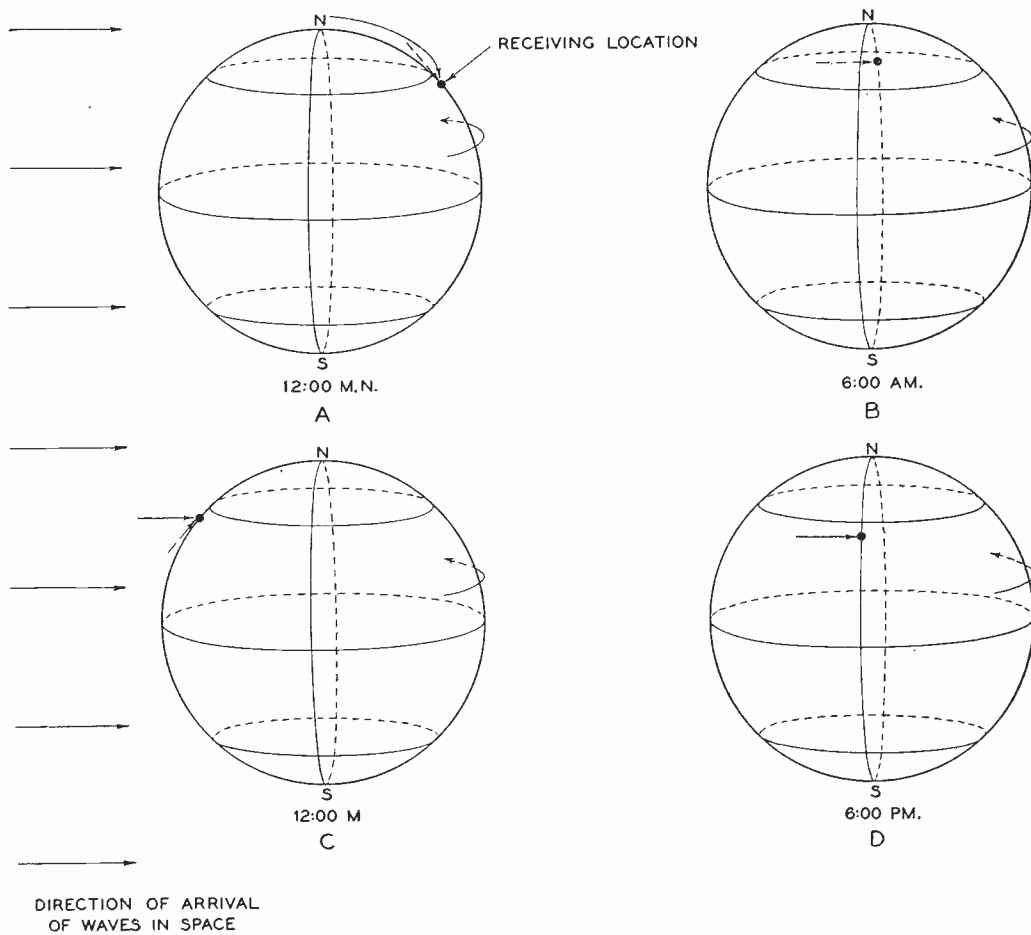

Fig. 4—The effect of the daily rotation of the earth on the direction of arrival as measured at the receiving location.

respect to the sun for the first day of each season are shown. Since the diameter of the earth's orbit is so small with respect to the distances to the stars, it is assumed that the earth is always at the center of the sphere at 0 and the rest of this discussion is based on that assumption. Accordingly, the plane of the celestial equator coincides with that of the earth's equator and the axis of the celestial sphere coincides with the earth's axis.

Now, if there were radio waves coming from a direction fixed in space and from a source so far removed from the sun that the direc-

tions of propagation throughout the whole solar system were substantially parallel, if there were no distortion in direction suffered by the waves during their passage through the ionized layers of the earth, if these waves had the ability to bend around the earth, and if there were no other unexplained phenomena taking place, then, for this idealized case, the horizontal component of the direction of arrival as measured at the receiving location would change 360 degrees during one complete rotation of the earth. Let us assume for the sake of argument that the right ascension of the direction of arrival of these idealized waves is 18 hours and its declination 0 degrees, that direction

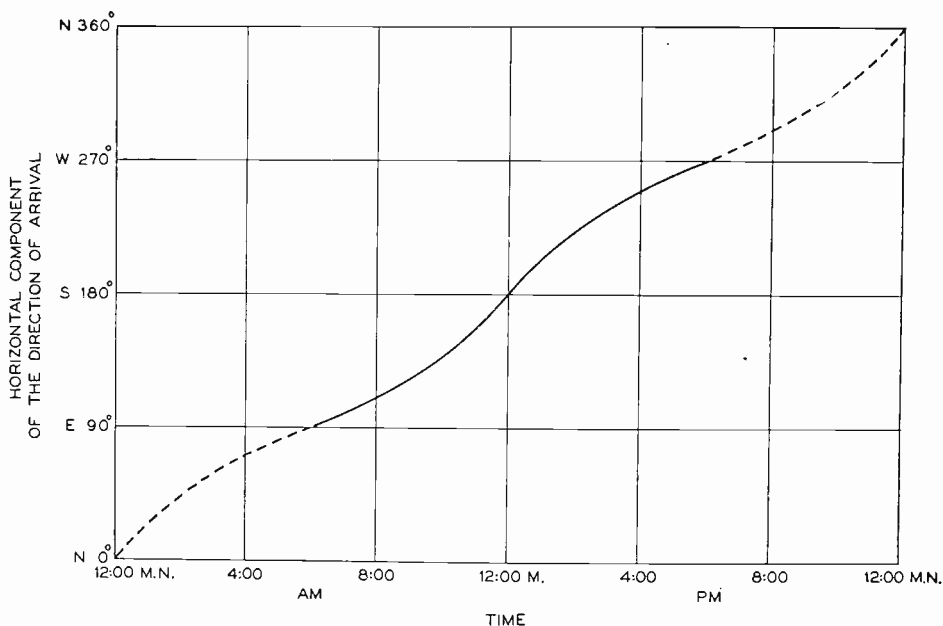

Fig. 5—Theoretical curve of the direction of arrival of idealized waves having a right ascension of 18 hours and a declination of 0 degrees.

represented by the line *DO* in Fig. 3. Then at midnight on the first day of winter, the relation between the direction of arrival and the location of the receiver will be as shown at *A* in Fig. 4. Since the receiver lies in north latitude 40 degrees 22 minutes and the declination of the direction or arrival of the waves is 0 degrees, then at the instant represented the horizontal component of the direction of arrival would be north as shown by the broken arrow. Six hours later the condition shown at *B* would exist and the horizontal component of the direction of arrival would coincide with the true direction and would be east. After another six hours, the direction of arrival would coincide with the meridian of the receiver, and its horizontal component would be south as shown by the broken arrow at *C*, after six hours more it would be west as at *D*, and finally after a complete rotation of the earth it would be back to north again. Or, if this horizontal component of the

direction of arrival were plotted against time of day, a curve like that shown in Fig. 5 would be obtained. The curve is dotted for that portion of the time during which the earth would be between the source of the waves and the receiver. As will be seen from the figure, the horizontal component of the direction of arrival changes 360 degrees in about 24 hours, or in exactly 23 hours and 56.06 minutes since that is the time required for the earth to make one complete revolution with re-

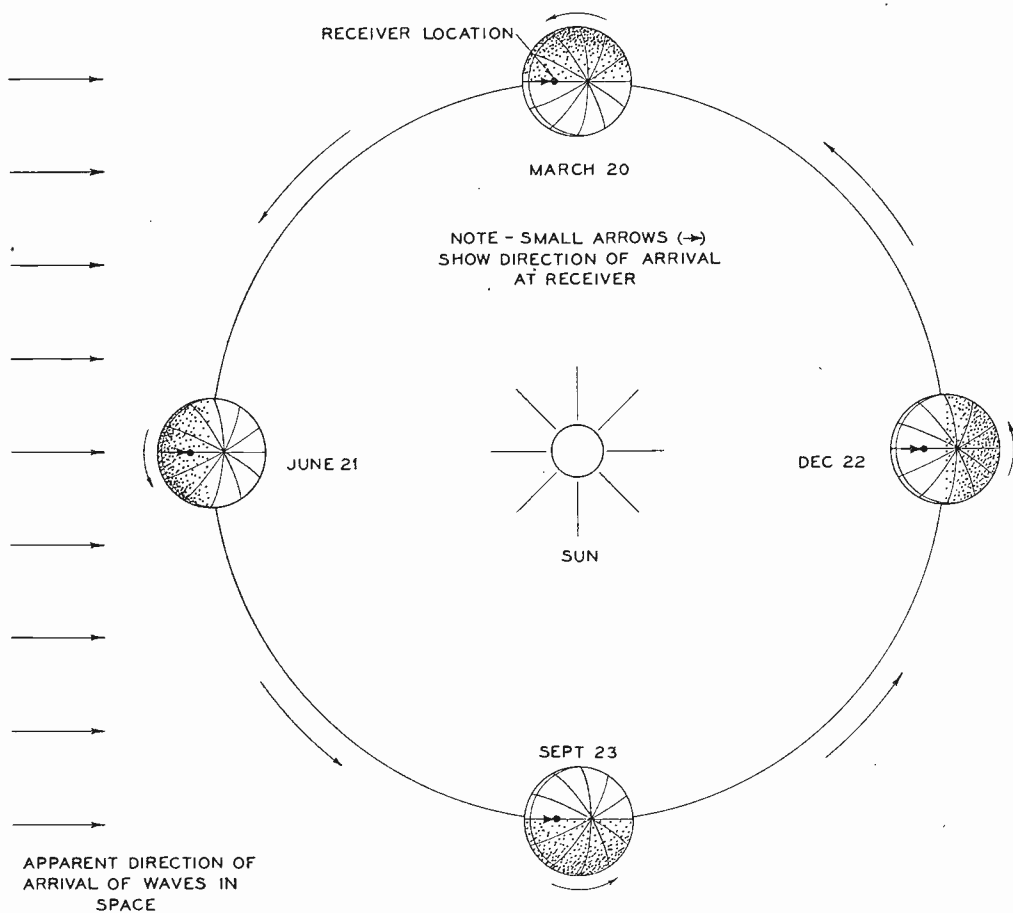

Fig. 6—The effect of the earth's orbital motion on the direction of arrival as measured at the receiving location.

spect to the stars. It is this difference between the length of the sidereal day and the mean solar day (3.54 minutes of solar time) that accounts for the uniformly progressive shift of the curves of Fig. 2 to the left.

Fig. 6 will illustrate just how this shift takes place. This figure shows the earth in its orbit around the sun as seen from above. If, as has been assumed, the direction of arrival of the waves has a right ascension of 18 hours, they can be represented by some such group of arrows as shown at the left in the figure. When the earth is in the position shown for June 21 then, regardless of the declination of the direc-

tion of arrival of the waves, the time at which this direction of arrival will coincide with the meridian of the receiver will be at midnight. On September 23 this time of coincidence will occur six hours earlier at 6:00 P.M. On December 22 it will occur another six hours earlier or at 12:00 noon and on March 20 it will occur at 6:00 A.M. Consequently if a curve like the one of Fig. 5 is plotted for every month of the year a family of curves like that of Fig. 7 will be obtained where each curve occurs approximately two hours earlier than the one for the preceding month. Note the similarity between this family of curves and that of Fig. 2.

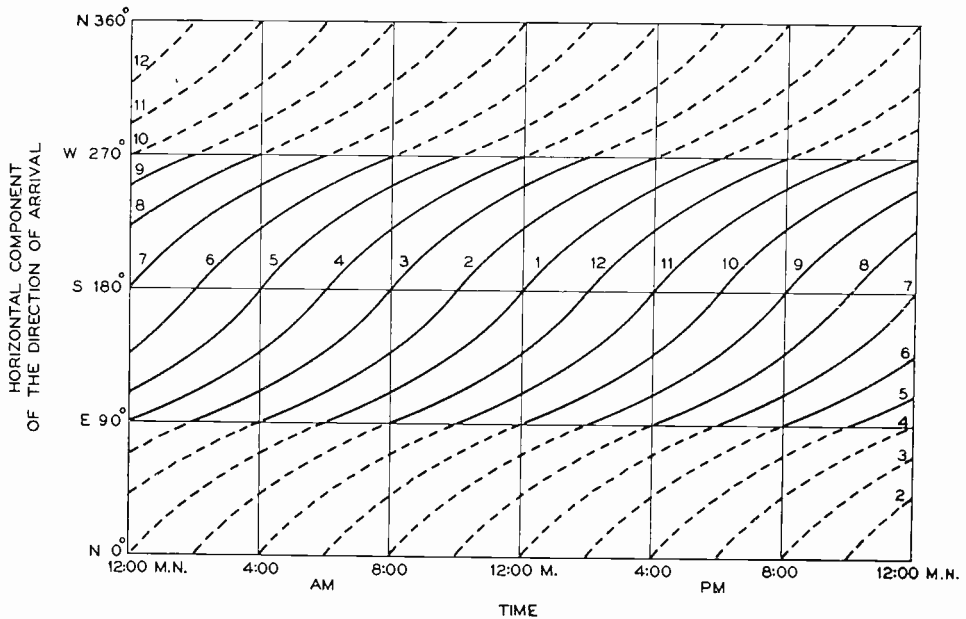

Fig. 7—Theoretical curves for twelve months of the direction of arrival of idealized waves having a right ascension of 18 hours and a declination of 0 degrees.

- |             |             |              |
|-------------|-------------|--------------|
| 1. Dec. 22  | 5. April 21 | 9. Aug. 22   |
| 2. Jan. 21  | 6. May 21   | 10. Sept. 23 |
| 3. Feb. 21  | 7. June 21  | 11. Oct. 23  |
| 4. March 20 | 8. July 22  | 12. Nov. 22  |

It will be shown later that for idealized waves having a direction of arrival the declination of which is between  $-40$  degrees, 22 minutes and  $+40$  degrees, 22 minutes the horizontal component of the direction of arrival is south when, and only when, the direction of arrival coincides with the meridian of the receiver. Therefore, the times at which the curves of Fig. 7 cross the line whose ordinate is 180 degrees (south) are spaced approximately two hours apart, and if these times are plotted against the day of the year represented by each curve the points will all lie on a straight line<sup>3</sup> the slope of which will be  $365.25/24$  days per hour.

<sup>3</sup> Strictly speaking the line should not be exactly straight. Of the many reasons why this is so the most important is that the earth's motion in its orbit



It will be shown later that the declination of the direction of arrival of the waves detected by the measuring equipment is between the values of  $-40$  degrees, 22 minutes and  $+40$  degrees, 22 minutes. Consequently, if the right ascension remains constant then points obtained from Fig. 2 in a manner exactly similar to that just explained should fall on a straight line the slope of which should be  $365.25/24$  days per hour. It was in this manner that the points of Fig. 8 were obtained. The

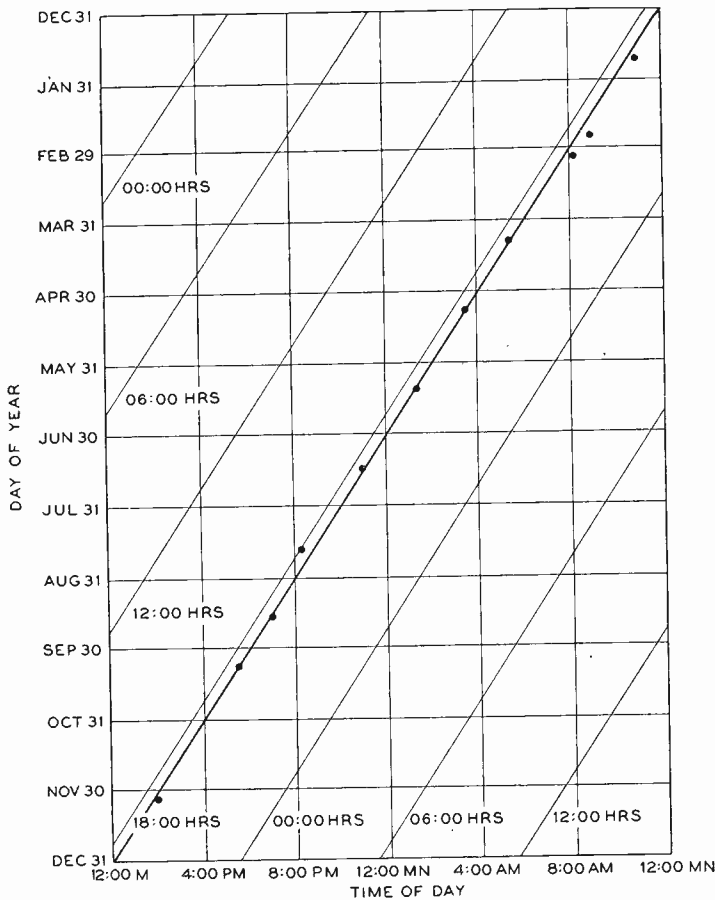

Fig. 8—Time of coincidence of the direction of arrival and the meridian of the receiver for the different days of the year.

correspondence of the points with the heavy line, the slope of which is  $365.25/24$  days per hour, cannot be accidental and proves that the right ascension of the direction of arrival of the waves is constant. The position of this heavy line on the graph is determined by the value of the right ascension. Thus the position of the curves corresponding to a right ascension of 0 hours, 6 hours, 12 hours, and 18 hours are shown by the light diagonal lines on the figure.

is not uniform. However, the effects are all so small that the greatest deviation would be scarcely perceptible on the curve so they will not be considered in this discussion.

From the relative positions of the heavy line and the light lines it will be seen that the measured direction of arrival occurs at a right ascension of approximately 18 hours, 30 minutes; however, because the mechanism of the recorder takes a finite time to record the field strength values, the directions measured on these records lag behind the true directions by a value varying from 4 degrees to 9 degrees. If the measured values are corrected for this error the right ascension of the direction of arrival becomes approximately 18 hours.<sup>4</sup>

Referring to Fig. 3, if the direction of arrival has a right ascension of 18 hours then it must lie in that half of the plane  $PDP'B$  to the left of  $PP'$ . One such direction is represented by the line  $XO$  in the figure.

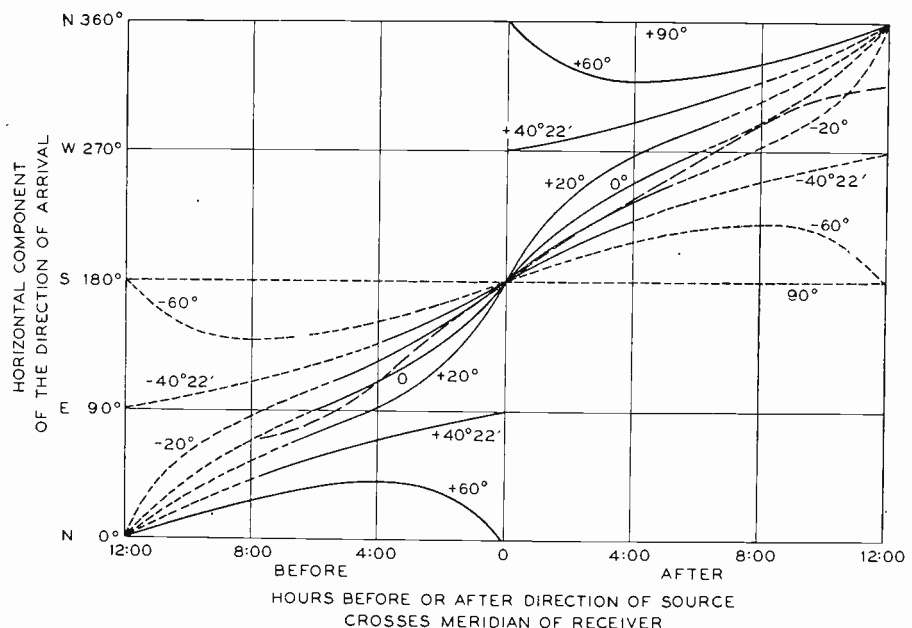

Fig. 9—Comparison between the actual curve of the horizontal component of the direction of arrival and the theoretical curves for different declinations.

The curve of Fig. 5 was drawn for the idealized waves having a declination of 0 degrees. Obviously, the shape of the curves would be considerably different for waves having different declinations. Fig. 9 shows the theoretical curves for several different declinations. In this figure the horizontal component of the direction of arrival is plotted against time, but here the time is given not in terms of the hours of the day but in terms of the time interval before and after the direction of arrival coincides with the meridian of the receiver. The values of declination used for the different curves are given in the figure. As before, the curves are dotted for that portion of the time during which

<sup>4</sup> The limit of error has not been exactly determined but is certainly not greater than  $\pm 7.5$  degrees, which is equivalent to  $\pm 30$  minutes of right ascension.

the earth would be between the source of the waves and the receiver.

For the purpose of making a comparison between these curves and those of Fig. 2, an average of the curves of Fig. 2 is shown in Fig. 9 by the broken line. It will be seen that for the greater part of the time during which the direction of arrival is above the horizon it lies between the curves for a declination of 0 degrees and  $-20$  degrees, giving a value of roughly  $-10$  degrees for the declination of the direction of arrival of the waves. In Fig. 3 the line *XO* is drawn with a declination of  $-10$  degrees and right ascension of 18 hours so that it represents the apparent direction of arrival of the waves.

Beyond the point where the direction of arrival drops below the horizon, the average curve is not at all similar to the theoretical curves of Fig. 9. However, for that portion of the curves the intensity is very weak (see the curve at the right in Fig. 2) and the directions cannot be measured very accurately. Furthermore, as the time interval before or after the direction of arrival coincides with the meridian of the receiver is increased, the waves must travel through an increasing thickness of the earth's atmosphere so that any bending of the waves caused by the ionized layers would increase also. At the time the direction of arrival coincides with the meridian of the receiver this bending is confined to the plane determined by the right ascension of the direction of arrival, and will therefore cause no error in the measurement of the right ascension if the data used for its determination are taken at this time, as has been done. It may, however, affect the measurement of the declination. At all other times, whatever bending the waves suffer will cause errors in both measurements and this bending might be the cause of the difference between the theoretical and actual curves noted.

It may very well be that the waves that reach the receiver instead of coming from a single point fixed in space originate in the earth's atmosphere, but are secondary radiations caused by some primary rays of unknown character, coming from a source or sources fixed in space, and striking the earth's atmosphere. If this is so the disturbance measured by the receiver is probably the summation of very many waves of various intensities coming from secondary sources in the earth's atmosphere that are scattered over a considerable area. In this case the declination of the source of the primary rays may be considerably different from that obtained from the curves; however, the measurement of its right ascension would not be affected appreciably if made in the manner described above.

On the other hand it may be that the waves that reach the receiver are the primary waves themselves coming from a great many sources scattered throughout the heavens. In this case the direction

measured would be the direction of the center of activity, and as before, the value of the right ascension would be accurate in spite of the bending of the rays in the ionized layers, and the declination would be in error by an amount equal to that for a single source at the center of activity.

From a consideration of the data and the method of interpretation it is believed that, in spite of the possible errors mentioned in the above cases, the declination of the source or center of activity, if there is more than one source, as measured would be accurate within an error not greater than  $\pm 30$  degrees.

The apparent direction of arrival of the waves has not as yet been definitely associated with any region fixed in space; however, there are two such regions that should be seriously considered. The point on the celestial sphere of right ascension 18 hours and declination  $-10$  degrees, the direction from which the waves seem to come, is very near the point where the line drawn from the sun through the center of the huge galaxy of stars and nebulae of which the sun is a member would strike the celestial sphere. The coördinates of that point are approximately right ascension of 17 hours, 30 minutes, declination  $-30$  degrees (in the Milky Way in the direction of Saggitarius<sup>5</sup>). It is also very near that point in space towards which the solar system is moving with respect to the other stars. The coördinates of this point are right ascension 18 hours and declination  $+28$  degrees.<sup>6</sup> Whether or not the actual direction of arrival of the primary rays coincides with either of these directions cannot be determined definitely until some method of accurately measuring their declination is devised and the measurements made.

In conclusion, data have been presented which show the existence of electromagnetic waves in the earth's atmosphere which apparently come from a direction that is fixed in space. The data obtained give for the coördinates of this direction a right ascension of 18 hours and a declination of  $-10$  degrees.

The experiments which are the subject of this paper were performed at Holmdel, N. J. (Latitude  $40^{\circ} 22' N$  and Longitude  $74^{\circ} 10' W$ ) during the year 1932.

#### ACKNOWLEDGMENT

The writer wishes to acknowledge the help of Mr. A. M. Skellett, also of the Bell Telephone Laboratories, in making some of the astronomical interpretations of the data.

<sup>5</sup> H. Spencer Jones, "General Astronomy," pp. 358, 359; Forest Ray Moulton, "Astronomy," pp. 479, 504-509.

<sup>6</sup> Russel-Dugan-Stewart, "Astronomy," vol. 2, p. 661.

## A PIEZO-ELECTRIC LOUD SPEAKER FOR THE HIGHER AUDIO FREQUENCIES\*

BY

STUART BALLANTINE

(Boonton Research Corporation, Boonton, New Jersey)

FOR the faithful electrophonic reproduction of the sounds of speech and music over a wide range of frequencies the advantages of employing several electrophone units, designed for optimum efficiency throughout different portions of the frequency range, are well recognized. The present paper is concerned with a description of an electrophone unit adapted for the reproduction of the higher audible frequencies and suitable for use as a component of such a composite reproducing system.

A coil-driven horn-type loud speaker unit for this purpose has been described by Bostwick.<sup>1</sup> The present instrument is of the horn type and is driven by a piezo-electrically active diaphragm built up of crystals of Rochelle salt (sodium potassium tartrate).

The piezo-electric effect in Rochelle salt is enormously greater than that exhibited by other materials. It is, however, somewhat more capricious in its dependence upon temperature, humidity, polarization, and variation from specimen to specimen. It also exhibits hysteresis and saturation. These properties of the clear homogeneous crystal have been investigated by Cady, Anderson, Valasek<sup>2</sup> and others. According to Sawyer<sup>3</sup> the undesirable effects of saturation and hysteresis may be sufficiently reduced by limiting the piezo-electric strain and securing mechanical magnification of the limited strains by employing two or more crystal sections acting in opposition as in the familiar bimetallic thermostat. This principle of opposed sections has been applied by Sawyer and his associates<sup>4</sup> in the construction of transducer elements in a number of electromechanical devices such as microphones, loud speakers, phonograph pick-ups, recorders, etc. In the present case torque-responsive units of this "bimorph" type are employed.<sup>5</sup>

\* Decimal classification: R365.2. Original manuscript received by the Institute, July 7, 1933.

<sup>1</sup> L. G. Bostwick, *Jour. Acous. Soc. Amer.*, vol. 2, p. 242, (1930).

<sup>2</sup> Valasek, *Phys. Rev.*, vol. 17, p. 475, (1921); vol. 19, p. 478, (1922); vol. 20, p. 639, (1922); vol. 24, p. 560, (1924).

Frayne, *Phys. Rev.*, vol. 21, p. 348, (1923).

Sawyer and Tower, *Phys. Rev.*, vol. 35, p. 269, (1930).

<sup>3</sup> C. B. Sawyer, *Proc. I.R.E.*, vol. 19, p. 2022, (1931).

<sup>4</sup> A. L. Williams, *Electronics*, p. 166, May, (1932).

<sup>5</sup> C. B. Sawyer, U. S. Patent 1,803,275, April 28, (1931).

The principal piezo-electric effect in a plate cut from a clear homogeneous crystal of Rochelle salt for fields applied along the electric axis is shown in Fig. 1. The orientations of the principal axes of the crystal

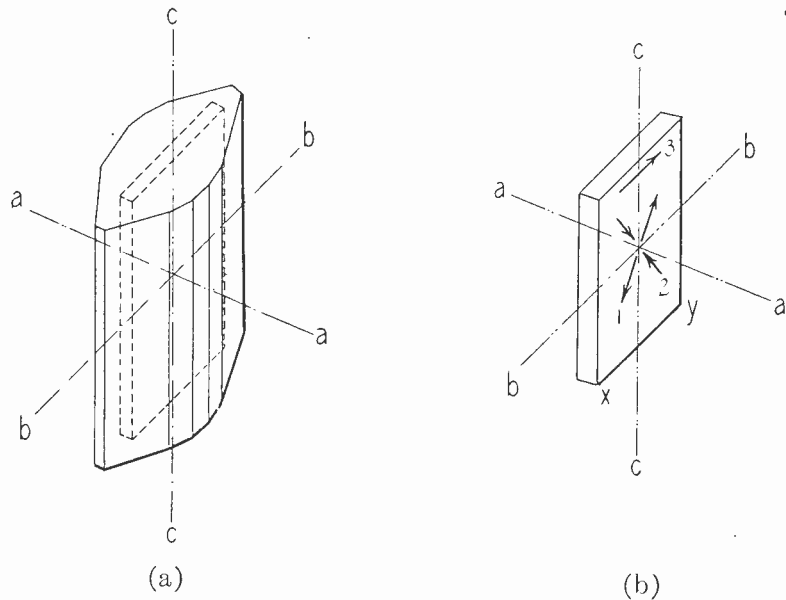

Fig. 1—(a) Orientation of plate cut from crystal of Rochelle salt with respect to the principal axes; (b) illustrating principal piezo-electric strains in Rochelle-salt plate due to an electric field along the electric (*a*) axis.

from which the plate Fig. 1 (b) is cut are illustrated in Fig. 1 (a). The plate is cut so that its plane is normal to the electric axis *a* and its sides are parallel to the *b* and *c* axes. If the crystal plate is subjected to an electric field along *a* it tends to be strained in directions 45 degrees to

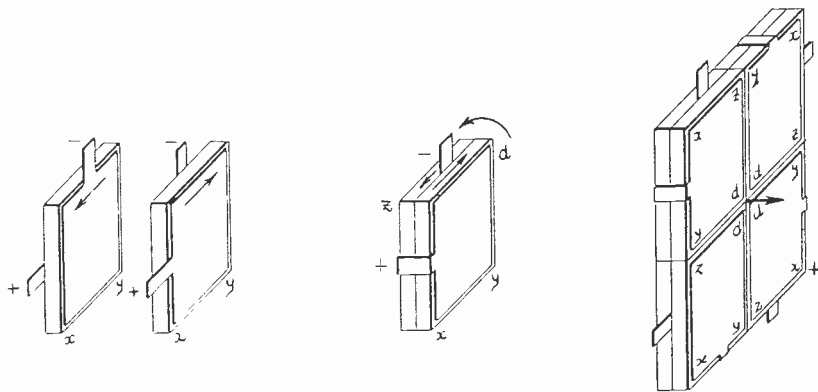

Fig. 2—(a) Illustrating formation of a torque-sensitive piezo-electric element from opposed shear-responsive Rochelle-salt plates; (b) piezo-electric diaphragm comprising four torque-sensitive elements.

the *b* and *c* axes, as shown by the arrows 1 and 2. If the lower corners *x* and *y* are clamped this results in a motion of the upper edge in shear as shown by the arrow 3. Fig. 2 shows two such shear-responsive plates provided with metal foil electrodes and so oriented that their resultant

motions are in opposition as shown by the arrows on their upper edges. If the juxtaposed faces are cemented together and the edge  $xy$  is clamped the upper corners of the assembly will now tend to twist in response to a potential difference between the foil electrodes. If one of the upper corners  $z$  is also clamped, the remaining corner  $d$  will move in a direction normal to the plane of the crystals as shown by the arrow.

Four of the torque-responsive units of Fig. 2 are now cemented together at their edges to form the square assembly shown in Fig. 2b. When this is clamped at the periphery, or at the corners  $x, y, z$ , the central parts  $d$  tend to move in and out normally to the plane of the assembly. The cement used in the quadrantal assembly should be capable of forming an air-tight seal without crevasses but at the same time should retain sufficient resiliency to avoid undue constraints to

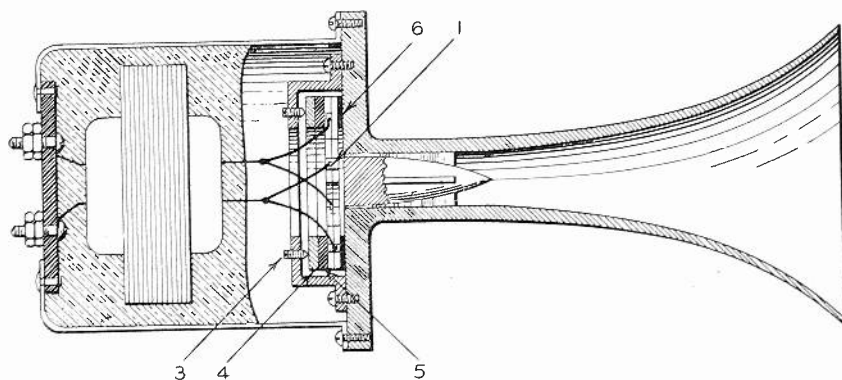

Fig. 3—Section through piezo-electric loud speaker.

the motion of the component units. This self-actuating diaphragm is the driving unit of the loud speaker.

A longitudinal central section through the loud speaker is shown in Fig. 3. The piezo-electric diaphragm (Fig. 2b) is shown at 1. Proper clearance between this and the base of the horn is provided by the annular spacer 6. The whole assembly is clamped by means of the screws 3 acting upon the annular clamping ring 4 and compressible ring 5. There is an optimum clamping pressure for maximum sound output. An impedance-matching transformer is enclosed by the cover. Sound-absorbing material may be provided to absorb the sound radiated by the rear of the diaphragm if necessary. The sound is radiated by a horn of exponential section. A bullet-shaped insert, supported by four longitudinal fins in the throat of the horn, is provided to form the usual annular throat passage.

The equivalent electrical circuit of the dynamical system of the loud speaker is shown in Fig. 4.  $F$  represents the force due to the piezo-electric effect.  $m_1$ ,  $c_1$ , and  $r_1$  represent the effective mass, compliance,

and resistance of the crystal diaphragm.  $r_1$  also includes the resistance reflected from the electrical supply circuit.  $c_2$  represents the compliance due to the throat chamber

$$c_2 = 7 \times 10^{-7} t / S_d$$

where  $t$  is the clearance between diaphragm and the base of the horn and  $S_d$  the effective area of the diaphragm.  $r_2$  represents the resistance due to the radiation of sound by the horn:

$$r_2 = 41.6 S_d^2 / S_t.$$

$S_t$  represents the area of the horn throat.  $v$  represents the velocity of the diaphragm and  $v_t = S_d v / S_t$  the velocity in the horn throat. The voltage drop across  $r_2$  is to be identified with the total pressure in the horn throat ( $= p S_t$ ). The sound pressure at a point on the axis of the

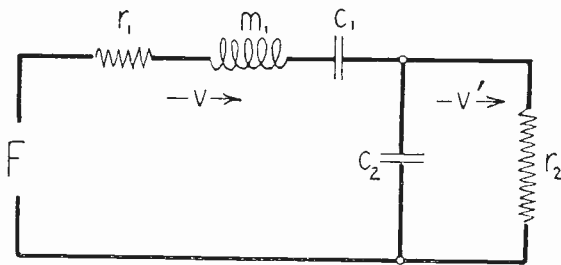

Fig. 4—Electrical circuit equivalent for loud speaker.

horn at a sufficient distance from the mouth (several wavelengths) to avoid diffraction effects will be roughly proportional to the product of the throat pressure and the frequency. The acoustic power output is proportional to the square of the throat pressure and, except for this, is independent of the frequency. If the design is such as to produce a constant acoustic power output the sound pressure on the axis will be roughly proportional to the frequency. This is due to the effect of diffraction whereby the sound at high frequencies tends to become concentrated along the axis.

The system in Fig. 5 is resonant at two frequencies  $f_1$  and  $f_2$  such that

$$f_1 = \frac{1}{2\pi} \sqrt{\frac{1}{c_1 m_1}} ; \quad f_2 = \frac{1}{2\pi} \sqrt{\frac{c_1 + c_2}{m_1 c_1 c_2}} .$$

The compliance  $c_2$  is large compared with that of the diaphragm so that  $f_1$  and  $f_2$  are close together. The dimensions of the crystals are selected for resonance at about 8000 cycles. In these circumstances at frequencies below and not too near the resonant frequency the throat velocity will vary approximately as the frequency and the axial sound



pressure in the sound field will increase approximately as the square of the frequency.

The sound-pressure—frequency characteristic of the loud speaker, with constant applied voltage across the crystals, is shown in Fig. 5. The mouth of the horn was terminated in a plane baffle. The various curves represent the sound pressures at points at constant distance from the mouth of the horn but in different angular directions with respect to the axis. It will be observed that the sound pressure on the axis varies approximately as the square of the frequency.

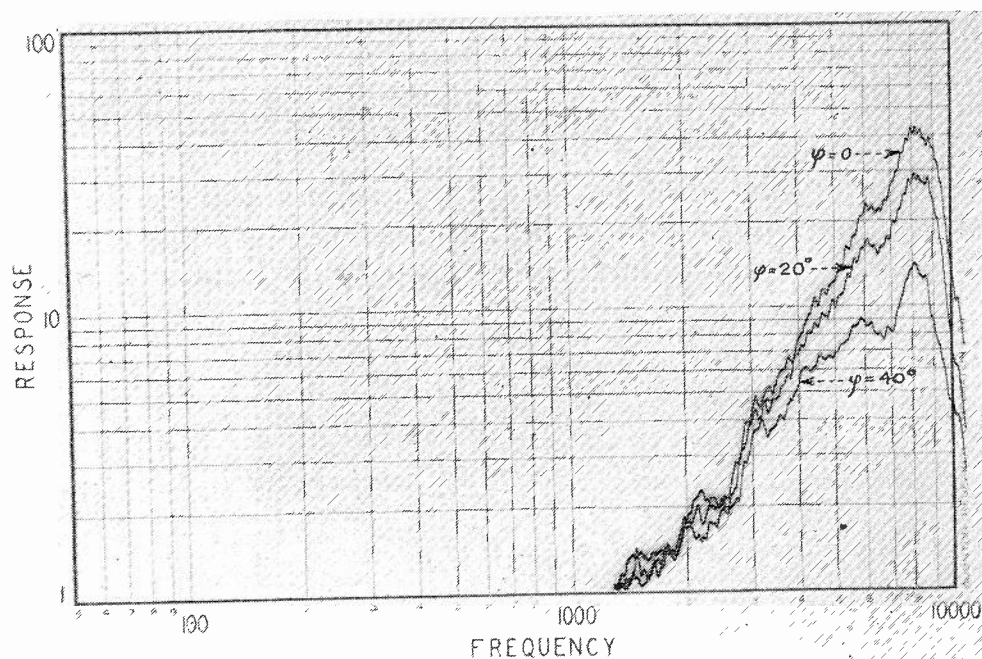

Fig. 5—Sound-pressure—frequency characteristic for constant applied voltage.

When the loud speaker is connected to a source having an internal resistance the voltage across the crystals has a tendency to fall off with increasing frequency and the sound pressure rises with frequency less rapidly than in the constant voltage curves of Fig. 5. It is possible to regulate the rate of rise over wide limits by suitable design of the electrical supply circuit. For many purposes a sound-pressure characteristic is desired which is uniform over a definite frequency range, diminishing sharply at each end. This kind of characteristic may be secured by means of the circuit shown in Fig. 6. The inductor  $L$  is chosen to resonate with the capacity of the crystals at some frequency lower than the resonant frequency of the horn. A proper impedance match with the generator resistance  $R$  is obtained by means of the transformer  $T$ . The inductance  $L$  may, of course, be built into  $T$  as leakage reactance.

In this way the power absorbed by the loud speaker at frequencies below its resonant frequency may be increased and the characteristic leveled off. A family of sound-pressure characteristics obtained by this method is shown in Fig. 7, where the various curves correspond to dif-

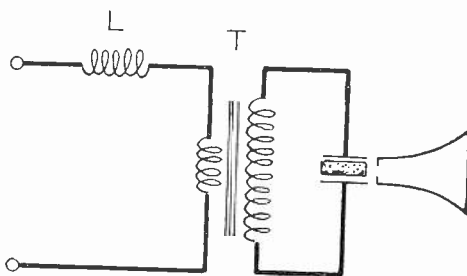

Fig. 6—Method of obtaining flat frequency—sound-pressure characteristic by means of series tuning inductance.

ferent values of the series inductance  $L$ . It will be observed that a flat response over a definite range may be secured, the range increasing with  $L$  and the response level decreasing with the increase in range.

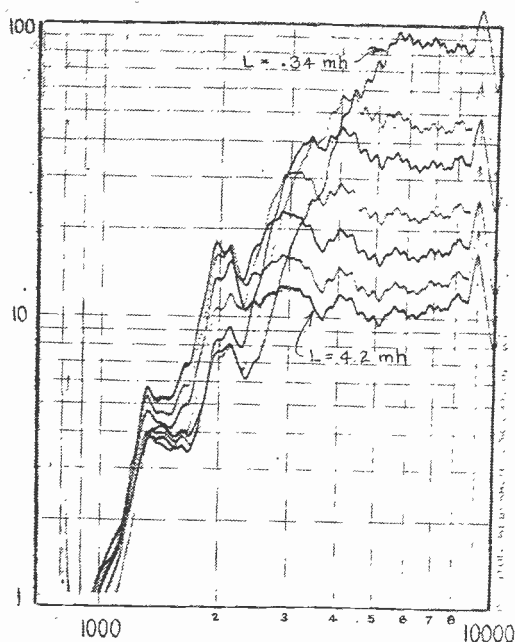

Fig. 7—Sound-pressure—frequency characteristic of loud speaker connected as shown in Fig. 6 showing effect of various series inductances in flattening response characteristic.

The response may also be leveled off by resonating *above* the resonant frequency of the crystals.

In the case of a high impedance source an impedance match may be effected by tuning with a shunt inductance instead of a series inductance.

The impedance frequency characteristics of the loud speaker are shown in Fig. 8 where the reactance has been plotted against resistance to indicate the motional impedance characteristics. The dotted curve represents the values obtained in air. A second curve (solid) was taken in a vacuum with the acoustical radiation load removed from the diaphragm for the purpose of determining the electro-acoustical efficiency.<sup>6</sup> The electro-acoustical efficiency is the ratio of the acoustical output to the total power supplied by the horn. The latter is made up of several components; the electrical losses in the quiescent crystals

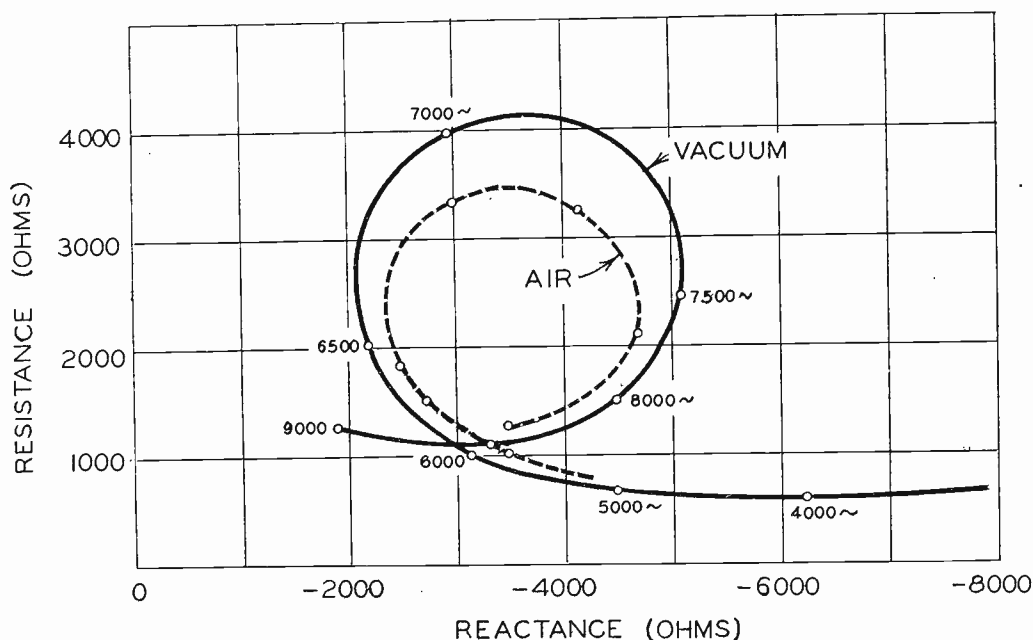

Fig. 8—Impedance characteristics of loud speaker in air and in vacuum.

(equivalent resistance,  $R_e$ ); the mechanical losses in the crystals and the acoustical radiation.

$$\text{Electro-acoustical efficiency} = \frac{R_m'}{R_e + R_m'} \left[ 1 - \frac{R_m'}{R_m} \right]$$

where  $R_m'$  = diameter of the motional impedance circle in air and  $R_m$  = diameter in vacuum. At mechanical resonance the electro-acoustical efficiency, in the case of Fig. 8, reaches about 14 per cent. Of the remaining energy, 32 per cent is electrical loss in the crystals and 54 per cent mechanical loss. The conversion efficiency is 68 per cent. The loss of sound from the rear of the crystal diaphragm is negligible.

In view of the pronounced effects of temperature upon the piezo-electric properties of Rochelle salt which have been reported by

<sup>6</sup> This method of determining the true efficiency is due to E. D. Cook, *Gen. Elec. Rev.*

Valasek, Frayne and others it was considered advisable to investigate this for the completed loud speaker. The microphone and loud speaker were set up in a small sound-treated enclosure. The temperature of the loud speaker was varied by varying the temperature of the air in the enclosure. Previous investigation had established the temperature coefficient of the condenser microphone and the corrections were negligibly small over the range employed. The results of a typical run are shown in Fig. 9. This represents the relation between the axial sound pressure and temperature of the crystals for constant applied voltage. The curves published by Valasek<sup>7</sup> for a number of different specimens of Rochelle salt show a decrease in piezo-electric activity which starts suddenly at 20 degrees centigrade. No effect of this kind was observed.

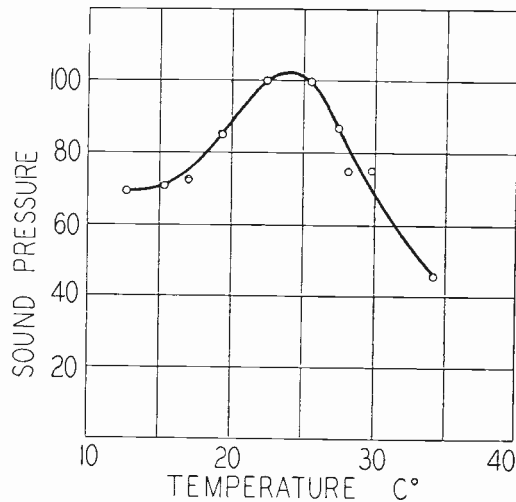

Fig. 9—Effect of temperature.

The maximum effect in Fig. 9 occurs at about 25 degrees centigrade which is in agreement with the maximum for the dielectric constant observed by Frayne.<sup>2</sup> With reasonable precautions as to installation it is felt that the variation in output with temperature shown in Fig. 9 will not be severe enough to cause any practical inconvenience. From this viewpoint the maximum is very fortunately situated on the temperature scale.

A composite reproducer (unmounted) employing the piezo-electric unit and designed for use in high fidelity radio broadcast receivers and for monitory purposes in radio broadcast studios, is shown in Fig. 10. The axial sound-pressure characteristic is shown in Fig. 11. The piezo-electric high-frequency unit is associated with a direct-radiating coil-driven cone specially designed for smooth response up to 3000 cycles with a rather abrupt cut-off beyond that point. The contributions of

<sup>7</sup> Valasek, *Phys. Rev.*, vol. 19, p. 478, (1922).

the separate units in the range of common response are represented by the dotted lines. The units are simply connected in parallel with a tuning inductance included in the small horn circuit. No filter circuits are required. By limiting the range of frequencies over which the response characteristics of the units overlap diffraction effects in the plane of a line joining the centers of the units are reduced. For the same reason the units are mounted as close together as possible and for ordinary purposes disposed one above the other. This gives a more uniform distribution of sound horizontally.

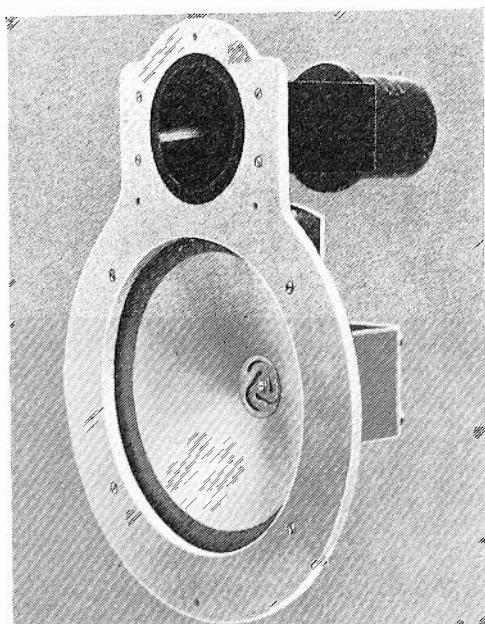

Fig. 10—BRC Model 3 high fidelity reproducer comprising coil-driven cone for low frequencies and piezo-electric loud speaker for higher frequencies.

This piezo-electric high-frequency unit provides a convenient means of extending the frequency range of existing equipment in cases where the range is limited only by the existing loud speaker and not by the other parts of the system. It is simply connected in parallel with the existing speaker and the series inductor adjusted for the best match. The installation is further simplified by the fact that no field excitation or polarization voltages are required. A simple and effective tone control is provided by a switch used to open and close the high-frequency horn circuit. This is especially desirable in radio broadcast reception of weak stations to limit the audibility of fluctuation and other noises. Cutting out the high-frequency unit in the Fig. 10 reproducer, for example, restricts the range to 3000 cycles which practical experience has shown to be a good compromise in the presence of noise.

Further progress in the improvement of broadcast receivers will undoubtedly be along the line of increased fidelity of reproduction. The combination reproducer (Fig. 10) employing the piezo-electric high-frequency unit is proposed as an economical and practical solution of the electro-acoustical aspect of this problem.

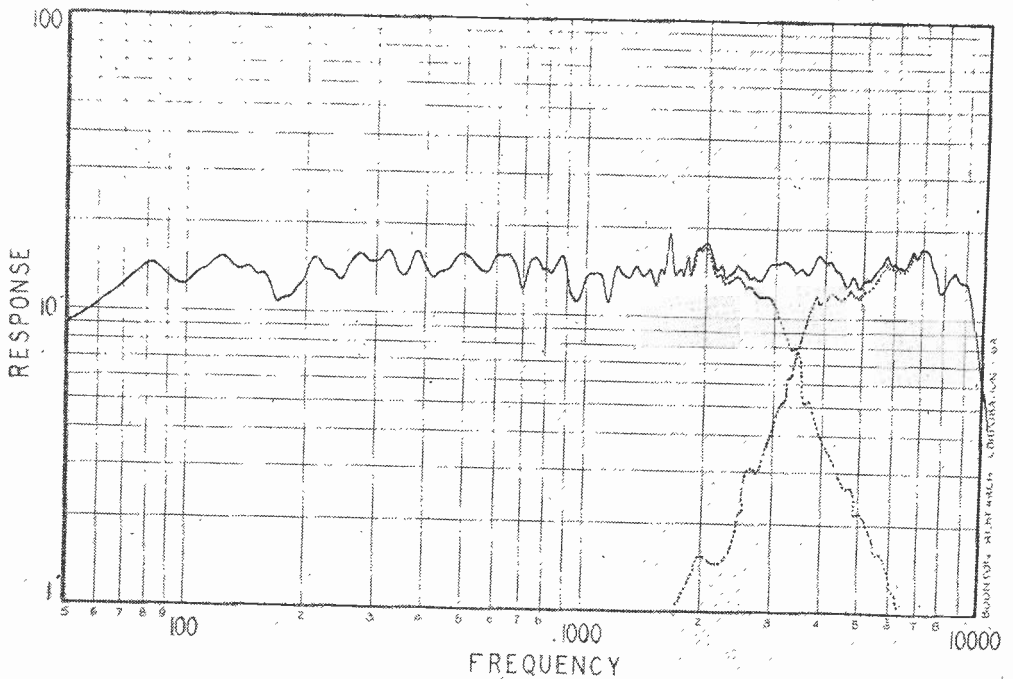

Fig. 11—Axial sound-pressure—frequency characteristic of BRC Model 3 high fidelity reproducer (Fig. 10).

#### ACKNOWLEDGMENT

The crystals employed were prepared by the Brush Development Company of Cleveland, Ohio, whose coöperation in the development of this device is gratefully acknowledged.



## A COMPACT, ALTERNATING-CURRENT OPERATED SPEECH INPUT EQUIPMENT\*

BY

W. L. BLACK

(Bell Telephone Laboratories, Inc., New York City)

*Summary*—This paper describes a simple, easily installed, alternating-current operated, speech input equipment primarily intended for installation as studio equipment for local channel broadcast stations or for permanent installation at outside pick-up points frequently used by large broadcast stations. The features of this equipment are the use of moving coil microphones, the inclusion of high quality, high gain, all alternating-current operated amplifiers capable of delivering a high output level. Mechanically, the principal component is a single factory-assembled and -wired metal cabinet.

AT THE present time there are three general types of studio plants utilized in radiotelephone broadcasting, which are as follows:

1. The elaborate installation involving three or more studios originating network programs as well as conducting local auditions and rehearsals while supplying programs to the associated radio transmitter, usually operated on a cleared channel.

2. The plant where two studios and two amplifier channels only are required so that rehearsals or auditions may be conducted from the second studio under actual broadcast conditions while the program on the air is being originated in the first studio. Such an assembly is in general associated with the transmitters operating on regional channels.

3. The small broadcast plant generally having only one studio and a minimum of technical operating personnel, using phonograph records or electrical transcriptions for at least part of the program in many instances and operating a low power radio transmitter on a local channel.

For the last of these classes of installations there has recently been developed a compact, high quality, alternating-current operated, speech input equipment known as the Western Electric No. 9A speech input equipment. This equipment has been designed specifically for application at stations having only one studio and utilizing a low power transmitter. In addition, this equipment may be utilized by larger stations at program pick-up points, outside of the main studio, where there are sufficient originating programs to justify a permanent or

\* Decimal classification: R440. Original manuscript received by the Institute, June 20, 1933. Presented before New York Meeting December 2, 1931.

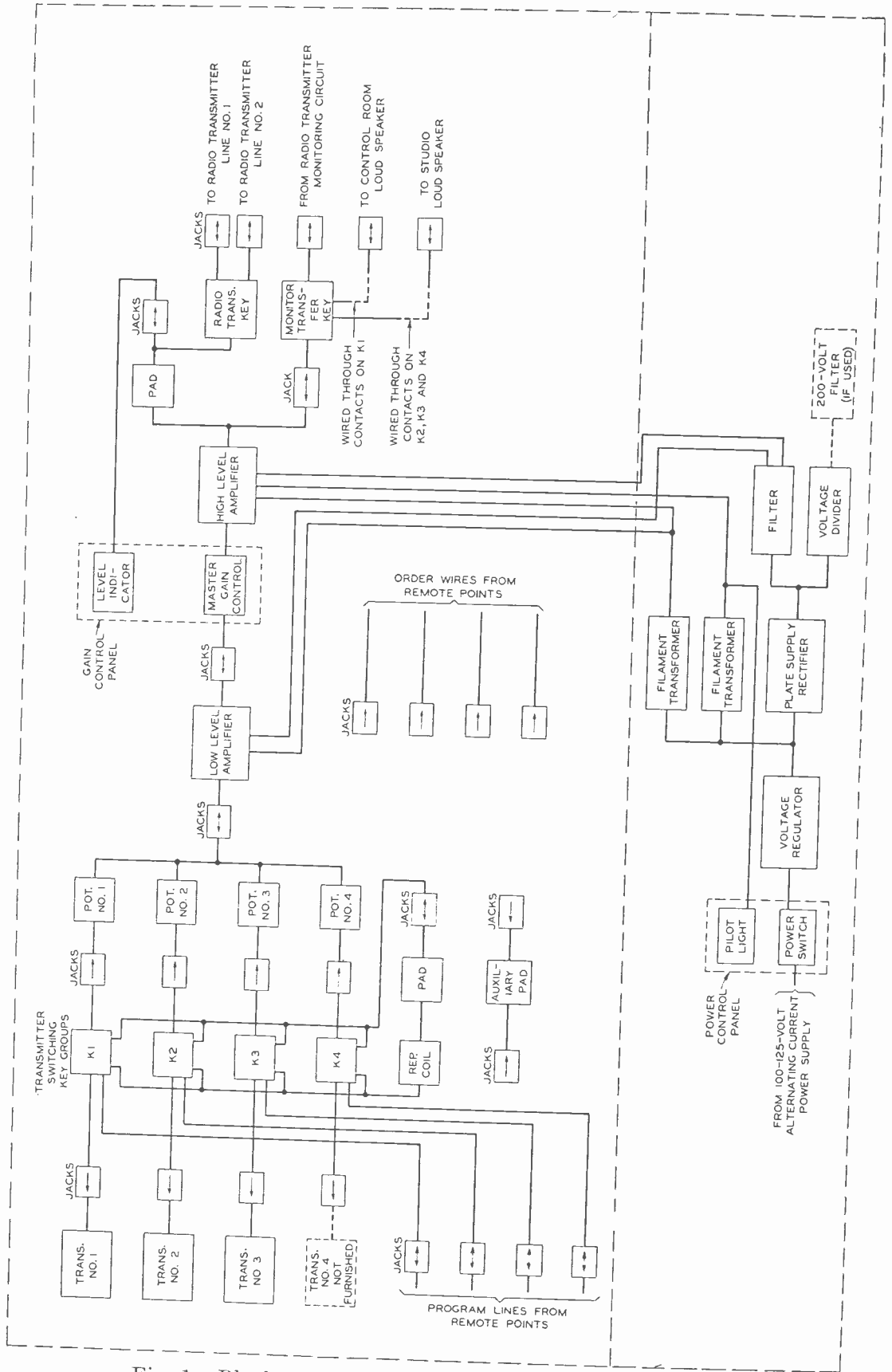

Fig. 1—Block schematic of 9A speech input equipment.



semipermanent installation of apparatus in view of the fact that such an application is analogous to the small permanent studio installation.

This equipment, in view of the limitations imposed by the type of service for which it is intended, has been designed with the following objectives.

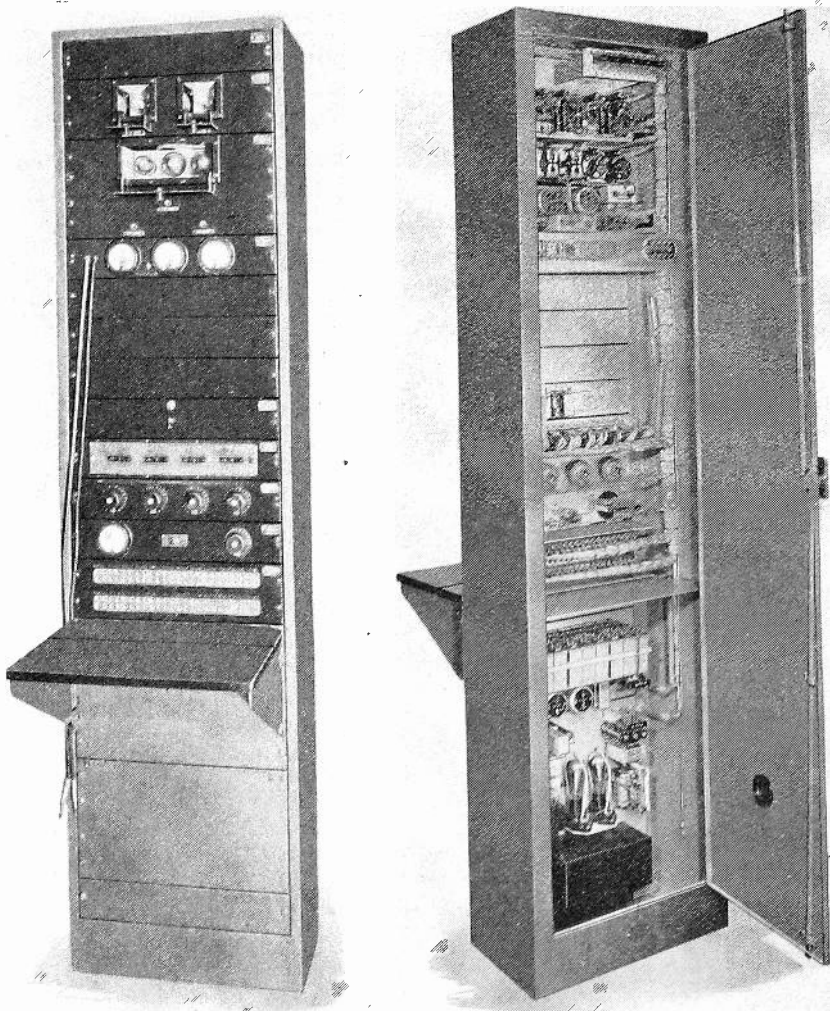

Fig. 2—Panel assembly, front view and rear view.

1. Operation entirely from alternating current.
2. All of the control apparatus within one factory-assembled and -wired unit.
3. An equipment capable of rapid and economical installation and maintenance.
4. The component apparatus so arranged that one operator can readily control the broadcasting of an entire program.

5. Appearance harmonizing with modern radio transmitting equipment.

Fig. 1 is a schematic of the equipment. Views of the single-panel assembly are shown in Fig. 2. A representative over-all frequency response characteristic is shown in Fig. 3.

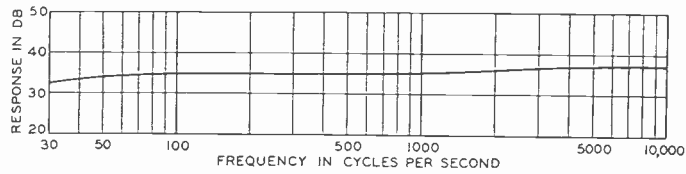

Fig. 3—Over-all frequency response characteristic of equipment.

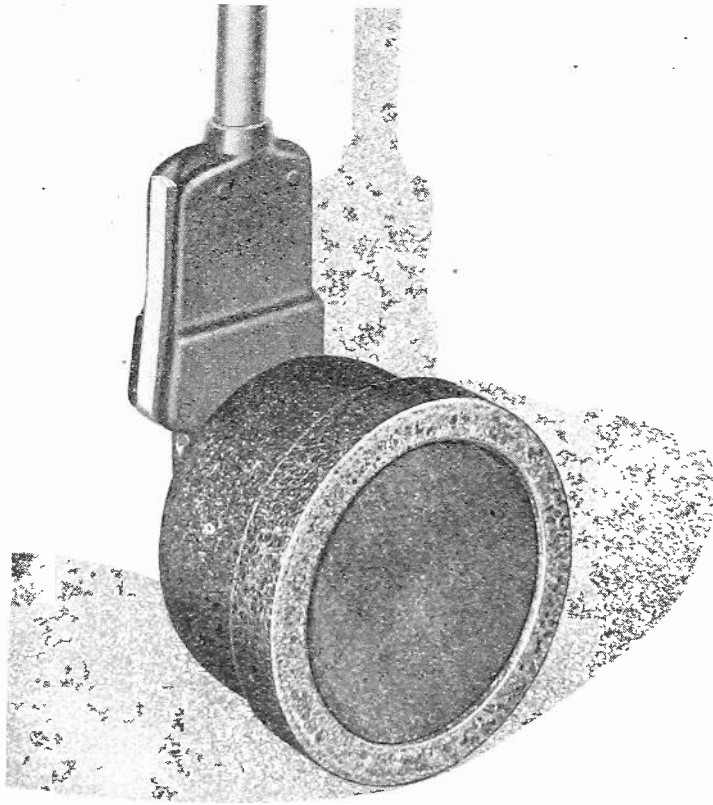

Fig. 4—618A transmitter (moving coil microphone).

#### MICROPHONES

Recently developed moving coil microphones of the type shown in Fig. 4 are utilized as a part of this equipment for program pick-up from the studio.<sup>1</sup> Three of these are included with the equipment, and provision is made for the addition of a fourth if desired.

<sup>1</sup> This device was more fully described in a paper presented before the Society of Motion Picture Engineers by W. C. Jones and L. W. Giles on May 29, 1931.

This microphone responds uniformly to a wide range of frequencies. It is more efficient than the more conventional form of condenser microphone without an immediately associated amplifier; and its transmission characteristics are unaffected by changes in temperature, humidity, and barometric pressure encountered under ordinary conditions. Due to its low impedance, it is less subject to interference from near-by circuits than the condenser microphone, and may be set up at a distance from the associated amplifier. It is of rugged construction and

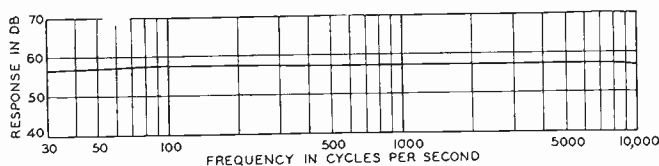

Fig. 5—Frequency response characteristic of 69A amplifier (low level amplifier).

when used in exposed positions is less subject to wind noise. Due to the fact that this microphone does not require any polarizing voltage, it is possible to operate the entire equipment from alternating current.

#### GAIN CONTROLS

Means for regulating the net amplification of the system are provided at two points. First, four potentiometers comprising a mixing circuit before the first amplifier, are included. Second, a single master gain control potentiometer is included which is connected between the output of the low level amplifier and the input of the high level amplifier.

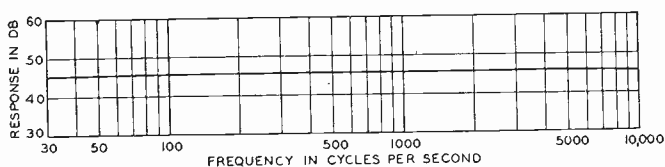

Fig. 6—Frequency response characteristic of 70A amplifier (high level amplifier).

The potentiometers utilized employ decade type switches and non-inductively wound fixed resistances. This type of structure requires a minimum amount of maintenance. In addition, due to the additional series resistance associated with each step, the potentiometer has a constant output impedance independent of setting if the appropriate input impedance is maintained. A further advantage of this type of potentiometer is that it is possible to have the introduced loss vary logarithmically with the angle of rotation. In this equipment both the

mixing potentiometers and the main gain control potentiometer are arranged to introduce attenuation in 2-decibel steps.

### AMPLIFIERS

Two amplifiers are included in this equipment, both having the cathode circuits of their vacuum tubes operated directly from alternating current.

The low level amplifier is a two-stage transformer coupled amplifier employing low current, indirectly heated, cathode vacuum tubes. This amplifier has approximately 57 decibels gain. It is designed to

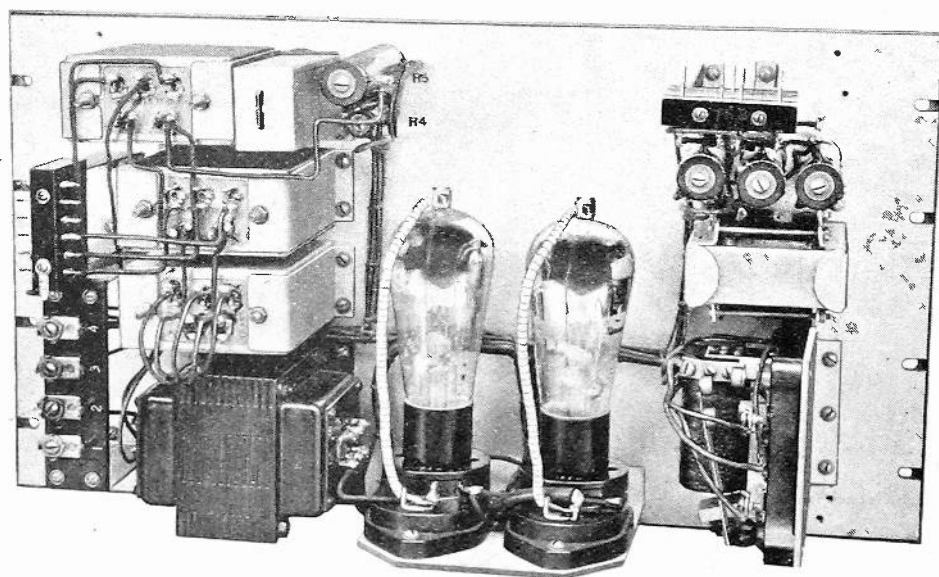

Fig. 7—Power supply panel, rear view.

operate from the combined output of the mixing potentiometers and into the main gain control potentiometer of the equipment. The frequency response characteristic of this amplifier is shown in Fig. 5.

The high level amplifier is also a two-stage transformer coupled amplifier employing the same type of tube as is used in the low level amplifier in its first stage and two medium power tubes in a push-pull circuit in the second stage. This amplifier has approximately 49 decibels gain. It is arranged to operate between the gain control potentiometer of the equipment and the output circuit consisting of one or two monitoring loud speakers and a fixed artificial line, the output of which is connected to the associated radio transmitter directly or through a telephone line. The frequency characteristic of this amplifier is shown in Fig. 6.

## MONITORING

As previously mentioned, the high level amplifier is capable of operating either one or two monitoring loud speakers in addition to supplying energy to the radio transmitter input circuit. It is planned to utilize a dynamic type speaker with this equipment. Ordinarily one of these speakers would be located in the control room near the panel assembly and the other either in the studio or in a public reception room.

## VOLUME INDICATOR

The volume indicator included in this equipment consists of a galvanometer containing a copper-oxide disk rectifier. This instrument is in turn associated with a suitable resistance network so that the im-

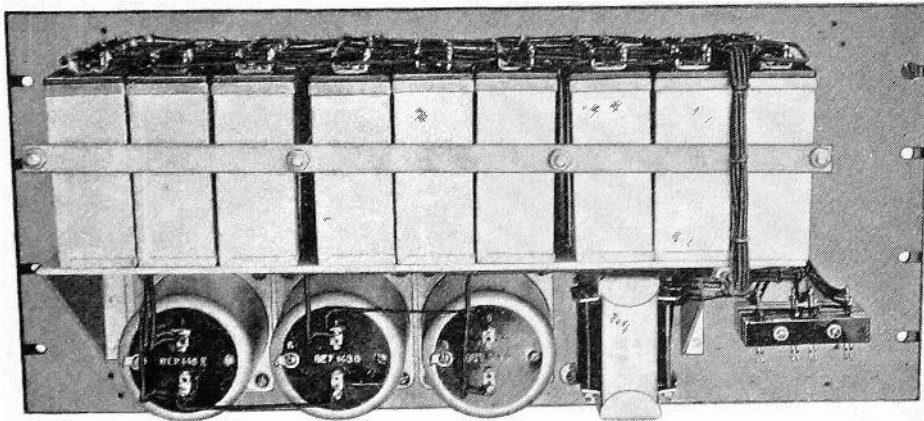

Fig. 8—Plate filter panel, rear view.

pedance bridged at the output of the equipment is substantially the same for each of the three levels provided for. The levels chosen are +10 decibels, zero, and -8 decibels based on a zero level of 6 milliwatts. A switching key provides means for operating the volume indicator at any one of three levels. The scale of the meter is so calibrated that indications one and two decibels above and below each of the reference values may be obtained.

## SWITCHING

The selection of input circuits to the equipment is accomplished by means of lever unit keys. Two keys mechanically yoked together comprise a key group associated with each of the four mixing potentiometers. This key group operated in one direction connects an associated microphone to the input of the mixing potentiometer, removes a

compensating resistance which is normally connected across the input to the potentiometer, and opens the loud speaker circuit to the studio where the microphone is located to avoid the possibility of acoustic coupling and consequent singing. The key group operated in the other direction connects an associated outside program line carrying either a locally originated or a network program through a balanced and shielded repeating coil and a fixed attenuator to the input of the associated mixing potentiometer.

Two other keys are provided. One of these is arranged to select either one of two outgoing program lines to the radio transmitting equipment. The other is arranged to switch the control room monitoring loud speaker from the output of the high level amplifier to the output of the monitoring circuit of the associated radio transmitter or the output of an associated radio receiver for comparison purposes.

Jacks are provided so that microphone outputs may be interchanged or microphone outputs not normally associated with the switching keys may be connected to the switching keys. Similarly, jacks are provided so that any one of a group of incoming program lines may be connected to the keys. Jacks to terminate the order wire circuits so that a telephone set may readily be connected to any order wire at will, are included. In addition, jacks are provided in the amplifier circuits for testing and switching the various components of these circuits.

#### POWER SUPPLY

The power supply apparatus is all contained in the lower part of the panel assembly as shown in Fig. 2.

Transformers are provided to light the filaments of the amplifiers directly from alternating current.

A rectifier for supplying the appropriate plate voltages for the vacuum tubes is also included. This is a full-wave, single-phase rectifier utilizing two-element mercury vapor rectifier tubes. The rectifier circuit contains a time delay device to insure that both the filaments of the amplifiers and of the mercury vapor rectifier tubes reach their proper operating temperatures before the high voltage is applied to the rectifier circuit. The unit containing this equipment is shown in Fig. 7.

A common retardation coil is provided to filter the high voltage supply for the plate circuits of the amplifiers. Beyond this is a load resistance which also serves as a voltage divider under certain conditions and an individual filter for each of the two amplifiers. The filter for the high level amplifier is a single-section filter while that for the low level amplifier is a three-section filter. This filtering apparatus is mounted as a single unit as shown in Fig. 8.

There is also included in the equipment a voltage regulator to minimize the effect of normal variations in supply voltage at a given location as well as to provide for differences in line voltage in various localities.

The power required from the commercial 110-volt alternating-current circuit is approximately 135 watts.

Supplementary to the power supply apparatus is a door switch which deenergizes all transformers when the door of the cabinet is opened. In addition, a double convenience outlet is provided inside of the cabinet ahead of the door switch so that a portable light and an

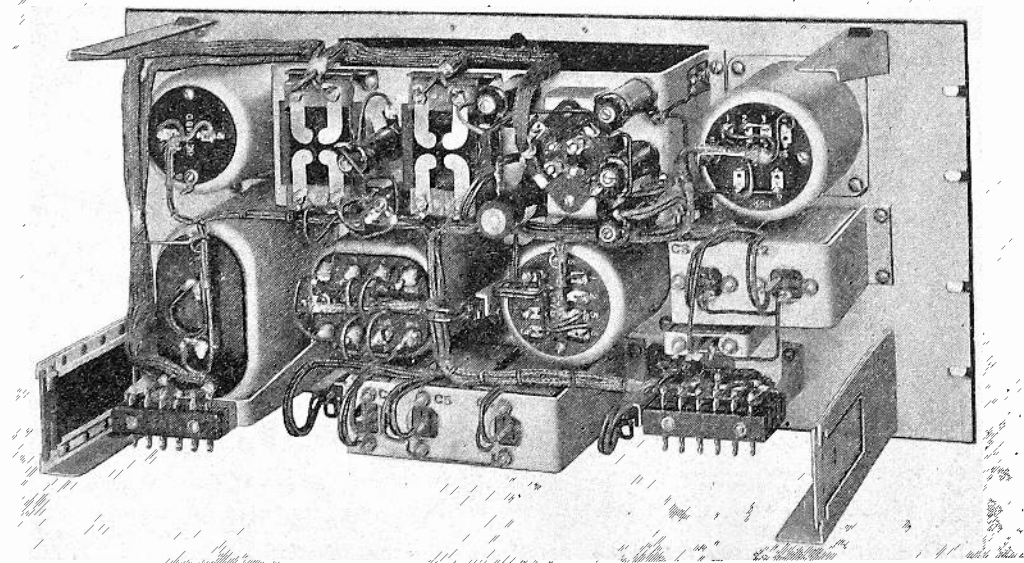

Fig. 9—70A amplifier, rear view.

electrical soldering iron may be readily connected for maintenance purposes. When the system is in readiness for operation the entire equipment may be energized by operating a single toggle switch on the front of the panel. Associated with this switch is a pilot light to give a positive indication of operation.

#### FLEXIBILITY

Wiring is provided in the panel assembly so that the necessary control panels for a maximum of three double-button carbon microphones may be added. If desired, control circuits for two condenser microphones and their associated amplifiers may be included or a total of two condenser microphones and two carbon microphones may be provided for. In case either type transmitter is used it is necessary to provide a small 12-volt storage battery together with suitable charging

equipment. In addition, if condenser transmitter amplifiers are used, a supplementary plate supply filter is required to be operated in conjunction with the voltage divider resistances to which previous reference has been made.

#### MECHANICAL FEATURES

The amplifiers, power supply equipment, control apparatus, and switching facilities are all contained in a steel cabinet approximately 83 inches high,  $19\frac{1}{4}$  inches wide, and  $12\frac{3}{4}$  inches deep. A writing shelf which also serves as an arm rest for the operator is provided at approximately table height on the front of this cabinet.

All the equipment mounted in the cabinet is assembled and wired in the factory. The external connections are provided for on a terminal strip mounted near the top of the assembly except the primary power connection which is provided for at the bottom. Arrangements are made so that the external wiring may be brought in either through the bottom of the cabinet when the rack is permanently installed or through the top if it is desired to use the equipment at a semipermanent location, such as a remote pick-up point.

Except for the writing shelf and the necessary control handles, no apparatus protrudes from the front of the panel.

An example of the type of construction employed in this equipment to conserve space as much as possible is exemplified in the high level amplifier, a rear view of which is shown in Fig. 9.

#### CONCLUSION

In the development of this equipment, several radical departures from the conventional design of equipment of this type have been incorporated. The operation from alternating current, the use of moving coil microphones, the use of a copper-oxide type rectifier for volume indication, and the mounting of all apparatus in a single, entirely enclosed, metal cabinet comprise the principal innovations.

As a result of these features it is felt that within the limitations imposed by the objectives in the design of this equipment, a highly satisfactory, easily installed and operated, speech input equipment has been made available for the small broadcast stations and for use by the large stations at points of program origin outside of the studio.





## REPORT OF COMMITTEE ON RADIO PROPAGATION DATA\*

THIS committee was established by the U.S.A. group preparing for the North American Radio Conference which opened in Mexico City July 10, 1933. The committee, composed of Dr. J. H. Dellinger (chairman); L. Espenschied, A. D. Ring, L. A. Briggs, R. Asserson, and S. S. Kirby, submitted its report March 28, 1933.

The purpose of the committee was to prepare radio wave propagation data, in as clear and concise form as possible, which would permit the quantitative evaluation of the various parts of the frequency range, as to field intensities produced and as to limitations imposed by atmospheric and man-made electrical noise and by fading. The frequency range covered is 150 to 1700 kilocycles, and distances up to 5000 kilometers (3107 miles).

The essential results are given in the figures. These comprise a series of graphs giving received field intensities under various conditions and a series of graphs showing the limitations upon reception imposed by atmospheric and man-made noise and by fading.

Figs. 1 to 6 give received field intensities and are extensions of the data prepared at Madrid by the van der Pol Committee<sup>1</sup> on radio propagation. The data have been extended in respect to transmission distance, frequency, and ground conductivity, and in addition the calculations of the van der Pol Committee have been checked.

The radio waves received at a distance from a transmitting station are in general a combination of a ground wave and a sky wave. At short distances the ground wave predominates, the sky wave is negligible, and the received wave is relatively steady (nonfading) both day and night. These conditions hold for distances less than about 40 kilometers for the lower conductivities, and the higher frequencies, and less than about 400 kilometers for the higher conductivities and the lower frequencies. At considerably greater distances, at night, the sky wave predominates, the ground wave is negligible, and the received wave fades or fluctuates in intensity. At the same greater distances in the daytime, the received wave is a combination of ground wave and sky wave, the relative amounts varying with season, time of day, frequency, ground conductivity, etc. For such distances, the received intensities approach more nearly the ground wave values in the summer time and at noon than at other times.

\* Decimal classification: R113.7. Original manuscript received by the Institute, June 21, 1933.

<sup>1</sup> Madrid Conference Document No. 383 R, Proc. I.R.E., vol. 21, p. 996; July, (1933).

On each of Figs. 1 to 5, the lower six curves give the intensity of the ground wave. The "quasi maximum night" curve represents intensities at night. At the distances shown these intensities are wholly those of

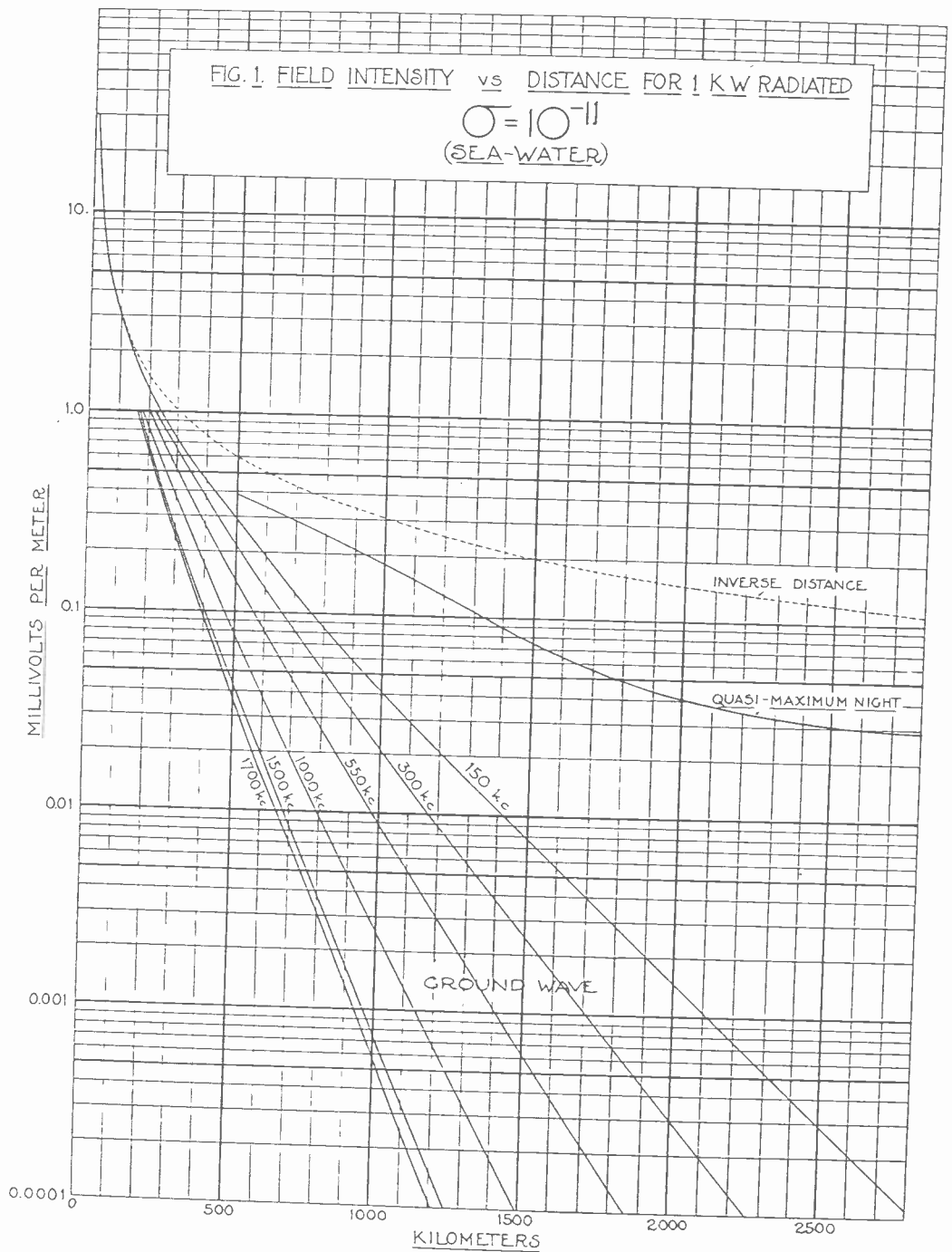

the sky wave. For distances greater than a few hundred kilometers, depending upon the frequency and ground conductivity, the intensities in the daytime lie between the ground wave curve and the quasi maximum night curve. The values of daytime intensity approach the

ground wave intensity more closely at noon in the summer than at any other time. (Recent observations at noon in the wintertime, for example, have shown that, for stations observed several hundred kilo-

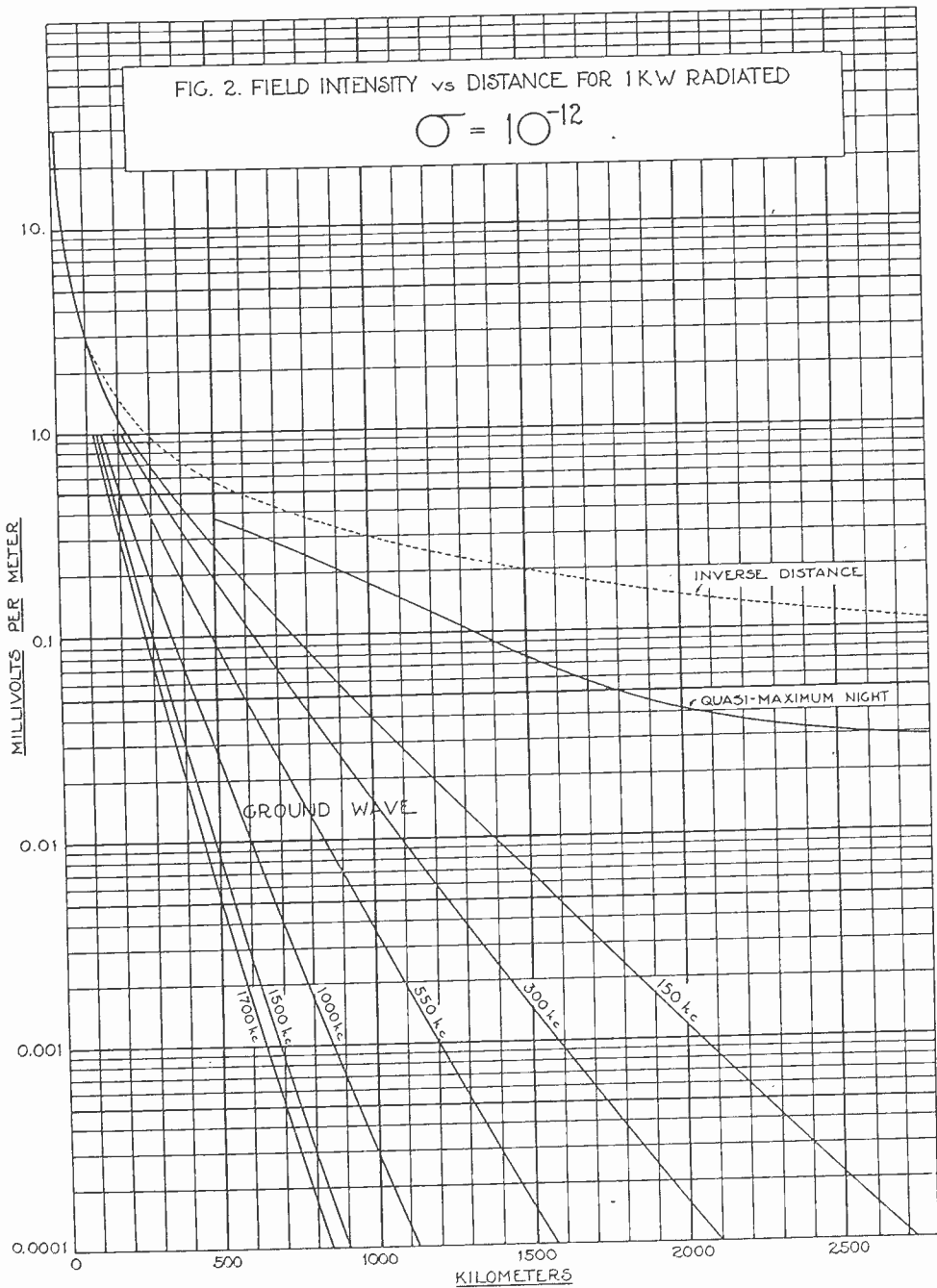

meters distant, the received intensity is many times the ground wave values and is fluctuating or fading as at night.)

Figs. 1 to 5 differ in the value of ground conductivity for which they are drawn. The highest value of ground conductivity ( $10^{-11}$

c.g.s. electromagnetic units) represents sea water, and the lowest value ( $10^{-15}$ ) represents about the poorest ground conductivity observed in North America. Ground conductivity is believed to average somewhat

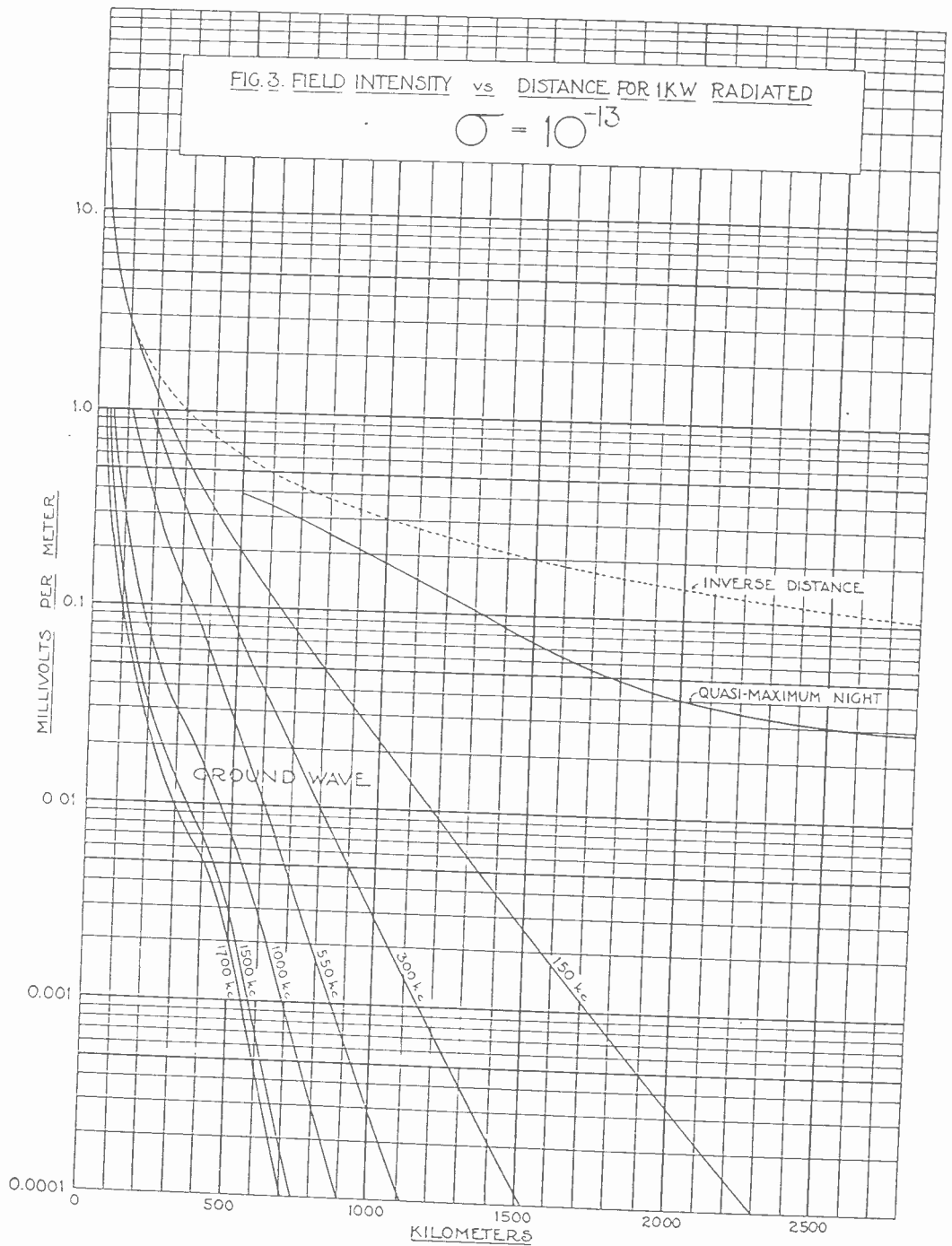

above  $10^{-13}$  in Europe and below  $10^{-13}$  in North America. The graphs depend relatively little on the values used for dielectric constant; the values were 80. for Fig. 1, 20. for Fig. 2, 14. for Fig. 3, 5. for Figs. 4 and 5.

Each of Figs. 1 to 5 gives ground wave curves for six frequencies (150, 300, 550, 1000, 1500, and 1700 kilocycles), a quasi maximum night curve, and an inverse distance curve. The latter two curves are

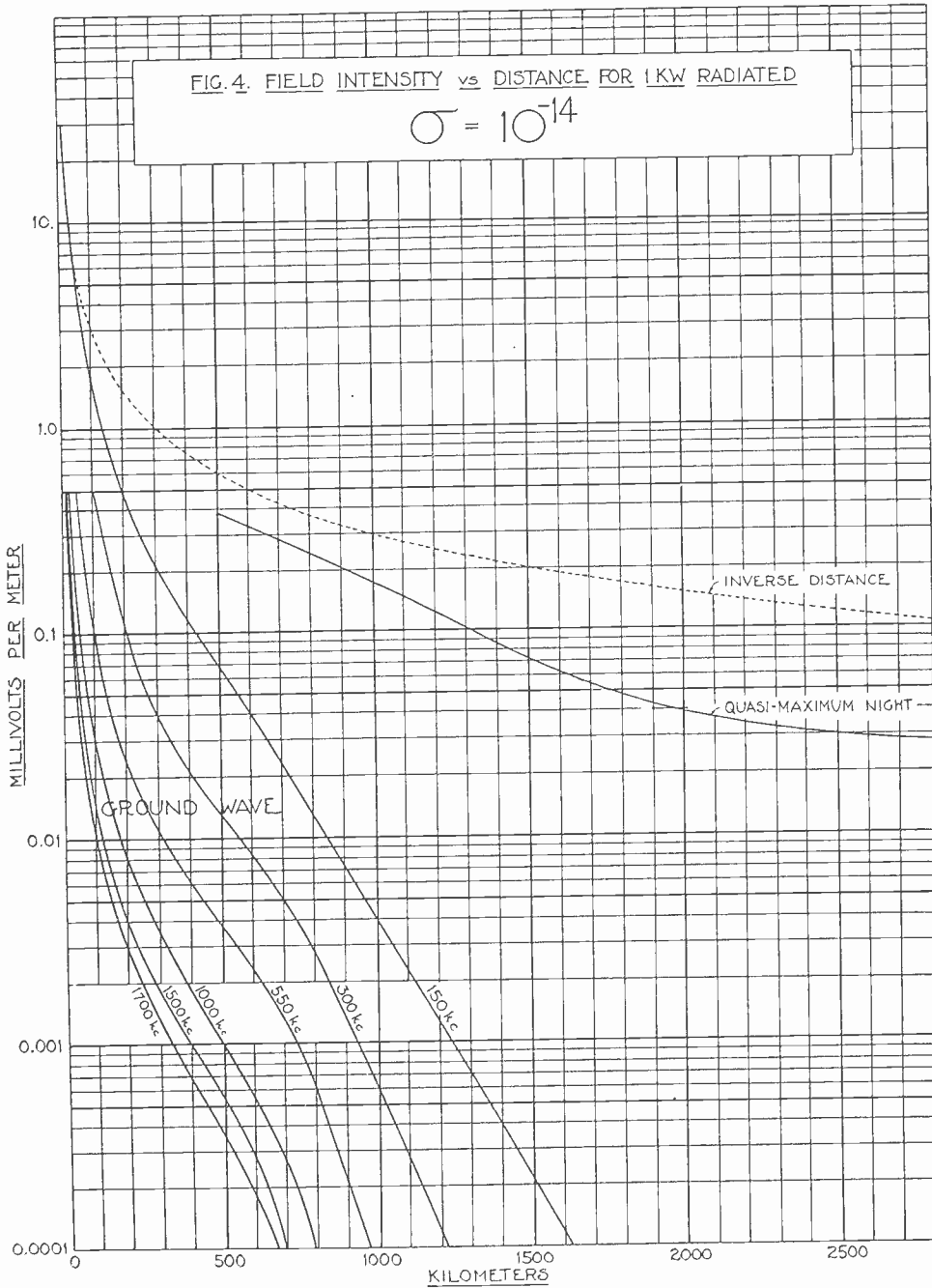

the same on all figures. The inverse distance curve is ordinarily the upper limit of instantaneous values. Figs. 11 to 15 give the ground wave curves with a distance scale convenient for short distances.

Each of these figures shows root-mean-square field intensities in

millivolts per meter for one kilowatt of radiated power, as a function of distance in kilometers. For other values of radiated power, field intensities are proportional to the square root of the power. The night

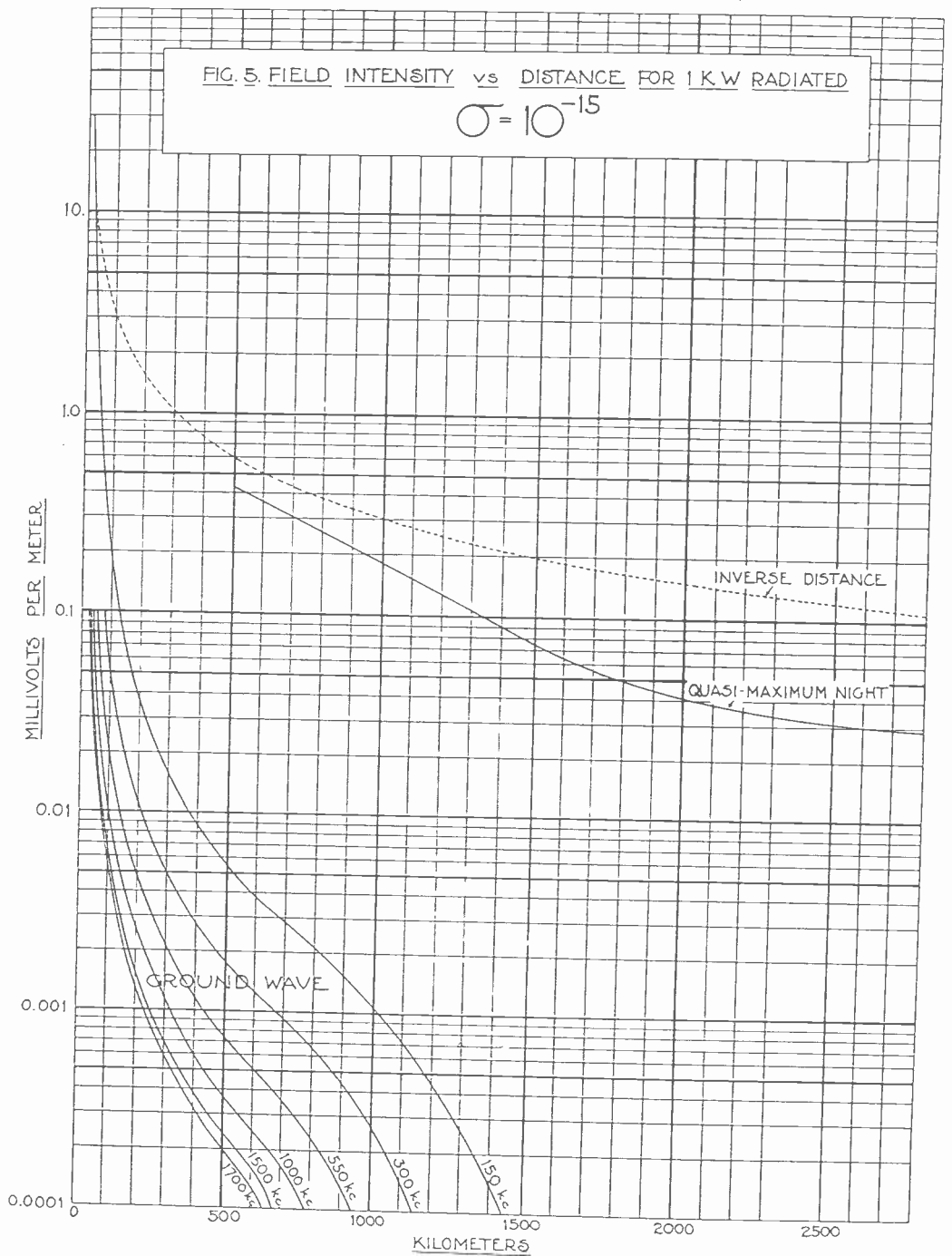

curve gives quasi maximum values of field intensity, the quasi maximum being defined as that value which is exceeded by the instantaneous values approximately 5 per cent of the time. Values are not shown for the night curve at distances less than 500 kilometers; that informa-

tion is given for two values of ground conductivity in Figs. 1 to 8 of the van der Pol Committee<sup>1</sup> report.

Figs. 1 to 5 are supplemented by Fig. 6 for greater distances. Figs. 1 to 5 are for distances up to only 2800 kilometers, but this distance is

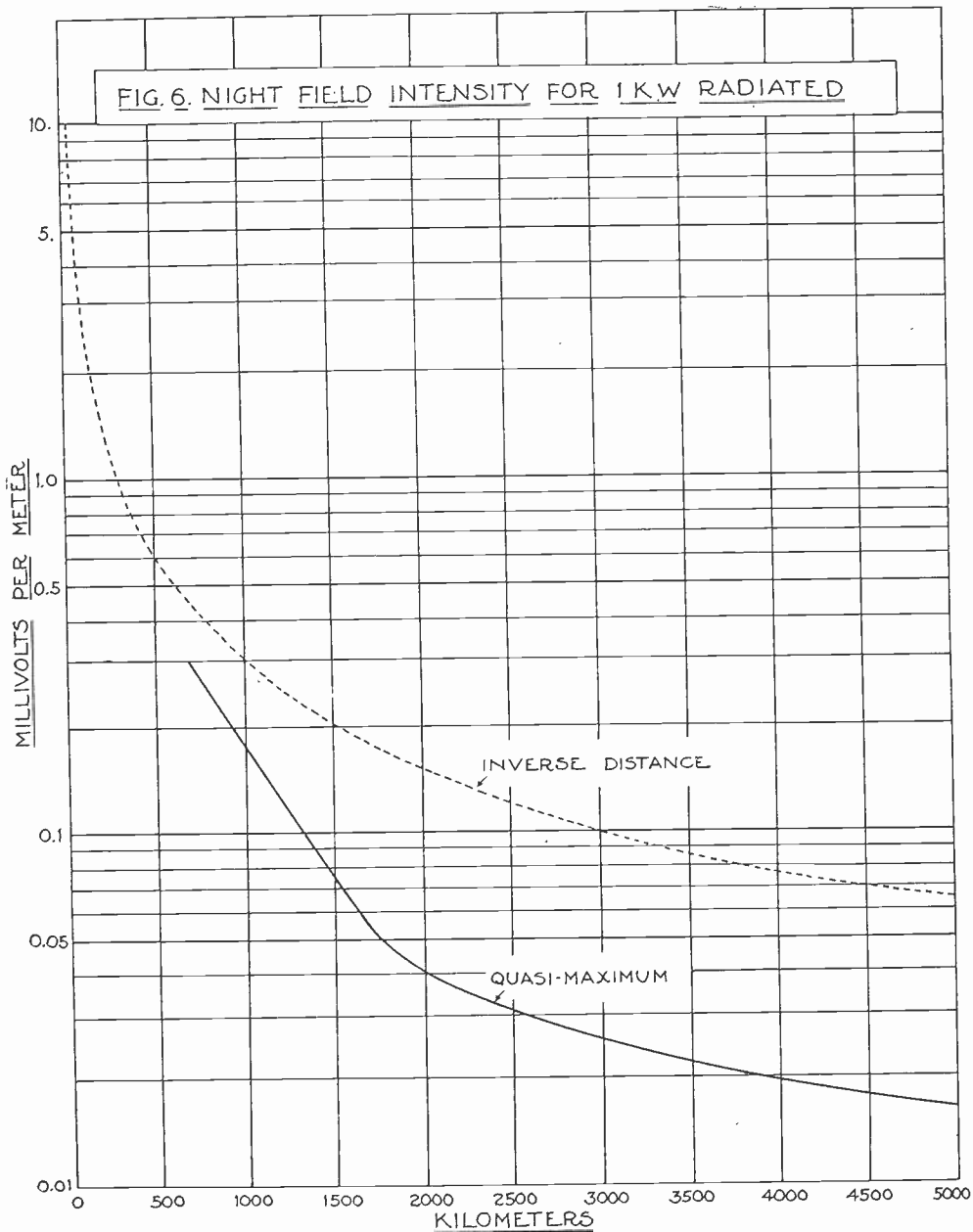

sufficient to show the ground wave curves down to values of 0.0001 millivolt per meter; the ground wave at greater distances is negligible. It remains to show only the night curve at greater distances; and this is done in Fig. 6, for distances up to 5000 kilometers.

The night curve is the same for all frequencies and other conditions

involved, and therefore the single solid curve of Fig. 6 gives all the information. For distances less than about 1600 kilometers, it is in agreement with the night curve of the van der Pol Committee,<sup>1</sup> which continued in a straight line to 2000 kilometers. The curve given in Fig. 6

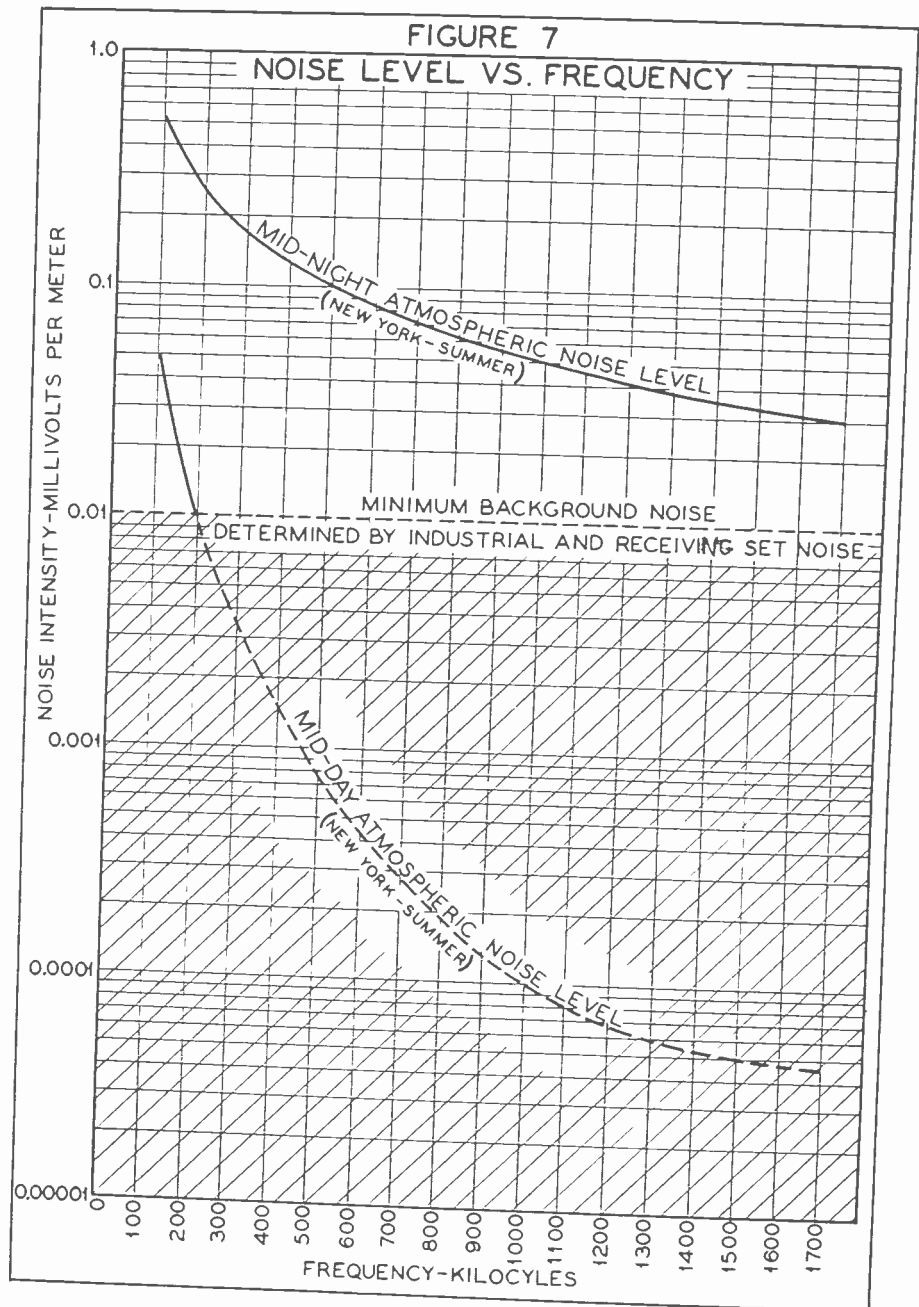

herewith is based on sixty-six observation periods at various times on twelve stations by the Bureau of Standards, eleven observation periods on six stations by the field staff of the Federal Radio Commission, and twenty-two observation periods on thirteen stations by the Russian radio administration. The individual observation periods were for a



few minutes up to an hour. The observations from the three sources agree very well. They are for stations between 1000 and 4200 kilometers distant, on frequencies between 150 and 1500 kilocycles.

It must be emphasized, just as was done by the van der Pol Committee,<sup>1</sup> that the curve gives merely average data. Actual cases vary from about one third to three times the values given in the graph. The differences observed in practice are due to differences and variations in antenna characteristics, ground conditions, direction, latitude, time of day or night, season, and year, these effects varying with conditions in the ionosphere.

For short distances the ground wave curves give the values of received intensity, both day and night, with considerable reliability. When the transmitting antenna is nondirectional and the station is situated in a region of uniform ground conductivity and unvarying topography, observed values check theoretical values closely. The curves (Figs. 11 to 15) can be used in calculating the primary service areas of broadcast stations on different frequencies. They are based on the measurement data available, and also on reliable theory. They were calculated on the basis developed by T. L. Eckersley,<sup>2</sup> representing the theory of Sommerfeld for the short distances, as amplified by van der Pol, Rolf, and Wise, and the theory of Watson as modified by T. L. Eckersley, for the longer distances. They are fully checked by measured values within the uncertainties of the measurements.

Coming now to the limitations imposed by atmospheric and man-made noise and by fading, this part of the subject will be treated with particular respect to broadcasting. In "noise" are included the electrical disturbances in radio receiving apparatus caused by atmospherics (static), by electrical interference, and by irregular actions in receiving apparatus. Figs. 7 to 10 give estimates of the limiting distances to which a reasonably useful signal intensity as required for broadcasting may be expected to be delivered, in the frequency range 150 to 1700 kilocycles. The limiting distances are determined in part by the attenuation of the signal waves as given in Figs. 1 to 6, and in part by atmospheric and man-made noise and by fading as explained below. In modern practice, weak signals can be amplified as required, up to the limit imposed by the noise produced in the receiver from either natural or man-made sources.

The signal intensity in relation to the noise level, or signal-to-noise ratio, is then a limiting factor in determining the distance range for which the different radio frequencies are effective. The noise values

<sup>2</sup> *Proc. Royal Soc., A*, vol. 136, p. 499, (1932); *Jour. I.E.E.* (London), vol. 71, p. 405, (1932); *Proc. I.R.E.*, vol. 20, p. 1555, (1932).

which have been taken for the curves are based upon data from measurements made in several parts of the United States and from the experience gained in practice. Noise from either atmospheric or man-made sources varies greatly with the particular conditions. In the following a representative condition is shown and also the effects of variations therefrom.

For nighttime transmission the atmospheric noise rather than the man-made noise is, in general, so high as to constitute the limiting factor. The atmospheric noise at night varies<sup>3</sup> inversely with frequency. For the general vicinity of New York City in the summer, it is indicated by the upper curve of Fig. 7. The daytime atmospheric noise varies<sup>3</sup> approximately inversely as the square of frequency. It is shown for the same place and season by the lower curve of Fig. 7.

For various other places on this continent and other times of year, the curves of atmospheric noise have the shapes shown in Fig. 7 but may have greatly different numerical values.<sup>4</sup>

The curve of midday atmospheric noise level is of very little practical significance, because of the effects of local thunderstorms, industrial noise (i.e., electrical interference), and noise originating within the receiving apparatus. While the intensity of atmospheric noise during times of local thunder storms varies greatly, the frequency distribution at such times<sup>4</sup> is, in general, similar to that for the normal case of nighttime transmission (i.e., inverse frequency). There are indications that, on the average, frequency distribution of industrial noise also is in the inverse frequency relation.<sup>5</sup> Therefore, during times of local thunderstorms and in areas where the industrial noise level is high, the form of the nighttime curve of Fig. 7 would probably be somewhat representative of daytime conditions as well. Because of this, and since the noise conditions at night are most severe, the nighttime curve is perhaps of the most importance for estimates of the distances reached by useful signals, even for many daytime conditions.

Even with atmospheric and industrial noise entirely absent, there are inherently present within the receiving apparatus sources of noise that require consideration. These are resistor noise,<sup>6</sup> tube noise, and

<sup>3</sup> Proc. I.R.E., vol. 20, p. 1512, (1932); Supplement 11 to Book of Proposals for the Madrid Conference, pp. 53-55.

<sup>4</sup> Proc. I.R.E., vol. 19, p. 1731, (1931); *Monthly Weather Review*, vol. 52, p. 337, (1924); "Geophysical Memoirs," No. 24, published by Meteorological Office of British Air Ministry.

<sup>5</sup> In the case of noise arising from some form of spark, the voltage components vary, on the average, according to the inverse frequency relation. In a wide variety of circumstances it is perhaps permissible to assume that this relation also holds for the noise fields produced. This may be considerably altered in particular cases by resonance effects in the conductors associated with the spark-producing contacts.

<sup>6</sup> *Phys. Rev.*, vol. 32, pp. 97 and 110, (1928).

noise associated with the tube power supply. In general, this receiving set noise is independent of frequency; a value of 0.01 millivolt per meter can be taken for the entire range of frequencies as a practical minimum value of background noise. This is shown by the horizontal line in Fig. 7.

Fig. 8 illustrates the relations which exist between the signal intensity and the noise level, as follows: (a) The curve (A) illustrates the attenuation of the signal intensity with distance; it is merely representative of any of the curves of received field intensity vs. distance,

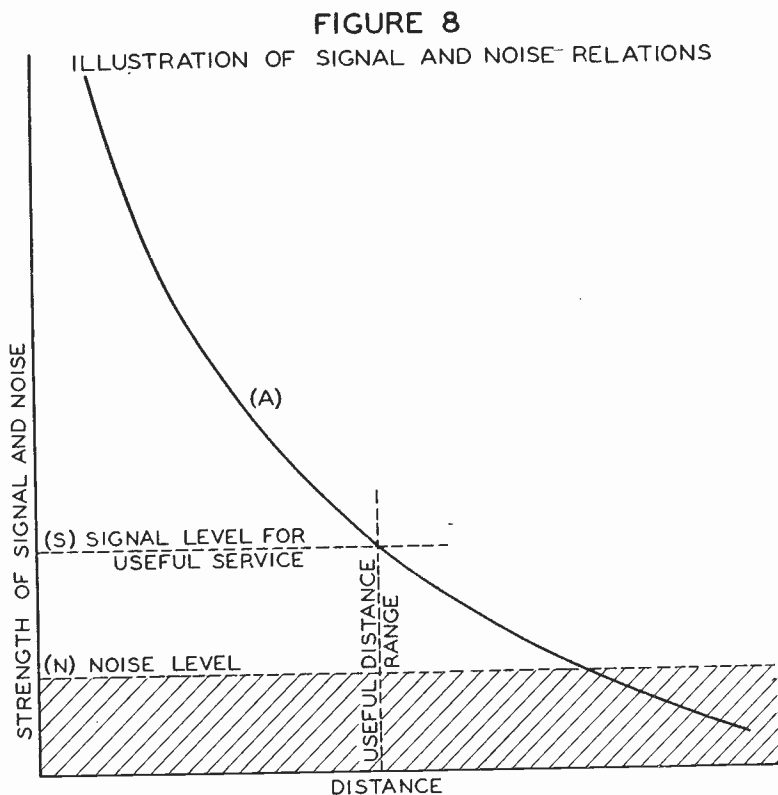

Figs. 1 to 6. (b) At the bottom of the figure in the shaded area is indicated the noise level  $N$  into which the desired signal intensity drops at the greater distances. This noise level is to be thought of as pervading the area to which service is to be given. It will vary with time and with the local conditions, and will vary with frequency as previously explained. (c) The line ( $S$ ) represents the signal intensity required to override the noise level ( $N$ ) by a certain amount. The ratio of level  $S$  to level  $N$  indicates the required signal-to-noise ratio. (d) The distance range of useful transmission is taken as that distance at which the intensity of the signal in accordance with the curve ( $A$ ) falls to the level  $S$ . The variations of this distance with frequency are shown in

Figs. 9 and 10, for different conditions as to power, noise level, and signal-to-noise ratio.

Fading is another limitation upon the serviceability of radio transmission. It results from the unstable character of the sky wave. The

FIGURE 9  
OVERLAND TRANSMISSION  
USEFUL DISTANCE VS FREQUENCY  
FOR THE AVERAGE GROUND CONDUCTIVITY  
 $\sigma=10^{-13}$

DASHED PORTIONS OF CURVES ARE CONTINUATIONS OF THE SOLID PORTIONS OF THE CURVES ON THE BASIS OF THE SAME AVERAGE SIGNAL-TO-NOISE RATIO. ON ACCOUNT OF FADING THE DISTANCES INDICATED BY THE DASHED PORTIONS OF THE CURVES REPRESENT LESS SATISFACTORY RECEPTION THAN THE DISTANCES INDICATED BY THE SOLID PORTIONS OF THE CURVES.

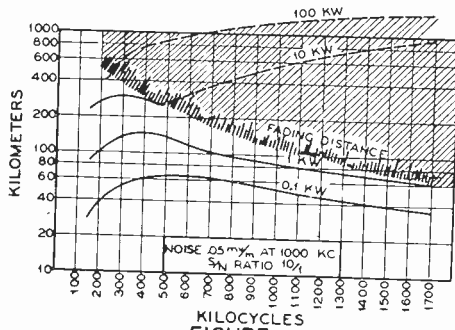

FIGURE 9-A

VARIATIONS WITH CHANGES IN POWER

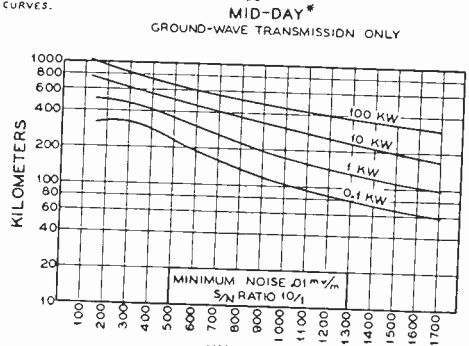

FIGURE 9-B

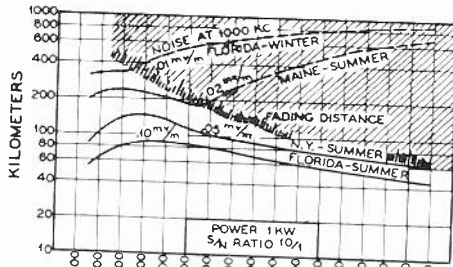

FIGURE 9-C

VARIATIONS WITH CHANGES IN NOISE LEVEL.

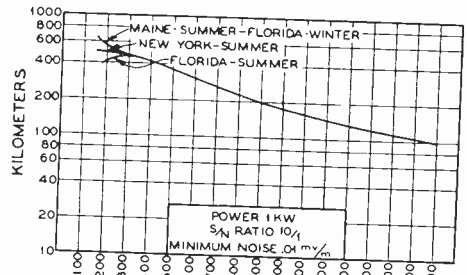

FIGURE 9-D

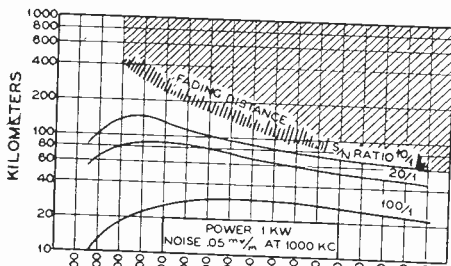

FIGURE 9-E

VARIATIONS WITH CHANGES IN SIGNAL-TO-NOISE RATIO

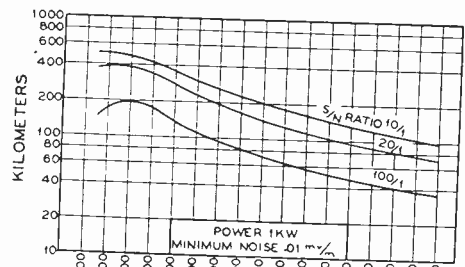

FIGURE 9-F

\* ASSUMING MOST FAVORABLE DAYTIME CONDITIONS AND A LIMITING BACKGROUND NOISE OF .04 IN MILLIVOLTS PER METER THROUGHOUT THE FREQUENCY RANGE.

effect is more pronounced on the higher than on the lower frequencies. The distances at which fading sets in for the different frequencies (indicated in the night graphs of Figs. 9 and 10 by the shaded line) are taken from the curves of the van der Pol Committee<sup>1</sup> as the distances

at which the ground wave and sky wave are of comparable intensity. The distances appear to be in reasonable accord with experience.

The curves showing useful distance versus frequency are in two

FIGURE 10  
SEAWATER TRANSMISSION  
USEFUL DISTANCE VS FREQUENCY

CONDUCTIVITY  $\sigma = 10^{-11}$

DASHED PORTIONS OF CURVES ARE CONTINUATIONS OF THE SOLID PORTIONS OF THE CURVES ON THE BASIS OF THE SAME AVERAGE SIGNAL-TO-NOISE RATIO. ON ACCOUNT OF FADING THE DISTANCES INDICATED BY THE DASHED PORTIONS OF THE CURVES REPRESENT LESS SATISFACTORY RECEPTION THAN THE DISTANCES INDICATED BY THE SOLID PORTIONS OF THE CURVES.

MID-NIGHT

MID-DAY\*  
GROUND-WAVE TRANSMISSION ONLY

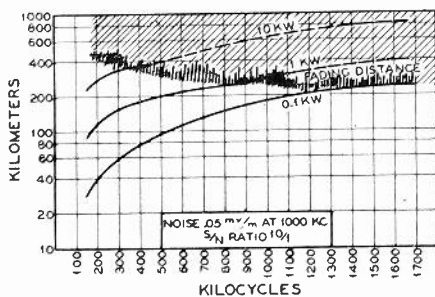

FIGURE 10-A

VARIATIONS WITH CHANGES IN POWER

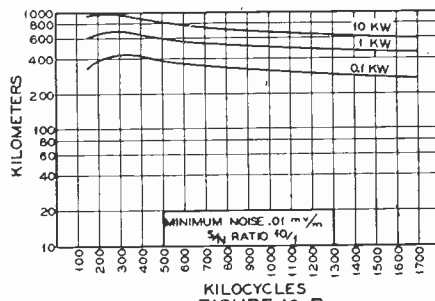

FIGURE 10-B

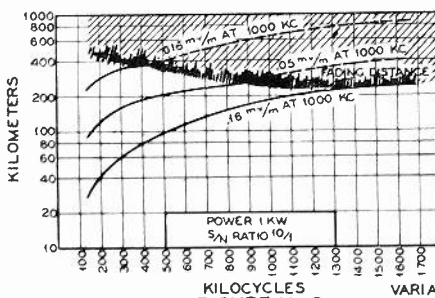

FIGURE 10-C

VARIATIONS WITH CHANGES IN NOISE LEVEL.

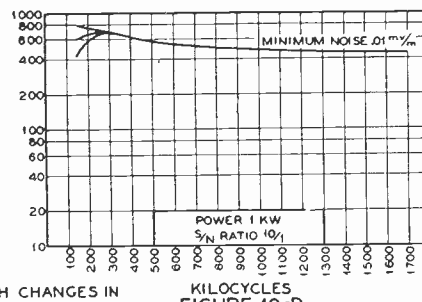

FIGURE 10-D

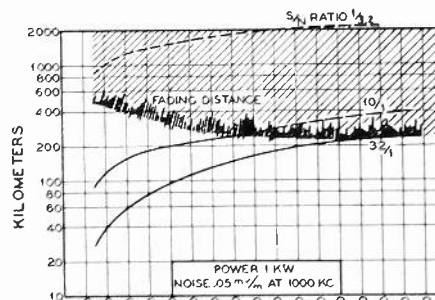

FIGURE 10-E

VARIATIONS WITH CHANGES IN SIGNAL-TO-NOISE RATIO.

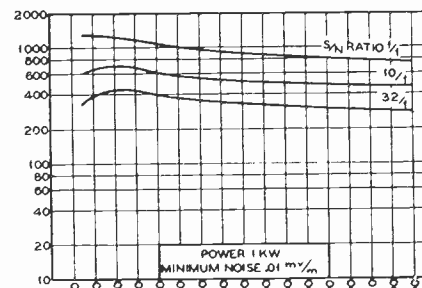

FIGURE 10-F

\* ASSUMING MOST FAVORABLE DAYTIME CONDITIONS AND A LIMITING BACKGROUND NOISE OF .01 IN MILLIVOLTS PER METER THROUGHOUT THE FREQUENCY RANGE.

sets, one for a case of overland transmission (Fig. 9) and the other for transmission over sea water (Fig. 10). Fig. 9 is for an average value of ground conductivity,  $10^{-13}$  c.g.s. electromagnetic units. The upper curves of Figs. 9 and 10 represent distance ranges for territory in

which the noise conditions shown in Fig. 7 apply. They are drawn for a received signal intensity 10 times<sup>7</sup> the noise intensities as shown in Fig. 7. This is probably the lower limit of what might be considered a useful signal for broadcast reception.

In each figure is included a series of curves for midnight and midday transmission; first, for various transmitting (radiated) powers, second, for various noise conditions showing particularly the effect of latitude; and third, for different assumed standards of reception as to signal-to-noise ratio.

The facts of overland transmission are shown by Fig. 9. The curves of Fig. 9-A show that, for distances below the fading line, there is a range of optimum frequencies of about 200 to 800 kilocycles for night use. Frequencies less than about 200 kilocycles are noticeably handicapped by the adverse effect of atmospheric noise. The distances below the fading distance represent stable ground wave transmission, while distances above the distance at which fading sets in represent sky wave transmission subject to fading. This is suggested in the figure by the use of dashed lines where the curves extend above the fading distance. The location of this fading line should not be considered as given precisely because it is subject to the numerous variations affecting the ground wave and the sky wave transmission. Above the fading line, greater distances are obtained for the higher frequencies, because the sky wave signal transmission does not vary with frequency (Fig. 6) while the atmospheric noise diminishes with frequency (Fig. 7). The dashed portions of curves are based on average night field intensities (i.e., values of field intensities which are exceeded by the instantaneous values 50 per cent of the time) as given in the van der Pol Committee report. The resulting distances given by these dashed portions of the curves are by no means "useful" distances in the same sense as are the distances given by the solid portions of the same curves; they are in fact greater than the distances at which reception is satisfactory for most purposes, first, because of the fading, and, second, because of large day-to-day variations.

As indicated in the heading for the midday curves in Figs. 9 and 10, the midday curves are based solely on ground wave transmission. These are also restricted to the noise conditions shown for midday in Fig. 7, particularly the existence of a background noise level of 0.01 millivolt per meter not varying with frequency. The midday curves must be used with great caution because of these two limitations. The ground wave transmission is supplemented by sky wave transmission at the greater distances, tending to make the distance range the same

<sup>7</sup> References 3 and 4; also *PROC. I.R.E.*, vol. 19, p. 1951, (1931).

for all frequencies. For rural or other locations where the man-made noise level is low, the atmospheric noise level is the limiting factor, and this also tends to increase the distance ranges for the high frequencies.

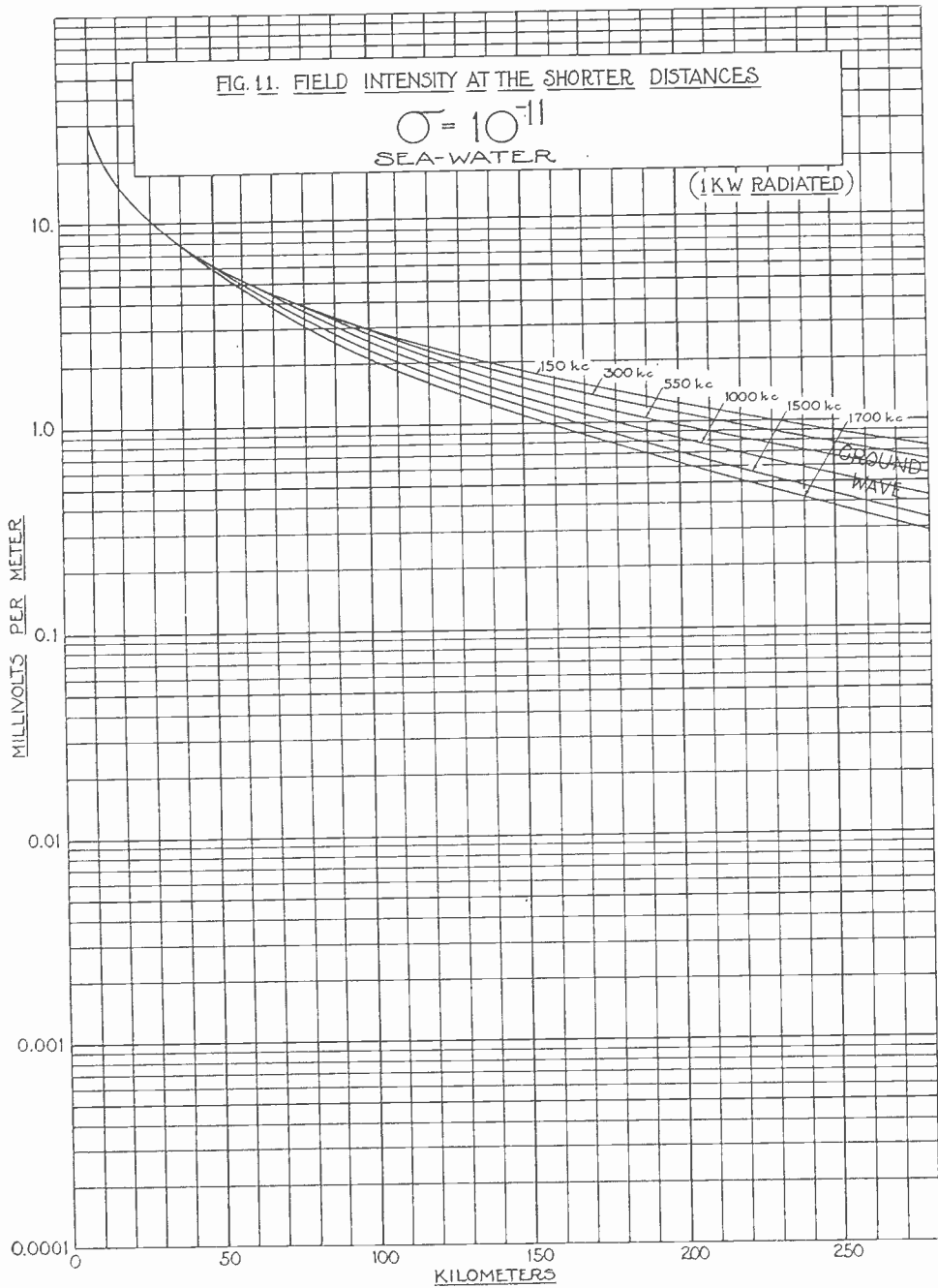

Both of these increases are however in the direction of greater instability (fading).

Fig. 9-C illustrates the effect upon distance range of differences in season and locality which differ materially in atmospheric noise level.

They show the results for one kilowatt power; a similar set of curves can be worked out from Fig. 9-A for other powers. For distances below the fading distance, they show that the lower frequencies are relatively

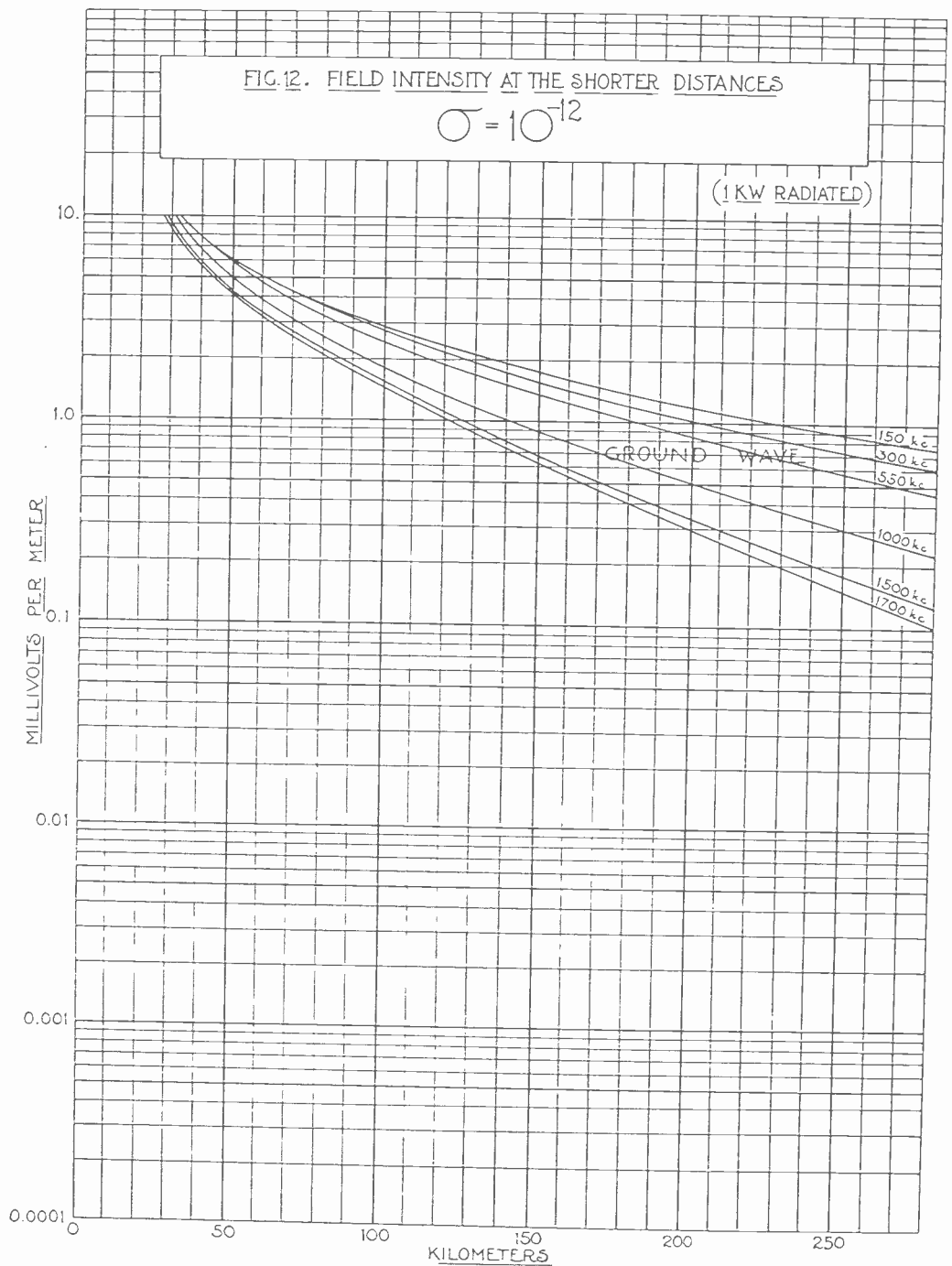

more advantageous where the atmospheric noise is low, and vice versa.

Fig. 9-D shows there is no daytime variation with season or locality, except for the very low frequencies, because of the minimum background noise being greater than the atmospheric noise in the daytime.



These curves do not hold in case of local thunderstorms or other noise varying with frequency.

Figs. 9-E and 9-F show how the useful distance varies with frequency

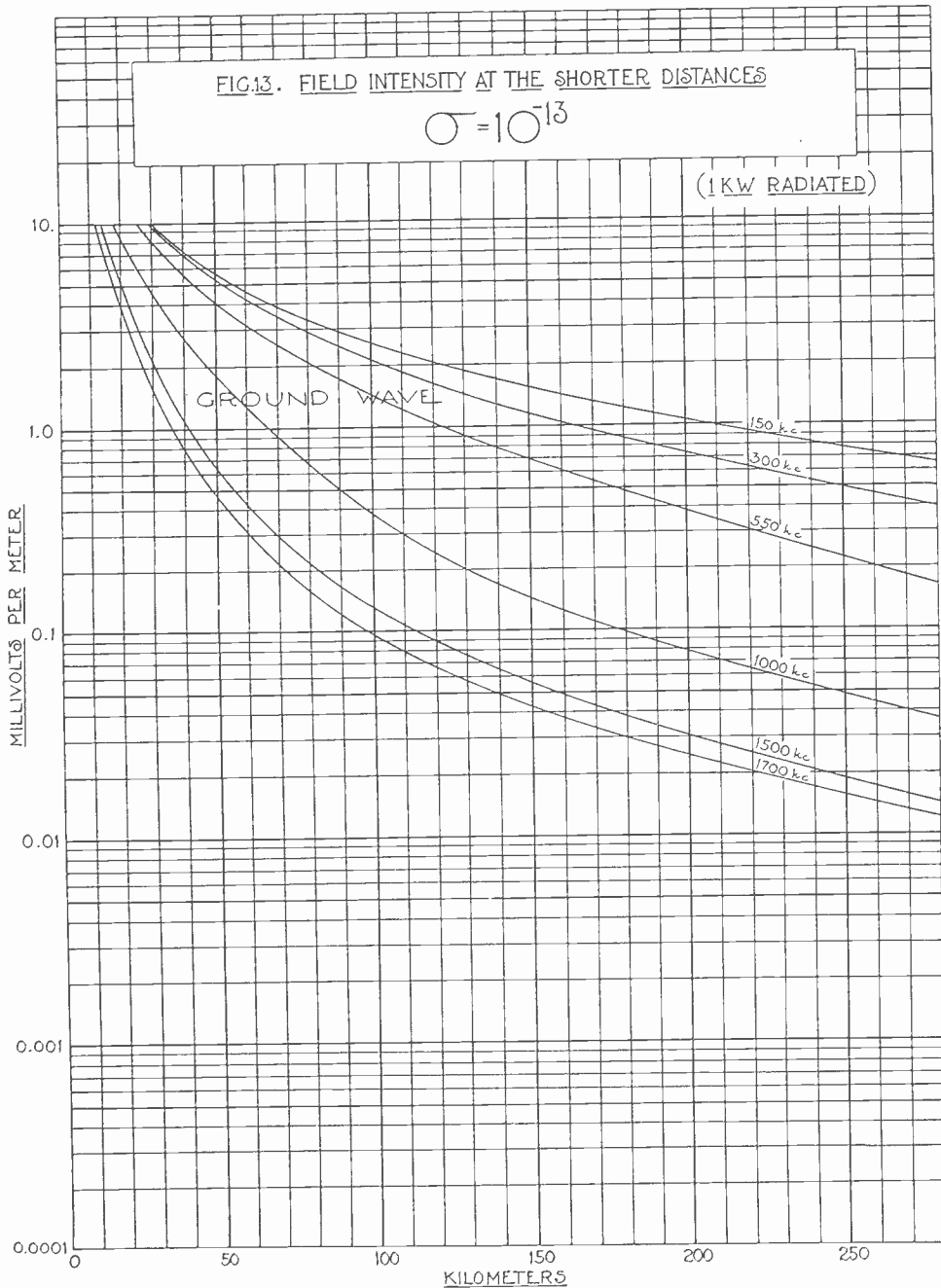

for different standards of reception in respect to signal-to-noise ratio.

The sea water transmission conditions are shown in Fig. 10. The curves are of course different from the corresponding overland curves because of the less attenuation over sea water. In general, the higher

frequencies become relatively more useful than when the transmission is over land.

The curves of Figs. 9 and 10 are of principal significance in showing relative values for different frequencies and for several conditions

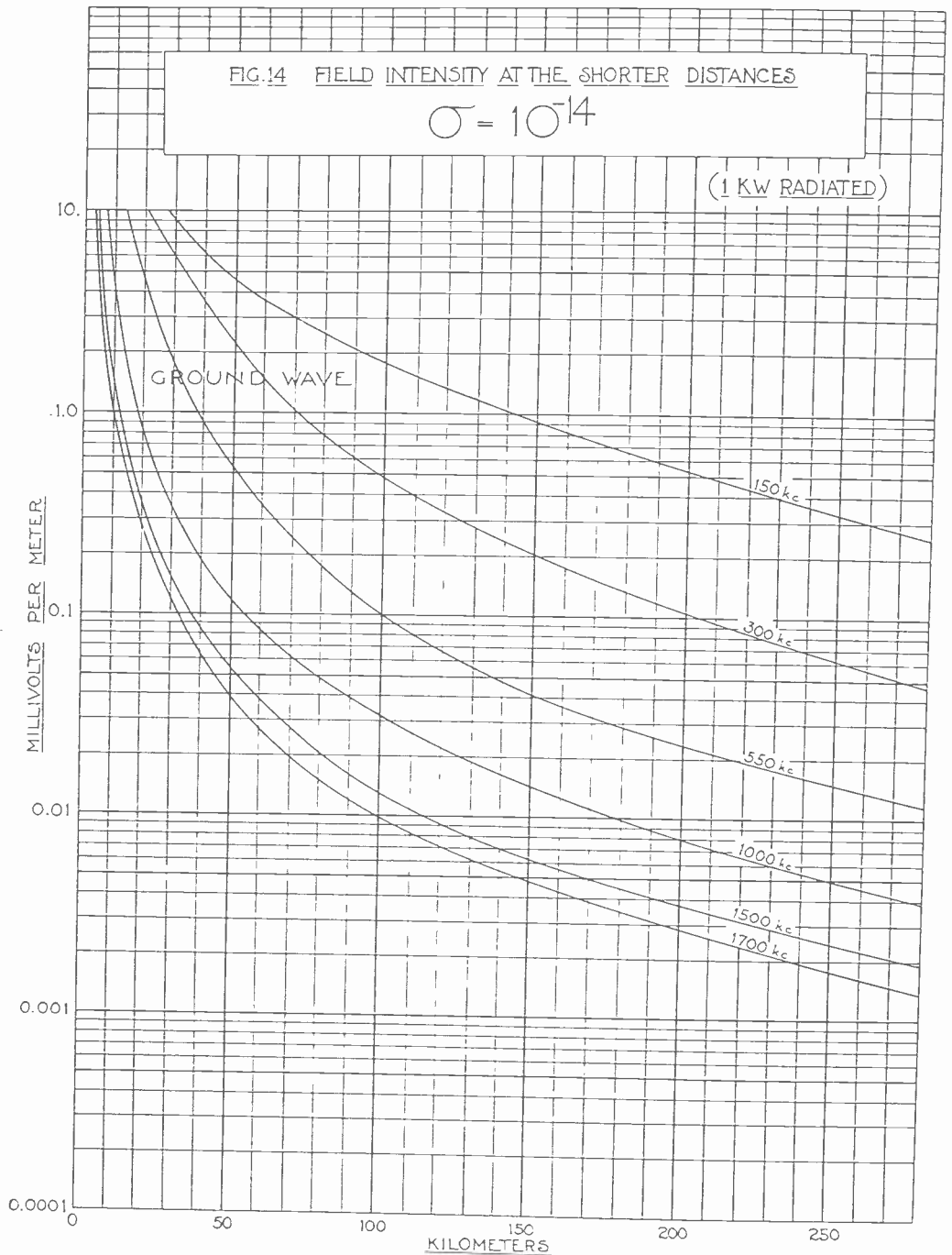

shown. The absolute values of distance shown are not of great significance, because the absolute values of noise intensity (and also daytime signal intensity at considerable distances) vary materially under different conditions from the values here set forth.

To recapitulate: the committee has given quantitative data on received field intensities and on the distance ranges of broadcast stations as limited by atmospheric and man-made electrical noise and by fading.

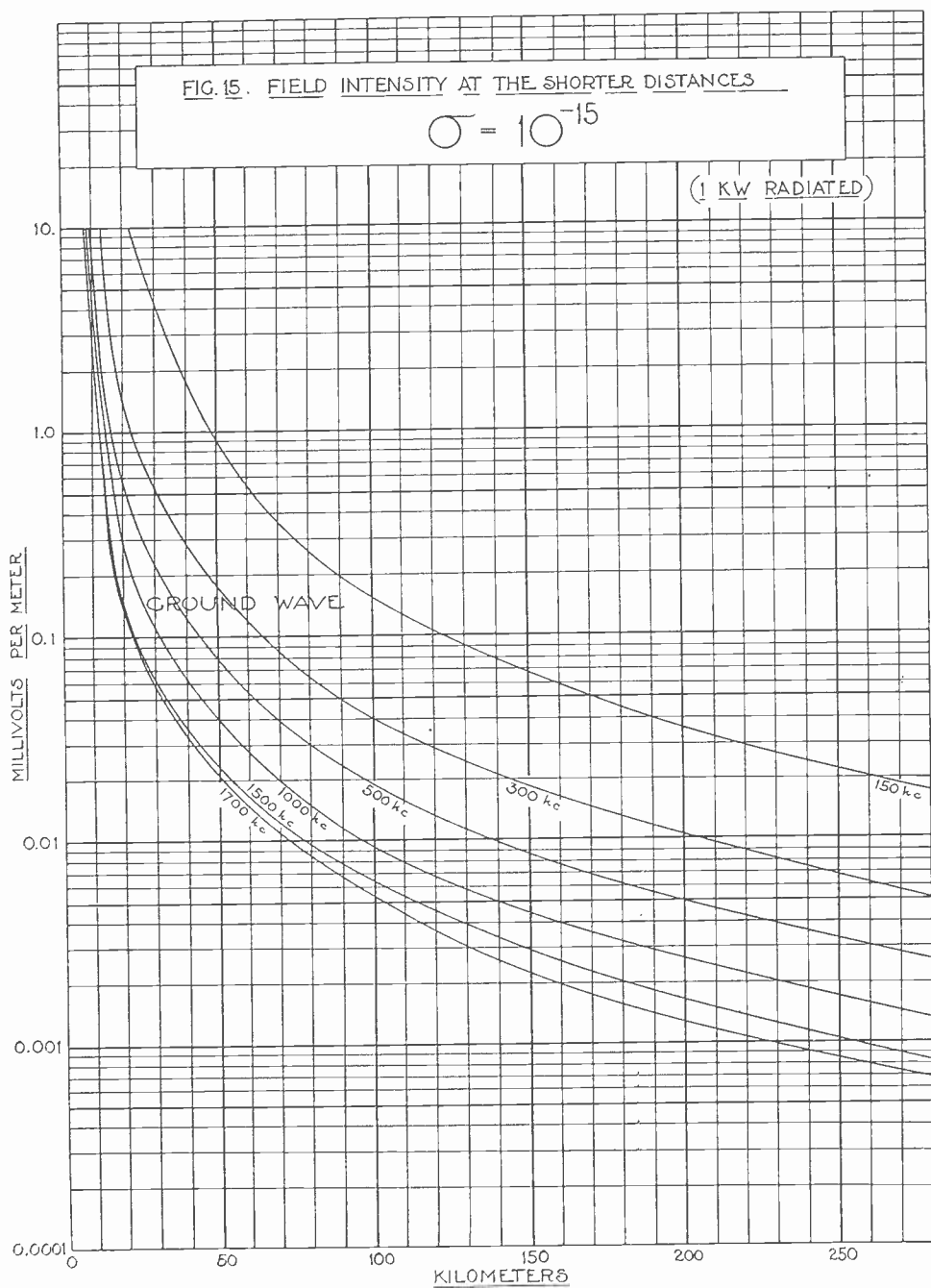

The frequencies covered are 150 to 1700 kilocycles per second. The data on received field intensities are given in Figs. 1 to 6, for distances up to 5000 kilometers (3100 miles). At short distances, both day and night, received intensities are steady and are given by the ground wave

curves of Figs. 1 to 5 (more conveniently by Figs. 11 to 15). At the greater distances, day intensities fluctuate (fade), and lie between the ground wave curves and the night curve; the night intensities fluctuate (fade), but exhibit a certain regularity when expressed in terms of the quasi maximum value, which at great distances is the same for all ground conditions and frequencies. Distance ranges of broadcast stations as limited by electrical noise and fading are shown as a function of frequency by the curves of Figs. 9 and 10. The values and trends shown in these curves must be interpreted carefully in terms of the several conditions explained in the text.



## THE CALCULATION OF HARMONIC PRODUCTION IN THERMIONIC VALVES WITH RESISTIVE LOADS\*

BY

D. C. ESPLEY

(Research Laboratories, General Electric Company, Limited, Wembley, England)

*Summary*—Formulas are obtained for the amplitudes of harmonic components and the direct-current change in the anode current of thermionic valves operating with resistive loads. These expressions for components up to the sixth harmonic are given in terms of points taken from the load line on the anode-voltage—anode-current characteristics at equally spaced intervals of grid voltage.

THERMIONIC valve characteristic curves are usually measured and plotted at equal intervals of grid voltage, and it is an advantage to have a method of harmonic content computation in terms of either the anode current or anode voltage values at the intercepts of these curves and the line representing a resistive load of any particular value. The formula making use of three intercepts, for the estimation of second harmonic, is well known, but in many cases this simple analysis is insufficient to represent the true performance of the valve. The solutions given in the present paper are available for any odd number of intercepts up to a maximum of seven, and an estimation of the harmonics can be obtained in the case where the peak voltage applied to the grid is any fraction of the voltage range between the extreme intercepts.

The equation of the load line is derived as a polynomial in terms of the grid voltage, and the introduction of a sinusoidal variable enables this polynomial to be expanded into harmonic components in terms of the original intercept values.

The required points on the  $E_a - I_a$  characteristics are at equal grid voltage intervals as contrasted with ordinary methods requiring points representing equal time intervals. The final formulas are complete in themselves, and all numbers involved are rational as opposed to the irrational terms in ordinary formulas.

### THE EQUATION OF THE LOAD LINE

The most flexible form for the anode current characteristic of a thermionic valve with a resistance load is a polynomial with suitably chosen parameters. Usually the applied voltage to the anode circuit is

\* Decimal classification: R146. Original manuscript received by the Institute, April 18, 1933.



In this analysis then we have the usual case

$$E_{g_n} - E_{g_{n-1}} = E_{g_{n-2}} = \dots = E_{g_2} - E_{g_1}. \tag{3}$$

$I_{a_{(n+1)/2}}$  is the anode current at the working grid bias of  $E_{g_{(n+1)/2}}$  volts.

Actually the performance of the valve is required when a variable grid voltage  $e_g$  is superimposed on the constant  $E_{g_{(n+1)/2}}$ . By a simple linear transformation (1) may be rewritten in terms of this more convenient variable, and although only a change of axis is implied some simplification is obtained on expansion of  $I_a$  in frequency terms. This step is illustrated in Fig. 1 and it will be seen that there is no loss of generality. The general equation is then

$$I_{a_r} = a_0 + a_1 e_{g_r} + a_2 (e_{g_r})^2 + \dots + a_{n-1} (e_{g_r})^{n-1} \tag{4}$$

in which  $e_{g_r}$  is the grid voltage displacement from the working point to give any particular anode current  $I_{a_r}$ . The simultaneous equations derived from (4) may now be solved for the unknown coefficients  $a_0 a_1 a_2 \dots a_{n-1}$  for various values of  $n$ . It is usual to take the same number of points on either side of the mean, so that  $n$  is odd.

$$\left. \begin{aligned} n &= 3 \\ I_a &= a_0 + a_1 e_g + a_2 (e_g)^2 \\ a_0 &= I_2 \\ a_1 &= \frac{1}{2(\Delta e_g)} \{ I_3 - I_1 \} \\ a_2 &= \frac{1}{2(\Delta e_g)^2} \{ I_3 - 2I_2 + I_1 \} \end{aligned} \right\} \tag{5}$$

$$\left. \begin{aligned} n &= 5 \\ I_a &= a_0 + a_1 e_g + a_2 (e_g)^2 + a_3 (e_g)^3 + a_4 (e_g)^4 \\ a_0 &= I_3 \\ a_1 &= \frac{1}{12(\Delta e_g)} \{ -I_5 + 8I_4 - 8I_2 + I_1 \} \\ a_2 &= \frac{1}{24(\Delta e_g)^2} \{ -I_5 + 16I_4 - 30I_3 + 16I_2 - I_1 \} \\ a_3 &= \frac{1}{12(\Delta e_g)^3} \{ I_5 - 2I_4 + 2I_2 - I_1 \} \\ a_4 &= \frac{1}{24(\Delta e_g)^4} \{ I_5 - 4I_4 + 6I_3 - 4I_2 + I_1 \} \end{aligned} \right\} \tag{6}$$

$$\begin{aligned}
 n &= 7 \\
 I_a &= a_0 + a_1 e_g + a_2 (e_g)^2 + a_3 (e_g)^3 + a_4 (e_g)^4 + a_5 (e_g)^5 + a_6 (e_g)^6 \\
 a_0 &= I_4 \\
 a_1 &= \frac{1}{60(\Delta e_g)} \{ I_7 - 9I_6 + 45I_5 - 45I_3 + 9I_2 - I_1 \} \\
 a_2 &= \frac{1}{360(\Delta e_g)^2} \{ 2I_7 - 27I_6 + 270I_5 - 490I_4 + 270I_3 - 27I_2 + 2I_1 \} \\
 a_3 &= \frac{1}{48(\Delta e_g)^3} \{ -I_7 + 8I_6 - 13I_5 + 13I_3 - 8I_2 + I_1 \} \\
 a_4 &= \frac{1}{144(\Delta e_g)^4} \{ -I_7 + 12I_6 - 39I_5 + 56I_4 - 39I_3 + 12I_2 - I_1 \} \\
 a_5 &= \frac{1}{240(\Delta e_g)^5} \{ I_7 - 4I_6 + 5I_5 - 5I_3 + 4I_2 - I_1 \} \\
 a_6 &= \frac{1}{720(\Delta e_g)^6} \{ I_7 - 6I_6 + 15I_5 - 20I_4 + 15I_3 - 6I_2 + I_1 \}
 \end{aligned} \tag{7}$$

In the above solutions  $\Delta e_g$  is the grid voltage interval at which the valve characteristics were measured. This may be taken as the unit interval of the variable, and according to (3) it may be defined as  $\Delta e_g = e_{g_r} - e_{g_{r-1}}$ , so that (4) for the anode current may be written as

$$I_a = a_0' + a_1'k + \dots + a_r'k^r + \dots + a'_{n-1}k^{n-1} \tag{8}$$

in which,

$$a_r' = a_r(\Delta e_g)^r.$$

and,

$$k = \frac{e_g}{\Delta e_g}.$$

#### THE EXPANSION OF FREQUENCY TERMS

Equation (8) is now in the simplest possible form, and with a sinusoidal input applied to the valve we may substitute  $e_g \sin \omega t$  for  $e_g$  and obtain all the frequency terms by expansion. Hence,

$$I_a = a_0' + a_1'(k \sin \omega t) + \dots + a'_{n-1}(k \sin \omega t)^{n-1}. \tag{9}$$

After expanding and collecting terms



$$\begin{aligned}
 I_a = & \left\{ a_0' + \frac{k^2 a_2'}{2} + \frac{3k^4 a_4'}{8} + \frac{10k^6 a_6'}{32} + \dots \right\} \\
 & + \sin \omega t \left\{ k a_1' + \frac{3k^3 a_3'}{4} + \frac{10k^5 a_5'}{16} + \dots \right\} \\
 & - \cos 2\omega t \left\{ \frac{k^2 a_2'}{2} + \frac{4k^4 a_4'}{8} + \frac{15k^6 a_6'}{32} + \dots \right\} \\
 & - \sin 3\omega t \left\{ \frac{k^3 a_3'}{4} + \frac{5k^5 a_5'}{16} + \dots \right\} \quad (10) \\
 & + \cos 4\omega t \left\{ \frac{k^4 a_4'}{8} + \frac{6k^6 a_6'}{32} + \dots \right\} \\
 & + \sin 5\omega t \left\{ \frac{k^5 a_5'}{16} + \dots \right\} \\
 & - \cos 6\omega t \left\{ \frac{k^6 a_6'}{32} + \dots \right\}
 \end{aligned}$$

All terms are of the form  $k^r a_r' / 2^{r-1}$  multiplied by a Pascal number.

It is clear from (10) that the order of the highest harmonic which can be evaluated is one less than the number of points available. The solution is now complete for the frequency components derived from a polynomial, which in turn has been fitted to seven or less points on the load characteristic. The variation of the steady direct-current component is also included in the solution. Polynomials of higher order than the sixth have not been treated here as the expressions become so unwieldy that calculation is far too laborious for ordinary use.

The coefficients  $a_0' a_1' \dots a_{n-1}'$  are known in terms of the points  $I_{a_1} I_{a_2} \dots I_{a_n}$ , and with a sinusoidal voltage input the constant  $k$  is given by the number of units ( $\Delta e_g$ ) excursion of the peak amplitude along the load characteristic. For example, if the valve characteristics have been measured at grid voltage intervals of 5 volts, and 20 volts peak is applied to the grid, then  $k = 20/5 = 4$ .

One advantage of the method is that the total harmonic content can be estimated for any value of grid voltage input, up to the maxi-

imum covering the range of the points. Reasonable extrapolation beyond this range usually gives quite satisfactory results. In most cases the harmonic content at full voltage input is of greatest interest and direct working expressions may be obtained from (10) by putting  $k = (n - 1)/2$  for the various values of  $n$  considered.

$n = 3$  maximum voltage input to cover range of points ( $k = 1$ ).

$$I_a = \frac{1}{4}\{I_3 + 2I_2 + I_1\} + \sin \omega t \cdot \frac{1}{2}\{I_3 - I_1\} - \cos 2\omega t \cdot \frac{1}{4}\{I_3 - 2I_2 + I_1\} \quad (11)$$

This leads to the well-known expression for the proportion of second harmonic derived from three points, viz:

$$\frac{\text{second harmonic}}{\text{fundamental}} = - \frac{I_3 - 2I_2 + I_1}{2(I_3 - I_1)}$$

$n = 5$  ( $k = 2$ )

$$I_a = \frac{1}{6}\{I_5 + 2I_4 + 2I_2 + I_1\} + \sin \omega t \cdot \frac{1}{3}\{I_5 + I_4 - I_2 - I_1\} - \cos 2\omega t \cdot \frac{1}{4}\{I_5 - 2I_3 + I_1\} - \sin 3\omega t \cdot \frac{1}{6}\{I_5 - 2I_4 + 2I_2 - I_1\} + \cos 4\omega t \cdot \frac{1}{12}\{I_5 - 4I_4 + 6I_3 - 4I_2 + I_1\} \quad (12)$$

$$\begin{aligned}
 & \underline{n = 7} \quad (k = 3) \\
 I_a = & \frac{1}{1280} \{ 167I_7 + 378I_6 - 135I_5 + 460I_4 - 135I_3 + 378I_2 + 167I_1 \} \\
 & + \sin \omega t \cdot \frac{1}{640} \{ 167I_7 + 252I_6 - 45I_5 + 45I_3 - 252I_2 - 167I_1 \} \\
 & - \cos 2\omega t \cdot \frac{1}{2560} \{ 559I_7 + 486I_6 - 1215I_5 + 340I_4 - 1215I_3 \\
 & \qquad \qquad \qquad + 486I_2 + 559I_1 \} \\
 & - \sin 3\omega t \cdot \frac{1}{256} \{ 45I_7 - 36I_6 - 63I_5 + 63I_3 + 36I_2 - 45I_1 \} \\
 & + \cos 4\omega t \cdot \frac{9}{1280} \{ 17I_7 - 42I_6 + 15I_5 + 20I_4 + 15I_3 - 42I_2 + 17I_1 \} \\
 & + \sin 5\omega t \cdot \frac{81}{1280} \{ I_7 - 4I_6 + 5I_5 - 5I_3 + 4I_2 - I_1 \} \\
 & - \cos 6\omega t \cdot \frac{81}{2560} \{ I_7 - 6I_6 + 15I_5 - 20I_4 + 15I_3 - 6I_2 + I_1 \}
 \end{aligned} \tag{13}$$

In all cases the coefficients of the component terms are peak amplitudes in the units of  $I_{a_r}$ .

The percentage of any particular harmonic is given directly by the ratio of the harmonic coefficient multiplied by 100, to the coefficient of the fundamental.

The general expression is obtained from (9) as *percentage of rth harmonic*

$$= 100 \left\{ \frac{ \frac{k^r a_r'}{2^{r-1}} + \frac{(r+2)k^{r+2} a'_{r+2}}{2^{r+1}} + \frac{(r+3)(r+4)k^{r+4} a'_{r+4}}{2^{r+4}} + \dots }{ k a_1' + \frac{3k^3 a_3'}{4} + \frac{10k^5 a_5'}{16} + \dots } \right\} \tag{14}$$

It should be remembered that the estimation of harmonic amplitudes by any method such as the above depends for its accuracy on the precision with which the valve characteristics have been measured and drawn.

Greater accuracy is always obtainable, and with less trouble, when the load resistance is conductively connected in the anode circuit and is not coupled by means of a transformer. In the former case the load line points required for the calculation can be measured directly, whereas with a transformer coupled load all the relevant lines of constant grid voltage must be drawn before the load line can be superimposed to find the intercepts  $I_1 I_2 \dots I_n$ . The case of a transformer coupled load is still further complicated by the necessity for correcting for rectification by the method described by Kilgour.<sup>2</sup>

Two other factors govern the accuracy of estimation. First, the greater the number of points available on the load line, within the range of applied grid voltage, the higher will be the accuracy with which any particular harmonic can be estimated; and second, with a given number of points within the range, the accuracy will decrease as the order of the desired harmonic increases.

<sup>2</sup> C. E. Kilgour, "Graphical analysis of output tube performance," *Proc. I.R.E.*, vol. 19, pp. 42-51; January, (1931).



## ATTENUATION OF OVERLAND RADIO TRANSMISSION IN THE FREQUENCY RANGE 1.5 TO 3.5 MEGACYCLES PER SECOND\*

BY

C. N. ANDERSON

(American Telephone and Telegraph Company, New York City)

*Summary*—Data on the effect of land upon radio transmission have been obtained during the past few years in connection with various site surveys. These data are for the general frequency range 1.5 to 3.5 megacycles per second and for various combinations of overwater and overland transmission as well as entirely overland. The generalizations in this paper are chiefly in the form of curves which enable one to make approximations of field strengths to be expected under the conditions noted above. The relation of these data to transmission in the broadcast frequency range is shown, and from the over-all picture, curves are developed which enable field strength estimates to be made for overland transmission in the extended frequency range.

IT HAS been recognized for many years that the attenuation of radio transmission over land (ground wave) is much higher than over water. It was not, however, until comparatively recently that it was generally appreciated that the effect of the ground per mile varies with distance from the transmitter and that the effect, for a given amount of land, is dependent on whether the transmission is entirely over land, or the land is adjacent to either the radio transmitter or receiver, or intermediate (nonadjacent). For that reason many of the generalizations as to attenuations of overland transmission have been attempts to fit the data to an empirical formula of the Austin-Cohen type. This type of formula presumes a constant absorption (in decibels) per mile and does not, therefore, accurately represent the facts.

In addition to the early papers of Sommerfeld and Zenneck there have been several papers<sup>1,2,3,4,5,6,7</sup> in recent years which have discussed

\* Decimal classification: R113.7×R270. Original manuscript received by the Institute, June 9, 1933. Presented before Eighth Annual Convention, Chicago, Illinois, June 27, 1933.

<sup>1</sup> Bruno Rolf, "Graphs to Prof. Sommerfeld's attenuation formula for radio waves," Proc. I.R.E., March, (1930).

<sup>2</sup> Balth. van der Pol and K. F. Niessen, "Über die Ausbreitung Electromagnetischer Wellen," *Ann. der Physik*, vol. 6, (1930); *Zeit. für Hochfrequenz. Tech.*, April, (1931).

<sup>3</sup> P. O. Pedersen, "The propagation of radio waves," Danmarks Naturvidenskabelige Samfund, No. 15a.

<sup>4</sup> W. Howard Wise, "The grounded condenser antenna radiation formula," Proc. I.R.E., September, (1931).

<sup>5</sup> R. A. Heising, "Effect of shore station location upon signals," Proc. I.R.E., January, (1932).

<sup>6</sup> S. S. Kirby and K. A. Norton, "Field intensity measurements at frequencies from 285 to 5400 kilocycles per second," Proc. I.R.E., May, (1932).

<sup>7</sup> T. L. Eckersley, "Direct-ray broadcast transmission," Proc. I.R.E., October, (1932).

one or more phases of the effect of land upon radio transmission. Much of this work has been theoretical and nearly all the data which have been published have been concerned with frequencies in the broadcast range and for cases where the transmission path is entirely over land.

The present paper presents data, in the 1.5 to 3.5 megacycles per second frequency range, which have been accumulated during the past few years chiefly in connection with surveys of various transmitting station sites. In addition to indicating the effect of entirely overland transmission paths on transmission, effects of various combinations of overland and overwater paths are discussed. In these combination land and water paths, the land has a different effect depending upon its location in the transmission path relative to the transmitter and measuring point. This aspect of radio transmission has not yet been adequately treated mathematically. At the end of the paper, a comparison is made with a brief analysis of some published data on overland transmission in the broadcast frequency range to give a somewhat more generalized picture of radio transmission.

The data discussed in this paper were obtained at Boston, Seattle, San Francisco, and Los Angeles on frequencies of about 2400–2600 kilocycles, at New York on 1600 kilocycles and 2400 kilocycles, and at Mendham, N. J., on 3415 kilocycles. Inasmuch as most of the data was taken in connection with site surveys, the measurement locations, even after careful selection, were usually far from ideal. These are, however, the conditions which are met with in practice. In view, therefore, of the errors in measurement and of transmission conditions peculiar to the individual observations, it is felt that the data allow only a very general analysis.

#### METHODS OF ANALYSIS

For transmission paths over a plane perfect conductor or for transmission in space, the field from a vertical radiating dipole (beyond a very short distance) decreases inversely with distance. If the transmission path is not of this sort, the propagation is affected, partially by energy dissipation, partially by interference between the wave reflected from the ground and the direct wave, and in some cases by diffraction and refraction.<sup>8</sup> The net result is that the field strength ordinarily falls off more rapidly than inversely with distance depending upon the configuration and the electrical constants of the transmission path.

For transmission over sea water, the differences between measured

<sup>8</sup> J. C. Shelleng, C. R. Burrows, and E. B. Ferrell, "Ultra-short-wave propagation," *Proc. I.R.E.*, March, (1933).

fields and inverse distance values are relatively small for frequencies lower than a few megacycles per second and for distances not exceeding a few hundred miles. Even on a frequency of 4000 kilocycles per second this difference is no greater for 150 miles of over sea water transmission than for one mile of overland transmission. As the frequency increases, however, the effect of the sea water upon attenuation increases so that at the ultra-high frequencies the fields fall off more nearly as the inverse square of the distance, even at distances of only a few miles from the transmitter.<sup>8</sup>

Because of the small effect of sea water on transmission up to distances of several hundred miles on frequencies lower than say four

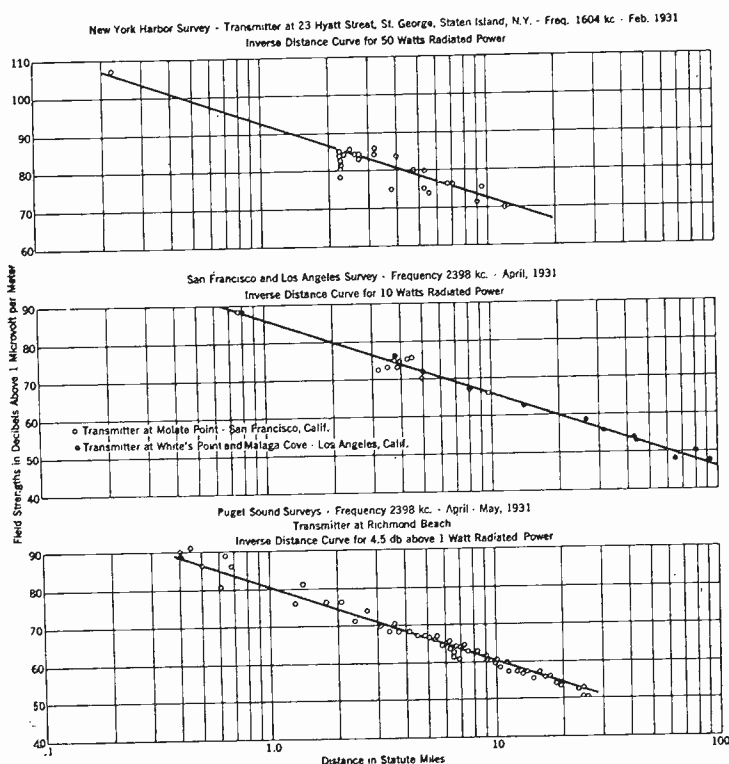

Fig. 1—Variation of field strengths with distance for overwater transmission. Corrected to 1.6 amperes antenna current and for sea water attenuation 0.06 decibel per mile.

megacycles per second, no great error is introduced by expressing the absorption, or apparent absorption, of sea water in decibels per mile by such an expression as the absorption coefficient of the Austin-Cohen formula. This empirical formula has been found to approximate the field strengths very well and the convenience in computations justifies its use. Compared with a condensed form of the Sommerfeld formula,<sup>1</sup> the Austin-Cohen formula differs in the so-called absorption coefficient. The Austin-Cohen expression is a simple one involving an "absorption

constant," distance, and wavelength, whereas the corresponding part in the Sommerfeld formula is a complicated expression involving distance, wavelength, conductivity, and inductivity. Fig. 1 shows several sets of data on overwater transmission which have been corrected up-

APPROXIMATE VARIATION OF DAYTIME OVERSEA WATER TRANSMISSION WITH DISTANCE AND FREQUENCY

BASED ON AUSTIN - COHEN FORMULA

Curves are for various frequencies in Kilocycles per second.  
 Dotted portions indicate that the effect of indirect "sky wave" may result in somewhat higher fields.  
 1 KW radiated power.

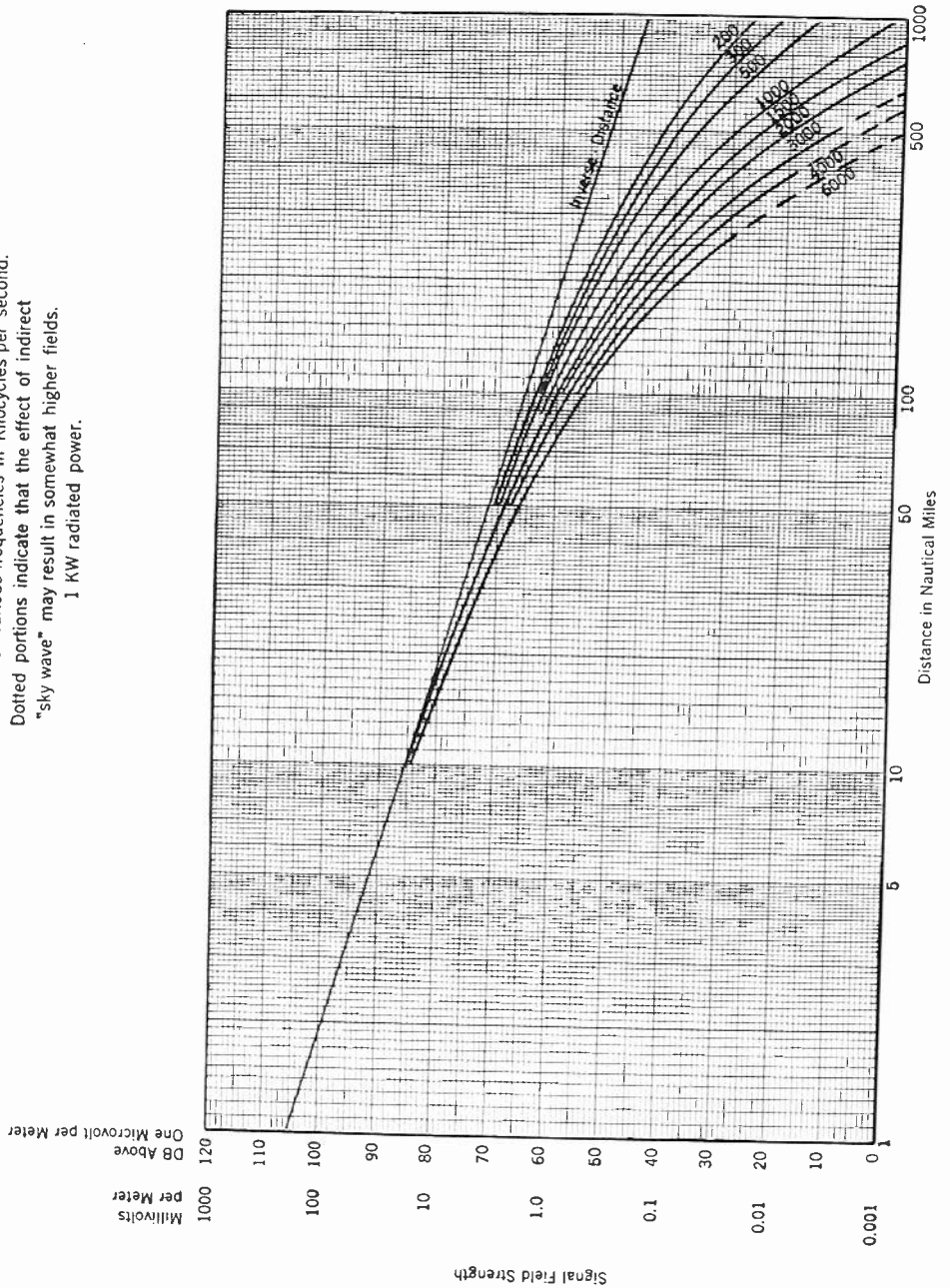

Fig. 2

ward to compensate for the effect of sea water (0.06 decibel per mile at 2400 kilocycles per second). The corrected fields agree very closely with the inverse distance curve. Up to 100 miles, at least, the sky wave reflected from the Heaviside layer on this frequency is too small compared with the direct transmission over water to be noticeable. The



approximate variation of daytime overwater signal fields with distance as computed by the Austin-Cohen formula for various frequencies is shown in Fig. 2.

In determining the effect of land upon radio transmission, it is first necessary to determine the value of signal field strength which would be expected at a given point provided that the transmission path had no effect upon transmission, that is, the inverse distance field. The fact that the effect of over sea water transmission can be closely approximated permits us to determine these inverse distance fields quite readily from overwater measurements. The difference between the in-

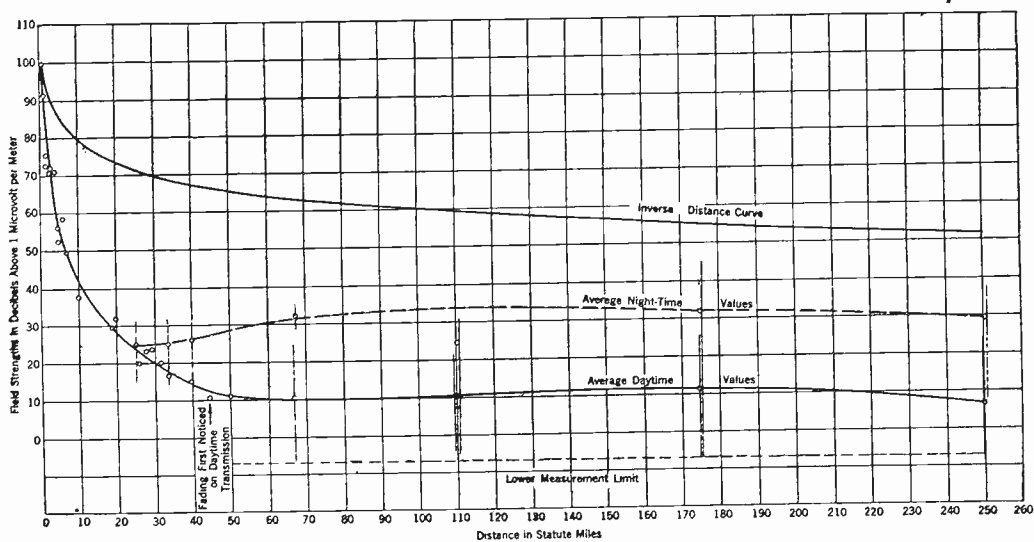

Fig. 3—Variation of daylight signal fields with distance. Overland transmission from Green Harbor, Mass. Frequency 2590 kilocycles. Radiated power 200 watts from 110-foot vertical conductor. September 26 to October 2, 1932.

verse distance fields and the actual fields for, say, overland transmission, represents the apparent absorption effect of the transmission path. Measurements of transmission over water are, therefore, very useful in the proper evaluation of the effect of the ground on attenuation.

#### ENTIRELY OVERLAND TRANSMISSION

The results of a set of measurements of overland transmission from Green Harbor, Mass., using 110-foot vertical conductor for the transmitting antenna, are shown in Fig. 3. The inverse distance curve was determined from a few measurements of overwater transmission. During the daytime it is evident that beyond forty-five or fifty miles the transmission is not simply the direct ground wave. At night the indirect wave affects the fields in as close as twenty to twenty-five miles,

This transmission characteristic is undoubtedly affected considerably by the type of antenna used as is seen by comparing the above curve with that of Fig. 4. These data were obtained at Mendham, N. J., and

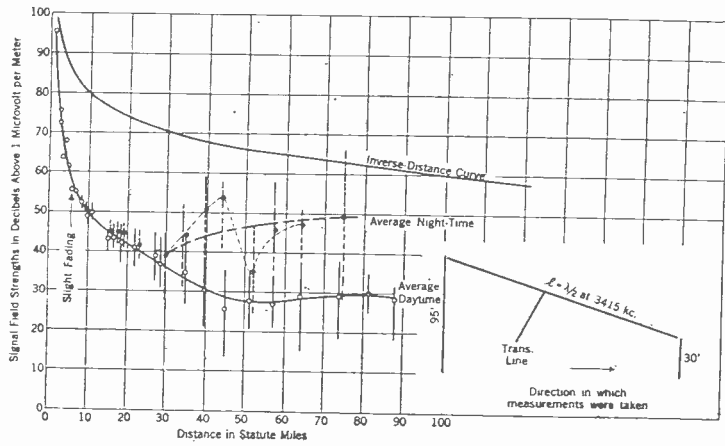

Fig. 4—Variation of daylight and nighttime signal fields with distance. Overland transmission from Mendham, N. J. Frequency 3415 kilocycles. Radiated power approximately 200 watts. Transmitting antenna type shown below. Measuring antenna 8-foot vertical rod. October 13, 1932.

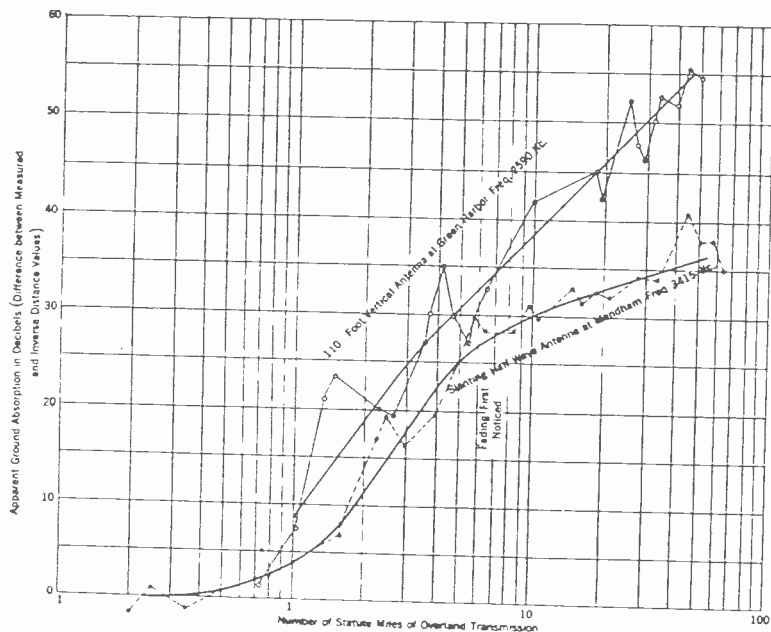

Fig. 5—Apparent ground absorption of overland transmission, Green Harbor, Mass., and Mendham, N. J. Difference in absorption of initial mile may be due to the Mendham antenna being situated on a knoll. Difference in apparent absorption beyond six miles probably due to feeding-in of sky wave energy. September to October, 1932.

on a somewhat higher frequency but with an antenna with a high angle radiation characteristic. Under these conditions fading was first noticed at six miles instead of fifty, and the average daytime and nighttime fields beyond fifty miles were about 20 decibels higher than the corre-

sponding fields from Green Harbor. No overwater measurements were possible but inasmuch as the same type of transmitter was used in both cases and the transmitter loads were approximately the same, the results are probably comparable.

Fig. 5 shows the apparent ground absorption, difference between inverse distance and the measured values, for the Green Harbor and Mendham data. The lower apparent absorption for the first mile in the case of Mendham may be due to the fact that the Mendham antenna is located on a knoll so that much of the land in the first mile lies below the air line of transmission. The effect of the succeeding miles

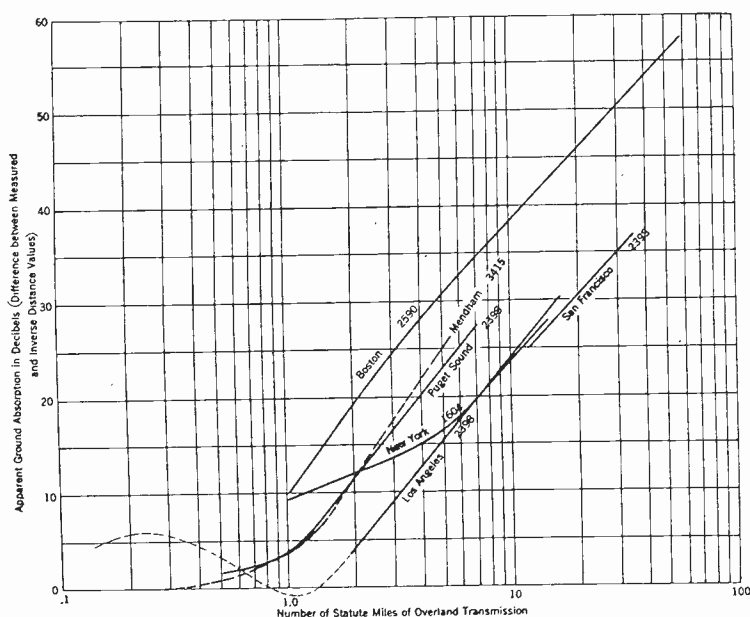

Fig. 6—Average absorption of overland radio transmission. Entire overland transmission—summaries of various harbor surveys. February to May, 1931.

of land at Mendham up to five or six miles is substantially the same as at Green Harbor. Beyond this distance, the indirect sky wave transmission causes a decrease in the apparent absorption.

Data on transmission from vertical transmitting antennas were also obtained at other locations, New York (1604 kilocycles), Seattle (2398 kilocycles), San Francisco (2398 kilocycles), and Los Angeles (2398 kilocycles). These data on "entirely overland transmission" are summarized in Fig. 6. Beyond a distance of two or three miles the slopes of these curves are very nearly the same, indicating the significant part that the initial miles play in affecting the overland transmission range of a transmitting station. Beyond these first few miles the effects of successive miles are respectively about the same for the various locations.

These curves are certainly of the same general shape as those indicated by various theoretical formulas, although the degree to which they coincide with such graphical curves of the Sommerfeld formula as those presented by Rolf<sup>1</sup> is not entirely satisfactory. No one Rolf curve can be made to fit a datum curve in its entirety, and several Rolf curves may be found to fit portions of each datum curve. Furthermore, whereas the Rolf curves indicate a tendency for the signal fields to vary inversely as the square of the distance at the greater distances, the data seem to indicate a somewhat higher rate of attenuation. The Rolf curve which best fits the Green Harbor data corresponds to a conductivity of about  $2 \cdot 10^{-14}$  and inductivity of 2 or 3. This value for induc-

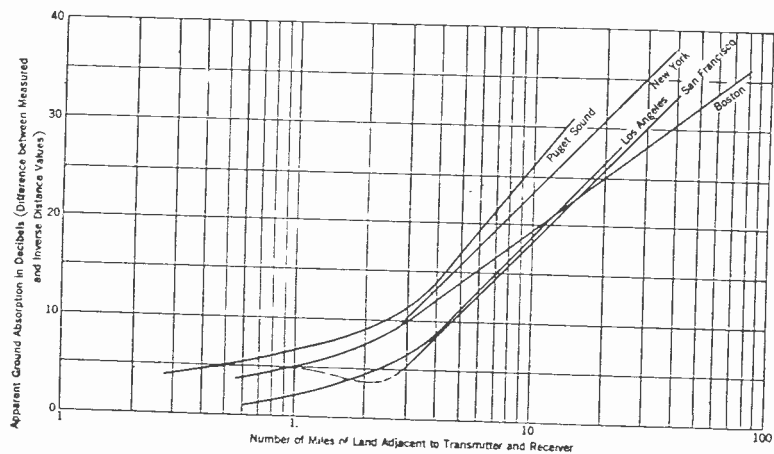

Fig. 7—Ground absorption of overland radio transmission. Summary of various sets of data when land is adjacent to transmitter or receiver. Frequency 2398 kilocycles except 1604 kilocycles for New York.

tivity appears to be far too low when compared with the values of 10 or 15 usually assumed.

It is granted that these data are not particularly suited for this type of study inasmuch as the terrain may be far from uniform. Although the data are taken in the same general vicinity, they do not necessarily represent transmission in the same direct line. However, the conditions were those encountered in practice, and special care was employed in securing reliable data because of anticipating such a study.

#### TRANSMISSION WITH LAND ADJACENT TO EITHER TRANSMITTER OR RECEIVER

The curves showing the apparent absorption for land adjacent to either the radio transmitter or receiver are shown in Fig. 7. The different curves are similar to each other in many respects but differ somewhat in magnitude. They are also similar to the curves for entire overland transmission except for a shift along the distance axis. For

example, the effect of fifteen miles of land adjacent to the transmitter or receiver is approximately equivalent to the effect of ten miles when the transmission is entirely over land.

If land is adjacent to both transmitter and receiver, high apparent absorption is encountered at each terminal. The total apparent absorption in such a case is equivalent to the sum of the absorption for each terminal as determined from the curves provided the intervening water is at least four miles across. If the intervening water is less than four miles across, the apparent absorption approaches that of entirely overland transmission. Only half a mile of intervening water may be neglected and the path treated as "entirely over land."

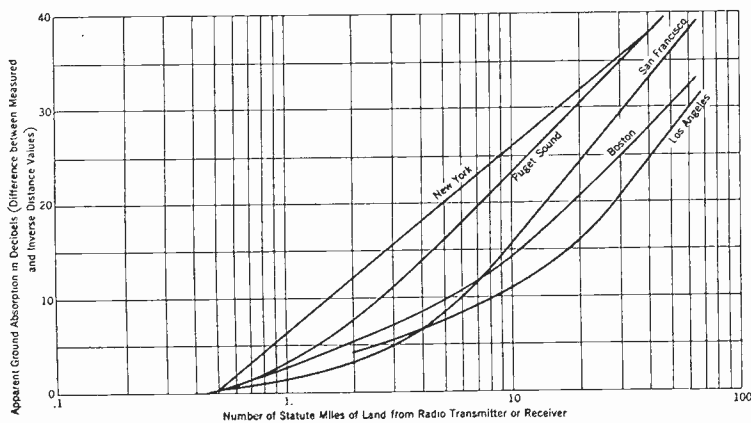

Fig. 8—Ground absorption of overland radio transmission. Land intermediate between radio transmitter and receiver—summary of various harbor surveys. Frequency 2398 kilocycles except 1604 kilocycles for New York. February to May, 1931.

The apparent absorption of the "over-sea-water" portion of the transmission path is estimated by the Austin-Cohen formula and the resultant signal field strength is the difference (units in decibels) between the inverse distance field and the total overland and overwater absorption.

#### TRANSMISSION WITH LAND INTERMEDIATE BETWEEN TRANSMITTER AND RECEIVER

The effect of transmission over land intermediate between the transmitter and receiver, but nonadjacent, is shown in the curves of Fig. 8. An example will indicate the use of these curves in determining the effect of intermediate land. An island in the Puget Sound region which is ten miles across and whose nearest edge is twenty miles from the transmitter (or receiver, whichever is nearest) will introduce an apparent absorption equivalent to the difference between the absorption as indicated at twenty miles (30 decibels) on the curve of Fig. 8 and that at thirty miles (35 decibels), that is, 5 decibels.

These curves were determined from simple cases of intermediate land. Often, as in the case of Puget Sound, the transmission path may be a complicated one of numerous islands, combined with some overland transmission adjacent to the transmitter or receiver, or both. Transmission paths will, of course, vary in degree of complexity, and some empirical rules of procedure must be necessary in arriving at any estimate of the field to be expected. Beginning with the simpler cases, certain assumptions were worked out which give the best results between the values so computed and the measured values. These are given below:

- (a) With no land adjacent to the transmitter or receiver, calculate the absorption from whichever is the nearer to the bulk of the land. Calculate only from the one or the other but never both. For instance, if there are two pieces of intermediate land, one relatively close to the transmitter and one relatively close to the receiver, treat them both as certain distances from, say, the transmitter if that is the nearer (or from the receiver if that is the nearer), but never one piece with regard to the transmitter and one with regard to the receiver.
- (b) With no land adjacent to the receiver, with the bulk of the intermediate land nearer to the receiver, or with only a small amount of land adjacent to the transmitter (up to a mile or so), treat the intermediate land as so many miles from the receiver and the land adjacent to the transmitter as "land adjacent."
- (c) Similarly with the positions of the transmitter and receiver reversed.
- (d) With considerable land adjacent to transmitter (or receiver), the evaluation of the land should be from the transmitter (or receiver).
- (e) With land adjacent to both transmitter and receiver, compute these separately as adjacent land and treat the intermediate land according to whichever one is nearer to the bulk of the land.
- (f) For complex paths of intermediate land interspersed with water, it was found that, in general, when the water was less than two miles, it should be treated as land.
- (g) Whenever the intermediate land was closer than 0.5 mile to either the transmitter or receiver, the absorption followed more closely that determined by the "land adjacent" curve.

It is evident from the foregoing that there is no simple straightforward method of determining approximate received field strengths which can be used in lieu of actual field surveys. On the other hand,

theoretical computations for anything but the simple case of "entirely overland transmission" would probably be impractical even if the theoretical treatment had been adequately worked out. The rules just described were reached after studying about 800 measurements, and the use of these rules in recomputing the data for the Pacific Coast harbors resulted in 90 per cent of the values lying within 4 decibels of the measured fields.

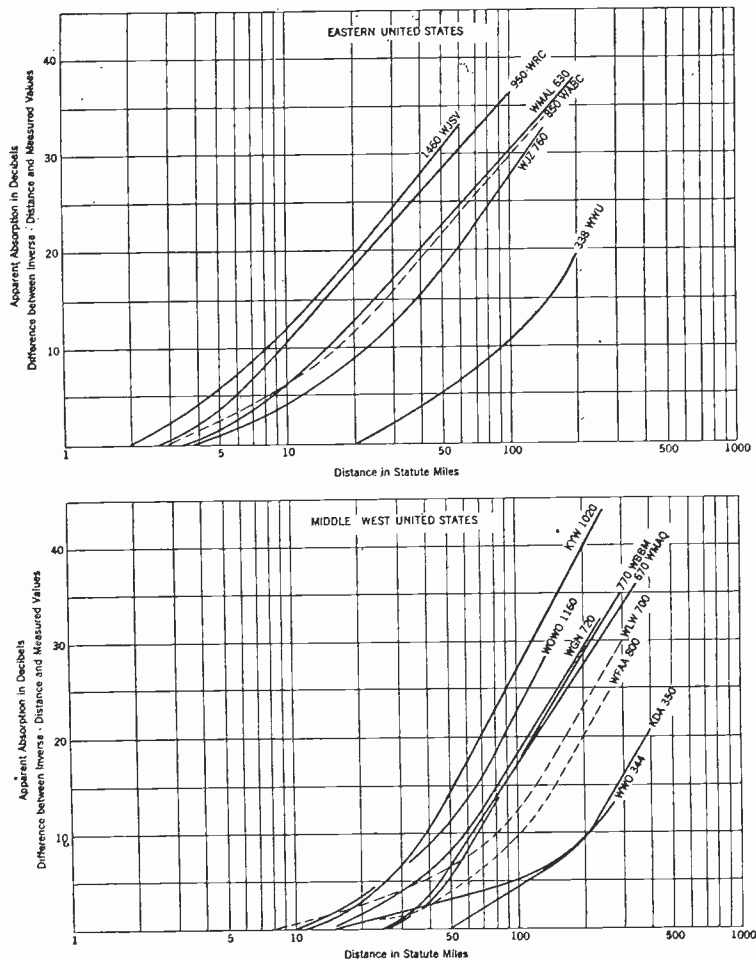

Fig. 9—Ground absorption of overland radio transmission. Station call letters and frequency in kilocycles shown on curves. Except for WABC, WLW, and WFAA, curves are derived from data by Kirby and Norton, Proc. I.R.E., May, (1932).

#### COMPARISON WITH OVERLAND TRANSMISSION AT OTHER FREQUENCIES

In order to obtain some comparison of the effect of land upon transmission in this frequency range 1.5 to 3.5 megacycles with the effect at other frequencies, a brief analysis was made of some published data on transmission in the broadcast range. These data are shown in the curves of Fig. 9. All but three of these curves were obtained from data

published by Kirby and Norton.<sup>6</sup> They are generally similar to the overland curves of Fig. 6 except for the displacement along the distance axis. This relation is more evident in Fig. 10 which shows the relation between the various groups of data, and also includes some reference curves prepared for the radio conference at Madrid. These are the same as those presented by Eckersley.<sup>7</sup>

In general decreasing frequency and increasing conductivity (conductivity of land in middle-west United States is conceded to be higher than in the East) tend to displace the curves along the distance axis. Some idea of this displacement along the distance axis for the various

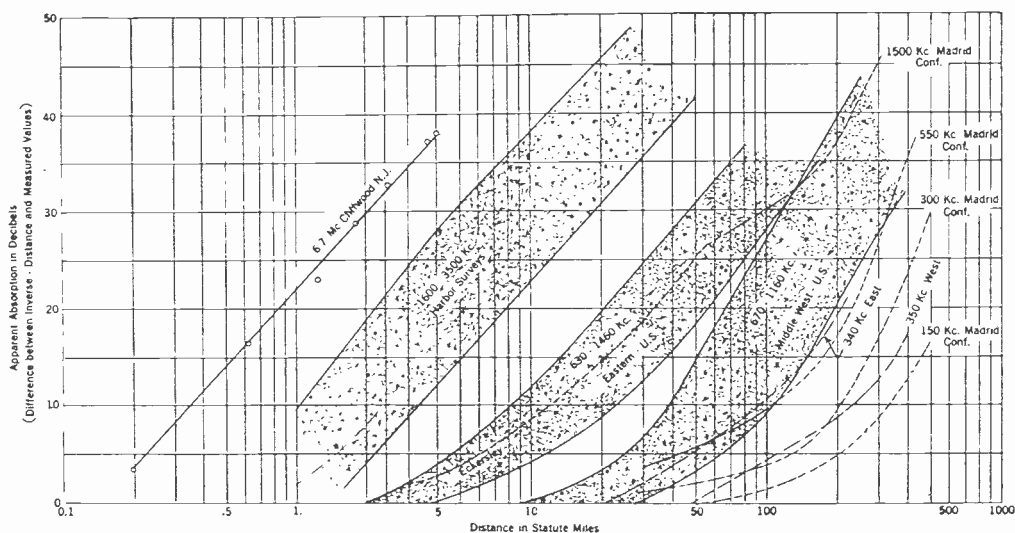

Fig. 10—Absorption of overland radio transmission. Summary of data in various frequency ranges. Data in broadcast range largely from Kirby and Norton, Proc. I.R.E., May, (1932).

frequencies is shown in Fig. 11 which gives a plot of the distance at which the apparent absorption is 20 decibels for the various frequencies. The relation which apparently holds is that the distance ratio is approximately inversely proportional to the square of the frequency ratio. This relation conforms with that indicated by Sommerfeld's results for the case where the dielectric currents can be neglected.<sup>3</sup> A distinction is made between the data for the eastern and the middle-western states. The few data available for the Pacific Coast seem to indicate that the ground conditions are similar to those of eastern United States.

It has been previously pointed out that the curves of apparent absorption for the eastern states are very similar except for the displacement along the distance axis for various frequencies. Furthermore, since Fig. 11 indicates approximately this distance displacement with



frequency, it should be possible to combine the two and obtain a generalized picture of the effect of ground upon radio transmission. The curve which is repeated for the various frequencies is a composite curve

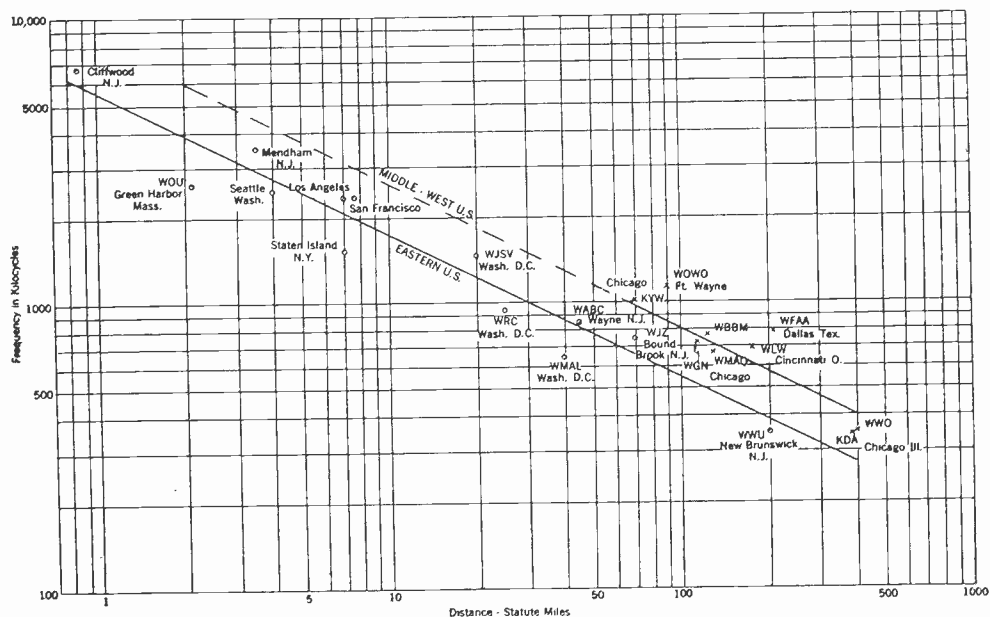

Fig. 11—Distance at which ground absorption reduces signal 20 decibels from inverse distance values—to show displacement of absorption curve with frequency. Middle-west U. S. curve corresponds approximately to  $\gamma = 10^{-13}$  in van der Pol's equation. Eastern U. S. curve corresponds approximately to  $\gamma = 3.7 \cdot 10^{-14}$  in van der Pol's equation. (N. J.  $4.5 \cdot 10^{-14}$ .)

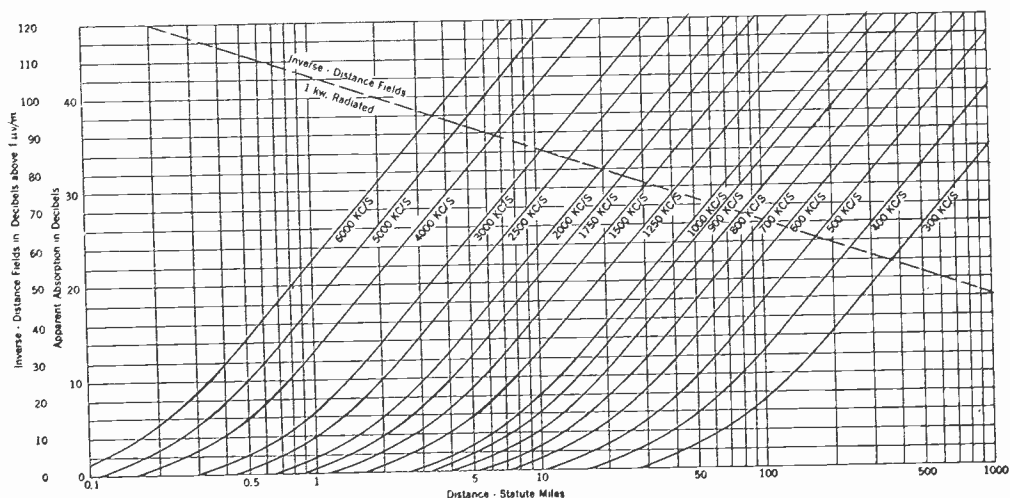

Fig. 12—Approximate variation of ground absorption with distance and frequency, eastern United States.

of the various absorption curves previously discussed. These absorption curves and the curve of inverse distance fields of Fig. 12 enable one to estimate readily the field expected for a given distance, fre-

APPROXIMATE VARIATION OF DAYTIME SIGNAL FIELD STRENGTH WITH OVERLAND DISTANCE AND FREQUENCY

BASED ON DATA OBTAINED IN EASTERN UNITED STATES  
 CURVES ARE FOR VARIOUS FREQUENCIES IN KILOCYCLES PER SECOND

For frequencies above the order of 2000 kc/s the ground wave is supplemented by the indirect sky wave at distances beyond the limits of the curves tending to increase the fields above the extrapolated values. On the low frequencies beyond distances of two or three hundred miles, the curvature of the earth's surface tends to reduce the fields below the extrapolated values.

1 Kw Radiated Power

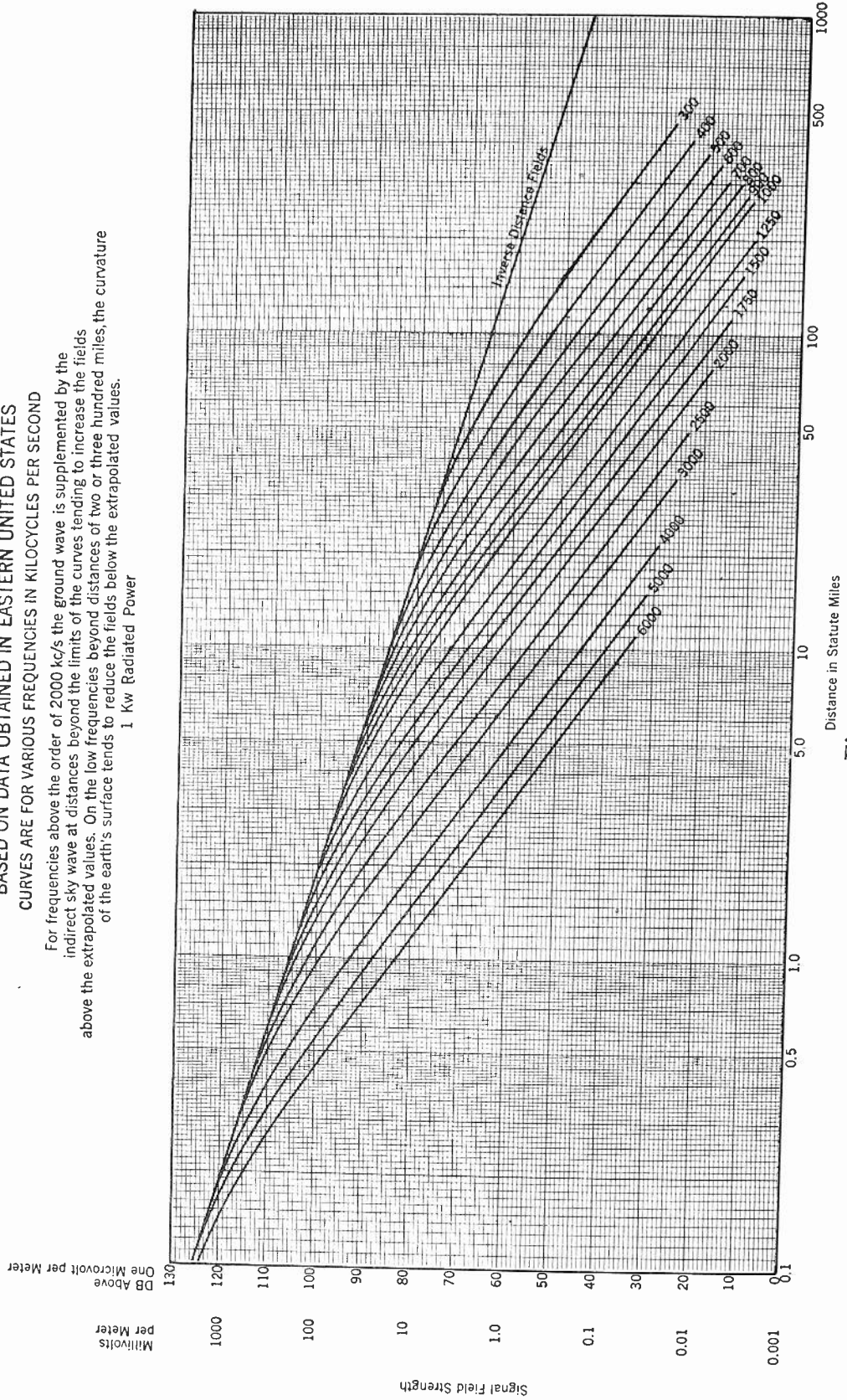

Distance in Statute Miles

Fig. 13

APPROXIMATE VARIATION OF DAYTIME SIGNAL FIELD STRENGTH WITH OVERLAND DISTANCE AND FREQUENCY

BASED ON DATA OBTAINED IN MIDDLE WEST UNITED STATES  
 CURVES ARE FOR VARIOUS FREQUENCIES IN KILOCYCLES PER SECOND

For frequencies above the order of 2000 kc/s the ground wave is supplemented by the indirect sky wave at distances beyond the limits of the curves tending to increase the fields above the extrapolated values. On the low frequencies beyond distances of two or three hundred miles, the curvature of the earth's surface tends to reduce the fields below the extrapolated values.

1 Kw Radiated Power

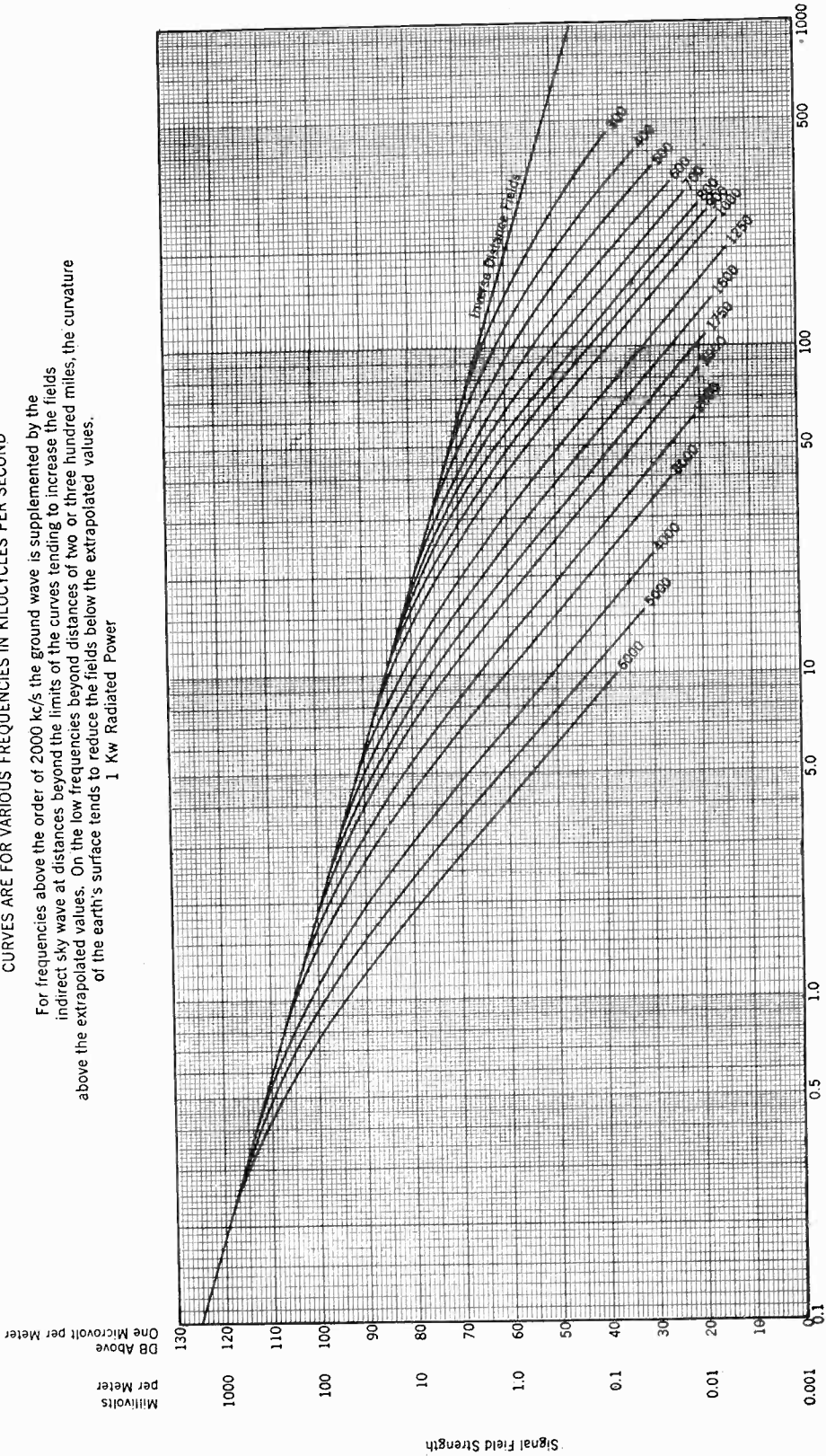

Distance in Statute Miles

Fig. 14

quency, and power as has been done in Fig. 13. Fig. 14 gives a similar set of curves for the middle-west United States.

It should be emphasized, of course, that fields so derived are only estimates of the daylight ground wave and that the actual fields may vary considerably due to varied ground conditions, antennas adapted for sky wave transmission, conditions peculiar to the particular measurement location, etc. Where a matter of 5 or 10 decibels is of considerable importance computations should not be relied upon but an actual survey should be made.

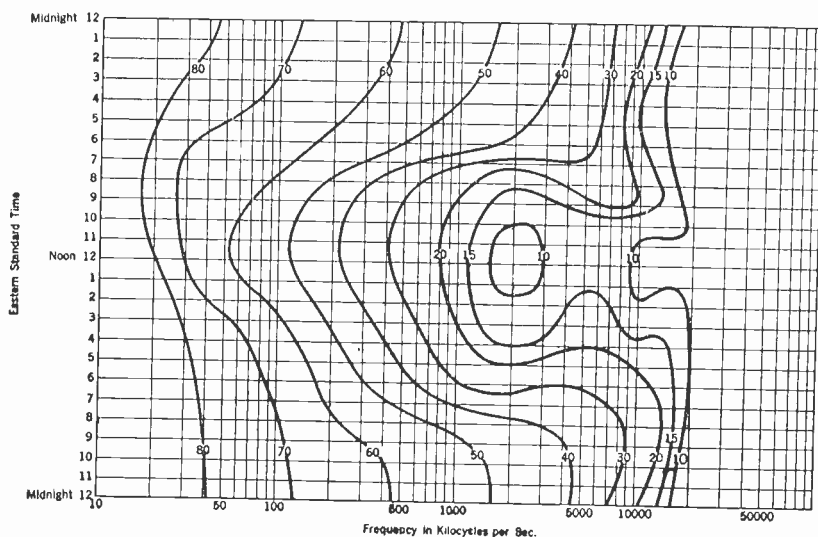

Fig. 15—Variation of radio noise with frequency and time of day. Maximum monthly averages for rural sections in vicinity of New York. Contours denote field strength in decibels above one microvolt per meter of nonfading carrier required for a radiotelephone circuit barely satisfactory for commercial use. For broadcast reception, approximately 20-decibel higher fields will be required than indicated, and for commercial telegraph reception, about 10 decibels less.

By combining these signal field strength curves of Figs. 2, 13, and 14 with a noise distribution curve similar to that shown in Fig. 15, and keeping in mind that the nighttime fields lie between the ground wave and the inverse distance values, we go a long way toward indicating the usefulness of transmissions on various frequencies over various types of transmission paths.



CONTINUOUS MEASUREMENTS OF THE VIRTUAL HEIGHTS  
OF THE IONOSPHERE\*

BY

T. R. GILLILAND

(Bureau of Standards, Washington, D. C.)

*Summary*—This paper is a report of continuous measurements of the virtual heights of the ionized regions of the upper atmosphere. Short pulses of radio-frequency energy are sent out by a transmitter operating on 4100 kilocycles per second. The time interval required for the pulses to go up to the ionosphere and back is recorded photographically in the same room by means of an oscillograph. The revolving mirror of the oscillograph and the chopper wheel which makes the transmitter pulses are driven on the same shaft by a synchronous motor. Records are shown which indicate the variability, especially at night. In the morning and afternoon reflections come from the F region showing virtual heights around 240 kilometers. However, during the middle of the day the reflection often splits into two components and the 240-kilometer reflection becomes weak and disappears. The remaining component often rises during the middle of the day to 300 or 320 kilometers and then drops gradually to join the 240-kilometer component which reappears before sunset. Records are given which show the rapid appearance and disappearance of reflection at night from both the E and F regions. An increase in ionization is probably responsible for the reappearance of E reflections of the type shown. However, F reflections which gradually become strong at night may possibly be explained by recombination in the lower part of the F region which exposes a more strongly ionized upper part. It is pointed out that the changes are so abrupt and irregular that data taken over a longer period and for other frequencies will be necessary before it is possible to establish the relative importance of such things as magnetic storms, meteor showers, sun spots, or thunderstorms.

## I. INTRODUCTION

THIS paper is presented as a brief report on experimental results obtained in the measurement of the virtual heights of the ionosphere with a continuous recorder between November, 1932, and March, 1933. The frequency used was 4100 kilocycles per second. This work was done at the Bureau of Standards transmitting station near Beltsville, Md. It is desired to show the type of record obtained and to point out the variability from day to day. Results in the past where measurements were made manually have shown the need for continuous records which give a more complete picture of the changes actually occurring.

\* Decimal classification, R113.61. Original manuscript received by the Institute, June 3, 1933. Presented at meeting of American Section, International Scientific Radio Union, Washington, D. C., April 27, 1933. Publication approved by the Acting Director of the Bureau of Standards of the U. S. Department of Commerce.

Briefly, the system used consists of a radio transmitter, receiving set, and galvanometer oscillograph with photographic attachment. The transmitter is made to send out short pulses of radio-frequency energy at regular intervals by means of a chopper driven by a synchronous motor. Besides the direct path from transmitter to receiver the pulse also may arrive by one or more paths from the ionosphere. The pulses received are passed through the oscillograph and by means of a synchronous revolving mirror the pattern is projected on to the moving photographic paper in such a manner that only the top portion of the pulse is recorded. Since the path length for the direct pulse is fixed it will cause a straight line to be recorded, but as the virtual height of the ionosphere changes the path lengths for the other impulses will change and the corresponding traces will shift with respect to the fixed or "ground" trace. The distance on the record from any trace to the ground trace will be a measure of the virtual height for the corresponding reflection. The system is similar to that described in a previous publication<sup>1</sup> except that in the present arrangement the revolving mirror of the oscillograph and the chopper controlling the transmitter are attached to the same shaft, the transmitting and receiving sets being in the same room. No trouble was experienced with overloading or blocking in the receiving set from the direct pulse. This consolidation of the apparatus has material advantages of convenience.

The transmitter consists of two 75-watt tubes of the screen-grid type (UX-860) connected in parallel in a Hartley oscillator circuit. A single tube of the same type is connected between the chopper and the oscillator grid circuit to avoid trouble from radio-frequency currents at the chopper contacts. (Fig. 1.) A half-wave horizontal doublet is used for transmitting while receiving is done with an "L" type antenna.

The receiving equipment consists of a tuned radio-frequency broadcast receiving set preceded by a high-frequency converter. The galvanometer oscillograph element of the fixed magnet type, the moving coil of the dynamic loud speaker, a copper-oxide rectifier and a 1-microfarad condenser are all connected in series in the output of the receiving set. The condenser, although not essential, serves to sharpen the pulses somewhat, thus giving narrower traces. No shift in the beginning time of the pulses could be detected with the addition of the condenser so that no change in accuracy of the records should be expected.

Helical gears with a ratio of 16 to 31 are used between the chopper-

<sup>1</sup> T. R. Gilliland and G. W. Kenrick, "Preliminary note on an automatic recorder giving a continuous height record of the Kennelly-Heaviside layer," *Bureau of Standards Journal of Research*, vol. 7, p. 783; November, (1931); *Proc. I.R.E.*, vol. 20, p. 54; March, (1932).

mirror shaft and the synchronous drive motor, giving slightly over 15 pulses per second. The odd gear ratio is employed to eliminate spurious results caused by noises occurring at power line frequency. The resolution obtained with the slower mirror speed is also more desirable. Recording is done on photographic paper moving at 4 centimeters per

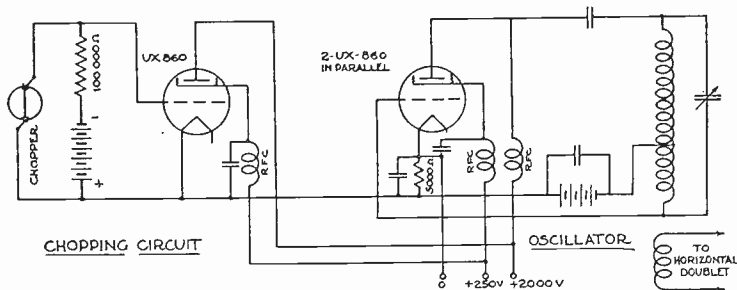

Fig. 1—Circuit diagram of transmitter. Closing of chopper contacts causes plate current to flow in chopping tube. This decreases the negative bias on the oscillator grid so that oscillation takes place.

hour. On the vertical scale 1.5 centimeters represent 100 kilometers in virtual height. Unevenness in the base line of some of the earlier records is caused by irregularities of the chopper brushes, but the virtual height can be measured for any instant by measuring vertically from the ground trace for that time. Since the beginning side of the peaks of the pulse pattern are almost of right angles to the zero-current line the virtual height may be determined by measuring from the lower edge of the ground trace to the lower edge of the reflection trace. It

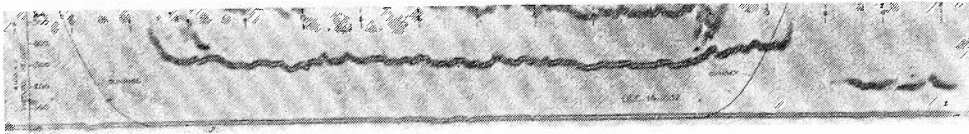

Fig. 2—Record taken during daytime. Note slight increase in height during middle of the day. E-region reflections appear after sunset. All times are U. S. Eastern Standard Time. All records are for 4100 kilocycles.

should be kept in mind that with this type of recorder the photographic paper moves in a direction parallel to the axis of the revolving mirror and perpendicular to the zero-current line projected by this mirror. The portion of the pulse pattern recorded was usually below the top of the peaks so that each trace appears as a double line. Where the trace appears single only the top of the peak is being recorded. The double trace might be mistaken for actual splitting but the latter phenomenon is so irregular that little confusion should result. A recent improvement has been the substitution of a spherical lens for the conventional cylindrical lens in the oscillograph optical system. By this

method the light from a considerable portion of the top part of the peak can be concentrated into a single bright spot on the paper, thus doing away with the double trace. Recording is done with the incandescent oscillograph lamp working at two-thirds normal voltage.

Recently other workers have used a gaseous discharge tube in place of the galvanometer oscillograph in the synchronous method of recording.<sup>2,3</sup> Since the speed of response with both types seems to be limited by the radio receiver it appears that the galvanometer oscillograph is at no great disadvantage unless it is desired to sacrifice selectivity. The oscillograph is of assistance when it is desired to monitor reception visually.

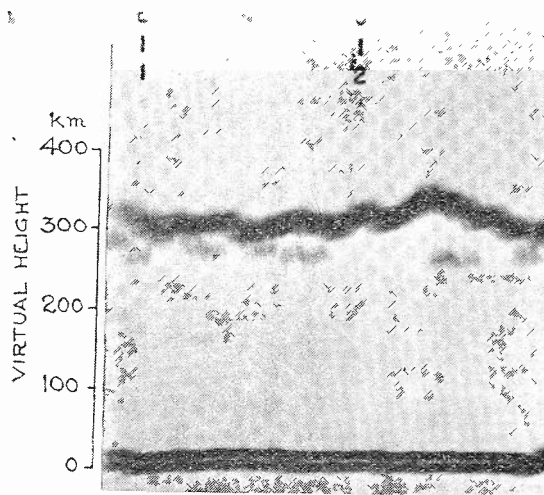

Fig. 3—Record showing two components during the noon hour.

## II. RESULTS

The changes that occur at night are the most striking, and the extreme variability from night to night makes it impossible to choose any record that can be called typical. In the daytime during the period of these observations reflections on this frequency usually came from the F layer<sup>4</sup> showing virtual heights ranging between 220 and 320 kilometers. Fig. 2 is an example of a record taken during the daytime (December 18). Here the rapid drop is noted in the morning. The trace

<sup>2</sup> Rukop and Wolf, "Eine leistungsfähige Einrichtung für Messungen an der Heavisideschichten," *Zeit. für Tech. Phys.*, vol. 13, p. 132, (1932).

<sup>3</sup> H. R. Mimno and P. H. Wang, "New devices for recording Kennelly-Heaviside layer reflections" (abstract), *Phys. Rev.*, vol. 41, p. 395, (1932).

<sup>4</sup> It has been shown that stratification exists in the ionosphere and the region showing virtual heights ordinarily of the order of 100 to 120 kilometers has been called the E layer while the region giving a virtual height of 200 kilometers or more has been called the F layer. This designation was originated by Prof. Appleton who first pointed out the existence of stratification. It is likely, in the light of more recent work, that other strata exist at times.



near the top of the record is a multiple of the first reflection indicating that pulse energy has made two round trips between the ground and the ionosphere. Splitting into two components which has been frequently observed by other workers and attributed to double refraction in the earth's magnetic field is noted at about 0800 and again at 1700 E.S.T. Here the component with the greater retardation is seen to rise

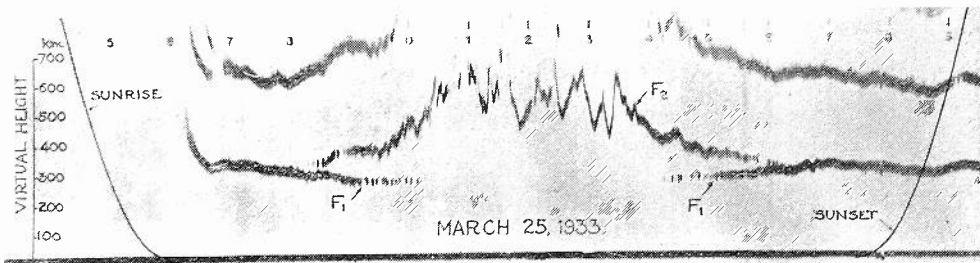

Fig. 4—Showing separation of the two components in the morning and joining again before sunset.

and fall rapidly. This phenomenon is more clearly seen in some of the records that follow. At about 1820 the virtual height increases rapidly until the trace moves off scale. The rapid drop in the morning and the rise at night indicated in this record are not observed on all days. Frequently the drop in the morning and more often the rise at night will be gradual. Occasionally reflections continue throughout the night with the virtual height not greater than 500 kilometers. In Fig. 2 reflections



Fig. 5—Showing momentary appearance of reflection at night. Also note rapid changes of component with greater retardation after sunrise.

from the E layer are noted between 1900 and 2115 E.S.T. giving a virtual height ranging from 120 to 170 kilometers.

In most of the daytime records it is noted that the height is greater at noon than for just after sunrise and before sunset. On some days the records indicate that splitting is occurring and one component ( $F_2$ ) with the longer retardation frequently giving a height of 280 to 320 kilometers becomes predominant near noon, while the other component ( $F_1$ ) at 220 to 240 kilometers shows in the morning and afternoon. Occasionally  $F_1$  shows intermittent weak reflections during the middle

of the day when  $F_2$  is strong. This is illustrated by Fig. 3. Fig. 4 shows the two components separating at about 0800.  $F_1$  disappears during the middle of the day but reappears at 1400 and joins  $F_2$  at about 1610. It is possible that  $F_2$  is the stronger at times even in the morning and afternoon but the receiving system cannot resolve it immediately after a very strong  $F_1$  reflection. The virtual heights for  $F_2$  increase during the middle of the day sometimes going as high as 800 kilometers with the peak usually between 1100 and 1300 E.S.T.<sup>5</sup>

Fig. 5 shows the momentary appearance of reflection at 0133 on November 30. The virtual height drops rapidly to 370 kilometers, the total time for appearance and disappearance being 10 minutes. Changes after sunrise are noted at the right where the retardation of one com-

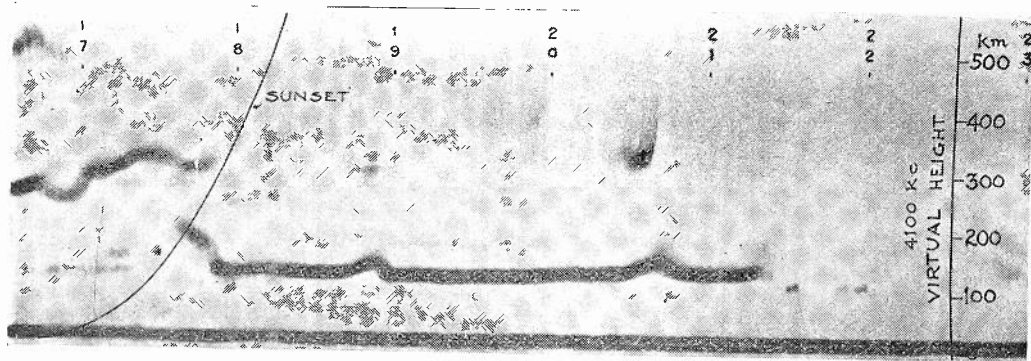

Fig. 6—Showing appearance of F-region reflections coincident with changes in E region.

ponent increases and decreases rapidly. Rapid changes of this type are also noted on the morning of January 21, Fig. 10.

Fig. 6 shows interesting changes on the evening of December 28. At 1738 reflections begin to appear from a virtual height of 190 kilometers. During the next fifteen minutes the height changes to 115 kilometers where it remains for about three and one-quarter hours except for momentary increases in height at about 1855 and 2030. These increases are practically coincident with appearance of reflections from the F layer. At 1855 the F-layer reflection is only momentary while at 2030 the time for appearance and disappearance covers about ten minutes. The F-layer ionization is probably present during the entire time but shows only during momentary decreases in E-layer ionization.

<sup>5</sup> In a paper now in preparation describing work here on various frequencies, S. S. Kirbey, L. V. Berkner, and D. M. Stuart have suggested that splitting of this type is due to stratification in the F region and that the high virtual heights of the  $F_2$  component during the day are due to a critical phenomenon in the lower  $F_1$  region much the same as that observed for the E layer about 1000 kilocycles lower in frequency. They have shown that where this critical effect is in evidence on 4100 kilocycles the virtual heights for  $F_2$  will decrease from the extremely high values as frequency is increased above 4100 kilocycles.

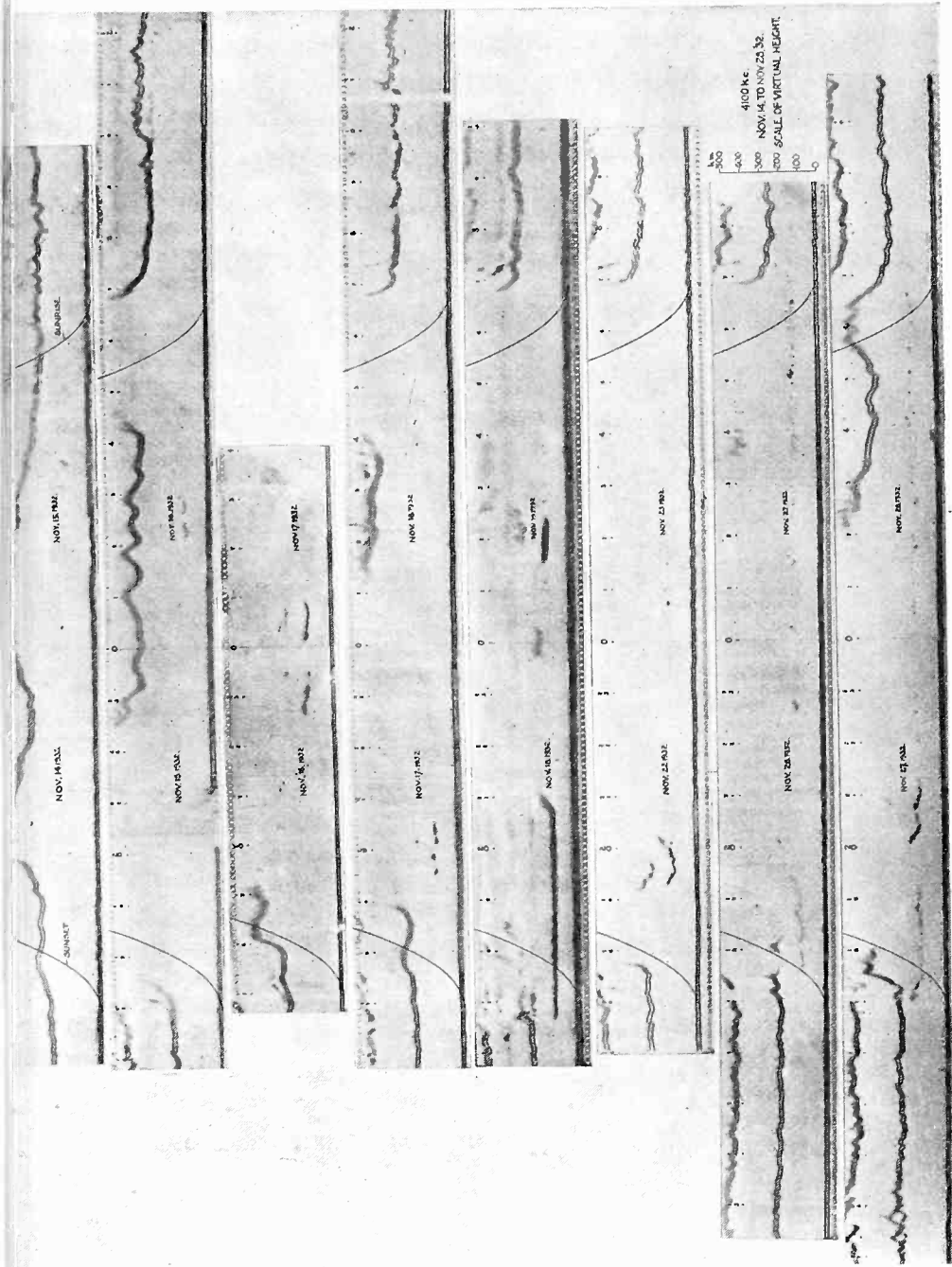

Fig. 7—Maximum of Leonid meteor shower occurred on night of November 14-15. The 14th and 16th are days of magnetic character one. Record for morning of November 23 shows virtual height decreasing at the rate of 1.1 kilometers per second for 90 seconds. The next record shows still more rapid change.

Records taken between November 14 and 27, 1932 are shown in Fig. 7. The 14th and 16th were of magnetic character one<sup>6</sup> while the other days of November were zero days. The maximum of the Leonid meteor shower occurred on the 14th. For the purpose of showing the complexity rather than for demonstrating any definite correlation the records of November 14, 15, and 16 are reproduced in Fig. 8 with records of horizontal intensity of the earth's magnetic field. The night of November 14-15 was the first during this series that reflections con-

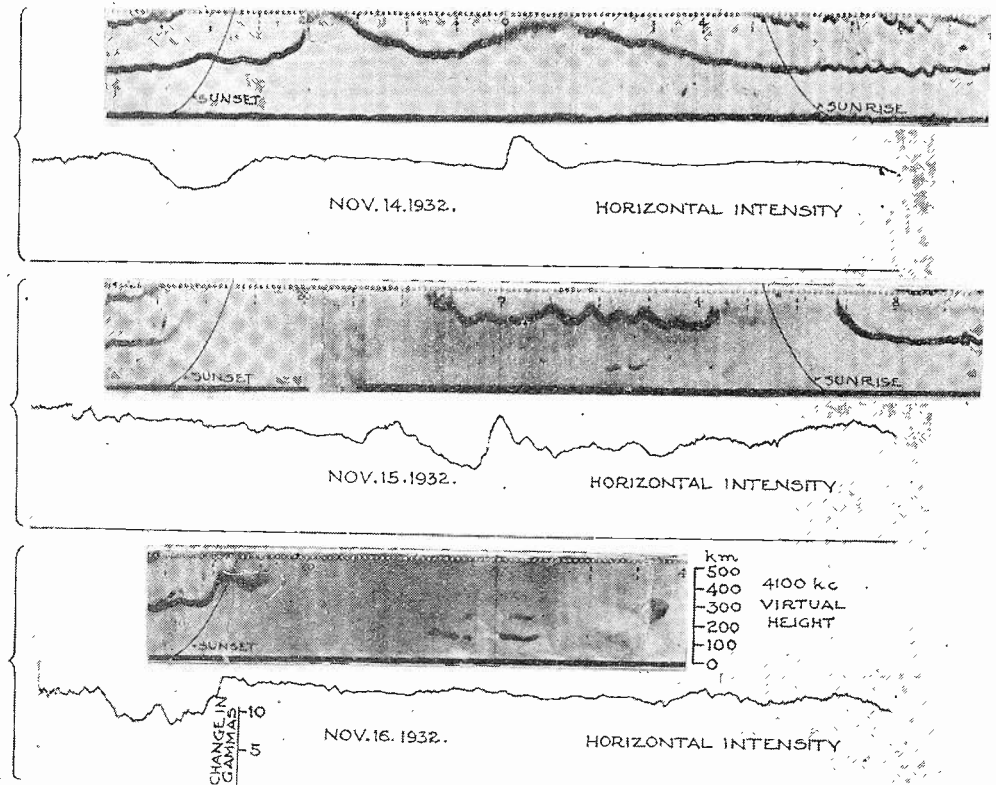

Fig. 8—Records of November 14, 15, and 16 replotted with curves of horizontal intensity of earth's magnetic field.

tinued throughout the night. Strangely enough there are practically no E-layer reflections visible on this record. It is possible that any E-layer ionization due to meteors was of such short duration that reflections failed to register. E-layer reflections are more in evidence on most other nights. Rapid changes in virtual height on this frequency are most likely to occur at sunrise and sunset, although such changes occur at other times when this frequency is near a critical value. The record for the morning of Nov. 23, Fig. 7, shows the virtual height of the F

<sup>6</sup> Zero-magnetic character indicates quiet days, No. 1, moderately disturbed, No. 2, severely disturbed. Magnetic records supplied by the Cheltenham, Md., Observatory of the Coast and Geodetic Survey.

layer decreasing at the rate of 1.1 kilometers per second for 90 seconds. The next record shows a much more rapid change but it is impossible to determine the rate of drop accurately because of the slow rate of movement of the film.

Records taken on December 7, 8, and 9 are shown with magnetic records in Fig. 9. The 7th and 9th are zero days while the 8th has magnetic character one. A magnetic storm is indicated by the rapid change in horizontal intensity beginning just before 1600 on the 8th.

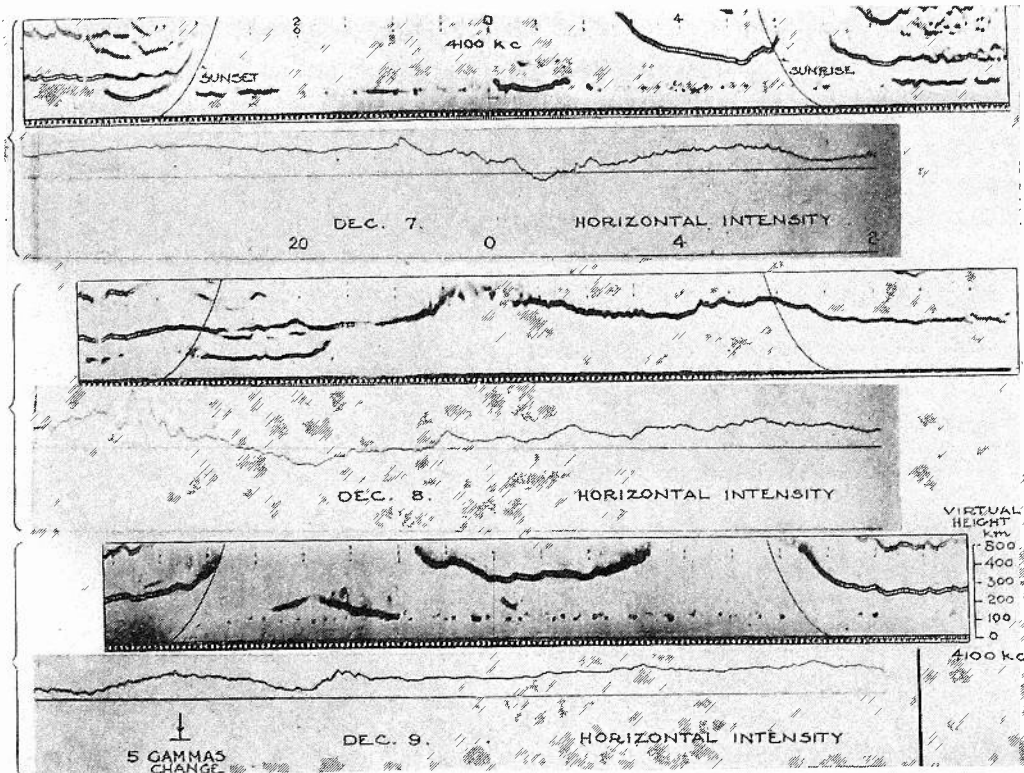

Fig. 9—Records for three days plotted with magnetic records. Magnetic storm is indicated by rapid change in horizontal intensity beginning just before 1600 on the 8th. Note strong reflections at night from both E and F regions.

Records obtained for four consecutive days from January 19 to January 23 are shown in Fig. 10. The Cheltenham Observatory gives the 20th and 22nd with character one while the 19th, 21st, and 23d are zero days.

The changes which have been observed in the ionosphere are so abrupt and irregular that it has been found very difficult to show in just what way they are connected with other phenomena such as magnetic storms, meteor showers, sun spots, or thunderstorms. It is likely that still other factors will be necessary to explain all the changes observed. It is thought advisable to await the accumulation of data over

a longer period of time and on other frequencies in order that a more complete study may be made.

The reappearance of reflections at night suggests an increase in ionization, especially where strong reflections from the E-layer suddenly occur. The first record of Fig. 9 shows a strong E reflection beginning after midnight and lasting until about 0200. At 0245 reflections appear from the upper region. Although these latter reflections may be explained by changing of the gradient of ionization in the F layer as mentioned below it is possible that ionization has merely passed through the E-layer critical values for the frequency used, and long retardation and high absorption are occurring between the disappear-

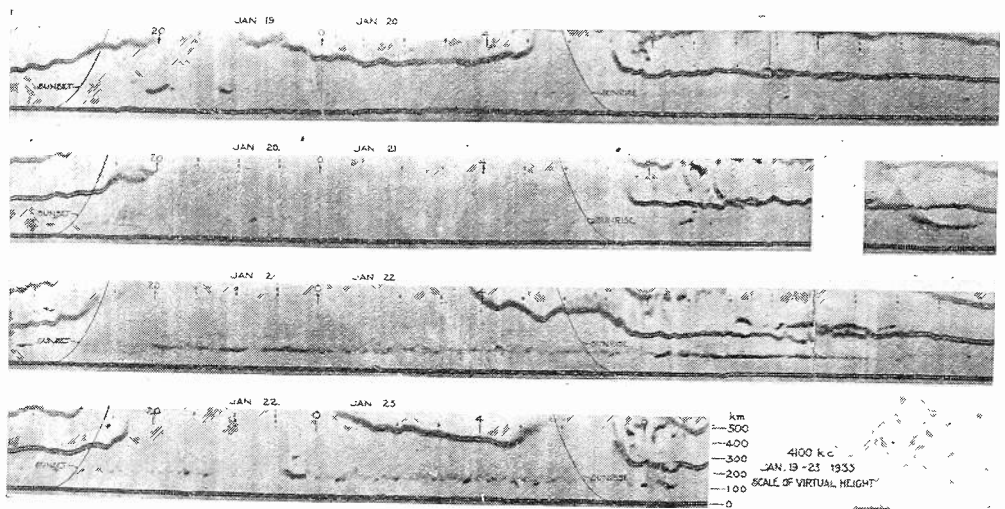

Fig. 10—Records for four consecutive days. The 20th and 22d are days of magnetic character one while the 19th, 21st, and 23d are zero days.

ance of the lower reflection and the appearance of the higher one. Another critical value is reached about 0600 and long retardation again occurs. At shortly after 0700 reflections again appear with sunrise. This occurs again on the third record earlier in the night.

Schafer and Goodall<sup>7</sup> have noted the reappearance of reflections at night from the E layer. They mention that a changing gradient of ionization may explain this reappearance, but they believe that an increase in ionization is more likely. The latter viewpoint would be supported by changes of the type shown in the first and third records of Fig. 9, where the appearance of strong reflections is sudden. In Fig. 11 are four records showing reflections at night from the upper layer without evidence of strong reflections from the lower layer. Here an increase in

<sup>7</sup> J. P. Schafer and W. M. Goodall, "Kennelly-Heaviside layer studies employing a rapid method of virtual height determination," *Proc. I.R.E.*, vol. 20, p. 1131; July, (1932).

ionization may not be occurring. Possibly as recombination begins after sunset a critical value is reached in the lower part of the F layer so that high absorption and long retardation result. However, as recombination proceeds farther an upper more richly ionized part of this region, where recombination is less rapid, begins to return energy. As conditions get farther from the critical value the virtual height is frequently seen to be as low as 280 kilometers. The ionization in this upper region appears to reach another critical value just before sunrise.

Fig. 12 contains records chosen to indicate the variability from night to night. The first two records give only slight indication of reflec-

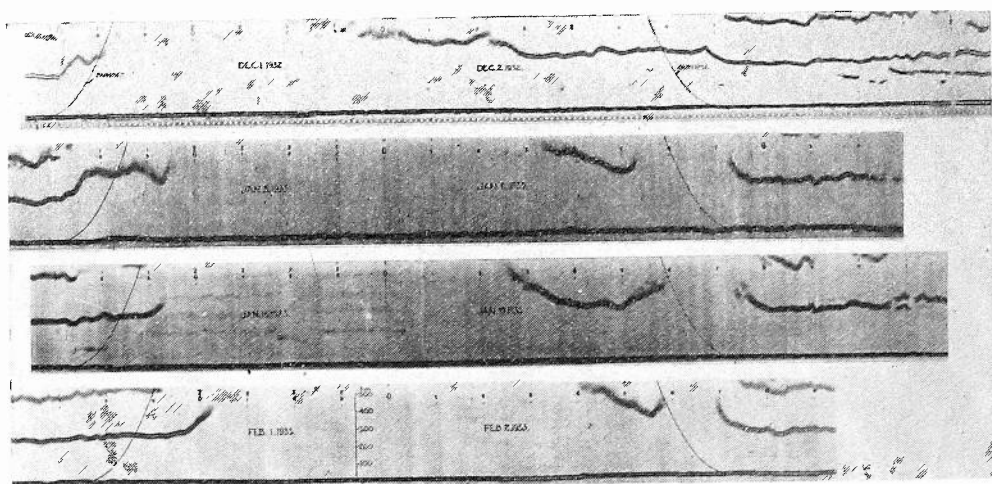

Fig. 11—Records showing reflection at night from the upper region without evidence of strong reflections from the lower region. January 6 has magnetic character one. Others are zero days.

tions at night. Note the rapid opening and closing of the split reflection at 1700 on the first record. The third to seventh records inclusive show appearance of reflections from both E and F layers while the last record shows strong reflections from only the E layer during the night.

### III. CONCLUSIONS

Of greatest interest perhaps is the reappearance of strong reflections at night from both E and F layers. Some of these reflections indicate sudden increases in ionization while others suggest that recombination in a lower part of the region exposes the upper part where ionization is richer.

Many of the changes observed are very sudden and strong reflections from the E layer may appear at almost any hour. Various explanations have been offered in the past, including sun spots, meteor

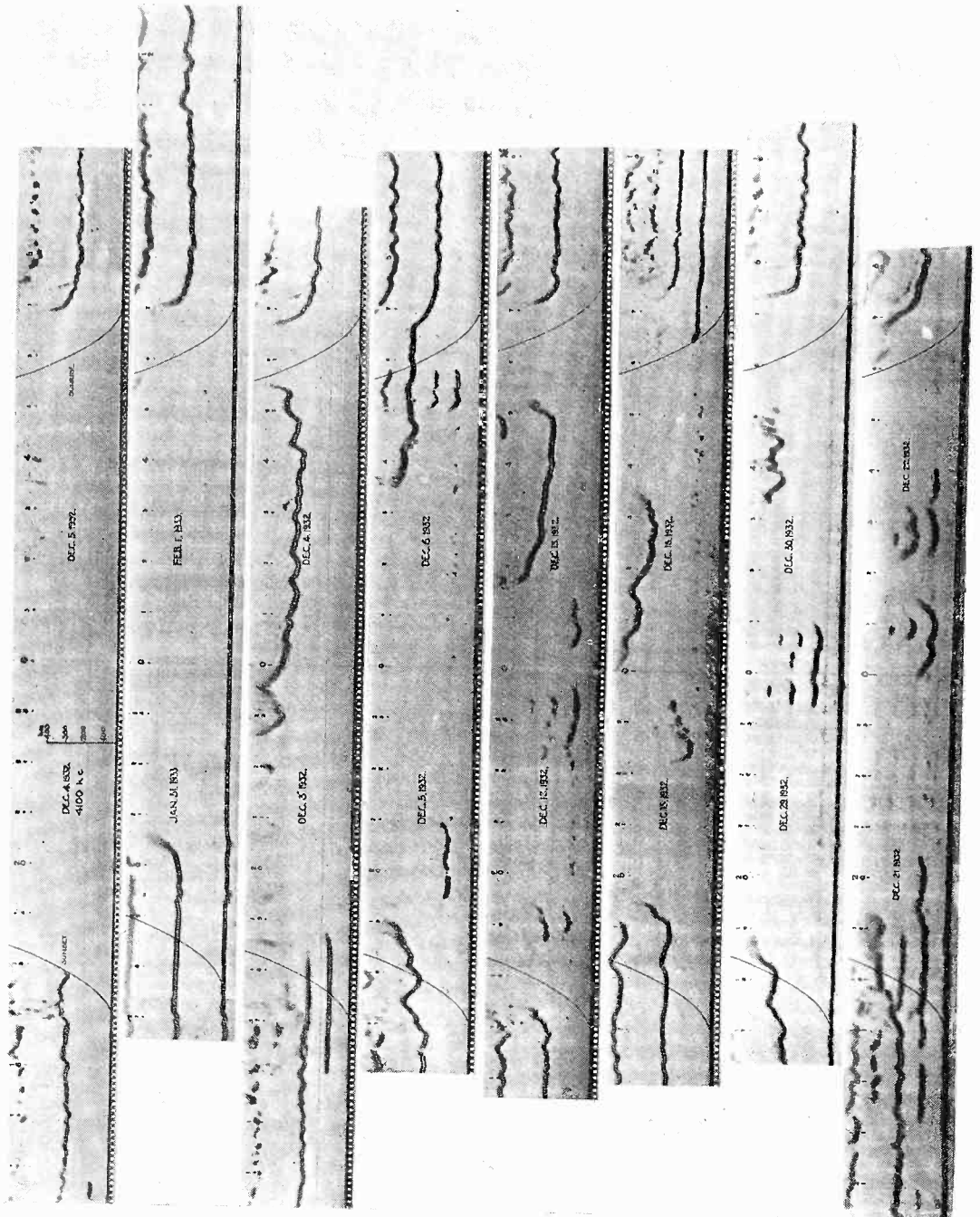

Fig. 12—Records chosen to indicate variability from night to night. The first two records give only slight indication of reflection at night. The third to seventh records inclusive show appearance of both E and F reflections while the last record shows strong reflections from the F layer.



showers, and thunderstorms. Comparisons are also made between such results and changes in the earth's magnetic field. Although certain peculiarities such as strong E reflections are observed at magnetically disturbed times quite similar phenomena are observed when no unusual magnetic changes are in evidence. Since the changes in the ionosphere are so frequent and so rapid it is impossible, with the small amount of data at hand, to show definitely just how important each factor is.

None of the explanations yet offered seems to explain satisfactorily the extremely high ionization frequently observed at night. Although E layer reflections appear at almost any time they occur most frequently around the time of sunset or shortly after on this frequency during the period of these observations.

This method offers a convenient means for studying the physical properties of the upper atmosphere and should prove helpful in the solution of certain radio transmission problems. With data of this type taken over a longer period and on other frequencies it is hoped that it will be possible to obtain a more exact picture of the changes which occur in the ionosphere and to determine some of the agencies responsible for these changes.



## AUDIO-FREQUENCY ATMOSPHERICS\*

BY

E. T. BURTON AND E. M. BOARDMAN

(Bell Telephone Laboratories, Inc., New York City)

*Summary*— Various types of musical and nonmusical atmospherics occurring within the frequency range lying between 150 and 4000 cycles have been studied. Particular attention is directed to two types of the former, one a short damped oscillation, apparently a multiple reflection phenomenon, and the other a varying tone of comparatively long duration, probably related to magnetic disturbances. Several quasi musical atmospherics which appear to be associated with the two more distinct types are described. Dependence of atmospheric variations on diurnal, seasonal, and meteorological effects are discussed. Characteristics of audio-frequency atmospherics are shown in oscillograms and graphs.

### INTRODUCTION

IN connection with a study of communication problems, observations of submarine cable interference were made over periods totaling about twenty months during the years 1928 to 1931. These experiments were conducted at Trinity, Newfoundland; Hearts Content, Newfoundland; Key West, Florida; Havana, Cuba; and at Frenchport, near Erris Head, Irish Free State. A few supplemental measurements of audio-frequency atmospherics received on large loop antennas were made in 1929, 1931, and 1932. These experiments were made at Conway, New Hampshire, at two locations in New Jersey, and in Newfoundland. Work carried out at the Newfoundland and New Hampshire locations has been commented upon in previous reports.<sup>1,2</sup>

Since, for the most part, industrial and communication interferences were of small magnitude at all locations, it has been possible to select for presentation data confined to atmospherics. These data will be limited mainly to the frequencies between 150 and 4000 cycles, although measurements were made over the range from 40 to 30,000 cycles.

The principal apparatus used at all locations consisted of an especially designed vacuum tube amplifier with which all other apparatus was associated. The over-all gains of the amplifiers used at the various locations varied somewhat according to the conditions to be

\* Decimal classification: R114. Original manuscript received by the Institute, June 30, 1933.

<sup>1</sup> E. T. Burton "Submarine cable interference," *Nature*, vol. 126, p. 55; July 12, (1930).

<sup>2</sup> E. T. Burton and E. M. Boardman "Effects of solar eclipse on audio frequency atmospherics," *Nature*, vol. 131, p. 81; January 21, (1933).

met, the frequency characteristics being adjusted approximately complementary to that of the pick-up conductors. The Ireland amplifier consisted of seven transformer coupled stages grouped to form three units. The impedance at the junction points of units was 600 ohms so as to permit insertion of attenuators and filters. The maximum gain for the three amplifier units was 200 decibels, attenuators and filters being used at all times to control the output intensity. The amplifier was designed to minimize noise, inherent in such apparatus, and to be highly stable throughout long periods of practically continuous operation.

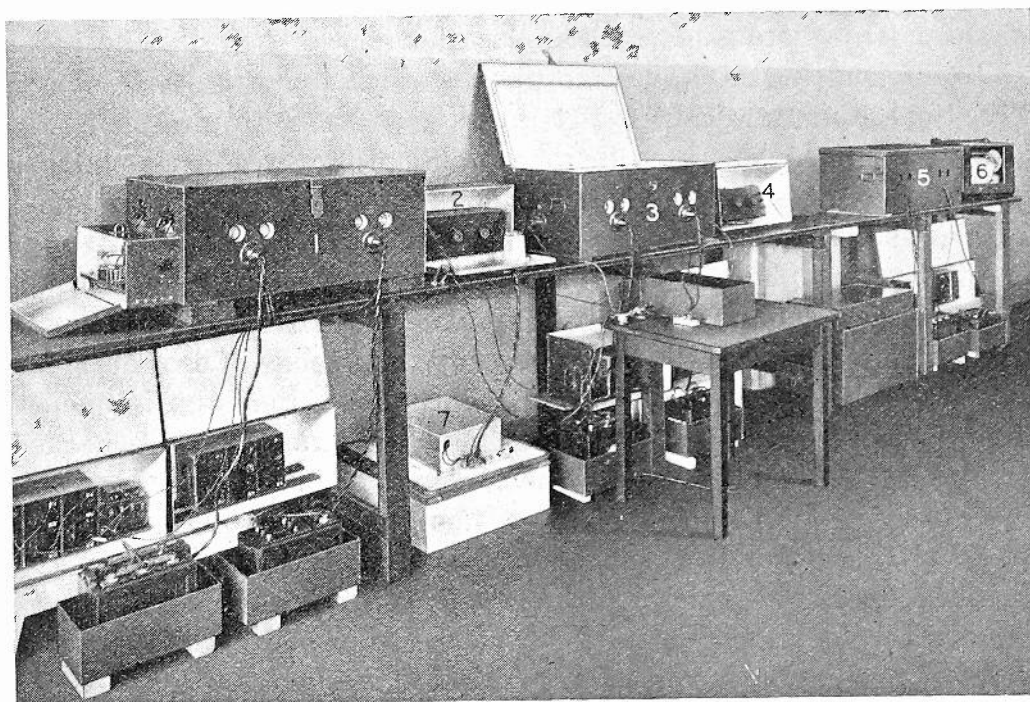

Fig. 1—Amplifier and associated apparatus used at Frenchport, Ireland.

- (1) First amplifier unit
- (2) First attenuator
- (3) Second amplifier unit
- (4) Second attenuator
- (5) Third amplifier unit
- (6) Recorder
- (7) Band-pass filter.

In addition to several high-pass and low-pass filters, 17 narrow band filters designed to cover in small steps the range from 150 to 3800 cycles were available. A filter switching panel was used to facilitate observations of various frequency ranges in rapid succession.

The output was arranged to supply various recording and indicating devices. Root-mean-square measurements were made by means of a thermocouple with a long period direct reading and recording

meter. A device employing three-element gas-filled tubes was used to measure peak voltages. A magnetic recorder was employed in securing a few sound records of atmospheric. Oscillograms which are shown in this article were subsequently prepared from these records. The Ireland amplifier with some of its associated apparatus is shown in Fig. 1.

The amplifier with each of the filters taken separately was calibrated with input supplied by the thermal agitation in standard resistances ranging from 50 to 250 ohms. The calibration temperature was approximately 23 degrees centigrade. Check calibrations were made weekly and at such times as changes were made in the apparatus. The stability of the entire system was such that over periods of months measurements were made with an accuracy closer than  $\pm \frac{1}{2}$  decibel.

In interpreting data on atmospheric of low amplitude, such as received on submarine cables, it is necessary to take into account the random voltages generated in the amplifier circuits and the thermal agitation voltages of the conductor connected to the amplifier input. Both of these voltages appear in the output circuits mingled with the amplified atmospheric. The former originate principally in the first stage of the vacuum tube amplifier. Thermal agitation produces a random voltage, uniformly effective at all frequencies. The root-mean-square amplitude of this voltage is dependent upon the frequency range considered, the resistive component of the impedance of the conductor, and the temperature of the conductor.<sup>3</sup> The conductor in this case is the cable or antenna circuit. The root-mean-square values of these voltages, when integrated over periods of time comparable with those occupied in taking data on atmospheric, are substantially steady; therefore, their separation from the atmospheric voltages is not difficult. Corrections for both amplifier and thermal noises have been made on the data presented.

Observations of audio-frequency atmospheric received on long antennas and loop aerials have been reported by several observers.<sup>4</sup> Their accounts describe the general characteristics, although some confusion has occurred in identification of the musical atmospheric. In view of the fact that the apparatus used by us was particularly adapted to reception and analysis of frequencies in the audio range, it appears that our data may add considerably to the information previously disclosed.

<sup>3</sup> J. B. Johnson, "Thermal agitation of electricity in conductors," *Phys. Rev.*, vol. 32, p. 97; July, (1928).

<sup>4</sup> H. Barkhausen, "Whistling tones from the earth," *Phys. Zeit.*, vol. 20, p. 401, (1919); T. L. Eckersley, "Electrical constitution of the upper atmosphere," *Nature*, vol. 117, p. 821; June 12, (1926).

## TYPES OF ATMOSPHERICS

Audio-frequency atmospherics observed on submarine cables are essentially the same as those received from a long antenna except for high attenuation and frequency discrimination attributable to the cable characteristics and to the shielding effect of sea water.<sup>5</sup> The low frequencies, when observed on a submarine cable, are of comparatively high amplitude, appearing as a deep rumble intermittently broken by noises variously described as splashes and surges. The range from 500 to 1500 cycles generally consists largely of clicks and crackling sounds which accompany the low-frequency surges. At times substantial amplitude increases occur accompanying quasi musical sounds, which may dominate this frequency range. In the upper voice range intermittent hissing or frying sounds are observed, often accompanying surges in the low-frequency range. Above 1800 cycles occur at least two ranges which at times possess slight tonal characters. In addition to the slightly musical sounds, two varieties of distinct musical atmospherics have been observed and given the onomatopœic names "swish" and "tweek." Particular interest attaches to these because of their extraordinary character.

## DIURNAL AND SEASONAL CHARACTERISTICS

The daytime nonmusical atmospherics consist ordinarily of intermittent low amplitude impulses. As a general rule the nighttime intensities are considerably higher; the impulses being more frequent and more prominent than during the daylight hours. The night intensity is further increased by the presence of the type of musical atmospheric known as tweek.

During a usual day, the intensity of audio-frequency atmospherics from sunrise until midafternoon is comparatively low. During the afternoon, a slow rise may or may not occur. Shortly following sunset, a gradual increase of intensity is usual. This rise continues for two hours or more after which a high level is maintained rather consistently until shortly before daybreak. A brief increase sometimes occurs at this time followed by a steady decrease, the daily minimum being reached usually shortly after sunrise.

Fig. 2 shows examples of summer and winter audio-frequency atmospheric intensities over twenty-four-hour periods. While these curves show the usual characteristics, extraordinary conditions may result in wide variations. The occurrence of local electrical storms or

<sup>5</sup> John R. Carson and J. J. Gilbert, "Transmission characteristics of submarine cables," *Jour. Frank. Inst.*, vol. 192, p. 705; December, (1921).

intense disturbances of the earth's magnetic field usually contribute markedly to these anomalies.

The diurnal amplitude variations of certain types of atmospherics may be reasonably explained by assuming the continued presence of an audio-frequency reflecting layer in the upper atmosphere, and assuming a low lying ionized attenuating region<sup>6</sup> to be present during daytime only. During the sunlight hours, disturbances occurring in the vicinity of the observation point may be received by direct transmission without unusual attenuation. Atmospherics of distant or high origin should suffer considerable attenuation in passing through the damping region. Following sunset, the damping ionization may be ex-

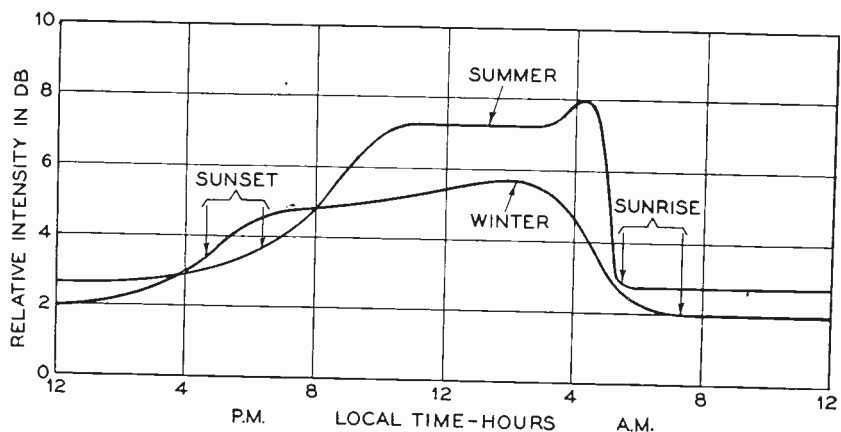

Fig. 2—Typical diurnal intensity curves, for frequency range from 150 to 3800 cycles.

pected to dissipate gradually, resulting in a slow increase of the static intensity as transmission from the upper atmosphere and from horizontally distant regions is improved.

It is probable that in the morning the damping ionization appears at a given point almost immediately upon arrival of the first direct sunlight, and that the transition period corresponds to the time required for the earth to rotate through an angle corresponding to that section of the damping region which may appreciably affect the atmospherics reaching the observation point.

Our observations have shown that the general intensity of the regularly occurring types of atmospherics increases in the spring, the rise beginning about March. During a period from possibly May to September, the intensity is comparatively high. During September and October a reduction occurs, and from the latter part of October until March the intensity is low. The periods as given above are approxi-

<sup>6</sup> Such a region affecting radio frequencies is described by R. A. Heising, *Proc. I.R.E.*, vol. 16, p. 75; January, (1928).



intense disturbances of the earth's magnetic field usually contribute markedly to these anomalies.

The diurnal amplitude variations of certain types of atmospherics may be reasonably explained by assuming the continued presence of an audio-frequency reflecting layer in the upper atmosphere, and assuming a low lying ionized attenuating region<sup>6</sup> to be present during daytime only. During the sunlight hours, disturbances occurring in the vicinity of the observation point may be received by direct transmission without unusual attenuation. Atmospherics of distant or high origin should suffer considerable attenuation in passing through the damping region. Following sunset, the damping ionization may be ex-

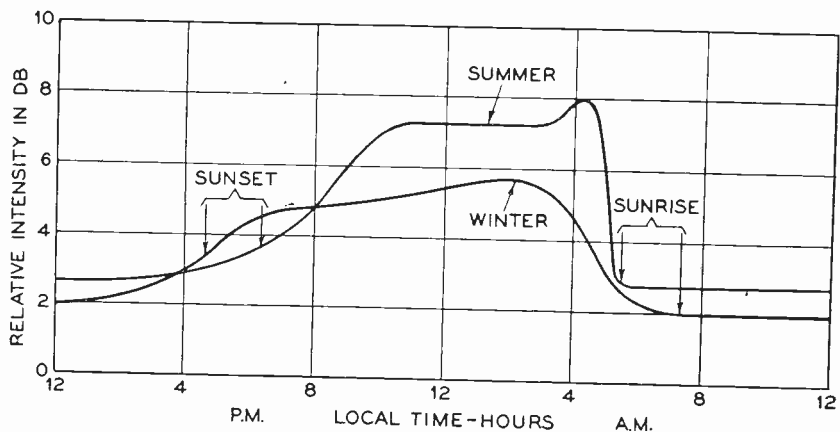

Fig. 2—Typical diurnal intensity curves, for frequency range from 150 to 3800 cycles.

pected to dissipate gradually, resulting in a slow increase of the static intensity as transmission from the upper atmosphere and from horizontally distant regions is improved.

It is probable that in the morning the damping ionization appears at a given point almost immediately upon arrival of the first direct sunlight, and that the transition period corresponds to the time required for the earth to rotate through an angle corresponding to that section of the damping region which may appreciably affect the atmospherics reaching the observation point.

Our observations have shown that the general intensity of the regularly occurring types of atmospherics increases in the spring, the rise beginning about March. During a period from possibly May to September, the intensity is comparatively high. During September and October a reduction occurs, and from the latter part of October until March the intensity is low. The periods as given above are approxi-

<sup>6</sup> Such a region affecting radio frequencies is described by R. A. Heising, Proc. I.R.E., vol. 16, p. 75; January, (1928).





Fig. 3—Oscillogram of tweeks. Timing impulse frequency, 1000 cycles.

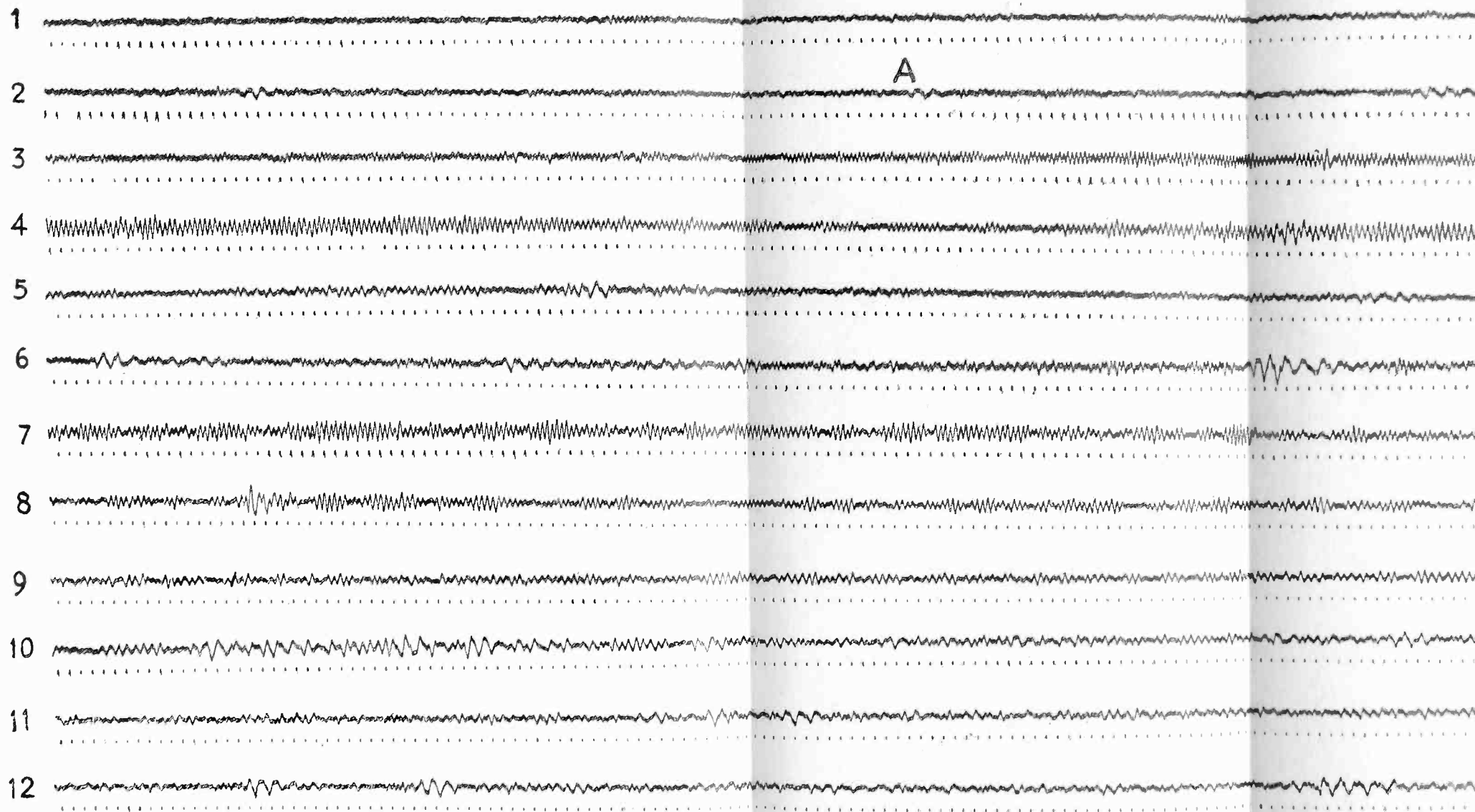

Fig. 8—Oscillogram of overlapping pair of swishes. *A* and *B* denote visible beginnings of the respective wave tra

intense disturbances of the earth's magnetic field usually contribute markedly to these anomalies.

The diurnal amplitude variations of certain types of atmospherics may be reasonably explained by assuming the continued presence of an audio-frequency reflecting layer in the upper atmosphere, and assuming a low lying ionized attenuating region<sup>6</sup> to be present during daytime only. During the sunlight hours, disturbances occurring in the vicinity of the observation point may be received by direct transmission without unusual attenuation. Atmospherics of distant or high origin should suffer considerable attenuation in passing through the damping region. Following sunset, the damping ionization may be ex-

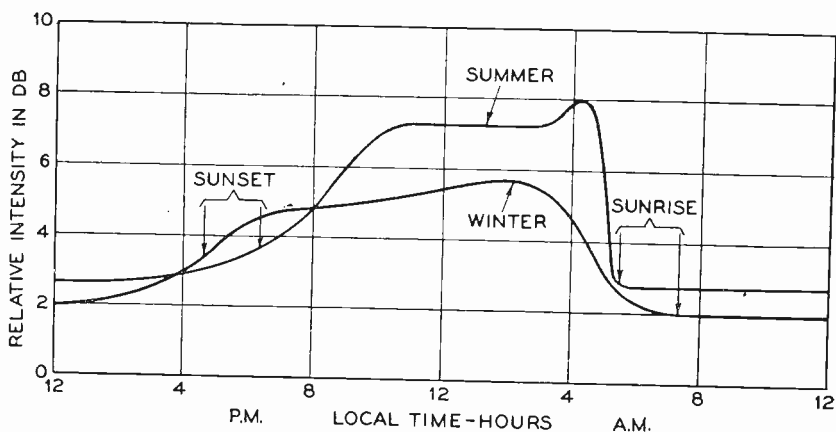

Fig. 2—Typical diurnal intensity curves, for frequency range from 150 to 3800 cycles.

pected to dissipate gradually, resulting in a slow increase of the static intensity as transmission from the upper atmosphere and from horizontally distant regions is improved.

It is probable that in the morning the damping ionization appears at a given point almost immediately upon arrival of the first direct sunlight, and that the transition period corresponds to the time required for the earth to rotate through an angle corresponding to that section of the damping region which may appreciably affect the atmospherics reaching the observation point.

Our observations have shown that the general intensity of the regularly occurring types of atmospherics increases in the spring, the rise beginning about March. During a period from possibly May to September, the intensity is comparatively high. During September and October a reduction occurs, and from the latter part of October until March the intensity is low. The periods as given above are approxi-

<sup>6</sup> Such a region affecting radio frequencies is described by R. A. Heising, Proc. I.R.E., vol. 16, p. 75; January, (1928).

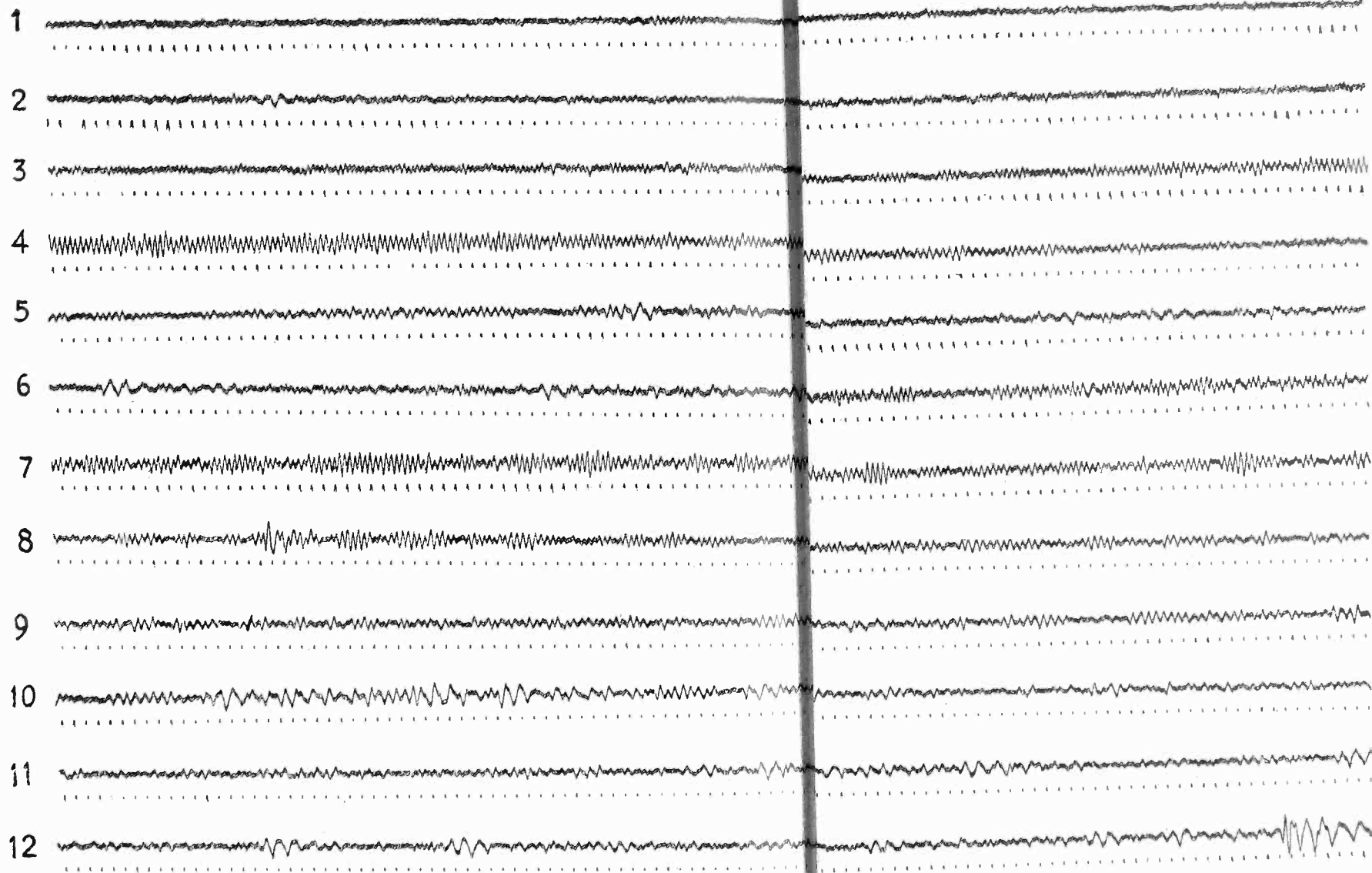

Fig. 8—Oscillogram of overlapping  $\text{Dy}$ , 1000 cycles.



mate, since they are based on fractional year observations in all except one case.

Comparison of Fig. 2 with diurnal variation curves of Potter<sup>7</sup> for 50 kilocycles and 2 megacycles, and with seasonal variations presented by Espenschied, Anderson, and Bailey<sup>8</sup> for 50 kilocycles shows definite similarities.

#### TWEEKS

A tweek consists of a damped oscillation trailing a static impulse. Its audible duration appears to be less than one-eighth of a second and the initial peak amplitude may approximate that of the maximum audio-frequency static impulses.

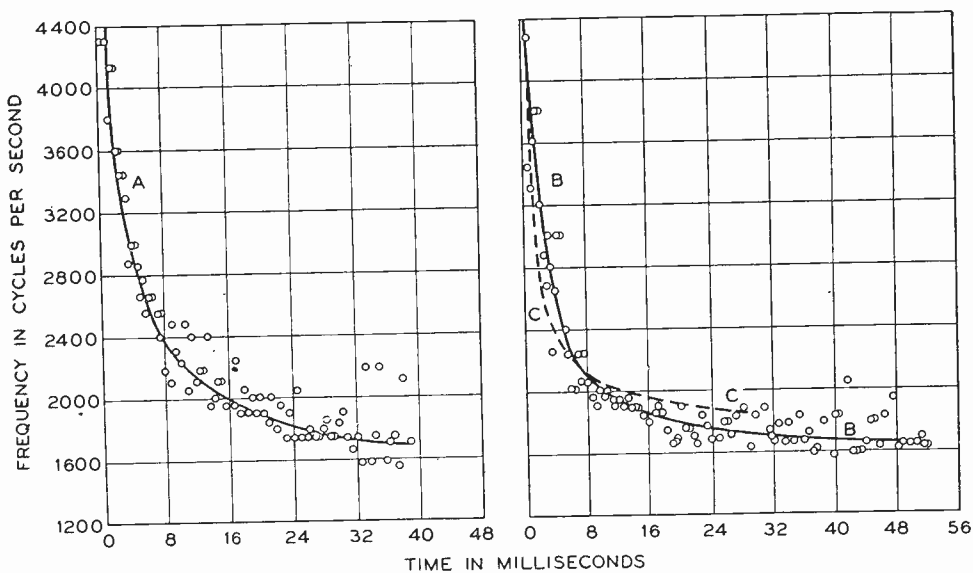

Fig. 4—A and B, tweek frequency variation curves. C, computed curve.

Oscillographic reproductions of sound records obtained in Ireland disclose that the tweeks practically always start above 2000 cycles and reduce very rapidly toward a lower limiting frequency where a considerable portion of the time of existence is spent. In some cases the highest observed frequency at the beginning of a tweek was in the vicinity of 4000 cycles, which was the upper transmission limit of the apparatus. In Fig. 3 is shown an oscillogram of tweeks trailing static surges. While in these tweeks, any initial high frequencies are obscured by the prominent static surge, some oscillograms have been made while using electrical filters to suppress the frequencies mainly responsible for the initial impulse. These oscillograms often showed

<sup>7</sup> R. K. Potter, "Frequency distribution of atmospheric noise," Proc. I.R.E., vol. 20, p. 1512; September, (1932).

<sup>8</sup> Espenschied, Anderson, and Bailey, "Trans-Atlantic radio telephone transmission," Proc. I.R.E., vol. 14, p. 7; February, (1926).

initial frequencies as high as 4000 cycles. Two tweek-frequency determinations made from oscillograms are shown in Fig. 4. These illustrate the initial rapid frequency reduction and the subsequent gradual approach to a constant. While not an accurate definition, frequency, as determined from the oscillograms, is taken as the reciprocal of the time spacing of successive impulses. Due to the difficulty in accurately measuring these short time intervals, especially in the presence of other forms of atmospherics, there is a possibility of error which might account for the irregularities in the location of points. However, irregularities in effective height of the reflecting layer might be expected to produce a like result.

With one possible exception,<sup>2</sup> tweeks have never been observed by us during daytime except near sunrise and sunset. In the usual case, the intensity of static impulses increases during the early evening with no indication of tonal quality. At twilight certain of the impulses are observed to be accompanied by a slight indication of a highly damped frequency. Shortly thereafter the characteristic tweek tone appears, often trailing a good share of the static impulses. Both tweek rate and intensity ordinarily increase for some two hours. For the remaining hours of darkness the tweeks, usually of low damping, continue with many irregular variations in intensity. Just previous to the approach of daylight a brief increase in tweek rate often occurs followed by a rapid reduction in both intensity and rate of occurrence. The last highly damped tweek is usually observed several minutes before sunrise.

H. Barkhausen<sup>3</sup> in attempting to explain the type of atmospheric tone known as the "swish" or the "long whistler" considers the multiple reflection of an impulse. While our observations indicate this theory to fail in explanation of the swish, it appears to be applicable to tweeks. According to this theory a tweek may be produced by energy, from a source of momentary static disturbance, arriving at a receiving point as a series of impulses. The first impulse arrives by direct transmission. Shortly thereafter a second impulse arrives after having suffered one reflection at an ionized layer in the upper atmosphere. The third impulse arrives after two reflections from the ionized layer and one from the earth's surface. Other impulses follow in like manner. In case the origin of the disturbance is not near the observation point, the time spacing of the observed impulses results in a reducing frequency, initially varying rapidly, and finally approaching an asymptotic value. The initial frequency is dependent upon the distance from source to observer and the reflecting layer height, while the lowest frequency de-

<sup>3</sup> H. Barkhausen, *Proc. I.R.E.*, vol. 18, p. 1155; July, (1930).

depends upon the height alone. The failure of tweeks to appear in daytime may be attributed to damping by sunlight ionization at low altitudes. Occasional highly damped and weak tweeks observed before sunset or after sunrise probably originate at considerable distance, respectively, to the east or west within regions not exposed to sunlight.

The multiple reflection theory of tweeks, as explained above, concerns a single wave train originating in a disturbance located near one of the reflecting surfaces. It may be shown that an impulse originating anywhere in the intervening space might produce a similar effect, although the initial frequency would be altered by the location in altitude. Furthermore, were the point of origin well separated from both surfaces, two simultaneous wave trains differing somewhat in rate of frequency change would occur. Phasing effects, which might be attributed to this have been found in several oscillograms.

Based on the multiple reflection theory, the curve *C* in Fig. 4 was calculated assuming the point of origin to be located near the earth's surface. The altitude of the reflecting layer was taken as 83.5 kilometers (55 miles) and the distance between source and observer as 1770 kilometers (1100 miles). While this curve only roughly approximates the form of the tweek curves of Fig. 4, an explanation of the discrepancy may lie in a variation in effective layer height in accordance with the change in angle of incidence of the successive impulses. Such a relation in the case of radio frequencies has been described by Taylor and Hulburt.<sup>10</sup>

Comparison of the lower limiting frequencies of individual tweeks with an oscillator calibrated in small steps has shown at times an almost continual drift in frequency. This may be interpreted as a corresponding variation in the effective height of the reflecting layer. In one five-minute period during complete darkness, examination of 24 tweeks showed the lower limiting frequency to vary irregularly between 1690 and 1720 cycles. This indicates a variation in effective layer height between approximately 88.5 and 87 kilometers. The variations of lower limiting tweek frequencies noted at our various observation points have indicated the reflecting layer to vary between 83.5 and 93.2 kilometers during the hours of complete darkness. No marked variations of mean tweek frequency, in respect to either season or latitude, have been observed.

During experiments carried out in New Jersey and New Hampshire,<sup>2</sup> a calibrated tone producing apparatus was available whereby frequencies of musical atmospheric, as observed by ear, could be

<sup>10</sup> A. H. Taylor and E. C. Hulburt, "Propagation of radio waves," *Phys. Rev.*, vol. 27, p. 189; February, (1926).

closely followed. It was found that in addition to tones, which could be considered as individual tweeks, there appeared at times a slight, almost unbroken resonance quality in the static. This resonance was always quite obscure, which may account for its escaping observation in previous work. It appeared to consist of a band of frequencies, the mid-point of which could usually be determined with an accuracy of approximately  $\pm 50$  cycles. The resonance was usually observed during the evening and morning twilight periods when the damping of tweeks was high, and appeared to be closely connected with the tweeks themselves, although ordinarily showing a somewhat higher frequency. During the hours of total darkness the resonance was either absent or

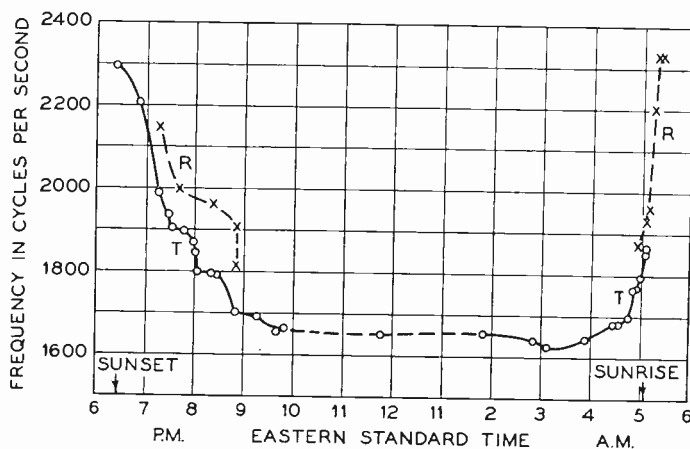

Fig. 5—*T*, *T* lower limiting tweek frequencies. *R*, *R* evening and morning resonance frequencies.

obscured by tweeks. At evening, resonance sometimes appeared at sunset or a short time before. Usually the first highly damped tweeks were observed at about the same time. In the early morning the resonance was observed sometimes several minutes after the last tweek.

Fig. 5 shows frequencies of the resonance tone and the lower limiting frequencies of individual tweeks as determined by aural observations made in the latter part of August, 1932. The tones began with frequencies well above 2000 cycles and decreased to approximately 1650 cycles in a period of two and one-half hours. The resonance disappeared as the tweeks approached the usual night intensity. Approximately a half hour before sunrise the resonance reappeared and a rapid frequency increase began. The last definite tweek observed in the morning was still under 2000 cycles, although the resonance rose well above 2000 cycles before disappearing. In approximate figures, the effective reflecting surface for audio frequencies is indicated by the data of Fig. 5 to be located at an altitude of 61 kilometers at sunset



and to rise to 88.5 kilometers in a period of two and one-half hours. A half hour before sunrise the indicated altitude is 87 kilometers and at fifteen minutes after sunrise it has returned to 61 kilometers.

It is possible that aural frequency observations result in erroneous determinations because of the rapid reduction in frequency which occurs during a tweek. If the damping is not excessive, the ear distinguishes the low frequencies of the tweek and thereon establishes the tonal characteristic. If the damping is great the lower frequencies may be reduced below audibility while the ear may distinguish the higher or

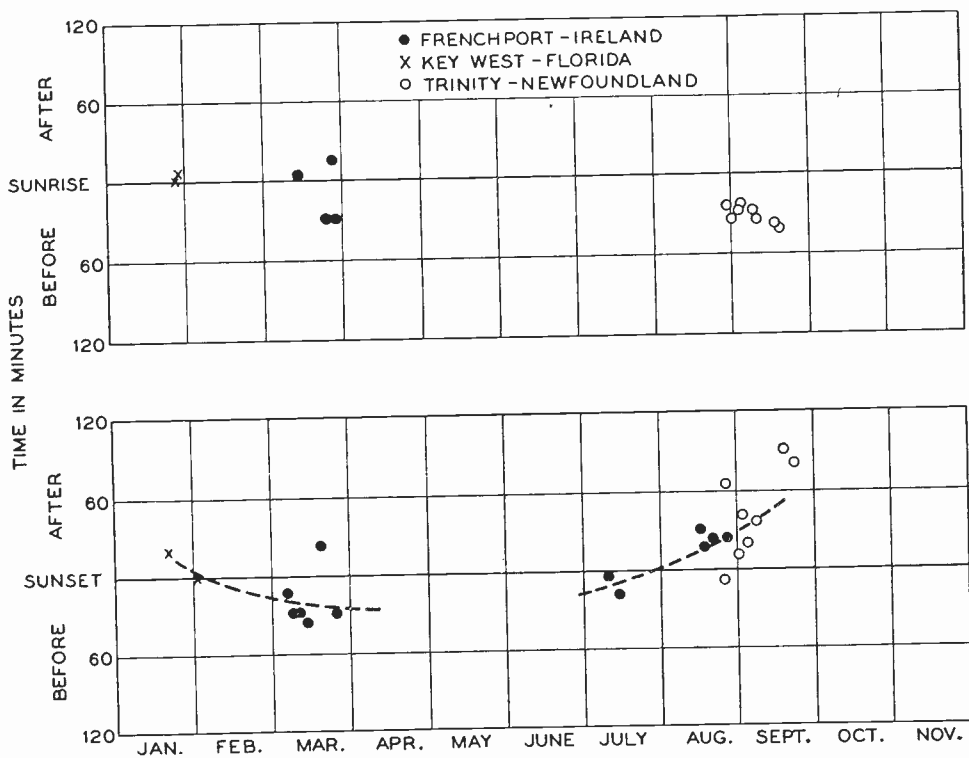

Fig. 6—Observations of first and last tweeks of nighttime periods.

intermediate frequencies as possessing tonal quality and thereon may base its estimation of frequency. Judging from the observations of resonance, where the sound may be almost continuous, it appears likely that these frequency determinations are of fair accuracy.

Observations have been made at various times to determine the time of appearance of the first and last tweeks of the nighttime period. Fig. 6 shows the time of first tweek to be quite variable, extending from approximately a half hour before sunset to one and one-half hours after. The time of the last tweek varies from forty minutes before sunrise to a few minutes after sunrise. The points obtained in Florida differ somewhat from those obtained in Newfoundland and Ireland, possibly because of the difference of latitude. Since the Florida obser-

vation point lies approximately 24 degrees south of the latter locations, it follows that here the interval between the time of incidence of the sun's rays at the position assumed for the damping region and actual sunrise is somewhat less than at the northern observation points. However, a seasonal effect may be responsible as is indicated by the dotted curve in Fig. 6.

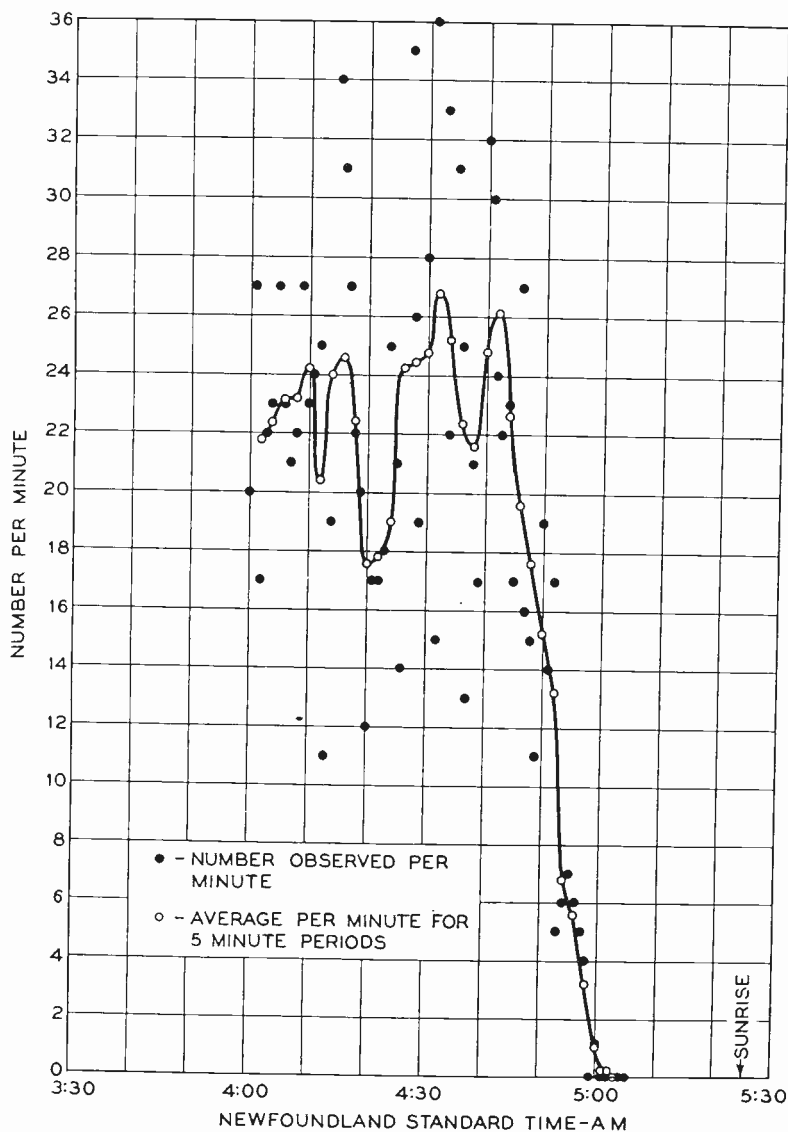

Fig. 7—Rate of occurrence of tweeks. Data taken during a period of high intensity.

There is a distinct seasonal variation in tweek numbers, the rate being consistently high during the summer and low during the winter and early spring, following approximately the variations in nonmusical atmospherics. At times in the summer, tweeks have been observed to occur at rates exceeding fifty per minute while during the winter as

few as one or two in five-minute periods is not unusual. A night completely free from tweeks has not been observed at any of our experimental locations. Fig. 7 shows results of a summer tweek count when the rate was high. This curve illustrates well the rapid variations which may occur during the morning twilight period.

#### SWISH AND RELATED MUSICAL ATMOSPHERICS

Swishes observed in Newfoundland have been described as, "musical sounds, such as made by thin whips when lashed through the air."<sup>1</sup> They are ordinarily distinctly musical in character, the frequency varying sometimes downward and at other times upward. At times upward and downward progressions are observed simultaneously. During the Newfoundland observations, the frequencies lay usually between 700 and 2000 cycles, but the individual tones in most cases did not exceed an octave in variation. The duration of these earlier observed swishes varied from approximately one fourth of a second to more than a second. In Ireland swishes of the same nature were observed, but a more usual type was longer and much clearer in tone. These swishes were audible from  $\frac{1}{2}$  second to possibly 4 seconds and covered a frequency range from well below 800 to above 4000 cycles. To the ear the frequency appeared to progress steadily with perhaps a slight lingering near the termination of the descending variety.

While in the earlier Newfoundland observations the swish usually appeared to be accompanied by a rushing sound, later work disclosed many nearly clear whistling tones which may be identified as the "long whistlers" reported by other observers. These sometimes swept upward or downward through the entire voice range and at other times varied only through the range between approximately 3000 and 4000 cycles. On a few occasions the whistles have been observed to hesitate and warble slightly before disappearing. Series of swishes have been observed following each other with almost perfectly regular spacing of a few seconds, the train persisting on occasion for as long as a few minutes. Some of these trains have successively increased in intensity, terminating abruptly while other trains have reduced gradually until submerged in the usual static. In addition to the distinctly musical tones, swishes have been heard in which the rushing or hissing sound is prominent while the tone may be nearly or entirely absent. Our observations have shown these often to appear during periods when the whistling tones are frequent, to correspond approximately to the length of the whistles and at times to appear in regularly spaced trains.

Many observations have indicated a relation between swishes and

the quasi musical sound in the range between 500 and 1500 cycles, which in an earlier paper has been called "intermediate-frequency noise."<sup>1</sup> Frequently this noise is first observed as a subdued jumble of hollow rustling or murmuring sounds. It often increases regularly in intensity for some time, after which faint swishes may begin to appear in the same frequency range. The swishes may increase in intensity and length, eventually submerging the murmuring sound. Occasionally the murmuring has continued for a short time after the swishes have reduced in amplitude or have disappeared. As a general rule the murmuring is not audibly prominent although it seems to be rather continuous in character. As a result it may considerably increase the atmospheric intensity in the intermediate voice range.

On a few occasions musical high frequencies similar in general character to the murmuring have been observed. This sound appears as a continual chirping or jingling in the vicinity of 3200 cycles. The amplitude is usually low and the duration short. Like the murmuring sound, it appears to accompany periods during which swishes are present, and probably is composed of large numbers of short, overlapping, high-frequency swishes.

These types of atmospherics appear to have no connection with the time of day, or with local weather conditions and there is no indication of any correlation with the time of year. During some periods they have been observed frequently during days and nights for possibly forty-eight hours or longer. They have been found at times to persist steadily through the early morning, bridging the transition period when the more common forms of atmospherics rapidly change character. At times several weeks of daily observation has passed with practically no appearance of swishes or related sounds.

During periods of prominent swishes the variation of intensity is usually gradual with maxima and minima spaced at irregular intervals of possibly a few minutes. At maxima, the swish may approximate the intensity of the usual audio nighttime atmospherics. The intensity which swishes may attain is evidenced by their occasional observation without use of amplifying apparatus. A twelve-mile telegraph line free from power interference has been found a satisfactory antenna, and with a telephone receiver between the line and earth, swishes of remarkable clearness have been observed. Tweaks have been heard with the same equipment.

In the short time during which the sound recording apparatus was available in Ireland, swishes were very infrequent with the exception of one day when all swishes were of the descending frequency type. These swishes were unusual in that they appeared in overlapping pairs.

Three minutes of record was obtained containing seven swish pairs. A representative oscillogram, shown in Fig. 8, is a record of 2.4 seconds, containing all that could be identified as a swish pair. The points "A" and "B" denote the visible starts of the first and second swishes, respectively. Filters used during the recording of this oscillogram account for the absence of frequencies above 3000 cycles and below 600 cycles.

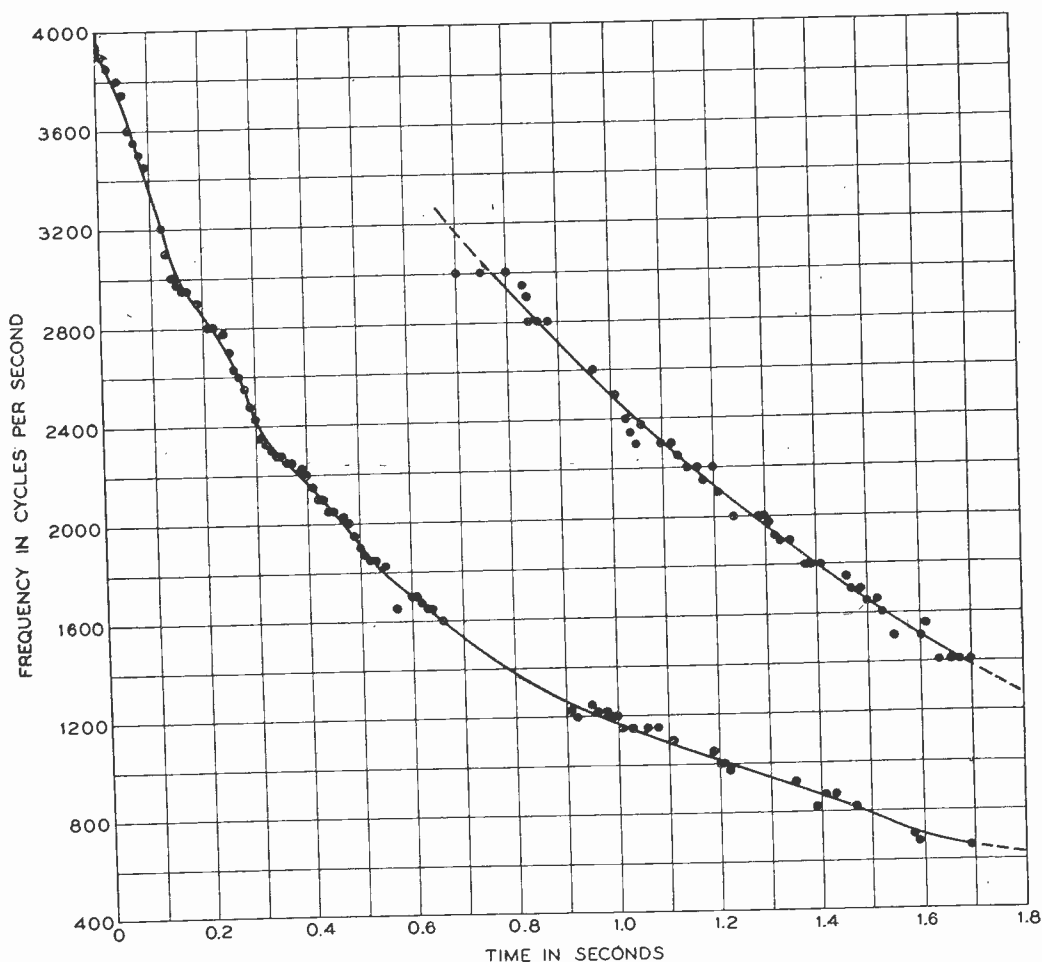

Fig. 9—Frequency curve of the swish pair shown in Fig. 8.

The frequency variation of this swish pair with time is shown in the curve of Fig. 9.

Eckersley<sup>11</sup> has reported observation of descending whistling tones following static crashes after a quiet period of a few seconds. During the New Hampshire observations this phenomenon was observed frequently. The swishes were observed to follow certain distinctive static crashes. This type of disturbance consisted of low and intermediate

<sup>11</sup> T. L. Eckersley, "Radio echoes and magnetic storms," *Nature*, vol. 122, p. 768; November, (1928).

impulses, persisting for a fraction of a second, accompanied by an unusually intense frying sound, indicating a predominance of high frequencies. At no time did this type of disturbance appear to possess marked tonal quality. Each impulse was followed by a quiet period after which a swish occurred. During several periods when the static was sufficiently intermittent, the interval between the beginning of the static impulse and the beginning of the swish was timed. Approximately seventy observations were made, the shortest period recorded being 1.2 seconds and the longest, accurately determined, 3.0 seconds. Many ranged between 2.5 and 2.8 seconds. No consistent progression of the length of this swish lag was observed although at certain times a predominance of either long or short periods existed. Later work indicated the long and short periods to be about equally divided between night and day.

During one night of the New Hampshire work an auroral arc appeared extending from northwest to northeast. Near the northwest end of the arc frequent flashes occurred, but these were too obscure for any details to be made out. A similar but much weaker flashing was observed to the southwest. At times the flashes appeared to extend along the horizon from northwest to southwest. By visual observation while listening to the atmospherics, it was found that nearly every flash coincided with a static crash possessing the prominent frying sound. These crashes, were in most cases followed by swishes, usually of the descending variety, although occasionally a short ascending whistle occurred simultaneously with the start of the descending swish.

According to information supplied by the United States Weather Bureau, no lightning storms occurring during this period lay in the direction where flashes were observed to be concentrated and no storms were reported as near as one hundred miles to our observation point. The Weather Bureau supplies the information that, under favorable reflecting conditions, lightning flashes might be seen forty miles, but could not be seen one hundred miles. It therefore appears reasonable to suppose that the flashes observed were of auroral origin. A report supplied by the U. S. Magnetic Observatory at Tucson, Arizona, shows a magnetic storm beginning August 27. Through the following days the disturbance gradually reduced, reaching a low level on September 1. Our observations show the swish intensity to be high from the evening of August 30, when observations began, to September 1. Through September 1 and up to the termination of the test on the morning of September 2, the swish intensity appeared to be reducing although occasional high intensity periods occurred. These and earlier data of like nature obtained by us and others indicate a correlation between

swish and magnetic disturbances. The accepted connection between auroral and magnetic field variations might justify a supposition that auroras and whistling tones may be directly related as indicated by the New Hampshire observations. An assumption that the tones originate at the altitudes usually occupied by auroral displays might lead to an explanation of the apparent absence of marked diurnal variations in the swish tones. The observed correlation between certain atmospheric crashes and the subsequent swishes appears to indicate either dependence of the latter on the former or origin of the two from a common source of energy. The first assumption points to multiple reflection or dispersion phenomena which may produce either ascending or descending tones. The time lag between the static impulse and the following swish would indicate either a low velocity or the traversing of a great distance. In either case, low attenuation is indicated by the long duration of some tones. It appears possible that the two radiations may result from sequential events occurring in the upper atmosphere by means of which nonmusical as well as musical atmospheric phenomena are produced. Assuming an emission of energy which persists more or less steadily over a period comparable with the duration of a swish, it is possible to account for the approximately uniform amplitude of a swish without the necessity of assuming a very low damping.

It is suggested that swishes may be related to the occasionally observed phenomenon of swinging and flashing auroral beams. In this case it appears necessary to consider a cyclic process in the behavior of the aurora which would account for the time lag between the radiation of an initial static disturbance and the following varying tone. The varying tones might be produced by energy radiated from swinging beams resonating within the space separating beams or in the space between a beam and a stationary reflecting layer.

It might be possible for standing waves to occur within a beam, variations in the length or other constants of the path producing the varying tones.

A correlation between swish and auroral phenomena is indicated in statements by witnesses of auroral displays. Professor Chapman<sup>12</sup> reviews the testimony of many observers who have witnessed auroral displays at extremely low altitudes. Some attest to having stood actually within the glow and to having heard, directly from the atmosphere, disturbances accompanying the visible phenomena. Some of their sound descriptions follow:

<sup>12</sup> S. Chapman, "Audibility and lowermost altitude of aurora," *Nature*, vol. 127, p. 341; March 7, (1931).

"Quite audible swishing, crackling, rushing sounds."

"A crackling so fine it resembled a hiss."

"Similar to escaping steam, or air escaping from a tire."

"Much like the swinging of an air hose with escaping air."

"The noise of swishing similar to a lash of a whip being drawn through the air."

"Likened to a flock of birds flying close to one's head."

Some of these phrases coincide with those used by us in describing swishes. Certainly the correlation of sound descriptions is remarkable.

Dr. Williams, an observer of auroras, comments on the sounds thus<sup>13</sup>: ". . . On several occasions I have heard the swishing sound. The sound accompanies only a certain type of auroral display. I have never heard this sound except when those tall, waving columns, with tops reaching nearly to the zenith were moving across the sky. . . . When these tall sweeping columns die down the sound, according to my experience, disappears."

Consideration has been given to the likelihood of swishes or other appreciable audio-frequency disturbances being produced by meteors. Lindemann and Dobson<sup>14</sup> estimate the energy liberation of an average meteor to exceed three kilowatts during the glowing period, and Skellet<sup>15</sup> states that a meteor may throw out an ionized trail extending laterally to a distance of a few kilometers. It has appeared advisable to search for magnetic disturbances which might show tonal qualities by resonance between the meteoric trail and some established reflecting surface. During two nights atmospherics were received with an audio-frequency amplifier and a loop antenna, located at a point in New Jersey. Observation of twenty-nine meteors, including six which could be classified as quite bright, disclosed no correlation with the sounds of audio-frequency atmospherics.

#### SOME THEORIES OF MUSICAL ATMOSPHERICS

In a paper entitled "Whistling Tones from the Earth" Barkhausen<sup>9</sup> describes observations made during the World War on an atmospheric, which appears to have been the same as the descending swish heard by us.

He states: "During the war amplifiers were used extensively on both sides of the front in order to listen in on enemy communications. . . . At certain times a very remarkable whistling note is heard in the tele-

<sup>13</sup> J. Leon Williams, "The sound of the aurora," *Literary Digest*, vol. 112, p. 28; February 20, (1932).

<sup>14</sup> F. A. Lindemann and G. M. B. Dobson, "Theory of meteors," *Proc. Roy. Soc. (London)*, vol. 102, p. 411, (1923).

<sup>15</sup> Skellet, "Effect of meteors," *Phys. Rev.*, vol. 37, p. 1668, (1931).



phone. So far as it can be expressed in letters the tone sounded about like "p̄eou."<sup>16</sup> From the physical viewpoint, it was an oscillation of approximately constant amplitude, but of very rapidly changing frequency . . . beginning with the highest audible tones, passing through the entire scale and becoming inaudible with the lowest tones. . . . The entire process lasted almost a full second."

Barkhausen presents two possible explanations for these sounds. The first assumes the presence of a reflecting layer in the upper atmosphere. An electromagnetic impulse originating at the earth's surface arrives at a distant receiver first over the direct path and then from reflections in the order 1, 2, 3, to  $n$ . Such a series of reflections would result in a wave train of rapidly diminishing frequency becoming asymptotic to a value dependent upon the height of the reflector.

The second of Barkhausen's theories depends upon ionic refraction in the Heaviside layer, resulting in the breaking up of an impulse into its component frequencies and a delay in the transmission of the lower frequencies with respect to the higher. It gives a rate of frequency progression which varies with distance and with the refractive index of the medium.

Eckersley<sup>17</sup> discusses apparently the same type of atmospherics. As an experimental background he notes frequent observations of audio-frequency disturbances received over large radio antennas. He states: "These (tones) have a very peculiar character: the pitch of the note invariably starts above audibility, often with a click, and then rapidly decreases, finally ending up with a low note of more or less constant frequency which may be of the order of 300 to 1000 a second.

"The duration . . . varies very considerably; at times it may be a very small fraction of a second, and at others it may be even one fifth of a second." He observes that they are infrequent in the morning, increasing throughout the day and reaching a maximum during the night. He develops a theory based on ionic refraction to account for these disturbances.

It appears that in these latter observations both swishes and tweeks were heard, but were not recognized as distinct phenomena. Such an error might be attributed to the irregularities of response which are common in the ordinary telephone receiver.

Barkhausen's first theory fails to explain swishes because of their upward as well as downward progression, long duration and frequency

<sup>16</sup> *P̄eou* slowly pronounced in a whisper excellently portrays a descending swish accompanied by the rushing sound.

<sup>17</sup> T. L. Eckersley, "Musical atmospheric disturbances," *Phil. Mag.*, vol. 49, p. 1250, (1925).

range. The theory, as previously pointed out, is adaptable to the explanation of tweeks. It does not appear probable that either Barkhausen's or Eckersley's refraction theory properly explains the tweek because of its lower limiting frequency of approximately 1600 cycles. It seems more than mere coincidence that this frequency is in the range that the multiple reflection theory predicts. Any theory adequately explaining the swishes or long whistlers should account not only for long duration and apparently constant amplitude but also for upward as well as downward progression and freedom from diurnal changes in tonal qualities.

#### ACKNOWLEDGMENT

The authors wish to acknowledge their indebtedness to Mr. A. M. Curtis and Dr. W. S. Gorton for valuable advice, and to Messrs. J. F. Wentz, A. B. Newell, and E. W. Waters who through long hours have worked patiently with us in procuring the data upon which this article is based.



## NOTE ON NEW METHODS TO MODULATE LIGHT\*

BY

G. WATAGHIN AND R. DEAGLIO

(R. Scuola di Ingegneria, Torino, Italy)

THIS note describes some methods for modulating light, which have been investigated by the authors.<sup>1</sup>

The light employed is that from an incandescent electrode, of an electron valve using one of the following methods for modulation.

(1) The method of the electron bombardment of an incandescent anode with a modulated anode current. The modulated light is the one emitted by this anode filament.

(2) The method of subtraction of energy from an incandescent cathode of an electron valve as a result of the work done by this extraction of the electrons. In this case for the modulation of this light the effect of the variable space charge (obtained in the conditions of validity of Langmuir's law) is employed, using the total emission from the cathode to the anode and to the grids, if any.

(3) The third method associates the above effects, with Joule's effect given by a current which heats the luminous electrode, and is modulated with the same law as that of the anode current of the valve.

The experiments made by these methods, both on ordinary valves and on especially made valves, have confirmed the desirability of the above methods instead of that of the ordinary neon lamps.

To reach modulations of sufficient amplitude with acoustic frequencies of the order of  $10^4$  cycles the filaments to be used as electrodes must possess a low heat capacity, for instance, tungsten filament with a diameter of 10 microns. Also metal film can be prepared on a support of low heat conductivity and low heat capacity. In both cases the modulating energy developed or lost at the surface by means of one of the above methods (1) and (2) give origin to damped heat waves which will propagate into the electrode. A simple calculation shows that at the higher frequencies, because of this damping, only the surface layer of the electrode will take part in the modulation.

Theory and experiments show that the effect of this damping for filaments of the order of 20 microns will be quite perceptible in the case of frequencies of the order of  $10^4$  cycles.

\* Decimal classification: R355.8. Original manuscript received by the Institute, March 23, 1933.

<sup>1</sup> *Atti R. Accad. di Scienze di Torino*, vol. 67, p. 309, p. 353, (1932); *Alla Frequenza*, vol. 1, no. 3, p. 326, (1932).

The advantages offered by valves with additional grids allow the above methods so as to fill many unusual conditions which might be required of modulated light; namely, a linear law of modulation, the independence from frequency, a sufficient intensity of modulation, etc. In particular, a controlling grid results in the reduction of the modulating power applied to the lamp.



## DISCUSSION ON "SUPERVISORY AND CONTROL EQUIPMENT FOR AUDIO-FREQUENCY AMPLIFIERS"\*

HARRY SOHON

A. F. Rose:<sup>1</sup> In Part I of the above paper, which describes the essential characteristics of a peak indicator, it is stated that under the present practice, using either a root-mean-square voltmeter or an average value voltmeter, the readings obtained from such instruments on other than sinusoidal voltages are merely approximations to the overload points of amplifiers. Experience in the Bell System in transmitting and reproducing speech and music had led to the development of instruments known as "volume indicators," for use in controlling the levels of transmitted material at various points along the electrical circuit. Among other characteristics, these indicators include one which has been found to be of great importance. This characteristic, simulating the "duration" characteristic of the human ear, is incorporated in the indicating meter, full deflection being reached only on impulses lasting 0.2 second or more. Overshooting of the needle is also controlled so that the visual indication given is closely correlated with a corresponding aural impression of loudness. While for absolute measurements of loudness on program circuits, a frequency weighting would also be theoretically required, from the practical standpoint the most frequent use of a volume indicator on program circuits is to avoid overloading, and for this purpose no weighting network is desired.

The "duration" characteristic of this indicator is important in controlling transmission levels so that overloading does not occur. Objectionable overloading results in a distortion which exceeds tolerable limits. While impulses of very short duration may be of sufficient instantaneous magnitude to overload, noticeable distortion in the reproduced output may not result. The correlations which it has been found possible to obtain between volume indicator readings and noticeable distortion, as determined by listening tests for the various types of transmitted material, have led to the establishment of transmission level limits above which, as shown by the volume indicator, excessive distortion occurs.

An indicator operating more rapidly than the 0.2-second meter may have some advantages in avoiding a temporary overloading of a radio transmitter and causing circuit breaker operation. However, in addition to its use to prevent overloading noticeable to the listener, satisfactory results have been obtained by test in setting upper limits to avoid breaker operation where the use of an instrument with a 0.2-second duration characteristic might be thought to be unreliable.

H. Sohon:<sup>2</sup> I am glad that Mr. Rose mentioned that the most frequent use of a volume indicator on program circuits is to avoid overloading. It is something that might well have been included in the original paper. I do not know what type of meter Mr. Rose is using with the "duration" characteristic, but an 0.2-second duration characteristic applied to either the rectifier voltmeter or the root-mean-square voltmeter will make the results differ very slightly from those indicated in the discussion of Fig. 1 and Table I of the paper for frequencies above sixteen cycles per second.

If the duration characteristic is desired, it might be incorporated in the peak voltmeter. Then the peak voltmeter would indicate overloads lasting 0.2 second or more.

\* *Proc. I.R.E.*, vol. 21, no. 2, pp. 228-237; February, (1933).

<sup>1</sup> Engineer, American Telephone and Telegraph Company, New York, N. Y.

<sup>2</sup> Instructor in Electrical Engineering, Cornell University, Ithaca, N. Y.

## BOOK REVIEWS

**Network Synthesis**, by Charles M. Son Gewertz. Published by Williams and Wilkins Co., Baltimore, Md. 257 pages, 120 figures. Price \$4.

The problem of network analysis is to calculate the current which will flow in a network of given configuration under a specified electromotive force. The solution by operational and other methods is treated in many published works.

The inverse problem of network synthesis assumes that the law of variation of the current is known, as the frequency of the given applied electromotive force is varied, and seeks to design a network whose properties are such as to allow a current to flow which will have the prescribed values and law of variation with the frequency.

This problem is more difficult than that of network analysis, and has hitherto received little attention. As far as the author and the publishers know, this is the first book which has appeared on the subject of network synthesis. It embodies largely the results of original research by the author. The treatment applies specifically to the synthesis of a finite four-terminal network from its prescribed driving point and transfer functions.

The first half of the book deals with a development of the mathematical conditions which must be satisfied by the short-circuit driving point and transfer admittances or impedances of a four-terminal network, considered as functions of the frequency, in order that a possible passive network representation may exist.

There follows then specific applications of this theory to standard  $L$ ,  $T$ ,  $\pi$  and lattice structures, and their combinations. Finally, a general method is outlined by which any given group of admittance or impedance functions, which satisfies the necessary mathematical conditions, may be represented by a combination of structures with known circuit elements.

There follows an appendix giving solutions of illustrative examples. These might better appear in the main body of the text, since their study renders easier an understanding of the theory. An extensive bibliography of the subject is provided.

Although the book is written more from the standpoint of the mathematician than that of the engineer, and labors under the disadvantage of an involved style of writing, the book is recommended as indispensable to the engineer interested in this new branch of communication theory.

\*F. W. GROVER

**Télévision et Transmission des Images**, by René Mesny. Published 1933 by Librairie Armand Colin, Paris. Price 10 f, 50 c. (about \$0.50).

This book gives a very practical, though brief, résumé of the present state of the television art and of facsimile transmission. Although written in French it should prove valuable to even those engineers who have no knowledge of the language, because the simplicity with which it is written and word similarities render it easy of interpretation.

\* Union College, Schenectady, New York.

The television problem is stated clearly and briefly. Considerable space is devoted to the following subjects: the various mechanical and electrical scanning systems which have been proposed at transmitter and receiver; photo-electric cells; light sources; the necessary frequency band and its amplification; aperture distortion; and photo-telegraphic apparatus.

Mathematical attacks upon various phases of the subject are indicated, but no complete analyses are given. The cathode ray tube systems of principal inventors both here and abroad are discussed in some detail. The treatment of electrical scanning and focus is somewhat brief. No design data is given.

†MADISON CAWEIN

† Hazeltine Corporation, Bayside L. I., New York.



## RADIO ABSTRACTS AND REFERENCES

THIS is prepared monthly by the Bureau of Standards,\* and is intended to cover the more important papers of interest to the professional radio engineer which have recently appeared in periodicals, books, etc. The number at the left of each reference classifies the reference by subject, in accordance with the "Classification of Radio Subjects: An Extension of the Dewey Decimal System," Bureau of Standards Circular No. 385, obtainable from the superintendent of Documents, Government Printing Office, Washington, D.C., for 10 cents a copy. The classification also appeared in full on pp. 1433-1456 of the August, 1930, issue of the PROCEEDINGS of the Institute of Radio Engineers.

The articles listed are not obtainable from the Government or the Institute of Radio Engineers, except when publications thereof. The various periodicals can be secured from their publishers and can be consulted at large public libraries.

### R000. RADIO (GENERAL)

- R090 Conquering the Atlantic. *Wireless World* (London), vol. 33, pp. 72-73; August 4, (1933).

A historical account is given of the first transatlantic radio communication.

### R100. RADIO PRINCIPLES

- R111 G. Beauvais. Recherches experimentales sur la reflexion totale des ondes Hertiennes. (Experimental researches on the total reflection of Hertzian waves.) *L'Onde Electrique*, vol. 12, pp. 161-179; April; pp. 213-235; May, (1933).

The first part of this article contains a historical discussion of total reflection. A radiometer is described. The second part gives the electromagnetic theory of total reflection. A theoretical study is made of evanescent waves under the two conditions: having the electric vector perpendicular to plane of incidence, and in the plane of incidence.

- R111 L. Tonk. Ionization density and critical frequency. *Nature* (London), vol. 132, p. 101; July, (1933).

The theoretical relation between ionization density  $N$  and critical frequency  $f$  is stated to be  $N = (\pi m / e^2) f^2$  and not  $N = (3/2)(\pi m / e^2) f^2$  as has been used in some papers recently.

- R113 R. C. Colwell and I. O. Myers. The reflecting layers of the upper atmosphere (abstract). *Phys. Rev.*, vol. 43, pp. 774-775; May 1, (1933).

Working at West Virginia University "during the past autumn simultaneous observations were made upon the short wave from station W8XK (6140 kilocycles) and the long wave from KDKA (980 kilocycles). The fading curves obtained were plotted upon maps of the United States Department of Agriculture Weather Bureau. It is seen at once that the signal strength of the long-wave varies over nightfall according to the change in barometric pressure, while the short waves have the same characteristic curve regardless of the weather. This indicates that the E layer is in the region connected with the varying pressures while the F layer is unaffected."

- R113 H. R. Mimno and P. H. Wang. A balanced receiver circuit for Kennelly-Heaviside layer observations (abstract). *Phys. Rev.*, vol. 43, p. 774; May 1, (1933).

\* This list compiled by Mr. A. H. Hodge and Miss E. M. Zandonini.



By balancing the radio-frequency voltage induced in the receiving antenna, by an equal and opposite voltage obtained directly from the transmitter coils, successful results have been obtained with the receiving apparatus about four meters from the transmitter. Several types of receiving antennas have been employed directly under the transmitting antenna.

- R113 H. R. Mimno and P. H. Wang. Double-refraction effects in the Kennelly-Heaviside layers. *Phys. Rev.*, vol. 43, pp. 769-770; May 1, (1933).

During the past year the authors have taken a large number of automatic photographic records over 24-hour periods, and have recorded, continuously since January 1, 1933, records of radio waves which have been refracted in the upper atmosphere. "Split echoes" were observed. In addition to the normal effects they have investigated many abnormal records produced by magnetic storms or other factors. They have used and discarded the "grid blocking" transmitter recently developed by the Radio Research Board (England).

- R113 N. Stoyko and R. Jouaust. Anomalies dans la propagation des ondes radioélectriques courtes. (Anomalies in the propagation of short radio-electric waves.) *Comptes Rendus*, vol. 196, pp. 1583-1585; May 22, (1933).

Signals from NAA received in France show retardations which indicate that there are two points of diffusion from which signals arrive with frequent delays. One point is said to be 900 kilometers from Annapolis, and the second 4000 kilometers distant.

- R113 M. Maire. Contribution expérimentales a l'étude de la propagation des ondes courtes. (Contribution to the experimental study of the propagation of short waves.) *L'Onde Electrique*, vol. 12, pp. 41-52; January, (1933).

The difficulties encountered in the industrial exploitation of short waves are enumerated. An interpretation is given of a group of experimental data taken to determine the best wavelength to use at different times in order to maintain best contact.

- R113.2 R. Bureau. Sur la variation rapide des atmosphériques au lever du soleil. (On the rapid variations of atmospherics at sunrise.) *Comptes Rendus*, vol. 196, pp. 1426-1428; May 8, (1933).

"The rapid decrease of atmospherics observed at sunrise on waves of the order of 30 kilocycles is a consequence of the violent changes imposed by the solar radiation on the propagation of waves coming from distant sources. I have given an experimental proof of this by comparing the atmospheric curves of Paris, Tunis, and Rabat, which are frequently identical during the night hours." The height of the reflecting layer is calculated to be 15 to 20 kilometers.

- R113.5 J. Fuchs. Der Einfluss des Wetters auf die Ausbreitung der Radiowellen. (The influence of the weather on the propagation of radio waves.) *Funkmagazin*, vol. 6, pp. 363-370; June, (1933).

The author discusses the possibility of processes in the troposphere affecting the propagation of space waves, and states that the ionization on a cloud region just before the occurrence of a lightning flash has sufficient ionization to affect such waves. The paper also deals with the influence of the stratosphere, discussing whether changes occur there which are related to the conditions in the troposphere.

- R113.6 J. A. Ratcliffe and E. L. C. White. The effect of the earth's magnetic field on the propagation of short wireless waves. *Phil. Mag.* (London), vol. 16, pp. 124-145; July, (1933).

The paper describes the construction and use of a circularly polarized receiver which makes it possible to pick out the right- and left-handed circularly polarized components for a wave incident vertically. The receiver is used to test several deductions from the magneto-ionic theory, for a wavelength less than the critical magneto-ionic wavelength of 214 meters. Electrons are found to be responsible for deviation of electric waves in both E and F regions. The occurrence of simultaneous reflections from the E and F regions is investigated, and the polarization of daytime signals is discussed.

- R113.6 W. G. Baker and A. L. Green. The limiting polarization of downcoming radio waves traveling obliquely to the earth's magnetic field. *Proc. I. R. E.*, vol. 21, pp. 1103-1131; August, (1933).

The paper is a theoretical discussion of the limiting polarization of downcoming electromagnetic waves propagated at oblique angles to the earth's magnetic field. The main

conclusions arrived at are: (a) The polarization of the downcoming wave tends to a definite limit on leaving the Kennelly-Heaviside layer; (b) The shape of the ellipse of polarization is determined by the frequency of the wave relative to the critical frequency, and by the angle between the direction of propagation and the lines of force of the earth's magnetic field; (c) The orientation of the ellipse is such that the principal axes are perpendicular to the direction of propagation, the major axis being in the plane containing the direction of the earth's magnetic field and the direction of propagation; (d) The sense of rotation of the electric vector contained by the ellipse is left-handed when the direction of propagation of the "ordinarily" downcoming ray makes an acute angle with the earth's field; the rotation is right-handed when the angle is obtuse. It has been shown to be possible to predict the polarization of the downcoming rays for any given distance and in any direction from the transmitter. In the Kennelly-Heaviside layer, the true direction of propagation is oblique to the wave front; (g) The relative attenuation factors of the "ordinary" and the "extraordinary" rays have been plotted for oblique propagation to the earth's field, assuming simple conditions.

- R113.61 T. R. Gilliland. Continuous measurements of the virtual heights of the ionosphere. *Bureau of Standards Journal of Research*, vol. 11, pp. 141-146; July, (1933). Research Paper No. 582.

Continuous measurements of the virtual heights of the ionosphere are reported. Pulses of radio-frequency energy are transmitted from and received in the same room. Frequency is 4100 kilocycles. In the morning and afternoon the F region is found to be about 240 kilometers high. At midday, the effective heights are 300-320 kilometers. Records show the rapid variations in the ionization conditions at night. Changes are so irregular that more data will be necessary to establish the relative importance of magnetic storms, meteor showers, sun spots, or thunder showers.

- R113.7 C. R. Burrows and E. J. Howard. Short-wave radio to South America. *Electrical Eng.*, vol. 52, pp. 529-531; August, (1933).

Results of a year's survey of transmission conditions between New York and Buenos Aires in the short-wave spectrum show that frequencies between 19 and 23 megacycles were best for daytime transmission and those between 8 and 10 megacycles for nighttime transmission. A transition frequency was required in the early morning, but the useful periods of the day and night frequencies overlapped in the evening. No variation that could definitely be traced to a seasonal effect was found.

- R131 H. N. Kozanowski and I. E. Mouromtseff. Vacuum tube characteristics in the positive grid region by an oscillographic method. *Proc. I. R. E.*, vol. 21, pp. 1082-1096; August, (1933).

A method of determining "complete" plate and grid characteristics of vacuum tubes in the positive grid region by means of oscillographic recording has been developed. A condenser of high capacity furnishes a single pulse of grid excitation which can be made to cover the entire region from any desired positive grid voltage to zero. Due to the rapidity of this excitation instantaneous power input to the tube of twenty to thirty times nominal rating has been recorded without danger to the tubes. Several typical complete charts of plate and grid characteristics obtained by this method for an experimental tube of the so-called "50-watt" type are given.

- R133 J. B. Hoag. A note on the theory of the magnetron oscillator. *Proc. xR355.9 I. R. E.*, vol. 21, pp. 1132-1133; August, (1933).

An equation by K. Okabe, *Proc. I. R. E.*, vol. 17, p. 652; (1929), gives  $\lambda H = 10,650$ . Experimentally the value is found to be approximately 13,000. This note derives the equation and gives a correction in better agreement with experiment.

- R133 J. Müller. Elektronenschwingungen im Hochvakuum. (Electronic oscillations in high vacuum.) *Hochfrequenz. und Elektroakustik*, vol. 41, pp. 156-167; May, (1933).

A theoretical investigation of the electron flow between two infinite parallel plane electrodes, taking into account the effect of space charge and limiting the treatment to those cases where at each point in the space only electrons of the same speed occur. It is shown that owing to the electron inertia such an electron stream acts as a negative resistance for frequencies within a certain band, and the question is examined whether this negative resistance is large enough to neutralize the damping of an oscillatory circuit.

- R133 E. Gossel. Messungen an Ultrakurzwellenröhren. (Measurements on ultra-short-wave tubes). *Hochfrequenz. und Elektroakustik*, vol. 42, pp. 1-10; July, (1933).

This is a report of an investigation into the mechanism of production of oscillations of very high frequency. A cylindrical tube with spiral grid is used. Methods of measuring the energy, the range of oscillation, the relation of oscillations to emission current, and the dependence of oscillations on anode voltage are investigated.

- R133 Ph. LeCorbeiller. Le mecanisme de la production des oscillations. (The mechanism of the production of oscillations.) *L'Onde Electrique*, vol. 12, pp. 116-148; March, (1933).
- Two general types of oscillating systems are studied. The first type consists of an irreversible relay whose output is coupled to the input by means of a passive quadripole. The second type is realized by means of a conductor having characteristics presented by a falling arc, connected to the source and to a passive dipole. The general nonlinear differential equation is set up. The equation of the second type is a particular case of the first. The oscillations of electrical or mechanical systems are then studied.
- R140 R. M. Foster. Mutual impedance of grounded wires lying on or above the surface of the earth. *Bell Sys. Tech. Jour.*, vol. 12, pp. 264-287; July, (1933).
- This paper presents a formula for the mutual impedance of any insulated wires of negligible diameter lying in horizontal planes above the surface of the earth and grounded by vertical wires at their four end points. The formula holds for frequencies which are not too high to allow all displacement currents to be neglected. Tables and curves are given to facilitate numerical computation by means of the formula.
- R140 R. King. Amplitude characteristics of coupled circuits having distributed constants. *PROC. I. R. E.*, vol. 21, pp. 1142-1181; August, (1933).
- A general solution for the amplitude characteristics for bridge-coupled circuits having distributed line constants is obtained and applied to typical circuit arrangements including those encountered in wavelength measurements using parallel wires. The physical conditions under which the theory may be applied are analyzed; theoretical curves are computed for a typical selection of constants and are shown to be in excellent agreement with corresponding experimental ones. A new precision method for measuring ultra-short waves is described. A method is devised for experimentally determining the characteristics of short-wave detectors and for measuring their input impedance at ultra-high frequencies.
- R140 W. Fehr and K. Kreisheimer. Über die Resonanzfrequenzen zweier gekoppelter Schwingungskreis. (On the resonance frequency of two coupled oscillating circuits.) *Zeit. für tech. Phys.*, no. 8, pp. 306-308; (1933).
- A brief theoretical note on coupled circuits.
- R140 W. Kautter. Die Herstellung von negativen Leitwerten mit Hilfe von Rückkopplungsschaltungen. (The production of negative conductances by means of retroactive couplings.) *Elek. Nach. Tech.*, vol. 10, pp. 199-214; May, (1933).
- In an earlier paper it is shown that the input circuit of a nonregenerative receiver can be represented by a parallel connection of positive conductance, fed by the antenna with a certain practically constant current. Potential changes at the first grid due to adjustments of the tuning can be represented by the corresponding changes in the resultant admittance. This paper extends the method to the case of a regenerative receiver by the introduction of a "negative conductance" which has practically no dependence on frequency.
- R140 A. Alford. A method for calculating transmission properties of electrical networks consisting of a number of sections. *PROC. I. R. E.*, vol. 21, pp. 1210-1220; August, (1933).
- The solution of certain electrical networks can be made to depend on the solution of a much-studied mathematical problem in difference equations. This fact, while recognized for some time, has not received as much attention as it deserves. On the following pages we have worked out several relatively simple electrical networks by the method of difference equations. Our aim was not to obtain the solutions of the particular cases considered, but rather to illustrate the procedure involved.
- R140 G. W. O. Howe. Why the double hump? *Wireless World* (London), vol. 33, pp. 74-76; August 4, (1933).
- Band-pass tuning is investigated.

- R140 M. Mezey. Etude du circuit d'entree d'un poste recepteur. (Study of the input circuit of a receiver.) *L'Onde Electrique*, vol. 12, pp. 149-160; March, (1933).

The article treats the theory of a band filter consisting of two magnetically coupled oscillating circuits. The first part contains the solution of general equations in a simplified formula, and gives the definition of the principle characteristics. The second part treats a numerical example and shows the importance of losses at high frequencies. The calculation is based on knowledge of these losses which have been studied experimentally by the author.

- R142 J. Mercier. Contribution a l'etude de la stabilite des oscillations de couplage. (Contribution to the study of the stability of oscillations in coupled circuits.) *L'Onde Electrique*, vol. 12, pp. 93-112; February, (1933.)

A theoretical and experimental investigation of the conditions under which zones of discontinuity of oscillation are liable to occur. In the case of the wavemeter, the paper shows that the resonance and absorption methods are equivalent except for some conveniences in the latter; that accurate measurement can not be accomplished with close coupling; and that suitable conditions for accurate measurement are indicated when the result is not altered by a distinct increase in coupling.

- R148 A. G. Tynan. Modulation products in a power law modulator. *PROC. I. R. E.*, vol. 21, pp. 1203-1209; August, (1933).

Expansion of the current as a function of the voltage in a multiple Fourier series is used to solve the problem of determining the amplitude of the various frequency components produced when a voltage is applied across a resistance, the current in which varies as a power of the voltage across it. Recurrence formulas are developed by which the higher order products can be computed from those of lower order. Certain of the integral coefficients in the Fourier series expansion are evaluated in the form of double summations.

- R148 L. E. Barton. Class B audio amplifier as a modulator for broadcasting stations. *Radio Eng.*, vol. 13, pp. 6-8; July, (1933).

An engineering discussion of the different types of modulation and the advantages and relative costs of each is given. The class B audio amplifier as a modulator for class C radio-frequency amplifier is recommended.

- R148 W. L. Barrow. Frequency modulation and the effects of a periodic capacity variation in a nondissipative oscillatory circuit. *PROC. I. R. E.*, vol. 21, pp. 1182-1202; August, (1933).

Certain fundamental characteristics of the theory of frequency modulation for arbitrarily large degrees of modulation and unrestricted modulation frequencies are developed from the differential equation for a dissipationless circuit with fixed inductance and variable capacitance. The several modes of modulating the frequency are discussed and classified; it is shown that they give the same results only when the amount of modulation is very small. The case of "inverse" capacity modulation is then treated in detail.

- R148 H. Roder. Graphische Behandlung von Modulationsproblemen. (The graphical treatment of modulation problems.) *Elek. Nach. Tech.*, vol. 10, pp. 225-229; May, (1933).

The article deals with the application of a graphical treatment of modulation to the transmission of carrier and side-bands from separate antennas, and to common-frequency broadcasting. Three methods of transmitting the carrier and side-bands from separate antennas are shown in Figure 4.

## R200. RADIO MEASUREMENTS AND STANDARDIZATION

- R214 K. Bucks and H. Müller. Über einige Beobachtungen an schwingenden Piezoquarzen und ihrem Schallfeld. (Some observations on oscillating quartz plates and their sound field.) *Zeit. für Phys.*, vol. 84, pp. 75-86; July 17, (1933).

Using a microscope for observing, the manner and amplitude of oscillation are studied. Stationary waves are set up between the quartz plate and a reflecting plate and photographed using air and also vapors for the propagating medium.

- R214 T. D. Parkin. The crystal drive of the experimental short wave broadcasting station G5SW. *Marconi Rev.*, no. 42, pp. 1-10; May-June, (1933).  
A piezo oscillator with temperature control for controlling a transmitter is described.
- R214 E. G. Lapham. A 200-kilocycle piezo oscillator. *Bureau of Standards Journal of Research*, vol. 11, pp. 59-64; July, (1933). Research Paper No. 576.  
This paper describes a piezo oscillator which is used to control the frequency of the standard-frequency transmissions of the Bureau. The unit incorporates in its design a double temperature control of the quartz plate, temperature control of the oscillator and amplifier, and a clamped type of quartz plate mounting.
- R242.13 L. B. Hilton. A current transformer for low radio frequencies. *Radio Eng.*, vol. 13, pp. 16-17; July, (1933).  
A transformer is described which is for use in measuring currents of 10 to 500 amperes at frequencies of the order of 60 kilocycles and whose potential above ground may be 10,000 volts.
- R262.8 A. L. W. Sowerby. The load line. *Wireless World* (London), vol. 33, pp. 38-40; July 21, (1933).  
Some families of vacuum tube characteristic curves are discussed. A method of computing undistorted output is given.
- R264.3 E. Seigel. Transformatoren mit veränderlich Kopplung. (Transformers with variable coupling.) *Hochfrequenz. und Elektroakustik*, vol. 41, pp. 167-176; May, (1933).  
Author's summary: It is shown that the behavior of a transformer with capacities in the primary and secondary circuits and with variable coupling can be represented by a circle diagram. For important special cases this diagram is investigated and formulas for the most important working conditions are developed. Further, the behavior of the transformer with capacities in the primary and secondary circuits, or with a capacity in either circuit with variable frequency and coupling is investigated and the most important conditions of these cases are presented graphically and analytically.
- R265.2 D. A. Oliver. The acoustical performance of a cone-type loudspeaker. *Wireless Engineer & Experimental Wireless* (London), vol. 10, pp. 420-429; August, (1933).  
This paper is an extension of a previous discussion [See *Experimental Wireless & Wireless Engineer*, vol. 7, p. 653, (1930)], "but it attempts primarily to illustrate the recommendations already made and to furnish a series of precision measurements on one instrument of the inductor type, when the boundary conditions are definite and the many variables kept under proper control." The experimental set-up is described. Results are given in graphical form.

## R300. RADIO APPARATUS AND EQUIPMENT

- R330 B. J. Thompson. Tubes to fit the wavelength. *Electronics*, vol. 6, pp. 214-215; August, (1933).  
The construction and use of very small vacuum tubes which may be used to generate ultra-high frequencies are discussed. Tube characteristics of some representative tubes are given.
- R330 R. Hertzberg. A new English all-metal tube. *Radio Craft*, vol. 5, pp. 75, 110; August, (1933).  
Descriptive material.
- R330 E. D. McArthur. Electronics and electron tubes. Part VI—Gas- or vapor-filled tubes. *Gen. Elec. Rev.*, vol. 36, pp. 371-376; August, (1933).  
A discussion of the conduction of electrons through gases and of the characteristics and operation of gas-filled tubes is given.

- R330 L. Martin. New tube data. *Radio-Craft*, vol. 5, pp. 78-79; August, (1933).  
Characteristics are given of a 12-volt output pentode, a high vacuum rectifier, a class B amplifier, and a 2-volt duo-diode triode.
- R330 L. van der Mel. The 2B6—A duplex triode. *Radio-Craft*, vol. 5, pp. 142-143; September, (1933).  
Description of a double triode with high power output and the quality characteristics of a triode.
- R331 E. E. Spitzer. The application of graphite as an anode material to high vacuum transmitting tubes. *Proc. I. R. E.*, vol. 21, pp. 1075-1081; August, (1933).  
Graphite has a number of advantages over other materials in the construction of anodes for high vacuum transmitting tubes of the radiation-cooled type. Graphite has a higher radiation emissivity, resulting in lower glass temperatures, and therefore less danger of glass electrolysis and strain cracking. Its use avoids anode warping and therefore results in tubes of much greater electrical uniformity. With proper manufacturing methods, there is no sacrifice in tube life when graphite is substituted for molybdenum.
- R337 R. M. Kime. A thyatron laboratory rectifier. *Electronics*, vol. 6, p. 219; August, (1933).  
A combination of grid bias and voltage ripple provides a grid voltage which phase controls the current passing through the rectifier. Voltage regulation and safety from overload are advantages of the thyatron rectifier.
- R337 The use of thyatrons as relays in heater sets. *Marconi Rev.*, no. 42, p. 27; May-June, (1933).  
A simple thyatron circuit is described in which alternating current is used on plate and cathode and a battery or rectified voltage may be used for control of tube.
- R339 W. S. Sears. Effect of circuit parameters on the constancy of the frequency of a pliodynatron. *Physics*, vol. 4, pp. 241-245; July, (1933).  
A study is made to determine the way in which the frequency of the pliodynatron oscillator depends upon the plate and grid-control voltages. The optimum operating voltages for greatest constancy of frequency are discussed. A new theoretical expression for the frequency of this oscillator is derived. The theoretical frequency variation with plate voltage is shown to be closely in agreement with the experimental variation.
- R355.21 The installation at WHAM. *Radio Eng.*, vol. 13, pp. 12-13; July, (1933).  
A brief technical description of the 50-kilowatt broadcast transmitter, Western Electric type, installed at WHAM.
- R355.4 G. Grammar. A simple 1750-kc auxiliary transmitter. *QST*, vol. 17, pp. 9-11; August, (1933).  
Constructional details of a small push-pull transmitter.
- R355.4 J. G. Nordahl. A radio transmitter for Central American service. *Bell Lab. Record*, vol. 11, pp. 381-385; August, (1933).  
A description is given of a Bell Telephone transmitter D-95539. It has two frequency bands: one from 6.0-9.6 megacycles per second and the other 9.6-16 megacycles per second.
- R355.5 D. A. Griffin. "Five and ten meter" oscillator-amplifier transmitters. *QST*, vol. 17, pp. 18-20; August, (1933).  
Constructional data for amateur transmitters.
- R355.7 H. P. Thomas. Determination of grid driving power in radio-frequency power amplifiers. *Proc. I. R. E.*, vol. 21, pp. 1134-1141; August, (1933).  
An approximate method of determining the power required to drive the grid circuit of a vacuum tube power amplifier of the class C type when operating at radio frequencies is developed, and a comparison given between the results obtained by this method, and more exact measurements made at sixty cycles. The only quantities which need to be known for the method described are the grid excitation voltage and the direct grid current, the driving power being given by the formula  $W_d = \sqrt{2}E_g I_o$ .

- R356.3 C. B. Brown. A rectifier system for broadcast speech input equipment using the new -83. *Radio Eng.*, vol. 13, pp. 10-11; July, (1933).  
Tube characteristics of the mercury-vapor tube type -83 and a schematic circuit diagram for a power supply are given.
- R360 F. N. Jacob; J. W. Leidy; R. O. Lewis. Cost versus quality in radio set components. *Electronics*, vol. 6, pp. 210-213; August, (1933).  
A symposium of papers delivered at the annual Institute of Radio Engineers convention in Chicago. The papers treat, respectively, broadcast receivers coils, transformers, and electrolytic condensers.
- R361 H. G. Cisin. Constructing the all-wave midget four. *Radio-Craft*, vol. 5, pp. 144-145; September, (1933).  
Constructional details.
- R361 H. B. Allen. New pentagrid tubes and coil switching in the amateur band superhet. *QST*, vol. 17, pp. 12-17; August, (1933).  
Constructional details of an economically designed receiver are given.
- R361.2 H. T. Budenbom. The 13A—A radio receiver for diversified uses. *Bell Lab. Record*, vol. 11, pp. 375-380; August, (1933).  
An alternating-current operated superheterodyne receiving set is described which has a frequency range from 2.2 to 25 megacycles. It is sold in a group of panels that mount on a seven-foot rack.
- R361.2 W. T. Cocking. The new monodial super. *Wireless World* (London), vol. 33, pp. 34-37; July 21, (1933); pp. 52-56, July 28, (1933).  
Constructional details are given for an alternating-current superheterodyne.
- R361.2 W. T. Cocking. New ideas for the superheterodyne. *Wireless World* (London), vol. 33, pp. 20-21; July 14, (1933).  
The author discusses the case of a single valve as combined first detector and oscillator in a superheterodyne and shows how the use of a new type of tube obviates the former disadvantages of a single tube and at the same time permits delayed automatic volume control to be used on the first detector.
- R363 P. A. MacDonald and E. M. Campbell. A high-voltage sensitivity direct-current amplifier. *Physics*, vol. 4, pp. 237-240; July, (1933).  
It is shown that a negative resistance of a definite value, introduced into the plate circuit of a thermionic valve theoretically allows the voltage sensitivity to become infinite. Practical application is made to construct high sensitivity direct-current amplifiers. The data show a mutual conductance of 30,000 microamperes per volt.
- R363 L. Gancher. How to make a high power a-c—d-c 6-volt p.a. amplifier. *Radio-Craft*, vol. 5, pp. 88-89; August, (1933).  
A 20-watt push-pull amplifier is described.
- R363.1 J. Marique. Note sur les amplificateurs pour haute frequence a circuit d'anode accorde et a transformateur. (A note on high-frequency amplifiers with tuned plate and transformer coupled circuits.) *L'Onde Electrique*, vol. 12, pp. 29-40; January, (1933).  
Author's summary: In this note, the author examines different curves taken from classical formulas which permit the comparison of the double point of view of amplification and selectivity, of amplification stages of tuned anode and of transformer coupling. He considers only simple linear amplification without much distortion and without reaction.
- R363.2 L. Gancher. Constructing a complete 26-watt dual channel p.a. system. *Radio-Craft*, vol. 5, pp. 146-147; September, (1933).  
A description of a portable four-stage amplifier for power amplifier work. The system is designed to operate from 100 volts alternating-current power line, or directly from a 6-volt battery.

- R363.2 W. Baggally. Distortion cancellation in audio amplifiers. *Wireless Engineer & Experimental Wireless* (London), vol. 10, pp. 413-419; August, (1933).

Author's summary: A method of amplification is described in which the input and output terminals of an amplifier are connected through a high resistance, the voltage existing between a point on this resistance and the earthy points being amplified and fed back to the input circuit. It is shown that under suitable conditions all forms of distortion vanish from the output circuit. The mathematical theory is first discussed, the conditions for distortionless working and for stability being derived. Experimental results are quoted showing that the residual harmonic distortion in the output of an amplifier working at full power may be less than 25 parts in 10,000. Practical details and circuit details are given.

- R366.2 H. W. Lord. A life test power supply utilizing thyatron rectifiers. *Proc. I. R. E.*, vol. 21, pp. 1097-1102; August, (1933).

Thyatron rectifiers for supplying high voltage direct current to radio transmitting tube life test racks are superior to motor-generator sets where quietness, flexibility, low operating cost, and safe operation over long intervals of time are desirable. An installation for supplying typical voltages, in conjunction with usual forms of electric power supplies is described.

- R387 E. and C. Seiler. Automatic overload protection and push button control. *QST*, vol. 17, pp. 31-32; August, (1933).

An overload protection system is described.

- R388 H. E. Hollmann. The use of the cathode-ray oscillograph at ultra-high frequencies. *Wireless Engineer & Experimental Wireless* (London), vol. 10, pp. 430-432; August, (1933).

Due to the finite velocity of the electrons that pass between the deflecting plates the cathode-ray tube is not free from an inertia effect. In this article the dynamic sensitivity of the cathode-ray oscillograph is investigated. The condition for maximum sensitivity is derived.

- R388 E. Hudec. Die Verzerrungen durch die Raumladung in der Braunch en Röhre. (Distortions caused by the space charge in cathode-ray tubes.) *Elek. Nach. Tech.*, vol. 10, pp. 215-220; May, (1933).

The cause and elimination of distortion in cathode-ray television devices are discussed. A bent tube is described.

- R388 V. K. Zworykin. On electron beams in high vacuum. *Phys. Rev.*, vol. 43, pp. 778-779; May 1, (1933).

An abstract is given of a paper presented before the 183rd meeting of the American Physical Society, New York, February 24-25, 1933. Methods of focusing electron beams are discussed.

#### R400. RADIO COMMUNICATION SYSTEMS

- R410 C. J. W. Hill and H. Page. A long-wave single side band telephony receiver for transatlantic working. *Marconi Rev.*, no. 42, pp. 13-26; May-June, (1933).

The various components and their functions in the single side band receiver are described. The receiver characteristics are shown graphically.

- R410 M. Kolesnikov. Radiotelephonie a bande laterale unique. (Single side band telephony.) *L'Onde Electrique*, vol. 12, pp. 237-249; May, (1933).

A theoretical discussion of single side band radiotelephony is given. The circuits and methods of using single side band telephony are then discussed.

- R412 Radiotelephone communication with the Caribbean countries. *Bell Lab. Record*, vol. 11, pp. 365-368; August, (1933).

Brief description of communication system between the United States and the major Caribbean countries and the Bahama Islands.



- R423.5 T. P. Leonard and C. F. Hadlock. The tool-box 56 mc trans-receiver. *QST*, vol. 17, pp. 23-25; August, (1933).  
A portable 5-meter station with a new type of antenna system. The antenna is the one designed by G. W. Pickard. It uses a special coupling transformer.
- R430 Interference with radio. *Electrician* (London), vol. 111, pp. 81-82; July 21, (1933).  
The difficulty of eliminating interference from small domestic apparatus is pointed out. Coöperation of users is urged.
- R430 C. V. Aggers and W. E. Pakela. Suppression of radio interference with capacity type filters. *Elec. Jour.*, vol., 30, pp. 337-339; August, (1933).  
The principles of the filter circuit are briefly presented. These principles are then applied to the elimination of radio interference arising from electrical machinery. Several graphs for design of filters give such quantities as the inductance, capacity, and impedance of standard conductors.
- R430 Wireless under way—Suppressing radiation from car electrical systems. *Wireless World* (London), vol. 33, pp. 18-19; July 14, (1933).  
The fitting of anti-interference devices, and the electrical systems of a typical automobile are described.
- R440 W. A. McMaster. Voice frequency control terminals for Caribbean radio systems. *Bell Lab. Record*, vol. 11, pp. 369-374; August, (1933).  
Description of voice frequency control apparatus.
- R450 J. S. Lyall. Simultaneous broadcasting—The technique of a regional network. *Wireless World* (London), vol. 33, pp. 68-70; August 4, (1933).  
The part played by land lines in broadcast systems is explained.

## R500. APPLICATIONS OF RADIO

- R522 S. G. Morgan. "Ultra-shorts" from the air. *Wireless World* (London), vol. 33, pp. 44-45; July 21, (1933).  
An account is given of an airplane test with a 5-meter transmitter. Several difficulties developed in the course of a several hour trip over England. Vacuum tubes seemed to be the greatest source of trouble. Transmitting apparatus used is described.
- R526.1 F. G. Kear. Phase synchronization in directive antenna arrays with particular application to the radio range beacon. *Bureau of Standards Journal of Research*, vol. 11, pp. 123-139; July, (1933). Research Paper No. 581.  
To overcome the difficulty arising from the slight detuning of the TL antennas two types of excitation systems have been developed in which the stability of the space pattern is independent of the antenna tuning to a marked degree. Either a parallel connected pair of lines 90 degrees in electrical length or a series connection of lines 180 degrees is shown to possess this characteristic. Experimental data on several types of lines show the system to be practical for use along the airways, and no sacrifice of the desirable features of the TL antenna is required.
- R526.1 F. S. Mabry. Radio range transmitters guide traffic of the air. *Elec. Jour.*, vol. 30, p. 333; August, (1933).  
The radio-range transmitter and antenna system which is used to guide airplanes is described. Either a visual or aural indication of the course is possible. Four 125-foot antenna towers were used to transmit two figure-of-eight patterns which are modulated at different frequencies.
- R536 A. Arenberg and W. Peicikov. Experiences sur la propagation des ondes tres courtes dans les tunnels. (Experiments on the propagation of very short waves in tunnels.) *L'Onde Electrique*, vol. 12, pp. 250-261; May, (1933).

Attempts to use high-frequency communication by radio in mines has proved this to be unfavorable. The trouble comes from absorption and the complicated types of interference encountered. Multiple reflections are a source of trouble. The apparatus and experiments are described.

- R583 N. Levin. New optical assembly for television projection receivers. *Marconi Rev.*, no. 42, pp. 11-12; May-June, (1933).

In the ordinary use of the Kerr cell half of the available light is wasted due to double refraction. In the method described here both the ordinary and extraordinary beams are utilized.

- R583 M. G. Fayard. Sur la détermination des fréquences les plus élevées a transmettre et l'influence de la distortion de phase en télévision. (On the determination of the highest frequency for a transmitter and the distortion of phase in television.) *L'Onde Electrique*, vol. 12, pp. 53-60; January, (1933).

A discussion of scanning is given.

- R590 H. H. Scott. Mixer circuits. *Radio Eng.*, vol. 13, pp. 14-15; July, (1933).

Some typical mixer circuits are shown. A few suggestions and precautions concerning the operation of mixer circuits are given.

- R590 C. H. W. Nason. Requirements of a-f systems. *Radio Eng.*, vol. 13, pp. 20-21; July, (1933).

The requirements of a high quality channel are stated, and the construction of an amplifier using 2A3 vacuum tubes is described.

#### R800. NONRADIO SUBJECTS

- 530 Electromagnetic induction. *Wireless Engineer & Experimental Wireless* (London), vol. 10, pp. 409-412; August, (1933).

A few confusing points concerning electromagnetic induction are discussed academically. As an example, one of the questions considered is whether the magnetic field of a bar magnet rotates when the bar is rotated about its long axis.

- 535.38 J. Kunz and J. T. Tykociner. A photo-electric valve. *Physics*, vol. 4, pp. 246-254; July, (1933).

Author's summary: "The object of this investigation was to determine the nature of the valve effect. After the description of the valve, some characteristic and photometric curves are given. Sensitivity curves are then described which show the effect between the wavelength and the photo-electric current per unit of light energy. These curves show distinct maxima, like ordinary photo-electric cells: this character of the sensitivity curves supports the theory that the effect is primarily a photo-electric phenomenon connected with space charges. Some additional phenomena, especially of the dark current, and experiments with various modifications of the valve are reported."

- 621.313.7 C. E. Hamann and E. A. Harty. Fundamental characteristics and applications of the copper-oxide rectifier. *Gen. Elec. Rev.*, vol. 36, pp. 342-348; August, (1933).

Characteristics, results of life tests, and design of rectifier circuits and apparatus are discussed.

- 621.382.4 H. Mögel. Über Schnelltelegraphie-Empfang im drahtlosen Überseeverkehr auf Kurzwellen. (On high speed telegraph reception on short waves.) *Elek. Nach. Tech.*, vol. 10, pp. 237-241; June, (1933).

The use of high speed code radiotelegraphy and the factors affecting reception are discussed. The recording system is briefly described.



CONTRIBUTORS TO THIS ISSUE

**Anderson, Clifford N.:** See PROCEEDINGS for January, 1933.

**Ballantine, Stuart:** Born September 22, 1897, at Germantown, Pennsylvania. Operator, Marconi Company, summers 1913, 1914, 1915; H. K. Mulford Company, bacteriologists, 1916; Bell Telephone Company of Pennsylvania, 1917; Expert Radio Aide, U. S. Navy, in charge of development of radio direction finder apparatus, Philadelphia Navy Yard, 1917-1920; organized Philadelphia Section of the Institute, chairman until 1926. Studied mathematics at Drexel Institute, 1919; mathematical physics, graduate school, Harvard University, 1920-1921. With L. M. Hull organized technical work at Radio Frequency Laboratories, Inc., Boonton, New Jersey, 1922-1923. John Tyndall Scholar in mathematical physics, Harvard University, 1923-1924. Privately engaged in scientific research at White Haven, Pennsylvania, 1924-1927. In charge of Research Division, Radio Frequency Laboratories, 1927-1929. President, Boonton Research Corporation, 1929 to date. Recipient Morris Liebmann Memorial Prize, Institute of Radio Engineers. Fellow, American Physical Society and Acoustical Society of America; Member, Franklin Institute. Associate member, Institute of Radio Engineers, 1916; Fellow, 1928.

**Black, W. Lindsay:** Born February 8, 1900, at Asbury Park, New Jersey. Graduated from Newark, New Jersey, public schools, 1918. Engineering Department, Western Electric Company, 1918-1925; Radio Development Department, Bell Telephone Laboratories, 1925 to date. Engaged in development and installation of audio amplifiers, carrier telephony, public address systems, power line carrier systems, radio transmitters, and since 1927, speech input equipment for radio broadcasting. Member, Acoustical Society of America; associate member, American Institute of Electrical Engineers. Nonmember, Institute of Radio Engineers.

**Boardman, E. M.:** Born Nevada, Iowa, January 6, 1906. Attended Parsons College and Iowa University, 1923-1926; physics department, Yale University, 1927-1928. Bell Telephone Laboratories, 1929 to date. Nonmember, Institute of Radio Engineers.

**Burton, Everett T.:** Born Indiana, April 21, 1893. Received A. B. degree, 1920; M. A. degree, 1924, Indiana University. Junior engineer, Chalmers Motor Company, 1916. Lieutenant, U. S. Engineers Corps, 1917-1918. Research Department, Western Electric Company and Bell Telephone Laboratories, 1920 to date, Associate member, Institute of Radio Engineers, 1930.

**Deaglio, Romolo:** Born Torino, Italy, January 15, 1899. Received degree, R. Scuola di Ingegneria, 1923; received degree in physics, R. Università di Torino, 1927. Member, Laboratorio di Fisica Sperimentale, R. Scuola di Ingegneria, Torino, Nonmember, Institute of Radio Engineers.

**Espley, Dennis Clark:** Born September 19, 1906, at Wellington, England. Received B. E. degree, 1928; M. E. degree, 1933, Liverpool University. International Telephone and Telegraph Laboratories, Inc., 1928-1929; telephone re-

search, Research Laboratories, General Electric Company, Ltd., 1930 to date. Nonmember, Institute of Radio Engineers.

**Gilliland, T. R.:** Born March 16, 1903, at Danville, Illinois. Received B.S. degree in electrical engineering, California Institute of Technology, 1927; M.S. degree in communication engineering, Harvard University, 1931. Commercial radio operator aboard ship for two years between 1923 and 1927. Radio Section, Bureau of Standards, 1928-1930, and June, 1931, to date. Associate member, Institute of Radio Engineers, 1928.

**Jansky, Karl G.:** Born October 22, 1905, at Norman, Oklahoma. Received A.B. degree, University of Wisconsin, 1927. Bell Telephone Laboratories, Inc., 1928 to date. Associate member, Institute of Radio Engineers, 1928.

**Wataghin, Gleb:** Born Leningrad, 1900. Received degree in physics, R. Università di Torino, 1922. In charge, advanced physics, R. Università di Torino; professor, experimental physics, R. Accademia Militare di Artiglieria e Genio, Torino. Nonmember, Institute of Radio Engineers.



# NEW.... a complete line of GRAPHITE ANODE TUBES by *Sylvania*

(Reg. U. S. Pat. Off.)

Hygrade Sylvania Corporation, through its newly established Electronics Department, is now in production on a complete new line of transmitting tubes which are revolutionary in design. They employ the new graphite anode structure conceived and perfected by the engineering organization of Hygrade Sylvania Corp. It adds the following major advantages:

1. High plate dissipation without overheating—a direct result of the high thermal emissivity of graphite.
2. Lower operating temperature at the anode. This results in a lower operating temperature of the other electrodes, preventing secondary and primary emission from the grid.
3. Uniformity of characteristics. The physical properties of graphite permit exact processing.
4. Long life. Comparative freedom from gas is another important effect of the graphite anode. High vacuum obtainable results in longer tube life.

An exclusive process enables us to reduce carbon to pure graphite with all amorphous carbon and other impurities removed.

Early this year Hygrade Sylvania Corp. established a separate new plant in Clifton, N.J., for the design and production of radio transmitters, transmitting tubes, industrial power tubes, and custom-built electronic devices. With modern research and manufacturing facilities, and unhampered by obsolete dies, processes and routine, Hygrade Sylvania now goes exclusively to this revolutionary new design.



## HYGRADE SYLVANIA CORPORATION

*Hygrade Lamps*      ELECTRONICS DEPARTMENT      *Sylvania Tubes*  
CLIFTON, N. J.

### FACTORIES

Salem, Mass.      Emporium, Pa.      St. Marys, Pa.      Clifton, N.J.  
*Warehouse Facilities In*  
Portland, Ore.      Chicago, Ill.      Philadelphia, Pa.      Los Angeles, Calif.      Atlanta, Ga.  
Salem, Mass.      New York, N.Y.

*When writing to advertisers mention of the PROCEEDINGS will be mutually helpful.*

# OBSOLESCENCE WORRIES ARE ENDED

*with this new  
test equipment*

Here is new test equipment that will never gather cobwebs because of obsolescence; never cost you real money in order to keep it up-to-date. The reasons are obvious:

The Weston Model 665 Selective Analyzer contains all the necessary voltage, current and resistance ranges. Separate Socket Selectors are provided to accommodate all 4, 5, 6 and 7 prong tubes. You merely attach the proper Socket Selector to the Analyzer and insert the plug into the tube socket of the radio set. Then, by plugging into the proper jacks, voltage, current and resistance may be read in any part of the entire network leading to the tube socket. *New tube bases merely mean a new, inexpensive Socket Selector.*

The Weston Model 674 Tube Checker is a real tube merchandiser. It shows good tubes as "GOOD", and is beautifully finished in three distinct tones of brown. Provides for testing all present tubes; and has seven spare sockets which can be quickly wired in to test some fifty-odd additional tubes when and if offered. All reference to or knowledge of tube characteristics is avoided. Quick and accurate indication is obtained by simply following the few concise steps on the tube limit chart. Other features make it the outstanding value today.

Weston Model 666 Socket Selectors can be used with any and all makes of Analyzers. Your present Analyzer can be brought up-to-date, and kept that way, with these simple, inexpensive units.

These and other Weston Radio Instruments are illustrated and described in the new bulletin RA. Send the coupon today, and receive your copy... Weston Electrical Instrument Corp., 589 Frelinghuysen Avenue, Newark, New Jersey.

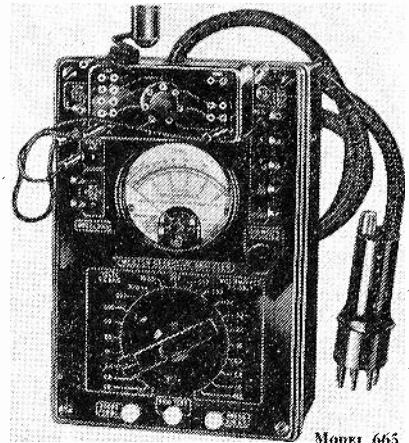

MODEL 665  
SELECTIVE ANALYZER



MODEL 674  
TUBE CHECKER

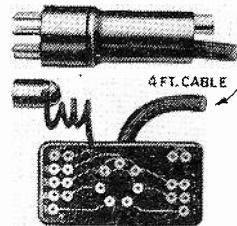

MODEL 666  
SOCKET SELECTOR

**WESTON**  
*Radio Instruments*



WESTON ELECTRICAL INSTRUMENT CORPORATION  
589 Frelinghuysen Avenue, Newark, N. J.  
Please send circular RA containing full information on Weston Radio Instruments.

Name.....

Address.....

When writing to advertisers mention of the PROCEEDINGS will be mutually helpful.



## WEAVING THE WORLD OF SPEECH

DAILY, as upon a magic loom, the world is bound together by telephone.

In and out of the switchboard move the cords that intertwine the voices of communities and continents. Swiftly, skilfully, the operator picks up the thread of speech and guides it across the miles.

She moves a hand and your voice is carried over mountains and to lands across the seas. London, Paris, Berlin—Madrid, Rome, Bucharest—Capetown, Manila, Sydney—Lima, Rio Janeiro and

Buenos Aires—these and many other cities overseas are brought close to you by telephone.

Every day go messages vital to the interests of nations, the course of international business, and the affairs of individuals.

Great progress has been made in the past few years in extending this service, in speeding connections and in giving clear transmission. Today, more than 90% of the world's telephones are within reach of your Bell telephone.



AMERICAN TELEPHONE  
AND TELEGRAPH COMPANY

*When writing to advertisers mention of the PROCEEDINGS will be mutually helpful.*

# CHANGE IN MAILING ADDRESS OR BUSINESS TITLE

Members of the Institute are asked to use this form for notifying the Institute office of a change in their mailing address or the listing of their company affiliation or title in the Year Book.

The Secretary,  
THE INSTITUTE OF RADIO ENGINEERS,  
33 West 39th Street,  
New York, N.Y.

Dear Sir:

Effective ..... please note change in my address  
(date)  
for mail as follows:

FROM

.....  
(Name)

.....  
(Street Address)

.....  
(City and State)

TO NEW ADDRESS

.....  
(Street Address)

.....  
(City and State)

Please note following change in my Year Book listing.

.....  
(Title)

.....  
(Company Name)

.....  
(Company Address)



# The Institute of Radio Engineers Incorporated

33 West 39th Street, New York, N. Y.

## APPLICATION FOR ASSOCIATE MEMBERSHIP

(Application forms for other grades of membership are obtainable from the Institute)

To the Board of Direction

Gentlemen:

I hereby make application for Associate membership in the Institute of Radio Engineers on the basis of my training and professional experience given herewith, and refer to the members named below who are personally familiar with my work.

I certify that the statements made in the record of my training and professional experience are correct, and agree if elected, that I will be governed by the constitution of the Institute as long as I continue a member. Furthermore I agree to promote the objects of the Institute so far as shall be in my power, and if my membership shall be discontinued will return my membership badge.

.....  
(Sign with pen)

.....  
(Address for mail)

.....  
(Date)

.....  
(City and State)

### References:

(Signature of references not required here)

Mr. .... Mr. ....

Address ..... Address .....

City and State ..... City and State .....

Mr. ....

Address .....

City and State .....

The following extracts from the Constitution govern applications for admission to the Institute in the Associate grade:

### ARTICLE II—MEMBERSHIP

Sec. 1: The membership of the Institute shall consist of: \* \* \* (c) Associates, who shall be entitled to all the rights and privileges of the Institute except the right to hold any elective office specified in Article V. \* \* \*

Sec. 4: An Associate shall be not less than twenty-one years of age and shall be a person who is interested in and connected with the study or application of radio science or the radio arts.

### ARTICLE III—ADMISSION AND EXPULSIONS

Sec. 2: \* \* \* Applicants shall give references to members of the Institute as follows: \* \* \* for the grade of Associate, to three Fellows, Members, or Associates; \* \* \* Each application for admission \* \* \* shall embody a full record of the general technical education of the applicant and of his professional career.

*ENTRANCE FEE SHOULD ACCOMPANY APPLICATION*





for  
**RADIO and TELEVISION**

ALSIMAG incorporates in a quality ceramic the desired characteristics of high dielectric strength—low losses at all frequencies—rigidity—permanence, beauty and unsurpassed strength against mechanical shock—heavy loads—and heat.

Your product needs this better insulation. Our new low cost production methods permit its use at a definite saving.



Use Alsimag  
 for broadcast-  
 ing or re-  
 ceiving  
 sets.

*A Few Uses*

- Support Insulator
- Coil Forms
- Lead-in Insulators
- Strain Insulators
- Resistor Spools
- Inductance Form
- Spacer Bars
- Condenser Supports
- Sockets

Also Manufacturers of

Aluminum and Magnesium Oxide for Vacuum Tubes

Alsimag and Lava Appliance and Specialty Insulators

**AMERICAN LAVA CORPORATION**  
 CHATTANOOGA, TENNESSEE

Sales Offices

- Boston—No. 80 Federal Street, Room 223
- Chicago—1112 Merchandise Mart
- Cleveland—Newman Stearns Building
- Washington—Room 441, Evening Star Building
- Newark—Globe Indemnity Bldg.
- St. Louis—1623 Locust Street
- San Francisco—163 Second Street

*When writing to advertisers mention of the PROCEEDINGS will be mutually helpful.*

# PRECISION RATINGS

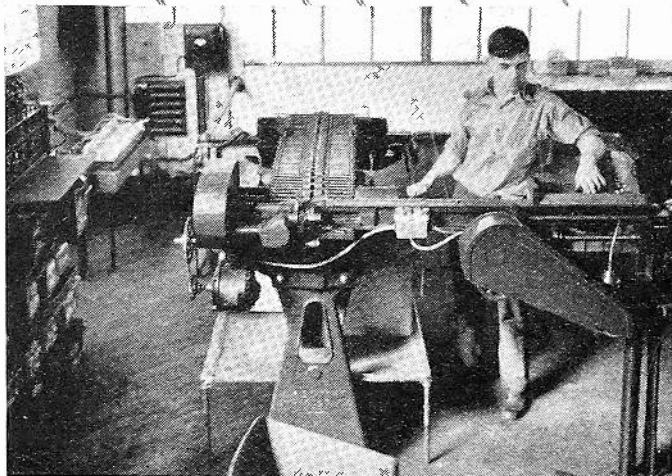
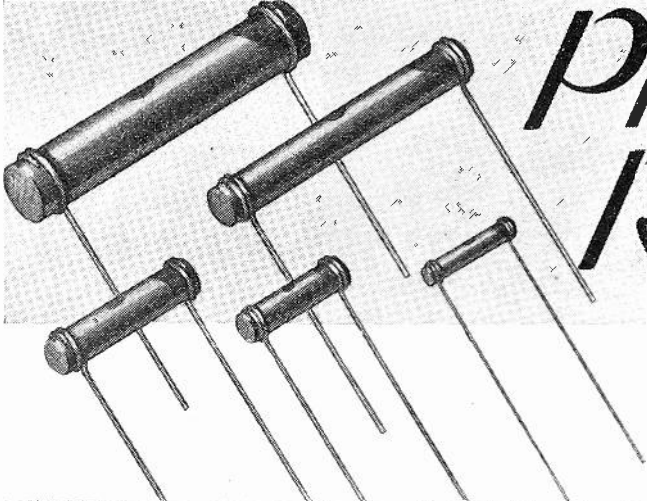

*Left. The electrically controlled and operated machine which automatically sorts values within predetermined percentages of tolerance limits.*

**T**HROUGHOUT the various stages involved in the manufacture of ERIE RESISTORS every possible precaution is taken to insure precision ratings.

Automatic machinery designed especially for our use, is employed throughout each of the many steps necessary to produce a dependable resistor. After completion, the work of the various machines is given a final check test by trained operators.

The thoroughness which characterizes ERIE RESISTOR manufacturing methods is reflected in a finished product which measures up to the most rigid requirements.

When you specify ERIE RESISTORS for your production you may be certain that you are giving your eventual customer the very best the market affords.

May we send you samples, prices and additional data?

## ERIE RESISTORS



ERIE RESISTOR CORPORATION, ERIE, PA.  
Factories in Erie, Pa., Toronto, Canada, and London, Eng.

*When writing to advertisers mention of the PROCEEDINGS will be mutually helpful.*

# PROFESSIONAL ENGINEERING DIRECTORY

For Consultants in Radio and Allied Engineering Fields

## FOR ADVANCED TRAINING

in:

Practical Radio Engineering  
Practical Television Engineering

write to

### CAPITOL RADIO ENGI- NEERING INSTITUTE

Riggs Bank Bldg.  
Washington, D.C.

## Cathode Ray Tubes and Associated Equipment For All Purposes

*Write for Complete  
Technical Data*

ALLEN B. DUMONT  
LABORATORIES  
UPPER MONTCLAIR, N.J.

## FOR MANY YEARS

the Professional Engineering Directory has helped consulting engineers, designers, and laboratory men make the right contacts in the radio industry. Perhaps we can help you with your problems too. For further information write to

*Advertising Department*

### INSTITUTE OF RADIO ENGINEERS

33 West 39th St.  
NEW YORK CITY, N.Y.

## LITTELFUSE LABORATORIES

*Specialists in*

Delicate Equipment Protection  
INSTRUMENTS and METERS  
RADIO RECEIVERS  
RADIO AMPLIFIERS  
RADIO TRANSMITTERS

*Write for new Technical Bulletin No. 5  
1764 Wilson Ave., Chicago, Ill.*

*For the Engineering Consultant*

*who can handle a little extra business this year*

*For the designer*

*who can manage some additional work*

*For the Patent Attorney*

*who is anxious to develop a larger clientele*

we suggest the Professional Engineering Directory of the PROCEEDINGS I.R.E. Manufacturers and organizations with special problems who need services such as yours come to the Professional Engineering Directory for information. Your name and special services announced here will tell them what you do and where to find you. Further information will be furnished on request. Special rates to members of the Institute.

*When writing to advertisers mention of the PROCEEDINGS will be mutually helpful.*

---

## *Alphabetical Index to Advertisements*

### A

American Lava Corporation.....XV  
American Tel. & Tel. Co.....XI

### C

Central Radio Laboratories.....XXII  
Cornell-Dubilier Corp.....XX

### E

Electrophone Corp.....XIX  
Employment Page.....XV  
Erie Resistor Corp.....XVI

### G

General Radio Co..Outside Back Cover

### H

Hygrade Sylvania Corp.....IX

### I

I.R.E. ....XII,  
XIII, XIV, XXI, Inside Back Cover

### P

Professional Eng. Directory.....XVII

### W

Weston Elect. Inst. Corp.....X

---

## PROCEEDINGS BOUND VOLUMES



Volume 20 (1932) of the Proceedings is now available in bound form to members of the Institute. It may be obtained in Buckram or Morocco leather for \$9.50 and \$11.00 respectively.

Bound copies of volumes 18 and 19 (1930 and 1931) are also available at the same price.

*When writing to advertisers mention of the PROCEEDINGS will be mutually helpful.*

# ANNOUNCING

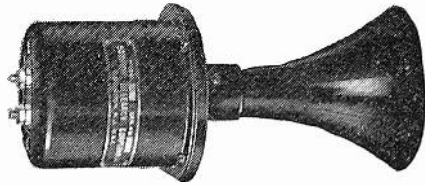

## MODEL 4A

# High-Frequency Electrophone

A high grade but inexpensive piezoelectric (Rochelle-salt) unit of scientific design for the distortionless reproduction of the higher audio frequencies.

For use in conjunction with ordinary cone or horn-type low-frequency loud speaker to obtain high-fidelity reproduction over the full audio range. Designed for direct parallel connection—no additional filters, special networks, field supply or polarizing voltage necessary.

An economical solution of the increasingly important problem of wide range reproduction immediately available for radio broadcast receivers, sound pictures and public address systems, both for new and existing equipment.

Acoustical engineering service available to manufacturers.

Built in accordance with design specifications of Boonton Research Corporation, (see article by Stuart Ballantine, Proceedings of the Institute of Radio Engineers, October 1933).

Technical Bulletin 1A sent free on request.

**ELECTROPHONE CORPORATION**  
2019A RITTENHOUSE SQUARE  
PHILADELPHIA, PA.

Licensed under patents and applications of Boonton Research Corporation and Brush Development Company.

*When writing to advertisers mention of the PROCEEDINGS will be mutually helpful.*

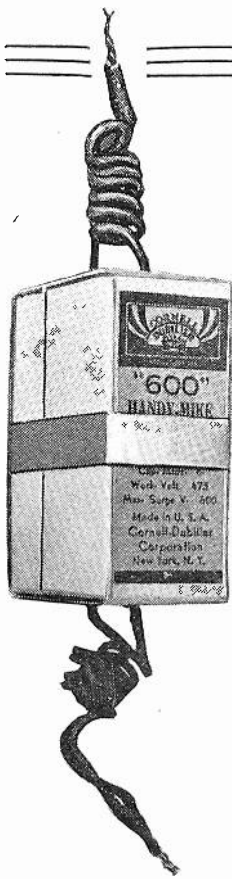

# Handy Mikes

Well named, these compact, sturdy, dependable electrolytic condensers covering all standard voltage and capacity requirements. Ideal for the laboratory. Just the thing for the experimental layout. Handy about the radio station. And positively indispensable, especially in kit form, for *profitable* service calls.

Cornell-Dubilier "600" Handy-Mike units are designed for maximum surge voltage of 600 D.C., or a working voltage of 475 D.C., and provide a single, universal voltage rating in various capacities to meet all customary needs.

Units encased in aluminum-finished cardboard containers. Long pigtail leads of push-back wire, sufficiently stiff for the self-supporting mounting of unit, make for handy installation, wiring and soldering. Handy metal clamp holds two or more units together, as shown. Available in 1, 2, 4, 6 and 8 mfd. capacities.

## CORNELL-DUBILIER Handy-Mike Condenser Kit

Just the thing for laboratory, experimenter, radio station, repair shop or service man. Contains ten Handy-Mike units:

- two 1 mfd.
- two 2 mfd.
- two 4 mfd.
- two 6 mfd.
- two 8 mfd.

Packed in attractive carton for counter display if desired. Each unit fully guaranteed for complete satisfaction and long service life.

This kit is offered to radio engineers, laboratory workers and service men at the exceptionally low price of \$8.94 NET.

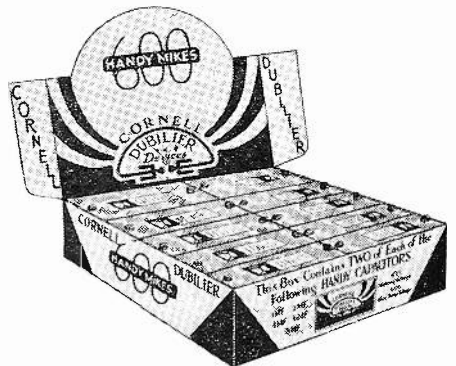

**Order Now!** Send your order to the local jobber if he handles the Cornell-Dubilier Complete Condenser Line. If not, order from us direct. And by the way, be sure to write for our new 1933 catalog.



## CORNELL-DUBILIER CORPORATION

4377 Bronx Boulevard - - - New York City

*When writing to advertisers mention of the PROCEEDINGS will be mutually helpful.*



# Don't Take Chances on Destroying Valuable Information!

Protect your back issues of the PROCEEDINGS with a binder that will stand abuse; a binder that will hold twelve issues and keep them all together for easy reference.

We can, to be sure, usually fill orders for back issues, but occasionally we may not have the one necessary to complete your reference work—this means unnecessary delay and delay means dollars.

Be sure—get a binder now and protect those back issues.

## PROCEEDINGS BINDER

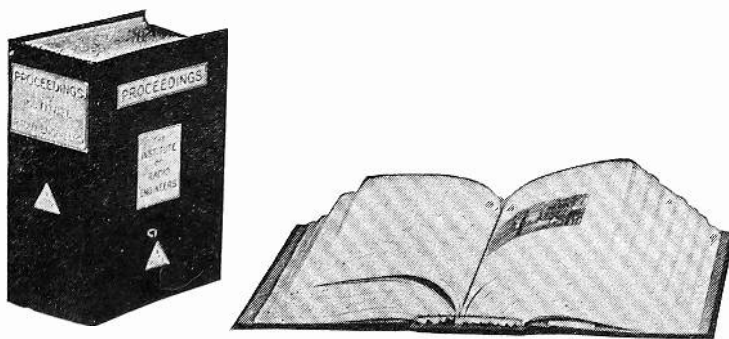

Binder of handsome Spanish Grain Fabrikoid in blue and gold. Can be used as temporary transfer binder or as a permanent cover. Wire fasteners hold each copy in place and permit removal of any issue from binder in a few seconds. All issues lie flat when binder is opened.

**BINDER** (holds complete 1931 or 1932 copies) .....\$1.75

*(Name stamped on volume for \$.50 additional)*

*Send orders for binders, accompanied by remittance, to*

**INSTITUTE OF RADIO ENGINEERS**

33 West 39th Street

New York City, New York

*When writing to advertisers mention of the PROCEEDINGS will be mutually helpful.*

**BOTH  
GIVE BETTER  
PERFORMANCE  
WHEN**

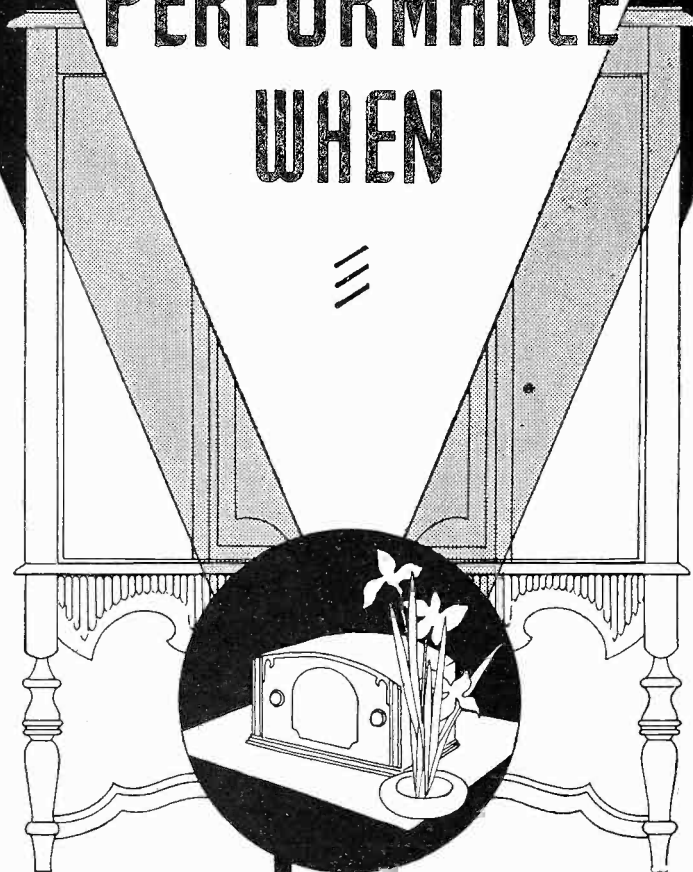

# Centralab RADIOHM EQUIPPED

The new Centralab Radiohm Volume Control strikes a new note . . . and embodies many unusual features.

Built for the new 1933 radio it continues to maintain its superior-

ity . . . it is still the standard by which all others are judged.

For details write to  
**Central Radio  
Laboratories**  
Milwaukee, Wis.

*When writing to advertisers mention of the PROCEEDINGS will be mutually helpful.*

# Take Your Choice

Every member of the Institute of Radio Engineers will want to wear one of these three attractive emblems. All of these emblems are appropriately colored to indicate the various grades of membership and each emblem is approximately the size of the following illustrations.



The **Lapel Button** is of 14k gold, with background enameled in the membership color, and with the lettering in gold. The screw-back on the back of this button fastens it securely to your coat.

\$2.75 postpaid—any grade.



The **Pin** is also of 14k gold. It is provided with a safety catch and is appropriately colored for the various grades of membership.

\$3.00 postpaid—any grade.



The **Watch Charm**, handsomely finished on both sides, is also of 14k gold. This charm is equipped with a suspension ring for attaching to a watch fob or chain.

\$5.00 postpaid—any grade.

*Orders, accompanied by checks made payable to the Institute of Radio Engineers, should be addressed to*

**THE INSTITUTE OF RADIO ENGINEERS**

33 West 39th Street  
NEW YORK CITY, N. Y.

*Send in your order now!*

# A PRACTICAL WAVE ANALYZER AT A PRICE YOU CAN AFFORD

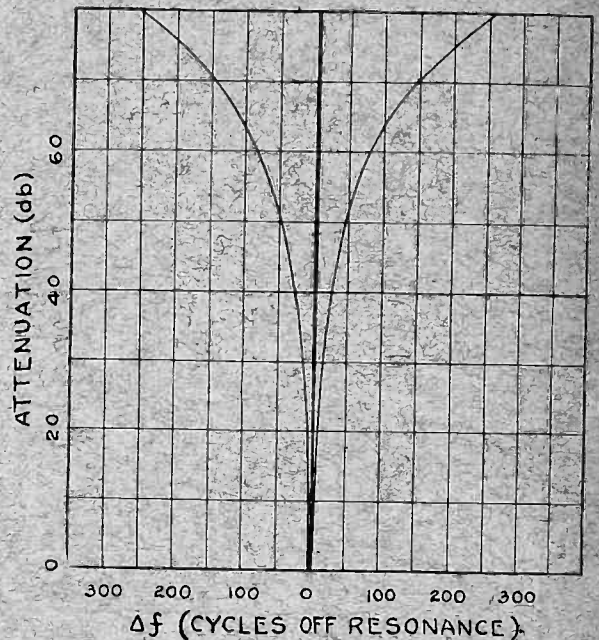
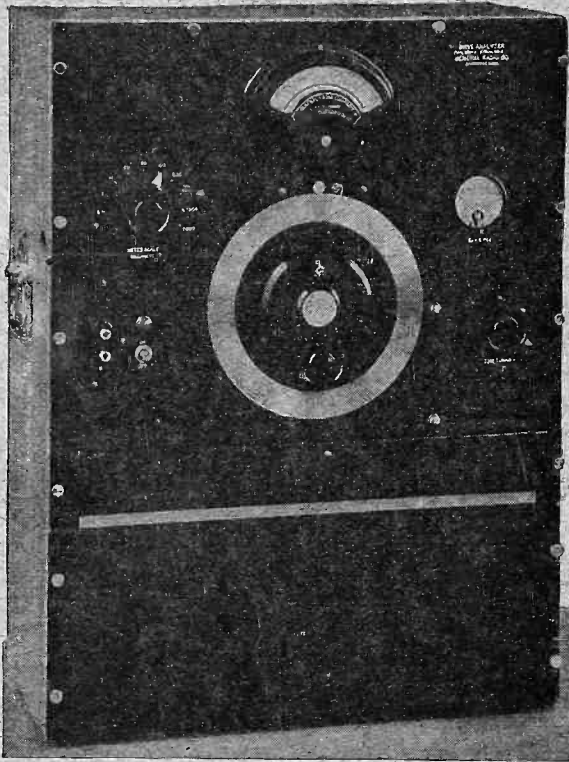

*The Type 636-A Wave Analyzer  
has a discrimination of 62 decibels  
for a separation of 100 cycles.*

Think of this wave analyzer as a sensitive voltmeter with a frequency discrimination sharp enough to resolve the 60-cycle sidebands on a 7000-cycle carrier. It will measure the amplitude of any audio component between 20 and 15,000 cycles.

As a voltmeter its range is from less than one millivolt up to 200 volts with an internal input impedance of 100,000 ohms or 10 megohms when using the external multiplier supplied with the instrument.

The Type 636-A Wave Analyzer is a heterodyne-type instrument with a 2-section quartz-crystal filter.

PRICE: \$475.00, COMPLETE

Write for Bulletin EX-3307

Address the General Radio Company  
Cambridge, Massachusetts

## GENERAL RADIO

GEORGE BANTA PUBLISHING COMPANY, MENASHA, WISCONSIN