

VOLUME 21

MARCH, 1933

NUMBER 3

PROCEEDINGS  
of  
**The Institute of Radio  
Engineers**



*Walter J. Malone*

Form for Change of Mailing Address or Business Title on Page XIX

---

# Institute of Radio Engineers Forthcoming Meetings

---

**CINCINNATI SECTION**

March 14, 1933

---

**CLEVELAND SECTION**

March 24, 1933

---

**CONNECTICUT VALLEY SECTION**

March 23, 1933

---

**DETROIT SECTION**

March 17, 1933

---

**NEW YORK MEETING**

March 1, 1933

April 5, 1933

---

**SAN FRANCISCO SECTION**

March 15, 1933

---

**WASHINGTON SECTION**

March 9, 1933

---

PROCEEDINGS OF  
**The Institute of Radio Engineers**

Volume 21

March, 1933

Number 3

Board of Editors

ALFRED N. GOLDSMITH, *Chairman*

R. R. BATCHER

H. H. BEVERAGE

F. W. GROVER

G. W. PICKARD

L. P. WHEELER

L. E. WHITTEMORE

WILLIAM WILSON

K. S. VAN DYKE

CONTENTS

PART I

|  |     |
|--|-----|
| Frontispiece, Hubert M. Turner, Director, 1933 | 330 |
| Institute News and Radio Notes                 | 331 |
| February Meeting of the Board of Directors     | 331 |
| Radio Transmissions of Standard Frequencies    | 337 |
| Committee Work                                 | 339 |
| Institute Meetings                             | 339 |
| Personal Mention                               | 346 |

PART II

*Technical Papers*

|  |  |     |
|--|--|-----|
| A Study of the Propagation of Wavelengths Between Three and Eight Meters | L. F. JONES                                      | 349 |
| Notes on Propagation of Waves Below Ten Meters in Length                 | BERTRAM TREVOR AND P. S. CARTER                  | 387 |
| Ultra-Short-Wave Propagation   | J. C. SCHELLENG, C. R. BURROWS AND E. B. FERRELL | 427 |
| Some Results of a Study of Ultra-Short-Wave Transmission Phenomena       | C. R. ENGLUND, A. B. CRAWFORD, AND W. M. MUMFORD | 464 |
| Book Review: "The True Road to Radio," by Albert Hall                    | S. S. KIRBY                                      | 493 |
| Booklets, Catalogs, and Pamphlets Received                               |  | 494 |
| Radio Abstracts and References   |  | 495 |
| Contributors to this Issue   |  | 502 |

Copyright, 1933, by the Institute of Radio Engineers

# The Institute of Radio Engineers

---

## GENERAL INFORMATION

**INSTITUTE.** The Institute of Radio Engineers was formed in 1912 through the amalgamation of the Society of Wireless Telegraph Engineers and the Wireless Institute. Its headquarters were established in New York City and the membership has grown from less than fifty members at the start to almost six thousand by the end of 1932.

**AIMS AND OBJECTS.** The Institute functions solely to advance the theory and practice of radio and allied branches of engineering and of the related arts and sciences, their application to human needs, and the maintenance of a high professional standing among its members. Among the methods of accomplishing this need is the publication of papers, discussions, and communications of interest to the membership.

**PROCEEDINGS.** The PROCEEDINGS is the official publication of the Institute and in it are published all of the papers, discussions, and communications received from the membership which are accepted for publication by the Board of Editors. Copies are sent without additional charge to all members of the Institute. The subscription price to nonmembers is \$10.00 per year, with an additional charge for postage where such is necessary.

**RESPONSIBILITY.** It is understood that the statements and opinions given in the PROCEEDINGS are views of the individual members to whom they are credited, and are not binding on the membership of the Institute as a whole. Papers submitted to the Institute for publication shall be regarded as no longer confidential.

**REPRINTING PROCEEDINGS MATERIAL.** The right to reprint portions or abstracts of the papers, discussions, or editorial notes in the PROCEEDINGS is granted on the express condition that specific reference shall be made to the source of such material. Diagrams and photographs published in the PROCEEDINGS may not be reproduced without making specific arrangements with the Institute through the Secretary.

**MANUSCRIPTS.** All manuscripts should be addressed to the Institute of Radio Engineers, 33 West 39th Street, New York City. They will be examined by the Papers Committee and the Board of Editors to determine their suitability for publication in the PROCEEDINGS. Authors are advised as promptly as possible of the action taken, usually within two or three months. Manuscripts and illustrations will be destroyed immediately after publication of the paper unless the author requests their return. Information on the mechanical form in which manuscripts should be prepared may be obtained by addressing the secretary.

**MAILING.** Entered as second-class matter at the post office at Menasha, Wisconsin. Acceptance for mailing at special rate of postage is provided for in the act of February 28, 1925, embodied in Paragraph 4, Section 412, P. L. and R., and authorization was granted on October 26, 1927.

---

Published monthly by

**THE INSTITUTE OF RADIO ENGINEERS, INC.**

Publication office, 450-454 Ahnaip St., Menasha, Wis.

BUSINESS, EDITORIAL, AND ADVERTISING OFFICES

Harold P. Westman, *Secretary*

33 West 39th Street, New York, N. Y.

## INSTITUTE SECTIONS

- ATLANTA—Chairman, H. L. Wills; Secretary, Philip C. Bangs, 23 Kensington Road, Avondale Estates, Ga.
- BOSTON—Chairman, E. L. Chaffee; Secretary, G. W. Kenrick, Tufts College, Mass.
- BUFFALO-NIAGARA—Chairman, L. Grant Hector; Secretary, E. C. Waud, 235 Huntington Avenue, Buffalo, N. Y.
- CHICAGO—Chairman, R. M. Arnold; Secretary, Donald H. Miller, McGraw-Hill Publishing Company, 520 N. Michigan Ave., Chicago, Ill.
- CINCINNATI—Chairman, C. E. Kilgour; Secretary, H. G. Boyle, Crosley Radio Corporation, Cincinnati, Ohio.
- CLEVELAND—Chairman, P. A. Marsal; Secretary, R. P. Worden, 1629 Cordova Ave., Lakewood, Ohio.
- CONNECTICUT VALLEY—Chairman, H. W. Holt; Secretary, C. B. De Soto, American Radio Relay League, 38 La Salle Rd., W. Hartford, Conn.
- DETROIT—Chairman, G. W. Carter; Secretary, E. C. Denstaedt, Detroit Police Department, Detroit, Mich.
- LOS ANGELES—Chairman, J. K. Hilliard; Secretary, N. B. Neely, 1569 Munson Ave., Los Angeles, Calif.
- NEW ORLEANS—Chairman, Pendleton E. Lehde; Secretary, Anton A. Schiele, 1812 Masonic Temple, New Orleans, La.
- PHILADELPHIA—Chairman, H. W. Byler; Secretary, G. C. Blackwood, 243 E. Upsal St., Mt. Airy, Philadelphia, Pa.
- PITTSBURGH—Chairman, R. T. Griffith; Secretary, C. K. Krause, 1541 Princess Ave., Pittsburgh, Pa.
- ROCHESTER—Chairman, A. E. Soderholm; Secretary, John J. Long, Radio Station WHAM, Sagamore Hotel, Rochester, N. Y.
- SAN FRANCISCO—Chairman, C. V. Litton; Secretary, K. G. Clark, Department of Commerce, 328 Custom House, San Francisco, Calif.
- SEATTLE—Chairman, H. H. Bouson; Secretary, Howard Mason, 2709-4th West, Seattle, Wash.
- TORONTO—Chairman, R. A. Hackbusch; Secretary, G. E. Pipe, Rogers-Majestic Corporation, Toronto, Ont., Canada.
- WASHINGTON—Chairman, H. G. Dorsey; Secretary, C. L. Davis, Patent Department, Radio Corporation of America, 1227-1233 National Press Building, Washington, D.C.

## GEOGRAPHICAL LOCATION OF MEMBERS ELECTED FEBRUARY 1, 1933

### Elected to the Associate Grade

|              |  |                    |
|--------------|--|--------------------|
| California   | Alhambra, 707 W. Hellman Ave.                            | Wiley, V. G.       |
|              | Gardena, 850 W. 161st St.                                | Zwaachka, A. R.    |
| Florida      | Dunnellon, P. O. Box 54                                  | Underwood, C. E.   |
| Illinois     | Albion, 17 W. Main St.                                   | Waters, W. N.      |
| Louisiana]   | Thibodaux, 403 Legarde St.                               | Hoyer, M. A.       |
| Montana      | Shelby, Box 153  | Stimpe, J. R.      |
| New Jersey   | Orange, 40 Hampton Ter.                                  | Morch, V. H. K.    |
| New York     | Jamaica, 85-32-168th St.                                 | Freeman, S. R.     |
|              | New York City, 545 W. 125th St.                          | Hildebrand, J. G.  |
| Ohio         | Dayton, 228 W. Norman Ave.                               | Hoffstetter, G. E. |
| Pennsylvania | Latrobe, R.D. No. 2, Box 70                              | Orvosh, P., Jr.    |
| Tennessee    | Kingsport, 1366 Catawba St.                              | Stout, G. P.       |
| Australia    | Ashfield, N.S.W., Rectory Ave.                           | Turner, O. C.      |
|              | East Sydney, N.S.W., c/o Thom & Smith, 55-57 Dowling St. | Thom, F. W. P.     |
|              | Gladesville, N.S.W., 18 Batemans Rd.                     | Bushby, T. R. W.   |
| Canada       | Mission City, B.C., Box 439                              | Lockley, W. A.     |
|              | Quebec, P.Q., 43 Artillery St.                           | Frenette, C.       |
|              | Sarnia, Ont., 110 Davis St.                              | Wilson, B.         |
|              | Vancouver, 6288 Sperling St.                             | McCallum, B. C.    |
| Denmark      | Copenhagen, 77 Bredgade                                  | Schiodte, E. J.    |
| England      | Hornchurch, Essex, 268 Osborne Rd.                       | Lancaster, E. S.   |
|              | Washington, Co. Durham, Coxgreen                         | Troupe, A.         |
| Hungary      | Budapest, Muegyetem                                      | Babits, V.         |
| Ireland      | Dublin, Clavadel, Claremont Rd., Sandymount              | Armstrong, A. R.   |
| Italy        | Milan, 34 v. Filippino Lippi                             | Jervia, E. R.      |
| Japan        | Kumamoto City, c/o JOJK Broadcasting Station             | Tokushima, G.      |
|              | Matsue, c/o JOJK Broadcasting Station                    | Tsuno, J.          |
|              | Sendaï, Elec. Eng. Dept., Tohoku Imperial University     | Uda, S.            |
| New Zealand  | Auckland, P. O. Box 390                                  | Edwards, S.        |
|              | Wellington, New Zealand Broadcasting Board               | Smith, J. R.       |
| Peru         | Lima, Wilson 500, Box 2679                               | Gallo, G.          |
| Scotland     | Grangemouth, Stirlingshire, "Avondale," Bo'ness Rd.      | Birch, A.          |

### Elected to the Junior Grade

|             |  |                 |
|-------------|--|-----------------|
| California  | Los Angeles, 179 W. 40th Pl.                           | Bensusen, N.    |
| Virginia    | Lynchburg, Route 1, Box 138                            | Williams, R. L. |
| New Zealand | Wellington, c/o Messrs. Green & Dixon, 35 Taranaki St. | Roberts, A.     |

### Elected to the Student Grade

|               |  |                   |
|---------------|--|-------------------|
| Georgia       | Atlanta, 745 Virginia Ave. N.E.        | Godinez, S. H.    |
| Massachusetts | Cambridge, Box 292, M.I.T. Dormitories | Allen, H. E., Jr. |
|               | Cambridge, Box 245, M.I.T. Dormitories | Bell, J. S.       |
|               | Cambridge, Lowell House K-42           | Ireland, F.       |
| New York      | Syracuse, 833 S. Crouse Ave.           | Smith, K. B.      |
| Oregon        | Corvallis, 206 N. 7th St.              | Beckendorf, H. P. |
| Rhode Island  | Providence, 62 Hamburg Ave.            | Levesque, N. G.   |
| Wisconsin     | Madison, 207 W. Washington Ave.        | Lange, R. W.      |



APPLICATIONS FOR MEMBERSHIP

Applications for transfer or election to the various grades of membership have been received from the persons listed below, and have been approved by the Committee on Admissions. Members objecting to transfer or election of any of these applicants should communicate with the Secretary on or before April 3, 1933. These applicants will be considered by the Board of Directors at its meeting on April 5, 1933.

For Transfer to the Member Grade

|            |                                     |                   |
|------------|-------------------------------------|-------------------|
| Michigan   | Detroit, 2041 McDougall Ave.        | Fienstaedt, E. C. |
| New Jersey | Whippany, c/o Bell Tel. Labs., Inc. | Stansel, F. R.    |
| Spain      | Madrid, Avenida P. y Margall, 2     | Wendell, E. N.    |

For Election to the Member Grade

|             |   |              |
|-------------|---|--------------|
| New York    | New Dorp, 81, 612 Rockland Ave.                     | Ligh, C.     |
| Australia   | Sydney, Supt. Engineers Branch, 219 Castlereagh St. | Weir, H.     |
| New Zealand | Wanganui, Telegraph Engineer                        | Allan, D. T. |

For Election to the Associate Grade

|                   |  |                   |
|-------------------|--|-------------------|
| Alabama           | Birmingham, 701 Protective Life Bldg   | Middlebrooks, J.  |
| California        | San Francisco, 2100 Montezey Blvd  | Fung, J. T. S.    |
|                   | San Francisco, c/o Byington Elec. Corp., 908 Leavenworth St.                         | Lewis, E. L.      |
|                   | Whittier, R. R. 2, Box 376   | Flutot, E.        |
| Connecticut       | Hamden, 75 Russell St.   | Kelly, F. G., Jr. |
|                   | Hamden, 57 Greenway St.  | Sparhawk, G. H.   |
|                   | New Haven, 2690 Yale Station   | Gilly, T. A.      |
|                   | New Haven, Box 1004-A Yale Station   | Van Voorst, M.    |
|                   | New Haven, Box 1004-A Yale Station   | White, D. B.      |
| Dist. of Columbia | Washington, c/o Adjutant General   | Meade, F. C.      |
| Florida           | De Land, 518 E. New York Ave.  | Smith, G. E.      |
| Illinois          | Carthage, Superior Broadcasting Service, WCAZ  | Fils, E. W.       |
|                   | Chicago, 2510 N. Mango Ave.  | Grace, J. R.      |
|                   | Chicago, 2915 Walnut St.   | Turnquist, L.     |
| Indiana           | Hinsdale, 119 N. Adams St.   | McKinley, J. C.   |
| Massachusetts     | Marion, 520 W. 10th St.  | Hillgrove, D. R.  |
|                   | Harwich Port, Box 404  | Fletcher, R. E.   |
|                   | Wakefield, 13 Summer St.   | Cahoon, E. V.     |
| Minnesota         | Jackson, 111 Alto Woods  | Davis, W. H.      |
| Missouri          | University City, 7126 Dartmouth  | Rosen, F.         |
| New York          | Brocklyn, 390 Parkade Ave.   | Bernstein, A. C.  |
|                   | Flushing, 35 35-1694th St.   | Lebert, A. W.     |
|                   | Hicksville, c/o Press Wireless Inc., Box 292   | De Neuf, D. K.    |
|                   | New York City, 62 E. 90th St.  | Johnson, E. H.    |
|                   | New York City, 795 Hudson St.  | Sharp, W. O.      |
|                   | New York City, M. S. Harbor Jensen, c/o Tropical Radio Tel. Co., Pier 3 N R.         | Strommen, E.      |
|                   | Woodside, E. F., 5854 43rd Ave.  | Thibault, A. H.   |
| Ohio              | Cincinnati, 1014 Franklin St.  | Smith, C. E.      |
| Pennsylvania      | New Castle, 599 Laurel Blvd.   | Jones, P. N.      |
| Texas             | San Angelo, Box 153  | Price, H.         |
| Utah              | Salt Air, K.H.I. Transmitter   | Kimball, R.       |
| Vermont           | Bennington, 523 Main St.   | Mullen, W. C.     |
| Virginia          | Norfolk, VP 10 Squadron, Fleet Air Base  | Johnston, R. A.   |
| England           | Dartford, Kent, 12 Carrington Rd.  | Mummers, A. C.    |
|                   | Hartley, Surrey, Radio House, Victoria Rd.   | Coutts, S. A.     |
|                   | Isleworth, Middlesex, Lensen, Ltd.   | Callender, M. V.  |
|                   | London 1, "The Larks Mercury"  | Prater, M.        |
|                   | London, N.W. 10, c/o E. J. Elford Esq., The Lawn Vicarage Rd., Eastham               | Elford, E. A.     |
|                   | London, N.W. 11, 11 Albany Mansions  | Mallinson, W. D.  |
| Japan             | Fukuoka City, Fukuokakohsokyoku  | Hirayama, Y.      |
|                   | Osaka, c/o Elec. Eng. Dept., Osaka Imperial University, G-chono, Higashinari, Kitaku | Aoyagi, K.        |
| Mexico            | Chihuahua, Chi., P.O. B. 157   | Isala, F. L.      |
| South Africa      | Durban, Natal, Broadcasting Station  | Dunning, C.       |

For Election to the Junior Grade

|             |   |                  |
|-------------|---|------------------|
| Georgia     | Atlanta, 794 Springdale Rd.             | Rainwater, B. V. |
| Illinois    | Chicago, 5020 N. Persim St.             | Nelson, W. T.    |
| New Zealand | Christchurch, Station 3YA, P.O. Box 219 | Ryland, A.       |

For Election to the Student Grade

|              |   |                 |
|--------------|---|-----------------|
| California   | Berkeley, 1650 Oxford St.                         | Craim, C.       |
| New York     | New York City, 1123 John Jay Hall, Columbia Univ. | Boe, J. H.      |
|              | Potomac, 2 Lawrence Ave.                          | Swain, E. W.    |
| Pennsylvania | Media, R. D. No. 2                                | Harper, R. E.   |
| Washington   | Seattle, 7216 James Ave. N.W.                     | Adams, A. W.    |
|              | Seattle, 4423-30th Ave. N.E.                      | Harned, G. C.   |
|              | Seattle, 2371-14th Ave. N.                        | McKinney, R. B. |
|              | Seattle, 4023 Corliss Ave.                        | Woodyard, H. R. |

## OFFICERS AND BOARD OF DIRECTORS, 1933

(Terms expire January 1, 1934, except as otherwise noted)

*President*

L. M. HULL

*Vice President*

JONATHAN ZENNECK

*Treasurer*

MELVILLE EASTHAM

*Secretary*

HAROLD P. WESTMAN

*Editor*

ALFRED N. GOLDSMITH

*Directors*

M. C. BATSEL

J. V. L. HOGAN

C. M. JANSKY, JR.

R. H. MANSON, *Junior Past President*

E. R. SHUTE

A. F. VAN DYCK

WILLIAM WILSON

Serving until January 1, 1935

W. G. CADY, *Junior Past President*

O. H. CALDWELL

C. W. HORN

E. L. NELSON

Serving until January 1, 1936

R. A. HEISING

H. M. TURNER

F. A. KOLSTER



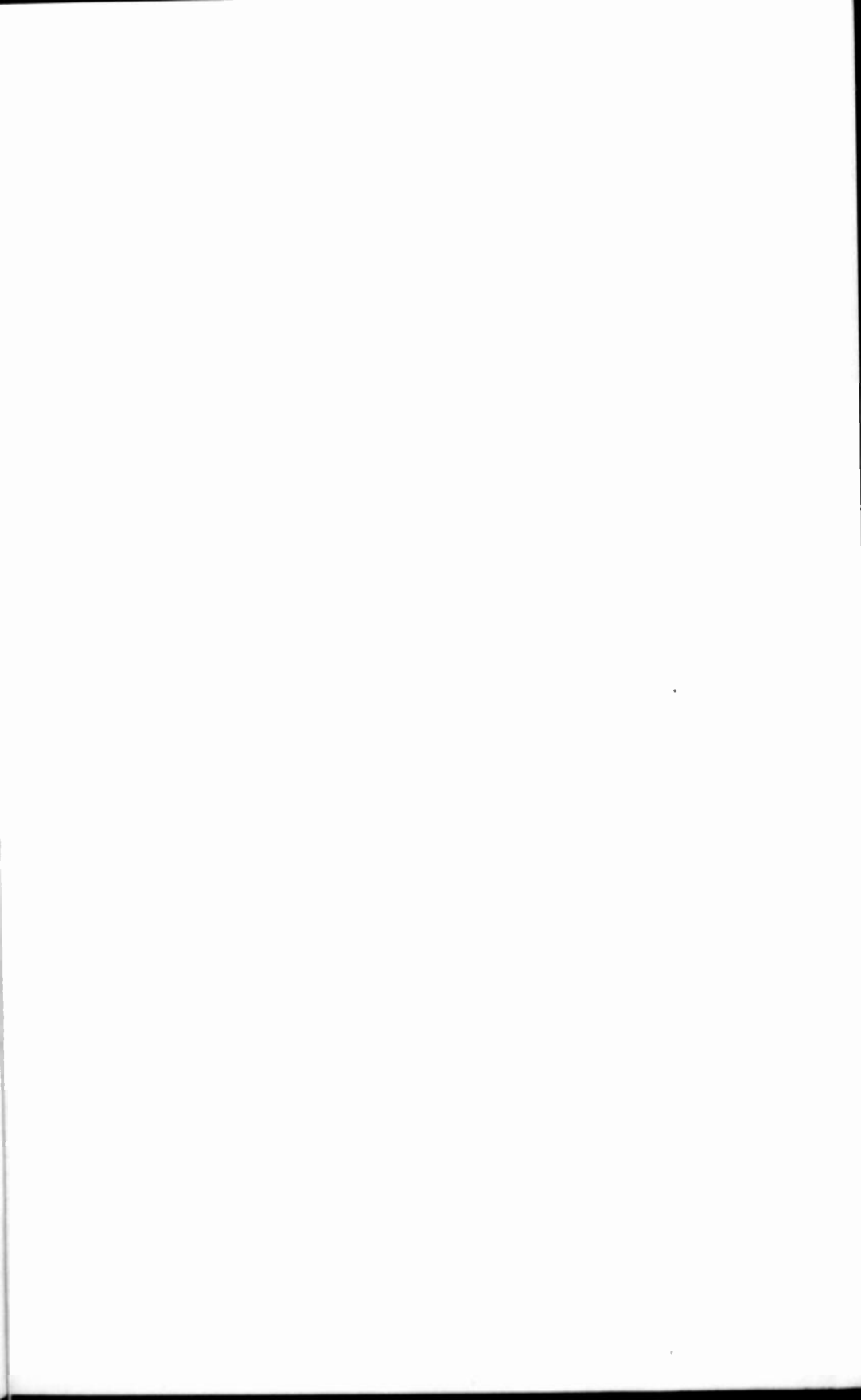



HUBERT M. TURNER, DIRECTOR, 1933

Hubert Michael Turner was born on July 20, 1882, at Hillsboro, Ill. After being graduated in electrical engineering from the University of Illinois in 1910, he remained as an assistant instructor for two years while taking graduate work in mathematics, physics, and electrical engineering. He received his Master's degree in 1915. From 1912 to 1918 he instructed at the University of Minnesota and organized courses in transient phenomena and radio. During the war he was placed in charge of technical instruction of the Signal Corps unit of enlisted men at the University of Minnesota. In October, 1918, he became assistant professor of radio with the Signal Corps School for Officer Candidates at Yale.

In 1919 he was appointed assistant professor of electrical engineering at Yale, and in 1926, associate professor. His entire time is devoted to the graduate course in communication engineering, and he has developed new methods of presenting theory and many special experimental methods as well as improved laboratory technique. He has had practical experience in both power and communication work, and has done consulting work in several branches of the electrical engineering field.

He is a member of the American Institute of Electrical Engineers, the International Union of Scientific Radio Telegraphy, the American Association for the Advancement of Science, the Franklin Institute, Sigma Xi, and has been active in committee work on matters relating to standardization, technical papers, instruments and measurements, and communications.

He became an Associate member of the Institute in 1914 and a Member in 1920.

## INSTITUTE NEWS AND RADIO NOTES

### February Meeting of the Board of Directors

At the February meeting of the Board of Directors held on the first of the month, I. M. Hull, president; Melville Eastham, treasurer; O. H. Caldwell, Alfred N. Goldsmith, R. A. Heising, J. V. L. Hogan, C. W. Horn, C. M. Jansky, Jr., F. A. Kolster, E. L. Nelson, E. R. Shute, H. M. Turner, A. F. Van Dyck, William Wilson, and H. P. Westman, secretary were present.

Thirty-two applications for the Associate grade, three for the Junior grade, and eight for the Student grade of membership were approved.

The 1932 Report of the Secretary was approved, and a portion of it specifically prepared for publication will appear in the April issue of the *PROCEEDINGS*.

A report of the Broadcast Committee under the heading of "Cleared Channels in American Broadcasting" was submitted and approved. Prepared in an endeavor to clarify thought on the position in American broadcasting held by stations operating on cleared channels as contrasted with those on shared channel assignments, the material is published in full immediately following this report.

### The Clear Channel in American Broadcasting

The combination of clear channels and shared channels which forms the basis for the plan of broadcast allocation now in effect in the United States was adopted by the Federal Radio Commission in 1928. The clear channel assignment was evolved at that time as the result of overwhelming expert testimony, based not only on the lessons of some seven years of broadcasting in its present form, but also on the more mature experience of the other older branches of the radio industry. During the past four years, ample opportunity has been afforded for both the expert and the layman to obtain first hand information on the relative advantages of the clear channel under a great variety of operating conditions. Yet current discussion of broadcast problems frequently discloses much inaccurate information and loose thinking on this important question. Under the circumstances, it is felt that a careful recapitulation of the engineering viewpoint on the place of the clear channel in the existing scheme should prove interesting and, perhaps, valuable. With this thought in mind, the brief dis-

cussion which follows has been prepared by the Broadcast Committee of the Institute of Radio Engineers.

It is characteristic of radio signals, in common with other types of wave motion, that once they are launched "on the air" they continue to travel away from their source while their intensity diminishes at a rate determined only by the conditions which they encounter in transit until they are too feeble to be detected or until they are lost in the prevailing noise level due to random electrical disturbances. There is no means known to the art whereby the projected waves can be abruptly brought to a stop at some remote point or whereby their intensity can be suddenly reduced to a negligible value at a predetermined distance. It is obvious, therefore, that from the radio transmission standpoint purely artificial boundaries such as those of the zone or the state or the nation are of no significance.

This same fundamental consideration governs the operation of two or more broadcast stations on a single assigned carrier frequency. The signals from any one station cannot be prevented from invading the areas local to the others. Successful shared channel broadcasting, therefore, hinges on the possibility of receiving a signal from the wanted station which is predominantly stronger than those from all other stations holding the same frequency assignment. Experience indicates that if the reproduced program is to have entertainment (as distinguished from novelty) value, the intensity of the wanted signal at any particular receiving point must be from 20 to 100 times the combined intensity of the interfering signals established at that point by all other stations operating on the same channel. Even these large ratios do not always represent a high standard of performance. The background of interference must be extremely feeble if it is not to detract from the artistic excellence of the reproduction, and for high-grade urban coverage an effort is usually made to obtain considerably greater ratios.

The result of the restrictive effects of interference described above is to limit the acceptable service from a shared channel station to areas where the received signal intensities are high, hence to areas within a few miles of the transmitter. The limitations of shared channel operation are, therefore, apparent. It is clear that while such an arrangement will accommodate a considerable number of stations and will afford service to a relatively large number of detached areas closely surrounding such stations, there will in general be much larger intervening areas in which no station produces a predominately strong signal and in which, therefore, no service worthy of the name can be given. This analysis, then, indicates that the field of the shared channel

is to serve important detached centers of population, such as our cities and larger towns.

In the United States, however, on account of its size and its important agricultural interests, a considerable part of the population is sparsely distributed in small towns and villages and on farms. It is essential that these people be given broadcast service as an ordinary matter of equity. In addition, they constitute a noteworthy fraction of the buying public, which is supporting American broadcasting as it is constituted today. The establishment of the present system of clear channels followed early appreciation of the fact that service to this group could not be provided on a shared channel basis but that national channels on which only one station operated at a time would have to be employed for the purpose. The experience of subsequent years has served only to emphasize the fundamental soundness of this conclusion.

On account of the absence of interference from other stations assigned to the same carrier frequency, the signals from a clear channel station (except where subject to excessive fading) will afford service until they have reached the point where they are too feeble to be heard above the prevailing electrical noise level with any degree of satisfaction. Fortunately, the electrical noise level in most rural districts is quite low, with the result that reasonably long distances can be covered with transmitting stations of moderate power. If higher power is employed, however, the range of the station and the area which it serves will be considerably extended. In addition, at the more remote receiving points the grade of service will be improved because the stronger signal is further above the prevailing electrical noise level and the reproduced program, therefore, suffers relatively less from an objectionable noise background. Since higher power on clear channels will thus extend and improve the broadcast service in outlying rural communities, since the avowed purpose of the clear channel is to serve such communities, and since clear channels by their very nature are reserved for the use of a single station so that interference with other stations assigned to the same carrier frequency is not a possibility, it is thought to be logical and consistent not only to permit but to require the use of adequate power by all stations holding clear channel assignments. This, briefly, is the basis for the practically unanimous engineering position regarding the use of high power on clear channels. Under existing conditions, there is no technical reason for not requiring all clear channel stations to employ transmitters of at least 50 kilowatts. Conversely, the denial to the rural listeners on many of the clear channels of the improved and extended service

which could be made available to them by requiring the use of 50-kilowatt transmitters on those channels is not based on technical reasons.

Failure, in the past, to use sufficiently high power to enable distant listeners to obtain the full advantage of the inherent characteristics of clear channel operation has led to suggestions for the virtual abandonment of these channels. Where the distances and time differences involved are no greater than those in the United States the assignment of additional stations to the existing clear channels must inevitably result in a real limitation of the areas served and the assignments will thus lose their clear channel nature. The engineering conception of the clear channel has always embodied high power as one of its essential accompaniments.

In addition to its value as a means of affording service to distant towns and extensive rural areas, the clear channel station is also well adapted to cover a single relatively large center of population, such as one of our major cities. This is due to the fact that high power can be employed and that the station will, therefore, be surrounded by a relatively large area in which strong signals prevail, permitting excellent reproduction to be obtained. There are easily recognized economic and operating advantages to be gained by a broadcast station in associating itself with a large city which will enable it to extend a service of the highest order to the mutual advantage of everyone concerned. Under the circumstances, it is not surprising that practically every one of the existing clear channel stations is identified with one of our larger cities. This fact, however, should not be allowed to direct attention from the principal purpose of the clear channel, that is, service to scattered outlying units of population, for which it would not be economically possible to obtain broadcasting on any other basis.

To recapitulate:

1. The field of the shared channel is to afford broadcast service to important detached centers of population, such as our cities and larger towns.
2. The field of the clear channel is to afford service to those vast intervening areas in which the density of population is so low that a broadcast service could not otherwise be supported and, in addition, to a single large center.

These principles, if kept firmly in mind, will afford insight into one phase of the broadcast allocation problem that has been the subject of spirited debate from the time that the establishment of clear channels was first suggested; namely, the relative advantage of increasing the total number of broadcast stations capable of being in operation at any one time by making multiple assignments to some of the existing

clear channels; or looking toward the opposite course, the relative merit of increasing the number of clear channels by deleting or transferring shared channel stations. The consequences of proceeding in either direction are evident:

1. Decreasing the number of clear channels by assigning additional stations (for nighttime operation) to channels now used by only one station at a time would have the effect of affording additional services to certain localized urban groups but at the expense of decreasing the service to rural listeners and to those at remote points.
2. Increasing the number of clear channels at the expense of the shared channels would have the opposite effect, assuming that assignments for the stations thus displaced could not be provided for on the remaining shared channels.

The foregoing statements are based on radio considerations of a very fundamental nature. However, in view of the industry's growing appreciation of the complexity of radio transmission phenomena and the store of experience that is the result of the past eleven years in broadcasting, the question naturally arises as to whether our increased knowledge and vastly improved technique do not now warrant modifications in these earlier generalizations. After a careful review of the situation the Broadcast Committee is forced to the conclusion that the clear channel is still essential to the extension of broadcast service to the populations of our rural areas and is likely to remain so for some time to come. Further, it is felt that many of the limitations that have been ascribed to the clear channel are the direct result of existing power limitations rather than of any inherent characteristic of clear channel coverage. The engineering case of the clear channel has always been based on the assumption that adequate power would be employed. There appears to be no technical reason why greatly increased power (in excess of 50 kilowatts) should not now be permitted to suitably equipped and appropriately located or relocated stations holding clear channel assignments.

Assuming that service to distant listeners is to be maintained, it is evident that continued provision must be made for an adequate number of clear channels. Whether the number should be forty, or more, or less, however, is a matter that can be determined only by careful study. The balance of service between the rural listener and the urban listener is determined in considerable measure by the relative number of allocated clear and shared channels. Decision as to the correct balance point is a matter of general policy.

which could be made available to them by requiring the use of 50-kilowatt transmitters on those channels is not based on technical reasons.

Failure, in the past, to use sufficiently high power to enable distant listeners to obtain the full advantage of the inherent characteristics of clear channel operation has led to suggestions for the virtual abandonment of these channels. Where the distances and time differences involved are no greater than those in the United States the assignment of additional stations to the existing clear channels must inevitably result in a real limitation of the areas served and the assignments will thus lose their clear channel nature. The engineering conception of the clear channel has always embodied high power as one of its essential accompaniments.

In addition to its value as a means of affording service to distant towns and extensive rural areas, the clear channel station is also well adapted to cover a single relatively large center of population, such as one of our major cities. This is due to the fact that high power can be employed and that the station will, therefore, be surrounded by a relatively large area in which strong signals prevail, permitting excellent reproduction to be obtained. There are easily recognized economic and operating advantages to be gained by a broadcast station in associating itself with a large city which will enable it to extend a service of the highest order to the mutual advantage of everyone concerned. Under the circumstances, it is not surprising that practically every one of the existing clear channel stations is identified with one of our larger cities. This fact, however, should not be allowed to direct attention from the principal purpose of the clear channel, that is, service to scattered outlying units of population, for which it would not be economically possible to obtain broadcasting on any other basis.

To recapitulate:

1. The field of the shared channel is to afford broadcast service to important detached centers of population, such as our cities and larger towns.
2. The field of the clear channel is to afford service to those vast intervening areas in which the density of population is so low that a broadcast service could not otherwise be supported and, in addition, to a single large center.

These principles, if kept firmly in mind, will afford insight into one phase of the broadcast allocation problem that has been the subject of spirited debate from the time that the establishment of clear channels was first suggested; namely, the relative advantage of increasing the total number of broadcast stations capable of being in operation at any one time by making multiple assignments to some of the existing



clear channels; or looking toward the opposite course, the relative merit of increasing the number of clear channels by deleting or transferring shared channel stations. The consequences of proceeding in either direction are evident:

1. Decreasing the number of clear channels by assigning additional stations (for nighttime operation) to channels now used by only one station at a time would have the effect of affording additional services to certain localized urban groups but at the expense of decreasing the service to rural listeners and to those at remote points.
2. Increasing the number of clear channels at the expense of the shared channels would have the opposite effect, assuming that assignments for the stations thus displaced could not be provided for on the remaining shared channels.

The foregoing statements are based on radio considerations of a very fundamental nature. However, in view of the industry's growing appreciation of the complexity of radio transmission phenomena and the store of experience that is the result of the past eleven years in broadcasting, the question naturally arises as to whether our increased knowledge and vastly improved technique do not now warrant modifications in these earlier generalizations. After a careful review of the situation the Broadcast Committee is forced to the conclusion that the clear channel is still essential to the extension of broadcast service to the populations of our rural areas and is likely to remain so for some time to come. Further, it is felt that many of the limitations that have been ascribed to the clear channel are the direct result of existing power limitations rather than of any inherent characteristic of clear channel coverage. The engineering case of the clear channel has always been based on the assumption that adequate power would be employed. There appears to be no technical reason why greatly increased power (in excess of 50 kilowatts) should not now be permitted to suitably equipped and appropriately located or relocated stations holding clear channel assignments.

Assuming that service to distant listeners is to be maintained, it is evident that continued provision must be made for an adequate number of clear channels. Whether the number should be forty, or more, or less, however, is a matter that can be determined only by careful study. The balance of service between the rural listener and the urban listener is determined in considerable measure by the relative number of allocated clear and shared channels. Decision as to the correct balance point is a matter of general policy.

**Letters from Doctors Poulsen and Zenneck**

In the election of officers for 1933, Dr. Valdemar Poulsen and Dr. Jonathan Zenneck ran as candidates for the vice presidency. The following letters which were intended to be read at the annual meeting held in New York City on January 4 arrived too late for this purpose. They are presented herewith, the comments of Dr. Poulsen following directly.

I am highly pleased to get this opportunity to express my heartiest feelings towards Dr. Walter G. Cady whose scientific research work is covering extensively the technical and physical field of high-frequency phenomenon.

I admire especially his pioneering investigations of the behavior of quartz crystals under the influence of high-frequency oscillations. Most physicists and radio engineers the world over are utilizing Dr. Cady's crystal control systems, thus giving evidence of how highly admirable is this achievement in the art of research.

With my greatest feelings of friendship and sympathy I am greeting you, Dr. Cady, on occasion of your retiring from the Presidency and I wish you health, happiness, and many new achievements in your future research work.

May I take occasion also to extend my greetings to the succeeding president, Dr. L. M. Hull, and to the retiring and succeeding vice presidents, my friends, Professor E. V. Appleton and Professor Jonathan Zenneck.

The contents of the letter forwarded by Dr. Zenneck are given below.

I first beg to express my most sincere thanks to the Board of Directors for having nominated me a candidate for the vice presidency and to the members of the Institute for having voted for me. This vote of confidence is a great honor to me and, having always been proud of being a Fellow of the Institute, I am delighted now to be its vice president.

The coupling element between this truly international institute and its non-American members is the PROCEEDINGS of the Institute. On my book shelf stands a complete series of the PROCEEDINGS from the very first volume of 1913 to volume 20 of 1932. These volumes when looked upon as historical documents tell us an impressive story about the development of radio communication and the development of this Institute.

The first volume of 1913 was made of not more than 268 pages and contained 14 papers on subject matters such as the work of the Federal Telegraph Company, the Sayville Station of the Atlantic Communication Company, the daylight effect in radiotelegraphy, and the heterodyne receiving system. The last volume of 1932 is a 5-pound-bulk of 2260 pages comprising 130 papers on all kinds of problems which are of interest to the present-day radio man. For instance, on tube oscillators and their control by piezo-electric crystals, on the distortion by amplifiers and loud speakers, on transatlantic radiotelephony, on the propagation of radio waves of every style, from the old-fashioned but powerful 10,000-meter waves down to the supermodern waves of a few meters wavelengths. From volume 1 to volume 20 is represented a path of scientific and technical progress of which at the time of Volume 1 not even the most fervent optimist would have dreamt.

Furthermore the first volume of 1913 did not contain any advertisements since in those days there was not much to be advertised and there were not many to buy radio apparatus, while in volume 20 there are about 500 additional pages filled with advertisements of broadcast apparatus of every kind and description. This shows better than anything else how radiotelegraphy which formerly had been the domain of a few so-called experts, has extended its territory, and that a radio industry grew up which gave labor to thousands of engineers and workmen, and that radiotelephony has become the entertainment and pleasure of millions of healthy and sick people of all nations. When we were boys, we tried to make the best bow and to carve the best arrows for playing Indians, while our boys now are competing in constructing the best receiving set and are trying to give their fathers some idea of the principles of radiotelegraphy.

Finally, when we go through the "Institute News" in volume 20, we read of the various meetings of the seventeen sections of this Institute, and we see from the numerous applications for membership, that in spite of the great depression prevailing in all countries, the number of members has still increased. Apparently the foundation of this Institute is so robust that its activity and its attractive power cannot be seriously affected by a minimum in the general prosperity curve.

Let us hope that this curve may go up soon and that the coming recovery of general conditions may give a new impetus to radio and to the Institute of Radio Engineers.

#### Radio Transmissions of Standard Frequencies

The Bureau of Standards transmits standard frequencies from its station WWV, Washington, D.C., every Tuesday. The transmissions are on 5000 kilocycles. Beginning October 1, the schedule was changed. The transmissions will be given continuously from 10 A.M. to 12 noon, and from 8:00 to 10:00 P.M., Eastern Standard Time. (From April to September, 1932, the schedule was from 2 to 4 P.M., and from 10 P.M. to midnight.) The service may be used by transmitting stations in adjusting their transmitters to exact frequency, and by the public in calibrating frequency standards, and transmitting and receiving apparatus. The transmissions can be heard and utilized by stations equipped for continuous-wave reception through the United States, although not with certainty in some places. The accuracy of the frequency is at all times better than one cycle (one in five million).

From the 5000 kilocycles any frequency may be checked by the method of harmonics. Information on how to receive and utilize the signals is given in a pamphlet obtainable on request addressed to the Bureau of Standards, Washington, D.C.

The transmissions consist mainly of continuous, unkeyed carrier frequency, giving a continuous whistle in the phones when received with an oscillatory receiving set. For the first five minutes there are transmitted the general call (CQ de WWV) and announcement of the frequency. The frequency and the call letters of the station (WWV) are given every ten minutes thereafter.

Supplementary experimental transmissions are made at other times. Some of these are made with modulated waves, at various modulation frequencies. Information regarding proposed supplementary transmissions is given by radio during the regular transmissions, and also announced in the newspapers.

The Bureau desires to receive reports on the transmissions, especially because radio transmission phenomena change with the season of the year. The data desired are approximate field intensity, fading characteristics, and the suitability of the transmissions for frequency measurements. It is suggested that in reporting on intensities, the following designations be used where field intensity measurement apparatus is not used: (1) hardly perceptible, unreadable; (2) weak, readable now and then; (3) fairly good, readable with difficulty; (4) good, readable; (5) very good, perfectly readable. A statement as to whether fading is present or not is desired, and if so, its characteristics, such as time between peaks of signal intensity. Statements as to type of receiving set and type of antenna used are also desired. The Bureau would also appreciate reports on the use of the transmissions for purposes of frequency measurement or control.

All reports and letters regarding the transmissions should be addressed to the Bureau of Standards, Washington, D.C.

---

### Proceedings Binders

Binders for the PROCEEDINGS, which may be used as permanent covers or for temporary transfer purposes, are available from the Institute office. These binders are of handsome Spanish grain fabrikoid, in blue and gold. Wire fasteners hold each copy in place, and permit removal of any issue from the binder in a few seconds. All issues lie flat when the binder is open. Each binder will accommodate a full year's supply of the PROCEEDINGS, and they are available at one dollar and seventy five cents (\$1.75) each. Your name, or PROCEEDINGS volume number, will be stamped in gold for fifty cents (50c) additional.

## Committee Work

### ADMISSIONS COMMITTEE

The Admissions Committee held a meeting on February 1, and those present were A. F. Van Dyck, chairman; O. H. Caldwell, H. C. Gawler, C. W. Horn, C. M. Jansky, Jr., E. R. Shute, and H. P. Westman, secretary.

The committee considered and approved three applications for admission to the grade of Member. In addition, it approved three for transfer to the grade of Member, denying one and tabling another pending receipt of additional information.

### BROADCAST COMMITTEE

A meeting of the Broadcast Committee was held on January 31. A report on "The Cleared Channel in American Broadcasting," which appears earlier in this issue, was put in final shape for submission to the Board of Directors for approval.

The meeting was attended by E. L. Nelson, chairman; Wilson Aull, (representing J. V. L. Hogan), Arthur Batcheller, C. W. Horn, C. M. Jansky, Jr., L. F. Jones, (representing B. R. Cummings), L. E. Whittemore, and H. P. Westman, secretary.

### MEMBERSHIP COMMITTEE

The Membership Committee held a meeting on February 1 which was attended by H. C. Gawler, chairman; W. F. Cotter, David Grimes, and E. W. Schafer. Some letters to be used in contacting with section officers in furthering membership activities were prepared.

---

## Institute Meetings

### BOSTON SECTION

A meeting of the Boston Section was held at Harvard University, on January 20 with the chairman, E. L. Chaffee, presiding.

"Some Results of a Study of Ultra-Short-Wave Transmission Phenomena" by C. R. Englund, A. B. Crawford, and W. W. Mumford of the Bell Telephone Laboratories was presented by Mr. Englund. The paper appears elsewhere in this issue and is accordingly not summarized here.

Messrs. Chaffee, Karplus, and Kenrick of the 150 members and guests in attendance participated in the discussion of the paper.

## CLEVELAND SECTION

The December meeting of the Cleveland Section was held at Case School of Applied Science on the 16th. E. L. Gove, chairman, presided and the attendance totaled twenty-four.

The paper of the evening "Factors Affecting Nighttime Range of Radio Stations" was presented by John F. Byrne of the Electrical Engineering Department, Ohio State University.

In his paper, Professor Byrne stressed particularly the relative efficiency of high- and low-frequency broadcast stations under nighttime conditions. This was on the basis of fading areas which approach the transmitter as the frequency is increased and which are not changed in extent by variations in power. The results of some field surveys using a loop-operated receiver on field measurements of four stations employing quarter-wave transmitting antennas showed the fading area varying between thirty-one and sixty-six miles as the frequency of transmission varied from 1450 kilocycles to 550 kilocycles. A vertical receiving antenna would have extended the fading areas to from forty-nine miles to ninety-two miles, respectively. It was pointed out that the loop-operated receiver best simulated conditions found in the average receiving aerial which is usually of the inverted-L type.

To indicate the effect upon transmission of the conductivity of the earth, conditions in Ohio were contrasted with those in the mountainous country around Asheville, N.C., where tests indicated the transmission efficiency at 550 kilocycles to be only as great as that at 1450 kilocycles in Ohio.

Graphs exhibited by the speaker showed very good agreement between calculated and observed transmission characteristics of waves of various frequencies making it possible to predict within close limits the reliable service areas of many stations.

On January 27 a meeting of the Cleveland Section was held at the Case School of Applied Science. P. A. Marsal presided.

"Communications and Other Engineering Developments in Russia," was the subject of a paper by K. H. Donaldson, Assistant Professor of Mining and Engineering at Case School of Applied Science. The paper was based upon the author's observations in communications and other engineering fields in addition to mining engineering, in which work he spent some months in the U.S.S.R. His investigation and travel covered chiefly eastern European Russia and particularly the Ural Mountain region and Leningrad. While the U.S.S.R. has used substantial quantities of electrical machinery, the speaker pointed out that radio has been used very little for the entertainment or the

instruction of the general public. Broadcasting was confined largely to matters of education or propaganda with little or no entertainment. Public receiving sets to which people may listen in large groups are of very poor tonal quality and homes are not equipped with receivers.

An interesting general discussion followed the presentation of the paper. The attendance totaled eleven.

#### DETROIT SECTION

On January 20 a meeting of the Detroit Section was held in the Detroit News conference room with G. W. Carter, chairman, presiding.

A paper on "Transmitter Development" was presented by L. M. Harding, Associate Radio Engineer of the Lighthouse Service of the United States.

The speaker first outlined the radio activities of the United States Lighthouse Service, describing weather and radio beacon services developed and maintained for the airways. This description indicated the requirements of the radio equipment employed and the conditions under which it operates. The particular transmitters developed for this service were then described. Because the equipment is in many cases operated and maintained by one who is not an experienced operator, the problems of design to permit simple installation and foolproof operation are numerous.

Considerable interest was shown in a fifty-watt transmitter, so arranged and metered, as often to permit troubles to be corrected simply through communication between the attendant and the field man, thus saving substantial amounts of time and money in traveling. A number of oscillograms were displayed to show the performance of the equipment.

A discussion which was participated in by a number of the forty-five members and guests in attendance followed the presentation of the paper.

#### LOS ANGELES SECTION

The annual meeting of the Los Angeles Section was held on December 20 at the Mayfair Hotel, and was presided over by E. H. Schreiber, chairman.

Balloting for officers resulted in the election as chairman of John K. Hilliard of the Fox Film Corporation; vice chairman J. M. Chapple, U. S. Assistant Radio Inspector, and secretary-treasurer N. B. Neely of J. S. Cole-Radio Enterprises.

Two papers were presented, the first of which on "Electron Coupled Oscillators," was by J. B. Dow, Lieutenant, U.S.N. The speaker

pointed out the causes of oscillator frequency instability and traced the development of a Colpitts oscillator to an electron coupled oscillatory circuit. Performance and circuit data were presented by means of slides.

T. E. Nikirk of the National Radio and Electrical School then presented a television demonstration through the courtesy of the National Automotive and Electrical School. The receiver was a product of the Western Television Corporation and the Sanabria system of television was employed. The demonstration was considered highly successful and entertaining by the eighty-seven members and guests who attended the meeting. Twenty-nine were present at the informal dinner which preceded it.

The January meeting was held on the 17th at the Mayfair Hotel and was presided over by J. K. Hilliard, chairman. The attendance totaled sixty, and nineteen were present at the informal dinner which preceded the meeting.

Before proceeding with the paper of the evening, Dr. Blackburn who was appointed chairman of the Meetings and Papers Committee suggested that the regular meetings be alternated with seminars or discussions on various subjects to be held at different locations to facilitate instructive and interesting demonstrations. He proposed that this plan be tried for the next six months at the end of which a vote be taken to determine if it should be continued. This suggestion was approved and subjects tentatively assigned for the next three seminar meetings.

A paper on "Wide Range Recording and Reproduction" was originally scheduled to be presented by Donald MacKenzie who unfortunately was unable to attend because of illness. H. C. Silent of Electrical Research Products presented the paper in the stead of Dr. MacKenzie. The speaker discussed the properties of sound as affecting the human ear. He then traced its transmission from the source through recording and reproducing mechanisms and discussed the various problems involved in obtaining satisfactory results. The acoustical properties of various instruments and groups of instruments were shown by means of slides. The use of filters to affect the transmission characteristics of circuits was outlined. The necessity of maintaining a satisfactory balance between high- and low-frequency response in reproduction was stressed, and it was pointed out that an allowance must be made for the peculiarities of the human ear in its response to reproduced sounds. The use of compensation networks for the correction of circuit types of distortion in recording and long line transmis-



sion was explained. The properties of various types of microphones and loud speakers in general use were discussed. A brief account of loud speaker efficiency and power output requirements for theater uses ended the paper.

#### NEW YORK MEETING

The February New York meeting of the Institute was held on the 1st of the month in the Engineering Societies Building and was presided over by President Hull. "Iron-Core Inductors and Permeability Tuning" was the subject of the paper by W. J. Polydoroff of the Johnson Laboratories of Chicago.

The speaker presented an analysis indicating that tuning by variation of inductance in such a manner that the  $L/R$  of the circuit is kept constant results in uniform selectance and amplification throughout the tuning range. He described the characteristics and construction of some finely divided and compressed magnetic core material which has been developed for this tuning purpose. It was pointed out that inductances with iron cores can be designed to produce simultaneously inductance and resistance values of the same order as obtained with air-core inductances. Because the core material described exhibits low losses at broadcast frequencies and possesses exceptional magnetic stability, it is applicable to other than radio purposes.

Constructional details were given of variable inductors and their behavior and application to radio circuits discussed. Their inherent uniformity makes these iron-core tuned inductors applicable in tuned radio-frequency receivers and the operation and construction of several forms were shown.

The meeting was attended by 200 members and guests and several of these participated in the discussion which followed the presentation of the paper.

#### PHILADELPHIA SECTION

On the afternoon of December 29, the Philadelphia Section held a meeting in Atlantic City as part of the general meeting of the American Association for the Advancement of Science. This meeting was held at the Haddon Hall Hotel and was devoted to the presentation of the five papers listed below:

"Creative Broadcasting from the Musician's Viewpoint," by C. H. Weyl of the University of Pennsylvania.

"The Measurement of Over-All Characteristics of Broadcast Receivers," by A. V. Loughren, RCA Victor Company.

"Electricity in Medicine," by Richard Kovacs, M.D., of the New York Polyclinic Medical School.

"Study of Reception from Synchronized Broadcast Stations," by C. B. P. Aiken, Bell Telephone Laboratories.

"High-Quality Ribbon Telephone Receivers," by F. Massa, RCA Victor Company.

Even though several other sections of the American Association for the Advancement of Science held meetings on this same afternoon, the attendance was quite satisfactory although it varied during the session.

The meeting was presided over by H. W. Byler, chairman, and G. C. Blackwood, secretary-treasurer.

The January 5 meeting of the Philadelphia Section was held at the Engineers Club, and was presided over by I. A. Travis. The attendance totaled sixty-one.

I. G. Maloff of the RCA Victor Company presented a paper on "New Methods of Solving Vacuum Tube Problems." In it, he pointed out that vacuum tubes are fundamentally nonlinear devices and purely analytical methods for calculating their performance are very involved. The paper dealt with an inverse method of calculating tube performance which is based upon an assumption of a certain output for which the necessary input is calculated. This method may be used for the computation of wave shape distortion in power amplifiers with reactive loads as well as in the case of amplifiers designed to deliver odd wave shapes in their output circuits. In modified form it is applicable to oscillators and multivibrators. By means of graphs, and the use of isoclines, difficult and laborious problems were reduced to simple numerical calculations. A general discussion followed the presentation of the paper.

#### PITTSBURGH SECTION

Chairman R. T. Griffith presided at the January 17 meeting of the Pittsburgh Section held in the Fort Pitt Hotel.

J. E. Henney of the Photophone Division of the RCA Victor Company presented a paper on "Some Recent Developments in Radio Broadcast Receivers."

The author discussed a number of commercial factors which have a substantial bearing upon the design of broadcast receivers and then proceeded to describe some new RCA receivers. These were discussed in detail and it was pointed out how they fulfilled present-day requirements. Particular attention was paid to automatic volume control and automatic tone control systems, and the circuits required to obtain these desirable characteristics were discussed in detail, and the functions of the equipment used for these purposes covered.

A general discussion followed the presentation of the paper, and was participated in among others by Messrs. Griffith, Haller, McKinley, Noble, and Sunnergren. The attendance totaled thirty-two.

#### SAN FRANCISCO SECTION

The Bellevue Hotel in San Francisco was the place of the January 18 meeting of that section which was presided over by K. G. Clark, secretary-treasurer.

The paper presented at the meeting was by Ralph M. Heintz, President and General Manager of Heintz and Kaufman, Ltd., who reported on "The International Radio Conference of 1932 held at Madrid, Spain."

The speaker outlined the procedure of the convention in both the plenary sessions and committees, and his report was plentifully interspersed with amusing incidents from his experiences in Madrid. He discussed the final draft of the convention and its possible effects on both the broadcast and marine radio interests in the United States.

Mr. Heintz had attended the preliminary technical meetings at both The Hague and Copenhagen, and was an accredited representative at Madrid.

Messrs. Fenner, Royden, Terman, Whitton and others of the forty members and guests in attendance participated in the discussion.

#### TORONTO SECTION

On December 14 the Toronto Section held a meeting at the University of Toronto which was presided over by R. A. Hackbusch. The attendance was seventy. A paper on "Mercury Vapor Rectifiers and Thyratrons" was presented by W. E. Pike of the General Electric Company.

Mr. Pike pointed out that the industrial application of electronic devices was of particular interest to radio engineers as their increased use would create a demand for engineers familiar with their operation. Various types of mercury vapor rectifiers and thyratrons were discussed and their applications outlined. Some troubles encountered and precautions to be observed in certain uses of these devices were explained.

A series of slides illustrated the mechanical construction and circuits applicable to thyratrons. A large number of uses in lighting control and for similar purposes was discussed. The paper was commented upon by Messrs. Choat, Fox, Price, and Smith.

## WASHINGTON SECTION

The January 12 meeting of the Washington Section was held at the Kennedy-Warren Apartment Hotel, and presided over by H. G. Dorsey, chairman.

"Some Results of a Study of Ultra-Short-Wave Transmission Phenomena," by C. R. Englund, A. B. Crawford, and W. M. Mumford of the Bell Telephone Laboratories was presented by Mr. Crawford. As the paper appears in this issue of the PROCEEDINGS, it will not be summarized here.

The new chairman of the section, Dr. Dorsey, announced the appointment of committees to serve during the coming year, and a report was read showing that the local engineering societies had failed to approve a registration law for engineering in the District of Columbia.

The meeting was attended by sixty-five of whom eighteen attended the informal dinner which preceded it.

---

**Personal Mention**

Formerly with the Western Electric Company of Brazil, G. W. Barzee has established a consulting practice for sound equipment engineering at Sao Paulo, Brazil.

F. E. Burley previously with the RCA Victor Company has joined the radio engineering staff of Philco Radio and Television Corporation.

H. A. Chinn has joined the engineering staff of the Columbia Broadcasting Company having formerly been research associate at the Round Hill Laboratory of the Massachusetts Institute of Technology.

G. E. Clarke has been transferred from the Baldock Radio Station to the Engineer in Chief's Office of the General Post Office, Radio Section, London, England.

W. M. Janes has been transferred from the RCA Victor Company of Camden to the research and development laboratory of the RCA Radiotron Company of Harrison, N.J.

Formerly with Boeing Air Transport, William Lawrenz has joined the staff of the United Air Lines at Chicago, Ill.

Lieutenant F. C. Layne, U.S.N., has been transferred from the U.S.S. Canopus to become assistant Asiatic communication officer at the Naval Radio Station, Los Banos, La Guna, P. I.

C. W. Martel is now with the Pilot Radio and Tube Company, Lawrence, Mass., having formerly been an assistant in the Physics Department of the Massachusetts Institute of Technology.

G. E. Maul previously with the Arcturus Radio Tube Company is resuming his engineering practice with headquarters at Chatham, N.J.

L. R. Morse has left the Peacock Motion Picture Company to become an engineer for the Asia Electric Company of Shanghai, China.

S. Nakajima has been transferred from the Naval Research Laboratory of the Imperial Japanese Navy to the Yokosuka Navy Yard.

Formerly with the Williams Piano Company, A. B. Oxley has become chief engineer for Philco Products, Ltd., of Canada at Toronto.

Junior Petterson, radio field engineer for the General Electric Company has been transferred from Atlanta, Ga., to Bridgeport, Conn.

A. E. Reoch has been transferred from the Radio Corporation of America New York office to the RCA Victor Company at Camden.

Previously with the RCA Victor Company, J. W. Summers has become a studio engineer for the National Broadcasting Company in San Francisco.



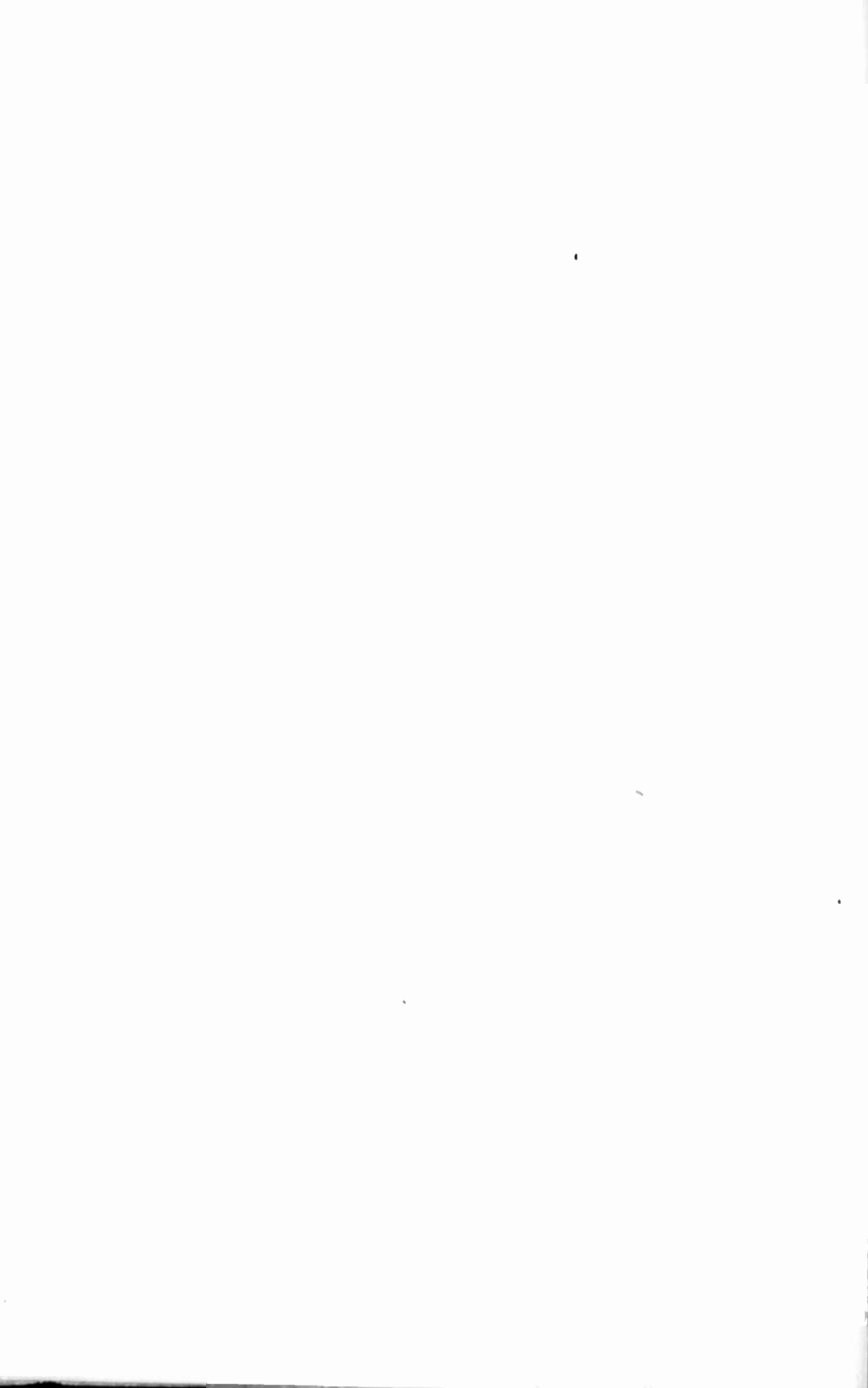

## TECHNICAL PAPERS

A STUDY OF THE PROPAGATION OF WAVELENGTHS  
BETWEEN THREE AND EIGHT METERS\*

BY

L. F. JONES

(RCA Victor Company, Inc., Camden, New Jersey)

*Summary*—A description is given of the equipments used in an airplane, dirigible, automobile, and indoors to measure the propagation characteristics of wavelengths between about three and eight meters. The majority of observations were of television transmissions from the Empire State building.

The absorption of ultra-short-waves traveling through or around large buildings is shown to be in terms of amplitude about 50 per cent every 500 feet for seven meters and 50 per cent every 200 feet for three meters. A number of reflection phenomena are discussed and the influence of interference patterns on receiving conditions is emphasized. It is shown that any modulation frequency is partly or completely suppressed if propagation to the receiver takes place over two paths differing in length by half of the hypothetical radio wavelength of the modulation frequency. For a good television picture this corresponds to a difference of about 500 feet.

Various types of interference are mentioned. There are maps of the interference patterns measured in a typical residential room. The manner in which traffic movements cause severe fluctuations in ultra-short-wave field strengths at certain indoor points is shown by recorded field strengths.

It is shown that the service range of the Empire State transmitters includes most of the urban and suburban areas of New York, and that the interference range is approximately 100 miles. Variations of field strength with altitude, beyond line of sight, are shown. Observations made at a distance of 280 miles are described.

An empirical ultra-short-wave propagation formula is proposed. Curves are then calculated showing the relations between wavelength, power, range, attenuation, and antenna height.

## INTRODUCTION

ULTRA-SHORT waves are being widely applied experimentally to radio communication and broadcasting, and already have limited commercial application.<sup>1</sup> Undoubtedly the commercial utilization of these waves will increase rapidly. For the intelligent application of any band in the radio-frequency spectrum, the propagation characteristics of that band must be known. To learn such char-

\* Decimal classification: R113. Original manuscript received by the Institute, October 14, 1932. Presented before New York meeting, November 2, 1932.

<sup>1</sup> Beverage, Peterson, and Hansell, "Application of frequencies above 30,000 kilocycles to communication problems," Proc. I.R.E., vol. 19, pp. 1313-1333; August, (1931).

acteristics, the RCA Victor Company, working jointly with RCA Communications, Inc., and the National Broadcasting Company, have investigated and are investigating the characteristics of wavelengths below ten meters. Others have experimented extensively on the same subject.<sup>2</sup>

Although the terms "ultra-short wave" and "ultra-high frequency" probably indicate a very wide band, from millimeters or centimeters to an upper wavelength limit of eight or ten meters, the range from about three meters to eight or ten meters will likely receive wide application prior to the still shorter waves. Transmitting and receiving equipment for operation on wavelengths below several meters is being developed by a number of investigators, but the necessity of parting from the more conventional radio practices retards commercialization of these wavelengths. The paper by Beverage, Peterson, and Hansell<sup>1</sup> shows that wavelengths higher than seven or eight meters are occasionally reflected from the Heaviside layer. The present paper deals only with the propagation characteristics of wavelengths between about three and eight meters. Probably wavelengths of eight to twelve meters have similar propagation characteristics to the shorter ones, except that sky wave reflections may be experienced during certain years of the eleven-year sun cycle, especially in the middle of the day. This may not prevent these waves from being widely used for some types of local communication.

#### PRELIMINARY TESTS

Early in 1930, Dr. Haigis<sup>3</sup> developed low power ultra-short-wave apparatus and conducted limited propagation experiments. Since the fall of that year various transmitters operating on wavelengths down to three meters have been manufactured and sold for special purposes.

Measurements made in 1930 of the coverage of a transmitter of several hundred watts power operating on about six meters, located 120 feet above the street level in Camden, indicated that valuable broadcast services could be rendered by ultra-short-wave transmitters. Television was partly in mind in view of the impossibility of securing adequate channel widths on higher wavelengths and of eliminating the effects of sky reflections. Later, under the direction of Mr. R. D. Kell, the transmitter power was increased to one kilowatt, and more extensive observations were made in the Camden-Philadelphia territory.

<sup>2</sup> E. Karplus, "Communication with quasi optical waves," *Proc. I.R.E.*, vol. 19, pp. 1715-1730; October, (1931); Fritz Schroter, "Concerning the question of ultra-short-wave broadcasting," *Elec. Nach. Tech.*, vol. 8, no. 10, pp. 431-437, (1931). (In German); J. R. Jousaust, "Some details relative to propagation of very short waves," *Proc. I.R.E.*, vol. 19, pp. 479-488. March, (1931).

<sup>3</sup> Then with RCA Victor Company, Inc.



Activities were then transferred to New York, where the preponderance of steel buildings, the remote locations of the suburbs, and the large amount of automobile ignition interference were expected to make most conditions of reception as severe as will be found in any American city. A fifty-watt transmitter was installed on the RCA Building at 51st Street and Lexington Avenue, the antenna being 650 feet above street level.

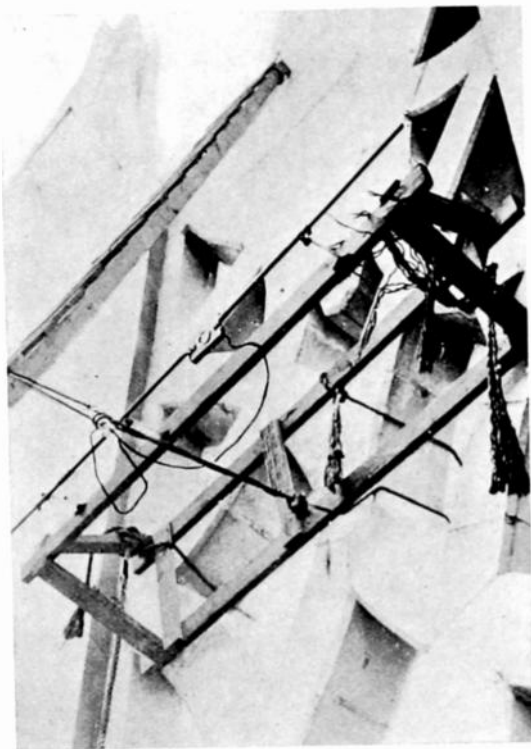

Fig. 1—Horizontal half-wave antenna.

A vertical half-wave antenna was used for the majority of the observations, and transmission was conducted on 3.5, 5, 6.5, and 8.5 meters. Observations were made in all directions inside and outside of buildings, and at distances up to thirty miles. It seemed advisable before making many observations to compare several antenna locations on the roof so that the optimum might be used for propagation measurement purposes. Six antenna positions were tested in the tower that constitutes the topmost portion of the RCA Building. This tower is hollow, about forty feet in height, and is made of a latticework of stone

and bricks that include many openings for artistic purposes. Fig. 1 shows one of the arrangements, where the antenna was placed horizontally within the hollow tower. Fig. 2 shows the final antenna location used for the tests. Differences between horizontally and vertically polarized waves appeared of little importance, but locating the antenna high enough to be practically clear of the surrounding stone work, as shown in Fig. 2, gave an increase in field strength of several hundred per cent. Absorption in the lattice stone work was very great for antenna locations such as shown in Fig. 1.

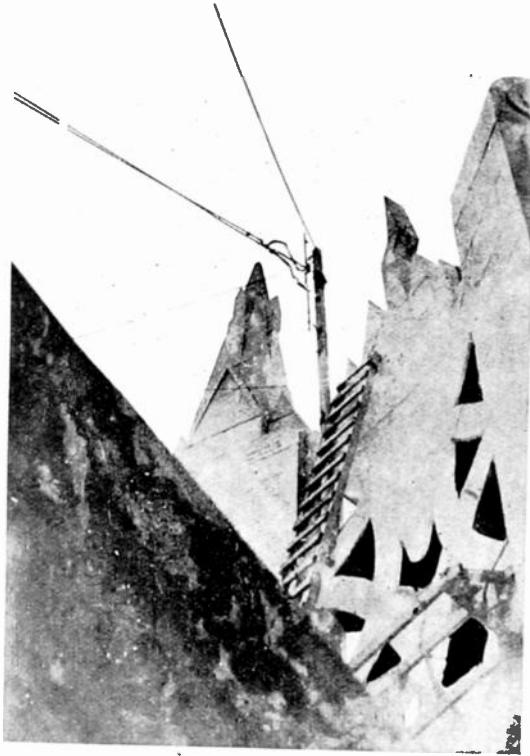

Fig. 2—Final antenna for RCA building test.

The propagation data gained from these preliminary Camden and New York tests were later enhanced by quantitative measurements made of transmission from the Empire State Building.

#### EQUIPMENT FOR EMPIRE STATE TESTS

##### *Transmitting Equipment*

Preliminary tests made with a portable ultra-short-wave transmitter located on the top of the Empire State building had shown the

superiority of the 1300-foot altitude of this building over the 650 feet of the RCA building, and for this and other reasons space was secured on the 85th floor for the installation of television transmitters and studios. A picture transmitter operating on a frequency of forty-four megacycles (6.8 meters) with about two kilowatts output, and sound transmitter operating on sixty-one megacycles (4.9 meters) with an output of about one kilowatt, were installed in July of 1931. Each transmitter was coupled through a 275-foot concentric tube transmission line to its antenna. Fig. 3 shows the antennas used for the propagation measurements. Each antenna was a half wavelength long and was made of

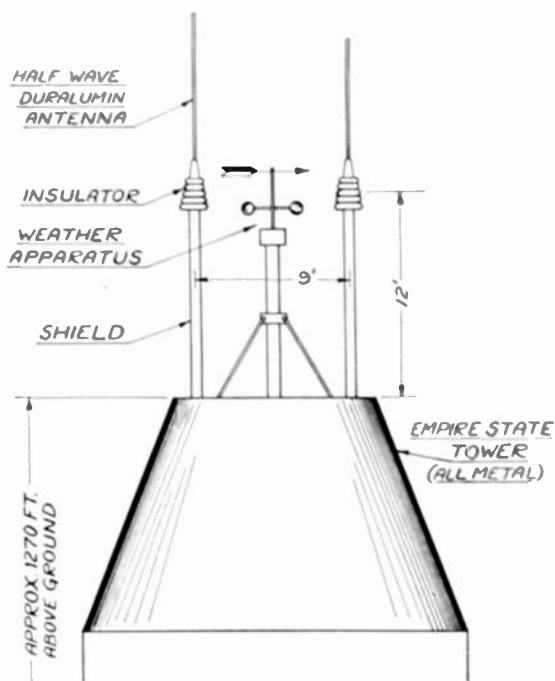

Fig. 3—General layout of Empire State building antennas.

one and one-quarter inch duralumin rod. The antennas were elevated above everything else, their bases being at about the same level as the top of the weather apparatus. In fact, the antennas were the highest structures above ground level ever erected anywhere. The antennas were spaced nine feet apart which rendered a reasonably small reflection effect of the one on the other.

The transmitters utilized precision quartz crystal oscillators, driving their respective power amplifiers through doubler and tripler stages. Each transmitter was modulated in its power amplifier stage, up to

100 per cent. Antenna currents as indicated by commercial thermocouple meters were about seven amperes, and five amperes on forty-four and sixty-one megacycles respectively, and are thought to indicate powers of about two kilowatts and one kilowatt.

### *Receiving Equipment Used*

Observations of the Empire State radiations were made by airplane, autogiro, dirigible, and automobile. The airplane observations were made by Bertram Trevor and are discussed in a separate paper.<sup>4</sup>

The measuring equipment used for the majority of observations consisted of a high sensitivity receiver of the superheterodyne type using detector, oscillator, three stages of six-megacycle intermediate-frequency amplification (using pentodes) and second detector. This receiver was developed and calibrated under the direction of Mr. G. L. Beers of the research division. An indicating microammeter, with bucking battery, was in the second detector plate circuit. Several stages of audio amplification followed for operating a loud speaker for the sake of convenience during certain tests. When used in an automobile the receiver was mounted on the rear seat and coupled to a half-wave vertical antenna. The receiver was calibrated by inserting a resistance of known value in the center of the half-wave receiving antenna, and by inducing therein a current of known value from a signal generator. This calibration was checked by other measurements. Although they checked reasonably closely, it is probable that considerable calibration error existed. The equipment was calibrated for field-strengths between twenty microvolts and ten millivolts per meter, on frequencies between forty and eighty megacycles. To measure field strengths higher than ten millivolts a low sensitivity loop receiver, shown in Fig. 5, was constructed. It was a simple push-pull rectifier and covered the range from 10 to 400 millivolts. Both receivers were portable and were frequently carried from the automobile to the insides of buildings and residences.

The equipment used in the dirigible was the loop set described above for low sensitivity usage, except that the loop antenna was replaced by a half-wave wire fastened to a bamboo pole. As shown in Fig. 4, this pole was held by the observer sitting near an open door of the cabin and it could be held in any position desired. During flight maximum field strength indication was generally obtained by holding the antenna in a vertical position.

In the autogiro the field strength meter and altimeter were mounted

<sup>4</sup> Bertram Trevor and P. S. Carter, "Notes on the propagation of wavelengths below ten meters in length," presented before November 2, 1932, New York meeting. *Proc. I. R. E.*, this issue, pp. 387-426.

together in front of a sixteen-millimeter movie camera, which was focused on the meters. Thus simultaneous recordings of altitude and field strength were readily made photographically. The Paulin altimeter was used in preference to any other type because there is a negligible time lag in the reading. A single-wire antenna as usually used with the field strength set was passed over the side of the cockpit, and during the descent of the autogiro hung very nearly vertically below the fuselage.



Fig. 4—Test in dirigible *Columbia*.

#### PROCEDURE

The phenomena particularly observed were attenuation, interference patterns, interference noises, service range, interference range, signal fluctuations, and local receiving conditions. Measurements were made by Messrs. Gihring and Turner along radials from the Empire State building in all directions except where water intervened. Two of the radials extended to 100 miles and another to 130 miles. In all cases interference patterns were found to be very common, and the field strength at any point was therefore considered as the average of five minimum and five maximum readings as the car was driven through five successive minima and maxima. Several observations were made at a distance of 280 miles.

Readings were taken inside of suburban homes, city office buildings, and apartment houses. Fluctuations found on the first floors of city

buildings were studied by attaching a recording microammeter to the measuring set so that continuous records of the fluctuations would be available. Television receivers were located in about twenty-five res-

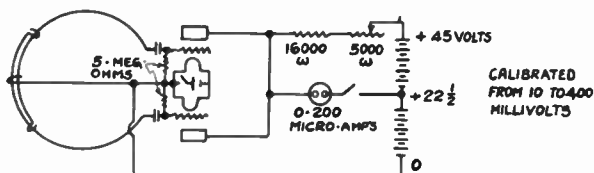

Fig. 5—Circuit used in low sensitivity loop receiver.

idences or apartments, both in the city and in suburbs, to ascertain the signal strengths required for television reception and to observe the effects of different types of interference.

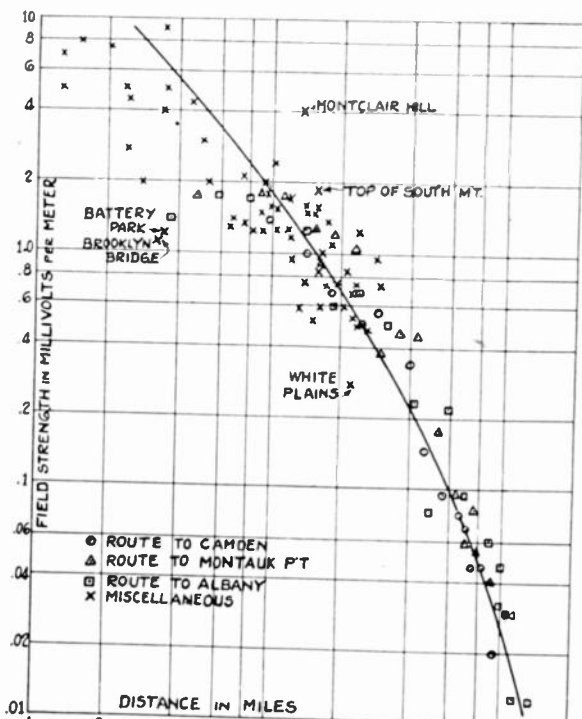

Fig. 6—Attenuation of 44-megacycle signals from Empire State building.

The autogiro tests were made about sixty miles southwest of New York and were for the purpose of determining variation of field strength with altitude. It was useful for this particular purpose because

with its motor shut off it could descend almost vertically. Descent of the ship was fairly regular with no appreciable swaying of the antenna. To eliminate ignition interference the motor was turned off during each descent, a dead-stick landing being made.

Tests in the dirigible *Columbia* were made to study signal variations directly above New York City. Various measurements were made at altitudes from 3000 feet down to 40 feet. Unfortunately, the data obtained are of doubtful utility due to the reflection of the received

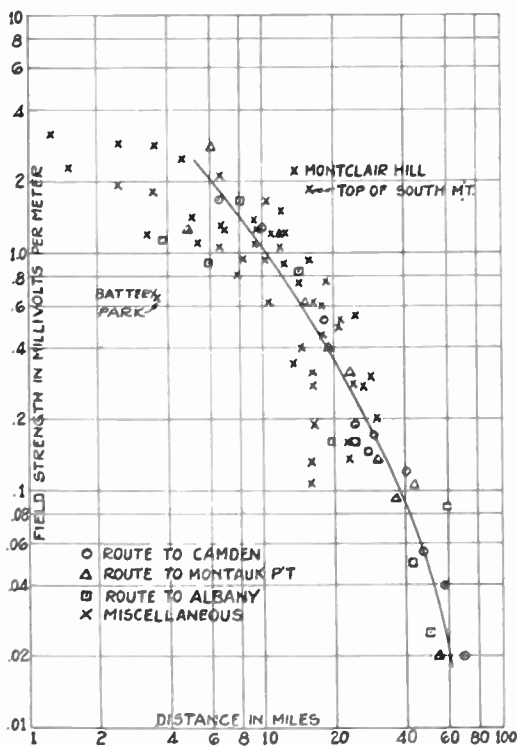

Fig. 7—Attenuation of 61-megacycle signals from Empire State building.

wave from the metal cabin of the ship and to excessive ignition interference.

#### ATTENUATION

Fig. 6 shows the average signal strength of the forty-four-megacycle Empire State signal to 130 miles, and Fig. 7 shows the same for sixty-one megacycles. These curves represent the averages of measurements in several directions. The locations of the points of measurement at distances less than about thirty miles were chosen at random and

correspond to average outdoor conditions. The points beyond thirty miles however were selected with an eye to elevation, since the maximum receiving distance was being considered, and therefore the field strengths for these points are somewhat optimistic. It is seen from Figs. 6 and 7 that the field strength within several miles of the transmitters is more variable than at greater distances. The diversity of the near-by measurements indicates that multistory steel-reinforced buildings have more influence on the field strength in the street than do the two- or three-story brick and frame houses farther away. On each of the three routes that extended 100 miles or more, the forty-four-megacycle signal was heard to the end of the route whereas the sixty-one-megacycle signal was lost between seventy and ninety miles.

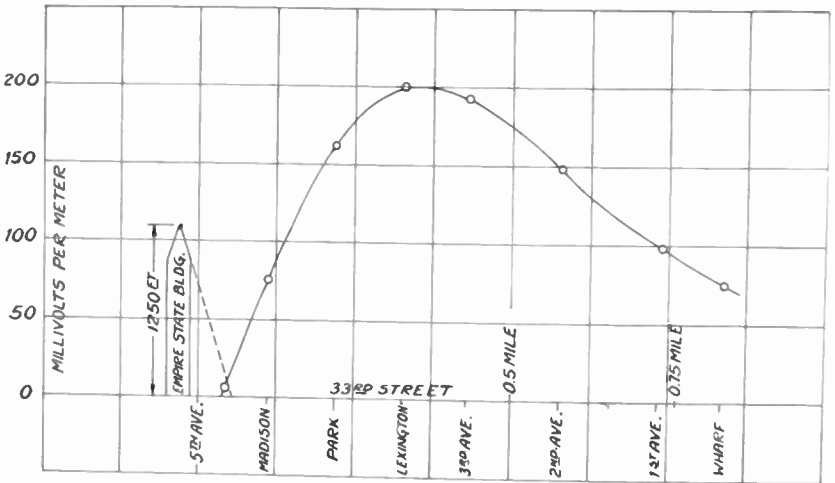

Fig. 8—Field strengths immediately adjacent to transmitter.

As mentioned above, each reading consisted of the average of about five maximum and minimum indications at any one location. If the maximum and minimum readings for any one location are compared to their average, a certain percentage of variation will be indicated. When these "percentage variation" or "percentage deviation" values are plotted for all distances measured, no correlation is found. In other words, the maxima and minima of the interference patterns are approximately as severe at great distances as at small distances. The mean "percentage variation" is sixteen per cent for forty-four megacycles and thirty seven per cent for sixty-one megacycles. This apparently indicates, as expected, that sixty-one megacycles is more efficiently reflected than forty-four megacycles and that the sixty-one-megacycle interference pattern is therefore more pronounced.



Fig. 8 shows the variation of signal strength with distance for the first several blocks from the Empire State building. The maximum signal strength exists approximately three blocks from the Empire State building. The low field intensity existing immediately adjacent to the building is probably caused by the small amount of energy radiated downward by a vertical half-wave antenna.

Observations made within buildings indicate considerable attenuation as the signal enters the building. Inside field strengths were from  $1/2$  to  $1/200$  of the field strengths immediately outside. (Refer to Figs. 15, 16, and 17, discussed below under "Reflections.") At the center of a number of large business buildings there was practically no signal. In such cases, at the side of the building toward the transmitter the signal increased, and similarly at the side of the building away from the transmitter the signal increased. The presence of a good signal on the

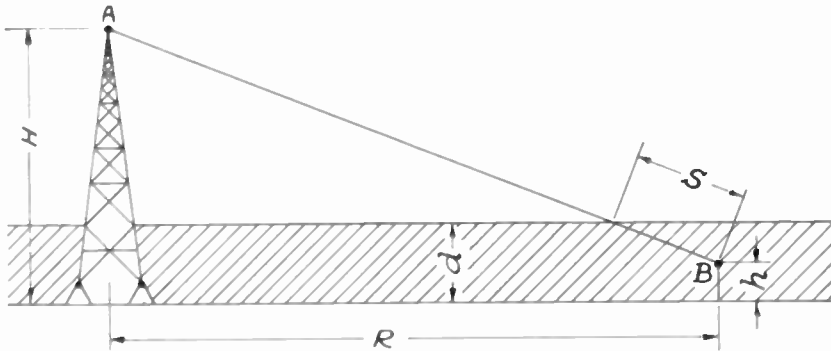

Fig. 9

side of a large building away from the transmitter when no signal could be heard in the center of the building indicated complete absorption of the wave by the building and fairly effective reflection from other surrounding buildings. To check this the receiver was taken to the top of the Woolworth tower. In that case, the signal inside the tower was zero, on the outside of the tower towards the transmitter the signal was very strong, and on the outside of the tower away from the transmitter the signal was zero. This checked with predictions since there are no buildings high enough and near enough to the Woolworth tower to reflect south traveling waves on to the south side of the tower. All observations seemed to show that ultra-short waves were considerably diffused when they reached the buildings of a metropolitan area. This general diffusion or dispersion is probably fortunate since it provides signals on the "shadow" sides of buildings, just as light enters through a window not exposed to the sun.

Observations from the RCA building transmitter were on wavelengths of 3.5, 5, 6.5, and 8.5 meters. The lesser absorption of the longer waves was clearly observed, also their greater ability to diffract. Behind hills the 6.5- and 8.5-meter waves could be heard fairly well whereas a definite "shadow" would exist for some distance for the 3.5-meter signal. Other experiments were conducted from the RCA building to compare vertical with horizontal polarization but no definite conclusions were reached.

#### Attenuation Formula

It was observed that at such points as Battery Park, where a large number of steel buildings project themselves between the transmitting and the receiving antennas, the readings were extremely low as compared to readings taken where line-of-sight exists between antennas.

An empirical measure of this attenuation caused by large buildings was obtained in the following manner. A practically identical method was used by Fritz Schroter.<sup>2</sup> Referring to Fig. 9,  $H$  is the height of the transmitting antenna,  $h$  is the height of the receiving antenna,  $R$  is the distance between transmitter and receiver, and  $d$  is the height of the absorbing layer. In the case of Manhattan the absorbing layer consists of an agglomeration of large and small buildings.  $S$  is the portion of the propagation path in which the wave must travel through or around buildings. We may assume that field strength varies inversely as the distance between the transmitter and receiver and that it has an additional attenuation, equal to  $e^{-\alpha S/\lambda}$ . The justification for using unity as the exponent for  $\lambda$  is discussed near the end of this paper. The attenuation constant is most conveniently evaluated by comparing field strengths measured under various conditions of  $R$  and  $h$ .

$$E_1 = \frac{K}{R_1} e^{-\alpha S_1/\lambda} \quad E_2 = \frac{K}{R_2} e^{-\alpha S_2/\lambda}$$

$$\frac{E_1}{E_2} = \frac{R_2}{R_1} e^{(-\alpha S_1)/\lambda - (-\alpha S_2)/\lambda} = \frac{R_2}{R_1} e^{\alpha(S_2 - S_1)/\lambda}$$

$$\log_e \frac{E_1}{E_2} = \log_e \frac{R_2}{R_1} + \alpha \left( \frac{S_2 - S_1}{\lambda} \right) \quad (1)$$

$$\alpha = \frac{\log_e \frac{E_1}{E_2} - \log_e \frac{R_2}{R_1}}{\frac{S_2 - S_1}{\lambda}} = \frac{\log_e \frac{E_1 R_1}{E_2 R_2}}{(1/\lambda)(S_2 - S_1)} \quad (2)$$

It is obvious that  $S_1 = R_1(d_1 - h)/(H - h)$  and  $S_2 = R_2(d_2 - h)/(H - h)$ , the refraction being negligible. Therefore, substituting in (2):

$$\alpha = \left( 2.303 \log_{10} \frac{E_1 R_1}{E_2 R_2} \right) \left( \frac{\lambda}{\frac{R_2(d_2 - h)}{H - h} - \frac{R_1(d_1 - h)}{H - h}} \right)$$

$$= \left( 2.303 \log_{10} \frac{E_1 R_1}{E_2 R_2} \right) \left( \frac{\lambda(H - h)}{R_2(d_2 - h) - R_1(d_1 - h)} \right). \quad (3)$$

If  $\alpha$  is to be evaluated on the basis of  $S$  and  $\lambda$  of (1) being expressed in kilometers, as is customary, (3) becomes:

$$\alpha = \left( 7550 \log_{10} \frac{E_1 R_1}{E_2 R_2} \right) \left( \frac{\lambda(H - h)}{R_2(d_2 - h) - R_1(d_1 - h)} \right) \quad (4)$$

where  $H$ ,  $h$ ,  $R_1$ ,  $R_2$ ,  $d_1$ , and  $d_2$  are expressed in feet.

TABLE I  
EVALUATION OF ATTENUATION CONSTANT.  $H = 1300$  ft.  $h = 8$  ft.  $\lambda = 7$  meters.

| Location                    | $R$   | $d$ | $E$  | $\alpha$ |
|-----------------------------|-------|-----|------|----------|
| 86th and 5th Ave.           | 13700 | 20  | 12.5 | 0.027    |
| 86th near 5th Ave.          | 13700 | 150 | 2.5  |          |
| 81st and Central Park West  | 12600 | 20  | 15   | 0.031    |
| 73rd and Park Ave.          | 10500 | 100 | 7.5  |          |
| 14th and 10th Ave.          | 6600  | 100 | 4.5  | 0.029    |
| Battery Park                | 18500 | 300 | 1.0  |          |
| Theoretical <sup>a</sup>    | 5280  | 0   | 20   | 0.016    |
| Several three-mile readings | 15840 | 150 | 2    |          |
| 24th St.—Roof               | 3160  | 0   | 70   | 0.055    |
| 24th St.—Street             | 3160  | 150 | 30   |          |

TABLE II  
EVALUATION OF ATTENUATION CONSTANT.  $H = 1300$  ft.  $h = 8$  ft.  $\lambda = 5$  meters.

| Location              | $R$   | $d$ | $E$  | $\alpha$ |
|-----------------------|-------|-----|------|----------|
| 24th St.—Roof         | 3160  | 0   | 50   | 0.043    |
| 24th St.—Street       | 3160  | 150 | 20   |          |
| 42nd St.—High balcony | 4000  | 0   | 50   | 0.026    |
| 42nd St.—Street       | 4000  | 150 | 25   |          |
| 80th St. and 1st Ave. | 12700 | 100 | 1.9  | 0.024    |
| Battery Park          | 18500 | 300 | 0.65 |          |
| 42nd St.—High balcony | 4000  | 0   | 50   | 0.016    |
| Jericho Turnpike      | 98000 | 30  | 0.4  |          |

<sup>a</sup> Calculated for line-of-sight at one mile.

Table I shows the attenuation constants derived from forty-four-megacycle field strengths received at eight New York points. It is seen that the attenuation constants obtained vary between 0.015 and 0.055, with 0.032 as the average value. Table II shows a similar set of data for sixty-one megacycles, the average value indicated being about

0.028. With due recognition of the several approximations involved, we may assume that an attenuation constant for the propagation of ultra-short waves through or around large buildings placed rather closely together is in the order of about 0.03 when used in (1). For seven meters this corresponds to an attenuation of about thirty-seven decibels per 1000 meters, or an attenuation in carrier amplitude of 50 per cent every 500 feet. For three meters this corresponds to an attenuation of 50 per cent every 225 feet. Of course this attenuation only applies to the distance through which propagation takes place in the absorbing area "d," and is in addition to the field strength decrease, that is, inversely proportional to the distance from the transmitter.

### REFLECTION

During propagation a radio wave always experiences attenuation, sometimes a change in polarization, and usually a certain amount of diffraction or other phenomenon changing the direction of travel. The more common phenomenon causing deviation of the direction of propagation are reflection, diffraction, and refraction. All may be grouped under the general heading of deflection.

Reflection may be of two types, diffused and specular. Diffused reflection is the throwing back of a wave by a surface having irregularities large compared to the wavelength. In specular reflection, the surface is smooth, with irregularities small compared to the wavelength. Diffraction is the deviating of a wave due to its finite size such as when the wave is partially cut off by an obstacle or passes near the edge of an opening. Refraction is the deviating of a wave as it passes through a medium of variable characteristics, wherein the velocity of propagation of some portions of the wave front are slower or faster than that of other portions. Another possible effect is scattering. Scattering is the dispersing of a wave in many directions by an object small compared to the wavelength.

In the case of ultra-short waves it will be shown below that the first of these phenomenon, reflection, is very common, both inside and outside of buildings. The extent to which diffraction and refraction take place should not be prophesied until more extensive data are available. The reception of five-meter signals at distances of 200 and 300 miles at points far below the line-of-sight, and reception behind hills, indicate that diffraction or refraction or both do exist to a very noticeable degree.

Returning to the subject of simple reflection, it was found that interference patterns invariably exist except where the terrain is open and flat. They are frequently caused by reflections from relatively

near-by objects. In many cases they are so severe that excellent signals will be received in "live spots" whereas several feet away from these spots no signal can be heard. The general occurrence and severity of interference patterns on these wavelengths is of great importance in the design of antennas for ultra-short-wave broadcast reception. The question of receiver antenna design is not discussed in this paper. The existence of an interference pattern infers reception over two or more paths of propagation. If the paths of propagation are sufficiently different in length, a distortion phenomenon similar to the distortion in ordinary selective fading will take place. In the case of television, where very high modulation frequencies are used when transmitting pictures of fine detail, the difference of path length that will produce distortion is surprisingly small.

If a transmitter working at the carrier frequency  $f$  is sinusoidally modulated by an audio frequency  $q$ , with modulation factor  $k$ , the radiated signal is

$$Y = A \sin 2\pi ft(1 + k \cos 2\pi qt).$$

As is well known this may be written

$$Y = A \sin 2\pi ft + \frac{1}{2}kA \sin 2\pi(f + q)t + \frac{1}{2}kA \sin 2\pi(f - q)t. \quad (5)$$

We shall analyze the case where two propagation paths exist between transmitter and receiver. The direct received ray may be represented by equation (5). Then the indirect (reflected) ray, traveling over a path  $S$  units longer than the direct path, reaches the receiver at the time

$$t - \frac{S}{C}$$

where  $C$  is the velocity of light expressed in the same units as  $S$ . Thus the direct signal received is:

$$\begin{aligned} Y_0 = & A \sin 2\pi ft && \text{carrier} \\ & + \frac{kA}{2} \sin 2\pi(f + q)t && \text{upper side band} \\ & + \frac{kA}{2} \sin 2\pi(f - q)t && \text{lower side band} \end{aligned} \quad (6)$$

and the indirect signal received is:

$$\begin{aligned}
 Y_1 = & B \sin 2\pi f \left( t - \frac{S}{C} \right) \quad \text{--- carrier} \\
 & + \frac{kB}{2} \sin 2\pi(f+q) \left( t - \frac{S}{C} \right) \quad \text{--- upper side band} \quad (7) \\
 & + \frac{kB}{2} \sin 2\pi(f-q) \left( t - \frac{S}{C} \right) \quad \text{--- lower side band.}
 \end{aligned}$$

Assuming that the two signals are received with equal amplitude, the terms  $A$  and  $B$  may be omitted.

The condition of distortion under discussion is that where the two upper side bands arriving over the different paths arrive 180 degrees out of phase, and the two lower side bands do also, but the carriers arrive in phase. For the two upper side bands to be 180 degrees out of phase:

$$\frac{k}{2} \sin 2\pi(f+q)t + \frac{k}{2} \sin 2\pi(f+q) \left( t - \frac{S}{C} \right) = 0 \quad (8)$$

and,

$$2\pi(f+q)t - 2\pi(f+q) \left( t - \frac{S}{C} \right) = \pi, 3\pi, 5\pi, \dots = n_1 \pi. \quad (9)$$

Similarly, the two lower side bands cancel when:

$$2\pi(f-q)t - 2\pi(f-q) \left( t - \frac{S}{C} \right) = \pi, 3\pi, 5\pi, \dots = n_2 \pi \quad (10)$$

where,

$$n_1 = 1, 3, 5, 7, \text{ etc.}, \text{ and } n_2 = 1, 3, 5, 7, \text{ etc.}$$

We are interested in the case where the difference in the lengths of the propagation paths is minimum. In this case obviously  $n_2 = n_1 - 2$  for the side bands to be 180 degrees out of phase and for the carriers to be in phase. Substituting in (9) and (10),

$$2(f+q)t - 2(f+q)t + \frac{S}{C} 2(f+q) = n_1$$

$$2(f-q)t - 2(f-q)t + \frac{S}{C} 2(f-q) = n_1 - 2.$$

Subtracting,

$$2 \frac{S}{C} (f+q - f+q) = 2 \frac{4qS}{C} = 2$$

$$S = \frac{C}{2q}.$$

(11)

Thus  $S$ , the minimum difference in propagation path lengths producing cancellation of a modulation frequency of  $q$  cycles per second, is the velocity of light expressed in the same unit per second as  $S$ , divided by twice the modulation frequency. Thus  $S$  is equal to half the hypothetical radio wavelength of the modulation frequency. A similar conclusion was independently reached by Hans Roder of the radio engineering department of the General Electric Company.

Now if we assume the transmission of a television picture requiring a modulation frequency of 1,000,000 cycles, which would be a picture of good detail, equation (11) shows that a difference in path length of only 490 feet will cause the side bands corresponding to the highest modulation frequency to arrive at the receiver 180 degrees out of phase, causing partial or complete cancellation of these frequencies. It should be noted that the determining factors in producing this selective distortion are not the absolute lengths of the propagation paths or the wavelength used but rather are the difference between propagation path lengths, the number of propagation paths, and the relative field strengths of the signals arriving over the several paths.

This reduction of modulation frequencies by cancellation of side bands may be explained by considering merely that a plurality of propagation paths will produce "double images." In case of greatest detail, the picture would have its elements alternately white and black. If the signal is received from two paths differing in length sufficiently so that the wave received from the longer path is just one picture element later than the wave received from the shorter path, then for every dark picture element received from one path there will be a light picture element received from the other path at the same instant. If the signals are of equal intensity the received picture will be without image and will be of an intensity half way between light and dark. Obviously the type image referred to is unusual, but it indicates that the detailed portions of any image would be lost under the specified propagation conditions. If this "double image" analysis is applied to the 1,000,000-cycle picture previously referred to it will again be found that a difference in propagation path lengths of 490 feet will produce cancellation.

If this selective distortion phenomena occurred in practice it would be a serious hinderance to television; consequently careful observations were made at a number of points to ascertain if such distortion is produced. Pictures of 120 lines were transmitted. Fortunately, no indications of decreased picture detail were found, and therefore it may be assumed that at reasonable ranges, signals seldom if ever arrive at a receiving point over two or more propagation paths differing by as

much as 2120 feet, that being the minimum path difference producing distortion of a 120-line picture. No observations were made on pictures of greater detail than 120 lines. Observations conducted at ranges beyond thirty miles were not numerous enough to make predictions regarding image distortion at long range. Additional data on reflection are discussed below under "Signal Fluctuations."

A path length difference of somewhat less than  $S$  will of course result in partial cancellation. If the carriers arrive somewhat out of phase the modulation frequency in question will not only be partly

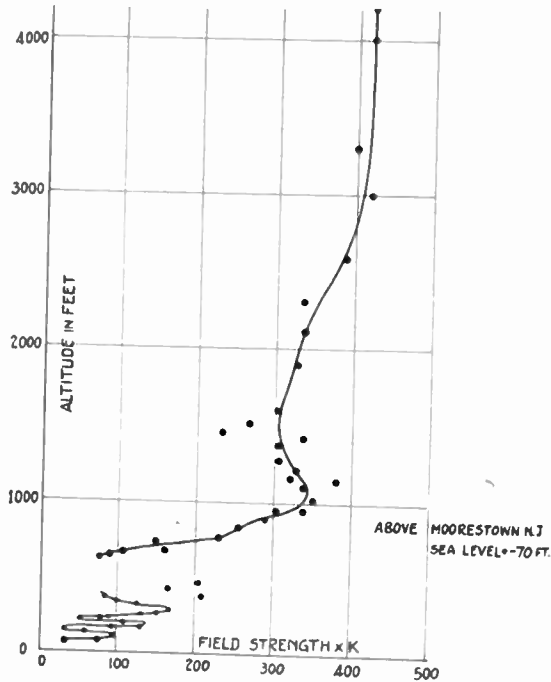

Fig. 10- Descent by autogiro over Moorestown, New Jersey.

suppressed but will also be somewhat distorted. The various types of distortion that might arise will not be discussed in this paper.

When listening to the small transmitter in the RCA building an interesting type of distortion was produced by coupling the master oscillator too closely to the power amplifier. This caused excessive frequency modulation. This frequency modulation shifted the locations, at modulation frequencies, of the maximums and minimums of the interference pattern. Thus distortion would be observed when the receiver was located on certain points of the interference pattern.



Reflections within the rooms of a residence were investigated by Messrs. Koch and Grundman of the research division in connection with the design of television receiving antennas. This paper does not deal with reception, nevertheless the field strength contour lines obtained on the first floor of the residence are reproduced in Figs. 15, 16, and 17 to indicate the general intensity of reflections. The data were obtained by using a small transmitter placed one hundred feet from

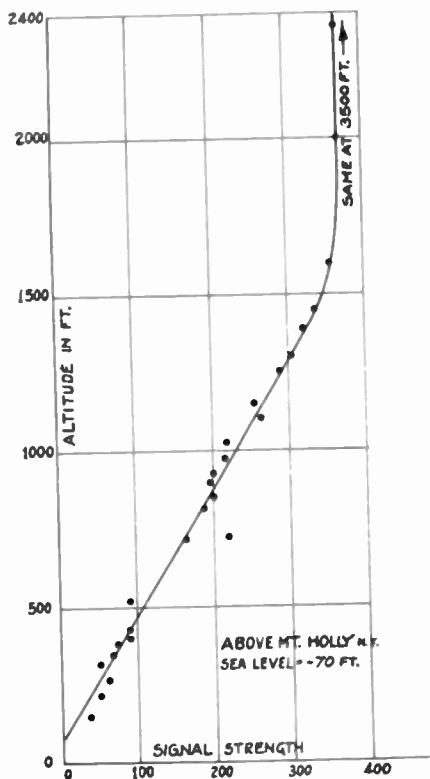

Fig. 11—Descent by autogiro over Mt. Holly, New Jersey.

the residence, and a small calibrated receiver. Polarization was vertical. Fig. 15 shows contours for a transmitted frequency of fifty megacycles. In Fig. 16 the transmitter location was shifted ninety degrees. The contours within the building changed completely. In Fig. 17 the transmitter was returned to the first location and its frequency changed to seventy megacycles. Again the contours were quite different.

For all measurements made near the ground, the predominating interference is caused by automobile ignition systems. Some makes of

cars can be heard at distances of several blocks, and all cars produce at least some interference. Airplanes in flight generally cause more trouble than automobiles but at most locations this type of interference is relatively rare. Telephone exchanges produce a distinct type of interference noise for a distance of several blocks. Street cars and elevated trains produce a clicking kind of interference, but often a six-car ele-

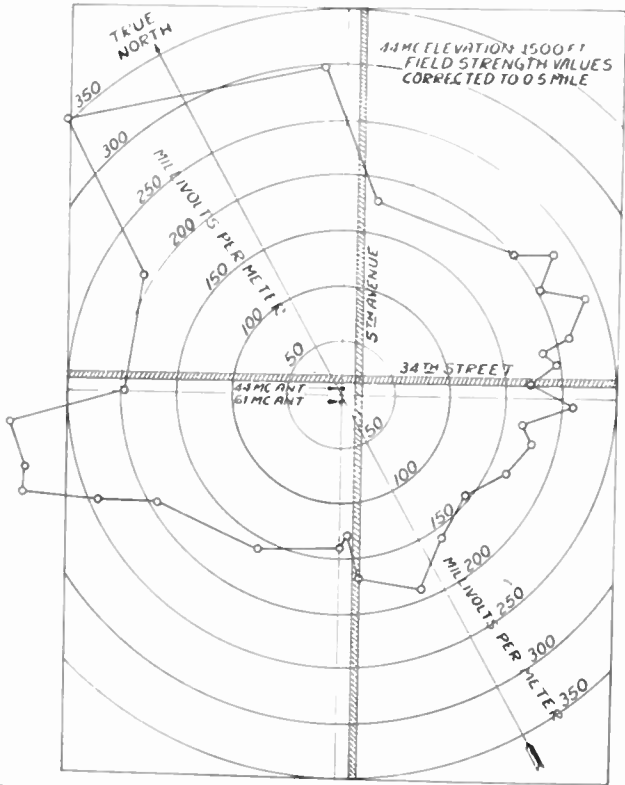

Fig. 12—Horizontal distribution of signal, 44 megacycles.

vated train is not as troublesome as single automobiles of certain makes. Interference from automobiles is effectively suppressed by means of resistors in series with the spark plugs and distributors and condensers in shunt with the generators, but in view of the great number of automobiles now in existence without such radiation suppressors, it is probable that this type of interference will be of prominence for a number of years. The ignition interference noise is best described as a series of short, sharp clicks. It was found on all wavelengths between three and ten meters with no apparent prominence at any one

wavelength. During sound reception ignition interference is noticeable at very low level due to its unpleasant sound. During television reception black or white stripes appear across the picture.

When listening some distance above the ground, such as when on the fourth floor or higher of a large building, the ignition systems of the individual engines can no longer be differentiated and it is not known whether the general noise then heard is chiefly ignition interference or not. Elevator motors are not especially bothersome but, along with

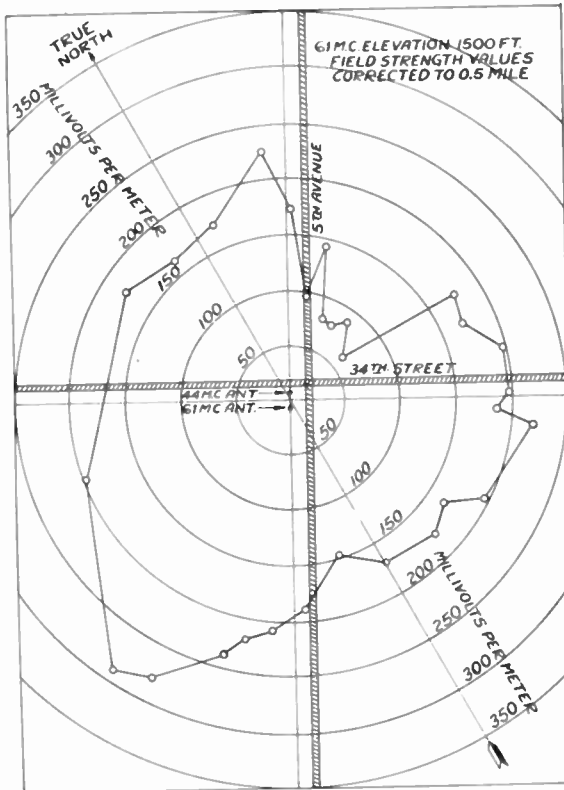

Fig. 13—Horizontal distribution of signal, 61 megacycles.

small motors, loose lighting connections, etc., cause a noticeable amount of trouble at certain locations.

Lightning struck the Empire State antennas several times when they were in operation with no effect except to produce a loud click in the output signal. Ordinary atmospheric static was not heard on ultra-short wavelengths, even during the middle of the summer, except on several occasions when lightning struck within one mile of the receiving point. Then several clicks were audible.

## MEASUREMENTS ABOVE GROUND

Fig. 10 shows measurements of field strength versus altitude, taken by Mr. C. J. Young in an autogiro over Moorestown, New Jersey. Moorestown is seventy-five miles from New York City. The field strength was practically constant from 4000 feet down to 3000, then fluctuated slightly down to 1000, and then decreased greatly during the remainder of the descent, with rapid but regular fluctuations during the last 400 feet. The causes of such relationships between field strength and altitude at distances beyond line-of-sight, and the constancy of

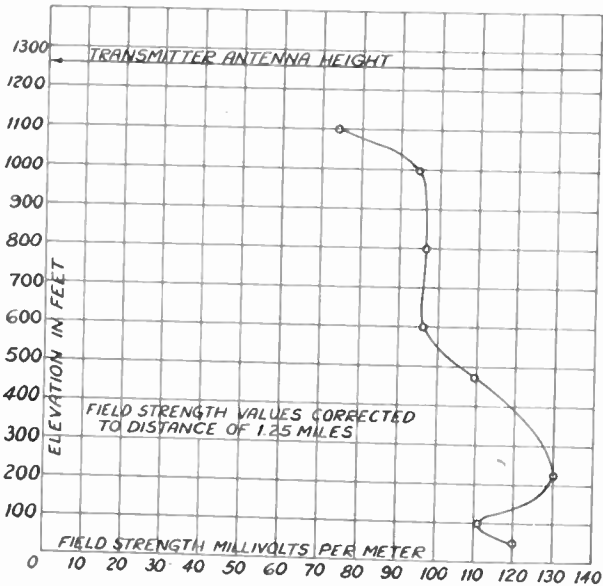

Fig. 14—Vertical distribution of signal, 44 megacycles.

this phenomena from day to day or from season to season, are not definitely known at this time. Fig. 11 shows the same data for the same frequency (forty-four megacycles) for a descent near Mt. Holly. Mt. Holly is sixty-four miles from New York City. In this case the signal strength remained constant, down to about 1500 feet, then decreased more or less linearly to the ground.

It was noted from these and other measurements made at long distances that the field strength increases with altitude far above the altitude for line-of-sight. This indicates a marked attenuation in the direct wave when it passes close to the ground before reaching the receiving antenna. At high altitudes the field strength varies essentially

inversely as the distance from the transmitter, indicating little or no absorption in propagation through clear atmosphere.

Measurements were made in the dirigible *Columbia* to explore the vertical and horizontal distribution of the field near the transmitting antennas. The ship proved somewhat unsuitable for the purpose because of the difficulty of flying in true circles, of making vertical descents, and of preventing reflections of the signals from the metal cabin. The ignition interference from one motor was very severe with the result that this motor was shut off during the test.

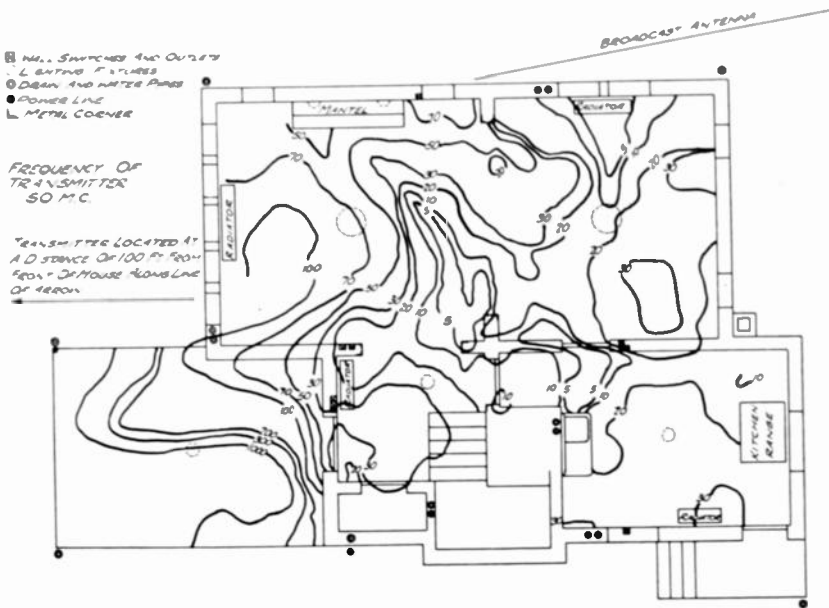

Fig. 15—Field strength within a residence, 50 megacycles.

The horizontal distribution of the field at 1500 feet for forty-four megacycles is shown by Fig. 12 and for sixty-one megacycles by Fig. 13. Except for the possibility of the action of one transmitting antenna upon the other, or of the weather instrument upon either antenna, the horizontal field patterns should be circles. The measured patterns are not circular but do not bear obvious relation to these reactions. An error was probably caused by the cross wind which prevented the center line of the ship from being perpendicular to the line to the transmitter, for most portions of the circle. Fig. 14 shows the data from one vertical descent from 1000 feet down to fifty feet. The descent was made over the East River at a distance of about 6000 feet from the

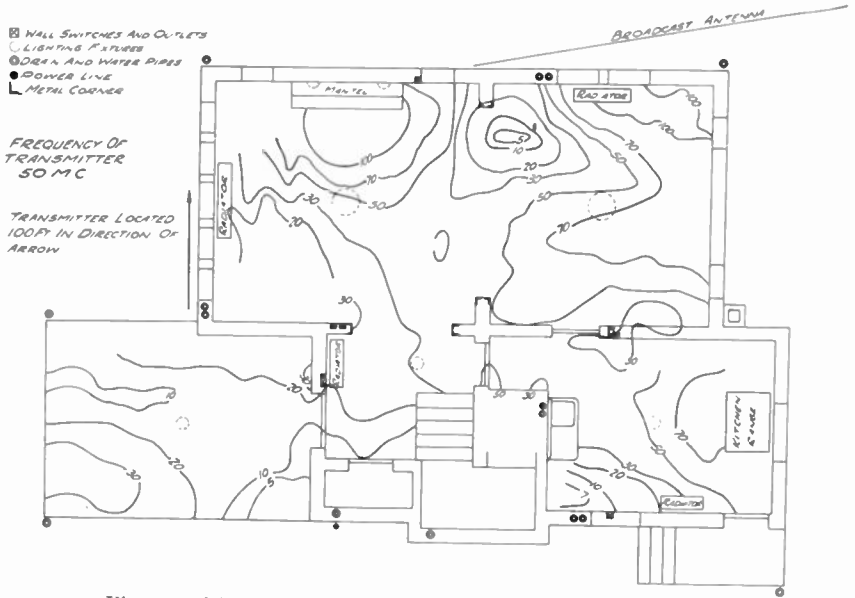

Fig. 16—Field strength within a residence, 50 megacycles.

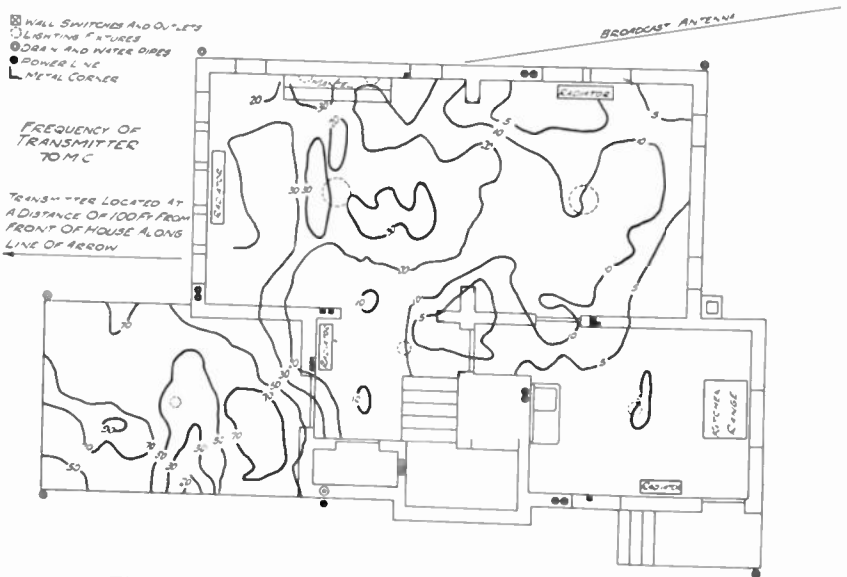

Fig. 17—Field strength within a residence, 70 megacycles.

Empire State antennas. The increase in signal strength at lower altitudes is probably accounted for by reflections from the ground and buildings, and especially from the water during the last several hundred feet of descent.

A number of observations made in the air by Bertram Trevor are described in a separate paper.<sup>4</sup>

#### SIGNAL FLUCTUATIONS NEAR TRANSMITTER

All ultra-short-wave observations made at distances within the line-of-sight have shown no indications of fading. However, a type of artificial fading caused by conditions near the receiving location was observed when receiving on the lower several floors of buildings on streets carrying considerable traffic. This type of signal fluctuation has been observed only in the business section of the city but may also apply to certain other locations. To study these fluctuations an automatic recorder was attached to the output of the field strength measuring set. Fig. 18, taken on the third floor of a large building about one

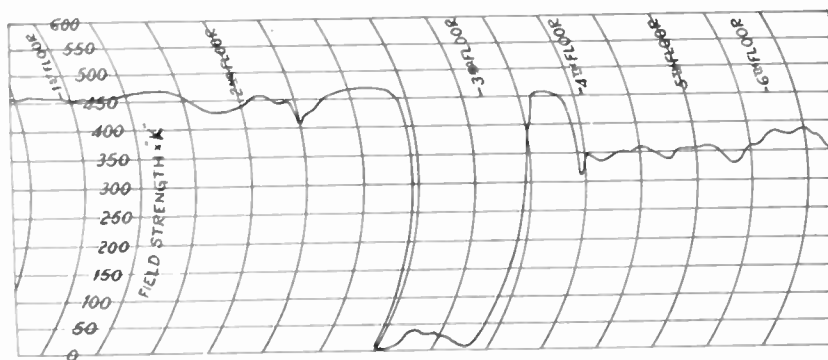

Fig. 18—Variation of field strength with elevator position.

mile from the Empire State Building, shows a severe decrease in field strength at the time when a freight elevator passed this third floor. The receiving antenna was located near the entrance to the elevator shaft. Fig. 19 shows the field strength recorded on the first floor of a large building on 24th Street at 5 p.m., whereas Fig. 20 shows exactly the same measurement taken at 9 p.m. At point "A," an automobile passed the building. The greater smoothness of Fig. 20 over Fig. 19 is accounted for almost entirely by the lack of traffic on 24th Street at 9 p.m. It is surprising to know that the receiver was located almost in the center of the building, seventy to one hundred feet from 24th

Street. The fluctuations shown had nothing to do with ignition interference, which in this case was completely overridden by the strong signal. For the measurements shown in Fig. 19 and Fig. 20 the receiv-

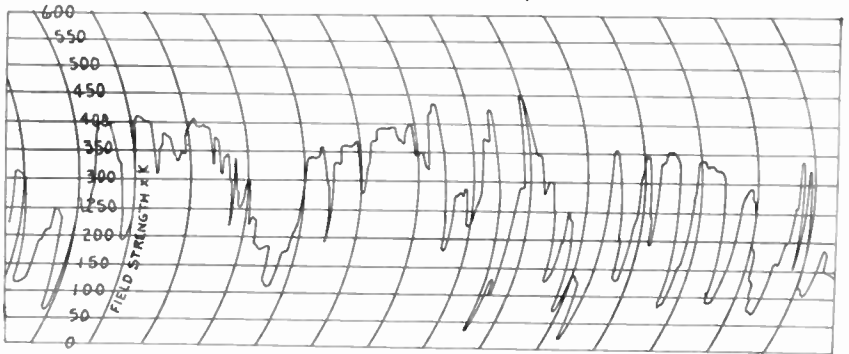

Fig. 19—Field strength at Twenty-fourth Street, 5 P.M.

ing antenna was placed at a point of minimum field strength. Fig. 21 shows a record taken at 9 P.M. with receiving antenna moved several feet to one side to a point of maximum field strength. This curve is much smoother than that in Fig. 20 and indicates the importance of locating the receiving antenna at a point of maximum field strength.

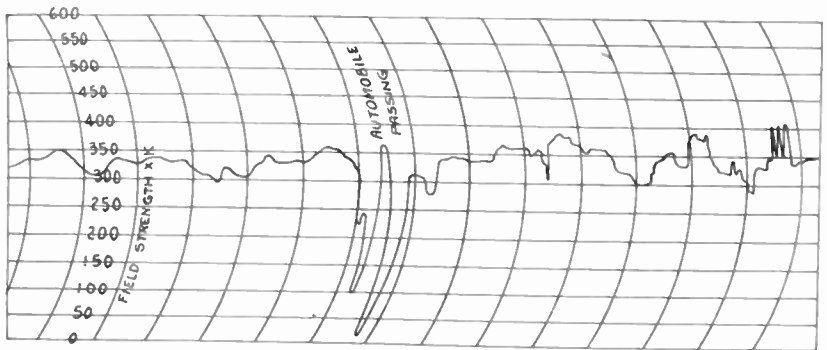

Fig. 20—Field strength at Twenty-fourth Street, 9 P.M.

Fig. 22 shows a record of field strength of the forty-four-megacycle transmitter measured on the second floor of the RCA building, near the northeast corner (51st Street and Lexington Avenue). The receiving antenna was at a point of maximum field strength. Fluctuations were of only minor extent and were less severe when the traffic lights were "go" for cross-town traffic. Fig. 23 shows the same thing with the



antenna moved several feet to a point of minimum field strength. In this case the fluctuations were prohibitively severe, particularly when Lexington Avenue traffic was running. Charts taken over a longer period of time than shown corroborate these statements. Again the

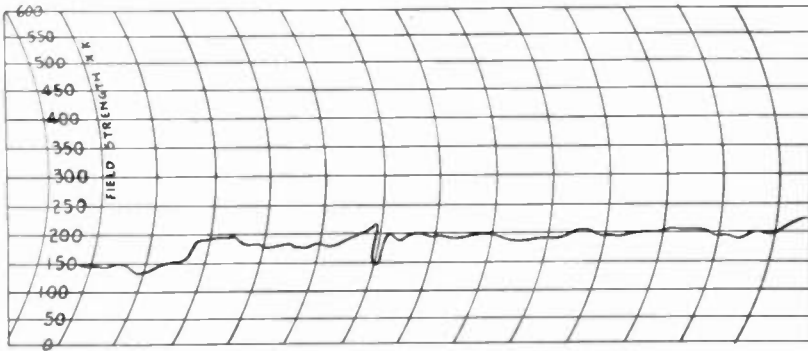

Fig. 21—Field strength at Twenty-fourth Street, 9 p.m., superior location.

necessity of locating a receiving antenna at a point of maximum field strength is made clear, and the surprising effect of moving objects upon the received field strength is shown. The major cause of the fluctuations is not so much an attenuation of the signal entering the build-

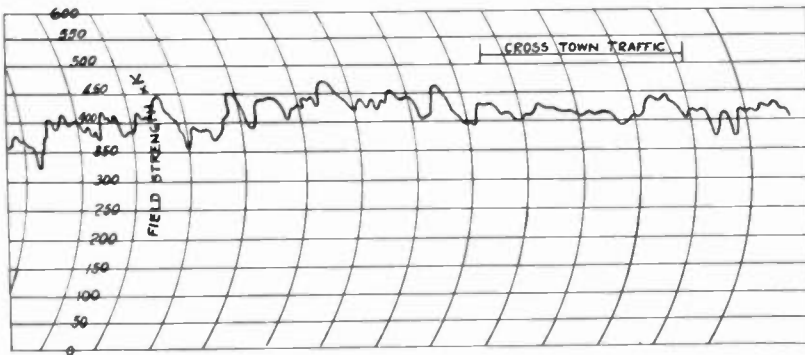

Fig. 22—Field strength in second floor of RCA building, superior location.

ing, although this effect may take place, as it is a shifting of the position and shape of the interference pattern within the building. This was indicated by locating several television receivers in a large first floor room of a downtown building. Television pictures would fluctuate in and out on the several receivers at random, seldom simultaneously, thereby indicating a shift of position of the interference pattern. It has

been shown that elevators, automobiles, and trucks cause the fluctuations under discussion, and undoubtedly any moving metal object such as elevated trains and steel frame doors will have similar results. It is well known that a person walking near a half-wave ultra-short-wave receiving antenna will considerably affect the amplitude of the received signal. These fluctuations must be taken into account in designing ultra-short-wave broadcast receivers and receiving antennas.

Observations made on the first floors of residences in the suburban area, and on the higher floors of apartment houses and hotels in the city areas, indicate that fluctuations are much less severe when the receiving point is not near traffic. Fluctuations of the severity shown

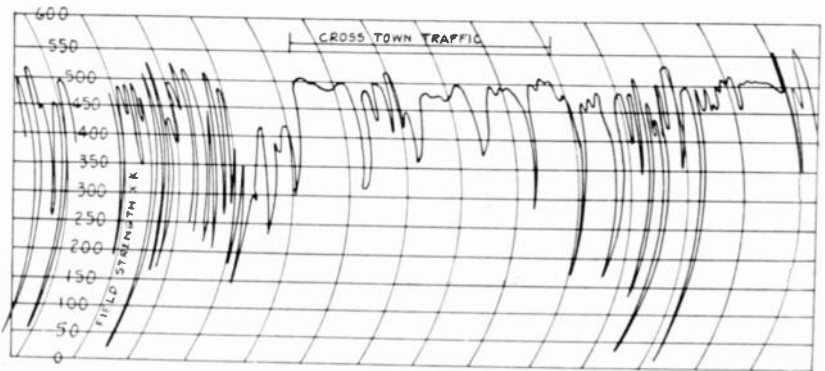

Fig. 23—Field strength in second floor of RCA building, inferior location.

above will not have to be contended with in the majority of ultra-short-wave broadcast receiver installations.

#### LONG-DISTANCE RECEPTION

To find the maximum range of the transmitters, observations were made at several distant points including Mt. Greylock and Mt. Washington. The high sensitivity receiver previously described was used for these tests, with a half-wave antenna fifteen or twenty feet above ground. Both the sixty-one- and forty-four-megacycle transmissions were observed, the observations usually being carried on alternately on each frequency for periods of ten to fifteen minutes. (See Fig. 28.)

The top of Mt. Greylock is 3505 feet above sea level, 140 miles from New York, and 5000 feet below line-of-sight to the Empire State antennas. Both signals were received at Mt. Greylock, with large but gradual variations in signal strength. During the eclipse of August 31, 1932, nothing unusual was observed.

The top of Mt. Washington is 6290 feet above sea level, 284 miles from New York, and 37,600 feet below line-of-sight to the Empire State antennas. On September 3 both signals were strong. Thereafter, on September 6, 7, and 8, the forty-four-megacycle signal was usually audible but seldom delivered more than one microvolt to the receiver terminals. The sixty-one-megacycle signal was inaudible most of the time. Its apparent inferiority may be accounted for by the use of program modulation, which was not as favorable for threshold hearing as the 1000-cycle tone used on forty-four megacycles.

Various types of fading phenomena presented themselves. At times the signal was nearly constant and at other times faded at various rates up to ten or twenty cycles per second. The peak amplitudes varied greatly. Sometimes the signal would burst through sharply for a short period, then be inaudible for a few seconds, then rapidly burst through again at different amplitudes. At other times marked fading at several cycles per second would be heard, the signal frequently dying out after five or six peaks. At times 2000 cycles, the second harmonic of the modulation frequency, was distinctly heard. On September 8, at 9:35 A.M., the signal, after being very weak whenever observed during the previous two days, suddenly started to increase. After a series of fading cycles, with each peak higher than the previous one, the signal delivered over ten microvolts to the receiver terminals. After reaching this peak the signal died off in a similar manner, the entire process lasting about fifteen seconds. During the peak of the cycle the signal varied from zero to its full value about three times per second. These types of ultra-short-wave fading differ from the fading experienced on higher wavelengths in that, instead of the signal varying between relatively fixed maxima and minima, it reaches momentarily an occasional maxima of great intensity.

Measurements were made at 200, 150, and 100 miles from New York at relatively low elevations. At 200 miles the signal was momentarily audible about every ten minutes or so. At 100 miles reception was almost identical to that on Mt. Washington, the same phenomena being noticed. This was north of New York. At Camden, eighty-five miles south of New York, the signal evidences less severe fluctuations. An observation taken at sea 170 miles east of New York, using an antenna sixty feet above sea level, indicated little or no variation in signal strength. Therefore long-distance reception is not always accompanied by severe fluctuations of the signal.

The exact manner in which long-distance ultra-short-wave propagation takes place cannot be predicted from the insufficient data on hand. Three possibilities regarding the Mt. Washington reception

seem highly improbable. The first is that local conditions around the receiver caused some of the variations. This is unlikely because conditions near the location were exceptionally constant due to the isolation of the location. Also identical results were obtained at several points of reception.

The second possibility is that the variations were caused by a single ray varying in amplitude. This may have occurred when the signal varied irregularly. But at times periodic fading was observed, and it is improbable that a single ray would vary uniformly at a rate of several cycles per second. Furthermore, the reception of a 2000-cycle tone intimates the existence of multipath propagation.

The third possibility is that the variations were caused by interference between two ground rays or between a ground ray and some other ray. A ground ray would be highly improbable at Mt. Washington due to the great attenuation. Furthermore, since all signal variations heard were relatively rapid, cancellation of the steady ground wave should be for only brief periods, whereas actually the signal was often inaudible for hours. The presence of a ground wave of the type observed for higher wavelengths, therefore, seems unlikely.

Whether the signals heard were diffracted or refracted or propagated in some unknown manner cannot be predicted as yet. It is possible that refraction due to air layers of different density, as suggested by R. Jouaust<sup>6</sup> is a cause of the fluctuations observed. If such fluctuations are ever controlled or eliminated, ultra-short wavelengths may prove useful for services extending to several hundred miles.

#### SERVICE AND INTERFERENCE RANGES

It seems incorrect to refer to a definite service range for an ultra-short-wave broadcast station. Conditions at receiver locations are so highly variable that many listeners twenty-five miles from a transmitting station will receive good service, when many fifteen miles from that station will receive poor service. Interference noises on wavelengths between three and ten meters propagate rather poorly, and therefore are sources of interference only in their immediate vicinity. Frequently a receiver several hundred yards from another will receive a serviceable signal when the other will not. Of course, this condition also occurs between the wavelengths of 200 and 550 meters, but not to such a great extent since interferences on higher wavelengths attenuate less rapidly and, in the case of thickly populated areas, tend to blend together into a considerably more

<sup>6</sup> R. Jouaust, "Some details relating to the propagation of very short waves," *Proc. I.R.E.*, vol. 19, pp. 479-488; March, (1931).

uniform "interference level" than is found on ultra-short waves. Therefore, any estimation of service range for ultra-short-wave broadcast transmission must be made with the full knowledge that it is only an average range. Many listeners within and without the range will receive unserviceable and serviceable signals, respectively. From the television observations and field strength measurements made under various conditions at points in and around New York, it seems that the average minimum field strength required for a serviceable 120-line television signal using simple half-wave receiving antennas is at least one millivolt. Higher field strength would have been needed for receiving pictures with more lines, because the receiver would have been designed to cover wider side bands with resulting increase in noise pick-up. The use of improved receiving antennas and higher receiving antenna locations might have permitted the proper reception of 120-line television signals with available field strengths of somewhat less than one millivolt.

Referring to Figs. 6 and 7, it is seen that the 120-line picture service range of the Empire State forty-four-megacycle transmitter is fifteen miles or more, depending on the type of receiving antenna used. With due care in designing and installing receiving antennas, the Empire State transmitters will adequately serve the majority of the urban and suburban areas of the country's largest city.

The interference range of ultra-short-wave transmitters is difficult to define due to the major dependence of the field strength upon altitude. As a consequence the question of whether or not a city 100 miles from an ultra-short-wave transmitter will receive interference depends largely upon the elevations of the two cities and the two antennas, and the elevations of the territory between them. It seems that transmitters of several kilowatts power with antennas approximately as high as those on the Empire State building should not be located as near to each other as 100 miles, if high quality broadcast service is to be rendered.

The data discussed above on attenuation, reflection, interference, signal fluctuations, and service range should be of some assistance in planning the use of the ultra-short-wave band. But some empirical formula is needed to show the relationship between wavelength, power, attenuation, and transmitter antenna height, especially as applied to propagation in metropolitan areas.

The presentation of any ultra-short-wave propagation formula, even though empirical, is accompanied by some hesitation at this comparatively early stage of ultra-short-wave investigation. However, although the formula and curves given below for propagation over urban

territories should be considered as preliminary, they are thought to be of enough value to justify their publication.

The calculated field strength is again based on the assumption that the wave, passing from transmitter antenna to receiver, first passes only through clear atmosphere with field strength inversely proportional to distance and then passes through a layer of height " $d$ " in which trees and buildings and other objects produce an additional attenuation due to absorption. We are now interested in calculating field strengths for distances greater than several miles and the value of  $\alpha$  found for propagation through large buildings cannot be used, neither can equation (3), because it does not take into account the curvature of the earth.

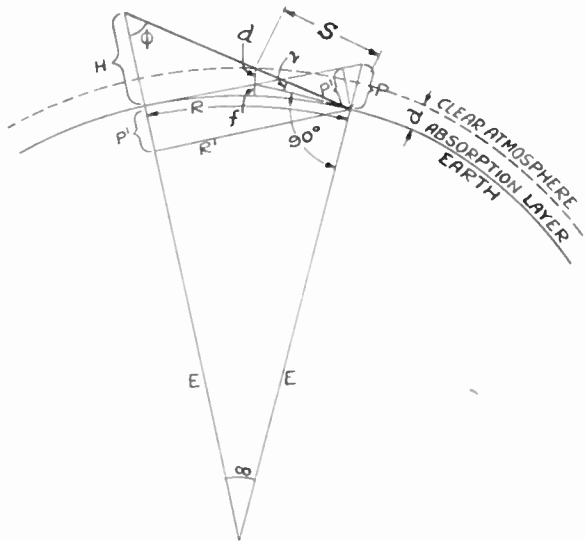

Fig. 24

Referring to Fig. 24,  $H$  is the transmitter antenna height,  $d$  is the height of the absorbing layer,  $R$  is the distance from transmitter to receiver, and  $P$  is the elevation needed for tangential line-of-sight to the distance  $R$ . The receiver antenna is assumed to be within a few feet of the ground. When it is not, the value chosen for  $d$  should be reduced accordingly.

$$\gamma + 90^\circ + \phi + \alpha = 180^\circ$$

$$\gamma = 90^\circ - \phi - \alpha.$$

It is well known that for distances not exceeding several hundred

miles, the range of vision to point of tangency varies as the square root of the elevation. Thus,

$$R = K\sqrt{P} \quad P = \frac{R^2}{K^2}$$

For  $R$  and  $P$  in feet,  $K=6500$ . Since  $\alpha$  is not over several degrees,  $P$  practically equals  $P^1$ , and  $R$  practically equals  $R^1$ . These will be considered as equalities.

$$\phi = \cos^{-1}\left(\frac{H + P}{R}\right) = \cos^{-1}\left(\frac{H + \frac{R^2}{K^2}}{R}\right)$$

$$\alpha = \sin^{-1}\left(\frac{R}{E}\right)$$

$$\gamma - 90^\circ = -\cos^{-1}\left(\frac{H + \frac{R^2}{K^2}}{R}\right) - \sin^{-1}\left(\frac{R}{E}\right)$$

$$90^\circ - \gamma = \cos^{-1}\left(\frac{H + \frac{R^2}{K^2}}{R}\right) + \sin^{-1}\left(\frac{R}{E}\right)$$

$$\cos(A + B) = \cos A \cos B - \sin A \sin B$$

$$\cos(90^\circ - \gamma) = \sin \gamma = \cos \left[ \cos^{-1}\left(\frac{H + \frac{R^2}{K^2}}{R}\right) \right] \cos \left[ \sin^{-1}\frac{R}{E} \right]$$

$$- \sin \left[ \cos^{-1}\left(\frac{H + \frac{R^2}{K^2}}{R}\right) \right] \sin \left[ \sin^{-1}\frac{R}{E} \right]$$

$$\sin \gamma = \left(\frac{H + \frac{R^2}{K^2}}{R}\right) \sqrt{1 - \frac{R^2}{E^2}} - \frac{R}{E} \sqrt{1 - \left(\frac{H + \frac{R^2}{K^2}}{R}\right)^2}$$

Just as,

$$P = \frac{R^2}{K^2}, \quad f = \frac{S^2}{K^2}$$

$$S \sin \gamma = d - f = d - \frac{S^2}{K^2}$$

Solving,

$$S = \frac{K^2 \sin \gamma \pm \sqrt{K^4 \sin^2 \gamma + 4dK^2}}{2} \quad (12)$$

If  $H$ ,  $E$ ,  $R$ ,  $d$ , and  $S$  are in feet,  $K = 6500$  and  $E = 19.4 \times 10^6$ . Then,

$$\sin \gamma = \left( \frac{H + \frac{R^2}{6500^2}}{R} \right) \sqrt{1 - \left( \frac{R^2}{376.4 \times 10^{12}} \right)} - \left( \frac{R}{19.4 \times 10^6} \right) \sqrt{1 - \left( \frac{H + \frac{R^2}{6500^2}}{R} \right)} \quad (13)$$

$$S = [42.2500 \times 10^6 \times \sin \gamma \pm \sqrt{(17.8506 \times 10^{14} \times \sin^2 \gamma) + (4d \times 42.2500 \times 10^6)}] / 2. \quad (14)$$

Values of  $\sin \gamma$  for use in (14) are found by (13). The distance  $S$  then given by (14) is the distance through which absorption will take place. The field strength  $E_s$  may be represented by the equation

$$E_s = \frac{K_0 \sqrt{W}}{R_0} e^{-\alpha S_0 / \lambda} \quad (15)$$

where,

$W$  = antenna power in watts

$R_0$  = total distance in kilometers =  $1.61 \times R$ .

$S_0$  = absorption distance in kilometers =  $1.61 \times S$ .

$\lambda$  = wavelength in kilometers

$K_0$  = constant

$E_s$  = field strength in millivolts per meter.

The exponent of  $\lambda$ ,  $x$ , has been evaluated at unity, which value seems to render the closest agreement between (15) and the available measurements. By comparison with the measurements it is found that  $K_0$  should be evaluated at 0.72. This does not check with the theoretical value but, for the sake of consistency in this paper, it will be used in calculating the curves below. Then, whether absolute values of field strength are correct or not, the relative values will be correct and conclusions regarding service areas will be unaffected by any error in  $K_0$ . Therefore,

$$E_s = \frac{0.72 \sqrt{W}}{R_0} e^{-\alpha S_0 / \lambda} \quad (16)$$



To evaluate  $d$ , the only unknown in the equation for  $S$  (equation (14)), and  $\alpha$ , which is the only remaining unknown of (16), several values of each were chosen arbitrarily and curves calculated for  $H=1300$  which is the value corresponding to the Empire State antennas. Comparison of the calculated and measured curves indicated that  $d=25$  feet and  $\alpha=0.004$  were appropriate empirical values to choose. Fig. 25 shows the correlation, on forty-four and sixty-one megacycles, between the calculated and measured field strengths. The empirical constants were purposely chosen to indicate greater attenuation than the actual measurements because the curves of actual measurements are somewhat optimistic at long distances due to favorable selection of the distant points of measurement.

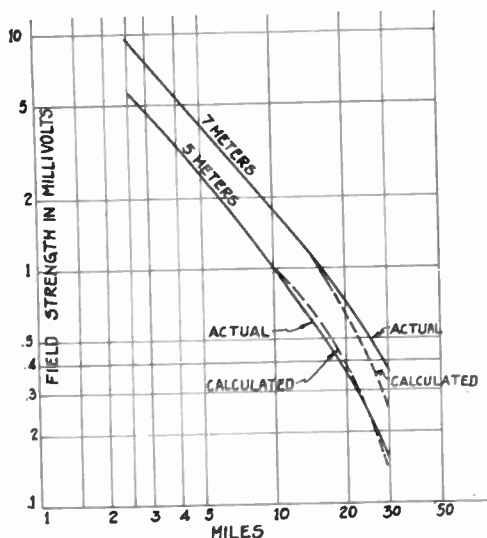

Fig. 25—Actual and theoretical attenuations.

Using the values of  $d$  and  $\alpha$  that were chosen, Fig. 26 shows the relationship between field strength, antenna height, distance, and wavelength. These curves are based on a power of one kilowatt but of course are applicable to any power,  $E$ , varying as the square root of the power. These curves are very useful in showing the increasing importance of antenna height with increasing distance, the necessity of very high antennas or very high powers for good television broadcast service, and the increasing superiority of the higher wavelengths with increasing distance.

Fig. 27 contains part of the information of Fig. 26 in a different

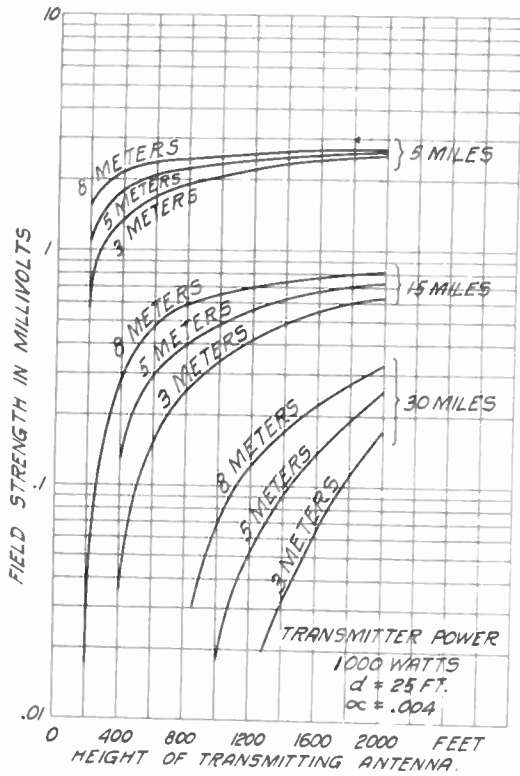

Fig. 26—Field strength vs. transmitter antenna height.

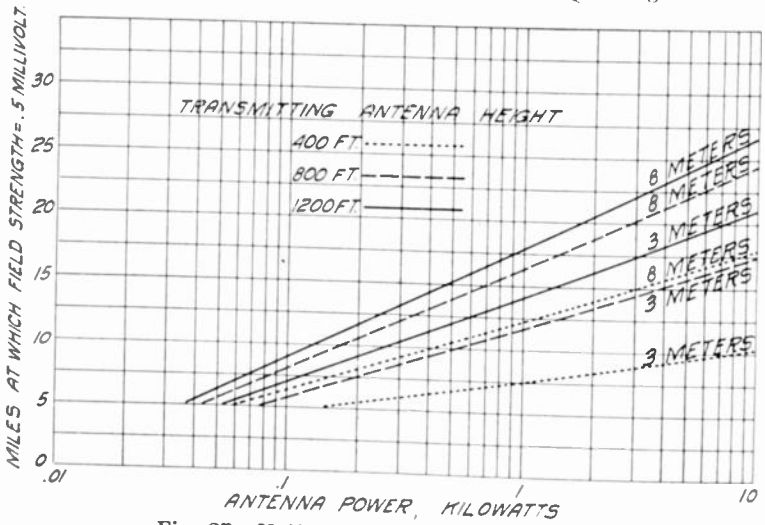

Fig. 27—Half-millivolt range vs. kilowatts.

form. It shows the range at which 0.5 millivolt will be obtained for various values of transmitter power, antenna height, and wavelength.

It must be emphasized that the field strengths shown in Fig. 26 and Fig. 27 are for outdoor points near the ground, such as when making measurements by automobile, and that higher intensities are always available by installing outdoor receiving antennas at higher elevations. The field strengths of Figs. 26 and 27 can be somewhat increased, for a given transmitter power, by the utilization of transmitting antennas producing greater horizontal concentration of the radiated energy. It must again be mentioned that the curves are based on (16), where  $K_0$  was arbitrarily chosen as 0.72 for the reasons stated, and furthermore that the curves do not apply to field strengths beyond

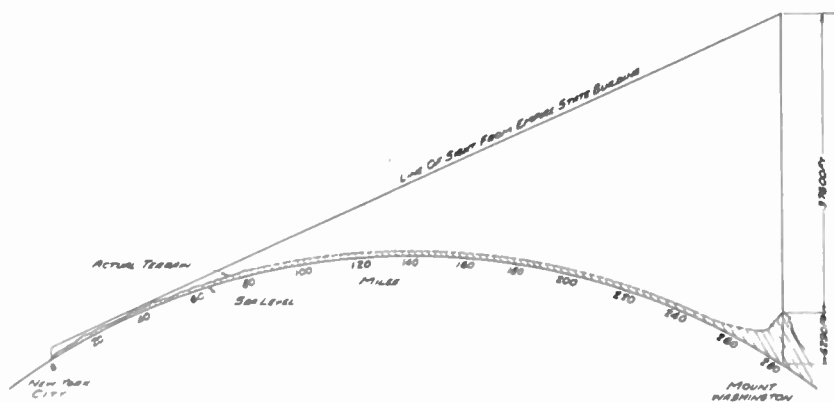

Fig. 28—Profile from New York to Mt. Washington.

the line-of-sight distance. The long-distance airplane observations indicated little or no absorption of the wave when the receiving point is sufficiently high so that the wave does not pass near the ground. Thus a five-meter transmitter with antenna 800 feet above ground will produce approximately the same field strength at 100 miles at high altitude as at fifteen miles on the ground.

### CONCLUSIONS

It is hoped that the above data and discussion will assist in visualizing the propagation of ultra-short waves and in bringing about their intelligent utilization. It is apparent that their propagation characteristics are as would be expected for wavelengths longer than those of light but shorter than those generally used for radio, and that no inexplicable phenomenon of immediate importance has as yet been encountered. It is assured that for the transmission of television broad-

casting, sound broadcasting, facsimile broadcasting, aircraft communications, police communications and certain other types of public and private communications, ultra-short waves will prove definitely useful.

#### ACKNOWLEDGMENT

Mr. W. S. Duttera of the National Broadcasting Company assisted in the measurement of signal fluctuations, and throughout all tests the coöperation of Messrs. R. M. Morris and R. E. Shelby of the same company was invaluable. Mr. C. J. Young of RCA Victor conducted the autogiro tests. Other engineers of RCA Victor who contributed to a major extent to the conducting of the tests were Messrs. G. L. Beers, R. D. Kell, A. H. Turner, H. E. Gihring, K. S. Sherman, and John Evans.



## NOTES ON PROPAGATION OF WAVES BELOW TEN METERS IN LENGTH\*

By

BERTRAM TREVOR and P. S. CARTER

(RCA Communications, Inc., Riverhead, L. I., N. Y.)

*Summary*—The results of a number of measurements of field strength variation with distance from the transmitter and height above ground for several wavelengths in the range below ten meters are shown. Observations of the two transmitters on the Empire State Building in New York City, on 44 and 61 megacycles, were made in an airplane over Long Island. These tests show the nature of the interference patterns set up by the combination of the direct and reflected rays. With low transmitting and receiving antennas, field strength measurements with distance were taken for both horizontal and vertical polarizations over Long Island sand on 41.4 and 61 megacycles. Similar tests were made over salt water with low antennas on 34.8 and 59.7 megacycles. Another airplane test was made on 34 megacycles with a higher transmitting antenna and increased power up to a distance of 200 kilometers. The intervening territory in this run was partly land and partly salt water.

The experimental data are discussed in comparison with the theoretical curves determined from optical principles. The experimental results are shown to conform in general with the predictions from theoretical considerations.

The derivation of the theoretical formulas is shown in the appendix.

### INTRODUCTION

WITH the increasing use of wavelengths below ten meters in connection with radio communication and television, it has become increasingly apparent that our knowledge of the propagation of waves in this range should be augmented. In a previous paper<sup>1</sup> the results of some experiments made by engineers of R.C.A. Communications, Inc., were described in a qualitative way. More recent developments of receiving and transmitting apparatus has made it possible to obtain quantitative data. At the present writing considerable additional information of value has been accumulated.

Experiments were made with several wavelengths over salt water and over Long Island ground with both horizontal and vertical polarizations on frequencies between 61 and 34 megacycles. A few tests were made on 435 megacycles but no quantitative information is available.

\* Decimal classification R113×R270 Original manuscript received by the Institute, November 7, 1932. Presented before New York meeting, November 2, 1932.

<sup>1</sup> H. H. Beverage, H. O. Peterson, and C. W. Hansell, "Application of frequencies above 30,000 kilocycles to communication problems," Proc. I.R.E., vol. 19, no. 8, pp. 1313-1333; August, (1931).

## I. EXPERIMENTS

*Propagation Over Long Island for Frequencies of 44 and 61 Megacycles*

A number of measurements of field strength from two transmitters located in the Empire State Building were made in an airplane flying over Long Island. The transmitting antennas were located above the Empire State tower at a height of 396 meters above sea level and were radiating vertically polarized waves on 61 and 44 megacycles. The receiver used for measuring field strengths consisted of three stages of tuned radio-frequency amplification and high-frequency detector in one unit, feeding into a revamped RCA AR-1286 aircraft beacon receiver serving as an intermediate-frequency amplifier, at 3113 kilocycles, second detector, and direct-current amplifier. The output of the direct-current amplifier was maintained constant on a milliammeter in the plate circuit of this tube. With this set-up no modulation was required and the carrier alone was used for observing field strengths.

The receiver with its supply batteries was installed in a Curtiss-Robin cabin monoplane with complete bonding and shielding to eliminate ignition interference. A vertical duralumin pipe two meters long mounted on the fuselage near the rear edge of the wing served as an antenna. Each observation of field strength included readings of both radio-frequency and intermediate-frequency screen-grid voltages to give constant output of the direct-current amplifier, and a record of altitude and location.

The calibration of receiver and antenna in the plane was effected by observing the output of a signal generator radiating a calculated field strength at a measured distance of about one wavelength.

It was found that the receiving antenna was quite directive on 61 and fairly nondirective on 44 megacycles. The directive diagram on 61 megacycles is shown in Fig. 1, and was obtained by flying in a flat circle over the Suffolk County Airport. It will be seen that the antenna directivity on 61 megacycles shows a variation of nearly 2 to 1. Some of the data taken were corrected for this directivity.

The profile map, Fig. 2, shows Farmingdale to have direct vision to the Empire State Tower. Patchogue comes 30 meters, Suffolk Airport 259 meters, and Montauk Point 1120 meters below the line of sight. Field strength readings were taken from 0 to 1200 meters altitude at North Beach, Farmingdale, Patchogue, Suffolk Airport, and Montauk Point. Also, readings were taken at altitudes of 300 and 1200 meters flying between these points. Both transmitters were observed in this manner with the exception that data were taken at 900 meters in place of 300 meters on 61 megacycles between Southampton

and Montauk Point, because the signal below 900 meters was too weak to measure. At Southampton readings were taken at altitudes of from 200 to 1200 meters on 61 megacycles.

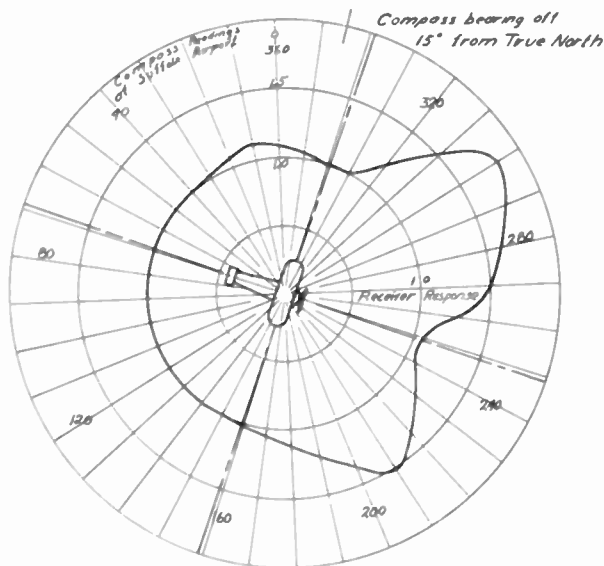

Fig. 1—Directive diagram of airplane antenna, 61 megacycles.

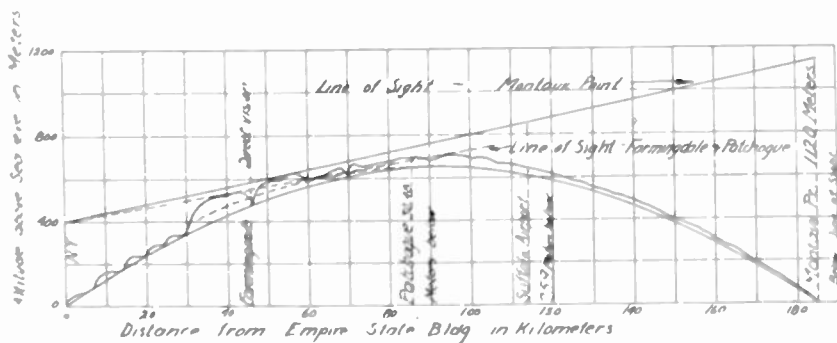

Fig. 2 Profile map airplane route from Empire State building over Long Island

Figs. 3 to 7 show the field strength variation with altitude at North Beach, Farmingdale, Patchogue, Suffolk Airport, and Montauk Point on 44 megacycles. The irregularities of Figs. 3, 4, and 5 show marked interference phenomena. As the interference patterns become more frequent nearing the transmitter, the variations in field strength were

so rapid that it was not possible for the observer to record them all. For this reason the curve, Fig. 3, from readings taken at North Beach, was drawn in by guess work.

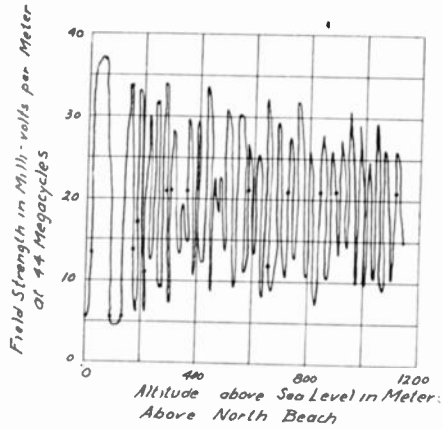

Fig. 3—Field strength vs. altitude at North Beach, 9.6 kilometers from Empire State 44-megacycle transmitter. Radiation 2 kilowatts.

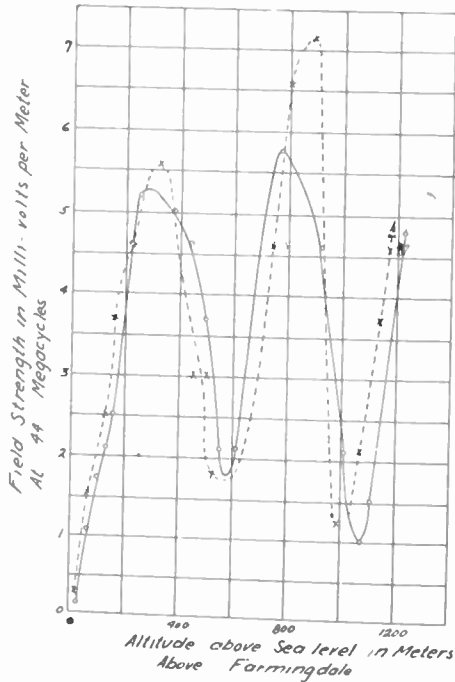

Fig. 4—Field strength vs. altitude at Farmingdale, 47 kilometers from Empire State 44-megacycle transmitter. Radiation 2 kilowatts.



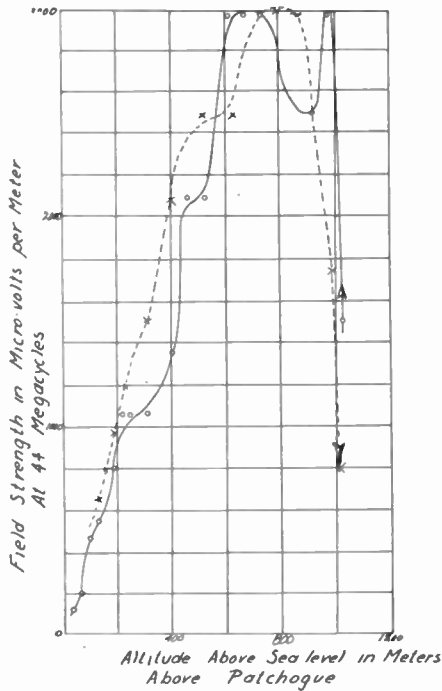

Fig. 5—Field strength vs. altitude at Patchogue, 85 kilometers from Empire State 44-megacycle transmitter. Radiation 2 kilowatts.

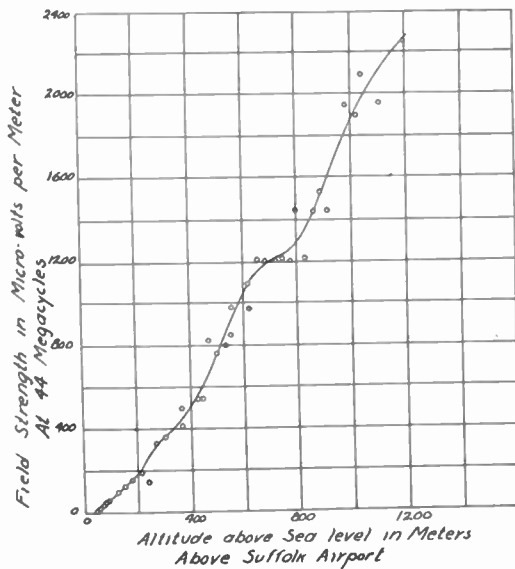

Fig. 6—Field strength vs. altitude at Suffolk Airport, 114 kilometers from Empire State 44-megacycle transmitter. Radiation 2 kilowatts.

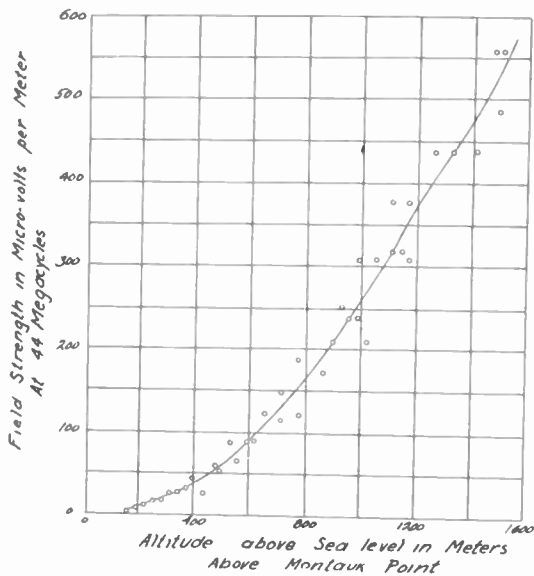

Fig. 7—Field strength vs. altitude at Montauk Point, 185 kilometers from Empire State 44-megacycle transmitter. Radiation 2 kilowatts.

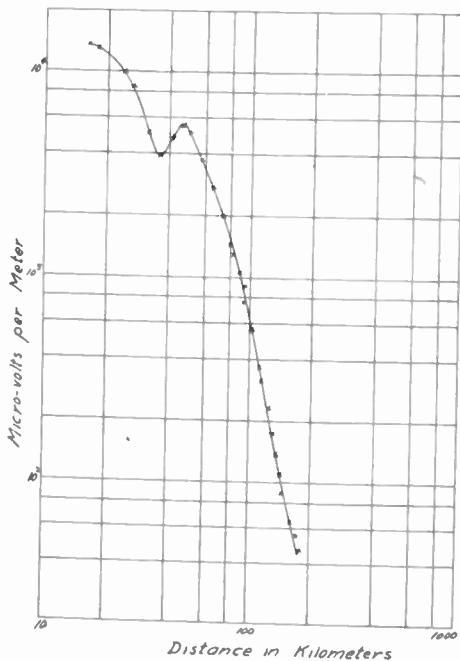

Fig. 8—Field strength vs. distance at 300 meters altitude—Empire State 44-megacycle transmitter. Radiation 2 kilowatts.

Fig. 8 represents the results of measurements when flying at 300 meters altitude between North Beach and Montauk Point, while Fig. 9

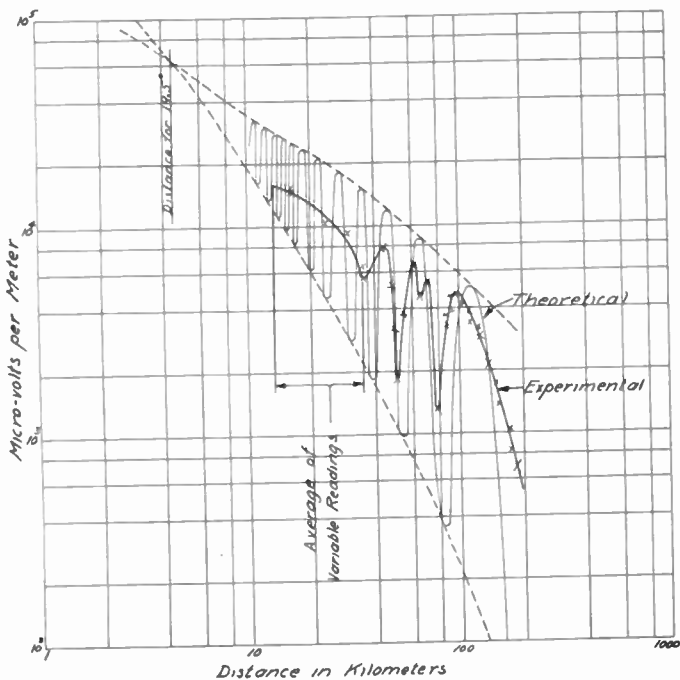

Fig. 9—Field strength vs. distance at 1200 meters altitude—Empire State 44-megacycle transmitter. Radiation 2 kilowatts.

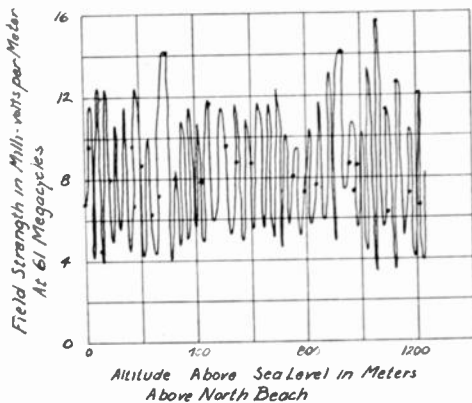

Fig. 10—Field strength vs. altitude at North Beach, 9.6 kilometers from Empire State 61-megacycle transmitter. Radiation 1 kilowatt.

is a similar curve showing the readings taken while flying at a 1200-meter altitude over the same route.

The curve, Fig. 4, from data taken at Farmingdale shows two distinct minimum points at 580 and 1000–1070 meters. The maximum points occur at 305, 760–910, and about 1200 meters. The two curves represent data taken descending and ascending, as shown by the direction of the arrows.

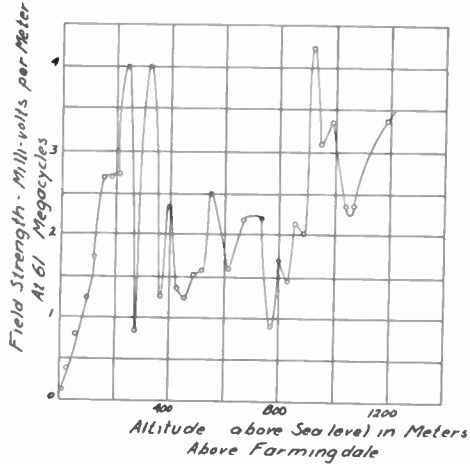

Fig. 11—Field strength vs. altitude at Farmingdale, 47 kilometers from Empire State 61-megacycle transmitter. Radiation 1 kilowatt.

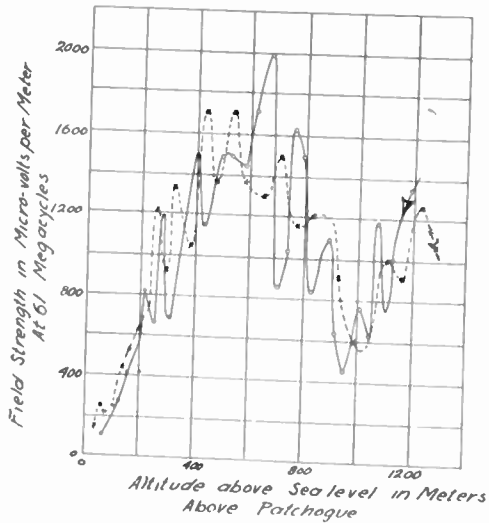

Fig. 12—Field strength vs. altitude at Patchogue, 85 kilometers from Empire State 61-megacycle transmitter. Radiation 1 kilowatt.

The data for 61 megacycles were more erratic than those on 44 megacycles, due partly to more uncertainty in the directivity of the

receiving antenna, more frequent interference effects, and possibly to more irregular reflections from large objects. Figs. 10 to 15 show the data on 61 megacycles at North Beach, Farmingdale, Patchogue, Suf-

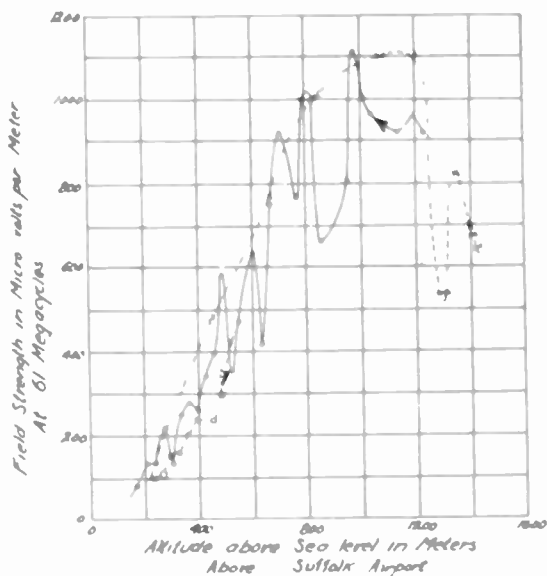

Fig. 13—Field strength vs. altitude at Suffolk Airport, 114 kilometers from Empire State 61-megacycle transmitter. Radiation 1 kilowatt.

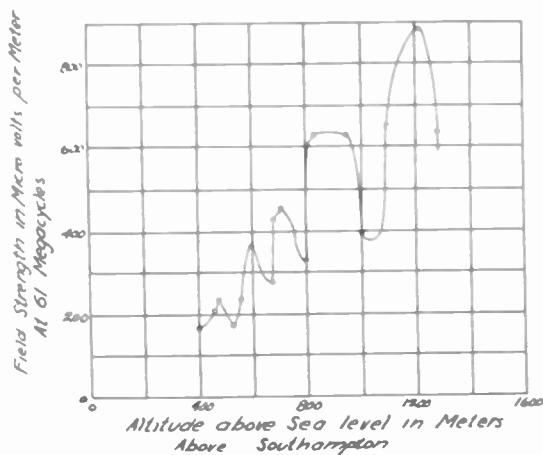

Fig. 14—Field strength vs. altitude at Southampton, 137 kilometers from Empire State 61-megacycle transmitter. Radiation 1 kilowatt.

folk Airport, Southampton, and Montauk Point. Fig. 10 is merely a symbolic representation of actual conditions as the interference effects were crowded extremely close together. The variation in field strength on 61 megacycles at Farmingdale and Patchogue follows a rapid oscillation in addition to the slower variation corresponding roughly to the curves for 44 megacycles.

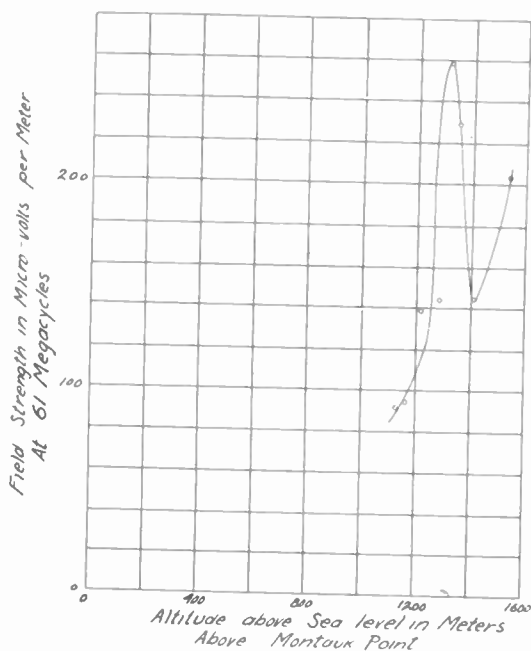

Fig. 15—Field strength vs. altitude at Montauk Point, 185 kilometers from Empire State 61-megacycle transmitter. Radiation 1 kilowatt.

#### *Measurements on the Ground with Low Transmitting Antennas*

Some further short-wave observations were made at Suffolk Airport by setting up a small transmitter at one end of the field and observing field strength versus distance for both vertical and horizontal polarization on 61 and 41.4 megacycles. The results of these tests are shown in Figs. 16 to 19. The center of the radiating antenna was 2.9 meters above level ground for both the horizontal and vertical positions. A vertical wire 2.11 meters long with its upper end 4.2 meters above ground was used for receiving the vertically polarized radiation, while a horizontal dipole 3.81 meters long, 1.6 meters above ground was used for receiving the horizontally polarized radiation. It will be seen that the horizontal polarization is attenuated more than the vertical

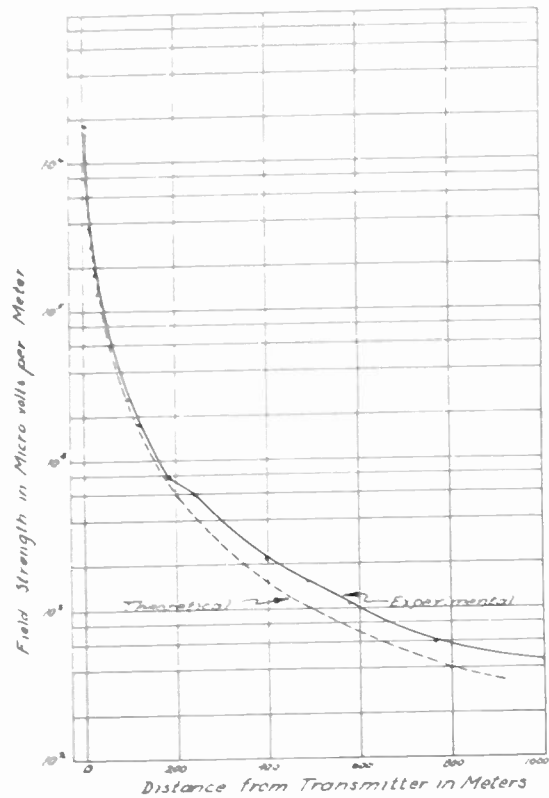

Fig. 16—Field strength vs. distance, vertical polarization, 61 megacycles. Transmitting and receiving antennas 2.9 and 3.1 meters above Long Island ground.

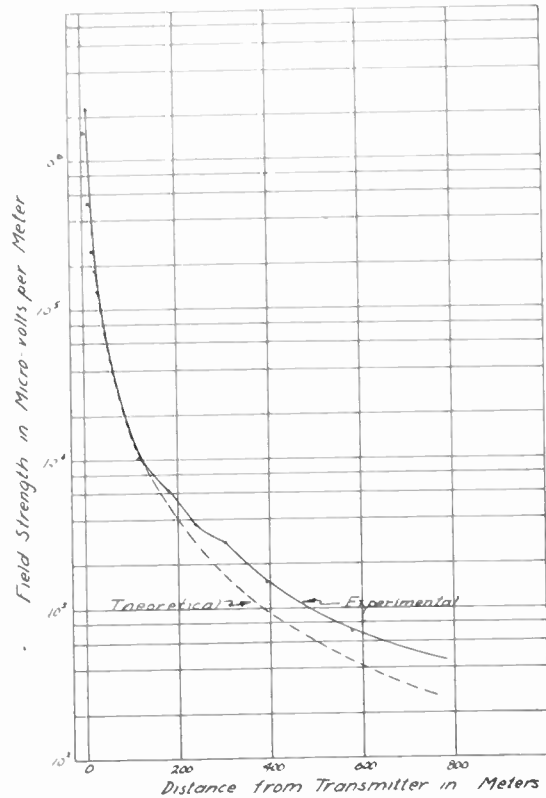

Fig. 17—Field strength vs. distance, horizontal polarization, 61 megacycles. Transmitting and receiving antennas 2.9 and 1.6 meters above Long Island ground.

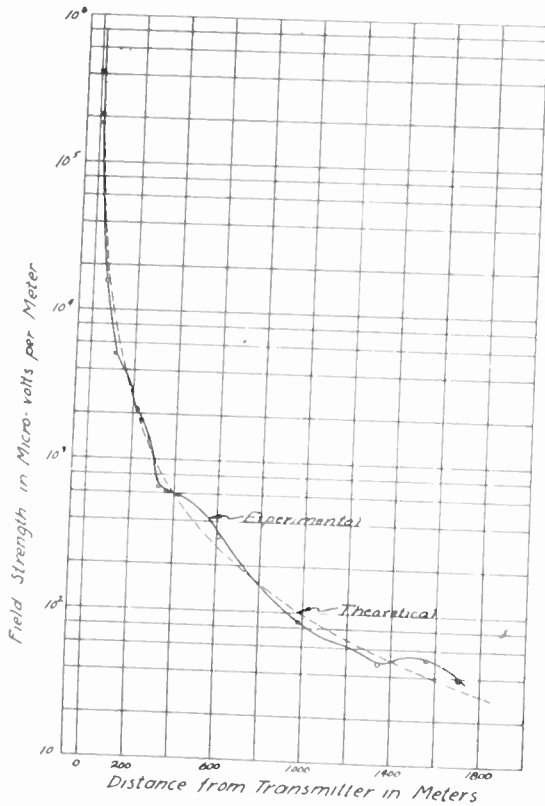

Fig. 18—Field strength vs. distance, vertical polarization, 41.4 megacycles. Transmitting and receiving antennas 2.9 and 3.1 meters above Long Island ground.

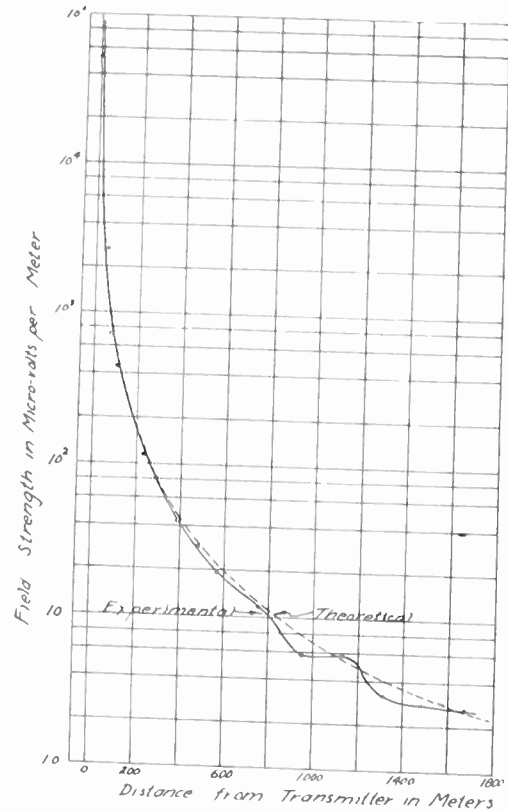

Fig. 19—Field strength vs. distance, horizontal polarization, 41.4 megacycles. Transmitting and receiving antennas 2.9 and 1.6 meters above Long Island ground.



and also that the higher frequency is attenuated more than the lower. It was interesting to note that any plane flying over the field would cause quite pronounced variations in receiver output due to the reflected radiation from the plane alternately reinforcing and weakening the direct ray from the transmitter. This phenomenon was most marked with a separation between the transmitter and receiver of about 800 meters. Interference effects caused by the plane were stronger as the plane came nearer the receiver, but were also noticeable with the plane beyond the receiver in a direction away from the transmitter.

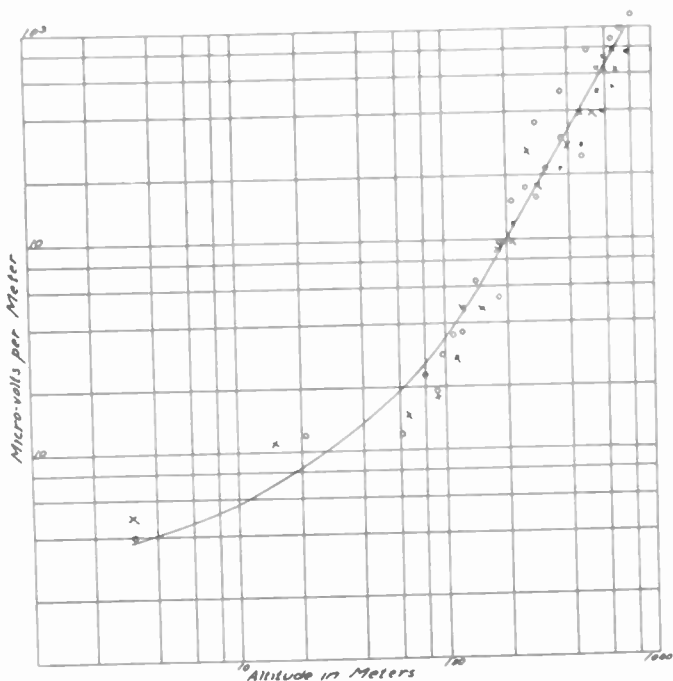

Fig. 20—Field strength vs. altitude at Roosevelt Field, 59.6 kilometers from Rocky Point 34-megacycle vertical transmitting antenna 39 meters high. Radiation 1 kilowatt.

#### *Airplane Tests on 34 megacycles*

A number of measurements were made on a Rocky Point transmitter radiating one kilowatt on 34 megacycles from a vertical antenna 39 meters above ground. A flight was made from Riverhead to Newark. Measurements were taken with altitude over Suffolk Airport, Farmingdale, Floyd Bennett Field, Roosevelt field, and Newark Airport. A curve of data taken over Roosevelt field is shown in Fig. 20.

The curves for the other airports are very similar and are not shown. The complete set of data is summarized in Fig. 21, which shows the variation of signal strength with both distance and altitude. This curve plainly shows the advantage gained by an increase in altitude at distances over 20 kilometers.

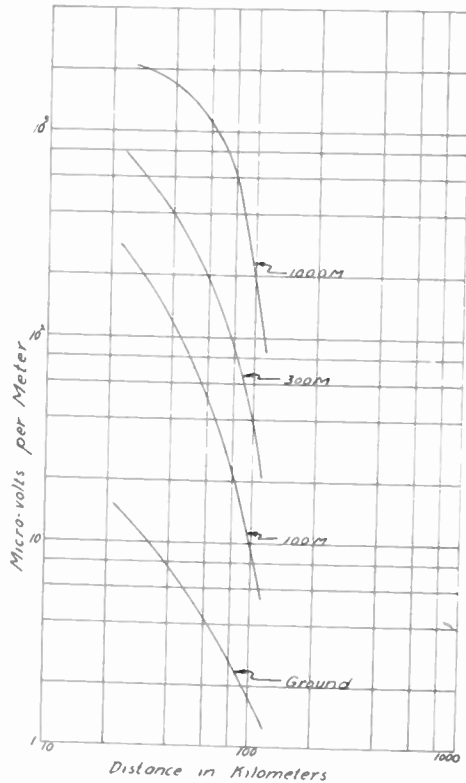

Fig. 21—Field strength variation with distance and altitude over Long Island from Rocky Point 34-megacycle vertical transmitting antenna 39 meters high. Radiation 1 kilowatt.

#### *Propagation Over Salt Water*

Several tests were made with both horizontal and vertical polarization on frequencies of 59.7 and 34.8 megacycles on Peconic Bay. In all of these experiments the height of the center of the transmitting antenna was 2.0 meters and that of the receiving antenna 2.7 meters. Fig. 22 shows the results at 59.7 megacycles when both receiving and transmitting antennas were horizontal, and Fig. 23 when both antennas were vertical. Fig. 24 shows a similar curve for 59.7 megacycles for vertical polarization.

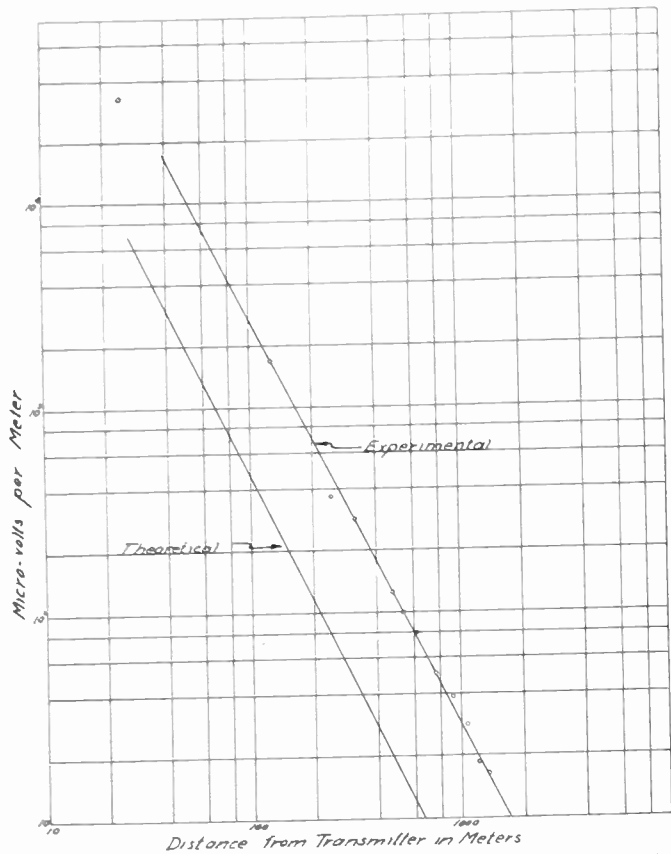

Fig. 22—Field strength vs. distance over salt water, horizontal polarization, 59.7 megacycles. Transmitting and receiving antennas 2 and 2.7 meters high. Radiation 1.8 watts.

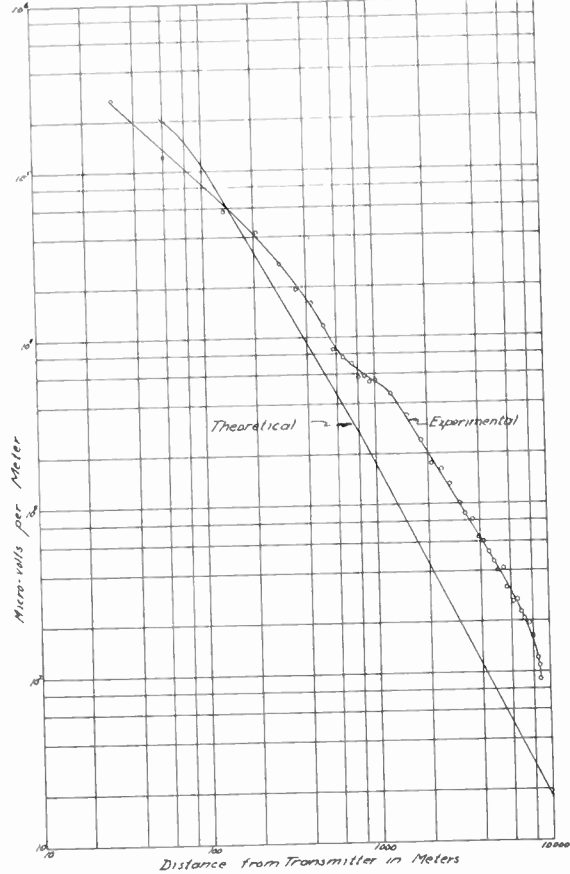

Fig. 23—Field strength vs. distance over salt water, vertical polarization, 59.7 megacycles. Transmitting and receiving antennas 2 and 2.7 meters high. Radiation 2.5 watts.

The great improvement of vertical as compared with horizontal polarization will be noted when using low antennas.

Fig. 25 shows a run made with vertical polarization on 34.8 megacycles on Block Island Sound. This run was taken to about 33 kilometers beyond the line of sight.

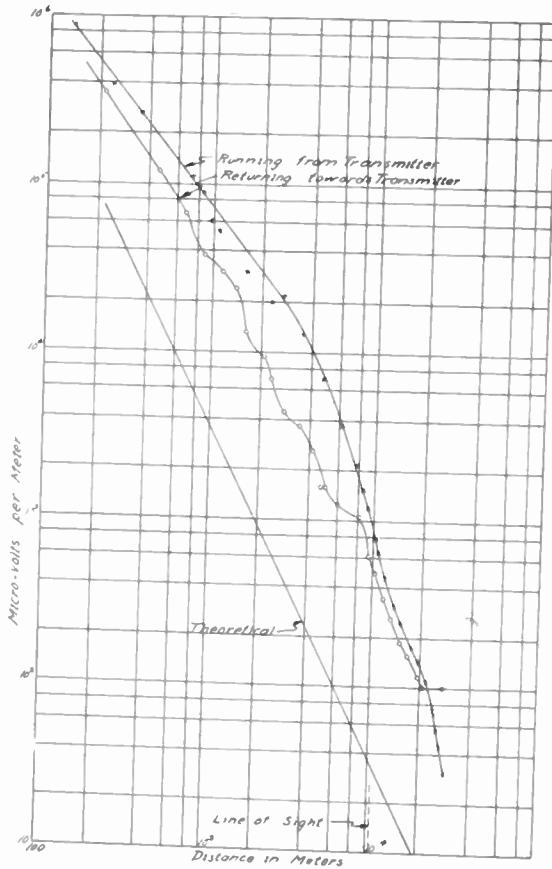

Fig. 24—Field strength vs. distance over salt water, vertical polarization, 59.7 megacycles. Transmitting and receiving antennas 2 and 2.7 meters high. Radiation 10 watts.

Airplane observations were made on 34 megacycles on a 1-kilowatt transmitter at Rocky Point, Long Island. The transmitting antenna was located 39 meters above ground and radiated vertically polarized waves. Fig. 26 shows the field strength variations with distance and altitude. This run was made between Rocky Point and Marion, Mass.,

which includes a path partly over land and partly over salt water. At several airports a large number of readings were taken descending and

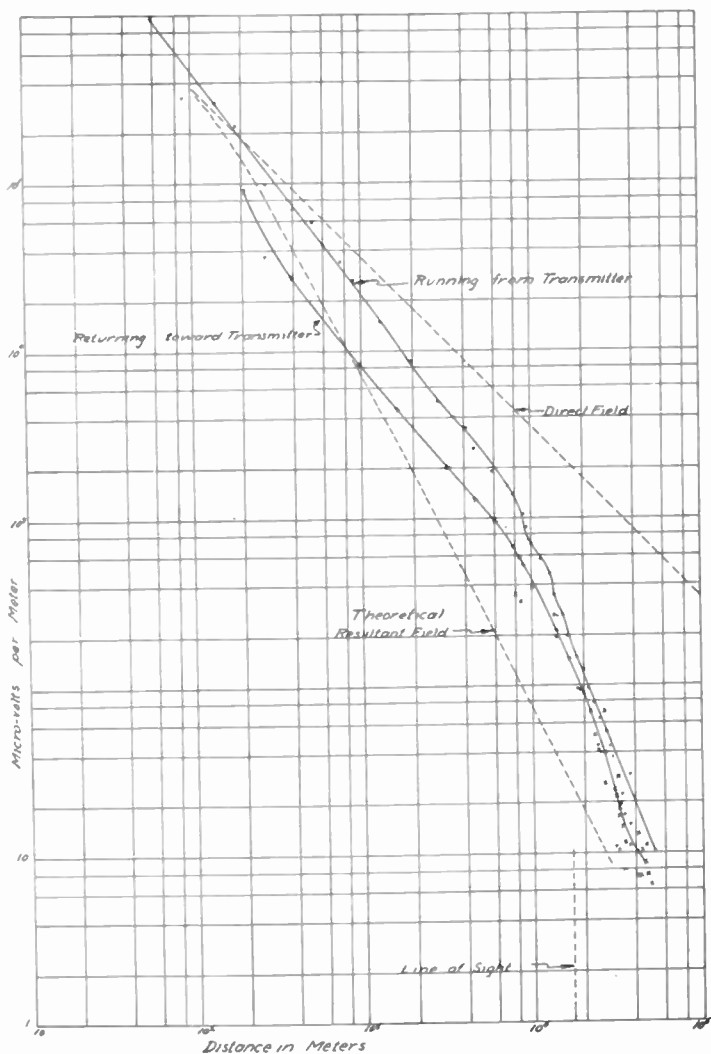

Fig. 25—Field strength vs. distance over salt water, vertical polarization, 34.8 megacycles. Transmitting and receiving antennas 2 and 2.7 meters high. Radiation 22 watts.

ascending so that the curves in Fig. 26 give the average results of these measurements. A curve from observations taken over Round Hill, Mass., Fig. 27, is typical of the others that are not here shown.

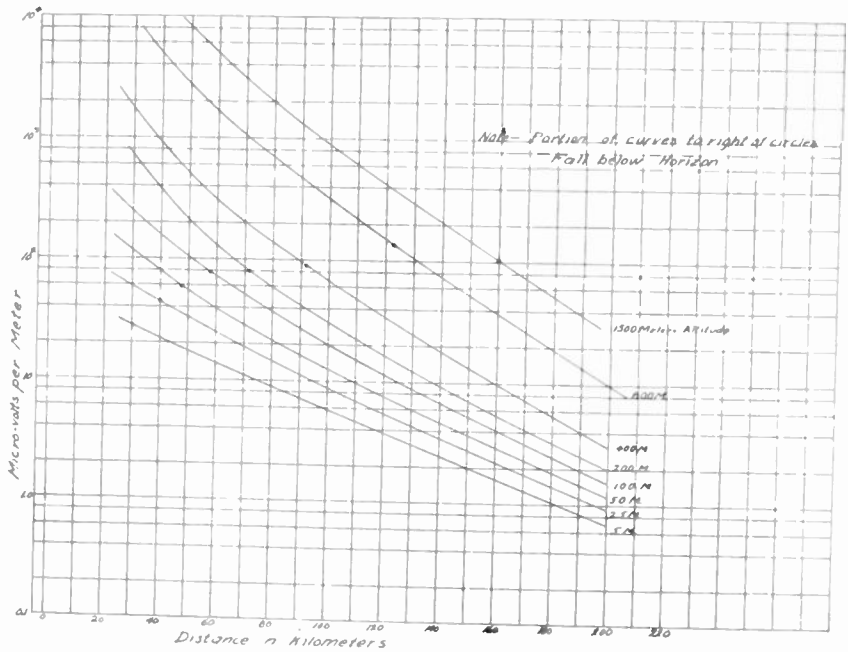

Fig. 26—Field variation with distance and altitude over water and land. Rocky Point 34-megacycle vertical transmitting antenna 39 meters high. Radiation 1 kilowatt.

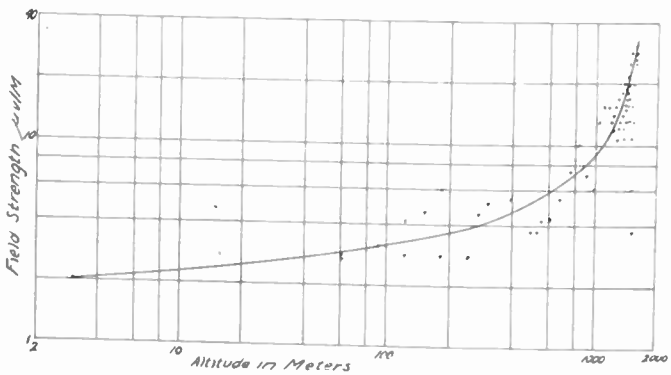

Fig. 27—Field strength vs. altitude at Round Hill, Mass. Rocky Point 34-megacycle vertical transmitting antenna 39 meters high, 182 kilometers distance from Rocky Point.

### Tests on 435 megacycles

About a year ago propagation observations were made on a Rocky Point 435-megacycle (69-centimeter) transmitter, on the ground, in an airplane, and on the Empire State Building in New York City. Reception up to 48 kilometers in an automobile, to nearly 110 kilometers in an airplane, and on the 300-meter level of the Empire State Building was accomplished, the distance from Rocky Point to New York being 90 kilometers. The 300-meter level of the Empire State Building is 200 meters below the line of sight from the Rocky Point antenna. This indicates considerable diffraction. No quantitative measurements were made at that time.

## II. THEORY AND DISCUSSION

The field from a transmitting antenna at a point in space may be considered as due to the combination of a direct and reflected ray<sup>2</sup> as shown in Fig. 28. The total distance of travel  $r_2$  of the reflected ray is

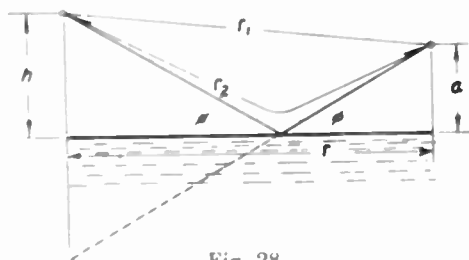

Fig. 28

greater than the distance of travel  $r_1$  of the direct ray, resulting in a phase difference between these two rays. In addition to this phase difference a phase shift in general takes place upon reflection. The laws of reflection are the same for radio waves as for light.

Consider first a pure dielectric. When a wave traveling through free space strikes a dielectric medium it divides into two rays, a refracted ray penetrating into the medium and a reflected ray. The angle of incidence of the reflected ray is equal to the angle of incidence of the main ray while the sine of the angle of incidence of the main ray is equal to the product of the square root of the dielectric constant of the dielectric medium and the sine of the angle of refraction.

Henceforth we shall speak in terms of the angle to the horizon rather than the angle of incidence. When the wave is horizontally polarized, the phase is always changed by 180 degrees upon reflection from a pure dielectric. The amplitude of the reflected wave is equal to

<sup>2</sup> P. O. Pedersen, "The Propagation of Electric Waves Along the Surface of the Earth and in the Atmosphere."

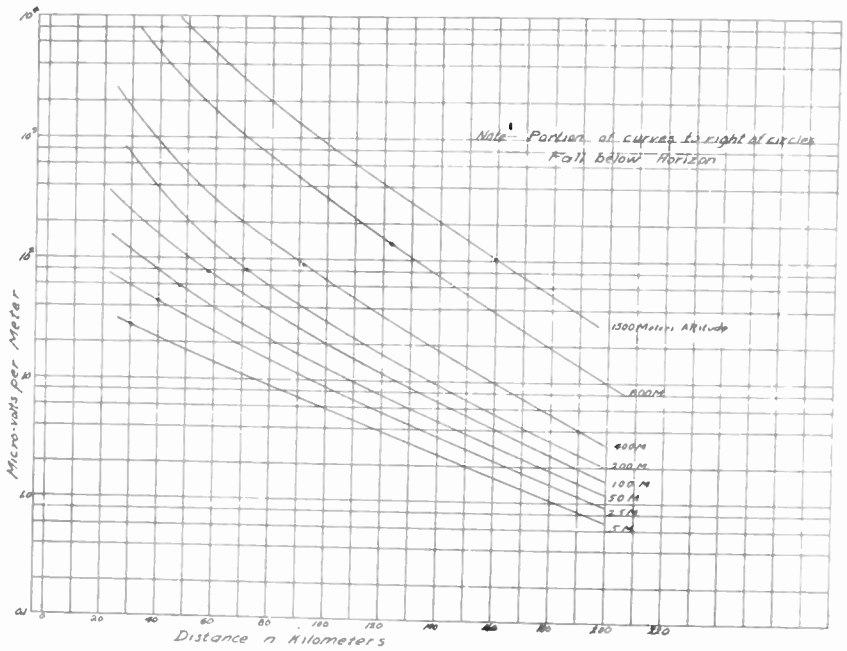

Fig. 26—Field variation with distance and altitude over water and land. Rocky Point 34-megacycle vertical transmitting antenna 39 meters high. Radiation 1 kilowatt.

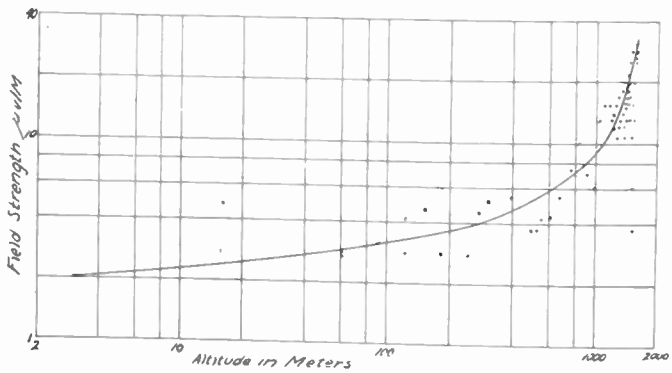

Fig. 27—Field strength vs. altitude at Round Hill, Mass. Rocky Point 34-megacycle vertical transmitting antenna 39 meters high, 182 kilometers distance from Rocky Point.



### Tests on 435 megacycles

About a year ago propagation observations were made on a Rocky Point 435-megacycle (69-centimeter) transmitter, on the ground, in an airplane, and on the Empire State Building in New York City. Reception up to 48 kilometers in an automobile, to nearly 110 kilometers in an airplane, and on the 300-meter level of the Empire State Building was accomplished, the distance from Rocky Point to New York being 90 kilometers. The 300-meter level of the Empire State Building is 200 meters below the line of sight from the Rocky Point antenna. This indicates considerable diffraction. No quantitative measurements were made at that time.

## II. THEORY AND DISCUSSION

The field from a transmitting antenna at a point in space may be considered as due to the combination of a direct and reflected ray<sup>2</sup> as shown in Fig. 28. The total distance of travel  $r_2$  of the reflected ray is

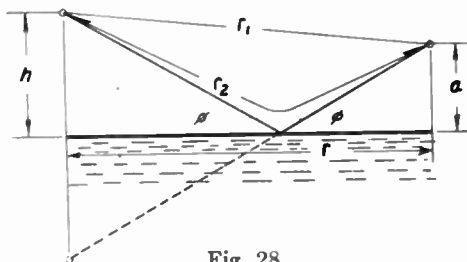

Fig. 28

greater than the distance of travel  $r_1$  of the direct ray, resulting in a phase difference between these two rays. In addition to this phase difference a phase shift in general takes place upon reflection. The laws of reflection are the same for radio waves as for light.

Consider first a pure dielectric. When a wave traveling through free space strikes a dielectric medium it divides into two rays, a refracted ray penetrating into the medium and a reflected ray. The angle of incidence of the reflected ray is equal to the angle of incidence of the main ray while the sine of the angle of incidence of the main ray is equal to the product of the square root of the dielectric constant of the dielectric medium and the sine of the angle of refraction.

Henceforth we shall speak in terms of the angle to the horizon rather than the angle of incidence. When the wave is horizontally polarized, the phase is always changed by 180 degrees upon reflection from a pure dielectric. The amplitude of the reflected wave is equal to

<sup>2</sup> P. O. Pedersen, "The Propagation of Electric Waves Along the Surface of the Earth and in the Atmosphere."

that of the wave before reflection at grazing incidence and continually decreases as the angle to the horizon is increased. When the wave is polarized in the plane of incidence (commonly called vertical polarization) the phenomenon is quite different. At grazing incidence the phase is shifted by 180 degrees, and the amplitude after reflection is equal to that before reflection. However, as the angle to the horizon is increased the amplitude of the reflected ray rapidly decreases until that angle is reached whose cotangent is equal to the square root of the dielectric constant. At this angle the amplitude of the reflected ray is zero. It is at this angle that the refracted and reflected rays become perpendicular to each other. In connection with light this is ordinarily called the angle of polarization. For angles greater than this critical value the phase remains unchanged upon reflection, and the amplitude of the reflected ray gradually increases again until it reaches a maximum at perpendicular incidence.

When the reflecting medium is partially conducting the phenomenon becomes more complex but in general is somewhat similar. When the approaching wave is polarized in the plane of incidence, a phase shift of 180 degrees takes place at grazing incidence and the amplitudes before and after reflection are equal, but as the angle is increased the phase shift decreases and there is no angle at which the reflected ray is of zero amplitude. However, there is a definite angle at which this amplitude becomes a minimum. Further increase of the angle gives a stronger reflected ray and a further decrease in the phase shift. For a fixed dielectric constant the angle of minimum reflection becomes smaller as the conductivity of the medium is increased or the frequency of the wave is decreased. For very long wavelengths and a ground which is highly conducting, the angle at which minimum reflection takes place may be only an extremely small fraction of a degree to the horizon.

In Fig. 29 is shown a polar diagram of the coefficient of reflection for salt water for a frequency of 33.3 megacycles when the wave is vertically polarized. The conductivity is assumed to be  $10^{10}$  electrostatic units and the dielectric constant 80. For Long Island ground a curve is shown in Fig. 30. The conductance of Long Island soil, which is mostly dry sand, is so low (about  $5 \times 10^4$  electrostatic units) that its effect upon the reflection is negligible. Its dielectric constant is about 9. Under the assumption as to conductivity, Fig. 30 holds for any frequency. However, Fig. 29 is representative for the frequency assumed.

For a horizontally polarized wave the coefficient of reflection, from a good conductor such as salt water, is nearly 100 per cent at all angles, and the phase shift changes gradually from 180 degrees at grazing in-

idence to about 178 degrees at perpendicular incidence. Hence a diagram for this condition is not worth showing.

For Long Island soil and horizontal polarization a curve of the reflection coefficient is given in Fig. 30 together with that for a wave polarized in the plane of incidence.

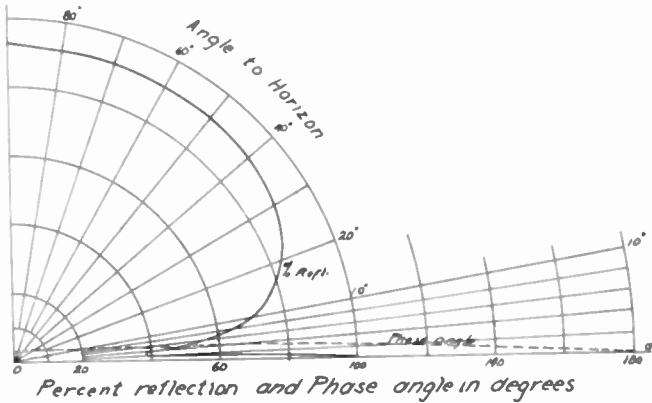

Fig. 29—Coefficient of reflection vs. angle to horizon for vertical polarization over salt water, 33.3 megacycles, assuming  $\epsilon = 80$ ,  $\sigma = 10^{10}$  electrostatic units.

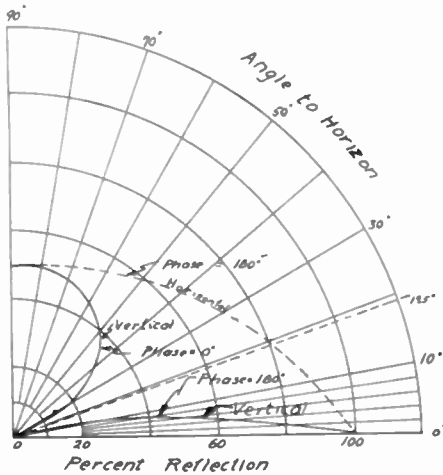

Fig. 30—Coefficient of reflection vs. angle to horizon for vertical and horizontal polarization for Long Island ground, assuming  $\epsilon = 9$ ,  $\sigma = 0$ .

The coefficient of reflection,  $K$ , is in general a complex quantity which may be expressed as:

$$K = Ae^{i\theta}$$

in which  $A$  is the ratio of the amplitude of the reflected to the incident

wave and  $\psi$  is the phase shift between them. For polarization in the plane of incidence

$$K_v = \frac{\left(\epsilon - j\frac{2\sigma}{f}\right) \sin \phi - \sqrt{\epsilon - j\frac{2\sigma}{f} - 1 + \sin^2 \phi}}{\left(\epsilon - j\frac{2\sigma}{f}\right) \sin \phi + \sqrt{\epsilon - j\frac{2\sigma}{f} - 1 + \sin^2 \phi}} \quad (1)$$

For horizontal polarization

$$K_H = \frac{\sin \phi - \sqrt{\epsilon - j\frac{2\sigma}{f} - 1 + \sin^2 \phi}}{\sin \phi + \sqrt{\epsilon - j\frac{2\sigma}{f} - 1 + \sin^2 \phi}} \quad (2)$$

where,

- $\epsilon$  is the dielectric constant
- $\sigma$  is the conductivity in electrostatic units
- $\phi$  is the angle to the horizon
- $f$  is the frequency.

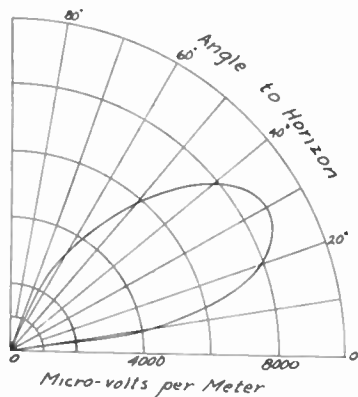

Fig. 31—Theoretical field strength vs. angle to horizon from horizontal Hertz doublet located one-half wavelength above salt water.  $f=33.3$  megacycles; power, 1 kilowatt; distance, 48 kilometers.

It may be of interest to show the theoretical resultant field strength with altitude for a given amount of power and at a fixed distance. For this purpose we shall take a distance of 48 kilometers, a wavelength of 9 meters and assume one kilowatt in a Hertz doublet located one-half wavelength above the ground or water, as the case may be. Fig. 31 shows the resulting field strength in microvolts per meter when the

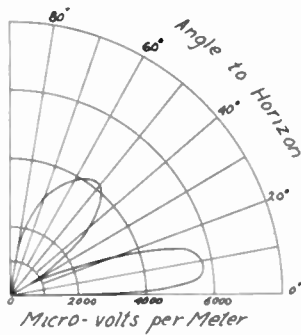

Fig. 32—Theoretical field strength vs. angle to horizon from vertical Hertz doublet located one-half wavelength above salt water.  $f=33.3$  megacycles; power, 1 kilowatt; distance, 48 kilometers.

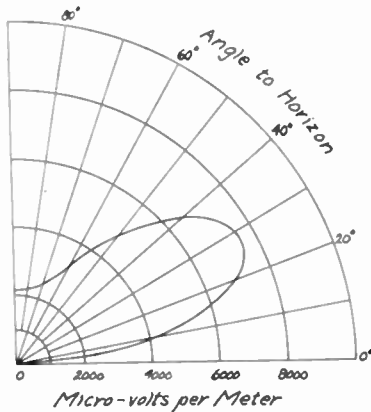

Fig. 33—Theoretical field strength vs. angle to horizon from horizontal Hertz doublet located one-half wavelength over Long Island ground.  $f=33.3$  megacycles; power, 1 kilowatt; distance, 48 kilometers.

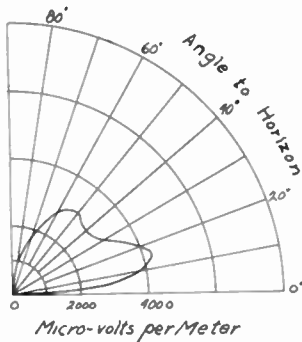

Fig. 34—Theoretical field strength vs. angle to horizon from vertical Hertz doublet located one-half wavelength over Long Island ground.  $f=33.3$  megacycles; power, 1 kilowatt; distance, 48 kilometers.

dipole is horizontal and located above salt water. Fig. 32 is a similar curve for the same dipole located vertically above salt water. Figs. 33 and 34 are similar curves for a dipole located near Long Island ground.

Since the coefficient of reflection is dependent upon the frequency it is desirable to show its effect over salt water upon the received field strength at low angles. Fig. 35 shows the field strength at the surface (height = 0) vs. wavelength at a distance of one kilometer from a dipole at a height

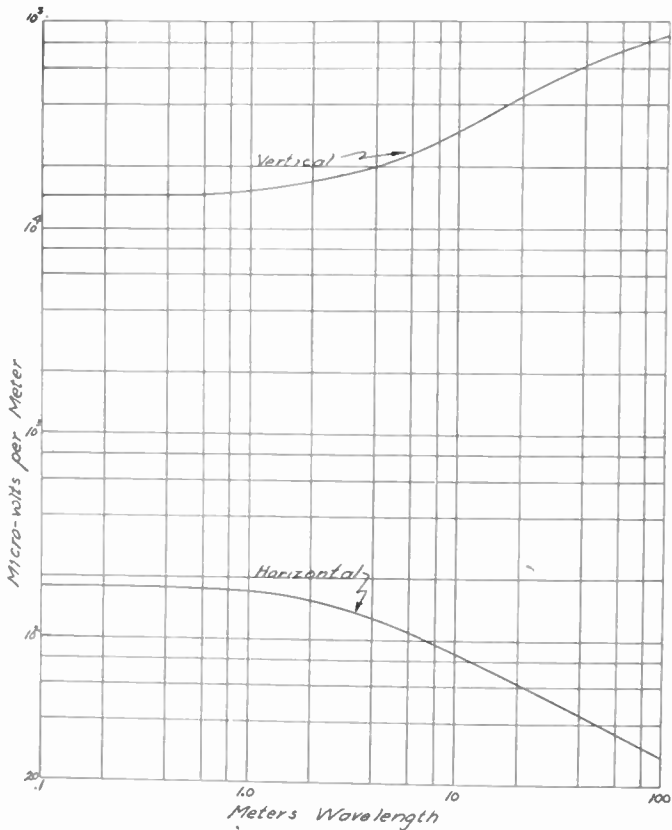

Fig. 35—Theoretical field strength vs. wavelength over salt water at a distance of 1 kilometer from a dipole 8 meters high radiating 1 watt for vertical and horizontal polarization. Receiving antenna height = 0.

of eight meters radiating one watt. It was previously stated that a high conductivity ground or a low frequency brings the reflected ray more nearly in phase with the direct ray at small angles with vertical polarization. This explains the rise of the curve with lower frequencies. With horizontal polarization there is no appreciable change in phase of the reflected ray with frequency, but the reflection becomes more efficient

with decrease in frequency resulting in a lower field strength. The great difference between horizontal and vertical polarization over salt water at low angles may be seen from these curves.

At distances sufficiently great, neglecting curvature of the earth, certain approximations can be made. These result in the following formulas for field strength above poorly conducting ground, where "h" is the height of the transmitting antenna and "a" the height of the receiving antenna,  $E_d$  the direct field,  $\epsilon$  the dielectric constant, and  $r$  the distance.

For vertical polarization:

$$E_V = E_d \times \frac{1}{r} \sqrt{\frac{4\epsilon^2}{\epsilon - 1}(h + a)^2 + \left(\frac{4\pi ha}{\lambda}\right)^2} \quad (3)$$

or, for a half-wave dipole from which the radiated power is  $W$  watts:

$$E_V = \frac{7\sqrt{W}}{r^2} \sqrt{\frac{4\epsilon^2}{\epsilon - 1}(h + a)^2 + \left(\frac{4\pi ha}{\lambda}\right)^2} \quad (4)$$

volts per meter for  $r$ ,  $h$ , and  $a$  in meters, only if

$$\frac{h + a}{r} < 0.05 \text{ and } \frac{4\pi ha}{\lambda r} < 0.05.$$

For horizontal polarization:

$$E_H = E_d \frac{1}{r} \sqrt{\frac{4(h + a)^2}{\epsilon - 1} + \left(\frac{4\pi ha}{\lambda}\right)^2} \quad (5)$$

or,

$$E_H = \frac{7\sqrt{W}}{r^2} \sqrt{\frac{4(h + a)^2}{\epsilon - 1} + \left(\frac{4\pi ha}{\lambda}\right)^2} \quad (6)$$

for a half-wave dipole under the same limiting conditions.

It will be noted that the factor by which the direct field must be multiplied to give the resultant total field varies as the inverse power of the distance. As the direct field is proportional to the inverse power of the distance, the resultant field therefore varies as the inverse square of the distance.

For the actual case of a curved earth the same formulas may be used in a modified form. In the Appendix the modifications are derived, and it may be seen that the two heights  $a$  and  $h$  are replaced by new ones,  $a'$  and  $h'$ , which depend only upon the distance  $r$ ,  $a$ , and  $h$ .

The reflection laws discussed take no account of the diffraction effect. This makes the formulas of doubtful value for very small angles to the horizon and of no use for zero and negative angles. We should expect an appreciable signal at zero and negative angles from optical diffraction theory, but of a low order of intensity as compared to large positive ones.

It has been stated that for small positive angles the signal intensity drops off as the inverse square of the distance, and diffraction theory indicates a similar law below the line of sight. This should give a fairly uniform dropping off from positive to negative angles according to an inverse square law.

For this reason we might expect (3), (4), (5), and (6), without correction for earth curvature, to give a rough approximation of signal intensities at any distance.

The effects of reflection from poorly conducting ground are well brought out by the curves of Figs. 16, 17, 18, and 19. A dashed curve has been plotted corresponding to the inverse square law. It will be noted that the curves for 41.4 megacycles with either polarizations almost coincide with the theoretical curves. At 61 megacycles the solid curves representing the experimental data both lie above the theoretical curves, showing that the received signal strength was greater than that anticipated from the theory. Since the phase of a wave is reversed upon reflection from a poorly conducting ground, the direct and indirect rays tend to cancel for grazing angles of incidence. Obviously, attenuation of the reflected wave makes cancellation less perfect and increases the signal strength. A layer of vegetation constitutes a poor dielectric, the attenuation due to which, increases with frequency. In these tests the amount of brush along the surface of the ground was small, but it would appear that its effect was appreciable on the 61-megacycle frequency and little, if any, upon the 41.4-megacycle frequency. It might be of interest to use the ratio of field strength for horizontal and vertical polarization to determine the effective dielectric constant of the ground. For 41.4 megacycles the ratio is 13.5, and for 61 megacycles, 13. From the theoretical considerations previously given it is apparent that this ratio should be equal to the dielectric constant for grazing angles of incidence. Some uncertainty exists in the effective heights of the horizontal and vertical receiving antennas used, so that the above conclusion is not reliable. The value 9 used in the theoretical curves was obtained from measurements of propagation along a wire pair buried in the soil under dry weather conditions.

In a paper by L. F. Jones entitled "Propagation of Wave-lengths



Between Three and Eight Meters," curves are shown giving the relationship between field strength and distance for the two transmitters in the Empire State Building on 44 and 61 megacycles. These curves show the result of a very large number of field strength measurements taken over a wide territory. These two curves have been replotted (Figs. 36 and 37) together with the theoretical ones, taking into account and neglecting the earth's curvature. In Fig. 36 for the 44-

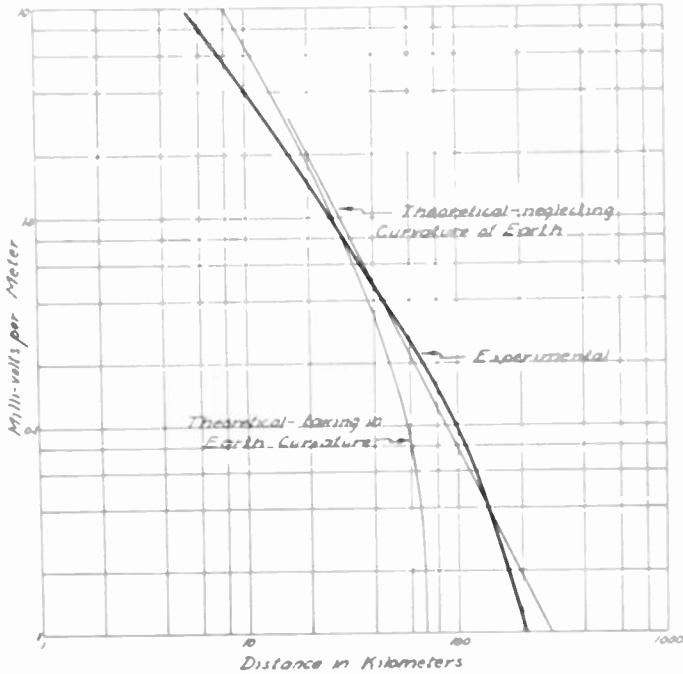

Fig. 36—Comparison of measured with theoretical field strength from the Empire State 44-megacycle transmitter. Radiation 2 kilowatts.

megacycle frequency the theoretical curve neglecting the earth's curvature agrees quite well with the experimental measurements whereas the curve taking into account the earth's curvature gives field strengths very much too low for large distances. This fact shows that neglecting the curvature of the earth approximately corrects for the effects of diffraction. In Fig. 37 the experimental curve lies between the two theoretical ones at the larger distances, indicating a smaller amount of diffraction with the higher frequency which is to be expected.

In many of the observations of the Empire State transmitters by

airplane the height of the receiving and transmitting antennas was large enough to invalidate the approximate method of determining the field strength. When a transmitting antenna is located many wavelengths above ground it is obvious that a large number of maximum and minimum field intensity areas will be set up due to the combination of the direct and reflected rays. Referring to Fig. 28 it may be seen that when the phase angle of the reflected ray, with reference to the direct ray, is zero, addition takes place producing a strengthened field,

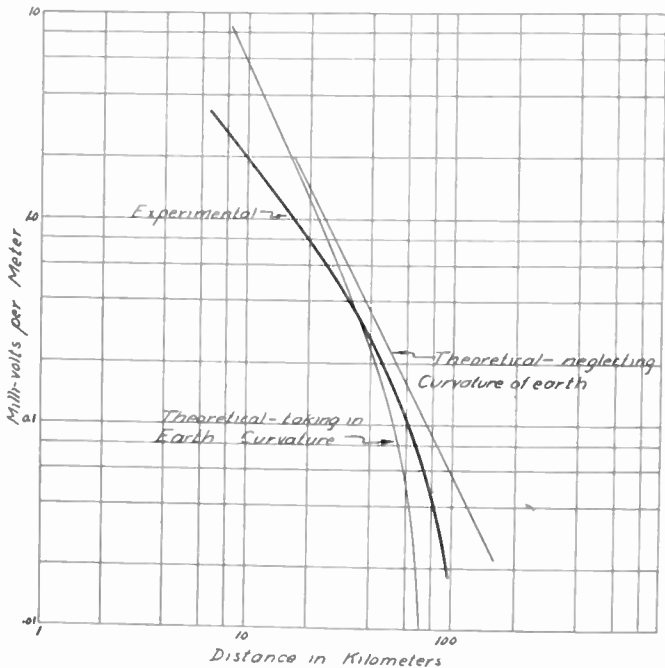

Fig. 37—Comparison of measured with theoretical field strength from the Empire State 61-megacycle transmitter. Radiation 1 kilowatt.

and when the angle is 180 degrees, subtraction occurs, giving a weakened field. This phase angle is determined by the sum of the phase angles due to the phase shift at reflection and that produced by the difference in length of path between the direct and reflected rays. Since for Long Island ground the phase shift at reflection is practically 180 degrees, for reflection angles up to 19.5 degrees, the difference in length of path of the two rays is the determining factor for the interference patterns. Figs. 38 and 39 show families of curves taking into account the effect of the earth's curvature showing the location of these

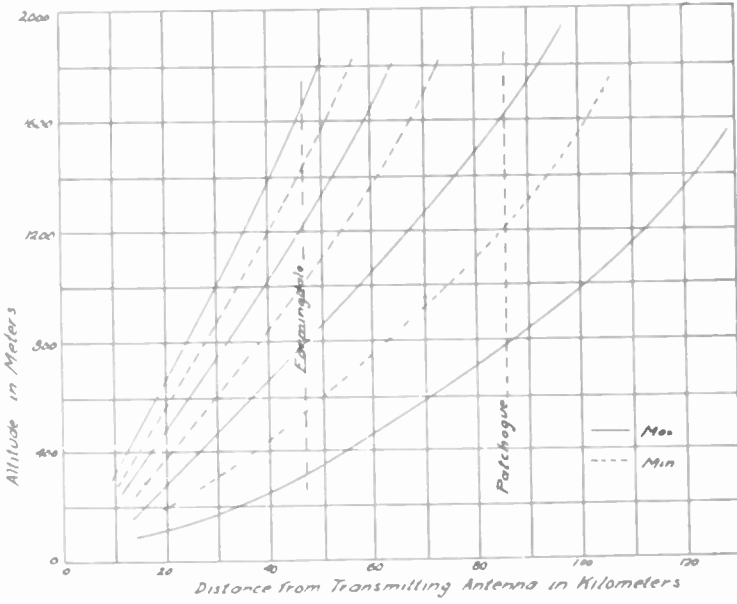

Fig. 38—Theoretical curves showing location of maximum and minimum field strengths produced by the Empire State 41-megacycle transmitter.

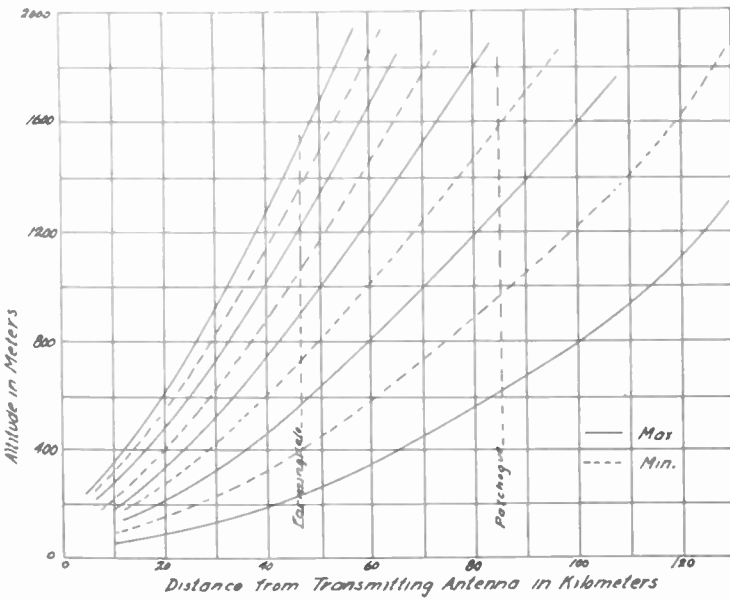

Fig. 39—Theoretical curves showing location of maximum and minimum field strengths produced by the Empire State 61-megacycle transmitter.

maximum and minimum field strength areas for 44 and 61 megacycles, and a transmitting antenna located 373 meters above ground. This is to correspond with the average conditions of reception on Long Island from the Empire State antenna. Although the actual height of this antenna above sea level is 396 meters, the average height above Long Island territory is about 23 meters less, as can be seen by inspection of the profile map. A small difference in the height above sea level at which reflection takes place has a large effect upon the altitude at which the maximum or minimum field strength will be received. It is of interest to compare the theoretical data with the experimental, which have already been shown. (Figs. 4, 5, 11, 12, and 13.) The tables below show a comparison of the theoretical heights for maximum and minimum field strength with the experimental at several distances from the transmitter.

TABLE I

| <i>44 Megacycles</i>                       |                               |                                  |
|--|-------------------------------|----------------------------------|
| 46.6 Kilometers from N.Y. (Farmingdale)    |                               |                                  |
| Field Strength                             | Observed Altitude<br>(meters) | Theoretical Altitude<br>(meters) |
| Maximum                                    | 270-300                       | 300                              |
| Minimum                                    | 550-580                       | 530                              |
| Maximum                                    | 760-880                       | 780                              |
| Minimum                                    | 990-1070                      | 990                              |
| 85.3 Kilometers from N.Y. (Patchogue)      |                               |                                  |
| Maximum                                    | 670-790                       | 760                              |
| Minimum                                    | 1000-1200                     | 1190                             |
| <i>61 Megacycles</i>                       |                               |                                  |
| 46.6 Kilometers from N.Y. (Farmingdale)    |                               |                                  |
| Maximum                                    | 270                           | 240                              |
| Minimum                                    | 460                           | 400                              |
| Maximum                                    | 880 (?)                       | 560                              |
| 85.3 Kilometers from N.Y. (Patchogue)      |                               |                                  |
| Maximum                                    | 500-670                       | 610                              |
| Minimum                                    | 940-1000                      | 970                              |
| Maximum                                    | 1220 (?)                      | 1300                             |
| 114 Kilometers from N.Y. (Suffolk Airport) |                               |                                  |
| Maximum                                    | 970-1130                      | 990                              |
| Minimum                                    | 1300 (?)                      | 1500                             |

It will be noted that for transmission at 44 megacycles the theoretical and actual minima and maxima are in very good agreement. At 61 megacycles there is such a rapid succession of minor interference effects taking place that a comparison between theoretical and actual results is difficult to make. Although the positions of maxima and minima check very well with theory it will be noted that the ratio of maximum to minimum amplitudes is very much less than that which

would be predicted by theory. In fact, this ratio corresponds to a coefficient of reflection which, on the average, is not over 60 per cent. Theory would give values ranging from 85 to 92 per cent for the distances considered. The actual conditions are no doubt considerably more complex than those assumed in the theory. The wave which is reflected from ground must first be propagated through what we might term a transition medium consisting of trees, brush, buildings, telephone and power wires, etc. This would cause considerable attenuation of the indirect ray both before and after reflection, thus giving a much more imperfect field cancellation than under the conditions of a perfectly smooth surface having no transition layer above it.

In Fig. 9 the theoretical curve showing the variation in field strength at a constant elevation of 1200 meters has been plotted along with the experimental data from the Empire State observations. The close agreement between the positions of the actual and theoretical maximum and minimum field strength areas is quite striking.

The curves in Figs. 22 and 23 show the theoretical and observed field strengths over salt water for a radiated power of 1.8 and 2.5 watts on 59.7 megacycles. The constants of salt water were assumed as  $\epsilon = 80$  and  $\sigma = 10^{10}$  electrostatic units. It will be noted that the theoretical curves fall considerably below the experimental at the greater distances. Some doubt exists as to the reliability of the absolute values of measured field strength but it is felt that the relative values are good for any one curve.

The ratio between the intensity for vertical and horizontal polarization at a distance of 3000 meters, assuming the curve for horizontal polarization extended, is 300, correcting for difference in power. This should be approximately equal to  $2\sigma/f$  or 334 when  $\sigma$  is taken as  $10^{10}$  electrostatic units. This value of  $10^{10}$  electrostatic units is the average of the data given by a number of investigators. However, a recent measurement of resistivity gave a value of 22 ohms per centimeter cube, which is equivalent to a conductivity of  $4 \times 10^{10}$  electrostatic units.

Since the ratio of field intensity for vertical polarization to that for horizontal over salt water is 334 at 59.7 megacycles, a horizontal transmitting dipole, tilted by an angle of  $1/334$  radian, or 0.17 degree, would give equal vertical and horizontal components at the receiving antenna. This probably accounts for the possibility of receiving a signal from a horizontal antenna on a vertical one as a slight tilt would be unnoticed. A slight unbalance in the feeding currents to the transmitting antenna would result in a vertical component in the radiated wave.

Fig. 24, showing another vertical polarization test on 59.7 megacycles, gives information over a greater distance than Fig. 23. Here the theoretical curve falls very much below the experimental one due probably to a faulty receiver calibration of absolute field strength values. There has been no opportunity to find the discrepancy between the absolute values of Figs. 23 and 24. Fig. 25 giving the results of the 33.4-megacycle run using vertical polarization, shows less attenuation than the higher frequency run, Fig. 24, which is to be expected.

In addition to the effects of diffraction upon the signal at distances where the receiver is below the horizon, it is well to consider the effects of refraction. In general, the dielectric constant of the air changes with altitude to such an extent that a ray of light is bent downward with a radius of curvature of about 5.7 times the earth's radius.<sup>3</sup> This gives a condition equivalent to that of an earth with a 21 per cent larger radius. This condition is subject to considerable variation due to temperature changes in the air. At night the temperature changes in the atmosphere are different from those existing during the daytime, which might account for increased refraction and a consequent increase of signal at night.

Propagation over land generally takes place partly through a transition layer of vegetation. Trees give the effect of a gradual increase in the dielectric constant from that of air at a height of around 50 feet at the tree tops to some higher value near the ground, where the vegetation is more dense. The conductivity undergoes a similar change from zero at the tree tops to a finite value near the ground. Under such conditions, a wave propagated through this medium must follow a curved path. If the effective dielectric constant changes from 1 to 1.002 in a distance of 50 feet, the radius of curvature of a ray will be approximately equal to the radius of the earth. Considerable attenuation must also take place through this medium, the lower rays being attenuated the most.

The resultant field intensity below the horizon is due to the combination of all the diffraction and refraction effects. It is obvious that the effects mentioned are capable of producing considerable bending of the rays beyond the horizon so that the signal intensity shows no sudden change with altitude as the horizon is passed.

#### CONCLUSION

It seems reasonable to assume that the field strength values of waves below 10 meters can be calculated with reasonable accuracy since there is no sky wave phenomenon to consider. The foregoing

<sup>3</sup> Humphreys, "Physics of the Air," p. 450.

experimental results indicate that we may approximately predict the field strength under various conditions. It should be mentioned that it is quite difficult to obtain an accurate calibration of the receiver in terms of absolute field strength at these high frequencies. This is especially true when the receiver and its antenna are installed in an airplane or a boat.

The superiority of vertical as compared with horizontal polarization over salt water with low antennas has been pointed out. However, this should not be misconstrued to indicate that such a relation necessarily holds true for high antennas. Previous tests in the Hawaiian Islands<sup>1</sup> have indicated no appreciable difference between vertical and horizontal polarization tests when using high antennas located several thousand feet above sea level.

A considerable amount of study of high-frequency propagation still remains to be done. It is felt that further knowledge will enable us to predict results with considerable accuracy under various conditions encountered in practice.

#### ACKNOWLEDGMENT

We are indebted to several engineers of R.C.A. Communications, Inc., for their help in obtaining data. Mr. G. W. Wickizer obtained many of the airplane observations as well as assisting in the salt water tests. Mr. D. R. Goddard furnished his boat, and together with Mr. G. E. Hansell also assisted with the salt water tests. Mr. N. E. Lindblad and Mr. O. E. Dow furnished transmission on 435 and 34 megacycles while Mr. R. W. George made observations on 435 megacycles. This work was under the supervision of Mr. H. H. Beverage, Chief Research Engineer, and Mr. H. O. Peterson, who gave valuable suggestions.

We also acknowledge the valuable coöperation of the NBC engineers for the transmissions on 44 and 61 megacycles from the Empire State building.

#### APPENDIX

##### 1. *Theory of Reflection*

Although the theory of reflection of electromagnetic waves is well known<sup>4</sup> a brief development will be given here for the sake of completeness before deriving the formulas made use of in connection with the particular conditions of propagation treated.

As general laws, we have Maxwell's equations:

<sup>4</sup> Drude, "Theory of Optics"; Jeans, "Mathematical Theory of Electricity."

$$-\frac{\mu}{c} \frac{d\mathbf{H}}{dt} = \text{curl } \mathbf{E} \quad (1)$$

$$\left(4\pi\sigma + \epsilon \frac{d}{dt}\right) \frac{\mathbf{E}}{c} = \text{curl } \mathbf{H} \quad (2)$$

where  $E$  and  $H$  are the electric and magnetic forces in electrostatic and electromagnetic units, respectively,  $\mu$  the permeability,  $\epsilon$  the dielectric constant,  $\sigma$  the conductivity in electrostatic units, and  $c$  the velocity of light.

When  $E$  and  $H$  are sinusoidal and represented by the real part of  $E'e^{i\omega t}$  or  $H'e^{i\omega t}$   $d/dt = j\omega$  and the two fundamental equations become:

$$-j\frac{\omega\mu}{c}\mathbf{H} = \text{curl } \mathbf{E} \quad (3)$$

$$\left(\frac{4\pi\sigma + j\omega\epsilon}{c}\right)\mathbf{E} = \text{curl } \mathbf{H}. \quad (4)$$

It is convenient to take care of a partially conducting medium by thinking of a complex dielectric constant  $\epsilon_0 = \epsilon - j(2\sigma/f)$  in which case the relations for conducting and nonconducting mediums become the same. In this discussion we shall assume  $\mu = 1$  under all conditions. The relations (3) and (4) then become:

$$-j\frac{\omega}{c}\mathbf{H} = \text{curl } \mathbf{E} \quad (5)$$

$$j\frac{\omega}{c}\epsilon_0\mathbf{E} = \text{curl } \mathbf{H}. \quad (6)$$

These relations result in the wave equations:

$$\nabla^2\mathbf{E} = -\frac{\omega^2}{c^2}\epsilon_0\mathbf{E} \quad \text{and} \quad \nabla^2\mathbf{H} = -\frac{\omega^2}{c^2}\epsilon_0\mathbf{H}. \quad (7)$$

For a plane wave the solution is

$$E = E'e^{j\omega(t-d/v)} \quad (8)$$

where  $V = c/\sqrt{\epsilon_0}$  = the velocity and  $d$  is the distance of travel from the position of reference for the time  $t$ . A similar equation holds for  $H$ .

In Fig. 40 let the  $ZY$  plane be the boundary between free space designated as (1) and a medium (2) having a generalized dielectric constant  $\epsilon_0$ . Assume that the electric field  $E$  of the incident wave lies in the  $XY$  plane or plane of incidence and that the ray makes an angle



of incidence  $\theta_1$  to the  $X$ -axis. This ray must divide into a refracted and reflected ray at angles  $\theta_2$  and  $\theta_3$  to the  $X$ -axis.

We may now write (8) in terms of the components, putting  $d$  in terms of  $X$  and  $Y$  and the direction cosines. Then:

$$E_{x1} = E_{x1}' e^{j\omega(t - (x_1 \cos \theta_1 + y_1 \sin \theta_1) / V_1)} \quad (9)$$

$$E_{y1} = E_{y1}' e^{j\omega(t - (x_1 \cos \theta_1 + y_1 \sin \theta_1) / V_1)} \quad (10)$$

$$H_1 = H_1' e^{j\omega(t - (x_1 \cos \theta_1 + y_1 \sin \theta_1) / V_1)} \quad (11)$$

Similar relations are also true of the reflected and refracted waves. The following conditions must be satisfied at the boundary:

1. The tangential components of electric and magnetic force must be continuous.

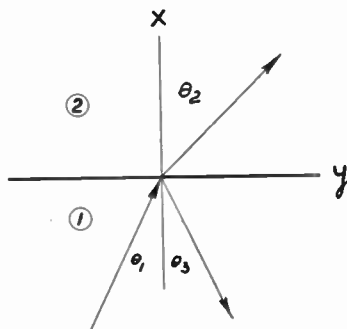

Fig. 40

2. The normal components of electric displacement and magnetic induction must be continuous.

Therefore,

$$E_{x1} + E_{x3} = \epsilon_0 E_{x2} \quad (12)$$

$$E_{y1} + E_{y3} = E_{y2} \quad (13)$$

$$H_1 + H_3 = H_2. \quad (14)$$

These relations can be satisfied only if

$$\frac{\sin \theta_1}{V_1} = \frac{\sin \theta_2}{V_2} = \frac{\sin \theta_3}{V_3}. \quad (15)$$

Hence  $\sin \theta_1 = \sin \theta_3$  but  $\theta_3$  cannot be identical with  $\theta_1$ , so

$$\theta_3 = 180 \text{ degrees} - \theta_1 \quad (16)$$

and,

$$\cos \theta_3 = -\cos \theta_1. \quad (17)$$

Also from the fundamental relations (5) and (6) we have

$$j\omega\epsilon_0 E_x = \text{curl}_x H = -j\frac{\omega}{V} H \sin \theta \quad (18)$$

$$j\omega\epsilon_0 E_y = \text{curl}_y H = j\frac{\omega}{V} H \cos \theta \quad (19)$$

$$-j\frac{\omega}{c} H = \text{curl}_z E = -j\frac{\omega}{V} E_y \cos \theta + j\frac{\omega}{V} E_x \sin \theta \quad (20)$$

for all three rays.

Hence,

$$\frac{E_x}{\sin \theta} = \frac{-E_y}{\cos \theta} = \frac{H_z}{\sqrt{\epsilon_0}} \text{ for all three rays.} \quad (21)$$

Combining these relations we get

$$-H_1 \cos \theta_1 + H_3 \cos \theta_3 = \frac{-H_2 \cos \theta_2}{\sqrt{\epsilon_0}} \quad (22)$$

$$H_1 + H_3 = H_2 \quad (14)$$

or,

$$\frac{H_3}{H_1} = \frac{1 - \frac{\cos \theta_2}{\sqrt{\epsilon_0} \cos \theta_1}}{1 + \frac{\cos \theta_2}{\sqrt{\epsilon_0} \cos \theta_1}} = \frac{\sqrt{\epsilon_0} \cos \theta_1 - \cos \theta_2}{\sqrt{\epsilon_0} \cos \theta_1 + \cos \theta_2} \quad (23)$$

but,

$$\sin \theta_2 = \frac{\sin \theta_1}{\sqrt{\epsilon_0}} \quad (24)$$

Hence,

$$\cos \theta_2 = \sqrt{1 - \frac{\sin^2 \theta_1}{\epsilon_0}} = \sqrt{\frac{\epsilon_0 - \sin^2 \theta_1}{\epsilon_0}} \quad (25)$$

and,

$$K_V = \frac{H_3}{H_1} = \frac{\epsilon_0 \cos \theta_1 - \sqrt{\epsilon_0 - \sin^2 \theta_1}}{\epsilon_0 \cos \theta_1 + \sqrt{\epsilon_0 - \sin^2 \theta_1}} \quad (26)$$

where,

$$\epsilon_0 = \epsilon - j\frac{2\sigma}{f}$$

In terms of the angle  $\phi$  to the boundary plane, since  $\phi = 90$  degrees  $-\theta$ , we obtain

$$K_v = \frac{\epsilon_0 \sin \phi - \sqrt{\epsilon_0 - 1 + \sin^2 \phi}}{\epsilon_0 \sin \phi + \sqrt{\epsilon_0 - 1 + \sin^2 \phi}} \quad (27)$$

For horizontal polarization a similar procedure gives:

$$K_H = \frac{\sin \phi - \sqrt{\epsilon_0 - 1 + \sin^2 \phi}}{\sin \phi + \sqrt{\epsilon_0 - 1 + \sin^2 \phi}} \quad (28)$$

## 2. Approximation for Field at a Receiver

Let " $h$ " be the height of the transmitting antenna, " $a$ " of the receiving antenna,  $r$  the intervening distance, and  $\phi$  the angle to the ground of the reflected ray,  $r_1$  the length of the path of the direct ray, and  $r_2$  that of the reflected ray (See Fig. 28.) The difference  $\Delta$  in length of the two paths is then

$$\Delta = r_2 - r_1 \quad (29)$$

but,

$$r_2 = r^* + (h + a)^2 \text{ and } r_1^2 = r^2 + (h - a)^2. \quad (30)$$

When  $r$  is large compared to  $a + b$

$$r_2 = r + \frac{1}{2} \frac{(h + a)^2}{r} \quad (31)$$

$$r_1 = r + \frac{1}{2} \frac{(h - a)^2}{r} \quad (32)$$

$$\text{and } \Delta = r_2 - r_1 = \frac{2ah}{r} \text{ and the phase angle } \psi = \frac{2\pi}{\lambda} \Delta = \frac{4\pi ah}{\lambda r} \quad (33)$$

Also, when  $r$  is large compared to  $a$  and  $h$  we may write

$$\sin \phi = \phi = \frac{h + a}{r} \quad (34)$$

For horizontal polarization we then obtain

$$\begin{aligned} K_H &= \frac{\sin \phi - \sqrt{\epsilon_0 - 1 + \sin^2 \phi}}{\sin \phi + \sqrt{\epsilon_0 - 1 + \sin^2 \phi}} = \frac{\phi - \sqrt{\epsilon_0 - 1}}{\phi + \sqrt{\epsilon_0 - 1}} \\ &= - \left( 1 - \frac{2}{r} \frac{(h + a)}{\sqrt{\epsilon_0 - 1}} \right) \end{aligned} \quad (35)$$

and,

$$K_V = \frac{\epsilon_0 \sin \phi - \sqrt{\epsilon_0 - 1 + \sin^2 \phi}}{\epsilon_0 \sin \phi + \sqrt{\epsilon_0 - 1 + \sin^2 \phi}} \quad (36)$$

$$\approx - \left( 1 - \frac{2\epsilon_0(h+a)}{r\sqrt{\epsilon_0 - 1}} \right) \text{ when } \frac{h+a}{r} \ll \left| \frac{1}{\sqrt{\epsilon_0}} \right|.$$

For the field at the receiver we then have for horizontal polarization

$$E_H \approx E_d(1 + K_H e^{i\psi}) \approx E_d \left[ 1 - \left( 1 - 2 \frac{h+a}{r\sqrt{\epsilon_0 - 1}} \right) e^{i\psi} \right] \quad (37)$$

$$\approx E_d e^{i\psi/2} \left[ 2 \frac{h+a}{r\sqrt{\epsilon_0 - 1}} - j \frac{4\pi}{\lambda} \frac{ha}{r} \right] \text{ when } \frac{4\pi ha}{\lambda r} < 0.05.$$

For vertical polarization

$$E_V \approx E_d e^{i\psi/2} \left[ \frac{2\epsilon_0(h+a)}{r\sqrt{\epsilon_0 - 1}} - j \frac{4\pi}{\lambda} \frac{ha}{r} \right] \text{ when } \frac{h+a}{r} \ll \left| \frac{1}{\sqrt{\epsilon_0}} \right| \quad (38)$$

and when  $\frac{4\pi ah}{\lambda r} < 0.05.$

For Long Island ground or other conditions where the conductivity may be neglected  $\epsilon_0 = \epsilon$  and we have for the effective value of the field

$$E_H = \frac{E_d}{r} \sqrt{\frac{4(h+a)^2}{\epsilon - 1} + \left( \frac{4\pi ha}{\lambda} \right)^2} \text{ when } \frac{4\pi ha}{\lambda r} < 0.05 \quad (39)$$

and,

$$E_V = \frac{E_d}{r} \sqrt{\frac{4\epsilon^2(h+a)^2}{\epsilon - 1} + \left( \frac{4\pi ha}{\lambda} \right)^2} \text{ when } \frac{4\pi ha}{\lambda r} < 0.05. \quad (40)$$

The direct field from a half-wave dipole is  $7 (\sqrt{W}/r)$  volts per meter for a distance  $r$  in meters and a radiated power  $W$  in watts. For a dipole considerably shorter than a half wavelength the direct field is  $6.7 (\sqrt{W}/r)$  volts per meter. For long Island ground where  $\epsilon = 9$  we then get for the field from a half-wave dipole:

$$E_V = 44.5 \frac{\sqrt{W}}{r} \text{ volts per meter} \quad (41)$$

$$E_H = 4.95 \frac{\sqrt{W}}{r} \text{ volts per meter if } \frac{2\pi ha}{r} \ll \left( \frac{h+a}{2} \right)^2. \quad (42)$$

For salt water if  $\epsilon = 80$  and  $\sigma = 10^{10}$  electrostatic units

$$\epsilon_0 = \left( 80 - j \frac{2 \times 10^{10}}{f} \right). \quad (43)$$

It is roughly correct to assume  $\epsilon_0 - 1 \approx \epsilon_0$

Then,

$$\frac{\epsilon_0}{\sqrt{\epsilon_0 - 1}} \approx \sqrt{\epsilon_0}. \quad (44)$$

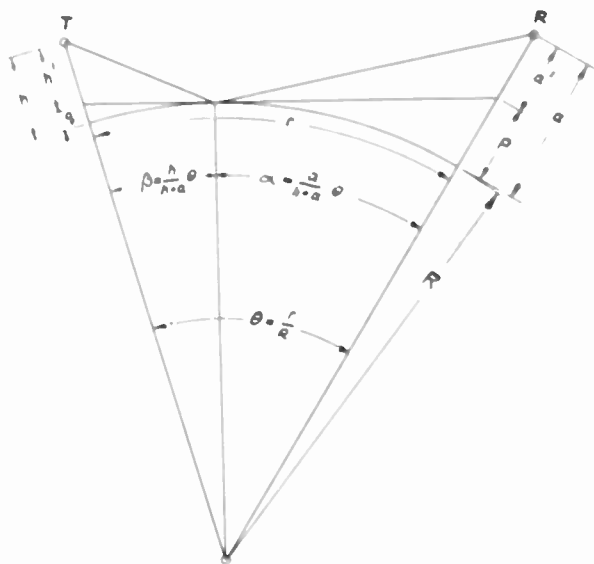

Fig. 41

### 3. Effect of Earth's Curvature

The preceding formulas for field strength may be used for the curved surface of the earth by using corrected heights  $h'$  and  $a'$  where  $h' = h - p$  and  $a' = a - q$  where

$$p = \frac{r^2}{2R} \left( \frac{h}{a+h} \right)^2 \quad (45)$$

and,

$$q = \frac{r^2}{2R} \left( \frac{a}{a+h} \right)^2 \quad (46)$$

in which  $R$  is the radius of the earth. Referring to Fig. 41 it is apparent

that we may write the following approximate relations

$$\alpha = \frac{a}{a+h}\theta, \quad \beta = \frac{h}{a+h}\theta \quad (47)$$

$$p = \frac{R}{\sqrt{1 - \sin^2 \alpha}} - R = R \times \frac{\alpha^2}{2} \quad (48)$$

$$q = \frac{R}{\sqrt{1 - \sin^2 \beta}} - R = R \times \frac{\beta^2}{2}. \quad (49)$$

Then,

$$p = \frac{r^2}{2R} \left( \frac{h}{a+h} \right)^2 \quad (50)$$

and,

$$q = \frac{r^2}{2R} \left( \frac{a}{a+h} \right)^2. \quad (51)$$



## ULTRA-SHORT-WAVE PROPAGATION\*

By

J. C. SCHELLENG, C. R. BURROWS, AND E. B. FERRELL

(Bell Telephone Laboratories, Inc., New York City)

**Summary**—Part I of this paper first describes a method of measuring attenuation and field strength in the ultra-short-wave range. A résumé of some of the quantitative experiments carried out in the range between 17 megacycles (17 meters) and 80 megacycles (3.75 meters) and with distances up to 100 kilometers is then given. Two cases are included: (1) "Optical" paths over sea water and (2) "Nonoptical" paths over level and hilly country. An outstanding result is that the absolute values of the fields measured were always less than the inverse distance value. Over sea water, the fields decreased as the frequency increased from 34 megacycles (8.7 meters) to 80 megacycles (3.75 meters), while the opposite trend was found over land. As a rule, the signals received were very steady, but some evidence of slow fading was obtained for certain cases when the attenuation was much greater than that for free space.

Part II gives a discussion of reflection, diffraction, and refraction as applied to ultra-short-wave transmission. It is shown, (1) that regular reflection is of importance even in the case of fairly rough terrain, (2) that diffraction considerations are of prime importance in the case of nonoptical paths, and (3) that refraction by the lower atmosphere can be taken into account by assuming a fictitious radius of the earth. This radius is ordinarily equal to about four thirds the actual radius.

The experiments over sea water are found to be consistent with the simple assumption of a direct and a reflected wave except for distances so great that the curvature of the earth requires a more fundamental solution. It is shown that the trend with frequency to be expected in the results for a nonoptical path over land is the same as that actually observed, and that in one specific case, which is particularly amenable to calculation, the absolute values also check reasonably well. It is found both from experiment and from theory that nonoptical paths do not suffer from so great a disadvantage as has usually been supposed.

Several trends with respect to frequency are pointed out, two of which, the "conductivity" and the "diffraction" trends, give decreased efficiency with increased frequency, and another of which, the "negative reflection" trend, gives increased efficiency with increased frequency under the conditions usually encountered.

The existence of optimum frequencies is pointed out, and it is emphasized that they depend on the topography of the particular paths, and that different paths may therefore have widely different optimum frequencies. Thus, among the particular cases mentioned, the lowest optimum values vary from frequencies which are well below the ultra-high-frequency range up to 1200 megacycles (25 centimeters). For other paths the lowest optimum frequency may be still higher.

### INTRODUCTION

WITH the extension of the radio-frequency spectrum to higher and higher frequencies have come new problems, both of experiment and of theory, which require quantitative study for solution. The fundamental similarity of visual light and radio waves

\* Decimal classification: R113×R270. Original manuscript received by the Institute, December 13, 1932. Presented before New York meeting, November 2, 1933.

makes it obvious that somewhere between these regions a transition region must occur in which the apparently different phenomena merge into each other. In theoretical studies of this region it is necessary to use concepts borrowed from both the adjacent frequency ranges. A survey of a part of this field has now been in progress for some time and some of the results obtained to date are given in this paper and in a companion paper by Englund, Crawford, and Mumford.<sup>1</sup>

Since the Kennelly-Heaviside layers do not reflect ultra-short waves sufficiently to be a factor in the ordinary phenomena of this range, our interest is confined to the "ground" or direct wave. This term refers to any and all signals which arrive at the receiver except those which are affected by the upper atmosphere. It is otherwise noncommittal as to the mechanism of transmission. The physical pictures of this mechanism which have been so useful in the case of long waves are of little help when the length of the wave is of the order of, or smaller than, the dimensions of irregularities of topography which it encounters. The well-known work of Abraham,<sup>2</sup> Zenneck,<sup>3</sup> Sommerfeld<sup>4</sup> and the more recent studies by Weyl,<sup>5</sup> Eekersley,<sup>6</sup> Strutt,<sup>7</sup> and Wise<sup>8</sup> apply to special cases of ultra-short-wave propagation, but generally speaking help but little in the more numerous problems where irregularity of topography is the rule. Likewise, the important work of Watson and of van der Pol<sup>9</sup> may perhaps find application in the diffraction problems of ultra-short waves, but only to a limited extent.

It is obvious that rigorous solutions of problems in transmission over rough surfaces are out of the question, but progress can be made

<sup>1</sup> See Proc. I.R.E., this issue, pp. 464-492.

<sup>2</sup> M. Abraham, "Elektromagnetische Wellen," *Enc. der math. Wissen.*, vol. 5, part 2, pp. 482-538.

<sup>3</sup> J. Zenneck, "Über die Fortpflanzung ebenen elektromagnetischer Wellen langs einer ebenen Leiterfläche und ihre Beziehung zur drahtlosen Telegraphie," *Ann. der Phys.*, series 4, vol. 23, p. 846, (1907).

<sup>4</sup> Arnold Sommerfeld, "Über die Ausbreitung der Wellen der drahtlosen Telegraphie," *Ann. der Phys.*, vol. 4, no. 28, pp. 665-756; March, (1909), and "Ausbreitung der wellen in der drahtlosen Telegraphie. Einfluss der Bodenbeschaffenheit auf gerichtete und ungerichtete Wellenzüge," *Jahr. d. drahtlosen T.*, vol. 4, p. 157, (1911).

<sup>5</sup> H. Weyl, "Ausbreitung elektromagnetischer Wellen über einer ebenen Leiter," *Ann. der Phys.*, series 4, vol. 60, pp. 481-500, (1919).

<sup>6</sup> T. L. Eekersley, "Short-wave wireless telegraphy," *Jour. I.E.E.* (London), vol. 65, pp. 600-644; June, (1927).

<sup>7</sup> M. J. O. Strutt, "Strahlung von Antennen unter dem Einfluss der Erdbodeneigenschaften," *Ann. der Phys.*, series 5, vol. 1, pp. 721-772, (1929); vol. 4, pp. 1-16 (1930); vol. 9, pp. 67-91 (1931).

<sup>8</sup> W. Howard Wise, "Asymptotic dipole formulas," *Bell Sys. Tech. Jour.*, vol. 9, pp. 662-671; October, (1929).

<sup>9</sup> G. N. Watson, "The diffraction of electric waves by the earth," *Proc. Roy. Soc.* (London), vol. 95, pp. 83-99; October 7, (1918); Balth. van der Pol, "On the propagation of electromagnetic waves around the earth," *Phil. Mag.*, series 6, vol. 38, pp. 365-380; September, (1919).



by way of the general concepts of reflection, diffraction, and refraction. We shall endeavor to show that many phenomena observed can be explained quantitatively in this way. Reflection, diffraction, and refraction all play their parts.

On the experimental side, the longer distance ultra-short-wave transmission studies described in the literature have been made almost exclusively with apparatus capable of making only qualitative measurements. In spite of this handicap, many valuable observations have been made.<sup>10</sup> The outstanding result of these has been the demonstration of the advantages of an "optical" path, or rather, one in which a straight line between the transmitting and receiving antennas is unbroken by the intervening terrain. In many cases, however, this advantage has been greatly overemphasized.

As a basis for studying the relative importance of the various mechanisms that have been suggested, quantitative measurement must replace qualitative observation. Part I of this paper presents some of the results of an experimental study of the propagation of ultra-short waves, made with the objective of obtaining quantitative data of sufficient accuracy to serve as a basis for theoretical work. Part II discusses the theory of ultra-short-wave transmission and analyzes some of the experimental results from that point of view.

## PART I—EXPERIMENT

### EQUIPMENT AND PROCEDURE

A considerable portion of the transmitting in connection with this survey was done with a 1000-watt transmitter located at Deal, N. J. In this transmitter the last stage employed four 1000-watt radiation-cooled tubes as an oscillator at 69 megacycles. The frequency was controlled by a 3833-kilocycle crystal oscillator acting through a chain of amplifiers and harmonic generators. A simple vertical half-wave antenna was used for most of the tests. It was located about 60 meters above ground, and was driven through a long two-wire transmission line. The stability of this transmitter was a definite advantage and facilitated the taking of reliable data. Another transmitter of slightly higher power was employed for the lower frequency tests from Deal. Similar antennas were used.

For most of the over-water tests use was made of a mobile transmitter of some 100 watts output, while for some of the very short-

<sup>10</sup> On account of the extensiveness of these qualitative studies, no attempt is made to give a complete bibliography. A few articles giving results of especial interest in connection with the present paper are cited in the text.

distance work, a simple portable oscillator using receiving tubes was employed. The radiator, a simple vertical antenna, was located on a wooden tripod on a bluff at Cliffwood Beach, N. J. This bluff overlooks New York Bay, and provided antenna heights up to 28 meters above sea level.

The receivers were, for the most part, triple detection sets with calibrated attenuators in the second intermediate frequency amplifier. To this extent they were similar to familiar types of sets used to measure field strengths on short waves,<sup>11</sup> and were capable of making accurate comparisons of voltages induced in the receiving antenna.

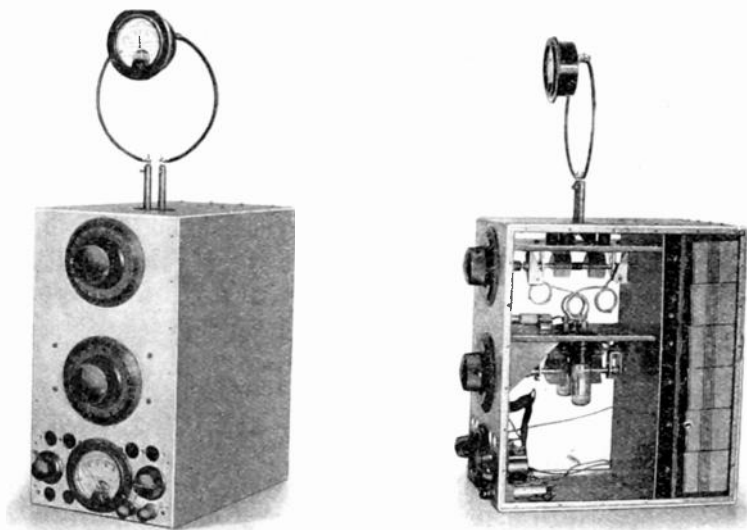

Fig. 1—Standard field generator.

None of the usual means for introducing a calibrating voltage in the set was provided. Instead, a method due to R.C. Shaw was used, in which calibrations were made by producing *at the antenna itself* a known field from a local source to which the name "standard field generator"<sup>12</sup> has been given. The standard field generator is a small com-

<sup>11</sup> In fact, one included a set similar to that described by Friis and Bruce, Proc. I.R.E., vol. 14, pp. 507-519; August, (1926). An extra ultra-high frequency combination (input circuits, beating oscillator, detector, and amplifier) provided input at 6 megacycles to the standard short-wave receiver. The latter was tuned to operate at 6 megacycles.

<sup>12</sup> Since the writing of this paper, our attention has been called to the method described by K. Sohnemann, *E.N.T.*, vol. 8, no. 10, p. 462, October, (1931). The Sohnemann method also uses a standard field generator but otherwise, the technique is entirely different from that of the Shaw method.

compact self-contained oscillator which is very carefully shielded except for a small balanced loop extending in a vertical plane above the shield (see Fig. 1). A thermomilliammeter is located in the loop at the point of low potential with respect to the shield. From the reading of the meter and the dimensions of the loop, the field at near-by points may be computed.<sup>13</sup> This, therefore, provides a field strength standard by comparison with which the unknown field can readily be obtained.

Signals were received by means of a simple half-wave antenna supported on a portable mast at heights up to twelve meters above the ground. For calibrating, however, the center of the antenna was located about four meters above the ground and the standard field generator was placed in operation at the same height one-half wavelength away. It has been determined experimentally that this avoided serious complications due to the proximity of the ground. There are certain other refinements which may or may not be important depending upon the accuracy required. Such, for example, is the effect of the finite length of the receiving antenna. It is beyond the scope of the present paper to enter into this matter. It is sufficient to say that the error so produced is less than one decibel. Field strengths of the order of two or three microvolts per meter could be measured in this way. This might be improved by increasing the sensitivity of the set or by using directional receiving antennas.

The meter in the transmitting antenna was calibrated by means of this same standard field generator. The signal from the transmitting antenna was measured at some near-by receiving point. The antenna was then lowered to the ground, the standard field generator was hoisted into the same position, and the signal from it measured at the same receiving point. Thus the field radiated from the transmitting antenna was known in terms of the field from the standard field gen-

<sup>13</sup> The field from a radiating loop in free space is given by,

$$E = \frac{120 \pi^2 N A I}{\lambda^2 D} \left( 1 - j \frac{\lambda}{2\pi D} \right)$$

where,

- $E$  = electric field strength in volts per meter
- $N$  = number of turns in loop
- $A$  = area of loop in square meters
- $I$  = current in loop in amperes
- $D$  = distance between loop and antenna in meters
- $\lambda$  = wavelength in meters

When the distance between the loop and the receiving antenna is a half wavelength the terms in the parenthesis become  $(1 - j 0.318)$  which has an amplitude of 1.05 (0.4 decibel above unity). Hence the second term increases the total field to 0.4 decibel above the "radiation" field at this distance.

erator. The meter-amperes in the transmitting antenna could then be calculated in terms of the standard field generator.

It is important that both transmitting and receiving equipments were calibrated in terms of the same standards, namely, the dimensions of the loop of the standard field generator and the current in it as indicated by the thermomilliammeter. So long as these were duplicated at both ends of the path, it was possible to determine the relative values of fields at the two ends, regardless of absolute errors. Investigation of the behavior of the meter and of the method in general, indicate that the absolute error itself is not large.

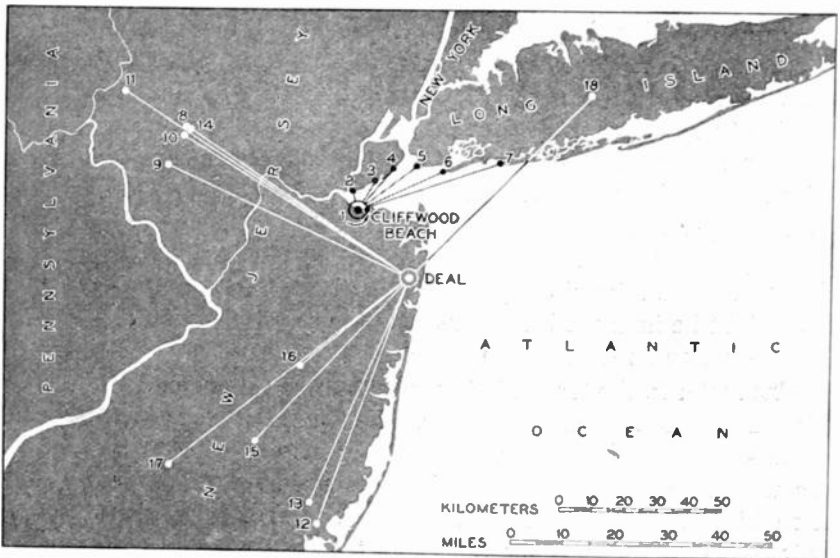

Fig. 2—Transmitting and receiving locations.

The map of Fig. 2 shows the locations of the transmitting and receiving sites used. The tests may be divided into two groups. Propagation over water was studied mainly with the transmitter located on the bluff at Cliffwood Beach. Measurements on transmission over land were made from the transmitter at Deal. Lines radiating from these two points indicate the various transmission paths studied.

#### TRANSMISSION OVER SEA WATER

For the measurements on propagation over water at 34, 51, and 80 megacycles, the receiving antenna was located at the water's edge, except for a few special tests. The height of its mid-point was varied up to a maximum of about twelve meters above sea level. The data

presented in Fig. 3 show the results with the maximum elevations and vertical polarization (vertical electric field).

This figure shows that the received field was below the inverse square field that would result from radiation in free space.<sup>14</sup> The field strength is more nearly inversely proportional to the second than to the first power of the distance as may be seen by comparison with the light dashed line in Fig. 3.

In addition to the measurements taken on the ground, measurements on the highest frequency, 80 megacycles, were made with the receiver in an airplane.<sup>15</sup> The results are discussed later in connection with Figs. 11 and 12.

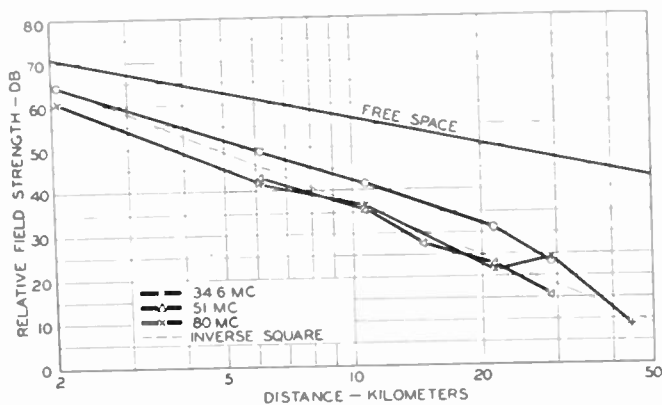

Fig. 3—Field strength as a function of distance for transmission over salt water from Cliffwood Beach.

The effect of altitude was determined at two distances, 77 and 142 kilometers, using the Deal transmitter at 69 and 17 megacycles. The results are shown in Figs. 4 and 5. The increase of signal with elevation was much greater on the higher frequency than on the lower frequency. Significance should not be attached to the ratio of field obtained on one frequency to that obtained on the other.

#### TRANSMISSION OVER LAND

The transmitters located at Deal were employed for studying the propagation of waves of 17, 34, and 69 megacycles over various types of terrain. The transmission paths are shown by the lines radiating

<sup>14</sup> In free space, the field produced by a given current in a doublet is one half as great as that produced by the same current and doublet when located at and perpendicular to the surface of a perfect conductor.

<sup>15</sup> These measurements were possible through the cooperation of Mr. F. M. Ryan.

from Deal on the map of Fig. 2. Three types of paths are represented. The best for ultra-short-wave work was found to be that with the other terminal on high ground, such as is found to the northwest. Another

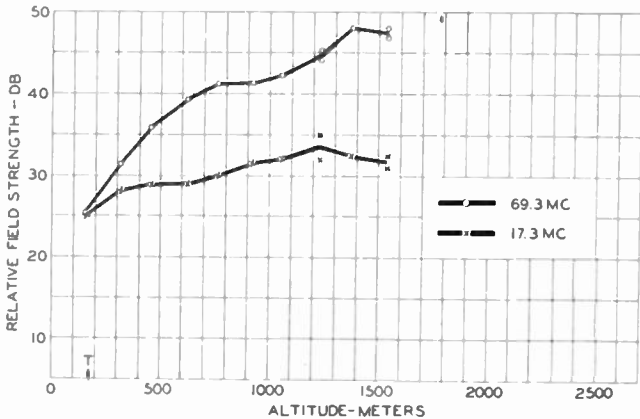

Fig. 4—Field strength as a function of receiver altitude at a distance of 77 kilometers. The path was mostly over water. The arrow shows the altitude at which the line of sight, neglecting refraction, becomes tangent to the earth's surface.

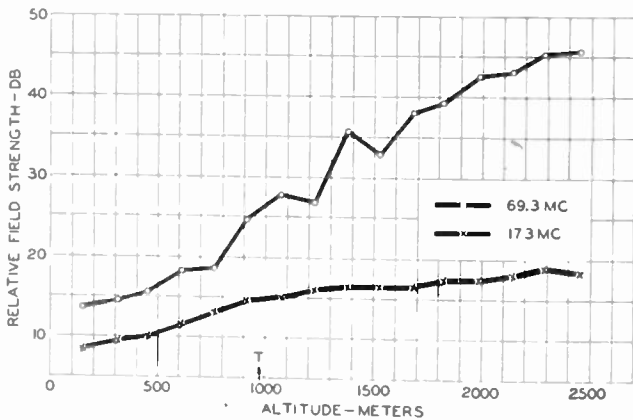

Fig. 5—Field strength as a function of receiver altitude at a distance of 141 kilometers. The path was mostly over water. The arrow shows the altitude at which the line of sight, neglecting refraction, becomes tangent to the earth's surface.

type, not so favorable to the transmission of ultra-short waves, but typical of flat country, could be studied by locating the receiving terminal to the south or southwest. Here the intervening ground is fairly level, and there are no high hills that can be used for the receiving

terminal. The third type of path is mostly over water to points on Long Island. Typical profiles of over-land paths are shown in Fig. 6.

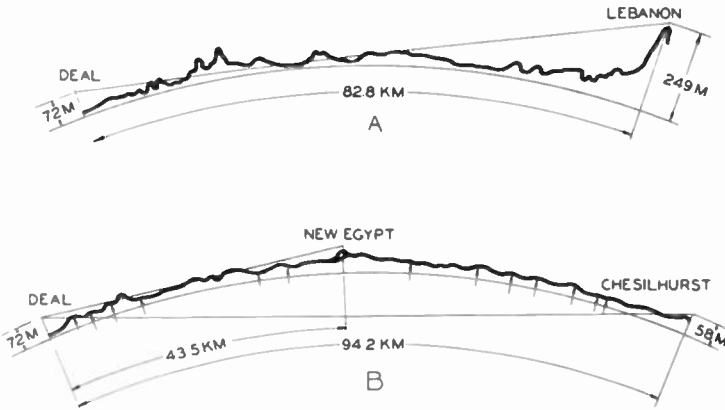

Fig. 6—Profiles of typical overland paths: A, path No. 8, over hilly country, with receiving location not masked by near-by hills; B, paths Nos. 16 and 17, over level country.

The experimental results of transmission over these paths, together with some of their characteristics, are given in the table of Fig. 7. In the last three columns is given the received field in decibels below the

| NO.                       | RECEIVING LOCATION | LAT W      | LONG. N    | ELEVATION m. | DISTANCE Km. | RECEIVED FIELD DB BELOW FREE SPACE VALUE |        |        |
|---------------------------|--------------------|------------|------------|--------------|--------------|--|--------|--------|
|                           |                    |            |            |              |              | 17.3mc                                   | 34.6mc | 69.3mc |
| HILLY COUNTRY OPEN SITE   |                    |            |            |              |              |  |        |        |
| 8                         | LEBANON 1          | 74°-51'-0" | 40°-39'-9" | 238          | 82.8         | 32.5                                     |        | 15.1   |
| 9                         | CHERRYVILLE        | 74°-53'-3" | 40°-33'-4" | 165          | 96.6         |  | 28.5   | 13.2   |
| HILLY COUNTRY MASKED SITE |                    |            |            |              |              |  |        |        |
| 10                        | LEBANON 2          | 74°-51'-0" | 40°-38'-5" | 119          | 81.3         | 45.0                                     | 35.5   | 40.0   |
| 11                        | MONTANA            | 75°-4'-2"  | 40°-45'-3" | 342          | 104.5        | 43.5                                     | 34.5   | 32.5   |
| LEVEL COUNTRY             |                    |            |            |              |              |  |        |        |
| 12                        | TUCKERTON 1        | 74°-22'-5" | 39°-35'-2" | 24           | 80.6         | 50.0                                     | 35.5   | 24.5   |
| 13                        | TUCKERTON 2        | 74°-23'-5" | 39°-38'-5" | 27           | 77.3         | 47.5                                     | 41.0   | 36.0   |
| 14                        | LEBANON 3          | 74°-49'-8" | 40°-39'-2" | 110          | 81.3         | 40.5                                     | 37.5   | 30.5   |
| 15                        | APPLE PIE HILL     | 74°-35'-5" | 39°-48'-5" | 63           | 69.2         | 40.0                                     | 35.0   | 27.7   |
| 16                        | NEW EGYPT          | 74°-25'-7" | 40°-0'-9"  | 61           | 43.5         |  |        | 27.1   |
| 17                        | CHESILHURST        | 75°-53'-9" | 39°-44'-2" | 46           | 94.2         |  |        | 48.3   |
| OVER WATER                |                    |            |            |              |              |  |        |        |
| 18                        | HALF HOLLOW HILLS  | 73°-23'-3" | 40°-47'-1" | 73           | 81.3         |  |        | 31.5   |
| 6                         | ROCKAWAY BEACH     | 73°-54'-0" | 40°-34'-0" | 0            | 34.8         |  | 29.3   | 30.5   |
| 5                         | NORTONS POINT      | 74°-1'-0"  | 40°-34'-5" | 0            | 35.1         |  |        | 28.4   |

Fig. 7—Table of data taken with transmitter at Deal.

free space value. At 69 megacycles the best paths, 8 and 9, gave values which were 15 and 13 decibels below the inverse distance amplitude.

The former gave 32 decibels at 17 megacycles and the latter gave 28 decibels at 34 megacycles. In general, the highest frequency showed the smallest attenuation over land.

It should be pointed out that these measurements are not independent of the local receiving conditions. The proximity of the ground has the effect of making the vertical directive characteristic far different from that of the same antenna in free space. In all cases the field increased as the receiving antenna was raised up to the maximum height available (12 meters). This effect of the ground was therefore more detrimental when the longer waves were used, since the antenna could not then be raised to corresponding heights. Even taking this into account, the over-land transmission paths of these tests favor the shorter wavelengths. A theoretical reason for this will be given later.

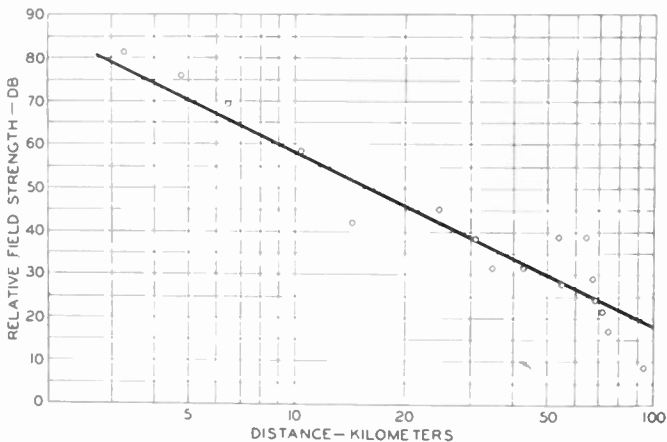

Fig. 8—Field strength as a function of distance for transmission over level country, along the profile of Fig. 6B.

In one direction from Deal, S  $50^{\circ} 46' W$ , measurements were made on 69 megacycles at numerous places along the beam of a directive antenna, up to a distance of about 95 kilometers. The profile of this path along the straight line to the most distant point, Chesilhurst, is shown in Fig. 6B. Displacements of intermediate points from this line are negligible except in the case of New Egypt. Here a slight displacement was made in order to use a favorable receiving site for more extensive measurements. The profile in this neighborhood is superposed on the main profile. The various receiving points are shown by small arrows.

The received field is plotted as a function of distance in Fig. 8. For comparison purposes a straight line representing the inverse square law is drawn. This represents the general trend very well.



Transmission along this path is of particular interest since it represents conditions to be expected over flat land. The profile in Fig. 6B shows that if the immediate neighborhood of terminal points be left out of consideration, the maximum difference in elevation along the path is only 45 meters. This path probably represents a spherical earth as well as any of similar length that exists in this part of the country.

#### STABILITY OF SIGNALS

Speaking generally, the signals received in ultra-short-wave transmission vary little, if at all. In this respect they are in marked contrast with signals of lower frequencies in the transmission of which the Kennelly-Heaviside layer is involved. In this work, definite indications of fading have been found only in the case of paths in which the attenuation in excess of that represented by the inverse distance formula has been in the order of 30 to 40 decibels. The variations were in the order of one or two decibels, and the period was a few seconds. This may have been due to variable atmospheric refraction. On the other hand, it is not inconceivable that it may have been due to reflection from clouds. It is, of course, easy to show that there is so little moisture in clouds that reflections must be extremely weak. But we have to explain coefficients of reflection in the order of only 0.01. This is plausible since we are concerned with reflection from the cloud at near-grazing incidence for which the coefficient tends to be unity regardless of the difference in dielectric constant. Further investigation is needed along these lines.

#### PART II THEORY

Before entering into a quantitative explanation of some of the results which have been presented, it may be well to direct attention to certain ways in which the present problem is related to the familiar concepts of optical reflection, diffraction, and refraction.

#### REFLECTION

Reflection constants are readily calculated in the case of smooth surfaces such as still water. Having obtained these, the resultant amplitude at the receiver can be calculated for different ground constants. (See Appendix I.)

Even if the surface is rough, it is to be expected that an ultra-short radio wave may be reflected regularly from a body of water. The existence of regular reflection is less obvious when transmission occurs over rolling land. In the first case we have the most simple conditions since the surface waves on the water are irregularities of a single gen-

eral type and range of dimensions. They are merely deviations from a plane, or rather from a sphere. But in the second case, the irregularities of the land are of all forms and dimensions, and the existence of regular reflection cannot be granted without consideration.

In most of the cases of radio propagation now being considered, we are concerned with near-grazing incidence since both transmitter and receiver are located near the ground and are separated horizontally by a comparatively large distance. That regular reflection may occur under such circumstances even over irregular ground can be shown by a simple optical experiment. A moderately rough piece of paper, such as a sheet of bond or any other paper without gloss is employed. The paper on which this is printed is rather too smooth to give a striking result, but it may be used. If the reader will focus his eye on some distant object which shows up with contrast against the sky, and if he will then hold the paper about a foot from the eye so that the line of sight is parallel and very close to the plane of the paper, it will be seen that the rough sheet has become a surface with a high gloss. It is helpful to bend the paper slightly so as to produce a cylindrical surface having elements parallel to the line of sight. Images of distant objects can be seen clearly in such a paper mirror, and considerable detail can be obtained provided that the angle of incidence differs from 90 degrees by something less than one degree. It is to be remembered that in most of the optical paths encountered in ultra-short-wave propagation, we are concerned with angles which are as near to grazing as this is.

The reason for this reflection from a rough surface is readily explained on the basis of Huyghens' principle. The situation is represented in Fig. 9. Let us suppose that the general level of the rough surface is below the line of sight  $TOR$  by a distance  $H$ .  $H$  is assumed small compared with  $D$ , the length of the path. As a result of variations in  $H$  due to the ruggedness of the terrain there will be corresponding variations in the total length of the optical path  $TSR$ . Reflections will be approximately regular, however, if these variations in  $TSR$  are small enough in comparison with half a wavelength. In Fig. 9, a change in level,  $h$ , is represented at  $S$ , the dotted line representing an irregularity which has been added. These assumptions lead readily to the requirement for regular reflections:  $h$ , the height of the hill, should be small compared with  $\lambda D/8H$ , which equals  $\lambda/4\theta$ , where  $\pi/2 - \theta$  is the angle of incidence. This relation expresses the fact that the regularity of reflection from a given rough surface can be improved either by increasing the wavelength or by decreasing the angle  $\theta$ .

While these considerations show the reasonableness of regularity of reflections, they do not enable us to calculate the value of the

coefficient. In the over-land tests which we have described, the amplitude of the coefficient of reflection would have been very near to unity and its phase angle would have been very near to 180 degrees if the ground had been smooth. In the absence of data on the reflection from rough surfaces, we have used these same values although it is apparent that the coefficient will be less than unity due to scattering and increased penetration. The fact that a fairly good quantitative check has

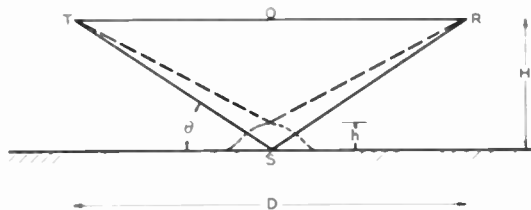

Fig. 9

been obtained experimentally indicates that this assumption is reasonable. The check is somewhat better when the magnitude of the reflection coefficient is somewhat reduced (see Fig. 17).

### DIFFRACTION

In ultra-short-wave propagation, the effect of an obstacle, such as a hill, can be visualized best by considering it from the point of view of this same principle of Huyghens. Fig. 10A represents this. A wave originates at *T* and travels unobstructed to *R*, passing through the plane *P*. It is, of course, incorrect to say that the effect travels ex-

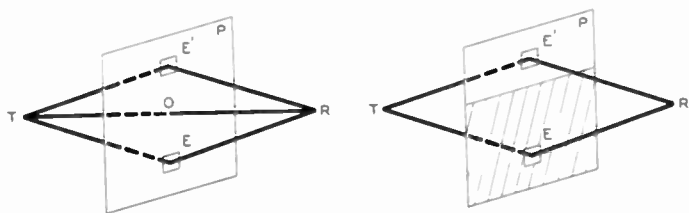

Fig. 10

clusively along the line *TOR*. Consideration must be given to other paths such as *TER*, and the effect of the latter can be neglected only in case the path length *TER* exceeds *TOR* by many wavelengths; or more properly, a region about *E* can be neglected only in case the phases of the components transmitted through the elements within it (e.g., along *TER*) are such as to cause destructive interference among themselves.

When a hill is interposed as shown in Fig. 10B, elements such as  $E$ , below the profile of the hill, are prevented from contributing to the signal at  $R$ , while elements such as  $E'$ , above the profile, contribute as before. This is the simple concept as used in optics and will be used without essential modification in the explanation of nonrectilinear radio transmission.

#### REFRACTION

Besides reflection and diffraction, a third optical concept, atmospheric refraction, must be considered in this study.<sup>16</sup> It is a well-known fact that a star, appearing to be exactly on the horizon, is really 35 minutes below it. It is obvious that the "image" of an ultra-short-wave transmitting antenna will be elevated above its true direction by this same means. The only question is whether the effect is appreciable or not. The answer, obtained theoretically, is that refraction must be taken into account. Unfortunately, we so far do not have quantitative measurements which show the effect of refraction of ultra-short waves in an unmistakable way. Those that we do have, however, appear to be consistent with expectations based on the theory which will now be presented.

The physical picture to be assumed is one in which the dielectric constant of the atmosphere decreases with height above sea level and is not a function of horizontal dimensions. In other words, the phase velocity of a wave in this medium becomes greater as the distance from the center of the earth increases. In the case of ultra-short waves, we are almost always interested in waves traveling in a substantially horizontal direction. The wave front, therefore, lies in a plane which is nearly vertical, and since the upper portions travel faster than the lower, there is a tendency for the ray to bend slowly back toward the earth.

This phenomenon, in its general aspects, is the same as that which is commonly assumed to explain the bending of longer waves about the earth. There is an important difference, however, in regard to the part of the atmosphere which is important. In the case of these longer waves, (for example, one having a wavelength of 15 meters or a frequency of 20 megacycles) the ionization in the atmosphere 100 to 400 kilometers above the earth is the cause of the refraction which makes long-distance signaling possible. In the case of ultra-short waves, however, (for example, one having a wavelength of 1.5 meters or a frequency of 200 megacycles) this upper region is of no importance but it is the

<sup>16</sup> Jouaust, *L'Onde Electrique*, vol. 9, pp. 5-17; January, (1930), has pointed out the importance of refraction in the propagation of ultra-short waves. The authors believe, however, that he has overemphasized its importance.

region below one kilometer or so, where the ionization is negligible, that is essential.

The radius of curvature of a ray traveling horizontally in the lower atmosphere can readily be calculated if it is known how the refractive index,  $n$ , varies from point to point. If  $H$  is the altitude above sea level the radius of curvature of the ray is simply,

$$\rho = - \frac{n}{dn/dH}.$$

But since  $n = \sqrt{\epsilon}$ , where  $\epsilon$  is the dielectric constant, the radius of curvature is

$$\rho = - \frac{2}{d\epsilon/dH},$$

provided  $n$  is not very different from unity.

In Appendix II the estimation of this radius of curvature is discussed in some detail. While some of the data upon which such a calculation can be based are rather uncertain, it appears that a good first approximation is obtained by assuming the radius of curvature,  $\rho$ , of the refracted ray to be four times the radius of the earth,  $r_0$ . As pointed out in the appendix, this varies to some extent with weather, and even as an average value, it may have to be changed when more reliable data on dielectric constants become available.

On first consideration of the ways in which refraction can be taken into account, it appears that the attempt must complicate an already involved situation. Fortunately, however, refraction is much simpler to calculate than diffraction or reflection. The method is presented rigorously in Appendix III. At this point we shall merely state the result and show its plausibility.

In ultra-short-wave work we are almost always concerned with propagation in a nearly horizontal direction. The curvature of the ray is  $1/\rho$ , while that of the earth is  $1/r_0$ . We are interested, however, in the relative curvature, which we shall call  $1/r_e$ . If, instead of using simple rectangular coördinates, we transform to a coördinate system in which the ray is a straight line, the curvature of the earth will become  $1/r_e$ , which is  $1/r_0 - 1/\rho$ . The equivalent radius of the earth would be

$$r_e = r_0 \left( \frac{1}{1 - r_0/\rho} \right),$$

and is therefore greater than the actual radius of the earth by a factor which in this case is 1.33. This fictitious radius is therefore 8500 kilometers instead of 6370 kilometers. Since in the new system of

coordinates, the ray is straight, the new equivalent dielectric is to be assumed constant and equal substantially to unity.

Refraction can therefore be taken into account as follows. In making calculations, we start with the topographical features of the path and construct an equivalent profile<sup>17</sup> of some sort plotted from known elevations of points along the path. If refraction were to be neglected, the actual radius of the earth would be used. To take refraction into account, the process is exactly the same except that the fictitious radius  $r_e (= 1.33 r_0)$  is now used. Reflection and diffraction calculations are then based on this equivalent profile, in which account has already been taken of refraction by means of the fictitious radius.

It follows from the discussion given in Appendix III, that this transformation is not limited to optical paths. The discussion applies to the amplitude of the disturbance set up at one point due to a radiating source at any other point, whether that source be an actual antenna or one of the elementary reradiating oscillators of Huyghens. Under all circumstances where Huyghens' principle applies, the signal is passed on from one intermediate plane to another by the repeated application of the principle. Since this transformation is justified for determining the effect that any elementary oscillator at one point produces at a second near-by point it is justified for the process as a whole provided only that the line connecting the two points is inclined to the horizontal by only a small angle.

#### OPTICAL PATH TRANSMISSION

Let us now consider the application of these concepts to the case of transmission along an optical path. It has been pointed out that in many cases we would expect to find a well-defined reflected wave superposed on the direct wave. The two will, therefore, interfere constructively or destructively depending on phase relations. In other words, a set of Lloyd's fringes will be set up.

The airplane measurements over New York Bay gave direct evidence of the existence of these fringes. In order to check this quantitatively, the data are presented in Fig. 11. Vertical polarization was used. Since the altitude of the transmitting antenna was small compared

<sup>17</sup> The elevations above sea level involved are so small compared with the distances along the surface of the earth that they cannot be plotted on the same scale. This difficulty can be overcome within limits by increasing the scale used in plotting elevations, and at the same time decreasing the scale used in plotting the radius of the earth by the same ratio. When this is done, a line which in the actual case is straight remains approximately so even with these distorted scales. This gives a general picture of the profile but due to the slight curvature introduced, all distances involved in the calculations of this paper have been determined analytically. The scales of the profiles shown have thus been altered by a factor of about 50.

with that of the airplane, we would expect, on the basis of the optical picture, that the field received would depend on the distance and the angle of elevation of the plane as seen at the transmitter. In the figure, the distance has been eliminated by recourse to the inverse distance law, which applies to the separate component waves. The result has been plotted for two elevations with varying distance. The peaks and troughs of the Lloyd's fringes are fairly well indicated.<sup>18</sup>

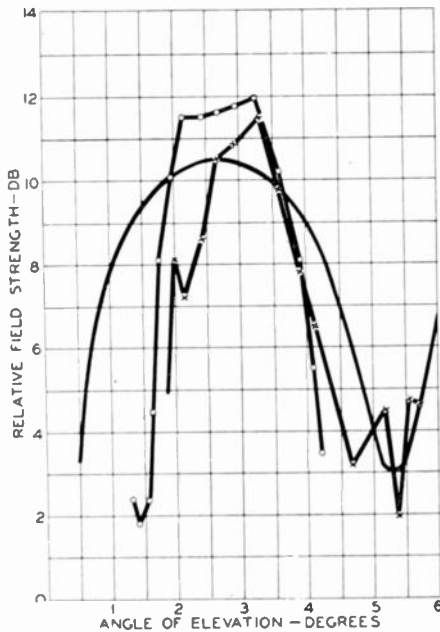

Fig. 11—Field strength as a function of the angle of elevation of the receiver, for transmission over salt water at 80 megacycles. The two experimental curves are from data taken with the receiver in an airplane flying at two constant altitudes. The smooth curve is theoretical.

While little weight can be given to the absolute values as measured in the airplane,<sup>19</sup> it is of interest to estimate the conductivity of the water from the relative values. Fig. 12 shows the theoretical location of maxima, minima and their ratio as functions of the conductivity of sea water. Four experimental values have been plotted. Their average indicates a conductivity of  $1.7 \times 10^{-11}$ . This, at least, has the correct

<sup>18</sup> Similar fringes were obtained over land by Englund, Crawford, and Mumford, *loc. cit.*

<sup>19</sup> Because of the irregular shape of the airplane, the orientation with respect to the line of sight affects the gain of the receiving antenna. Each of the two curves has been plotted from data taken with approximately constant orientation of the airplane.

order of magnitude, but the experimental data are too inaccurate to justify much faith in the numerical value otherwise. The important point is that the field pattern is qualitatively what would be expected. The theoretical characteristic for this value is also plotted in Fig. 11.

Turning now to the more accurate data taken on the ground (already presented in connection with Fig. 3), theoretical curves have been fitted to the data in Fig. 13. In the experiment, the antennas were some 25 and 6 meters above sea level and under this condition the

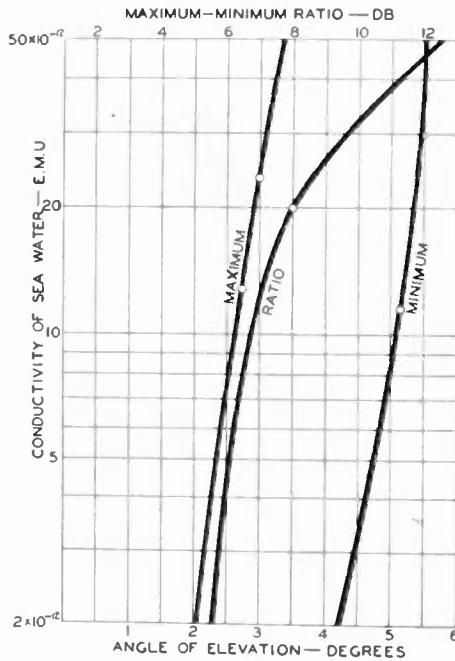

Fig. 12—Theoretical angles of elevation of maximum and minimum, and magnitude of their ratio, as functions of the conductivity of the water for a dielectric constant of 80, and a frequency of 80 megacycles. The experimental points shown (from Fig. 11) indicate a conductivity of about  $17 \times 10^{-12}$  electromagnetic units.

effect of earth curvature cannot be neglected in the calculation except for paths less than a kilometer in length. This curvature has been taken into account here to the extent of replacing the curved surface by a plane which is tangent to the earth at the point where the reflected ray of geometric optics touches the earth. This is justified for short optical paths but cannot be used at the longer distances when the receiver nearly disappears from the view of the transmitter.



Fig. 13 shows the theoretical curve for vertical polarization based on a conductivity of  $1.5 \times 10^{-11}$  electromagnetic units and a dielectric constant of 80 electrostatic units. Other values of conductivity give the same type of curve but the best fit to the experimental data is obtained by this curve. The dielectric constant was chosen equal to that which has been found to hold for fresh water throughout this frequency range.<sup>20</sup>

The agreement between the experimental and theoretical curves is reasonably satisfactory. By varying one constant, the conductivity, it has been possible to check approximately the absolute attenuation at two distances and two frequencies.

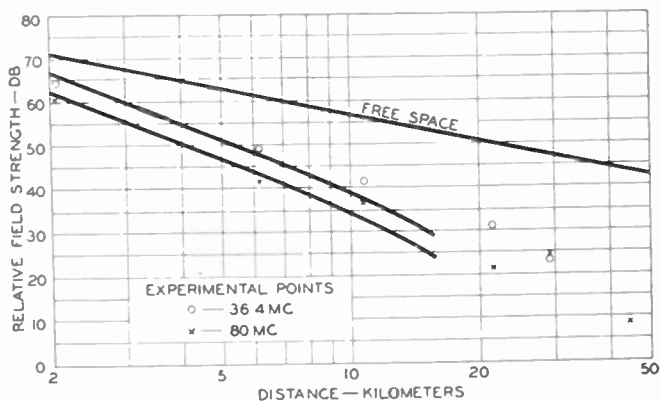

Fig. 13—Theoretical characteristics for transmission over salt water ( $\sigma = 15 \times 10^{-12}$  electromagnetic units,  $\epsilon = 80$  electrostatic units) on the basis of simple optical reflection. Upper curve: 36.4 megacycles. Lower curve: 80 megacycles.

The conductivity ( $1.5 \times 10^{-11}$ ) is lower than that measured for sea water at low frequencies. For this reason, it was considered desirable to check the low-frequency conductivity in this part of the bay since it may have been reduced by the fresh water emptied into the bay by numerous near-by streams. A number of samples were taken from different points between the transmitting and the receiving locations at both low and high tide. The values varied between  $2.9 \times 10^{-11}$  and  $3.7 \times 10^{-11}$  electromagnetic units, with an average of about  $3.3 \times 10^{-11}$ .

<sup>20</sup> Since the writing of this paper, an article by R. T. Lattey and W. G. Davies on "The influence of electrolytes on the dielectric constant of water" has appeared, *Phil. Mag.*, vol. 12, pp. 1111-1136; December, (1931). Their results indicate that the dielectric constant is materially increased by salt in the water. Their experiments were made for solutions that were very much more dilute than sea water. This, together with the fact that the effect of a combination of solutions was not determined, makes it impossible to estimate the dielectric constant of sea water from their results with a reasonable degree of certainty.

This is more than twice the value of  $1.5 \times 10^{-11}$  indicated by the optical calculations. A sample of undiluted ocean water taken at the same time had a conductivity of  $4.3 \times 10^{-11}$ .

This agreement of experiment with simple optical theory does not prove that the assumed picture of a direct and a reflected wave is complete. It is to be pointed out that a rigorous solution (as opposed to the simple reflection picture), might require an appreciably different conductivity. C. B. Feldman of these laboratories has made some short-distance experiments over smooth land.<sup>21</sup> Using frequencies in the short-wave range he found that the simple optical picture cannot always explain the results obtained with vertical polarization. With horizontal polarization, however, satisfactory agreement was obtained. The propriety of the simple optical picture is therefore much clearer for horizontal than for vertical polarization.

Reasons have been given in an earlier section for expecting regularity of reflection even in the case of rugged land, if the incidence is near enough to grazing. It was also shown that there probably exists an effective coefficient of reflection which is actually near to  $-1$  for both polarizations. At the receiver the phase relation between the direct and reflected waves, and hence the field, thus depend only on the path difference measured in wavelengths. A set of interference fringes will, therefore, be set up, and the received signal at any given point will be a function of the frequency.

Making these assumptions as to reflection and taking refraction into account, it is interesting to calculate the frequency characteristic of a typical path. For this purpose, we may choose the path from Beer's Hill to Lebanon, which is discussed by Englund, Crawford, and Mumford. The characteristic which would be obtained from the foregoing considerations of reflection and refraction is shown in Fig. 14. The light curve shows the frequency characteristic that results by neglecting refraction. It can be seen that below about 500 megacycles the expected gain due to refraction is about 5 decibels, a gain which is by no means inconsiderable. For 70 megacycles, the field strength indicated by the curve is in fair agreement with measurements made over this path by Englund, Crawford, and Mumford.

The effect of reducing the reflection coefficient to  $-0.8$  is to raise the low-frequency end of the curve, to reduce the maxima to 5.1 decibel and to raise the minima to  $-14$  decibels. This is shown by the dashed curve of Fig. 14.

Another point in connection with the solid curve in Fig. 14 is of

<sup>21</sup> C. B. Feldman, "The optical behavior of the ground for short radio waves," to be published.

interest. At 715 megacycles (42 centimeters) the path difference is half of a wavelength and the two components now add in phase. This is the optimum phase relation since it gives the largest possible resultant. Hence 715 megacycles is an optimum frequency for this particular path on these assumptions, and a field 6 decibels above the inverse distance value would be expected. Even at one third this frequency, 240 megacycles (126 centimeters), fields equal to the inverse distance value might be expected. For higher frequencies many maxima and minima are indicated.

Since the lowest optimum frequency depends on the difference between the path lengths of the direct and reflected frequencies by picking paths in which the terminals are located very much higher than the valley

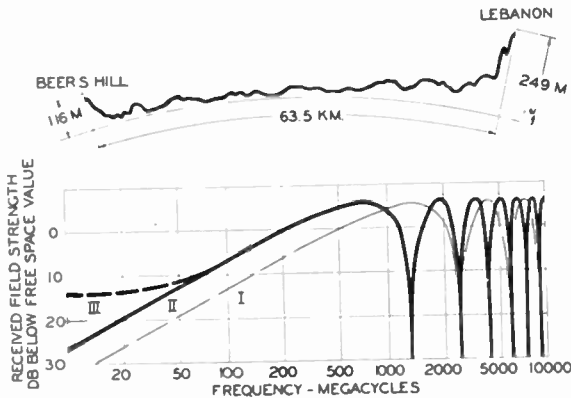

Fig. 14—Above: Profile of "optical" path between Beer's Hill and Lebanon.  
Below:

- (calculated frequency characteristics for this path.
- Curve I, reflection only (coefficient,  $-1$ ).
- Curve II, refraction and reflection (coefficient,  $-1$ ).
- Curve III, refraction and reflection (coefficient  $-0.8$ ).

between them. Thus, optical paths more than one hundred miles long may be found in California for which the lowest optimum frequencies may be considerably less than 30 megacycles (10 meters).

Error in the assumption of a phase shift of 180 degrees would change the frequency at which maximum and minimum fields occur, and failure to obtain a reflection coefficient of unity might materially reduce the difference between the received field and the free space value.

The profile shown in Fig. 15 is used to illustrate the effects of change in polarization and ground constants as indicated by calculations based on simple optical theory. In the computations indicated by the various frequency characteristics of this figure, the same profile has always been

used, but two different sets of ground constants, and both horizontal and vertical polarizations, have been employed. The curves are self-explanatory. It is especially to be noted that for horizontal polarization the field decreases with decrease in frequency and is nearly the same for land as for sea water; i.e., it is nearly independent of conductivity and dielectric constant. For vertical polarization this trend is reversed for frequencies such that the conduction currents are large compared with the displacement currents. In this example, this occurs in the neighborhood of 60 megacycles in the case of sea water, and 5 megacycles in the case of "average" land. Thus for vertical polarization there exists a "poorest" frequency separating the excellent transmission at very low frequencies, where there is no phase shift due either to reflection or to path difference, from the excellent transmission at very high fre-

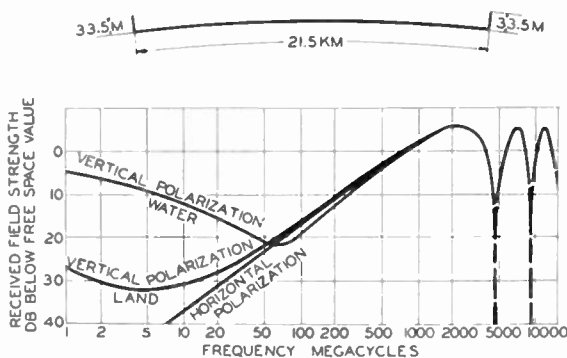

Fig. 15—Above: Profile of a hypothetical path. Below: calculated frequency characteristics for various conditions. Curves are shown for vertical polarization over sea water ( $\sigma = 20 \times 10^{-12}$  electromagnetic units,  $\epsilon = 80$  electrostatic units), for vertical polarization over land ( $\sigma = 5 \times 10^{-14}$  electromagnetic units,  $\epsilon = 15$  electrostatic units), and for horizontal polarization over either (ground constants not important in this case).

quencies (e.g., 2000 megacycles) where large phase shifts due to these two causes nullify each other.

In those cases in which calculations of this sort indicate a very weak resultant field, these estimates may be considerably in error due to neglect of terms which are usually unimportant.

It may be of interest to note that two of the experiments described have given an inverse square of distance variation. In both cases the antennas were near the surface of the earth. It can easily be shown that this should be expected when total reflection occurs with reversal of phase provided that the difference in path length is smaller than one sixth of a wavelength. Thus, in Fig. 9 the signal received at *R* will tend to be zero or very small, except as the phase relation is altered by

the difference in the path lengths  $TOR$  and  $TSR$ . The corresponding phase difference in radians is  $4\pi H^2/D\lambda$ , if  $H$  is small. Since the differences of two vectors of equal magnitude are equal to the product of their phase difference, if small, and their magnitude, the resultant field is equal to  $4\pi KH^2/\lambda D^2$ . One of the inverse distance factors is due to the phase angle and the other is due to the fact that the amplitude,  $K/D$ , of the direct wave itself varies inversely with the distance. Under these conditions, therefore, the signal would vary inversely as the square of the distance,  $D$ , directly as the square of elevation,  $H$ , and inversely as the wavelength. Qualitatively, at least, all of these tendencies have been observed experimentally. Even with vertical polarization, the reflection coefficient is also approximately  $-1$  for transmission over smooth land with near-grazing incidence. The same inverse square tendency is therefore to be expected with vertical polarization under these conditions.

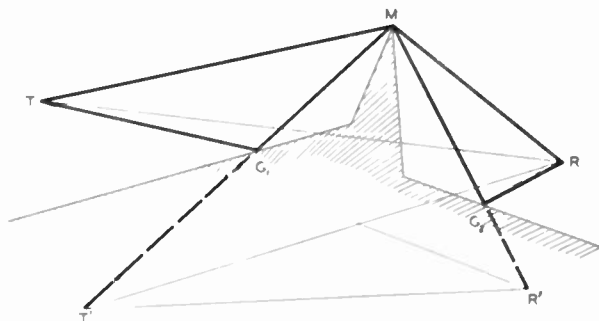

Fig. 16

### NONOPTICAL PATHS

We shall now discuss one type of nonoptical path which is of interest both because it occurs frequently and because on the basis of the assumptions made it is amenable to approximate calculation. It is represented in simplified form in Fig. 16.

$T$  and  $R$  are located on opposite sides of a hill,  $M$ , and the distances  $TM$  and  $TR$  are great compared with the altitudes involved. The low land on both sides of the hill is comparatively flat, though not necessarily coplanar. As previously discussed, the magnitude of the coefficient of reflection to be expected will be close to unity<sup>22</sup> for many con-

<sup>22</sup> An exception to this occurs in the case of vertical polarization over surfaces having appreciable conductivity, such as sea water. Recent experimental work not described in this paper indicates that the assumption is incorrect over land at frequencies considerably higher than those of the present experiment. In such cases the theory is still tenable if appropriate constants are used.

ditions likely to be met, and the phase change will be not much different from 180 degrees. In other words, the wave reflected from the ground between  $T$  and  $M$  will appear to have come from a negative virtual image,  $T'$ . The disturbance above the mountain,  $M$ , will be made up of two components corresponding to the antenna and its negative image. In passing from the region above  $M$  to the receiver,  $R$ , each of these components is broken down into two new components due to reflection between  $M$  and  $R$ . One of these proceeds directly to the receiving antenna. The other proceeds indirectly, being reflected by the intervening ground; it may be thought of as traveling to the virtual image of the receiving antenna,  $R'$ , with a phase change of 180 degrees due to reflection between  $M$  and  $R$ .

The received field is therefore propagated in four ways: (1) directly from  $T$  to  $R$  by diffraction at  $M$ , represented by  $TMR$ , (2) by reflection at  $G_1$  and diffraction at  $M$ , represented by  $TG_1MR$ , (3) by diffraction at  $M$  and reflection at  $G_2$ , represented by  $TMG_2R$ , and (4) by reflection at  $G_1$ , diffraction at  $M$  and a second reflection at  $G_2$ , represented by  $TG_1MG_2R$ . The amplitudes and phases of these four components can be calculated by usual methods of diffraction (see Appendix IV) by assuming the components to travel from the real transmitting antenna or its virtual image, to the real receiving antenna or its virtual image. The ratio of the received field to the free space field may then be calculated by combining the four components as follows:

$$\begin{aligned}
 E/E_0 = & C_1 \exp j(\eta_1 + \zeta_1) \\
 & + C_2 K_1 \exp j(\eta_2 + \zeta_2 - \phi_1) \\
 & + C_3 K_2 \exp j(\eta_3 + \zeta_3 - \phi_2) \\
 & + C_4 K_1 K_2 \exp j(\eta_4 + \zeta_4 - \phi_1 - \phi_2)
 \end{aligned}$$

where the  $C$ 's are the ratios of the field strengths with and without diffraction, the  $\eta$ 's are the phase lags introduced by diffraction, and the  $\zeta$ 's are the phase lags due to path lengths  $TR$ ,  $T'R$ ,  $TR'$ , and  $T'R'$ , while the  $K$ 's are magnitudes of the reflection coefficients and the  $\phi$ 's are the phase advances at reflection.

It is true that actual conditions will seldom be as simple as these. The valleys will not be flat. There will often be more than one hill, and it may be impossible to represent the obstructions accurately by the single straight edge,  $M$ , which we shall assume. It will often be possible, however, to choose equivalent planes and straight edges in such a way as to justify some confidence in the results.

On these assumptions the frequency characteristic of the transmission path from Deal to Lebanon has been calculated. (See Fig. 17.)

By actual measurement it has been found that the attenuation over this path at 17 megacycles (17 meters) was more than that at 69 megacycles (4 meters). This characteristic of poorer transmission on the longer wavelengths is the opposite of what would have been expected either on the basis of diffraction alone or by analogy with the trend observed on lower frequencies. The calculations show, however, that this is the characteristic that we should expect on the theory outlined. In view of uncertainties in the reflection coefficients and errors of measurement, the agreement of the absolute values calculated and measured is as good as should be expected. An improvement in this agreement is obtained by assuming a reflection coefficient of  $-0.8$ . The resulting curve is shown dotted in Fig. 17. In the case of the optical path of Fig. 14 reflection coefficients of  $-1$  and  $-0.8$  agree equally

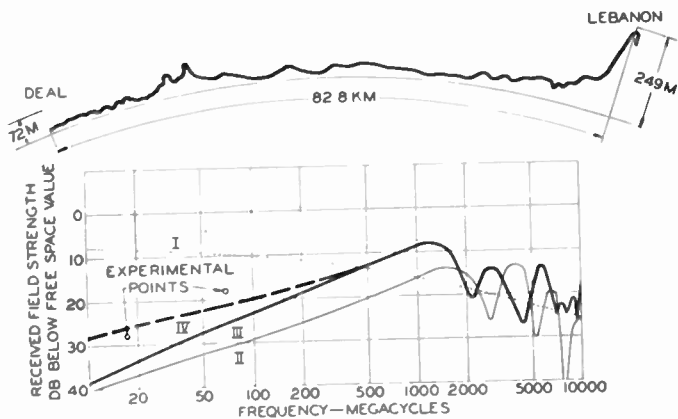

Fig. 17—Above: Profile of "nonoptical" path between Deal and Lebanon. Below: Frequency characteristics for this path calculated on various assumptions.

Curve I takes only the shadow effect (diffraction) into account. Note that the experimental points fall far below it.

Curve II is calculated on the basis of diffraction and reflection (coefficient  $-1.0$ ). Note that this gives a better check with experiment, but values are too low.

Curve III adds to II a correction for refraction.

Curve IV assumes diffraction, refraction, and a reflection coefficient of  $-0.8$ . It checks the experimental points to within experimental error.

The original experimental data have been corrected to eliminate the effect of ground reflection near the receiver. The transmitter, being above level ground, needed no such correction.

well with the experimental point. (In Fig. 17 a correction has been applied to the experimental data eliminating the effect of local reflections at the receiver.)

This curve brings out the important fact that even for nonoptical paths, one may expect to find optimum frequencies. On this particular path the simple assumptions give 1200 megacycles (25 centimeters)

for the lowest of these. On other paths which have been calculated, optimum frequencies would be expected in the range between 1 and 10 meters.

It is fully realized that the details of these curves will probably not be found experimentally. We do not as yet have sufficient experience to pick the simple picture that will in effect represent a complicated topography and transmission mechanism, and it is obvious that this may never be possible. It is encouraging, however, that the limited number of measurements, which have already been made experimentally, agree reasonably well with the theory proposed.

#### DISCUSSION OF CERTAIN TRENDS WITH RESPECT TO FREQUENCY

It may be helpful, in recapitulating, to consider the different trends which ultra-short-wave transmission shows with respect to frequency, and to mention their relationships to the phenomena of the ground wave at lower frequencies.

The simplest trend is that to be found in free space, that is, in cases for which the effect of the ground is negligible. Changes, if any, in transmission efficiency with frequency are then due to the air itself. Such evidence as there is on this point indicates that the assumption of absorption by the air is unnecessary within the range of our experiments, and in fact this is to be expected on theoretical grounds. The "free space" trend therefore gives merely a horizontal line. In Figs. 14 and 15 the high-frequency portion of the curve oscillates about this line and would approach it if reflections from the earth were decreased in strength.

In general, however, the effect of the earth will alter this trend in such a way as to give a variation with respect to frequency. Perhaps the most familiar variation is the loss of efficiency in going to high frequencies when vertical polarization is used. The decrease is due to conduction losses in the ground. This "conductivity trend" appears, for example, in the work of Sommerfeld and of Zenneck. Many experimental observations have been made of it at broadcast frequencies for distances up to a few hundred miles over paths which are obviously "nonoptical." We have seen it here in the optical path tests made over sea water, Fig. 3. It appears also in the low-frequency end of the "vertical polarization over water" curve in Fig. 15.

In several cases we have noted that 69 megacycles was more efficiently transmitted over land than 17 megacycles. This is opposite to the conductivity trend and appears to have a very different cause. For both optical and nonoptical paths it is believed to be associated with a phase change at reflection of 180 degrees, and the effect is most pro-



nounced when reflection occurs without appreciable loss of amplitude. This "negative reflection" trend is exemplified on the one hand by the very poor transmission with very low frequencies when horizontal polarization is used, and, on the other, by the excellent transmission at 75 megacycles (4 meters) between Beer's Hill and Lebanon. (Fig. 14.) In the latter case the difference in path lengths of direct and reflected waves was not negligible compared with a half wavelength, and it is a phase shift due to this cause which apparently prevents destructive interference. This negative reflection trend also appeared in the non-optical paths over level land (Fig. 8). It is affected not only by the negative reflection in the neighborhood of the antennas (negative image), but also by negative reflection all along the path. (The term "negative reflection" is used here even in the nonoptical case, since when we visualize the process in terms of Huyghen's principle, it is apparent that this case is merely a succession of optical paths.) At higher frequencies this characteristic will cease to rise steadily and at least in the case of simple optical paths will oscillate up and down instead. The rising trend at lower frequencies, however, is found so often that it deserves special mention. It is illustrated by the rising curve and the experimental points shown in Fig. 17.

A fourth trend is due to diffraction and it is in the same direction as the conductivity trend. Long waves bend more easily about obstacles than do the short; the obstacle may be a mountain or it may be the ever-present bulge of the earth. This type of characteristic is indicated in Fig. 17 in the high-frequency part of the calculated curve, but in our experiments we have so far not had conditions in which its effect could with certainty be separated from the opposite "negative reflection" trend. The reason for this is that the diffraction trend does not predominate except with frequencies which are sufficiently high. In tests from Deal to Lebanon (Fig. 17) it appears that frequencies greater than 1200 megacycles might have to be used in order to separate these effects clearly. This is a point of great importance in view of the widespread belief that ultra-short waves suffer most in transmission because of the failure of the waves to bend around obstacles. Except when high mountains or very short waves are involved, the loss in transmission is more likely to be due to reflection.

When reflection of vertically polarized waves takes place from a very good conductor, there is no change of phase at reflection, the "negative reflection" mechanism is therefore absent, and the tendency is toward reinforcement rather than cancellation. Physically these conditions can be found in the case of transmission over sea water for frequencies less than 5 megacycles. In this case, as shown in an as yet

unpublished study, the diffraction trend has definitely been found experimentally and checked quantitatively with theory.

#### OPTIMUM FREQUENCIES

In the preceding pages calculations have been made for various types of path. Both for optical paths and for nonoptical paths these have pointed to certain frequencies which, from the transmission standpoint, give most efficient results. The value of this optimum frequency depends almost entirely upon the topography of the path and therefore changes from path to path.<sup>23</sup> At the same time there are certain frequencies which give results which are poorer than those obtained with higher or lower frequencies. It is obviously desirable to avoid these in practice. In general, it seems important that in making a choice of frequency, the particular path should be considered by itself in order to insure that maximum transmission efficiency, or at least the best compromise with apparatus difficulties, will be obtained.

#### ACKNOWLEDGMENT

The experiments described in this paper have been possible only through the assistance of many members of the Bell Telephone Laboratories, and we wish to make acknowledgment of this coöperation. We also wish to express our appreciation of the support and encouragement given in the course of this work by Dr. W. Wilson.

#### APPENDIX I

##### REFLECTION CALCULATIONS

The ratio of the resultant of the direct and reflected waves to the direct wave is

$$\sqrt{1 + K^2 - 2K \cos \gamma} = \sqrt{(1 - K)^2 + 4K \sin^2(\gamma/2)},$$

where  $K$  is the ratio of the amplitude of the reflected wave to that of the direct wave, and  $\gamma \pm \pi$  is their phase difference.

$$\gamma = \psi - \Delta,$$

where  $\Delta$  is  $2\pi$  times the path difference in wavelengths, and

$$\phi = \psi \pm \pi$$

<sup>23</sup> Beverage, Peterson, and Hansell, "Application of frequencies above 30,000kilocycles to communication problems," *Proc. I.R.E.*, vol. 19, pp. 1313-1333; August, (1931), found that a maximum range was obtained with a frequency of 35 megacycles in some tests made over sea water. This maximum, if not due to peculiarities of the apparatus, it would seem, must be a function of the heights of transmitting and receiving antennas above sea level and above local ground.

is the phase advance at reflection. The convention here used for phase change at reflection is the change in phase of the vertical component in the case of vertical polarization, and the change in phase of the horizontal component in the case of horizontal polarization. In the case of vertical polarization this is different from the convention used in optics.

$$K = \sqrt{\frac{1-\alpha}{1+\alpha}}, \quad 1 - K = \alpha \left[ 1 - \frac{\alpha}{2} + \frac{\alpha^3}{2} - \frac{3}{8}\alpha^5 + \dots \right]$$

$$\psi = \tan^{-1} \beta = \beta \left[ 1 - \frac{\beta^2}{3} + \frac{\beta^4}{5} - \frac{\beta^6}{7} + \dots \right]$$

$$\alpha = \frac{a \sin \xi}{1 + c \sin^2 \xi}$$

$$\beta = \frac{b \sin \xi}{1 - c \sin^2 \xi}$$

$$c = \frac{\pi}{2} - \theta$$

where  $\theta$  is the angle of incidence and for vertical polarization,<sup>24</sup>

$$a = \frac{\sqrt{2}}{s} [\epsilon \sqrt{s+r} + q \sqrt{s-r}],$$

$$b = \frac{\sqrt{2}}{s} [q \sqrt{s+r} - \epsilon \sqrt{s-r}],$$

$$c = \frac{1}{s} (\epsilon^2 + q^2);$$

while for horizontal polarization,

$$a = \frac{\sqrt{2}}{s} \sqrt{s+r},$$

$$b = -\frac{\sqrt{2}}{s} \sqrt{s-r},$$

$$c = \frac{1}{s},$$

<sup>24</sup> Vertical polarization refers to vertical electric field and horizontal polarization refers to horizontal electric field. (This is different from the concepts of optics.)

where,

$$q = 2\sigma/f,$$

$$r = \epsilon \left( 1 - \frac{\cos^2 \xi}{\epsilon} \right)$$

$$s = \sqrt{r^2 + q^2}$$

$f$  is the frequency in cycles per second, and  $\epsilon$  and  $\sigma$  are the dielectric constant and conductivity, respectively, both in electrostatic units.<sup>25</sup>

For angles near grazing incidence, both  $(1-K)$  and  $\psi$  are proportional to  $\xi$ .

$$1 - K = a\xi, \quad \xi \rightarrow 0,$$

$$\psi = b\xi, \quad \xi \rightarrow 0,$$

where  $a$  and  $b$  are now both independent of  $\xi$ . If  $K=1$ , the ratio of the resultant of the direct and reflected waves to the direct wave becomes  $2 \sin(\gamma/2)$ . If in addition  $\gamma$  is small, this ratio becomes simply  $\gamma$ .

For angles near normal incidence, both  $K$  and  $\psi$  are independent of  $\xi$ .

$$K = \sqrt{\frac{1+c-a}{1+c+a}}, \quad \xi \rightarrow \pi/2,$$

$$\psi = \tan^{-1} \left( \frac{b}{1-c} \right), \quad \xi \rightarrow \pi/2,$$

where  $a$ ,  $b$ , and  $c$  are now independent of  $\xi$ .

For good conductivity,  $q(=2\sigma/f) \gg \epsilon > r(=\epsilon - \cos^2 \xi)$ ;  $a=b=\sqrt{2q}$ ;  $c=q$  for vertical polarization. For horizontal polarization,  $a=-b=\sqrt{2}/s$ ,  $c=1/q$ .

For poor conductivity,  $q(=2\sigma/f) \ll r(=\epsilon - \cos^2 \xi) < \epsilon$ ;  $a=2\epsilon/\sqrt{r}$ ;  $b=0$ ;  $c=\epsilon^2/r$ ;  $\psi=0$  when  $\xi < \cot^{-1} \sqrt{\epsilon}$  and  $\psi=\pi$  when  $\xi > \cot^{-1} \sqrt{\epsilon}$  for vertical polarization. For horizontal polarization,  $a=2/\sqrt{r}$ ,  $b=0$ ,  $c=1/r$ ,  $\psi=0$ .

## APPENDIX II

### REFRACTIVE INDEX AND CURVATURE OF RAYS

The dielectric constant,  $\epsilon$ , of dry air is given by the expression

$$\epsilon - 1 = 210 \times 10^{-6} p/K$$

where  $p$  is the pressure in millimeters of mercury and  $K$  is the temperature in degrees absolute.

<sup>25</sup> If  $\sigma$  is expressed in electromagnetic units,  $q=2\sigma V^2 f$ , where  $V$  is the velocity of light ( $3 \times 10^{10}$ ).

When water is present, however, an appreciable change is produced in the dielectric constant, and doubtful points arise, such, for example, are the effect of association of water molecules with each other or with other molecules, and the effect of adsorption on the surface of the plate of the test condenser. The work of Zahn<sup>2</sup> seems to have clarified the situation for pure water vapor. He showed that in his own experiments the anomalies which appeared at the lower temperatures were probably due to adsorption and not to association as Jones had assumed, and he states that his results are consistent with those measured by Jones at higher temperatures.

For pure water vapor, we may use the following formula which has been based on Zahn's data:

$$\epsilon - 1 = 1800 \times 10^{-6} \frac{Y}{p} \left( 1 + \frac{Y}{200} \right)$$

Even though the separate values for water and for air may be considered to be known with sufficient accuracy, it does not follow that a mixture of the two will necessarily follow the usual additivity law for mixtures of gases. According to this law the values of  $\epsilon - 1$  for the several components may be added to give the  $\epsilon - 1$  for the mixture. Debever, Günthart, and Hirsch<sup>3</sup> gave some data for moist air taken as a preliminary to a more thorough study. They interpreted their results as deriving this law for a mixture of water and air. Their experiments were carried out at 15 and at 25 degrees centigrade. It should be noted that this is the temperature range in which Zahn found anomalous behavior due to adsorption. It is therefore natural to suppose that the same spurious effect may have been present in the work of Debever, Günthart, and Hirsch.

It seems, therefore, that the law of additivity has at least not been disproved for this particular mixture and that we can do no better for the present than to assume that it does hold. We shall, therefore, proceed on this basis.

In obtaining the derivative with respect to height  $dh/dH$ , it must be remembered that  $\epsilon$  is a function of the partial pressure of dry air and water vapor, and of the temperature. All of these vary with  $H$ . The values of refractive index are those occurring in the first kilometer or so above the ground. The conditions actually observed are variable, and we have therefore chosen to give average values as given by Hünig.<sup>4</sup> *M. Jour. Phys. Zet.*, vol. 29, p. 11, (1919).  
<sup>3</sup> *Phys. Zeits.*, vol. 27, p. 429, March, (1926).  
<sup>4</sup> *J. Opt. Soc. Am.*, vol. 20, p. 11, (1919).  
<sup>5</sup> *J. Opt. Soc. Am.*, vol. 27, p. 429, March, (1926).

phreys,<sup>29</sup> obtaining the rates of change from the values that he gives for 0.0 and 0.5 kilometers above sea level.

The following table summarizes the results obtained:

TABLE II

| Condition                           | Radius of Curvature of Ray = $\rho$ | $\rho/r_0$ | Equip Earth Radius Without Refraction, $r_e$ | $r_e/r$ |
|-------------------------------------|-------------------------------------|------------|--|---------|
| Average summer (average moisture)   | 23,800 km                           | 3.74       | 8,650  | 1.36    |
| Same without moisture               | 31,600                              | 4.95       | 7,950  | 1.25    |
| Average winter                      | 26,500                              | 4.15       | 8,420  | 1.32    |
| Same without moisture               | 29,300                              | 4.61       | 8,100  | 1.27    |
| Annual average used in computations |                                     | 4.0        | 8,500  | 1.33    |

$r_0$  = radius of the earth = 6370 kilometers

### APPENDIX III

#### EFFECT OF REFRACTION

In the following it will be shown that the transformation given in the text gives the proper path for the ray and the proper phase relations. The latter are more conveniently treated by determining the "phase time," or the time required for a given phase to traverse the path. As a matter of fact the ray paths and phase times are not exactly the same in the two constructions, but it will be shown that for one distribution of refractive index,  $n$ , which closely resembles that actually encountered, the error is negligibly small.

As indicated, this analysis is based on the customary ray treatment of refraction through a medium with a continuously varying refractive index. This simple ray theory is known not to be exact but in the present case we shall always be dealing with very small gradients, a condition in which the error becomes very small.

A good summary of the relations which we shall use is given in "The Propagation of Radio Waves," by P. O. Pedersen on pp. 154 and 155. The nomenclature is indicated in Fig. 18.

The length of the element of path,  $bb'$ , equals

$$\frac{rd\theta}{\sin\phi} \quad (1)$$

<sup>29</sup> "Physics of the Air," p. 55 and p. 74, McGraw-Hill, (1929).

† It is inferred from a statement made by Jouaust, Proc. I.R.E., vol. 19, p. 487; March, (1931), that for his experiments between France and Corsica  $\rho/r_0$  would have to be 5 or less in order for the direct ray to be unobstructed. Our figure of 4 therefore would indicate that his is an "optical" path. We do not believe, however, that an optical path is a necessary or sufficient condition for strong signals, although it certainly does help to make them probable.

and the time required for the wave to traverse it is

$$dt = \frac{rd\theta}{c \sin \phi} = \frac{nr}{c} d\theta \quad (2)$$

( $c$  is velocity of light and  $n$  the refractive index, which is assumed approximately equal to one at point  $a$ ). But by Pedersen's equation (9)'

$$nr \sin \phi = r_0 \cos \psi \quad (3)$$

Hence

$$dt = \frac{n r^2}{r c \cos \psi} d\theta. \quad (4)$$

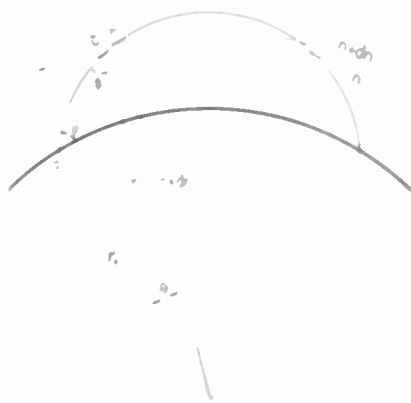

FIG. 15

Now Feeder<sup>25</sup> has shown that when the dielectric constant varies with  $r$ , (distance to center of earth) as follows

$$n = \left( \frac{r}{r_0} \right)^{2-1} \quad (5)$$

the solution for the path of the ray is

$$r^2 \cos \psi = \text{const} = r_0^2 \cos \psi_0 \quad (6)$$

Here  $\psi_0$  is a constant and  $r_0$  is the distance to the center of the earth from  $a$ , the arbitrarily fixed point of reference in the path.  $r_0$  is therefore not very different in our case from the radius of the earth.

By combining (5) with (6) we find that

$$nr = \frac{r_0 \cos \psi_0}{\cos (\psi - \psi_0)} \quad (7)$$

which when substituted in (4) gives

$$dt = \frac{r_0 \cos \psi}{c} \cdot \frac{d\theta}{\cos^2 (s\theta - \psi)} \quad (8)$$

integrating which from  $\theta=0$  to  $\theta$  we obtain

$$t - t_0 = \frac{r_0 \cos \psi}{cs} [\tan (s\theta - \psi) + \tan \psi]. \quad (9)$$

If  $s$  in (5) is made somewhat less than one in absolute value and is negative, we obtain a fairly good approximation of the distribution actually encountered. The exponent  $s+1$  has then a small positive value and from (5)

$$\rho = -\frac{1}{dn/dr} = \frac{r}{n(s+1)}. \quad (10)$$

Since  $n$  is very close to unity and since we may assume  $\rho/r=4.0$  (Appendix II), we find that  $s = -0.75$ . This value will be used later.

Consider now a second series of values in (9),  $t'$ ,  $r_0'$ ,  $s'$ , etc., which represent another situation which we shall define as follows:

$$\begin{aligned} s' &= -1 \text{ (i.e., constant index and no bending of the rays)} \\ \psi' &= \psi \text{ (i.e., no change in the initial direction of the ray)} \\ s't' &= s\theta \text{ and } r_0' = -\frac{r_0}{s}, \end{aligned}$$

so that  $r_0'\theta' = r_0\theta$ , that is, the peripheral distance traveled is the same in the two cases although the radius of the earth has been increased from  $r_0$  to  $r_0' (-1/s)$ .

By substituting these new primed values for the unprimed values in (9), we obtain

$$t' - t_0' = \frac{r_0 \cos \psi}{cs} [\tan (s\theta - \psi) + \tan \psi] \quad (11)$$

which is identical with  $(t-t_0)$  in (9). Note that the only assumption that has been made, limiting the generality of this equivalence, is the special distribution assumed in (5). The phase time is therefore unaltered by this substitution.

We have yet to prove, however, that in these two cases, rays leaving at the same angle, ( $\psi = \psi'$ ), and describing angles  $\theta$  and  $\theta'$  at the real and fictitious centers of the earth, will have the same increase in



elevation above sea level. If this can be shown, the equivalence will have been completely established.

The increases in elevation of the ray above that of the starting point is found with the help of (6) to be as follows for the two cases:

$$r - r_0 = r_0([1 + L]^{1/s} - 1) \quad (\text{real case}) \quad (12)$$

$$(r' - r_0') = -\frac{r_0}{s}([1 + L]^{-1} - 1) \quad (\text{fictitious case}) \quad (13)$$

where  $L$  is defined by the equation

$$(1 + L) = \left(\frac{r}{r_0}\right)^s = \frac{\cos(s\theta - \psi)}{\cos\psi} \quad (14)$$

$L$  is small compared with unity in the cases that we are considering. By expanding each and subtracting, the error caused by assuming that  $(r - r_0)$  equals  $(r' - r_0')$  is found to be

$$\frac{r_0 L^2}{2s^2} (1 + s) + \text{higher order terms in } L. \quad (15)$$

We have found above that  $s$  is approximately equal to  $-0.75$ . Taking  $r_0 = 6370$  kilometers, and remembering that we are ordinarily not concerned with rays further above the earth than, say, 5 kilometers, we have from (14)

$$\frac{r}{r_0} = (1 + L)^{1/s} \leq \frac{6375}{6370}$$

where,

$$0 \geq L \geq -0.006.$$

Substituting these values in (15) we find that the error in height is less than 50 centimeters. This is negligible in the altitude of 5 kilometers which was assumed, and we may consider the equivalence to be proved.

#### APPENDIX IV

##### DIFFRACTION CALCULATIONS

The method of Huyghens applied to optical diffraction past a straight edge results in the following expression for the received field,  $E$ , in terms of Fresnel integrals.

$$\frac{E}{E_0} = a + jb = C \exp(j\eta)$$

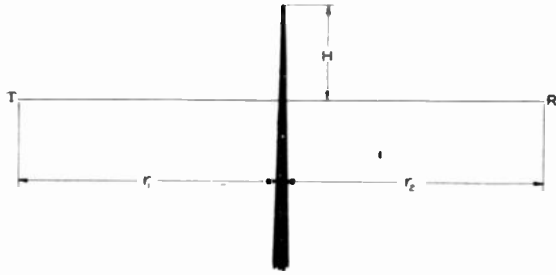

Fig. 19

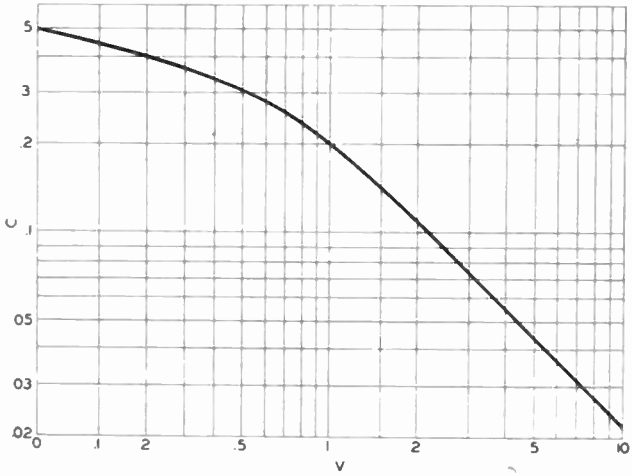

Fig. 20

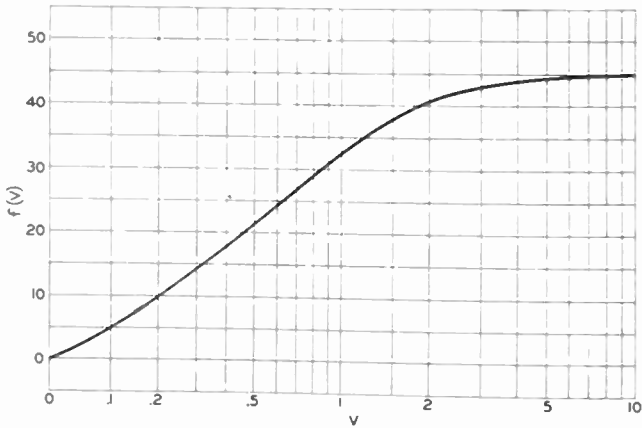

Fig. 21

where

$$a = \frac{1}{\sqrt{2}} \int_0^r \cos \frac{\pi t}{2} dt$$

$$b = \frac{1}{\sqrt{2}} \int_0^r \sin \frac{\pi t}{2} dt$$

and

$$r = H \sqrt{\frac{2}{\lambda} \left( \frac{1}{r_1} + \frac{1}{r_2} \right)}$$

$E$  is the field with straight edge removed,  $a$  and  $b$  are Fresnel integrals,  $H$  is the height of the obstruction above the straight line from transmitter to receiver,  $r_1$  and  $r_2$  are the distances from the obstruction to the transmitter and receiver, respectively. (See Fig. 19.)

To facilitate calculation the value of  $\eta$  has been plotted in Fig. 20.  $\eta$  may be expressed as follows:

$$\eta = f(r) + \pi r^2/2$$

where  $f(r)$  is the function plotted in Fig. 21.



## SOME RESULTS OF A STUDY OF ULTRA-SHORT-WAVE TRANSMISSION PHENOMENA\*

By

CARL R. ENGLUND, ARTHUR B. CRAWFORD, AND  
WILLIAM W. MUMFORD

Bell Telephone Laboratories, Inc., New York City

**Summary**—The results of a series of transmission experiments made in the range 3.7 to 4.5 meters and over distances up to 125 miles are reported. These observations were chiefly confined to the region reached by the directly transmitted radiation and are found in good agreement with the assumption that such transmission consists mainly of a directly transmitted radiation plus the reflection components which would be expected from the earth's contour. The residual field not thus explained consists of a more or less pronounced diffraction pattern due to the irregularities of the earth's surface. A hill-to-hill transmission has three demonstrable reflection surfaces.

Quantitative checks on hill-to-hill transmission have been obtained and it has been found that a field intensity of 50 microvolts per meter gives very good transmission. Static is ordinarily entirely absent and no Heaviside layer reflections have been observed.

The almost universal standing wave diffraction patterns have been studied and sample records are given. The methods of measuring field intensity which we have used are described in an appendix. No long range transmissions, such as harmonic of distant (greater than 500 miles) short-wave stations would yield, have been observed.

### INTRODUCTION

THIS paper details the results of certain studies which have been made on phenomena connected with the transmission of ultra-short waves during the past few years. The work was carried on coincidentally with that described in the companion paper by Schelleng, Burrows, and Ferrell.<sup>1</sup> It deals in particular with the establishment of the presence of various ground reflections which must be taken into account in computing ultra-short-wave transmission and with the local disturbances due to both stationary and moving near-by objects.

### APPARATUS

The transmitting apparatus used by us possessed little novelty; one type of generator has already been described in an earlier paper:

\* Decimal classification: R113. Original manuscript received by the Institute, December 12, 1932. Revised manuscript received by the Institute, December 21, 1932.

<sup>1</sup> Schelleng, Burrows, and Ferrell, "Ultra-short-wave propagation," Proc. I.R.E., this issue, pp. 427-463.

<sup>2</sup> *Bell Sys. Tech. Jour.*, vol. 7, p. 404; July, (1928).

a second type consisted of a pair of 75-watt tubes operated "push-pull" and fed by a constant-current modulating system of orthodox type. This latter apparatus served permanently as station W2XM at our Holmdel laboratory, and was ordinarily modulated with the output from a broadcast receiver. We first employed superregenerative receivers and constructed several different types of these. All the quantitative data, however, were obtained with a measuring set employing a double detection receiver.

This receiver is of much the same type as the one described by Friis and Bruce,<sup>3</sup> the modifications in the short-wave circuits necessary to reach the ultra-short-wave range being obvious if not exactly easy to carry out. The intermediate frequency is 1300 kilocycles; there are five amplifier stages preceded by a double tube short-wave detector and followed by a single tube low-frequency detector. The band width (6 decibels down) is approximately 80 kilocycles, and the over-all gain 103 decibels. The amplifier tubes are shielded grid type, and the beating oscillator input is introduced, balanced, in the first detector grid-filament connection. The ultra-short-wave tuning circuits have commercial micrometer heads clamped to the condenser dials. This has proved to be a satisfactory type of vernier adjustment. The shielding extends to the individual tubes and coupling circuits and is complete and thorough. By-pass filters to ground are on all the power input connections. The range is 3.7 to 12 meters using several sets of coils. Two photographs of this receiver are given in Figs. 1a and 1b. For some of this work a manually operated gain recorder was fastened on the set base, with operating pen belted to the set attenuator handle. This recorder is a remodeled sample of the type 280 General Radio fading recorder.

#### EXPERIMENTAL, PRELIMINARY

The first ultra-short-wave receptions, made in September, 1930, with the superregenerative receiver, showed that a cross-country transit was accompanied by marked variations in field intensity over even rather short distances (one meter for example). Locations were readily found where the reception was very weak, usually areas, as gullies, below the average land level. Hilltop reception was uniformly good and a range of 50 miles (80.5 kilometers) was attained on the third trip. At this site (Museoneteong Mountain, N. J.) the reception, weak at the ground level, was greatly improved by carrying the receiver to the top of an airplane beacon tower. A 75-mile (120.8-kilometer) re-

<sup>3</sup> Proc. I.R.E., vol. 14, p. 507, (1926).

ception at the Pocono Mountains in Pennsylvania failed, the path being unfavorable for the amount of power available at the transmitter. There was ample indication that straight-line or "optical" transmission was not the only possibility, and there were indications that both earth-reflected and earth-diffracted radiations were present. No fading and no static were noticed. Later trips added little of sig-

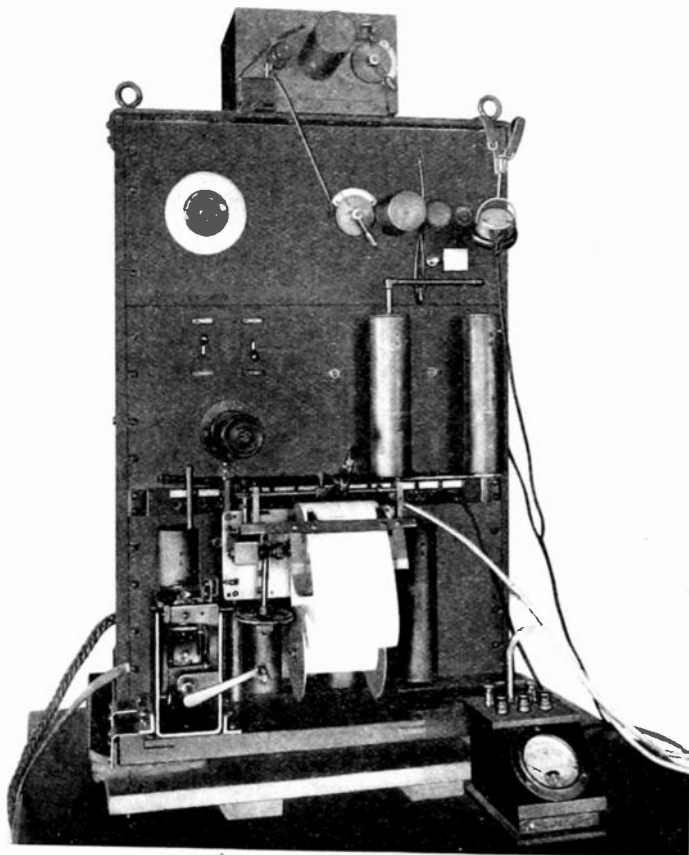

Fig. 1a—Front view of measuring set.

nificance to these observations as the superregenerative receiver is fundamentally incapable of quantitative field strength indications.

Further work was therefore undertaken using the double detection field strength measuring set. The transmitter site was at first the same as for the preceding autumn, viz., the Holmdel Laboratory where a half-wave center-tapped antenna on a 65-foot (20-meter) pole was fed

with a simple parallel wire transmission line of No. 14 B & S gauge tinned copper wire, 1/4-inch (0.635-centimeter) spacing, with 246 ohms characteristic impedance. With the antenna impedance equal to approximately 73 ohms the mismatch did not exceed 4 to 1 which gave less than one decibel added loss over impedance matching.<sup>4</sup> As a

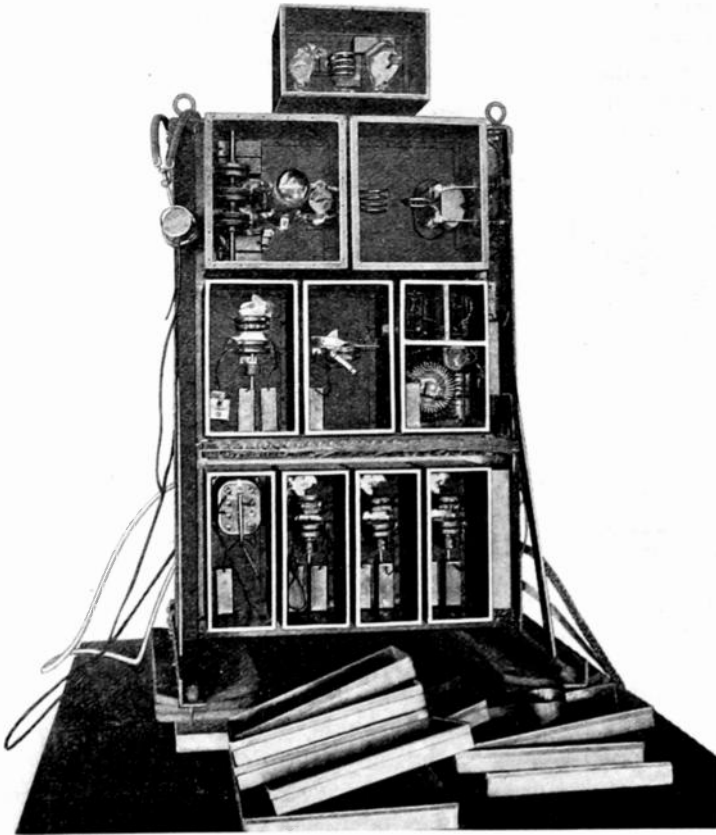

Fig. 1b—Rear view of measuring set with shielding covers removed.

considerable wavelength range had to be covered, a single wavelength match was of no utility. An open-wire line of less than 250 ohms impedance is not easy to construct. A thermocouple was located at the antenna connection, and the resulting direct current was fed down the transmission line and filtered out by a choke-coil—condenser unit to

<sup>4</sup> See Sterba and Feldman, Proc. I.R.E., vol. 20, p. 1163, Fig. 12; July, (1932).

operate the antenna meter. The antenna current was of the order of 0.6–0.8 ampere ordinarily.

For the entire northwestern half of the horizon the near-by Mt. Pleasant hills screened the country beyond from direct radiation components. The reception in these directions was thus entirely a diffraction phenomenon. Fig. 2 gives the result of a cross-country transit out beyond these hills. The wavelength was 4.6 meters and at each point the field intensity was obtained by averaging over several maxima and minima. As closely as possible a fixed direction was maintained. The field strengths were first observed as decibels left in the set attenuator and were afterwards corrected as described in a later paragraph. An

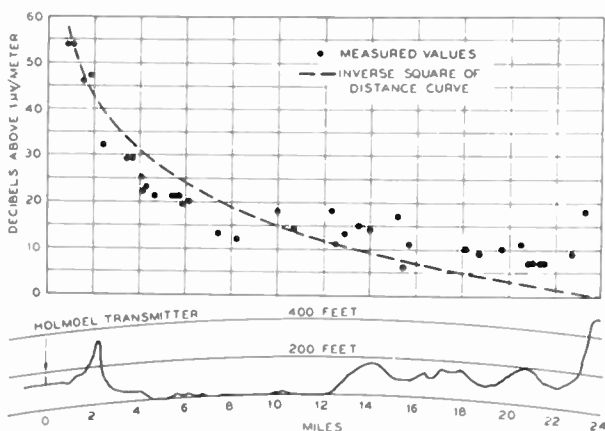

Fig. 2—Transmission along radial line from Holmdel laboratory to Watchung Mountains.

inverse square of distance curve is drawn in for comparison purposes. Up to the hills a direct plus a reflected radiation component constitutes the transmission; back of the hill a diffraction phenomenon occurs. The transmitting antenna was vertical, and the radiation was received by a short rod antenna projecting through the top of the light truck carrying the receiving set.

The observed values are rather erratic, and later experience has shown that this irregularity may be expected for measurements taken on or at the ground level and that it is due to an almost universal and highly irregular standing wave pattern.

#### STANDING WAVE PATTERNS

This standing wave pattern has not yet been sufficiently studied. It is easy, by driving the receiver car sufficiently slowly, to show that



some of the "fringes" are due to reradiation from individual trees along the roadside. Vertical metallic guy wires and other metallic structures are equally good reradiators. The type of interference pattern which would be expected from a reradiating tree is shown in Fig. 3, and this is substantially what was found by driving the receiver car around isolated trees. But in general the pattern is not as simple as this and, what is of more importance, the maximum-minimum ratio may run as high as fifty to one. A road bordered with trees gives a very rough pattern.

An open field of some 20 acres extent was available about a mile (1.6 kilometers) from the transmitter. This field lay on a "bench" about 90 feet (27.5 meters) above the Holmdel laboratory ground

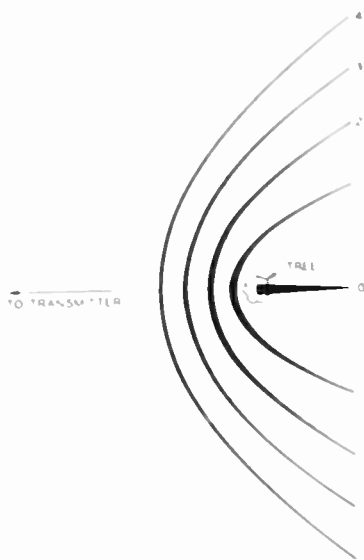

Fig. 3—Standing wave system surrounding a tree. Phase shift on reflection 180 degrees. Curves show first five lines of minimum field.

level and the bench slope, and a strip of woods lay immediately in front of the field and on the transmitter side. Covering the entire field was an irregular "fringe" system, the fringe spacing varying something like one to four times the wavelength (4.6 meters). By driving the receiver car back and forth across the field a particularly high field intensity line was located and marked for perhaps a hundred yards (91.5 meters). The car was then placed exactly on the line and the receiving set meter carefully watched for any change in the location of this line. No noticeable shift occurred, and the line was checked on the following day and again several days later. A car movement of one foot (30.5 centimeters)

was immediately detected by the receiving set meter. It was necessary each time to drive the car in straight parallel lines since the polar receiving characteristic of the combination of metal car body and radio receiver was not a circle. Opening a car door immediately altered this characteristic. This high field intensity line was not a straight line, being a bit "snaky", and it suffered a shift varying from 2 to 15 feet (0.6 to 4.6 meters) when the transmitting wavelength was changed from 4.6 to 3.7 meters.

These standing wave patterns subside on cleared hilltops and need not therefore seriously affect actual ultra-short-wave channels. They have not been studied by us at distances much exceeding 10 miles (16 kilometers) from the transmitter but they no doubt exist at all ranges. It is certain that both reradiating trees and ground irregularities produce them. By mounting the receiving set with manual recorder in a light truck equipped with superballoon tires we have been able to obtain continuous records of field strength as the truck is slowly (2 to 5 miles per hour) driven along the roads in the neighborhood of the transmitter. Seven of these records and a map of the country are given in Figs. 4 to 6. The records are made by recording the variation in set gain necessary to hold the set output constant versus the distance traversed. They have all been reduced to decibels above one microvolt per meter. The transmitter site was the Beer's hill one, later described, and the records were obtained this year. They are all for a vertical transmitting antenna; the corresponding results for a horizontal antenna are complicated by the almost universal presence of horizontal conductors along the roads. These wires scarcely affect vertical transmission.

As the map indicates, the seven records were taken at distances from two to six miles (air line) from the transmitter. Six were taken along public highways, the seventh was taken in a private field. Of the six, five were taken along roads substantially radial to the transmitter, the sixth along a tangential road.

Record "A" was taken along a new road running northwestward from Matawan, N. J. The direction of feed of these records is from left to right, and the arrow indicates that the car was driving northwestward, away from the transmitter. This is a radial road and, being new, is not bordered by staggling trees. It covers 1.7 miles of gently rolling country without steep cuts.

A correspondence of field intensity with topography is to be expected, the favorable addition of direct and reflected radiations being facilitated on slopes facing towards the transmitter and being militated against on slopes facing away from the transmitter. Since the

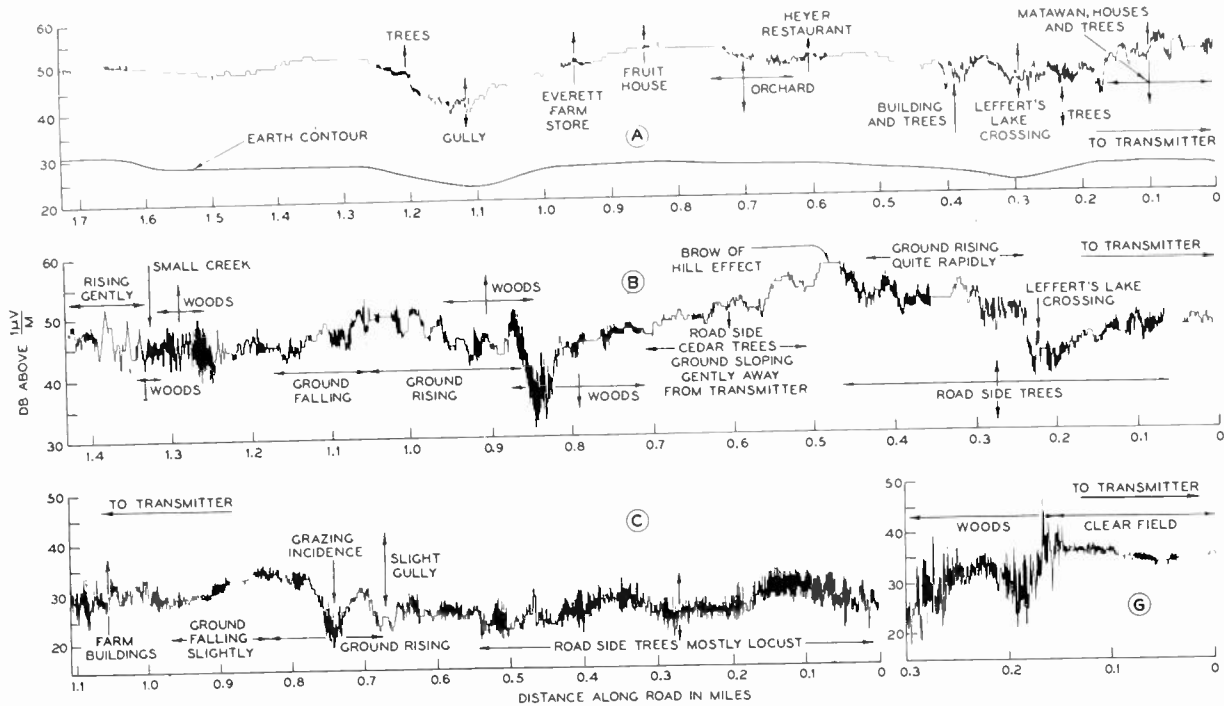

Fig. 4—Four diffraction patterns taken along lines radial to transmitter.

“A” radial 2.54–4.25 miles from transmitter 8–25–’32.

“B” radial 2.94–4.29 miles from transmitter 6–23–’32.

“C” radial 4.25–5.3 miles from transmitter 6–16–’32.

“G” radial 6–23–’32.

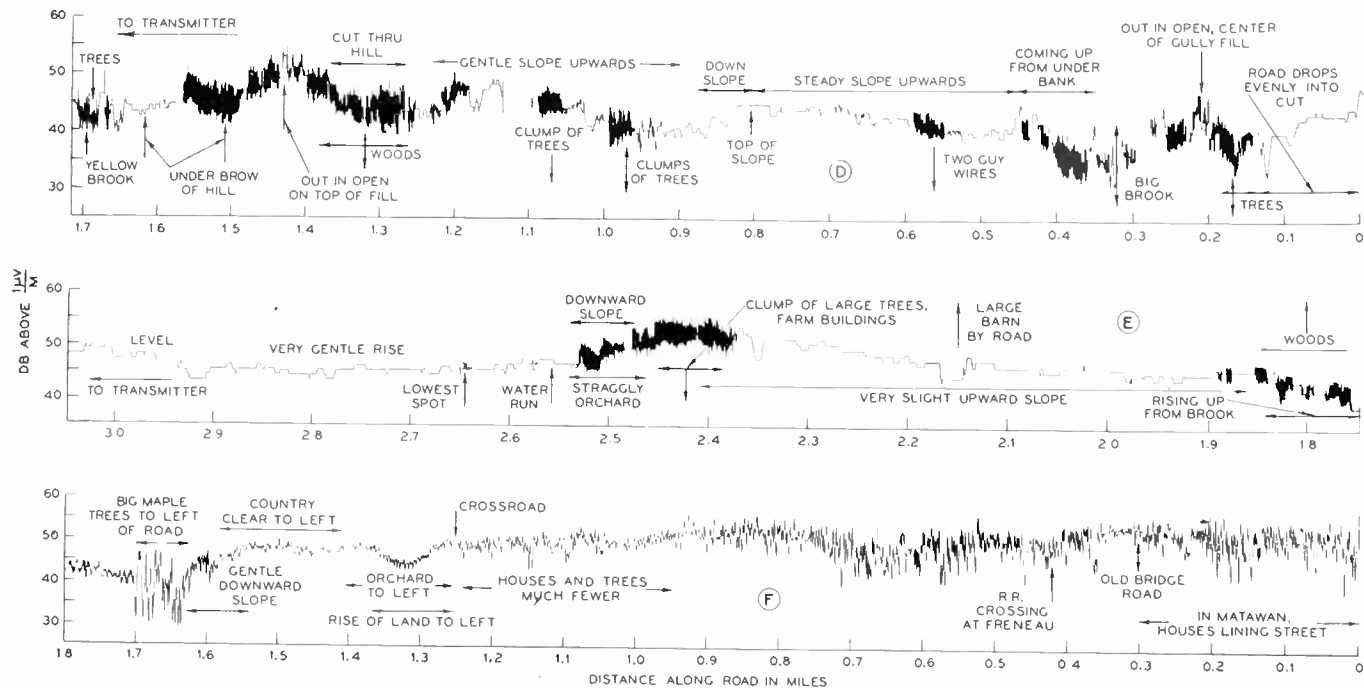

Fig. 5—Three diffraction patterns, two taken along lines radial to transmitter, one along a line perpendicular to transmitter direction.

"D" radial 3.28–1.95 miles from transmitter 6-15-'32.

"E" radial 2.0–3.28 miles from transmitter 6-8-'32.

"F" tangential 2.6–2.7 miles from transmitter 8-25-'32.

slopes are often short this will put the field maxima near their tops and this is what is found. This record shows this effect perhaps better than any of the others; a profile of the land is included. Profiles are not drawn in on the remaining curves as the country is mostly so irregular that profiles are misleading. Where this topographical coincidence occurs it is noted on the curve.

As the set is carried past them, trees, wired houses, and the like make their presence known on the record. Extended areas of trees, as woods and orchards, usually involve a marked absorption of signal intensity which, however, does not extend much beyond their boundaries.

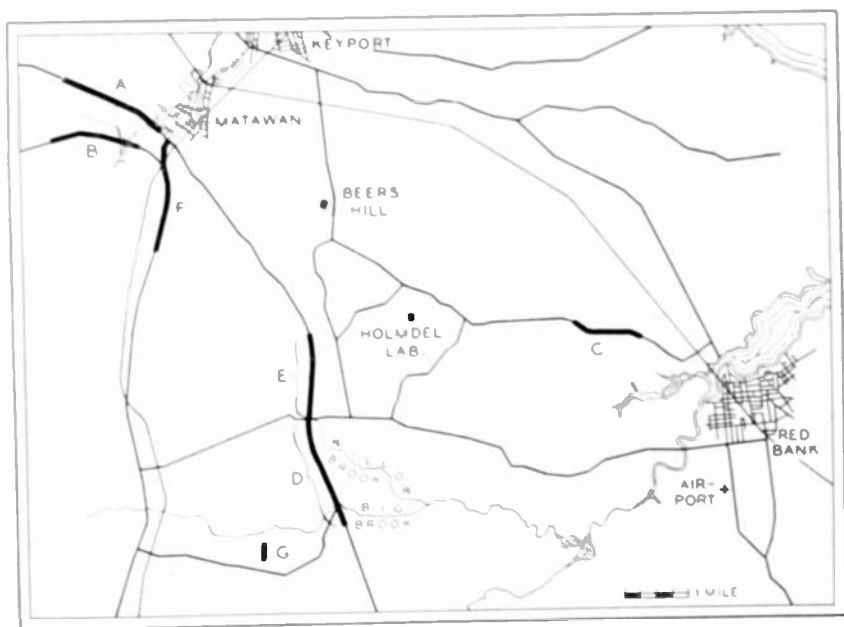

FIG. 6. Map of Holmdel region

Record "B" was taken along another radial road not far distant and roughly parallel to that of "A". This is an old road and has the usual string of nondescript trees along the road edges. These trees roughen up the pattern always, sometimes badly, but the ground slope changes can usually be identified (compare with the previous record). The marked maximum at 0.47 mile, where direct and reflected radiations add favorably, is the equivalent of the "brow-of-hill effect" found for short waves.<sup>5</sup> The very marked undulation at 0.85 mile is apparently

<sup>5</sup> Potter and Friis, Proc. I.R.E., vol. 20, p. 699; April, (1932).

due to the overlapping of two extensive patches of woods which here, for a short distance, blanket both sides of the road. In the written comment on the records the direction of the arrows indicates the side of the road on which the objects mentioned lie.

Record "C" is that for a radial road southeast of the transmitter. This is an old tree-bordered road and has several turns in it. The trees are mostly locust, and there are quite a few vertical guy wires on the power and telephone poles. In the pattern these guy wires are usually indistinguishable from trees. The correspondence with topography appears in several places, but there is an unexpected and deep minimum at 0.74 mile. There are no trees or other objects to explain this, and our feeling is that it is due to a topographical peculiarity whereby the direct and reflected radiations nearly cancel. The road is rising here, in a cut about four feet deep, and in the direction of the transmitter the ground billows up so that one can visualize the explanation given.

Records "D" and "E" were taken along a new radial road (an extension of "A," in fact New Jersey highway No. 34). At the right of "D" the road starts downward towards the transmitter at the same time entering a cut. There are no trees and the resulting record is a fast dropping smooth one. Further on the marked effects of a pair of guy wires and some clumps of trees can be seen; the absence of other trees giving an undisturbed background to work against. A favorable slope, or "brow-of-hill" effect, is seen at 1.43 miles. The latter part of the record is through a succession of cuts and fills, with trees about, and the record is correspondingly rough.

Record "E" continues the previous record. There is an initial rise at the start, due to rising ground, and woods to the right roughen up the pattern. From here on to the end there is a slow ground rise, a slight fall, and a final rise. At the center of the stretch is an isolated clump of trees with farm buildings and a straggly orchard below. The contrast between the treeless stretch and that with trees is very marked. The effect of the trees begins suddenly, at about 150 feet in from the edge of the grove.

Record "F" is that of a tangential run along the old Matawan-Morganville road. Starting in the town of Matawan, with houses and trees about, the pattern irregularities subside slowly as these objects decrease in number up to 0.95 mile. At 1.26 miles a rise of ground to the left (transmitter side) is covered with an orchard. Apparently the unfavorable slope is more potent than the trees, in reducing field intensity, as the field falls and rises more in accord with this land rise than with the orchard. At the end of the record some large old maples

on the transmitter side of the road roughen up the pattern very markedly.

Record "G" is a short run taken on a private road where the car was run in from a cleared field into woods.

### FIELD FLUCTUATIONS FROM MOVING BODIES

It is well known that the motion of conducting bodies, such as human beings, in the neighborhood of ultra-short-wave receivers produces readily observable variations in the radio field. This phenomenon extends to unsuspected distances at times. Thus, while surveying the field pattern in the field described above, we observed that an airplane flying about 1500 feet (458 meters) overhead and roughly along the line joining us with the transmitter, produced a very noticeable flutter, of about four cycles per second, in the low-frequency detector meter. We then made a trip to the near-by Red Bank, N. J., airport, distant about 5 1/2 miles (8.8 kilometers) and observed even more striking reradiation phenomena. Near-by planes gave field variations up to two decibels in amplitude, and an airplane flying over the Holmdel laboratory and towards this landing field was detected just as the Holmdel operator announced "airplane overhead." These were all fabric wing planes. If the reradiation field to which such an airplane is exposed is of inverse distance amplitude type while the directly received ground fields are of more nearly inverse distance square type, as in Fig. 2, it is easy to see that at five miles an overhead airplane is exposed to a field intensity about ten times (20 decibels) that existing at the ground, and for ordinary airplane heights a high energy transformation loss in the reradiation process can occur and still give marked indications in the receiver meter. This airplane reradiation was noticed at various subsequent times, sometimes when the airplane itself was invisible. A set of theoretical beat frequency versus distance curves are given in Fig. 7.

### AIR-LINE TRANSMISSION

While ordinary ultra-short-wave transmission is complicated by local reradiations and diffraction phenomena these should become relatively innocuous for favored locations such as hilltop-to-hilltop transmissions with the air-line path between them clearing all intervening obstacles. Here the presence of fading, day-to-night changes in transmission, amount of static interference, and the rôle of the earth-reflected radiations should be determinable. After some days of rough surveying such a pair of hilltops was found 39 miles (63 kilometers)

apart. We would have preferred a greater distance but none such could be located with certainty, with one of the hills necessarily local.

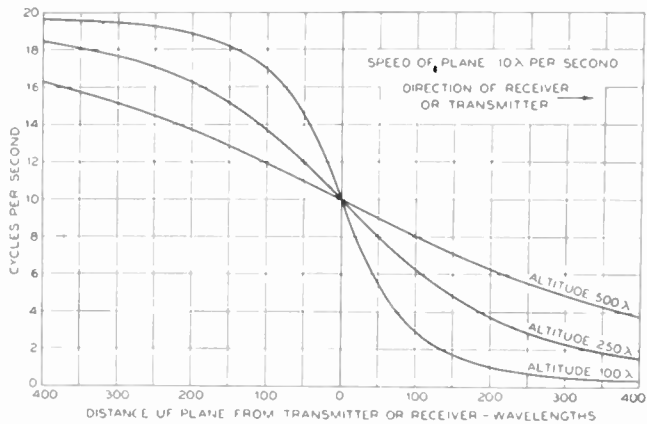

Fig. 7—Beat frequencies produced by reflection from a moving airplane.

The transmitter was mounted on this local hilltop, Beer's Hill, two miles (3.2 kilometers) air line to the north northwest of the laboratory. The apparatus consisted of a 40-foot (12.2-meter) lattice mast with nonmetallic guys, mounting a half-wave linear antenna which could be rotated between a vertical and a horizontal position. A low impedance (246-ohm) transmission line, similar to the one earlier described, carried the ultra-short-wave current from the generator shack at the foot of the mast to the antenna itself. The termination and method of antenna current indication were as described for the Holmdel laboratory transmitter. The hilltop altitude (U. S. Bench Mark) was 343 feet (104.6 meters) and the antenna was thus 383 feet (116.8 meters) above sea level.

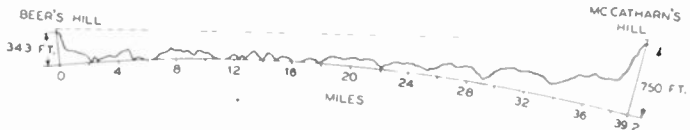

Fig. 8—Profile map, Beer's Hill to McCatharn's Hill.

The receiver site was located on a hill spur on the P. K. McCatharn farm  $2\frac{1}{2}$  miles north of Lebanon, N. J., and at an altitude of 750 feet (228.5 meters). Taking the altitudes from the New Jersey geological survey maps and correcting for earth curvature gives the profile map of Fig. 8, where it is seen that the air line clears the intervening



country everywhere by 200 or more feet (61 meters). We were unable to check this by direct optical observations as no sufficiently clear day occurred during our tenure of the Lebanon site but we were able to identify a neighboring hill of about the same altitude (Mt. Cushtunk) and we have no doubt that an air-line path existed.

If we imagine a transmitting and receiving antenna pair located above the earth's surface it is easy to see that the received radiation will consist of a direct plus a reflected component. If now we complicate matters by adding a pair of hills to support the antennas we shall add a pair of reflections from the slopes of the two hills to the initial two radiation components. A final random corrugation of the earth and we have the actual Holmdel-Lebanon situation. The conditions under which the first reflection occurs, practically grazing incidence, with the earth irregularities very small compared with the optical path length, make it very certain that this reflection will substantially survive the corrugation; the proximity of the hills to the antennas themselves ensures the presence of the second pair of reflections. The actual transmission should thus consist of a direct component plus a three-surface set of major reflection components, together with a background of scattered and diffracted radiation arising from the corrugations of the earth's surface. For an extreme path length the lens effect of the earth's atmosphere, decreasing in density upwards and thus refracting the entire radiation ensemble downwards, will produce a path deviation which cannot be neglected.

A verification of this radiation picture should be possible. The hill-side reflection components can be demonstrated by separately raising and lowering the two antennas. Inasmuch as the reflections occur near by, only a small movement of an antenna is required to vary the path difference between the direct and reflected rays by half a wavelength and thus vary the received signal intensity through a maximum-to-minimum, or reversed, cycle. The earth reflection occurs substantially halfway between the antenna sites, and very great altitude changes become necessary to exhibit a maximum-to-minimum cycle. This reflection component cannot thus be demonstrated from two hill locations such as we had; but one of the hills together with a receiver carried by an airplane will suffice. We were able thus to demonstrate all the three main reflections.

Fig. 9 gives a profile of the McCatharn Hill along the radio transmission line and Figs. 10 and 11 show the received field strength

<sup>6</sup> Pedersen, "Propagation of Radio Waves," chap. X, p. 150. The importance of this refraction effect has most recently been pointed out by Schelleng, Burrows, and Ferrell. *See Proc. I.R.E.*, this issue, pp. 427-463.

variation as the antenna was raised and lowered<sup>7</sup> for both horizontally and vertically polarized radiations. Assuming this hill to be a medium of dielectric constant 10 and resistivity 10,000 ohms per centimeter

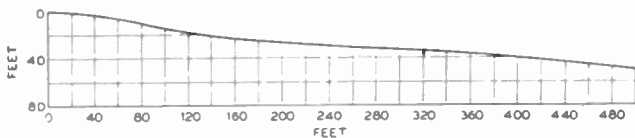

Fig. 9—Profile map of McCatharn's Hill.

cube, and to have a plane reflecting surface inclined to the horizontal at an angle of 5.9 degrees, reception curves for an antenna raised and lowered over it have been calculated and are compared with the experimental results. These measurements, being relative only, have been adjusted to best coincidence by adding the necessary decibels. The resulting fit is fairly good. A quantitative comparison between theory and experiment is later given.

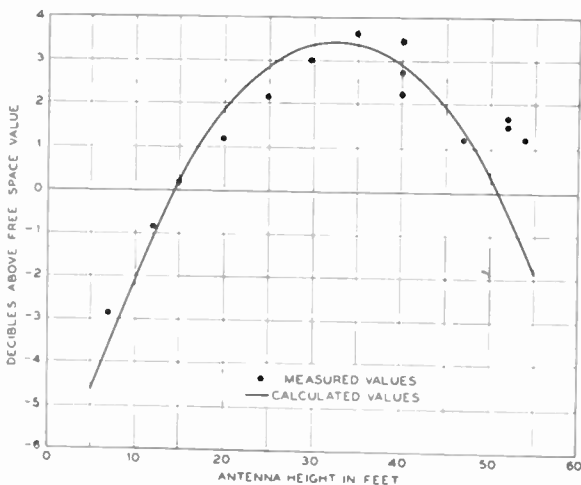

Fig. 10—Local reflection at McCatharn Hill. Vertical polarization  $\lambda = 4.08$  meters.

<sup>7</sup> The receiving set, in the truck, was located on the hilltop after making sure that stationary diffraction fringes were of negligible amplitude. By permission of the owner, some trees below the hill were cut down to clear the radiation path. The antenna structure was a 40-foot lattice mast with a boom carrying the antenna itself and extending fifteen feet above the mast top. The transmission line was incandescent lamp cord (a twisted pair of rubber and cotton insulated conductors) and was tied to boom and mast so as not to swing. It had a measured loss (erected and measured at Holmdel) of 0.1 decibel per foot. The boom swung in an arc in a plane perpendicular to the line of transmission. No evidence of a rotation of the plane of polarization was observed.

With a sufficiently plane slope a maximum-to-minimum field comparison should yield a dependable value of the amplitude of the reflection coefficient since the other two reflection components (transmitter hill and intermediate earth surface) are not rapidly varied by such a limited change in receiving antenna height. Unfortunately the antenna could not be elevated above 55 feet (16.8 meters), and with the moderate hill slope existing, this was insufficient to reach the first above-ground field minimum.

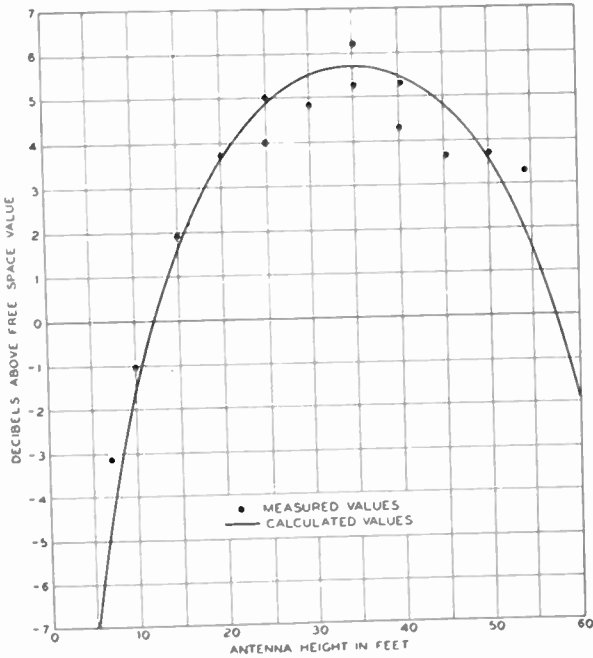

Fig. 11—Local reflection at McCatharn Hill. Horizontal polarization  $\lambda = 4.39$  meters.

The intermediate earth surface reflection component, at this near-grazing incidence, acts to reduce the total received field, and it is important to obtain an idea of how great this effect is likely to be. It is necessary to rely on the accuracy of the topographical maps as issued by the state of New Jersey but a conservative use of them indicates that at a wavelength of 4.45 meters a phase difference of about 198 degrees exists between the direct and reflected components and the resultant field should be about 31 per cent of that of a simple inverse distance transmission. (The effect of air refraction is included.) This is adequate for good reception at the McCatharn Hill.

Fig. 12 gives a profile of Beer's Hill along the line of transmission, and Figs. 13 and 14 the McCatharn Hill reception as the transmitting antenna was elevated. The hill slope is steeper here (Beer's Hill) and the curves obtained for the original 10-foot (12.2-meter) structure

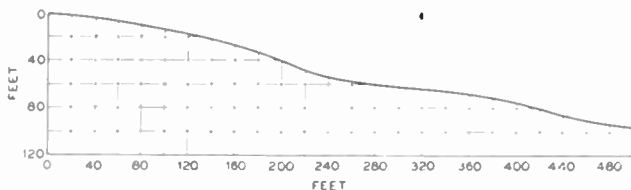

Fig. 12—Profile map of Beer's Hill.

having indicated that the first off-ground field minimum could be reached with a little more height, an additional 20-foot section was added to the lattice mast making it 60 feet (18.3 meters) high. The difficulty of handling a low-loss bare wire transmission line, as the height was varied, caused us to substitute a twisted pair incandescent-lamp cord for it. In raising and lowering the antenna this transmission line was simply permitted to pile up on the ground. The antenna am-

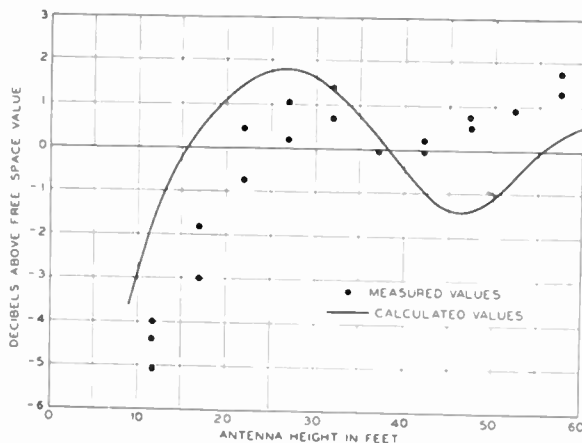

Fig. 13—Local reflection at Beer's Hill. Vertical polarization  $\lambda = 4.45$  meters.

meter showed only small current variations as this coil was handled or pushed about. We originally had some doubts as to whether this hill would give a clean-cut reflection since the surface in the receiver direction was somewhat undulating and had a gully with trees beginning some 200 feet down the hillside. However, as the results indicate, a fairly definite reflection component is produced.

The dots in Figs. 13 and 14 are observed values, the full lines are theoretical curves. These latter were obtained by taking the hill constants the same as for the McCatharn Hill, but the hill itself was not assumed to be a plane. Instead, by graphical plotting from the hill contour, the tangent plane for each antenna height was located and used for the calculation for that height only. The resulting curve is a somewhat better fit than is obtained by averaging the hill to a common plane.

This surface, as stated earlier, is a rather poor fit to a plane (the profile cross section shows the hill up too favorably) and has quite a few

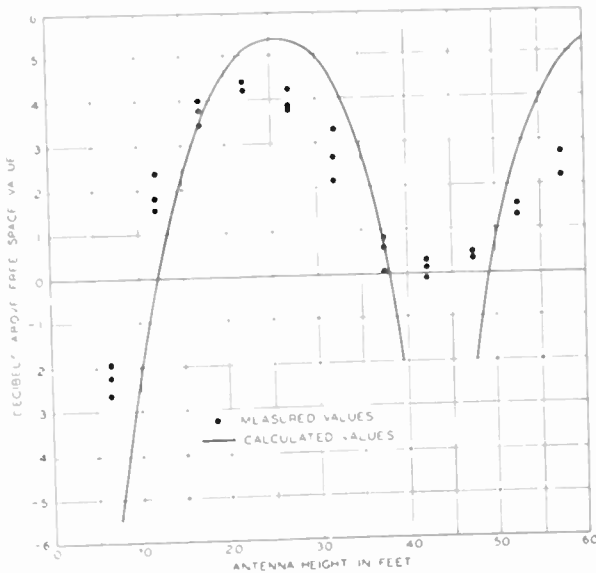

Fig. 14—Local reflection at Beer's Hill. Horizontal polarization  $\lambda = 4.15$  meters.

trees located on or about the reflection area corresponding to the higher antenna positions. The result is particularly noticeable for the vertically polarized transmission where the fit between observation and experiment is poor. This experiment was later repeated with the same results. The conclusion follows that while the oscillatory character of the field intensity curves indicates a definite local reflection component, it is not as simple as the one arising from a smooth surface by plane optical reflection.

The middle distance reflection was clearly established by airplane observations. For these only vertically polarized radiation was used, and a simple vertical rod antenna was thrust out of the airplane cabin

ceiling. This limited the maximum range which was attained, but antennas of greater effective height were difficult to construct. This plane was the Laboratories Ford trimotor, and we are indebted to Mr. F. M. Ryan and his staff for their cooperation in this work. The manual recorder already mentioned was used throughout the runs, which were made by flying directly from Beer's Hill to Easton, Pa., and then veering slightly to the left to follow the main New York-to-Chicago airplane route. Flights were made at 8000, 5000, 2500, and 1000 feet (2440, 1525, 763, and 305 meters) above sea level, and the results are given in Figs. 15 to 20 inclusive. Fig. 21 gives a map of the country.

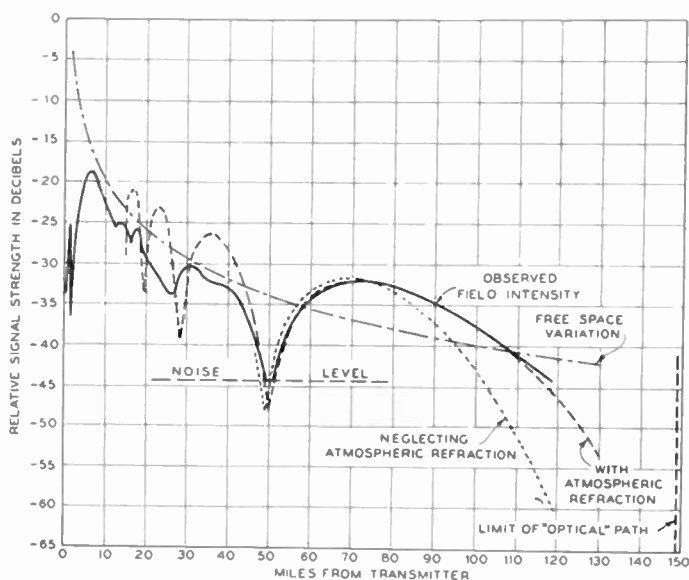

Fig. 15—Flight from transmitter. Altitude—8000 feet; wavelength—4.3 meters, June 24, 1931.

In these figures the experimental curves are supplemented by theoretical ones, these latter being calculated by assuming the earth at the reflection point to be equivalent to a plane surface medium of a dielectric constant 10 and a resistivity of 10,000 ohms per centimeter cube and 100 feet (30 meters) above sea level. This point, for the outermost deep minimum, varied in location from 1.5 miles out, for the 1000-foot flight, to 2 miles out, for the 8000-foot flight, with corresponding angles of incidence of 88 and 88.5 degrees. The area involved is fairly level and open. The earth's curvature is taken into account and refraction corrections are applied using the Schelleng, Burrows, and Ferrell formula. As shown in Fig. 15 the fit at the extreme distances is considerably im-

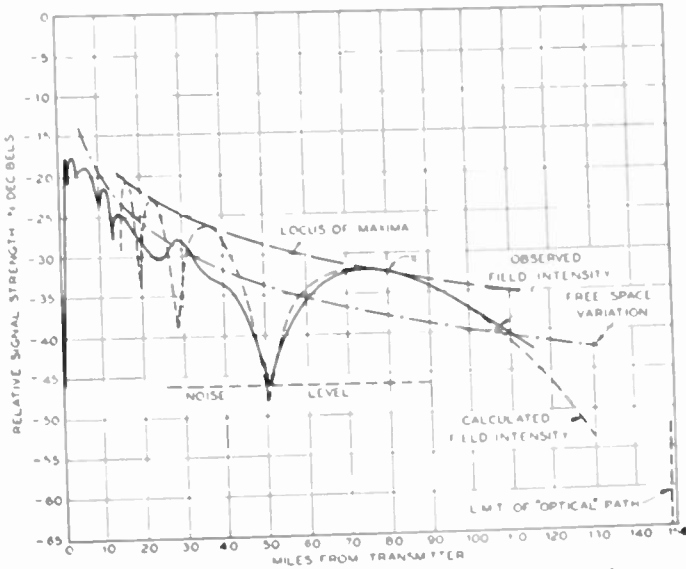

Fig. 16—Flight toward transmitter. Altitude—8000 feet; wavelength—4.3 meters, June 21, 1931.

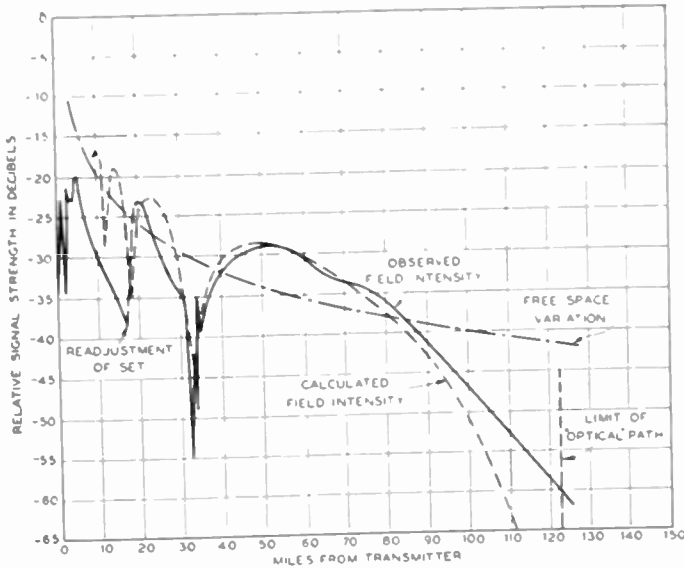

Fig. 17—Flight from transmitter. Altitude—5000 feet; wavelength—4.3 meters, June 29, 1931.

proved by this latter correction, thus indicating its validity. The deep and outermost minimum is due to the middle distance reflection with a

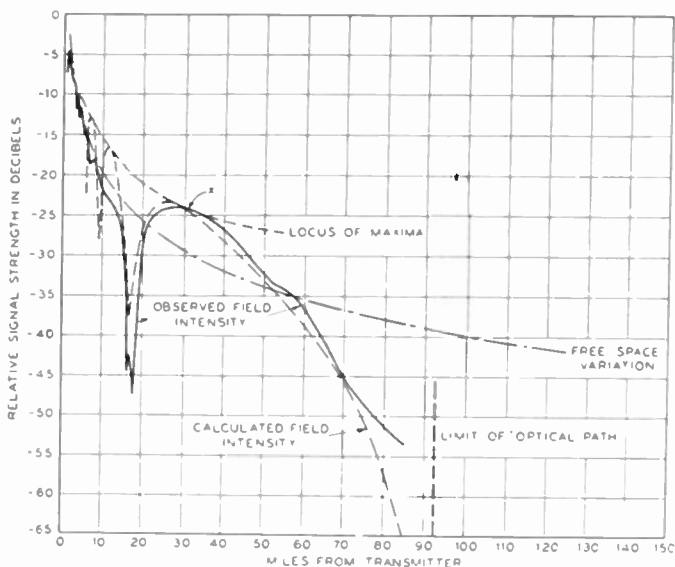

Fig. 18—Flight from transmitter. Altitude—2500 feet; wavelength—4.3 meters, June 26, 1931.

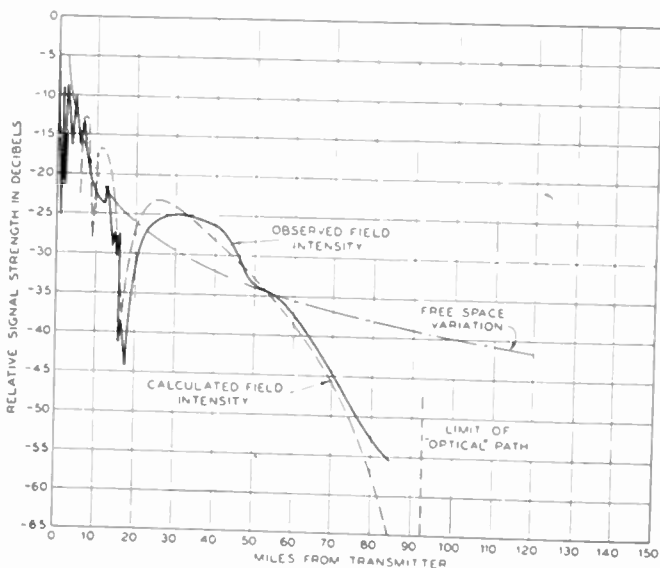

Fig. 19—Flight toward transmitter. Altitude—2500 feet; wavelength—4.3 meters, June 26, 1931.

540-degree phase difference. It is unmistakable and definite. The minima corresponding to phase differences of odd numbers of 180-



degree angles greater than three are not so clear cut. It is here that the ground corrugations will have the greater destructive effect.

The method of calculation is more fully explained in Appendix I, and the effect of a possible diffraction by Mt. Cushtunk in Appendix II. In the 8000-foot curves ignition noise masked the deep outermost minimum, and in the 10000-foot curve it is poorly defined, but it appears well marked in the 7000- and 2500-foot curves, and is roughly 10 decibels below the theoretical value. This minimal depth corresponds to a reflection coefficient of about 0.92 for this angle of incidence (88.4 degrees); the theoretical reflection coefficient is 0.8.

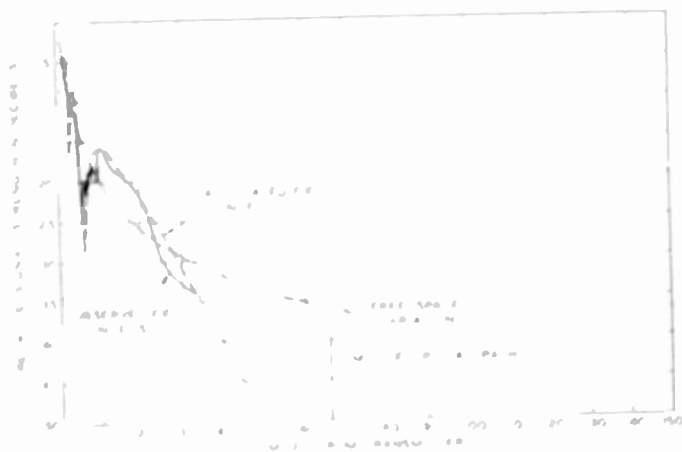

Fig. 20. Eight-foot transmitter. Altitude, 1000 feet. Wave length, 4.3 meters. June 29, 1931.

#### GENERAL OBSERVATIONS

During these experiments no static was observed. It has since been found by Mr. Tansky of the Laboratories that local summer thunder storms produce noticeable static interference, and that such storms may sometimes be detected up to a distance of 30 miles (81 kilometers). This interference is, however, very much less than on short-wave reception.

One continuous transmission test from Holmdel and Beer's Hill to Lebanon was made April 24 and 25, 1931, extending through the night and over both the sunset and sunrise periods. The Beer's Hill transmission was horizontally polarized, the Holmdel transmission vertically polarized. The wavelengths were 4.17 and 4.5 meters respectively. Quarter hourly observations were taken during the night, and observations were made every five minutes through the sunrise and sunset periods. No signal variations or abnormalities were observed.

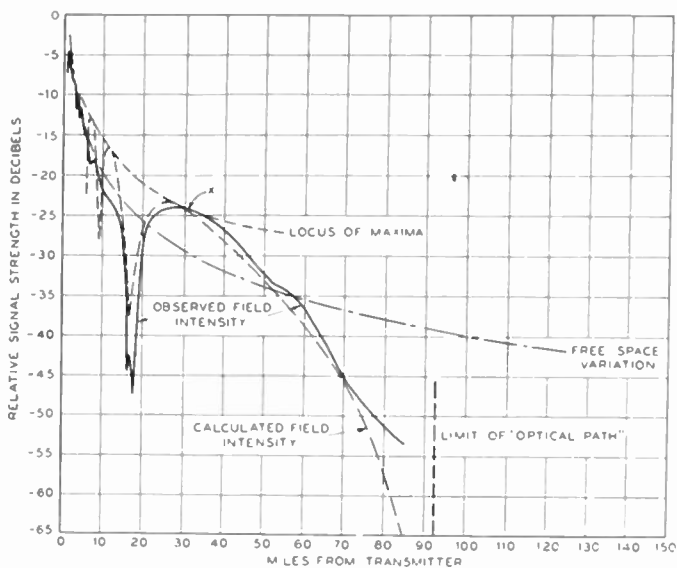

Fig. 18—Flight from transmitter. Altitude—2500 feet; wavelength—4.3 meters, June 26, 1931.

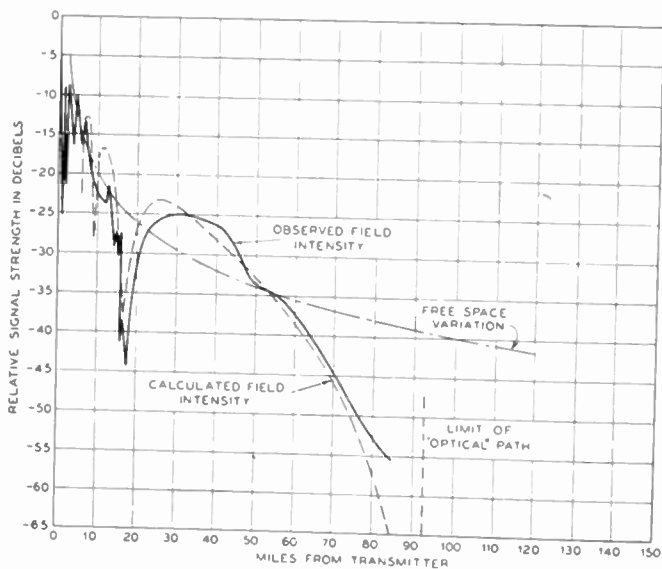

Fig. 19—Flight toward transmitter. Altitude—2500 feet; wavelength—4.3 meters, June 26, 1931.

540-degree phase difference. It is unmistakable and definite. The minima corresponding to phase differences of odd numbers of 180-

degree angles greater than three are not so clear cut. It is here that the ground corrugations will have the greater destructive effect.

The method of calculation is more fully explained in Appendix I, and the effect of a possible diffraction by Mt. Cushtunk in Appendix II. In the 8000-foot curves ignition noise masked the deep outermost minimum, and in the 1000-foot curve it is poorly defined, but it appears well marked in the 5000- and 2500-foot curves, and is roughly 10 decibels below the theoretical value. This minimal depth corresponds to a reflection coefficient of about 0.92 for this angle of incidence (88.4 degrees); the theoretical reflection coefficient is 0.8.

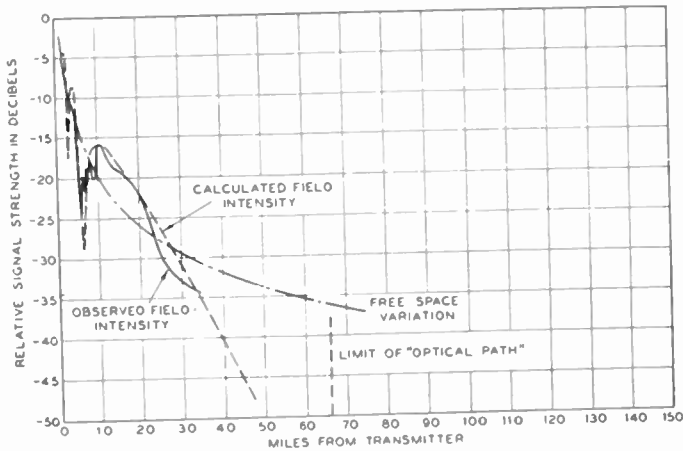

Fig. 20—Flight toward transmitter. Altitude—1000 feet; wavelength—4.3 meters, June 29, 1931.

#### GENERAL OBSERVATIONS

During these experiments no static was observed. It has since been found by Mr. Jansky of the Laboratories that local summer thunderstorms produce noticeable static interference and that such storms may sometimes be detected up to a distance of 50 miles (81 kilometers). This interference is, however, very much less than on short-wave reception.

One continuous transmission test from Holmdel and Beer's Hill to Lebanon was made April 24 and 25, 1931, extending through the night and over both the sunset and sunrise periods. The Beer's Hill transmission was horizontally polarized, the Holmdel transmission vertically polarized. The wavelengths were 4.17 and 4.5 meters, respectively. Quarter-hourly observations were taken during the night, and observations were made every five minutes through the sunrise and sunset periods. No signal variations or abnormalities were observed,

and harmonics of short-wave stations, though looked for, could not be heard. We have since observed these harmonics, for high power stations, but not from any great distance.

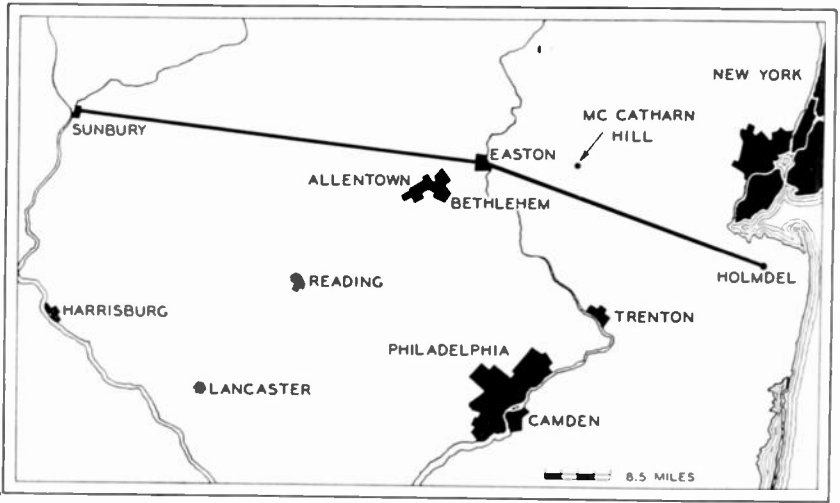

Fig. 21—Map of line covered by airplane flights.

The Beer's Hill transmitter power during all our tests never exceeded 6 watts, and gave an ample signal intensity at Lebanon, in spite of the 198-degree phase difference of the middle distance reflection component. Telephone transmission was uniformly good.

APPENDIX I

CALCULATION OF AIRPLANE RECEPTION CURVES

The resultant field strength at a point in the line of flight (Fig. 22) is

$$E_r = \frac{E_0}{D} (1 + K e^{i[\theta + (2\pi/\lambda)(r_2 - r_1)])} \tag{1}$$

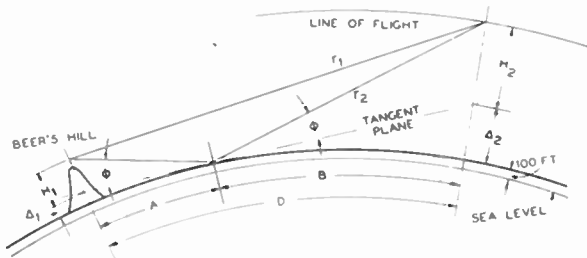

Fig. 22—Geometry of airplane reception.

where,

$E_0$  = the free space field at distance of one mile

$K$  = amplitude change at reflection

$\theta$  = phase change at reflection

( $K$  and  $\theta$  are functions of the angle of incidence and the ground constants)

$(r_2 - r_1)$  = the path length difference between direct and reflected rays

$$(r_2 - r_1) = \frac{2H_1H_2}{D} = \frac{2AB \tan^2 \Phi}{D} \quad (2)$$

provided  $H_1$  and  $H_2$  are small in comparison with  $D$ .

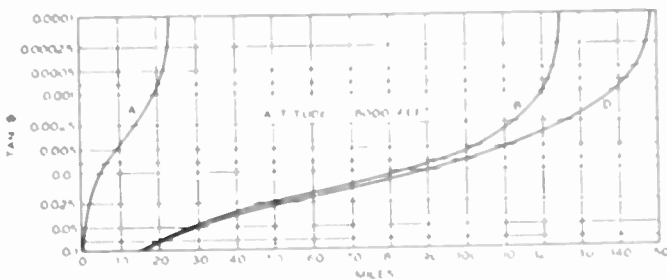

Fig. 23. Sample curve for calculating airplane results.

$H_1$  and  $H_2$  are the heights of transmitter and receiver above the plane tangent to the earth at the point of reflection.

The height of the tangent plane above the earth's surface is

$$\Delta_1 = R \left( -1 + \sqrt{1 + \frac{A^2}{R^2}} \right) = \frac{A^2}{2R} \text{ (app.)} \quad (3)$$

and,

$$\Delta_2 = \frac{B^2}{2R}$$

$R$  is the radius of the earth, which, due to atmospheric refraction, is taken to be 5260 miles,\* an increase of 33 per cent over the actual radius.  $(H_1 + \Delta_1)$  is always 280 feet, the height of the transmitting antenna above the reflecting surface, which, in the case at hand, is about 100 feet above sea level.

$(H_2 + \Delta_2)$  is constant for any flight at constant altitude.

For any value of  $A$ ,  $H$ , and hence  $\tan \Phi$  may be calculated and plotted as in Fig. 23. In this figure  $B$  is also plotted, for a flight at 8000

\* See Schelleng, Burrows, and Ferrell paper, Proc. I.R.E., this issue, pp. 427-463.

feet, against  $\tan \Phi$ . The total distance  $D$  is obtained by adding  $A$  and  $B$  at constant  $\tan \Phi$ . Thus, for any distance of the plane, we can read from the curves the values of  $A$ ,  $B$ , and  $\tan \Phi$ , and can calculate the path difference  $(r_2 - r_1)$  by equation (2).

In this manner, the theoretical reception curves, which are given in Figs. 15 to 20 (dotted curves), were calculated for flights at 8000, 5000, 2500, and 1000 feet. The ordinate "Relative Signal Strength—Decibels," is  $20 \log_{10} E_0/E_r$ , and gives the received signal strength in decibels below the field strength in free space at a distance of one mile from the transmitter.

Since the scale of the observed reception curves is unknown, they are superimposed upon the calculated ones by causing the maxima of the observed curves to coincide at some point with the theoretical loci of maxima (see for example, the points marked "x" in Figs. 16 and 18).

In the limit, as grazing incidence is approached, the theoretical reception approaches zero. In equation (1),  $K$  becomes unity and  $\theta$  becomes 180 degrees and the path length difference  $(r_2 - r_1)$  becomes zero. The observed field at distances greater than those required for grazing incidence is a diffraction one.

## APPENDIX II DIFFRACTION CALCULATIONS

In Fig. 25 the data of Fig. 17 for the 5000-foot airplane flight are compared with a theoretical curve which has been corrected from that

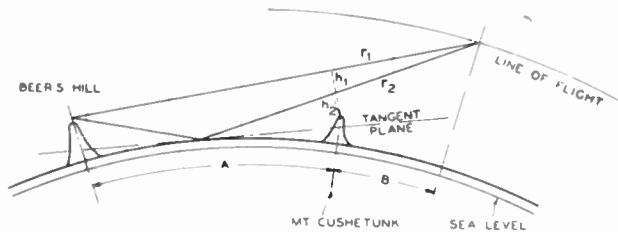

Fig. 24—Diffraction by Mt. Cushtunk.

of Fig. 17 by considering a possible diffraction around Mt. Cushtunk. This hill, 650 feet high, is 36 miles from Beer's Hill along the line of flight, and is the first major obstruction to an optical path at the greater airplane distances. For this calculation the points of reflection, angles of incidence, and path length differences are determined in the manner described in Appendix I, just as if the hill were absent. The hill is then introduced in the picture and, considering it as a straight edge, its effect on both direct and reflected rays is calculated. (See Fig. 24.)

The resultant field at the receiver is then,

$$E_r = \frac{E_0}{(a + b)} [F_1 + KF_2 e^{i[2\pi/\lambda(r_2-r_1)+\theta+\beta_2-\beta_1]}] \tag{4}$$

where,

- $F_1$  = amplitude change in the direct ray due to diffraction
- $F_2$  = amplitude change in the reflected ray due to diffraction
- $\beta_1$  = phase change of the direct ray produced by diffraction
- $\beta_2$  = phase change of the reflected ray produced by diffraction
- $K$  = amplitude change due to reflection at the ground
- $\theta$  = phase change at reflection
- $E_0$  = free space field strength at distance of one mile

The amplitude factors  $F_1$  and  $F_2$  and the phase changes  $\beta_1$  and  $\beta_2$  may be calculated from the Fresnel integrals to the parameter "v" (see note at end), where

$$v_1 = h_1 \sqrt{\frac{2}{\lambda} \left( \frac{1}{a} + \frac{1}{b} \right)}$$

$$v_2 = h_2 \sqrt{\frac{2}{\lambda} \left( \frac{1}{a} + \frac{1}{b} \right)} \tag{5}$$

" $h_1$ " and " $h_2$ " are the heights of the direct and reflected rays above the straight edge.

" $a$ " and " $b$ " are distances from the straight edge to transmitter and receiver.

A comparison of Figs. 17 and 25 shows that by taking account of diffraction around Mt. Cushtunk better agreement of calculated and observed curves is obtained. However, at grazing incidence this simple theory is inadequate; in this case  $F_1 = F_2$ ,  $\beta_1 = \beta_2$ ,  $K = 1$ ,  $\theta = 180$ , and the resultant field strength is zero as in the reflection case treated above.

For large values of  $v_1$  and  $v_2$ , that is for  $h_1$  and  $h_2$  large,  $F_1$  and  $F_2$  approach unity, and  $\beta_1$  and  $\beta_2$  approach zero. Equation (4) then reduces to the ordinary reflection case of equation (1).

Note: The ratio of the diffracted field strength to the field with edge removed is  $Fe^{i\theta} = 1/\sqrt{2} (C + iS)$

where,

$$C = \int_{-\infty}^v \cos \frac{\pi v^2}{2} dv = \frac{1}{2} + \int_0^v \cos \frac{\pi v^2}{2} dv$$

$$S = \int_{-\infty}^v \sin \frac{\pi v^2}{2} dv = \frac{1}{2} + \int_0^v \sin \frac{\pi v^2}{2} dv$$

and,

$$F' = \frac{1}{\sqrt{2}} \sqrt{C^2 + S^2}.$$

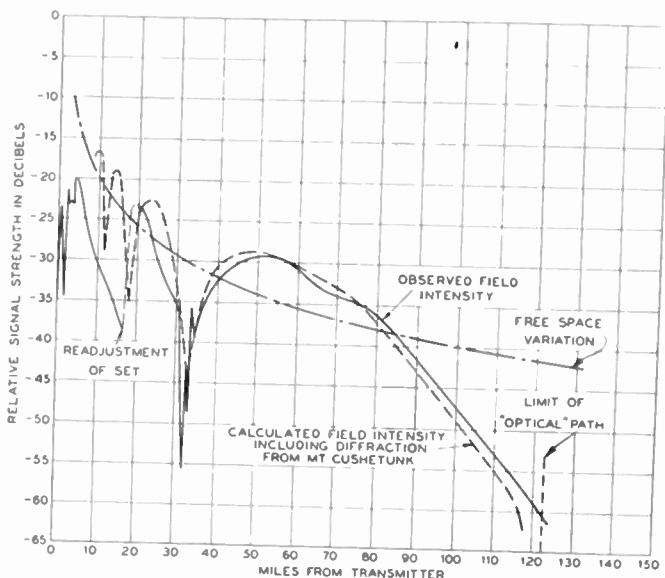

Fig. 25—Flight from transmitter. Altitude—5000 feet; wavelength—4.3 meters, June 29, 1931.

### APPENDIX III

#### Quantitative Check on the Beer's Hill—McCatharn Hill Transmission.

The Beer's Hill antenna was set at the height of 22 feet, and the receiver taken to the McCatharn Hill where it was operated out of a portable antenna 18 feet high. The optimum height here was 35 feet, and to reach it a more elaborate antenna would have had to be erected. The height used was just as good for a quantitative check as the optimum height. The effective radius of curvature of the earth's surface, corrected for air refraction, is taken as 5260 miles.

#### *Intermediate Reflection Component*

|                                 |                          |
|---------------------------------|--------------------------|
| Beer's Hill antenna             | 365 feet above sea level |
| Intermediate reflection surface | 67 feet above sea level  |
| McCatharn Hill antenna          | 768 feet above sea level |



Referring to the equations of Appendix I, we have

$$\begin{cases} D = 39.2 \text{ miles} \\ A = 13.7 \text{ " } & \tan \Phi = 0.00278 \\ B = 25.5 \text{ " } \end{cases}$$

and path difference between direct and reflected rays

$$= \frac{2AB \tan^2 \theta}{D} = 0.727 \text{ feet, or at } 1.45$$

meters wavelength an equivalent phase difference of 17.9 degrees results.

The angle of incidence is  $90 - \Phi = 89.84$  degrees and hence

$K = 0.977$  for vertical polarization

$= 1.0$  for horizontal polarization

$\theta = 180$  degrees for both polarizations

Adding these to the free space field " $E_0$ " the middle distance reflected component, we obtain

$$E = E_0(1 + Ke^{i197.9^\circ})$$

and,

$$\begin{cases} \frac{E_v}{E_0} = 0.308 = -10.24 \text{ db} \\ \frac{E_H}{E_0} = 0.311 = -10.14 \text{ db} \end{cases}$$

#### Local Hill Reflection Components

By the same process as for the above, and taking the geometry of Figs. 9 and 12 we obtain the site gains,

Beer's Hill reflection vertical polarization +1.5 decibels

Beer's Hill reflection horizontal polarization +5.1 decibels

McCatharn Hill reflection vertical polarization +0.68 decibels

McCatharn Hill reflection horizontal polarization +2.76 decibels

giving finally:

Vertical polarization transmission 8.1 decibels below free space transmission.

Horizontal polarization transmission 2.3 decibels below free space transmission.

#### Measured Field Values

The actual field intensity measurements were made using a split half-wave antenna with a transmission line which gave a total loss of about one decibel. Knowing the radiation resistance of antenna and

grid circuit input impedance, the transfer voltage ratio could be calculated, and from the grid-to-grid over-all amplification of the receiver the voltage step-up for a given set output determined. The field intensity in microvolts per meter was thus obtained. The measured values were

|                         |                           |
|-------------------------|---------------------------|
| Vertical polarization   | 21.6 microvolts per meter |
| Horizontal polarization | 38.5 microvolts per meter |

The transmitter antenna current was 0.05 ampere, and the free space field to be expected at 39.2 miles equal to 47.5 microvolts per meter.

Summarizing the results we have:

|                                   |                                 |
|-----------------------------------|---------------------------------|
| Predicted vertical polarization   | +8.1 db below free space field. |
| Measured vertical polarization    | +6.8 db below free space field. |
| Predicted horizontal polarization | +2.3 db below free space field. |
| Measured horizontal polarization  | +1.8 db below free space field. |

The measured values are thus within 16 and 6 per cent, respectively, of the calculated values, a satisfactory agreement.

#### APPENDIX IV

We have given three methods of field intensity measurement a trial. These are:

1. Comparison of field intensity with the mean first circuit noise voltage of the receiver. As shown by Johnson<sup>9</sup> the latter can be calculated, and by knowing the transfer voltage factor of the antenna—transmission-line input circuit combination and the difference in receiver set amplification for the two voltages the field intensity can be calculated.

2. Local oscillator comparison.<sup>10</sup> Here a local oscillator, with a small loop antenna is mounted in the neighborhood of the set, precautions being taken to keep ground reflected fields down in intensity. From loop current and physical dimensions and the oscillator-receiver spacing the resultant field is calculated and compared with the field to be measured.

3. Modified short-wave method. This is the method we have chiefly used and which appears at the moment to be most promising. From a knowledge of the impedances of antenna and receiver input circuits the voltage transfer ratio from effective antenna input to resultant grid input can be calculated, for optimum power transfer conditions, and to a good degree of accuracy. This factor together with the antenna effective height and over-all set gain permits a measurement of the field intensity. In effect this is a variation of the Friis and Bruce method.

<sup>9</sup> Johnson, *Phys. Rev.*, vol. 32, p. 97, (1928).

<sup>10</sup> Described in the Schelleng, Burrows, and Ferrell paper.

## BOOK REVIEW

**The True Road to Radio**, by Albert Hall. Published by Ferranti, Inc., 130 West 42nd Street, New York, N. Y. 243 pp. 8 x 10 1/2 in. 135 figures. Price, \$2.00.

The author of this book is a designer of commercial sets for Ferranti, Ltd., who has chosen this book as the means of making the results of his experience public. The book is a consecutive engineering story of the receiving set, with curves and illustrations. The more important mathematical formulas are given in separate mathematical sections following the descriptions to which they apply.

The material discussed includes radio-frequency amplification, detection, audio-frequency amplification, power amplification, loud speakers, power supplies, calculations of iron-cored structures, radio receiver circuit arrangements, and tube data. Much numerical information is given and many curves are plotted from measurements to illustrate the points discussed. Practical suggestions on shielding and arrangements of parts are given. Variable-mu screen-grid tubes are not discussed. Superheterodynes are discussed very briefly.

The title gives little information as to the contents of the book and might suggest to the American reader the chaffy popular type of book. This book, however, is a well-written, well-illustrated, readable discussion of radio receivers.

S. A. KIRBY

\* Bureau of Standards, Washington, D. C.

**BOOKLETS, CATALOGS, PAMPHLETS RECEIVED**

Copies of the publications listed on this page may be obtained gratis by addressing the manufacturer or publisher.

Kenyon Transformer Company of 122 Cyprus Avenue, New York City, has issued a catalog covering laboratory and general purpose amplifier equipment, universal replacement transformers, and audio components for manufacturers' uses.

"Faradon Mica Capacitors" is the title of a catalog recently issued by the RCA Victor Company of Camden, N.J.

The Weston Electrical Instrument Corporation of Newark, N.J., offers catalogs covering standardized service units, radio instruments, as well as wiring diagrams and technical data on Weston volt-ohm meters and universal meter kits. Adapter data sheets for Weston-Jewell service equipment are also available.

Blue prints showing lug positions on standard coils and a schematic circuit diagram for a five-tube superheterodyne receiver are available from the General Manufacturing Company, 8066 South Chicago Ave., Chicago, Ill.

"Acoustic and Noise Control" is the subject of a booklet issued by Electrical Research Products, Inc., of 250 West 57th Street, New York City.

A number of sheets bringing their catalog on radio tube parts up-to-date has been issued by Goat Radio Tube Parts, Inc., of 814 Dean Street, Brooklyn, N.Y.

The Cannon Electric Development Company of 420 West Avenue 33, Los Angeles, has issued a leaflet covering their double action relays.

The Federal Anti-Capacity Switch Corporation of 42 Laird Avenue, Buffalo, N.Y., has published a leaflet on the Century high frequency buzzer.

A booklet of technical data on the Wunderlich tube covering the characteristics of the tube and a number of circuits in which it may be employed has been issued by the Wunderlich Corporation of 1337 Fargo Avenue, Chicago, Ill.

A piezo-electric microphone is the subject of a pamphlet issued by the Brush Development Company of 3715 Euclid Avenue, Cleveland, Ohio.

A new series of high voltage condensers and midget electrolytic condensers is covered in some leaflets recently published by the Dubilier Condenser Corporation of 4377 Bronx Blvd., New York City.

Bulletins 1103 and 1104 of the Ward-Leonard Electric Company, Mt. Vernon, N.Y., cover vitrohms coil type rheostats and vitrohms adjustostats.

Little-Fuse Laboratories of 1772 Wilson Avenue, Chicago, have published a booklet describing their fuses for the protection of measuring instruments and low current devices.

"Instruments for Line Measurements and Laboratory Use" is the title of the catalog issued by Telefonaktiebolaget L. M. Ericsson, Kungsgatan 33, Stockholm, Sweden.

## RADIO ABSTRACTS AND REFERENCES

THIS is prepared monthly by the Bureau of Standards,\* and is intended to cover the more important papers of interest to the professional radio engineer which have recently appeared in periodicals, books, etc. The number at the left of each reference classifies the reference by subject, in accordance with the "Classification of radio subjects: An extension of the Dewey Decimal System," Bureau of Standards Circular No. 385, obtainable from the Superintendent of Documents, Government Printing Office, Washington, D.C. for 10 cents a copy. The classification also appeared in full on pp. 1433-1456 of the August, 1930, issue of the Proceedings of the Institute of Radio Engineers.

The articles listed are not obtainable from the Government or the Institute of Radio Engineers, except when publications thereof. The various periodicals can be secured from their publishers and can be consulted at large public libraries.

### R000. RADIO (GENERAL)

- R005 W. B. Kouwenhoven and O. R. Langworthy. Injuries produced by contact with electric circuits. *Jour. Frank. Inst.*, vol. 215, pp. 1-26; January, (1933).

A report is given of experimental tests made on animals to determine the effects of electric shock. Special study was made of the effects on the heart and nervous system. An examination was also made of the injuries to two human bodies that had suffered electrocution. Conclusions are deduced concerning the injuries to human bodies. An extensive bibliography is included. The causes of death were found to be asphyxiation, injury to the nervous system, injury to the heart, and burns.

- R009 Radio research. *Electrician* (London), vol. 109, p. 750, December 9, (1932).

A brief note on the scope of the work reported in the annual report of the Radio Research Board.

### R100. RADIO PRINCIPLES

- R113 R. M. Morris and W. A. R. Brown. Transoceanic reception of high-frequency telephone signals. *Proc. I.R.E.*, vol. 21, pp. 63-80; January, (1933).

The application of high-frequency telephone transmission to international rebroadcasting is treated. Brief descriptions are given of the method used in rating the suitability of reception for rebroadcasting, the effects of magnetic disturbances upon transmission, the correlation of magnetic activity with transmission, and the forecasting of magnetic disturbances and resultant transmission conditions.

- R113  
×R270 C. N. Anderson. North Atlantic ship-shore radiotelephone transmission during 1930 and 1931. *Proc. I.R.E.*, vol. 21, pp. 81-101; January, (1933).

Considerable data on radio transmission were collected during the years 1930 and 1931 incidental to the operation of a ship-shore radiotelephone service with several passenger ships operating in the North Atlantic. This paper discusses briefly the results of an analysis of these data.

\* This list compiled by Mr. A. H. Hodge and Miss E. M. Zandonini.

- R113 C. R. Burrows and E. J. Howard. Short-wave transmission to South America. *Proc. I.R.E.*, vol. 21, pp. 102-113; January, (1933).  
The results of a year's survey of transmission conditions between New York and Buenos Aires in the short-wave radio spectrum are presented in this article. Surfaces showing the received field strength as a function of time of day and frequency are given. These show that frequencies between 19 and 23 megacycles were best for daytime transmission, and those between 8 and 10 megacycles for nighttime transmission.
- R113 G. Millington. Ionization charts of the upper atmosphere (From Chapman's theory). *Proc. Phys. Soc. (London)*, vol. 44, pp. 580-593; September 1, (1932).  
Prof. Chapman's theory of the ionization of the upper atmosphere by solar radiation has been applied to construct a set of charts giving contour lines of equal ionic density over the surface of the earth. A method of solving the fundamental differential equation of the theory by a rapid arithmetical process is described. Charts are drawn for winter, equinox, and summer conditions.
- R113.3  
×R521 H. Diamond. The cause and elimination of night effects in radio range-beacon reception. *Bureau of Standards Journal of Research*, vol. 10, pp. 7-34; January, (1933). RP513.  
A new antenna system is described for use at radio range-beacon stations which eliminates the troublesome night effects hitherto experienced in the use of the range-beacon system. Data are given which show the severity of night effects. Because of the magnitude of these effects the range-beacon is often useless over large distances. With the new antenna system developed, referred to as the transmission-line antenna system, the beacon course is satisfactory throughout its entire distance range, the night effects becoming negligible. An analysis is included which explains the occurrence of night effects with the range-beacon system when using loop transmitting antennas. The significant element of the system consists of the use of transmission line for confining the radiation to the four vertical antennas.
- R113.61 S. K. Mitra and H. Rakshit. On a study of the upper atmosphere in Bengal by wireless echoes of short delay. *Phil. Mag. and Jour. Sci. (London)*, vol. 14, pp. 20-32; January, (1933).  
The height of the upper ionized F layer was measured in Bengal with wavelengths of 42, 50, 75, and 80 meters. No marked variation in height is found with variation of frequency. Daily and seasonal variations are recorded. Average height in afternoon 250 km. Data indicate that multiple echoes are due to multiple reflection. Intensity of successive echoes do not follow any regularity. Probable causes of this anomaly are discussed.
- R114 T. Yanagimoto. On the relation between atmospheric and meteorological elements observed at Okinawa. *Report of Radio Researches & Works in Japan*, vol. 2, pp. 2-3; September, (1932).  
The atmospheric maximum (June) was one month earlier than at Tokyo, the minimum (February or March) one month later. This is the same as the behavior of meteorological elements especially of temperature. Atmospherics due to typhoons were weaker in summer and stronger in spring and autumn.
- R120 O. Schmidt. Messungen über die Strahlungsinduzierung symmetrischer Antennen. (Measurements on the radiation resistance of symmetrical antennas.) *Hochfrequenztechnik und Elektroakustik*, vol. 40, pp. 158-167; November, (1932).  
This paper is divided into five parts as follows: (1) method of measurement; (2) transition from a non-radiating to a strongly radiating system; (3) the radiation resistance as a function of the height above the earth; (4) the fictitious impedance and velocity of propagation; (5) measurements on a radiation-coupled antenna system.
- R120 F. H. Murray. Asymptotic dipole expansions for small horizontal angles. *Proc. Cambridge Phil. Soc. (London)*, vol. 28, pp. 433-41; October, (1932).  
The wave function  $r$  for a vertical dipole above the earth's surface has been expanded by a method differing somewhat from that of Sommerfeld, expansions being obtained for large and small numerical distances respectively.

- R120 F. H. Murray. Mutual impedance of two skew antenna wires. *Proc. I.R.E.*, vol. 21, pp. 154-158; January, (1933).

It has been shown that related double integrals can be reduced to sums of logarithmic integrals and their limits; in the present paper this reduction is generalized. The mutual impedance of two antenna wires in space which do not intersect may be calculated in terms of the integrals discussed, but these integrals can be evaluated by known tables only if the wires are in the same plane. The integrals of Carter result from a suitable limiting operation; a direct evaluation is also possible and is given.

- R133 H. Edler. Berechnung des Anfachmechanismus von Schwingungen bei einer Elektronenröhre in Barkhausen-Kurz Schaltung. (Calculation of the mechanism of generation of oscillations with an electron tube in a Barkhausen-Kurz circuit.) *Archiv. für Elek. tech.*, vol. 26, pp. 841-849; December, (1932).

The mechanism of generation of the Barkhausen-Kurz oscillator is calculated on the basis of energy considerations. It is shown that for a produced result the oscillation range and the voltage amplitude of oscillation can be determined. The maximum power which a tube can give is determined and the conditions under which this is obtained are given.

- R133 Short-wave oscillations. *Electrician* (London), vol. 110, p. 11; January 6, (1933).

Production of electronic oscillations. Methods of using the Magnetron short-wave oscillator.

- R133 L. B. Arguimbau. An oscillator having a linear operating characteristic. *Proc. I.R.E.*, vol. 21, pp. 14-28; January, (1933).

A review of conventional linear equilibrium conditions is given. It is shown that these conditions are not usually at all applicable to practical oscillators. The relation of non-linear effects to frequency modulation is pointed out. A modified type of oscillator which conforms to the elementary linear conditions is described.

- R140 S. J. Model. Transmission curves of high-frequency networks. *Proc. I.R.E.*, vol. 21, pp. 114-143; January, (1933).

This article deduces the design data on frequency transmission which are necessary in designing the networks for high-frequency modulated waves. In the first section the general laws of current variations in circuits tuned to carrier frequency with and without tube generator are derived; the interdependence of current curves of various circuits forming a given network is also clarified. The second section gives the derivation of the transmission curve equation for a two-circuit system.

- R140 J. G. Brainerd. Equivalent circuits of an active network. *Proc. I.R.E.*, vol. 21, pp. 144-153; January, (1933).

The problem considered in this paper is that of setting up an exactly equivalent circuit for a four-terminal network containing one emf and any number of impedances connected in any manner. Several relatively simple circuits which can be used to represent any such active network, and some others which can be used in special cases, are completely specified.

## R200. RADIO MEASUREMENTS AND STANDARDIZATION

- R212 J. B. Hoag. Measurement of the frequency of ultra-radio waves. *Proc. I.R.E.*, vol. 21, pp. 29-36; January, (1933).

An analysis of a particular Lecher wire system whose characteristic impedance matches its input impedance and whose output end is short circuited, has led to an equation permitting the measurement of ultra-radio frequencies to three significant figures. The method is independent of end effects and has been applied to a determination of the velocity of propagation along iron wires.

- R214 Eine Quarzuhr für Zeit- und Frequenzmessung sehr hoher Genauigkeit. (A quartz-controlled clock for time and frequency measurement of very high precision.) *Zeits. für tech. Phys.*, No. 12, pp. 591-593; (1932).

Results obtained with a quartz-controlled clock at the Physikalisch-Technischen Reichsanstalt are given. It is stated that over a period of six months the frequency remained constant to  $\pm 2 \times 10^{-8}$  cycles.

- R220 J. Clay. Genaue und absolute Messung kleiner Kapazitäten. (Exact and absolute measurement of small capacities.) *Zeit. für Phys.*, vol. 78, pp. 250-256; (1932).  
A condenser is described with which it is possible to measure small capacities absolutely with a degree of accuracy of 1:13000. It is now possible to measure exactly the capacity of an electrometer with an internal, insulated system, without the necessity of considering the probe electrode.
- R223 M. Czerny and W. Schottky. Über die Bedeutung der Ultraroten Eigneschwingungen der Stoffe für ihre dielektrischen Verluste. (On the bearing of natural infra-red oscillations of materials on their dielectric losses.) *Zeits. für Phys.*, vol. 78, pp. 220-229; (1932).  
In a solid dielectric the same cause which gives rise to absorption in natural infra-red oscillations can also affect dielectric losses in the region of short waves. The absorption in the case of rock salt is calculated from a dispersion formula. It is shown that for very short waves, dielectric losses of noticeable size may be expected to arise.
- R243 H. B. Brooks and A. W. Spinks. A multirange potentiometer and its application to the measurement of small temperature differences. *Bureau of Standards Journal Research*, vol. 9, pp. 781-798; December, (1932).  
A six range potentiometer is described. When used with 10 thermocouples in series it provides temperature difference ranges of 0 degrees to 0.1, 0.2, 0.5, 1, 2, and 5. Each range corresponds to a pointer deflection of 100 divisions, readable by estimation to 0.1 division.
- R243.1 R. M. Somers. An improvement in vacuum-tube voltmeters. *Proc. I.R.E.*, vol. 21, pp. 56-62; January, (1933).  
A vacuum-tube voltmeter for the measurement of audio frequencies, which depends for its operation almost entirely upon the amplification factor of the tube, is described. This voltmeter combines the marked advantages of a single voltage source for filament, grid and plate supply with the absence of zero adjustment requirements on the indicator. It has a further advantage over the more common type of vacuum-tube voltmeters in that it can usually be made direct reading in volts on a 0-2 milliamperere thermocouple type of indicating instrument.
- R243.1  
×R243 T. P. Hoar. The use of triode and tetrode valves for the measurement of small d.c. potential differences. *Wireless Engineer & Experimental Wireless* (London), vol. 10, pp. 19-25; January, (1933).  
This article summarizes the literature dealing with vacuum-tube potentiometers and electrometers. It summarizes the various modifications that have been proposed, indicates practical difficulties, and suggests suitable circuits for particular problems. A bibliography of 28 references is given.
- R270 C. H. Smith. Recording field strength—Equipment used by the British Broadcasting Company for automatic measurement. *Wireless Engineer & Experimental Wireless* (London), vol. 10, pp. 14-18; January, (1933).  
A description of apparatus.
- R300. RADIO APPARATUS AND EQUIPMENT
- R330 Tubes with cold cathodes. *Electronics*, vol. 6, p. 6; January, (1933).  
A brief description of the gas-filled tube is taken from a paper presented by Dr. A. Hund before a meeting of the New York Section of the Institute of Radio Engineers, January 4, 1933.
- R330 H. A. Pidgeon. Measuring microphonic noise in vacuum tubes. *Bell Laboratories Record*, vol. 11, pp. 145-150; January, (1933).  
A test set is described in which microphonic response is indicated by a steady deflection of the output meter. It includes an agitation unit in which the tube under test is mounted and continuously agitated, and an amplifying and measuring circuit which gives a steady reading of the microphonic noise in db below an arbitrary level.



- R330 Emission of positive ions from hot tungsten. *Proc. Cambridge Phil. Soc.* (London), vol. 28, pp. 490-496; October, (1932).  
Measurements were made of the positive ion currents emitted by tungsten at temperatures between 3000 degrees K and 3200 degrees K. The results are in agreement with the values calculated on the basis of the Soha equation from the rate of evaporation of neutral atoms, the electron work-function and the ionization potential of tungsten. The work function associated with the ionic evaporation appears to lie between 10 and 11 electron volts.
- R331 A. J. Marino. The place of nickel in radio tube manufacture. *Electronics*, vol. 6, pp. 4-5; January, (1933).  
× R280 The chief reasons for the use of nickel in tube manufacture are its uniformity, ease of working, high melting point, reasonable price, valuable scrap, forms alloys easily. Its uses are briefly discussed.
- R331 K. T. Compton. Accommodation coefficient of gaseous ions at cathodes. *Proc. Nat. Acad. Sci.*, vol. 18, pp. 705-711; December, (1932).  
The pressure and energy relations occurring at cathodes due to the bombardment of gaseous ions are considered. Observed effects are described in terms of an "accommodation coefficient  $\alpha$ ." It is concluded that molecules resulting from the neutralization of ions do not rebound from the cathode if the mass of the impinging ion is greater than the mass of the surface atom. It is also shown that the accommodation coefficient is smallest for light ions.
- R355.9 J. G. Kreer. A heterodyne oscillator of wide frequency range. *Bell Laboratories Record*, vol. 11, pp. 137-139; January, (1933).  
A heterodyne oscillator covering the frequency range of 200 to 3500 cycles is described.
- R357 C. E. Smith. Frequency doubling in a triode vacuum tube circuit. *PROC. I.R.E.*, vol. 21, pp. 37-50; January, (1933).  
This paper gives a quantitative analysis of operating performances of a triode vacuum tube as a frequency doubler. With slight changes this analysis can be applied to tripling, quadrupling, etc. Three methods of attack are outlined. The primary object of this work is to investigate the conditions that will give maximum plate efficiency and consequently the most desirable operating conditions, also keeping in mind that power output and power amplification are important factors to consider in the practical application of the frequency doubler.
- R361 S. Takamura. Radio receiver characteristics related to the side-band coefficient of the resonant circuit. *Report of Radio Researches & Works in Japan*, vol. 2, pp. 97-129; September, (1932).  
The author has dealt with the modulated current in the resonant circuit mathematically and introduced a factor "the side-band coefficient," into the equations of the modulated current and the receiver output. He has given observations of the combined side-band coefficient of the receiver and the explanations of the resonance curves.
- R363 P. A. McDonald and J. T. MacPherson. A direct-current amplifier. *Phil. Mag. and Jour. Sci.* (London), vol. 14, pp. 72-81; January, (1933).  
A direct-current amplifier based on the fact that the direction of flow of the grid current alters at a definite value of the grid potential. A two-tube arrangement is used, the plate of one tube being connected to the grid of another. The amplifier is said to be very stable, have high sensitivity, yet be rugged and easy to use.
- R365.21 Circuits for amplified automatic volume control. *Electronics*, vol. 6, pp. 16-17; January, (1933).  
Several circuits, and the advantages of each are described.
- R365.21 N. E. Wunderlich. Inter-carrier noise suppression. *Electronics*, vol. 6, p. 13; January, (1933).  
× R330 The electrode construction of the Wunderlich B type tube is taken advantage of to accomplish a new system of noise suppression. A longer cathode and a small additional anode placed at the top of the structure and shielded from the other elements make possible the amplification of the AVC potentials before they are applied.

- R388 A. B. DuMont. The cathautograph—An electron pencil. *Electronics*, vol. 6, p. 7, January, (1933).

A cathode-ray tube having a screen of special salts which have a decay period of several seconds for the fluorescence is described. It may be used for transfer of messages, etc.

#### R400. RADIO COMMUNICATION SYSTEMS

- R400 Y. Niwa and T. Hayashi. A system for the inversion of frequency distribution. *Report of Radio Researches & Works in Japan*, vol. 2, pp. 195-210; September, (1932).

The input voltage, frequency distribution of which is to be inverted, is combined with a carrier current a little above the frequency band of the input voltage. Four kinds of voltages are applied to the grids of four tubes. The outputs of two tubes are connected so as to have the output current added while output circuit of the remaining two tubes are so connected as to be subtracted from the former two tubes. In this way the lower and upper side bands of the input waves modulated by the carrier current are obtained. If one receives only the lower side band the inverted spectrum of the input wave is obtained.

- R400 T. Matsuyuki. A bridge type speech inverter (for secret radio telephony). *Report of Radio Researches & Works in Japan*, vol. 2, pp. 187-193; September, (1932).

A device for speech inversion developed by Japanese Department of Communications. One arm of a resistance bridge contains two triodes with the plate of one connected to the filament of the other and vice versa.

- R400 T. Kujirai and T. Sakamoto. Secret (telegraphic and telephonic) communication by phase modulation method. *Report of Radio Researches & Works in Japan*, vol. 2, pp. 175-186; September, (1932).

A bridge device is described by means of which a voltage having a constant amplitude and a variable phase can be obtained. If the source of supply voltage for the bridge is of audio frequency and the capacity is changed corresponding to a telegraphic signal, the output voltage changes phase according to the change in capacity. If the source is of radio frequency and the capacity is changed with audio frequency, the output changes its phase with audio frequency. A special means of detection is then used.

- R423.5 Radio micro waves. *Electrician* (London), vol. 110, pp. 3-6; January, 6, (1933).

The part of Marconi's address before the Royal Institution which describes recent experimental work on very short waves is given. Circuit arrangements, transmitting apparatus, and wave patterns are illustrated.

- R423.5 Ultra-short waves. *Electrician* (London), vol. 109, p. 758; December, 9, (1932).

Notes from Marchese Marconi's lecture given at the meeting of the Royal Institution.

#### R500. APPLICATIONS OF RADIO

- R526.1 E. Kraemer. Die Ultrakurzenwellen—Funkbake. (The ultra-high-frequency beacon.) *Elek. Nach. Tech.*, vol. 9, pp. 469-473; December, (1932).

A general description of the method of operation of the radio beacon is given.

- R550 Y. Takata and M. Kinase. Some experiments on common frequency broadcasting. *Report of Radio Researches & Works in Japan*, vol. 2, pp. 75-90; September, (1932).

Using a quartz oscillator at each station the receiving conditions for common and for different programs are investigated for both day and night transmissions. Receiving conditions are found to become worse with an increase of the number of stations.

- R583 E. L. White. Modulation frequencies in visual transmission. *Proc. I.R.E.*, vol. 21, pp. 51-55; January, (1933).

A method of computing the maximum frequencies produced in television transmission is shown. This method is based on the consideration of the degree of edge definition produced. It is shown that these frequencies are independent of the amount of detail in transmitted pictures for equal edge definition.

## R800. NONRADIO SUBJECTS

- 537.65 E. Schwartz. Experimentelle Untersuchungen über die piezoelektrischen und dielektrischen Eigenschaften des Seignettesalzes. (Experimental investigations on the piezoelectric and dielectric properties of Rochelle salts.) *Elek. Nach. Tech.*, vol. 9, pp. 481-495; December, (1932).  
 A method of growing and working Rochelle salt crystals is given. The dielectric and piezoelectric properties are quite completely given as indicated by the following curves which are plotted: dielectric constant as a function of the temperature, piezoelectric charge against temperature, charge density against field strength, dielectric constant against field strength, temperature and pressure. A bibliography is given.
- 537.65 B. Nussbaumer. Experimental determination of the first piezo modulus of quartz. *Zeits. für. Phys.*, vol. 78, pp. 781-790; (1932).  
 A method given by Szekeley has been used to determine the piezoelectric modulus  $d_{11}$  of quartz with a quartz resonator. Measurements on a quartz rod with twinning formations of different structure gave a marked decrease in the value of  $d_{11}$ .
- 537.65 J. M. Cork. Laue patterns from thick crystals at rest and oscillating piezoelectrically. *Phys. Rev.*, vol. 42, pp. 749-752; December 15, (1932).  
 Data obtained indicate that further elaboration of the Laue diffraction theory seems necessary to account for the multiple structure of spots formed by an ideally perfect crystal.
- 621.353 J. H. Park. Effect of service temperature conditions on the electromotive force of unsaturated portable cells. *Bureau of Standards Journal Research*, vol. 10, pp. 89-98; January, (1933).  
 The effect of external temperature disturbances such as might occur in practice on the electromotive force of unsaturated portable standard cells of the model in general use was investigated. In some cases emf variations were found of 1.8 millivolts or almost 0.2 of 1 per cent. Data are shown in curves. Methods of protecting cells were shown to be effective.
- 621.385.96 C. Dreher. Control of sound quality in picture production. *Electronics*, vol. 6, pp. 10-12; January, (1933).  
 A description of maintenance and test methods.



CONTRIBUTORS TO THIS ISSUE

**Burrows, C. R.:** Born June 21, 1902, at Detroit, Michigan. Received B.S. degree in E.E., University of Michigan, 1924; M.A. degree in Physics, Columbia University, 1927. Radio research department, Western Electric Company, 1924-1925; Bell Telephone Laboratories, 1924 to date. Engaged primarily in radio transmission studies at Deal, New Jersey. Associate member, Institute of Radio Engineers, 1924.

**Carter, Philip S.:** Born July 22, 1896, at Glastonbury, Connecticut. Received A.B. degree in M.E., Stanford University, 1918. Signal Corps, U. S. Army, 1918. Test and radio engineering department, General Electric Company, 1919-1920; engineering department, Radio Corporation of America, 1920-1929. Research and development division, RCA Communications, Inc., 1929 to date. Associate member, Institute of Radio Engineers, 1929.

**Crawford, Arthur B.:** Born February 26, 1907, at Graysville, Ohio. Received B.S. degree in E.E., Ohio State University, 1928. Member, technical staff, Bell Telephone Laboratories, Inc., 1928 to date. Associate member, Institute of Radio Engineers, 1929.

**Englund, Carl B.:** Born at Sioux City, Iowa. Received B.S. degree, University of South Dakota, 1909. Chemist, teacher, and graduate student, 1909-1914. Member, technical staff, Western Electric Company, Bell Telephone Laboratories Inc., 1914 to date. Associate member, Institute of Radio Engineers, 1917; Fellow, 1928.

**Ferrell, Enoch B.:** Born June 1, 1898, at Sedan, Kansas. Received B.A. degree, University of Oklahoma, 1920; B.S. degree in E.E., 1921; M.A. degree, 1924. Instructor in mathematics, University of Oklahoma, 1921-1924. Member, technical staff, Bell Telephone Laboratories, Inc., 1924 to date. Engaged primarily in radio transmitter development at Deal, New Jersey. Associate member, Institute of Radio Engineers, 1925; Member, 1929.

**Jones, L. F.:** Born July 4, 1905, at St. Louis, Missouri. Received B.S. degree, Washington University, 1926. Radio engineering department, General Electric Company, 1926-1928. Graduate School of Business Administration, Stanford University, 1928-1929. Radio engineering department, General Electric Company, 1929-1930. Transmitter engineering department, RCA Victor Company, Inc., 1930 to date. Europe and Russia, 1930-1931, Camden and New York Laboratories, 1931 to date. Member, Sigma Xi. Junior member, Institute of Radio Engineers, 1926; Associate member, 1926.

**Mumford, W. W.:** Born June 17, 1905, at Vancouver, Washington. Received B.A. degree, Willamette University, 1930. Radio operator, U.S.C.G. *Algonquin*, 1923-1924. Member, technical staff, Bell Telephone Laboratories, Inc., 1930 to date. Associate member, Institute of Radio Engineers, 1930.

**Schelling, J. C.:** Born November 12, 1892, at Freeport, Illinois. Received A.B. degree, Cornell University, 1915. Instructor and graduate student, Department of Physics, Cornell University, 1915-1918; Western Electric Company, 1918-1925; radio research engineer, Bell Telephone Laboratories, Inc., 1925 to date. Associate member, Institute of Radio Engineers, 1923; Member, 1925; Fellow, 1928.

**Trevor, Bertram:** Born February 26, 1906, at Ithaca, N. Y. Received E.E. degree, Cornell University, 1928. Research and Development Division, RCA Communications, Inc., 1928 to date. Associate member, Institute of Radio Engineers, 1929.



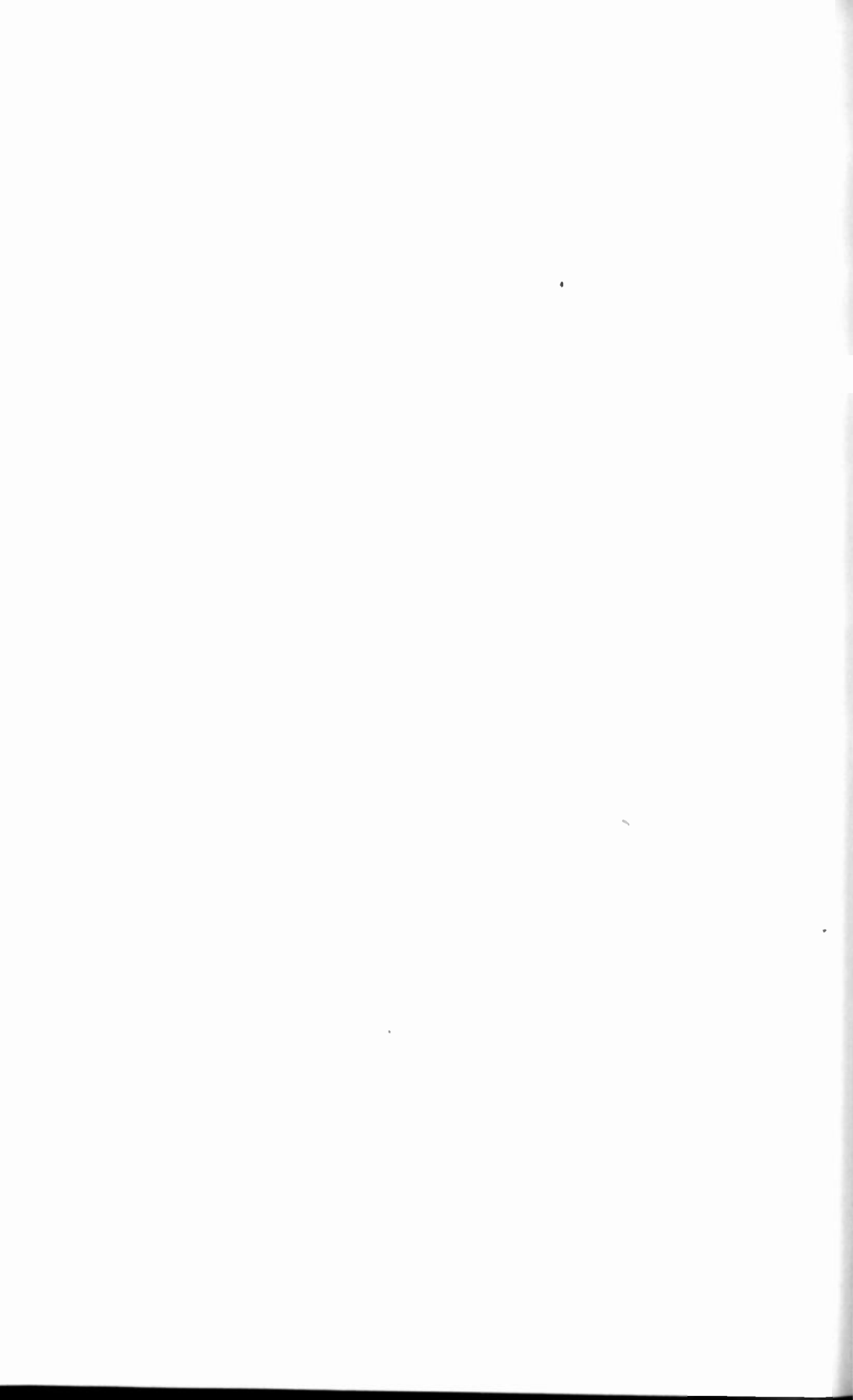

# TONE COMPENSATION—pioneered by Allen-Bradley



## ORDINARY Volume Control without Tone Compensation

Curve No. 1 illustrates how all frequencies are equally attenuated when the volume is reduced with the ordinary type of volume control. Due to the characteristics of the ear, the low and high frequency tones are reduced in loudness much more than the middle register.

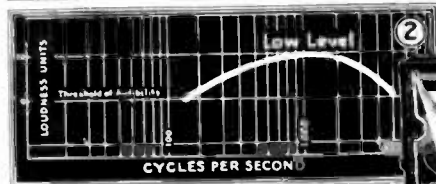

## Bradleyometer Volume Control with Tone Compensation

The Allen-Bradley Company has pioneered an outstanding improvement in audio volume control. It is the Tapped Bradleyometer which does not attenuate all frequencies equally as shown in curve 3, and therefore sustains the loudness of the low and high frequency tones at reduced volume. See curve 4.

With Bradleyometer control, the receiver quality is sustained at low as well as high levels.

Allen-Bradley engineers will gladly cooperate with set manufacturers in designing low-level tone compensation systems.

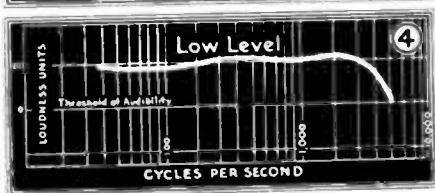
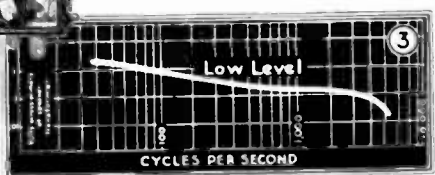

# Allen-Bradley Resistors

The Choice of the World's Largest Radio Manufacturers



## BRADLEYUNITS

Bradleyunits are the solid molded fixed resistors used by the largest manufacturers of radio receivers. Their production represents years of pioneering research in the production of stable, fixed resistors.

Bradleyunits are made in five sizes, with or without leads, and are R. M. A. color-coded for resistance value identification. Do not risk the reputation of your receiver with poor resistors. Use Allen-Bradley resistors and forget your resistor troubles.



## BRADLEY SUPPRESSORS

Bradley Suppressors are special solid molded resistors, used by prominent car manufacturers to provide individual resistors for each spark plug and for the common cable to the distributor on radio-equipped cars.

They increase the resistance of the high tension ignition system and minimize the disturbing oscillations in the ignition circuit which interfere with the radio receiver in the car. When used with suitable by-pass condensers in other parts of the circuit, shielded ignition cables are unnecessary.



**ALLEN-BRADLEY COMPANY, 116 W. Greenfield Ave., Milwaukee, Wisconsin**

*When writing to advertisers mention of the PROCEEDINGS will be mutually helpful.*



THESE MEN ...  
**STEER THEIR OWN SHIP**

**T**HE major portion of the stock of the Hygrade Sylvania Corporation is owned by the same men who manage and control the business.

These men have skillfully steered their own ship during some of the most difficult years ever known in the radio industry. To-day the Hygrade Sylvania Corporation makes more tubes for original set equipment than any other manufacturer.

Hygrade Sylvania has pioneered in the technical field.

It has advertised consistently over the air. The popular Frank Luther musical program brings thousands of requests for Sylvania's educational booklet.

Thus "management-owned" is more than a phrase. It is a guarantee of full cooperation and quality standards! . . . The Hygrade Sylvania Corporation, Sylvania Division, Emporium, Penna.

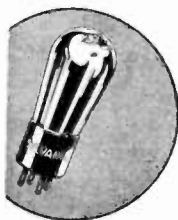

*Sylvania*  
(Reg. U. S. Pat. Off.)

**THE SET-TESTED RADIO TUBE**

*When writing to advertisers mention of the PROCEEDINGS will be mutually helpful.*



# WITHIN THE REACH OF MILLIONS



**T**HE most valuable things on earth are the commonest things. Gifts of Mother Nature—air, rain, sunlight and colors in the sky, grass underfoot and foliage overhead. Gifts of human nature—love, loyalty, hand-claps and friendly speech.

Then, of material things, some of the most useful are the commonest and cheapest. These we take almost for granted. There is no way to reckon their actual worth.

It is a great tribute to the value of the telephone that within a few short generations it has come to be ranked among these common things. Its daily use is a habit of millions of people. It speeds and eases and simplifies living. It extends the range of your own personality. It offers you gaiety, solace, security—a swift messenger in time of need.

Daily it saves untold expense and waste, multiplies earning power, sweeps away confusion. Binds together the human fabric. Helps the individual man and woman to triumph over the complexities of a vast world.

You cannot reckon fully the worth of so useful and universal a thing as the telephone. You can only know that its value may be infinite.

AMERICAN TELEPHONE AND TELEGRAPH COMPANY



*It has been found by advertisers working on the PROCEEDINGS will be mutually helpful.*

Cornell

# Cornell

TRADE MARK REG.

Cornell

## ELECTROLYTIC CONDENSERS

### A Most Complete Line For Radio and Industrial Use

Single and Dual Sections  
in Cardboard Boxes

Multiple Sections in  
Rectangular Metal Cans

By-Pass Dry Electrolytics

Cartridge Type Dry  
Electrolytics

Single, Dual and Multiple  
Sections  
in Round Metal Cans

High Capacity Dry A.C.  
Electrolytics

Paper and Dry Electrolytic  
Transmitting Condensers



#### WRITE FOR NEW CORNELL CATALOG

Our new catalog is just off the press. It illustrates and describes the complete Cornell line of Cub Condensers, Electrolytic Condensers, Paper Dielectric Capacitors for radio, television and ignition, and Resistors for radio and television.

### CORNELL ELECTRIC MFG. CO., Inc.

*Manufacturers of  
CORNELL "CUB" CONDENSERS  
Filter and By-Pass Condensers, Interference Filters and  
All Types of Paper Dielectric Capacitors and Resistors*

LONG ISLAND CITY, NEW YORK

Cornell

Cornell

*When writing to advertisers mention of the PROCEEDINGS will be mutually helpful.*

# The Institute of Radio Engineers

Incorporated

33 West 39th Street, New York, N. Y.

## APPLICATION FOR ASSOCIATE MEMBERSHIP

(Application forms for other grades of membership are obtainable from the Institute)

To the Board of Direction

Gentlemen:

I hereby make application for Associate membership in the Institute of Radio Engineers on the basis of my training and professional experience given herewith, and refer to the members named below who are personally familiar with my work.

I certify that the statements made in the record of my training and professional experience are correct, and agree if elected, that I will be governed by the constitution of the Institute as long as I continue a member. Furthermore I agree to promote the objects of the Institute so far as shall be in my power, and if my membership shall be discontinued will return my membership badge.

.....  
(Sign with pen)

.....  
(Address for mail)

.....  
(Date)

.....  
(City and State)

### References:

(Signature of references not required here)

Mr. .... Mr. ....

Address ..... Address .....

City and State ..... City and State .....

Mr. ....

Address .....

City and State .....

The following extracts from the Constitution govern applications for admission to the Institute in the Associate grade:

### ARTICLE II—MEMBERSHIP

Sec. 1: The membership of the Institute shall consist of: \* \* \* (c) Associates, who shall be entitled to all the rights and privileges of the Institute except the right to hold any elective office specified in Article V.

Sec. 4: An Associate shall be not less than twenty-one years of age and shall be a person who is interested in and connected with the study or application of radio science or the radio arts.

### ARTICLE III—ADMISSION AND EXPULSIONS

Sec. 2: \* \* \* Applicants shall give references to members of the Institute as follows: \* \* \* for the grade of Associate, to three Fellows, Members, or Associates; \* \* \* Each application for admission \* \* \* shall embody a full record of the general technical education of the applicant and of his professional career.

**ENTRANCE FEE SHOULD ACCOMPANY APPLICATION**



# Piezo Electric Crystals

*"Superior by Comparison"*

Since 1925



## WHY YOU SHOULD USE SCIENTIFIC RADIO SERVICE CRYSTALS

1. SINCE 1925 we have been specializing in producing Piezo Electric Crystals exclusively
2. SINCE 1925 SCIENTIFIC RADIO SERVICE CRYSTALS have stood the test and are recognized the world over for their DEPENDABILITY, OUTPUT and ACCURACY OF FREQUENCY
3. SINCE 1925 Owners of BROADCAST and COMMERCIAL SHORT WAVE STATIONS have found that no chances can be taken in getting the cheaper grade of crystals and that invariably they call on SCIENTIFIC RADIO SERVICE for the BEST
4. SINCE 1925 We could be depended upon to make PROMPT SHIPMENTS. This coupled with a crystal SECOND TO NONE considering OUTPUT and ACCURACY OF FREQUENCY has earned during these years a reputation which we jealously guard. Therefore, GET THE BEST

*Price list sent upon request*

## SCIENTIFIC RADIO SERVICE

*"The Crystal specialists"*

124 Jackson Avenue, University Park  
HYATTSVILLE, MARYLAND

*When writing to advertisers mention of the PROCEEDINGS will be mutually helpful.*

# Take Your Choice

Every member of the Institute of Radio Engineers will want to wear one of these three attractive emblems. All of these emblems are appropriately colored to indicate the various grades of membership and each emblem is approximately the size of the following illustrations.



**The Lapel Button** is of 14k gold, with background enameled in the membership color, and with the lettering in gold. The screw-back on the back of this button fastens it securely to your coat.

\$2.75 postpaid—any grade.



**The Pin** is also of 14k gold. It is provided with a safety catch and is appropriately colored for the various grades of membership.

\$3.00 postpaid—any grade.



**The Watch Charm**, handsomely finished on both sides, is also of 14k gold. This charm is equipped with a suspension ring for attaching to a watch fob or chain.

\$5.00 postpaid—any grade.

*Orders, accompanied by checks made payable to the Institute of Radio Engineers, should be addressed to*

**THE INSTITUTE OF RADIO ENGINEERS**

33 West 39th Street

NEW YORK CITY, N. Y.

*Send in your order now!*

# PROFESSIONAL ENGINEERING DIRECTORY

For Consultants in Radio and Allied Engineering Fields

## FOR ADVANCED TRAINING

in:

Practical Radio Engineering  
Practical Television Engineering

write to

## CAPITOL RADIO ENGI- NEERING INSTITUTE

Riggs Bank Bldg.  
Washington, D.C.

## Cathode Ray Tubes and Associated Equipment For All Purposes

Write for Complete  
Technical Data

ALLEN B. DUMONT  
LABORATORIES  
UPPER MONTCLAIR, N.J.

## FOR MANY YEARS

the Professional Engineering Directory has helped consulting engineers, designers, and laboratory men make the right contacts in the radio industry. Perhaps we can help you with your problems too. For further information write to

Advertising Department  
INSTITUTE OF RADIO  
ENGINEERS

33 West 39th St.  
NEW YORK CITY, N.Y.

## LITTLEFUSE LABORATORIES

Specialists in

Delicate Equipment Protection

INSTRUMENTS and METERS  
RADIO RECEIVERS  
RADIO AMPLIFIERS  
RADIO TRANSMITTERS

1764 Wilson Ave., Chicago, Ill.

*For the Engineering Consultant*

*who can handle a little extra business this year*

*For the Designer*

*who can manage some additional work*

we suggest the Professional Engineering Directory of the I.R.E. PROCEEDINGS. Manufacturers who need services such as yours and organizations with special problems come to our Professional Engineering Directory for information. Your name and special services announced here will put you in line for their business. For further information and special rates for I.R.E. members write to the Institute of Radio Engineers.

*When writing to advertisers mention of the PROCEEDINGS will be mutually helpful.*

# EMPLOYMENT PAGE

Advertisements on this page are available to members of the Institute of Radio Engineers and to manufacturing concerns who wish to secure trained men for positions. All material for publication on this page is subject to editing from the Institute office and must be sent in by the 15th of the month previous to the month of publication. (March 15th for April PROCEEDINGS IRE, etc.) Employment blanks and rates will be supplied by the Institute office. Address requests for such forms to the Institute of Radio Engineers, 33 West 39th Street, New York City, N.Y.

**MANUFACTURERS** and others seeking radio engineers are invited to address replies to these advertisements at the Box Number indicated, care the Institute of Radio Engineers. All replies will be forwarded direct to the advertiser.

---

**GRADUATE** of University of Pennsylvania with B.S. and M.S. in electrical engineering. Has had four years experience with large manufacturer on design and development of modern broadcast receivers for both American and European short and long wave use. Desires employment in radio or associated fields including teaching in college or other schools. Age 25. Single. Will travel. Box 139.

---

**DEVELOPMENT ENGINEER** A college graduate with three years experience with broadcast and commercial receivers, one year on five and twenty k.w. high frequency transmitters, one year as sales and development engineer for small ship receivers and transmitters, and one year as superintendent and factory engineer in electrical manufacturing concern. Desires factory management or production engineering work. Age 31, Single. Will travel. Box 140.

---

**COMMUNICATION ENGINEER** with two years experience on military telephone and telegraph engineering problems. Six years with a large manufacturer on development of testing equipment for radio, telephone and sound picture apparatus. One year as consultant and designer of radio equipment. Desires placement in communication group, preferring field work or development of testing equipment. Age 32. Single. Will travel. Box 136.

*When writing to advertisers mention of the PROCEEDINGS will be mutually helpful.*





# 2 Accurate Indicators of Radio Fundamentals

Capacity and resistance are two of radio's fundamentals. In the Model 663 Volt-Ohmmeter and the Model 664 Capacity Meter, Weston now offers two modern Standardized Service Units which quickly and accurately measure these quantities.

Circuits may, and will change but these instruments will always be up-to-date because they measure fundamental quantities. Both instruments are built on rugged, enduring Bakelite panels. Each can be mounted in an individual case or with others of

the Weston Standardized Service Units in a combination case.

The Model 663 provides for the measurement of all values of resistance as well as all values of DC current and voltage encountered in radio servicing. Similarly the Model 664 provides for the measurement of all capacity values, AC voltages and output readings ordinarily encountered. Fill in coupon below and mail for complete information. Weston Electrical Instrument Corp., 589 Frelinghuysen Ave., Newark, N. J.

## WESTON·JEWELL *Radio Instruments*

Weston Electrical Instrument Corp.  
589 Frelinghuysen Avenue  
Newark, N. J.

Please send me further  
information on Weston-  
Jewell Service Equipment.

Name.....

Address.....

*When writing to advertisers mention of the PROCEEDINGS will be mutually helpful.*

---

---

---

---

---

---

***Now Ready!***

**THE IMPROVED 1933**

**A C R A C O N ★**

**Electrolytic Condensers**

**B**IGGER and better performance than ever! Semi-dry units in round aluminum, cardboard, or metal filter types. Wet unit particularly suitable for inverted vertical mounting above the chassis. Write for specifications and characteristics that prove Acracon's leadership!

***The Complete Acracon Line Includes  
A Condenser for Every Requirement:***

**BY-PASS CONDENSERS**

for general purpose by-pass and replacement work.

**"MIKE" CONDENSERS**

small tubular condensers in aluminum tubes for use where fractional capacities are desired.



*Write Today for 1933 Catalog Just Out!*

**CONDENSER CORP. OF AMERICA**

259 Cornelison Ave., Jersey City, N.J.

*Factory Representatives In:*

Chicago    Cincinnati    St. Louis    San Francisco    Los Angeles    Toronto

**And Other Principal Cities**

★ Patents Pending on All Acracon Features

---

---

---

---

---

---

*When writing to advertisers mention of the PROCEEDINGS will be mutually helpful.*

# CHANGE IN MAILING ADDRESS OR BUSINESS TITLE

Members of the Institute are asked to use this form for notifying the Institute office of a change in their mailing address or the listing of their company affiliation or title in the Year Book.

---

The Secretary,  
**THE INSTITUTE OF RADIO ENGINEERS,**  
33 West 39th Street,  
New York, N.Y.

Dear Sir:

Effective ..... please note change in my address  
(date)  
for mail as follows:

**FROM**

.....  
(Name)

.....  
(Street Address)

.....  
(City and State)

**TO NEW ADDRESS**

.....  
(Street Address)

.....  
(City and State)

Please note following change in my Year Book listing.

.....  
(Title)

.....  
(Company Name)

.....  
(Company Address)

---

## *Alphabetical Index to Advertisements*

|                                       |   |
|---------------------------------------|---|
| <b>A</b>                              | <b>H</b>  |
| Allen Bradley Co. ....VII             | Hygrade Sylvania Corp. ....VIII                             |
| American Tel. & Tel. Co. ....IX       |   |
|                                       | <b>I</b>  |
| <b>C</b>                              | I.R.E. ....XI, XII, XIV, XVI, XIX,<br>XX, Inside Back Cover |
| Central Radio Laboratories ....XXII   |   |
| Condenser Corp. of America ...XVIII   | <b>P</b>  |
| Cornell Electric Mfg. Co. ....X       | Professional Eng. Directory ....XV                          |
|                                       | <b>S</b>  |
| <b>E</b>                              | Scientific Radio Service .....XIII                          |
| Erie Resistor Corp. ....XXI           |   |
|                                       | <b>W</b>  |
| <b>G</b>                              | Weston Elec. Inst. Corp. ....XVII                           |
| General Radio Co. .Outside Back Cover |   |

---

## PROCEEDINGS BOUND VOLUMES

Volume 20 (1932) of the Proceedings is now available in bound form to members of the Institute. It may be obtained in Buckram, or Morocco leather for \$9.50 and \$11.00 respectively.

Bound copies of volumes 18 and 19 (1930 and 1931) are also available at the same price.

*When writing to advertisers mention of the PROCEEDINGS will be mutually helpful.*

# SET MANUFACTURERS ARE

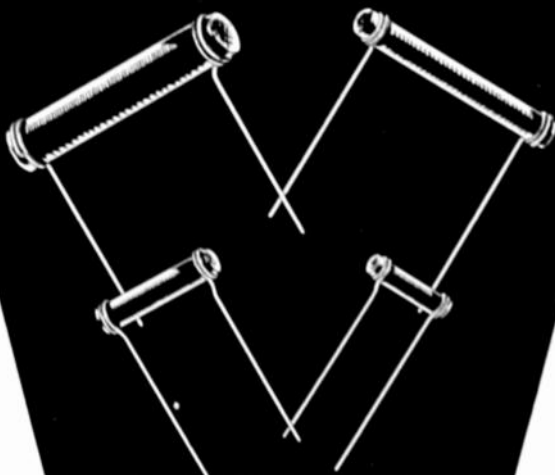

# SAVING WITH

Manufacturers of radio sets are effecting appreciable savings with Erie Resistors because only one stock need be carried where the same resistance value is to be used on different voltages.

This is possible because the change of resistance with voltage is very small in Erie Resistors. In fact it is less than 2% in the majority of cases.

It is not necessary to specify the testing voltage except where special precision is necessary.

The manufacturing processes by which Erie Resistors are made has been developed over a period of years—every step in the development of Erie Resistors has resulted in new and improved methods.

When you specify Erie Resistors you are getting the very best moulded type resistors of fixed resistance value that the market affords.

Ask for book of data sheets showing test charts which fully explain the technical data on Erie Resistor Corporation High Resistance Products.

#### Erie Suppressor

An Erie Suppressor Resistor will not fail mechanically at 120°C and 100% relative humidity.

The resistance unit is enclosed in a ceramic tube to protect it from mechanical breakage as well as from oil, dirt and moisture.

# ERIE RESISTORS



ERIE RESISTOR CORPORATION, ERIE, PA.  
Factories in Erie, Pa., Toronto, Can., and London, Eng.



*When writing to advertisers mention of the PROCEEDINGS will be mutually helpful.*

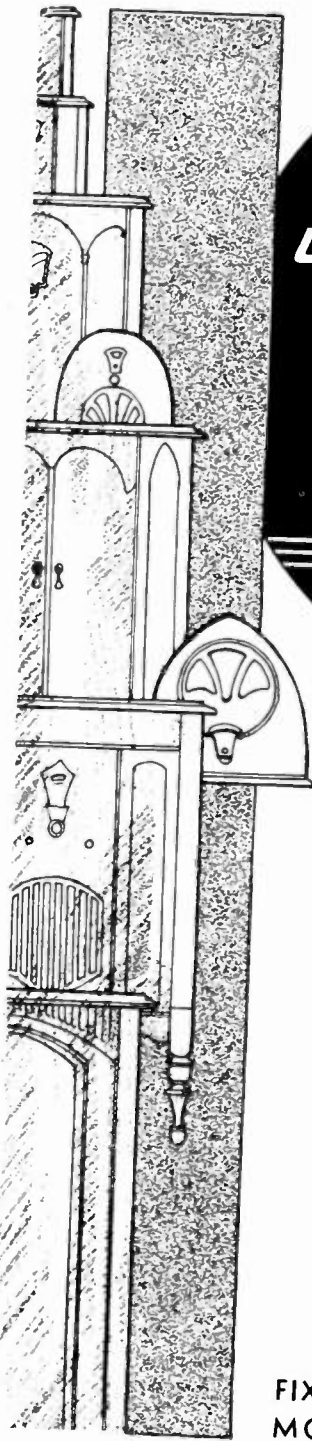

*Step out  
with New Models  
but **PLAY**  
**SAFE**  
with*  
**CENTRALAB**

New models—new circuits—new parts clamoring for recognition in a highly competitive market. Take no chances on performance . . . play safe with CENTRALAB Volume Controls and CENTRALAB Fixed Resistors.

Specify CENTRALAB . . . and make no apologies for performance.

CENTRAL RADIO LABORATORIES  
MILWAUKEE, WIS.

**Centralab**  
CRL

FIXED RESISTORS-VOLUME CONTROLS  
MOTOR RADIO NOISE SUPPRESSORS

*When writing to advertisers mention of the PROCEEDINGS will be mutually helpful.*

# Back Numbers of the Proceedings, Indexes, and Year Books Available

**M**EMBERS of the Institute will find that back issues of the Proceedings are becoming increasingly valuable, and scarce. For the benefit of those desiring to complete their file of back numbers there is printed below a list of all complete volumes (bound and unbound) and miscellaneous copies on hand for sale by the Institute.

The contents of each issue can be found in the 1909-1930 Index, the 1931 Year Book and in the December, 1932, Proceedings.

## BOUND VOLUMES:

- Vol. 10 (1922), \$8.75 per volume to members
- Vol. 18 (1930), \$9.50 to members
- Vol. 19 (1931), \$9.50 to members
- Vol. 20 (1932), \$9.50 to members

## UNBOUND VOLUMES:

- Vols. 3, 6, 8, 9, 10, 11, 13, 14, 18, and 19 (1917-1918-1920-1921-1922-1923-1925-1926-1930-1931), \$6.75 per volume (1917-1926) and \$7.50 per volume (1927-1931) to members

## MISCELLANEOUS COPIES:

- Vol. 1 (1913) July and December
- Vol. 2 (1914) June
- Vol. 3 (1915) December
- Vol. 4 (1916) June and August
- Vol. 7 (1919) February, April, August, and December
- Vol. 12 (1924) April, June, August, October and December
- Vol. 15 (1927) January, April, May, June, July, October, November, and December
- Vol. 16 (1928) February, March, April, May, June, July, August, October, November, and December
- Vol. 17 (1929) January, February, March, April, May, June, July, August, September, November, and December.
- Vol. 20 (1932) January, March, April, May, June, July, August, September, October, November, and December.

These single copies are priced at \$1.13 each to members to the January, 1927, issue. Subsequent to that number the price is \$0.75 each. Prior to January, 1927, the Proceedings was published bimonthly, beginning with the February issue and ending with the December issue. Since January, 1927, it has been published monthly.

**M**EMBERS will also find that our index and Year Book supplies are becoming limited. The following are now available:

## INDEX

The Proceedings Index for the years 1909-1930 inclusive is available to members at \$1.00 per copy. This index is extensively cross indexed.

## YEAR BOOK

The 1932 Year Book is now available to members at \$1.00 per copy. This Year Book includes a current alphabetical catalogue of the I.R.E. membership, in which the mailing address and business affiliation of each member is listed, as well as current information on standard measurements for tubes and sockets and standard requirements for radio receivers.

Make remittances payable to the Institute of Radio Engineers and send orders to:

**THE INSTITUTE OF RADIO ENGINEERS**

33 West 39th Street  
NEW YORK CITY, N.Y.

---

# TRIODES - TETRODES - PENTODES

— this bridge measures all tubes

Type 561-A  
Vacuum-Tube  
Bridge

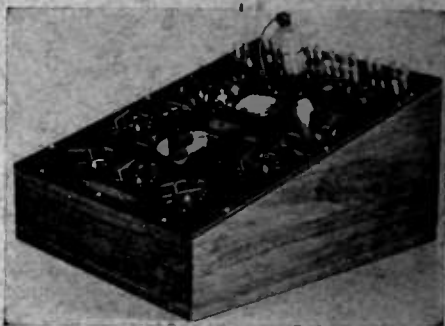

**T**HIS new instrument measures all three dynamic characteristics of all tubes. It is direct reading to three significant figures and each parameter is determined independently of the others.

It is equally effective at high and low values of all three quantities.

Provision is made for attaching socket adaptors to take care of any future developments in tube bases.

This bridge is an indispensable piece of equipment in every laboratory that designs tubes or auxiliary equipment.

Price \$345.00

**GENERAL RADIO COMPANY**  
CAMBRIDGE, MASSACHUSETTS