

VOLUME 20

OCTOBER, 1932

NUMBER 10

PROCEEDINGS  
*of*  
**The Institute of Radio  
Engineers**



Form for Change of Mailing Address or Business Title on Page XV

---

# Institute of Radio Engineers Forthcoming Meetings

---

**DETROIT SECTION**

October 21, 1932

---

**LOS ANGELES SECTION**

October 18, 1932

---

**NEW YORK MEETING**

November 2, 1932

---

**WASHINGTON SECTION**

October 13, 1932

---

PROCEEDINGS OF  
**The Institute of Radio Engineers**

Volume 20

October, 1932

Number 10

Board of Editors

ALFRED N. GOLDSMITH, *Chairman*

R. R. BATCHER

H. H. BEVERAGE

F. W. GROVER

G. W. PICKARD

L. P. WHEELER

L. E. WHITTEMORE

WILLIAM WILSON

K. S. VAN DYKE

CONTENTS

PART I

|   |      |
|---|------|
| Frontispiece, Reginald A. Fessenden. . . . .              | 1548 |
| Institute News and Radio Notes. . . . .                   | 1549 |
| Institute Meetings. . . . .                               | 1550 |
| Radio Signal Transmissions of Standard Frequency. . . . . | 1551 |
| Committee Work. . . . .                                   | 1552 |
| Personal Mention. . . . .                                 | 1553 |

PART II

*Technical Papers*

|  |      |
|--|------|
| Direct Ray Broadcast Transmission. . . . . T. L. ECKERSLEY   | 1555 |
| Visual Test Devices. . . . . O. H. SCHUCK  | 1580 |
| Copper-Oxide Rectifier Used for Radio Detection and Automatic Volume Control. . . . . L. O. GRONDAHL AND W. P. PLACE | 1599 |
| The Detection of Microwaves. . . . . NELLO CARRARA   | 1615 |
| A New Electrical Method of Frequency Analysis and its Application to Frequency Modulation. . . . . W. L. BARROW      | 1626 |
| A Fourier Analysis of Radio-Frequency Power Amplifier Wave Forms. . . . . L. B. HALLMAN, JR.                         | 1640 |
| Note on Network Theory. . . . . J. G. BRAINERD   | 1660 |
| Book Reviews: "Foundations of Radio" by R. L. DUNCAN. . . . . S. S. KIRBY  | 1665 |
| "Radio Receiving Tubes" (2nd edition) by J. A. Moyer and J. F. Wostrel. . . . . S. S. KIRBY                          | 1665 |
| Radio Abstracts and References. . . . .  | 1666 |
| Contributors to This Issue. . . . .  | 1674 |

Copyright, 1932, by the Institute of Radio Engineers

# The Institute of Radio Engineers

---

## GENERAL INFORMATION

**INSTITUTE.** The Institute of Radio Engineers was formed in 1912 through the amalgamation of the Society of Wireless Telegraph Engineers of Boston, Massachusetts, and the Wireless Institute of America of New York City. Its headquarters were established in New York City and the membership has grown from less than fifty members at the start to almost seven thousand by the end of 1931.

**AIMS AND OBJECTS.** The Institute functions solely to advance the theory and practice of radio and allied branches of engineering and of the related arts and sciences, their application to human needs, and the maintenance of a high professional standing among its members. Among the methods of accomplishing this need is the publication of papers, discussions, and communications of interest to the membership.

**PROCEEDINGS.** The PROCEEDINGS is the official publication of the Institute and in it are published all of the papers, discussions, and communications received from the membership which are accepted for publication by the Board of Editors. Copies are sent without additional charge to all members of the Institute. The subscription price to nonmembers is \$10.00 per year, with an additional charge for postage where such is necessary.

**RESPONSIBILITY.** It is understood that the statements and opinions given in the PROCEEDINGS are views of the individual members to whom they are credited, and are not binding on the membership of the Institute as a whole.

**REPRINTING PROCEEDINGS MATERIAL.** The right to reprint portions or abstracts of the papers, discussions, or editorial notes in the PROCEEDINGS is granted on the express condition that specific reference shall be made to the source of such material. Diagrams and photographs published in the PROCEEDINGS may not be reproduced without making specific arrangements with the Institute through the Secretary.

**MANUSCRIPTS.** All manuscripts should be addressed to the Institute of Radio Engineers, 33 West 39th Street, New York City. They will be examined by the Papers Committee and the Board of Editors to determine their suitability for publication in the PROCEEDINGS. Authors are advised as promptly as possible of the action taken, usually within two or three months. Manuscripts and illustrations will be destroyed immediately after publication of the paper unless the author requests their return. Information on the mechanical form in which manuscripts should be prepared may be obtained by addressing the secretary.

**MAILING.** Entered as second-class matter at the post office at Menasha, Wisconsin. Acceptance for mailing at special rate of postage is provided for in the act of February 28, 1925, embodied in Paragraph 4, Section 412, P. L. and R., and authorization was granted on October 26, 1927.

---

Published monthly by

**THE INSTITUTE OF RADIO ENGINEERS, INC.**

Publication office, 450-454 Ahnaip St., Menasha, Wis.

BUSINESS, EDITORIAL, AND ADVERTISING OFFICES

Harold P. Westman, *Secretary*

33 West 39th Street, New York, N. Y.

## INSTITUTE SECTIONS

- ATLANTA—Chairman, H. L. Wills; Secretary, Philip C. Bangs, 23 Kensington Road, Avondale Estates, Ga.
- BOSTON—Chairman, E. L. Chaffee; Secretary, G. W. Kenrick, Tufts College, Mass.
- BUFFALO-NIAGARA—Chairman, L. Grant Hector; Secretary, E. C. Waud, 235 Huntington Avenue, Buffalo, N. Y.
- CHICAGO—Chairman, J. Barton Hoag; Secretary, Donald H. Miller, McGraw-Hill Publishing Co., 520 N. Michigan Ave., Chicago, Ill.
- CINCINNATI—Chairman, C. E. Kilgour; Secretary, H. G. Boyle, Crosley Radio Corp., Cincinnati, Ohio.
- CLEVELAND—Chairman, E. L. Gove; Secretary, Deane S. Kintner, 3622 Lindholm Rd., Cleveland, Ohio.
- CONNECTICUT VALLEY—Chairman, L. F. Curtis; Secretary, George Grammer, American Radio Relay League, 38 La Salle Rd., W. Hartford, Conn.
- DETROIT—Chairman, H. L. Byerlay; Secretary, Samuel Firestone, Detroit Edison Co., 2000 Second Avenue, Detroit, Mich.
- LOS ANGELES—Chairman, E. H. Schreiber; Secretary, H. W. Andersen, 2332 Lake View Ave., Los Angeles, Calif.
- NEW ORLEANS—Chairman, Pendleton E. Lehde; Secretary, Anton A. Schiele, 1812 Masonic Temple, New Orleans, La.
- PHILADELPHIA—Chairman, H. W. Byler; Secretary, G. C. Blackwood, 243 E. Upsal St., Mt. Airy, Philadelphia, Pa.
- PITTSBURGH—Chairman, R. T. Griffith; Secretary, C. K. Krause, 1541 Princess Ave., Pittsburgh, Pa.
- ROCHESTER—Chairman, H. A. Brown; Secretary, M. A. Wood, 175 Winbourne Ave., Rochester, N. Y.
- SAN FRANCISCO—Chairman, C. V. Litton; Secretary, K. G. Clark, Department of Commerce, 328 Custom House, San Francisco, Calif.
- SEATTLE—Chairman, Leslie C. Austin; Secretary, Herbert H. Bouson, 2225-33rd Ave., Seattle, Wash.
- TORONTO—Chairman, R. A. Hackbusch; Secretary, G. E. Pipe, Rogers-Majestic Corporation, Toronto, Ont, Canada.
- WASHINGTON—Chairman, J. H. Dellinger; Secretary, Major Hugh Mitchell, Signal Corps, Office Chief Signal Officer, Munitions Building, Washington, D.C.

## GEOGRAPHICAL LOCATION OF MEMBERS ELECTED SEPTEMBER 7, 1932

### Transferred to the Member Grade

|            |   |                  |
|------------|---|------------------|
| California | Los Angeles, 1365 Edgecliff Dr.....                       | Lubcke, H. R.    |
| Michigan   | Detroit, 2000-2nd Ave.....                                | Buchanan, A. B.  |
| Missouri   | St. Louis, Radio Station KMOX, 401 S. 12th St.....        | West, W. H.      |
| England    | Harrow Weald, Middlesex, "Fayrene," 2 Whitefriars Dr..... | Henderson, F. A. |

### Elected to the Member Grade

|              |  |                   |
|--------------|--|-------------------|
| Connecticut  | South Manchester, 176 Wadsworth St.....                    | Reinartz, J. L.   |
| Illinois     | Chicago, 100 W. Monroe St., 20th Fl.....                   | Larsen, C. J.     |
| New York     | Brooklyn, c/o Cable Tube Radio Corp., 84-90 N. 9th St..... | Lyle, A. E.       |
|              | New York City, 195 Broadway.....                           | Shackleton, S. P. |
| Pennsylvania | Emporium, Box 725.....                                     | Miller, H. J.     |

### Elected to the Associate Grade

|                   |   |                    |
|-------------------|---|--------------------|
| California        | Bolinas, R.C.A. Communications, Inc.....                              | Forster, A. G.     |
|                   | Coronado, Squadron VS-15M, Fleet Air Base.....                        | Walker, C. W.      |
|                   | Los Angeles, 1461 Ridge Way.....                                      | McDill, J. L.      |
|                   | San Pedro, U.S.S. Salt Lake City, c/o Postmaster.....                 | McGirr, W. P.      |
| Dist. of Columbia | Bellevue, Radio Material School.....                                  | Salisbury, L. C.   |
| Georgia           | LaGrange, 124 College Ave.....  | White, C. J., Jr.  |
| Kentucky          | Covington, c/o Station WCKY.....                                      | Topmiller, C. H.   |
| Massachusetts     | Springfield, United American Bosch Corp.....                          | Biernacki, F. L.   |
|                   | Springfield, United American Bosch Corp.....                          | Guertin, C. E.     |
| Michigan          | Royal Oak, 203 Allenhurst Ave.....                                    | Larime, L. H.      |
| Missouri          | St. Louis, c/o General Electric Supply Corp., 200 S. 7th St.....      | Jenkins, H. D.     |
|                   | St. Louis, 200 S. 7th St.....   | King, H. T.        |
| New Jersey        | Madison, 37 Kings Rd.....   | Felch, E. P.       |
|                   | Newark, 839 Bergen St.....  | Elston, G. F.      |
| New York          | Brooklyn, 1444 Carroll St.....  | Bulkowstein, W. A. |
|                   | Brooklyn, 1715 Caton Ave.....   | Kurtz, J. A.       |
|                   | New York City, 100 Haven Ave.....                                     | Whistler, J. P.    |
| Ohio              | Mogadore, 3666 Market St.....   | DuBois, W. R.      |
|                   | Springfield, 581 Selma Rd.....  | Ditty, A. V.       |
| Texas             | Plainview, P.O. Box 516.....  | McInnish, G. J.    |
| Canada            | Vancouver, B. C., 2027 Granville St.....                              | Dery, A. W.        |
| China             | Shanghai, c/o Mr. Hung Lieh-Yang, P.P.O. Post Office.....             | Ming-Yang, H.      |
| England           | Tsainan, Dept. of Physics, Cheeloo University.....                    | Wu, C.             |
|                   | Colchester, Essex, 9 St. John's St.....                               | Straw, F. W.       |
|                   | Hull, Yorks, 50 St. Hilda St., Beverley Rd.....                       | Simison, J.        |
|                   | Kenton, Middlesex, "Rima," Kenton Park Close.....                     | Mitchell, R. B.    |
|                   | London, N. W. 4, 2 Ridge Close.....                                   | Benham, W. E.      |
|                   | London, E. 15, 178 Plaistow Rd., West Ham.....                        | Clack, W. H.       |
|                   | London, N.W. 9, Standard Telephones and Cables, The Hyde, Hendon..... | Larnder, H.        |
|                   | London, E. 8, 46 Shacklewell Lane, Dalston.....                       | Pritchard, W. H.   |
|                   | Woodford Green, Essex, St. Just, 15 Fullers Ave.....                  | Reid, D. G.        |
| India             | Bangalore, Wireless Dept., Indian Inst. of Science.....               | Narayanan, P. I.   |
| Java              | Karanganjar-Soerakarta.....   | Cheong, E.         |
| Latvia            | Riga, Rigas 2 Radiostacija.....                                       | Akmentins, A.      |
| New Zealand       | Wellington, 36A Severn St., Island Bay.....                           | Wilkinson, K. T.   |
| Norway            | Tromso, Nordlys Observatoriet.....                                    | Builder, G.        |
| S. Rhodesia       | Salisbury, Box 1089, Beam Wireless Station.....                       | Tyrer, A. R.       |

### Elected to the Junior Grade

|               |                                 |              |
|---------------|---------------------------------|--------------|
| Massachusetts | Roxbury, 86 Burrell St.....     | Brown, H. W. |
| New York      | Buffalo, 604 Washington St..... | O'Meara, L.  |

### Elected to the Student Grade

|               |   |                 |
|---------------|---|-----------------|
| California    | Stanford University, Box 1453.....                | Rogers, V. C.   |
| Iowa          | Ames, 2713 Lincoln Way.....                       | Bachman, C. H.  |
|               | Iowa City, 49-B Quad.....                         | Hahn, J. H.     |
|               | Sac City, 225 S. 9th St.....                      | Hoyt, C.        |
| Maryland      | Baltimore, 1642 N. Monroe St.....                 | Chinn, G. I.    |
|               | Madison.....                                      | Jones, T. B.    |
| Massachusetts | Allston, 1177 Commonwealth Ave.....               | Wagner, H. M.   |
|               | Worcester, 964 Pleasant St.....                   | Morse, R. S.    |
| Michigan      | Adrian, R.F.D. No. 2.....                         | Clement, P. F.  |
|               | Grand Rapids, 1537 Broadway Ave.....              | Rasikas, W.     |
| New Jersey    | Harrison, Development Lab., RCA Radiotron Co..... | Schafer, E. W.  |
| New York      | Albany, 31 Hampton St.....                        | Di Lello, P. J. |
|               | Albany, 31 Bogart Ter.....                        | Wolberg, L.     |
|               | Buffalo, 46 Welmont Pl.....                       | Pries, L. F.    |

*Geographical Location of Members Elected September 7, 1932*

|              |  |                  |
|--------------|--|------------------|
|              | New York City, 3812 Waldo Ave.....           | Riesenkönig, H.  |
|              | Troy, 2216-15th St.....                      | King, P. B., Jr. |
| Oregon       | Troutdale, Route 2, Box 67.....              | Johnson, H. M.   |
| Pennsylvania | Carlisle, 143 S. West St.....                | Fagan, C. C.     |
|              | Lebanon, 1324 W. Oak St.....                 | Sowers, J. E.    |
| South Dakota | Huron, 780 Illinois Ave. S.W.....            | Pasek, D. M.     |
| Washington   | Mount Vernon, 148-6th and Evergreen Sts..... | Barr, L. R.      |
|              | Puyallup, Route 2, Box 455.....              | Herr, M. D.      |



## APPLICATIONS FOR MEMBERSHIP

Applications for transfer or election to the various grades of membership have been received from the persons listed below, and have been approved by the Committee on Admissions. Members objecting to transfer or election of any of these applicants should communicate with the secretary on or before October 31, 1932. These applicants will be considered by the Board of Directors at its meeting on November 2, 1932.

### For Transfer to the Member Grade

|              |   |                  |
|--------------|---|------------------|
| California   | Los Angeles, 740 S. Olive St. . . . .                                   | Schreiber, E. H. |
|              | Los Gatos, 134 Hernandez Ave. . . . .                                   | Cole, B. R.      |
| Michigan     | Detroit, 5104 Balfour . . . . .   | Byerlay, H. L.   |
| Pennsylvania | Philadelphia, 1321 Arch St. . . . .                                     | Leitch, J. G.    |
| England      | London N.W. 9, Standard Telephones & Cables, The Hyde, Hendon . . . . . | Mirk, D. B.      |

### For Election to the Member Grade

|            |   |                   |
|------------|---|-------------------|
| California | San Diego, U.S.S. Wright, c/o Postmaster . . . . .              | Pitts, H. L.      |
| New Jersey | East Orange, 28 Madison Ave. . . . .                            | Smith, J. P., Jr. |
| New York   | New York City, American Tel. & Tel. Co., 195 Broadway . . . . . | Wise, W. H.       |

### For Election to the Associate Grade

|              |  |                   |
|--------------|--|-------------------|
| California   | Los Angeles, 2911 Estara Ave. . . . .                                | Beal, G. M.       |
|              | Oakland, 441-28th St. . . . .  | Aldritt, K.       |
|              | Palo Alto, 168 Webster St. . . . .                                   | Wunderlich, G. F. |
| Indiana      | Hartford City, 121 E. Washington St. . . . .                         | Huffman, F. E.    |
| Missouri     | St. Louis, 3115 Washington Blvd. . . . .                             | Napper, M.        |
|              | Springfield, 847 Kingshighway . . . . .                              | Anderson, V. F.   |
| New Jersey   | Ridgewood, 51 Sherman Pl. . . . .                                    | Hodges, A. R.     |
| New York     | Brooklyn, 1096 Ocean Ave. . . . .                                    | Hutchinson, H. P. |
|              | Brooklyn, 2110 Westbury Ct. . . . .                                  | Prensky, S. D.    |
|              | Corning, Corning Glass Works . . . . .                               | Guyer, E. M.      |
|              | New York City, 395 Hudson St. . . . .                                | Downing, H. L.    |
| Pennsylvania | Reading, 341 N. Front St. . . . .                                    | Landis, H. O.     |
|              | Yeadon, 910 Duncan Ave. . . . .                                      | Crapp, G. L.      |
| Virginia     | Langleyfield, Post Radio Station WYC . . . . .                       | Murr, V. E.       |
| Argentina    | Buenos Aires, Calle Pasteur 177, -Dto "A" . . . . .                  | Casanova, R.      |
| England      | Croydon, Waddon, Surrey, British N. S. F. Co., Ltd. . . . .          | Schwaiger, C.     |
|              | Edmonton, London, 45 St. Edmunds Rd. . . . .                         | Emsley, W. T.     |
|              | London S.W. 20, 16 Abbott Ave., Wimbledon . . . . .                  | Dalton, J. W.     |
|              | Stoke-on-Trent, Staffs, "Glenville" Garden Pl., Harpfields . . . . . | Hughes, C. F. C.  |
|              | Watford, Herts, 317 St. Albans Rd. . . . .                           | Gray, G. A.       |
| South Africa | Johannesburg, 74 Smal St. . . . .                                    | David, M.         |

### For Election to the Junior Grade

|               |   |                 |
|---------------|---|-----------------|
| Indiana       | Indianapolis, 1653 N. Talbot Ave. . . . . | Brockway, R. M. |
| Massachusetts | Mattapan, 48 Idaho St. . . . .            | Bradshaw, D. B. |

### For Election to the Student Grade

|          |  |              |
|----------|--|--------------|
| Idaho    | Idaho City, c/o United States B.R.P. . . . . | Wrathall, G. |
| Missouri | Butler . . . . .                             | Henry, R. E. |





## OFFICERS AND BOARD OF DIRECTORS, 1932

(Terms expire January 1, 1933, except as otherwise noted)

*President*

W. G. CADY

*Vice President*

E. V. APPLETON

*Treasurer*

MELVILLE EASTHAM

*Secretary*

HAROLD P. WESTMAN

*Editor*

ALFRED N. GOLDSMITH

*Directors*

ARTHUR BATCHELLER

LEE DE FOREST, *Junior Past President*

J. V. L. HOGAN

WILLIAM WILSON

C. M. JANSKY, JR.

H. W. HOUCK

R. H. MARRIOTT

Serving until January 1, 1934

L. M. HULL

R. H. MANSON, *Junior Past President*

A. F. VAN DYCK

Serving until January 1, 1935

O. H. CALDWELL

E. L. NELSON



*International*

The Board of Directors of the  
Institute of Radio Engineers at its first meeting after the death of

**Reginald A. Fessenden**

on July 23, 1932, expressed unanimously its deep regret at the loss  
to radio engineering of this eminent pioneer and constructive in-  
ventor.

## INSTITUTE NOTES

### September Meeting of the Board of Directors

The September meeting of the Board of Directors was held on the 7th and attended by W. G. Cady, president; Melville Eastham, treasurer; Alfred N. Goldsmith, editor; Arthur Batcheller, O. H. Caldwell, J. V. L. Hogan, H. W. Houck, L. M. Hull, C. M. Jansky, Jr., R. H. Marriott, E. L. Nelson, A. F. Van Dyck, William Wilson, and H. P. Westman, secretary.

A. B. Buchanan, F. A. Henderson, H. R. Lubcke, and W. H. West were transferred to the grade of Member. C. J. Larsen, A. E. Lyle, H. J. Miller, J. L. Reinartz, and S. P. Shackleton were admitted to the grade of Member.

Thirty-six Associates, two Juniors, and twenty-two Students were elected to membership.

The Board accepted with regret the resignation of Mr. Dudley as assistant secretary which was submitted in order that he might resume his college work.

In view of the present economic situation, it was decided that no new assistant secretary be appointed at this time.

A slight expansion in the amount of material to be printed on each page of the PROCEEDINGS was approved in order to obtain the small saving which will result therefrom.

Operation of the office staff on a five-day week basis is to be continued until sufficient data are obtained to indicate the desirability of further change.

The Emergency Employment Committee reported receipt of applications for assistance from two hundred and ninety-three Institute members and thirty-three nonmembers. During its operation, it has employed seventy-five members on broadcast survey work and has placed thirty-three in permanent or temporary positions.

In view of the Institute's reduced income this year, it was felt that no additional treasury funds should be expended for the direct assistance of unemployed members but that such funds as are expended from the Institute treasury be devoted entirely to the defraying of the overhead expenses of the committee. A noncumulative appropriation not to exceed \$300 per month was made from the Institute's treasury for this purpose. It is anticipated that membership contributions will be sufficient to permit substantial assistance to be rendered to the unemployed by the committee. It is hoped that the mem-

bership at large will realize the necessity of contributing to this fund in order that the committee may be enabled to assist those in need.

The personnel of the Emergency Employment Committee was expanded to include the chairman of each Institute section or his representative, and President Cady was requested to ask each section chairman to make an announcement at section meetings concerning the work of the Emergency Employment Committee and endeavor to obtain the names of those members who would be interested in contributing \$1 or more per month for this work. Members who are interested in contributing regularly to this fund should forward their names to the Institute office.

Under the present arrangement several months elapse between the filing of an application for membership and its approval by the Board of Directors. This is particularly damaging in the case of student members who are interested in obtaining the PROCEEDINGS during their scholastic term. Accordingly it was agreed that it be permissible to forward the PROCEEDINGS upon receipt of an application for the Student grade of membership when same is in good order and accompanied by remittance in full.

In order that advantage might be taken of the presence in New York of P. P. Eckersley who is en route from Australia to his home in England, Section 23 of the By-Laws of the Institute was temporarily suspended and the regular New York meeting which would normally have been held on October 5, was advanced one week to September 28. At this meeting Captain Eckersley will present a paper on "Required Minimum Frequency Separation Between Carrier Waves of Broadcast Stations."

Copies of the most recent version of a model law for the Registration of Professional Engineers and Land Surveyors were placed in the hands of the Constitution and Laws Committee.

---

### **Institute Meetings**

#### **ROCHESTER FALL MEETING**

The Rochester Fall Meeting for 1932 will be a two-day session, and is scheduled for November 14 and 15.

The final program of technical papers to be presented is not as yet in shape for publication but will appear in the November issue of the PROCEEDINGS. However, those who have attended past fall meetings have the assurance of the committee that papers will be just as timely and important as those which have been presented in the past and will,

we are sure, make full preparations for attending the meeting. The informal banquet is scheduled for the evening of the 15th, and as in the past the radio industry will supply the major portion of the entertainment.

---

### Radio Transmissions of Standard Frequencies

The Bureau of Standards transmits standard frequencies from its station WWV, Washington, D.C., every Tuesday. The transmissions are on 5000 kilocycles. Beginning October 1, the schedule will be changed. The transmissions will be given continuously from 10 A.M. to 12 noon, and from 8:00 to 10:00 P.M., Eastern Standard Time. (From April to September, 1932, the schedule was from 2 to 4 P.M., and from 10 P.M. to midnight.) The service may be used by transmitting stations in adjusting their transmitters to exact frequency, and by the public in calibrating frequency standards, and transmitting and receiving apparatus. The transmissions can be heard and utilized by stations equipped for continuous-wave reception through the United States, although not with certainty in some places. The accuracy of the frequency is at all times better than one cycle (one in five million).

From the 5000 kilocycles any frequency may be checked by the method of harmonics. Information on how to receive and utilize the signals is given in a pamphlet obtainable on request addressed to the Bureau of Standards, Washington, D. C.

The transmissions consist mainly of continuous, unkeyed carrier frequency, giving a continuous whistle in the phones when received with an oscillatory receiving set. For the first five minutes there are transmitted the general call (CQ de WWV) and announcement of the frequency. The frequency and the call letters of the station (WWV) are given every ten minutes thereafter.

Supplementary experimental transmissions are made at other times. Some of these are made with modulated waves, at various modulation frequencies. Information regarding proposed supplementary transmissions is given by radio during the regular transmissions, and also announced in the newspapers.

The Bureau desires to receive reports on the transmissions, especially because radio transmission phenomena change with the season of the year. The data desired are approximate field intensity, fading characteristics, and the suitability of the transmissions for frequency measurements. It is suggested that in reporting on intensities, the

following designations be used where field intensity measurement apparatus is not used: (1) hardly perceptible, unreadable; (2) weak, readable now and then; (3) fairly good, readable with difficulty; (4) good, readable; (5) very good, perfectly readable. A statement as to whether fading is present or not is desired, and if so, its characteristics, such as time between peaks of signal intensity. Statements as to type of receiving set and type of antenna used are also desired. The Bureau would also appreciate reports on the use of the transmissions for purposes of frequency measurement or control.

All reports and letters regarding the transmissions should be addressed to the Bureau of Standards, Washington, D. C.

---

### Committee Work

#### ADMISSIONS COMMITTEE

A meeting of the Admissions Committee was held on September 7, and was attended by A. F. Van Dyck, chairman; Arthur Batcheller, C. M. Jansky, Jr., and H. P. Westman, secretary. The committee reviewed six applications for transfer to the grade of Member, of which five were approved. It also approved three of five applications for admission to the grade of Member.

#### STANDARDIZATION

##### STANDARDS COMMITTEE—I.R.E.

A two-day meeting of the main Standards Committee of the Institute was held on September 1 and 2 in the Institute office. Those who were present at the meeting were J. W. Horton, chairman; J. Blanchard, (representing William Wilson) R. D. Campbell, (representing L. E. Whittemore) E. D. Cook, A. B. DuMont, Malcolm Ferris, J. V. L. Hogan, H. M. Lewis, E. L. Nelson, J. C. Schelleng, J. C. Warner, (representing B. E. Shackelford) H. A. Wheeler, B. Dudley, Standards Committee secretary, and H. P. Westman, Institute secretary.

The committee reviewed the major portion of the material submitted to it by its various technical committees. It did not complete its report, and an additional meeting was scheduled for September 14 at which it is hoped the report can be completed and put in shape for submission to the Board of Directors for final approval and subsequent publication.

### Personal Mention

Formerly with Bell Laboratories, Paul Brake has become a radio engineer for American Airways of St. Louis, Mo.

Commander C. R. Clark, U.S.N., has been transferred from the U.S.S. Richmond to the Washington Navy Yard.

Major D. M. Crawford, U.S.A., now located at Fort Leavenworth, Kansas, previously served in the Office of the Chief Signal Officer at Washington.

Formerly with the Dubilier Condenser Company of England P. P. Eckersley is now chairman of the Radio Service Company of London.

F. A. Henderson has left Standard Telephones and Cables, Limited, to become technical manager of International Marine Radio Company of London.

Previously with Bell Telephone Laboratories, W. B. Morehouse is now in charge of the vacuum tube laboratories of the Federal Telegraph Company, Newark, N. J.

Lieutenant Commander M. C. Partello, U.S.N., has been transferred from the U.S.S. Helena to the U.S.S. Bulner.

Now on the U.S.S. California, Lieutenant A. W. Peterson, U.S.N., was previously on the U.S.S. West Virginia.

P. C. Sandretto previously with Bell Telephone Laboratories is now a communication engineer for United Airlines in Chicago.

Formerly with Polymet Manufacturing Company, Nathan Schnoll has become a general engineer for Solar Manufacturing Company of New York City.

Previously with the Radio Corporation of America at Riverhead, L. I., S. H. Simpson, Jr. is now program service supervisor for RCA Communications in New York City.

M. G. Smith previously with Lissen, Limited, has become chief radio engineer for Radio Service, Limited, of London.

J. C. Van Horn formerly vice president of RCA Institutes has become president of the Philadelphia Wireless School of Telegraphy.

---

### Errata

The following corrections have just been received to the paper entitled "The Nonuniform Transmission Line" by A. T. Starr, published in vol. 20, no. 6, p. 1052-1063; June, (1932):

Page 1054, line 26  $(\pm 1 + \alpha)/(2 + \alpha + \beta)$  should read  $\pm(1 + \alpha)/(2 + \alpha + \beta)$

Page 1055, lines 3 and 5,  $(\pm 1 + \alpha)/(2 + \alpha + \beta)$  should read  $\pm(1 + \alpha)/(2 + \alpha + \beta)$

Page 1055, line 17,  $(-1 + \alpha)/(2 + \alpha + \beta)$  should read  $-(1 + \alpha)/(2 + \alpha + \beta)$

Page 1057, Case 2, line 4,  $f_3(x) = -j \sqrt{\frac{y}{x}} x^{(1-\alpha)/2} J_{-(1+\alpha)/2}[j\sqrt{yz}x]$  should read

$$f_3(x) = -j \sqrt{\frac{y}{z}} x^{(1-\alpha)/2} J_{(-1+\alpha)/2}[j\sqrt{yz}x]$$

Page 1063, line 2,  $\theta = 2 \log_e(\sqrt{ad} + bc)$  should read  $\theta = 2 \log_e(\sqrt{ad} + \sqrt{bc})$





## TECHNICAL PAPERS

### DIRECT-RAY BROADCAST TRANSMISSION\*

BY

T. L. ECKERSLEY

(Research Department, Marconi's Wireless Telegraph Company, Ltd., Chelmsford, England)

*Summary*—The propagation of long and short waves over long distances has been extensively studied, and the underlying principles are, to a large extent, understood. The question of the propagation of medium waves by direct ray, which forms the subject of the following paper, has not previously received so much attention.

The paper is written with a view of enabling predictions to be made as to the field strength of direct-ray transmission on wavelengths between 60 meters and 2000 meters.

The main part of the paper is concerned with daylight transmission. The question of night transmission and the influence of the Heaviside layer is considered briefly at the end.

THIS paper concerns the transmission of waves from a broadcast transmitter in the range between 60 meters and 2000 meters.

The curves shown are designed to give the field strength, in daytime, of a station of known power transmitting over a terrain of known conductivity.

In order to make full use of the curves, some knowledge of the nature of the transmission of broadcast waves is necessary, as well as the assumption involved in the calculations. It will then be possible to make an estimate of the modifications that may occur on account of reflection from the Kennelly-Heaviside layer, irregularities in the country, variations in conductivity, and of the effect of buildings, trees and structures, etc.

It is generally assumed that in daytime, transmission is effected by the direct or surface ray, and that no appreciable energy is reflected from the Heaviside layer in such conditions.

The observed absence of fading, the correctness of the bearings taken with a frame or loop, and the general agreement of observed field strengths with those calculated on the direct-ray theory in full daylight conditions and at medium distances, are guarantees of the correctness of this assumption. It has, however, been discovered recently, that at extreme distances, 700 to 1000 kilometers, there is ap-

\* Decimal classification: R113. Original manuscript received by the Institute, June 6, 1932.

preciable reflection from the Kennelly-Heaviside layer even in full daylight conditions (midday), which shows itself as marked fading of the signals.

The region where these effects occur is generally outside the working range of a broadcast station, but is not necessarily beyond the working range of a telegraph station. In the curves given this reflected ray is neglected.

The period during which the signals are free from an appreciable reflected component require a rather more definite specification. The ratio of the reflected ray to the direct ray depends on a variety of circumstances. In the first place it is clear that it is independent of the power of the transmitter. If this is increased fourfold, for instance, the intensity of the reflected wave as well as that of the direct wave will be doubled and their ratio will be unaltered. The factors which affect this ratio are as follows:

- (1) The distance of the receiver from the transmitter (and nature of the intervening terrain).
- (2) Wavelength of the transmission.
- (3) The local time.
- (4) The season.
- (5) The latitude of the station.

Knowledge of the complete diurnal, seasonal, and latitude variations of the reflected ray is very incomplete so that a definite specification of the conditions for direct-ray reception alone is not possible, though it is possible to give results in fairly general terms.

With regard to (1):

Sufficiently close to the transmitter the main ray entirely swamps the reflected one at all hours of day or night and at all latitudes or seasons. Even though it is possible to obtain reflected waves of recordable intensity at a few kilometers from the transmitter with wavelengths of 100 meters or less, the reflected wave, even at nighttime, does not assume any practical importance until ranges of over 60 to 100 kilometers are reached. The relative intensity of the reflected to direct-ray increases with increasing frequency, so that the undisturbed range of the direct-ray decreases with wavelength.

In all but exceptional cases, day or night, we may consider the region within a radius of 50 kilometers from the transmitter to be undisturbed by reflected waves.

In the daytime in summer in these latitudes the undisturbed region is largely increased and probably includes practically all the working range of a broadcast transmitter within the wave range of 200 to 2000 meters. The reflected ray may become comparable with the direct ray

at distances from 600 to 1000 kilometers depending chiefly on the amount of attenuation of the direct rays. As an example, it is found that the signals received in Chelmsford, England, from broadcast station at Rome and Stockholm, (approximately 400 meters wavelength) at a distance of approximately 1000 kilometers, are subject to quite large amplitude fading even at midday in midsummer. For such conditions we may assume an undisturbed direct-ray range up to 600 and 700 kilometers. In wintertime (in these latitudes) the undisturbed range is very much restricted. At about 200 kilometers it is only for a period of approximately one hour round midday that undisturbed direct-ray transmission takes place. At shorter distances the period is longer and at greater distances less. Sufficient material has not yet been obtained to specify the undisturbed ranges and periods completely, though in general up to distances of 150 kilometers undisturbed transmission of the direct ray is the main factor during the period one hour after sunrise to one hour before sunset.

In the following theoretical calculations undisturbed direct-ray transmission is assumed.

The reflected ray is not amenable to calculation, and our knowledge is empirical. Some results and the interpretation of them are given at the end of the paper.

The computations refer to an ideal problem; complication due to surface irregularities, changes in resistivity, etc., cannot naturally be included.

Successive approximations of the ideal towards the actual are, in order, first, the transmission of a Hertzian oscillator over a perfectly conducting plane, considered by Hertz; second, the transmission over a semiconducting plane (considered by Sommerfeld); and third, the transmission of electromagnetic waves from a point source over a semiconducting sphere (Watson).

The first is so far idealized that it is of little use for giving an account of actual transmission. It neglects the attenuation due to the earth resistivity which, as had been found, both experimentally and theoretically, is a major factor in direct-ray transmission.

Nevertheless, it gives a clear picture of the simplest case of the spherical spreading of waves from a point source. The Sommerfeld theory comes very much closer to actuality especially in the intermediate ranges up to 200 or 300 kilometers or so where the accumulative effect of the earth's curvature can be neglected and the earth can be considered as substantially flat.

At greater distances, however, the diffraction effect of the earth's curvature has to be taken into account. Actual signal intensities are

found to fall well below the values calculated for a flat earth and the necessity for some modification of Sommerfeld's theory becomes apparent. At great distances diffraction rapidly becomes the determining factor.

Sommerfeld's analysis is applicable up to ranges of 300 kilometers or so (depending slightly on the wavelength).

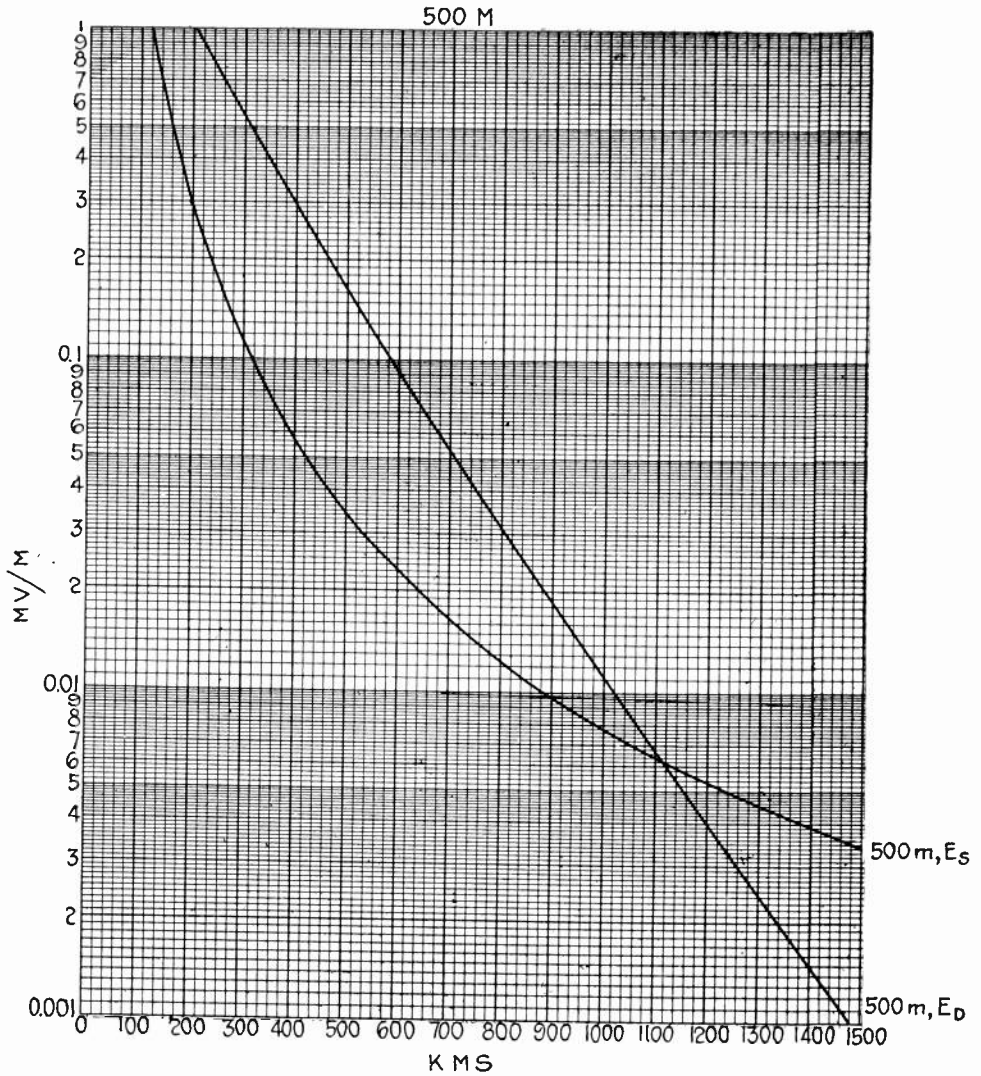

Fig. 1

Watson's analysis, which takes account of the earth's curvature, is not valid for regions near the transmitter.

According to van der Pol the formula is only applicable where  $x > 140$ ,  $x$  being  $(r_{km}/\lambda_{km})^{1/3}$  thus for  $\lambda = 1$  kilometer, the region of validity is greater than 140 kilometers; or with a 100-meter wave, it is approximately 300 kilometers.

Some modification of the original "Watson" diffraction formula is necessary. The Watson analysis was restricted to conductivities and wavelengths rather greater than those considered here. For wavelengths greater than about 2 kilometers and the usual accepted values of earth conductivity, it was shown by Watson that the intensity of the diffracted wave, in the region of its validity, is practically independent of the earth's resistivity and we are faced with the difficulty of joining a set of diffraction curves (independent of the earth's resistivity and valid for great distances) on to a set of Sommerfeld curves valid for shorter distances, which change very markedly with the earth resistivity. Assuming a given wavelength and earth resistivity, the appropriate Sommerfeld attenuation curve and diffraction curve can be drawn. For wavelengths less than about 1000 meters the two curves cross at approximately 1100 kilometers. For shorter distances the Sommerfeld curve lies well below the diffraction curve but at longer distances the diffraction curve drops away rapidly and falls well below the Sommerfeld curve. An example for  $\lambda = 500$  (1 kw radiated) is shown below, (Fig. 1). It will be seen that the two curves do not run smoothly into one another; they cut at a fairly wide angle. The run of the curve in the transition range where neither formula is valid is difficult to gauge. Watson's mathematical result, that the diffracted wave intensity is independent of the earth's resistivity, is a consequence of the fact that in the range of wavelengths considered and for conductivities likely to be found on the earth's surface the earth behaves substantially as a perfect conductor. This conclusion is verified by applying Sommerfeld's flat earth analysis to the same range of wavelengths and conductivities.  $\sigma\lambda c$  is so large that we find, in fact, the effect of earth resistivity is small except at extreme distances. It may be argued then that Watson's result is only true in the range of wavelengths well above that considered here, and that in the broadcast range the simple Watson formula is not valid and must be corrected to take account of the effect of earth's resistivity.

On examining Watson's analysis it is found that it is difficult to determine the effect of the earth's resistivity without repeating the complex mathematical procedure by which the original diffraction formula was evolved.

Recently, however, the writer has found that it is possible to derive Watson's formula<sup>1</sup> (by a phase integral method) in such a form that the correction due to the earth's resistivity can easily be incorporated.

The modification required is as follows:

<sup>1</sup> T. L. Eckersley, "Radio transmission problems treated by phase integral method," *Proc. Roy. Soc., Series A*, vol. 136, no. A830; June 1, (1932).

The original Watson formula is in the form

$$\frac{0.5365}{(\sin \theta)^{1/2}} \frac{hI}{\lambda^{7/6}} \exp\left(\frac{-K\theta}{\lambda^{1/3}}\right) \text{ millivolts/m}$$

where  $K$  is a factor depending only on the earth's radius and in this case is 23.9;  $\theta$  is the angular distance between transmitter and receiver (in radians), and  $\lambda$  the wavelength and  $h$  the effective height of the transmitter are in kilometers.

In the formula, amended for the effect of earth resistivity,  $K$ , instead of being a constant, is found to be a function of  $\lambda$  and  $\sigma$  (the conductivity) in such a form that, for a given earth radius,  $K_{(\sigma\lambda)}$  is only a function of  $\sigma^{1/2}\lambda^{5/6}$ .

This function has been computed and is plotted in Fig. 2 as a function of this quantity.

Ultimately, assuming 1 kw radiated, and that  $\sigma = 10^{-13}$  (an average value found from measurements made in England and Europe) the modified Watson diffraction curve may be computed from the formula

$$E = \frac{34.0}{x^{1/2}\lambda^{1/6}} e - \left( K_{\sigma\lambda} \frac{x}{\lambda^{1/3}R} \right) \quad (1)$$

where  $K_{\sigma\lambda}$  is the appropriate value of  $K$  taken from the graph (2). If now the Sommerfeld curves for  $\sigma = 10^{-13}$  are drawn, a much better fit is found than with the unmodified Watson curves.

Thus for wavelengths above about 600 meters the curves are nearly tangent at a distance of some 300 kilometers and can be fitted together without discontinuity of the absolute value or gradient.

For shorter waves the two curves cross at approximately 400 kilometers but at a fairly acute angle, so that it is possible to sketch in the transition range without serious error. The graphs given have been formed in this manner and give the computed field intensity, for 1 kw radiated on a series of wavelengths from 2000 meters to 60 meters. The ranges are up to 1500 kilometers and intensities down to 0.001 millivolt per meter or 1 microvolt per meter. This should cover the entire working range of broadcast and telegraph transmitters working between the limits of wavelength specified unless the stations are of excessive power.

#### THE SOMMERFELD THEORY

The mathematical details of the theory have been worked out very fully by Sommerfeld himself, by Balth. van der Pol and K. F. Niessen, Howard Wise, and Rolfe and others. An attempt is made here to express the physical significance of the results obtained. Starting with

the simplest case of the transmission of waves over a perfectly conducting plane (as considered by Hertz) we may think of the effect of the finite resistivity of the earth as a slight modification of the Hertzian régime. The effects produced are fairly obvious physically, at least in the light of the full analysis.

The Hertzian régime is one in which the transmitted wave spreads out spherically in such a manner that the total energy radiated through any hemisphere centered on the transmitter is constant.

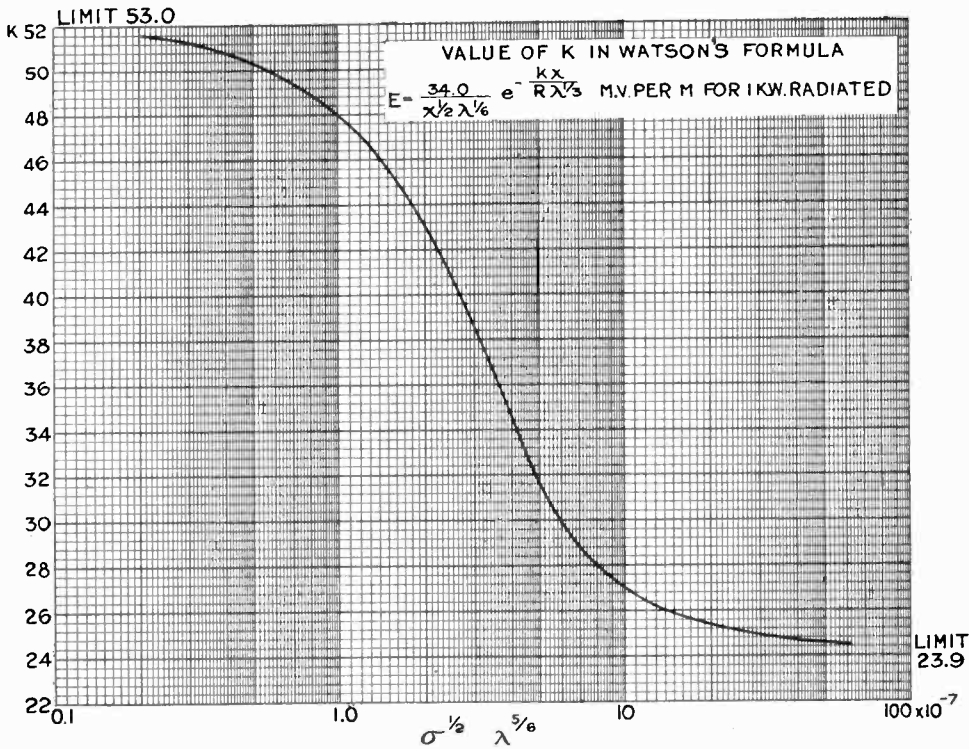

Fig. 2

It is therefore legitimate to represent the radiation in the form of a polar diagram. The energy radiated per unit solid angle at any angle of elevation  $\theta$  is constant and can be represented by the radius vector from a point 0. The locus of the end points of these vectors will give the radiation distribution of the transmitter as a function of  $\theta$ . This is the radiation polar diagram, and in this simple case the radiated energy per unit solid angle in a direction (the angle of elevation above the surface of the plane) is proportional to  $\cos^2 \theta$ .

The modification produced by the finite resistivity of the earth may be considered to be a surface effect. The earth currents are modified and the disturbance starts from the earth's surface and produces a modification of the Hertzian régime in the neighborhood of  $\theta = 0$ .

Looking at the matter physically, the energy that flows along the earth's surface is attenuated, rapidly if the resistivity is high and less rapidly if the resistivity is small. At sufficient distance the energy flux parallel to the earth's surface is almost entirely obliterated and the flux at small angles of elevation greatly reduced.

The energy flux, at all angles, except  $\theta=0$  and at sufficiently great distances, that is, the energy polar diagram, can be determined with as great an accuracy as we please on choosing a sufficient distance, by a device which makes use of the Sommerfeld reciprocal theorem.

The method is outlined in the writer's "Short Wave Wireless Telegraphy," Journal I.E.E., vol. 65, no. 366, pp. 602-603; June, (1927).

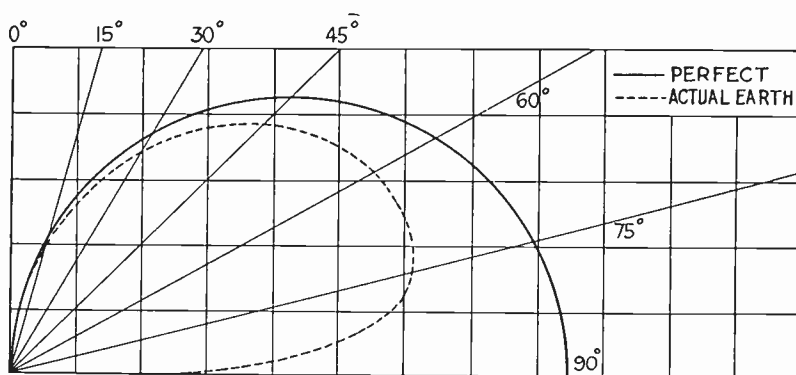

Fig. 3—Vertical polar diagrams near earth's surface ( $\epsilon=10$   $p=1.8 \times 10^{13}$  electromagnetic units.)

It is shown, there, that the energy flux at a point  $P$  sufficiently far distant from the transmitter  $T$ , and such that  $P$  is many wavelengths above the earth's surface, is the same as that due to the aerial  $T$  and its image  $T'$ , the image being taken with a suitable relative phase and intensity. This relative phase and intensity is determined by the reflection coefficient  $r$  of the earth at  $T$ .

If this reflection coefficient is  $r = |r|e^{i\phi}$ ,  $|r|$  being less than unity, then the phase of the current in the image is shifted an angle  $\phi$  relative to phase of the direct transmitting and the current amplitude is reduced in the ratio ( $|r|$ ) to 1. This method enables the complete polar diagram of the transmitter, on an imperfectly conducting earth, to be computed, except for the transmission just in the neighborhood of the surface of the earth. Unfortunately this is just the region which is required in the calculation of the direct-ray transmission over the surface of the earth. The polar diagram considered is entirely adequate in consideration of short-wave transmission where only the rays at a finite angle of elevation are used, but fails for surface wave transmission utilized in broad-



casting. For this purpose it is necessary to use the complex analysis of Sommerfeld, which gives a precise measure of the surface wave.

It is satisfactory that this image method bears out the general physical considerations given above, to the effect that the polar diagram of the transmission for a perfectly conducting earth is modified by the earth resistivity by the reductions of the intensity of the rays with small angles of elevation as shown in the descriptive Fig. 3.

The same form is given by the image theory, since for small angles of elevation the reflection coefficient is nearly  $-1$  and we have a negative image which practically cancels all energy radiated at small angles.

### THE SURFACE WAVE

The intensity of the surface wave can be computed from the results of Sommerfeld's analysis.

Even this surface wave is really composite, although the parts are not separated but considered together in Sommerfeld's formula. At distances where the wave front is approximately plane; i.e., where the radius of curvature of the wave front is large compared with the wavelength, there is a true surface wave of the Zenneck type, with an attenuation depending on the earth's constants.

It is a surface wave in the sense that it is of maximum intensity on the earth's surfaces and dies away very rapidly downwards in the earth, and much more slowly upwards.

On account of the attenuation factor it dies away finally at great distances. If this were the only surface wave we should be left at great distances with an energy flux represented completely by the distant polar diagram determined by the image method in which the energy flux is confined to a region well above the earth's surface. But as is well known, the wave energy is not entirely confined to the rays, the relative intensity of which is given by the polar diagram, but spreads by diffraction into the shadow region.

At distances therefore where the Zenneck surface wave has been reduced to negligible proportions, the earth is illuminated by diffraction from the energy aloft.

This wave has no attenuation properly speaking, and is propagated with the velocity of light, in the same way as the higher angle rays, and its intensity varies inversely as the square of the distance from the transmitter. The region where diffraction of this type sets in is determined by what Sommerfeld calls the "numerical distance" which is the controlling factor in surface wave transmission.

Diffraction of this type is the main factor when the numerical distance is large compared with unity.

This numerical distance  $\rho_0$  is determined by the actual distance  $x$ , the wavelength  $\lambda$ , the earth conductivity  $\tau$ , and earth inductivity  $K$  according to the relation

$$\rho = j \frac{K_1^3 x}{K_2^2}$$

where,

$$K_1^2 = \left( \frac{2\pi}{\lambda} \right)^2$$

$$K_2^2 = \left( \frac{2\pi}{\lambda} \right)^2 \{ K + 2j\sigma\lambda c \}$$

or,

$$K_2^2 = \left( \frac{2\pi}{\lambda} \right)^2 \left\{ K + j \frac{2c^2}{\rho\nu} \right\}$$

where  $\rho$  is the resistivity and  $\nu$  the frequency.

It will be noticed that  $\rho$  and  $\nu$  enter together as a product in the formulas for surface wave transmission so that the effect of a given earth resistivity is much greater at high frequencies than low. In the case of the longer waves and high conductivities where  $2\sigma\lambda c$  is so large that  $K$  may be neglected by comparison, the numerical distance is a purely real number and equal to  $(\pi x/\lambda) \times (1/2\sigma\lambda c)$ . In deriving the Sommerfeld curves in Figs. 11 to 14 this condition is assumed.

Serious deviations are only likely to occur where the earth has a high dielectric constant and high resistivity simultaneously. In general, however, a high dielectric constant implies a wet earth, with correspondingly low resistivity. In the case of very short wavelengths, say  $\lambda = 40$  meters,  $K$  and  $2\sigma\lambda c$  may be of the same order even in normal earth conditions. The curves given, therefore, in which  $K$  is neglected in comparison with  $2\sigma\lambda c$ , refer strictly to the longer wave range covered by the broadcast waves.

If we put  $\tan \phi = K/2\sigma\lambda c$  and call this the phase angle of the earth, then the propagation conditions are a function of this phase angle as well as of the conductivity of the earth. The modifications to the normal Sommerfeld curves, occasioned by taking this phase angle into account have been considered by Rolf.<sup>2</sup> The most striking feature of this modification is the predicted existence of certain blind spots.

The physical significance of these is as follows: In normal conditions when the earth phase angle is small  $2\sigma\lambda c > K$ , the Zenneck surface wave and the diffracted wave are 90 degrees out of phase and the result-

<sup>2</sup> B. Rolf, "Numerical discussion of Prof. Sommerfeld's attenuation formula for radio waves, *Ingeniørens videnskaps Akademi*, no. 96, (1929).

ant is a quantity which decreases smoothly with the distance. If, however, the earth phase angle is sufficiently large the relative phases of the two components of the surface wave are altered and the two components can interfere at certain points and produce complete phase cancellation.

The formula actually used is given below.

Thus if  $E_s$  is the signal strength at a distance from an aerial of effective height  $n$

$$E_s = 120\pi \left( \frac{hI}{\lambda} \right) \frac{1}{x} S \text{ millivolts per meter}$$

where  $x$  is in kilometers, and  $K$  and  $\lambda$  are in the same units.  $S$  is a reduction factor showing the modification of the simple Hertz formula due to ground losses. It is a function of the numerical distance  $\rho_0$  given as above in the form  $\rho_0 = (\pi x/\lambda) \times (1/2\sigma\lambda c)$ .

$$\rho_0 = \frac{\pi x}{\lambda} \frac{1}{2\sigma\lambda c}$$

The functional dependence of  $S$  on  $\rho_0$  is given by the formula

$$S = \sum \frac{\Gamma(2n-1)}{2^{2n-1}\Gamma(n-1)} - \frac{1}{\rho_0^n}$$

If the aerial is less than  $1/4\lambda$  in height the radiation resistance is given by

$$R_r = 160 \frac{\pi^2 h^2}{\lambda^2} \text{ ohms}$$

and the power radiated is  $W$  watts given by

$$R_r I^2 = 160 \frac{\pi^2 h^2 I^2}{\lambda^2} \text{ watts}$$

so that,

$$\frac{hI}{\lambda} = \frac{\sqrt{\omega}}{\pi\sqrt{160}}$$

and,

$$E_s = \frac{3\sqrt{10\omega}}{x} S \text{ millivolts per meter.}$$

For the radiation of 1 kw,  $W = 1000$  and  $E_s = \left( \frac{300}{x} \right) S$  millivolts per meter.

A curve has been drawn giving the values of  $S$  up to  $\rho_0 = 100$ ; above this value  $S = 1/2\rho_0$  within 1 per cent. The actual calculation of the Sommerfeld curves, when the earth phase angle is small, is thus quite an easy process. The set of curves exhibited is computed with  $\sigma = 10^{-13}$ . This value of  $\sigma$  is close to the average value determined by many observations made in England.

In the conditions specified it is easy to get the corresponding Sommerfeld curves for any other value of  $\sigma$ , (so long as  $\sigma$  is not so small that  $2\sigma\lambda c$  is comparable with  $K$ ) for

$$E_s = \frac{300}{x} S(\rho_0)$$

where  $S$  is written in the form  $S(\rho_0)$  to indicate that it is a function of  $\rho_0$ .

Now  $\rho_0$ , when  $x$ ,  $\lambda$  are in kilometers and  $\sigma$  in cgs electromagnetic units is given by  $5.236 \times 10^{-16} x / \sigma \lambda^2$ .

Thus  $E_s$  at a given distance  $x$  for 1 kw radiated is only a function of  $\sigma \lambda^2$ .

Thus suppose we have the  $E_s$ ,  $x$  curves for  $\sigma = \sigma_0$  and for all wavelengths.

If now we require the  $E_s$ ,  $x$  curve for a wavelength  $\lambda$  and conductivity  $\sigma' = k^2 \sigma_0$ ,  $k$  being a suitable numerical factor, then since  $E_s$  for a given distance  $x$  is only a function of  $\sigma \lambda^2$  say  $f(\sigma \lambda^2)$ .

Then  $E_s$  required

$$\begin{aligned} &= f(k^2 \sigma_0 \lambda^2) \\ &= f(\sigma_0 (k\lambda)^2) \\ &= f(\sigma_0 (\lambda')^2) \end{aligned}$$

thus the curve required is the standard curve with the value of  $\lambda$  changed to  $k\lambda$ . It is therefore only necessary to look up the standard  $k\lambda$  curve to obtain the required curve for  $\lambda$  and  $k^2 \sigma$ .

Thus for other values of  $\sigma$  we can use the same set of curves by choosing instead of the curve for the actual wavelength  $\lambda$  the curve for an equivalent wavelength  $\lambda$  given by  $10^{-13} (\lambda')^2 = \sigma \lambda^2$ .

This may be written

$$[\log \lambda' = \log \lambda + \frac{1}{2} \log (\sigma \times 10^{13})].$$

A set of curves has been prepared to give the relation between  $\lambda^1$  and  $\lambda$  for values of  $\sigma$  from  $10^{-16}$  to  $10^{-11}$ . (Fig. 4).

By choosing graph paper with a log scale both ways the curves become straight lines at a slope of 45 degrees and are very convenient to use.

The wavelengths are actually given from 1 to 100, but the curves can be used over any range and for any units by multiplying both scales by the same factor.

The following examples illustrate the use of the curves in this way:

- (1) given  $\lambda = 500$  meters and  $\sigma = 10^{-14}$   
 we find that for  $\lambda = 50$  and  $\sigma = 10^{-14}$ ,  $\lambda = 15.8$ ,  
 so that the required value of  $\lambda^1$  is 158 meters

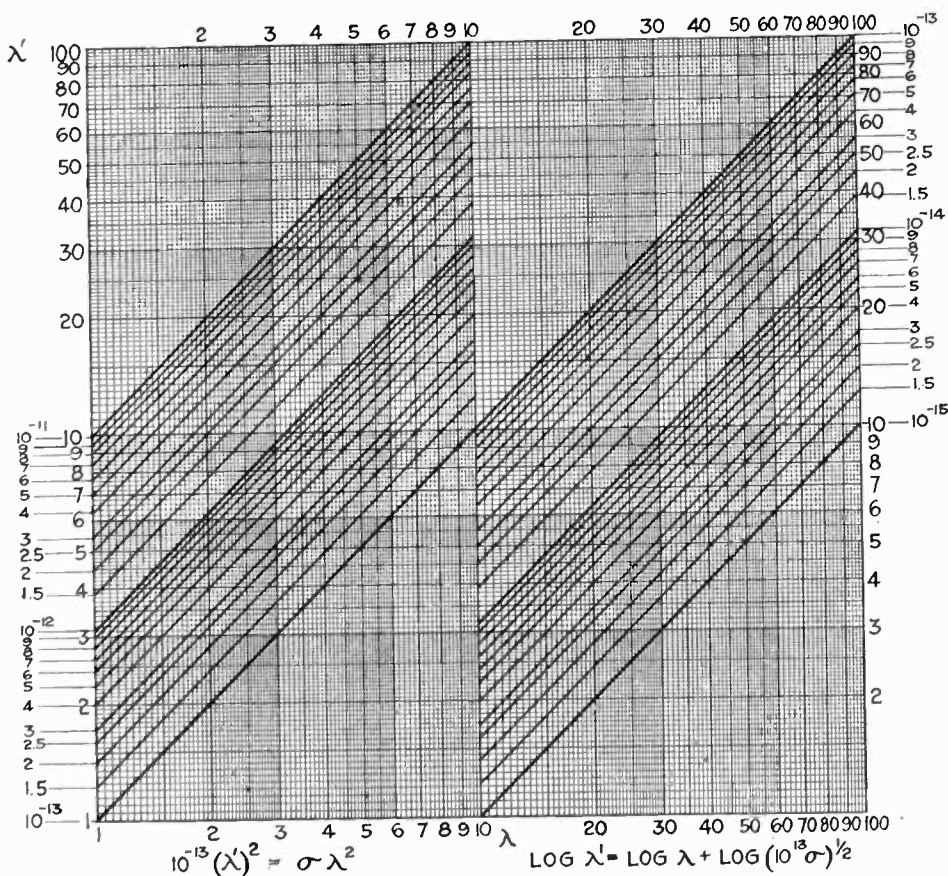

Fig. 4

- (2) given  $\lambda = 120$  meters  $\sigma = 2.5 \times 10^{-12}$   
 we find that for  $\lambda = 1.2$  and  $\sigma = 2.5 \times 10^{-12}$ ,  $\lambda = 5.95$   
 so that the required value of  $\lambda^1$  is 595 meters.

This transformation can only be carried out in the range of validity of the Sommerfeld formula, and for such values of  $\sigma$  and  $\lambda$  that  $2\sigma\lambda c$  is always large compared with  $K$ . Since the diffraction curves are not changed in the same way, the complete  $E, \lambda$  curve for an altered  $\sigma$  is not necessarily one of the standard curves. The modification to the diffraction curve can, however, be found where necessary by using the

diffraction formula (1) with the appropriate value of  $K_{\sigma\lambda}$  given in graph (2).

Some difficulty may be found in deciding what is the range of validity of the Sommerfeld curves.

As a rough guide we may use the set of curves shown in Fig. 5 in

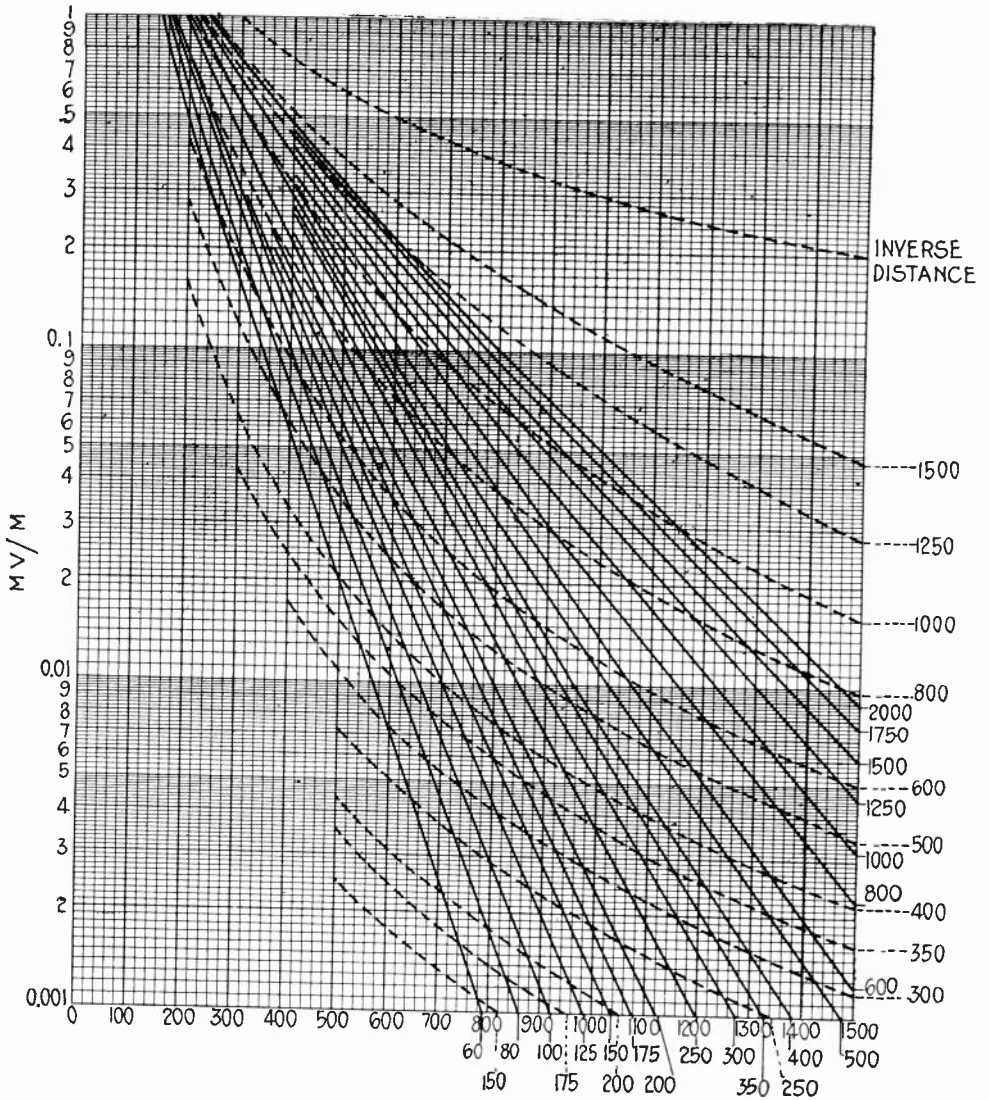

Fig. 5— --- Sommerfeld formula  $\sigma = 10^{-13}$  cgs units. — Watson's formula

which the standard Sommerfeld curves are extended beyond their normal range of validity and the diffraction curves are produced backwards towards the transmitter, so that in general the two curves for a given  $\sigma$  cross.

In determining the range of validity of the Sommerfeld curves for a given  $\sigma$  and  $\lambda$  we proceed down the appropriate equivalent  $\lambda'$  curve till

it crosses (or approaches closest to) the corresponding  $\lambda$  diffraction curve for  $\sigma = 10^{-13}$  and consider the region of validity of the Sommerfeld curve to lie well within this range. Strictly speaking, we ought to use the diffraction curve appropriate to  $\sigma$  and  $\lambda$ , not  $10^{-13}$  and  $\lambda$ , but since these do not vary largely with  $\sigma$  (except at great distances) we can take

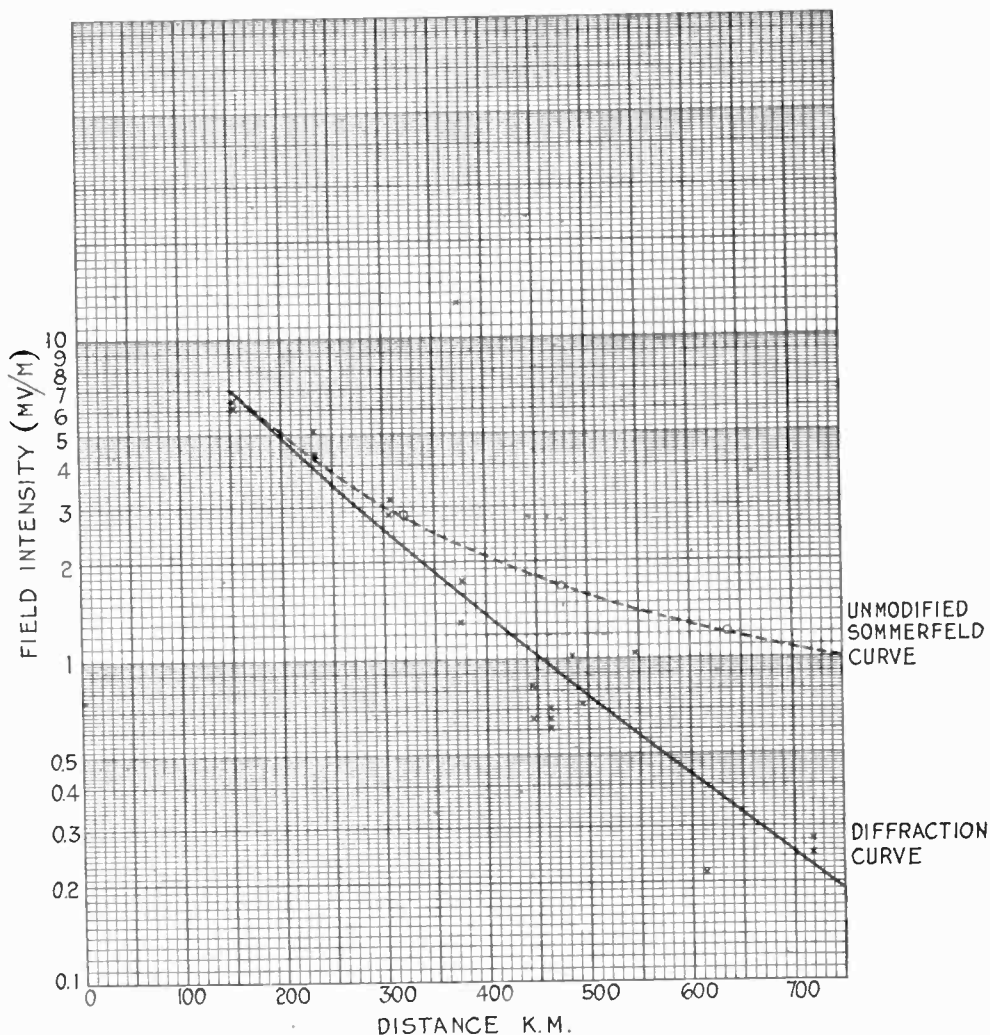

Fig. 6—5XX Daventry field strength, midday, July, 1931.  $\lambda$  1550 meters.  
Normal power, 25 kw.

a mean value of  $10^{-13}$  for the diffraction curve without involving any large error. With these curves, therefore, it should be possible to obtain the direct-ray field strengths of stations in the range from 60 to 2000 meters up to distances of 2000 kilometers or alternatively distances where the field intensity has dropped to less than 1 microvolt per meter for 1 kw radiated.

Such ideal conditions as considered here are seldom met with in practice.

The earth conductivity is not likely to remain uniform over the whole range. Hills, woods, and other obstructions are likely to alter the local field intensities, nevertheless, when the irregularities of the measured field intensity curves are smoothed out in taking averages, the observed curves do conform closely to the theoretical ones and the theoretical results given may be considered to give the smoothed curves.

Many results have been given of measurements by the British Broadcasting Corporation in England by Smith-Rose and Barfield, etc., which for distances up to 100–200 kilometers show good agreement with the Sommerfeld curves with  $\sigma = 10^{-13}$ . There are not many observations to test the newly developed diffraction theory. For this purpose measurements are required, in general, beyond the working range of a broadcast transmitter and at levels of field intensity below the working level. Recently I have obtained through the courtesy of Mr. Kirke of the British Broadcasting Corporation measurements of 5XX, the long-wave ( $\lambda 1550$ ) Daventry broadcast station, as far as 720 kilometers, measurements being taken in a line northward to Thurso in Scotland. The results are plotted in Fig. 6, the measured points being given by the crosses (they are a little scattered). The full curve is the modified Sommerfeld diffraction curve calculated with  $W = 25$  kw and  $\sigma = 10^{-13}$ . The dotted curve is the unmodified Sommerfeld curve. There is no doubt that the modified diffraction curve gives the results most accurately. The unmodified Sommerfeld curve gives values some 4 to 5 times too great at 700 kilometers.

The measurement of the Warsaw signals at Chelmsford affords another check on the diffraction theory. According to the unmodified Sommerfeld theory the field intensity for  $\sigma = 10^{-13}$  should be approximately 460 microvolts per meter for 100 kw radiated. Actually at mid-day the field intensity was slightly variable even in midsummer indicating a small reflected component, but the mean value which should correspond closely to the direct wave was 40 microvolts per meter.

This large difference can hardly be attributed to excessively high earth resistivity (part of the journey is over water) and is, I think, undoubtedly due to diffraction.

The following results are obtained on the diffraction theory:

|          |          |            |            |
|----------|----------|------------|------------|
| $\sigma$ | $\infty$ | $10^{-12}$ | $10^{-13}$ |
| $E$      | 97       | 39.6       | 15 mv/m    |

the best results in this case being obtained with  $\sigma = 10^{-12}$ .



The experimental evidence is therefore in favor of the modified diffraction theory on which the curves, given in this paper, are based.

### EFFECT OF HILLS AND OBSTACLES

The diffraction theory can be used to give a rough approximation of the effect of broken country, hills, etc.

The shadows cast by hills are essentially a diffraction phenomenon. There are two extreme cases in which the effects vary markedly, one in which the obstacle, hill, or whatever it is, is small compared with the wavelength, and the other in which it is large.

Taking the latter first, consider for the sake of definiteness the shadow cast by a definite spherical hump on a plane surface.

Thus let the hill be represented by  $A B C$ , Fig. 7,

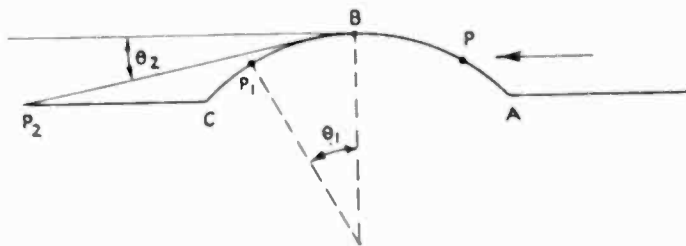

Fig. 7

and assume the wave to be traveling from right to left as shown by the arrow.

Let  $R$  be the radius of curvature of the hill. The condition that the obstacle may be considered large compared with the wavelength is that  $2\pi R/\lambda \gg 1$ . At a point  $P$  on the illuminated side of the hill, the field intensity (except near the crest  $B$ ) will be the field due to the sum of the direct and reflected ray. At a point  $P_1$  on the shadow side of the hill, general considerations based on the diffraction theory show that  $E$  will be of the order  $E_0 e^{-K\theta}$  where  $E_0$  is the value of  $E$  at the crest and  $K$  is the diffraction attenuation coefficient given in (1) with the appropriate value of  $R$  in the place of the earth's radius.

The formula is, explicitly, (neglecting the effect of finite resistivity)

$$e^{-(2\pi R/\lambda)^{1/3} \sqrt{3/2} \times 0.8083\theta}$$

where  $\theta_1$  is the angle in radians that the tangent at the point  $P_1$  makes with the horizontal plane. At a point  $P_2$  on the plain beyond the hill the intensity will be of the same form with  $\theta_2$  in the place of  $\theta_1$ , where  $\theta_2$  is the apparent angle of elevation of the crest of the hill as seen from  $P_2$ .

It will be seen that, since  $\theta_2$  decreases as the distance  $P_2$  from the foot of the hill increases, the shadow fills up at sufficient distance. This is a well-known observed effect.

As an illustration we may take the effects observed by R. O. Cherry (Signal Strength Measurements of 3LO, Melbourne, Part II) in which the field intensity round a hill has been investigated. The contour of the hill is given on page 17, Fig. 9, and approximates to the form given above (Fig. 7).  $R$  is of the order 770 meters and  $\lambda 371$ .  $2\pi R/\lambda$  though greater than unity is hardly sufficiently great for the above formula to be valid. It does, however, give results of the right order for at the

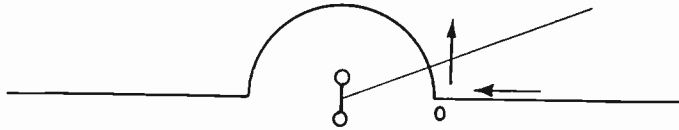

Fig. 8

foot of the hill on the shadow side  $\theta$  is of the order 20 degrees, and hence the exponential factor is

$$e^{-0.6} = 0.55$$

so that  $E$  should be  $0.55 \times E_0$  or  $0.55 \times 30 = 16.5$ . The actual value given is 16.0.

This agreement is probably to a large extent accidental, but at least it is of the right order.

When the obstacle is small compared with the wavelength, a simple example will show the effects likely to be observed.

The example is that of an inverted bowl upon a flat surface, the radius being not large compared with the wavelength. If a plane wave travels over the surface of the ground the obstacle will produce a secondary scattered wave.

In the case of an inverted hemisphere the approximate disturbance field is very simple. It is in fact the field due to a small Hertzian doublet, of appropriate strength, placed at the center of the sphere, as illustrated in Fig. 8.

The strength of the Hertzian doublet is that required to balance the vertical electric force at 0 since this must be zero, as it lies parallel to the surface of the sphere (supposed to be perfectly conducting).

If the potential of the doublet be

$$\pi = M \frac{e^{i2\pi r/\lambda}}{r}$$

then  $M$  is approximately

$$R_0 E_0 / \left\{ \left( \frac{2\pi}{\lambda} \right)^2 (1 + (\lambda/2\pi R_0)^2)^2 + \frac{1}{R_0^2} \right\}$$

which when  $R_0$  is small compared with  $\lambda$  becomes

$$2\pi R_0^2 E_0 / \lambda.$$

The total vertical field can then be represented approximately as shown in Fig. 9.

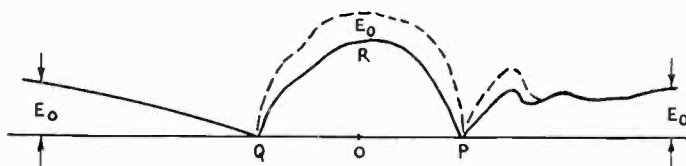

Fig. 9

It tends to approach  $E_0$  on the plane at a few wavelengths distance from  $O$ , it is zero at  $P$  and  $Q$ , and is  $E_0$  again at the top of the hill. On the plane on the illuminated side of the hill there are a number of maxima and minima every half wavelength due to the interference of the direct and reflected waves, but on the shadow side it tends smoothly to the limit  $E_0$ . It will be observed that the shadow cast by the obstacle persists only for a few wavelengths and is entirely local in contrast with a big obstacle which casts a shadow for a distance large compared with its dimensions.

The field is a maximum at the summit of the hill and dies away rapidly towards the foot where it is zero. In this respect it is similar to the field observed by Cherry in the neighborhood of an isolated hill. Even where the hill is not spherical, effects of the same nature will occur, with slight modifications due to the altered geometry of the system.

These ideal cases help to give an insight into the behavior of waves in hilly country, give the shadow regions, and also a measure of the reduction of intensity in such shadows.

The examples are only intended as a guide. It is hardly possible to give an accurate means of calculation in a complex hilly or broken country, but it follows from these results that the strongest fields are likely to occur on summits of hills or places where there is an unbroken view to distant horizons in the direction of the transmitter.

## NIGHT TRANSMISSION

Although this paper is primarily concerned with direct-ray transmission, actual broadcasting is much complicated by the effect of rays reflected from the Kennelly-Heaviside layer. For completeness some

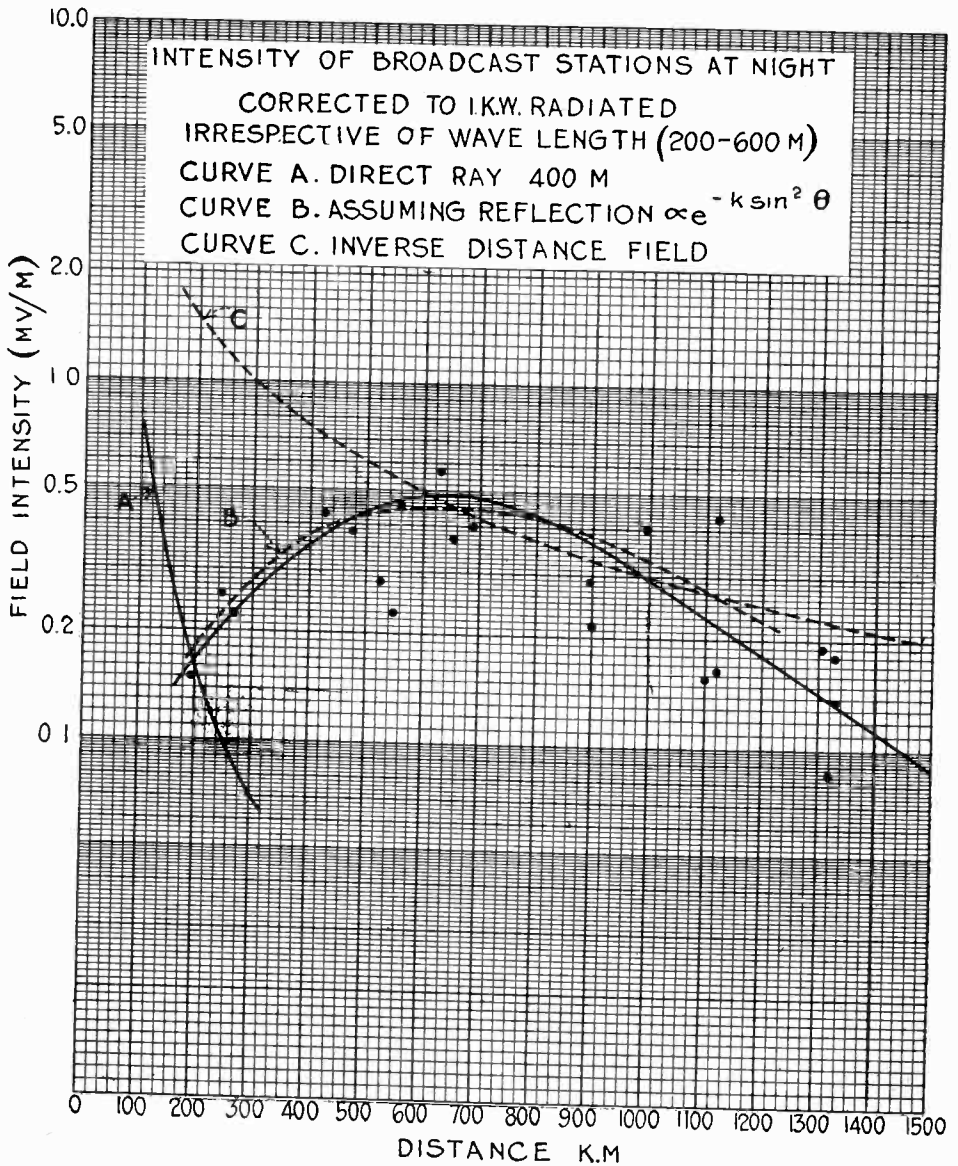

Fig. 10

discussion of the reflected wave is given here, since it is such an important factor in transmission at nighttime.

The results so far obtained are more or less empirical and the theory used in explanation merely tentative, and can be considered in no sense as an accurate means of computation.

The radio engineer is more concerned with the signal he can actually get than the signal that would be produced in some ideal conditions, it is therefore necessary to supplement the field intensity curves given for the ideal case of no reflection with curves showing the probable intensity of the reflected wave. Such information as has been obtained is necessarily incomplete.

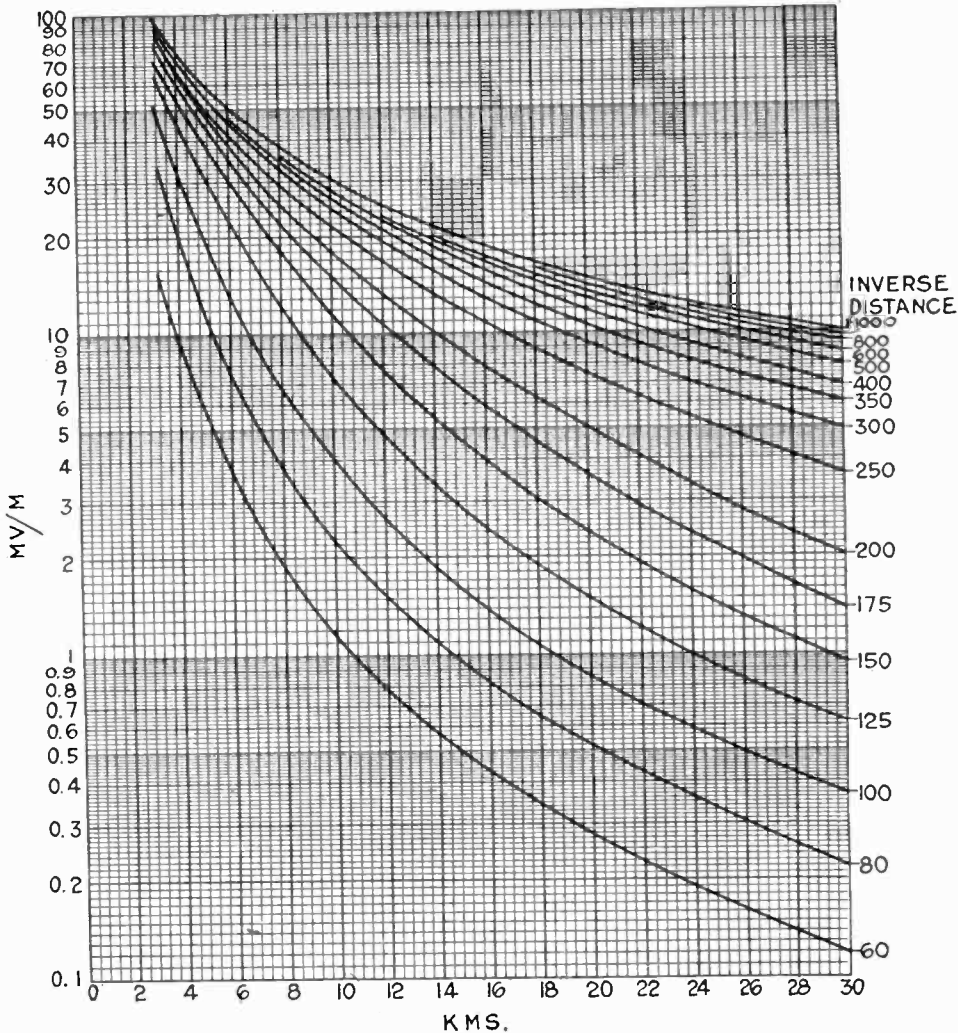

Fig. 11— $\left. \begin{array}{l} 0-30 \text{ kilometers} \\ 100-0.1 \text{ millivolts per meter} \end{array} \right\} \sigma = 1 \text{ kw. } 10^{-13} \text{ cgs units}$

The material available consists of a large number of observations of the field intensity of distant broadcast stations, taken at Broomfield near Chelmsford, England, during January, February, and March, 1929.

The results are shown in Fig. 10 where the field intensities are plotted against the distance of the station. They are corrected as far as

possible for a given power output level in the transmitter; i.e., 1 kw in the aerial. The range of wavelengths of the station observed was from 200 to 600 meters.

The variability and uncertainties due to fading appear to swamp any real changes due to wavelength in this range, all wavelengths are

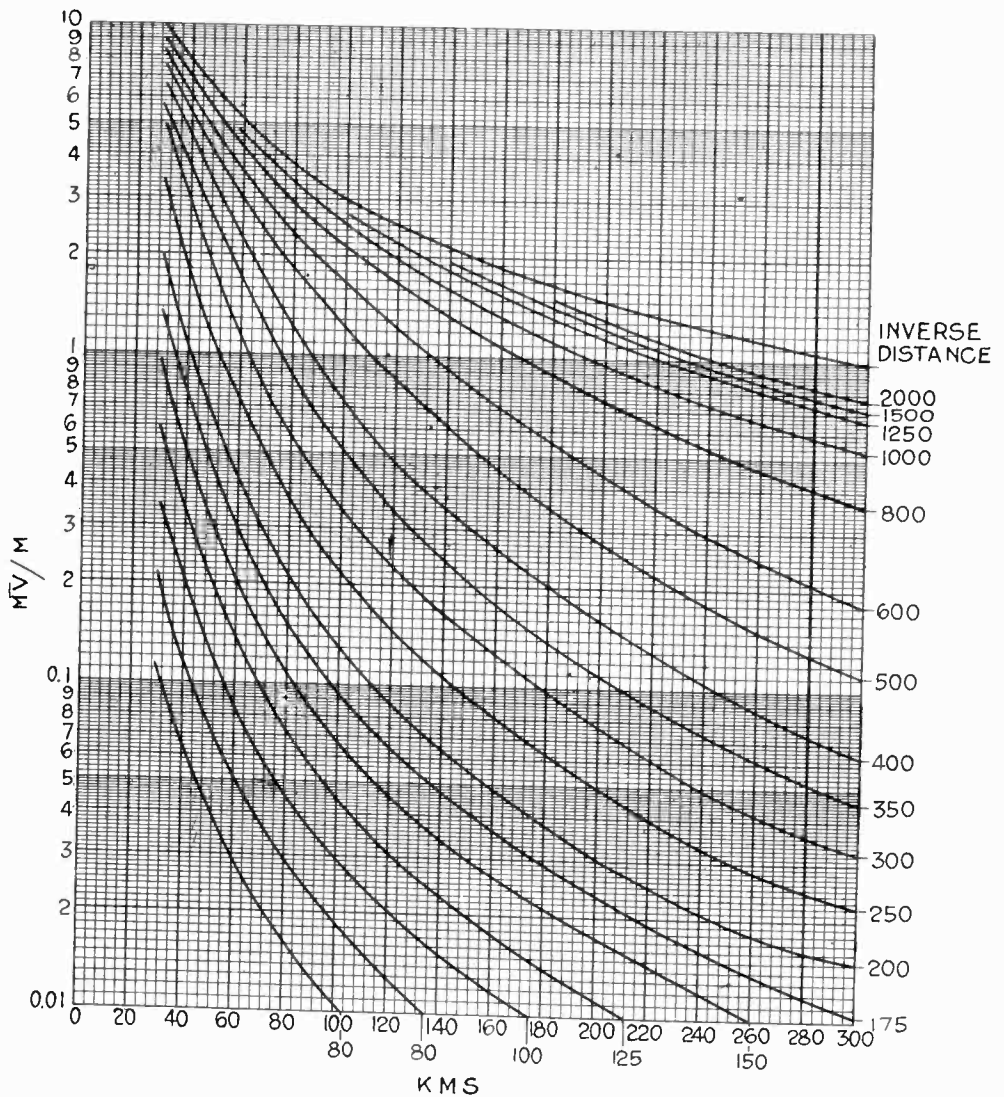

Fig. 12— $\left. \begin{array}{l} 30-300 \text{ kilometers} \\ 10-0.01 \text{ millivolts per meter} \end{array} \right\} \sigma = 1 \text{ kw.} \\ 10^{-13} \text{ cgs units}$

therefore considered together. Contrary to expectation there also appears to be little variation on account of the direction of the station relative to the magnetic meridian. These conditions appear to be confirmed by results published recently by the U.I.R. in "Documents du Comité Consultatif International Technique des Communications

Radioélectriques," page 709, in which a similar but rather wider field of observation is discussed. In the observations discussed here which were taken in the period between 1800 and 2400 G.M.T., the procedure was to take a record on a recording milliammeter over a period of five minutes or so. The maximum and minimum field intensities recorded

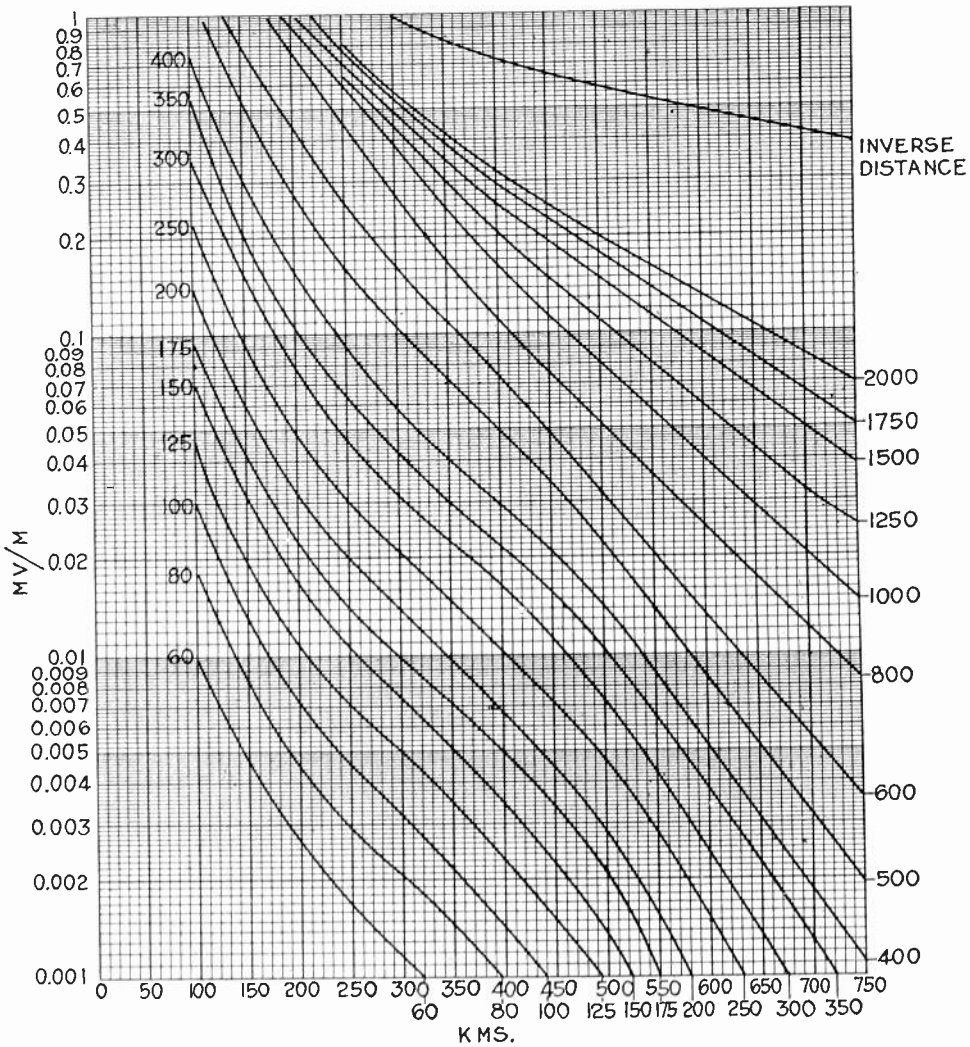

Fig. 13— $\left\{ \begin{array}{l} 100-750 \text{ kilometers} \\ 1.0-0.001 \text{ millivolts per meter} \end{array} \right\} \sigma = 1 \text{ kw. } 10^{-13} \text{ cgs units}$

were then measured. The intensities shown in Fig. 10 are the maximum observed intensities in the corresponding period. By such a method the effect of reduction by interference is minimized, but naturally the results will still be irregular on account of fading. This irregularity is revealed in the figure, but the observations are sufficient to show a very marked rise in intensity as the distance increases from 200 to 600 kilo-

meters where there is a fairly pronounced maximum. This maximum at 600 kilometers distance is also a feature of the U.I.R. curves. The figure, in fact, shows a great similarity to the "skip effect" observed on the shorter waves 15 to 60 meters.

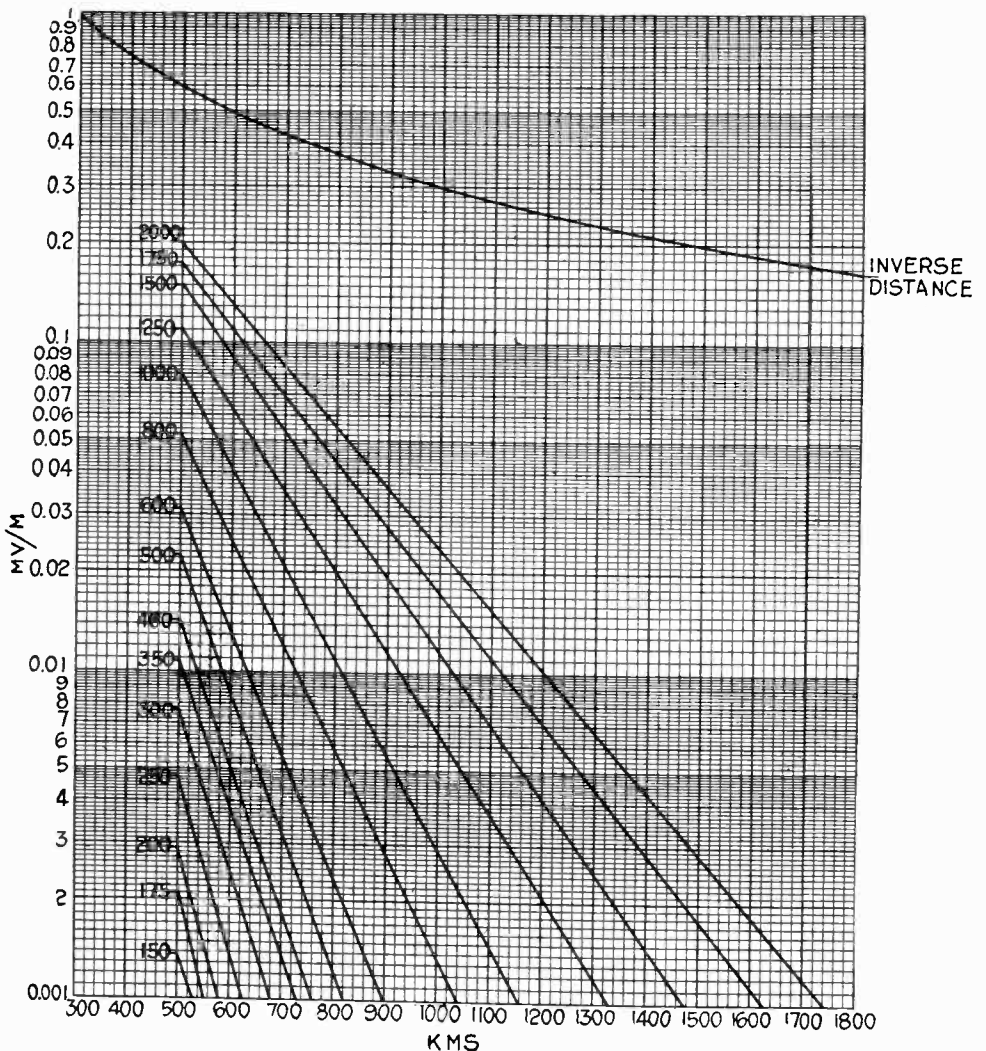

Fig. 14 — { 500–1800 kilometers }  $\sigma = 1 \text{ kw. cgs units}$   
 { 1.0–0.001 millivolts per meter }  $10^{-13} \text{ cgs units}$

These results enable an estimate of the probable reflected ray field intensity to be made. The theoretical significance of these observations will be reserved for another paper, it will be sufficient to note here that the intensities observed can be accounted for approximately on the assumption that the reflection coefficient of the layer is proportional to  $\sin^2\theta$ , where  $\theta$  is the complement of the angle of incidence of the ray at



the layer. The dotted curve represents the field intensity calculated on this assumption. The reflection coefficient is of the order of 10 per cent at 200 kilometers and approaches unity at 600 to 700 kilometers. The inverse distance curve is inserted for comparison. The field intensity of a single ray perfectly reflected should approach this ideal curve. In some cases the observed fields actually exceed the inverse distance field. This may imply the existence of more than one ray or may merely be due to the necessary inaccuracy of the measurements.

It is hoped that the results given in this paper will prove useful to radio engineers, especially those interested in broadcast problems. An outline of the main effects is given and the theoretical curves should enable one to predict the field of direct-ray transmission with some precision.



## VISUAL TEST DEVICES\*

BY

O. H. SCHUCK

(University of Pennsylvania, Philadelphia, Pa.)

*Summary*—A device for showing on a screen the frequency-response curve of a tuned circuit, tuned transformer, amplifier or complete radio set is described in this paper. The action of the device is practically instantaneous, and the effect of circuit adjustments may be seen immediately. The principles and operation of the device are explained, and it is shown how the derivative of the response curve may be obtained electrically and shown on the screen, to allow more accurate location of the resonant frequency, by giving a sharp crossing of the axis at that frequency.

Operating characteristics and fidelity curves for the latest development of this device are given.

MEANS for the rapid alignment and testing of radio receivers is a necessity if they are to be built in quantity. In the manufacture of receivers employing the superheterodyne circuit, difficulty has been experienced in properly aligning the intermediate-frequency amplifier by the usual maximum response methods. The three-stage transformer coupled intermediate-frequency amplifier of the earliest Radiola superheterodyne, which was built in catacomb form, gave a great deal of trouble in production testing and it was realized that the only really accurate test of its performance would be an examination of its amplifications versus frequency curve—the “frequency-response” curve. But the usual laboratory point-by-point method for determining this curve is long and tedious, and it was utterly out of the question to test each receiver in that way, as each time an adjustment was made, a new curve would have had to be run to note its effect. A testing apparatus was required which would show the frequency-response curve very quickly, so that the effect of adjustments could be noted, and the receiver trimmed for maximum efficiency in a reasonable length of time.

The first device developed to fill this need utilized a pointer with which the operator manually followed the movements of the output meter needle, as a motor driven condenser in the circuit of a vacuum tube oscillator slowly changed the frequency of the test signal input to the receiver. A pencil linked by a pantograph to the hand operated pointer drew a curve on a sheet of paper which was moved at right angles to the motion of the pencil at a rate proportional to the change

\* Decimal classification: R261. Original manuscript received by the Institute, May 5, 1932.

of frequency of the oscillator, so that the frequency-response curve was obtained. This was fairly satisfactory, and was used in production for some time after its introduction several years ago, but it was recognized as being much too slow. Subsequently a visual test device was developed to meet this problem.

The basic principles on which this visual test device operated were not entirely new. The forerunner of the modern visual test device is probably found in the patent of R. Hirsch,<sup>1</sup> dated 1911, for a visually indicating wavemeter. This wavemeter had a motor driven condenser with a neon lamp on the end of an arm attached to the condenser shaft and rotating with it. The neon lamp was wired to glow when the condenser setting was such that the condenser-coil circuit was resonant to the transmitter's frequency, and as the condenser rapidly rotated, the lamp glowed momentarily at a certain position in each revolution. Due to retentivity of vision, a stationary spot of light, whose position could be noted on a scale behind the lamp, was thus visible. Since the speed of revolution was fairly great, the effect of tuning adjustments to the transmitter could be noted almost instantaneously. In 1912, Marx and Banneitz published<sup>2</sup> a similar method for showing resonance curves by use of a cathode ray oscillograph. A fixed frequency oscillator was used and the motor driven condenser varying the tuning of the resonant circuit was mechanically coupled to an arm rotating in contact with a resistance in the form of a ring. The resistance, which was in series with the deflecting coils of the cathode ray tube, was thus varied in synchronism with the variation of capacitance of the condenser and the current variation through the deflecting coils swept the spot of light across the screen at a rate proportional to the rate of change of capacitance. The voltage across the condenser in the resonant circuit was impressed upon the deflecting plates of the cathode ray tube, and the envelope of the resultant curve on the screen had the shape of the resonance curve of the resonant circuit.

Considerable work had also been done by J. W. Legg<sup>3</sup> and H. I. Becker<sup>4</sup> on a device for showing the resonance curve of a single tuned circuit by means of a moving spot of light on a screen, the position of the spot being controlled by simultaneous movements of a galvanometer mirror and a rocking mirror. The principles used by these men have been embodied in the present apparatus.

<sup>1</sup> Patent 1064325.

<sup>2</sup> E. Marx and F. Banneitz, *Jahrbuch der Drahtlosen Telegraphie und Telephonie*, vol. 6, p. 146, (1912).

<sup>3</sup> J. W. Legg, Westinghouse Manufacturing Company.

<sup>4</sup> H. I. Becker, General Electric Company.

## DEVELOPMENT

Since 1925 all Radiola superheterodyne receivers have been adjusted and tested by use of the visual test devices. Improvements and refinements, including the development of the Universal Visual principle which will be mentioned later, were continually being made on the apparatus in use until 1930, when the concentration of all broadcast receiver manufacture at the Camden factory necessitated the installation of new and uniform test equipment. Development of this equipment was carried on at Camden in the spring of 1930 to prepare for a large production schedule in the fall. In fulfilling this schedule, the visual test devices were highly successful, and experience with their operation has enabled the building of the latest refined model of the visual testing device, which it is the purpose of this paper to describe in detail.

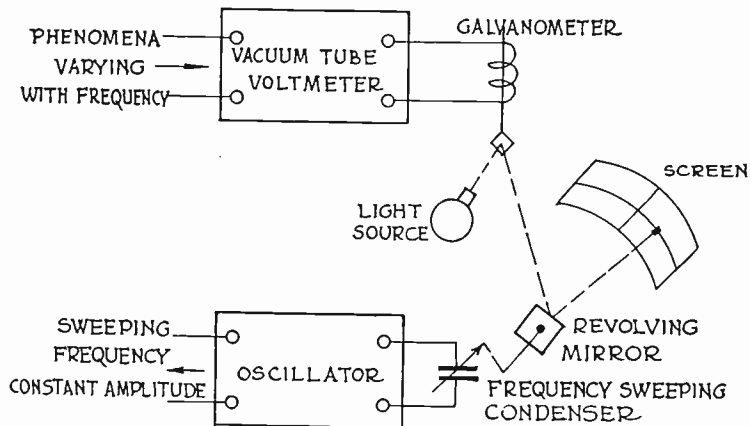

Fig. 1—Fundamental principle of the visual test.

## DESCRIPTION OF OPERATION

First, it may be well to review the theory of operation of visual testing devices. Since most performance characteristics with which the engineer deals can be represented by curves, it has become customary to illustrate performance in this manner—by a curve showing how one quantity in which we are interested varies as the value of another quantity (upon which the first is dependent) changes. The radio engineer is particularly interested in those characteristics of electrical apparatus which depend upon frequency, so let us consider the apparatus as arranged for such a test. Referring to Fig. 1, the constant amplitude output current from a vacuum tube oscillator whose frequency is determined by the setting of a variable condenser is fed to the apparatus being tested. As the variable condenser is driven by a motor, the frequency of the output current will periodically be swept between defi-

nite limits a number of times a second and will therefore be referred to as the "sweeping frequency." An alternating-current voltage representing the output of the apparatus being tested (which varies with the instantaneous value of the frequency) is impressed upon the grid circuit of a vacuum tube voltmeter, whose direct-current plate current then depends upon the amplitude of the alternating-current voltage. This varying direct current flows through an oscillograph galvanometer, and controls the vertical motion of a spot of light on a screen. The horizontal motion of the spot is simultaneously controlled by a revolving mirror geared to the motor driven frequency-sweeping condenser, so that its position at every instant shall depend upon the fre-

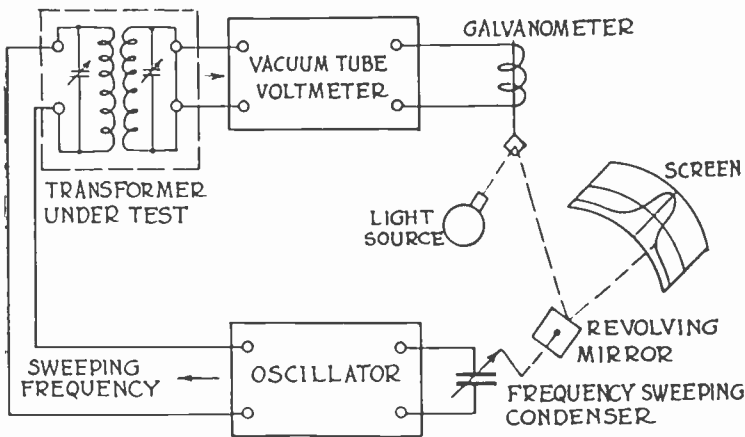

Fig. 2—Visual test of transformers.

quency of the oscillator at that instant. As the condenser revolves, the spot thus repeatedly traces the desired curve on the screen. Due to persistence of vision, if the speed of repetition is great enough, the curve is seen as a line of light on the screen.

The visual test device is much used in the alignment of intermediate frequency transformers. See Fig. 2. It is seen that the vacuum tube voltmeter measures the amplitude of the voltage across the secondary of the transformer. The spot of light then traces the secondary voltage vs. input frequency curve (frequency-response curve) the usual method of representing the behavior of a tuned transformer. The effect of tuning the primary, tuning the secondary and varying the coupling may be readily observed.

#### UNIVERSAL VISUAL PRINCIPLE

If the primary of the transformer as shown in Fig. 2. be made to have a small reactance and is not tuned, it will have a negligible effect on the tuning of the secondary, and the response curve for the trans-

former will be the resonance curve of the tuned circuit which is used as the secondary. Such a circuit may be used for the rapid testing of coils for proper inductance by substitution for the standard in the secondary tuned circuit. If the frequency of resonance is the same, as shown by the location of the maximum point of the response curve on the screen, the inductance of the coil being tested is the same as that of the standard. Condensers may be similarly tested by substitution for the standard condenser.

It is well known that it is difficult to determine the exact frequency of resonance by examination of the resonance curve, due to the usual wide, rounded shape of the top of the curve. However, if the first de-

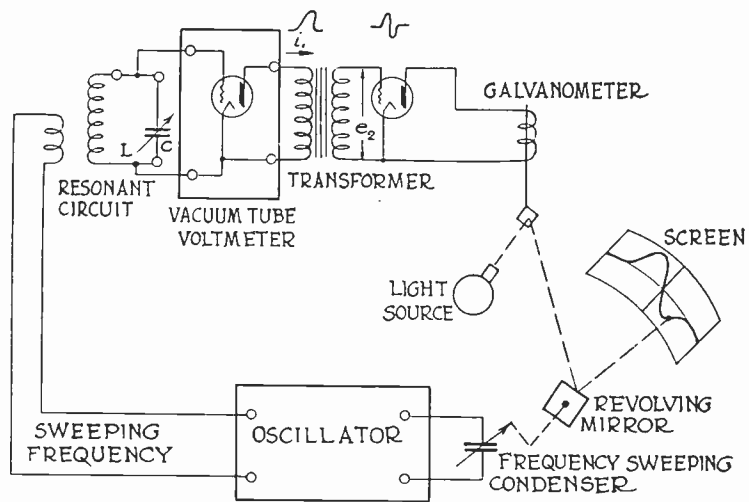

Fig. 3—Universal visual.

ivative of this curve be taken, it will be found to cross the horizontal axis sharply at the frequency of the maximum point of the response curve. This intersection is much easier to locate than the maximum point of the simple response curve, and is to be preferred for indication in production testing.

The first derivative curve may be electrically obtained by simple means. One method uses a transformer, as shown in Fig. 3. The plate current of the vacuum tube voltmeter flows through the low impedance primary of this transformer instead of through the galvanometer and induces a voltage across the secondary proportional to the time rate of change of the primary current. (See Appendix A.) By means of a vacuum tube amplifier, with the transformer secondary in its grid circuit and the galvanometer in its plate circuit, the spot of light on the screen is caused to move in a vertical direction in proportion to the secondary voltage of the transformer. As the spot is also being moved

horizontally by the rotating mirror in proportion to the frequency, it will trace the first derivative curve of the resonance curve.

A resistance-capacitance coupled stage of amplification may also be used to obtain the derivative curve. If the capacitor be small, the voltage across the grid resistance will be the derivative with respect to time of the plate current of the preceding vacuum tube voltmeter. (See Appendix B.) This is the method now used, as it permits more simple switching in selecting either the resonance curve or the derivative curve.

#### DESCRIPTION OF LATEST MODEL

Benefiting from several years' experience in building and using visual test equipment, a model incorporating many improvements has recently been developed in the laboratories of the RCA Victor Company. This device may be used either for the alignment of radio- and intermediate-frequency transformers and amplifiers, or for the testing of coils and condensers. The change from frequency-response curve to derivative curve is made by the turn of a switch. As a transformer testing device, it can be used to show the frequency-response curves of individual transformers or the over-all response curve for any number of tuned stages, over any desired frequency range from 40 kc to 1500 kc. The range of frequency covered during each revolution of the sweep-condenser can be varied from 30 per cent to 1/10 of 1 per cent of the mean frequency.

As a universal visual testing device, it can be used to test coils and condensers at any frequency from 40 kc to 1500 kc. Self-contained means are provided to measure the inductance of coils of 1 microhenry to 100 millihenries, and the capacitance of condensers of 3 microfarads to 10 microfarads. Calibration curves and alignment charts enable rapid adjustment and measurement. Provision is made for photographic recording of curves.

#### MECHANICAL DESIGN

A general view of this Visual Testing Instrument is given in Fig. 4. It is a self-contained unit, requiring only a 75-watt, 110-volt alternating-current supply and a 2-watt, 180-volt direct-current supply for power; it is contained in a cabinet 25 inches high, 24 inches wide, and 13 inches deep. On the front near the top is mounted the removable visor, to shield the translucent celluloid screen on which the curve appears from extraneous light. Below this visor are two panels, the upper one being the main control panel and carrying the controls for adjustment of mean frequency and range of frequency sweep. This panel also carries the output meter, master attenuator, and three individual stage

attenuators, so that in testing an amplifier, one, two, and three stages may be tested successively without changing the height of the response curve, since the input to the amplifier is reduced as more stages of amplification are tested.

The lower panel is in three sections. On the left-hand section are two switches, one to enable the detector tube to be used as an amplifier when the second detector of the radio set being tested is used, the other to allow either the resonance curve or the derivative curve to be



Fig. 4—General view of visual testing instrument.

obtained at will. In the center are the controls for the inductances and capacitances used in testing coils and condensers by use of the "universal principle"; and at the right is the tube load panel, whose single knob adjusts a resistance used as a load, to enable matching the plate resistance of the second detector tube in testing superheterodyne receivers, and to simulate the plate resistance of a tube when feeding a tuned circuit under test.

The top of the cabinet has a lid that may be raised to give access to the upper compartment which contains the optical system, whose components are mounted on a shelf forming the top of the main control unit (immediately behind the main control panel). The main con-



trol unit and optical system may be removed from the cabinet together for inspection and servicing as shown in Fig. 5. In this photograph, taken from the rear, it will be seen that a partition divides the upper compartment, so that the only light that can reach the screen *F* from the lamp *A* at the right, is that coming through the condensing lens and slit contained in the tube *B*. After passing through the condensing lens and into the larger compartment, the beam of light is reflected from the mirror of the galvanometer *C* and given a vertical deflection proportional to the current through the galvanometer. Then, after passing

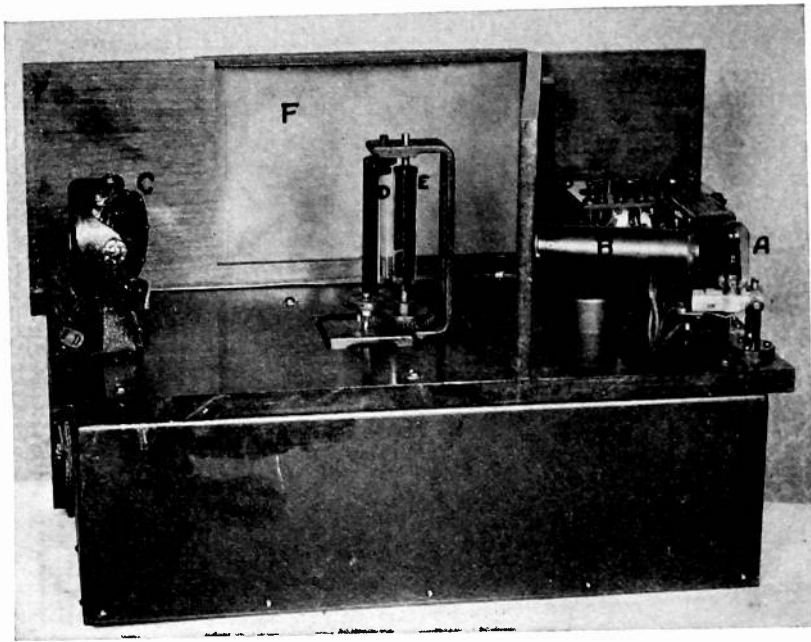

Fig. 5—Optical system and main control unit—rear view.

through the cylindrical condensing lens *D*, it is reflected to the curved translucent screen *F* by the square revolving mirror *E* which gives it a horizontal deflection proportional to the frequency. This mirror, which gives the spot of light formed on the screen by the beam its horizontal motion, is geared to the sweep-condenser immediately below in the main control unit, and is belt driven by a small electric motor. This motor was removed to allow a full view of the galvanometer and consequently does not appear in Fig. 5.

In order to allow permanent records of curves to be made photographically, the visor and screen may be removed to permit attachment of a special camera loaded with 4 inch  $\times$  5 inch cut film. A shutter controlled by the mirror gear is used to allow exposure during just one trace of the curve by the spot of light.

The electrical circuit is shown in block form in Fig. 6. It is seen that the motor drives the sweep-condenser and the rotating mirror in synchronism, so that as the sweep-condenser varies the frequency of the oscillator, the spot of light is caused to move across the screen in proportion to frequency. The oscillator output current is led through the attenuator to the Universal panel, which contains a tuned circuit with adjustable parameters, into which the inductance or capacitance to be tested may be inserted.<sup>5</sup> The radio-frequency voltage whose amplitude is varying with the phenomena being tested is led to the detector and

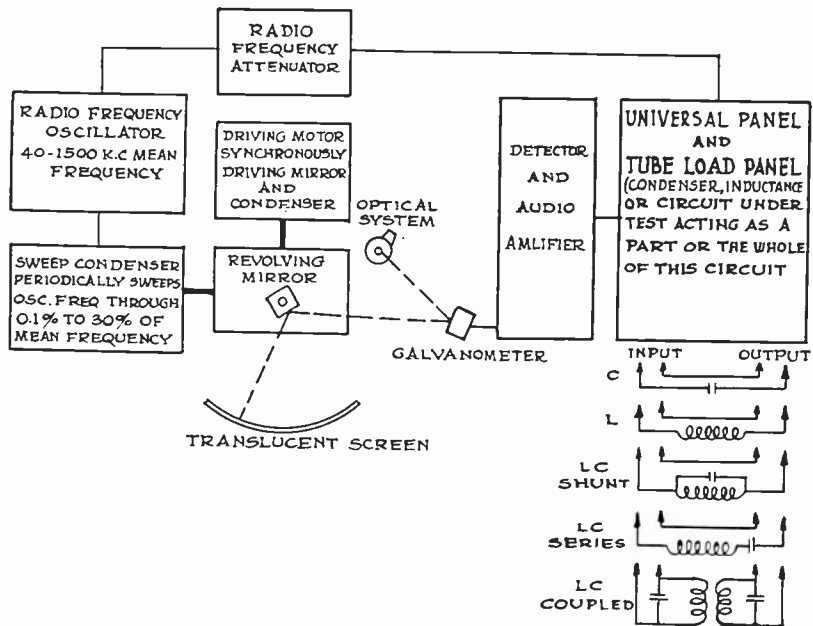

Fig. 6—Universal visual—schematic diagram.

audio amplifier, whose output causes the galvanometer to give the spot of light on the screen its vertical motion, as explained before. The resistance-capacitance coupling between the detector tube and amplifier tube may be changed so that either the frequency-response curve or its derivative curve is obtained on the screen. (See Appendix B.)

#### DESCRIPTION OF OPERATION

When used to align tuned radio-frequency receivers, the mean frequency of the oscillator is adjusted to the desired testing frequency with a sweep of about 40 kc and its output is introduced through the master attenuator to the input circuit of the receiver. The detector is connected to the tube-load resistance, and the self contained detec-

<sup>5</sup> Switching arrangements are available for eliminating these adjustable parameters when testing transformers and amplifying stages.

tor tube in the visual test set is used as an amplifier. The frequency-response curve is obtained on the screen, and by adjustments on the receiver under test may be made to take the desired position and shape.

Complete superheterodyne receivers, or their radio-frequency amplifying stages alone, may be similarly tested. In aligning the intermediate-frequency amplifier of a superheterodyne receiver, the output voltage from the receiver is obtained as before, from the plate circuit of the second detector. The mean frequency of the oscillator is set to the intermediate frequency (usually 175 kc) with a sweep of about 40 kc, and its output, after passing through the master attenuator and the

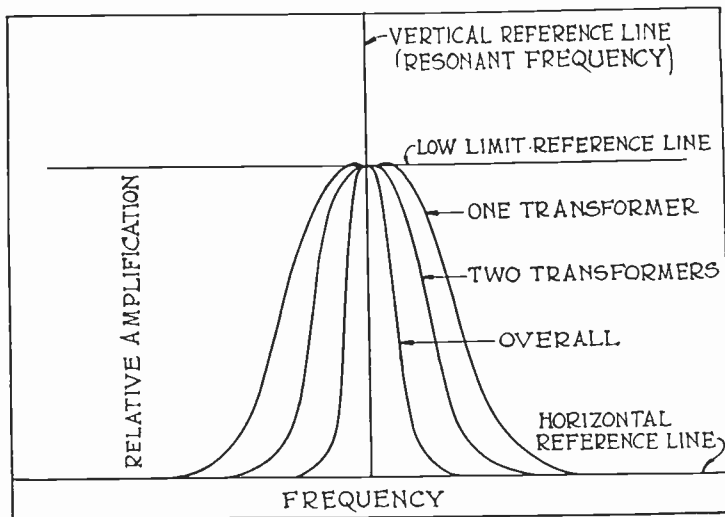

Fig. 7—Typical response curves of three-stage intermediate-frequency amplifier.

stage attenuators, is introduced into the grid circuit of the tube feeding the transformer under test. It is possible to test the third, second-third, or first-second-third stages, in succession. By means of the three stage-attenuators, input may be so decreased as more stages are tested, that the height of the frequency response curve will be the same in each case. It is thus possible to align the transformers one at a time in the circuit in which they are to be used, and finally to see the over-all frequency response curve of the complete amplifier. Sample curves thus taken are shown in Fig. 7.

Before the intermediate-frequency transformers are assembled in the complete receiver, each one, in its metal shielding can, may be first separately aligned. For this purpose, the mean frequency of the oscillator is adjusted as before to 175 kc with 40-kc sweep, and its output is introduced into the primary circuit of the transformer through the master attenuator and tube-load panel as in Fig. 6. The voltage across

the secondary of the transformer is impressed between the grid and cathode of the detector in the visual test set, now biased as a detector, and the frequency-response curve is obtained on the screen. By adjusting the condensers tuning the primary and secondary, the re-

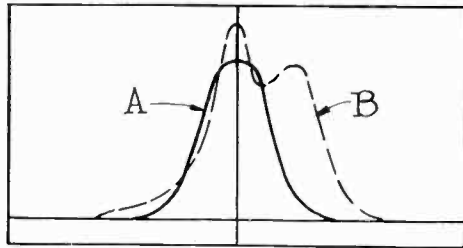
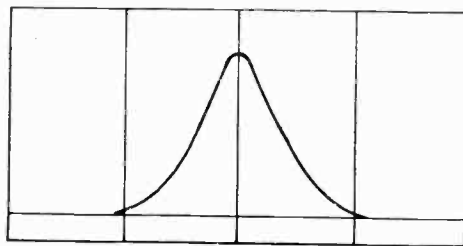
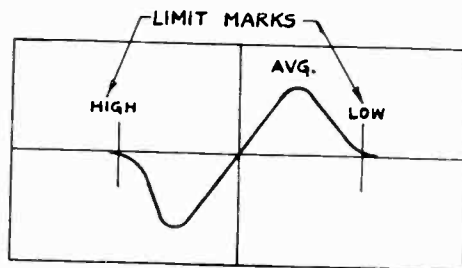

Fig. 8—Response curves on intermediate-frequency transformer.  
 A—Curve obtained after adjustment on visual test instrument.  
 B—Curve obtained by aligning transformer with crystal oscillator and output meter.

sponse curve of the transformer may be made to take the desired position and to have the desired shape—either flat-topped or peaked. Sample curves for single transformers are shown in Figs. 7, 8, and 9A



A



B

Fig. 9A—Typical screen image of simple resonance curve.  
 Fig. 9B—Typical screen image of first derivative curve of simple resonance curve.

Curves giving cause for rejection of defective transformers are shown in Fig. 10. Fig. 8 shows how a transformer giving a double-hump curve would be recognized by use of the visual method, while it would be passed as satisfactory by the usual method using a fixed frequency and

tuning for maximum reading of an output meter. The advantage of the visual method in such tests is obvious.

In order to test component parts, the parameters of the circuit in the universal panel are adjusted by reference to the calibration charts, the part to be tested is connected as shown in Fig. 6, and the mean frequency of the oscillator is adjusted to the average frequency at which the part is to be used (to allow for skin effect, distributed capacitance, and distributed inductance) with a sweep of about 20 per cent of the mean frequency. If, for instance, a condenser is to be tested at 1000 kc, it is either made part of a circuit which should be resonant at 1000 kc if its capacitance is correct, or is substituted for a standard

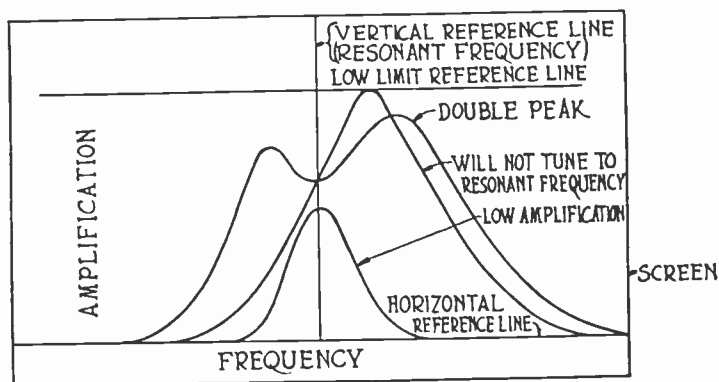

Fig. 10—Curves of rejected intermediate-frequency amplifiers as shown by visual test equipment.

condenser in a circuit already resonant at that frequency. The sweeping-frequency current is introduced into the resonant circuit through a resistance while the voltage across the resonant circuit is impressed between the grid and cathode of the self contained detector tube and the switch thrown to give the derivative of the frequency-response curve, that is, the derivative of the resonance curve of the tuned circuit. If the condenser has the proper capacitance, the resonance curve will be as in Fig. 9A, and the derivative curve will be seen on the screen as shown in Fig. 9B. High and low acceptance limit lines can be drawn on the screen to facilitate rapid production testing. If the sweep is 5 per cent of the mean frequency, a difference in the resonant frequency of as little as  $\frac{1}{4}$  of 1 per cent—corresponding to  $\frac{1}{2}$  of 1 per cent error in the total capacitance—is shown by a half-inch displacement of the line of light on the screen.

Coils may be similarly tested, as well as either series or shunt combinations of coils and condensers, as shown in Fig. 6.

## IMPROVEMENTS ON PREVIOUS MODELS

In comparison with previous models, the new universal visual test set shows many improvements and refinements in its mechanical design. Placing the lamp in a separate compartment has completely eliminated stray light on the screen. Use of a concentrated filament lamp and an improved optical system has resulted in a twelvefold reduction of the size of the spot of light on the screen, so that a curve shows up on the screen as a line of light no wider than a heavy pencil line. The slight wobble of the curve due to the inequalities of the four faces of the previous metal mirror has been eliminated by employing a smaller, silvered-glass-on-steel mirror with a bearing at each end of its shaft.

To replace the previous electrocardiograph galvanometer whose response limit was 100 cycles per second a new instrument was specially designed with an upper limit of about 800 cycles per second to allow the spot to follow faithfully the most complex resonance curves possible. Since the galvanometer was so much faster, it was possible to increase the condenser and mirror speed so that the spot of light now makes about twenty traces of the curve per second, thus completely eliminating flicker.

In raising the upper frequency-response limit of the galvanometer, it was necessary to decrease the sensitivity, but the useful output of the oscillator was so greatly increased by changing the measuring instrument to one consuming negligible power as to much more than counterbalance the decreased sensitivity. A 4.5-ohm thermocouple meter had previously been shunted across the output of the oscillator, but now a high resistance vacuum thermocouple meter is used.

In the present design of the electrical circuit, the attempt has been made to make this visual test set flexible but self-contained. Thus the master attenuator, stage attenuators, and tube loads are all included within the cabinet instead of in special test jigs as before; and the same instrument may now be used to give either the frequency-response curve or its derivative curve by turning a switch. No adjustment of amplitude is necessary when making this change, since the derivative curve is obtained by the use of the resistance-capacity coupled amplifier stage method as explained in Appendix B, and by proper selection of the sizes of resistors and condensers, the sizes of the two curves on the screen are kept approximately the same.

Changes in the capacitance circuit of the oscillator, including the insertion of a calibrated condenser in series with the sweep-condenser, have made possible the control of the limits between which the frequency varies, as well as its mean value.

## OPERATING CHARACTERISTICS

*-Frequency Stability*

Inspection of the frequency stability curve of Fig. 11 will show that the mean frequency of the oscillator drops continuously throughout the day, the drop during the first hour being more than half the total drop of 0.1 per cent at 180 kc. The curve asymptotically approaches a limiting frequency determined by temperature equilibrium, but after the first hour the variation is not more than 0.05 per cent at 180 kc. This variation should be negligible in ordinary work, and can be eliminated by allowing the instrument to warm up a sufficiently long time before use.

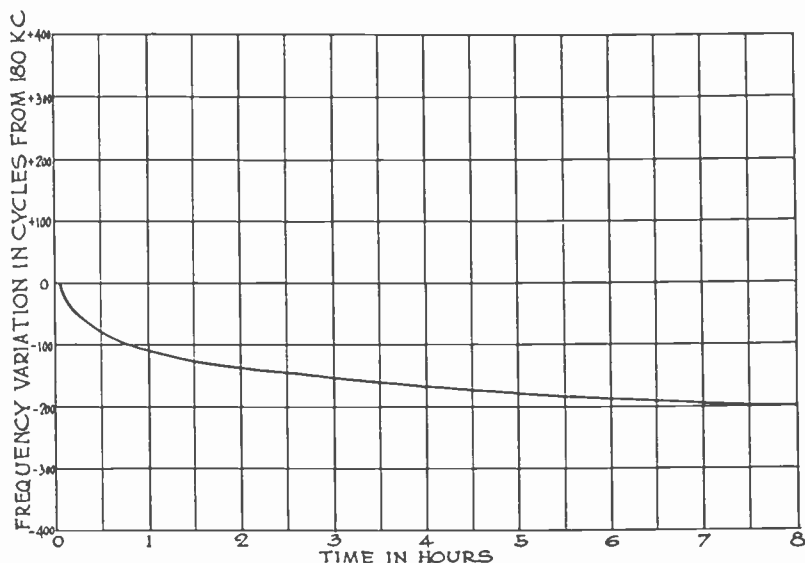

Fig. 11—Oscillator frequency stability curve.

*Frequency Variation in Sweep Range*

A practical compromise is necessary between flexibility and accurate straight line variation of frequency over the sweep range. However, Fig. 12 shows that the frequency variation is very nearly linear with motion of the spot of light on the screen. Only the middle half of the screen is ordinarily used, and the least linear curve is only 1.5 kc off straight-line variation at the left-hand limit of the middle half. By working to the right of the center of the screen in this case, it will be seen that this error may be eliminated.

*Detector Calibration*

The curvature of the detector characteristic is of greater concern. By using a screen-grid tube as a fixed bias detector, it was possible to

make the upper five-sixths of the curve of plate current increase against input alternating-current voltage (see Fig. 13) substantially a straight

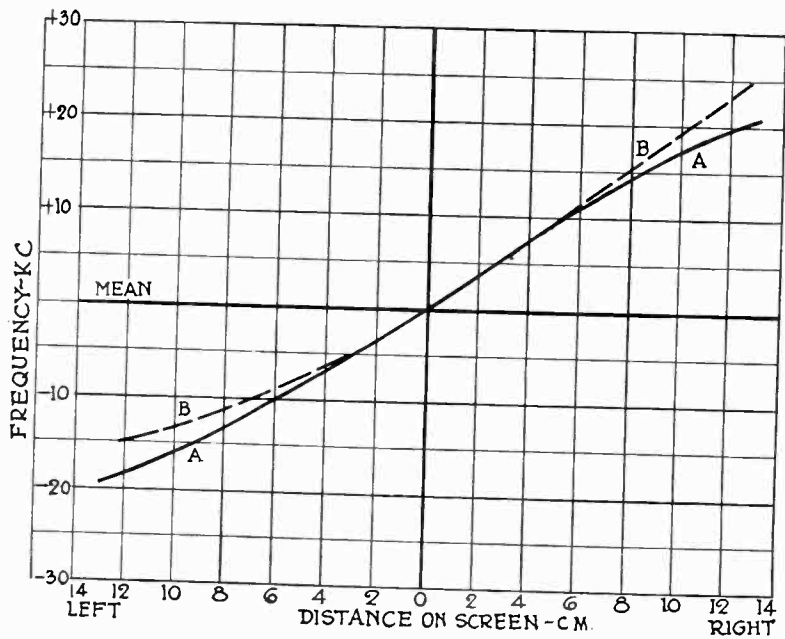

Fig. 12—Frequency variation within sweep range.  
Mean frequency—A—175 kc and 600 kc; B—1400 kc.  
Frequency sweep—40. kc.

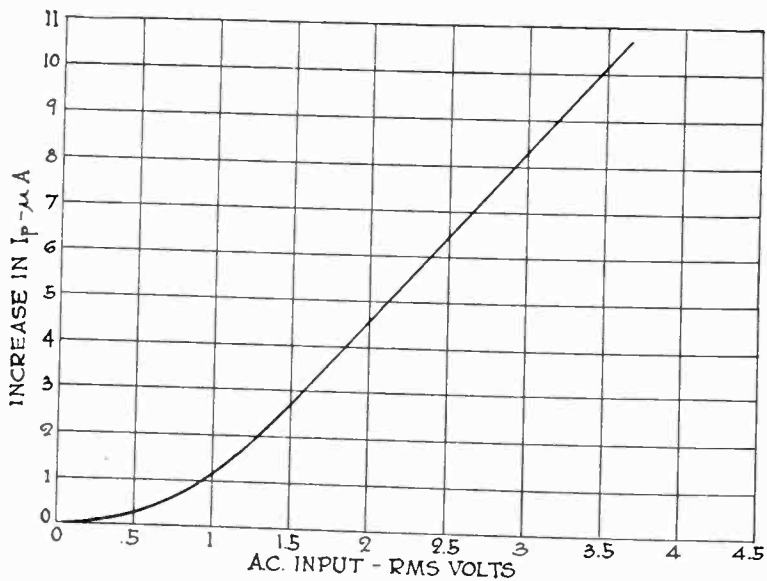

Fig. 13—Detector calibration curve. UY-224 at 175 kc.

line. The curvature at the foot of the curve has the effect of shrinking the lower parts of the response curve in a vertical direction. Since usually it is the peaks of the curve that are of particular interest, this



nonlinearity of indication with response in the lower part of the curve is advantageous as a greater portion of the screen may be used for the peak of the curve. If the whole true response curve is desired, the curve as shown on the screen may be replotted using the detector calibration curve.

#### Galvanometer Calibration

The deflection of the spot of light on the screen is exactly proportional to the current through the galvanometer, within the limits of measurement, spot size, etc. Since the screen is a vertical surface, and the angular deflection of the galvanometer is proportional to current, the deflection current curve should vary about the center position ac-

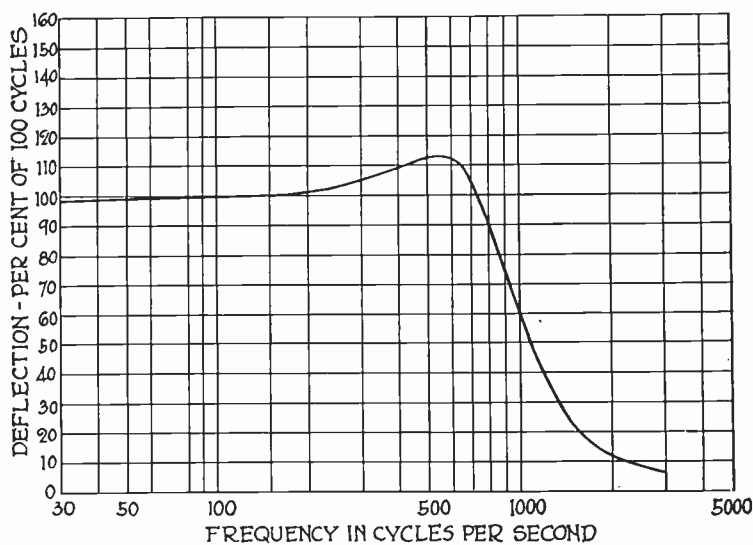

Fig. 14—Frequency response curve of galvanometer in plate circuit of UY-227 tube. Galvanometer temperature 31.5 degrees Centigrade.

ording to a trigonometric tangent curve. However, the angle is so small that the tangent curve does not measurably deviate from a straight line in the height of the screen.

The frequency response curve of the galvanometer now used is given in Fig. 14. This was taken at a temperature reached after several hours of operation. This precaution was necessary, as the oil used as a damping medium becomes less viscous with increase of temperature. Deflection constant with frequency to within twelve per cent is shown up to 900 cycles per second. A Fourier analysis of the most critical form of response curve; i.e., the flat-topped curve, shows that at the usual operating speed of twenty sweeps per second, a galvanometer capable of indicating frequencies up to 600 cycles per second will correctly indicate the response curve to within the width of the line, so that error due to the galvanometer is negligibly small.

### Speed Fidelity

In Appendix B, it is shown that the response curve itself is obtained exactly if the ratio of capacitance to resistance of the resistance-coupled stage be made large enough. If this ratio is not sufficiently large, the response curve of a tuned circuit when shown on the screen will change when the number of sweeps, and therefore the speed of sweep, is changed. Fig. 15 shows three tracings of the very critical double-peak response curve, taken respectively at a very slow speed, the normal operating speed, and a high speed. The curves are so nearly alike that the as-

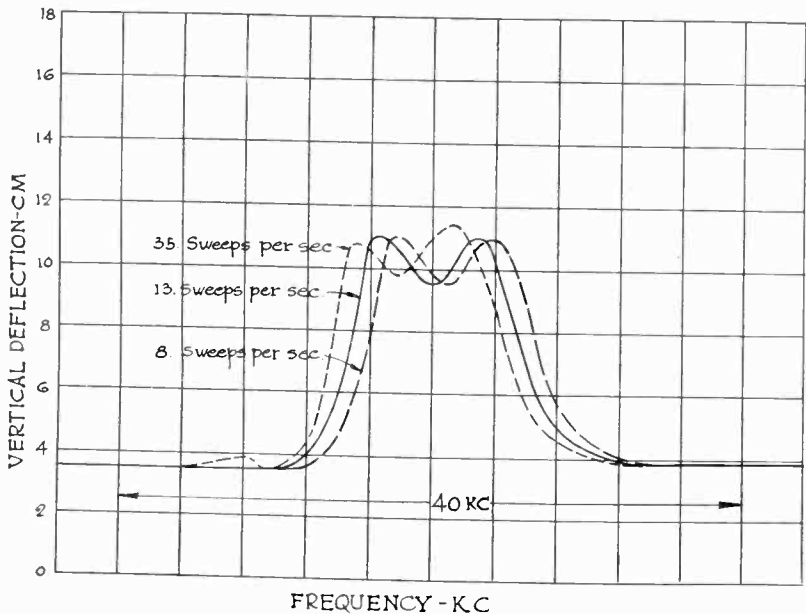

Fig. 15—Speed fidelity curves. Single intermediate-frequency transformer. Primary and secondary tuned. Coupling greater than critical.

sumptions made are considered justified. The respective time shifts are due to the phase shift introduced by a condenser inserted in series with the galvanometer for the purpose of blocking the steady component of the amplifier tube plate current.

Considering all the various sources of error, it may be said that this latest model of the visual test instrument, when properly used, is sufficiently accurate for all ordinary laboratory and production work.

### ACKNOWLEDGMENT

The writer is indebted to the RCA-Victor Company for assistance rendered in the preparation of this paper, and particularly to Mr. H. J. Schrader of the RCA-Victor Company for taking the performance curves included in this paper.

## APPENDIX

Analysis of methods of obtaining derivative curve of resonance curve.

A—Transformer Coupling—See Fig. 16 and refer to "Universal Visual Principle."

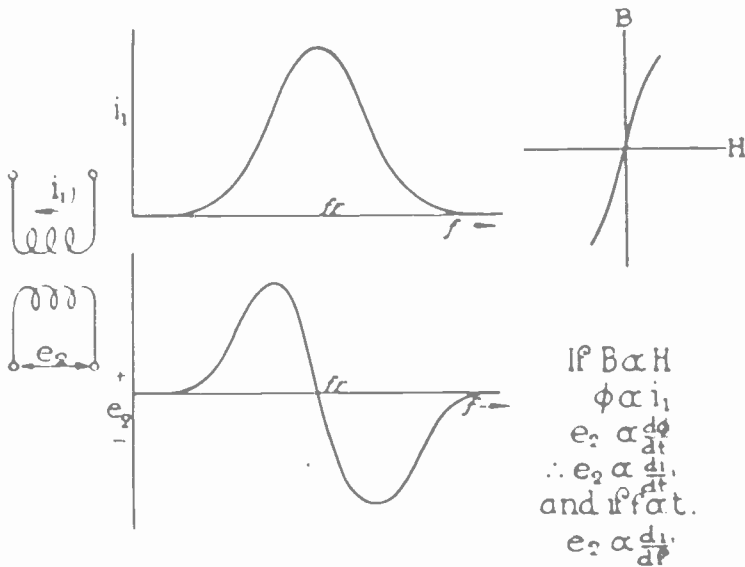

Fig. 16 Universal visual principles.

B—Resistance Capacitance Coupling. Refer to Fig. 17.

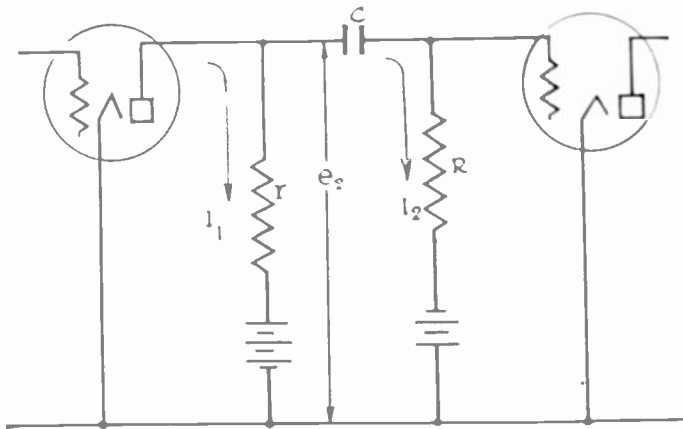

Fig. 17

If  $i_0$  is assumed zero, and  $r$  is fairly small compared with the impedance of  $C$  and  $R$  in series, so that  $e_2$  may be assumed equal to  $ri_1$ , where  $i_1$  and  $i_2$  represent currents in the first and second mesh, then

$$e_2 = Ri_2 + \frac{1}{C} \int i_2 dt.$$

If  $C$  is small, so that at the frequency used, 20–100 cycles per second,  $X_c \gg R$  we may neglect  $R$ .

Then,

$$e_2 = \frac{1}{C} \int i_2 dt$$

and,

$$\frac{de_2}{dt} = \frac{1}{C} \cdot i_2$$

so that,

$$i_2 = C \frac{de_2}{dt} = Cr \frac{di_1}{dt}$$

and,

$$e_0 = Ri_2 = RCr \frac{di_1}{dt}$$

Since,

$$f = Kt$$

$$\therefore e_0 = KRCr \frac{di_1}{df}$$

If however,  $(X_c + R)$  be still large compared to  $r$ , but the ratio of  $X_c$  to  $R$  be changed so that  $R$  is large compared to  $X_c$  then we may neglect  $X_c$  in

$$e_2 = Ri_2 + \frac{1}{C} \int i_2 dt$$

and then

$$e_2 = Ri_2$$

$$i_2 = \frac{e_2}{R} = \frac{ri_1}{R}$$

$$e_0 = \frac{Rri_1}{R} = ri_1.$$

If the assumptions made as to the relative sizes of  $(X_c + R)$  and  $r$  are not justified, the variation of  $e_2$  will not be exactly according to the resonance curve as shown by the variation of  $i_1$ . Also, if the assumptions made as to the relative sizes of  $X_c$  and  $R$  are not true, a combination of the resonance curve and the derivative curve will be obtained.

## COPPER-OXIDE RECTIFIER USED FOR RADIO DETECTION AND AUTOMATIC VOLUME CONTROL\*

BY

L. O. GRONDAHL AND W. P. PLACE

(Union Switch and Signal Company, Swissvale, Pennsylvania)

*Summary*—A new type of radio detector has been developed which depends for its action on the rectifying properties of the boundary between copper and cuprous oxide formed on the copper at a high temperature. In order to make the copper-oxide rectifier useful up to broadcast frequencies, it was necessary to use small disks and a high current density. The high current density was obtained in part by connecting an inductance in parallel with the rectifier and tuning it with the rectifier capacity.

The circuits developed possess unique advantages in that harmonic distortion is practically eliminated, a stage of audio-frequency amplification is eliminated, and automatic volume control of variable  $\mu$  tubes as well as other tubes is achieved without the necessity of using an auxiliary tube for volume control. A new form of automatic volume control made possible by the use of a single rectifier element as an asymmetrical resistance is described and discussed.

### I. GENERAL

IN THE early days of radio, when the spark transmitters were common and vacuum tubes were not, the crystal detector was accepted as standard. With the coming of broadcasting and the intensive development in radio which came with it, the crystal detector still persisted for a time because of the higher quality that resulted when it was used. As radio became commonplace, however, and the average listener became one who demanded reliable performance, the crystal detector was soon crowded out by the more reliable tube detector and development of the crystal detector ceased.

Tube detectors took the field because of their convenience and reliability. While it was known from the beginning that tube detectors introduced a certain amount of second harmonic distortion, this distortion was not great compared with the distortion introduced by other parts of the circuit and could therefore be overlooked. In the past few years, with improved broadcasting stations, improved radio frequency tuners, and improved amplifiers and speakers, the distortion introduced by the conventional tube detector has become more important and has been receiving more and more criticism and attention. Studies made by various men indicate that the more widely used tube

\* Decimal classification: R356.3. Original manuscript received by the Institute, June 22, 1932.

detectors introduce amounts of second harmonic distortion ranging from a little less than 5 per cent to more than 10 per cent, depending on the type of detector, the input voltage level, the percentage of modulation, etc.<sup>1</sup> The need of a linear detector has been realized and many attempts to get one have been made.<sup>2</sup>

## II. PRESENT-DAY DETECTORS

In the following paragraphs we mention the most popular systems of tube detection with some of their characteristics:

(1) One of the most popular forms of tube detectors is the *power grid detector*. This type of detector gives fairly good quality, the second harmonic distortion being somewhat less than 5 per cent when the detector is operated under favorable conditions.<sup>1</sup> One of its deficiencies lies in the fact that the power output is limited; so that until the coming of the pentode, an intermediate stage of amplification between the detector and the power output stage was necessary. Another unsatisfactory condition is that it produces attenuation of the higher modulation frequencies.<sup>3</sup>

(2) The *bias rectification*, or *plate rectification*, type of detector has some advantage in that the power delivered by it is somewhat larger than that delivered by the power grid detector and its frequency response is somewhat better than the power grid type,<sup>3</sup> but its harmonic distortion is considerably greater.<sup>1</sup>

(3) Another form of detector that seems to be gaining some popularity is the *diode detector*. This detector employs but two elements—usually the cathode and the grid, or sometimes the cathode as one element and the grid and plate tied together as the other element. This diode is then used as a simple half-wave rectifier.

This scheme enables detection to take place with a smaller amount of second harmonic distortion, but it is expensive not only in that the tube used as the detector adds nothing to the gain of the set, but also in that, because of its relatively large amount of damping, it requires more amplification ahead of it than does either of the other two types of detector mentioned. Another disadvantage is that it must be followed by a stage of audio amplification in order to raise the audio-frequency voltage sufficiently to energize the power output stage.

(4) A fourth type of the tube detector is the *push-pull detector*.

<sup>1</sup> Terman and Morgan, "Some properties of grid leak power detection," PROC. I.R.E., vol. 18, p. 2160-2175; December, (1930).

<sup>2</sup> Stuart Ballantine, "Detection at high signal voltages," PROC. I.R.E., vol. 17, p. 1153-1177; July, (1929).

<sup>3</sup> J. R. Nelson, "Grid circuit power rectification," PROC. I.R.E., vol. 19, p. 489; March, (1931).

This detector has been given some notice on account of its low harmonic distortion, but it is expensive because two tubes are necessary.

### III. DETECTOR REQUIREMENTS

The requirements of an ideal detector may be summed up as follows:

- (1) It should introduce no appreciable harmonic of the modulation frequency.
- (2) It should have a good frequency characteristic; that is, it should not discriminate for or against any of the modulation frequencies in the audible range.
- (3) It should deliver sufficient power to feed the power output stage directly and thus do away with the intermediate audio-frequency amplifier stage.
- (4) The number of tubes should be kept down to a minimum.

As far as the authors are aware, there is no type of tube detector that satisfactorily meets all these requirements. The fact that set manufacturers are willing to add extra tubes in order to get rid of the harmonic distortion introduced by the usual type of detector, and the fact that the buying public is willing to pay the extra cost show that there is a real demand for higher quality. The copper-oxide detector was developed with a view toward getting the best possible quality and at the same time keep down the cost by making extra tubes unnecessary.

### IV. COPPER-CUPROUS-OXIDE RECTIFIER

It has been suggested from time to time that the copper-oxide rectifier,<sup>4</sup> which has a very high ratio of rectification and a high efficiency and a very long life in ordinary commercial applications,<sup>5</sup> would be useful as a radio detector, but it is only during the last year, prompted by the great interest shown in the elimination of distortion in radio detectors, that intensive work has been done on this problem.

The characteristics of the copper-oxide rectifier which make it ideal for use as a radio detector are illustrated by the voltage-resistance curve shown in Fig. 1. An inspection of this curve shows that while the absolute magnitudes both of the forward resistance and of the back resistance change considerably with increased voltage, the relative magnitudes do not change greatly once a small voltage is applied. As the voltage is increased, if a suitable load resistance has been chosen, the forward resistance quickly becomes negligibly small in comparison with the load resistance and the back resistance becomes so large that

<sup>4</sup> L. O. Grondahl, U. S. Patent No. 1,640,335.

<sup>5</sup> L. O. Grondahl and P. H. Geiger, *Proc. A.I.E.E.*, p. 357, (1927).

its effect can be neglected. It should be noted also that this holds true over a very considerable range of voltage. More will be said about the rectifier characteristics later.

There are, however, characteristics that impose difficulties. One of the circumstances that has caused experimenters to hesitate to try to use the copper-oxide rectifier as a detector is the high electrostatic capacity of the rectifying boundary. The most important step in the present development consisted in finding the conditions under which the effect of this capacity becomes negligible. One way of reducing the effect of the capacity is to use a small area of rectifying boundary. This

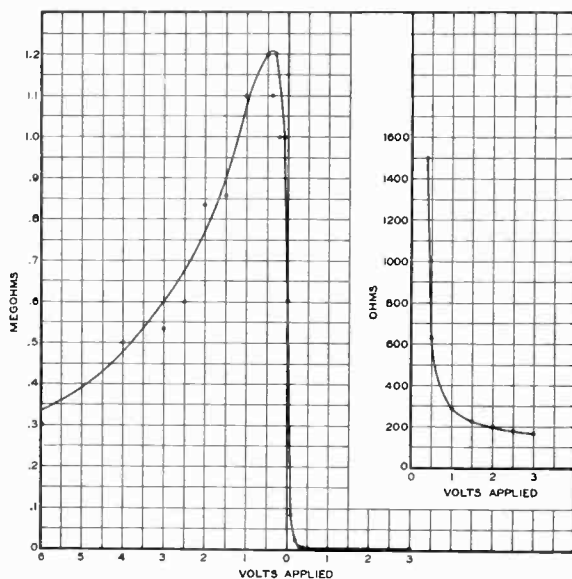

Fig. 1—Resistance voltage characteristic of small-area copper-oxide rectifier. Insert: Low resistance on larger scale.

reduces the capacity, because the capacity is proportional to the area of the boundary; and it also reduces the effect of the capacity, because with a given load it increases the current density in the rectifier. The capacity seems to be affected only to a small extent by changes in current density, and the forward resistance decreases rapidly as the current density increases. The result is that the capacity is less effective at high current densities than it is at low current densities.

Another important step in the same direction was made by balancing the rectifier capacity by means of a reactor. That has two effects: It reduces the load on the vacuum tube, since the capacity of the rectifier and the inductance of the reactor are arranged in a parallel tuned circuit; and it helps to increase the current density in the rectifier. The result of these two developments is that the copper-oxide rectifier can be used very satisfactorily at radio frequencies.



## V. PROPOSED CIRCUITS

(1) The earliest circuit developed for the copper-oxide detector is that shown in Fig. 2.<sup>6</sup> In this circuit the detector tube was changed to a radio frequency amplifier tube. This tube was then inductance-coupled to the copper-oxide rectifier through blocking condensers  $C_1$  and  $C_2$ . The tuned inductance in parallel with the input of the rectifier is shown as  $L_1$ . By means of it the capacity was balanced and the

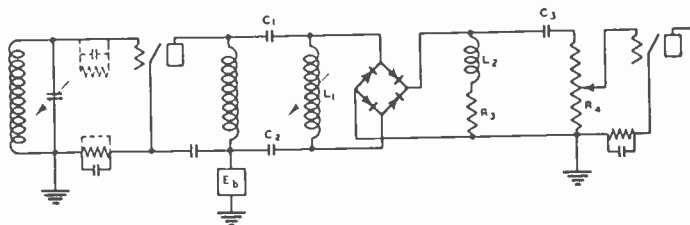

Fig. 2—Radio circuit with copper-oxide rectifier as detector. Variable inductance for tuning of rectifier.

amplifier tube was relieved of the capacity load which the rectifier would otherwise have imposed.

On the direct-current side of the rectifier the resistance in series with the audio-frequency choke,  $L_2$ , was placed there in order to provide a high resistance path for the direct-current component of the rectified carrier wave. The modulation-frequency component of the rectified carrier wave was then conducted through blocking condenser

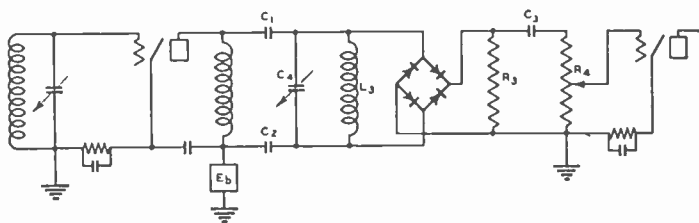

Fig. 3—Radio circuit with fixed inductance and variable condenser to tune rectifier.

$C_3$  and voltage divider  $R_4$ . This voltage divider was used to regulate the input to the succeeding audio amplifier, which in this case consisted of a type-27 tube in cascade with two type 45 tubes in push-pull. This circuit was developed with a view toward adapting existing receivers to use the copper-oxide rectifier as a detector and gave very satisfactory results.

(2) It was thought desirable to try to simplify the circuit just described as much as possible. The result of this attempt is shown in Fig. 3.<sup>6</sup> The first thing that suggested itself was to replace the variable in-

<sup>6</sup> W. P. Place, Patent Application Serial No. 540,348.

ductance,  $L_1$ , by a suitable fixed inductance,  $L_3$ , and a variable condenser,  $C_4$ . The next thing was to eliminate  $L_2$  and to make  $R_4$  a much higher resistance than  $R_3$ .  $R_3$  then provided the necessary path for the direct current and the voltage drop of the current variations corresponding to a rectified modulated carrier wave was applied to  $R_4$  through condenser  $C_3$ .

(3) A circuit was tried in which the input was coupled to the rectifier through a transformer with a tuned secondary. This circuit was not as satisfactory as the others already described, because the coupling between primary and secondary of the transformer was not as efficient as the direct inductive coupling, and because the fact that both the stationary and the movable plates of the tuning condenser had to be insulated from ground caused the amplifier to have a tendency to oscillate.

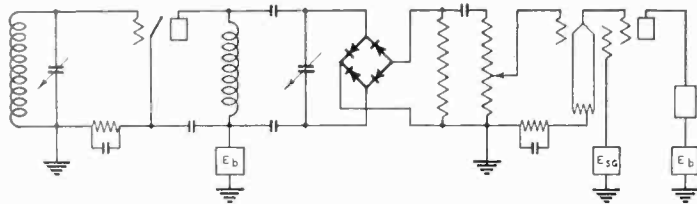

Fig. 4—Most satisfactory radio receiver circuit using copper-oxide detector.

(4) Further simplification of the circuit was gained by making the tuned inductance used for balancing out the capacity act also as the coupling inductance. A single pentode was used as the output tube.

A triode was used to energize the copper-oxide detector because with the rectifiers which were available at the time, a better impedance match could be secured if a tube having relatively low plate resistance were used. The effective resistance of the rectifier and inductance combination when tuned to parallel resonance at 1000 kc was found to vary with input voltage. This resistance was as low as 10,000 ohms at about 1 volt per disc, and increased to 50,000 ohms or more at 3 or 4 volts per disc. The simplest way of avoiding distortion caused by this variation was to use a tube with a plate resistance low in comparison with the input resistance of the copper-oxide detector. Since a type-27 tube has a sufficiently low plate resistance, it was chosen as the tube to energize the rectifier.

The circuit selected as most useful is that shown in Fig. 4.<sup>6</sup> This circuit is most desirable not only from the standpoint of simplicity and economy, but also from the standpoint of providing an excellent means of automatic volume control for even the newer variable  $\mu$  tubes with-

out the necessity of using an extra tube for this purpose. More will be said of automatic volume control in the following pages.

## VI. DISCUSSION OF CIRCUITS

The circuit shown by Fig. 2 is satisfactory as far as linear detection is concerned, but it requires the use of a variable inductance. This is not as desirable as the fixed inductance and variable capacity combination shown in Fig. 3. The circuit shown in Fig. 3 is superior also from the standpoint of cost, in that the high inductance,  $L_2$ , is eliminated with negligible sacrifice in efficiency.

Both of these circuits fall short of the ultimate aim, in that a stage of audio-frequency amplification precedes the power output stage. It has been thought best to avoid audio-frequency amplification as much as possible.

The circuit shown in Fig. 4 is not only simple, but since the copper-oxide rectifier is connected directly to the output tube, there is very little left in the circuit which could cause frequency discrimination among the modulation frequencies. The power output transformer, the biasing device, and the relative magnitudes of the coupling condenser and the voltage divider may be designed so as to avoid frequency distortion to any desired degree. Tests of the copper-oxide detector indicate that it is able to follow modulation frequencies up to 10,000 cycles with no appreciable attenuation of these higher frequencies.

In certain other types of detectors attenuation of the modulation frequencies begins in the neighborhood of 1000 to 3000 cycles and progresses with the increase in modulation frequencies until the output is practically reduced to zero, usually in the neighborhood of 10,000 cycles.<sup>3</sup>

There are two reasons for the good behavior of the copper-oxide rectifier in this respect. One is that the capacity of the rectifier and the resistance of the voltage divider are such that the circuit has a small time constant. The other is that because full-wave rectification is achieved, the amount of filtering necessary to eliminate the radio-frequency ripple of the rectified carrier from the modulation frequencies is reduced to a minimum.

The last two copper-oxide detector circuits possess another advantage. When a stage of audio-frequency amplification is eliminated, it is necessary to replace it with an additional stage of radio-frequency amplification which can be made useful to improve the selectivity of the receiver.

The discussion has been limited to radio frequencies in the broadcast band, because the higher frequencies present the greatest difficul-

ties. Any of the circuits described will operate satisfactorily at the intermediate frequencies employed in the superheterodyne type of receiver, and with somewhat greater efficiency, as will be made apparent in the subsequent discussion.

## VII. QUALITY OF DETECTION

It was expected that the amount of second harmonic distortion introduced by the copper-oxide rectifier when used as a detector would be small; and when measurements were made, the results more than justified the expectation. Measurements were made using from 4 to 10 volts per disc and modulations of as high as approximately 70 per cent, and in no case was the second harmonic distortion chargeable to the detector any higher than 0.5 per cent.

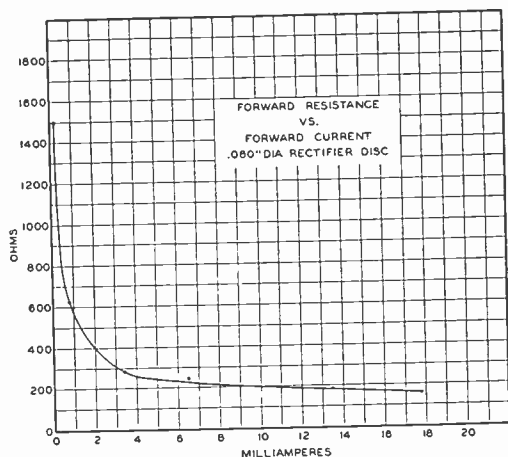

Fig. 5—Resistance current characteristic of small copper-oxide rectifier.

## VIII. FURTHER DISCUSSION OF BEHAVIOR OF COPPER-OXIDE RECTIFIER

A more detailed study of the copper-oxide detector is set forth in the following paragraphs to illustrate more fully its behavior at radio frequencies.

The key to the explanation of its action is the current-resistance characteristic of the copper-oxide rectifier when current flows in the forward direction. The current-resistance characteristic of a typical copper-oxide disk is shown in Fig. 5. As may be seen, the resistance decreases greatly as the current density is increased. In an ordinary circuit in which a load is connected to the direct-current terminals of a bridge-type rectifier, the forward resistance of two arms of the rectifier is in series with the load during each half cycle. If the load is maintained constant and the impressed voltage is increased, the forward

resistance of the rectifier arms is decreased with the resulting increased current density, so that a smaller part of the impressed voltage is across the rectifier and the ratio of rectified voltage to impressed alternating-current voltage is increased. At radio frequencies this is especially significant from another standpoint, since here the capacity reactance of each arm acts as a shunt across the load during every other half cycle. This capacity reactance is so low that it is necessary to operate the rectifier at relatively high current density in order to obtain such a low resistance in the forward direction that the voltage drop across this resistance is small compared to the voltage drop across the capacitance which, in effect, shunts the load. For these two reasons the rectifying properties of the copper-oxide detector is improved with increased current density.

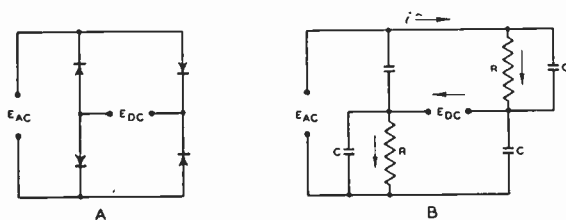

Fig. 6—(A) Circuit diagram of bridge-type rectifier.

(B) Equivalent circuit of bridge-type rectifier operating at high frequencies.

The second characteristic, namely, the increase in the effective alternating-current resistance of a tuned circuit of which the rectifier is a part, can likewise be explained by considering the effect of the forward resistance and the capacity reactance of the rectifier at radio frequencies. As was mentioned before, the copper-oxide rectifier has a static capacity which appears to shunt the resistance of each element both in the high-resistance and in the low-resistance direction. At radio frequencies the capacity reactance is considerably lower than the resistance of the element in the high-resistance direction, so much lower, in fact, that the resistance in the high-resistance direction can be neglected in comparison with it. In the low-resistance direction, this shunting capacity reactance is usually higher than the resistance of the element but not so high that its effect can be neglected.

When the copper-oxide rectifier is used at radio frequencies, the resistance load across the direct-current side of the rectifier is quite high, so that it can be considered infinite. Then the bridge-type rectifier, which consists of four arms arranged as in Fig. 6a, can be represented during each half cycle by the equivalent circuit shown in Fig. 6b.  $C$  represents the capacity of each arm, and  $R$  represents the forward resistance.

When this circuit is connected in parallel with an inductance and the whole tuned to parallel resonance, the effective alternating-current resistance (neglecting the losses in the inductance) is an inverse function of the power factor of the rectifier. There are two conditions which would make the losses in the rectifier zero: The first is the condition where  $R$  is infinite, in which case no rectification would occur; and the second is the condition where  $R$  is zero. It is this latter condition which the rectifier approaches as the voltage is raised, since increased voltage results in increased current density, which in turn results in lowering the value of  $R$ . As the power factor is lowered, the effective parallel resistance of the rectifier and inductance combination is increased.

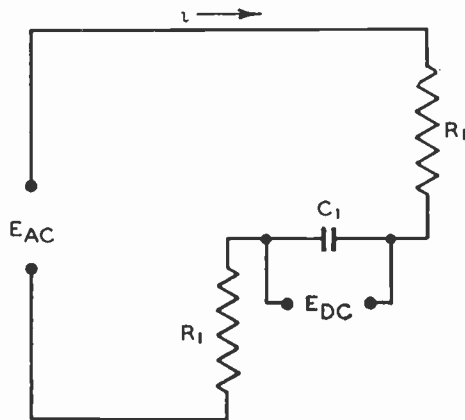

Fig. 7—Another method of representing a bridge-type rectifier operating at high frequencies.

The third characteristic, the linear relation between the impressed and the rectified voltage, may be explained by considering the action of the rectifier at radio frequencies with a very high resistance load. It should be remembered in this connection that our aim is to apply a high voltage to the grid of the following tube. When  $R$  is a fraction of capacity reactance  $C$ , the circuit can be proved to be nearly equivalent to that shown by Fig. 7. The mathematical transformations necessary to do so, while laborious, are straightforward and need not be given here. When represented in this way, the equivalent circuit illustrates clearly that the static capacity of the rectifier elements can be represented as an equivalent capacity load in series with the two low-resistance arms of the rectifier.

The fact that this is a capacity load is fortunate, since the instantaneous voltage drops in the arms of the rectifier and across the equivalent capacity reactance add vectorially instead of linearly, as would be the case if an equivalent resistance were substituted. Since the voltage drop in the equivalent resistance of the arms adds vectorially

to the voltage drop in the equivalent capacity reactance, its effect becomes negligible at much higher values of  $R$  than it would were a resistance load substituted; and a much wider variation in this resistance voltage drop in the arms of the rectifier can be tolerated before the

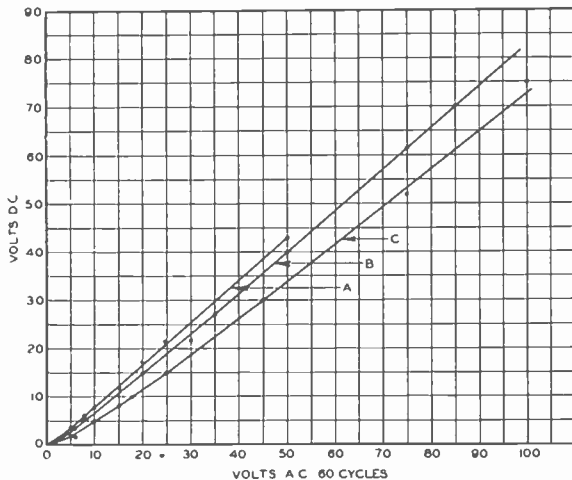

Fig. 8—Direct-current versus alternating-current characteristic of bridge-type rectifier operating at 60 cycles with different values of resistance connected to the direct-current terminals.

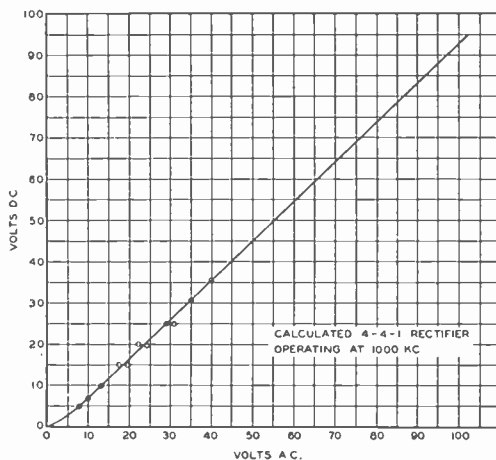

Fig. 9—Direct-current versus alternating-current characteristic of bridge-type rectifier operating at 1000 kc with 0.25-megohm resistor connected to direct-current terminals.

alternating-current versus direct-current voltage characteristic departs appreciably from a linear relation.

This discussion will serve to point out the conditions under which a copper-oxide rectifier will be found to be satisfactory at radio frequencies. The curves in Fig. 8 illustrate the action of a commercial rectifier connected to a resistance equivalent to the capacity reactance

at radio frequencies. Curve *A* was taken with infinite resistance connected to the direct-current side, curve *B* was taken with a resistance equivalent to the capacity reactance at 150 kilocycles, and curve *C* was taken with the rectifier connected to a resistance equivalent to the capacity reactance at 1000 kilocycles. From these data the curves shown in Figs. 9 and 10 were computed. It will be noted that both curves become linear after a voltage corresponding to about 1 volt per disc is reached.

The curve shown in Fig. 9 was checked by actual measurements made at 1000 kilocycles on a small 4-4-1 rectifier suitably designed for radio detection. The points shown represent the measurements and fall satisfactorily on the calculated curve.

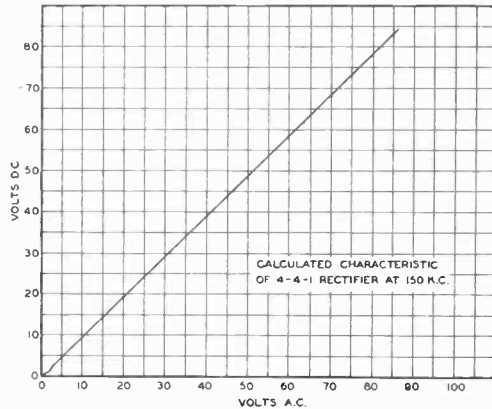

Fig. 10—Calculated direct-current versus alternating-current characteristic of bridge-type rectifier operating at 150 kc with infinite resistance connected to direct-current terminals.

## IX. CONSTRUCTION

The rectifiers used as detectors in the circuits described were made up of copper discs 0.080 inch in diameter. These discs were assembled to make up bridge-type rectifiers having from 4 to 8 discs in each arm and 4 arms per rectifier. The discs were assembled in blocks of insulating material in which holes were drilled just large enough to receive the copper discs. Then the oxidized-copper discs and lead discs shaped as a frustrum of a cone were loaded into each hole. A metal spacer and a spring were then placed in each hole to hold the discs together, and metal plates on the end served both to hold the stack together and to act as terminals. Sketches showing the assembly of one stack and the connections are given in Fig. 11. The final assembly of these stacks of discs into a complete rectifier may take on several forms. The photograph, Fig. 12, shows three satisfactory assemblies: On the left is a bridge-type rectifier that can be plugged into a vacuum tube socket;



in the center is a somewhat similar assembly with threaded studs, which are used for both mounting and connections; and on the right is another form of assembly in which each arm is assembled in an individual cartridge, which can be mounted in spring clips.

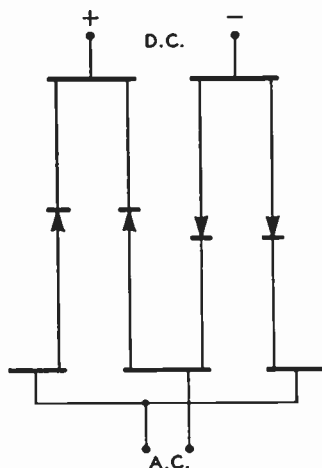
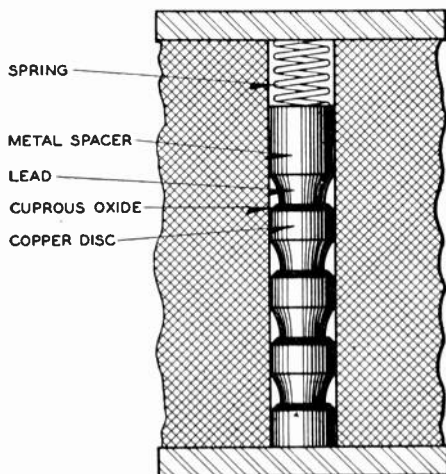

Fig. 11—A satisfactory method of assembling the small-area rectifier elements.

The rectifiers made up of 0.080-inch copper disks, 4 disks per arm and 4 arms per rectifier, proved the most satisfactory in the circuit in which the rectifier feeds the pentode output stage.

#### X. AUTOMATIC VOLUME CONTROL

We shall return now to the simple arrangement for automatic volume control that is made possible by the use of the copper-oxide detector. The circuit is described in the following paragraphs:

An inspection of Fig. 4 will make apparent the fact that there is a direct-current component of voltage applied across the resistor which is connected across the direct-current terminals of the rectifier, and that this direct-current voltage is a function of the mean value of the unrectified carrier wave. This voltage provides an excellent means of

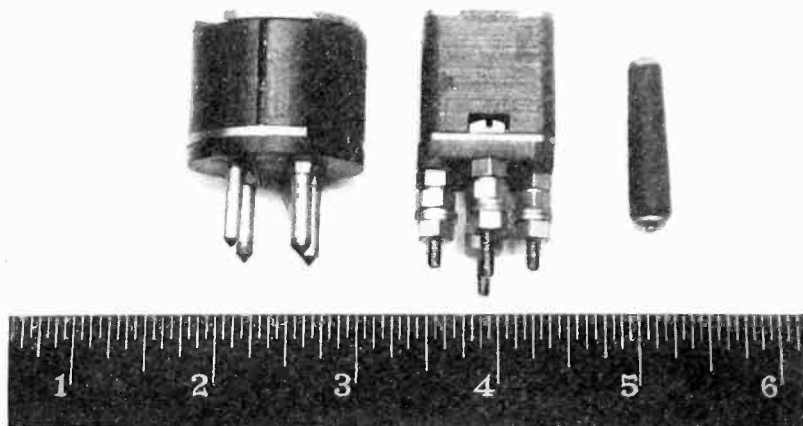

Fig. 12—Three convenient rectifier assemblies.

automatic volume control, since it can be applied, after suitable filtering, to the control grids of the preceding amplifier tubes in such a manner that as the strength of the mean value of the carrier wave is increased, the voltage applied to the control grids increases in the negative direction, thereby reducing the over-all gain of the radio-frequency

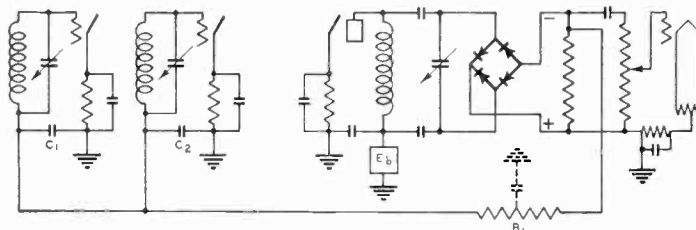

Fig. 13—Automatic volume-control circuit. Negative direct-current potential from rectifier is applied directly to control grids of preceding tubes through filtering resistor  $R_1$ .

amplifier. The circuit for accomplishing this is shown in Fig. 13.  $R_1$  is a high resistance which, in conjunction with the by-pass condensers  $C_1$  and  $C_2$ , filters out the alternating components of the voltage appearing across the direct-current side of the rectifier, so that only pure direct-current voltage appears at the grids of the preceding tubes.

This method of automatic volume control is not only simple but possesses the additional advantage that the direct-current voltage ap-

pearing at the rectifier may be as high as 20 or 30 volts. This is sufficient voltage for adequate control even of the variable- $\mu$  tubes.

This method of volume control has the advantage that no extra tube is required, but it is no better than other forms, in that it will not maintain the voltage across the rectifier as constant as could be desired. A new type of automatic volume control<sup>7</sup> that will keep the voltage appearing at the rectifier constant within extremely close limits is shown in Fig. 14.

This method is applicable only to receivers employing tubes having characteristics similar to the type-24 tubes, namely, tubes in which the amplification decreases tremendously with an increase in the negative grid bias of about 10 volts or less. The voltage divider,  $R_5$ , is used to adjust the level to which the automatic volume control is to maintain

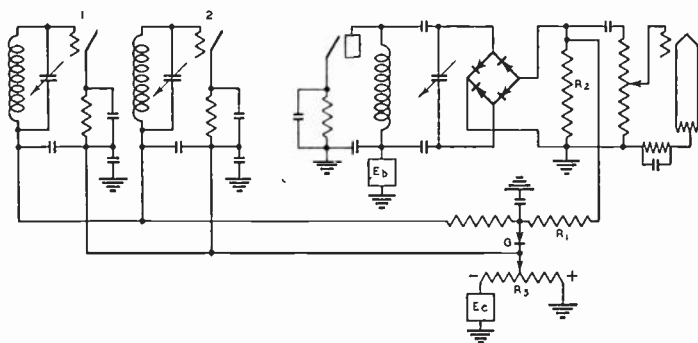

Fig. 14—Preferred automatic volume-control circuit. Rectifier element  $G$  acts as asymmetrical resistance to give very close regulation of rectified voltage appearing across  $R_2$ .

the signal voltage. Suppose the contact on  $R_5$  is set at  $-30$  volts. There will be a current flowing from the grounded end of the stabilizing resistor,  $R_2$ , through isolating and filtering resistor  $R_1$ , and through rectifier element  $G$ . Since this single element is connected so that it offers low resistance to a flow of current in this direction, only a small amount of the total 30 volts of  $IR$  drop in this circuit, say,  $2\frac{1}{2}$  volts, occurs in the rectifier. This then makes the grid voltage  $-27\frac{1}{2}$  volts. The resistor in the cathode circuit of each tube is of such value that the cathode is normally 4 volts positive with respect to the potential regulated by voltage divider  $R_5$ . Hence, the cathode potential is normally  $-26$  volts with respect to ground; and since the grid is  $-27\frac{1}{2}$  volts, the grid is  $1\frac{1}{2}$  volts negative with respect to the cathode, and the receiver operates at maximum sensitivity.

This condition holds with little change until the signal strength increases so that the mean direct-current voltage applied across  $R_2$  is

<sup>7</sup> W. P. Place, patent applied for.

nearly equal to the voltage applied by the voltage divider. Then the  $IR$  drop through the rectifier element becomes less and the relative voltage applied to the grid becomes greater. If the mean direct-current voltage delivered by the detector becomes higher than the voltage applied by the voltage divider, the direction of flow of current through this circuit reverses and the rectifier resistance becomes high compared to  $R_1$ . Then the grid bias rises directly as the mean direct-current voltage applied to  $R_1$ , and the automatic volume control assumes full control of the receiver sensitivity.

Thus, the high voltage which may be applied to the copper-oxide rectifier when used as a detector, and the fact that one element of the copper-oxide rectifier can be used as an asymmetrical resistance, make possible an automatic volume control which does not require an extra tube and which is ideal in its operation.



## THE DETECTION OF MICROWAVES\*

BY

NELLO CARRARA

(Regio Istituto Elettrotecnico e delle Comunicazioni della Marina, Leghorn, Italy)

**Summary**—The results of researches made to recognize the best conditions in which triodes can be used for the detection of microwaves (frequencies of about  $10^9$  per sec) are reported here. It seems that the detecting triodes, which must have their grids at a very high positive potential and the anode at a potential just lower than that of the positive end of the wire, act simply like rectifying diodes with electrodes very near to one another.

### I.

A TRIODE with cylindrical electrodes, with a low anode potential and a highly positive grid potential,<sup>1</sup> is capable of generating electromagnetic waves of a very high frequency (microwaves), due to the pendular movement of electrons through the meshes of the grid, between the filament wire and the anode. Although the theoretical development of the phenomenon is not yet clear in all its phases, the essentials have been discovered by many experimenters.<sup>2</sup> It is easy to design a transmitter of radio signals of this type, modulating the microwaves with the methods already known and used in broadcasting at the usual frequencies. These radio signals can be received on a crystal; but, in that case, notwithstanding the use of parabolic reflectors, (which prove to be very efficient because of the very high frequencies of microwaves), it is only possible to cover a very short distance (a few meters) because the receiver has a very low sensitivity and the transmitter gives only a limited power. Thus special valve receivers have been studied. Triodes of the same type as those used for transmission, and fed in a similar way (that is, with very high grid potential and low anode potential) have proved to be very efficient. The various authors,<sup>3</sup> who have given accounts of their

\* Decimal classification: R134. Original manuscript received by the Institute April 2, 1932.

<sup>1</sup> Barkhausen and Kurz, *Phys. Zeit.*, vol. 1, p. 1, (1920).

<sup>2</sup> Many works have subsequently appeared. Among those published in Italy, we remember: A. Rostagni, *Atti della R. Acc. delle scienze di Torino*, vol. 66, p. 123, (1931); vol. 10, p. 17; N. Carrara, *L'Elettrotecnica*, p. 874, December 5, (1931).

One may consult also the bibliography of: Hollmann, *Jahr. der Drat. Telegraf.*, vol. 33, no. 1, p. 27, (1929); Pierret, *Onde Electrique*, vol. 8, no. 93 (1929). (It would be impractical to report here the complete list, which contains more than 150 items.)

<sup>3</sup> Shintaro Uda, *Zeit. für Hoch.*, vol. 35, p. 129, (1930).

W. Pistor, *Zeit. für Hoch.*, vol. 35, p. 135, (1930).

Beauvais, *Compt. Rend.*, vol. 187, p. 1288, (1928).

Beauvais, *Onde Electrique*, vol. 9, no. 106, (1929).

Pierret, *Compt. Rend.*, vol. 189, p. 741, (1929).

experiments of radio communications, explain in some way the reasons why the apparatus they have effected may receive. The practical arrangements generally adopted (superregeneration, circuits oscillating on relatively low frequencies, etc.) seem to be based on the general opinion as follows:<sup>4</sup> the triode must be in a condition just under that necessary for the formation of electronic oscillations, so that it may be set into oscillation every time it is reached by microwaves coming from the transmitter.

After comparative studies of the various systems, an arrangement has been realized, as reproduced in Fig. 1 (*a*, *b*, are two small impedances, made of a few turns of wire) which has allowed us to make experiments, using special triodes, upon waves of down to about 14 cm in length.

We may resume the results of our experiments as follows:

(a) The optimum values of  $V_f$  and  $V_p$  must be found with a certain accuracy, not letting them have critical values, by means of the input rheostat  $R$  and of the potentiometer  $P$ . For each value of the tension it is necessary to find the optimum value of anode tension. However the value of  $V_p$  for which the reception is found to be stronger, is lower than  $V_f$  and increases as  $V_f$  increases.

Besides,  $V_f$  must not exceed a certain limit, which starts electronic oscillations in the valve. In fact, as soon as these oscillations start (as indicated by an abnormally high value of the anode current, or when upon putting a conductor plate or simply a hand near the valve, the value of the current undergoes strong variations) the reception ends abruptly.

(b) The value of  $V_g$  may vary between wide limits, for instance from 100 to 300 volts, without a great variation of the intensity and quality of the reception. As  $V_g$  varies, it is also necessary to vary  $V_p$  somewhat.

(c) When the best conditions of  $V_p$ ,  $V_g$ , and  $V_f$ , for the reception of waves of a determined frequency have been found, these should prove to be the best for the reception of waves of any other frequency, even an ordinary one. Thus we have also been able to receive waves of 100 and more meters as well.

(d) Accessory circuits, as those meant to obtain superregeneration etc., have proved to have a very limited efficiency and are often harmful.

(e) The low-frequency amplifier or simply the telephones may be inserted either in the anode circuit or in the grid circuit. It has been

<sup>4</sup> Okabe, Proc. I.R.E., vol. 18, no. 6, p. 1028; June, (1930).

possible, with the indicated disposition and the help of parabolic mirrors, to cover distances of about 10 kilometers.

All this makes us think, contrary to the aforesaid opinion, that reception takes place due to a rectification of the potentials (periodically variable at the frequency of the arriving waves, that is, of the oscillations which the wave collector applies to the anode) rather than through any kind of electronic oscillations inside the receiving triode.

It seems that the triode, in the indicated supply conditions does not behave differently than a simple rectifying valve; especially considering the fact that, under similar conditions, the reception of waves of any frequency is possible, and that these conditions, (the grid being always at a high potential), are, in fact, a bit

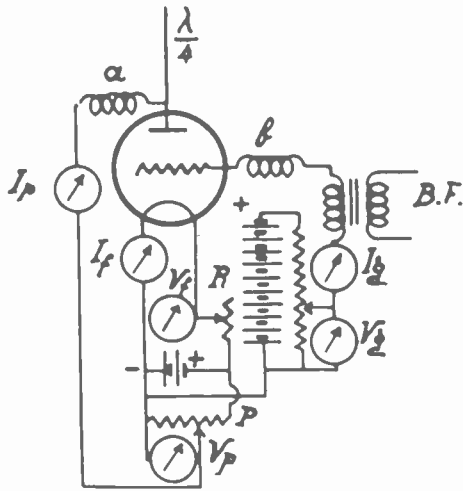

Fig. 1

different from those necessary for the formation of electronic oscillations. In fact, for a special type of triode, the conditions for the production of waves of 18 cm arc, for instance,  $V_p = -30$ ;  $V_g = 220$ ;  $V_f = 4$ . And for the reception:  $V_p = 1.6$  to  $1.8$ ;  $V_g = 100$  to  $300$ ;  $V_f = 2 \div 2.8$ .

## II.

In order to judge of the validity of this theory, we have measured the anode current  $I_p$ , as a function of the anode potential, under various conditions. The arrangement used for these measurements is that of Fig. 1, having taken off the antenna and the low frequency *B.F.* The measurements have been made upon a number of valves, with quite uniform results.

Some of the results obtained with one of these valves are reported in the graphs of Fig. 2 and Fig. 3, where we have used logarithmic scales. In the same graphs the values of  $V_g$  and  $V_f$  are indicated at

which measurements have been made. We notice that as  $V_p$  increases,  $I_p$  increases very rapidly and in the space from  $V_p = +0.5$  to  $V_p = +1.6$  the preceding is nearly rectilinear with logarithmic scales.

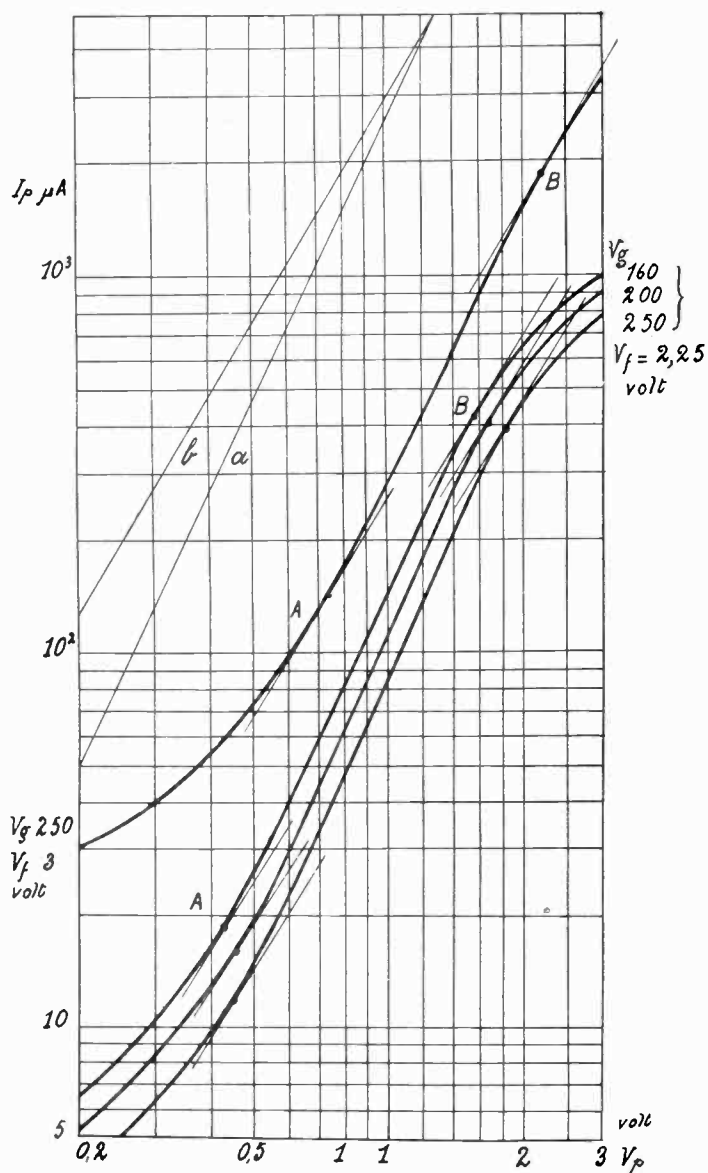

Fig. 2.

Within these limits we may write:

$$I_p = CV_p^n \quad (1)$$

in which  $C$  and  $n$  are constants. The constant  $n$  is measured by the slope of the rectilinear parts (since these are quite parallel to each other, we infer that it does not depend upon  $V_g$  nor upon  $V_f$ ) and has



a value very near to  $5/2$ , as we may observe from the slope of the straight line  $a$  which is just  $5/2$ .

$C$  depends, instead, upon  $V_o$  and  $V_f$ . The graphs show that, all other conditions being equal,  $I_p$  decreases as  $V_o$  increases, and increases as  $V_f$  increases. For values of  $V_f$ , higher than 3 volts, electronic oscillations start. The results then obtained are, naturally, altogether different. From (1) we infer that the conductivity for each value of  $V_p$  is:

$$\frac{dI_p}{dV_p} = CnV_p^{n-1}.$$

Consequently we may have the rectification of an alternative potential applied to a plate, in addition to a continuous component, be-

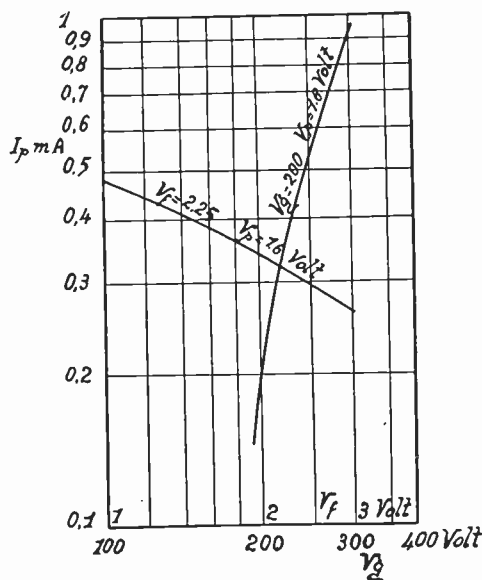

Fig. 3

cause in our case  $n$  is not unity. Now, rectification is more efficient the more rapid the variation of the conductivity. The efficiency of the rectification may be thus measured by:

$$\frac{d^2I_p}{dV_p^2} = n(n-1)CV_p^{n-2}.$$

For  $n=2$  the efficiency is independent of the plate potential, but for  $n>2$  (or lower) the efficiency increases (or decreases) with  $V_p$ . In our case, having drawn the straight line  $b$  (Fig. 2) having a slope 2, these points,  $A$ ,  $B$ , for which the tangent to the curves has the slope 2 may be easily found on the graphs. Between  $A$  and  $B$  the slope is

more than 2 (in fact it is about  $5/2$ ), so the efficiency increases with  $V_p$ . From  $B$  on the efficiency decreases, and it decreases also while  $V_p$  increases from zero to the value corresponding to  $A$ .

The best value for the rectification is thus the value of  $V_p$  at points such as  $B$ . We see that this value is not much lower than the value at the positive end of the filament, and that it increases as  $V_f$  and  $V_o$  increase.

All these deductions correspond perfectly to the results of the experimental researches made on the effective reception of microwaves, with the same triodes.

Not only the intensity of reception decreases beginning from  $V_p = 0$  and then increases up to a value of  $V_p$  just somewhat less than that of  $V_f$ , but, the best value of  $V_p$  increases with  $V_f$  and  $V_o$  and, in any case, it coincides with the value that corresponds to points like  $B$  in Fig. 2.

Considering finally that the filament-plate resistance is always much less than the filament-grid resistance, it is easily understood that it is more convenient to insert the primary winding of the low-frequency transformer  $B.F.$ , which has a resistance generally very high, in the grid circuit rather than in the plate circuit, although the reception is possible in both cases.

All that has been said before strengthens the hypothesis, expressed at the beginning, that the function of the triode that permits reception of microwaves, is reduced to a simple rectification. Then, considering that the exponent  $n$ , in (1) is nearly exactly  $5/2$  we can compare the triode to a diode. In fact, we have for a diode, not considering the initial speed of the electrons, and being  $0 \leq V_p \leq V_f$ :

$$I_p = \frac{kl}{r_p \beta^2 V_f} V_p^{5/2} \quad (2)$$

where  $k$  is a constant,  $r_p$  the radius of the plate,  $\beta^2$  a known function<sup>5</sup> of the ratio  $r_p/r_c$ ,  $r_c$  the radius of the cathode,  $l$  the length of the axis of the cathode.

That is, other conditions remaining the same

$$I_p = CV_p^{5/2}$$

which is perfectly in agreement with (1).

Substituting in (2) the values of  $I_p$ , as a function of  $V_p$ , obtained from the measurements made on the triodes, for certain values of  $V_o$ ,  $V_f$ , etc., it is possible to deduce  $r_c$ . Making the calculations,  $r_c$  results in our case nearly equal to  $r_p$ . So if the radius of the plate of the diode

<sup>5</sup> van der Bijl, "The Thermionic Vacuum Tube," p. 66.

were equal to the radius of the plate of the triode, the radius of the cathode of the diode would have to be greater than the grid radius of the triode.

From this the idea comes that the grid, at a high positive potential, determines the formation in the triode of a virtual cathode near the plate, similarly to what happens in valves with two grids, between the internal grid and the external one.

### III.

If this cathode were not formed, that is, if we could do without considering the space charges, due to those electronic densities, which, under normal working conditions, establish themselves between the filament and the grid on one side, and between the grid and the plate on the other, the proceeding of  $I_p$ , in function of  $V_p$ , could not be that given by experiments.

In fact, let us consider a triode, with its grid at a high positive potential  $V_g$ , its equipotential cathode at zero potential, and the plate at a potential of  $V_p$ . We shall suppose that:

(a) The initial velocity of the electrons, at the time of their issue from the filament, is nil.

(b) The trajectories of the electrons, between filament and plate, may be considered rectilinear, in the direction of the normal axis common to the electrodes, (for instance, the trajectories are supposed to be so in the theories of electronic oscillations by Barkhausen and Kurz, already mentioned, and in the theories of the valves with two grids).

(c) Space charges between grid and plate are negligible.

It is easily possible to recognize immediately that the portion  $\eta n$  of the  $n$  electrons, emitted by each unit length of filament, in a unit of time, which passes through the grid and penetrates the space between grid and plate, will arrive or not on the plate, (depending whether  $V_p \geq 0$  or  $V_p < 0$ ). Hence calling  $I_s$  the current emitted by a filament of unit length, the plate current would have the values 0 or  $\eta I_s l$  ( $l$  = length of the filament) depending whether  $V_p < 0$  or  $V_p \geq 0$ . It must be noticed that, under the assumed conditions  $\eta$  is independent of the potentials and equal to the ratio between the area of the cylinder of the grid and the area which remains free between the meshes of the grid. (We have often found in literature mention of the constancy of  $\eta$ .)<sup>6</sup> Then reckoning the fall of potential along the filament from  $V_f$  to 0, in the case of  $0 \leq V_p \leq V_f$ , we obtain:  $I_p = CV_p$ .

<sup>6</sup> Rostagni, *loc. cit.*

Hyatt, *Phys. Rev.*, vol. 33, p. 1100, (1929).

Lange, *Zeit. für Hochfrequenz.*, p. 105, (1925).

Let us consider a section of a triode, obtained with two planes perpendicular to the electrodes and intersecting the points  $P$ ,  $R$ , of abscissas  $x$  and  $x+dx$  (Fig. 4), wherein the negative end of the filament is considered the origin of the abscissas. The section may be considered as the section of a triode, with an equipotential cathode, at the potential  $v_f = V_f/l x$ ,  $v_f$  being the potential across the portion  $dx$  of filament. The electrons that the filament emits, find themselves in the accelerating field of  $V_g - v_f$  and, notwithstanding the space charge, they all arrive with a speed  $V$ , because of the high value of  $V_g$ , (which is higher than that necessary to extract from the filament the saturation current) in the place occupied by the grid. A portion will be absorbed by the grid; the remainder will pass through the grid and come in the retarding field  $V_g - V_p$  that exists between the grid and the plate. It is understood that, neglecting the space charges, the speed of the electrons passing through the grid, enable them to reach the plate only

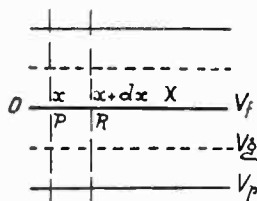

Fig. 4

if  $v_f \leq V_p$ . With these conditions all the electrons are issued by the portion of filament included between 0 and  $X$  (the abscissa of the point that has a potential equal to  $V_p$ ). Hence the plate current will be:

$$I_p = \int_0^X \eta I_s dx = \eta \frac{I_s l}{V_f} V_p. \quad (3)$$

Consequently the plate current ought to increase linearly with  $V_p$  until  $0 \leq V_p \leq V_f$  and, for  $V_p > V_f$ , it ought to remain equal to  $\eta I_s l$ , which is in any case the highest value it can assume. The characteristics of  $I_p$ , as a function of  $V_p$ , (furnished by experiments, as we have seen) is instead altogether different; consequently it forces us to admit that, a space charge is formed between grid and plate, the effect of which cannot be that of limiting the plate current. Because of this spacial charge, not all the electrons issued by the portion of filament between 0 and  $X$  and which have gone through the grid, can reach the plate. A portion must necessarily return towards the grid and this cannot take place unless there exists between grid and plate a geometrical position of points, having values between 0 and  $X$ , in which the velocity of the electrons becomes nil, that is, where the potential is

equal to that of the points of the filament that have the same abscissa. This geometrical place constitutes a virtual cathode, from which we may assume the plate gets the electrons forming  $I_p$ . As the electrodes of the triode are cylindrical, for reasons of symmetry, the points of the virtual cathode, that have the same abscissa, will have also the same distance  $r_c$  from the filament.

Since  $n$  is the number of electrons issued by the filament in one unit of time, for each unit of length in the section  $dx$  of the triode already considered,  $ndx$  electrons will set forth towards the grid. Of these,  $\eta ndx$  will reach the virtual cathode. Here they will be divided into two portions; one  $\alpha\eta ndx$ , will reach the plate, the other  $(1-\alpha)\eta ndx$  will return. Some, and exactly  $(1-\alpha)\eta^3 ndx$ , will come back again to the virtual cathode after having passed the grid twice, in the direction of plate to filament and filament to plate; of these  $\alpha(1-\alpha)\eta^3 ndx$  will reach the plate while  $(1-\alpha)^2\eta^3 ndx$  will return, and so on.

Hence of the  $ndx$  electrons, emitted by the section  $dx$  of filament in a unit of time,  $\eta ndx$ ,  $(1-\alpha)\eta^3 ndx$ ,  $(1-\alpha)^2\eta^5 ndx \dots$  electrons go successively from the grid towards the virtual cathode.

Thus under normal working conditions of

$$n\eta(1 + (1-\alpha)\eta^2 + \dots + (1-\alpha)^m\eta^{2m} + \dots)dx = \frac{n\eta}{1 - (1-\alpha)\eta^2}dx \quad (4)$$

electrons pass through the grid at a time.

Of these

$$\alpha n\eta \frac{1}{1 - (1-\alpha)\eta^2} dx$$

will reach the plate while

$$n(1-\alpha)\eta \frac{1}{1 - (1-\alpha)\eta^2} dx$$

will return to the grid.

Calling  $I_s$  the saturation current, corresponding to the  $n$  electrons, we will have:

$$dI_p = I_s \alpha \eta \frac{1}{1 - (1-\alpha)\eta^2} dx = \frac{k(V_p - V_f)^{3/2}}{r_p \beta^2} dx \quad (5)$$

$$dI_o = I_s (2-\alpha) \eta \frac{1}{1 - (1-\alpha)\eta^2} dx = \frac{k(V_o - V_f)^{3/2}}{r_o \beta'^2} dx. \quad (6)$$

In the calculation of the grid current it has been assumed that the space charge is due to those electrons that return from the virtual

cathode to the grid, and to those that go from the grid to the virtual cathode,<sup>7</sup> and where  $\beta^2$  depends on the ratio  $r_p/r_c$  and  $\beta'^2$  depends on the ratio  $r_g/r_p$ . The radius  $r_c$  of the virtual cathode evidently depends upon potentials  $V_g - V_f$  and  $V_g - V_p$ . As, in our case,  $V_g$  is much higher than  $V_p$  and  $V_f$ , we will admit that  $r_c$  has the same value for any value of  $V_f$  and of  $V_p$ .

From the first of the preceding equations we will then have:

$$I_p = \frac{2}{5} \frac{kl}{r_p \beta^2} \frac{V_p^{5/2}}{V_f}, \quad (7)$$

which is in very good agreement with the experimental results, at least in the portion comprehended between the points *A* and *B* (Fig. 2). The effect of the initial speeds justifies the fact that the experimental characteristics, in the initial portion, are far from rectilinear curves having a slope of 5/2; while, for the portion after *B*, we consider the fact that the plate potential gets near the value of the positive end of the filament, so there must intervene particular conditions in the accelerating and retarding spaces  $V_g - V_f$  and  $V_g - V_p$ .

The formula that we have found does not let us recognize the dependence of  $I_p$  from  $V_g$  and from  $V_f$ . This, in fact, requires the determination of the radius  $r_c$  of the virtual cathode as a function of those potentials. This determination could be made by means of the two preceding equations, if serious mathematical difficulties did not interfere.

Having admitted the existence of the virtual cathode, it is possible to determine, as already been told, the order of magnitude of its radius  $r_c$  by means of (2).

It is then possible to calculate the time it takes the electrons to cover the distance  $r_p - r_c$ . Executing the calculations for the valves we have studied, we have obtained, for the said time, values less than the period of microwaves. This is necessary in order to render possible their rectification.

The triode, with its grid at a high positive potential, can thus reveal microwaves, because it behaves as a diode with very small internal capacities and in which the inertia of the electrons, because of the extreme nearness of the virtual cathode to the anode, is negligible, even when the plate potential varies periodically at a very high frequency. Conditions such as these would not be possible to realize with an ordinary diode.

<sup>7</sup> In order to have the total grid current it is also necessary to consider those electrons that stop on the grid, moving from the filament towards the grid in the space between filament and grid.

### CONCLUSIONS

From the experiments and considerations referred to above, it appears clearly that a triode detector of microwaves, under the usual conditions, behaves like a simple rectifying diode with its electrodes very near to each other.

### ACKNOWLEDGMENT

The author is very grateful to Mr. H. E. Vallauri, and thanks him for his advice and help, and to Mr. M. Isidor of the I.E.C. of the Royal Navy, who has contributed in all the researches.



## A NEW ELECTRICAL METHOD OF FREQUENCY ANALYSIS AND ITS APPLICATION TO FREQUENCY MODULATION

BY

W. L. BARROW

(Massachusetts Institute of Technology, Cambridge, Massachusetts)

*Summary*—A method of analyzing an arbitrary combination of sine wave voltages is described and the analysis of several examples carried out. The method is based on the appearance of certain figures, typical of definite frequency ratios, appearing in an oscillogram of the superposition of a constant frequency and a "search" voltage. The resolving power of the method is very high, allowing component voltages of only two cycles per second frequency difference to be clearly resolved. A frequency modulated wave is then analyzed and the spectrum representation  $f(t) = \sum_{n=-\infty}^{\infty} J_n(\Delta f/\alpha) \sin 2\pi(f + n\alpha)t$  found to hold under the approximate conditions  $\Delta f < f_0/10$ ,  $\alpha < f_0/10$ . The consequences of the periodicity or nonperiodicity which can occur with relatively large  $\Delta f$  and  $\alpha$  is discussed. A simple expression for the spectrum of a wave with both amplitude and frequency modulation is derived, which allows an immediate oversight of the changes in side band magnitude occurring when one type of undesired modulation accompanies the other. Finally, the relation of the oscillogram of superposed constant frequency and search voltages to Lissajous figures is pointed out, and a comparison with diatonic harmony made.

### I. INTRODUCTION

A SINE wave generator whose frequency is periodically varied about a mean value without alteration of amplitude produces a wave form of frequency modulated type. This process is one of growing importance in several branches of applied physics, especially in acoustics, where a tone having the above characteristics is used to eliminate interference effects in measurements of reverberation time and other such quantities, and in radio. In the latter case an undesired modulation of the carrier frequency may occur despite the excellence of crystal control, etc.; in addition, the idea of using frequency modulation instead of amplitude modulation for telephonic communication is receiving renewed attention<sup>1</sup> at the present time. It is therefore of value to verify experimentally the spectrum representation of a frequency modulated wave as given originally by J. R. Carson.<sup>2</sup> While the question of the reality of the side bands involved will not be argued here, nevertheless this phase of an analysis may be of interest to some.

In most cases of practical interest considerable experimental diffi-

\* Decimal classification: 537.7. Original manuscript received by the Institute, May 5, 1932.

<sup>1</sup> Hans Roder, PROC. I.R.E., vol. 19, p. 2145, (1931).

<sup>2</sup> J. R. Carson, PROC. I.R.E., vol. 10, p. 57, (1922).



culty is met with because the components to be separated by the analyzer lie relatively very close together, particularly, for example, in the type of frequency modulated wave used in acoustics called a "warble tone." Besides this a proof of the individual existence of these components as discrete sinusoidal oscillations is desired. Analyzers having as their essential element an ordinary tuned circuit are entirely unsuitable, because the resolving power demanded is in general far too great; it seems possible that a tuned circuit analyzer employing regeneration to reduce the damping of this circuit might give favorable results. One such analyzer with which the author has had experience has been developed in the communication division at Massachusetts Institute of Technology and it is hoped that this will be described in the literature soon. The methods of Grutzmacher,<sup>3</sup> Suits<sup>4</sup> and others could not meet the rigorous requirements imposed by the problem at hand. These methods, that of Suits excepted, also do not allow a positive conclusion to be drawn of the existence of a single discrete, monochromatic oscillation; a very narrow band of noise might presumably be interpreted as a single frequency of corresponding amplitude.

The method developed here, while having the disadvantage that it requires an oscillograph and gives only a rough determination of the amplitudes, has however proved itself of great value for the problem at hand. Because of the unusually large resolving power it is felt that it might be of further use in special cases similar to this one.

It should be mentioned at the outset that the analysis has been carried out on an audio-frequency wave, commonly called a "warble tone," but that the results are applicable without reservation to any frequency. The relative magnitudes of modulation frequency and total frequency variation were approximately the same as that to be expected in the case of radio transmission, thus allowing an immediate carrying over of the findings of the investigation from the audio to the radio-frequency field.

## II. OSCILLOGRAPHIC ANALYSIS OF OSCILLATIONS

### (a) Method

The method of analysis employed<sup>5</sup> is based on the appearance of a distinctive figure in an oscillogram of two linearly superposed oscillations made in the following manner. Since the method relates to elec-

<sup>3</sup> M. Grutzmacher, *Zeit. für techn. Phys.*, vol. 10, p. 570, (1929); *E.N.T.*, vol. 4, p. 533, (1927).

<sup>4</sup> Chauncey Guy Suits, *Proc. I.R.E.*, vol. 18, p. 178, (1930).

<sup>5</sup> W. L. Barrow, "Dissertation," *Techn. Hochschule, München*, (1931). Part of the material presented here appeared in the *Annalen der Physik*, footnote 8.

trical oscillations the word "voltage" will be used as synonymous with "oscillation" in what follows. A voltage of constant frequency and amplitude is superposed on a voltage whose amplitude is constant but whose frequency is varied once slowly and continuously from a lower to an upper limit (a so-called "search voltage"), and the resultant oscillographed at so slow a speed that the individual oscillations are not quite resolved on the film. As the search-voltage frequency passes through a one-to-one ratio with the constant voltage a distinctive figure is recorded on the oscillogram, due to the occurrence of beats between the two voltages in this region. Other figures, to be discussed later, are formed for different integral ratios of the two frequencies, but because of their complexity would never be confused with the very simple 1:1-ratio figure.

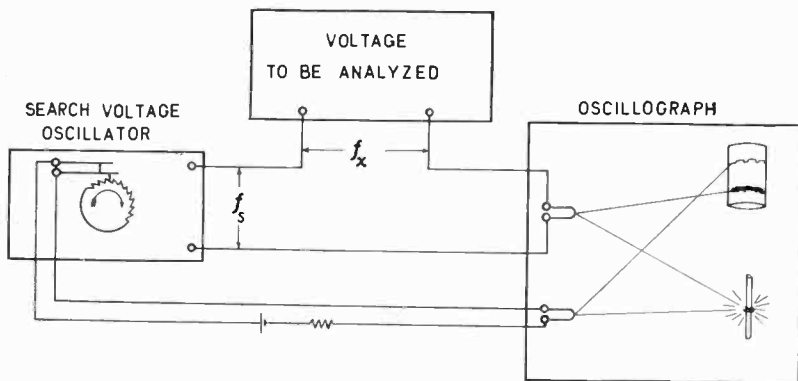

Fig. 1—Schematic circuit for making the analysis oscillograms.

The circuit used for making this and the other analysis oscillograms of this paper is shown schematically in Fig. 1. The search voltage is produced by a beat-frequency oscillator in which the frequency control condenser is turned through one rotation very slowly by a small motor and speed-reduction arrangement. The dial of this condenser carries a disk with notches which operate a contactor as certain predetermined frequencies are reached; the operation of this contact mechanism closes a small battery over one vibrator of the oscillograph and thus registers the frequency scale of the search oscillator on the oscillogram. The voltage of the search oscillator is practically constant over the operating range of 100–1000 cycles per second and of quite good wave form. The output of this oscillator ( $f_s$ ) is superposed on the voltage to be analyzed ( $f_x$ ), in this case a single frequency oscillation, and impressed on the second oscillograph vibrator.

The resulting oscillogram is reproduced in Fig. 2. The frequency of the constant oscillation was 190 cycles per second, while the frequency

of the search oscillation at the left end was a little less than 190 and at the right end a little greater than 380 cycles per second. The frequency ratios 1:1 and 2:1 appear especially prominent in the figure. The picture of the resultant current is particularly simple for the frequency ratio 1:1. It is to be noted however, that the form of the delineation for a 1:1 ratio depends upon the phase<sup>6</sup> displacement of the two superposed oscillations; oscillograms are reproduced in Fig. 3 which also correspond to a 1:1 ratio but with different phase relations. The effect of different amplitude relations of the two currents is to make the depth of the valleys and height of the crests different. These two variations of the typical figure in no way hinder its recognition, and indeed the latter allows a rough comparison of amplitudes to be made.

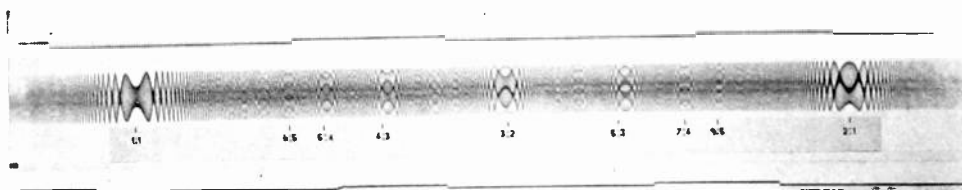

Fig. 2—Oscillogram of the linear superposition of a single constant-frequency voltage and a search voltage—individual oscillations not resolved.

The present method of analysis is based on these facts. If we are concerned with the frequency spectrum analysis of an arbitrary mixture of sinusoidal oscillations, then the same 1:1 figure appears at all points at which the frequency of the search voltage passes through one of the frequencies contained in the mixture. The procedure is then to substitute the unknown voltage at  $f_x$  in Fig. 1, make an oscillogram as above and locate the 1:1 figures appearing in the oscillogram; the frequencies are then read from the frequency scale of the search tone registered on the film. The relative depth of the several frequencies gives a comparison of amplitudes. Keeping Fig. 2 in mind a rough idea of the phase relations among the components may also be had.

#### (b) Application to Two Sine Waves

The procedure will first be illustrated by two examples of practical importance. The first is that of a fundamental and its second harmonic, that is, of two frequencies of ratio 2:1 which had the values of 190 and 380 cycles per second respectively and practically the same amplitude;

<sup>6</sup> While the word "phase" is not very accurately used here it is intended to indicate the different time relations of the search- and constant-frequency voltages which result in different phases at the time of coincidence of the two frequencies, and thus in the different figures of Fig. 3.

these two voltages of equal amplitudes were produced for convenience by two separate vacuum tube oscillators, combined with the search voltage and the resultant oscillographed. The resulting oscillogram

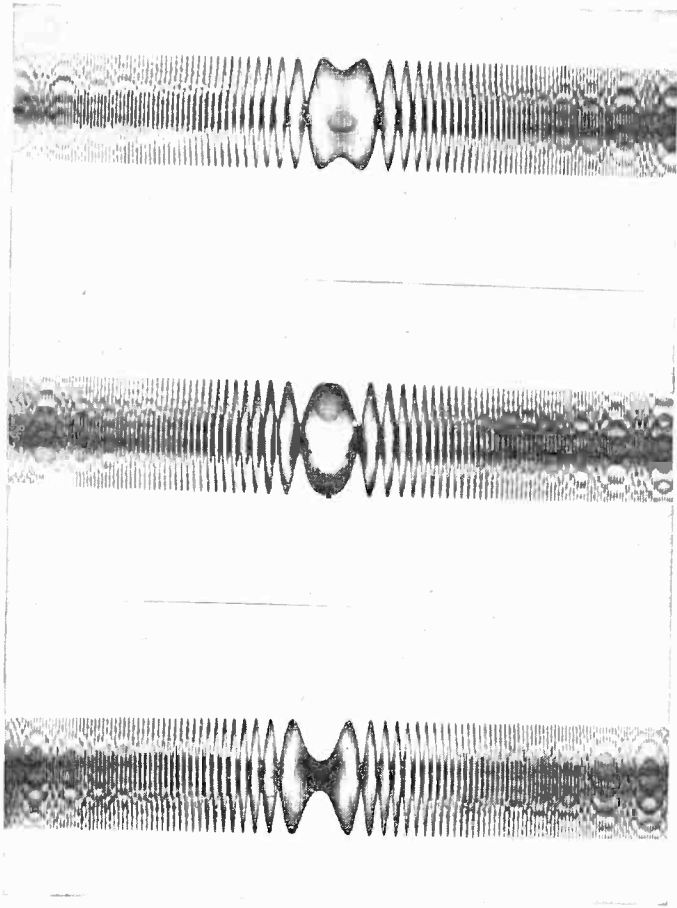

Fig. 3—Illustrating effect on 1:1 frequency ratio figure of different phase relationships of constant frequency and search frequency voltages.



Fig. 4—Analysis oscillogram of equal amplitude fundamental and second harmonic voltages.

is reproduced in Fig. 4, which will now be examined and interpreted. Both at 190 and 380 cycles per second the typical 1:1 figure may be differentiated. Simultaneously the figure for the frequency ratio 2:1 appears at these same places; the reason for this is that when the search

voltage goes through a 1:1 ratio with one component, say the fundamental, it also goes through a 2:1 ratio with the second harmonic component, thus forming in the oscillogram both the 1:1 and 2:1 figures at one place. Nevertheless the ensuing oscillogram may, with a little practice, be easily interpreted. We therefore conclude that within the

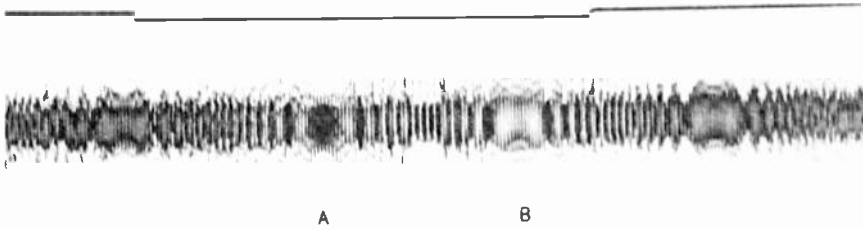

Fig. 5a—Analysis oscillogram of two constant-frequency voltages of 500 (A) and 540 (B) cycles per second, respectively. Acceleration of search voltage frequency = 20 cycles per second per second oscillograph paper velocity about 3 centimeters per second.

band examined the unknown voltage is composed of only two components, one of 190 and the other of 380 cycles per second, and that their amplitudes are approximately the same.

The second example illustrating the method will be that of two frequencies lying very close together. At the same time the question is to

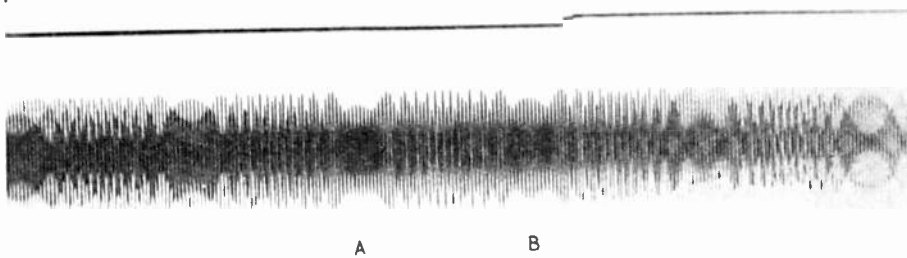

Fig. 5b—Analysis oscillogram of two constant-frequency voltages of 500 (A) and 504 (B) cycles per second, respectively. Acceleration of search voltage frequency = 4 cycles per second per second, oscillograph paper velocity greater than in 5a.

be considered of how close together two frequencies may be and yet be separated by this mode of analysis; i.e., what is the limit of the resolving power of this analysis method and what factors influence it? The resolving power depends essentially on two things; namely, the rate at which the frequency of the search voltage is changed, and the velocity

of the oscillograph film. For example, in Fig. 5a oscillograms are reproduced of two oscillations, of 500 and 540 cycles per second respectively, with a frequency difference of 40 cycles per second taken with a frequency acceleration of the search voltage of 20 cycles per second per second and a speed of oscillograph film of about 3 cm per sec.; the components are immediately recognizable at *A* and *B*. When the frequency difference was made only 4 cycles per second the frequencies could no longer be resolved with the same adjustments of search voltage and oscillograph speed. However, this was easily accomplished by lowering the acceleration of the frequency of the search voltage to 4 cycles per second and running the film slightly faster (Fig. 5b). The resolving power may in this manner be raised to quite high values, of which the illustration given here is by no means the limit. Instability of either search frequency or the frequency of the oscillation being analyzed would prove disturbing at great resolving powers, requiring well-constructed apparatus. This caused no difficulty in resolving audio frequencies only 1 cycle per second apart, the greatest resolution attempted with the present apparatus.

### III. ANALYSIS OF A FREQUENCY MODULATED WAVE

#### (a) Theoretical Frequency Spectrum

The case of a constant amplitude wave with sinusoidally varying frequency has been treated analytically in a number of papers<sup>2,7,1</sup> etc., the results of which are mutually in agreement and will be taken here without proof. The symbols will be used:

$$\begin{aligned} f_0 &= \text{middle frequency or carrier in cycles per second} \\ 2 \cdot \Delta f &= \text{total modulation range in cycles per second} \\ \alpha &= \text{modulation frequency} \end{aligned}$$

A general expression for the spectrum of a frequency modulated wave has not yet been obtained, but under certain limitations a simple solution is possible, namely, when:

$$\left. \begin{aligned} \Delta f &\ll f_0 \\ \alpha &\ll f_0 \end{aligned} \right\} \quad (1)$$

Under these assumptions the frequency modulated wave may be expressed as:

$$\phi(t) = \sin \left( 2\pi f_0 t + \frac{\Delta f}{\alpha} \sin 2\pi \alpha t \right). \quad (2)$$

<sup>7</sup> Balth. van der Pol, Proc. I.R.E., vol. 18, p. 1194, (1930).

<sup>1</sup> A good bibliography is given by H. Roder.

This may be expanded in terms of Bessel's functions  $J_n(\Delta f/\alpha)$  of order  $n$  and argument  $\Delta f/\alpha$ , giving the spectrum or side band representation:

$$\phi(t) = \sum_{n=-\infty}^{+\infty} J_n \left( \frac{\Delta f}{\alpha} \right) \sin 2\pi(f_0 + n\alpha)t. \quad (3)$$

According to (3) the spectrum is composed of discrete components located symmetrically about the middle frequency  $f_0$ , mutually separated by  $\alpha$  cycles per second and of amplitude  $J_n(\Delta f/\alpha)$ . Van der Pol has pointed out that those components lying outside of the band ( $f_0 \pm \Delta f$ ) are very small compared to those inside this band.

### (b) Analysis

The existence and range of validity of the spectrum representation (3) will now be experimentally investigated for the acoustical case by

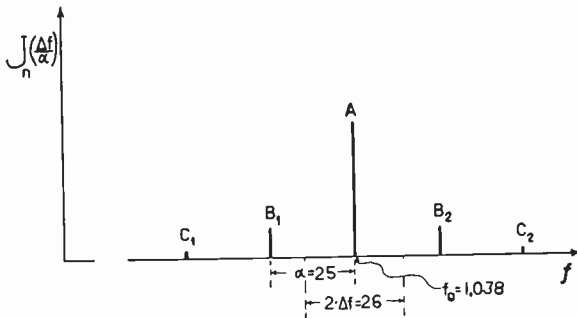

Fig. 6—Calculated amplitude-frequency spectrum of frequency-modulated wave used as example.

the method of analysis described in Section II of this paper. Quite a few examples of frequency modulated waves with various ranges of  $\Delta f$  and frequencies of modulation  $\alpha$  have been studied, but only one will be given as illustration, chosen because of the particularly clear oscillogram obtained. The frequency modulated wave was produced in two ways; for modulation frequencies  $\alpha < 15$  cycles per second a heterodyne oscillator with motor driven rotating condenser was used, while for values of  $\alpha > 15$  cycles per second a special low-frequency oscillator<sup>8</sup> was used, consisting of a vacuum tube generator whose oscillatory circuit contained iron-core coils. By means of a periodic magnetization of the iron cores with a current of frequency  $\alpha$  the inductance of the coils and therewith the frequency of the generator could be varied at arbitrarily high rates. Oscillographic and other tests made it certain that a very good electrical analog of equation (2) was being produced.

<sup>8</sup> W. L. Barrow, *Ann. d. Phys.*, vol. 11, p. 147, (1931).

Fig. 6 shows the spectrum of the frequency modulated wave being analyzed, as calculated from (3); the values were  $f_0 = 1038$ ,  $\Delta f = \pm 13$ ,  $\alpha = 25$  cycles per second. Accordingly we may expect practically only three components, of which the middle one alone possesses a relatively large amplitude. That this is actually the case can be recognized easily from the analysis oscillogram of this wave, reproduced in Fig. 7. At A can be seen a very strongly accentuated component whose measured frequency is quite accurately  $f_0$  in magnitude and at  $B_1$  and  $B_2$  are seen two much weaker components whose frequencies are  $f_0 - \alpha$  and  $f_0 + \alpha$ , respectively. The frequencies of these components measured from the oscillogram thus correspond to the calculated values, as do the amplitude ratios in a qualitative way. The amplitudes of the other components are so small that their appearance in the analysis figures is not to be expected from the start.

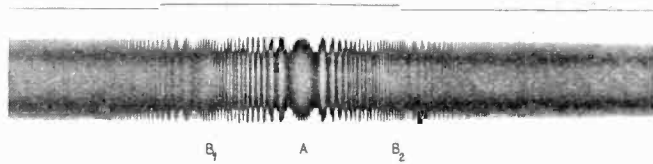

Fig. 7—Analysis oscillogram for frequency modulated wave;  $f_0 = 1038$  cycles per second,  $\Delta f = 26$  cycles per second,  $\alpha = 25$  cycles per second.

Analysis of many other typical examples brought out the fact that for moderately large  $\Delta f$  and  $\alpha$  compared to  $f_0$  the expression (3) was entirely correct, as would be anticipated, but that for large values of these parameters this representation apparently no longer held, as judged by the fact that the analysis oscillograms for these cases were very irregular and obscure in the sense of the method. This is also in accord with the assumptions underlying (1). It could not be determined what the nature of the spectrum was for large  $\Delta f$  and  $\alpha$ ; indeed, it is to be doubted that a discrete frequency spectrum then exists except in very special instances discussed in paragraph (c) below. Examples with successively larger  $\Delta f$  and a fixed small value of  $\alpha$  and examples with successively larger  $\alpha$  and a fixed small value of  $\Delta f$  were studied in detail. Based on the results of this work it is estimated that quite approximately the spectrum representation (3) may be considered valid when

$$\Delta f < \frac{1}{10}f_0, \quad \alpha < \frac{1}{10}f_0.$$



## (c) Periodicity

Because of the underlying assumptions (1) it is then to be expected that the simple spectrum representation (3) does not hold when the modulation range is large compared to the middle frequency. This case is particularly likely to be met with in the warble tone, where, for example, the modulation band is sometimes made say,  $\pm 100$  cycles per second for a middle frequency of 500 cycles per second or less. In this connection it is of importance to consider the fact that in general a frequency modulated wave is not in the usual sense a periodic phenom-

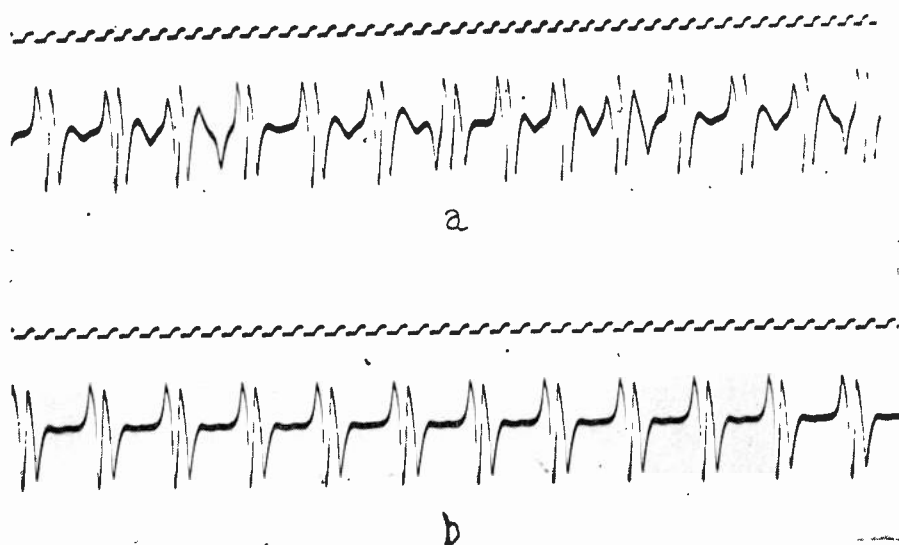

Fig. 8—Wave form of extreme case of frequency modulation;  $f_0 = 30$  cycles per second,  $\Delta f = \pm 25$  cycles per second,  $\alpha = 11$  cycles per second.

a— $\alpha = 11$  cycles per second  $+\delta$   
 b— $\alpha = 11$  cycles per second  $-\delta$

ena. The case of frequency modulation in radio transmission allows of so simple an analysis only because of the relatively small  $\alpha$  and  $\Delta f$ ; analytically it belongs to the quasi-periodic class of functions. However, in the case of the warble tone  $\alpha$  and  $\Delta f$  are relatively large. Whether or not the oscillation is then periodic depends for a given  $f_0$  and  $\Delta f$  upon the value of  $\alpha$ ; this is demonstrated by the oscillograms or Figs. 8a and 8b for the extreme case of  $f_0 = 30$ ,  $\Delta f = \pm 25$ , and  $\alpha = 11$  cycles per second. The Figs. 8a and 8b differ only by an almost imperceptible change in  $\alpha$ , yet the curve of the first is completely aperiodic, while that of the latter displays perfect periodicity. It is clear that the wave of Fig. 8b can be developed into a Fourier series, giving a spectrum of discrete frequencies, while as a consequence of the absence of a definite period

for the wave of Fig. 8a it is necessary to employ a Fourier integral, which results in a continuous spectrum.

Whether or not this question of periodicity or nonperiodicity of a frequency modulated oscillation bears any practical importance depends essentially upon the damping of the system on which it is impressed. If this damping is so large that the effect of one group (i.e., a complete cycle of  $\alpha$ ) has died away before the beginning of the following group, then the periodicity characteristics of the oscillation play no part. On the other hand, when the damping is so small that this is not so (for instance, a resonant circuit with low dissipation, a room with a large reverberation time, etc.) the periodicity must be considered, as a continual interference takes place between the free oscillations of the system and the applied frequency modulated oscillation. Such a case

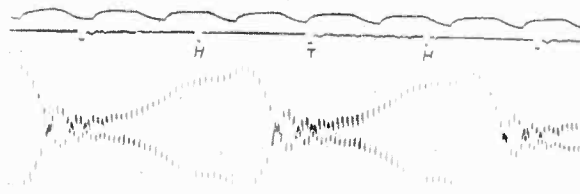

Fig. 9—Current through tuned circuit of low damping produced by frequency modulated voltage.

is shown by the oscillogram of the current caused to flow in a resonant circuit upon application of a warble tone voltage, reproduced in Fig. 9 ( $T$  = point of lowest frequency,  $H$  = point of highest frequency of warble tone, which was also equal to the resonant frequency of the circuit). A kind of beat interference of the natural oscillations of the tuned circuit and the driving oscillations of the warble tone voltage takes place, seen on the oscillogram between  $H$  and  $T$ . At  $H$  the instantaneous value of the search-voltage frequency goes through the natural frequency of the circuit; which is then forced into strong damped oscillations; these then beat with the search oscillation which continues to change in frequency. Shortly after passing  $T$  the natural oscillations are damped out, the beats disappear and the cycle is repeated.

#### (d) Simultaneous Frequency and Amplitude Modulation

In many instances an amplitude modulation accompanies frequency modulation, and vice versa, and it is then important to know the amplitudes of the components of the resulting spectrum. While this situation has been handled by several writers it seems worth while

nevertheless to reproduce the following presentation, which, it is thought, gives a clearer and more concise idea of magnitudes and changes than the customary treatment. The usual case of a synchronous amplitude and frequency modulation will be assumed; notation remains as before, with the addition of the amplitude modulation factor  $c \leq 1$ . Under the assumptions expressed in (1) the general expression may be written:

$$f(t) = \left\{ \sum_{n=-\infty}^{+\infty} J_n \left( \frac{\Delta f}{\alpha} \right) \sin 2\pi(f_0 + n\alpha)t \right\} \cdot (1 + c \cos 2\pi\alpha t). \quad (4)$$

Making use of the relation:

$$J_{-n}(x) = (-1)^n J_n(x)$$

we get, after simplification:

$$f(t) = \left\{ \sum_{n=0}^{+\infty} J_n \left( \frac{\Delta f}{\alpha} \right) \sin 2\pi(f_0 + n\alpha)t + \sum_{n=1}^{+\infty} (-1)^n J_n \left( \frac{\Delta f}{\alpha} \right) \sin 2\pi(f_0 - n\alpha)t \right\} \cdot (1 + c \cos 2\pi\alpha t).$$

This may be arranged as:

$$f(t) = \sum_{n=0}^{+\infty} \left\{ J_n \left( \frac{\Delta f}{\alpha} \right) + \frac{c}{2} J_{n-1} \left( \frac{\Delta f}{\alpha} \right) + \frac{c}{2} J_{n+1} \left( \frac{\Delta f}{\alpha} \right) \right\} \sin 2\pi(f_0 + n\alpha)t + \sum_{n=1}^{+\infty} \left\{ J_n \left( \frac{\Delta f}{\alpha} \right) + \frac{c}{2} J_{n-1} \left( \frac{\Delta f}{\alpha} \right) + \frac{c}{2} J_{n+1} \left( \frac{\Delta f}{\alpha} \right) \right\} \sin 2\pi(f_0 - n\alpha)t.$$

Using the recursion formula for the Bessel's functions of first kind:

$$\frac{2n}{x} J_n(x) = J_{n-1}(x) + J_{n+1}(x)$$

the spectrum representation follows at once:

$$f(t) = \sum_{n=0}^{+\infty} \left\{ 1 + \frac{cn}{\left( \frac{\Delta f}{\alpha} \right)} \right\} J_n \left( \frac{\Delta f}{\alpha} \right) \sin 2\pi(f_0 + n\alpha)t + \sum_{n=1}^{+\infty} (-1)^n \left\{ 1 + \frac{cn}{\left( \frac{\Delta f}{\alpha} \right)} \right\} J_n \left( \frac{\Delta f}{\alpha} \right) \sin 2\pi(f_0 - n\alpha)t. \quad (5)$$

From (5) it is seen that an added amplitude modulation of the type under consideration does not cause frequencies to appear in the spectrum of the wave which were not already present in that of the pure frequency modulated wave. However the amplitudes of the components have been altered. The total amplitude of the  $n$ th component ( $n$ th side band) is thus given by:

$$\left\{ 1 + \frac{cn}{\left(\frac{\Delta f}{\alpha}\right)} \right\} J_n \left( \frac{\Delta f}{\alpha} \right) \quad (6)$$

and the percentage change in side band amplitude is given by the simple expression:

$$\gamma = \frac{\left\{ 1 + \frac{cn}{\left(\frac{\Delta f}{\alpha}\right)} \right\} J_n \left( \frac{\Delta f}{\alpha} \right) - J_n \left( \frac{\Delta f}{\alpha} \right)}{J_n \left( \frac{\Delta f}{\alpha} \right)} \cdot 100 = \frac{cn}{\left(\frac{\Delta f}{\alpha}\right)} \cdot 100. \quad (7)$$

Since  $c$ ,  $n$ , and  $\Delta f/\alpha$  are all positive quantities it is clear that the effect of an additional amplitude modulation on a frequency modulation wave is to increase the magnitude of all of the components except the carrier or middle frequency  $f_0$  ( $n=0$ ). The effect increases with  $n$ , so that those components lying furthest from the carrier  $f_0$  will undergo the greatest alteration; thus, the effective side band width is increased. In the case of a warble tone this will not be very large, since  $\Delta f/\alpha$  appears in the denominator and is usually made large. While no radio system is known to be in use using frequency modulation it is probable that this would also be true here. The more general case of non-sinusoidal modulation may be carried out without difficulty in exactly the manner above.

#### IV. DISCUSSION OF INTERVAL FIGURES

The procedure by which Fig. 2 was made gives as a result the linear superposition of a constant sinusoidal oscillation on one with continuously variable frequency; as a consequence every possible ratio of the two frequencies between an upper and a lower limit appears on the oscillogram. Let this ratio be measured by the "acoustical interval"  $f_s/f_k$ , where:  $f_s$  = instantaneous frequency of search oscillation, and  $f_k$  = frequency of constant oscillation. Fig. 2 is thus characterized by the occurrence of typical figures for certain "intervals," namely those where

$f_s$  and  $f_k$  are small positive integers; these typical markings will be called "interval figures."

For the 1:1 interval, used in the analysis method preceding, beats occur, which can only take place when the two frequencies are almost identical. At the 2:1 interval an equally pronounced figure is formed, chiefly by a back-and-forth displacement about the center line. Then in between these are to be seen quite a number of other more complicated interval figures; if the interval numbers of the more pronounced of these are tabulated as they occur in the oscillogram the result is:

$$\frac{1}{1} \quad \frac{7}{6} \quad \frac{6}{5} \quad \frac{5}{4} \quad \frac{4}{3} \quad \frac{3}{2} \quad \frac{5}{3} \quad \frac{7}{4} \quad \frac{9}{5} \quad \frac{11}{6} \quad \frac{2}{1} .$$

These figures are found to be broader and simpler the smaller the integers are which form the interval. One particular oscillogram similar to Fig. 2, but made more slowly, allowed the discernment of 80 such figures between 1:1 and 2:1. Naturally similar figures are also obtained in the 2:1 to 3:1 octave, etc., which are more and more complicated as 1:1 is departed from.

A close comparison between these interval figures and the well-known Lissajous figures can be made. They might in fact be considered as a sort of continuous Lissajous figure. The places corresponding to integral frequency ratios, for which ordinary Lissajous figures are stationary, are indicated by figures of certain types.

Another striking comparison may be drawn between these figures and the musical harmony of two tones. For instance, unison is the strongest diad,—likewise this condition results in the simplest and broadest interval figure. A tone and its octave come next, being practically of the same degree of consonance as unison,—the 2:1-interval figure is equally broad and only slightly more complicated than the 1:1-interval figure. Next comes the perfect fifth, corresponding to the 3:2 figure, etc. In general, the strongest consonants are those with smallest integer ratios and these in turn form the broadest and simplest interval figures. Thus, the breadth and structure of the interval figures are measures of the pleasantness of concordance of the corresponding musical diatone, and furthermore only the consonants are selected from all possible diads.



## A FOURIER ANALYSIS OF RADIO-FREQUENCY POWER AMPLIFIER WAVE FORMS\*

BY

L. B. HALLMAN, JR.

(Chief Engineer, Montgomery Broadcasting Co., Montgomery, Alabama)

**Summary**—A theoretical treatment of class B and C radio-frequency amplifier wave forms by means of the Fourier series is presented.

Assuming constant plate tuned circuit impedance, general expressions for the Fourier coefficients for any value of grid bias from cut-off to the position for class A operation are derived. The variation in plate circuit efficiency as the bias is moved from the position for class A operation to cut-off is considered.

Ideal wave forms with which class C operation would be obtained are analyzed. The extent to which the ideal forms may be approached in actual operation is considered and a wave form which may be approximated in practice is analyzed. The efficiency of the several wave forms is discussed.

### INTRODUCTION

THE fundamental purpose of any amplifier is to increase the effectiveness of the output of one system upon the input of another. If the system into which the amplifier is working is primarily voltage operated, the amplifier should give the maximum possible voltage amplification. In such an amplifier, the relation between the input voltage and the voltage across the output terminals should be linear. The current flowing may be small and consequently the efficiency of the amplifier, as regards input and output power, is of little importance. If the amplifier must deliver power, however, its efficiency becomes a matter of importance. Furthermore, the relation between the input voltage and output current should be linear.

In the vacuum tube amplifier the function of the input power is to control a larger amount of power supplied by a local source to the output circuit. This larger local source is, of course, applied to the plate circuit. Hence, the efficiency which is of importance in determining the amplifier operation characteristics is the plate circuit efficiency.

Until a comparatively recent period the study of radio-frequency amplifiers was confined largely to problems encountered in receiving systems using predetector radio-frequency amplification. As the detector is primarily a voltage operated device, radio-frequency power amplifiers have been neglected to a great extent. The operation of the class B amplifier when biased close to the cut-off point ( $-E_p/\mu$ ) has recently attracted considerable attention. Modulation in radio-

\* Decimal classification: 537.7×R363.1. Original manuscript received by the Institute, May 2, 1932.

telephony is often accomplished at low power levels and the output of the modulated amplifier is amplified to obtain the required output power. The so-called class *A* amplifier is unsatisfactory because of its low efficiency. The class *B* amplifier, usually biased at cut-off, has consequently become very important and its operation is fairly well understood. So far as the writer is aware, no theoretical treatment of the class *C* amplifier has been published. The vacuum tube oscillator has, with certain limitations, been completely analyzed, but these analyses are concerned primarily with conditions of constant power output and consequently do not consider the linear relations necessary in amplifier operation.

A Fourier analysis of the wave forms involved shows in a clear and simple manner how the radio-frequency power amplifier operates. It also affords a convenient tool for investigating the possible efficiencies obtainable. This paper is concerned with such an analysis.

The action of the plate tuned circuit in discriminating against the harmonic content of the plate current wave form has been fully explained by Fay<sup>1</sup> and Moullin.<sup>2</sup> These treatments demonstrate conclusively that if the amplitude of no harmonic in the plate current wave form is as great as the fundamental, then the amplitude of no harmonic current in the inductance leg of the tuned circuit (the tuned circuit being tuned to the fundamental) will be as much as 0.4 per cent of the fundamental current in the inductance leg. In the analysis which follows, if the amplitude of no harmonic in the plate current wave form is as great as that of the fundamental, it is assumed that the effect of the harmonics in the tuned circuit inductance is negligible.

Throughout this paper a class *B* amplifier is understood to mean an amplifier functioning in such a manner that the power output is a linear function of the square of the exciting or input voltage;<sup>3</sup> that is, the current flowing in the plate tuned circuit inductance is proportional to the input grid voltage. A class *A* amplifier is one which operates in such a manner that the plate current wave form is essentially the same as that of the exciting grid voltage. Since it is evident that the class *A* amplifier also satisfies the definition given of the class *B* amplifier we may conclude that the class *A* radio-frequency amplifier is a special case of the class *B* radio-frequency amplifier. The class *C* amplifier is an amplifier which operates in such a manner that the output power is proportional to the square of the plate voltage. The class

<sup>1</sup> C. E. Fay, "The operation of vacuum tubes as class *B* and *C* amplifiers," *PROC. I.R.E.*, vol. 20, no. 3, pp. 553-554; March, (1932).

<sup>2</sup> E. B. Moullin, "The Theory and Practice of Radio Frequency Measurements," Second Edition, pp. 111-113.

<sup>3</sup> See 1931 Standardization Report, *YEAR BOOK I.R.E.*, p. 71, (1931).

*C* operation is essentially that of an oscillator when the coupling between the grid and plate circuits is close.

### THE GRID-PLATE CHARACTERISTIC

In Fig. 1 is shown a typical vacuum tube characteristic curve. Along the  $X$ -axis is plotted  $E_G = E_c + e_o$ ; where  $E_c$  is the effective bias voltage and  $e_o$  is the voltage applied to the input circuit of the tube. This curve, we will assume, is obtained when the plate circuit resistance is  $R$  and the plate voltage supply is  $E_b$ .

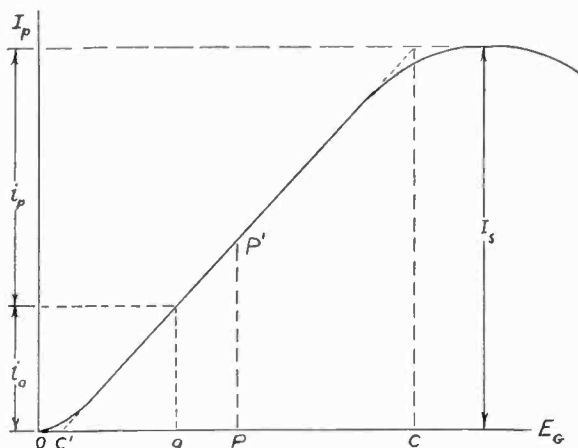

Fig. 1

It will be assumed that this characteristic is given, between  $C'$  and  $C$ , by:

$$I_p = KE_G + k. \quad (1)$$

Further it will be assumed that (1) holds true regardless of the wave form of  $e_o$ . This means, first, that the curvature of the characteristic is neglected. The effect of this curvature, in the region of point  $C$ , is to flatten the resulting plate current wave form when the exciting grid voltage is sinusoidal—considering, of course, that the input grid potential does not swing  $E_G$  past  $C$ . The result of this distortion is to decrease the amplitude of the even numbered harmonics and increase the amplitude of the odd numbered harmonics in the Fourier expansion of the plate current wave form, as compared with the excitation grid voltage wave form.

The plate circuit impedance will consist of a tuned tank circuit. Hence, the static characteristic of Fig. 1 will only coincide with the dynamic characteristic at the fundamental frequency to which the plate circuit impedance is tuned. At the fundamental frequency the plate circuit becomes a pure resistance,  $R \doteq \omega^2 L^2 / r$ , (parallel phase



resonance), where,  $L$  is the inductance of the tuned circuit,  $r$  is the resistance of the circuit (assumed to be concentrated in series with  $L$ ), and  $\omega$  the angular velocity of the vector representing the fundamental component of the alternating plate current. To the second harmonic the plate circuit impedance ( $Z_2$ ) drops to a small value. The amount of the drop depends on the value of  $r$ . For ordinary tuned circuits the value of  $Z_2$  will be in the vicinity of 0.4 per cent of  $R$  and for the higher harmonics still less.<sup>4</sup> The reactive component of  $Z_n$ , where  $n$  is the order of the harmonic, will be capacitive and the phase angle will approach 90 degrees as  $n$  increases and probably be between 89 and 90 degrees for the second harmonic. The dynamic characteristic for the second and all higher harmonics will therefore be elliptical. However, for any reasonably efficient tank circuit,  $Z_n$  is small compared with  $R$  and with the internal resistance of the tube. Consequently the dynamic characteristic for the second and all higher order harmonics has a greater slope than that of the fundamental; it may be taken simply as the static characteristic for the tube with the external plate circuit impedance zero.

If the bias is adjusted to any point between  $P$  and  $C'$ , as  $a$ , and the peak grid swing is greater than  $aC'$ , a portion of the negative half-cycle of the grid input voltage will have no effect on the tube. As a result, the effective input voltage may be represented by a Fourier series; the amplitude of the harmonic components varying as the percentage of the negative half-cycle during which the grid swing is past  $C'$  is changed. The dynamic characteristic for the fundamental will be the characteristic of Fig. 1. The dynamic characteristic for the harmonics, however, will have a greater slope than that of the curve in Fig. 1. This will have the effect of increasing the amplitude of all harmonics in the plate current wave form, relative to the fundamental, over the corresponding value for the original exciting grid voltage wave form. It will be remembered that the effect of the curvature at the extremes of the characteristic is to decrease the amplitude of the even numbered harmonics and to increase the amplitude of the odd numbered harmonics. Hence, we may conclude that the result of neglecting both the curvature of the characteristic of Fig. 1 and of taking this curve to be the dynamic characteristic for a sinusoidal grid excitation for all values of grid bias between  $P$  and  $C'$  is:

<sup>4</sup> These statements are based on an assumed tank circuit resistance of around two ohms. In actual amplifier circuits it is possible to have considerably greater values of resistance coupled into the tuned circuit. When this is true the harmonics will have greater amplitude and their effect on the wave form and the dynamic output curves may be appreciable. A discussion of this factor, however, is considered outside the scope of the present paper.

First, the two effects are subtractive in the case of the even numbered harmonics. Hence the net effect in this instance will be small and possibly zero.

Second, the two effects are additive for the odd numbered harmonics. Consequently, neglecting these effects in this instance will tend to give odd numbered harmonics in the plate current wave form of somewhat smaller amplitude than would actually occur in a physical set-up. It will, however, be noted from the work that follows that the amplitude of the odd numbered harmonics, other than the fundamental, are comparatively small and have little effect on the resulting wave form. Hence, the amplitude distortion which may result in the case of these harmonics should have a negligible effect on the resulting wave form. The assumptions made in regard to the characteristic curve are, therefore, justifiable.

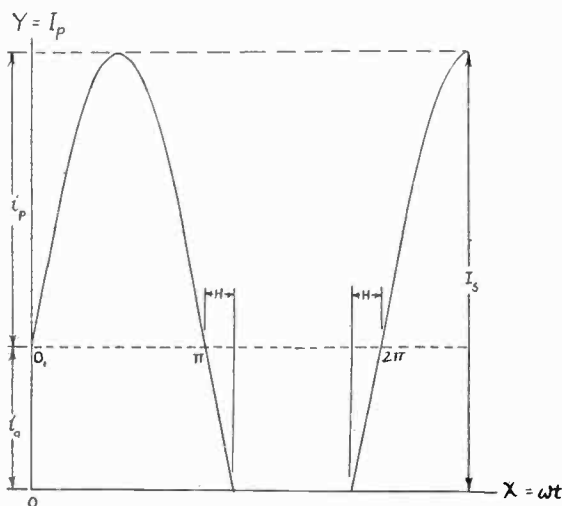

Fig. 2

### THE CLASS B AMPLIFIER

Referring to Fig. 1, assume  $E_c$  has been adjusted to the point  $a$ . Now let a sinusoidal voltage of amplitude  $aC$  be impressed on the grid. It is evident that the plate current wave form is that shown in Fig. 2.  $H = \sin^{-1} (|i_a/i_b|)$ .

The wave form of Fig. 2 may be defined as follows:

When,

$$\begin{aligned} 0 < x < (\pi + H); & \quad I_p = f(x) = i_p \sin x, \\ (\pi + H) < x < (2\pi - H); & \quad f(x) = -i_a \\ (2\pi - H) < x < 2\pi; & \quad f(x) = i_p \sin x. \end{aligned}$$

Also,  $f(x) = f(\pi - x)$ . Consequently, the terms  $\sum A_p \cos px$  and  $\sum B_q \sin qx$ , where  $p$  is an odd integer and  $q$  is an even integer, drop out of the Fourier series for the function,<sup>5</sup> leaving as the resulting expansion:

$$f(x) = 0.5A_0 + \sum A_q \cos qx + \sum B_p \sin px.$$

The evaluation of the constants  $0.5A_0$ ,  $A_q$ , and  $B_p$  are given in Appendix I. Taking the values derived there for the wave form of Fig. 2 we have:

$$\begin{aligned} 0.5A_0 &= (i_p/\pi) [\cos H - (i_a/i_p)(\pi/2 - H)] \\ A_2 &= (i_p/\pi) [(i_a/i_p) \sin 2H - (4/3)((i_a/i_p) \sin 2H \\ &\quad + (\frac{1}{2}) \cos H \cos 2H)] \\ A_4 &= (i_p/\pi) [(i_a/2i_p) \sin 4H - (8/15)((i_a/i_p) \sin 4H \\ &\quad + (\frac{1}{4}) \cos H \cos 4H)] \\ A_6 &= (i_p/\pi) [(i_a/3i_p) \sin 6H - (12/35)((i_a/i_p) \sin 6H \\ &\quad + (\frac{1}{6}) \cos H \cos 6H)] \\ A_8 &= (i_p/\pi) [(i_a/4i_p) \sin 8H - (16/63)((i_a/i_p) \sin 8H \\ &\quad + (\frac{1}{8}) \cos H \cos 8H)]. \end{aligned}$$

Or, in general

$$\begin{aligned} A_q &= (i_p/\pi) [(2i_a/qi_p) \sin qH - (2q/q^2 - 1)((i_a/i_p) \sin qH \\ &\quad + (1/q) \cos H \cos qH)] \\ B_1 &= (i_p/\pi) [(2i_a/i_p) \cos H + H - (\frac{1}{2}) \sin 2H + \pi/2] \\ B_3 &= (i_p/\pi) [(2i_a/3i_p) \cos 3H + (3/4) ((\frac{1}{3}) \sin 3H \cos H \\ &\quad - (i_a/i_p) \cos 3H)] \\ B_5 &= (i_p/\pi) [(2i_a/5i_p) \cos 5H + (5/12)((1/5) \sin 5H \cos H \\ &\quad - (i_a/i_p) \cos 5H)] \\ B_7 &= (i_p/\pi) [(2i_a/7i_p) \cos 7H + (7/24)((1/7) \sin 7H \cos H \\ &\quad - (i_a/i_p) \cos 7H)] \end{aligned}$$

Or, in general, when  $p > 1$ :

$$B_p = (i_p/\pi) [(2i_a/pi_p) \cos pH + (2p/p^2 - 1)((1/p) \sin pH \cos H - (i_a/i_p) \cos pH)].$$

See Appendix I for the special case of  $B_1$ .

<sup>5</sup> M. G. Malti, "Electric Circuit Analysis," see Table I opposite p. 176.

The above expressions give the Fourier coefficients as a function of  $|i_a/i_p|$ , which is dependent upon the position of the point  $a$ . As the point  $a$  may be located anywhere between  $C'$  and  $P$  (Fig. 1) by properly adjusting  $E_c$ , it is evident that the above coefficients will determine the appropriate Fourier expansion for any particular class B plate current wave form.

Let  $E_c$  be adjusted to the point  $P$ . Then,  $i_a/i_p = 1$ ,  $H = \sin^{-1} 1 = \pi/2$ . Substituting these values in the expressions for the Fourier coefficients gives,

$$\begin{aligned} 0.5A_0 &= 0 \\ A_2 &= A_4 = A_q = 0 \\ B_1 &= i_p = I_s/2 \\ B_3 &= B_5 = B_p = 0. \end{aligned}$$

Therefore the Fourier expansion for the plate current wave form in this instance reduces to:

$$f(x) = I_p = (I_s/2) \sin x,$$

which is evidently the wave form for a class A amplifier with a sinusoidal voltage of amplitude  $PC = PC'$  applied to the grid. As is implied in the method of deriving the above expressions, the origin of coördinates is taken on the  $I_p$  axis at the point  $i_a = I_s/2$ .

If now  $E_c$  is adjusted to the point  $C'$  and the amplitude of  $e_c$  is  $CC'$ ,  $i_a/i_p = 0$  and  $H = \sin^{-1} 0 = 0$ . Hence:

$$\begin{aligned} 0.5A_0 &= I_s/\pi \\ A_2 &= -2I_s/3\pi \\ A_4 &= -2I_s/15\pi \\ A_6 &= -2I_s/35\pi \\ A_8 &= -2I_s/63\pi \\ A_q &= -2I_s/(q^2 - 1)\pi \\ B_1 &= I_s/2 \\ B_3 &= B_5 = B_7 = B_p = 0. \end{aligned}$$

And the Fourier series for the operation wave form is:

$$\begin{aligned} I_p &= (I_s/2) [2/\pi + \sin x - (4/\pi)((\frac{1}{3}) \cos 2x \\ &\quad + (1/15) \cos 4x + (1/35) \cos 6x + \dots) ] \end{aligned}$$

This is the series for the wave form shown in Fig. 3 where  $I_p$  is a pure sine wave for one-half cycle and 0 for the succeeding half cycle.

If the amplifier is to be linear the amplitude of the fundamental component of the plate current wave form should be proportional to the amplitude of the excitation grid voltage. Also, if the amplitude of all harmonic components in the inductance leg of the tuned circuit is to be negligible, the amplitude of all harmonics in the plate current wave form should be less than the amplitude of the fundamental. It should be of interest, then, to determine how closely these conditions are approached for different adjustments of  $E_c$  between  $P$  and  $C'$ .

The results obtained by solving the expressions for the Fourier coefficients for several values of  $i_a/i_p$  between 1 and zero (that is, by adjusting  $E_c$  to various points between  $P$  and  $C'$  and varying the input

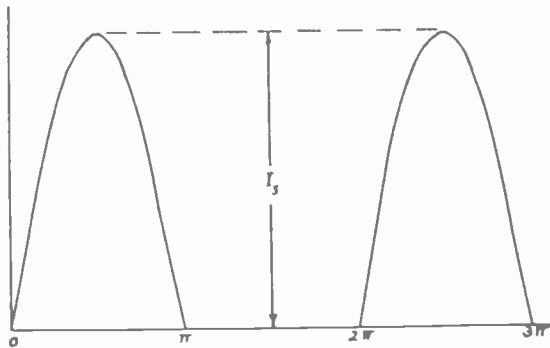

Fig. 3

voltage so that the peak grid swing just reaches the point  $C$  in each instance) are given in Table I. The coefficients for the harmonics to, and including, the fifth are shown. It is evident that the higher harmonics are of negligible importance to this analysis.

The variation of  $0.5A_0$  and  $B_1$  as  $i_a/i_p$  is varied between 0 and 1.0 is shown in Fig. 4. These curves are plotted from Table 1.

TABLE I

| $i_a/i_p$ | $H$      | $0.5A_0$    | $B_1$       | $A_1$        | $B_1$       | $A_1$        | $B_1$        |
|-----------|----------|-------------|-------------|--------------|-------------|--------------|--------------|
| 1.0000    | $\pi/2$  | 0           | $I_s/2$     | 0            | 0           | 0            | 0            |
| 0.7071    | $\pi/4$  | $0.0281I_s$ | $0.5331I_s$ | $-0.0441I_s$ | $0.0551I_s$ | $-0.0181I_s$ | $-0.0061I_s$ |
| 0.5000    | $\pi/6$  | 0.073       | 0.535       | -0.067       | 0.046       | -0.064       | 0.009        |
| 0.3420    | $\pi/9$  | 0.124       | 0.536       | -0.129       | 0.045       | -0.008       | 0.019        |
| 0.1737    | $\pi/18$ | 0.201       | 0.522       | -0.172       | 0.030       | -0.028       | 0.017        |
| 0         | 0        | 0.318       | 0.500       | -0.212       | 0           | -0.042       | 0            |

It will be noted that, as  $i_a/i_p$  is varied between 1.0 and 0, if the peak grid voltage is just sufficient to draw saturation plate current,<sup>6</sup> the amplitude of  $B_1$  will vary from  $0.5I_s$  by 7.2 per cent. When the amplifier is biased between  $C'$  and  $P$  it is evident that the ratio  $i_a/i_p$  will vary for varying amplitudes of input voltage because of the vary-

<sup>6</sup> That is, keeping  $i_a + i_p = I_s$ .

ing percentage of time that the negative half cycle is past the cut-off point. The amplifier will, therefore, not be strictly linear when biased in this way. It is of interest to investigate just how much the amplifier operation departs from the linear relation for different values of  $E_c$  and varying input voltage.

Assume, for simplicity,  $E_p$  to have such a value that when  $E_c = 0$  the alternations of the grid input voltage take place around  $P$ . If the

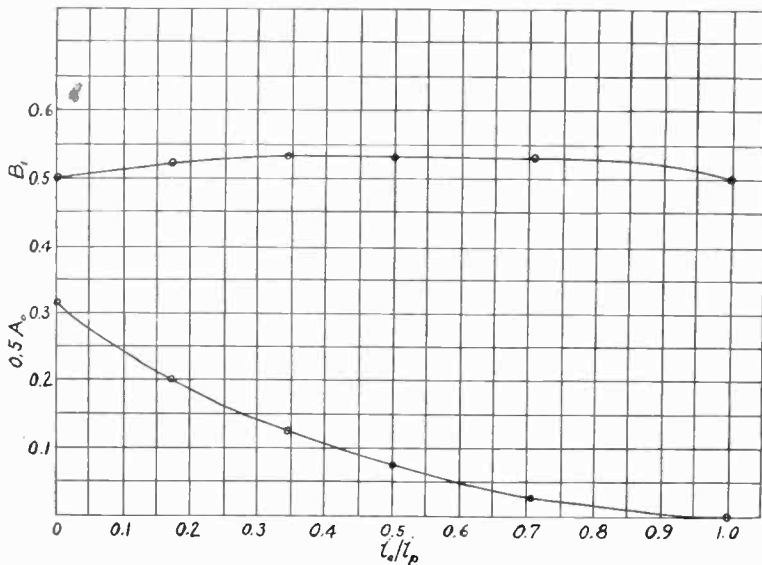

Fig. 4

amplitude of  $e_g$  is not sufficient to draw saturation plate current at its peak positive value the amplitude of  $B_1$  will not be  $0.5I_s$  but will be  $0.5I_{s1}$  where  $I_{s1}$  is given by,<sup>7</sup>

$$I_{s1} = I_s(e_g/e_{gm}).$$

$e_{gm}$  is the maximum positive swing of  $e_g$  required to draw saturation plate current—or, to reach to point  $C$ . It is equal to  $CP - E_c$ . As we are only dealing with the region between  $C'$  and  $P$ ,  $E_c$  is always negative. Hence,  $e_{gm} > PC$  when  $E_c < 0$ .

Table II gives values for the amplitude of the fundamental in the plate current wave form for different values of peak input voltage between  $0.1 CC'$  and  $0.9 CC'$  when  $E_c$  is  $-0.4 CC'$ . When  $E_c = -0.4 CC'$  it is evident that  $e_{gm} = 0.9 CC'$ ; whence the values for  $I_{s1}$  follow.

<sup>7</sup> In general, this relation would be:

$$I_{s1} = I_s(f(e_g)/Ke_{gm}).$$

When the main part of the dynamic characteristic is straight, as in Fig. 1, it reduces to the equation used above. In any problem where the dynamic characteristic curve for the amplifier cannot be taken as essentially linear the curves of Fig. 5 will be altered accordingly.

TABLE II

| $e_0$  | $i_a/i_p$ | $B_1$          | $I_{a1}$    | Amplitude of Fundamental |
|--------|-----------|----------------|-------------|--------------------------|
| 0.1CC' | 1.00      | 0.500 $I_{a1}$ | 0.111 $I_a$ | 0.056 $I_a$              |
| 0.2    | 0.50      | 0.535          | 0.222       | 0.119                    |
| 0.3    | 0.33      | 0.536          | 0.333       | 0.179                    |
| 0.4    | 0.25      | 0.530          | 0.444       | 0.235                    |
| 0.5    | 0.20      | 0.527          | 0.555       | 0.293                    |
| 0.6    | 0.17      | 0.522          | 0.666       | 0.348                    |
| 0.7    | 0.14      | 0.518          | 0.777       | 0.403                    |
| 0.8    | 0.13      | 0.516          | 0.888       | 0.458                    |
| 0.9    | 0.11      | 0.514          | 1.00        | 0.514                    |

Similar tables may be prepared for any values of  $E_c$  between  $C'$  and  $P$ . A family of curves prepared in this way is shown in Fig. 5. The amount of distortion to be expected when operating the amplifier

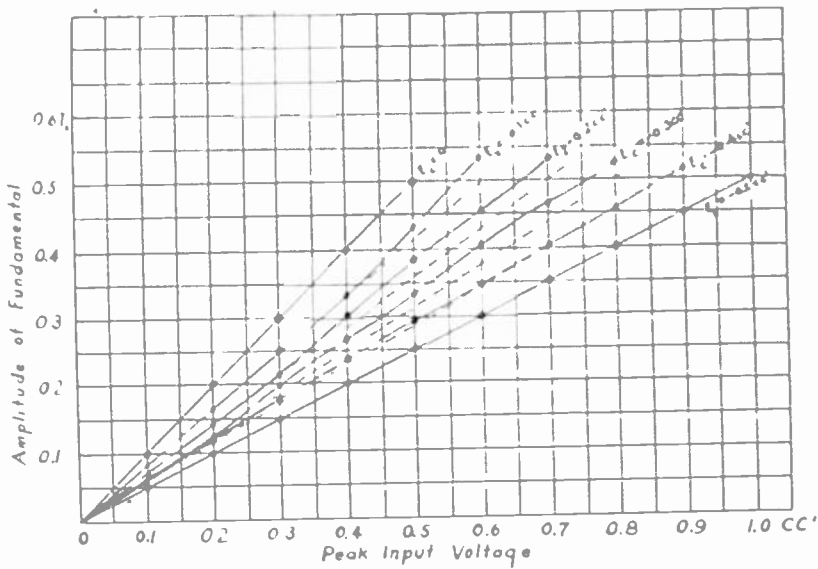

Fig. 5

biased at any point between  $C'$  and  $P$  may be estimated from an examination of these curves. It is clear that the amplifier is perfectly linear, so far as the fundamental is concerned, when  $E_c$  is adjusted either to the point  $P$  ( $E_c = 0$ ) or  $C'$  ( $E_c = -0.5$  CC').

The variation of efficiency as the ratio  $i_a/i_p$  is changed is extremely important. The efficiency to be considered is the plate circuit efficiency. The Fourier coefficients provide a convenient means of determining this efficiency for representative values of  $i_a/i_p$ . The constant term  $0.5A_0$  gives the direct current component to be used in computing the power input. It must, however, be referred to the basic X-axis and not to the axis which varies with  $i_a/i_p$  as was done in Table I. Both values of  $0.5A_0$  are given in Table III. The value used in computing the power input is called  $I_{dc}$ . As has already been noted, the amplitudes of all

harmonic components flowing in the inductance leg of the tank circuit are negligible. Hence, the value,  $I_0$ , to be used in computing the power output is given by  $AB_1/\sqrt{2}$ .  $A$  is a constant multiplying factor for a given tuned circuit and is equal to  $B_{1t}/B_1$ , where  $B_{1t}$  is the maximum amplitude of the fundamental current component measured in the tuned circuit. The efficiency when  $i_a/i_p = 1$  (class A amplifier) is taken to be 50 per cent and the other values given are based on this.

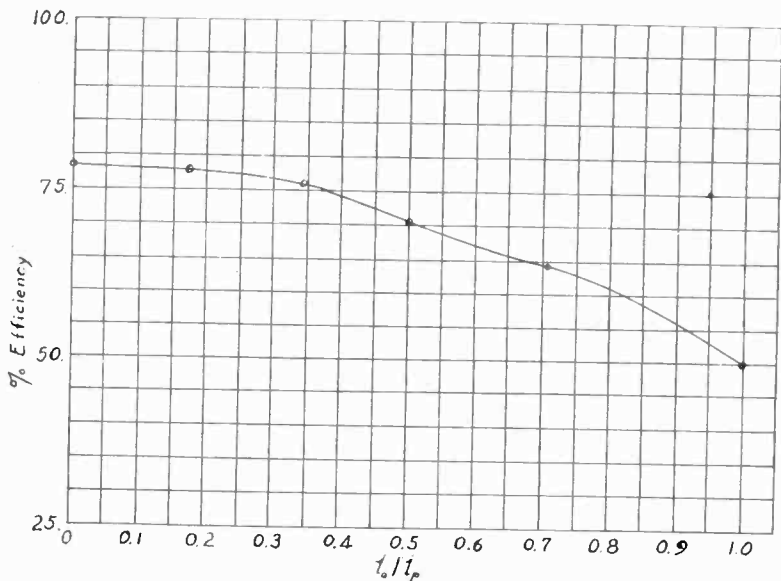

Fig. 6

It is seen that immediately upon moving the bias from  $P$  toward  $C'$  an improvement in efficiency results. The curve in Fig. 6 is plotted from Table III and illustrates this. It will be noted that maximum efficiency is obtained with the amplifier biased at cut-off.  $i_a/i_p$  may be as much as 0.25, however, without any great reduction in efficiency.

TABLE III

| $i_a/i_p$ | $0.5A_0$   | $I_{dc}$   | $I_0$       | $I_{dc}E_b$   | $I_0^2r$         | Efficiency |
|-----------|------------|------------|-------------|---------------|------------------|------------|
| 1.000     | 0.         | $0.500I_s$ | $0.353AI_s$ | $0.500I_sE_b$ | $0.125A^2I_s^2r$ | 50.0%      |
| 0.707     | $0.028I_s$ | 0.443      | 0.376       | 0.443         | 0.141            | 64.2       |
| 0.500     | 0.073      | 0.407      | 0.378       | 0.407         | 0.143            | 70.3       |
| 0.342     | 0.124      | 0.378      | 0.379       | 0.378         | 0.144            | 76.0       |
| 0.174     | 0.201      | 0.349      | 0.369       | 0.349         | 0.136            | 78.0       |
| 0         | 0.318      | 0.318      | 0.353       | 0.318         | 0.125            | 78.5       |

### THE CLASS C AMPLIFIER

Consider the typical lumped voltage characteristic of Fig. 7. ( $E_\gamma = E_p + \mu E_G + e$ ; where  $E_p$  is the effective plate voltage,  $E_G$  is as defined in the discussion of the class B amplifier,  $\mu$  is the voltage amplification constant, and  $e$  is a constant which is related to the contact



difference of potential between the materials of the plate and filament).<sup>8</sup> With a given value of filament current there will be a definite value of  $E_\gamma$  at which all electrons that the filament is capable of emitting will be drawn to the grid and plate, and the plate current will be a maximum. Call the value of plate current at this instant  $I_{s0}$ , and the value of plate voltage  $E_{p0}$ . Then:

$$I_{s0} = \alpha(E_{p0} + \mu E_G + e)$$

If the grid excitation is constant,  $\mu E_G + e = K_0$ , where  $K_0$  has a constant value every instant that  $I_{s0}$  occurs. Hence, we may write:

$$I_{s0} = \alpha(E_{p0} + K_0). \quad (2)$$

Now let  $E_p$  be changed to  $E_{p2}$ . It is evident that  $I_s$  will be changed also and if  $E_{p2}$  is less than  $E_{p0}$  the corresponding value of  $I_s$  will be

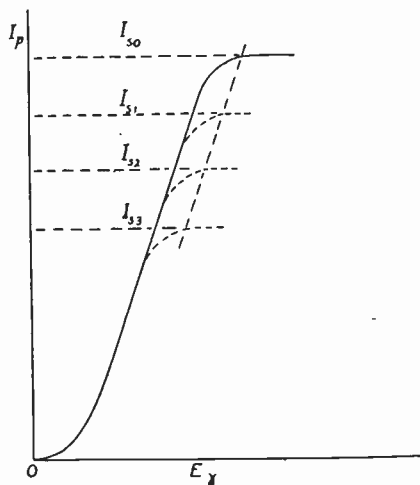

Fig. 7

less than  $I_{s0}$ —call it  $I_{s2}$ . If the excitation voltage is unchanged  $K_0$  does not change. Also, the proportionality factor,  $\alpha$ , does not change as these operations are along that portion of the characteristic which is essentially linear. Therefore, as long as the exciting grid voltage is constant and is sufficient to draw saturation plate current at the peak plate voltage  $E_{p0}$ , both  $\alpha$  and  $K$  are constants and (2) becomes the equation of a straight line. Thus the relation between  $I_s$  and  $E_p$  is linear and the condition for class C operation is fulfilled.

Summarizing, the conditions for class C operation are: First, the plate voltage must not exceed the value  $E_{p0}$ .

Second, the amplitude of grid voltage swing must be sufficient to

<sup>8</sup> H. J. van der Bijl, "The Thermionic Vacuum Tube," p. 44.

cause saturation plate current to flow when the plate voltage is  $E_{p0}$ . Also, the period of time during which the plate current is approaching and receding from the saturation value should be negligible in comparison with the period during which saturation exists. This follows from the fact that the linear relation does not necessarily hold for values of plate current other than saturation. This simply means that the sides of the plate current wave form should be as nearly vertical as is possible. Two ideal shapes for which the above linear power relation will hold are shown in Fig. 8.

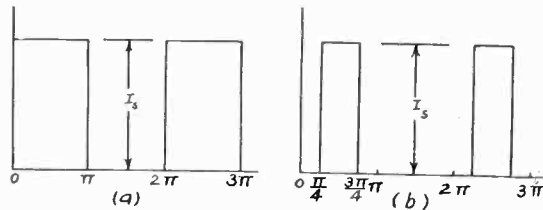

Fig. 8

Of course the linear power relation will hold for a rectangular wave form that persists for any fractional part of the positive half cycle. The above shapes are selected only because they represent two extremes and are easily analyzed with the Fourier series. The appropriate Fourier coefficients for the form 8(a) are derived in Appendix II. They are:

$$\begin{aligned} 0.5A_0 &= I_s/2 \\ B_1 &= 2I_s/\pi \\ B_3 &= 2I_s/3\pi \\ B_5 &= 2I_s/5\pi \\ A_2 &= A_4 = A_6 = 0. \end{aligned}$$

Whence,

$$I_p = (I_s/2) \left[ 1 + (4/\pi) \left( \sin x + \left(\frac{1}{3}\right) \sin 3x + \left(\frac{1}{5}\right) \sin 5x + \dots \right) \right].$$

The amplitude of the fundamental is  $0.636I_s$ . Hence the plate circuit efficiency is,

$$0.405A^2I_s^2r/I_sE_b = 0.405A^2I_s r/E_b.$$

Assuming the theoretical efficiency of the ideal class A amplifier as 50 per cent we find the efficiency of the wave form 8(a) to be 81 per cent.

Proceeding as above for wave form 8(b) the appropriate Fourier series may be shown to be: (see Appendix II)

$$I_p = (I_s/2) \left[ \frac{1}{2} + (4/\pi\sqrt{2})(\sin x - \frac{1}{3} \sin 3x - \frac{1}{5} \sin 5x + (1/7) \sin 7x - \dots) - (4/\pi\sqrt{2})((\sqrt{2}/2) \cos 2x - (\sqrt{2}/6) \cos 6x + (\sqrt{2}/10) \cos 10x - \dots) \right].$$

The amplitude of the fundamental is  $0.45I_s$ . Hence, the efficiency for this wave form is also 81 per cent. It would appear, therefore, that no increase in efficiency is to be expected from decreasing the portion of the half-cycle during which saturation current flows if the above shapes are obtainable.

It will be noted that the amplitude of none of the harmonics of the above two series is as great as the fundamental. Consequently, we may conclude that the effect of the harmonics in the inductance leg of the tank circuit will be negligible.

It is impossible, in practice, to obtain a wave form such as is shown in Fig. 8(a). If the amplitude of the input voltage were sufficient to give a plate current wave form approximating 8(a), the grid would be at such a high positive potential during most of the half-cycle that the plate current would be zero; the total electron flow going to the grid. The resulting wave form would approach that shown in Fig. 9. The

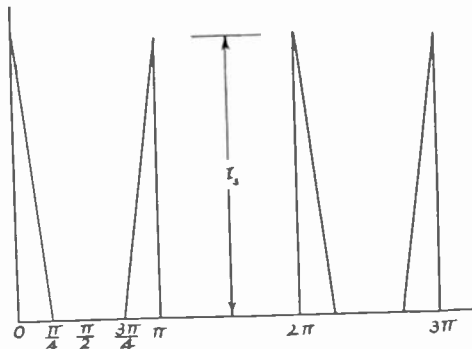

Fig. 9

appropriate Fourier series, the derivation of which is given in Appendix III, is:

$$I_p = (I_s/2) \left[ \frac{1}{4} + (2/\pi) \left( (2 - 4\sqrt{2}/\pi) \sin x + \frac{1}{3} (2 - 4\sqrt{2}/3\pi) \sin 3x + (1/5) (2 + 4\sqrt{2}/5\pi) \sin 5x + \dots \right) + (2/\pi^2) (2 \cos 2x + \cos 4x + (2/9) \cos 6x + \dots) \right].$$

This series shows at once that an amplifier operating in such a manner would not give an undistorted output. The amplitude of the second harmonic is 3.2 times as great as the fundamental, the third harmonic 2.4 times as great, the fourth 1.6 times as great, and the fifth

2.4 times as great. A generator operating in this fashion would be unusually rich in harmonics but the mode of operation is useless for amplification purposes.

Biasing the tube past cut-off, that is to the left of point  $C'$  in Fig. 1, reduces the portion of the half-cycle during which grid or plate current flows. Consequently, the ideal wave form with a flat top as shown in Fig. 8(b) is approached. Actually, of course, the wave form approximated is that shown in Fig. 10.

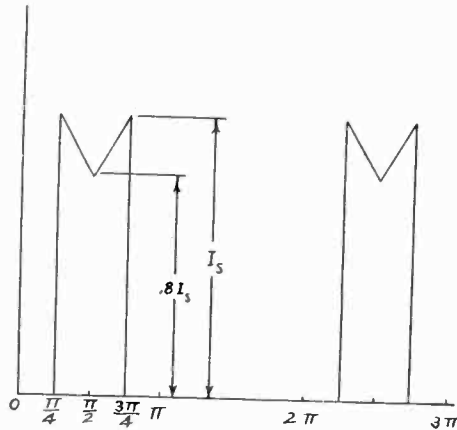

Fig. 10

The appropriate Fourier expansion is: (see Appendix IV)

$$\begin{aligned}
 I_p = I_s [ & 9/40 + (1/\pi) \{ (\sqrt{2} + (4/5\pi)(\sqrt{2} - 2)) \sin x \\
 & + (\frac{1}{3})(-\sqrt{2} + (4/15\pi)(\sqrt{2} + 2)) \sin 3x \\
 & - (1/5)(\sqrt{2} + (4/25\pi)(\sqrt{2} + 2)) \sin 5x + \dots \\
 & + ((2/5\pi) - 1) \cos 2x - (1/5\pi) \cos 4x + ((2/45\pi) \\
 & + (\frac{1}{3})) \cos 6x - \dots \} ].
 \end{aligned}$$

As the amplitude of the fundamental is greater than that of the harmonics it may be concluded that the effect of the harmonics in the plate tank circuit inductance will be negligible. The amplitude of the fundamental is  $0.402I_s$ . Hence, the efficiency of this form is:

$$0.162A^2I_s^2r/0.450I_sE_b = 0.360A^2I_s r/E_b.$$

Or, using the ideal class A amplifier as a basis we find the efficiency to be 72 per cent.

Thus the dip in the top of the form gives an efficiency 9 per cent less than would be obtained if the wave form were flat across the top. It is possible to closely approximate the form of Fig. 10 in actual operation

and so the value of 72 per cent should give an idea as to what may be expected in practice. The efficiency would, of course, be less than 72 per cent as it is impossible to obtain 50 per cent with the class A amplifier.

By increasing the negative grid bias and adjusting the grid excitation voltage correspondingly, it is possible to reduce further the portion of the half-cycle during which plate current flows. Hence, the dip in the top of the form could be reduced. This should bring the plate circuit efficiency nearer the maximum attainable value of 81 per cent.

It would appear that the increase in efficiency commonly experienced with an increase of negative bias and increase of exciting grid voltage is not, as is often supposed, due to the decrease in the period of time during which power is dissipated on the plate, but is caused by the decrease in the period of time during which the grid can draw current from the plate; or, we may say, the decrease in the period of time during which power is dissipated on the grid.

#### CONCLUSIONS

(1) As regards input voltage and output current, a radio-frequency amplifier is perfectly linear only when operating as a class A amplifier or when biased at cut-off.

(2) The efficiency is greatest when the amplifier is biased at cut-off. However, it changes very little in the region near the cut-off point.

(3) To obtain the maximum efficiency and minimum distortion the class C amplifier should be biased (negative) considerably past the cut-off point. The grid input voltage should have a positive peak amplitude sufficient to cause saturation plate current to flow at the maximum value of plate voltage to be applied during the operation of the amplifier.

#### APPENDIX I

Derivation of Fourier coefficients for the wave form of Fig. 2.

$$\begin{aligned}
 0.5A_0 &= (1/2\pi) \int_0^{2\pi} f(x) dx = (1/2\pi) \left( i_p \int_0^{\pi+H} \sin x dx \right. \\
 &\quad \left. - i_a \int_{\pi+H}^{2\pi-H} dx + i_p \int_{2\pi-H}^{2\pi} \sin x dx \right) \\
 &= (i_p/\pi) (\cos H - (i_a/i_p)(\pi/2 - H)) \\
 A_q &= (1/\pi) \int_0^{2\pi} f(x) \cos qx dx = (1/\pi) \left( i_p \int_0^{\pi+H} \sin x \cos qx dx \right.
 \end{aligned}$$

$$\begin{aligned}
& - i_a \int_{\pi+H}^{2\pi-H} \cos qx dx + i_p \int_{2\pi-H}^{2\pi} \sin x \cos qx dx \\
= & (1/\pi) [(i_p q/q^2 - 1)(\sin x \sin qx + (1/q) \cos x \cos qx)_0^{\pi+H} \\
& - (i_a/q)(\sin qx)_{\pi+H}^{2\pi-H} + (i_p q/q^2 - 1)(\sin x \sin qx \\
& + (1/q)(\cos x \cos qx)_{2\pi-H}^{2\pi}] \\
= & (i_p/\pi) [(2i_a/qi_p) \sin qH - (2q/q^2 - 1)((i_a/i_p) \sin qH \\
& + (1/q) \cos H \cos qH)].
\end{aligned}$$

Hence, by making the proper substitutions for  $q$ , the values given for  $A_2$ ,  $A_4$ ,  $A_6$ , and  $A_8$  readily follow.

$$\begin{aligned}
B_p &= (1/\pi) \int_0^{2\pi} f(x) \sin px dx = (1/\pi) \left( i_p \int_0^{\pi+H} \sin x \sin px dx \right. \\
& \left. - i_a \int_{\pi+H}^{2\pi-H} \sin px dx + i_p \int_{2\pi-H}^{2\pi} \sin x \sin px dx \right) \\
= & (i_p/\pi) [(2p/p^2 - 1)((1/p) \sin pH \cos H - (i_a/i_p) \cos pH) \\
& + (2i_a/pi_p) \cos pH].
\end{aligned}$$

It will be noticed that the above equation is indeterminate when  $p=1$ . We can, however, obtain  $B_1$  by substituting directly in the general expression for  $B_p$  before integrating. This gives:

$$B_1 = (i_p/\pi)((2i_a/i_p) \cos H + H - (\frac{1}{2}) \sin 2H + \pi/2).$$

The values given for  $B_3$ ,  $B_5$ ,  $B_7$ ,  $\dots$ , follow readily when the proper substitutions for  $p$  are made in the general expression.

## APPENDIX II

The wave form of Fig. 8(a) is defined as follows:

When  $0 < x < \pi$ ,  $f(x) = I_s$ ; when  $\pi < x < 2\pi$ ,  $f(x) = 0$

Whence,

$$\begin{aligned}
0.5A_0 &= (1/2\pi) \int_0^{2\pi} f(x) dx = (I_s/2\pi) \int_0^{\pi} dx = I_s/2 \\
A_q &= (1/\pi) \int_0^{2\pi} f(x) \cos qx dx = 0 \\
B_p &= (1/\pi) \int_0^{2\pi} f(x) \sin px dx = (I_s/\pi) \int_0^{\pi} \sin px dx \\
&= - (I_s/p\pi)(\cos px)_0^{\pi} = - (I_s/p\pi)(\cos p\pi - 1).
\end{aligned}$$

The values of  $B_1$ ,  $B_3$ , and  $B_5$  given in the text follow readily when proper substitutions are made for  $p$ .

8(b) is defined as follows:

When  $0 < x < \pi/4$ ,  $f(x) = 0$ ; when  $\pi/4 < x < 3\pi/4$ ,  $f(x) = I_s$ ; when  $3\pi/4 < x < 2\pi$ ,  $f(x) = 0$ .

Therefore,

$$0.5A_0 = (I_s/2\pi) \int_{\pi/4}^{3\pi/4} dx = I_s/4$$

$$\begin{aligned} A_q &= (I_s/\pi) \int_{\pi/4}^{3\pi/4} \cos qx dx = (I_s/q\pi) (\sin qx)_{\pi/4}^{3\pi/4} \\ &= (I_s/q\pi) (\sin (3q\pi/4) - \sin (q\pi/4)). \end{aligned}$$

From which it follows:  $A_2 = -I_s/\pi$ ;  $A_4 = 0$ ;  $A_6 = I_s/3\pi$ ;  $A_8 = 0$ ;  $A_{10} = -I_s/5\pi$

$$\begin{aligned} B_p &= (1/\pi) \int_0^{2\pi} f(x) \sin pxdx = (I_s/\pi) \int_{\pi/4}^{3\pi/4} \sin pxdx \\ &= - (I_s/p\pi) (\cos px)_{\pi/4}^{3\pi/4} = - (I_s/p\pi) (\cos 3p\pi/4 - \cos p\pi/4). \end{aligned}$$

Whence:

$$B_1 = I_s\sqrt{2}/\pi, B_3 = -I_s\sqrt{2}/3\pi, B_5 = -I_s\sqrt{2}/5\pi, B_7 = I_s\sqrt{2}/7\pi.$$

Therefore the series given in the text follows.

### APPENDIX III

The wave form of Fig. 9 may be defined as follows:

When  $0 < x < \pi/4$ ,  $f(x) = I_s(1 - 4x/\pi)$ ; when  $\pi/4 < x < 3\pi/4$ ,  $f(x) = 0$ ; when  $3\pi/4 < x < \pi$ ,  $f(x) = I_s(4x/\pi - 3)$ ; when  $\pi < x < 2\pi$ ,  $f(x) = 0$ .

Thus:

$$\begin{aligned} 0.5A_0 &= (1/2\pi) \int_0^{2\pi} f(x) dx = (1/2\pi) \left( I_s \int_0^{\pi/4} (1 - 4x/\pi) dx \right. \\ &\quad \left. + I_s \int_{3\pi/4}^{\pi} (4x/\pi - 3) dx \right) \\ &= (I_s/2\pi) (\pi/4 - \pi/8 + 7\pi/8 - 3\pi/4) = I_s/8 \end{aligned}$$

$$\begin{aligned} A_q &= (1/\pi) \int_0^{2\pi} f(x) \cos qxdx = (I_s/\pi) \left( \int_0^{\pi/4} (1 - 4x/\pi) \cos qxdx \right. \\ &\quad \left. + \int_{3\pi/4}^{\pi} (4x/\pi - 3) \cos qxdx \right) = (I_s/\pi) [(1/q) \sin q\pi/4 \end{aligned}$$

$$\begin{aligned}
 & - (4/q\pi) \left\{ (\pi/4) \sin q\pi/4 + (1/q) \cos q\pi/4 - (1/q) \right\} \\
 & + (4/q\pi) \left\{ (1/q) \cos q\pi - (3\pi/4) \sin 3q\pi/4 - (1/q) \cos 3q\pi/4 \right\} \\
 & + (3/q) \sin 3q\pi/4].
 \end{aligned}$$

Or, substituting for  $q$ :  $A_2 = 2I_s/\pi^2$ ,  $A_4 = I_s/\pi^2$ ,  $A_6 = 2I_s/9\pi^2$ . . . .

$$\begin{aligned}
 B_2 & = (1/\pi) \int_0^{2\pi} f(x) \sin px dx = (I_s/\pi) \left( \int_0^{\pi/4} (1 - 4x/\pi) \sin px dx \right. \\
 & \quad \left. + \int_{3\pi/4}^{\pi} (4x/\pi - 3) \sin px dx \right) = (I_s/\pi) [ - (1/p)(\cos p\pi/4 - 1) \\
 & \quad - (4/p\pi)((1/p) \sin p\pi/4 - (\pi/4) \cos p\pi/4) + (4/p\pi)(-\pi \cos p\pi \\
 & \quad - (1/p) \sin 3p\pi/4 + (3\pi/4) \cos 3p\pi/4) \\
 & \quad + (3/p)(\cos p\pi - \cos 3p\pi/4)].
 \end{aligned}$$

Substituting for  $p$ :  $B_1 = (I_s/\pi)(2 - 4\sqrt{2}/\pi)$ ,  $B_3 = (I_s/3\pi)(2 - 4\sqrt{2}/3\pi)$ ,  $B_5 = (I_s/5\pi)(2 + 4\sqrt{2}/5\pi)$ . . . . Thus we obtain the Fourier series given in the text for Fig. 9.

#### APPENDIX IV

The wave form of Fig. 10 may be defined as follows:

When  $0 < x < \pi/4$ ,  $f(x) = 0$ ; when  $\pi/4 < x < \pi/2$ ,  $f(x) = (2I_s/5)(3 - 2x/\pi)$ ; when  $\pi/2 < x < 3\pi/4$ ,  $f(x) = (2I_s/5)(1 + 2x/\pi)$ ; when  $3\pi/4 < x < 2\pi$ ,  $f(x) = 0$ .

Thus:

$$\begin{aligned}
 0.5A_0 & = (1/2\pi) \int_0^{2\pi} f(x) dx = (I_s/5\pi) \left( \int_{\pi/4}^{\pi/2} (3 - 2x/\pi) dx \right. \\
 & \quad \left. + \int_{\pi/2}^{3\pi/4} (1 + 2x/\pi) dx \right) = 9I_s/40 \\
 A_q & = (1/\pi) \int_0^{2\pi} f(x) \cos qxdx = (2I_s/5\pi) \left( \int_{\pi/4}^{\pi/2} (3 - 2x/\pi) \cos qxdx \right. \\
 & \quad \left. + \int_{\pi/2}^{3\pi/4} (1 + 2x/\pi) \cos qxdx \right) \\
 & = (2I_s/5\pi) [(3/q)(\sin q\pi/2 - \sin q\pi/4) - (2/q\pi)((\pi/2) \sin q\pi/2 \\
 & \quad - (\pi/4) \sin q\pi/4 + (1/q) \cos q\pi/2 - (1/q) \cos q\pi/4) \\
 & + (1/q)(\sin 3q\pi/4 - \sin q\pi/2) + (2/q\pi)((3\pi/4) \sin 3q\pi/4 \\
 & \quad - (\pi/2) \sin q\pi/2 + (1/q) \cos 3q\pi/4 - (1/q) \cos q\pi/2)].
 \end{aligned}$$



Substituting for  $q$ :

$$A_2 = (I_s/\pi)(2/5\pi - 1), \quad A_4 = - (I_s/5\pi^2)$$

$$A_6 = (I_s/\pi)(2/45\pi + \frac{1}{3}) \dots$$

$$\begin{aligned} B_p &= (1/\pi) \int_0^{2\pi} f(x) \sin px dx = (2I_s/5\pi) \left( \int_{\pi/4}^{\pi/2} (3 - 2x/\pi) \sin px dx \right. \\ &\quad \left. + \int_{\pi/2}^{3\pi/4} (1 + 2x/\pi) \sin px dx \right) \\ &= (2I_s/5\pi) \left[ - (3/p)(\cos p\pi/2 - \cos p\pi/4) - (2/p\pi)((1/p) \sin p\pi/2 \right. \\ &\quad - (1/p) \sin p\pi/4 - (\pi/2) \cos p\pi/2 + (\pi/4) \cos p\pi/4) \\ &\quad - (1/p)(\cos 3p\pi/4 - \cos p\pi/2) + (2/p\pi)((1/p) \sin 3p\pi/4 \\ &\quad \left. - (1/p) \sin p\pi/2 - (3\pi/4) \cos 3p\pi/4 + (\pi/2) \cos p\pi/2) \right]. \end{aligned}$$

Substituting for  $p$ :

$$B_1 = (I_s/\pi)(\sqrt{2} + (4/5\pi)(\sqrt{2} - 2)),$$

$$B_3 = (I_s/3\pi)(-\sqrt{2} + (4/15\pi)(\sqrt{2} + 2)),$$

$$B_5 = - (I_s/5\pi)(\sqrt{2} + (4/25\pi)(2 + \sqrt{2})) \dots$$

Thus the constants for the Fourier series of Fig. 10 are determined.



## NOTE ON NETWORK THEORY\*

BY

J. G. BRAINERD

(Moore School of Electrical Engineering, University of Pennsylvania, Philadelphia, Pa.)

**Summary**—Passive transducers may be connected in any manner between two pairs of terminals to form a resultant passive transducer between those terminals. In this note are given or indicated general expressions for the important properties of such a resultant transducer in terms of those of the transducers forming it for the case in which the arrangement of the subsidiary transducers can be achieved by some combination of series and parallel connections. Section (a) treats of transducers in parallel; (b), in series; (c), in series-parallel.

**B**ETWEEN two given pairs of terminals any number of passive transducers, each with two pairs of terminals, may be connected in any fashion to form a resultant passive transducer. Filter lines, transmission lines, transformers or other networks in parallel, series, or otherwise are examples.<sup>1</sup> The resultant transducer has properties which depend upon those of the subsidiary transducers and in certain special cases the relationships have been investigated.

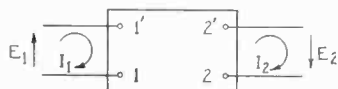

Fig. 1.—Transducer.

A four-terminal passive transducer (sometimes called a passive quadripole) is completely specified at a given frequency as far as steady-state reactions in the circuit external to it are concerned when three independent properties<sup>2</sup> of it are known. It will be convenient to use here the three so-called short-circuit impedances, and as it is not customary to express explicitly the properties of a transducer in terms of these three, the following list is added for convenience. The results may be checked by showing that they hold for a  $T$  section; since any passive quadripole can be represented by a  $T$  section it follows that the results must hold in general.<sup>3</sup>

Let  $z_A$  (Fig. 1) be the impedance measured at 11' terminals when  $E_2=0$  (short-circuit or zero impedance between 22' terminals;

\* Decimal classification: R140. Original manuscript received by the Institute, April 15, 1932.

<sup>1</sup> See T. E. Shea, "Transmission Networks and Wave Filters," Chap. III.

<sup>2</sup> These can always be measured or calculated for a given passive quadripole.

<sup>3</sup> For a direct check, each quantity may be determined from the general equations of a passive quadripole:  $I_1 = E_1/z_A + E_2/z_B$  and,  $I_2 = E_1/z_B + E_2/z_C$ .

$z_A$  is the short-circuit input impedance) and let  $z_C$  be the corresponding impedance measured at the 22' terminals (11' short-circuited). Let  $z_B$  be the (short-circuit) transfer impedance  $E_1/I_2$  when  $E_2=0$  or  $E_2/I_1$  when  $E_1=0$ . In all that follows the subscripts of these three short-circuit impedances and of the receiver impedance  $z_r$  will be written for the impedances. For any passive quadripole (all quantities are complex):

$$\text{Input impedance when } E_2 = -z_r I_2: z_1 = \frac{AB^2(r + C)}{B^2(r + C) - rAC} \tag{1}$$

$$\text{Transfer impedance when } E_2 = -z_r I_2: z_t = B(r + C)/C. \tag{2}$$

Iterative characteristic impedance:

$$z_{1K} = \frac{B^2(A - C) \pm \sqrt{B^4(C + A)^2 - 4A^2B^2C^2}}{2(B^2 - AC)}. \tag{3}$$

$$\text{Short-circuit current ratio } \sigma_{1s} = I_2/I_1 \text{ when } E_2 = 0: \sigma_{1s} = A/B. \tag{4}$$

Iterative current ratio  $\sigma_{1K} = I_2/I_1$  when  $E_2 = -z_{1K}I_2$ :

$$\sigma_{1K} = Cz_{1K}/B(C + z_{1K}). \tag{5}$$

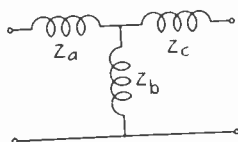

Fig. 2—T section.

For the equivalent T section of the quadripole (Fig. 2)

$$\begin{aligned} z_a &= AB(B - C)/(B^2 - AC) \\ z_b &= ABC/(B^2 - AC) \\ z_c &= BC(B - A)/(B^2 - AC). \end{aligned} \tag{6}$$

The impedances  $z_1$  and  $z_{1K}$  are the input and iterative impedances looking into the transducer at the 11' terminals; there are corresponding impedances  $z_2$  and  $z_{2K}$  at the 22' terminals. Likewise there are ratios  $\sigma_{2s}$  and  $\sigma_{2K}$  corresponding to  $\sigma_{1s}$  and  $\sigma_{1K}$ . The open-circuit input impedances may be obtained by making  $r = \infty$  in  $z_1$  and  $z_2$ . The ratio  $\sigma_{1K}$  is equal to  $\epsilon^{-\theta}$  where  $\epsilon$  is the base of the natural logs and  $\theta$  the transfer factor.

(a) *Transducers in Parallel.* Consider two transducers in parallel (Fig. 3). The short-circuit input impedance  $A$  measured at 11' is simply equivalent to  $A_\alpha$  and  $A_\beta$  in parallel, where subscripts  $\alpha$  and  $\beta$  refer to transducers  $\alpha$  and  $\beta$ , respectively, and  $C$  is similar:

$$A = \frac{1}{\frac{1}{A_\alpha} + \frac{1}{A_\beta}}; \quad C = \frac{1}{\frac{1}{C_\alpha} + \frac{1}{C_\beta}}$$

Likewise the short-circuit transfer impedance  $B$  is

$$B = \frac{1}{\frac{1}{B_\alpha} + \frac{1}{B_\beta}}$$

which may be seen from the figure or may be shown by substituting a T section for each subsidiary transducer ( $\alpha$  and  $\beta$ ) and analyzing the circuit.

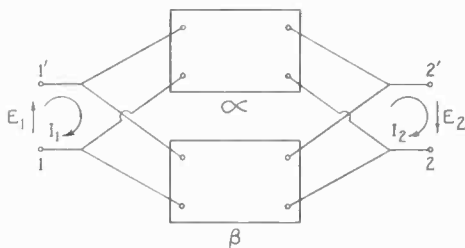

Fig. 3—Transducers in parallel.

No other major properties of the resultant transducer are derivable in so simple a manner from the properties of the subsidiary transducers. If  $n$  transducers are in parallel,

$$A = \frac{1}{\frac{1}{A_\alpha} + \frac{1}{A_\beta} + \dots + \frac{1}{A_n}}; \quad B = \frac{1}{\frac{1}{B_\alpha} + \frac{1}{B_\beta} + \dots + \frac{1}{B_n}};$$

$$C = \frac{1}{\frac{1}{C_\alpha} + \frac{1}{C_\beta} + \dots + \frac{1}{C_n}}; \quad (7)$$

and the open-circuit, short-circuit, transfer, and iterative impedances, current ratios, equivalent T section, etc., of the resultant transducer may be obtained by substituting in the equations given above for  $z_1$ ,  $z_t$ , etc., for a single quadripole.

One special case of importance is that in which symmetry exists in each subsidiary transducer, so that  $A_\alpha = C_\alpha$ ,  $A_\beta = C_\beta$ , etc. The iterative impedance  $z_K (= z_{1K} = z_{2K})$  is then

$$z_K = \sqrt{\frac{1}{\frac{1}{A^2} - \frac{1}{B^2}}}$$

or,

$$\frac{1}{z_K^2} = \left(\frac{1}{A_\alpha} + \frac{1}{A_\beta} + \dots + \frac{1}{A_n}\right)^2 - \left(\frac{1}{B_\alpha} + \frac{1}{B_\beta} + \dots + \frac{1}{B_n}\right)^2 \quad (8)$$

For  $n$  identical symmetrical transducers in parallel,  $z_K = z_K'/n$  where  $z_K'$  is the iterative impedance of each of the subsidiary transducers. This indicates that a small over-all iterative impedance may be obtained by paralleling sections of high iterative impedance. It is interesting to note that for symmetrical subsidiary transducers

$$\sigma_K = \epsilon^{-\theta} = \frac{1}{\frac{B}{A} + \sqrt{\frac{B^2}{A^2} - 1}} \quad (9)$$

and for any number of symmetrical sections in parallel, if  $B/A = B_\alpha/A_\alpha = \dots$ , etc., the transfer or propagation constant  $\theta$  of the resultant transducer is the same as that of each subsidiary transducer. On the other hand, if there are two or more symmetrical dissimilar transducers in parallel, the transfer constant of the group cannot be expressed in a simple manner in terms of the transfer constants of the subsidiary transducers, as may be seen by substituting for  $A$  and  $B$  in (9).

However, it is possible in the case of filters in parallel to check the well-known fact that every pass-band of a subsidiary transducer is, usually, a pass-band of the resultant transducer. Consider (Fig. 3) two transducers  $\alpha$  and  $\beta$  in parallel, the former ( $\alpha$ ) with equivalent T section as in Fig. 2 representing one filter, the latter ( $\beta$ ) representing all other filters in parallel with this one. Then, assuming symmetry ( $z_a = z_c$ ) and no resistance, if  $\rho_\alpha = z_a/2z_b = (B_\alpha/2A_\alpha - 1/2)$ , every cut-off frequency of  $\alpha$  yields either 0 or  $-1$  for  $\rho_\alpha$ . The ratio of the total series to four times the shunt impedance of the equivalent T of both transducers ( $\alpha$  and  $\beta$ ) is

$$\rho = \frac{1}{2} \left( \frac{B}{A} - 1 \right) = \frac{1}{2} \left[ \frac{(a + b)A_\beta B_\beta + \phi_\alpha B_\beta}{A_\beta (bB_\beta + \phi_\alpha)} - 1 \right]$$

where  $a$  has been written for  $z_a$ , etc., and  $\phi_\alpha \equiv a^2 + 2ab$ . Cut-off frequencies of the resultant transducer correspond to  $\rho = 0$  or  $\rho = -1$ .

Case I: When,  $\rho_\alpha = 0$ ,

$$a = 0, \quad \phi_\alpha = 0, \quad \rho = 0.$$

Case II: When,  $\rho_\alpha = 0$ ,

$$b = \infty, \quad \phi_\alpha = 2ab, \quad \rho \neq 0 \quad \text{unless } a = 0 \text{ also.}$$

Case III: When,  $\rho_\alpha = -1$ ,

$$a = -2b, \quad \phi_\alpha = 0, \quad \rho = -1.$$

The result of II shows that a cut-off frequency of  $\alpha$  is not necessarily a cut-off frequency of the resultant transducer, a result which might have been surmised from physical considerations. In the case of a constant  $K$  filter,  $a=0$  when  $b=\infty$ . Provided  $-1 \leq \rho \leq 0$  for all values of  $\rho_\alpha$  between 0 and  $-1$ , the pass-bands of the subsidiary transducer will be pass-bands of the resultant transducer. This will usually, but does not necessarily, hold.

(b) *Transducers in Series.* Transducers in series have been studied extensively. For the present purpose it is convenient to repeat here that (1) and (2) may be considered recursion formulas. For example, the input impedance of one transducer is

$$\frac{A_\alpha B_\alpha^2 (r + C_\alpha)}{B_\alpha^2 (r + C_\alpha) - r A_\alpha C_\alpha}$$

If  $r$  is replaced in this by the input impedance of a transducer which is connected to the first transducer at the 22' terminals (Fig. 1), then the short-circuit input impedance  $A$  of the two in series may be obtained by setting  $r=0$  in the resultant equation;  $C$  may be determined similarly, and the open-circuit input impedances follow from setting  $r=\infty$ , etc. Likewise (2) can be made to yield the transfer impedance  $B$  of a transducer containing any number of subsidiary transducers in series.

(c) *Transducers in Series-Parallel.* By determining the over-all short-circuit impedances of each group containing two or more transducers in series according to the method of (b), and then following the method of (a) in handling the resulting paralleled transducers, the properties of a transducer composed of any number of subsidiary transducers joined in some arrangement which can be built up by series, and parallel connections may be expressed in terms of the properties of the subsidiary transducers.



**BOOK REVIEWS**

**Foundations of Radio**, by Rudolph L. Duncan. Published by John Wiley & Sons, Inc., New York. 246 pages, 145 figures. Price, \$2.00.

This is a text for the beginning student presenting clearly the elementary principles of electricity and allied subjects that apply to radio with no attempt to treat the theory and practice of radio itself. The subjects discussed include electrical units, static electricity, magnetism, electromagnetism, resistance and conduction, Ohm's law, primary cells, sound, and preparatory mathematics. Simple experiments are described to illustrate the text and many worked examples are given. A list of problems for solution is given at the end of each chapter.

\*S. S. KIRBY

**Radio Receiving Tubes**, by Moyer and Wostrel. Published by McGraw Hill Book Company, Inc., New York. 323 pages, 203 figures. Price, \$2.50.

In this book the essential principles underlying the operation of vacuum tubes are so explained as to present a well defined picture to students and general readers. In several introductory chapters the history and the construction of vacuum tubes and the elementary fundamental electrical relations involved in vacuum tube circuits are discussed. Then the use of vacuum tubes as detectors, amplifiers and oscillation generators is taken up in considerable detail. Specifications of vacuum tubes, methods of testing, and reactivating are given, and equipment for testing and reactivating is described.

Many vacuum tube characteristics are given and their use explained. Circuit diagrams are given illustrating the various points discussed in the text.

This book should be very useful to service men and students as a source of practical information and an explanation of the simpler principles of vacuum tube action.

\*S. S. KIRBY

\* Bureau of Standards, Washington, D.C.



RADIO ABSTRACTS AND REFERENCES

THIS is prepared monthly by the Bureau of Standards,\* and is intended to cover the more important papers of interest to the professional radio engineer which have recently appeared in periodicals, books, etc. The number at the left of each reference classifies the reference by subject, in accordance with the "Classification of radio subjects: An extension of the Dewey Decimal system," Bureau of Standards Circular No. 385, obtainable from the Superintendent of Documents, Government Printing Office, Washington, D. C., for 10 cents a copy. The classification also appeared in full on pp. 1433-56 of the August, 1930, issue of the PROCEEDINGS of the Institute of Radio Engineers.

The articles listed are not obtainable from the Government or the Institute of Radio Engineers, except when publications thereof. The various periodicals can be secured from their publishers and can be consulted at large public libraries.

R100. RADIO PRINCIPLES

- R113 L. V. Berkner. Note on reception of radio broadcast stations at distances exceeding 12,000 kilometers. *Proc. I.R.E.*, vol. 20, pp. 1324-27; August, (1932). *National Broadcast Reporter*, p. 7; August 6, (1932).

Results of aural observations of broadcast stations made during the operations of the Byrd Antarctic Expedition in New Zealand and between New Zealand and Antarctica are given. Tables are given showing stations most frequently heard.

- R113 Polar Year. *Electrician* (London), vol. 109, p. 52; July 8, (1932).

The brief article discusses the expeditions which will take part in the polar year activities, the objects of the polar year, and the apparatus to be carried.

- R113.55 A. E. Kennelly. Radio during solar eclipses. *Electronics*, vol. 5, pp. 248-249; August, (1932).

The phenomena which may be watched for during the eclipse of August 31 are outlined. Briefly, results of other observations are mentioned.

- R120 F. M. Colebrook. An experimental and analytical investigation of earthed receiving aerials. *Jour. I.E.E.*, (London), vol. 71, pp. 235-51; July, (1932).

The paper is concerned with the behavior of earthed open antenna receiving systems. Part I gives the theoretical formulas for the case of a plain antenna with uniformly distributed constants, and the detail of the variation with frequency of the resistance and reactance components of the effective impedance of such an antenna. Part II is devoted to purely analytical methods.

- R120 L. Bergmann and W. Doerfel. Messungen in Strahlungsfeld einer in ihrer Grundschiwingung erregten Vertikalantenne zwischen zwei vollkommen leitenden Ebenen. (Measurements between two perfectly conducting planes in the radiation field of a vertical antenna excited to its fundamental vibration.) *Ann. der Phys.*, vol. 13, pp. 409-29; May, (1932).

\* This list compiled by Mr. A. H. Hodge and Miss E. M. Zandonini.



Description is given of a transmitter using a vertical antenna and having symmetrical radiation characteristics, and a receiving apparatus. Results of measurements made at various distances from the antenna and with the receiving apparatus at various heights above ground are given. For a definite height a complete representation of the field distribution between the parallel plates is given.

- R125.3 L. S. Palmer and L. L. K. Honeyball. The action of short-wave frame  
×R325.3 aerials. *PROC. I.R.E.*, vol. 20, pp. 1345-67; August, (1932).

A theoretical investigation of a tuned frame aerial is given. A high-frequency transmitter, the receiving frame, and experimental results are described. Data are given in the form of curves. Conclusions resulting from the investigation are enumerated and may be summed up in the statement that the maximum frame current only results when the frame is both tuned and formatized.

- R131 Standard "micromesh" a.c. values. *Wireless World*, vol. 31, pp. 102-103; August 5, (1932).

Construction details are described by means of which it is possible to use very close spacing in tube construction and thereby increase mutual conductance.

- R133 L. Rohde. Über Senderöhren zur Erzeugung von Meterwellen. (A transmitting tube for the production of meter waves.) *Hochfrequenz und Elektroakustik*, vol. 40, pp. 3-5; July, (1932).

The principal difficulties encountered in the production of meter waves are given. A table of commercial vacuum tubes which have been found to give results is included. A home-made type of water-cooled vacuum tube which shows possibilities of further development is described.

- R133 Ch. Maurain. Du rôle des phénomènes de propagation dans les enregistrements d'atmosphériques. (The role of propagation phenomena in the recording of atmospheric.) *Comptes Rendus*, vol. 195, pp. 69-71; July 4, (1932).

Records of the number of atmospheric per minute taken at Paris and at Tunis and Rabat are compared and found to present the same character. Curves from Africa are also found to be similar to those from Paris.

- R133 W. Kreibel. Über die Erzeugung ungedämpfter Schwingungen von Dezimeterwellenlänge in der Rückkopplungsschaltungen. (On the production of undamped oscillations of 10 cm wavelength in regenerative circuits.) *Ann. der Phys.*, vol. 14, pp. 80-102; (1932).

Proceeding from a discussion of oscillations of ten centimeter wavelength in the Barkhausen-Kurz circuit, the question is investigated, whether and under what conditions oscillations of equally short wavelength may be produced by the usual regenerative circuit. It is found that it is possible to produce such short waves, and 31 centimeter waves are experimentally produced.

- R133 R. L. Smith-Rose and J. S. McPetrie. The propagation along the earth of radio waves on a wave-length of 1.6 meters. *Proc. Phys. Soc.* (London), vol. 44, pp. 500-510; July 1, (1932).

A brief description is given of a simple, yet efficient transmitting and receiving apparatus. Results are given of field intensity measurements at different distances from the transmitter with the transmitter at various heights above the ground. Maxima and minima of intensity are found when the transmitter is a distance above ground equal to a wavelength. Theoretical curves are calculated.

- R133 G. Potapenko. Investigations in the field of the ultra-short electromagnetic waves. IV. On the dependence of the ultra-short electromagnetic waves upon the heating current and upon the amplitude of the oscillations. *Phys. Rev.*, vol. 41, pp. 216-30; July 15, (1932).

It is found that the length of the normal waves increases, while the length of the dwarf waves of all orders decreases as the heating current is decreased. Neglecting the alternating potentials on the electrodes introduces a large error in results of existing theories of the generation of ultra-short waves.

- R140 R. King. Wavelength characteristics of coupled circuits having distributed constants. *Proc. I.R.E.*, vol. 20, pp. 1368-1400; August, (1932).
- The wavelength characteristics of a simple circuit and of a coupled circuit regenerative oscillator having distributed circuit constants are derived for the case of small resistance and compared with experimental results. A comparison is made with analogous characteristics of circuits with lumped constants and of the electron oscillator.
- R140 F. Ollendorf. Elektrische Wellen in Verzweigten Netzen. (Electric waves in a branched network.) *Archiv für Elek. tech.*, vol. 26, pp. 457-70; July 5, (1932).
- The transmission of electric waves in a branched net is treated mathematically.
- R140 M. F. Peters; G. F. Blackburn; P. T. Hannen. Theory of voltage dividers and their use with cathode-ray oscillographs. *Bureau of Standards Journal of Research*, vol. 9, pp. 81-113; July, (1932).
- Four requirements are given for voltage dividers, and equations are developed for the most general type of capacitance voltage divider. Spark discharge oscillograms confirm the equations. Equations are given for resistance voltage dividers. Methods are given for the determination of the sensitivity of the cathode beam at the photographic plate, as well as the determination of the reduction ratio of the voltage divider.
- R141 M. Knoll and M. Freundlich. Ein Kipprelais sehr kurzen Schaltzeit. (A vacuum-tube relay of quick reaction time.) *Elek. tech. Zeits.*, vol. 53, pp. 669-73; July 14, (1932).
- The circuit and construction details of a vacuum-tube relay of quick reaction time are given. The time of delay is given as  $1-3 \times 10_s^7$ .
- R142 N. M. McLachlen. On the frequencies of double circuit screen-grid valve oscillators. *Wireless Engineer & Experimental Wireless* (London), vol. 9, pp. 439-44; August, (1932).
- The problem of the mutual influence of two oscillatory circuits, one radio and the other audio, on each other is analyzed. Graphic illustrations of wave forms are shown.
- R148 B. Brown. Series modulation for television transmitters. *Electronics*, vol. 5, p. 263; August, (1932).
- The advantages of series modulation are pointed out. A circuit arrangement is given.
- R148.1 R. O. Carter. The theory of distortion in screen-grid valves. *Wireless Engineer & Experimental Wireless* (London), vol. 9, pp. 429-38; August, (1932).
- This article is a mathematical investigation of distortion in screen-grid high-frequency amplifiers; it leads to important results which are useful in the design of screen-grid valves particularly those of the variable conductance type. The method is an application of principles described by Ballantine and Snow. The results are worked out in detail and several important conclusions are given.
- R161.1 J. J. Lamb. Short wave receiver selectivity to match present conditions. *QST*, vol. 16, pp. 9-20, August, (1932).
- Constructional and operating features of the single signal superheterodyne receiving set.
- R161.5 J. O. McNally. Analysis and reduction of output disturbances resulting from the alternating-current operation of the heaters of indirectly-heated cathode triodes. *Proc. I.R.E.*, vol. 20, pp. 1263-83; August, (1932).

This paper discusses the disturbance currents in the output circuits of indirectly-heated cathode triodes, introduced by the use of alternating current in the heaters. It indicates that the disturbance currents are introduced into the output circuit by (1) the electric

field of the heater, (2) the magnetic field of the heater current, and (3) the resistance between heater and grid and between heater and plate, and the capacitance between heater and grid and heater and plate. Use has been made of this disturbance current analysis in the development of an extremely low disturbance output tube which is described.

- R162 C. H. Walter. Über eine neue Gleichrichtermessanordnung. (On a new rectifier circuit arrangement.) *Zeits. für tech. Physik*, no. 8, pp. 363-67; (1932).

A rectifier bridge arrangement is described. The principle, circuit constants, and application are discussed.

- R163 E. V. Appleton and D. W. Fry. Wireless signals—Their mutual influence and simultaneous detection. *Electrician* (London), vol. 109, pp. 83-84; July 15, (1932).

Results are discussed of a repetition of the observations of Appleton and Boohariwalla to test whether the mutual interaction of signals tends to disappear as the time constant of the grid circuit of a cumulative grid rectifier is increased; the signal frequency difference being maintained constant.

## R200. RADIO MEASUREMENTS AND STANDARDIZATION

- R207 B. Hague. Alternating-current bridge methods. (book). Reviewed in *Wireless Engineer & Experimental Wireless* (London), vol. 9, p. 448; August, (1932). Published by Pitman, London, 3rd edition, price 15 shillings.

A useful book on alternating-current bridge methods.

- R214 A. L. Loomis and W. A. Marrison. Modern developments in precision time keepers. *Electrical Engineering*, vol. 51, pp. 542-49; August, (1932).

Time keepers which depend on gravity and those which depend on elasticity for the restoring force are discussed and compared. Results of intercomparisons between separate clocks of the same type and also between timekeepers of different types are given. Some applications are pointed out which are both useful from the practical standpoint and interesting from purely scientific point of view.

- R241 G. V. Hetherington. A direct-reading ohmmeter. *Elec. Jour.*, vol. 29, p. 387; August, (1932).

Description of a small ohmmeter.

- R261 V. D. Landon and E. A. Sveen. A solution of the superheterodyne tracking problem. *Electronics*, vol. 5, pp. 250-51; August, (1932).

A mathematical treatment is given which enables one to determine without recourse to experiment, the correct conditions for tracking at three points in the frequency band.

## R300. RADIO APPARATUS AND EQUIPMENT

- R330 L. Martin. Still more new tubes. *Radiocraft*, vol. 4, pp. 142-44; September, (1932).

The '55, ER49, BR rectifier, '43, '29 and '69 and TS-257 tubes are described. Circuit connections and uses are shown.

- R330 Technical data on new tubes. *Electronics*, vol. 5, pp. 252; August, (1932).

Data are given on the following types of vacuum tubes: '43, '55, '85, '89, and '83.

- R330 G. F. Metcalf and T. M. Dickinson. New low noise vacuum tube. *Physics*, vol. 3, pp. 11-17; July, (1932).

A tube with very low noise level is described. The low noise level allows the amplification of low-frequency voltages of less than one microvolt over the entire frequency band below 100 cycles.

- R330 J. C. Warner; E. W. Ritter; D. F. Schmit. Recent trends in receiving tube design. *Proc. I.R.E.*, vol. 20, pp. 1247-62; August, (1932).

This paper gives a brief summary of the important steps in receiving tube design over the past ten years. The significance of new forms of grids and in particular the suppressor grid are discussed.

- R339 L. Körös and R. Seidelbach. Berechnung der durch Glimmteiler stabilisierten Stromquellen bei vorgegebener Stromennahme. (Calculations concerning "Glimmteiler" stabilized current sources under given load conditions.) *Hochfrequenz. und Elektroakustik*, vol. 40, pp. 9-14; July, (1932).

The working equations are set up for the "Glimmteiler" for the case where the load is given. With these equations it is proved that the voltage fluctuations across the "Glimmteiler" resulting from fluctuations in the voltage source are negligible. An example of the practical use of the formulas is given.

- R339  
×R133 I. E. Mouromtseff and H. V. Noble. A new type of ultra-short-wave oscillator. *Proc. I.R.E.*, vol. 20, pp. 1328-44; August, (1932).

A new oscillator for generating ultra-short waves, in which the conventional tank circuit is replaced by a portion of concentric transmission line, is described. Electrically the tube structure forms an integral part of the transmission line. For this the quantity  $VC/L$  for the tube must be the same as for the rest of the line,  $C$  and  $L$  being capacity and inductance per unit length of the line. Some of the oscillator characteristics are given for wavelengths of 5 and 3 meters with 15- and 12-kw output, respectively.

- R355.3 G. Grammar. Building a low-cost 1750 kc 'phone-CW transmitter. *QST*, vol. 16, pp. 9-12, July; pp. 21-26, August, (1932).

Constructional details are given.

- R355.9 J. M. Hudack. A low-frequency oscillator. *Bell Laboratories Record*, vol. 10, pp. 378-80; July, (1932).

An oscillator having good wave form and frequency range of from 3 to several thousand cycles.

- R356.3 A. Gehrts. Glühkathodengleichrichter mit Gasfüllung. (Gas-filled hot-cathode rectifiers.) *Zeits. für tech. Phys.*, no. 7, pp. 303-308; no. 8, pp. 351-56; (1932).

The effects of not using the correct gas pressure in a gas-filled hot-cathode rectifier are described. It is shown that different gas pressures are required for best results at different anode voltages. Attention is called to the fact that in designing full-wave rectifiers the gas pressure and dimensions of the tube must be such as to prevent voltage breakdown between the anodes.

- R357 W. T. Cocking. Single valve frequency changers. *Wireless World*, vol. 31, pp. 74-75, July 29; pp. 110-111, August 5, (1932).

In Part I, a method of using a single vacuum tube as frequency changer and thereby making possible a 4 tube superheterodyne is given. In Part II, the use of the pentode as a single tube frequency changer is described.

- R363 C. B. DeSoto. A high-output amplifier for the battery receiver. *QST*, vol. 16, pp. 29-32; August, (1932).

An application for the new class B audio tubes.

- R363 D. G. C. Luck. A simplified general method for resistance-capacity coupled amplifier design. *Proc. I.R.E.*, vol. 20, pp. 1401-1406; August, (1932).

The steady state analysis of the general resistance-capacity coupled amplifier stage is thrown into such a form that any amplifier stage is characterized by three easily com-

puted constants which make it possible to read off its complete steady state performance immediately from three perfectly general analytical curves. These curves are shown, as are some applications of the method.

- R365.21 W. S. Williams. Operation and service of automatic volume control systems. *Radiocraft*, vol. 4, p. 155; September, (1932).  
The action of the common types of volume control is explained.
- R385.5 I. J. Saxl. A new lapel microphone. *Radiocraft*, vol. 4, p. 141; September, (1932).  
Description of small microphone.
- R385.5 H. C. Harrison and P. B. Flanders. An efficient miniature condenser microphone system. *Bell Sys. Tech. Jour.*, vol. 11, pp. 451-61; July, (1932).  
It has been shown recently that microphones and contiguous amplifiers distort the sound field in which they are placed by reason of their size and the cavity external to the diaphragm of the microphone. This paper describes a laboratory model of a Wentz-type condenser microphone of high efficiency and an associated coupling amplifier which are of such small size that reflection and phase difference effects are of negligible importance within the audible frequency range; while the cavity is so proportioned that its resonance effect is an aid rather than a detriment to uniformity of response in a constant sound field.
- R386 E. A. Guillemin. A recent contribution to the design of electric filter networks. *Jour. Math. and Phys.*, (Massachusetts Institute of Technology), vol. 11, pp. 150-211; June, (1932).  
This paper outlines the Caer method of design in a manner which is not as rigorous and general as that used in Caer's own publication, but is more readily understood and applied with sufficient accuracy for most cases.
- R387.7 H. A. Frey; K. A. Hawley; W. L. Lloyd; J. J. Torok; C. G. Archibald. Insulator performance studied by flashover tests. *Electrical Engineering*, vol. 51, pp. 505-16; July, (1932).  
A group of three articles is given. The first two articles deal with the effect of various factors on insulator spark-over characteristics, the third article deals with the flash-over characteristics of suspension insulators.
- R388 M. von Ardenne. Investigations on gas-filled cathode-ray tubes. *Proc. I.R.E.*, vol. 20, pp. 1310-23; August, (1932).  
In considering the function of initial concentration and ray focusing it is found, for tubes using slow electrons (up to 4000 volts) that both a Wehnelt cylinder and a molecular concentrator are necessary. The action of molecular concentration has been studied thoroughly, and the static relation between pressure, beam current and anode potentials is explained. The use of plate potentials higher than about 5000 volts is found to be unsuitable. Special phenomena accompanying concentration are taken up. The reaction of the Braun tube upon the circuit is taken up and the avoidance of distortion and origin displacements by means of circuit precautions are described.
- R388 G. Goubau. Eine Methode sur radialen Ablenkung an der Braunschen Röhre. (A new method for producing radial reflections in a Braun tube.) *Hochfrequenz. und Elektroakustik*, vol. 40, pp. 1-3; July, (1932).  
A circuit arrangement is described which allows the revolving field rotating spot in a Braun tube to deflect in a radial direction. This circuit arrangement when connected to a Braun tube is especially suited for observation of echoes from the ionized layers of the atmosphere and enables an accurate measurement of the virtual height of the Kennelly-Heaviside layer to be made.
- R388 H. Klemperer and O. Wolff. Die Verzerrungen im Kathodenoszillographen bei hohen Messgeschwindigkeiten. (The distortion in the cathode-ray oscillograph at high measuring velocities.) *Archiv für Elek. tech.*, vol. 26, pp. 495-502; July 5, (1932).

The distortion introduced by several factors is discussed. It is shown that great care must be exercised in determining the dimensions and in constructing the oscillograph.

- R390 H. Baatz; M. Freundlich; W. Holzer. Verzögerungsschaltungen bei Aufnahmen mit dem Kathodenstrahl-oscillographen. (Delay circuits for making photographs with a cathode-ray oscillograph.) *Elek. tech. Zeits.*, vol. 53, pp. 696-98; July 21, (1932).

Apparatus for obtaining an arbitrary time delay is described.

#### R400. RADIO COMMUNICATION SYSTEMS

- R430 A defect in transmissions. *Wireless World*, vol. 31, pp. 52-53; July 22, (1932).

The article discusses the aspects of mutual interference of adjacent stations.

- R450 S. B. Wright and D. Mitchell. Two-way radio telephone circuits. *Bell Sys. Tech. Jour.*, vol. 11, pp. 368-82; July, (1932).

This paper deals with the problems of joining long-distance radio telephone transmission paths to the ordinary telephone plant. It gives the possibilities and limitations of various methods of two-way operation of such circuits where the radio channels employ either long or short waves. It also describes the special terminal apparatus for switching the transmission paths under control of voice currents and lists the advantages of using voice-operated devices.

#### R500. APPLICATIONS OF RADIO

- R520 H. H. Nance. Wire communication aids to air transportation. *Bell Sys. Tech. Jour.*, vol. 11, pp. 462-76; July; (1932). *Electrical Engineering*, vol. 51, pp. 492-96; July, (1932).

The service rendered to air transportation by wire line communication is outlined.

- R526 A. P. Berejkoff and C. G. Fick. Modern radio equipment for air mail and transport use. *Proc. I.R.E.*, vol. 20, pp. 1284-95; August, (1932).

The general requirements for aircraft radio equipment for air mail and transport use are discussed. This is followed by a discussion of the factors which are considered in the design of an aircraft radio telephone and telegraph equipment. A description is then given of the mechanical and electrical features of a specific equipment.

- R531.5 A. Muri. The Swiss broadcast network. *Electrical Communication*, vol. 11, pp. 9-12; July, (1932).

A description of the wire line network which is used by the broadcast stations.

- R531.5 A. R. A. Rendall. Standard broadcasting land line equipment. *Electrical Communication*, vol. 11, pp. 13-21; July, (1932).

Description of the standard land line system.

- R537.1 F. E. Nancarrow. Frequency control. *Electrician* (London), vol. 109, p. 241; July 29, (1932).

A method of controlling the frequency of a power supply is given. A tuning fork and harmonic amplifier are used.

- R550 F. C. McLean. The new Swiss broadcasting station. *Electrical Communication*, vol. 11, pp. 3-8; July, (1932).

×R612.1

The plan of the Swiss Administration for improving the broadcast service is given. A new 50-kw station is described.

- R566 Capt. Voit. Teleprinter network of the Berlin Police Administration. *Electrical Communication*, vol. 11, pp. 22-31; July, (1932).

An extensive description of the police installation is given.

- R583 Bibliography on television. *Electronics*, vol. 5, p. 265; August, (1932).

A partial bibliography on television is presented through the courtesy of Miss E. Harder of the Engineers Book Shop, 227 Park Ave., New York City.

### R600. RADIO STATIONS

- R612.1 O. B. Hanson. Planning the NBC studios for Radio City. *Proc. I.R.E.*, vol. 20, pp. 1296-1309; August, (1932).

A description of the plans and facilities of Radio City is given.

### R800. NONRADIO SUBJECTS

- 535.38 C. H. Prescott and M. J. Kelly. The Caesium-oxygen-silver photoelectric cell. *Bell Sys. Tech. Jour.*, vol. 11, pp. 334-67; July, (1932).

Technique is described permitting the formation of caesium-oxygen-silver photoelectric cells under controlled conditions. It is shown that the essential conditions are a quantitative control of the degree of oxidation of the silver cathode base and the amount of caesium generated together with a regulation of the amount of chemical interaction by a control of the time and temperature of the heat treatment.

- 535.38 L. Bergmann. Über Messungen an Selen Sperrschicht Photozellen. (Measurements on selenium type Barrier layer photocells). *Phys. Zeits.*, vol. 33, pp. 513-19; July 1, (1932).

Results of a large number of measurements on the "Sperrschicht" photocell are given in graphic form.

- 535.38 M. Q. Majorana. Sur un nouveau phénomène photoélectrique. (On a new photoelectric phenomena). *Comptes Rendus*, vol. 195, pp. 226-29; July 18, (1932).

Thin films of metal are fastened to a thin plate of glass. A current is passed through the film and the primary of a transformer, the secondary of which is connected to the grid of a four-stage amplifier. A chopper allows light to fall on the thin film. A sound whose frequency is the same as the frequency of the light pulses is taken from the amplifier.

- 621.313.7 A. C. Seletzky and S. T. Shevki. Characteristics of a mercury-vapor tube. *Electrical Engineering*, vol. 51, pp. 500-505; July, (1932).

Results of an investigation of the grid and plate currents in a grid-controlled mercury-vapor tube show that the direction of grid current in these tubes depends not only on the instantaneous polarity of the grid, but also upon the magnitude of both the grid voltage and the plate current. It is shown also that the inverse plate current flows whenever grid current is flowing during the negative half cycle of plate voltage.

- 621.374.31 J. C. Street and T. H. Johnson. The use of a thermionic tetrode for voltage control. *Jour. Franklin Inst.*, vol. 214, pp. 155-162; August, (1932).

A method for controlling the voltage for a low current consuming device is given.



CONTRIBUTORS TO THIS ISSUE

**Barrow, W. L.:** Born October 25, 1903, at Baton Rouge, Louisiana. Received B.S. degree in E.E., Louisiana State University, 1926; law student, Louisiana State University, 1926-1927; M.S. degree in E.E., Massachusetts Institute of Technology, 1929; D.Sc. degree in Physics, Technische Hochschule of Munich, Germany, 1931. Assistant, Electrical Engineering Department, Louisiana State University, 1925-1926; instructor, Communications Division, Electrical Engineering Department, Massachusetts Institute of Technology, 1928-1929; Redfield Proctor Fellow in Physics, Technische Hochschule of Munich, 1929-1931; Round Hill Research and instructor, Communications Division, Massachusetts Institute of Technology, 1931 to date. Associate member, Institute of Radio Engineers, 1928.

**Brainerd, John Grist:** Born 1904. Police reporter, staff of metropolitan newspaper, 1923-1925. Instructor, Moore School of Electrical Engineering, University of Pennsylvania, 1925 to date. Nonmember, Institute of Radio Engineers.

**Carrara, N.:** Born February 19, 1900, at Florence, Italy. Studied at the Superior Normal School of Pisa. Received Physics degree, 1921. Physics assistant, Royal University of Pisa, 1921-1924; instructor in Physics, Royal Naval School, Leghorn, 1924 to date; professor, Electrotecnic and Communications Institute of the Royal Navy, 1931 to date. Nonmember, Institute of Radio Engineers.

**Eckersley, T. L.:** Born December 27, 1886. Received B.S. degree in E.E., University College, London, 1908. National Physical Laboratory, 1909; Cambridge, 1910; research at Cavendish; appointed inspector in Egyptian Government Survey Department, 1912. Served during war with R. E. Wireless Intelligence work; Research department, Marconi Company, 1919 to date. Nonmember, Institute of Radio Engineers.

**Grondahl, L. O.:** Born November 27, 1880 at Hendrum, Minnesota. Received B.S. degree, 1904; M.S. degree, St. Olaf College, 1905; Ph.D. degree, Johns Hopkins University, 1908. Instructor in physics, St. Olaf College, 1904-1905; lecture assistant, Johns Hopkins University, 1906-1908; professor, physics and mathematics, Spokane, 1908-1909; instructor in physics, University of Washington, 1909-1912; instructor, Carnegie Institute of Technology, 1912-1914; assistant professor, 1914-1917; associate professor, 1917-1920; research work, Naval Consulting Board, 1917-0919; director of research, Union Switch and Signal Company, 1920 to date. Fellow, American Physical Society, American Association for the Advancement of Science; Member, Optical Society of America, American Electrochemical Society, Franklin Institute, Sigma Xi. Nonmember, Institute of Radio Engineers.

**Hallman, L. B., Jr.:** Born July 21, 1907, at Sneads, Florida. Received B.S. degree in E.E., Alabama Polytechnic Institute, 1929. Engineer, WAPI, 1926-1929; instructor in radio, Alabama Polytechnic Institute, 1927-1928; chief engi-



neer, Montgomery Broadcasting Company, 1930 to date. Junior member, Institute of Radio Engineers, 1927; Associate member, 1929.

**Place, W. P.:** Born November 7, 1906, at Walkerton, Indiana. Received B.S. degree in E.E., Purdue University, 1928. Radio engineer, Westinghouse Electric and Manufacturing Company, 1928-1930; general engineer, 1930; research engineer, Union Switch and Signal Company, 1930 to date. Member, Eta Kappa Nu. Associate member, Institute of Radio Engineers, 1932.

**Schuck, O. H.:** Born September 20, 1909, at Philadelphia, Pennsylvania. Received B.S. degree in E.E., Moore School of Electrical Engineering, University of Pennsylvania, 1931; M.S. degree in E.E., 1932. Member, Eta Kappa Nu, Tau Beta Pi, Sigma Tau, Sigma Xi, A.I.E.E. Nonmember, Institute of Radio Engineers.

\* **Clausing, Arthur:** Born November 18, 1893, at Berlin, Germany. Real-School graduate, three years of practical apprenticeship, theoretical studies, Gaus School, Berlin; lecturer at the Technical High School, Berlin. Managing chief engineer of four laboratories, Siemens and Halske, Central Laboratory; chief engineer, radio receiver development of the Telefunken Company, Siemens and Halske, and German General Electric Company. Nonmember, Institute of Radio Engineers.

\* **Kautter, Wolfgang:** Born April 22, 1907, at Kirchheim, u.T., Württemberg. Graduated from the Tübingen Gymnasium, 1925; Civil Engineer examination, Technical High School, Stuttgart, 1929; promoted to doctor engineer, Danzig Technical High School, 1932. Central Laboratory, Siemens and Halske, 1929-1931; Radio Laboratory, Telefunken Company, 1931 to date. Nonmember, Institute of Radio Engineers.

\* Paper published in September, 1932, PROCEEDINGS.



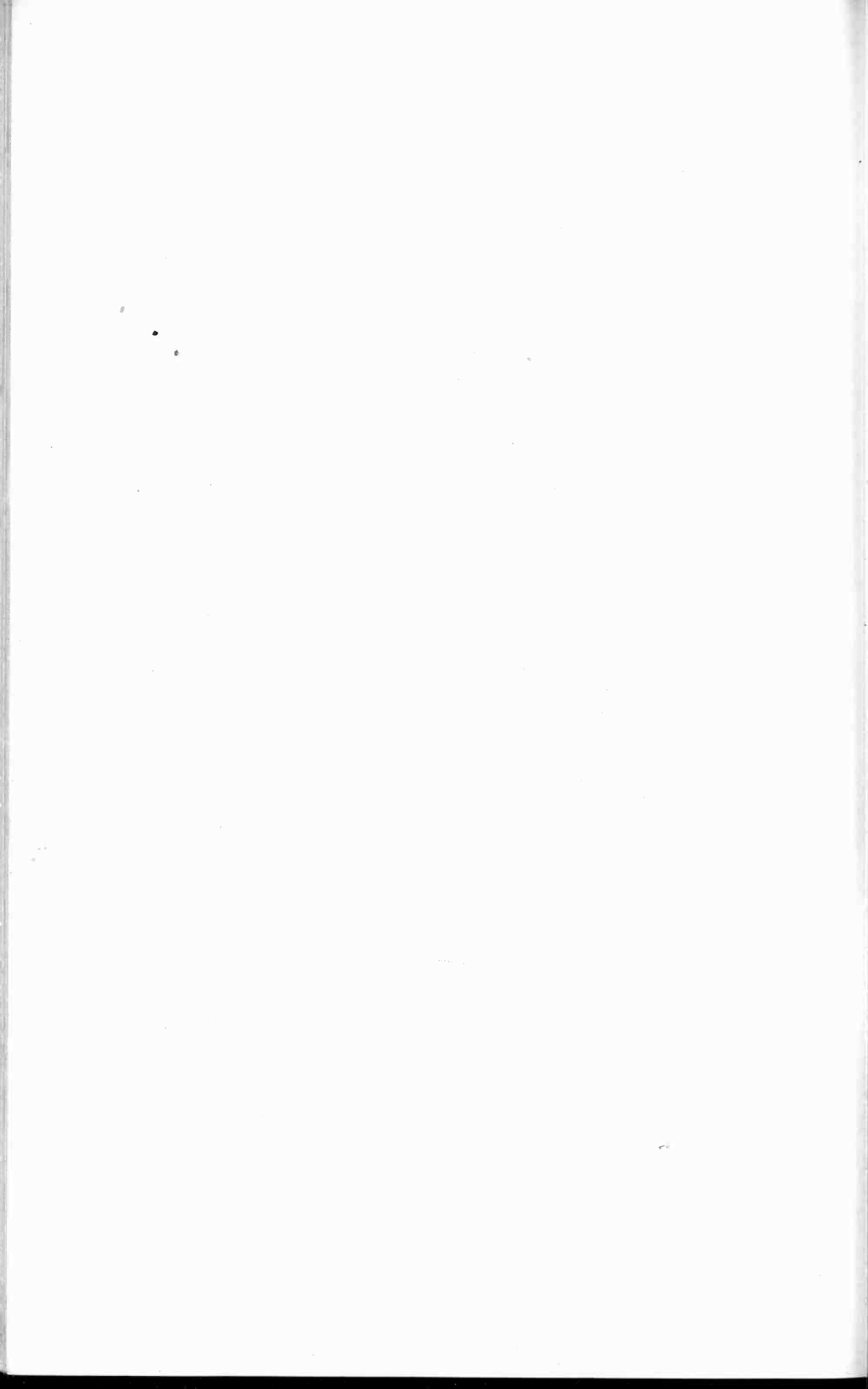

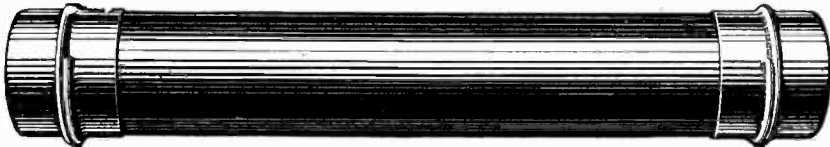

Bradleyunits for All Radio Circuits

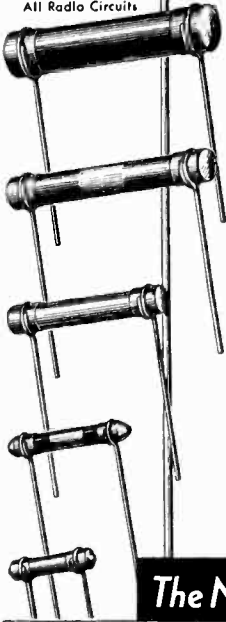

Bradley Suppressors for Auto Radio

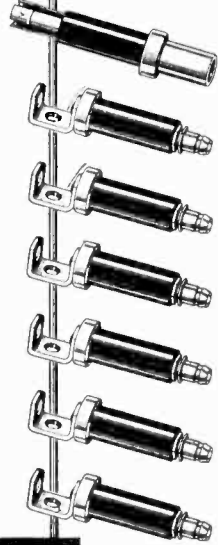

# Bradleyunits Solid Molded Resistors

The Choice of the World's Largest Radio Manufacturers

Don't risk the reputation of your receiver with poor resistors. Standardize on Bradleyunit Resistors because their resistance values are stable under varying conditions of load, temperature and moisture.

Bradleyunit Resistors are made in five sizes, with or without leads, and are R.M.A. color coded for resistance value identification. These solid molded resistors are accurately calibrated and have great mechanical strength. Get an Allen-Bradley quotation on your next order.

Allen-Bradley Co., 116 W. Greenfield Avenue., Milwaukee, Wis.



## The New Tapped Bradleyometer

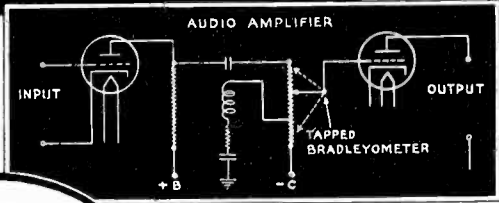
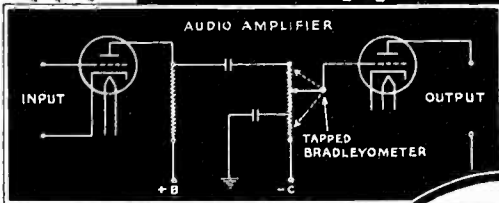

The new Topped Bradleyometer provides automatic tone correction with volume control. It achieves this result in any one of several audio frequency networks. (See above diagrams.)

A tap on the resistance element is brought out to a fourth terminal. The network necessary to provide tone correction is usually connected between this tap and the grounded or low

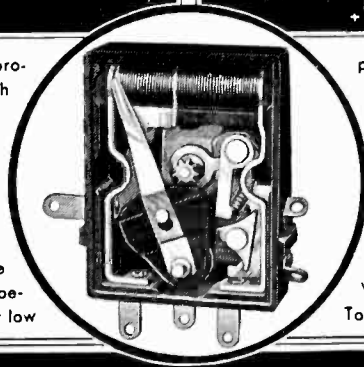

potential end of the Bradleyometer.

A single-pole line switch approved by the Underwriters' Laboratories and the Hydro Electric Power Commission of Ontario with a rating of 2 amperes, 125 volts, can be provided within the Bradleyometer and is operated by the regular control knob.

Write for complete data on the New Topped Bradleyometer.

# ALLEN-BRADLEY RESISTORS

Produced by the makers of Allen-Bradley Control Apparatus

When writing to advertisers mention of the PROCEEDINGS will be mutually helpful.

BLUE TUBES  
in FRANCE



BLUE TUBES  
in CHINA



and in **74** other countries  
throughout the world—

# ARCTURUS

## BLUE Tubes



*ANY Set is Better  
with Arcturus Blue*

**T**HE world over, where quality is essential, Arcturus Blue Tubes are used. Many American set manufacturers, through experience, equip all their export sets exclusively with Arcturus Tubes. They, like their foreign accounts, cannot take chances with tubes that are put in service thousands of miles away.

No other radio tube has been paid as great a tribute.

In the United States, Arcturus Tubes are used by more set manufacturers as initial equipment than any other tube—a signal tribute to *the* quality tube.

When engineers include Arcturus Blue Tubes in their specifications, when radio jobbers and dealers offer them to the public, they have the ample justification of world-wide approval.

**ARCTURUS RADIO TUBE CO., NEWARK, N. J.**

*When writing to advertisers mention of the PROCEEDINGS will be mutually helpful.*



---

## AN IMPORTANT MEMBER OF YOUR FAMILY

---

THE telephone is something more than an instrument to carry your voice across the miles. It is a most important member of your family.

Faithfully, constantly, cheerfully it serves you. Keeps you in touch with friends. Stands guardian over your home. Helps to put more pleasure and achievement into life and living. And does it all so capably.

When you are moving, you keep your telephone in the old home until the last van has gone and you place the key in the lock for the final turn. You arrange in advance to have a telephone ready at the new

address so there will be no break in your contact with the world.

When a young couple starts housekeeping. When there is illness in the home. When somebody goes away. When distances are great. When emergencies arise. On all of these occasions the telephone earns its right to family membership.

Day or night, any part of the telephone company's army of skilled workers, intricate equipment, and millions of miles of wire is at your command. It is the Bell System's constant endeavor to make the telephone worth more and more to every subscriber.

---

AMERICAN TELEPHONE AND TELEGRAPH COMPANY



*When writing to advertisers mention of the PROCEEDINGS will be mutually helpful.*

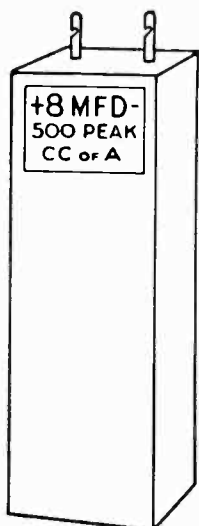

Type DC-8  
Acracon  
Semi-Dry Unit

**Compare . . .  
and be convinced  
of the superiority  
of**

## ***the new* ACRACON SEMI-DRY ELECTROLYTIC CONDENSER**



Type DE-8  
Acracon  
Semi-Dry Unit

- peak operating voltage 500
- surge voltage 600
- low initial leakage
- leakage current at 500 volts less than .2 mils per mfd.
- constant capacity; does not decrease with use
- stable power factor; does not increase with use
- non-corrosive connections
- metal or fibre container
- standard and special sizes

*Write Today For Catalog!*

\* Acracon Features are Protected by Patents Pending

## **Condenser Corporation of America**

259 Cornelison Ave., Jersey City, N.J.

Factory Representatives In:

Chicago

Cincinnati

St. Louis

San Francisco

Los Angeles

Toronto

And Other Principal Cities

*When writing to advertisers mention of the PROCEEDINGS will be mutually helpful.*

# CENTRALAB MOTOR RADIO NOISE SUPPRESSORS FORGE AHEAD TO POPULARITY



## REAL QUALITY · AT THE RIGHT PRICE

Orders for these sturdy units are taxing production. No wonder; for here at last is a suppressor that is strong, sturdy, generous in size and gives from 50% to 500% more efficiency in reducing spark noise. The resistance material and the ceramic covering are baked *together* at a temperature of 2700 degrees. No wonder they're strong.

Centralab suppressors are built for performance . . . yet their very simplicity enables us to offer them at an exceptionally low price.

CENTRAL RADIO LABORATORIES · MILWAUKEE

# Centralab



*When writing to advertisers mention of the PROCEEDINGS will be mutually helpful.*

# AMERTRAN

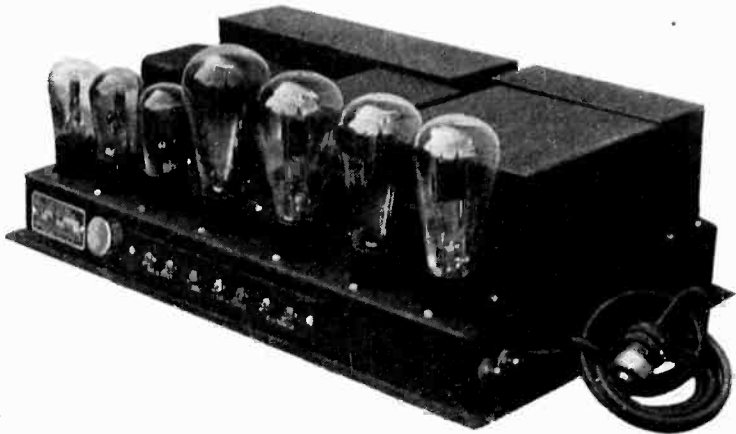

## New Type PA-86 M Public Address Amplifier

Type PA-86M is the ideal quality Amplifier of low cost for Public Address from a single microphone or phonograph pick up. It is a complete practical system of  $12\frac{1}{2}$  watts output and may be operated without the addition of accessory equipment, such as Input Matching Transformers and Volume Control.

All that is necessary to install Type PA-86M is to connect the input source and loud speakers to the proper terminals, plug in the 110 volts AC bracket, and insert tubes. The input source may have an impedance of either 200 or 500 ohms, and, if it is

a double button carbon microphone, button current is provided by the power supply. The output source has 500 ohms impedance and an additional 15 ohm winding is provided for the connection of a monitor speaker.

The complete equipment is mounted on a compact metal chassis, thus making it ideal for portable service. It includes a three stage double push-pull Amplifier with self contained power supply.

The Quality throughout is up to the usual AmerTran Standard. Write for prices and further information.

**American Transformer Company**

*Main Office and Factory*

**178 Emmet Street**



**Newark, N. J.**

*When writing to advertisers mention of the PROCEEDINGS will be mutually helpful.*



# CHANGE IN MAILING ADDRESS OR BUSINESS TITLE

Members of the Institute are asked to use this form for notifying the Institute office of a change in their mailing address or the listing of their company affiliation or title in the Year Book.

The Secretary,  
THE INSTITUTE OF RADIO ENGINEERS,  
33 West 39th Street,  
New York, N.Y.

Dear Sir:

Effective ..... please note change in my address  
(date)  
for mail as follows:

**FROM**

.....  
(Name)

.....  
(Street Address)

.....  
(City and State)

**TO NEW ADDRESS**

.....  
(Street Address)

.....  
(City and State)

Please note following change in my Year Book listing.

.....  
(Title)

.....  
(Company Name)

.....  
(Company Address)

# EMPLOYMENT PAGE

Advertisements on this page are available to members of the Institute of Radio Engineers and to manufacturing concerns who wish to secure trained men for positions. All material for publication on this page is subject to editing from the Institute office and must be sent in by the 15th of the month previous to the month of publication. (August 15th for September PROCEEDINGS IRE, etc.) Employment blanks and rates will be supplied by the Institute office. Address requests for such forms to the Institute of Radio Engineers, 33 West 39th Street, New York City, N.Y.

**MANUFACTURERS** and others seeking radio engineers are invited to address replies to these advertisements at the Box Number indicated, care the Institute of Radio Engineers. All replies will be forwarded direct to the advertiser.

---

**COLLEGE GRADUATE** with three years experience as test engineer on receiver test equipment, one year as power pack and audio amplifier engineer, one year as microphone man, and three years as sound recordist desires position for which past experience qualifies him. Prefers work in application engineering—development work or operating engineering. Age 30. Will travel. Box 133.

---

**COLLEGE GRADUATE** with eight years experience with amateur transmitters and with two years experience as engineer for large concern on circuit design and testing of engineering models for two channel long wave transatlantic radio receiver. Desires work similar to work already done—especially work in short wave field. Age 25. Box 134.

---

**EXPERIMENTER**, High School Graduate, has done experimental work at home and holds New York City Institute certificate. Desires work on transmitting or receiving equipment in a laboratory. Interested specially in laboratory work in South or Central America. Age 25. Box 135.

*When writing to advertisers mention of the PROCEEDINGS will be mutually helpful.*

# Cornell

TRADE MARK REG.

## CAPACITORS

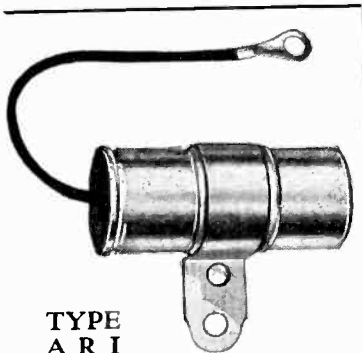

TYPE  
A R I

For  
AUTO  
RADIO

This unit has been expressly designed for use as an interference eliminator in connection with automobile radio equipped motor cars. It consists of a one microfarad condenser, thoroughly protected against heat, with a high melting point wax compound.

*Our engineers invite the submission of special designs and particular problems on special requirements of ignition types.*

**CORNELL ELECTRIC MFG. CO., Inc.**

*Manufacturers of  
CORNELL "CUB" CONDENSERS  
Filter and By-Pass Condensers, Interference Filters and  
All Types of Paper Dielectric Capacitors and Resistors  
LONG ISLAND CITY, NEW YORK*

*When writing to advertisers mention of the PROCEEDINGS will be mutually helpful.*

### TEMPERATURE RISE WITH LOAD

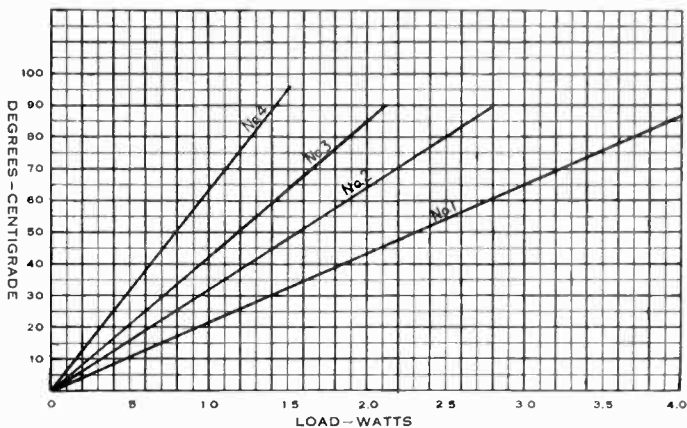

## CONSERVATIVE RATING

You can save space with safety and use smaller size resistors in your radio sets—with ERIE RESISTORS.

ERIE RESISTORS are very conservatively rated. Repeated tests have shown no failures after 2,000 hours or more at loads 50% over the continuous rating.

And yet, even with this conservative rating, the nominal  $\frac{1}{4}$  watt size will carry  $\frac{2}{3}$  watt at its continuous rating and 1 watt at its overload rating. The  $\frac{1}{2}$  watt size also will carry 1 watt at its continuous rating and  $1\frac{1}{2}$  watts at its overload rating.

## RATINGS OF ERIE RESISTORS

| Size  | Nominal Rating     | Recommended Voltage Limit | Continuous Rating 40°C. Ambient Temp. | 100-Hour Rating 40°C. Ambient Temp. | Max. Voltage Rating |
|-------|--------------------|---------------------------|---------------------------------------|-------------------------------------|---------------------|
| No. 1 | 2 watts            | 500 volts                 | 2 watts                               | 3 watts                             | 1000 volts          |
| No. 2 | 1 watt             | 500 volts                 | $1\frac{1}{3}$ watts                  | 2 watts                             | 1000 volts          |
| No. 3 | $\frac{1}{2}$ watt | 350 volts                 | 1 watt                                | $1\frac{1}{2}$ watts                | 500 volts           |
| No. 4 | $\frac{1}{4}$ watt | 200 volts                 | $\frac{2}{3}$ watt                    | 1 watt                              | 300 volts           |

Note: All ratings given are for either D.C. or R.M.S.—A.C., except the "Maximum Voltage Rating" which is for peak values of applied voltage.

The continuous rating of ERIE RESISTORS is 83°C actual temperature. At 40°C ambient temperature the allowable temperature rise with load is 43°C for continuous loads. At higher ambient temperatures the load rating must be decreased in order not to exceed the temperature limit of 83°C. The load rating at any ambient temperature may be obtained from chart shown above.

# ERIE RESISTORS



ERIE RESISTOR CORPORATION, ERIE, PA.  
Factories in Erie, Pa., Toronto, Canada and London, Eng.

*When writing to advertisers mention of the PROCEEDINGS will be mutually helpful.*

# The Institute of Radio Engineers Incorporated

33 West 39th Street, New York, N. Y.

## APPLICATION FOR ASSOCIATE MEMBERSHIP

(Application forms for other grades of membership are obtainable from the Institute)

To the Board of Direction

Gentlemen:

I hereby make application for Associate membership in the Institute of Radio Engineers on the basis of my training and professional experience given herewith, and refer to the members named below who are personally familiar with my work.

I certify that the statements made in the record of my training and professional experience are correct, and agree if elected, that I will be governed by the constitution of the Institute as long as I continue a member. Furthermore I agree to promote the objects of the Institute so far as shall be in my power, and if my membership shall be discontinued will return my membership badge.

.....  
(Sign with pen)

.....  
(Address for mail)

.....  
(Date)

.....  
(City and State)

### References:

(Signature of references not required here)

Mr. .... Mr. ....

Address ..... Address .....

City and State ..... City and State .....

Mr. ....

Address .....

City and State .....

The following extracts from the Constitution govern applications for admission to the Institute in the Associate grade:

### ARTICLE II—MEMBERSHIP

Sec. 1: The membership of the Institute shall consist of: \* \* \* (c) Associates, who shall be entitled to all the rights and privileges of the Institute except the right to hold any elective office specified in Article V. \* \* \*

Sec. 4: An Associate shall be not less than twenty-one years of age and shall be a person who is interested in and connected with the study or application of radio science or the radio arts.

### ARTICLE III—ADMISSION AND EXPULSIONS

Sec. 2: \* \* \* Applicants shall give references to members of the Institute as follows: \* \* \* for the grade of Associate, to three Fellows, Members, or Associates; \* \* \* Each application for admission \* \* \* shall embody a full record of the general technical education of the applicant and of his professional career.

**ENTRANCE FEE SHOULD ACCOMPANY APPLICATION**

(Typewriting preferred in filling in this form) No.....

### RECORD OF TRAINING AND PROFESSIONAL EXPERIENCE

Name .....  
(Give full name, last name first)

Present Occupation .....  
(Title and name of concern)

Business Address .....

Permanent Home Address .....

Place of Birth..... Date of Birth..... Age.....

Education .....

Degree ..... (college) ..... (Date received)

### TRAINING AND PROFESSIONAL EXPERIENCE

DATES

|  |  |
|--|--|
|  |  |
|  |  |
|  |  |
|  |  |
|  |  |
|  |  |
|  |  |
|  |  |
|  |  |
|  |  |
|  |  |
|  |  |
|  |  |
|  |  |
|  |  |
|  |  |
|  |  |
|  |  |
|  |  |
|  |  |
|  |  |
|  |  |
|  |  |
|  |  |
|  |  |

Record may be continued on other sheets of this size if space is insufficient.

Receipt Acknowledged..... Elected..... Deferred.....  
Grade ..... Advised of Election..... This Record Filed.....

# BUILT to HIGH-QUALITY STANDARDS — *the Low Prices*

*are Surprising*

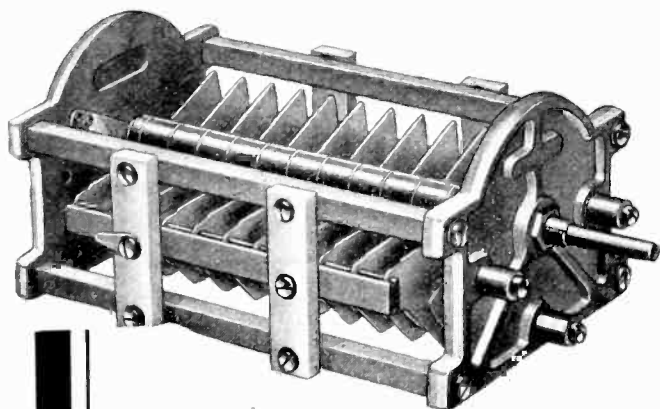

For the advanced model radio you are designing—for that new laboratory equipment you have promised yourself—**QUALITY**, of course!

But **QUALITY** at a **PRICE** is even more *satisfying*.

Hammarlund is organized to meet current price levels, without compromising with sound engineering.

## The New **HAMMARLUND** *Transmitting* **CONDENSER**

A strong, good-looking, low-priced precision instrument worthy of any laboratory, professional or amateur use.

Heavy, polished aluminum plates, with rounded edges. Ten per cent wider spacing than others. Lowest-loss Isolantite insulation. Rigid cast-aluminum frame. Perfect-fitting bearings. Smooth, self-cleaning rotor contact. *All standard sizes.*

## **ACCURATE TUNING of** **INTERMEDIATE TRANSFORMERS**

Proved design. Will not change in resistance or capacity from humidity, temperature or vibration. Specially-tested Isolantite base mounts inside of transformer shield. Self-aligning, phosphor bronze, adjustable spring plates—double-riveted. Selected mica insulation. *Forty ranges, in single and dual models —10 mmf. to 2100 mmf.*

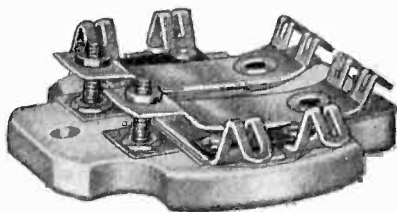

*Mail Coupon  
for New Catalog*

**HAMMARLUND MFG CO.**  
424 W. 33rd St., New York  
Please send your new catalog of high-quality, low-priced radio equipment. I am especially interested in

Name .....

Address .....

PE-10

For Better Radio  
**Hammarlund**  
PRECISION  
PRODUCTS

*When writing to advertisers mention of the PROCEEDINGS will be mutually helpful.*

# Proven Instruments that you can safely recommend



## ● *the Jewell Pattern 444 Set Analyzer*



This proven instrument provides every facility for making necessary socket tests on all types of radio receivers, including those equipped with 6 and 7 prong tubes.

In addition, direct current, alternating current, receiver output, and resistance measuring ranges are available at pin jacks for independent tests on all receiver components.

Ease of operation, portability, and sturdiness are combined with low cost, providing in the Jewell Pattern 444 a set analyzer value unapproached by competitive equipment. This instrument in the hands of your service organization assures excellent service facilities for your receivers.



## ● *The Weston Model 677 Tube-Seller*



In this new type tube checker, produced by the combined efforts of Weston and Jewell engineers, new tube merchandising possibilities are provided. The easy-to-read three-color test meter; line voltage compensating adjustment; high voltage short check; and test facilities for 4, 5, 6, and 7 prong tubes—as well as other proven Weston-Jewell features—are provided.

The Weston Model 677 Tube-Checker is a profit builder for any well managed radio shop.



Write for  
this new  
catalog

# WESTON - JEWELL

Weston Electrical Instrument Corp.  
Jewell Electrical Instrument Co.  
589 Frelinghuysen Ave., Newark, N. J.

Please send us copy of the W-J bulletin which describes the complete Weston-Jewell line of radio instruments.

Name .....

Address .....

*When writing to advertisers mention of the PROCEEDINGS will be mutually helpful.*



# PROFESSIONAL ENGINEERING DIRECTORY

For Consultants in Radio and Allied Engineering Fields

## FOR ADVANCED TRAINING

in:

Practical Radio Engineering  
Practical Television Engineering

write to

### CAPITOL RADIO ENGI- NEERING INSTITUTE

Riggs Bank Bldg.  
Washington, D.C.

## WILLIAM W. GARSTANG

*Consulting Engineer*

Electrolytic Condensers—Power  
Supply—"B" Battery Substi-  
tutes—Television

Office and Laboratory

550 Century Building, Indianapolis, Ind.

## ALLEN B. DU MONT

*Consulting Engineer*



|           |                       |
|-----------|-----------------------|
| Phone     | Office and Laboratory |
| Montclair | 9 Bradford Way        |
| 2-2176    | Upper Montclair, N.J. |

## JENKINS & ADAIR, INC.

*Engineers*

Designers and manufacturers of appara-  
tus essential to broadcasting, sound re-  
cording and sound measurement work.

3333 Belmont Ave., Chicago, U.S.A.

Cable Address: *Jenkadair*

Telephones: Keystone 2130

## ELECTRICAL TESTING LABORATORIES

Tests of Inductances.  
Condensers. Transform-  
ers etc. Life and charac-  
teristics of Radio Tubes

80th. Street and East End Ave.  
• • NEW YORK, N. Y. • •

## Greenleaf Whittier Pickard

*Consultant*

59 Dalton Road,  
Newton Centre, Mass.

*For the Engineering Consultant*

*who can handle a little extra business this year*

*For the Designer*

*who can manage some additional work*

we suggest the Professional Engineering Directory of the I.R.E. PROCEEDINGS. Manufacturers who need services such as yours and organizations with special problems come to our Professional Engineering Directory for information. Your name and special services announced here will put you in line for their business. For further information and special rates for I.R.E. members write to the Institute of Radio Engineers.

*When writing to advertisers mention of the PROCEEDINGS will be mutually helpful.*

---

---

## *Alphabetical Index to Advertisements*

### A

Allen-Bradley Co.....IX  
American Tel. & Tel. Co.....XI  
American Transformer Co.....XIV  
Arcturus Radio Tube Co.....X

### C

Cardwell, Allen D., Mfg. Corp..XXVII  
Central Radio Laboratories.....XIII  
Condenser Corp. of America.....XII  
Cornell Electric Mfg. Co.....XVIII

### D

Allen B. DuMont Labs.....XXVI

### E

Erie Resistor Corp.....XVIII

### G

General Radio Co..Outside Back Cover

### H

Hammarlund Mfg. Co.....XXI

### I

I.R.E. ....XV,  
XVI, XIX, XX. Inside Back Cover

### P

Professional Eng. Directory....XXIII

### S

Scientific Radio Service.....XXVIII  
Soreng-Manegold Co.....XXV

### W

Weston Elec. Inst. Co.....XXII

---

---

*When writing to advertisers mention of the PROCEEDINGS will be mutually helpful.*

# SPECIAL ITEMS FOR RADIO MANUFACTURERS



No. 7280A  
3 gang, 4 positions  
single circuit

Readily adaptable to  
other specifications

No. 7260A  
3 gang, 2 positions  
2 circuits

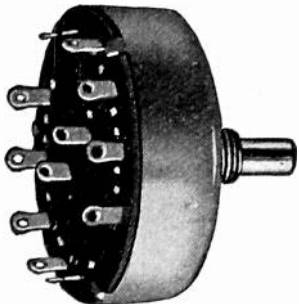

No. 7150A  
5 positions, 2 circuits

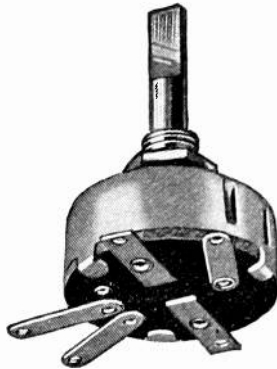

No. 7120A  
Combined Acoustic and muting  
switch 2 or 3 positions

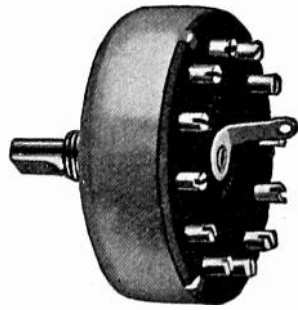

No. 7220A  
12 positions, single circuit

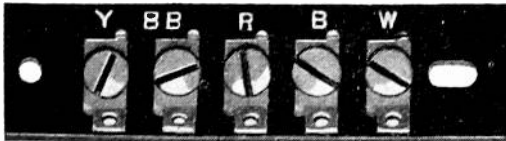

Terminal Strip  
5 Lugs No. 6880A, 4 lugs No. 6990A



Terminal Strip  
4 Clips, No. 6830A



Terminal Strip  
5 Lugs, No. 6950A

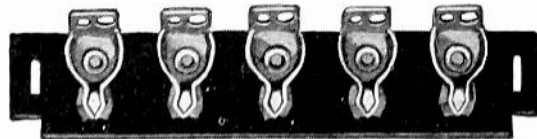

Terminal Strip  
5 Clips, No. A6310AA, 4 Clips No. A6320AA

## SORENG - MANEGOLD CO.

1901-9 Clybourn Avenue, CHICAGO, ILL.

1646 W. Adams St.  
Los Angeles, Cal.

701 Stephenson Bldg.  
Detroit, Mich.

245-5th Ave.  
New York City

*When writing to advertisers mention of the PROCEEDINGS will be mutually helpful.*

# CATHODE RAY TUBES AND ASSOCIATED EQUIPMENT

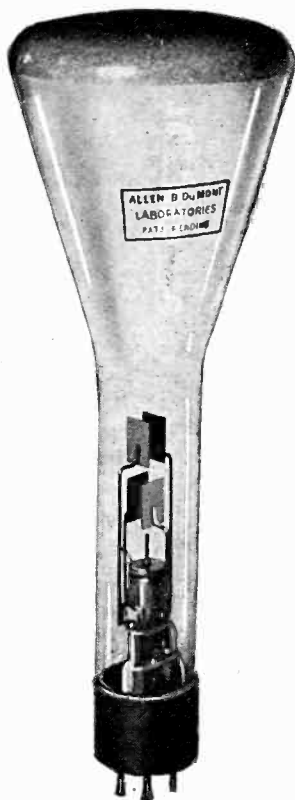

Receiving Set Measurements  
Audio Measurements  
Transmitter Modulation  
Transient Phenomena Study  
Hysteresis Curves  
Circuit Analysis  
Cardiograph  
Magnification of Small Mechanical Movements  
Insulation Tests  
Performance of Relay and Switching Equipment  
Television  
Classroom Demonstrations

Tube prices range from  
\$10 to \$100

There is now available a complete line of precision cathode ray tubes—2 in. to 9 in. in screen diameter. These tubes are possessed of unusual characteristics as follows: *Pinpoint spot—sensitivity as low as 30 volts per inch—500 volts on the accelerating electrode—rugged filaments, visible in daylight—hi-vacuum permitting hi-frequency uses.*

Associated equipment available for any use such as power supply, sweep circuit for linear time base, and tube holder.

*Write for complete technical data.*

**ALLEN B. DUMONT LABORATORIES**  
UPPER MONTCLAIR, N.J.

*When writing to advertisers mention of the PROCEEDINGS will be mutually helpful.*

# FOR ULTRA-EFFICIENT, HIGH QUALITY RECEIVING APPARATUS

**T**O MEET the high standards of performance required in certain receiving apparatus where condensers of ordinary construction and quality did not produce the desired results, CARDWELL has developed several completely shielded models employing the CARDWELL Midway "Featherweight" size condenser, with compensating or trimmer capacities incorporated. Shields are provided between sections in the gang condensers. To our knowledge this is the only light weight small size variable air condenser manufactured having a complete shield and dust cover.

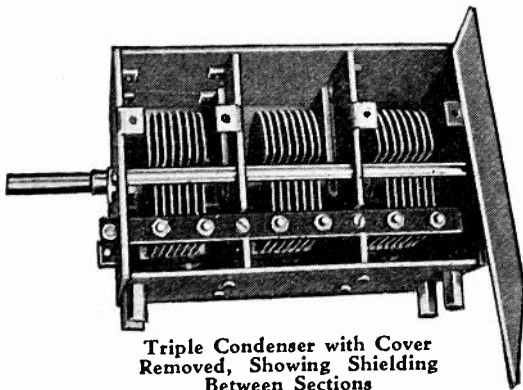

Triple Condenser with Cover  
Removed, Showing Shielding  
Between Sections

This illustration shows a triple gang unit of 150 mmfds. per section. This condenser is  $5\frac{1}{2}$ " long (back of panel) and  $3\frac{1}{4}$ " square. The weight is 22 ounces. The single unit is  $2\frac{1}{2}$ " long (back of panel) and  $3\frac{1}{4}$ " square and weighs 8 ounces. The sectional shield, of heavy gauge aluminum, makes of the whole an exceptionally rigid and sturdy unit.

These condensers can now be supplied on special order and we solicit from interested manufacturers inquiries and capacity requirements for our quotations in quantities.

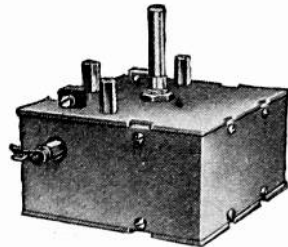

Single Condenser,  
Completely Shielded

SEND FOR LITERATURE

## CARDWELL CONDENSERS RECEIVING TRANSMITTING

The Allen D. Cardwell Mfg.  
Corporation  
93 Prospect St.  
Brooklyn, N.Y.

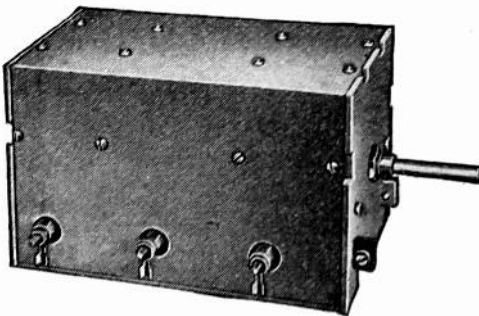

Triple "Featherweight"  
Condenser, Completely Shielded

THE STANDARD OF COMPARISON

*When writing to advertisers mention of the PROCEEDINGS will be mutually helpful.*

# Piezo Electric Crystals

*Does the frequency of your monitor comply with the new regulations of being within the plus or minus 50 cycle limits? If not, we are at your service to adjust your monitor to within those limits. Ship your monitor to us for either adjustment or grinding a new crystal if necessary. Our charge for this service is right, and will require but seven to ten days to perform this work. Ask any broadcast radio engineer what he thinks of our service.*

## CRYSTALS                      CRYSTALS                      CRYSTALS

Prices for grinding POWER CRYSTALS in the various frequency bands are as follows:

| Frequency Range      |         |
|----------------------|---------|
| 100 to 1500 Kc.....  | \$40.00 |
| 1501 to 3000 Kc..... | \$45.00 |
| 3001 to 4000 Kc..... | \$50.00 |
| 4001 to 6000 Kc..... | \$60.00 |

The above prices include holder of our Standard design, and the crystals will be ground to within .03% of your specified frequency. If crystal is wanted unmounted deduct \$5.00 from the above prices. Delivery two days after receipt of your order. In ordering please specify type tube, plate voltage and operating temperature.

*Special Prices Will Be Quoted in Quantities of Ten or More*

### POWER CRYSTALS FOR AMATEUR USE

The prices below are for grinding a crystal to a frequency selected by us unmounted, (if wanted mounted in our Standard Holder add \$5.00 to the prices below) said crystal to be ground for POWER use and we will state the frequency accurate to better than a tenth of one per-cent. IMMEDIATE SHIPMENT CAN BE MADE.

|                           |              |
|---------------------------|--------------|
| 1715 to 2000 Kc band..... | \$12.00 each |
| 3500 to 4000 Kc band..... | \$15.00 each |

### LOW FREQUENCY STANDARD CRYSTALS

We have stock available to grind crystals as low as 13 Kilo-cycles. Prices quoted upon receipt of your specifications.

### PIONEERS: POWER CRYSTALS SINCE 1925

This record is proof to you that you will get the best there is in Piezo Electric Power Crystals. Get the best. It is more economical.

## Scientific Radio Service

*"THE CRYSTAL SPECIALISTS"*

124 Jackson Ave., University Park                      Hyattsville, Maryland

*When writing to advertisers mention of the PROCEEDINGS will be mutually helpful.*

Be  
sure not  
to forget to

**R E S E R V E**

the dates of

**NOVEMBER 14 and 15**

for your attendance at the 1932

**ROCHESTER FALL MEETING**

which will be devoted to the presentation of  
a number of technical papers of importance to all  
radio engineers.



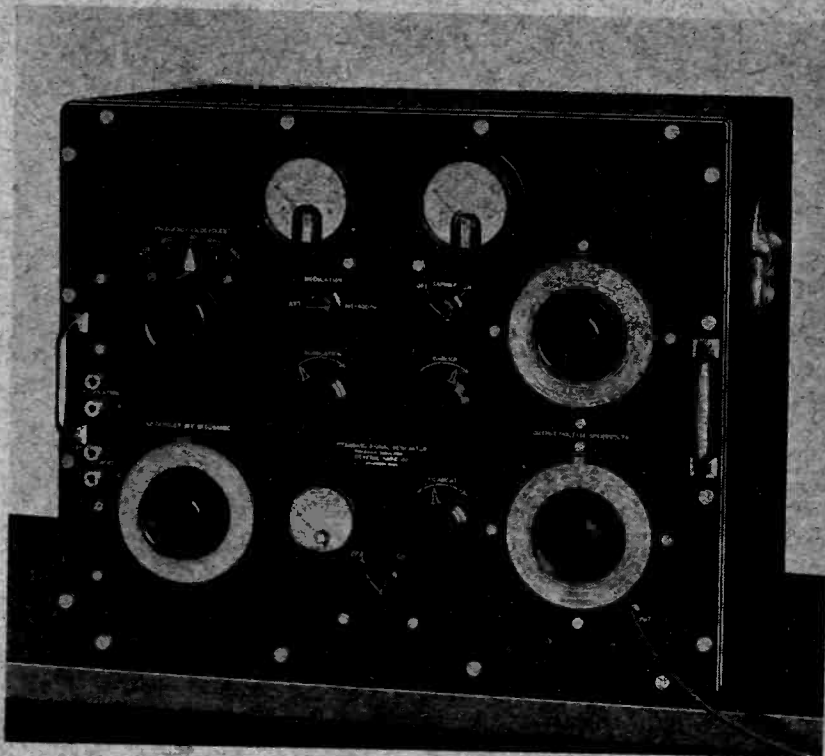

## A STANDARD-SIGNAL GENERATOR WITH GOOD MODULATION

Thorough performance tests on broadcast receivers are most reliable when the modulation performance of the standard-signal generator simulates, as closely as possible, the modulation performance of the average broadcasting station. While duplicate results cannot be obtained, a standard-signal generator designed for a minimum of distortion at high percentages of modulation goes a long way toward making fidelity tests represent actual operating conditions.

Since modulation quality is so important, please let us tell you about our TYPE 600-A Standard-Signal Generator. Ask for operating data.

Price \$885

**GENERAL RADIO COMPANY**  
CAMBRIDGE A MASSACHUSETTS