

VOLUME 20

SEPTEMBER, 1932

NUMBER 9

PROCEEDINGS
of
**The Institute of Radio
Engineers**



Form for Change of Mailing Address or Business Title on Page XV

Institute of Radio Engineers

Forthcoming Meetings

CLEVELAND SECTION

September 16, 1932

DETROIT SECTION

September 16, 1932

LOS ANGELES SECTION

September 20, 1932

NEW YORK MEETING

September 7, 1932

PITTSBURGH SECTION

September 27, 1932

SEATTLE SECTION

September 29, 1932

WASHINGTON SECTION

October 13, 1932

PROCEEDINGS OF
The Institute of Radio Engineers

Volume 20

September, 1932

Number 9

Board of Editors

ALFRED N. GOLDSMITH, *Chairman*

R. R. BATCHER
H. H. BEVERAGE
F. W. GROVER
G. W. PICKARD

L. P. WHEELER
L. E. WHITEMORE
WILLIAM WILSON
K. S. VAN DYKE

CONTENTS

PART I

Frontispiece, Officers of Toronto Section.....	1420
Institute News and Radio Notes.....	1421
Radio Transmissions of Standard Frequency	1421
Institute Meetings.....	1422
Personal Mention.....	1425

PART II

Technical Papers

Problems in Selective Reception.....	M. V. CALLENDAR	1427
Linear Distortions in Broadcast Receivers and their Compensation by Low-Frequency Equalization Devices.....	A. CLAUSING AND W. KAUTTER	1456
Dynamic Symmetry in Radio Design.....	A. F. VAN DYCK	1481
An Estimate of the Frequency Distribution of Atmospheric Noise.....	R. K. POTTER	1512
Current Rectification at Metal Contacts.....	S. P. CHAKRAVARTI AND S. R. KANTEBET	1519
Discussion on "Campbell Shackelton Shielded Ratio Box" by Leo Behr and A. J. Williams, Jr.....	R. F. FIELD	1535
Book Reviews: "The Standards Year Book" by the Bureau of Standards	L. E. WHITEMORE	1537
"The National Directory of Commodity Specifications," by the Bu- reau of Standards.....	L. E. WHITEMORE	1537
Booklets, Catalogs, and Pamphlets Received.....		1538
Radio Abstracts and References.....		1539
Contributors to this Issue.....		1546

The Institute of Radio Engineers

GENERAL INFORMATION

INSTITUTE. The Institute of Radio Engineers was formed in 1912 through the amalgamation of the Society of Wireless Telegraph Engineers of Boston, Massachusetts, and the Wireless Institute of America of New York City. Its headquarters were established in New York City and the membership has grown from less than fifty members at the start to almost seven thousand by the end of 1931.

AIMS AND OBJECTS. The Institute functions solely to advance the theory and practice of radio and allied branches of engineering and of the related arts and sciences, their application to human needs, and the maintenance of a high professional standing among its members. Among the methods of accomplishing this need is the publication of papers, discussions, and communications of interest to the membership.

PROCEEDINGS. The PROCEEDINGS is the official publication of the Institute and in it are published all of the papers, discussions, and communications received from the membership which are accepted for publication by the Board of Editors. Copies are sent without additional charge to all members of the Institute. The subscription price to nonmembers is \$10.00 per year, with an additional charge for postage where such is necessary.

RESPONSIBILITY. It is understood that the statements and opinions given in the PROCEEDINGS are views of the individual members to whom they are credited, and are not binding on the membership of the Institute as a whole.

REPRINTING PROCEEDINGS MATERIAL. The right to reprint portions or abstracts of the papers, discussions, or editorial notes in the PROCEEDINGS is granted on the express condition that specific reference shall be made to the source of such material. Diagrams and photographs published in the PROCEEDINGS may not be reproduced without making specific arrangements with the Institute through the Secretary.

MANUSCRIPTS. All manuscripts should be addressed to the Institute of Radio Engineers, 33 West 39th Street, New York City. They will be examined by the Papers Committee and the Board of Editors to determine their suitability for publication in the PROCEEDINGS. Authors are advised as promptly as possible of the action taken, usually within two or three months. Manuscripts and illustrations will be destroyed immediately after publication of the paper unless the author requests their return. Information on the mechanical form in which manuscripts should be prepared may be obtained by addressing the secretary.

MAILING. Entered as second-class matter at the post office at Menasha, Wisconsin. Acceptance for mailing at special rate of postage is provided for in the act of February 28, 1925, embodied in Paragraph 4, Section 412, P. L. and R., and authorization was granted on October 26, 1927.

Published monthly by

THE INSTITUTE OF RADIO ENGINEERS, INC.

Publication office, 450-454 Ahnaip St., Menasha, Wis.

BUSINESS, EDITORIAL, AND ADVERTISING OFFICES

Harold P. Westman, *Secretary*

33 West 39th Street, New York, N. Y.

INSTITUTE SECTIONS

- ATLANTA—Chairman, H. L. Wills; Secretary, Philip C. Bangs, 23 Kensington Road, Avondale Estates, Ga.
- BOSTON—Chairman, E. L. Chaffee; Secretary, G. W. Kenrick, Tufts College, Mass.
- BUFFALO-NIAGARA—Chairman, L. Grant Hector; Secretary, E. C. Waud, 235 Huntington Avenue, Buffalo, N. Y.
- CHICAGO—Chairman, J. Barton Hoag; Secretary, Donald H. Miller, McGraw-Hill Publishing Co., 520 N. Michigan Ave., Chicago, Ill.
- CINCINNATI—Chairman, C. E. Kilgour; Secretary, H. G. Boyle, Crosley Radio Corp., Cincinnati, Ohio.
- CLEVELAND—Chairman, E. L. Gove; Secretary, Deane S. Kintner, 3622 Lindholm Rd., Cleveland, Ohio.
- CONNECTICUT VALLEY—Chairman, L. F. Curtis; Secretary, George Grammer, American Radio Relay League, 38 La Salle Rd., W. Hartford, Conn.
- DETROIT—Chairman, H. L. Byerlay; Secretary, Samuel Firestone, Detroit Edison Co., 2000 Second Avenue, Detroit, Mich.
- LOS ANGELES—Chairman, E. H. Schreiber; Secretary, H. W. Andersen, 2332 Lake View Ave., Los Angeles, Calif.
- NEW ORLEANS—Chairman, Pendleton E. Lehde; Secretary, Anton A. Schiele, 1812 Masonic Temple, New Orleans, La.
- PHILADELPHIA—Chairman, H. W. Byler; Secretary, G. C. Blackwood, 243 E. Upsal St., Mt. Airy, Philadelphia, Pa.
- PITTSBURGH—Chairman, R. T. Griffith; Secretary, C. K. Krause, 1541 Princess Ave., Pittsburgh, Pa.
- ROCHESTER—Chairman, H. A. Brown; Secretary, M. A. Wood, 175 Winbourne Ave., Rochester, N. Y.
- SAN FRANCISCO—Chairman, C. V. Litton; Secretary, K. G. Clark, Dept. of Commerce, 328 Custom House, San Francisco, Calif.
- SEATTLE—Chairman, Leslie C. Austin; Secretary, Herbert H. Bouson, 2225-33rd Ave., Seattle, Wash.
- TORONTO—Chairman, R. A. Hackbusch; Secretary, G. E. Pipe, Rogers-Majestic Corp., Toronto, Ont, Canada.
- WASHINGTON—Chairman, J. H. Dellinger; Secretary, Major Hugh Mitchell, Signal Corps, Office Chief Signal Officer, Munitions Building, Washington, D.C.

GEOGRAPHICAL LOCATION OF MEMBERS ELECTED AUGUST 3, 1932

Elected to the Associate Grade

California	Dixon, P.O. Box 671	Hall, E. M.
	Inglewood, 541 W. Arbor Vitae St.	Phillips, R. W.
	Los Angeles, National Electric School, 4006 S. Figueroa St.	Maybee, J. K.
	Piedmont, 1338 Grand Ave.	Cohn, J.
Florida	Dunnellon, Box 453	Hughson, C. O.
Georgia	Rome, Box 518	Hicks, J. B.
Kentucky	Louisville, 531 W. Main St.	Hobbs, W. H.
Massachusetts	Chicopee Falls, 29 Grove Ave.	Seibert, J. L.
	Newton Upper Falls, 15 Williams St.	Gaisunas, A. E.
Minnesota	Fergus Falls, 629 Laurel Ave. W.	Haagensohn, A.
Missouri	St. Louis, 4430 S. Grand Blvd.	John, R.
Nebraska	Omaha, 4708 N. 39th St.	Nielsen, H. A.
New Jersey	Camden, 414 State St.	Arcury, P. F.
New York	Buffalo, 148 Walden Ave.	Bruch, R.
	Buffalo, 565 Minnesota Ave.	Martin, E. J.
	Buffalo, c/o Control Room, Station WBEN, Hotel Statler	Roy, E. H.
	Buffalo, 985 Eggert Rd.	Vishion, G.
	New York City, 1269 Findlay Ave.	Patorno, G. E.
	New York City, 864 Cauldwell Ave.	Rappaport, M.
	St. Albans, 116-38-193rd St.	Reinecke, B. V.
Ohio	Akron, 37 Charlotte St.	Suhadolink, L. E.
	Cincinnati, 1651 Westmoreland Ave.	Bill, A. G., Jr.
	Cincinnati, Box 23-A Harrison Pike, Bridgetown	Kramer, A.
	Cincinnati, 1709 Race St.	Swagler, R. E.
Wisconsin	Milwaukee, 820 E. Wells St.	Watts, H. M.
Canada	Montreal, P.Q., Marconi Station CFCF, Kings Hall	Sheppard, W. A.
	Vermilion, Alta., Box H.	Hill, M.
England	London, S.W. 1, c/o Messrs. Claude Lyons, Ltd., 40 Buckingham Gate	Bone, P. N.
	London, N. 18, 47 College Gardens	Pugsley, C. P.
	London, 49 Stafford Rd.	Rymer, J. J.
	Southport, Lanes., 39 Aughton Rd., Birkdale	Smith, G.
South Africa	Johannesburg, c/o P. J. Myburgh, 54 Robinson Deep	Austin, D. R.

Elected to the Junior Grade

Wisconsin	LeCrosse, 433 N. 6th St.	Rhode, E. A.
Canal Zone	Coco Solo, U. S. Submarine Base	Stapp, G. A.

Elected to the Student Grade

California	San Jose, 1202 Shortridge Ave.	Taylor, H. A.
	Stanford University, Box 1915	Eldred, W. N.
Georgia	Quitman, 107 Stevens	Spencer, S. W.
Maine	Orono, 104 Main St.	Elmore, J. H.
Michigan	Ann Arbor, 516 Cheever Ct.	Muffy, G.
New Hampshire	Wilton	Ring, J. P.
New York	Hamilton	Edwards, D. A.
	Ithaca, School of Elec. Engineering, Cornell Univ.	Cotner, W. W.
Oregon	Albany, Route 3	Ekstrand, P.



APPLICATIONS FOR MEMBERSHIP

Applications for transfer or election to the various grades of membership have been received from the persons listed below, and have been approved by the Committee on Admissions. Members objecting to transfer or election of any of these applicants should communicate with the Secretary on or before October 3, 1932. These applicants will be considered by the Board of Directors at its meeting on October 5, 1932.

For Election to the Associate Grade

California	Los Angeles, 1117 Venice Blvd.	Weaver, L. W.
Colorado	Silverton	Mathews, H.
Indiana	Bryant	Fritzinger, G. H.
	Marion, U.S. Radio and Television Corp.	Batchelor, J. C.
Massachusetts	Brookline, 34 Manchester Rd.	Donovan, A. C.
New Jersey	Lyndhurst, 441 Hazel St.	Bartholy, F. E.
New York	Kenmore, 399 Washington Ave.	Biskner, L. J.
Ohio	Cincinnati, 1320 Chase Ave.	Schultz, F. V.
Texas	San Antonio, 327 Halliday Ave.	Jackson, W. M.
Canada	Sioux Lookout, Ont.	Linklater, T. B.
	Toronto, Ont., 2 Cameron St.	Claridge, R. E.
England	Dalston, London, E. 8, 46 Shacklewell Lane	Pritchard, W. H.
	Halifax, c/o The Beacon Radio Mfg. Co., Ltd., 8 St. James Rd.	Rawling, G. I.
	London, N. 12, 55 Friern Watch Ave.	Bliss, J. L.
	London, E. C. 2, H.M.S. <i>Royal Oak</i> , c/o G.P.O.	Pearce, W. J.
	Potter's Bar, nr. London, "Trelawny," Oakmere Ave.	Jackson, H. E. A.
	Walworth, London, S.E. 17, 8 Brettel St.	Thynne, A. W.
Greece	Athens, Asklipion Str. 131	Palaiologos, C.
Japan	Hokkaido, nr. Sapporo, Tsukissappu, Broadcasting Station	Iida, K.
	Tokyo, Japan Wireless Tel. Co., Ltd., JIJI Bldg. 2-18, Marunouchi	Fukata, M.
Territory of Hawaii	Luke Field, Headquarters Dept.	Archer, C. J.

For Election to the Junior Grade

Kansas	Topeka, 2235 Pennsylvania Ave.	Pratt, D.
Missouri	St. Louis, 2847-A Montgomery St.	Parker, A.
Pennsylvania	Seranton, 1012 Vine St.	Koran, S. W.

For Election to the Student Grade

Massachusetts	Cambridge, Massachusetts Institute of Technology Dormitories	Burns, G. K.
---------------	--	--------------



OFFICERS AND BOARD OF DIRECTORS, 1932

(Terms expire January 1, 1933, except as otherwise noted)

President

W. G. CADY

Vice President

E. V. APPLETON

Treasurer

MELVILLE EASTHAM

Secretary

HAROLD P. WESTMAN

Editor

ALFRED N. GOLDSMITH

Directors

ARTHUR BATCHELLER

LEE DE FOREST, *Junior Past President*

J. V. L. HOGAN

WILLIAM WILSON

C. M. JANSKY, JR.

H. W. HOUCK

R. H. MARRIOTT

Serving until January 1, 1934

L. M. HULL

R. H. MANSON, *Junior Past President*

A. F. VAN DYCK

Serving until January 1, 1935

O. H. CALDWELL

E. L. NELSON



R. A. HACKBUSCH
Chairman



W. F. CHOAT
Vice Chairman



G. E. PIPE
Secretary-Treasurer



R. C. POULTER
Assistant Secretary

OFFICERS OF TORONTO SECTION—1932

INSTITUTE NOTES

Radio Transmissions of Standard Frequency

The Bureau of Standards transmits standard frequencies from its station WWV, Washington, D.C., every Tuesday. The transmissions are on 5000 kilocycles. Beginning October 1, the schedule will be changed. The transmissions will be given continuously from 10 A.M. to 12 noon, and from 8:00 to 10:00 P.M., Eastern Standard Time. (From April to September, 1932, the schedule was from 2 to 4 P.M., and from 10 P.M. to midnight). The service may be used by transmitting stations in adjusting their transmitters to exact frequency, and by the public in calibrating frequency standards, and transmitting and receiving apparatus. The transmissions can be heard and utilized by stations equipped for continuous-wave reception through the United States, although not with certainty in some places. The accuracy of the frequency is at all times better than one cycle (one in five million).

From the 5000 kilocycles any frequency may be checked by the method of harmonics. Information on how to receive and utilize the signals is given in a pamphlet obtainable on request addressed to Bureau of Standards, Washington, D. C.

The transmissions consist mainly of continuous, unkeyed carrier frequency, giving a continuous whistle in the phones when received with an oscillatory receiving set. For the first five minutes there are transmitted the general call (CQ de WWV) and announcement of the frequency. The frequency and the call letters of the station (WWV) are given every ten minutes thereafter.

Supplementary experimental transmissions are made at other times. Some of these are made with modulated waves, at various modulation frequencies. Information regarding proposed supplementary transmissions is given by radio during the regular transmissions, and also announced in the newspapers.

The Bureau desires to receive reports on the transmissions, especially because radio transmission phenomena change with the season of the year. The data desired are approximate field intensity, fading characteristics, and the suitability of the transmissions for frequency measurements. It is suggested that in reporting on intensities, the following designations be used where field intensity measurement apparatus is not used: (1) hardly perceptible, unreadable; (2) weak, readable now and then; (3) fairly good, readable with difficulty; (4)

good, readable; (5) very good, perfectly readable. A statement as to whether fading is present or not is desired, and if so, its characteristics, such as time between peaks of signal intensity. Statements as to type of receiving set and type of antenna used are also desired. The Bureau would also appreciate reports on the use of the transmissions for purposes of frequency measurement or control.

All reports and letters regarding the transmissions should be addressed Bureau of Standards, Washington, D. C.

Institute Meetings

ATLANTA SECTION

On June 9 a meeting of the Atlanta Section was held at the Atlanta Athletic Club with chairman H. L. Wills presiding.

The speaker of the evening, C. J. Faulstich of the RCA Victor Company, presented a paper on "New Tubes and their Use in New RCA Victor Receiving Sets."

The speaker discussed the constructional details of several of the new tubes recently placed upon the market and showed their various operating characteristics by means of graphs. The use of these tubes in the new RCA Victor receivers was then outlined and the characteristics of the sets discussed in detail. One of these receivers was set up and operated to demonstrate its over-all characteristics for the benefit of the twenty members and guests present. At the conclusion of the demonstration, the paper was discussed by Messrs. Bangs, Etheredge, Gardberg, and Wills.

The July meeting of the Atlanta Section was held on the 14th at the U. S. Naval Reserve Armory Station NDJ. In the absence of both chairman and vice chairman, H. F. Dobbs became acting chairman.

The new transmitter at this Naval Reserve Station was placed in operation and a number of tests were made showing the ease of operation of this set. The circuit was examined and discussed by Messrs. Bangs, Brewin, and Dobbs. In addition, a number of those present operated the SW-5 National receiver used at the station. At the close of the meeting, Lieutenant H. F. Dobbs, who is in command of the Atlanta Unit of the Naval Reserves, conducted the members and guests around the armory showing the equipment and explaining the methods of instruction which is given the reserves.

The meeting was attended by fourteen members and guests.

LOS ANGELES SECTION

The Los Angeles Section held a meeting on May 17 at the Mayfair Hotel, chairman E. H. Schreiber presiding.

"Photoelectricity" was the subject of a paper by Arthur Warner of the University of California. Dr. Warner outlined the history of the photoelectric effect, pointing out that in contrast to the photronic effect, the current output of a photoelectric cell is directly proportional to the light intensity and follows its changes instantaneously. The selenium cell of today was shown to be photoelectric for small light intensities and short intervals of time. The use of silver-oxygen-caesium coating has greatly improved the sensitivity and color response compared to the older type cells using an alkaline metal only. The paper was concluded by a demonstration of the use of a copper oxide rectifier as a photronic device. It was stated that outputs as high as a half or three-quarters of a volt may be obtained from such devices. The meeting was attended by seventy-six members, of whom twenty-two were present at the informal dinner which preceded it.

The July meeting of the Los Angeles Section was held on the 19th at the Mayfair Hotel with chairman E. H. Schreiber presiding. A symposium on "Present Day Broadcast Problems" was presented by J. K. Hilliard of United Artist Studios Corporation and P. F. Johnson of the Southern California Telephone Company.

Mr. Hilliard opened the discussion with a paper on "Tower Detuning." In it he compared centralized and sectionalized insulated towers pointing out that a tower insulated at the base proved easier to detune. If the tower is detuned by inserting an inductance of large copper tubing between its base and the ground, the tower lighting circuit may readily be detuned by threading the feed wires through the inductance. The same author then presented a paper on "The Permanent Magnet Ribbon Microphone," giving a description of this device and pointing out its highly directional pick-up characteristics. Following this a discussion was held on high fidelity transmitters and receivers in which it was shown that the transmitter was still in advance of the receiver as concerns frequency and volume range. The increase in distortion in receivers due to the use of pentodes was deplored.

The next paper presented was entitled "The Eight Thousand-Cycle Transcontinental Line," and was delivered by Mr. Johnson. He stated that in 1925 there was in use approximately a thousand miles of program lines which had increased to thirty-four thousand miles in 1930 in addition to fifty thousand miles of telegraph circuits. A frequency

range of from twenty cycles to twenty thousand cycles was considered as being ideal but for economic reasons is impracticable at the present time. It was pointed out, however, that extensive tests by a group of trained listeners indicated a range of from thirty-five to eight thousand cycles was ample for apparently natural reproduction of music. The average radio receiving set seldom reproduces anything above five thousand cycles and it was, therefore, considered satisfactory for a program line to handle frequencies from thirty-five to eight thousand cycles. The next limiting factor of the line was its volume range capabilities. It was stated that a symphony orchestra when playing covers an intensity range of approximately sixty decibels. The noise level in the average home is so high that if a radio set is operated at such a level that the lower passages are audible, the higher passages will overload the set. Therefore a range of forty decibels was chosen as one both practicable and economical. It was also pointed out that the broadcast transmitting station can handle a range of volume of only thirty-five decibels if a satisfactorily high percentage of modulation is to be maintained. The effect of phase distortion was discussed and some phonograph records were played indicating the effect of various amounts of such distortion.

A number of the thirty-eight members and guests in attendance participated in the discussion and thirteen were present at the dinner which preceded the meeting.

PHILADELPHIA SECTION

The Philadelphia Section held its annual meeting on June 30 at the Engineers Club with G. W. Carpenter, chairman, presiding.

The paper of the evening, by Robert Adams, 3rd, was on "Radio Amateur Activities." The discussion which followed it centered chiefly around five-meter transmission. The activities of the South Jersey Radio Association in this field were outlined by Edward Braddock who discussed particularly their work in conjunction with the Forestry Service. J. Haydock described a single tube five-meter super-regenerative receiver which permits telephonic communication between Hadonfield and Frankford, a distance of eight miles.

Following the presentation of the paper and the discussion, the annual business meeting was held with W. F. Diehl as acting secretary. Reports of the Membership Committee, the financial report and that of the Auditing Committee were then given and the Nominating Committee's recommendations for officers for the succeeding year were read. No further nominations were offered and the following officers were elected: Chairman, H. W. Byler, of the RCA Victor Company;

Vice Chairman, I. A. Travis, of the Moore School of Electrical Engineering, University of Pennsylvania; and Secretary, G. C. Blackwood of Philadelphia, reelected.

Mr. Byler, the newly elected chairman, was then introduced by Mr. Carpenter and after a short address of appreciation, the meeting was adjourned. The attendance totaled sixty members and guests.

Personal Mention

J. R. Bird, formerly of Bell Telephone Laboratories, has joined the engineering staff of The Rola Company, Cleveland, Ohio.

C. M. Burrill has left Rogers-Majestic Corporation, Toronto, to rejoin the engineering staff of RCA Victor at Camden.

J. H. DeWitt has become chief engineer of broadcast station WSM, Nashville, Tenn.

Frank Freimann, previously technical editor of "Radio Age," is now president of Electro Acoustic Products Co. at Fort Wayne, Ind.

H. J. Heindel has become chief engineer of Fada Radio and Electric Corporation.

Lieutenant D. L. Mulkey has been transferred from the Signal Corps Laboratory, Washington, D.C. to Ft. De Lesseps, Panama Canal Zone.

A. C. Rockwood is now in the engineering department of the Raytheon Production Corporation having previously been with Hygrade Lamp Company.

Previously with RCA Victor Company, F. W. Townsley has joined the radio engineering staff of the Federal Telegraph Company at Newark, N.J.

Errata

The following corrections have just been received to the paper entitled "A Simplified General Method for Resistance-Capacity Coupled Amplifier Design," by David G. C. Luck, published in vol. 20, no. 8, August, (1932) issue of the Proceedings, pages 1401-1406:

Page 1402, line 11, in the last of the three equations (3a), R_p should be R_l .

Page 1402, lines 13 and 14, on the right hand side of each of the first two equations below (3a), R_l should be R_p .

Page 1402, line 19, in the second line of text above equation 4, C_o/c should be C_o/C .

Page 1405. The symbol ω in the equation should be w .

TECHNICAL PAPERS

PROBLEMS IN SELECTIVE RECEPTION*

BY

M. V. CALLENDAR

(Research Department, Lissen Ltd., Isleworth, England)

Summary—In this paper we are comparing from a theoretical standpoint the methods of attainment of the highest degree of selectivity required by present broadcasting conditions, and investigating the distortions introduced by receivers employing such methods in practice.

The equations for magnification and phase differences introduced by one or more simple tuned circuits are first obtained in a convenient form: corresponding expressions are obtained for the band-pass circuit, and a note is appended upon circuits with reaction. We then investigate the effect of the detector by determining the audio output from a square law rectifier when an amplitude modulated wave of general form is applied to it: the effective selectivity of, and audio distortion introduced by, the tuners previously discussed are thus obtained. The whole process is then repeated for the more difficult case of the linear detector and the harmonic distortion here calculated: the "demodulation" effect which occurs when two transmissions are received simultaneously is considered in theory and practice.

The two rival systems of selective tuning—viz., the band-pass and the simple sharp tuner with audio tone correction—are compared as regards their ability to deal with the direct and also the heterodyne interference from unwanted neighboring transmissions: the probability of frequency and harmonic distortion in the resulting reception under practical operating conditions is also discussed, and it is shown in particular that the band-pass system is inferior on at least two of these four heads.

PART I.

A. EQUATIONS FOR THE NORMAL RESONANT CIRCUIT.

WE HAVE, for voltage magnification of a parallel resonant circuit

$$M = V/e = \frac{1}{\sqrt{R^2 + (\omega L - 1/\omega C)^2}} \times 1/\omega C'$$

Also for phase angle between V and e , we have

$$\tan \theta = \frac{\omega L - 1/\omega C}{R}$$

* Decimal classification: R161.1. Original manuscript received by the Institute, April 13, 1932. Revised manuscript received, June 9, 1932.

or,

$$\cos \theta = M \cdot R\omega C'$$

we may simplify these expressions by putting $K = R/\omega L$ and $\omega_r^2 = 1/LC$

$$\therefore M = \frac{1}{\sqrt{K^2 \cdot \frac{\omega^2}{\omega_r^2} + \left(\frac{\omega^2}{\omega_r^2} - 1\right)^2}}$$

and then, if $\omega = \omega_r + \partial\omega$, we have

$$M = \frac{1}{\sqrt{K^2 + \frac{4\partial\omega^2}{\omega_r^2} \left(1 + \frac{\partial\omega}{\omega_r}\right)}}$$

here we have neglected the terms $K^2 \cdot \partial\omega/\omega$, and $\partial\omega^4/\omega_r^4$ under the root sign, and these will not introduce errors in M of more than 2 per cent under any likely practical conditions (i.e. provided $K < 0.04$ and $\partial\omega < 0.4\omega_r$). In this expression K , the power factor of the circuit, is not strictly constant with frequency: this variation will, however, rarely affect the form of the ordinary resonance curve appreciably since the term in K will only be important over a limited range of $\partial\omega$ (see below); moreover, the power factor for circuits employing coils of the same dimensions and type will not vary by more than some ± 25 per cent over a wide range of L , ω , and C , provided that air dielectric condensers are used and the shunt loads imposed by valves, etc., do not form a very large part of the total losses.

The expressions given hold for a single tuning circuit: for n similar circuits in cascade, being coupled by screen grid valves or any other device giving nonreactive coupling and introducing no appreciable losses, we will have:

$$\text{over-all magnification} = (M \text{ for single circuit})^n$$

$$\text{over-all phase shift} = n \times (\theta \text{ for single circuit}).$$

We will now enumerate three cases in which the expression can be simplified, giving expressions which are well known, but whose limitations are not always observed.

1.* For small values of $\partial\omega/\omega_r$, we may say:

$$M = \frac{1}{\sqrt{K^2 + 4\partial\omega^2/\omega_r^2}}$$

* In these formulas we may clearly substitute f_r and ∂f for ω_r and $\partial\omega$ for calculation purposes.

the limits of application of this formula are given by $\partial\omega < \omega_r/10$ for 5 per cent accuracy, and it can be therefore applied to most problems of audio-frequency note cut-off except those with intermediate frequency amplifiers or those where several (n) tuned circuits are used, when we must have $\partial\omega < \omega_r/10_n$ for 5 per cent accuracy.

2. For large values of $\partial\omega/\omega_r$, we may use:

$$M = \frac{\omega_r}{2\partial\omega\sqrt{1 + \partial\omega/\omega_r}}$$

the limits of application of this formula are given by $\partial\omega/\omega_r > k$, or, cut-off to less than half the peak, for 10 per cent accuracy; it can therefore be applied to most problems of selectivity ratio for a single circuit except on very short waves (e.g. below 200 m) and in cases of high power factor: for two tuned circuits, however, it is limited to points where the cut-off is down to <0.1 and for three circuits to <0.03 and hence it is unsuitable for a multicircuit tuner.

3. For a limited range of $\partial\omega/\omega_r$, we can employ a double simplification giving $M = \omega_r/2\partial\omega$: the limits of use of this linear formula are, of course, as given in 1 and 2 above and it is therefore only useful as a rough approximation except in a few cases of very low power factor (e.g. audio discrimination of a single circuit with considerable reaction on medium or short waves).

B. THE BAND-PASS CIRCUIT.

Previous analyses¹ of the band-pass circuit have been mainly concerned with determining the "peak separation" and with methods for keeping this constant over a whole waveband for a signal frequency filter: we will here adopt a quite different line of attack, by comparing

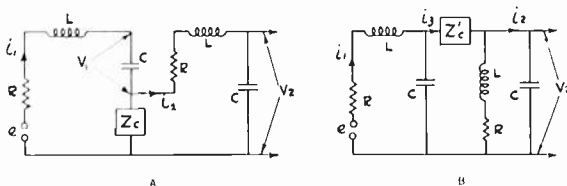

Fig. 1.

the band-pass with a simple 2-circuit cascade tuner, and the criteria obtained in this way will be found to be more useful for our purpose than the "peak separation" constant. The usual radio frequency band-pass circuit is of one of the forms shown in Fig. 1; the circuit in which a mutual inductance is employed is clearly a special case of Fig. 1a.

¹ N. R. Bligh, *Wireless Engineer and Experimental Wireless*, February, (1932); also E. A. Uehling, *Electronics*, September, (1930).

Writing $Z = R + j\omega L + 1/j\omega C$ for short, we have, in Fig. 1a,

$$e = i_1 Z + (i_1 - i_2) Z_c$$

$$0 = i_2 Z + (i_1 - i_2) Z_c$$

whence

$$V_2 = i_2 / j\omega C'$$

$$i_1 = \frac{i_2(Z + Z_c)}{Z_c}$$

$$\begin{aligned} \therefore i_2 &= \frac{e}{Z_c} + \frac{(Z + Z_c)^2}{Z_c^2} \cdot i_2 \\ &= \frac{e \cdot Z_c}{Z^2 + 2ZZ_c} \end{aligned}$$

$$V_2 = \frac{e}{j\omega C'} \cdot \frac{Z_c}{Z(Z + 2Z_c)} \text{ and similarly } V_1 = \frac{e}{j\omega C'} \cdot \frac{Z + Z_c}{Z(Z + 2Z_c)}$$

or from Fig. 1b, we obtain the same equation as above except that Z_c is replaced by $(j\omega L + R/j\omega C \cdot Z_c')$. Now for a simple cascade tuner, comprising circuits of impedances (Z) and $(Z + 2Z_c)$, we have:

$$V_2 = \frac{e}{\omega^2 C'^2} \cdot \frac{1}{Z(Z + 2Z_c)}$$

This is of exactly the same form as the first band-pass equation with the exception of the factor $1/j\omega C' \cdot Z_c$; we see that for the common

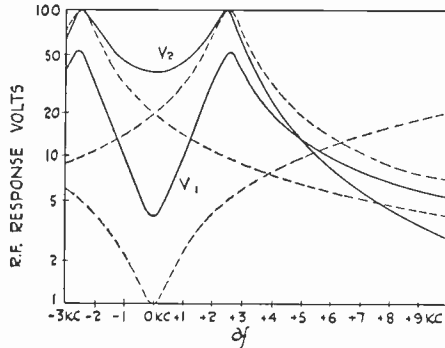

Fig. 2.

capacity coupled filter, this factor can be left out of account, while for the inductive or resistive filter the resulting factor in $1/\omega$ or $1/\omega^2$ will merely introduce a dissymmetry which will be unimportant except in a few particular cases (e.g. first intermediate frequency in a superheterodyne). It is also clear that the case of Z_c purely resistive does not

yield a true filter, while for the reactive coupling, the difference between the resonant frequencies of the two equivalent component circuits represents the upper limit for $R \rightarrow 0$ of the band-pass "peak separation": this latter is given by the well-known formula—peak separation $= \sqrt{B_c^2 - R^2} / 2\pi L$, where B_c is the reactance of Z_c .

The two component curves are easily drawn, being identical except for the frequency displacement, and hence the band-pass curve is

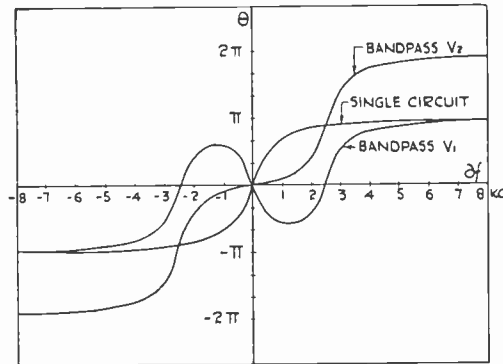

Fig. 3.

arrived at as in Fig. 2: here the curve obtained if the voltage is taken off at V_1 is also plotted and it is seen that this shows a larger trough, a wider peak separation, and a selectivity comparable with that of a single tuned circuit: the phase angles introduced in this case for various degrees of detuning are also given in Fig. 3 and a little consideration will show that there is no dissymmetry about the point $\delta f = 0$ for any 2-circuit band-pass.

It is of importance (see PART IV) to compare the radio-frequency selectivity of the band-pass with that of a simple cascade tuner em-

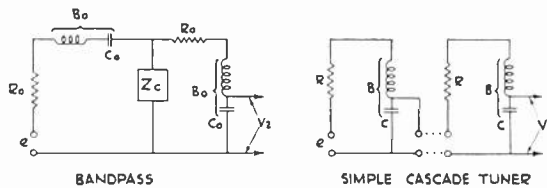

Fig. 4.

ploying the same coils: using the symbols of Fig. 4 with suffix r added where necessary to denote their value at the resonant frequency, we have, for the magnification at the tuning point:

$$\text{at } d\omega = 0 \quad \left\{ \begin{array}{l} \text{for band-pass} \\ \text{for 2 circuits} \end{array} \right. \quad \begin{array}{l} M_r = \frac{1}{j\omega_r C_0} \cdot \frac{Z_{cr}}{(R_0 + Z_{cr})^2} \\ M_r = \frac{1}{\omega_r^2 C^2} \cdot \frac{1}{R^2} \end{array}$$

while for the height of the curve at a point well off tune, where $B \gg R$:

$$\text{at } \frac{\partial \omega}{(\omega = \omega')} \text{ large } \begin{cases} \text{for band-pass} & M' = \frac{1}{j\omega' C_0} \cdot \frac{Z_c'}{B_0(B_0 + 2B_c)} \\ \text{for 2 circuits} & M' = \frac{1}{\omega'^2 C^2} \cdot \frac{1}{B^2} \end{cases}$$

hence, taking M_r/M' as our definition of radio-frequency selectivity ratio, we have the selectivity for the band-pass tuner equal to that for the simple tuner multiplied by a factor of

$$\left(\frac{Z_{cr}\omega' \cdot B_0(B_0 + 2B_c)}{Z_c' \cdot \omega_r} \cdot \frac{\omega_r^2 R^2}{(R_0 + Z_{cr})^2} \cdot \frac{\omega_r^2 B^2}{\omega'^2 B^2} \right).$$

Now for the same tuning point for band-pass and simple tuner, we have $B = B_0 + B_c$: thus, for an inductively coupled band-pass where $R_0 + Z_{cr} = R + j\omega L_c$, the factor reduces to

$$\frac{\omega_r^2}{\omega'^2} \cdot \frac{R^2}{R^2 + \omega_r^2 L_c^2}$$

and similarly for a capacity coupled band-pass we get $\frac{R^2}{R^2 + 1/\omega_r^2 C^2}$

or for a resistance-coupled arrangement we have $\frac{\omega_r}{\omega'} \cdot \frac{R^2}{(R + R_c)^2}$.

Thus, if we leave out of consideration the dissymmetry with the L filter for $\partial\omega$ very large, we see that the selectivity for the band-pass would tend, as expected, to that for the 2-circuit simple tuner as the coupling impedance was reduced: the condition for no peak separation is given by $R_0 = B_c$ and hence we see that for a practical band-pass, the radio-frequency selectivity ratio for $\partial\omega$ large will be equal to, or slightly less than, half that for the simple 2-circuit tuner. Typical curves for a band-pass and the corresponding simple tuner have been plotted in Fig. 5 for three different values of coil resistance.

From the formulas above, we may also observe the interesting fact that when we adjust the scales as above, so that the curves for the band-pass and the simple tuner coincide at some 20 kc or more off resonance, the magnification for the band-pass at $\partial f = 0$ is equal to that of the corresponding simple tuner at a value of $\partial f = 1/2(f_1 - f_2)$ where f_1 and f_2 are the resonance frequencies of the component equivalent circuits Z and $Z + 2Z_c$. We can thus regard the band-pass tuning curve as

approximating to that of the corresponding simple tuner with the peak truncated, as shown in Fig. 6, this approximation becoming more and more accurate as the ideal "square peak" form is approached:

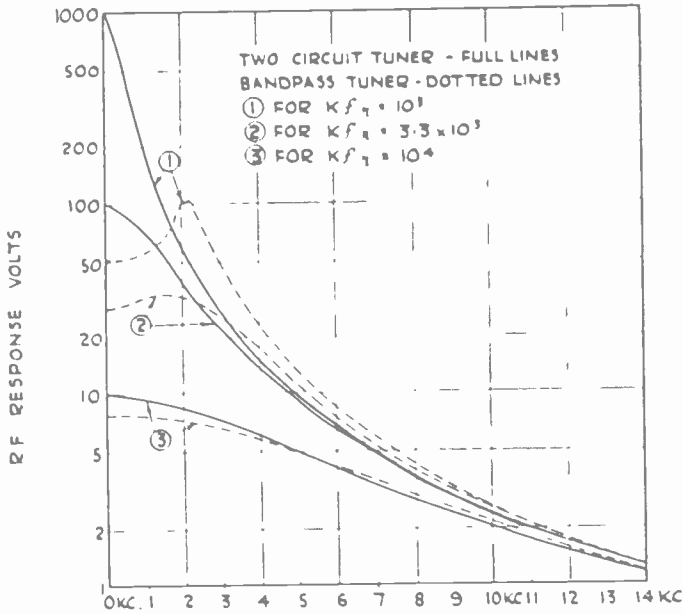

Fig. 5

the corners will, of course, be somewhat rounded off always, but, referring again to the equations above, we see that for a value of $B_c = 2R$, we obtain about the best approximation to the ideal, the peak being

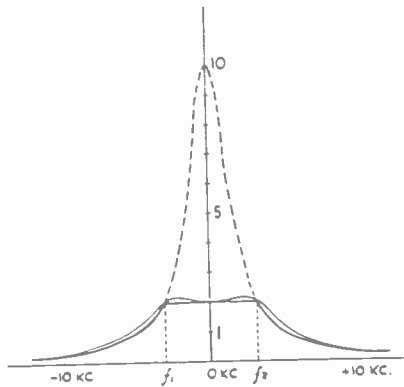

Fig. 6—Diagrammatic approximation for band-pass. (Thin line is practical curve.)

truncated to $1/5$ of its original height and the actual curve coinciding with the diagrammatic approximation at the two points $\partial f = 0$ and $\partial f = 1/2(f_1 - f_2)$. (cf., curve No. 2 in Fig. 5).

C. CIRCUIT WITH REACTION.

If we neglect second order effects, we can show that the application of reaction is equivalent to the use of a tuning coil of lower radio-frequency resistance by the usual simple treatment: thus in Fig. 7:

$$e = (R + j\omega L + 1/j\omega C)i_1 + j\omega M i_2$$

and
$$i_2 = V \frac{\partial i_2}{\partial V} = i_1/j\omega C' \cdot \frac{\partial i_2}{\partial V}$$

whence
$$V = \frac{e}{j\omega C' \left(R + M/C' \cdot \frac{\partial i_2}{\partial V} + j\omega L + 1/j\omega C \right)}$$

Thus the application of reaction is exactly equivalent to a reduction in circuit resistance, provided that $\partial i_2/\partial V$ is constant and wholly real

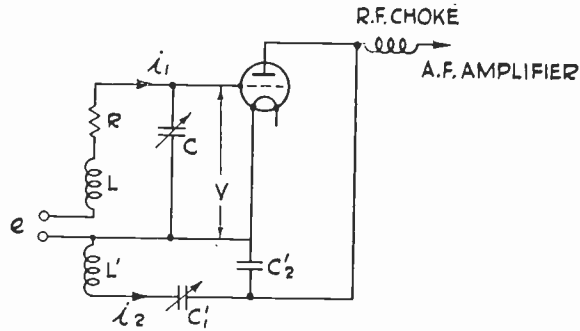

Fig. 7—Typical reaction circuit.

(i.e. i_2 in phase with i_1): in the simplest case, we have $\partial i_2/\partial V = \mu/\rho$ very nearly, but in practice, there will generally be two forms of deviation from this:

1. Owing to the reactive impedances in series with ρ , the phase of i_2 and magnitude of $\partial i_2/\partial V$ will vary somewhat with frequency, and this variation will be very considerable in cases where the impedance of the anode load is large, or where any resonance is approached (e.g. in Fig. 7 resonance of L' with C_1' or C_2'): this consideration will limit the value of added R which can be compensated for by reaction. Moreover, the distuning of the resonant circuit by reaction will be appreciable if i_2 is put out of phase with i_1 by large reactances.

2. The valve characteristics are not linear: since we are concerned here only with the fundamental radio-frequency component of i_2 , the second power term in the valve characteristic will not affect us, but the third power term (which will be negative in general) will become important at large inputs where it will appear as a reduction in $\partial i_2/\partial V$:

thus we may expect a resonance curve with reaction to be somewhat flattened at the top in those cases where V is sufficient to give linear detection, since we are here working on a part of the V input - I output characteristic where the rate of change of slope due to the third power term is neutralizing that due to the second power term. (See B. van der Pol² for a mathematical analysis of reaction with a nonlinear characteristic, though his conclusions must be applied with caution to any particular practical case.)

Of these two effects, 1 is generally the more important, and we will consider this in more detail. The threshold of oscillation will clearly be reached when $\partial i_2/\partial V = -RC/M$, if we include here only the inphase fundamental frequency components of $\partial i_2/\partial V$: now this expression is equal to $1/LMR_p$, where R_p is the dynamic shunt resistance of the circuit, which will be nearly proportional to frequency over the wave band for an average tuned circuit taken by itself, but will be more nearly constant where a relatively heavy shunt resistance load is imposed (e.g. a power grid detector on the long wave band): thus we see that it is desirable to keep $\partial i_2/\partial V$ constant or to make it decrease slowly with frequency over the wave band according to the circuit constants, in order to achieve the desirable constancy of reaction setting, and also to avoid the difficulty of tuning which arises when the receiver breaks into oscillation when slightly off tune on one side of the station being received (i.e., when the tuning curve is effectively unsymmetrical). For this reason, and also in order to minimise phase differences and to reduce Miller effect input damping, it is advantageous in all cases to employ as low a value of L' for a given M as is practicable: i.e. the reaction coil should always be coupled as tightly as possible: again, the use of a tuning circuit of low power factor will allow of a lower value of M , while in general, we desire to keep the series circuit resistance, and any variable components of the shunt resistance (e.g. Miller damping) small in comparison with the constant shunt resistance losses (e.g., grid leak and conductance).

We will now proceed to a comparison of the various common reaction circuits in the light of the general considerations above:

(a) With the simplest circuit comprising a reaction coil arranged in variable mutual inductive relationship, i_2 will be nearly in phase with i_1 and reasonably constant with frequency provided the two coils are always coupled fairly tightly: the movement in position of L' will however generally upset the tuning to some extent, apart from certain obvious mechanical disadvantages of this arrangement.

² Balth van der Pol, "Effect of regeneration in the receiver signal," Proc. I.R.E., vol. 17, p. 339-346; February, (1929).

(b) If the circuit of Fig. 7 is employed without the bypass C_2' , since $1/\omega C_1'$ must be appreciable relative to ρ if we are to obtain a reasonable control of i_2 by varying C_1' , $\partial i_2/\partial V$ will necessarily increase undesirably with frequency, and will also contain an appreciable out-of-phase component: if, however, a bypass C_2' can be added which has a low radio-frequency impedance relative to the valve, both these disadvantages are removed. It is as usual important to use a reaction coil coupled as closely as possible, the number of turns used being a compromise between the very small inductance desirable to keep $\omega L' \ll 1/\omega C_1'$, and the considerable coupling M required to allow of the use of a relatively large bypass.

(c) If we attempt to use a variable resistance (with, of course, a large condenser to insulate for direct current instead of the variable condenser C_1'), we will obtain i_2 nearly in quadrature with i_1 , if we retain the large bypass C_2' : we are therefore faced with the practical disadvantage of having to omit the bypass.

(d) It is possible to use instead a variable resistance shunt R_s for the reaction coil: in this case the phase of the current in the coil will vary with the degree of shunting, being nearly in quadrature with i_1 for $R_s < \omega L'$ for all reasonable values of C_1' and C_2' (i.e., values which will not give resonance, etc).

On experiment, we find that the practical "smoothness" of reaction, and absence of unwanted noises on the threshold of oscillation, varies roughly as expected from the above considerations: in particular, the practical superiority of capacitive reaction control with large bypass and tightly coupled coil can readily be demonstrated, and also a tuning coil of low power factor is generally found to give better results even when used with critical reaction than another with higher losses. It seems possible for small inputs to reduce the effective power factor of a normal circuit to below 10^{-4} without any serious departure from the form of the normal circuit curve.

PART II.

A. ACTION OF PARABOLIC DETECTOR.

The general equation of an amplitude modulated wave may be written, in terms of carrier and side bands, as

$$V = A_0 \sin(\omega t + \theta_0) + A' \sin(\omega t - pt + \theta') + A'' \sin(\omega t + pt + \theta'')$$

where p is 2π times modulation frequency (n), and $\theta_0, \theta', \theta''$ are relative phase angles. Let us now apply this voltage to a parabolic detector, having a characteristic of the form $I = \alpha V + \beta V^2$. Squaring out, and omitting the sensitivity constants, we obtain:

$$\begin{aligned}
 I &= \text{high frequency terms in } \sin \omega t, \sin^2 \omega t, \text{ etc.} \\
 &+ 2A_0A' \sin (\omega t + \theta_0) \cdot \sin (\omega t - pt + \theta') \\
 &+ 2A_0A'' \sin (\omega t + \theta_0) \cdot \sin (\omega t + pt + \theta'') \\
 &+ 2A'A'' \sin (\omega t - pt + \theta') \cdot \sin (\omega t + pt + \theta'')
 \end{aligned}$$

from these three terms we obtain the audio notes:

$$\begin{aligned}
 I_{AF} &= A_0A' \cos (pt + \theta_0 - \theta') + A_0A'' \cos (pt - \theta_0 + \theta'') \\
 &\quad + A'A'' \cos (2pt + \theta' - \theta'')
 \end{aligned}$$

or, if we add together the two vectors for fundamental modulation frequency and omit inessential phase differences,

$$I_{AF} = A_0 \sqrt{A'^2 + A''^2 + 2A'A'' \cos (\theta' + \theta'' - 2\theta_0)} \cdot \cos pt + A'A'' \cos 2pt.$$

(This result may be obtained also by squaring the expression for $f(\cos pt)$ in the next section on linear detectors.)

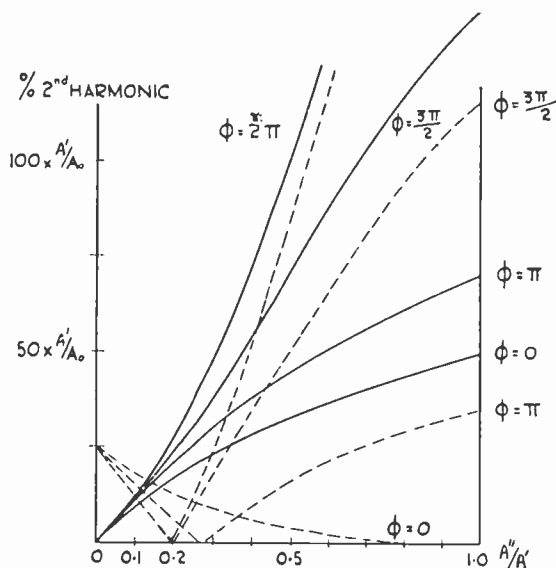

Fig. 8—Per cent harmonic from a parabolic detector for various relative amplitudes and phases of side bands. (Per cent harmonic for linear detector dotted curves.)

We here require to deal with the case where a carrier e.m.f., e , symmetrically modulated at m per cent is injected into the first circuit of a receiver, such e.m.f. arriving at the detector in the unsymmetrical form investigated above owing to the unequal magnifications M_0, M', M'' , and phase angles $\theta_0, \theta', \theta''$ impressed upon the carrier and side bands by the tuning circuits. We have now $A' = me/2M'$, etc., and, if we write $\phi = \theta' + \theta'' - 2\theta_0$ we will have:

$$I_{AP} = me^2 \left[\sqrt{M'^2 + M''^2 + 2M'M'' \cdot \cos \phi} \cdot M_0/2 \cdot \cos pt \right. \\ \left. + 2M'M'' \cdot \frac{m}{4} \cdot \cos 2pt \right].$$

We see here that the well-known expression $m/4$ for the per cent of 2nd harmonic introduced by a parabolic detector is obtained only in the case of a symmetrical tuner giving no side-band cut-off (i.e., $M_0 = M' = M''$ and $\phi = 0$): the per cent harmonic obtained for any value of A'/A_0 , A''/A' , and ϕ can be read off from the curves of Fig. 8, which have been plotted from the above equation: these curves are still applicable for values of $A'/A_0 = mM'/2M_0$ greater than one, provided, of course, that we still make A' refer to the larger of the side bands.

The case where two or more modulation frequencies are present is important from the viewpoint of distortion: for two modulation frequencies p_1 and p_2 , when we square out and transform as before, in addition to the terms representing modulation frequency components p_1 and p_2 and their second harmonics, we will obtain four additional terms as follows:

$$\left\{ \begin{array}{l} A_1'A_2' \cos ((p_1 - p_2)t + \theta_1' - \theta_2') \\ A_1''A_2'' \cos ((p_1 - p_2)t + \theta_2'' - \theta_1'') \\ A_1'A_2'' \cos ((p_1 + p_2)t + \theta_1' - \theta_2'') \\ A_1''A_2' \cos ((p_1 + p_2)t + \theta_2' - \theta_1'') \end{array} \right.$$

Now it is clear that these audio sum and difference (combination) tones will not cancel out except for the abnormal case of $\theta_1' + \theta_1'' = 2\pi \pm (\theta_2' - \theta_2'')$: for the symmetrical case of $A_1' = A_1''$ etc., we may most easily estimate the distortion by writing the input as $A(1 + m_1 \cos p_1t + m_2 \cos p_2t) \cos \omega t$, whence we have:

$$\begin{aligned} \sqrt{\text{power in fundamentals}} &= 2\sqrt{m_1^2 + m_2^2} \\ \sqrt{\text{power in harmonics}} &= \frac{1}{2}\sqrt{m_1^4 + m_2^4} \\ \sqrt{\text{power in sum and difference terms}} &= \sqrt{2m_1m_2} \end{aligned}$$

thus for $m_1 = m_2$ we will have a per cent $\sqrt{\text{power}}$ in 2nd harmonics of $m/4$ as usual, while the combination tones will contribute a per cent $\sqrt{\text{power}}$ of $m/2$ and this will probably be far more aurally distressing than the mere excess of harmonics. For the more general case where $m_1 \neq m_2$ the combination tones will have a smaller amplitude relative to the harmonics than that given above: for the perfectly general unsymmetrical case, the per cent of combination tones will vary in the

same way as the second harmonic, plus a variation as above to a maximum in cases where the modulation ratios at the detector for the two side bands are of the same order.

We may note here that for the case where one side band is of very small amplitude compared with the other, we will not obtain any appreciable 2nd harmonic, but the combination tone $A_1'A_2' \cos(p_1 - p_2)t$ above will still be present, and will give a per cent $\sqrt{\text{power}}$ in undesired frequencies up to a maximum of $A/\sqrt{2}A_0 = m/2\sqrt{2}$ occurring as before where $A_1 = A_2$: this case will be common in very selective receivers, and, of course, is that met with in single side-band transmission.

B. EFFECTIVE SELECTIVITY CURVES.

The audibility of interference from a transmission to which the receiver is not tuned is clearly determined by the form of the curve

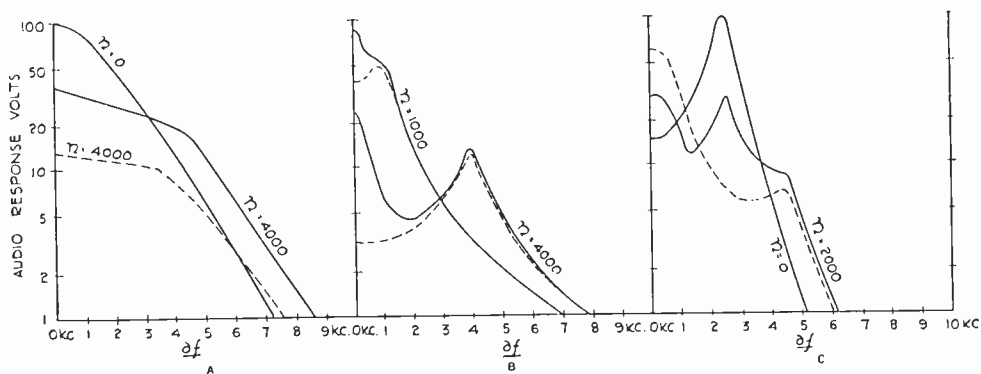

Fig. 9—(a) Four circuits $K = 0.01\epsilon \quad f_0 = 10^6 CY$ } (b) Single circuit $K = 0.01\epsilon \quad f_0 = 10^5 CY$ } (c) Band-pass
 or $K = 0.001\epsilon \quad f_0 = 10^6 CY$ } $K = 0.01\epsilon \quad f_0 = 10^5 CY$ }

for $I_{AF} \propto \partial f$, here to be called the effective selectivity curve, which shows the result of combining the effect of the detector with the radio-frequency tuning curve. In order to compute this for a receiver, we must first plot the curves for magnification and phase angles from the formulas of PART I: the curve for $I_{AF} \propto \partial f$ for any given value of n is then calculated direct from the formula above, where M_0, M', M'' and $\phi = \theta' + \theta'' - 2\theta_0$ are read off from the radio-frequency curves. Some examples of such curves are given in Fig. 9: the constant factor me^2 has been omitted and the value of the product $M'M''$ has been added as a dotted curve, so that the per cent harmonic may be seen at once as being the standard value $m/4$ multiplied by the ratio of ordinates for the two curves. For large values of ∂f the curves revert to the simple form of $I_{AF} \propto e^2 M_0^2 m$, being roughly independent of n provided that ∂f is at least $4n$, and, in addition, the per cent harmonic here approaches the

standard $m/4$: for these reasons the curves have only been plotted up to 10 ke off tune, this being sufficient to show the striking peaks on the curves and the variation of per cent harmonic when a sharply tuned circuit is employed.

C. AUDIO-FREQUENCY DISCRIMINATION CURVES.

The distortion of the audio-frequency—amplitude curve due to the tuned circuits may be calculated in the same way from the same equations. Thus, if the transmission is exactly tuned in ($\partial f = 0$) we have $M' = M''$, $\phi = 0$, and the form of the curve for fundamental audio output is precisely the same as that for M ; the curve for per cent harmonic will also have the same form, the maximum of 25 per cent occurring only at the lowest frequencies. We may also find the form of the audio-

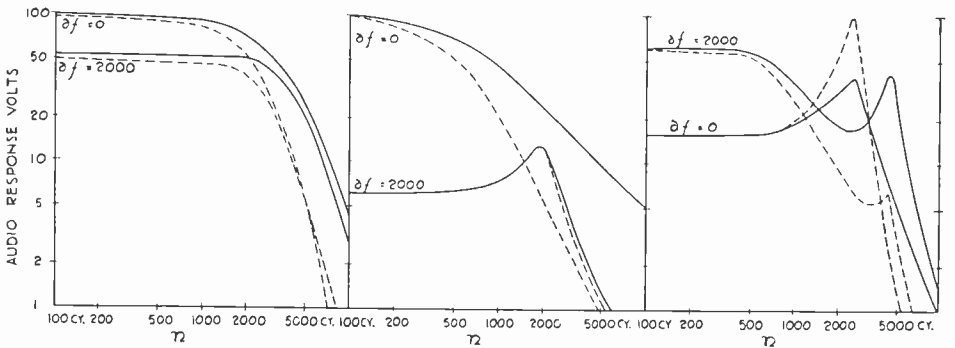

Fig. 10—(a) Four circuits $K = 0.01\epsilon$ $f_0 = 10^6 CY$ (b) Single circuit $K = 0.01\epsilon$ $f_0 = 10^5 CY$ or $K = 0.001\epsilon$ $f_0 = 10^6 CY$ (c) Band-pass $K = 0.01\epsilon$ $f_0 = 10^5 CY$

frequency output curve when the transmission is slightly distorted by a frequency ∂f_0 : there will tend to be a rise in this curve for a frequency n of about $=\partial f_0$ where the side band comes into tune, and this effect may actually appear as a large peak with per cent harmonic greater than $m/4$ if the value of $\partial f/Kf$ is large. Examples of such curves have been plotted in Fig. 10, the harmonic being added as before on a scale such that the per cent harmonic is equal to $m/4$ multiplied by the ratio of the ordinates for the two curves: the curves are distinguished by letters to correspond with the effective selectivity curves, but are drawn on log-log paper for convenience of comparison with the usual audio-frequency fidelity characteristics.

(See also Colebrook³ who gives the equation for fundamental of I_{AF} but does not deal with the distortion introduced.)

³ F. M. Colebrook, *Experimental Wireless and Wireless Engineer*, January, (1931).

PART III.

A. ACTION OF LINEAR DETECTOR: RECEPTION OF A SINGLE TRANSMISSION.

For the usual power detector, we have a relation of the form—Rectified Current = $\gamma(V_{AC} - \delta)$: thus we can say that the rectified current wave form will follow the envelope of the radio-frequency wave exactly provided that the detector circuit is properly designed for the amplification of the modulation frequency concerned and provided that the minimum value of the radio-frequency envelope is never less than about $= \delta$ volts. We thus require to find the form of the envelope of the general modulated wave:

$$V = A_0 \sin(\omega t + \theta_0) + A' \sin(\omega t - pt + \theta') + A'' \sin(\omega t + pt + \theta'')$$

this we do by adding the vectors for carrier and side bands, thus transforming the wave to the form $V = f(\cos pt) \cdot \cos(\omega t + \epsilon)$ where

$f(\cos pt)$

$$= \sqrt{A_0^2 + (A' - A'')^2 + 2A_0 \sqrt{A'^2 + A''^2 + 2A'A'' \cos \phi} \cdot \cos pt + 4A'A'' \cos^2 pt}$$

where $\phi = \theta' + \theta'' - 2\theta_0$ as before. In its general form this expression can only be expanded in terms of powers of $\cos pt$, thus indicating that an infinite series of harmonics is introduced, while it is readily seen that it reduces to the normal value $f(\cos pt) = A_0 \pm 2A' \cos pt$ for the symmetrical case of $A' = A''$ and $\phi = 0$: for the general case, we will attempt an approximation by expanding the square root by the binomial theorem:

let
$$P = A_0^2 + (A' - A'')^2$$

and
$$Q = 2A_0 S \cos pt + 4A'A'' \cos^2 pt$$

where S = vector sum of side-band amplitudes, and can be evaluated from the tuning curve equations.

$$\text{then } f(\cos pt) = \sqrt{P} \left(1 + \frac{Q}{2P} - \frac{Q^2}{8P^2} + \frac{Q^3}{16P^3} - \frac{7Q^4}{156P^4} + \text{etc.} \right)$$

this expression will be very complex in the general case; we will therefore only evaluate:

1. The fundamental modulation frequency component will be given by:

$$\frac{A_0 S \cos pt}{P} \left[1 + \frac{3}{8} \cdot \frac{A_0^2}{P^2} \left(S^2 - \frac{4A'A''}{A_0^2} \right) + \frac{35}{64} \cdot \frac{A_0^4 S^4}{P^4} \left(S^2 - \frac{4A'A''}{A_0^2} \right) + \text{etc.} \right]$$

This expression is only evaluable for small values of A' and A'' : if we have $A' - A''/A < 0.3$, we will introduce < 5 per cent error by taking $\sqrt{P} = A_0$, and if, in addition, we have $A' + A''/A_0 < 0.2$, we may use the approximation:—*fund. freq. output* = S —with less than about 5 per cent error.

2. The harmonics also will clearly decrease in amplitude for higher orders fairly rapidly except for values of s/A of the order of one or greater: the 2nd harmonic component will be given very nearly by half the sum of the coefficients of $\cos^2 pt$ and $\cos^4 pt$, and is thus:

$$\frac{\sqrt{P}}{2} \left[\frac{2A'A''}{P} - \frac{A_0^2 S^2}{2P^2} + \frac{2A'^2 A''^2}{P^2} + \frac{3A_0^2 S^2 A'A''}{P^3} - \frac{5}{8} \cdot \frac{A_0^4 S^4}{P^4} \right].$$

Approximating as before, for 5 per cent accuracy, provided $A' + A''/A_0 < 0.25$

$$\text{2nd harmonic Amplitude} = \frac{1}{4A_0} (4A'A'' - S^2).$$

The values of the per cent harmonic introduced have been calculated from this limited formula and are plotted in Fig. 8 for various values of ϕ , A'/A_0 , and A''/A_0 : we see that the first term in the formula represents a component equal to the total per cent harmonic ($A'A''/A_0 S$) for the parabolic detector, while the second term represents another component 180 degrees out of phase with this, and exactly neutralizing it for the symmetrical case of $\phi = 0$ and $A' = A''$.

3. The distortion introduced in cases where A' and/or A'' are of the same order as A_0 can only be directly calculated for the case where one side band (say A'') is negligible compared with the other: here we have:

$$f(\cos pt) = \sqrt{A_0^2 + A'^2 + 2A_0 A' \cos pt}$$

whence by expanding as before, we have:

$$f(\cos pt) = A_0(1 + x/2 - x^2/8 + x^3/16 + \text{etc.}) \left(1 + \frac{x}{1+x^2} \cdot \cos pt - \frac{x^2}{(1+x)^2} \cdot \cos^2 pt + \frac{x^3}{2(1+x^2)^3} \cdot \cos^3 pt + \text{etc.} \right)$$

$$\text{where } x = A'/A_0:$$

We see that the per cent harmonic decreases rapidly with x , the per cent 2nd harmonic being the largest. By taking the first five terms of the series, the curve given in Fig. 11 has been computed: for $A'/A_0 > 1$, we may use the same expressions provided that we interchange A' and A_0 in order to keep x always < 1 . We are here dealing with the second

of the two harmonic components mentioned in the last paragraph, whence we obtain the approximation of $A' \approx 4A_0$ for the per cent harmonic which is seen from Fig. 11 to hold well up to about $x = 0.5$.

The case where two or more modulation frequencies are present is again interesting: in general, as with the parabolic detector, we will obtain sum and difference (combination) tones, but these will cancel out in common with the harmonics for the linear detector in the symmetrical case, where we can represent the output directly as $A_0(1 + m_1 \cos p_1 t + m_2 \cos p_2 t)$. The general case is intractable as before, and we can only say that the amplitudes of the combination tones will vary in a similar way to that given above for the harmonics; we can,

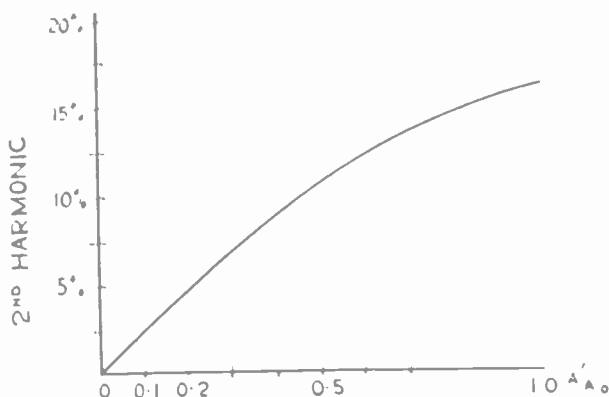

Fig. 11—Per cent harmonic from a linear detector on a single side-band transmission. (A' / A_0 negligible) N.B. Per cent harmonic from parabolic detector is zero for single side-band.

however, attempt the important case where one set of side bands is much larger than the other. (cf., paragraph 3 above). Proceeding to sum the vectors as before:

$$\begin{aligned}
 & A_0 \cos(\omega t + \theta_0) + A_1 \cos(\omega t + p_1 t + \theta_1) + A_2 \cos(\omega t + p_2 t + \theta_2) \\
 &= \cos(\omega t + \epsilon) \sqrt{A_0^2 + A_1^2 + A_2^2 + 2A_0 A_1 \cos(p_1 t + \theta_1 - \theta_0) + 2A_2 \sqrt{A_0^2 + A_1^2} + 2A_0 A_2 \cos(p_2 t + \theta_2 - \theta_0 - \epsilon)} \\
 & \quad \cos(p_1 t + \theta_1 - \theta_0) \cdot \cos(p_2 t + \theta_2 - \theta_0 - \epsilon)
 \end{aligned}$$

here ξ does not concern us, but we have

$$\epsilon = \tan^{-1} \frac{A_1 \sin(p_1 t + \theta_1 - \theta_0)}{A_0 + A_1 \cos(p_1 t + \theta_1 - \theta_0)}$$

As usual, we can only evaluate this expression for small values of A_1 / A_0 and A_2 / A_0 : here $\epsilon \approx A_1 / A_0 \cdot \sin p_1 t$ approx., and thus can be neglected in comparison with $p_2 t$ to the first approximation: then, expanding as in previous cases but omitting the terms involving harmonics, we obtain:

$$\begin{aligned}
 & f(\cos p_1t, \cos p_2t) \\
 &= \sqrt{A_0^2 + 2A_0A_1 \cos p_1t + 2A_0A_2(1 + A_1/A_0 \cdot \cos p_1t) \cos p_2t} \\
 &= A_0 + A_1 \cos p_1t + A_2 \cos p_2t + \frac{A_1A_2}{2A_0}(\cos (p_1 - p_2)t + \cos (p_1 + p_2)t)
 \end{aligned}$$

thus we obtain a maximum per cent $\sqrt{\text{power}}$ in the combination tones $= A_1/2A_0$ for $A_1 = A_2$, and this is nearly as great as the per cent obtained under these conditions with a parabolic detector.

Effective Selectivity Curves have been plotted in Fig. 12 as for the parabolic detector, the actual figure for per cent 2nd harmonic being given as before by the ratio of ordinates of the two curves multiplied by the standard value $m/4$. These curves for fundamental and more

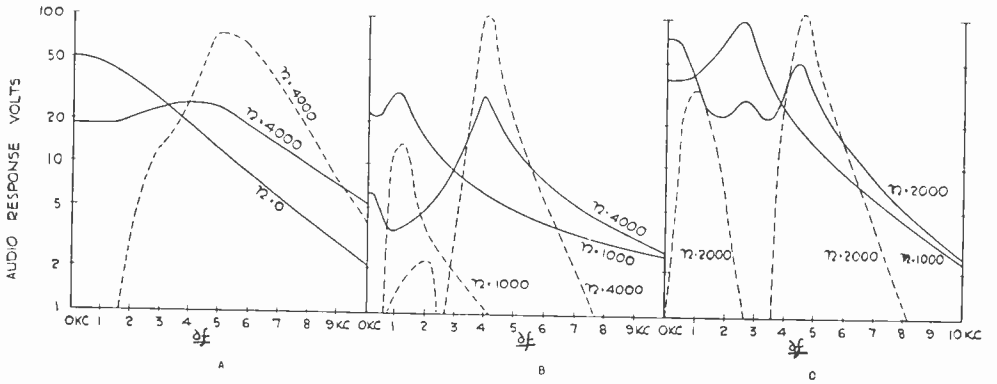

Fig. 12—(a) Four circuits $K = 0.01\epsilon f_0 = 10^6$ cycles $\left. \begin{array}{l} \text{(b) Single circuits } K = 0.01\epsilon f_0 = 10^5 \text{ cycles} \\ \text{or } K = 0.001\epsilon f_0 = 10^6 \text{ cycles} \end{array} \right\} \text{(c) Band-pass } K = 0.01\epsilon f_0 = 10^5 \text{ cycles}$

particularly for harmonic content are, however, only strictly applicable for low per cent modulations of the transmitter, a limitation which does not apply to the curves of Figs. 9 and 10: this limitation will be strictest for points on the curve where one side band is magnified considerably more than the fundamental, and here the per cent harmonic can never exceed 17 per cent, and may actually decrease for large per cent modulations (see last paragraph.) The curves are seen to differ from those of the parabolic detector in reduced selectivity, comparative absence of the center of the three peaks for high modulation frequencies, and in a quite different and generally lower per cent harmonic distortion.

Audio Discrimination curves are given in Fig. 13, and the limitations discussed in the last paragraph apply here again: we may note that the form of the curves for the fundamental is exactly the same as for the parabolic detector, though the relative amplitude when de-

tuned is, of course, altered. [See Colebrook⁴ for a more accurate and elaborate method of obtaining the percentage harmonics under the conditions noticed in 3 above, where one side band is negligible].

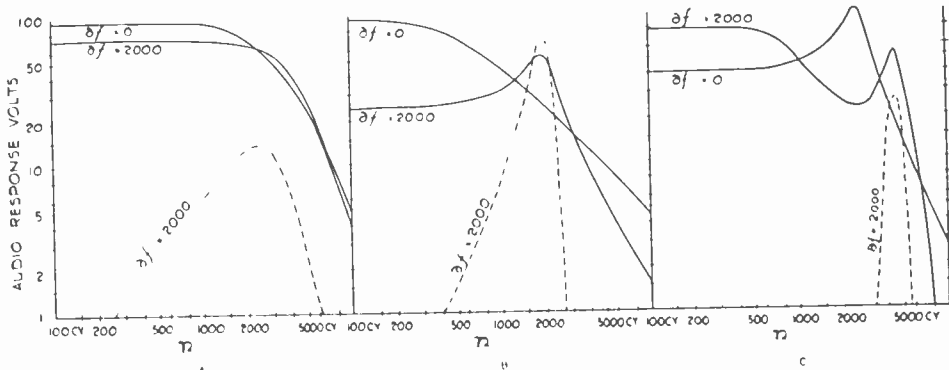

Fig. 13—(a) Four circuits $K = 0.01\epsilon f_0 = 10^6$ cycles (b) Single circuits $K = 0.01\epsilon f_0 = 10^5$ cycles or $K = 0.001\epsilon f_0 = 10^6$ cycles (c) Band-pass $K = 0.01\epsilon f_0 = 10^5$ cycles

B. SIMULTANEOUS RECEPTION OF TWO TRANSMISSIONS: "DEMODULATION."

The phenomenon of the depression of the modulation ("demodulation") of a weak signal (B) by a stronger one (A) at a linear detector has been considered by several investigators. Aiken⁵ notices the phenomenon when considering in detail the interference between two

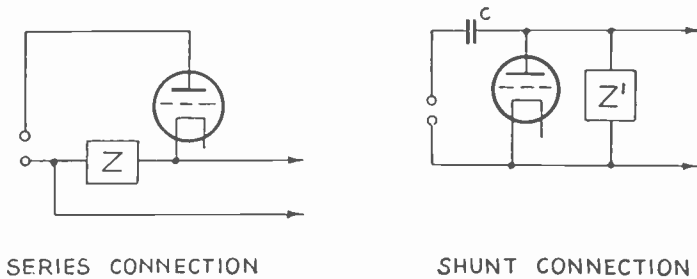

Fig. 14—Fundamental rectifier circuits. (Shunt connection is equivalent to the series connection for the usual tuned input circuit if we have $Z = Z'$ and C in parallel.)

stations operating nominally but not exactly on the same wavelengths. Butterworth,⁶ and following him, Colebrook,⁷ set out to consider the question from our point of view of receiver selectivity, and we will

⁴ F. M. Colebrook, *Experimental Wireless and Wireless Engineer*, April, (1932).

⁵ Aiken, "Detection of two modulated waves which differ slightly in carrier frequency," vol. 19, p. 120-137; *PROC. I.R.E.*, January, (1931).

⁶ Butterworth, *Experimental Wireless and Wireless Engineer*, November, (1929).

⁷ Colebrook, *Experimental Wireless and Wireless Engineer*, August, (1931).

here attempt to revise and extend their conclusions in a practical direction.

We must first picture two voltage waves, of frequencies f and $f + \partial f$ and amplitudes A and B , applied to a perfect linear rectifier which will cut off the lower half of the waves, as in Fig. 15: the voltage across the output load impedance Z (Fig. 14) will be called V , and the rectified voltage V_R is the mean of V taken over many cycles of ∂f : we may distinguish three classes of circuit:

(1) if Z is substantially constant from a frequency 0 up to a frequency f : V will follow the radio-frequency impulses exactly and V_R will be the mean of the radio-frequency envelope amplitude divided by π .

(2) if Z is substantially constant from zero frequency up to the frequency ∂f , but is very much lower for the frequency f : V will follow

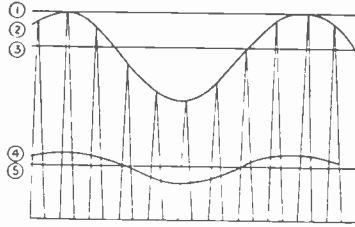

Fig. 15--Voltages across the output load Z of rectifier.

Curve 1 is V and V_r for class (3) circuit

Curve 2 is V for class (2) circuit

Curve 3 is V_r for class (2) circuit

Curve 4 is V for class (1) circuit

Curve 5 is V_r for class (1) circuit

the radio-frequency envelope exactly, while V_R will clearly be the mean of this.

(3) if Z is very low for frequencies f and ∂f compared with its value at zero frequency: V and V_R will both be equal to the peak radio-frequency envelope amplitude $A + B$.

Now class (1) refers to the rectifier without any bypass condenser (see Fig. 16) which is unsuitable for radio-frequency work owing to stray capacities except in the form of a low impedance diode, and is in any case of less practical interest owing to its lower sensitivity: the normal detector with bypass will fall in class (2) for values of ∂f within the range of modulation frequencies for which it was designed, while it will come under class (3) for higher values of ∂f .

The demodulation ratio is defined by Butterworth as the ratio of $\partial V_r / \partial B$ with transmission A present to that with A not present: we see at once that there is no demodulation for class (3) perfect rectifiers. For classes (1) and (2), however, we must determine the mean of the

envelope amplitude, and the reader cannot do better than refer to Butterworth's article for the mathematical analysis and tables for demodulation ratio, provided he keeps in mind the fact that they will be applicable generally only in practice for values of ∂f within the audio range: this limitation is not at all evident in the original article where the analysis is specifically stated to refer only to supersonic frequencies.

A few experiments were made to test these conclusions, and in particular to obtain some idea of the demodulation under the conditions

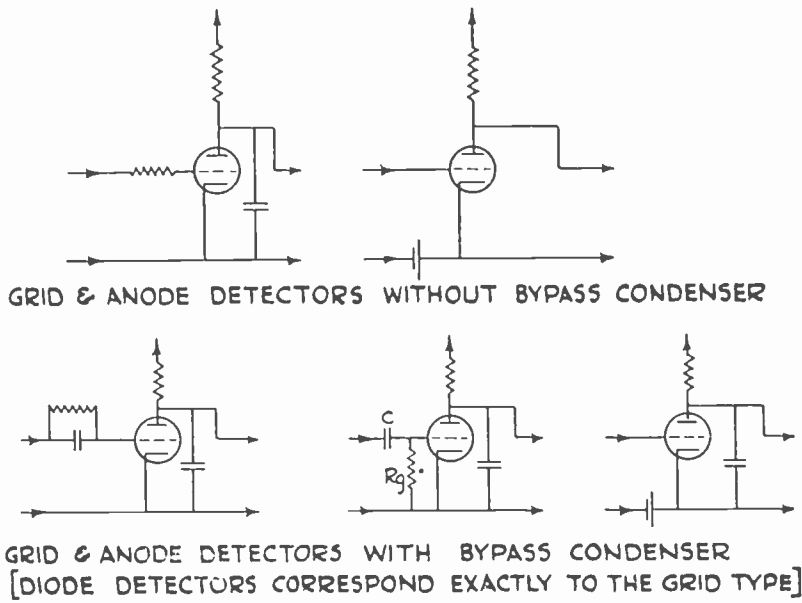

Fig. 16.

usually met with in practice; here V is always slightly less than the peak volts input, and thus we must expect some small degree of demodulation even for ∂f supersonic, and in addition owing to the detector not being strictly linear the theoretical ratios will have to be multiplied by a factor depending upon the ratio of detector sensitivity at an input of the magnitude of B to that at an input of the magnitude of A plus B .

TABLE I

Expt. Demodulation ratio	Demodulation Ratio for various values of C and R_g			
	$n = 50$ cycles $\partial f = 10$ kc.	1Ω .0001 μ fd.	0.05Ω .0001 μ fd.	0.05Ω 0.002 μ fd.
A/B				
1		1.3	1.9	1.7
2		1.4	4.7	2.0
4		1.6	11	3.0
10		2.5	25 approx.	5.5

{Input $V = 2v.$ from A.
{AC/P valve at 15 ma as
power grid det.

The table shows that there may be appreciable demodulation even for ∂f supersonic (columns 1 and 3), particularly if the ratio of leak resistance to internal valve grid impedance is not high: all the ratios are, however, higher than the theoretical, and this is due to a rather excessive input from A causing incipient overloading. The curves of Fig. 17 show clearly the improvement in selectivity obtained by the use of a smaller grid condenser to allow demodulation to continue up to some 20,000 cycles instead of only some 2000 cycles.

We require also to determine whether the intensity of the heterodyne note between A and B is affected by the demodulation for ∂f of audio frequency. Adding the vectors $A \cos \omega t$, $B \cos (\omega t + \partial \omega t)$, we obtain $\sqrt{A^2 + B^2 + 2AB \cdot \cos \partial \omega t}$ for the envelope of the radio-frequency combined wave: this expression is the same as that obtained in the last section for a single side-band transmission, and we may therefore extract from the expansion given there:

$$(1) \text{ Rectified current} = \sqrt{A^2 + B^2} (1 - A^2 B^2 / 4(A^2 + B^2)^2 - \text{etc.}).$$

This corresponds to Butterworth's integral for I_r (q.v. loc. cit): it is not so convenient as his method for A and B of the same order, but gives, on expanding further, the approximation, for $B/A < \text{about } 0.3$, $I_r = A(1 + B^2/4A^2)$, whence demodulation ratio $= \partial I_r / \partial B = B/2A$.

(2) The heterodyne note is seen to contain harmonics, which will amount to some 20 per cent for $A = B$: for $A/B < \text{about } 0.3$, however, these will be small and we will have the amplitude of the heterodyne note $= AB / \sqrt{A^2 + B^2} = B(1 - B^2/2A^2)$.

(3) The expression $\partial I_r / \partial B$ will only be an accurate measure of the depression of modulation of B when the latter transmission is substantially undistorted in symmetry by the tuned circuits it has traversed, and when its per cent modulation at the detector is comparatively small. In the practical case of a very selective receiver, one side band B' of the unwanted carrier B will be very much greater than the other at the detector, and this will be particularly true for the higher modulation frequencies of a transmission which is not far off tune, when we may even have $B' > B$. Thus we are here required to find the sum of the vectors $A \sin (\omega t + \partial \omega t)$, $B \sin \omega t$, and $B' \sin (\omega t + pt)$: the summation process is identical with that given in the last section for a carrier A_0 and two side bands A' and A'' , whence we obtain, provided that B/A and B'/A are both less than about 0.2, an output, omitting the harmonic terms, of: $((A + B) \cos \partial \omega t + B' \cos (\partial \omega - p)t + BB'/2A \cdot \cos pt)$; this shows that the demodulation ratio is still $B/2A$ for any per cent modulation when one side band is much larger than the other, while the heterodyne notes are, as expected, unaltered in amplitude.

To sum up our conclusions: for a perfectly linear rectifier when two transmissions are received simultaneously, the ratio of audio strengths of stronger to weaker station will be roughly double that obtained with a parabolic detector provided the difference in frequency between their carriers is within the range of audio frequencies to which the detector circuit was designed to respond: for the practical detector, this relation

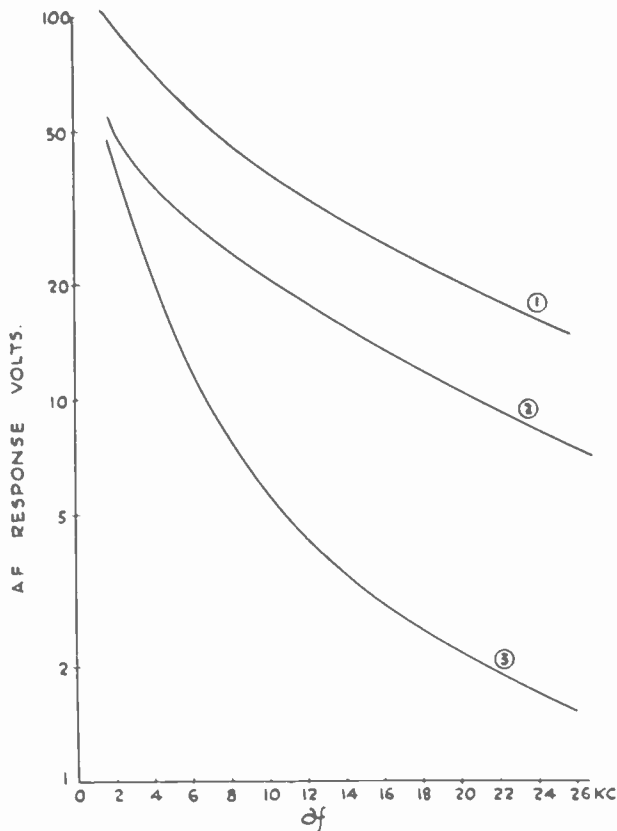

Fig. 17—Experimental selectivity curves with linear detector: receiver tuned to *A*, and response to *B*'s modulation is plotted as *B* is distuned.

1 *A* absent: $C = 0.0001 \mu\text{fd.}$

2 *A* present: $C = 0.001 \mu\text{fd.}$

3 *A* present: $C = 0.0001 \mu\text{fd.}$

(Increase in circuit damping for curve 2 compensated for by 0.2Ω shunt resistance.) $B = A$ at resonance.

$$R_0 = 0.1 \Omega$$

will hold only very approximately except in favorable cases, while the detector will normally fail to contribute to the selectivity in this way except where the transmissions are on adjacent channels (9 kc or less apart). In particular, there are no grounds for the popular conception of a linear detector as giving, by virtue of "demodulation," a notably greater freedom from interference than is obtained with a parabolic detector. (Since the above was written E. V. Appleton⁸ has published

⁸ *Experimental Wireless and Wireless Engineer*, March, (1932).

a paper, giving in particular an accurate experimental verification of the demodulation formula, which should be added to the references given.)

PART IV.

A. NATURE OF INTERFERENCE BETWEEN NEIGHBORING TRANSMISSIONS.

If we are trying to receive a station A , there are four main types of interference to be expected from a station B working on a neighboring frequency (Fig. 18):

(1) Direct interference by hearing B 's transmission i.e., difference tones between f_B and $f_{B'}$ and $f_{B''}$.

(2) Continuous heterodyne whistle, i.e., difference tone between f_A and f_B .

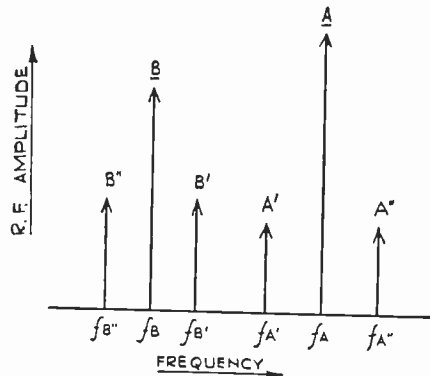

Fig. 18—Illustrating two transmissions with their carriers A and B and their side bands A' , B' , etc.

(3) Intermittent heterodyne notes, i.e., difference tones between f_A and $f_{B'}$. There will also be other heterodyne notes present, but these will clearly be small compared with these mentioned.

(4) Interference due to nonlinearity in the high-frequency stages of the receiver, (cross-talk): the interference due to nonlinearity or over-modulation at the transmitter may also be included here.

Of these, we will not consider (4) here, since this is a problem of a quite different type from the tuning problems to be discussed: the selectivity of a receiver is generally taken to refer to its ability to deal with interference of type (1), and we will deal with that first.

B. DIRECT INTERFERENCE RATIO FOR BAND-PASS AND SIMPLE SHARP TUNERS.

We require to calculate for a receiver with given tuning system and detector, the interference ratio N for any value of ∂f , i.e., the ratio of audio voltages received from two transmitters, whose carriers have frequencies of f_r and $f_r + \partial f$, and which cause equal e.m.f.'s equally

modulated at a frequency n to be injected into the first circuit. If M_a is the magnification of the tuner for the desired carrier, $M_a X_n$ that for the desired side bands (assuming the tuning curve to be nearly symmetrical), and M_b that for the undesired carrier, we have, for the parabolic detector, (provided $\partial f >$ about $2n$), $N = M_a^2 X_n / M_b^2$. For the practical power detector, there is, as we have seen, no exact solution: however, the previous ratio $M_a^2 X_n / M_b^2$ may be used as a rough approximation up to 5 to 10 kc off tune, while for larger values of the selectivity ratio will be intermediate between this and $M_a X_n / M_b$. We may now use the expression $M_a^2 X_n / M_b^2$ for N , keeping its limitations in mind, to compare the interference ratios for a band-pass tuner and for a simple sharp tuner employing the same coils: from the diagrammatic approximation of Fig. 6, we see at once that for the lowest audio frequencies, where $X_n = 1$, N is very much greater for the simple tuner, in the ratio of the squares of the relative M_a values for the two tuners: for the high modulation frequencies (i.e., $n \geq 1/2(f_1 - f_2)$ in Fig. 6) on the other hand, the simple tuner loses much of its advantages, being only better in the direct ratio of the M_a values. Thus, for the typical band-pass where $B_c = 2R_0$, (See PART I, B) we will have 25 times less interference with the simple tuner for the low notes, this ratio falling with increasing modulation frequency to only 5 towards the top of the range of audio frequencies which we are attempting to receive.

Moreover, it is clear that any tone correction in the audio frequency amplifier cannot alter these ratios; the response to the lower modulation frequencies of the desired station is cut down to the required fidelity, while an interfering transmission on a neighboring channel would, of course, sound exceedingly high pitched. The state of affairs when a transmission is being received on such a tone corrected system may be pictured by forgetting the audio corrector, and picturing the side bands as being tuned in on the diagrammatic band-pass curve, while the carrier amplitude still reaches the original peak: thus we may note in passing that if it is attempted to improve the selectivity of any simple tuner by reduction in the power factor k (say by reaction) plus suitable tone correction, the sensitivity of the receiver will also rise in direct proportion to $1/k$ if the detector is parabolic, but would not alter if it was strictly linear and the tone correction was strictly accurate up to high audio frequencies.

C. HETERODYNE INTERFERENCE.

Referring again to Fig. 18, it appears that if either the side band B' , or the carrier B is nearer to A than the outermost desired side band of A , then we will obtain a heterodyne note which cannot be cut out

without impairing A 's transmission. The best we can do is to arrange for the sharpest possible discrimination against interfering waves (either side band or carrier) outside the frequency band covered by the desired side bands. This can be accomplished in two distinct ways, namely, (a) by a suitable radio or, better, intermediate-frequency band-pass filter, or (b) by cutting out all audio frequencies above those desired by an audio-frequency filter: these two processes give the same results, but there is the important difference that it is easier to make such an audio-frequency filter (say to pass 100 per cent at 4000 cycles and cut down to 10 per cent at 5000 cycles and <1 per cent at 7000 cycles) than to make the corresponding band-pass, particularly if it is to act upon the signal frequency (say to give a tuning curve substantially level from $+4$ kc to -4 kc, cutting down to 10 per cent at ± 5 kc and <1 per cent at ± 7 kc).

From PARTS II and III, it is clear that the detector action, and in particular the demodulation phenomenon, will have no material effect upon the heterodyne interference ratio, which is, under practical conditions, equal to the ratio of radio-frequency voltage received by the detector from the undesired wave to that received from the two desired side bands.

From theory, it is clear that these relations will hold equally well for the interfering carrier and for its side bands: however, owing to certain statements in the press to the contrary, several experiments were made with a selective receiver, employing local transmitters modulated with single audio-frequency notes: in all cases it was found that the undesired side band B' behaved exactly like any other desired or undesired wave, e.g., (1) the heterodyne interference from B' (set at 1000 cycles from A) was not altered at all in intensity as the carrier B was moved away to 10,000 cycles off tune at which point it was reduced to less than 1 per cent of its original value at 2500 cycles off tune: (2) A and B were adjusted to give equal radio-frequency voltages at the detector when tuned in in turn: then the side band B' was set exactly halfway between A and B in frequency, and with the receiver tuned to A , the heterodyne note AB' was found to give just half the audio voltage given by the B transmission when tuned in. When comparing the interference from the carrier and the side bands however, we must remember that the average per cent modulation of the high notes (say above 1500 cycles) in a transmission is very small, and it seems probable that this fact, taken together with the difficulty of detecting by ear the absence of the very high frequencies (say above 2500 cycles), may account for most of the reports of satisfactory reception with carrier frequency separations as small as 5000 cycles.

PART V.

FREQUENCY AND HARMONIC DISTORTION IN A SELECTIVE RECEIVER.

As a preliminary, we must distinguish two standards of fidelity performance which may be required from a selective receiver, which for this purpose will be taken as one giving an interference ratio (see PART IV) for 9 kc off tune of the order of 10^{-4} or less for average modulation frequencies.

a. The receiver may be such that the operator is enabled to adjust the tone of a transmission until he considers by ear that the balance between low and high notes is satisfactory.

b. The receiver may be such that any transmission tuned in is up to

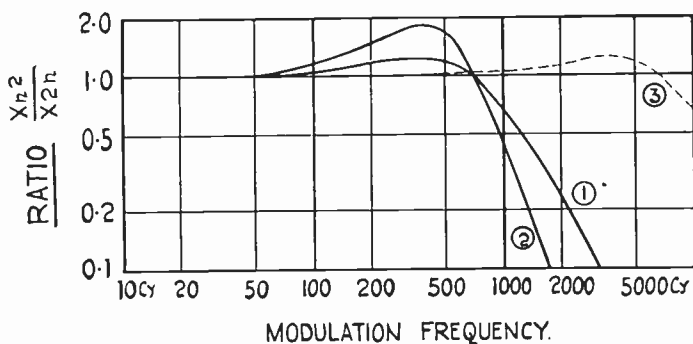

Fig. 19—Harmonic distortion at different frequencies with tone corrector system relative to that with a perfect band-pass. (Curves only exactly applicable for parabolic detector.)

Curves { 1 for 2-circuit tuner and $Kfr = 10^3$
 2 for 4-circuit tuner and $Kfr = 10^3$
 3 for 2-circuit tuner and $Kfr = 10^4$

a required standard of fidelity without the necessity of using aural judgement.

In class a, it is clear that any form of tuning curve (i.e., variation of circuit constants whether incidental, or due to the use of reaction, and even any reasonable degree of inaccuracy of tuning) can be roughly compensated for as regards audio discrimination by the use of a suitable tone control plus careful tuning: harmonic distortion will, however be introduced if there is any dissymmetry in the transmission as received at the detector (see below), and moreover, the critical nature of the adjustments and the difficulty of deciding aurally upon their best setting for minimum distortion renders such a receiver only suitable for experts, or those who take their radio as a sport: the best example of this class would be a receiver with a single circuit tuner with well designed reaction and tone controls.

In class *b*, the necessity for accurate visual tuning (by anode current meter or neon indicator) and for invariable tuning curve form excludes many types of circuit, and leaves only a few definite alternatives for practical design: thus:

1. The use of sharply tuned signal frequency circuits would appear to be completely precluded since the exact form of the tuning curve will vary materially with the frequency to which the receiver is tuned, even apart from the difficulties of really accurate ganging, or of obtaining adequate selectivity without the use of reaction. Thus we should employ a superheterodyne receiver with a relatively flatly tuned signal frequency pre-selector (e.g., a band-pass tuner with about 10-15 kc peak separation).

2. The band-pass tuner suffers from the fatal disadvantage that the nearer we attain to the perfect square topped form with it, the less is it possible to tune in accurately by a meter, or even by ear.

3. Any kind of variable reaction control is of course precluded, and even the volume control will need careful design if it is not to have some effect upon the feed-back or circuit damping.

4. Each receiver would have to have its tone corrector set for its individual requirements, and special precautions would have to be taken to ensure permanence of the constants of the tuning circuits and even of the associated amplifier circuits.

Harmonic distortion will be most serious with both types of detector in cases where the two side bands are not greatly smaller than the carrier and are roughly equal in magnitude, but nearly opposite in phase (i.e., ϕ nearly 2π): it is also appreciable (up to 25 per cent) for the parabolic detector in all cases except where the side band cut-off X_n is large, and for the linear detector in the special, and not uncommon, case where one side band is much larger than the other and of the same order as the carrier in amplitude. Thus, with the modern transmitter running up to 100 per cent modulation on the middle frequencies (400-1000 cycles), a certain degree of harmonic is unavoidably introduced by a parabolic detector except when accurately tuned with an exceptionally sharp symmetrical simple tuner: with a strictly linear detector, we need have no harmonic provided we can avoid (a) any dissymmetry in the tuning curve: this will occur if there are any errors in the ganging of tuners with three or more circuits and may also often be introduced by interaction or by incipient band-passing of loose couplers. (b) any inaccuracy in the tuning point: the effects of this are clearly brought out by Figs. 10 and 13.

However, it would appear that in practice the harmonic distortion from the linear detector will rarely be very serious since it will, except

where an abnormal degree of selectivity is attempted, only affect the higher frequencies, above say 2000 cycles, where the per cent modulation will be generally very low and the aural effects not very noticeable: as extreme cases, however, we may note that it would be possible to obtain a large per cent harmonic from a complicated band-pass arrangement, when we may have both side bands larger than the carrier, with or without large values of ϕ , while for the simple sharp tuner with slight mistuning, one side band may be considerably larger than the carrier, the other being necessarily very small, and, although we will here have no serious harmonic distortion, we might easily obtain combination tones for two modulation frequencies which would be larger than the fundamentals.

The effect of any audio-frequency *tone corrector* will be in general to increase the per cent harmonic: for a parabolic detector, if the fundamental n is cut down to a fraction X_n by the tuner, we will have a per cent 2nd harmonic $m \cdot 4 \cdot X_n$ from the detector increased to $mX_n^2 / 4X_{2n}$ by the corrector. Thus we see that, provided the side-band dissymmetry is not large, the system sharp tuner plus tone correction will here give a per cent harmonic equal to that for a perfect band-pass multiplied by a factor X_n^2 / X_{2n} : some typical values of this factor have been plotted in Fig. 11, whence it is seen that it will rarely depart widely from unity in practical cases. For a power detector, the same kind of effects will occur, though in this case the results will tend to be more in favor of the tone corrector system owing to the extremely small harmonic introduced at any but very high modulation percentages. (i.e., the percent harmonic introduced by such a detector does not vary linearly with X_n .)

In conclusion, the author desires to acknowledge his indebtedness to Messrs. Lissen, Ltd., for permission to publish the results of work done in their laboratories.



LINEAR DISTORTIONS IN BROADCAST RECEIVERS AND THEIR COMPENSATION BY LOW-FREQUENCY EQUALIZATION DEVICES*

By

ARTHUR CLAUSING AND WOLFGANG KAUTER

(Communication from the Central Laboratory of the Werner Works of Siemens & Halske A.-G.,
Berlin-Siemensstadt, Germany.)

Summary—This paper shows how the selectivity as well as the processes in the detector and low-frequency part cause distortion in broadcast receivers. The chief cause of poor fidelity must be sought in the selectivity of the tuning means. This can be raised to high values by increasing the number of tuning circuits, and by improving the quality of the coils (sharpness of tuning). The need for many selection means and sharpness of tuning depends less on the desire for greater amplification than on the necessity of being able to make a good separation of radio transmissions which are close together. The usual tuning circuits show, qualitatively, the same character of frequency drop independent of the number and sharpness of tuned circuits. Therefore in order to separate side frequencies that are comparatively close together (neighboring transmitters), frequencies must be considerably weakened which are indispensable for tone-true reproduction. Consequently, this paper shows methods which, in the low-frequency part, equalize, for the most important frequencies, what is lost in the high-frequency part. These methods will become unnecessary only when it becomes possible to build cheap, reliable radio-frequency band filters with constant band width but variable average transmission range. This is not as simple as the names applied to all possible designs would lead us to believe.

IN PREVIOUS papers it has frequently been stated¹ that in the high- and low-frequency parts of a broadcast receiver there appear limitations of the modulation frequency bands, which result in a suppression of the higher modulation frequencies. These linear distortions are due to the selectivity of the tuning device and to the grid and plate circuit of the rectifier stage, in which the process of changing from high frequency to low frequency takes place. In this paper we shall first review the magnitude and cause of these distortions and some of the principal methods for their compensation, in so far as they enter into the special questions and problems of the construction of broadcast apparatus.

The main cause of linear distortion in receiving sets lies in the selectivity of the tuning device, which, precisely speaking, reaches a maximum at only one frequency. This phenomenon appears more plainly

* Decimal classification: R148.1. Original manuscript received by the Institute, August, 24, 1931. Revised manuscript received, November 27, 1931. Translation received by the Institute, March 18, 1932.

¹ French patent 700,642. A. Clausing, address before the Elektrotechnischen Verein on October 21, 1930. *Elek. Nach. technik.* vol. 7, p. 477, (1930).

with increasing sharpness of tuning and with an increasing number of circuits, so that with increased selectivity the higher modulation frequencies are greatly affected. Band filters with approximately rectangular resonance curves² are necessary in order to transmit a sufficient frequency band width. Certain difficulties are encountered in their manufacture on a large scale so that it seems advisable in many cases to introduce the necessary compensation in the transmission of the modulation frequencies by suitable design of the low-frequency part. Many papers³ have appeared on band filters, so it is not necessary to review them here.

The comparatively few papers that have been published on distortion deal almost exclusively with equalizers for telephony and cable purposes.⁴ Since in these cases there are involved only small circuit impedances, generally of the order of 600 ohms, very simple equalization methods are frequently sufficient. With the high impedances encountered in broadcast receivers many of these methods become useless, entirely aside from the fact that the use of many of them is prevented because of manufacturing processes.

A. CAUSES OF LINEAR DISTORTIONS

1. Selectivity of the Tuning Device

In the treatment of selectivity we differentiate between two cases, depending on whether the tuned circuit is coupled to a real (high-frequency stage) or imaginary (antenna) resistance. Fig. 1 shows the essential elements for discussing the selectivity of the former, the tuned plate circuit. Fig. 2 shows the rigorous equivalent diagram of a transformer coupling. By applying Fig. 2 to Fig. 1, we get Fig. 3. If we neglect σL ($\sigma = 1 - M^2/L_1L_2$) relative to R_1 , and introduce the current-source equivalent diagram, Fig. 4, we obtain Fig. 5, from which we can deduce directly that the shape of the resultant resonance curve is determined by a resistance R_2' , with the magnitude $R_2' = R_2(1 + M^2/M_0^2)$. For the most favorable coupling, $\omega M_0 = \sqrt{R_1R_2}$, one obtains exactly a doubling of the resonance curve width. Therefore it is sufficient if we make once for all the calculation for the natural selectivity⁵ of an oscillating

² Feldtkeller, *Wissenschaftliche Veröffentlichungen aus dem Siemens-Konzern*, vol. 6, no. 1, p. 81, (1927).

³ Riegger, *Wissenschaftliche Veröffentlichungen aus dem Siemens-Konzern*, vol. 1, no. 3, p. 126, (1921); same vol. 3, no. 1, p. 190, (1923). Zobel, *Bell Sys. Tech. Jour.*, vol. 2, no. 1, p. 1, (1922). Campbell, *Bell Sys. Tech. Jour.*, vol. 1, no. 2, p. 1, Johnson and Shea, *Bell Sys. Tech. Jour.*, vol. 4, no. 2, p. 52, (1925). French patent 702,189.

⁴ Feldtkeller and Bartels, *Wissenschaftliche Veröffentlichungen aus dem Siemens-Konzern*, vol. 6, no. 1, p. 65, (1927); Gandtner and Wohlgemuth, *Wissenschaftliche Veröffentlichungen aus dem Siemens-Konzern*, vol. 7, no. 2, p. 67, (1929).

⁵ Runge, *Telefunken-Zeitung*, vol. 11, no. 47, p. 50, (1927).

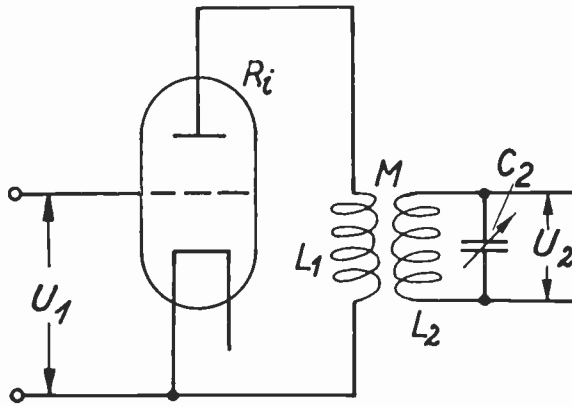

Fig. 1—Basic alternating current circuit for a radio-frequency amplifier.

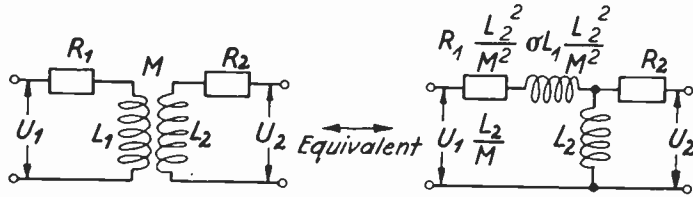

Fig. 2—Equivalent circuit for a radio-frequency transformer.

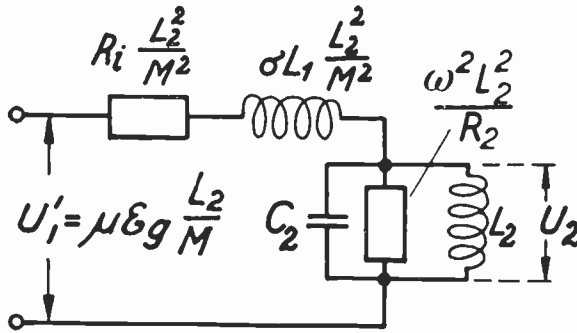

Fig. 3—Equivalent circuit for the radio-frequency amplifier.

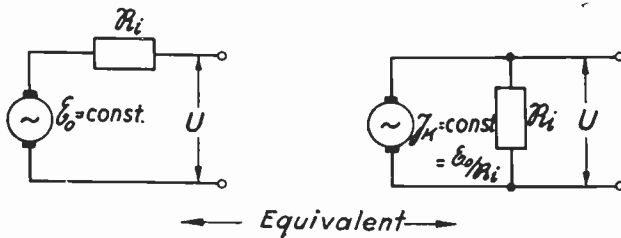

Fig. 4—Equivalent circuit for voltage and current source.

circuit with the time constant τ and insert in the corresponding formula for the selectivity $\psi_0 = \sqrt{1 + 4\tau^2\Delta\omega^2}$ instead of τ , with the resultant time constant $\tau = (L_2/R_2')$.

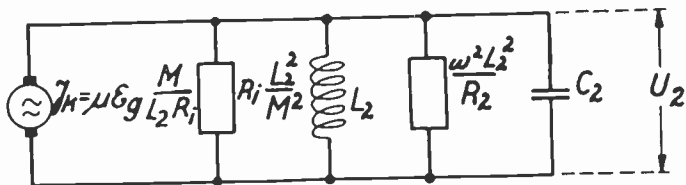

Fig. 5—Transformation of Fig. 3, using the diagram for the equivalent current source in Fig. 4.

$\Delta\omega$ represents here 2π times the modulation frequency Δf ; ψ_0 indicates how much the transmission of the side band is poorer than that of the carrier wave. Figs. 6 and 7 give a general representation of the selectivity ψ as a function of the product $\tau\Delta f$, for 1 to 4 by reaction-im-

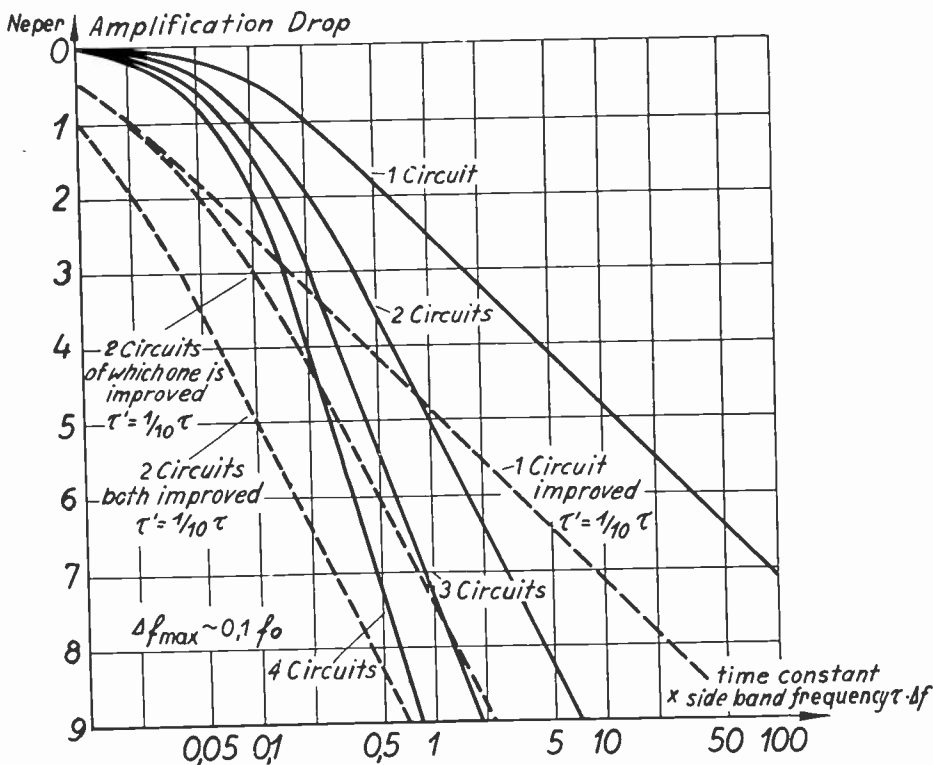

Fig. 6—Amplification drop as a function of de-tuning towards the carrier frequency.

proved or normal, tuned circuits. It is assumed that the time constant of the sharply tuned circuit is increased ten times by tuning. With greater detuning the selectivity values are differentiated according to

whether the detuning is towards higher or lower frequencies. The simple approximation formula for the selectivity no longer holds, and a resultant $\Delta f' = \Delta f \times g(\Delta f/f_0)$ must first be calculated from Fig. 7, and we use Fig. 6 with this $\Delta f'$.

High-frequency transformers are not used with screen-grid tubes. One must even step down to the tuned circuit in order to approach a condition of matched impedances; but it is practically impossible to make the transformers suitable for this. Therefore, with screen-grid

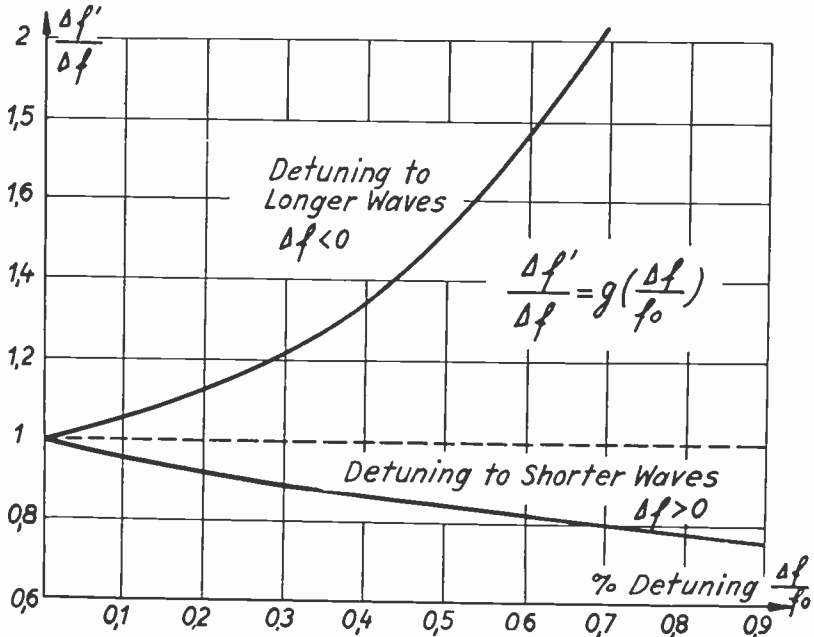

Fig. 7—Selectivity conversion curves for great detuning.

tubes, we generally find only the direct connection, the so-called suppression filter circuit. The formula for τ' is for direct insertion modified in

$$\tau'/\tau = \frac{1}{1 + \frac{L/CR}{R_i}}$$

In the previous considerations we assumed the internal resistance R_i to be real. Resonance phenomena between the tuned circuit and the internal resistance of the generator are outside the question. But it is different with the tuned input circuit at the antenna. This has an imaginary internal resistance if one works below and not at its natural wave as shown in Fig. 8. Then we obtain resonance phenomena between the antenna and the input circuit⁶ correspondingly detuned with re-

⁶ Kautter, *Elek. Nach. technik.*, vol. 8, no. 6, p. 245, (1931).

speed to its natural wave. The selectivity depends on the coupling α α_0 of the tuned circuit to the antenna. In accordance with the results in the reference just cited, we can introduce also here an average time

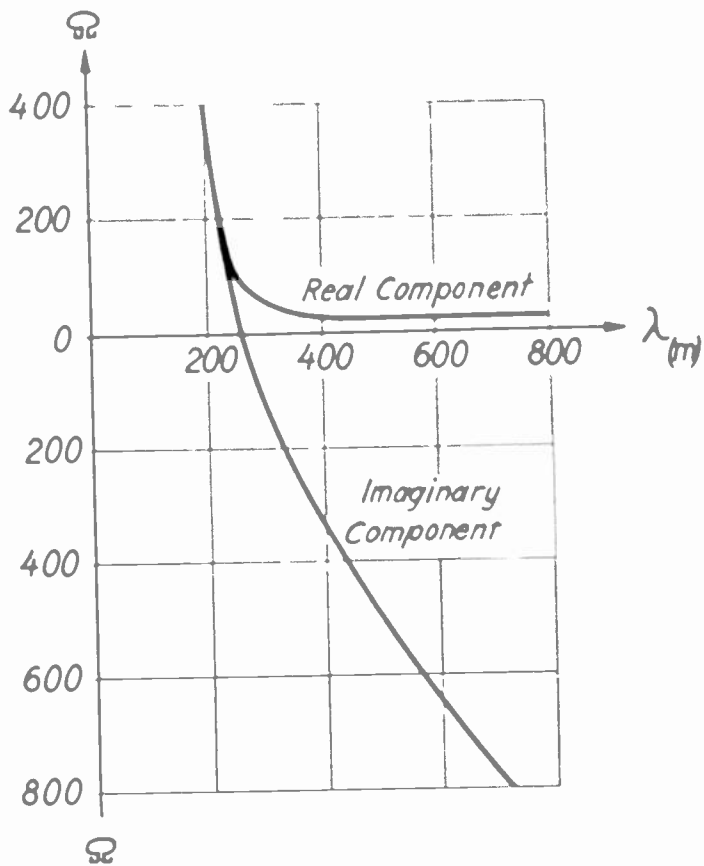

Fig. 8—Impedance of antenna.

constant determining the selectivity,

$$\tau' = \frac{\tau}{1 + \frac{\alpha^2}{\alpha_0^2}}$$

so that the fundamental results remain the same. It may be stated that with inductive (L_1L_2M) or capacitive coupling of a tuned circuit L_2C to an antenna $R_A C_A$ (including series aerial condenser) we have for α_0 :

(a)—inductive coupling

$$\alpha = M/L_2, \quad \alpha_0 = \frac{C}{C_A} \sqrt{R/R_A} \left(1 - \frac{\omega^2}{\omega_s^2}\right), \quad \omega_s^2 = \frac{1}{\sigma L_1 C_A}$$

(b)—capacitive coupling

$$\alpha = C_A/C, \quad \alpha_0 = \sqrt{R/R_A}$$

2. Effect of Low-Frequency Linear Distortions in the Grid and Plate Circuit of the Rectifier Stage

As a result of the rectifying effect of the grid-cathode path in the detector, a low-frequency alternating potential is produced which acts

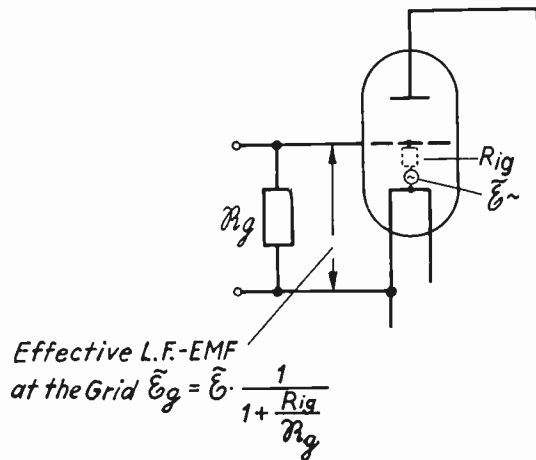

Fig. 9—Low-frequency equivalent circuit for the detector.

upon the grid through a comparatively high internal resistance R_i' . On account of the resistances in the grid circuit, which are formed by the grid-leak resistance and the low-frequency parallel blocking con-

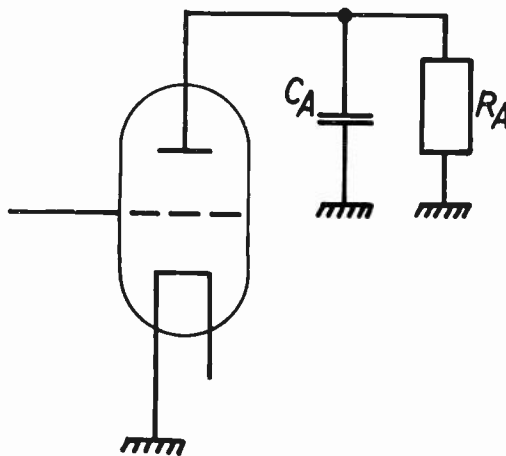

Fig. 10—Principle of the voltage division by a capacitive plate conductance.

denser, there is formed a capacitive voltage division (Fig. 9) which influences the reproduction of the higher frequencies. The same is true of the conditions in the plate circuit (Fig. 10) where the high-frequency by-pass condenser also changes the voltage division between R_i and

R_a . Fig. 11 gives a general idea of the conditions prevailing here as a function of the frequency ratio f/f_0 , in which

$$2\pi f_0 = \frac{1}{C_A \frac{R_i R_A}{R_i + R_A}}$$

3. The Effect of the Frequency Characteristics of the Output Tube and Loud Speaker

The frequency response of the power taken by the loud speaker depends on the impedance characteristic of the loud speaker. The effect becomes more pronounced as the loud speaker impedance becomes

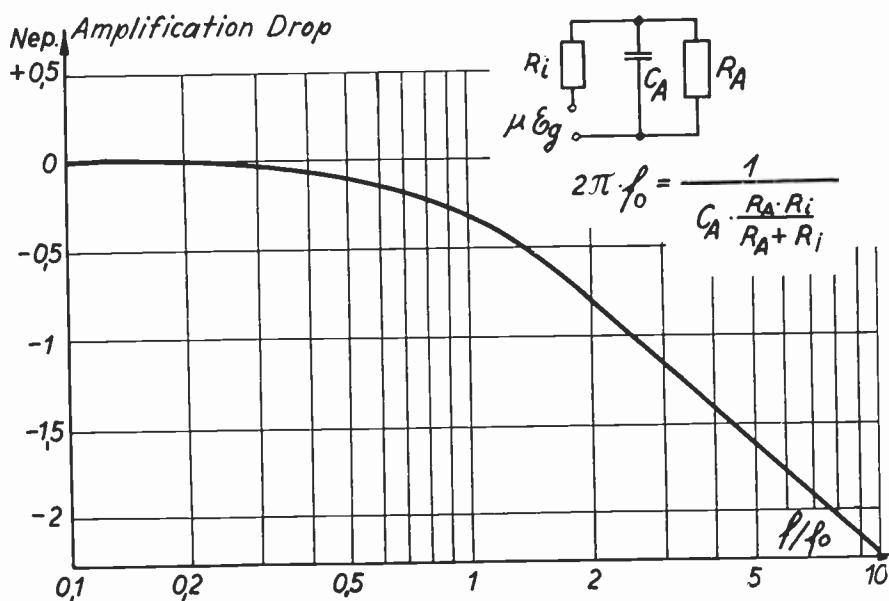

Fig. 11—Frequency response of amplification at capacitive plate conductance.

lower than that required for correct matching with the output tube. Fig. 12 shows the impedance curve of a modern magnetic loud speaker. With the exception of a small loop below the frequency band necessary in broadcast transmissions, we can assume a constant phase angle of about 60 degrees over the entire range. The ratio of the apparent power to the actual power taken by the loud speaker is therefore independent of frequency. The sound power delivered by the loud speaker bears a very complicated relation to the actual power taken, involving the acoustic efficiency. It does not lie within the scope of this paper to take up these relationships, but they must be outlined in a general way because, with constant excitation of the grid of the output tube, the effec-

tiveness of the loud speaker changes with frequency. If, in the first approximation, we disregard the variation in loud speaker efficiency, we can assume the frequency response of the sound power to be proportional to the apparent power of the loud speaker. Fig. 13 shows the relation between the frequency and the square root of the apparent power

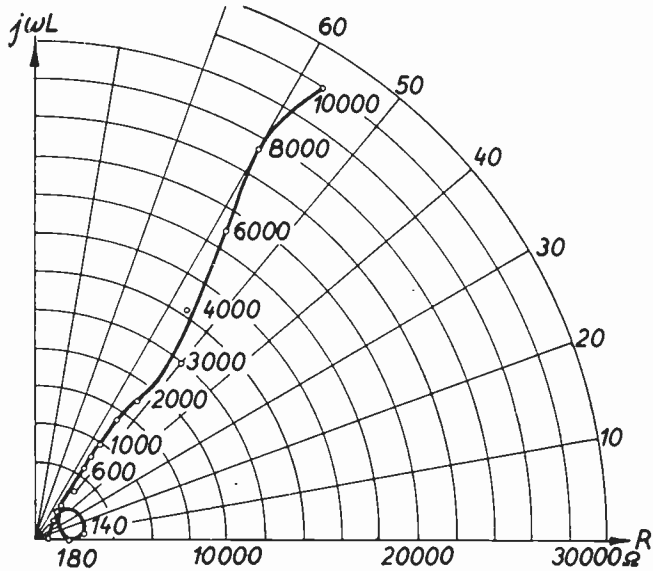

Fig. 12—Impedance characteristic of a modern loud speaker.

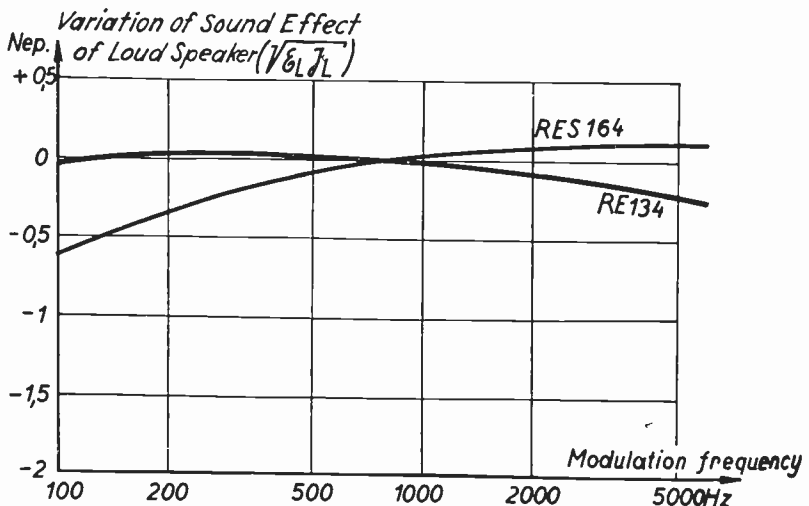

Fig. 13—Frequency curve for the sound action of a loud speaker with 1- and 2-grid output tubes (loud speaker adapted for 800 cycles). Top, left: Variation in sound action of loud speaker. Bottom, right: Modulation frequency.

of the loud speaker with optimum matching to an RES 164 screen-grid tube, or an RE 134 single-grid tube. We see that the screen-grid tube itself impairs the lower frequencies. This must be taken into consideration when designing equalizers.

B. THE COMPENSATION OF LINEAR DISTORTIONS BY MEANS OF LOW-FREQUENCY EQUALIZERS

1. General

In the above we stated the principal causes of linear sound distortions in broadcast receivers. The total distortion is made up of various component distortions. Fig. 14 shows the relation of output amplitude to frequency in a two-circuit set with feed-back coupling, with and without one of the equalizing circuits to be described later. With the

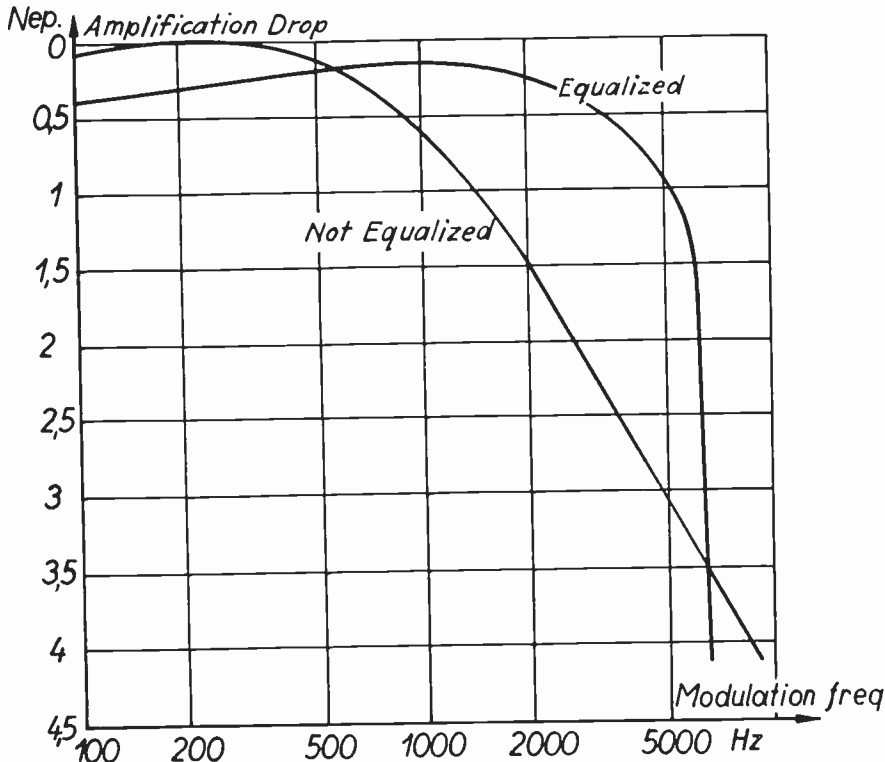

Fig. 14—Modulation-frequency response of a 2-circuit set with close feed-back coupling.

equalizing circuit it is possible to approximate closely the ideal rectangular amplification curve. Recently, as was stated above, attempts have been made to produce such curves even in the high-frequency component (band filters). With the time constants of 2 to 4×10^{-5} seconds that do occur in practical work, it is possible, as seen in Fig. 6, to have a loss of 3 nepers* with a modulation frequency of 5000 cycles per second. This is shown also by the actual measured curves of a two-circuit set with feed-back coupling (Fig. 14). The equalizers must overcome this loss. From the curve (without equalizer) in Fig. 14, and a rectangular curve considered ideal, it is possible to draw the ideal frequency

* One neper is equivalent to approximately 8.7 db.—Ed.

curve of a low-frequency equalizer in Fig. 15, which is an attempt to secure uniform equalization. The extent to which success has been attained in reaching this ideal frequency curve is shown by the more or less complete equalization. The close frequency spacing of about 9000 cycles between adjacent transmitters does not permit the transmitted frequency band to be made wider than about 5000 cycles, as otherwise the heterodyne tones of adjacent transmitters would become too

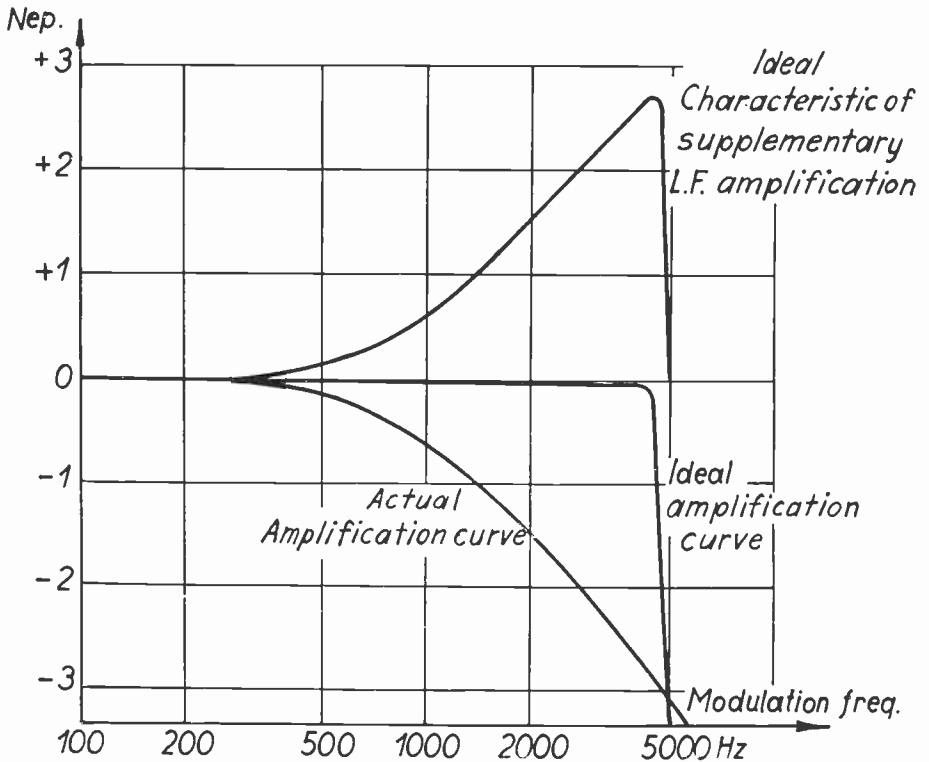

Fig. 15—Different types of equalization curves.

1. Ideal shape of supplementary low-frequency amplification
2. Ideal amplification curve
3. Actual amplification curve

strongly audible. This pronounced cut-off at 5000 cycles also has important advantages in cases where the lower frequencies are not appreciably increased. This is provided for by special simple additions to low-frequency transformers, which will be discussed later. The cut-off then appears to be as a by-product, so to speak, without necessitating special attention.

As derived above, an equation in the form

$$\frac{v_h}{v_{oh}} = \frac{1}{\sqrt{(1 + m^2 f_m^2)^{n-a}} \times (1 + 100m^2 f_m^2)^a}$$

is valid for the high-frequency amplification drop in an n -circuit receiver with a circuits, improved by reaction, as a function of the modulation frequency f_m . The low-frequency amplification, which has the magnitude v_{om} at a minimum frequency, therefore must have the reciprocal shape as a function of the modulation frequency:

$$\frac{v_n}{v_{om}} = \sqrt{(1 + m^2 f_m^2)^{n-a} \times (1 + 100 m^2 f_m^2)^a}$$

$$f_m \leq 5000 \text{ cycles.}$$

m must be determined so that with the highest modulation frequency f_{om} the value of the square root is: $(v_n/v_{om}) \leq 20$ (3 nepers). With low frequencies the second factor is the controlling one and therefore we can make the approximation

$$\frac{v_n}{v_{om}} \leq (1 + 100 m^2 f_m^2)^{a/2}.$$

The better the low-frequency curve is adapted to this shape, the more uniform becomes the equalization. It would lead us too far, analytically, to take up the entire shape including the drop above 5000 cycles.

The following must, in general, be observed in equalization:

(a) The equalization must be easy to cut out on changing from broadcast reception to gramophone pick-ups.

(b) In order to obtain simple circuit elements, the equalization must be effected at points where little power is transmitted, e.g., in the plate circuits of the CW-tube* or the detector tube.

(c) The method of equalization should not depend on the type of loud speaker. Because of this and also, in part, because of point (b), equalizers cannot be placed in the plate circuit of the output tube. It is also not advisable to put equalizers in the loud speaker itself, even if they can be disconnected.

(d) Any equalization means a weakening of frequencies which are not to be equalized, for it is evident that there is an optimum amplification and any relative accentuation of a frequency can be obtained only through the fact that frequencies that are not to be prevailing are amplified less than would be actually possible.

(e) The high frequencies that must be emphasized in broadcast equalization are of secondary importance in the total loudness. Therefore, such equalization is necessarily accompanied by a reduction in total loudness, which is roughly, numerically equal, to equalization. This loss must be made up by greater amplification.

* CW-tube is an intermediate tube between detector and power stage, which operates with resistance-capacity-coupling on the grid of the power tube.

(f) Equalizing by means of a tuned circuit should not be carried to such an extent that its damping is reduced too far. The resultant increase in amplification would only be used in a very restricted frequency range. But if the curve to be equalized is adapted over a sufficient range, it is possible to obtain the desired equalization of 3 nepers, for example. But in the range that is most important for the total loudness we lose about 2.4 nepers as compared with an unequalized amplifier.

(g) Low-frequency feed-back coupling is not to be recommended because of paragraph (f). In addition, there is the danger that the arrangement will generate low-frequency singing.

(h) The side bands corresponding to frequencies of 100 and 5000 cycles are very close together from the viewpoint of high frequency. Only when fully utilizing the frequency curves of combinations of coils

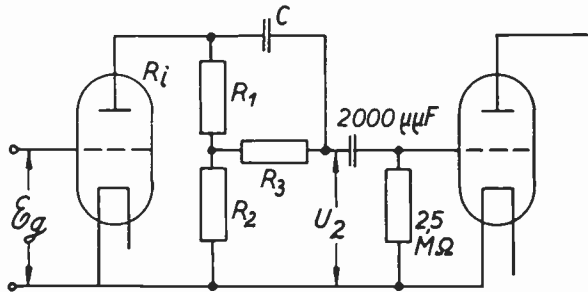

Fig. 16—Capacity-resistance equalizer.

and condensers is it possible to reach these high selectivities with such close frequency spacing. From the viewpoint of low frequency, however, the band from 100 to 5000 cycles, in percentages, is very wide. In order to obtain uniformly increasing equalization in this range, combinations of coils and resistances, or condensers and resistances, are used. In order to cut off sharply above 5000 cycles, use will also be made of resonance (coils and condensers).

(i) In many cases the frequency response of the coupling resistance in the plate circuit is used to obtain equalization. In order to render this possible, the highest value of the coupling resistance should correspond, at the most, to that required for matching. Otherwise the frequency characteristic can not act at all on the voltage division.

(j) In view of the high internal resistance of the ordinary CW-tube, the equalizing is not done in its plate circuit, especially as it is becoming more customary to control the output tube directly, or through the transformer of the rectifier stage. In view of point (c) above, the plate circuit of the rectifier stage is to be considered first.

2. *The Main Types of Equalization for Broadcast Sets*

(A) Equalizer consisting of condensers and resistances

Fig. 16 shows a simple arrangement of condensers and resistances for the plate circuit of the detector. The usual coupling resistance in the plate circuit is divided into two parts R_1 and R_2 . At the junction between R_1 and R_2 there is derived a resistance R_3 to transmit the low frequencies. In addition, the plate of the detector is connected through a condenser C directly with the grid condenser of the following tube. In accordance with well-known formulas, Fig. 16 gives us the following expression for the voltage transformation

$$\frac{U_2}{\mu E_e} = \frac{R_1 R_2}{R_1 + R_2 + \frac{1}{j\omega C}}$$

$$R_3 = R_1 + R_2 + \frac{R_1 R_2}{j\omega C} \left(R_3 + \frac{1}{j\omega C} \right)$$

$$R_1 R_3 + (R_1 + R_2) R_2 + R_3 = \frac{R_2}{j\omega C}$$

$$R_1 R_3 + (R_1 + R_2) R_2 + R_3 = \frac{1}{j\omega C} (R_1 + R_2 + R_3) \tag{11}$$

This expression is of the form

$$Z = \frac{U_2^2}{\mu E_e^2} = \frac{a + b\omega^2}{c + d\omega^2} \tag{12}$$

For very low frequencies Z approaches the value a/c , and approaches b/d for very high frequencies, and there is a gradual transition between the two. Thus, for low frequencies we get

$$\frac{U_2}{\mu E_e} = \frac{R_2}{R_1 + R_2 + R_3}$$

and for very high frequencies:

$$\frac{U_2}{\mu E_e} = \frac{R_2 + \frac{R_1 R_3}{R_1 + R_3}}{R_1 + R_2 + \frac{R_1 R_3}{R_1 + R_3}}$$

These limiting values can be taken directly from Fig. 16. In order to show this we shall introduce various relationships such as ordinarily will be fulfilled:

$$R_1 \ll R_3$$

$$R_2 \ll R_i$$

$$R_2 + R_1 = R_i \text{ (optimum matching condition).}$$

Then we get:

$$\frac{U_2}{\mu E_g} = \frac{R_1}{2R_i} \frac{R_3 + \frac{R_2/R_1}{j\omega C}}{R_3 + 1/j\omega C}$$

R_1/R_2 , corresponding to the desired equalization, is rather small. The general curve of the amount of voltage amplification depends on the function

$$y = \left| \frac{U_2}{\mu E_g} \right| \frac{2R_i}{R_i} = \sqrt{\frac{\frac{f^2}{f'^2} + \frac{1}{\gamma}}{\frac{f^2}{f'^2} + 1}} \tag{13}$$

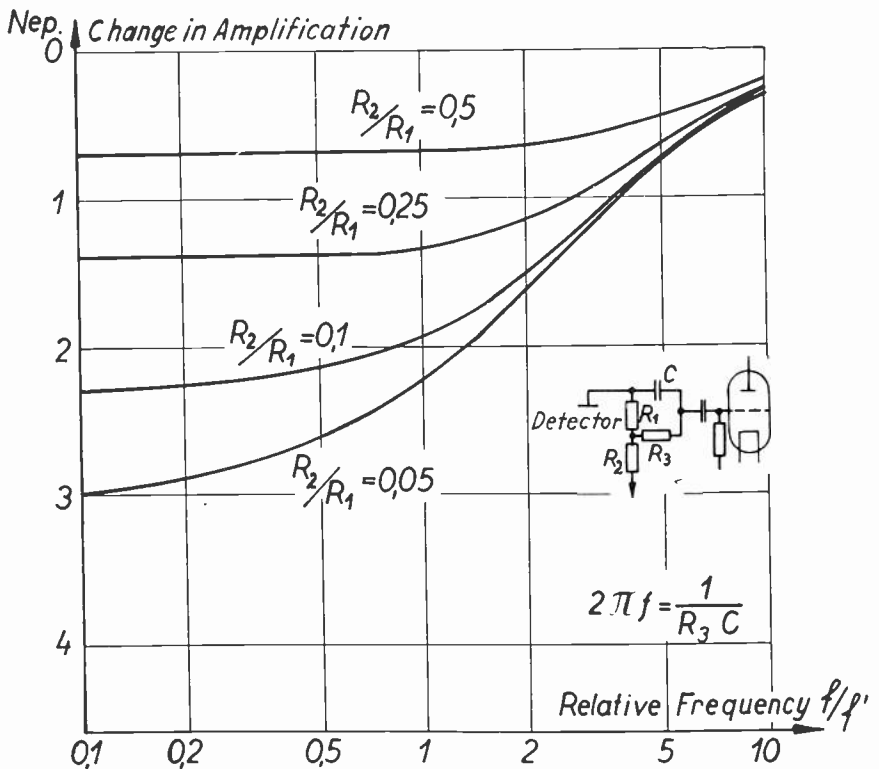

Fig. 17—Equalization by means of condensers and resistances.

in which $2\pi f' = (1/R_3C)$ (cut-off frequency) and $R_1/R_2 = \gamma$ (equalization). Fig. 17 shows the curve of y as a function of the relative frequency f/f' with the equalization γ as parameter. Fig. 17 can be used to calculate the magnitude of the coupling elements for a given tube and a desired equalization. The rise in amplification takes place very gradually; the amplification for high frequencies tends to reach a limiting value. As a result of the coupling capacity C_2 , which cannot be taken into consideration here, there will be a drop in amplification above a certain frequency, which is determined essentially by R_1 and C_2 . For very high frequencies the amplification curve has a shape corresponding to the type in Fig. 11.

A variation of the equalizer just described is obtained if R_3 in Fig. 16 is bridged. This gives us Fig. 18, in which the internal resistance of the generator is $R_1 + R_2$ for low frequencies, while for high fre-

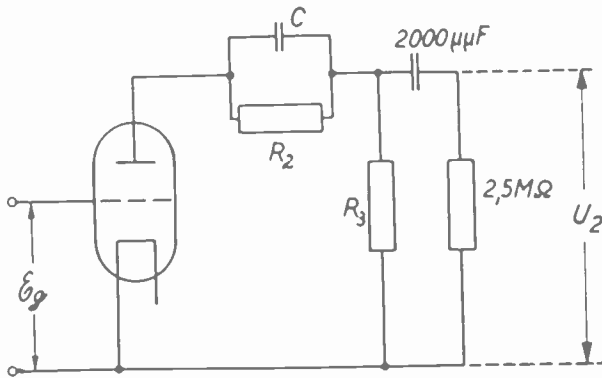

Fig. 18—Equalization by capacity bridging of generator resistance.

quencies, the additional resistance R_2 is increasingly short-circuited by the condenser. For the amplification we readily get

$$\frac{U_2}{\mu E_g} = \frac{R_3}{R_3 + R_i + \frac{R_2}{1 + j\omega CR_2}} \quad (14)$$

If here $2\pi f' = (1/CR_2)$ and $R_3 = R_i$ (matching for high frequencies) we obtain essentially the same formula as above, namely

$$\left| \frac{U_2}{\mu E_g} \right| = \frac{1}{2} \sqrt{\frac{1 + (f/f')^2}{(1 + (R_2/2R_3)^2 + (f/f')^2)}} \quad (15)$$

Here also we get uniformly increasing equalization in a very simple manner. If it is also desired to get a pronounced cut-off at high frequencies, it is only necessary to place a resonance equalizer (described in section (C)) comprising a coil and condenser between R_3 and the

the U_1 and U_2 voltages are measured simultaneously with the aid of a special circuit. The circuit is shown in Fig. 1. The U_1 and U_2 voltages are measured with the aid of two separate test leads. The test leads are connected to the contacts of the test specimen. The test leads are connected to the contacts of the test specimen. The test leads are connected to the contacts of the test specimen. The test leads are connected to the contacts of the test specimen.

The U_1 and U_2 voltages are measured simultaneously with the aid of a special circuit. The circuit is shown in Fig. 1. The U_1 and U_2 voltages are measured with the aid of two separate test leads. The test leads are connected to the contacts of the test specimen. The test leads are connected to the contacts of the test specimen.

The U_1 and U_2 voltages are measured simultaneously with the aid of a special circuit. The circuit is shown in Fig. 1. The U_1 and U_2 voltages are measured with the aid of two separate test leads. The test leads are connected to the contacts of the test specimen. The test leads are connected to the contacts of the test specimen.

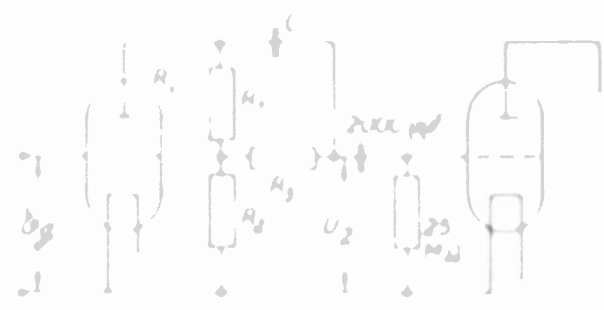

Fig. 1

The U_1 and U_2 voltages are measured simultaneously with the aid of a special circuit. The circuit is shown in Fig. 1. The U_1 and U_2 voltages are measured with the aid of two separate test leads. The test leads are connected to the contacts of the test specimen. The test leads are connected to the contacts of the test specimen.

The U_1 and U_2 voltages are measured simultaneously with the aid of a special circuit. The circuit is shown in Fig. 1. The U_1 and U_2 voltages are measured with the aid of two separate test leads. The test leads are connected to the contacts of the test specimen. The test leads are connected to the contacts of the test specimen.

2. *The Main Types of Equalization for Broadcast Sets*

(A) Equalizer consisting of condensers and resistances.

Fig. 16 shows a simple arrangement of condensers and resistances for the plate circuit of the detector. The usual coupling resistance in the plate circuit is divided into two parts R_1 and R_2 . At the junction between R_1 and R_2 there is derived a resistance R_3 to transmit the low frequencies. In addition, the plate of the detector is connected through a condenser C directly with the grid condenser of the following tube. In accordance with well-known formulas, Fig. 16 gives us the following expression for the voltage transformation:

$$\frac{U_2}{\mu E_g} = \frac{R_2 + \frac{R_3 R_1}{R_1 + R_3 + \frac{1}{j\omega C}}}{R_i + R_2 + \frac{R_1 \left(R_3 + \frac{1}{j\omega C} \right)}{R_1 + R_3 + \frac{1}{j\omega C}}} = \frac{R_2(R_1 + R_3) + R_1 R_3 + \frac{R_2}{j\omega C}}{R_1 R_3 + (R_i + R_2)(R_1 + R_3) + \frac{1}{j\omega C}(R_1 + R_1 + R_2)} \quad (11)$$

This expression is of the form

$$Z^2 = \left| \frac{U_2}{\mu E_g} \right|^2 = \frac{a^2 + b^2 \omega^2}{c^2 + d^2 \omega^2} \quad (12)$$

For very low frequencies Z approaches the value a/c , and approaches b/d for very high frequencies, and there is a gradual transition between the two. Thus, for low frequencies we get

$$\frac{U_2}{\mu E_g} = \frac{R_2}{R_1 + R_2 + R_i}$$

and for very high frequencies:

$$\frac{U_2}{\mu E_g} = \frac{R_2 + \frac{R_1 R_3}{R_1 + R_3}}{R_i + R_2 + \frac{R_1 R_3}{R_1 + R_3}}$$

These limiting values can be taken directly from Fig. 16. In order to show this we shall introduce various relationships such as ordinarily will be fulfilled:

$$R_1 \ll R_3$$

$$R_2 \ll R_i$$

$$R_2 + R_1 = R_i \text{ (optimum matching condition).}$$

Then we get:

$$\frac{U_2}{\mu E_0} = \frac{R_1}{2R_i} \frac{R_3 + \frac{R_2/R_1}{j\omega C}}{R_3 + 1/j\omega C}$$

R_1/R_2 , corresponding to the desired equalization, is rather small. The general curve of the amount of voltage amplification depends on the function

$$y = \left| \frac{U_2}{\mu E_0} \right| \frac{2R_i}{R_i} = \sqrt{\frac{\frac{f^2}{f'^2} + \frac{1}{\gamma}}{\frac{f^2}{f'^2} + 1}} \tag{13}$$

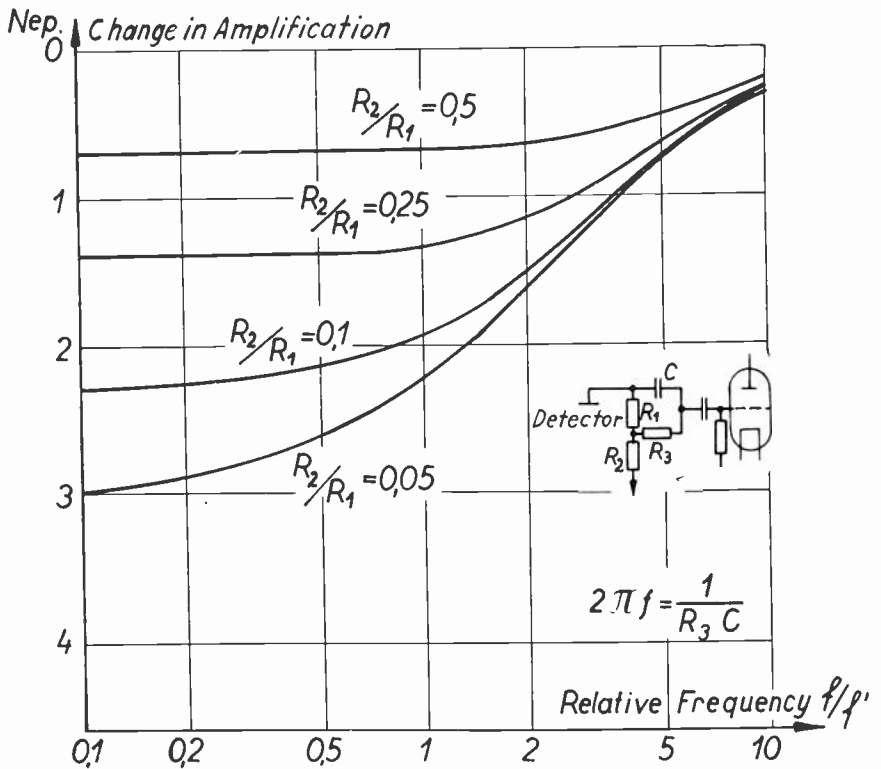

Fig. 17—Equalization by means of condensers and resistances.

in which $2\pi f' = (1/R_3C)$ (cut-off frequency) and $R_1/R_2 = \gamma$ (equalization). Fig. 17 shows the curve of y as a function of the relative frequency f' with the equalization γ as parameter. Fig. 17 can be used to calculate the magnitude of the coupling elements for a given tube and a desired equalization. The rise in amplification takes place very gradually; the amplification for high frequencies tends to reach a limiting value. As a result of the coupling capacity C_2 , which cannot be taken into consideration here, there will be a drop in amplification above a certain frequency, which is determined essentially by R_1 and C_2 . For very high frequencies the amplification curve has a shape corresponding to the type in Fig. 11.

A variation of the equalizer just described is obtained if R_3 in Fig. 16 is bridged. This gives us Fig. 18, in which the internal resistance of the generator is $R_1 + R_2$ for low frequencies, while for high fre-

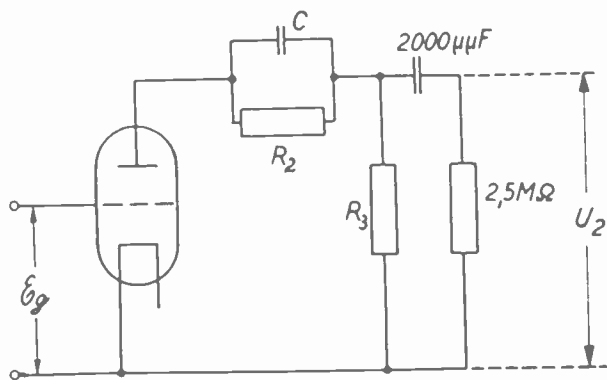

Fig. 18—Equalization by capacity bridging of generator resistance.

quencies, the additional resistance R_2 is increasingly short-circuited by the condenser. For the amplification we readily get

$$\frac{U_2}{\mu E_g} = \frac{R_3}{R_3 + R_1 + \frac{R_2}{1 + j\omega C R_2}} \tag{14}$$

If here $2\pi f' = (1/CR_2)$ and $R_3 = R_1$ (matching for high frequencies) we obtain essentially the same formula as above, namely

$$\left| \frac{U_2}{\mu E_g} \right| = \frac{1}{2} \sqrt{\frac{1 + (f/f')^2}{(1 + (R_2/2R_3)^2 + (f/f')^2)}} \tag{15}$$

Here also we get uniformly increasing equalization in a very simple manner. If it is also desired to get a pronounced cut-off at high frequencies, it is only necessary to place a resonance equalizer (described in section (C)) comprising a coil and condenser between R_3 and the

grid blocking condenser. For the higher frequencies, at which the attenuation begins, it is possible to assume that R_2 is already bridged and thus $R_3/2$ is the magnitude of the ohmic component R determining the type of drop.

(B) Equalization by means of tuned circuits⁷ (shunt equalization).

In the tuned circuits for higher audio-frequencies, the condenser losses can not always be neglected as compared with the coil losses. If τ is the time constant of the coil used, and δ the phase angle of the condenser, the resonance resistance Z_{res} can be calculated as

$$Z_{res} = \frac{\omega_0 L}{\delta + \frac{1}{\tau \omega_0}}$$

If it is desired to have a resonance resistance of fixed magnitude, the necessary L can be calculated according to the formula:

$$L = \frac{Z_{res} \left(\delta + \frac{1}{\tau \omega_0} \right)}{\omega_0} \quad (16)$$

Under section (i) in the general consideration we pointed out that in equalizing for any frequencies there should be at the most, adaptation. If tuned circuits are connected in the plate circuit for the purpose of

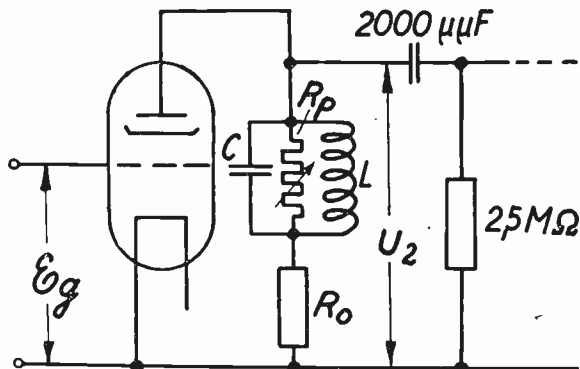

Fig. 19—Equalization by differently damped tuned circuit.

shunt equalization, it is necessary to use a screen-grid tube, such as an RENS 1204, in the radio-frequency stage. In Fig. 19 there is in the plate circuit, for coupling purposes, a series connection of a resistance R_0 which is small in terms of Z_{res} , corresponding to the desired equaliz-

⁷ Austrian patent 101.577.

ing and to a tuned circuit. Parallel to the tuned circuit there is a high-ohmic variable resistance R_p , which makes it possible to limit the sharpness of resonance and thus the maximum equalization. At the resonance frequency of the tuned circuit, which should be 4500–5000 cycles, there is then obtained a coupling corresponding to the real resistance.

$$R_0 + \frac{Z_{res}}{1 + \frac{Z_{res}}{R_p}} = R_0 + Z'.$$

For low frequencies, only R_0 acts as a coupling. At frequency f_0 we therefore obtain a voltage amplification:

$$\left| \frac{U_2}{\mu E_g} \right| = \frac{R_0 + Z'}{R_i + R_0 + Z'} \sim \frac{Z'}{R_i + Z'}$$

and at low frequencies

$$\left| \frac{U_2}{\mu E_g} \right| \cong \frac{R_0}{R_i + R_0} \sim \frac{R_0}{R_i}$$

We shall designate the ratio of these amplifications as equalization,

$$\gamma = \frac{Z'}{R_0} \cdot \frac{1}{1 + \frac{Z'}{R_i}} \tag{17}$$

The RENS 1204 tube gives us the following table for the equalization, as a function of R_0 , with a maximum impedance of the tuned circuit equal to 200,000 ohms:

R_0	<i>Nepers</i>
5,000	3.3
10,000	2.6
20,000	1.9
50,000	1
100,000	0.3

The amplification curve between the two limiting values is fixed by the curve for the impedance characteristic of the tuned circuit, which can be determined graphically by means of the locus curve, or can be calculated in any of the well-known ways. There are no important details in the design of the equalizer circuit. Fig. 20 shows curves of this type, plotted experimentally for an equalizer circuit in a two-circuit set. The

resistance parallel to the tuned circuit was thereby variable, in order to be able to control the magnitude of equalization. At the same time, the curves show plainly that a reduction of the tuned circuit damping

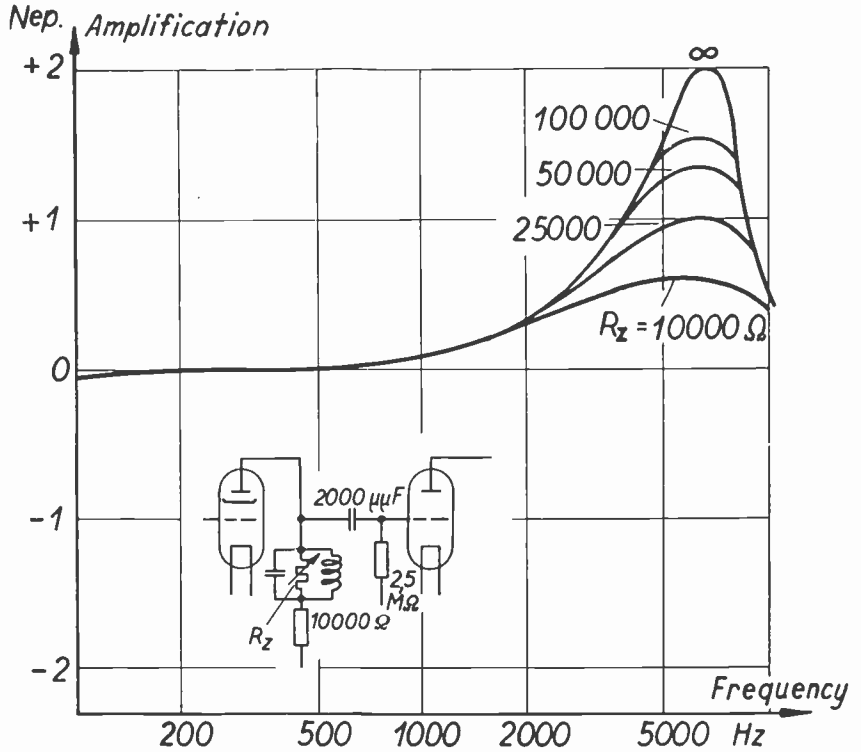

Fig. 20--Equalization by an audio-frequency circuit of different damping values.

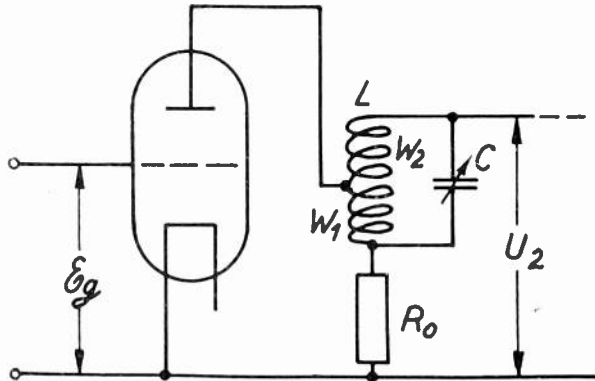

Fig. 21--Equalization by a transformer-coupled tuned circuit.

below a certain amount, would involve an increasingly restricted frequency range which is not desirable after what has been stated above.

The absolute magnitude of the equalization depends on the choice of R_0 . In Fig. 20 the maximum equalization has been fixed at 2 nepers. The equalization by means of the tuned circuit can take place after

screen-grid tubes, as well as after single-grid tubes, if the matching conditions are observed. Fig. 21 shows how only one part of the tuned circuit impedance is tapped, and how it is placed in the plate circuit. This even results in a certain transformer action and a most favorable tapping point. If it is too large, there is over-matching and less transformer action; if it is too small, the primary impedance drops and consequently the voltage on the primary side. The optimum coupling, $\alpha = w_1 = w_2$, can be determined by a simple calculation of the maximum. For the resonance frequency we get an amplification,

$$U_2 = \frac{R_0}{R_1} \alpha \frac{Z_0}{R} \quad (18)$$

$$\mu E_{\nu} \left[1 + \frac{R_0}{R_1} \alpha \frac{Z_0}{R} \right]$$

This amplification becomes a maximum for

$$\alpha_{pt} = \frac{R_0}{Z_0} \left(\sqrt{1 + \frac{Z_0}{R} \left(1 + \frac{R_0}{R} \right)} - 1 \right)$$

or, to a close approximation

$$\alpha_{pt} \approx \sqrt{\frac{R_0 + R_1}{Z_0}}$$

This coupling α_{pt} gives maximum amplification,

$$v_{max} = \frac{U_2}{\mu E_{\nu, max}} = \frac{R_0 + \sqrt{Z_0 (R_0 + R_1)}}{2(R_0 + R_1)} \quad (19)$$

The tuned circuit does not act at low frequencies, and we have

$$v_{min} = \frac{U_2}{\mu E_{\nu, min}} = \frac{1}{1 + (R_0 + R_1)}$$

The equalizing is again

$$\gamma = \frac{v_{max}}{v_{min}} = f \left(\frac{R_0}{R_1} \right),$$

using the usual values of Z_0 and R_1 . The equalizing takes place here because there is only matching for high frequencies while the plate coupling member is more or less under-matched for low frequencies. Therefore for low frequencies, as stated previously, the amplifier in case of equalizing, amplifies less than normally. This ratio between the 1:1 voltage division and the voltage transformation v_{min} can be designated as the amplification loss due to equalization. It increases with the mag-



(R_1/R_a). Here also we can disregard the voltage division resulting from the grid circuit elements R_g and C_g . If we set (R_1/R_a) (R_1+R_a) equal to R , and U_1 equal to $\mu E_g \times 1/(1+(R_1/R_a))$, we immediately obtain for the amplification

$$\frac{U_2}{U_1} = \frac{1/j\omega C}{R + j\omega L + 1/(j\omega C)}$$

If we set $\omega_0^2 = (1/LC)$, we obtain

$$\left| \frac{U_2}{U_1} \right| = \frac{1}{\sqrt{\left(1 - \frac{\omega^2}{\omega_0^2}\right)^2 + \frac{\omega^2}{\omega_0^2} \times \frac{R^2}{\omega_0^2 L^2}}} \quad (20)$$

The frequency curve of this formula controls, among other things, the phenomenon⁸ of the leakage peak in transformers. For the resonance frequency ω_0 we obtain an increase in amplification from 1 to the value $\alpha = (\omega_0 L) / R$. At still higher frequencies there is a steep fall in amplification. R is understood to be, strictly speaking, the sum of (R_1/R_a)/(R_1+R_a) and the coil loss resistance R_s . In general, however, the first factor predominates. The effect of R , is appreciably to reduce the resonance peak. If R_a is reduced, the average amplification drops more and more, but the relative magnitude of the resonance increases until finally the coil losses become more and more noticeable in the ohmic resistance, and in spite of a further drop in R_s there is no longer an increase in the peak. In accordance with a proposal of Bartels, small air-core inductances wound on spools are used in ordinary amplifiers as series inductances without any under-matching of R_a . In this way there is obtained an equalization of about one neper per stage without any noticeable weakening of the other frequencies. Fig. 23 shows a graph for the experimental measurements of low-frequency amplification by means of such coils. Greater equalization can be obtained by under-matching. Such circuits are well suited, in all cases, for marked limitation of the frequency band at high frequencies.

Feldtkeller and Bartels⁴ have suggested an equalization circuit for telephony in accordance with a similar principle. In series with the transformer impedance there is placed an equalizer reactance which causes a potential resonance at certain frequencies, and thus an increase in the frequencies involved. Like the circuit described above, this one is also best suited for adaptation to low resistances.

By suitable proportioning of the normal low-frequency coupling it is also possible to secure potential resonance between leakage inductance and shunt capacity.

⁸ Feldtkeller-Bartels, *Elek. Nach. technik.*, vol. 6, no. 2, p. 87, (1929).

nitude of the desired equalizing but is always smaller than this, since, owing to the resonance of the tuned circuit, the highest frequency is increased more than the lowest frequencies are reduced. When using ordinary chokes, it is possible to obtain only a slight amplification gain for the highest frequency of about 0.6 neper. As already stated, by using special non-damping material, it is possible to reach higher values, but they act only in a narrow frequency range. The following table shows a series of experimental values:

Resistance ratio R_0/R_i	1/10	1/5	1/3	1/2	1
Equalization, nepers	3.04	2.4	2	1.65	1.20
Amplification loss	2.4	1.8	1.4	1.05	0.7

There is some difficulty in the plate circuit of audio-frequency circuits in the pre-magnetization of the choke, which necessitates the use of larger dimensions. But relatively small cores are sufficient as rather high frequencies are the more involved.

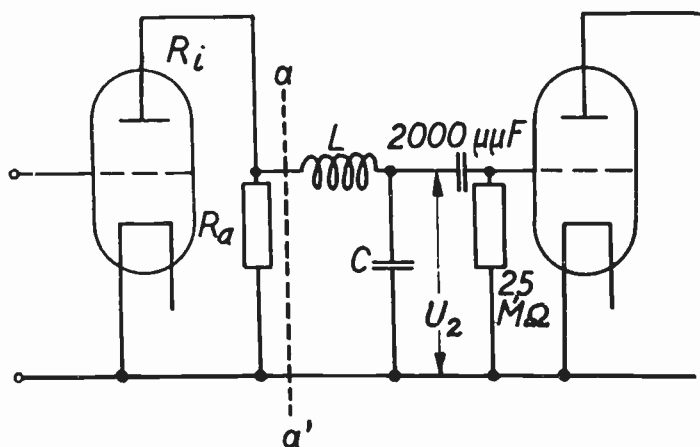

Fig. 22—Equalization by means of voltage resonance in the plate circuit.

(C) Equalization by means of Series Resonances (Series Equalization)

The first condition of this type of equalization is the use of tubes with low R_i , since R_i is series-connected with the reactances giving rise to resonance and thus reducing the magnitude of the resonance. Fig. 22 shows a series connection of inductance and capacity in the plate circuit. The grid of the next tube is connected to the capacity. In order to apply direct current to the plate there must be an ohmic resistance R_a in the plate circuit. Therefrom results a voltage division in the plate circuit because of R_a . In Fig. 22 we can consider the tube, together with R_a , to be a generator having the resultant internal resistance $(R_i R_a)/(R_i + R_a)$ and the resultant electromotive force $\mu E_g \times 1/(1 +$

(R_s/R_a). Here also we can disregard the voltage division resulting from the grid circuit elements R_g and C_g . If we set $(R_s/R_a)/(R_s+R_a)$ equal to R , and U_1 equal to $\mu E_g \times 1/(1+(R_s/R_a))$, we immediately obtain for the amplification

$$\frac{U_2}{U_1} = \frac{1/j\omega C}{R + j\omega L + 1/(j\omega C)}$$

If we set $\omega_0^2 = (1/LC)$, we obtain

$$\left| \frac{U_2}{U_1} \right| = \frac{1}{\sqrt{\left(1 - \frac{\omega^2}{\omega_0^2}\right)^2 + \frac{\omega^2}{\omega_0^2} \times \frac{R^2}{\omega_0^2 L^2}}} \quad (20)$$

The frequency curve of this formula controls, among other things, the phenomenon⁸ of the leakage peak in transformers. For the resonance frequency ω_0 we obtain an increase in amplification from 1 to the value $\alpha = (\omega_0 L) / R$. At still higher frequencies there is a steep fall in amplification. R is understood to be, strictly speaking, the sum of $(R_s/R_a) / (R_s+R_a)$ and the coil loss resistance R_c . In general, however, the first factor predominates. The effect of R_c is appreciable to reduce the resonance peak. If R_a is reduced, the average amplification drops more and more, but the relative magnitude of the resonance increases until finally the coil losses become more and more noticeable in the ohmic resistance, and in spite of a further drop in R_a there is no longer an increase in the peak. In accordance with a proposal of Bartels, small air-core inductances wound on spools are used in ordinary amplifiers as series inductances without any under-matching of R_a . In this way there is obtained an equalization of about one neper per stage without any noticeable weakening of the other frequencies. Fig. 23 shows a graph for the experimental measurements of low-frequency amplification by means of such coils. Greater equalization can be obtained by under-matching. Such circuits are well suited, in all cases, for marked limitation of the frequency band at high frequencies.

Feldtkeller and Bartels⁴ have suggested an equalization circuit for telephony in accordance with a similar principle. In series with the transformer impedance there is placed an equalizer reactance which causes a potential resonance at certain frequencies, and thus an increase in the frequencies involved. Like the circuit described above, this one is also best suited for adaptation to low resistances.

By suitable proportioning of the normal low-frequency coupling it is also possible to secure potential resonance between leakage inductance and shunt capacity.

⁸ Feldtkeller-Bartels, *Elek. Nach. technik.*, vol. 6, no. 2, p. 87, (1929).

We know that at a certain high frequency ω_0 the leakage inductance σL_1 becomes resonant with the transformed secondary capacity $L_2 \ddot{u}^2$.

$$\omega_0^2 = \frac{1}{\sigma L_1 C_2 \ddot{u}^2}$$

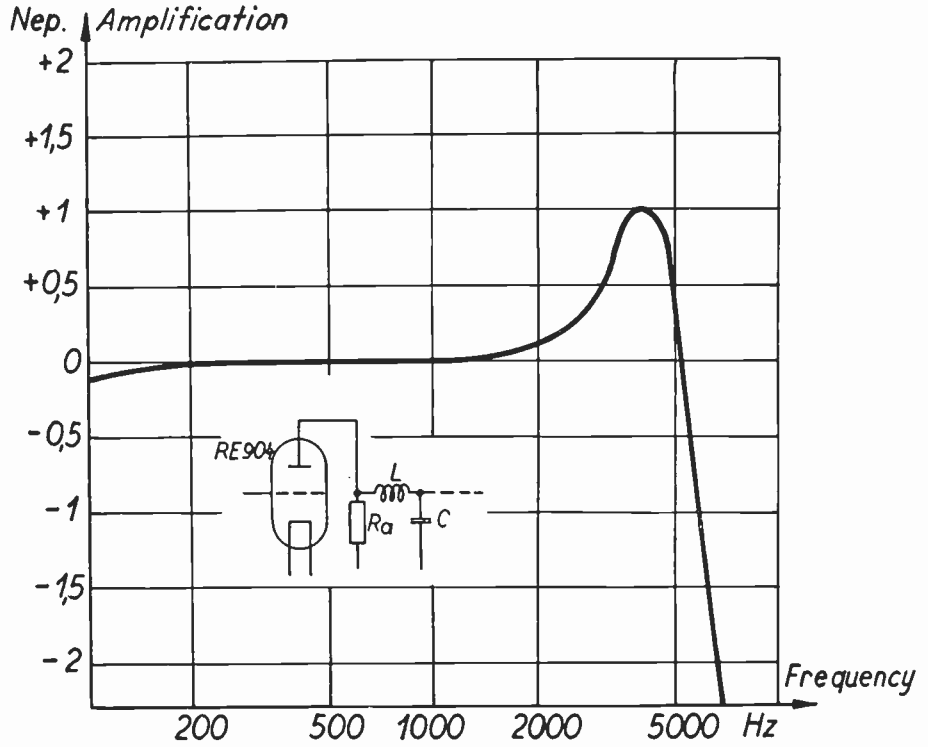

Fig. 23—Series equalization (voltage resonance).

Just as with the circuit described, we also obtain a relative height of resonance

$$\alpha = \frac{\omega_0 \sigma L}{R_i}$$

C_2 as well as R_1 and L is generally fixed. Therefore if it is desired to reach a certain resonance magnitude α at a certain frequency ω_0 , these conditions give us

$$\sigma = \frac{R_i \alpha}{\omega_0 L} \tag{21a}$$

and the maximum permissible transformation ratio is

$$\ddot{u} = \frac{1}{\sqrt{\alpha L C_2 \omega_0^2}} \tag{21b}$$

The σ calculated by the above formula is obtained by a magnetic shunt which is inserted in the leakage path between the primary and secondary windings, and in this way increases its magnetic conductiv-

ity. After the primary winding of the transformer has been completed, an iron foil of given width and length which however must not form a short circuit winding is insulated and placed around it. Then the secondary winding is applied. Because of the counter-action of the primary and secondary mutual inductance (ampere-turns), a certain flux

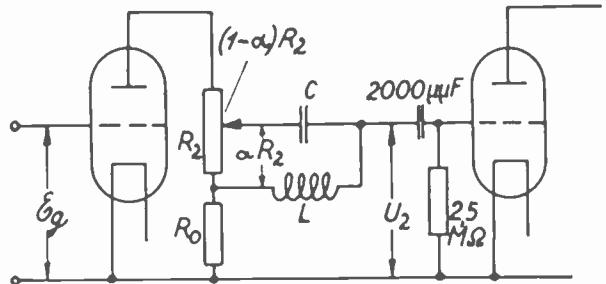

Fig. 24— Equalization by inductive or capacity path.

corresponding to the magnetic conductance of the winding space is driven through this winding space in the axial direction. This flux and the leakage coefficient increase if the winding space is made a better

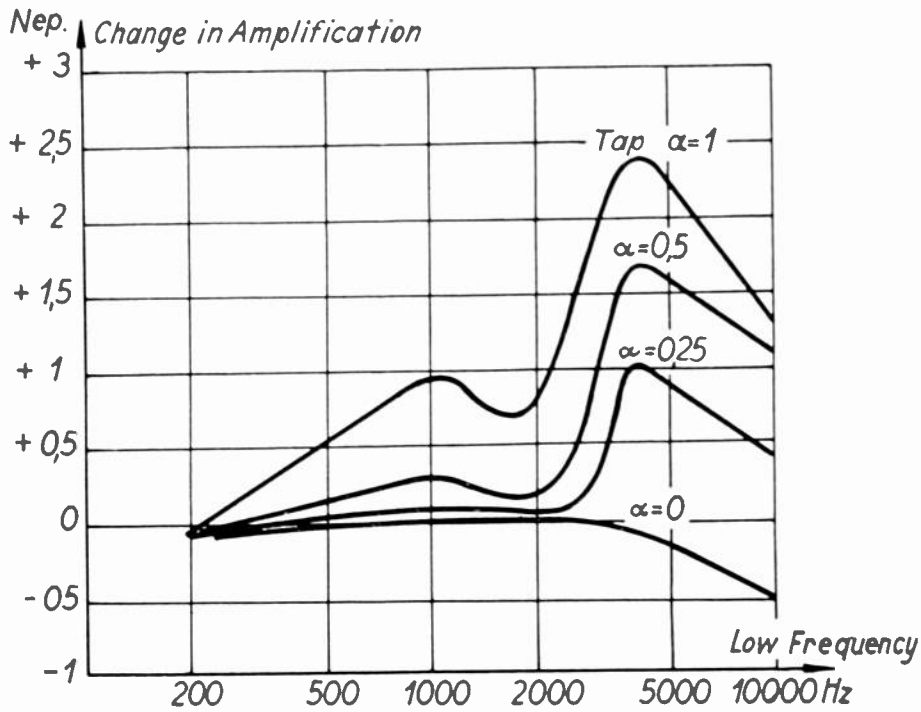

Fig. 25—Equalization curve using the circuit in diagram 26.

magnetic conductor by using the iron foil. The proper adaptation of the foil must be found experimentally, using models. Fig. 26 shows an amplification curve obtained by means of a transformer, almost without any loss in the obtainable gain.

This circuit is suited particularly for band restriction. As soon, however, as we reduce R_a , disregarding average amplification, we obtain higher equalizations of about 1.6 to 2 nepers. Also in this case, the resonance peak is then essentially limited by the iron loss.

If this series resonance is to be used for greater equalizations, it is no longer possible to use ordinary iron cores; only iron dust cores can be considered.

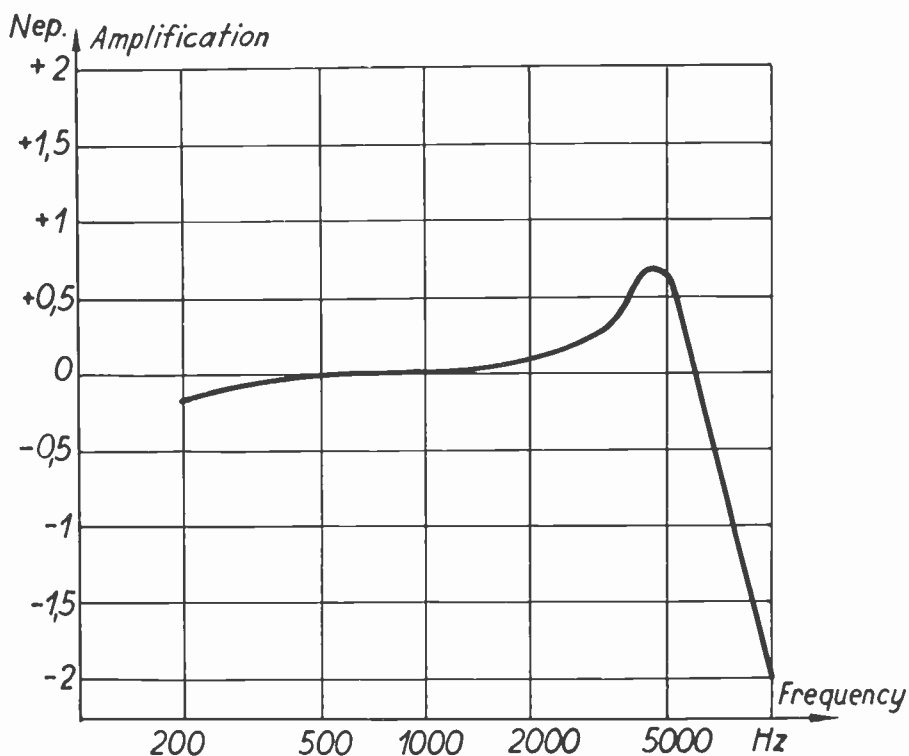

Fig. 26—Low-frequency amplification of a transformer with leakage foil (magnetic shunt).

(D) Equalization by means of coupling through different channels.

The idea of these equations is completely to couple the high frequencies through a capacity, while the low frequencies are applied through a choke only to one part of the coupling resistance. In Fig. 24 the tap for the high frequencies is made variable in order to permit different accentuation of the higher frequencies. At very low frequencies the coupling is effected almost entirely across R_0 . At resonance between LC the tapped part αR_2 is short circuited, the internal resistance of the generator seems reduced, and thus a first amplification maximum is obtained. At a still higher frequency the coupling, at first with a voltage division between L and C , acts more and more through C and finally a second maximum is reached. At still higher frequencies there is a voltage drop between R_i and the operation capacity. Fig. 25 shows experimental curves of this type.

DYNAMIC SYMMETRY IN RADIO DESIGN*

BY

ARTHUR VAN DYCK

(Radio Corporation of America, New York City)

Summary—This paper reviews some of the principles of dynamic symmetry, the science of vital relations of areas, which was the basis of ancient Greek art, as rediscovered by Jay Hambidge about fifteen years ago, and described in his works "Dynamic Symmetry" and "The Diagonal," published by the Yale University Press. A list of the most important shapes is given, and diagrammatic examples of them, which are useful for reference purposes. Some methods and suggestions for application to radio design are given.

UNTIL the time when radio entered the home in broadcast service, radio design requirements were almost entirely utilitarian in nature. Now, however, an important part of the design problem in apparatus for the home is that of appearance, or the artistic aspect. Cabinets or other housings, panels, knobs, dials, escutcheons, and all those parts which present in any degree a freedom of choice in form, size, and position, give opportunity for design decisions whose correctness determines the artistic merit of the product. The design of useful cabinets has always presented some difficulty in artistic aspects, and radio cabinets are particularly difficult because of the numerous and strict technical requirements which are involved. Therefore it has seemed to the writer that any new "tools" for such design, which may be found, will be useful to those engineers dealing with such radio design, including both preliminary layouts and final detailing.

It is realized that the nature of this subject is very different from that of most papers presented to engineering societies. The writer feels, however, that it may be useful because of the ever closer relationship between art and engineering, particularly apparent in radio at this time.

A powerful new "tool" is available in dynamic symmetry, a theory of art, which was discovered, or rediscovered, only a few years ago. The subject has a strong fascination to engineers because it affords an interesting and useful tie between art and engineering. This paper is intended to give only an outline of the subject and to point out its principles, methods, and applications. It is largely a review of publications on the subject, particularly those of Jay Hambidge, published by the Yale University Press, New Haven, Connecticut.

* Decimal classification: R004. Original manuscript received by the Institute, March 24, 1932. Presented before Twentieth Anniversary Convention, Pittsburgh, Pa., April 8, 1932.

For centuries past, artists have admired the classic perfection of all forms of ancient Greek and Egyptian art,—have marvelled at the apparent ease with which it was obtained, and have wondered over the fact that so little was recorded of the designers who accomplished it. It has been admitted that but little of modern art approached the ancient perfection, and the secret of the ancients has been sought assiduously. About fifteen years ago, Jay Hambidge, a professor of art at Yale University, made the astonishing discovery that the beauty of ancient art, in sculpture, architecture, ceramics, jewelry, etc., was due not merely to artistic inspiration, but to the use of exact geometrical formulas. Hambidge found, furthermore, that the geometrical relations used were very simple, as in fact they had to be, because the ancients had no knowledge of geometry as we know it today, or even of higher arithmetic. Geometry was developed later by the Greeks. Hambidge was able to prove his theory conclusively, and it is accepted generally today.

Artists, sculptors, and architects who were trained without aid of this revolutionary idea, have naturally been somewhat slow in applying it in their work. However, it is spreading rapidly among the new generation, and many authorities on art believe that the rebirth of dynamic symmetry will bring about a renaissance of art of vast possibilities eventually far surpassing the ancient art, because of the present better understanding of geometrical and arithmetical relations and elaborations.

Of importance to the engineer is the fact that knowledge of these principles makes it possible for him to enrich his designs with true art, with a resultant beauty of form and detail which previously he has been educated to believe could be supplied only by the "inspired" artist. We have become accustomed to the fact that civil engineers designed beautiful bridges without the aid of artists, but now we know that this is because the bridge designer is guided by exact geometrical rules having fundamental beauty as well as fundamental structural correctness. Now we hope that other branches of engineering may be enriched, and the writer's intention in these notes is to assist, in a small beginning way, the work of the radio engineer in its artistic aspects.

The science of "preferred numbers" is receiving increasing attention among engineers, particularly in connection with standardization work of various kinds. Preferred numbers bear a distinct relation to dynamic symmetry, and a study of the latter will help greatly in any application of the former. This connection is separate from the primary object of these notes and is mentioned here only to call attention to the relation.

Dynamic symmetry is the science of *relations of areas*. Static symmetry involves the relations of *lengths*. If the various *areas* of any design are properly related to each other, the impression or “feeling” which the beholder obtains, is that of life and growth—the design seems vital, pleasing, and “right.” In nature, dynamic symmetry is universal and controls the orderly arrangement of members of organisms—shells, plant leaves and seeds, even the human body.

Before examining some of the rules and methods of Hambidge, it may be well to see how they are to be used, in one or two simple applications. For example, in the design of a radio panel with various devices located thereon, locations for these devices may be chosen at random, as well as the panel proportions, or they may be chosen with exact regard for the panel proportions. Also correct panel proportions may be chosen which will provide better-looking locations.

In a specific example, it is desired to locate a name plate on a panel in the middle near the top. What should be the shape of the name plate if it must be 4 inches long?

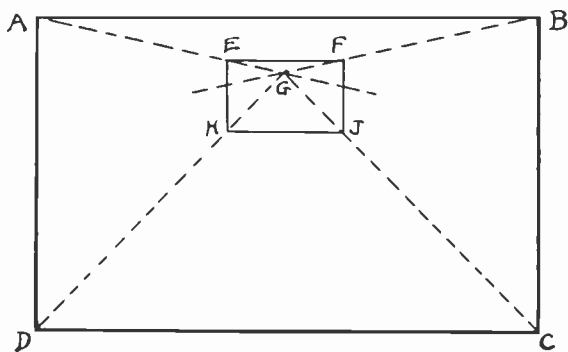

Fig. 1

Fig. 1 shows one possibility, whose construction is:

- Given $ABCD$ and EF
- Draw AE and BF , thus giving G
- Draw GD and GC
- Draw EH and FJ perpendicular to EF
- $EFJH$ is the desired shape.

If the obtained shape is higher than desired, construct as in Fig. 2, using other vital points of the panel rectangle.

Still other proportions may be had, as will be shown later, but these suffice for this example.

Fig. 3 is an example of formation of a decorative design starting with a simple rectangle. It shows the possibilities of harmonious *growth* when proper fundamental ratios are chosen for basic plans. The design can be extended to any degree, whatever is done remains in

harmony *automatically*, and the eventual design has coherence, vitality, and feeling.

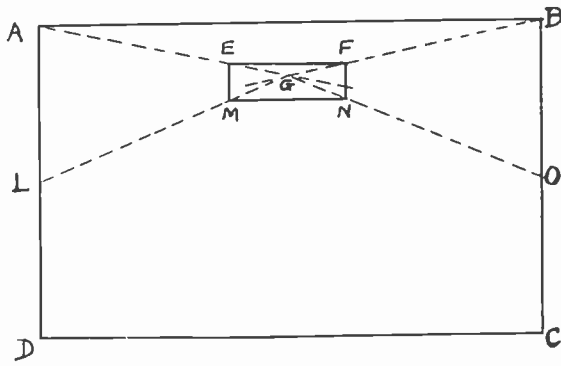

Fig. 2

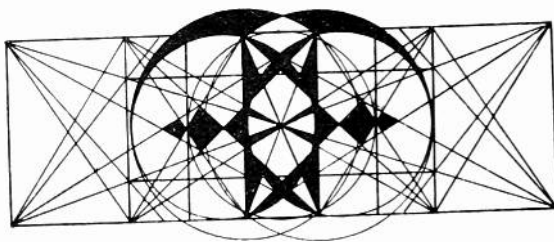
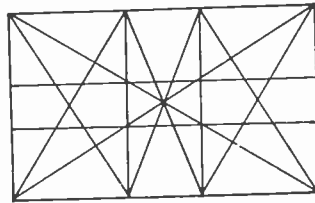
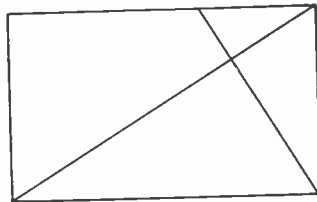
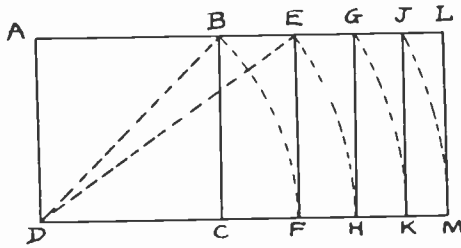

Fig. 3

SOME IMPORTANT RECTANGLE SHAPES

Let us now examine some of the relations of areas and lengths. Squares and rectangles are of course the most useful and most powerful areas. To be truly vital, that is, capable of systematic pleasing subdivision or extension, they must have certain fundamental relations. These *area* relations are the basis of all work on the subject. The most simple relations of area are, of course, 1, 2, 3, 4, 5, etc.

Consider the construction of Fig. 4:



Reproduced from "The Diagonal," by courtesy Yale University Press.
Fig. 4

- Given square $ABCD$
- Swing arc DB to F
- Draw FE
- Swing arc DE to H
- Draw HG
- etc.

If $ABCD$ has one unit of area, and a side of unit length,
 then a square with AE as side has 2 units of area
 and " " " AG " " " 3 " " "
 " " " " AJ " " " 4 " " "
 " " " " AL " " " 5 " " "

Another condition of fundamental importance is the ratio of the *sides* of these areas because the laying out of designs must utilize linear dimensions rather than areas, although proportional areas are being sought.

It is found in Fig. 4 that:

$$\begin{aligned} \text{If } AB &= 1 = \sqrt{1}, \text{ then,} \\ AE &= \sqrt{2} \\ AG &= \sqrt{3} \\ AJ &= \sqrt{4} \\ AL &= \sqrt{5}. \end{aligned}$$

Then,

$ABCD$ is a square, or root-one rectangle (ratio of sides = $\sqrt{1}/1$)

$AEFD$ is a root-two rectangle (ratio of sides = $\sqrt{2}/1 = 1.414/1$)
 $AGHD$ is a root-three rectangle (ratio = $\sqrt{3}/1 = 1.732/1$)
 $AJKD$ is a root-four rectangle (ratio = $\sqrt{4}/1 = 2/1$)
 $ALMD$ is a root-five rectangle (ratio = $\sqrt{5}/1 = 2.236/1$).

Each one of these rectangles is a "powerful" shape, that is, each contains geometrical relations which can be used in various ways to produce proportional areas and other pleasing related shapes. They can also be constructed *inside* a square as shown in Fig. 5.

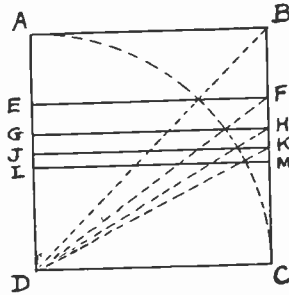

Reproduced from "Dynamic Symmetry," by courtesy Yale University Press.

Fig. 5

Given square $ABCD$

Swing arc DA to C

Draw DB

Where DB cuts arc, draw horizontal EF

Draw DF

Where DF cuts arc, draw horizontal GH

etc.

Then,

$ABCD$ is a square

$EFCD$ is a root-two rectangle

$GHCD$ is a root-three rectangle

$JKCD$ is a root-four rectangle

$LMCD$ is a root-five rectangle.

An interesting extension of the above square inscribing is shown in Fig. 6, and the inscribing is done by another method than that used in Fig. 5:

Inscribe a semicircle on CD

Bisect CD at O

Erect perpendicular at O

With CP as radius, draw PF

Draw EF parallel to AB

$EFCD$ is the root-two rectangle.

Also $QFCO$ is a root-two rectangle, the reciprocal of $EFCD$.
 Draw DF
 Draw arc CR to CH
 Draw HG parallel to AB ,
 etc., forming root-two, -three, -four, and -five rectangles.

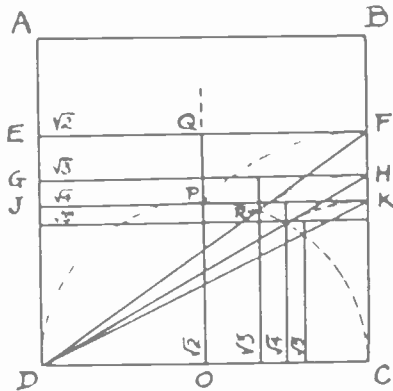

Reproduced from "*Dynamic Symmetry*," by courtesy Yale University Press.
 Fig. 6

There is one more useful, and very powerful fundamental shape, perhaps the most powerful one of all. This one is called the rectangle of the "whirling squares," for reasons explained later. It is formed from a square as shown in Fig. 7. The ratio of the sides is readily calculable and is found to be $1.618/1$.

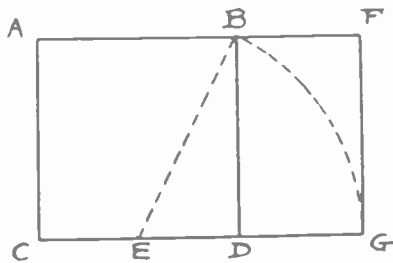

Reproduced from "*The Diagonal*," by courtesy Yale University Press.
 Fig. 7

- Draw square $ABCD$
- Bisect CD at E
- With radius EB , swing arc BG
- Draw perpendicular GF
- Draw BF
- Then $ABCD$ is a square
- $BFGD$ is a whirling-squares rectangle
- $AFGC$ is a whirling-squares rectangle

Euclid demonstrated (see Fig. 8) that if a whirling-square rectangle is constructed on the radius of a circle, then

the side of the rectangle is the side of a hexagon,
 the end of the rectangle is the side of a decagon,
 the diagonal of the rectangle is the side of a pentagon,
 all inscribed in the circle.

The inherent quality of growth of dynamic shapes is well exemplified by this theorem.

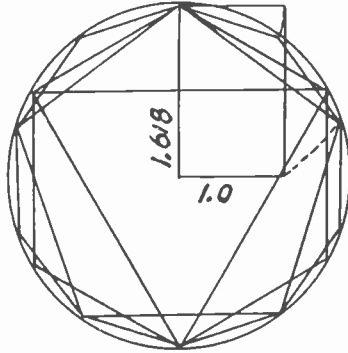

Reproduced from "The Diagonal," by courtesy Yale University Press.
 Fig. 8

Therefore, we have the following "parent" rectangles (expressed as ratio of long side to short side).

- 1.0 (square)
- 1.414 (root-two)
- 1.618 (whirling-squares)
- 1.732 (root-three)
- 2.0 (root-four)
- 2.236 (root-five)

Some of the above are not as powerful as combinations of them are, and from the above ratios, an indefinitely large number of others can be derived. For example, adding a square (or 1.0) to each gives:

- 2.0
- 2.414
- 2.618
- 2.732
- 3.0
- 3.236

Similarly, the reciprocals and the half values are related and useful. Therefore, the available ratios are many, far too many to be worth

while listing completely. The following list gives the principal ratios, and the most important ones are italicized.

1.0	1.7135
1.118	<i>1.809</i>
1.1545	1.854
1.191	<i>2.236</i>
1.2236	<i>2.309</i>
<i>1.236</i>	<i>2.4472</i>
<i>1.309</i>	<i>2.472</i>
1.382	<i>2.618</i>
1.4045	<i>2.764</i>
<i>1.414</i>	<i>2.809</i>
<i>1.4472</i>	2.8944
<i>1.528</i>	<i>3.236</i>
<i>1.618</i>	3.427
	<i>3.618</i>

Root-two and root-three ratios are not found in nature or in Greek statuary, and do not combine well with root-five or whirling-square ratios. They are, therefore, much less important.

The most important ratios in the above list are shown in Fig. 9 with the manner of their generation, which is in effect simple division of them. Also, to the right of each rectangle, is shown the *reciprocal* of that rectangle, which is that rectangle which is proportional to the larger one, and has its long side equal to the short side of the larger one. Some possible divisions of these are also shown. These figures are reproduced in this paper for illustration and reference. They are, of course, only certain ones of the many different subdivisions possible in each dynamic rectangle.

MISCELLANEOUS EXAMPLES OF DYNAMIC RELATIONS

Before proceeding to practical applications, let us examine a few of the countless fascinating relations which are hidden in dynamic ratios and shapes. These are informative, interesting, and useful.

The square and its diagonal furnish the series of root rectangles. The square and the diagonal of half the square furnish the remarkable shapes upon which nature bases the architectural plans of plants and the human figure.

The root-five rectangle and its main divisions are the shapes most used in nature. It should be noted especially that *the three shapes of square, root-five rectangle, and whirling-square rectangle are very closely related.* (See Fig. 10.)

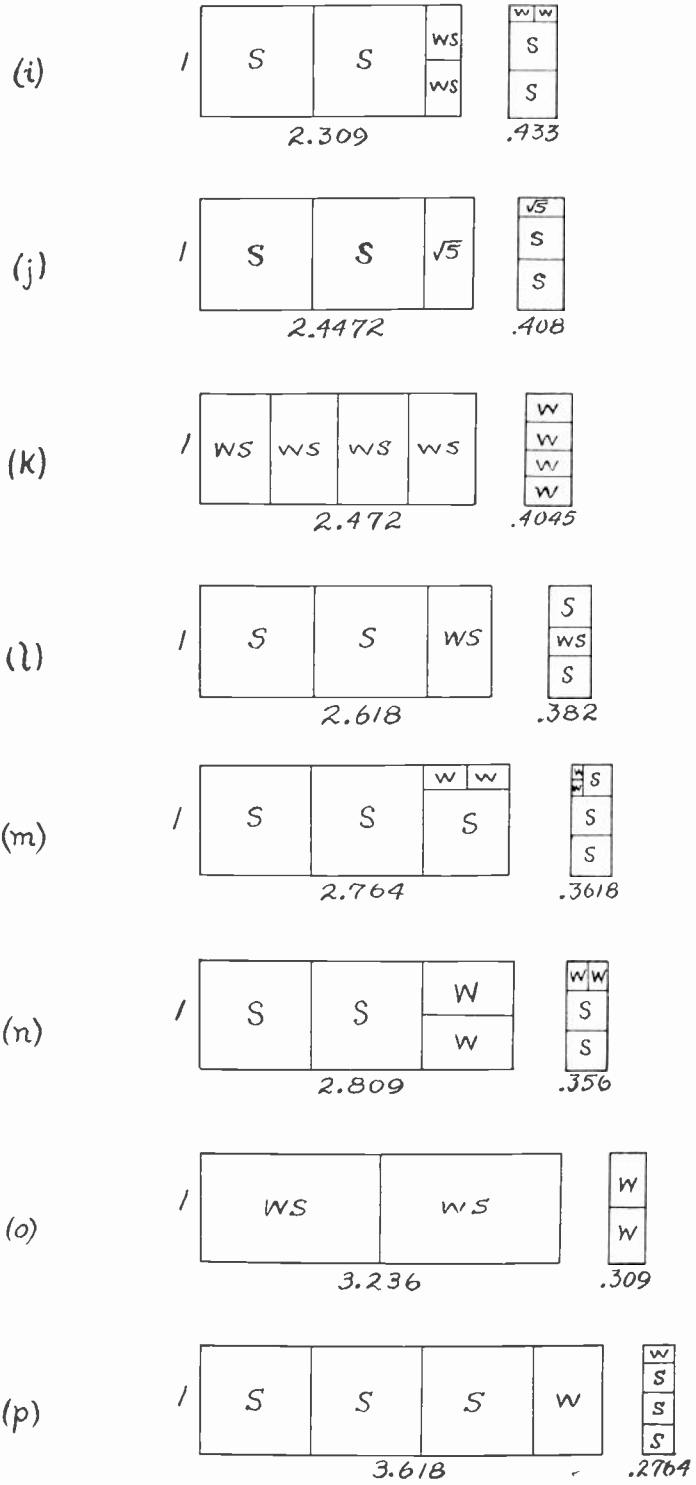

Reproduced from "The Diagonal," by courtesy Yale University Press.
Fig. 9a

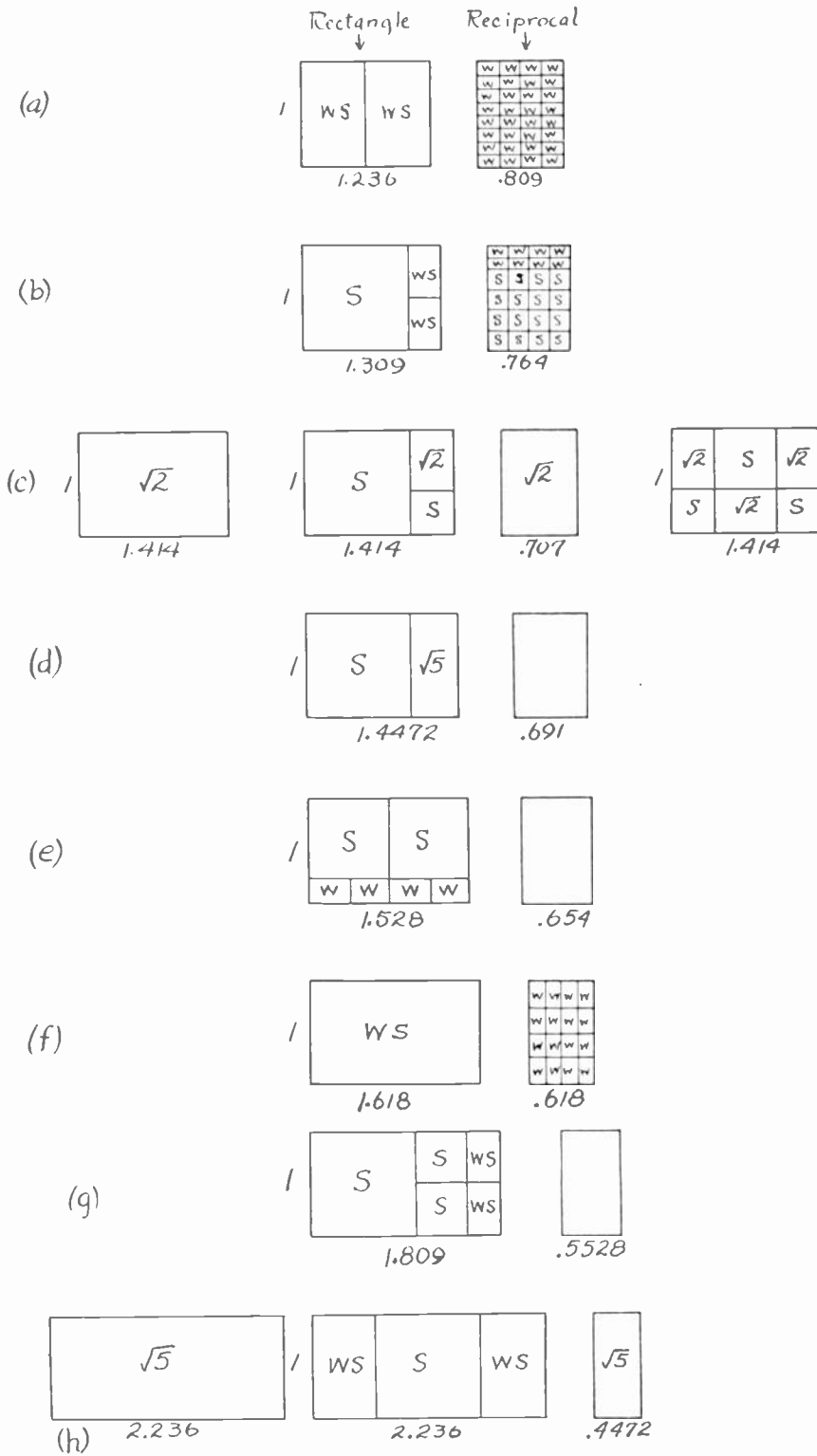

Fig. 9b

Construction and relation of square, root-five, whirling-squares (Fig. 10).

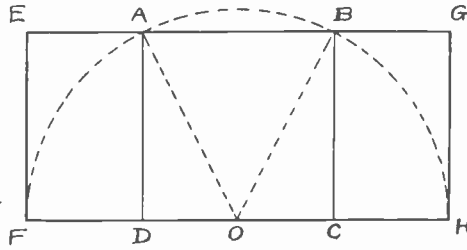

Fig. 10

ABCD is a square

EGIH is a root-five rectangle

BGIC, *EAFD*, *AGID*, and *EBCF* are whirling-square rectangles.

Derivation of whirling squares and spirals (Fig. 11).

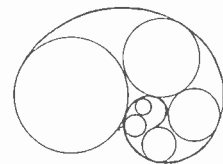
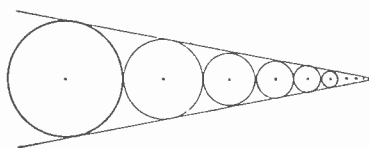
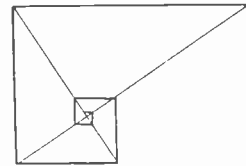
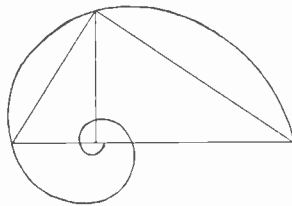
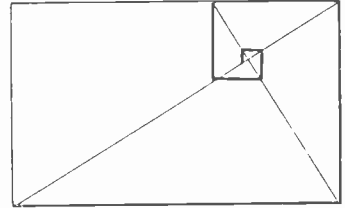
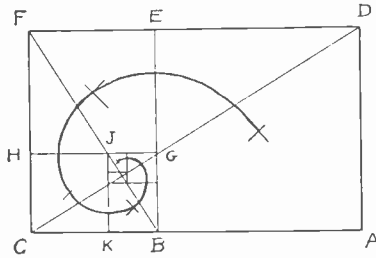

Reproduced from "*Dynamic Symmetry*," by courtesy Yale University Press.

Fig. 11

Draw a whirling-squares rectangle $ACFD$
 Draw one diagonal and the perpendicular to it
 Then draw BE
 $ABDE$ is a square
 $BCFE$ is a whirling-squares rectangle
 Repeat by drawing GHI (the same diagonals serve as for the first rectangle)
 $GHFE$ is a square
 Repeat by drawing JK
 $KCHI$ is a square,
 etc.

This construction reveals a series of squares arranged in a spiral whirling to infinity around a point formed by drawing a curve through the centers of the squares. This curve is widely used in nature.

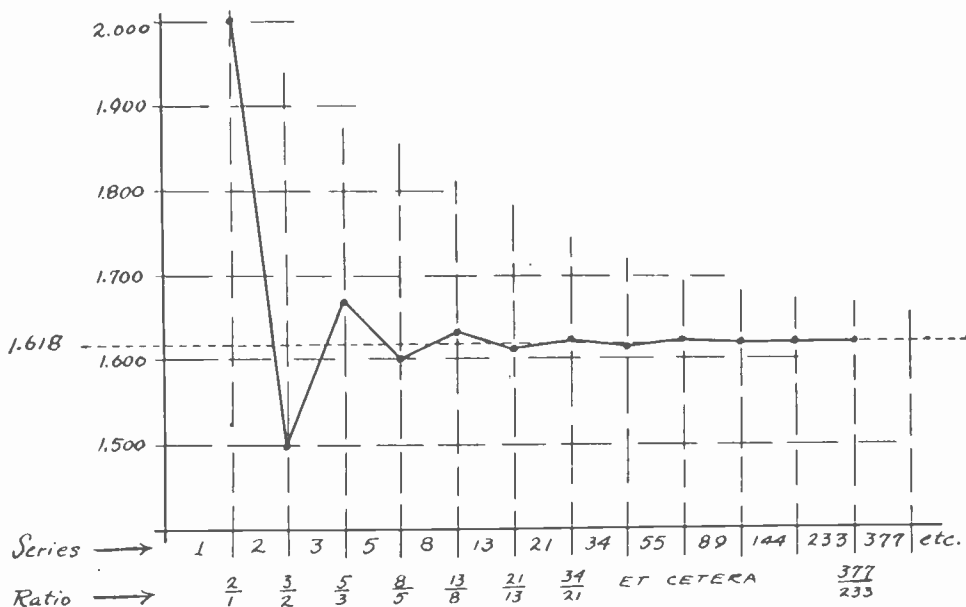

Fig. 12

Nature uses not only the whirling-square rectangle ratio (1.618), but a number series involving it. Note the following summation series (known as the Fibonacci series): 1, 2, 3, 5, 8, 13, 21, 34, 55, 89, 144, etc. (each term is the sum of the two preceding terms).

Fig. 12 plots the ratio of each number to the one preceding it against the terms, and it will be noticed that the geometrical progression approaches the ratio 1.618. The above series does not represent the true series exactly, but is fairly close. A closer series is 118, 191, 309, 500, 809, 1309, 2118, 3427, 5545, etc., which are the values previously

associated with the fundamental rectangle shapes.

Note that—

Any two terms added equals the next term.

Every term divided into its successor equals 1.618

- “ “ “ “ a third term equals $(1.618)^2 = 2.618$
- “ “ “ “ a fourth “ “ $(1.618)^3 = 4.236$
- “ “ “ “ a fifth “ “ $(1.618)^4 = 6.854$

etc.

Powers of 1.618 divided by 2 produce the series of numbers.

Many other dynamic numerical relations also are present.

The above series has long had interest to mathematicians and records of work on it go back hundreds of years. An illustration of its application in geometrical figures is given in Fig. 13.

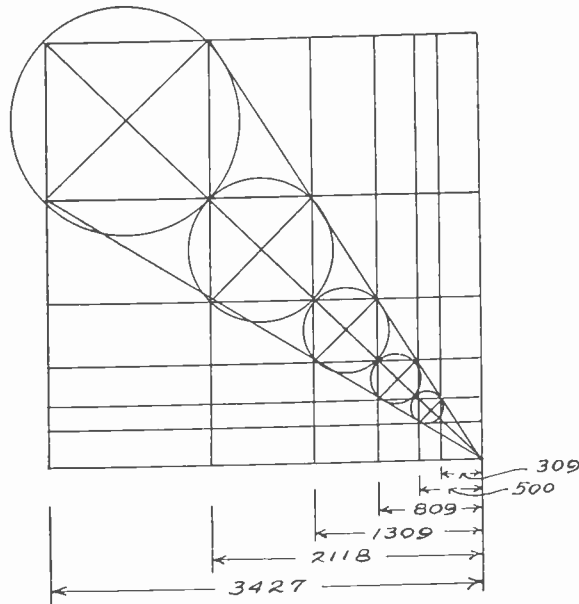

Reproduced from "The Diagonal," by courtesy Yale University Press.

Fig. 13

SOME EXAMPLES OF CONSTRUCTIONS

Given a square, draw a whirling-square rectangle inside it. Then diagonals of the square and the rectangle define a small square concentric with the large square. (See Fig. 14.)

If the sides of the small square of Fig. 14 are extended, as in Fig. 15, a nest of squares and whirling-square rectangles is formed.

The intersections of the diagonals of the whirling-square rectangle inscribed in a square with their perpendiculars, form the "eyes" of the rectangle, and also are vital spots of the square. (See Fig. 16.)

A very interesting and frequently useful relation is that formed by the diagonals of dynamic rectangles and their perpendiculars.

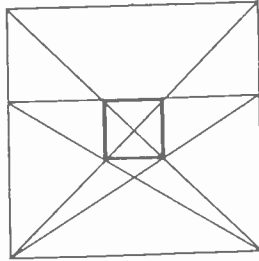

Reproduced from "The Diagonal," by courtesy Yale University Press.
Fig. 14

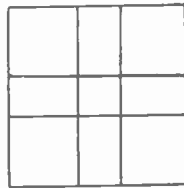

Fig. 15

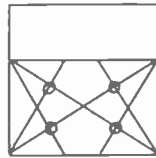

Fig. 16

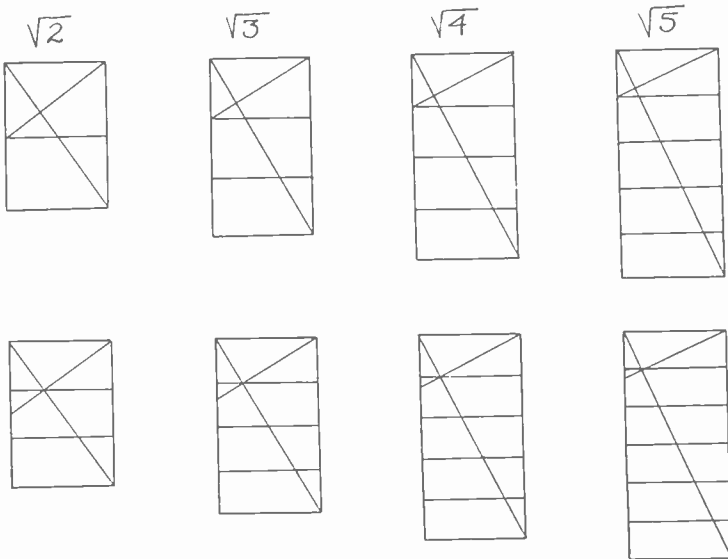

Fig. 17

(See Fig. 17.) Note that they divide
 a root-two rectangle into two or three parts,
 a " -three " " three " four " ,
 a " -four " " four " five " ,
 etc.

depending upon whether the dividing lines are drawn through the points where the perpendiculars strike the sides or through the intersections of the diagonals.

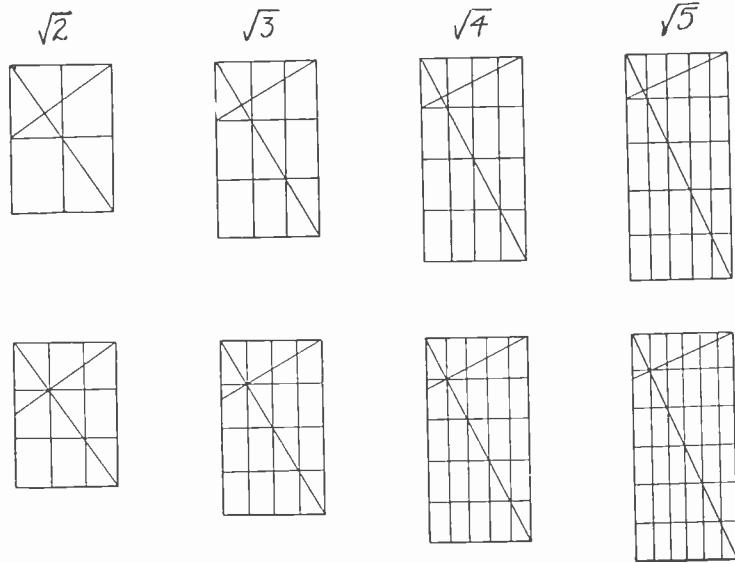
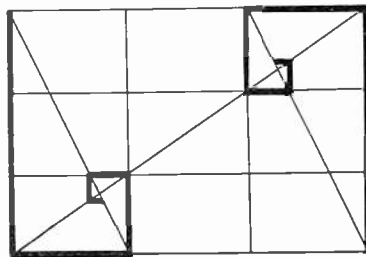

Fig. 18

Dynamic rectangles may similarly be divided into smaller rectangles *proportional to the whole*, as shown in Fig. 18.

It may be noted that the lines which subdivide the *n* root rectangles into *n* parts in each direction, are the extensions of the spiral lines



Reproduced from "The Diagonal," by courtesy Yale University Press.
 Fig. 19

around the eyes of the rectangle, as shown more clearly in Fig. 19. Also the division process can be carried to infinity.

Some subdivisions of the root-two rectangle are shown in Fig. 20.

- (a) is constructed by making $AB = AE$, the rest being obvious. The points O are the foci of the escribed ellipse and P is a focus of the inscribed semiellipse touching E, F, D .
- (b) is constructed by making $AB = BC$, and $CD = DE$, the rest being obvious. The known ancient use of this familiar symbol is evidence that this rectangle was used long ago.

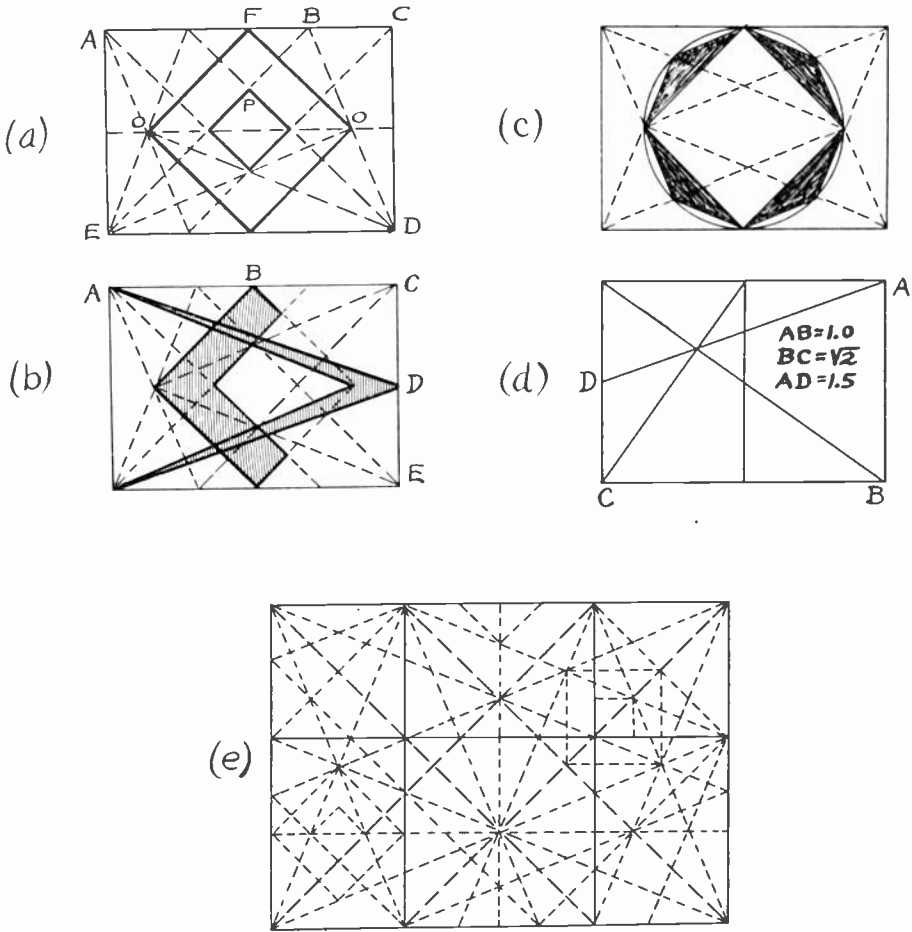

Reproduced from "The Diagonal," by courtesy Yale University Press.
Fig. 20

- (c) shows relation of this rectangle to the square and octagon.
- (d) $AB = 1.0$
 $BC = \sqrt{2} = 1.414$
 $AD = 1.5$
- (e) shows the indefinite extension possibilities of a dynamic plan for design purposes. Hidden shapes and relations continually appear, to prove the basic correctness and inherent harmony of a true fundamental plan.

The root-two plan is a favorite one for books and writing paper design, because the open and closed conditions have similar shapes and therefore more pleasing appearance.

The mathematical relations between the several root rectangles is shown in the two constructions of Figs. 21 and 22.

DYNAMIC SYMMETRY IN NATURE

Designs of nature are based upon dynamic symmetry principles, which is "natural" since nature's handiwork is infinite growth upon an orderly basis. Consideration of this phase of the subject is beyond the scope of these notes. Adequate treatment may be found in the publications of Hambidge and others, with proof of the discovery that the designs of nature are not accidental, but are in harmony with definite, exact basic plans. They warrant and should induce a faith in the validity and utility of these laws in all design work. The published works of

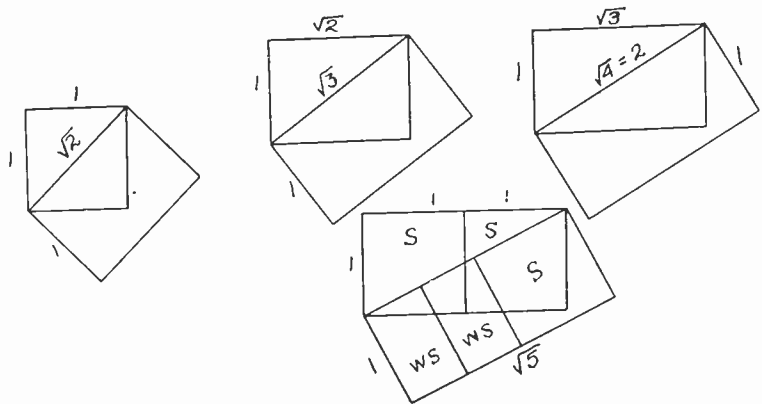

Reproduced from "The Diagonal," by courtesy Yale University Press
Fig. 21

Hambidge show various illustrations of these relations. For purposes of this paper, we need note only that dynamic ratios exist not only in plants but throughout the human body, with an astonishing degree of fidelity in any normal specimen. This was apparently discovered first by the Greeks, probably in the sixth or seventh century B. C., shortly after they acquired knowledge of the subject from the Egyptians, who first practiced it in the first or second dynasty (4000-5000 B.C.). The Egyptians, therefore, had practiced it for thousands of years, particularly in building work, but had not refined or extended it. The Greeks, with their greater philosophical and mathematical abilities, did extend and refine its practice, and soon far outstripped the Egyptians in its use. Among the Greek discoveries and applications was the one that the human body was in accord with dynamic growth principles, and

this resulted in the extraordinary advance in Greek art, which we today call the "classic Greek," and which has not since then been surpassed or equalled. In fact, Hambidge considers that the human skeleton is the best source of the most vital principles of design.

Incidentally, it is interesting to note that the Romans did not learn the secret from the Greeks *correctly*. Mathematics was so unde-

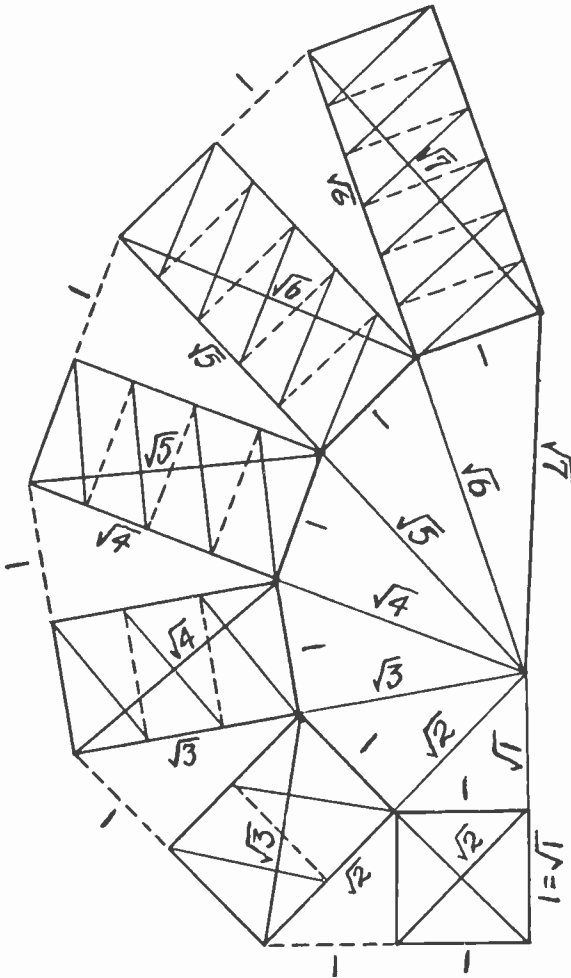

Reproduced from "The Diagonal" by courtesy Yale University Press.

Fig. 22

veloped that they made the easy mistake of thinking that similarity of *line* was involved, rather than area, and therefore Roman art did not rise above the possibilities of "static symmetry," which is better than no theoretical basis at all, but is much less vital and effective than is "dynamic symmetry." Greek and Egyptian art is much superior to the Hindu, Chinese, Japanese, Byzantine, etc., the former being "dynamic" and all the latter "static".

RADIO DESIGN METHODS AND APPLICATIONS

The principles described previously are very simple. Nevertheless, their application to actual design is not easy when one first tries to use them, because we have been trained so long to design without fundamental plan. Considerable study and practice is necessary before useful results are obtained readily. Effort is well worth while, however, because not only is beauty of design assured, but such beauty can be obtained with certainty, ease, and efficiency, as reward of the effort.

The most useful and most frequently needed application of dynamic symmetry to radio design is, at present, to the cabinets and panels of broadcast receivers. In these instruments, a high standard of artistic excellence is desired, and it would be of much advantage to radio design if the radio engineer could execute properly the fundamental features of his cabinets, even if the decorative detail were left to the trained cabinet designer artist. This advantage would result from the fact that the preliminary layout work of the radio engineer could be guided properly by himself, and proper choice made from the various possible arrangements which are usually present. The need for *extensive* later work by an artist, with possible requirements of changes and delays, is thereby lessened, and the form, dimensions, and specifications given by the engineer to the artist for decorative treatment will be fundamentally correct, and will not require change to result in an excellent completed design.

Dynamic symmetry has been used by Tiffany, famous jewelers and precious metal workers, for several years, and it is generally believed that their designs have improved enormously as a result and now have a fine classic beauty which was not often obtained by them before, even in work such as that which created the Tiffany reputation. Also, a considerable number of independent artists of high reputation are using it increasingly with excellent results. It should be understood that most of the so-called "Modern Art" has no relation whatever to dynamic symmetry. Much of modern art has been merely excessive and bizarre application of simple geometrical figures of nondynamic proportions, and largely resulting in displeasing, often ugly designs. Dynamic designs are not limited to simple forms, straight lines, etc., but are those which employ proper proportions in whole, in parts, and in relations of all parts to the whole. Some modern design is dynamic, pleasing, and such work is likely to have lasting value and influence. It appears likely that use of dynamic principles will extend rapidly after a few more commercial demonstrations have been made.

Before proceeding with illustrations of application of the prin-

principles to specific radio design problems, let us review some of the constructions which are most useful in that work.

To place a whirling-square rectangle (1.618 ratio) within a square, proceed as in Fig. 23.

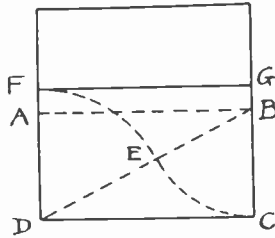

Reproduced from "The Diagonal," by courtesy Yale University Press.
Fig. 23

- Given the square
- Bisect it at AB
- Draw BD
- Swing arc to E with radius BC
- With radius DE , swing arc to F
- Draw FG
- $FGCD$ is the whirling-square rectangle.

To place a root-five rectangle within a square, proceed as in Fig. 24.

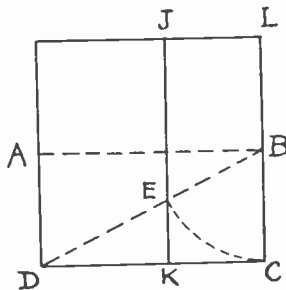

Reproduced from "The Diagonal," by courtesy Yale University Press.
Fig. 24

- Given the square
- Bisect it at AB
- Draw BD
- Swing arc to E with radius BC
- Draw JK
- $JLCK$ is the root-five rectangle.

Given any rectangle, to produce similar ones of different size but with two sides coincident, proceed as in Fig. 25. For concentric location, proceed as in Fig. 26.

Given any rectangle, to produce a similar one at any points in the rectangle, proceed as in Fig. 27.

$ABCD$ is the rectangle
 C and D are the points
 Draw AC and BD through O

Draw OC and OD
 Draw DE and CF parallel to AD
 $CDEF$ is proportional to $ABCD$.

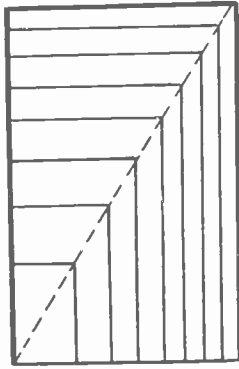

Reproduced from "The Diagonal," by courtesy Yale University Press.
 Fig. 25

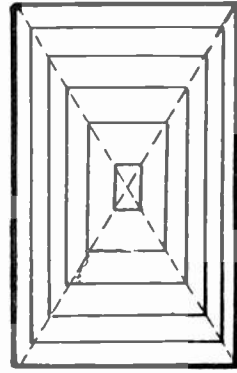
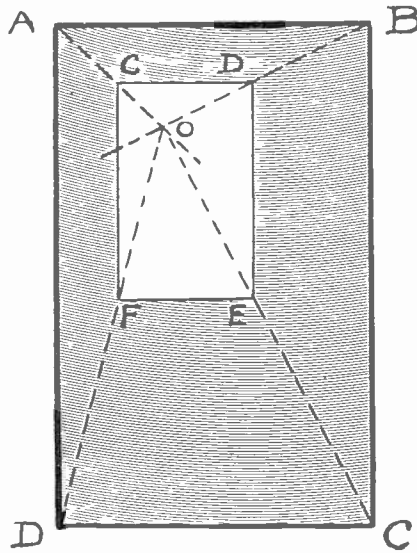

Fig. 26



Reproduced from "The Diagonal," by courtesy Yale University Press.
 Fig. 27

The above three constructions apply to rectangles of any ratio, dynamic or not. But unless dynamic ratios are used, the results will be limited, flat, and dead. Every choice of rectangle, line, and point should be made with reference to and by aid of dynamic relations. This will ordinarily not conflict with practical requirements to serious degree, because the vital relations are many, and one usually can be found close enough to that required by practical considerations to satisfy them.

For example, consider some of the various dynamic rectangles (which can be put inside a given dynamic rectangle, at about a certain position and of about a certain size. All of the rectangles are dynamic

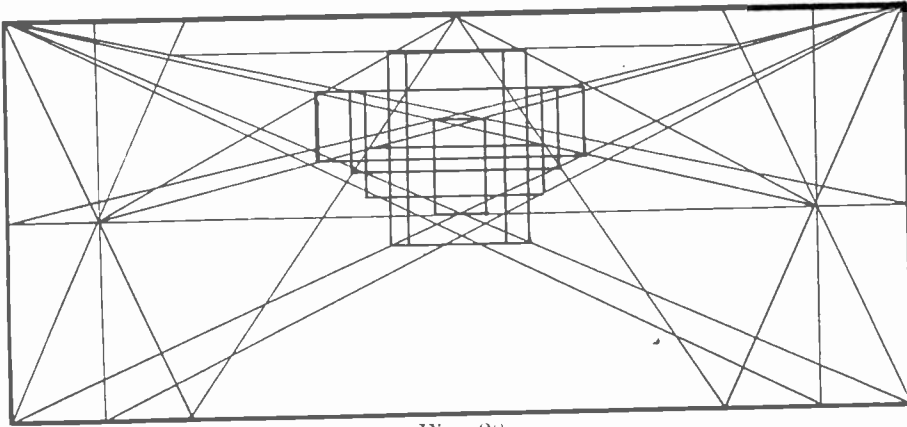
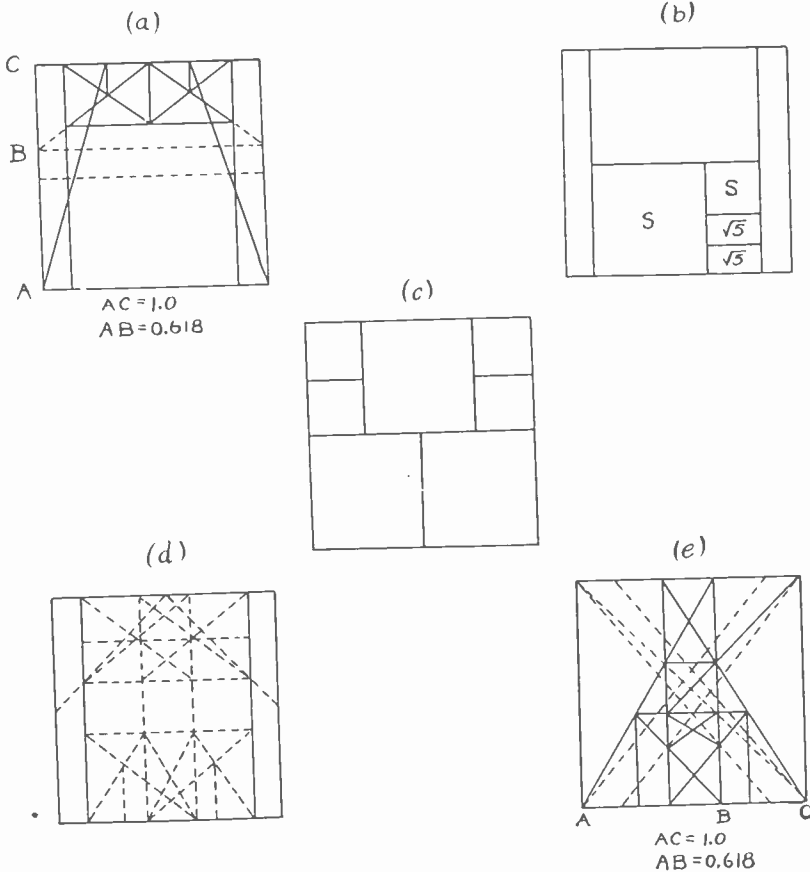

Fig. 28



Reproduced from "The Diagonal," by courtesy Yale University Press.
Fig. 29

and any one nearest to practical requirements may be used. (See Fig. 28.)

Fig. 29 gives a few of the possible subdivisions of a square. Resulting lines, points, and areas may be used for location and sizes of parts.

Fig. 30 gives a few divisions of certain dynamic rectangles.

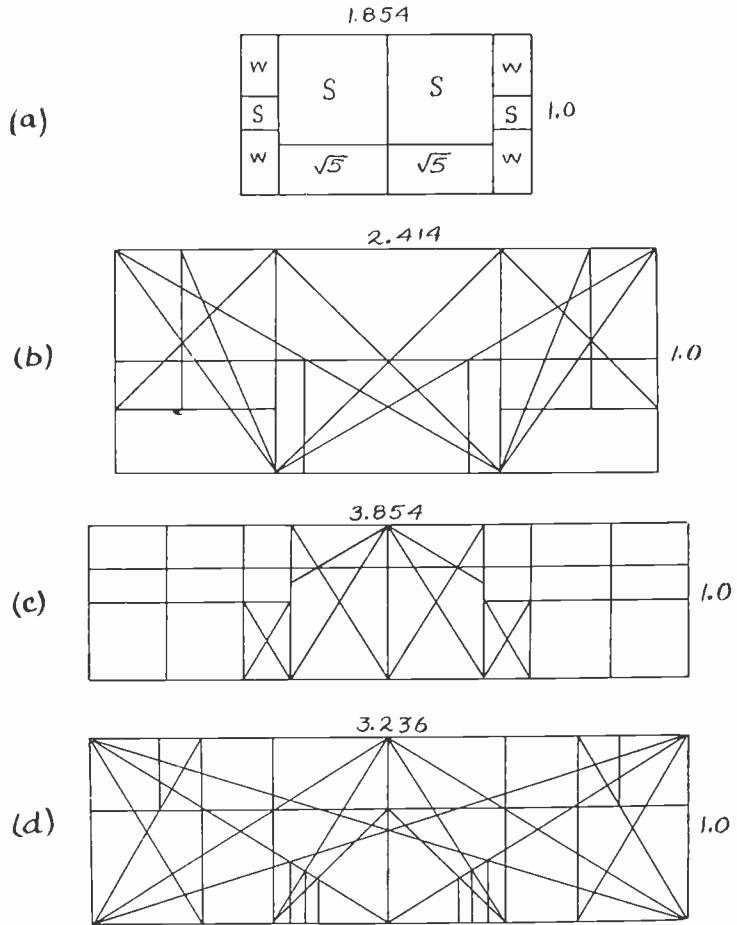

Fig. 30

METHODS AND EXAMPLES IN SPECIFIC RADIO PROBLEMS

The geometric illustrations which have been given in the foregoing are obviously but a few of the countless manners of division which are possible in dynamic shapes. In attacking a definite design problem one will need to search for that plan of growth or division which meets the practical specifications of the job. Usually certain dimensions are adjustable, within certain limits at least, and others cannot be changed. Where the latter are too numerous, it will probably be difficult to find a completely satisfactory solution, although some assistance and benefit can be had even under such disadvantageous circumstances.

In the examples of cabinet design given herein, only the front elevation is shown. It must be understood that these principles are appli-

cable to *three-dimensional use*, and must be applied to *all* views of objects such as cabinets, if the objects are to have dynamic appearance in perspective view from any side. Different ratios may be used for different sides, of course, but they must be related ratios.

There are two general methods of procedure, which we may call respectively the convergent and the divergent. In the convergent method we would start with a plan for the outline of the whole object and work inward searching for proper sizes and locations of interior parts. In the divergent method, we would start with some central small part of the object and work outward toward other parts and the whole outline.

The convergent method may be more convenient where the outline dimensions are already approximately fixed, as for example in a radio cabinet desired to be of approximately a certain height, width, and depth.

To use this method, first select that dynamic shape which is nearest in ratio to that of the desired approximate outline dimensions. Lay out that ratio rectangle, and next draw in a few of the most important division lines and areas thereof, including especially the ones thought most likely to fit known details of the desired design. Then roughly block in the major elements of the object, with some regard for vital locations and some for practical requirements. Then check the layout carefully for practical requirements, and make changes where necessary, always seeking new locations or sizes which will conform to other vital parts of the basic rectangle. These can be discovered as needed. The operation is therefore convergent in another sense also, with attention alternating between practical and dynamic requirements until both are satisfied.

The "divergent" method is perhaps a more natural one, and usually more simple, to use. It utilizes the outward growth or unfolding from a nucleus, thus imitating the method of growth in Nature. Under this method, we would start with some important component part of the desired design and build the other parts around it. Both methods are exemplified in the following radio illustrations.

As a first example, consider the commercial loud speaker shown in Fig. 31 (Radiola Loud Speaker Model 100-A).

This figure shows the outline of the speaker to accurate scale and the dynamic plan is dotted in. The design is based upon the root-two rectangle, which forms the over-all outline, and is a pleasing one, although it has two slight departures from complete correctness. The *AB* dimension is determined by division with diagonals. (See the method of Fig. 17.) The points of beginning of the side curves (*G* and

II) are determined by the intersection of diagonals with the horizontal center line. The base moulding is determined by further division with diagonals and its general direction by diagonal EF .

The center of the circles (0) is not placed vitally in the design, and would be better slightly lower with the circles slightly smaller. The points C and D are not placed vitally and should be slightly lower or higher.

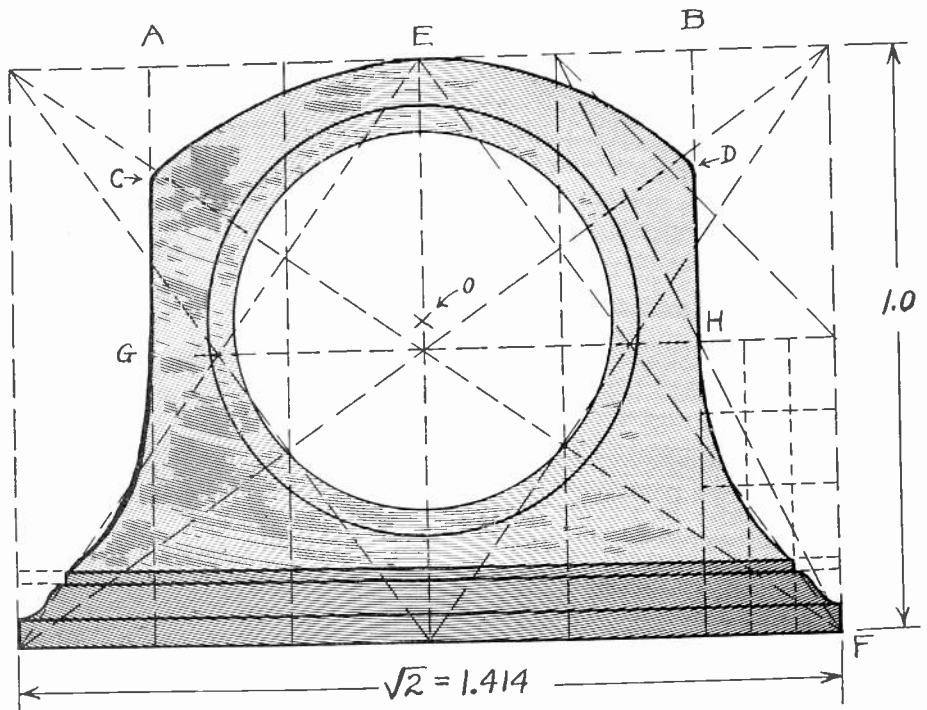

Fig. 31

The next example utilizes the divergent method. In this suppose it is desired to design a new vacuum tube envelope of approximately certain shape and size, but with considerable freedom as to detail dimensions. One rigorous specification is given, namely the base diameter. The internal parts require clearances about as shown in Fig. 32, and a metal terminal is to be located on top.

We decide to start from the base, since that is an important part of the tube and since its diameter is specified. From general knowledge of bases we decide that the ratio of its diameter to height could be 1.309 and adopt that as a plan. We therefore lay out the base $ABCD$ (Fig. 33a) with that ratio. Since we know that the envelope is to be wider than the base by about one-third, we will add on some 1.309 rectangles with the longer side horizontal, and the shorter side equal to the longer side of the base rectangle. Three such rectangles take us

to the necessary height. To obtain a few more divisions, let us cut squares from top and bottom, bisect the top rectangle horizontally and extend the base sides up through the figure (Fig. 33b). If the calculations are made it will appear that the top rectangle *EFGH* has the ratio of 2.618 or a whirling-square rectangle plus a square. Therefore, since squares have powerful relation in this rectangle let us cut a square off each end of it (Fig. 33c).

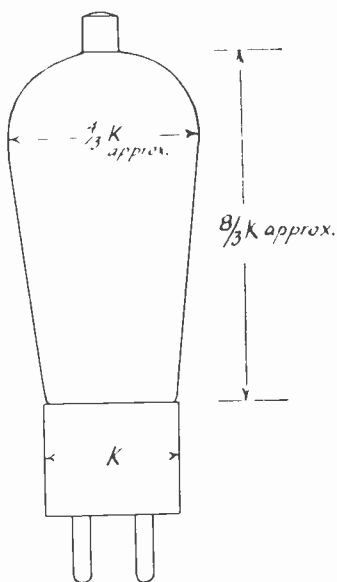

Fig. 32

For the tube prongs we need an area below the tube base somewhat less than the base in height. A 1.309 rectangle may provide this if constructed vertically downward with *DC* as its short side, as *DCMN*.

We now have enough plan possibilities to rough out a tube outline and, possibly after a few trials, we decide upon the one shown in Fig. 34a. Then with suitable rounding and shaping we have the final outline design of Fig. 34b. The original specification of Fig. 32 has been fully met with a minimum of glass and evacuated space, some practical advantages such as better handhold, and an appearance which is likely to be more pleasing than would have been obtained by drafting without plan. Also if we later desire larger or smaller sizes in the same style, we have a basis for rapid reproduction of proportional ones which will have harmonious relation.

As example of a radio cabinet design, Fig. 35 shows a design obtained convergently, starting with a root-two rectangle, the divisions being bisection, removal of a square, and construction of diagonals.

A simple and frequently advantageous application of planned design is found in such problems as packing carton dimensions. If funda-

mentally correct dimensions for single cartons are used, for vacuum tubes as example, it will be found that various quantities of single car-

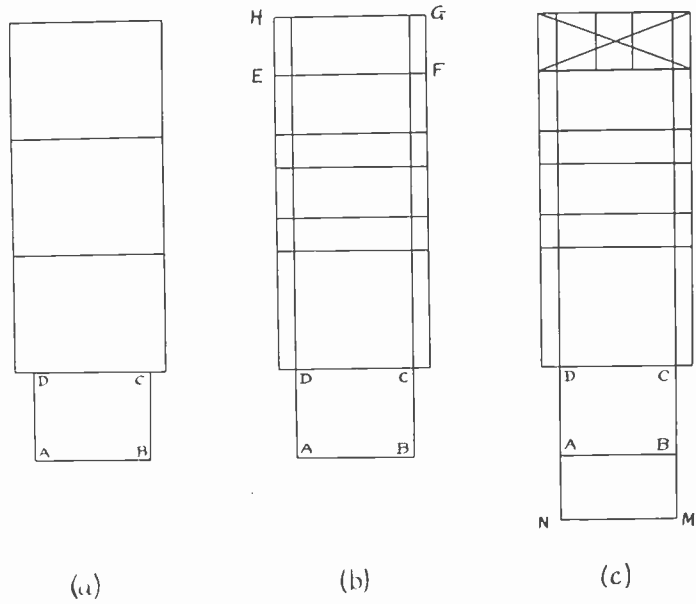

Fig. 33

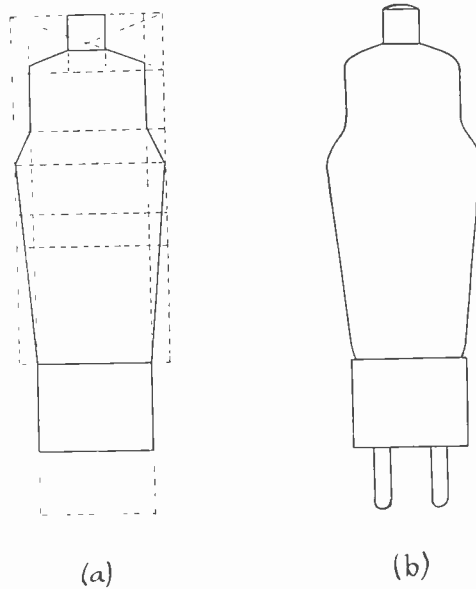

Fig. 34

tons can be grouped into efficient packages and that various sizes of single cartons can be grouped into one package with convenient and efficient results.

The study of motion picture screen area shapes is an interesting application. A paper by Loyd A. Jones¹ concerns this subject and gives data on the proportions used by master artists. While established practice is a controlling factor in this field, future changes, if any, may be guided advantageously by dynamic principles.

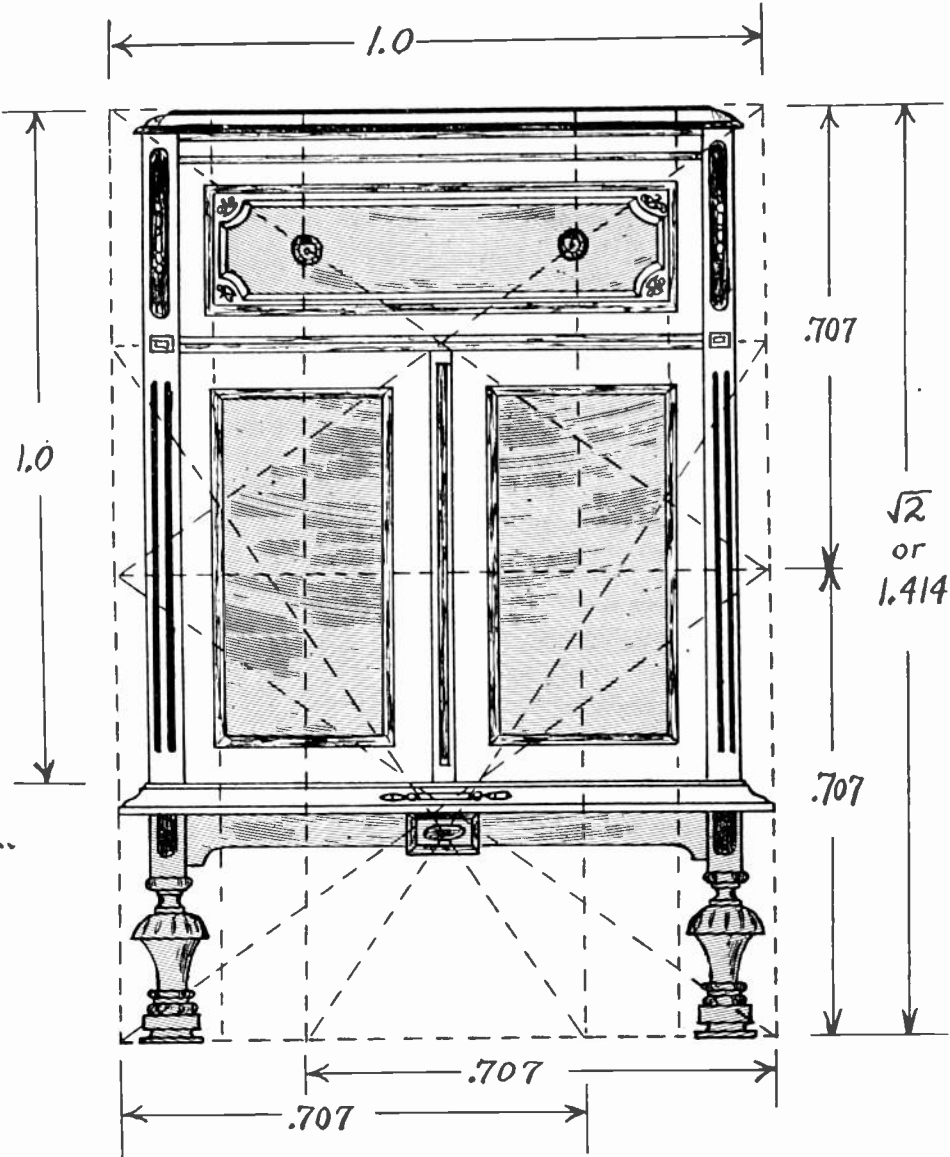

Fig. 35

Switchboard design permits useful application of these principles, in over-all proportions, and in location of individual instruments. Rack panels, so widely used in radio and telephone practice for amplifying equipment, etc., are particular examples.

¹ Loyd A. Jones, "Rectangle proportions in pictorial composition," *Jour. S. M.P.E.*, January, (1930).

CONCLUSION

It should be understood clearly that the use of dynamic symmetry principles does not result in mere geometrical designs having none of the beauty of form and detail which is associated with the work of the artistic genius. The true artist with genuine creative ability has freedom for the revelation of his art, even when he employs dynamic principles to the utmost. They merely guide and assist him. They give greater aid to those designers not endowed with that artistic sense which instinctively selects those forms which are pleasing. While the work of such designers will not be as effective as that of true artists, even though it is aided by dynamic principles, it is likely to be much more acceptable than if it had been carried out with no vital basic plan.

After the decline of Greece politically, the use of dynamic symmetry decreased, probably coincidentally with the lessening of appreciation of art and the increase of materialism. It seems to have disappeared completely during the first century B.C. Now, after two thousand years, it has been rediscovered, and it is the author's belief that it will again become a dominant force in all design work. If so, we can hope confidently that the world—with its present knowledge of arithmetic, geometry, and science, and its wide industrial opportunities, all denied to the ancients—will see a classic art period far surpassing those already recorded in history.

The author wishes to emphasize that although one may find difficulty in the first attempts at applying these principles, it is well worth while to study and apply them, not only for assistance in design work, but for the enjoyment and appreciation one obtains from a clearer understanding of the universal power and applicability of nature's laws of life and growth.

ACKNOWLEDGMENT

Acknowledgment is made to the publications listed in the appended bibliography, and in particular to the works of Jay Hambidge, ("Dynamic Symmetry, The Greek Vase" and "The Diagonal") from which many of the figures and explanations have been taken by permission of the Yale University Press.

Bibliography

- Jay Hambidge, "Dynamic Symmetry, The Greek Vase", Yale University Press.
 Jay Hambidge, "The Diagonal", Yale University Press.
 L. D. Caskey, "The Geometry of Greek Vases", Yale University Press.
 W. H. Goodyear, "Greek Refinements", Yale University Press.
 Jay Hambidge, "The Elements of Dynamic Symmetry", Brentano's, New York.
 Michel Jacobs, "The Art of Composition", Doubleday Page & Co.

- Charles R. Richards, "Art in Industry", Macmillan Co.
D. S. MacColl, "Confessions of a Keeper", Macmillan Co.
Lloyd A. Jones, "Rectangle proportions in pictorial composition," *Jour. S.M.P.E.*, January, (1930).
Robert W. Gardner, "Standardized proportion of Greek vase and ornament," *Jour. Amer. Ceramic Soc.*, vol. 9, no. 7, July, (1926).
Marie Gugle, "Dynamic symmetry," *Bull. Amer. Ceramic Soc.*, vol. 5, no. 2, February, (1926).
Claude Bragdon, "A dissertation on dynamic symmetry," *Arch. Record*, vol. 56, p. 305, (1924).
Vashti Morgan, "Practical dynamic symmetry," *Design*, vol. 32, p. 104.
Albert A. Southwick, "A study of dynamic symmetry," *Architecture*, vol. 47, p. 111, (1923).
George Bellows, "What dynamic symmetry means to me," *American Art Student*, vol. 3, p. 5, June, (1921).
Howard Giles, "Dynamic symmetry in the class room," *American Art Student*, vol. 3, p. 7, (1921).
F. Westerberg, "Some illustrations of dynamic symmetry," *The Internat. Photographer*, June and July, (1929).
Wilfred S. Conrow, "What next in art and architecture," *N. Y. Times Magazine*, February 3, (1924).
Ford Robbins, U. S. Patent 1,790,074, instrument for obtaining dynamically symmetrical ratios.



AN ESTIMATE OF THE FREQUENCY DISTRIBUTION OF ATMOSPHERIC NOISE*

By

R. K. POTTER

(Department of Development and Research, American Telephone and Telegraph Co.,
New York City)

Summary—A relation between atmospheric noise intensity and frequency is estimated upon the basis of noise measurement data covering the frequency range between 15 and 60 kilocycles, and 2 and 20 megacycles.

IN CONNECTION with the study of radiotelephone transmission rather extensive measurements of atmospheric noise have been made over the last several years. Early measurements of this sort were confined to the range between 15 and 60 kilocycles.¹ Following the installation of high-frequency circuits the measurement work was extended to include the upper frequency range between 2 and 20 megacycles.

The low-frequency measurement sites in this country were confined to the northeastern United States. Measurements in this lower range were also made in England. High-frequency noise measurements according to a regular schedule were first made in England during the development stages of the high-frequency transatlantic radiotelephone circuits.² Since that time the technique of noise measurement has improved and a more general survey of high-frequency noise has been accomplished.³ During the past few years, measurements in the upper frequency range have been made at several widely separated points in the United States. These include the states of Maine, New York, New Jersey, Florida, California, and Washington. Noise measurements on these higher frequencies have also been made recently in Bermuda.

The extent of the useful radio band covered by the low- and high-frequency measurements mentioned above is illustrated by the block diagram in Fig. 1. In this collection of data there is sufficient information to justify an estimate of the relation between atmospheric noise

* Decimal classification: R114. Original manuscript received by the Institute, June 6, 1932. Presented at the Washington meeting, U.R.S.I., April 29, 1932.

¹ R. Bown, C. R. Englund and H. T. Friis, "Radio transmission measurements," Proc. I.R.E., vol. 11, p. 115-155; April, (1923); L. Espenschied, C. N. Anderson and A. Bailey, "Transatlantic radio telephone transmission" Proc. I.R.E., vol. 14, p. 7-57; February, (1926).

² C. R. Burrows, "The propagation of short radio waves over the north Atlantic," Proc. I.R.E., vol. 19, p. 1634-1660; September, (1931).

³ R. K. Potter, "High-frequency atmospheric noise," Proc. I.R.E., vol. 19, p. 1731-1766; October, (1931).

intensity and frequency for the range within which such noise has an appreciable effect upon reception. Preliminary to an estimate of this kind a selection and correlation of data are required since several measurement methods have been used. Some of the methods were based upon the integration of noise energy over a certain period, or an estimate of the average or maximum noise field. Others measured the noise in terms of its disturbing effect.

For the purpose of this estimate two of the most comprehensive groups of data were selected. The data for the low-frequency range are in terms of the disturbing effect of the noise upon signal reception. Measurements by this particular method depend upon audible interference of the noise with a frequency modulated signal, the strength of which is adjustable.¹ The data representing the high-frequency range are based upon the peak method of measurement.³ The arithmetic average of the ten highest deflections observed on the output meter of a field

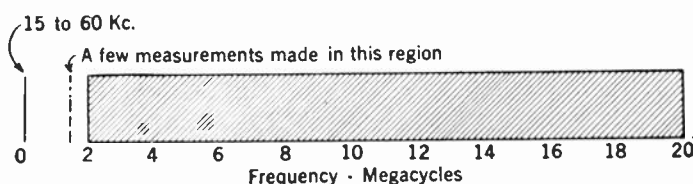

Fig. 1—Block diagram illustrating extent of useful radio band over which noise measurements were made. Measurement range shown by shaded area.

strength measuring set during a period of one minute is expressed in terms of "equivalent" microvolts per meter. Data obtained by these two methods were compared through a knowledge of the signal-to-noise ratio required for an equivalent grade of signal reception in the two cases. In addition to the equation of units, several incidental corrections were necessary in order to account for differences in antenna directional discrimination, measurement site, frequency band width, and the effect of fading on the higher frequencies. The evaluation of these factors was for the most part based upon measurement data. An independent check upon the correlation of these low- and high-frequency data was also available in some atmospheric noise measurements made in these two frequency bands by K. G. Jansky, using an energy integration method.⁴

An estimate of the frequency distribution of atmospheric noise, based upon the data described above, is shown in Fig. 2. Logarithmic scales are used so that noise intensity is expressed linearly in decibels and the low-frequency range is extended. Three curves are shown in

⁴ Paper to be presented at meeting of U.R.S.I., Washington, D.C., April, 1932.

the figure in order to represent the change in the relation for extreme conditions. Curves A and B are estimates of the average distribution around midday and midnight at the point of measurement. Curve C represents the probable distribution at times of local thunderstorms, that is, when the source of disturbance is in the immediate vicinity of the receiving point. While the relative vertical displacement of curves A and B is significant, that of curve C is meaningless since it seems very likely that the intensity of local disturbances may vary considerably. The particular scale of relative noise intensity shown is based upon the "equivalent" noise fields measured by the peak method in the

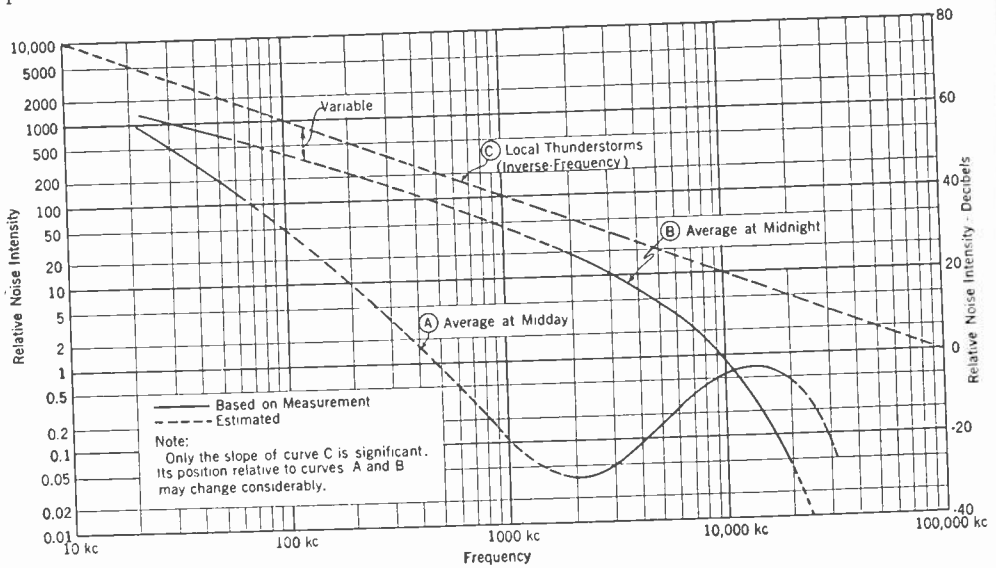

Fig. 2—Reliable variation of radio noise intensity with frequency for northeastern United States as measured on simple vertical antenna.

high-frequency range. In this range the noise intensity as represented by curves A and B corresponds, on the average, to values that have been obtained by the peak method.

Curves A and B are, of course, only cross-sections of a surface which might be used to represent the diurnal variation in noise distribution. The shape of such a surface can be visualized to some extent by a comparison of the somewhat idealized diurnal characteristics for 50 kilocycles, and yearly average diurnal characteristics for 2, 10, and 15 megacycles shown in Fig. 3. The surface sections represented by curves A and B are indicated. It will be noticed that the maximum noise occurs before midnight. This is due to the more frequent occurrence of thunderstorms within an intermediate range during the evening and early nighttime period.

CURVE LIMITATIONS

Obviously it is impossible to show more than the most elementary picture of noise distribution throughout the radio band by means of a few curves. These curves have limitations which restrict their interpretation. The restrictions are as follows:

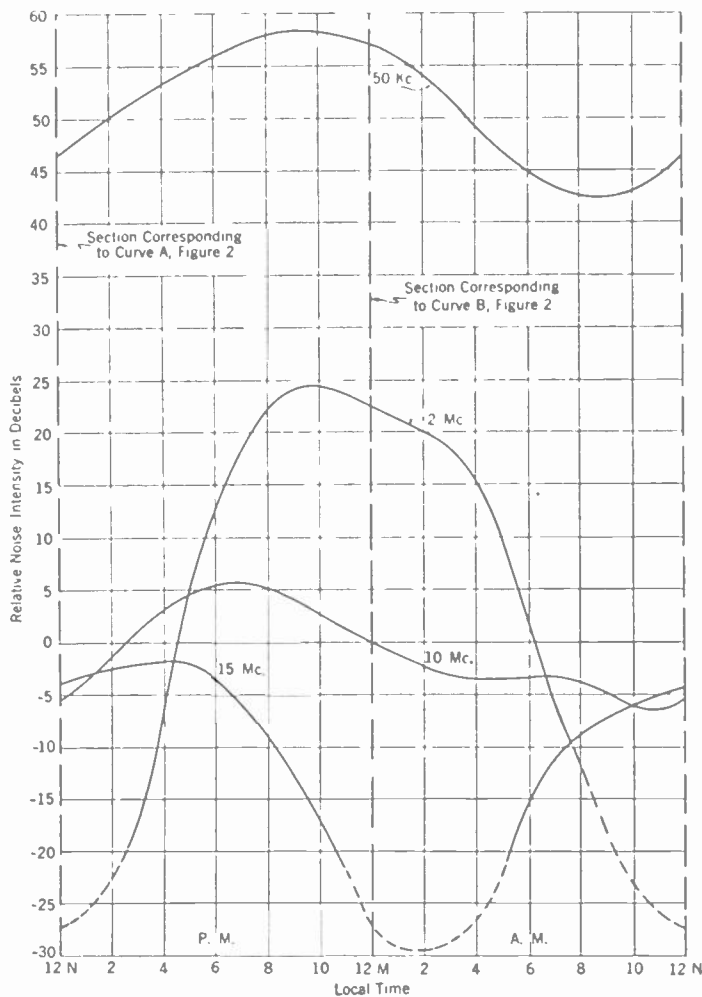

Fig. 3—Average diurnal variation of atmospheric noise representative of several frequencies.

1. They are estimates of the *average* distribution of noise. The relation appears to change somewhat with seasons of the year.
2. The noise levels shown by the curves of Fig. 2 are entirely relative. The absolute intensity may vary considerably. This means that in the absence of local disturbances the noise over the whole frequency range would, on the average, be expected to rise and fall proportionally.

3. The noise distribution shown applies specifically to the vicinity of New York. Measurements on 2, 5, 10, and 15 megacycles made in widely separated parts of the United States suggest that the relation is not greatly altered within this area.

4. The distribution represented applies to magnetically undisturbed conditions. The high-frequency noise decreases during disturbed periods. The low-frequency noise would, according to experience with signal transmission, be expected to increase somewhat.

5. The distribution shown is for nondirectional reception (vertical antenna). It will probably change somewhat with direction of reception, since the range of the effective noise source would vary. The most noticeable change would occur at the higher frequencies.

6. The relation may also depend to some extent upon ground conditions at the point of reception, and in the practical case upon the dimensions of the antenna used in measurement. Ground conditions and antenna dimensions alter the vertical directivity at the higher frequencies. All the high-frequency measurements used in estimating the curves of Fig. 2 were made on vertical antennas that were less than a quarter wavelength high. The ground conditions varied considerably.

COMPARISON OF LOW- AND HIGH-FREQUENCY RECEPTION

There seems on first consideration to be some inconsistency in the very great difference in noise intensity between the low- and high-frequency ends of the curves in Fig. 2. A brief discussion of this difference is perhaps called for.

The noise at 60 kilocycles is shown in Fig. 2 as between 40 and 50 db (some 200 times) higher than that around 15 megacycles. For the same average signal-to-noise ratio when receiving these two frequencies on simple vertical antennas the low-frequency field would, for example, have to be some 2000 microvolts per meter while the 15-megacycle field is only 10 microvolts per meter. This comparison refers, of course, to average conditions. Much lower field strengths would often be satisfactory on 60 kilocycles. At the same time fields much lower than 10 microvolts per meter would as often be satisfactory on 15 megacycles if it were not for the noise inherently associated with the early circuit elements in the receiver where the signal level is low.⁵ Due to this receiver noise, the minimum field which will provide satisfactory speech reception on the vertical antenna in the absence of any atmospheric noise is in the order of 1 microvolt per meter.

⁵ J. B. Johnson, "Thermal agitation of electricity in conductors," *Phys. Rev.*, vol. 32, p. 97; July, (1928); H. Nyquist, "Thermal agitation of electric charge in conductors," *Phys. Rev.*, vol. 32, p. 110; July, (1928).

In the 60-kilocycle transatlantic radiotelephone receiving equipment at Houlton, Maine, it is estimated that the signal-to-noise advantage is, on the average, about 35 db when the reception is compared to that of undistorted high-frequency signals received on a simple vertical antenna with an ordinary high-quality receiving set. This includes the effect of antenna discrimination against noise, single side-band reception, and a limited frequency band width. Compared to a site in the vicinity of New York the location in Maine has an average noise advantage on a nondirective antenna of about 8 db. When a comparison of this low-frequency receiving site in Maine is made with reception on the high frequencies in the vicinity of New York, it is also necessary to consider the effects of fading in the latter case. High-frequency field strengths are usually expressed in terms of average field. Perhaps half of the time the fields are lower than this average, and the signal-to-noise ratio is correspondingly low at these times. For a satisfactory circuit on the high frequencies a much stronger average strength of fading signal is necessary than would be required if the amplitude were constant. The requirement is increased somewhat further by distortion due to selective fading on the high frequencies. When all the factors mentioned above have been considered and suitable correction is made for the difference in field strength measured on the normal and single side-band receivers, the relative noise levels at 60 kilocycles and 15 megacycles as indicated by the curves of Fig. 2 do not seem unreasonable.

SOME GENERALITIES CONCERNING NOISE CURVES

Over the frequency band wherein daytime signal strength continually decreases with distance, the noise decreases with frequency. At night this decrease in noise approaches an inverse frequency relation. In the daytime the noise intensity appears to decrease approximately as the inverse of the frequency squared. The apparent noise advantage of frequencies in the neighborhood of one to three megacycles will probably be greatly modified by the relatively high signal attenuation at these frequencies.

In the high-frequency range it is evident that frequencies in the vicinity of 2 megacycles could be used very effectively for short range (ground wave) circuits during the daytime, while frequencies in the vicinity of 15 or 20 megacycles might be used for the same purpose at night. The fields required would, except during local disturbances, depend largely upon noise originating within the receiver. During local storms there may be a considerable increase in the intensity of received noise.

The serious handicap of high-frequency circuits used for long-range transmission at night is illustrated by the curves A and B of Fig. 2. Comparing night transmission on 5 megacycles with daytime transmission on 15 megacycles, the curves show that the noise in the former case is some 18 db higher. Probably this in part accounts for the fact that long-range transmission conditions approaching perfection are occasionally experienced in the daytime on the higher frequencies, while this condition is very rare at night.

The shapes of curves A and B in Fig. 2 depend upon the combined effect of several factors, such as the variation in noise intensity with frequency at the points of origin, the space distribution of these points, and the attenuation along the paths between these points and the measurement site. The influence of the variation in intensity with frequency at the source is fairly evident when the general slopes of curves A and B are compared with the inverse-frequency relation of curve C which is believed to approximate the distribution of noise intensity at the source. If there were no change in attenuation with frequency, curves A and B would assume a simple inverse-frequency relation corresponding to curve C. Departure from the shape of curve C depends largely upon the variation in attenuation with frequency. Although the curves A and B are estimated between 60 kilocycles and 2 megacycles, there is definite evidence of high daytime attenuation in the vicinity of 2 megacycles (or possibly lower). At night this region of high attenuation either disappears entirely or is shifted well into the low-frequency range. A recent comparison of noise on 2 and 1.4 megacycles indicates that there is no sudden dip within this interval. That a well-defined depression occurs at a lower frequency is improbable judging from the field strengths required for a satisfactory nighttime signal-to-noise ratio within this estimated section of curve B.

It is concluded, therefore, that the region of high daytime attenuation agrees reasonably well with that which might be expected either upon the basis of so-called electron resonance in the presence of the earth's magnetic field,⁶ or the normal change in attenuation with frequency for "ground" and "refracted" waves.^{7,8} The absence of a dip in the nighttime curve around 1.4 megacycles is difficult to explain in terms of the electron resonance theory, since, as has been pointed out by Meissner,⁸ the resonant effect should be most pronounced during the night.

⁶ H. W. Nichols and J. C. Schelleng, *Bell Sys. Tech. Jour.*, vol. 4, no. 2, April, (1925); E. V. Appleton and M. A. F. Barnett, *Electrician*, p. 398, April, (1925); *Proc. Camb. Phil. Soc.*, vol. 22, part 5, p. 672, (1925).

⁷ P. O. Pedersen, "The Propagation of radio waves," Copenhagen, p. 235, Chap. XI, (1927).

⁸ A. Meissner, *Elek. Nach. Tech.*, vol. 3, p. 321, (1926).

CURRENT RECTIFICATION AT METAL CONTACTS*

BY

S. P. CHAKRAVARTI AND S. R. KANTEBET

(Communication Engineering Laboratories, Indian Institute of Science, Bangalore, India)

Summary—Six different contacts of dissimilar metals, namely Cu-Fe, Cu-Sn, Sn-Zn, Zn-Fe, and Pb-Sn, were studied for their rectifying properties. As far as possible small lengths of cylindrical rods with circular section were used. Their tips barely touched each other producing an imperfect contact at which rectification was found to take place best.

In all cases, static characteristics showed that when the thermopositive element was given a positive polarity, the characteristic reached saturation conditions, while with reversed polarities the contact behaved like an ohmic resistance. On the positive side the characteristic starts with being straight for a distance and then with a sudden rise, reaches saturation.

The effect of varying contact area, pressure, and temperature were next studied. Rectification improved with diminution of contact area, point-to-point contact being the best. The rectification vanished on either side of the limiting added weights (1 to 2 grams). External heating of contact renders the characteristics almost a straight line up to the saturation bend.

An attempt is made to explain the rectifying property by assuming that a thermo e.m.f. develops at the contact and that the resistance of the contact itself varies with terminal voltage.

I. INTRODUCTION

A CONTACT of two metals is of common occurrence in all electrical circuits. In heavy electrical technology contacts normally met with are copper-to-copper as in switches and circuit breakers and copper-carbon-copper as between brush gear and commutator segments in direct-current machines and phosphor bronze-carbon-copper in the case of slip rings on alternating-current machinery. Under communication engineering technique telegraph and telephone relay contacts of platinum-iridium, bronze contacts on chains of selector switches in automatic telephony, jack and plug contacts in manual operation, carbon granule contacts of the microphone and metal crystal contacts for radio-frequency detection are some of the well-known instances. Despite such common use of metallic contacts, little information is available about their precise behaviour in electrical circuits. It was early recognized that the resistance of such contacts differed from ordinary ohmic resistances of materials in that they showed clear evidence of directional characteristics with consequent capacity for rectifying alternating currents. The demand for a

* Decimal classification: R149. Original manuscript received by the Institute, January 22, 1932.

cheap rectifier for wireless broadcast reception lent great impetus to the study of metal-crystal contact conductivities during the last decade. It was, however, not so well known that contacts of pure metals and even of the same metal showed the property of rectification.

Pélabon¹ first drew attention to detection's taking place at metal contacts. Prior to this, contacts studied were mostly galena-Ni or those formed by different sulphides or oxides. Rectification was attributed either to a thermo e.m.f. or a change of resistance developing at the contacts. Ettenreich² indicated the probability of a "reaction time" (time lag) existing between the application of the exciting e.m.f. and the development of the second e.m.f. Pélabon prepared a contact between a steel sphere and a steel plane surface, and observed that the rectified current was from plate to sphere. He also experimented with a steel sphere and plates of different metals (*Pb*, *Sn*, *Al*, *Cd*). He did not get good detection with plates of *Zn* and *Cu*. The rectified current in all cases was from sphere to plate. He also experimented with contacts prepared of two similar spheres of the same metal, and of one steel cylinder resting on another identical cylinder. This brings us to the beginning of 1929.

One of the present authors undertook at the Imperial College, London, in 1929, a thorough study of the rectification of the audio-frequency alternating currents by a metal contact. Work has been in progress in this department on a number of contacts between metals since November, 1930. The present communication is an account of these investigations. The experimental work consisted of the following studies, namely

1. Static characteristics of the contacts.
2. Effect of area of contact on characteristics.
3. Effect of pressure on characteristics.
4. Effect of temperature on characteristics.

II. PREPARATION OF CONTACTS

The careful preparation of contacts is of primary importance. Six contacts of dissimilar metals were formed as follows: *Cu-Fe*, *Cu-Sn*, *Sn-Zn*, *Zn-Fe*, *Bi-Fe*, and *Pb-Sn*. For the first five combinations, an end of a small rod of each metal was turned into a fine point, and the two were mounted in a fiber block such that the points touched each other lightly and were held in position by fixing screws. In the case of the *Pb-Sn* contact (which was used for the pressure experiment), a plane surface of *Pb* was placed against a plane surface of *Sn*, so as to

¹ Pélabon, *L'Onde Electrique*, September 5, (1926.)

² *Akad. Wiss. Wien*, (1919).

make a contact. The cross section of the rods was 0.04 square inches.

As it was known from one of the authors' previous experiments that rectification took place only at a certain state of contact in between the perfect contact and no contact states, extreme care was taken, while adjusting the tips, to bring about this particular state by means of a milliammeter, a battery, and a resistance box. The resistance of the contact at this state would be sufficient, and neither infinitely small (as at perfect contact state) nor infinitely great (as at no contact state).

The two vertical screws S were fitted to maintain the tips in the same state of contact for all the experiments. A terminal screw T was also fitted to each of the rods for screwing the leads carefully. The leads from each of the metals were as far as possible made of the same metal. The plan and sectional elevation are given in Fig. 1.

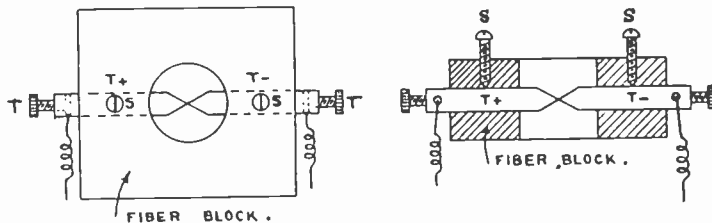

Fig. 1—Contact mounting.

III. STATIC CHARACTERISTICS OF THE DIFFERENT METAL CONTACTS; EFFECT OF THE AREA OF CONTACT SURFACE

(a) Method of Experimentation

The circuit used to obtain the static characteristics of the contacts is shown in Fig. 2.

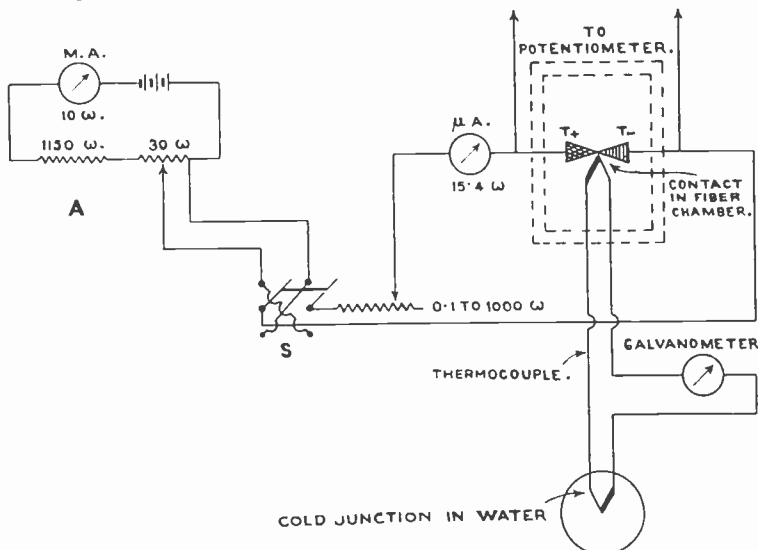

Fig. 2—Circuit used to obtain static characteristics of contacts.

First, the thermopositive metal of the contact was given positive potentials. The corresponding currents were observed in the microammeter. The *P.D.*'s across the contact were measured by the potentiometer. The bias obtained by the tapping arrangement was of the order of millivolts.

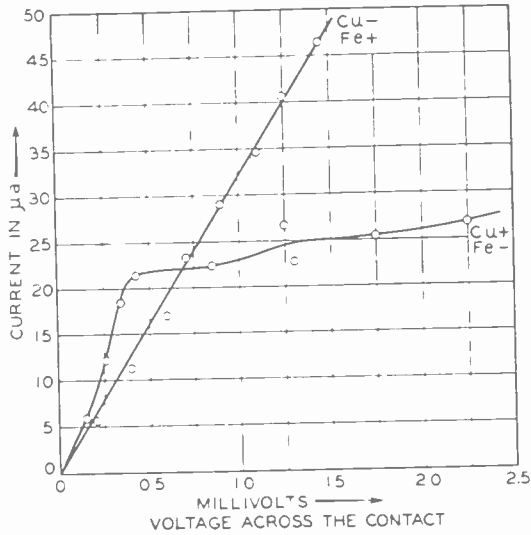

Fig. 3—Copper-iron contact.

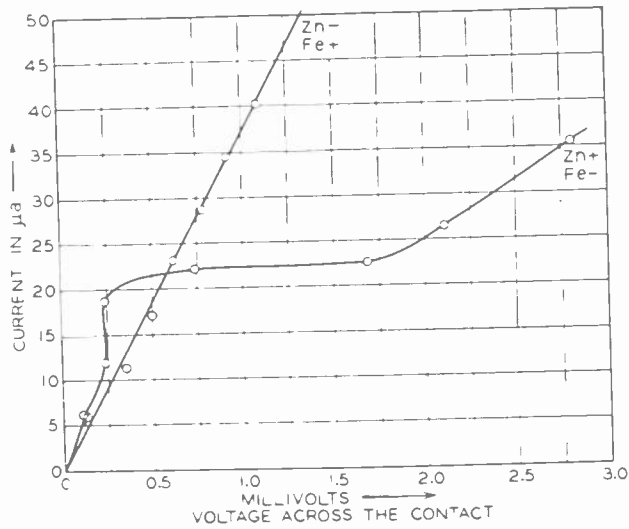

Fig. 4—Zinc-iron contact.

Next, negative potentials were given to the thermopositive metal by reversing the switch *S* and similar readings were taken.

To find out whether appreciable heat developed at the contact, a thermocouple with extremely fine junctions was constructed; one junction was fixed near the contact, and the other one in a beaker of

water at room temperature. The current due to the thermo e.m.f. developed in the thermocouple circuit was measured by a mirror galvanometer with lamp and scale arrangement. A very slight deflection was noticed, as the heat developed was extremely small.

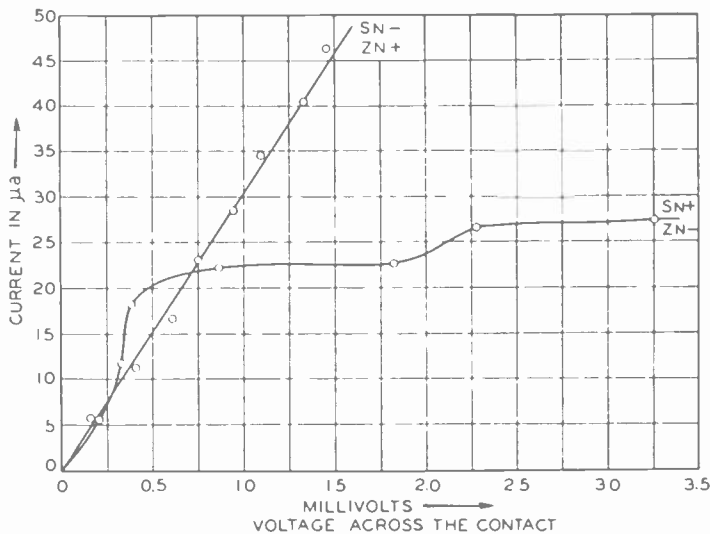

Fig. 5—Tin-zinc contact.

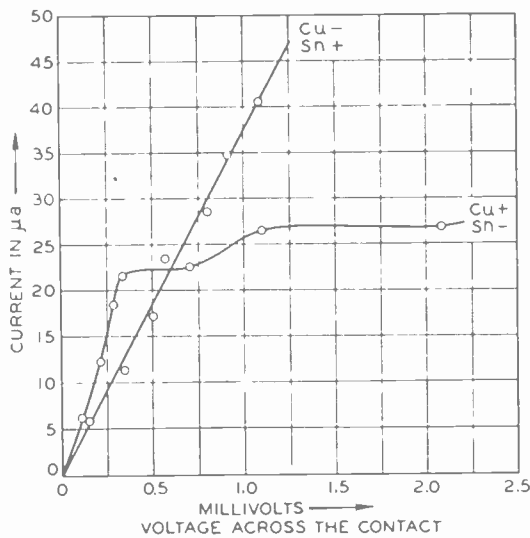

Fig. 6—Copper-tin contact.

The calibration curves for the mirror galvanometer and the milli- and microammeters were drawn before using them in the circuit.

The effect of the areas of the contact surfaces was investigated with various types of electrodes.

(b) Discussion of Results

The observed current changes for various terminal voltages are plotted in Figs. 3 to 7. It is evident from these that when the thermopositive element of a contact is given a positive polarity the curves have the same form and show a definite tendency towards reaching saturation conditions. When on the other hand, the thermopositive element is given a negative polarity, the contact appears to follow Ohm's law, the current being proportional to the terminal e.m.f. The approximate saturation currents for *Cu-Fe*, *Sn-Zn*, *Zn-Fe*, *Cu-Sn*, and *Bi-Fe* are

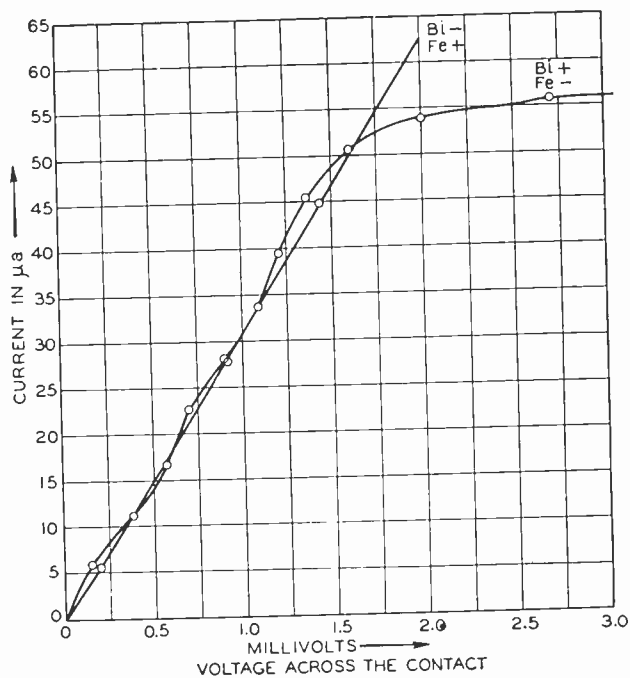

Fig. 7—Bismuth-iron contact.

respectively 25.5, 22.5, 22.5, 27, and 55 microamperes. The slight irregularities noticed in the curves might have been due to impurities present in the samples.

The curves of Fig. 8 are derived from the previous ones and show how the contact resistance varies with the polarity and magnitude of the terminal voltages.

The curves of Fig. 9 show the effect of area of contact. Generally point-to-point contact appears to have better rectifying properties than point-to-plane. Plane-to-plane contact has little directional conductivity. It is thus evident that there is definite state of resistivity at the contact on either side of which the circuit loses its rectifying properties. The greater the area of contact, the less the resistance, and consequently the poorer the rectification.

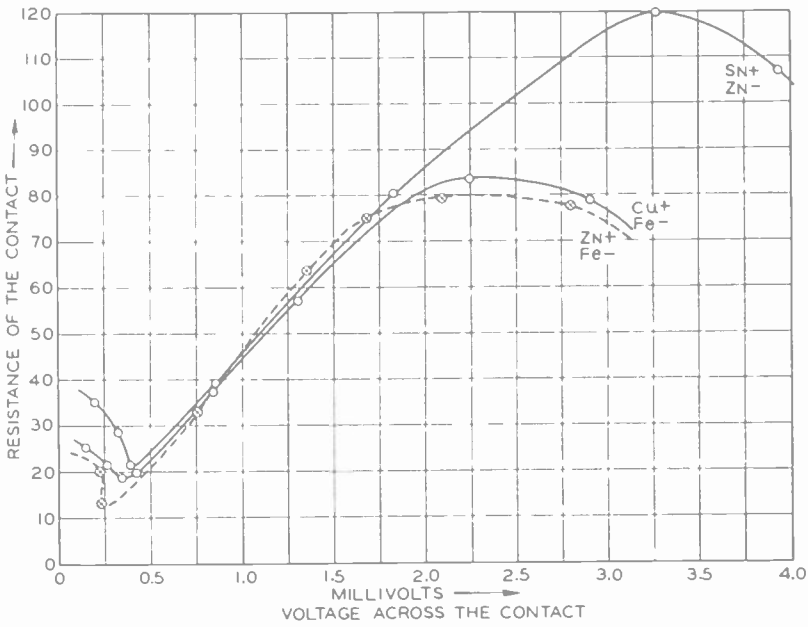

Fig. 8—Variation of resistance with impressed voltages.

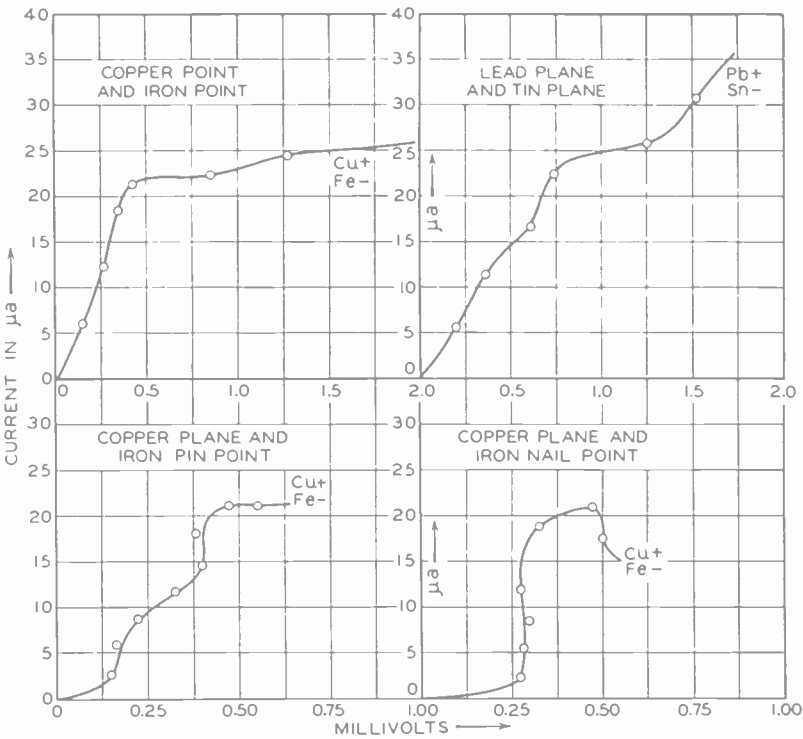

Fig. 9—Effect of the surface areas of contact.

IV. EFFECT OF PRESSURE ON THE CHARACTERISTICS

(a) *Method of Experimentation*

A lead-tin contact was used for the experiment, lead being thermopositive and tin thermonegative. The contact was formed by placing a plane surface of a lead rod over the plane surface of a tin block. The exact arrangement is shown in Fig. 10.

The tin block was rigidly fixed to the platform. The vertical lead block was held at its upper portion by means of an ebonite collar rigidly fixed to the clamp stand. Different weights were placed on the other end of the lead rod, and the observations were repeated as usual. The area of the contact surface was 0.38 square centimeters.

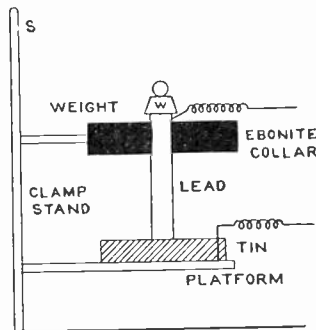

Fig. 10—Elevation.

(b) *Discussion of Results*

The curves of Fig. 11 show the performance for various weights as the terminal voltage is varied. From zero to 3 grams added weight, the possibility of rectification occurring gradually increases and then diminishes until at 5 grams the circuit loses this property and behaves like a pure resistance. This set of experiments further confirms the view that rectification takes place only at a certain state of contact between open circuit and perfect conductivity—a state called “imperfect contact state.” In this particular experiment the weight of rod appears just enough to bring the contact to the desired state of resistivity while 6 grams or thereabouts completely destroy the rectification property.

V. EFFECT OF TEMPERATURE ON THE CHARACTERISTICS

(a) *Method of Experimentation*

The contact was electrically heated with a flat spiral of nichrome wire carrying 1.6 amperes and placed immediately underneath the contact. The contact was carefully enclosed in a small fiber enclosure, and a thermocouple was placed very near the contact to give an indication of the temperature rise. Before observations were started, the cur-

rent was passed through the heater wire sufficiently long so that the temperature might be constant. This was indicated by the deflection of the galvanometer in the thermojunction circuit. Then the observations were taken just as in the preceding cases. The circuit arrangements are shown in Fig. 12.

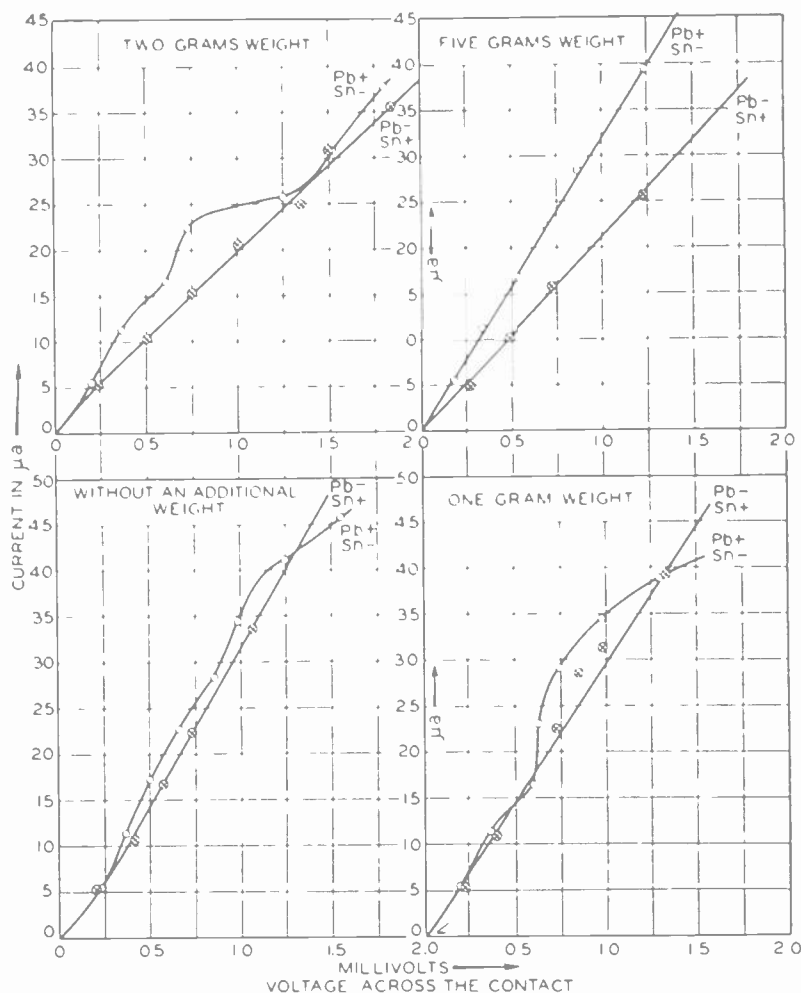

Fig. 11—Effect of pressure. Lead-tin contact. Area of the contact surface = 0.38 sq. cm.

(b) Discussion of Results

The effect of the external heating has been to alter the form of the characteristics according to the authors' expectations. Two points are of special interest in case of the positive side characteristic; i.e., when the thermopositive element is electrically positive.

First, the portion of the characteristic from the origin to the saturation bend is very nearly straight. This is because $e_c T$ does not vary with the variation of T (temperature) since $T = \text{constant}$.

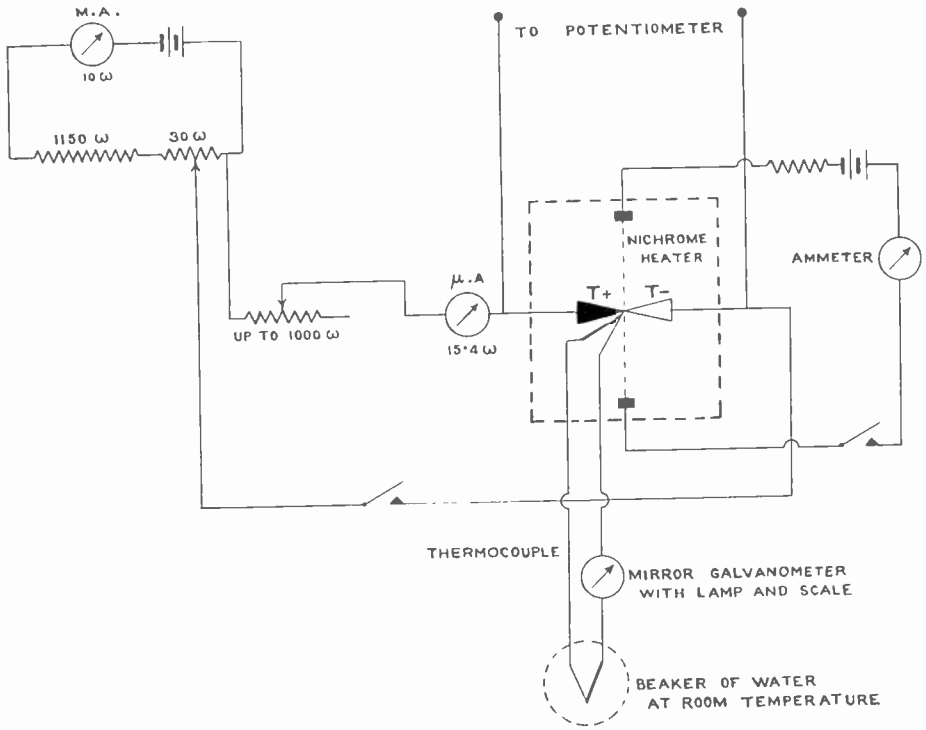

Fig. 12—Circuit diagram.

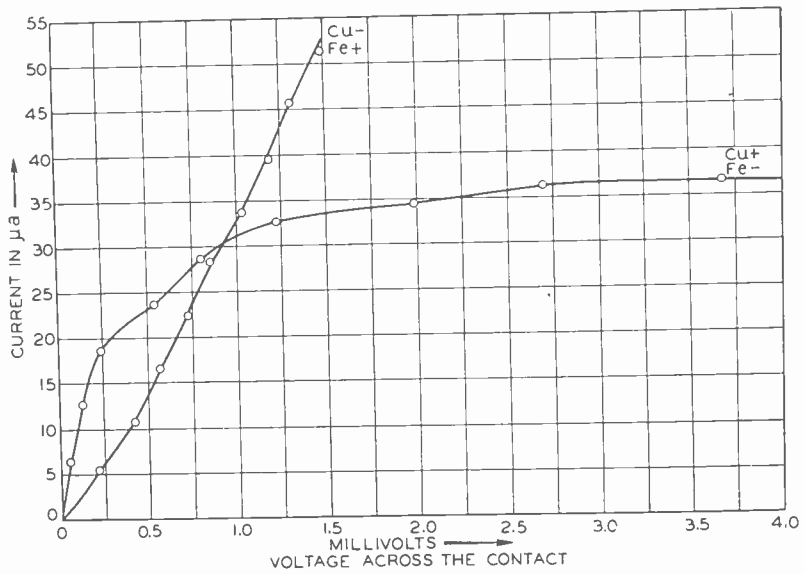

Fig. 13—Effect of temperature. Copper-iron contact. Temperature = 10° above room temperature.

Second, the saturation current is greater than that at room temperature, and the saturation is more definite and takes place at a higher contact potential difference. The saturation currents are 36.7 and 40 microamperes for the two temperatures considered, against 25.5 microamperes at room temperature.

On the negative side curve, the points lie very nearly on a straight line as usual, but near the origin the characteristic shows some curvature.

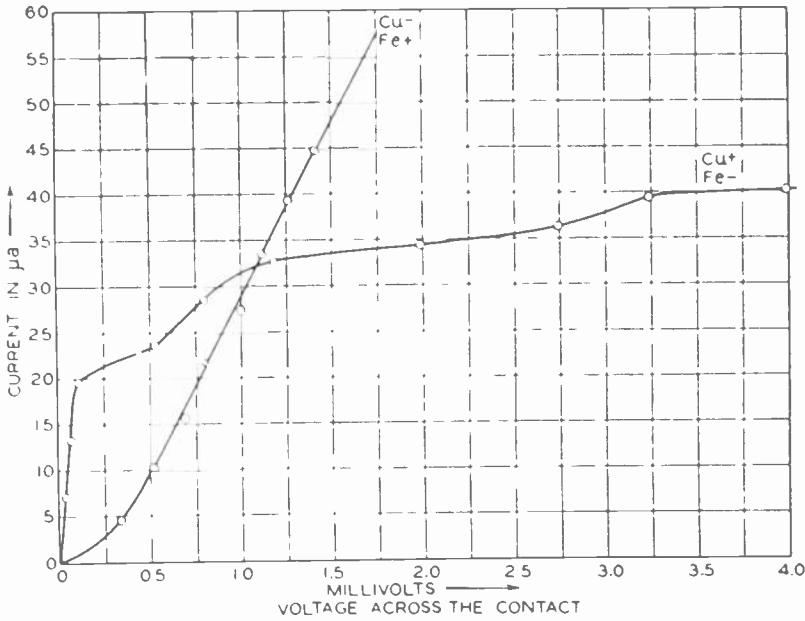

Fig. 14—Effect of temperature. Copper-iron contact. Temperature = 35°C above room temperature.

VI. PROPOSED THEORY OF THE ACTION

The rectifying action of metallic contacts may be explained from two principal causes; namely, (1) the development and variation of a thermo e.m.f. after the polarizing e.m.f. in the circuit is switched on, and (2) the variation of the contact resistance with the voltage impressed across it.

There is an appreciable time interval between the development of this thermo e.m.f. and the application of the exciting e.m.f. to the circuit. Ettenreich² gave the magnitude of this time lag to be about 2 microseconds in case of galena-Ni and perikon. In the present case, this period appears to be sufficiently great as the Ohm's law part of the characteristic is long.

Referring to Fig. 15, here the thermopositive element is given a positive bias with respect to the thermonegative element. On passing

a current across the contact (junction) from the thermopositive ($T+$) element to the thermonegative ($T-$), the contact gets slightly cool due to the Peltier effect. Further, as the contact resistance is sufficiently high, a certain amount of heat is simultaneously developed due to the Joule effect. As long as the heat absorbed equals the heat developed, the temperature remains the same as that of the surroundings, and the characteristic obeys Ohm's law. The period during which this state lasts is the "time lag" and can be calculated easily.

Subsequently, the temperature of the contact rises above that of the surroundings, as the net heat units developed increases. A thermo e.m.f. e_c for every 1° temperature difference is developed in the same direction as that of e . Simultaneously a change of the contact resistance takes place according as the resulting e.m.f. in the circuit is

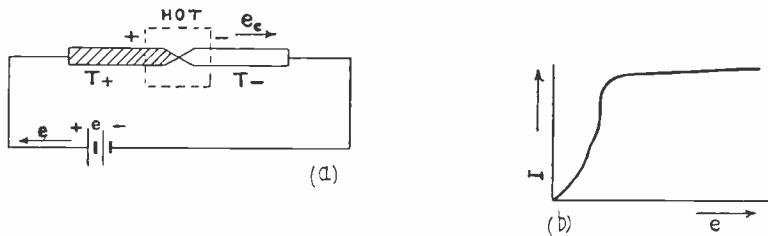

Fig. 15

altered. The change of curvatures in characteristics and the attainment of a saturation state, though imperfect, are mainly due to the development in the circuit of this increasing e.m.f. $e_c T$ and to its reaching a steady value. The partial saturation state and the appearance of irregularities in curves may be due to impurities present in the metals employed.

Till the temperature rises T° above the surroundings, the contact obeys the law $R = \text{constant}$. Subsequently at any instant, if e be the exciting e.m.f. in the circuit and $e_c T$ the developed thermo e.m.f., the total e.m.f. acting in the circuit $= e + e_c T$. Now $e_c T = e' = a + bT + cT^2$, where a , b , and c are constants depending upon the metals forming the thermoelectric circuit.

$$\begin{aligned} \text{Then the total e.m.f. } E &= e + e_c T \\ &= e + (a + bT + cT^2) \\ &= e + f(T). \end{aligned}$$

Further, the resistance R (at that instant) $= \phi(E) = \phi[e + f(T)]$. Hence, the current

$$I = \frac{E}{R} = \frac{e + f(T)}{\phi[e + f(T)]}.$$

The current, therefore, varies with the variation of both T and e .

When the temperature becomes constant; i.e., $T = T_0$, then $f(T) = f(T_0) = k$ (say), $E' = e + k$ and $R' = \phi(e + k)$. The current

$$I' = \frac{E'}{R'} = \frac{e + k}{\phi(e + k)}$$

Now $\phi(e + k) = \phi(e) + k\phi'(e) + (k^2/2!)\phi''(e) + \dots$, etc. so that

$$I' = \frac{e + k}{\phi(e) + k\phi'(e)}$$

neglecting the third and higher terms of the expression. To evaluate I' completely, the exact law of variation of R with E must be known.

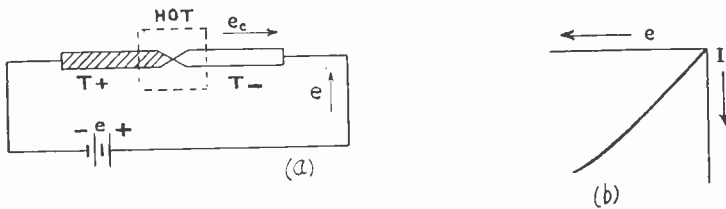

Fig. 16

Suppose the law is linear, that is, $R = A + BE$. Then $\phi(e) = A + Be$ and $\phi'(e) = B$. Therefore,

$$I' = \frac{e + k}{Be + (A + kB)} = \frac{1}{B} \text{ approximately = constant.}$$

If the law of variation is given by $R = A + BE + CE^2$, then

$$I' = \frac{e + k}{A + Be + Ce^2 + k(B + 2Ce)} = \frac{e + k}{(B + 2kC)e + (A + kB) + \dots \text{ etc.}}$$

$$= \frac{1}{B + 2kC}$$

$$= \text{constant.}$$

The effect of externally heating the contact may be explained as follows. From the origin to the saturation bend the curve is practically straight. For this part, the "Constant Law," that is, $R = A = \text{constant}$, is obeyed. The current $I = (e + k)/R$, $k = f(T_0) = \text{constant}$. From the saturation bend onwards, the linear or the square law ($R = A + Be$, or $R = A + Be + Ce^2$) is obeyed, or in other words, $R = \phi(e)$. The current value then remains practically constant. Now consider Fig. 16. Here the thermo-positive element is given a negative bias with respect to the

thermo-negative element. When a current passes across the contact from $(T-)$ to $(T+)$ the contact gets slightly warm due to the Peltier effect. Some heat is also developed due to the Joule effect, so that from the very beginning a temperature difference is created. In the previous case there was a time period during which the Joule effect and the Peltier effect tended to neutralize each other, leaving the junction appreciably at room temperature. This temperature difference gradually increases. The total heat developed at any instant

$$= \frac{1}{4 \cdot 2} \left(\frac{e^2}{r} + \frac{\pi e}{r} \right) = MT,$$

where M is a constant and T the temperature developed.

$$MT = \frac{1}{4 \cdot 2} \cdot \frac{e^2}{r} \left(1 + \frac{\pi}{e} \right) = \frac{1}{4 \cdot 2} \cdot \frac{e^2}{r}$$

nearly, so that

$$T = \frac{1}{4 \cdot 2M} \cdot \frac{e^2}{r} = \frac{1}{4 \cdot 2M} \cdot \frac{e^2}{\phi(e)} = ke \text{ nearly,}$$

if $\phi(e)$ is linear.

Suppose the resistance R_0' at any instant, after the development of thermo e.m.f. is given by

$$R_0' = \frac{e - e_c T}{I_1} + [\phi(e) - \phi(e - e_c T)] = \frac{e - e_c T}{I_1} + e_c T \phi'(e).$$

If e is now changed to $e + \delta e$, the current I_1 changes to $I_1 + \delta I_1$ and the temperature T to $T + \delta T$. The new resistance

$$R' = \frac{(e + \delta e) - e_c(T + \delta T)}{I_1 + \delta I_1} + \delta R_1,$$

where δR_1 = resistance change due to change of impressed voltage.

If $R_1 = \phi(e - e_c T)$, then $\delta R_1 = (\delta e - e_c \delta T) [\phi'(e) - e_c T \phi''(e)]$. Therefore, the new resistance is given by

$$\begin{aligned} R' &= \frac{(e + \delta e) - e_c(T + \delta T)}{I_1 + \delta I_1} + (\delta e - e_c \delta T) [\phi'(e) - e_c T \phi''(e)], \\ &= R_0' + \frac{\delta e - e_c \delta T}{I_1 + \delta I_1} + [\delta e - e_c(T + \delta T)] \phi'(e), \end{aligned}$$

since $\phi''(e) = 0$, $\phi(e)$ being linear.

$$\doteq R_0' + \frac{\delta\epsilon(1 - \epsilon k)}{I_1 + \delta I_1} + A'\delta\epsilon[1 - \epsilon k],$$

since $\phi'(e) = \text{a constant} = A'$, $T + \delta T = T$ nearly.

$$\doteq R_0' + \delta\epsilon \left(A' + \frac{1}{I_1 + \delta I_1} \right)$$

$$\doteq R_0'.$$

The resistance is therefore the same throughout.

VII. CONCLUSION

(1) Rectifying properties of six different metal junctions are studied. In all cases it is found that when the thermopositive element is given a positive polarity, the current passing the junction shows a limiting value. Consequent rectification being far from linear can be represented by

$$\int_0^{T_1} i dt \gtrsim \int_{T_2}^T i dt.$$

This by suitably biasing the junction can be converted to

$$\int_0^{T_2} i dt \gtrsim \int_{T_2}^T i dt.$$

(2) The contact under rectifying conditions has a resistance of the order of 10 to 100 ohms. This state of conductivity can be destroyed by increasing the mechanical pressure on the contact, when the junction ceases to function as a rectifier.

(3) Point-to-point contacts are best suited for rectification work, the flatter the contact the less the rectification.

(4) External heating of junction destroys rectifying property.

(5) The farther apart in the thermoelectric series the two metals of the junction are, the better the rectifier.

(6) Metal contact rectifiers work best at low alternating-current voltages of the order of a few millivolts.

(7) Metal contact rectification is explained on the assumption that after the application of the e.m.f., a thermo e.m.f. is generated and that the contact resistance also varies. A mathematical analysis is attempted in explanation of the observed phenomena.

Bibliography

- (1) J. de Pauw, "Effects of contact upon telegraphic and telephonic currents," Belgium *Elec. Bull.*, January, 1902.
- (2) H. Hausrath, and R. Rinkel, "Die Wirkungsweise des Kontaktdetektors," *Jahr. draht. Tel. u. Tel.*, vol. 10, p. 64-86; August, (1915).
- (3) Robert Ettenreich, "Reaktionsbeit von Kontaktdektoren," *Akademie der Wissenschaften, Sitzungsberichte, Mathematischnaturwissenschaftliche Klasse*, vol. 128, 2a, p. 1169-1200, (1919).
- (4) Robert Ettenreich, "Schwebungsmethode zur Prüfung der Tragheit von Kontaktdektoren," *Phys. Zeit.*, vol. 21, no. 8, p. 208-214; April 15, (1920).
- (5) Hermann Rohmann, "Elektrische Kontakte," *Phys. Zeit.*, vol. 21, no. 16, p. 418-423; August 15, (1920); no. 23-24, p. 699-703; December 1-15, (1920).
- (6) J. Zenneck, "Trägheit von Thermodetektoren," *Jahr. draht. Tel. u. Tel.*, vol. 17, no. 3, p. 162-179; March, (1921).
- (7) R. Audubert, "Contribution a l'etude des detecteurs a contacts solides," *Jour. de Physique*, 5th ser., vol. 7, p. 127-128, 172-183, 209-223; November-December, (1917).
- (8) J. Cayrel, "Influence de la force pressante sur le fonctionnement des detecteurs a contact solide," *Comptes Rendus*, vol. 179, p. 259-263; July 28, (1924).
- (9) A. Blanc, "Sur les detecteurs a contacts rectifiants," *Annales de Physique*, 10th ser., vol. 2, p. 435-460; November-December, (1924).
- (10) Iwan Stranski, "Ueber die Gleichrichterwirkung der Kontaktdektoren," *Zeit. f. physik. Chemie*, vol. 113, p. 131-144; October 18, (1924).
- (11) H. Pelabon, "Sur la detection par les contacts metalliques," *Onde Electrique*, vol. 5, p. 464-475; September, (1926).
- (12) H. Pelabon, "Sur les contacts imparfaits," *L'Onde Electrique*, vol. 6, p. 401-426, September, (1927).
- (13) Fritz Regler, "Vorläufige Mitteilung über die Theorie des Kontaktdektors," *Phys. Zeit.*, vol. 29, no. 13, p. 429-437; July 1, (1928).
- (14) H. Pelabon, "Sur la rectification par les mauvais contacts purement metalliques," *Comptes Rendus*, vol. 188, p. 382-384; January 28, (1929).
- (15) J. Cayrel, "Effet du champ magnetique sur la resistance electrique d'un contact," *Comptes Rendus*, vol. 187, p. 1287-1288, December 26, (1928).



DISCUSSION ON "THE CAMPBELL-SHACKELTON SHIELDED RATIO BOX"*

LEO BEHR AND A. J. WILLIAMS, JR.

R. F. Field:¹ The earth connection as originally devised by Wagner removed the ground entirely from the bridge and compensated for the unsymmetrical capacitances to ground of the input transformer. The earth connections described in this paper in Figs. 11a, 12a, and 13a, are important modifications which compensate also for the capacitance to ground of the leads to the high-potential terminals of the unknown and standard condensers.

In the method for the grounded point bridge shown in Fig. 11a, the placing of the resistances of the Wagner ground in parallel with the condensers decreases the sensitivity of balance of the bridge, noticeably for the capacitive balance, and seriously for the resistive balance. These resistances are 10 kilohms each. The reactance of a capacitance of 1000 $\mu\mu\text{f}$ at a frequency of 1 kc is 160 kilohms. For a power factor of 0.001 for this condenser its parallel resistance is 160 megohms. Placed in parallel with 10 kilohms it will produce a change of 0.6 ohm. It will be difficult to observe this change with satisfactory accuracy.

When known resistance boxes are used in making the resistance balance as shown in Fig. 12a, the resistance of the Wagner ground is unnecessary. The resistance calculated for the unknown condenser is merely the difference in resistance of the unknown and standard condensers. The resistance of the standard condenser must be known before that of the unknown can be obtained. The power factor of a well-designed standard air condenser set at 1000 $\mu\mu\text{f}$ is about 0.00005 which is appreciable compared to the value of 0.001 previously discussed. This power factor varies inversely with the capacitance.

The loss in sensitivity due to the use of parallel resistors may be eliminated by the use of series resistors, both in the Wagner ground and for the resistance boxes. The inductance of the added resistance box will be of consequence only at high frequencies. The effect of energy loss in the standard condenser may be practically eliminated by using a substitution method in which the standard condenser is always kept in circuit, and the unknown condenser connected and disconnected.

The consideration of impurities in the standard is perhaps beyond the scope of this paper, as implied in the summary. But the choice of a method is frequently determined by the characteristics of the available standards.

Leo Behr:² As mentioned by Mr. Field, Figs. 11a and 12a represent a convenient and useful bridge circuit. It does not seem fitting however, to term them modifications of the Wagner earth connection, for the circuits and their advantages were completely described by Dr. G. A. Campbell in 1904,³ some seven years before the publication of Wagner's paper.⁴

The circuit of Fig. 13a is a convenient modification of the Wagner earth connection, particularly when it is desired to keep one terminal of the detector permanently connected to earth or when very small admittances are being compared.

* Proc. I.R.E., vol. 20, p. 969; June, (1932).

¹ General Radio Company, Cambridge, Mass.

² Leeds and Northrup Company, Philadelphia, Pa.

³ Elec. World and Eng., vol. 43, p. 647, (1904).

⁴ Elek. Tech. Zeit., vol. 32, p. 1001, (1911).

The shunt connection for measuring conductance, as shown in Fig. 12a, is preferred to the use of a series resistance as in Fig. 12c, because of the wide range of the former and because correctly shielded equipment for the shunt circuit is less expensive and is commonly available. With the series resistance, the double shielding of Fig. 12c is necessary, if the possibility of serious error⁵ is to be avoided. We have used the circuit of Fig. 12a to study the losses, at 50,000 cycles, in an air condenser of about the same characteristics as that described by Mr. Field. The sensitivity for the resistance balance was approximately 0.01 ohm and was sufficient for a determination of the distribution of the losses among the individual insulating supports of the condenser.

⁵ Cf. R. P. Siskind "Capacitance and Power Factor Measurement by the Capacitance Bridge," A.I.E.E. Convention, January, 1932.



BOOK REVIEWS

Standards Year Book, 1932, U. S. Department of Commerce, Bureau of Standards. Miscellaneous Publication No. 133. 394 pages. Price \$1.00. Superintendent of Documents, Government Printing Office, Washington, D. C.

The Standards Year Book for 1932 is the Sixth Edition in this series published by the U. S. Department of Commerce. A special feature of the 1932 Year Book which is of interest to radio engineers is the symposium on "Standardization in Communication" which occupies the first 62 pages of the book. This symposium consists of articles by various persons engaged in communication work giving a discussion of the value of research as an aid to standardization, as well as brief summaries of the accomplishments in the fields which are covered. Among the subjects to which the articles relate are, aviation, telephony, telegraphy, transportation, postal service, and various aspects of radio communication.

Additional portions of the Year Book cover in detail such subjects as international standardizing agencies, national standardizing laboratories and national industrial standardizing bodies of various countries, federal standardizing agencies of the United States, with particular reference to the Bureau of Standards, municipal, county, and state purchasing agencies and general standardizing agencies of the United States. The Year Book contains a detailed subject index and includes a descriptive alphabetical list of 416 standardizing agencies of the United States.

*J. E. WHITEMORE

* American Telephone and Telegraph Company, New York City.

National Directory of Commodity Specifications, U. S. Department of Commerce, Bureau of Standards. Miscellaneous Publication No. 130. 548 pages. Price \$1.75. Superintendent of Documents, Government Printing Office, Washington, D. C.

This Directory contains classified and alphabetical lists and brief descriptions of commodity specifications of national recognition in the United States. It is the first revision of a Directory issued as Miscellaneous Publication No. 65. The commodities covered include animal and vegetable products, textiles, paper, minerals, metals, machinery, chemicals, and other commodities, including many manufactured products.

The section on Electrical Machinery and Supplies occupies 50 pages and includes a number of references to specifications covering radio equipment.

*L. E. WHITEMORE

* American Telephone and Telegraph Company, New York City.



BOOKLETS, CATALOGS, AND PAMPHLETS RECEIVED

A manual of receiving vacuum tubes manufactured and sold by the RCA Radiotron Company has recently been published and is available from the Commercial Engineering Section, RCA Radiotron Company, Harrison, N. J. An identical manual, except that it deals with the corresponding Cunningham tubes, is also available from the Commercial Engineering Section, E. T. Cunningham, Inc., Harrison, N. J. Both manuals give a brief introduction into the theory and operation of tubes, their manufacture, characteristics, installation, and applications. Each type of tube is also separately described and a set of characteristic curves given. Both 84-page manuals are very completely illustrated and in these days of new tubes should be of considerable assistance to those working with vacuum tubes.

A 24-page booklet is available from the Publicity Department of the Western Electric Company, 195 Broadway, New York, describing three models of Western Electric radio frequency distribution systems for hotels and apartments. The No. 1A system will serve fifteen Western Electric 10A receivers, while the No. 2A system and the No. 3A system will serve, respectively, up to ten and up to 3000 receivers of any make.

A multiple pole, multiple throw switch designed for changing the frequency ranges of high-frequency receivers, is described in a folder issued by the Oak Manufacturing Company, 308 W. Washington Street, Chicago.

Part II, of Bulletin 100-F of Isolantite, Inc., 75 Varick Street, New York, illustrates the application of isolantite to apparatus intended for operation at high radio frequencies. Besides products manufactured exclusively by Isolantite, Inc., apparatus manufactured by other firms using isolantite is illustrated.

A series of permanent magnet dynamic speakers manufactured by the Magnavox Company of Fort Wayne, Ind., is described in a folder issued by this concern. Speakers of the type described have wide application for battery operated receivers, where the current consumption must be a minimum.

A series of bulletins of Silver-Marshall, Inc., 6401 West 65th Street, Chicago, describes their line of audio-frequency equipment. Sheet No. 1 describes microphones, meter panels, gain controls and other general sound equipment. Volume or power level indicators are described in sheet No. 2. A complete line of speakers is described in sheet No. 3, and sheet No. 4 deals with the Silver-Marshall line of audio amplifying transformers. Input control panels are described in sheet No. 5.

The catalog of the Cannon Electric Development Company, 420 West Avenue, 33, Los Angeles, describes a complete line of plugs, receptacles, and fittings for newsreel equipment, sound installations and the like.

A spectroscope of great intensity and a vacuum iron arc lamp for spectroscopic work are described in bulletins recently issued by P. J. Kipp and Soñs, Delft, Holland.

Bulletin No. 200 of National radio products describes the complete line of equipment manufactured by the National Company of Malden, Mass. "Below Ten Meters," a 64 page manual of ultra short wave radio communication, is a general treatment of high-frequency apparatus and communication. Most of the material in "Below Ten Meters" is taken from the writings of those experimenters most active in this field.

RADIO ABSTRACTS AND REFERENCES

THIS is prepared monthly by the Bureau of Standards,* and is intended to cover the more important papers of interest to the professional radio engineer which have recently appeared in periodicals, books, etc. The number at the left of each reference classifies the reference by subject, in accordance with the "Classification of radio subjects: An extension of the Dewey Decimal system," Bureau of Standards Circular No. 385, obtainable from the Superintendent of Documents, Government Printing Office, Washington, D.C., for 10 cents a copy. The classification also appeared in full on pp. 1433-56 of the August, 1930, issue of the Proceedings of the Institute of Radio Engineers.

The articles listed are not obtainable from the Government or the Institute of Radio Engineers, except when publications thereof. The various periodicals can be secured from their publishers and can be consulted at large public libraries.

R100. RADIO PRINCIPLES

- R113 Wireless measurements in the Arctic Circle—Radio Board's "Polar Year" expedition. *Wireless World*, vol. 31, p. 17; July 8, (1932).

Note on the type of observations to be made and type of apparatus carried on the expedition led by Prof. E. V. Appleton.

- R113 M. J. O. Strutt. Zusammenfassender Bericht: Der Einfluss der Erdbodeneigenschaften auf die Ausbreitung elektromagnetischer Wellen. (A comprehensive treatment—The influence of the properties of the earth's surface on the transmission of electromagnetic waves). *Hochfrequenz und Elektroakustik*, vol. 39, pp. 177-185, May; pp. 220-225, June, (1932).

The treatment is divided into four parts, the first part treats electromagnetic radiation without an earth. Part II is devoted to radiation diagrams under the influence of the earth. Part III treats the field strength on the earth's surface. Part IV takes up the experimental determination of the "Erdbodeneigenschaften."

- R113.5 E. Bruche. Polarlicht und Heavisideschicht. (Polar light and Heaviside layer). *Zeits. für tech. Phys.*, no. 7, pp. 336-341; (1932).

×R113.61

The northern lights and the Heaviside layer are discussed.

- R113.6 W. Köhler. Die Wirkungsweise von Vollmetall- und Gitterreflektoren bei ultrakurzen Wellen. (The operation of solid metal and grid reflectors for ultra-short waves). *Hochfrequenz. und Elektroakustik*, vol. 39, pp. 207-219; June, (1932).

The operation of plane metal reflectors and grid reflectors on receiver and transmitter for wavelengths of 16.8 cm is investigated. It is shown that a parabolic reflector is far superior to a plane mirror. It is found that a parabolic reflector should have a width of 5 wavelengths of the reflected wave. The grid reflector produces large back radiation and small amplification.

- R113.61 J. P. Schafer and W. M. Goodall. Kennelly-Heaviside layer studies employing a rapid method of virtual-height determination. *Proc. I.R.E.*, vol. 20, pp. 1131-48; July, (1932).

* This list compiled by Mr. A. A. Hodge and Miss E. M. Zandonini.

This paper describes a new method of determining the virtual height of the ionized regions by visual observations of the received pulse pattern on a cathode-ray oscillograph tube, both for single frequencies and for two frequencies simultaneously. A résumé of the data obtained during observations of some three hundred hours is given. The frequencies used for these tests were 1604 kc, 2398 kc, 3256 kc, 4795 kc, and 6425 kc. A number of the tests included measurements made upon two frequencies in rapid rotation. The more important results are summarized.

- R113.7 G. H. Munro. The attenuation of short wireless waves at the surface of the earth. *Jour. I.E.E.*, (London), vol. 71, pp. 135-143; June, (1932).

An apparatus is described for measuring relative field intensities of wireless waves of the order of 20 meters and the results of a series of measurements taken with it on wavelengths of approximately 25 meters for distances of from 200 feet to 60 miles from the transmitter are shown as "Intensity/Distance" curves. For distances greater than 2 miles the decrease of intensity is found to be approximately proportional to the inverse square of the distance as predicted by the Sommerfeld theory. For shorter distances the curves are much straighter than predicted by the theory.

- R114 H. Norinder. Die Blitzentladungen als Ursache Atmosphärischer Rundfunkstörungen. (Lightning discharge as a cause of atmospheric disturbances). *Elek. Nach. Tech.*, vol. 9, pp. 195-201; June, (1932).

A specially constructed cathode-ray oscillograph was used to study lightning discharges. Several oscillograms are shown. The time of duration and nature of the discharge are investigated.

- R116 E. J. Sterba and C. B. Feldman. Transmission lines for short-wave
×621.319.2 radio systems. *PROC. I.R.E.*, vol. 20, pp. 1163-1202; July, (1932).

The requirements imposed on transmission lines by short-wave radio systems are discussed, and the difference in the requirements for transmitting and receiving purposes is emphasized. Particular attention is given to concentric tube lines and balanced two-wire lines. The concentric tube line is particularly valuable in receiving stations where great directional discrimination is involved and low noise and static pick-up is required. Excellent agreement between calculations and measurements is found for the high-frequency resistance of concentric lines, using the asymptotic skin effect formula of Russell. Practical aspects of line construction such as joints, insulation, and provision for expansion with increasing temperature are discussed. Some difficulties encountered in transmission line practice, such as losses due to radiation, reflections from irregularities, effects of weather and spurious couplings between antenna and line are discussed.

- R133 A. Giacomini. On the production of ultra-short electromagnetic
×R355.5 waves. *Phys. Rev.*, vol. 41, p. 113; July 1, (1932).

The author states that he has obtained short electromagnetic waves with several types of heater tubes. Working conditions are given.

- R133 G. Potapenko. Investigations in the field of ultra-short electromagnetic
×R355.5 waves—Electronic oscillations in vacuum tubes and the cause of the generation of dwarf waves. *Phys. Rev.*, vol. 40, pp. 988-1001; June 15, (1932).

The purpose of this paper is the elucidation of the causes of the generation of the dwarf waves, i.e., of waves with frequencies exceeding many times the frequency of the oscillations of the electrons about the grid of the tube. By a consideration of the motion of electrons it is shown that the reason a vacuum tube can generate dwarf waves is because the tube can transmit energy into the oscillating circuit coupled with it and transmit it periodically with a period equal to the natural period of the circuit not only when this period T is equal to the period of electronic oscillations τ (normal waves) but also when $T = \tau/2$, $T = \tau/3$, $T = \tau/4$. . . (dwarf waves).

- R133 C. J. de Lussanet de la Sablonière. Über die Arbeitsweise von
Schirmgitter-Senderöhren. (On the method of operation of a screen-grid transmitting tube). *Hochfrequenz. und Elektroakustik*, vol. 39, pp. 191-99; June, (1932).

The position and purpose of the screen-grid are discussed. From the static characteristics of the screen-grid tube curves are drawn which for a definite control voltage show the direct-current plate current, screen-grid current and the antenna current as a function of the screen-grid voltage. Approximate formulas are set up for the screen-grid and plate loss. Assuming a relation between the antenna current and the screen-grid voltage a kind of circular diagram is constructed.

- R143 J. Labus. Berechnung der Einschwingzeit von Bandfiltern. (Calculation of the transient time of band filters). *Elek. Nach. Tech.*, vol. 9, pp. 226-33; June, (1932).

The purpose of this investigation is to determine the "Einschwingdauer" of band filters and to compare the results with existing formulas. The transient effect of an indefinitely long network is calculated. A direct-current voltage is considered as the source of excitation. Then an alternating disturbance is considered.

- R149 E. B. Moullin. The detection by a straight line rectifier of modulated and heterodyne signals. *Wireless Engineer and Experimental Wireless* (London), vol. 9, pp. 378-83; July, (1932).

The problem of a strong signal demodulating a weak one is treated from the standpoint of why the interfering program gets through in the presence of the strong signal. After considering rectification of a heterodyne signal where the two voltages are sustained, the case in which one voltage is modulated is treated. The condition for immunity from an interfering station is developed. A numerical example of the immunity ratio is given.

- R162 L. G. A. Sims. New pentode output circuit. *Wireless World and Radio Review*, vol. 30, pp. 677-81; June 29, (1932).

It is pointed out that an improvement in bass response can be affected by the use of a small capacity in the choke filter output circuit of a pentode. A condenser of about one-eighth of the usual capacity is made to resonate with the output choke at low frequencies and a circuit very similar to that of the parallel fed low-frequency transformer results. The resonance is damped out by the low impedance of a triode but remains almost unaltered by the high pentode impedance. Practical examples are outlined.

R200. RADIO MEASUREMENTS AND STANDARDIZATION

- R201.7 L. A. Wood. A method of frequency measurement with the cathode-ray oscillograph. *Rev. Sci. Inst.*, vol. 3, pp. 378-83; July, (1932).

A simple method of frequency measurement is given.

- R201.7 J. T. MacGregor-Morris and H. Wright. Accuracy of measurements made with hot-filament cathode-ray tubes of the gas focused type. *Jour. I.E.E.*, (London), vol. 71, pp. 57-68; June, (1932).

The rapid development of the hot-filament type of cathode-ray tube is outlined, and various sources of error which are encountered in its use as a measuring instrument are discussed, including errors inherent to the tube, especially those due to the effect of gas conduction, then errors of manipulation and those due to external influences are reviewed. Recording is next dealt with. A quantitative examination of the "threshold effect" is given. In an appendix particulars relating to the latest pattern of low voltage tube are given, and its sensitivity discussed.

- R214 V. J. Andrew. The design of temperature control apparatus for piezo oscillators. *Rev. Sci. Inst.*, vol. 3, pp. 341-51; July, (1932).

The procedure is described for calculating the dimensions of the different components of a temperature control system consisting of conducting and insulating layers outside the thermostat, and absorbing, and in some cases insulating layers between the thermostat compartment and the quartz plate mounting. A method is explained for observing and empirically reducing the effect of variations of room temperature on the controlled temperature of the apparatus. This effect depends on the relative positions of the thermostat, the heater, and the quartz plate. It is usually the limiting factor in precision of control.

- R223 W. Anderson. The dielectric constant and power factor of some solid dielectrics at radio frequencies. *Phil. Mag.* (London), vol. 13, pp. 986-93; May, (1932).

The variation of the dielectric constant and power factor with frequency between 150 and 1500 kilocycles of some solid dielectrics is investigated.

- R242.16 A. S. McFarlane. Some aspects of the valve bridge with a description of a new compensated valve-voltmeter. *Phil. Mag.* (London), vol. 14, pp. 1-17; July, (1932).

The general theoretical relationships which hold in a Wheatstone bridge system, two of the arms of which consist of triode vacuum tubes, are considered and an expression is deduced, and experimentally verified, for the condition that the bridge may be simultaneously balanced and compensated against fluctuations in the plate supply. The theory of a device whereby the filament and grid voltages are derived from the 4-volt battery in such a way that minor changes in the voltage of this battery have no significant effect on the bridge zero, is given. A practical form of vacuum-tube voltmeter is described. It is compensated against changes of 20 volts in plate supply and 0.3 volt in the common grid, low voltage supply.

- R243.1 J. Thomson. A new thermionic voltmeter. *Jour. Sci. Inst.*, vol. 9, pp. 186-91; June, (1932).

A thermionic voltmeter is described which depends upon the emission of secondary electrons from the plate of a new type of vacuum tube. It is suitable for measurement of high potentials at high frequencies.

- R254 H. L. Kirke. Recording of modulation level of a broadcast system. *Wireless Engineer and Experimental Wireless* (London), vol. 9, pp. 369-77; July, (1932).

Apparatus is described which has been developed for indicating and recording the modulation level of a broadcast system. Such recording may take place at any convenient point in the chain of apparatus between the microphone and transmitter or may be used in conjunction with receiving apparatus. In the latter case, if the receiver is situated at a distance from the transmitter such that fading occurs, automatic gain control is provided to compensate for fading.

- R261 H. A. Thomas. Development in the testing of radio receivers. *Jour. I.E.E.*, (London), vol. 71, pp. 114-33; June, (1932).

The paper describes the improvements in the technique of radio receiver testing that have been made at the National Physical Laboratory. The arrangements now used for this purpose having been described in Part I, a proposed specification of methods of testing broadcast receivers is given in Part II together with experimental results obtained on such receivers. This specification is examined as to its applicability to the relative comparison of widely different types of receivers, and a classification is suggested so as to diminish the number of tests which it is necessary to make in order to assign a figure of merit to a particular receiver.

- R261.5 W. Brintzinger and H. Viehmann. Das Rauschen von Empfängern. (The noise of receiving sets). *Hochfrequenz. und Elektroakustik*, vol. 39, pp. 199-207; June, (1932).

Results of an investigation of the noise in radio receiving sets is given. Various measurements are made on several receiving sets by several operators and the noise recorded. An extensive bibliography is included.

- R262.3 S. K. Mitra and B. Charon. On the variation of the resistance of thermionic valves at high frequencies. *Phil. Mag.* (London), vol. 13, pp. 1081-98; June, (1932).

Experiments have been made to determine the variation of conductivity of the plate-grid space of a triode vacuum tube within the frequency range of 10^7 to 6×10^7 cycles per second. The results show that in going from the lower to the higher frequency the conductivity decreases by more than 100 per cent. A theory of the variation of resistance is developed.

- R270 Marconi portable field strength measuring equipment. *Marconi Review*, no. 36, pp. 14-19; May-June, (1932).

A portable field strength measuring equipment is described.

- R281 S. Shimizu. A preliminary report on the anomalous variation of the electrical conductivity of quartz with temperature. *Phil. Mag.* (London), vol. 13, pp. 907-34; May, (1932).

× R214

Results of an experimental study of the variation of electrical conductivity of quartz with temperature are given. Discontinuous changes are found at the transformation point.

R300. RADIO APPARATUS AND EQUIPMENT

- R330 P. K. Turner. A new valve characteristic. *Wireless Engineer and Experimental Wireless* (London), vol. 9, pp. 384-87; July, (1932).
A means is suggested by which the performance of a vacuum tube as a grid rectifier can be judged. I_a/E_a characteristics taken with varying amounts of alternating-current input to a grid rectifying circuit are given.
- R335 W. I. G. Page. Variable mu valves. *Wireless World and Radio Review*, vol. 30, pp. 630-32; June 15, (1932).
A brief summary of the advantages of the variable mu vacuum tubes together with data on the new tubes are given.
- R339 A neon-filled grid-glow tube. *Electric Journal*, vol. 29, pp. 351-53; July, (1932).
A tube is described which is especially suited for applications where the ambient temperature is subject to wide fluctuations. Type KU-610 oxide-coated cathode. Characteristics are given.
- R339 C. F. Stromeyer. Triple-twin tubes. *PROC. I.R.E.*, vol. 20, pp. 1149-62; July, (1932).
This paper describes a new tube and circuit which utilizes the positive, as well as the negative region of the E_g-I_p characteristic and has a negligible amount of distortion. The fundamental circuit is described. Operating notes and a push-pull circuit are also discussed. A commercial triple-twin's output and sensitivity are compared with a pentode and a triode. All have the same plate voltage rating. The triple-twin delivers nearly twice the pentodes power and three times that of the triode. Its power sensitivity is many times greater than its contemporaries.
- R339 J. L. Zehner. "Cheater circuits" for synthetic testing of mercury-vapor tubes. *Electronics*, vol. 5, p. 224; July, (1932).
A note concerning a circuit arrangement which is being developed by General Electric Company for testing mercury-vapor power tubes. The circuit arrangement accomplishes a saving of power.
- R355.9 W. F. Diehl. A standard microvolter. *Electronics*, vol. 5, pp. 230-
×623.374.3 231; July, (1932).
An instrument for generating and measuring very weak radio-frequency voltages is described. Its uses and data are given.
- R361 New radio receivers show improved technical design. *Electronics*, vol. 5, pp. 218-19; July, (1932).
A survey of 1932 receiving sets showing results of new tubes and circuits.
- R361 Marconi short-wave receiver. *Marconi Review*, no. 36, pp. 20-26; May-June, (1932).
The type Rg31a receiver of double detection type, covering a wave band of 15-200 meters by means of five sets of coils, is described.
- R363 J. R. Nelson. A theoretical comparison of coupled amplifiers with staggered circuits. *PROC. I.R.E.*, vol. 20, pp. 1203-20; July, (1932).
Detuned or staggered single tuned circuits are compared theoretically with the so-called band-pass or coupled circuits. The networks in each case are compared with each other by expressing the ratio of the input to output voltage in terms of the amplifications, A_0 of a single tuned stage. It is shown that approximately the same results are obtained up to optimum coupling by either method. If very broad curves are desired, coupled circuits give more amplification than staggered circuits. Resonance curves for each case are calculated. Some experimentally determined selectivity curves are given for staggered stages. These curve slopes bear out the theory given. Methods of obtaining the required detuning are discussed.
- R363 H. Peek. Ein neuer Gleich- und Wechselstromverstärker. (A new direct and alternating current amplifier). *Archiv für Elek.*, vol. 26, pp. 443-452; June, (1932).

An amplifier which amplifies equally well direct current and alternating current is described. The amplifier has a special coupling which consists of a glow lamp between plate and grid of successive stages. An arrangement is given for making the output independent of voltage fluctuations in the working voltage.

- R363 L. C. Waller. The new '57 as a high gain audio amplifier. *QST*, vol. 16, pp. 17-18; July, (1932).
The uses of the '57 in amateur 'phone transmitting sets is described.
- R363.2 L. E. Barton. Applications of the class B audio amplifier to a-c operated receivers. *Proc. I.R.E.*, vol. 20, pp. 1085-1100; July, (1932).
The class B audio output system is a somewhat radical departure from the present system, and for a given cost permits an output of two to three times the power output of the present class A amplifier. This paper discusses the special circuit requirements of an alternating-current receiver to use the new RCA -46 class B tube successfully in a class B audio output system.
- R381 H. Wommelsdorf. Eine neue Art von Hochspannungs-kondensatoren. (A new high-voltage condenser). *Zeits. für tech. Phys.*, no. 7, pp. 328-30; (1932).
A condenser made by sealing metal plates in a glass tube is described. The apparatus is very similar to the Leyden jar, but would not discharge in damp weather as the Leyden jar does.
- R382.1 H. B. Dent. Practical transformer construction. *Wireless World and Radio Review*, vol. 30, pp. 662-64; June 29, (1932).
Constructional details of a transformer for feeding a metal rectifier.
- R383 L. Behr and R. E. Tarpley. Design of resistors for precise high-frequency measurements. *Proc. I.R.E.*, vol. 20, pp. 1101-16; July, (1932).
New shielded and unshielded resistance boxes and fixed standards of resistance for use in precise alternating-current measurements are described in detail and numerical values are given for the residual inductance or capacitance of the individual coils and of the boxes at various settings, and for the resistance error at 1 and 50 kc. A new coil construction and two new types of decades are used. In one of the resistance boxes for any setting of the dials only one coil of each decade is in the circuit, while the idle coils are completely disconnected, and in addition the configuration of the circuit inside the box remains constant for all settings of the dials.
- R383 F. E. Henderson. Lamp resistances for d.c. receivers. *Wireless World and Radio Review*, vol. 30, pp. 594-96; June 8, (1932).
The article explains why the metal filament lamps are superior to the carbon filament type for resistors for direct-current receivers.
- R384.1 How electron-coupled oscillators make still better frequency meters. *QST*, vol. 16, pp. 26-30; July, (1932).
Description of two new models of frequency meters.
- R388 E. Hudec. Die Helligkeitssteuerung von Braunschen Röhren. (Controlling the brightness of the Braun tube). *Elek. Nach. Tech.*, vol. 9, pp. 213-25; June, (1932).
A comprehensive treatment of the cathode-ray tube is given. The different methods of using a cathode-ray tube are studied. Constructional details and control of the beam are discussed with diagrams. Different arrangements of elements are illustrated by several photographs.
- R388 A circular time axis giving radial deflections for use with the cathode-ray oscillograph. *Jour. I.E.E.*, (London), vol. 71, pp. 82-85; June, (1932).
In the study of electromotive forces varying with time, the electromotive force under examination is caused to modulate similarly and simultaneously two voltages which are applied in quadrature to the deflecting plates of a cathode-ray oscillograph. The

resultant screen image on the oscillograph consists of a circular time base on which are superposed radial deflections delineating the wave form and time relationships of the applied electromotive forces.

- R388 A. B. Wood. Recent developments in cathode-ray oscillographs. *Jour. I.E.E.*, (London), vol. 71, pp. 41-56; June, (1932).

The paper deals briefly with some of the more important developments in design and use of cathode-ray oscillographs. Methods of increasing the photographic or recording sensitivity are first considered, particular attention being given to (a) focusing the cathode-ray stream; (b) increasing the sensitivity of the photographic film; (c) the use of phosphorescent materials as a means of increasing photographic sensitivity and of facilitating "external" photography; and (d) increasing the exciting voltage and consequently the kinetic energy and penetrating power of the cathode rays. Consideration is given to the various methods of producing a time axis. The paper concludes with a section dealing with the recording of isolated electrical impulses. An extensive list of references is given.

- R388 Cossor cathode-ray oscillograph. *Wireless Engineer and Experimental Wireless* (London), vol. 9, p. 387; July, (1932).

A. C. Cossor, Ltd., London, has introduced a new Braun tube in which the conductance of the deflector plate has been reduced by extending the plate to surround the deflector system. A handbook (B15) setting forth the properties of the tube is available on application.

- R388 W. Holzer and M. Knoll. Kathodenstrahlscillograph für Registrierung im Hochvakuum. (A cathode-ray oscillograph for recording in high vacuum). *Zeits. für Instr.*, no. 6, pp. 274-81; June, (1932).

A cathode-ray oscillograph is described which has a double barometer tube, and a continuous film carriage in a high vacuum.

R400. RADIO COMMUNICATION SYSTEMS

- R430 W. Baggally. A carrier interference eliminator. *Wireless Engineer and Experimental Wireless* (London), vol. 9, pp. 388-90; July, (1932).

A circuit arrangement for suppressing carrier interference is described.

- R450 S. B. Wright and D. Mitchell. Two-way radiotelephone circuits. *Proc. I.R.E.*, vol. 20, pp. 1117-30; July, (1932).

This paper deals with the problems of joining long-distance radio-telephone transmission paths to the ordinary telephone plant. It gives the possibilities and limitations of various methods of two-way operation of such circuits where the radio channels employ either long or short waves. It also describes the special terminal apparatus for switching the transmission paths under control of voice currents and lists the advantages of using voice-operated devices.

R500. APPLICATIONS OF RADIO

- R550 Polish National Broadcasting. *Marconi Review*, no. 36, pp. 27-29; May-June, (1932).

×R270

Results of a survey of field strength distribution indicate that all of Poland is served by the transmitter at Warsaw.

R800. NONRADIO SUBJECTS

- 535.38 C. W. LaPierre. A precision photoelectric controller. *Gen. Elec. Rev.*, vol. 35, p. 403; July, (1932).

×536

An arrangement of apparatus by which a sensitive instrument may be used for control purposes is described. As an example of the usefulness of the controller an arrangement for controlling the temperature of a standard cell oil bath is described.



CONTRIBUTORS TO THIS ISSUE

Callendar, M. V.: Born October 5, 1906 at London, England. Received B. A. degree in Physics, Cambridge University, 1928. Research physicist, Lissen, Limited, 1928; in charge, radio development department, 1932. Nonmember, Institute of Radio Engineers.

Chakravarti, S. P.:

Clausing, A.:

Kantebet, S. R.: Born in 1900. Graduated, Bombay University, 1921. Studied electrical technology course, Indian Institute of Science, Bangalore, 1921-1924; assistant engineer, Bombay Telephone Company, Ltd., studied radio communication, Marconi's Wireless College, Chelmsford, England; assistant engineer, Marconi's Wireless Telegraphy Company, Ltd., on erection and testing of the Wireless Beam Station at Poona for England-India service, 1924-1928; assistant professor, electrical communication engineering, Indian Institute of Science, 1928 to date. Associate member I.E.E. Associate member, Institute of Radio Engineers, 1925; Member, 1931.

Kautter, W.:

Potter, Ralph Kimball: See PROCEEDINGS for April, 1932.

Van Dyck, A. F.: Born May 20, 1891 at Stuyvesant Falls, New York. Received Ph.B. degree, Sheffield Scientific School, Yale University, 1911. Amateur experimenter and commercial operator at sea, 1907-1910. With National Electric Signalling Company, Brant Rock, Massachusetts, 1911-1912; Research department, Westinghouse Electric and Manufacturing Company, 1912-1914; instructor in electrical engineering, Carnegie Institute of Technology, 1914-1917; expert radio aide, U. S. Navy, 1917-1919; Marconi Company, Aldene, New Jersey; in charge, radio receiver design, General Electric Company, 1920-1922; Radio Corporation of America, 1922 to date. Charter Associate member, Institute of Radio Engineers, 1913; Member, 1918; Fellow, 1925.





Bradleyunits for All Radio Circuits

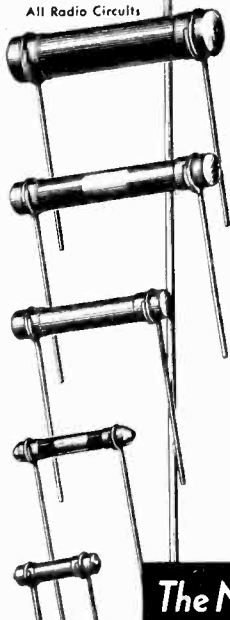

Bradley Suppressors for Auto Radio

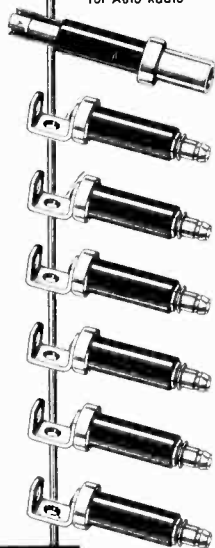

Bradleyunits Solid Molded Resistors

The Choice of the World's Largest Radio Manufacturers

Don't risk the reputation of your receiver with poor resistors. Standardize on Bradleyunit Resistors because their resistance values are stable under varying conditions of load, temperature and moisture.

Bradleyunit Resistors are made in five sizes, with or without leads, and are R.M.A. color coded for resistance value identification. These solid molded resistors are accurately calibrated and have great mechanical strength. Get an Allen-Bradley quotation on your next order.

Allen-Bradley Co., 116 W. Greenfield Avenue., Milwaukee, Wis.



The New Tapped Bradleyometer

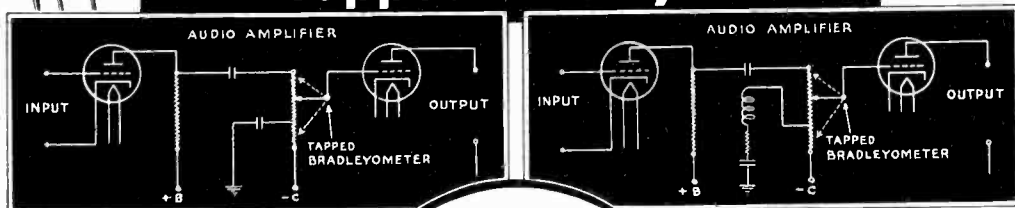

The new Tapped Bradleyometer provides automatic tone correction with volume control. It achieves this result in any one of several audio frequency networks. (See above diagrams.)

A tap on the resistance element is brought out to a fourth terminal. The network necessary to provide tone correction is usually connected between this tap and the grounded or low

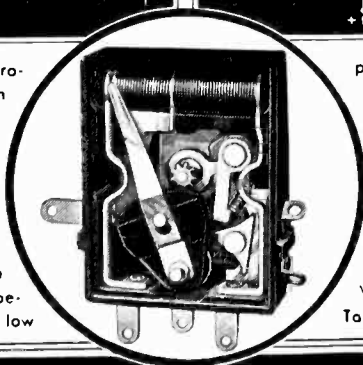

potential end of the Bradleyometer.

A single-pole line switch approved by the Underwriters' Laboratories and the Hydro Electric Power Commission of Ontario with a rating of 2 amperes, 125 volts, can be provided within the Bradleyometer and is operated by the regular control knob.

Write for complete data on the New Tapped Bradleyometer.

ALLEN-BRADLEY RESISTORS

Produced by the makers of Allen-Bradley Control Apparatus

When writing to advertisers mention of the PROCEEDINGS will be mutually helpful.

FOR

Transmitting and Power Purposes

An Exceptionally
Efficient Ultra-High
Frequency Oscillator

5 METERS

(60 Megacycles)

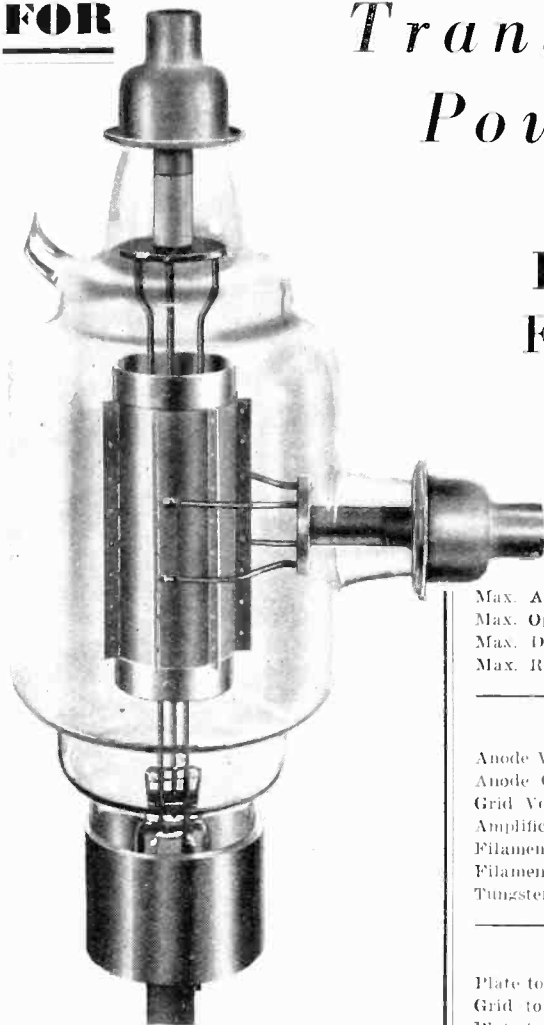

TYPE 100

Max. Anode Dissipation	500 watts
Max. Operating Anode Voltage	2000 volts
Max. D.C. Anode Current	0.500 amps.
Max. R.F. Grid Current	30 amp.

Average Characteristics

Anode Voltage	2000 volts
Anode Current	0.175 amps.
Grid Volts	0
Amplification Factor	11.
Filament Volts	11.
Filament Current	25.
Tungsten Filament	

Interelectrode Capacities

Plate to Grid	10 M.M.F.
Grid to Filament	4 M.M.F.
Plate to Filament	2 M.M.F.

THE F. T. C. Type 100 is a rugged, dependable and efficient oscillator for all ultra-high frequency purposes. It has extremely low interelectrode capacities—plate and grid leads of minimum inductance and low resistance to handle large circulating currents—rigid structure to withstand shipment and other abuses—well aged and selected for ability to dissipate heat at ultra-high frequencies.

*The F. T. C. Type 100 is guaranteed to give 1000 hours
satisfactory service within its ratings.*

WRITE FOR BULLETIN

FEDERAL TELEGRAPH COMPANY

200 Mt. Pleasant Ave., Newark, N. J.

When writing to advertisers mention of the PROCEEDINGS will be mutually helpful.



SENTINEL OF THE NIGHT

DEEP NIGHT . . . before the first grey streaks of dawn silver the eastern sky. On a table beside the bed rests a little black instrument . . . silent, unobtrusive, seemingly inert there in the stillness. It is the *telephone*, sentinel of the night.

Ready to call a policeman at the first unexplained sound . . . ready to summon the fire department at the first ominous whiff of smoke . . . primed to rouse a physician, a nurse, or a neighbor when illness intrudes. For the wired world is at the other end, waiting for your outstretched hand and your plea: "Come quickly!"

Sentinel duty, of course, is a small part of the manifold service your telephone renders. The incidents of

every-day store orders, of friendly chats; the joy and comfort of familiar voices as though from across the room; these, too, make the telephone a valued member of the family.

Behind your telephone is the nationwide organization of trained minds and hands whose ideal is to serve you in a manner as nearly perfect as is humanly possible. Seven hundred thousand stockholders—men and women like yourself—have invested their money in this system of the people and for the people.

The telephone is a vital link in the chain of modern living. It gives much in convenience and safety. It offers a wide range of usefulness. It serves you day and night.

AMERICAN TELEPHONE AND TELEGRAPH COMPANY



When writing to advertisers mention of the PROCEEDINGS will be mutually helpful.

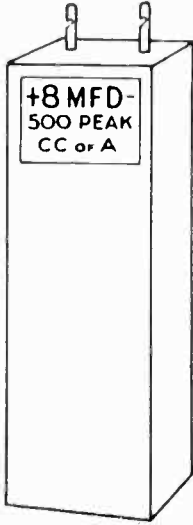

Type DC-8
Acracon
Semi-Dry Unit

**Compare . . .
and be convinced
of the superiority
of**

***the new* ACRACON SEMI-DRY ELECTROLYTIC CONDENSER**



Type DE-8
Acracon
Semi-Dry Unit

- peak operating voltage 500
- surge voltage 600
- low initial leakage
- leakage current at 500 volts less than .2 mils per mfd.
- constant capacity; does not decrease with use
- stable power factor; does not increase with use
- non-corrosive connections
- metal or fibre container
- standard and special sizes

Write Today For Catalog!

* Acracon Features are Protected by Patents Pending

Condenser Corporation of America

259 Cornelison Ave., Jersey City, N.J.

Factory Representatives In:

Chicago

Cincinnati

St. Louis

San Francisco

Los Angeles

Toronto

And Other Principal Cities

When writing to advertisers mention of the PROCEEDINGS will be mutually helpful.

Precision

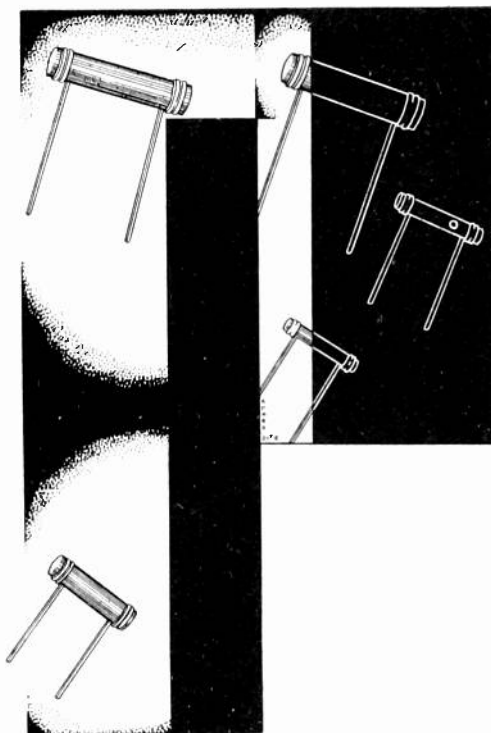

in manufacturing ERIE RESISTORS is assured by methods developed over a period of years.

Every step in the development of ERIE RESISTORS has resulted in new and improved methods—every one of which has had as its objective precision in manufacture.

A rejection record of less than $\frac{1}{2}$ of 1% over a period of years is the result.

When you specify ERIE RESISTORS you may be certain that you are getting the very best moulded type resistor of fixed resistance value that the market affords.

May we send you samples and prices?

ERIE SUPPRESSORS

If you build an automobile radio set, ask for information on ERIE SUPPRESSORS. Made in lug, screw and distributor types.

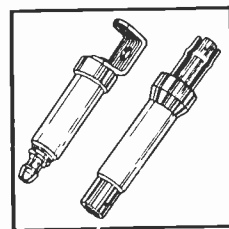

ERIE RESISTORS



ERIE RESISTOR CORPORATION, ERIE, PA.
Factories in Erie, Pa., Toronto, Can., and London, Eng.

When writing to advertisers mention of the PROCEEDINGS will be mutually helpful.

AMERTRAN *Portable* PUBLIC - ADDRESS SYSTEM

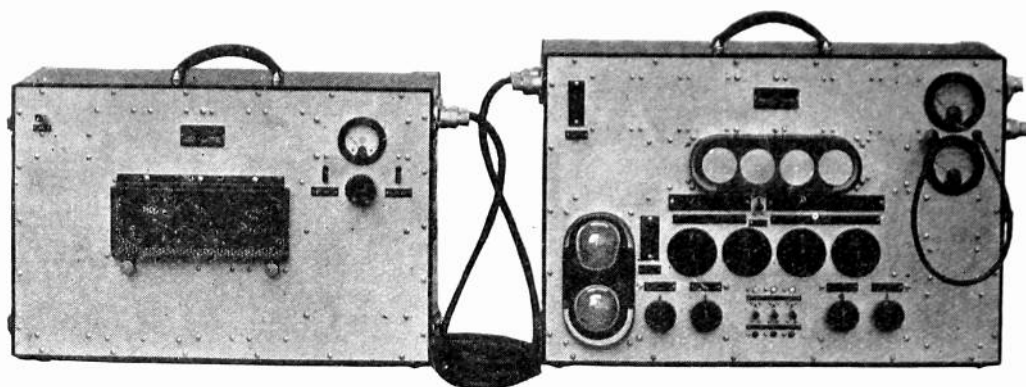

AMERTRAN Type PA-71 is a complete portable public-address system mounted in two units which may be carried about easily. Although of such compact design, frequency characteristics and the efficiency of the circuits equal in performance the standard panel-type Amer-Tran Sound Systems.

The equipment is mounted in attractive, durable cases of quartered oak with nickel plated hardware, fitted with convenient handles. Plugs with cables facilitate rapid connection of the apparatus. Instruments and controls, with engraved bakelite designation strips are mounted on aluminum panels.

The larger unit contains a three-circuit mixer feeding into a four-stage amplifier having an undistorted output of 33dB (12.5 watts). Operating power is obtained from the smaller

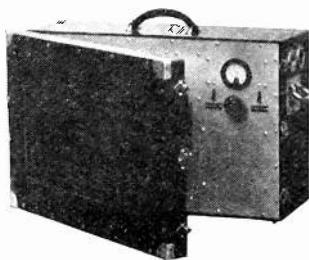

unit housing a rectifier and filter system. The system may be operated wherever 110 volt, 60 cycle lighting circuits are available, and the source of signal may be microphones, phonograph or radio set.

Overall measurements on Type PA-71 indicate a frequency variation of less than 2dB throughout the band of 40 to 8000 cycles, and a gain which is ample for all requirements, no additional preamplifier being necessary when using microphones.

Unusual freedom from a.c. hum is also obtained by supplying filaments of heater type tubes with rectified and filtered current instead of the usual raw a.c. Furthermore, the equipment may be used with all standard apparatus, as the three input circuits each have 200 ohms impedance and the output has an impedance of 500 ohms.

Write us direct for prices and further information.

AMERICAN TRANSFORMER COMPANY

Main Office and Factory

178 Emmet Street



Newark, N. J.

When writing to advertisers mention of the PROCEEDINGS will be mutually helpful.

Piezo Electric Crystals

Does the frequency of your monitor comply with the new regulations of being within the plus or minus 50 cycle limits? If not, we are at your service to adjust your monitor to within those limits. Ship your monitor to us for either adjustment or grinding a new crystal if necessary. Our charge for this service is right, and will require but seven to ten days to perform this work. Ask any broadcast radio engineer what he thinks of our service.

CRYSTALS CRYSTALS CRYSTALS

Prices for grinding POWER CRYSTALS in the various frequency bands are as follows:

Frequency Range	
100 to 1500 Kc.....	\$40.00
1501 to 3000 Kc.....	\$45.00
3001 to 4000 Kc.....	\$50.00
4001 to 6000 Kc.....	\$60.00

The above prices include holder of our Standard design, and the crystals will be ground to within .03% of your specified frequency. If crystal is wanted unmounted deduct \$5.00 from the above prices. Delivery two days after receipt of your order. In ordering please specify type tube, plate voltage and operating temperature.

Special Prices Will Be Quoted in Quantities of Ten or More

POWER CRYSTALS FOR AMATEUR USE

The prices below are for grinding a crystal to a frequency selected by us unmounted, (if wanted mounted in our Standard Holder add \$5.00 to the prices below) said crystal to be ground for POWER use and we will state the frequency accurate to better than a tenth of one per-cent. IMMEDIATE SHIPMENT CAN BE MADE.

1715 to 2000 Kc band.....	\$12.00 each
3500 to 4000 Kc band.....	\$15.00 each

LOW FREQUENCY STANDARD CRYSTALS

We have stock available to grind crystals as low as 13 Kilo-cycles. Prices quoted upon receipt of your specifications.

PIONEERS: POWER CRYSTALS SINCE 1925

This record is proof to you that you will get the best there is in Piezo Electric Power Crystals. Get the best. It is more economical.

Scientific Radio Service

"THE CRYSTAL SPECIALISTS"

124 Jackson Ave., University Park

Hyattsville, Maryland

When writing to advertisers mention of the PROGRAMS will be mutually helpful.

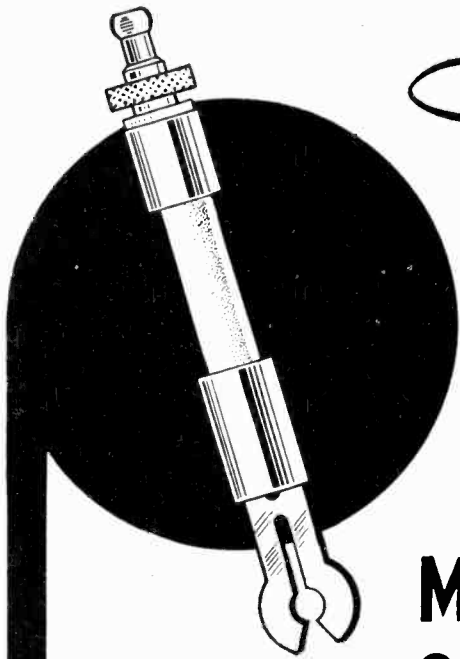

*Typical of
Centralab
Quality—*

**THESE
MOTOR RADIO
SUPPRESSORS**

provide the greatest possible resistance to R.F. current with the lowest possible resistance to D.C. spark energy. Centralab Suppressors are as simple as they are efficient. Simple—because there are no complicated, loosely assembled parts; efficient because they offer, by actual tests, from 50% to 500% more effectiveness in eliminating spark interference.

The resistance material and the ceramic jacket are baked together as one solid rod (a full $1\frac{1}{2}$ " long) at a temperature of 2700 degrees.

. . . and what is equally interesting, CENTRALAB suppressors, by virtue of their simplicity, COST LESS.

**CENTRAL RADIO
LABORATORIES**

MILWAUKEE, WIS.

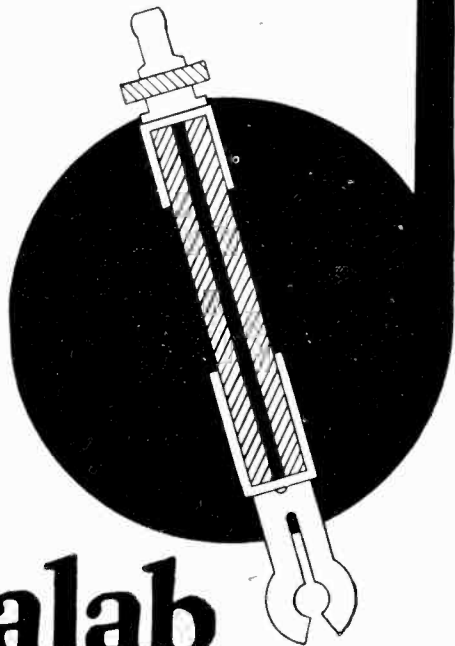

Centralab
CRL

When writing to advertisers mention of the PROCEEDINGS will be mutually helpful.

CHANGE IN MAILING ADDRESS OR BUSINESS TITLE

Members of the Institute are asked to use this form for notifying the Institute office of a change in their mailing address or the listing of their company affiliation or title in the Year Book.

The Secretary,
THE INSTITUTE OF RADIO ENGINEERS,
33 West 39th Street,
New York, N.Y.

Dear Sir:

Effective please note change in my address
(date)
for mail as follows:

FROM

.....
(Name)

.....
(Street Address)

.....
(City and State)

TO NEW ADDRESS

.....
(Street Address)

.....
(City and State)

Please note following change in my Year Book listing.

.....
(Title)

.....
(Company Name)

.....
(Company Address)

When writing to advertisers mention of the PROCEEDINGS will be mutually helpful.

Back Numbers of the Proceedings, Indexes, and Year Books Available

MEMBERS of the Institute will find that back issues of the Proceedings are becoming increasingly valuable, and scarce. For the benefit of those desiring to complete their file of back numbers there is printed below a list of all complete volumes (bound and unbound) and miscellaneous copies on hand for sale by the Institute.

The contents of each issue can be found in the 1909-1930 Index and in the 1931 Year Book.

BOUND VOLUMES:

- Vol. 10 (1922), \$8.75 per volume to members
- Vol. 18 (1930), \$9.50 to members

UNBOUND VOLUMES:

- Vols. 6, 8, 9, 10, 11, 13, 14, 18, and 19 (1918-1920-1921-1922-1923-1925-1926-1930-1931). \$6.75 per volume (1918-1926) and \$7.50 per volume (1927-1931) to members

MISCELLANEOUS COPIES:

- Vol. 1 (1913) July and December
- Vol. 2 (1914) June
- Vol. 3 (1915) December
- Vol. 4 (1916) June and August
- Vol. 5 (1917) April, June, August, October, and December
- Vol. 7 (1919) February, April, August, and December
- Vol. 15 (1927) April, May, June, July, October, November, and December
- Vol. 16 (1928) February, March, April, May, June, July, August, October, November, December
- Vol. 17 (1929) January, February, March, April, May, June, July, August, September, November, and December.

These single copies are priced at \$1.13 each to members to the January, 1927, issue. Subsequent to that number the price is \$0.75 each. Prior to January, 1927, the Proceedings was published bimonthly, beginning with the February issue and ending with the December issue. Since January, 1927, it has been published monthly.

MEMBERS will also find that our index and Year Book supplies are becoming limited. The following are now available:

INDEX

The Proceedings Index for the years 1909-1930 inclusive is available to members at \$1.00 per copy. This index is extensively cross indexed.

YEAR BOOK

The 1931 Year Book is available to members at \$1.50 per copy. Make remittances payable to the Institute of Radio Engineers and send orders to:

THE INSTITUTE OF RADIO ENGINEERS

33 West 39th Street
NEW YORK CITY, N. Y.

When writing to advertisers mention of the PROCEEDINGS will be mutually helpful.

It's here!
THE NEW CINCH
low-cost
BINDING POST

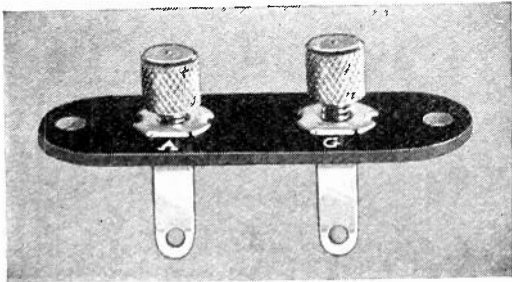

No. 1720-A

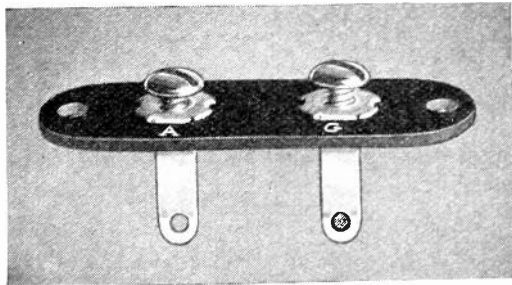

No. 1720

Another Cinch success! In keeping with present day requirements, Cinch offers a *new low-cost* Binding Post . . . in two types. No. 1720 is a machine screw type. No. 1720-A is provided with knurled head screws. Both types give quick, positive, dependable contacts . . . yet are priced to help you *economize!*

1 $\frac{1}{16}$ " standard mounting centers. Lugs sturdily mounted in bakelite plate $\frac{1}{16}$ " thick. Lugs and screws are Cinch Solder Coated to resist corrosion and oxidization. Will accommodate any size wire.—Samples and prices upon request. Write today.

CINCH PRODUCTS:

Standard and Midget Size Radio Sockets with the new "Floating Contacts" . . . Binding Posts . . . Soldering Lugs . . . Insulated Mounting Strips . . . Tip-Jacks . . . Small Intricate Metal Stampings.

CINCH MANUFACTURING CORP.

2335 W. Van Buren St., Chicago, Ill.

Subsidiary of

UNITED-CARR FASTENER CORP.
CAMBRIDGE, MASS.

When writing to advertisers mention of the PROCEEDINGS will be mutually helpful.

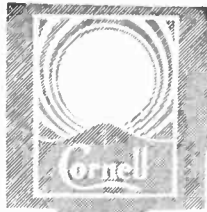

Cornell

TRADE MARK REG.

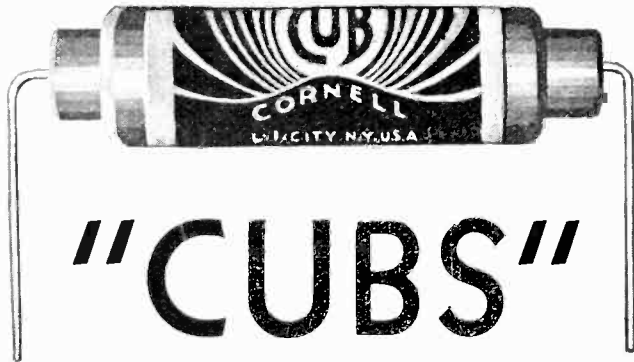
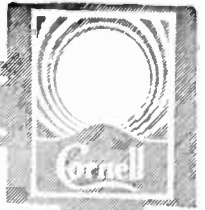

"CUBS"

These now famous condensers are engineered and manufactured in a modern plant by an old established and financially sound organization worthy of your confidence in our guarantee of quality, service and delivery.

WRITE FOR CATALOG A

Describing our complete line of Paper Dielectric Capacitors for radio, television and ignition, and Resistors for radio and television.

CORNELL ELECTRIC MFG. CO., Inc.

Manufacturers of
CORNELL "CUB" CONDENSERS
Filter and By-Pass Condensers, Interference Filters and
All Types of Paper Dielectric Capacitors and Resistors
LONG ISLAND CITY, NEW YORK

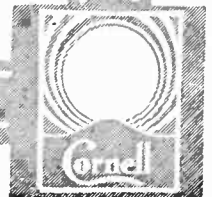
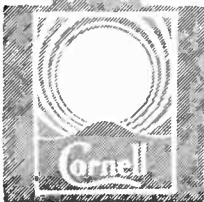

When writing to advertisers mention of the PROCEEDINGS will be mutually helpful.

The Institute of Radio Engineers Incorporated

33 West 39th Street, New York, N. Y.

APPLICATION FOR ASSOCIATE MEMBERSHIP

(Application forms for other grades of membership are obtainable from the Institute)

To the Board of Direction
Gentlemen:

I hereby make application for Associate membership in the Institute of Radio Engineers on the basis of my training and professional experience given herewith, and refer to the members named below who are personally familiar with my work.

I certify that the statements made in the record of my training and professional experience are correct, and agree if elected, that I will be governed by the constitution of the Institute as long as I continue a member. Furthermore I agree to promote the objects of the Institute so far as shall be in my power, and if my membership shall be discontinued will return my membership badge.

.....
(Sign with pen)

.....
(Address for mail)

.....
(Date)

.....
(City and State)

References:

(Signature of references not required here)

Mr. Mr.
Address Address
City and State City and State

Mr.
Address
City and State

The following extracts from the Constitution govern applications for admission to the Institute in the Associate grade:

ARTICLE II—MEMBERSHIP

Sec. 1: The membership of the Institute shall consist of: * * * (c) Associates, who shall be entitled to all the rights and privileges of the Institute except the right to hold any elective office specified in Article V. * * *

Sec. 4: An Associate shall be not less than twenty-one years of age and shall be a person who is interested in and connected with the study or application of radio science or the radio arts.

ARTICLE III—ADMISSION AND EXPULSIONS

Sec. 2: * * * Applicants shall give references to members of the Institute as follows: * * * for the grade of Associate, to three Fellows, Members, or Associates; * * * Each application for admission * * * shall embody a full record of the general technical education of the applicant and of his professional career.

ENTRANCE FEE SHOULD ACCOMPANY APPLICATION

RECORD OF TRAINING AND PROFESSIONAL EXPERIENCE

Name
(Give full name, last name first)

Present Occupation
(Title and name of concern)

Business Address

Permanent Home Address

Place of Birth..... Date of Birth..... Age.....

Education

Degree
(college) (Date received)

TRAINING AND PROFESSIONAL EXPERIENCE

DATES

Record may be continued on other sheets of this size if space is insufficient.

Receipt Acknowledged..... Elected..... Deferred.....
Grade Advised of Election..... This Record Filed.....

The Whole World Listens-in with ARCTURUS



Over 75 different nations attest
the superiority of the BLUE Tube

In every territory of the United States and in 76 foreign countries you will find Arcturus *Blue* Tubes. Tried and proved by critical engineers here and abroad, the *blue* tube has achieved world-wide acceptance.

Blue Tubes are the product of the engineering experience that pioneered unitary structure and practically every major advance in a. c. tubes. They are constructed with 'die-like' precision within the most rigid limits. Their perfection is guarded by 137 tests and checks.

For these reasons, it is readily understood why more set manufacturers use the *blue* tube as initial equipment than any other tube . . . why the people of more than 75 different countries use Arcturus Tubes . . . why more eminent radio engineers the world over specify Arcturus . . . why more dealers sell them.

Every industry has its symbol of excellence . . . in radio, it is *Blue* . . . Arcturus *Blue* Tubes.

ARCTURUS RADIO TUBE CO., NEWARK, N. J.

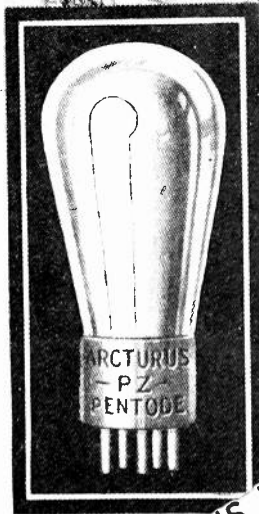

*Any SET IS BETTER
with BLUE ARCTURUS*

ARCTURUS

The BLUE TUBE with the LIFE-LIKE TONE

When writing to advertisers mention of the PROCEEDINGS will be mutually helpful.

TIME-INSURED QUALITY

CARDWELL variable condensers and CARDWELL-designed and built-to-order apparatus have, for considerably more than a decade, enjoyed a reputation for outstanding excellence won by conscientious adherence to an ideal of fair dealing and a determination to sponsor only *quality* products.

Look around. Somewhere, in the majority of the really fine radio installations and equipments in the country, governmental, broadcast, commercial or amateur, will be found some product of CARDWELL manufacture.

What better proof of the recognized excellence of CARDWELL apparatus could be offered?

The CARDWELL line of condensers includes transmitting condensers for high, medium and low power, and receiving condensers in infinite variety. The CARDWELL Midway Featherweight (all aluminum, none over 7 ounces in weight) for transmitting, receiving and neutralizing, is unequalled for aircraft and portable equipment.

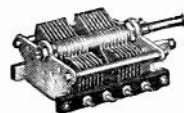

May we send our literature?



CARDWELL CONDENSERS AND MANUFACTURING SERVICE

The Allen D. Cardwell Mfg. Corpn.
93 Prospect Street, Brooklyn, N.Y.

“THE STANDARD OF COMPARISON”

When writing to advertisers mention of the PROCEEDINGS will be mutually helpful.

PROFESSIONAL ENGINEERING DIRECTORY

For Consultants in Radio and Allied Engineering Fields

FOR ADVANCED TRAINING

in:

Practical Radio Engineering
Practical Television Engineering

write to

**CAPITOL RADIO ENGI-
NEERING INSTITUTE**
Riggs Bank Bldg.
Washington, D.C.

WILLIAM W. GARSTANG
Consulting Engineer

Electrolytic Condensers—Power
Supply—"B" Battery Substi-
tutes—Television

Office and Laboratory
550 Century Building, Indianapolis, Ind.

ALLEN B. DU MONT
Consulting Engineer



Phone	Office and Laboratory
Montclair	9 Bradford Way
2-2176	Upper Montclair, N.J.

JENKINS & ADAIR, INC.
Engineers

Designers and manufacturers of appara-
tus essential to broadcasting, sound re-
cording and sound measurement work.

3333 Belmont Ave., Chicago, U.S.A.
Cable Address: *Jenkadair*
Telephones: Keystone 2130

ELECTRICAL TESTING LABORATORIES

Tests of Inductances.
Condensers. Transform-
ers etc. Life and charac-
teristics of Radio Tubes

80th Street and East End Ave.
• • NEW YORK, N. Y. • •

Greenleaf Whittier Pickard
Consultant

59 Dalton Road,
Newton Centre, Mass.

*For the Engineering Consultant
who can handle a little extra business this year*

*For the Designer
who can manage some additional work*

we suggest the Professional Engineering Directory of the I.R.E. PROCEEDINGS. Manufacturers who need services such as yours and organizations with special problems come to our Professional Engineering Directory for information. Your name and special services announced here will put you in line for their business. For further information and special rates for I.R.E. members write to the Institute of Radio Engineers.

When writing to advertisers mention of the PROCEEDINGS will be mutually helpful.

Alphabetical Index to Advertisements

A

Allen-Bradley Co. VII
American Tel. & Tel. Co. IX
American Transformer Co. XII
Arcturus Radio Tube Co. XXI

C

Cardwell, Allen D., Mfg. Corp. XXII
Central Radio Laboratories. XIV
Cinch Mfg. Corp. XVII
Condenser Corp. of America. X
Cornell Electric Mfg. Co. XVIII

E

Erie Resistor Corp. XI

F

Federal Telegraph Co. VIII

G

General Radio Co. Outside Back Cover

I

I.R.E. XV, XVI, XIX, XX, XXV

P

Preprints Available. Inside Back Cover
Professional Eng. Directory. XXIII

R

RCA Victor Co., Inc. XXVI

S

Scientific Radio Service. XIII
Soreng-Manegold Co. XXV

When writing to advertisers mention of the PROCEEDINGS will be mutually helpful.

SPECIAL ITEMS FOR RADIO MANUFACTURERS

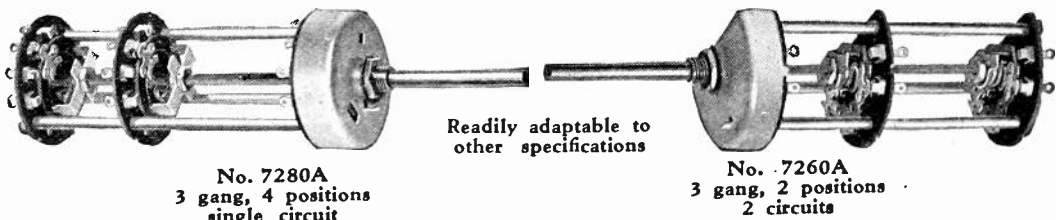

No. 7280A
3 gang, 4 positions
single circuit

Readily adaptable to
other specifications

No. 7260A
3 gang, 2 positions
2 circuits

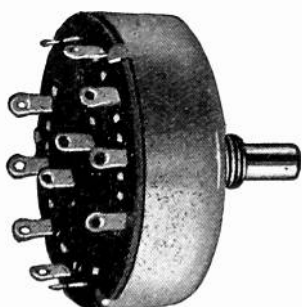

No. 7150A
5 positions, 2 circuits

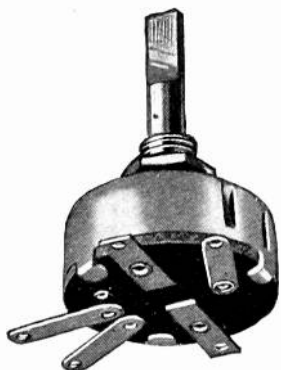

No. 7120A
Combined Acoustic and mut-
ing switch 2 or 3 positions

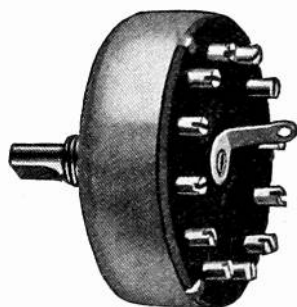

No. 7220A
12 positions, single circuit

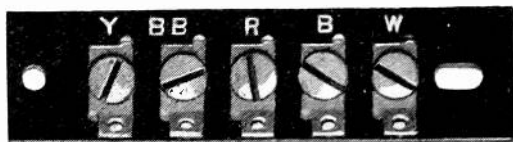

Terminal Strip
5 Lugs No. 6880A, 4 lugs No. 6990A



Terminal Strip
4 Clips, No. 6830A



Terminal Strip
5 Lugs, No. 6950A



Terminal Strip
5 Clips, No. A6310AA,
4 Clips No. A6320AA

SORENG - MANEGOLD CO.

1901-9 Clybourn Avenue, CHICAGO, ILL.

1646 W. Adams St.
Los Angeles, Cal.

701 Stephenson Bldg.
Detroit, Mich.

245-5th Ave.
New York City

When writing to advertisers mention of the PROCEEDINGS will be mutually helpful.

Now . . . A Revolutionary Development!

RCA Victor VELOCITY MICROPHONE

"THE MICROPHONE WITHOUT A DIAPHRAGM"

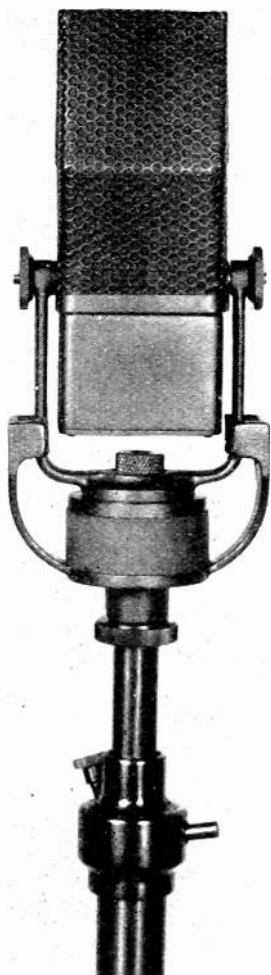

VELOCITY ACTUATED!

Most microphones (all those using a diaphragm) are subject to pressure-doubling and hence accentuate certain of the higher frequencies. The VELOCITY MICROPHONE avoids this because it is not a pressure-operated device. Its moving element is a light metal ribbon which vibrates at a velocity proportional to the velocity of the sound wave. Unlike a pressure-operated diaphragm, this ribbon element has no resonant frequency in the audible range . . . hence does not accentuate any notes . . . and does not require a compensated amplifier.

WIDER FREQUENCY RANGE!

The e. m. f. generated by the ribbon element is proportional to the velocity of the sound wave. Since this velocity is independent of the frequency, the response of the VELOCITY MICROPHONE is nearly uniform over a range extending from 30 cycles to beyond 14,000 cycles.

GREATLY IMPROVED FIDELITY!

Old-style microphones presented an impeding surface to sound waves which set up reflections and caused cavity resonance with consequent humps in the frequency characteristic. The VELOCITY MICROPHONE does not—it is open—the sound waves penetrate it freely. Because there are no peaks whatever in its response, it reproduces with perfect fidelity every note of the program presented before it.

DIRECTIONAL CHARACTERISTIC!

The VELOCITY MICROPHONE has very marked directional characteristics (entirely independent of frequency) which greatly facilitate pickup of desired features and elimination of extraneous noise. However—since it is bi-directional—it actually provides greater space for artists.

INCREASED PICKUP!

The energy response of this microphone to reflected sounds is only one-third that of non-directional (diaphragm) microphones. Since the ratio of direct to reflected sounds determines the distance of satisfactory pickup, this microphone may be used at distances 1.7 times those for other types of microphones of the same sensitivity.

LOW IMPEDANCE!

The impedance of the VELOCITY MICROPHONE is low. This eliminates inductive pickup and makes possible location at a distance from the amplifier with resulting increase in convenience and decrease in amplifier cost.



ENGINEERING PRODUCTS DIVISION
RCA Victor Company, Inc.
A Radio Corporation of America Subsidiary
CAMDEN, N. J.
"RADIO HEADQUARTERS"

When writing to advertisers mention of the PROCEEDINGS will be mutually helpful.

Preprints Available



A LIMITED number of preprints of some of the papers presented at the technical sessions of the Twentieth Anniversary Convention of the Institute are available without cost to members of the Institute. They are as follows:

2. "Design of Resistors for Precise High-Frequency Measurements," by L. Behr and R. E. Tarpley.

3. "The Campbell-Shakelton Shielded Ratio Box," by L. Behr and A. J. Williams, Jr.

6. "Westinghouse Radio Station at Saxonburg, Pa.," by R. L. Davis and V. E. Trouant.

7. "Radio Dissemination of the National Standard of Frequency," (Abstract), by J. H. Dellinger and E. L. Pall.

9. "A New Circuit for the Production of Ultra-Short-Wave Oscillations," by H. N. Kozanowski.

10. "A New Water-Cooled Power Vacuum Tube," by I. E. Mouromtseff.

11. "The Precision Frequency Measuring System of RCA Communications, Inc.," by H. O. Peterson and A. M. Braaten.

12. "Kennelly-Heaviside Layer Studies Employing a Rapid Method of Virtual-Height Determination," by J. P. Schafer and W. M. Goodall.

13. "Transmission Lines for Short-Wave Radio Systems," by E. J. Sterba and C. B. Feldman.

15. "Note on the Measurement of Resistance at High Frequency," by P. B. Taylor.

16. "Dynamic Symmetry in Radio Design," by Arthur Van Dyck.

Requests for copies of any of the above should be made to the Institute office, 33 West 39th Street, New York City.

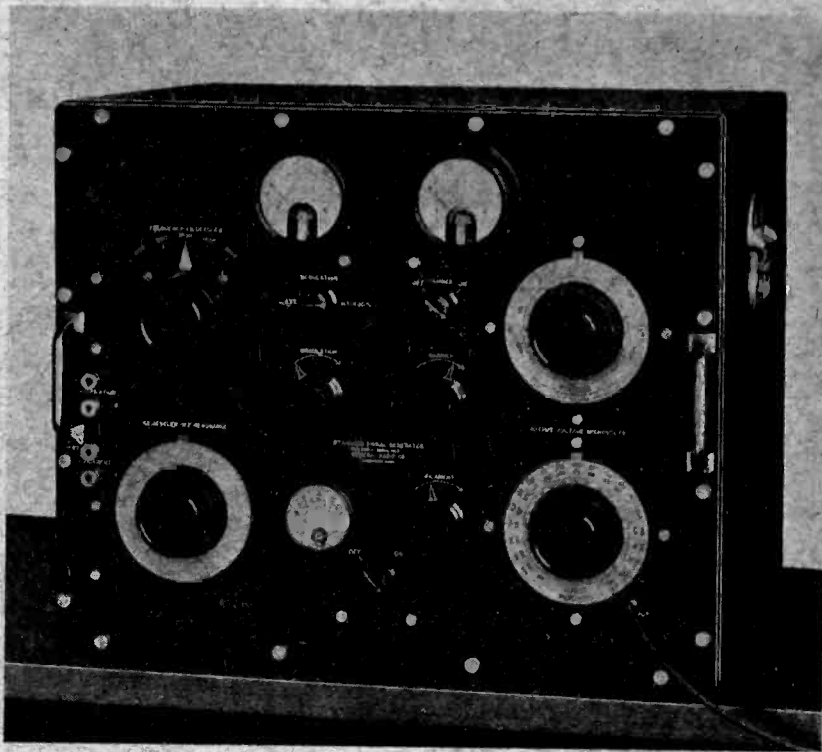

A STANDARD-SIGNAL GENERATOR WITH GOOD MODULATION

Thorough performance tests on broadcast receivers are most reliable when the modulation performance of the standard-signal generator simulates, as closely as possible, the modulation performance of the average broadcasting station. While duplicate results cannot be obtained, a standard-signal generator designed for a minimum of distortion at high percentages of modulation goes a long way toward making fidelity tests represent actual operating conditions.

Since modulation quality is so important, please let us tell you about our TYPE 600-A Standard-Signal Generator. Ask for operating data.

Price \$885

GENERAL RADIO COMPANY
CAMBRIDGE A MASSACHUSETTS