

VOLUME 19

APRIL, 1931

NUMBER 4

PROCEEDINGS  
*of*  
**The Institute of Radio  
Engineers**



**1931 CONVENTION**  
**Chicago, Illinois**  
**June 4, 5, and 6**

Form for Change of Mailing Address or Business Title on Page XLIII

---

# Sixth Annual Convention

*of the*

# Institute of Radio Engineers



Chicago, Illinois

---

June 4, 5, and 6

---

PROCEEDINGS OF  
**The Institute of Radio Engineers**

Volume 19

April, 1931

Number 4

Board of Editors

ALFRED N. GOLDSMITH, *Chairman*  
STUART BALLANTINE                      G. W. PICKARD  
RALPH BATCHER                              L. E. WHITEMORE  
W. WILSON

CONTENTS

	Page
PART I	
Frontispiece, Air View of Chicago.....	512
Institute News and Radio Notes.....	513
March Meeting of the Board of Direction.....	513
American Standard.....	513
Radio Transmissions of Standard Frequency.....	513
Committee Meetings.....	515
Institute Meetings.....	519
Personal Mention.....	523
PART II	
<i>Technical Papers</i>	
Diversity Receiving System of R.C.A. Communications, Inc., for Radio-telegraphy..... H. H. BEVERAGE AND H. O. PETERSON	531
Diversity Telephone Receiving System of R.C.A. Communications, Inc. .... H. O. PETERSON, H. H. BEVERAGE, AND J. B. MOORE	562
A Radio Beacon and Receiving System for Blind Landing of Aircraft.... H. DIAMOND AND F. W. DUNMORE	585
Analysis of a Piezo-Electric Oscillator Circuit..... L. P. WHEELER	627
Alternating-Current Measuring Instruments as Discriminators Against Harmonics..... IRVING WOLFF	647
Improvement of Thin Film Caesium Photo-Electric Tubes..... S. ASAO AND M. SUZUKI	655
Direct-Reading Frequency Meter. F. GUARNASCHELI AND F. VECCHIACCHI	659
A System for Suppressing Hum by a New Filter Arrangement..... PALMER H. CRAIG	664
Negative Circuit Constant..... L. C. VERMAN	676
Corrections.....	682
Book Review, "Acoustics" (G. W. Stewart and R. B. Lindsay)..... IRVING WOLFF	683
Monthly List of References to Current Radio Literature.....	684
Contributors to this Issue.....	692

*Copyright, 1931, by the Institute of Radio Engineers*

# The Institute of Radio Engineers

## GENERAL INFORMATION

The PROCEEDINGS of the Institute is published monthly and contains papers and discussions thereon submitted for publication or for presentation before meetings of the Institute or its Sections. Payment of the annual dues by a member entitles him to one copy of each number of the PROCEEDINGS issued during the period of his membership.

Subscription rates to the PROCEEDINGS for the current year are received from nonmembers at the rate of \$1.00 per copy or \$10.00 per year. To foreign countries the rates are \$1.10 per copy or \$11.00 per year.

Back issues are available in unbound form for the years 1918, 1920, 1921, 1922, 1923, and 1926 at \$9.00 per volume (six issues) or \$1.50 per single issue. For the years 1913, 1914, 1915, 1916, 1917, 1919, 1923, 1924, and 1925 miscellaneous copies (incomplete unbound volumes) can be purchased for \$1.50 each; for 1927, 1928, and 1929 at \$1.00 each. The Secretary of the Institute should be addressed for a list of these.

Discount of twenty-five per cent is allowed on all unbound volumes or copies to members of the Institute, libraries, booksellers, and subscription agencies.

Bound volumes are available as follows: for the years 1922 and 1926 to members of the Institute, libraries, booksellers, and subscription agencies at \$8.75 per volume in blue buckram binding and \$10.25 in morocco leather binding; to all others the prices are \$11.00 and \$12.50, respectively. For the year 1929 the bound volume prices are: to members of the Institute, libraries, booksellers, and subscription agencies, \$9.50 in blue buckram binding; to all others, \$12.00. Foreign postage on all bound volumes is one dollar, and on single copies is ten cents.

The 1930 Year Book, containing general information, the Constitution and By-Laws, catalog of membership, etc., is available to members at \$1.00; to nonmembers, \$1.50.

Contributors to the PROCEEDINGS are referred to the following page for suggestions as to approved methods of preparing manuscripts for publication in the PROCEEDINGS.

Advertising rates for the PROCEEDINGS will be supplied by the Institute's Advertising Department, Room 802, 33 West 39th Street, New York, N.Y.

Changes of address to affect a particular issue must be received at the Institute office not later than the 15th of the month preceding date of issue. That is, a change in mailing address to be effective with the October issue of the PROCEEDINGS must be received by not later than September 15th. Members of the Institute are requested to advise the Secretary of any change in their business connection or title irrespective of change in their mailing address, for the purpose of keeping the Year Book membership catalog up to date.

The right to reprint portions or abstracts of the papers, discussions, or editorial notes in the PROCEEDINGS is granted on the express condition that specific reference shall be made to the source of such material. Diagrams and photographs published in the PROCEEDINGS may not be reproduced without making special arrangements with the Institute through the Secretary.

It is understood that the statements and opinions given in the PROCEEDINGS are views of the individual members to whom they are credited, and are not binding on the membership of the Institute as a whole.

All correspondence should be addressed to the Institute of Radio Engineers, 33 West 39th Street, New York, N.Y., U.S.A.

Entered as second class matter at the Post Office at Menasha, Wisconsin.

Acceptance for mailing at special rate of postage provided for in the Act of February 28, 1925, embodied in paragraph 4, Section 412, P. L. and R. Authorized October 26, 1927.

Published monthly by

**THE INSTITUTE OF RADIO ENGINEERS, INC.**

Publication office, 450-454 Ahnaip Street, Menasha, Wis.

BUSINESS, EDITORIAL, AND ADVERTISING OFFICES,

Harold P. Westman, *Secretary*

33 West 39th St., New York, N.Y.



# SUGGESTIONS FOR CONTRIBUTORS TO THE "PROCEEDINGS"

## Preparation of Paper

**Form**—Manuscripts may be submitted by member and nonmember contributors from any country. To be acceptable for publication, manuscripts should be in English, in final form for publication, and accompanied by a summary of from 100 to 300 words. Papers should be typed double space with consecutive numbering of pages. Footnote references should be consecutively numbered and should appear at the foot of their respective pages. Each reference should contain author's name, title of article, name of journal, volume, page, month, and year. Generally, the sequence of presentation should be as follows: statement of problem; review of the subject in which the scope, object, and conclusions of previous investigations in the same field are covered; main body describing the apparatus, experiments, theoretical work, and results used in reaching the conclusions and their relation to present theory and practice; bibliography. The above pertains to the usual type of paper. To whatever type a contribution may belong, a close conformity to the spirit of these suggestions is recommended.

**Illustrations**—Use only jet black ink on white paper or tracing cloth. Cross-section paper used for graphs should not have more than four lines per inch. If finer ruled paper is used, the major division lines should be drawn in with black ink, omitting the finer divisions. In the latter case, only blue-lined paper can be accepted. Photographs must be very distinct, and must be printed on glossy white paper. Blueprinted illustrations of any kind cannot be used. All lettering should be  $3/16$  in. high for an 8 x 10 in. figure. Legends for figures should be tabulated on a separate sheet, not lettered on the illustrations.

**Mathematics**—Fractions should be indicated by a slanting line. Use standard symbols. Decimals not preceded by whole numbers should be preceded by zero, as 0.016. Equations may be written in ink with subscript numbers, radicals, etc., in the desired proportion.

**Abbreviations**—Write a.c. and d.c. (a-c and d-c as adjectives), kc,  $\mu$ f,  $\mu\mu$ f, e.m.f., mh,  $\mu$ h henries, abscissas, antennas. Refer to figures as Fig. 1, Figs. 3 and 4, and to equations as (5). Number equations on the right in parentheses.

**Summary**—The summary should contain a statement of major conclusions reached, since summaries in many cases constitute the only source of information used in compiling scientific reference indexes. Abstracts printed in other journals, especially foreign, in most cases consist of summaries from published papers. The summary should explain as adequately as possible the major conclusions to a nonspecialist in the subject. The summary should contain from 100 to 300 words, depending on the length of the paper.

## Publication of Paper

**Disposition**—All manuscripts should be addressed to the Institute of Radio Engineers, 33 West 39th Street, New York City. They will be examined by the Committee on Meetings and Papers and by the Editor. Authors are advised as promptly as possible of the action taken, usually within one month.

**Proofs**—Galley proof is sent to the author. Only necessary corrections in typography should be made. *No new material is to be added.* Corrected proofs should be returned *promptly* to the Institute of Radio Engineers, 33 West 39th Street, New York City.

**Reprints**—With the galley proof a reprint order form is sent to the author. Orders for reprints must be forwarded promptly as type is not held after publication.

## INSTITUTE SECTIONS

<i>Chairmen</i>	<i>Secretaries</i>
	<b>ATLANTA</b>
H. F. Dobbs	Philip C. Bangs, 23 Kensington Rd., Avondale Estates, Ga.
	<b>BOSTON</b>
George W. Pierce	Melville Eastham, 30 State St., Cambridge, Mass.
	<b>BUFFALO-NIAGARA</b>
Stanley W. Brown	E. C. Waud, 235 Huntington Ave., Buffalo, N. Y.
	<b>CHICAGO</b>
Byron B. Minnium	J. Barton Hoag, Ryerson Laboratory, University of Chicago, Chicago, Ill.
	<b>CINCINNATI</b>
D. D. Israel	Ralph P. Glover, 5737 Hamilton Ave., Cincinnati, Ohio.
	<b>CLEVELAND</b>
G. B. Hammon	P. A. Marsal, National Carbon Co., Inc., P.O. Box No. 400, Cleveland, Ohio.
	<b>CONNECTICUT VALLEY</b>
R. S. Kruse	George Grammer, 52 S. Beacon St., Hartford, Conn.
	<b>DETROIT</b>
Lewis N. Holland	Samuel Firestone, Room 615, 2000 Second Ave., Detroit, Mich.
	<b>LOS ANGELES</b>
T. E. Nikirk	L. Elden Smith, 340 N. Painter Ave., Whittier, Calif.
	<b>NEW ORLEANS</b>
Pendleton E. Lehde	Anton A. Schiele, 1812 Masonic Temple, New Orleans, La.
	<b>PHILADELPHIA</b>
W. R. G. Baker	G. C. Blackwood, 243 E. Upsal St., Mt. Airy, Philadelphia, Pa.
	<b>PITTSBURGH</b>
L. A. Terven	C. F. Donbar, 233 South Starr Ave., Bellevue, Pa.
	<b>ROCHESTER</b>
Harry E. Gordon	Howard A. Brown, Rochester G. & E. Co., 89 East Ave., Rochester, N. Y.
	<b>SAN FRANCISCO</b>
Walter D. Kellogg	Paul R. Fenner Custom House, San Francisco, Calif.,
	<b>SEATTLE</b>
Abner R. Willson	L. C. Austin, Woolley and Co., Inc., 1113 Third Ave., Seattle, Wash.
	<b>TORONTO</b>
J. M. Leslie	R. A. Hackbusch, Stromberg Carlson Tel. Mfg. Co., 211 Geary Ave., Toronto, Ont., Canada.
	<b>WASHINGTON</b>
L. P. Wheeler	Herbert G. Dorsey, U. S. Coast and Geodetic Survey, Washington, D. C.

## GEOGRAPHICAL LOCATION OF MEMBERS ELECTED MARCH 4, 1931

### Transferred to the Member grade

New Jersey	Red Bank, Box 97	Mutch, W. W.
New York	Rochester, 63 Sonora Parkway	Long, John J., Jr.
	West New Brighton, S. I., 102 Bard Ave.	Dinsdale, A.
South Africa	Durban, Studio Town Hall, African Broadcasting Co.	Cumming, Noel Douglas

### Elected to the Member grade

New York	New York, 75 Varick St.	Manley, Lee L.
	New York, 463 West St.	Strieby, Maurice E.
Washington	Seattle, 3910 Densmore Ave.	Wiltse, George V.
England	Somerset, Portishead, Redcliffe Bay, Hillcrest Rd.	Wilson, Frank
Poland	Warsaw, Grazyń 7	Groszkowski, J.

### Elected to the Associate grade

California	Hollywood, 1006 N. Spaulding Ave.	Holden, Dale S.
	Los Angeles, 4583 Ellenwood Drive	Currie, Burton A.
	Pasadena, 935 Palm Terrace	Moore, Robert M.
	San Francisco, 311 California St., Dollar SS Co.	Bender, John A.
	San Pedro, Box 10, U.S.S. Saratoga	Brown, L. D.
	Wilmington, 111 East "N" St.	Blank, S. A.
Connecticut	Elmwood, 221 South St.	Battley, E. L.
Dist. of Columbia	Washington, 316 Todd Pl., N. E.	Bertonis, Peter W.
	Washington, Navy Dept.	Dugan, Paul F.
	Washington, 6701-6th St., N. W.	Holt, Laurence J.
	Washington, 4509 Illinois Ave., N. W.	Reymer, Stephen E.
Georgia	Hapeville, P. O. Box No 1	Shuman, Geo. W., Jr.
Illinois	Chicago, 9705 Cottage Grove Ave.	Arnold, R. M.
	Chicago, 4209 N. Albany Ave.	Cerman, Herman A.
	Chicago, 3802 Ellis Ave.	Chan, G. S.
	Chicago, 400 W. Madison, The Chicago Daily News	Hathaway, Kenneth A.
	Chicago, 3350 N. Halsted St.	Kester, Arthur S.
	Chicago, 5901 Race Ave.	Sherk, Lynn E.
	Chicago, 100 West Monroe St.	Willet, G. Rush
	Elgin, 121 Vine St.	Meyers, Carl J.
	Elmhurst, 206 E. Grantley Ave.	Kennedy, Edward J.
	Peoria, 1008 Eiler Ave.	Janssen, John F.
Indiana	Evansville, 10 S. E. 7th St., Smith Radio Corp.	Rowland, Stirman
	Valparaiso, 822 E. Institute St.	Miller, Emmert C.
Kansas	Iola, 219 South Buckeye	Major, A. R.
Kentucky	Owensboro, 411 W. 13th St.	Bain, George W.
	Owensboro, 106 W. Eight St.	Waugh, George T.
Louisiana	New Orleans, 321 St. Charles St., Tropical Radio	Williams, L. P.
Maine	Bangor, 16 N. Park St.	Webb, Harold S.
Maryland	Annapolis, Postgraduate School, U.S.N.A.	Cogswell, W. P.
	Annapolis, Postgraduate School, Naval Academy	Levasseur, J. T.
	Baltimore, 121 S. Gay St.	Petersen, F. T.
Massachusetts	Arlington, 41 Milton St.	Benham, Harold J.
	Boston, 536 Statler Bldg., R. C. A. Photophone, Inc.	Cox, Wallace
	Cambridge, Harvard University, Cruft Laboratory	Foley, Joseph H.
	Cambridge, Harvard University, Cruft Laboratory	Ragan, Thomas C.
	Franklin, Pleasant St.	Miller, O. F., Jr.
	Hyde Park, 19 Summer St.	Rossignol, Thomas
	Newton Centre, 142 Jackson St.	Gorman, Walter R.
	Salem, 18 New Derby St.	LeBlanc, William A.
	Springfield, 35 Long Hill St.	Letellier, Roy T. L.
	Taunton, 49 Broadway	Tracy, John B., Jr.
Michigan	Detroit, c/o Superintendent of Lighthouses	Richie, S. M.
	Detroit, 1984 Taylor	Stanfield, Lionel J.
	Detroit, 3490 Lincoln Ave.	Truesdale, James R.
	Detroit, 5736 Field Ave.	Wendler, Edward A.
	Manistee, 605 Maple St.	Halliday, L. R.
	Mt. Clemens, 105 Grand Ave.	Sonnenberg, John H.
Mississippi	Biloxi, 210 1/2 Keller Ave.	Manuel, John G.
Missouri	Kansas City, 4235 Holmes St.	Dodds, Leonard F.
Montana	Butte, Radio Station KGIR	Craney, E. B.
New Jersey	Audubon, 510 Cuthbert Rd.	Currier, Stuart E.
	Camden, 1062 Everett St.	Kerniet, Leon S.
	Camden, 222 North Second St.	Mac Millan, William T.
	Camden, R.C.A.-Victor Co., Engineering Dept.	Norton, William B.
	Camden, R.C.A.-Victor Co., Building 6	Williams, A. F.
	Collingswood, 100 Haddon Ave.	Baldwin, Charles F.

*Geographical Location of Members Elected March 4, 1931*

New Jersey (cont.)	Collingswood, 403 Comly Ave.....	Knight, Robert W.	
	Delanco, 209 Vine St.....	Thaidigsman, J. H.	
	Glen Ridge, 16 Midland Ave.....	Menut, George H.	
	Gloucester, 623 Hunter St.....	Landgraf, Harry S.	
	Haddonfield, 604 Avondale Ave.....	Mickel, Harry F.	
	Haddon Heights, 414 Ninth Ave.....	Flaherty, Mark	
	Harrison, R.C.A.-Radiotron Co., Inc., Dev. Lab.....	Orth, R. T.	
	Merchantville, 606 W. Maple Ave., Apt. E-2.....	Taylor, D. A.	
	Merchantville, 4723 Lafayette Ave.....	West, Kenneth A.	
	Newark, 705 Ridge St.....	Duvall, F. B.	
	Oaklyn, 165 Kendall Blvd.....	Neal, George F.	
	Red Bank, Box 97.....	Ring, Douglas H.	
	Stratford, Princeton Ave.....	Gardiner, A. N.	
	Westville, 325 Highland Ave.....	Chew, Stephen A.	
	New York	Brooklyn, 208 Barbey St.....	Nixon, George M.
		Brooklyn, 365 E. 16th St., Sir Henry Hotel.....	Petersen, Carl O.
		Brooklyn, 3921 Seventh Ave.....	Prigge, John, Jr.
		Buffalo, 404 Hickory St.....	Silvermans, Sidney
		Harrison, RCA Radiotron Corp., Dev. Lab.....	Kauzmann, A. P.
		Jamaica, L. I., Central Queens, Y.M.C.A.....	Read, Oswald W.
New York, 790 Riverside Drive, Apt. 1K.....		Core, Christopher W.	
New York, 490 E. 189th St.....		Duggan, Jack	
New York, International Comm. Labs., 67 Broad St.....		Garceau, E. L.	
New York, Bell Tel. Labs., 463 West St.....		Jameson, Malcolm	
New York, Bell Tel. Labs., 180 Varick St.....		Levin, Samuel A.	
New York, Bell Tel. Labs., 463 West St.....		Moore, George E.	
New York, 210 Sixth Ave.....		Tinus, William C.	
New York, Columbia Broadcasting Co. 485 Madison.....		Vanderhoeven, R. M. P.	
New York, 17 Battery Pl. c/o J. H. Winchester.....		Walker, G.	
New York, 304 W. 34th St.....		Wright, W. S.	
Richmond Hill, L. I., 8427-105 St.....		Jacobs, Frank	
Rochester, 33 Erion Crescent.....		Bullis, Ormond F.	
Rochester, 287 Genesee Park Blvd.....		Gardner, Kenneth J.	
Rochester, 413 Lexington Ave.....		Marsh, Albert H.	
Schenectady, 947 Maple Ave.....	Becker, Stewart		
Syracuse, 253 Roosevelt Ave.....	Mullin, LeRoy A.		
Utica, 1119 Taylor Ave.....	Allen, Raymond H.		
Ohio	Cincinnati, 2953 Coleraine Ave.....	Chamberlain, Paul	
	Cincinnati, 2131 Kindle Ave.....	Ginandt, George, Jr.	
	Cincinnati, 3302 Coleraine Ave.....	Macy, Fred E.	
Oklahoma	Dayton, 2212 Wayne Ave.....	Byrd, Nevin C.	
	Norman, 227 East Main St.....	Bettis, Lloyd D.	
Oregon	Medford, 721 Alder St.....	Walker, Verl G.	
	Portland, 5350-70 Ave.....	Tonn, Alfonse H.	
Pennsylvania	East Pittsburgh, Westinghouse Elec. & Mg. Co.....	Swedlund, L. E.	
	Lima, Delaware Co.....	Wolf, Donald G.	
	Philadelphia, 3453 N. Sydenham St.....	Goodwin, Winfield	
	Philadelphia, 3048 "D" St.....	Ingham, James, Jr.	
	Philadelphia, 3800 Archer St.....	Kurdziel, John F.	
	Philadelphia, 6483 Malvern Ave.....	Packard, Charles A.	
	Philadelphia, 645 N. 39th St.....	Rose, William A.	
	Philadelphia, 210 N. 33rd St.....	Ruelius, Louis Franz	
	Philadelphia, 2019 N. Broad.....	Stelzer, Alphonse C.	
	Pittsburgh, 327 Craft Ave.....	Palmer, Harris C.	
	Wayne, R.F.D. No. 1.....	Skerrett, W. H. W.	
	Rhode Island	Providence, 92 Keene St.....	Kraus, Charles N.
		Providence, 242 Rugby St.....	Perron, Raymond T.
Texas	Brownsville, P.O. Box 318.....	Crosas, Ernesto G.	
	Dallas, 2214 Pine St.....	Hulse, Daniel O.	
Utah	Salt Lake City, c/o Radio Station (Airway).....	Waterman, Edward C.	
Virginia	Alexandria, 815 Prince St.....	Bailey, W. B.	
	Norfolk, 222 Brewer St., Radiomarine Corp. of America.....	Cain, O. J.	
Washington	Quantico, 87th Co., Signal Bn.....	Macy, Spencer A.	
	Quantico, 87th Co., Signal Bn.....	Stachura, Edward J.	
	Edmonds.....	Leyda, G. D.	
	Raymond, Box 992.....	Wills, James E.	
	Seattle, 1423-32nd Ave.....	Frazier, R. K.	
	Seattle, 5280-45th S. W.....	Neelands, F. J.	
	Seattle, 617-28th Ave., No.....	Pinkman, Herbert N.	
	Seattle, 3937 Whitman Ave.....	Welbon, Roy	
	Snohomish, 509 Pearl St.....	Kester, C. O.	
	Milwaukee, 1905 No. Prospect Ave.....	Halinton, Harry	
Argentina	Buenos Aires, Defensa 143, Cia Internacional de Radio.....	Toombs, R.	
Australia	Victoria, Melbourne, 346 St. Kilda Rd.....	Gronow, W. R.	
Brazil	Sao Paulo, Praca Ramos de Azevedo 16, Western Electric Company of Brazil.....	Barzee, G. W.	
Canada	Kitchener, Ont., 28 Gordon Ave.....	Tremain, Earnest L.	
	London, Ont., 336 Oakland Ave.....	Kimble, Earle B.	
	Montreal, Que., 4912 Sherbrooke, W.....	Robertson, W. G.	
	Montreal, Que., c/o Canadian Marconi Company, Mount Royal Factory.....	Jaederholm, H. W.	

*Geographical Location of Members Elected March 4, 1931*

Canada (cont.)	Parkhill, Ont.....	Penhale, A.
	Toronto, Ont., 505-90 Carlton St.....	Jacobs, G. Ansley
	Winnipeg, Man., 65 Rorie St., c/o Northern Electric Co., Ltd.....	Grimes, H. B.
China	Winnipeg, Man., Northern Electric Co., Ltd.....	Miller, S. S.
Denmark	Shanghai, 24 Hankow Rd., c/o N.Z. Kov, The Shun Pao.....	King, P. K.
England	Copenhagen, Classensgade 19 A.....	Bramslev, G.
	Ascot, Berks., New Road, Linda Cottage.....	Taylor, A. S.
	Bolton, Lancashire, 37 Stanley Rd.....	Sheffield, Charles W.
	Chelmsford, 3 Tudor Ave.....	Gifford, K. H. B.
	Chelmsford, 28 Van Diemens Road.....	Varley, W. C. E.
	Farnsborough, Hants., 30 Manor Road.....	Kirkman, R. A.
	Harefield, Middlesex, Pinner Rd. "Lynton".....	Dockree, G. E.
	Leigh-on-Sea, Essex, 42 Leigham Court Dr.....	Woodward, L. A.
	London, W.C.1, BM/ZNOC.....	Conway, M. J.
	London, W.7, 141 Clitherow Ave.....	Hoar, Harold G.
	London, Blackheath, 169 Old Dover Rd.....	McLelland-Brown, G. F.
	Purley, Surrey, 22 Station Approach.....	Forbes, F. D.
	Seedley, Manchester, 12 Scales St.....	Percival, W. R.
	Sheffield, Essex, Priests Lane, "Elnido".....	Young, A. M.
	Wealdstone, Middlesex, Station Rd. No. 7 Flat.....	Loos, G. F.
	Westerham, Kent, Tatsfield, B.B.C.....	Partridge, J. A.
Federated Malay States	Lumpur, Kuala, Petaling Hill, Wireless Station.....	Oakes, W. G.
France	Paris, 207 Bd. Raspail, Paris 6.....	Asche, R. E.
	Paris, 66 Boulevard de la Gare.....	Hummel, J. E.
	Paris, 1 Rue Octave, Fevillet.....	Klappenbach, W.
	Saint-Cloud Seto, 52 Avenue Bernard Palissy.....	Higonnet, R. A.
India	Bangalore, Indian Institute of Science.....	Mohammed, A.
	Ahmedabad 1, Advance Mills Ltd.....	Shroff, T. R.
Japan	Kawasaki, c/o The Tokyo Electric Co.....	Kamio, K.
	Kinutamura, nr. Tokyo, Japanese Broadcasting Co.....	Mukai, T.
	Kinutamura, nr. Tokyo, Japanese Broadcasting Co.....	Suzuka, M.
	Kinutamura, nr. Tokyo, Japanese Broadcasting Co.....	Suzuka, T.
	Kinutamura, nr. Tokyo, Nihon-Hosokyokai, Gijutsuken-kyujo.....	Takamura, S.
	Kinutamura, nr. Tokyo, Japanese Broadcasting Co.....	Yokoyama, H.
	Siba, Tokyo, c/o Teisin-Kanri-Renshujo-Musen.....	Takase, J. Yosiaki
	Tokyo, Waseda University, Elec. Eng. Department.....	Iwakata, H.
New Zealand	Ashburton, 74 Wills St.....	Buchanan, D. W.
	Christchurch, 204 Salisbury St.....	Hurrell, L. W.
	Masterton, 35 Queen St.....	Ansell, W. D.
Peru	Lima, c/o All American Cables.....	Pedersen, A. A.
	Talara, S/S Incalite, c/o Inter. Petroleum Co.....	Hampton, S. G. A.
Port. E. Africa	Lourenco Marques, Post Office.....	Gordinho, T. J.
South Africa	Johannesburg, Transvaal, 23 York St.....	Levington, Abie
Sweden	Hedemora.....	Wollert, Bertil

**Elected to the Junior grade**

Indiana	Oakland City, 414 W. Columbia St.....	Harper, Everett L.
Iowa	Ames, 2644 Lincoln Way.....	Andersen, Donald E.
Kansas	Manhattan, 731 Humboldt St.....	Allen, John H.
Massachusetts	Boston, M.I.T. Dormitories.....	Jacobson, L.
Minnesota	Moorhead, Concordia College.....	Distad, M.
Nebraska	Lincoln, c/o Nebraska Wesleyan University.....	Jensen, R. R.
New York	Brooklyn, 456-7th St.....	Simmons, R. A., Jr.
	New Rochelle, 261 Sickles Ave.....	Wilson, R. F.
	New York, 230 W. 107th St.....	Garner, Melvin E.
	New York, Bell Tel. Labs., 463 West St.....	Kobliha, F. E.
	New York, 1127 Sheridan Ave.....	Samuelson, C. D.
	New York, 251 W. 102nd St.....	von Doenhoff, A. E.
	Rochester, 341 Farmington Rd.....	Anderson, Roy S.
Pennsylvania	Duquesne, 312 Viola Ave.....	Murcek, S. J.
	Philadelphia, 801 S. St. Bernard St.....	Ludwig, C. S., Jr.





APPLICATIONS FOR MEMBERSHIP

Applications for transfer or election to the various grades of membership have been received from the persons listed below, and have been approved by the Committee on Admissions. Members objecting to transfer or election of any of these applicants should communicate with the Secretary on or before April 29, 1931. These applicants will be considered by the Board of Direction at its May 6th meeting.

For Transfer to the Member Grade

California	San Francisco, 2120 Lyon St.	Bradley, John T.
Dist. of Columbia	Washington, 3166 Mt. Pleasant St., N. W.	Rietzke, E. H.
India	Bangalore, Hebbal Indian Science Institute	Kantebet, S. R.

For Election to the Associate Grade

California	Inverness	Thomas, H. E.
	Los Angeles, 3523 Roseview Ave.	Fetterhoff, M. J.
	Los Angeles, 2739 Cochran Ave.	Shepherd, Leo
	Los Angeles, 1578 W. 50th St.	Warne, Vearn J.
	San Francisco, 140 New Montgomery St.	Blake, Robert I.
	San Francisco, 140 New Montgomery St.	Cole, C. H.
	San Francisco, 140 New Montgomery St.	Cone, Donald I.
	San Francisco, Tropical Radio Tel. Co., 1001-4th St.	Connolly, N. C.
	San Francisco, 140 New Montgomery St.	Hartz, J. E.
	San Francisco, Mackay Radio & Tel. Co., 22 Battery St.	Kirkland, R. D.
	San Francisco, 735 Larkin St.	Nicolaides, G.
	San Francisco, 140 New Montgomery St.	Sandfort, Mark
	San Francisco, 140 New Montgomery St.	Whitten, S.
	San Pedro, U. S. S. Saratoga	Bassler, C. J.
	San Pedro, U. S. S. West Virginia, c/o Postmaster	Mareck, A. J.
	Santa Monica, 925 Yale St.	Best, A. O.
	Stockton, 521 E. Washington St.	Preston, Cecil H.
Dist. of Columbia	Washington, 1414-21st St., N. W.	Kennedy, John H.
	Washington, Bureau of Standards	Lapham, E. G.
Florida	Clearwater, P. O. Box 573	Crowley, C. G.
Georgia	Atlanta, Candler Field, Eastern Air Transport, Inc.	Cochrane, N. R.
	Hapeville, Airways Radio Station, Dept. of Commerce	Frazier, H. G.
	Hapeville, 797 Virginia Ave.	Weinberg, B. L.
Illinois	Chicago, 4714 N. Spaulding Ave.	Carter, R. G.
	Chicago, 5435 W. Kamerling Ave.	Gustafson, M. F.
	Chicago, 2445 S. Spaulding Ave.	Kolar, E. F.
	Chicago, National Broadcasting Co., Merchandise Mart.	Luttgens, H. C.
	Chicago, 1460 E. 57th St.	Richards, S.
	Chicago, 2017 W. Monroe St.	Wong, C. L.
	Geneva, Riverbank Laboratories	Anderson, C. A.
	Springfield, 713 S. English Ave.	Ring, E. F.
Indiana	Anderson, 1121 Central Ave.	Wend, Clyde
	Indianapolis, 3327 Washington Blvd.	Garstand, W. W.
	Valparaiso, 405 E. Monroe St.	Seese, W. B.
Kansas	Topeka, Adjutant General's Department	Mc Farland, W. E.
Maine	Houlton, 20 Park St.	Crandell, E. L.
	South Portland, 22 Angell Ave.	Cobb, Stanley W.
Maryland	Baltimore, 2810 Ailsa Ave.	Eckels, August E.
Massachusetts	Boston, RCA Photophone, Inc., 536 Statler Bldg.	Kirchhoff, W. J.
	Lawrence, Box No. 146	Montgomery, J. L.
	North Andover, 165 Railroad Ave.	Lemieux, C. J.
	Springfield, 104 Oswego St.	Sherwood, J. W.
Michigan	Detroit, 17208 Pierson Ave.	Rifenbergh, C. M.
Minnesota	Minneapolis, 2100 Fairmont St., S. E.	Knox, Martin E.
Missouri	St. Louis, 5020a Mardel Ave.	Walker, James H.
Nebraska	North Platte, R. 1, Box 499A	Flebbe, W. E.
New Mexico	Raton, Radio Station KGFL	Wolfe, C. R.
New Jersey	East Orange, 331 N. Grove St.	Loratt, H. S.
	Harrison, Engineering Dept., RCA Radiotron Co.	Jones, Margaret C.
	Merchantville, 123 S. Lexington Ave.	Matheus, G. E.
	Paterson, 280 E. 24th St.	Weiner, Max J.
	Ridgewood, 123 S. Maple Ave.	Roucler, Harold
	Stanhope, P. O. Box 123	Williams, Frank J.
New York	Astoria, L. I., 30-49 Crescent St.	Lurie, Eli M.
	Auburn, 16 Parker St.	Gere, J. A.
	Brooklyn, 1807 Brooklyn Ave.	Petry, G. F.
	New York City, 32 W. 111th St.	Conviser, Harry
	New York City, 2473 Elm Pl.	Grosselfinger, W. H.
	New York City, Bell Telephone Labs., 163 West St.	Mendenhall, H. E.
	New York City, 1240 Olmstead Ave.	Synnot, Burton
	Rochester, 654 Chili Ave.	Henry, William F.

## Applications for Membership

North Dakota	Fargo, c/o WDAY, Inc.	Hetland, J. M.
Ohio	Canton, 825 Harriet Ave., N. W. Cincinnati, Rm. 101, Swift Hall, University of Cincinnati	Gockstetter, G. J.
Oklahoma	Bartlesville, Research Lab., Phillips Petroleum Co.	Drake, Robert L.
Oregon	Corvallis, E. E. Dept., Oregon State College	Eastman, Fred T.
Pennsylvania	Germantown, 6339 Homer St. Philadelphia, 2002 N. Broad St. Scranton, 1806 W. Gibson St.	Albert, A. L. Daly, George M. Airston, A. J. Wilson, G. H.
Washington	Arlington Seattle, RCA Victor Co., Inc., 502 National Bldg.	Murray, Henry Hucke, H. M.
Canada	Bowmanville, Ont., c/o CKGW, R. C. No. 4 Halifax, N. S., 95 Morris St. Toronto, Ont., 338 Walmer Rd. Toronto, Ont., 189 Dufferin St. Toronto, Ont., 9 Cortleigh Blvd.	Shane, W. A. Martlieu, C. H. O. Harris, Edward Price, L. M. Stiff, G. F.
Canal Zone	Cristobal, P. O., Box 5056	Angus, G. W.
England	Bradford, 473-475 Manchester Rd. Leeds, Yorkshire, 43 Clarendon Rd. London, N. 15, 242 High Rd. London, W. 3, 18 Twyford Avenue London, S. E. 3, Blackheath, Messrs. Burndept Wireless (1928) Ltd. Newport, Manchester, 6 Upton Rd. Wembley, Middlesex, 7 Berkhamsted Ave. Honolulu, 1255 Rycroft St. Bangor, Co. Down, 88 Hamilton Rd. Hiroshima, Asagun, Nagatukamura, c/o T. Ikeda Kojimachi, Tokyo, 22-5 Chome Hirakawacho.	Dobson, Jonas Fox, P. X. Hogben, B. Merdlar, L. R. Oliphant, W. D. Cooper, K. S. Lince, R. Morioka, G. M. Taggart, D. Siro, A. Sugi, C.
Hawaii	Manila, Sampaloc, 408 San Anton	Lorenzo, Eugenio
Ireland	Tutuila, U.S.N. Radio Station	Yolden, A. G.
Japan	Natal, Durban, Kings Kinewa Transvaal, Benoni, P. O. Box No. 208 Barcelona	Harris, Isidore Renshaw, J. B. Texido, P.
Philippine Islands	Zurich, Zurich Physical Institute, E. T. H. Gloriastr. 35	Tank, Franz
Samoa		
South Africa		
Spain		
Switzerland		
<b>For Election to the Junior Grade</b>		
Arkansas	Texarkana, R. No. 3, Box 305	Mathis, C., Jr.
New York	New York, 1825 Lacombe Ave.	Anderon, H. L.
Ohio	Blanchester, 503 W. Main St. Conneaut, P. O. Box No. 14, Jester Station	Saville, H. F. Hirsimaki, N.

## OFFICERS AND BOARD OF DIRECTION, 1931

(Terms expire January 1, 1932, except as otherwise noted)

*President*

RAY H. MANSON

*Vice President*

C. P. EDWARDS

*Treasurer*

MELVILLE EASTHAM

*Secretary*

HAROLD P. WESTMAN

*Editor*

ALFRED N. GOLDSMITH

*Managers*

ARTHUR BATCHELLER  
J. H. DELLINGER

LLOYD ESPENSCHIED  
HARRY HOUCK

C. M. JANSKY, JR.

Serving until January 1, 1933

J. V. L. HOGAN

R. H. MARRIOTT

Serving until January 1, 1934

L. M. HULL

A. F. VAN DYCK

---

*Junior Past Presidents*

A. HOYT TAYLOR  
LEE DE FOREST

---

*Board of Editors, 1931*

ALFRED N. GOLDSMITH, *Chairman*

STUART BALLANTINE

G. W. PICKARD

RALPH BATCHER

L. E. WHITTEMORE

W. WILSON

---

## COMMITTEES OF THE INSTITUTE OF RADIO ENGINEERS 1931

### Committee on Papers

W. WILSON, *Chairman*

Theory, Circuit, and General	Aircraft Radio
L. M. HULL	F. M. RYAN
Generating Apparatus and Theory	Stations and Operating, Broadcasting
B. R. CUMMINGS	E. K. COHAN
L. P. WHEELER	R. M. MORRIS
Receiving Apparatus and Theory	Television
C. E. BRIGHAM	D. E. REPLOGLE
H. A. WHEELER	Picture Transmission
Transmission Through Space	R. H. RANGER
G. W. KENRICK	Miscellaneous Communication Systems
R. K. POTTER	H. A. AFFEL
Measurements and Standards	Piezo-Electricity
J. K. CLAPP	W. G. CADY
E. L. HALL	Historical Bibliographies, Book Reviews
Miscellaneous Technical Papers	S. S. KIRBY
K. S. VAN DYKE	Radio Communication Systems
Vacuum Tubes and Thermionics	T. A. M. CRAVEN
W. C. WHITE	Radio Manufacturing
Aerials and Aerial Systems	G. G. THOMAS
G. C. SOUTHWORTH	Nonradio and Radio Law
Acoustics and Audio Frequencies	R. H. MARRIOTT
IRVING WOLFF	

### Committee on Admissions

C. M. JANSKY, JR., *Chairman*

R. A. HEISING, *Vice Chairman*

C. N. ANDERSON	A. V. LOUGHERN
ARTHUR BATCHELLER	R. H. MARRIOTT
C. P. EDWARDS	E. R. SHUTE
H. C. GAWLER	J. S. SMITH
A. G. LEE	A. F. VAN DYCK

### Committee on Awards

ALFRED N. GOLDSMITH, *Chairman*

STUART BALLANTINE	MELVILLE EASTHAM
RALPH BOWN	A. HOYT TAYLOR

### Committee on Bibliography

J. H. DELLINGER, *Chairman*

M. C. BATSEL	G. W. PICKARD
W. G. CADY	B. E. SHACKELFORD
MELVILLE EASTHAM	E. R. SHUTE
G. W. GIBBS	H. M. TURNER
C. B. JOLLIFFE	A. F. VAN DYCK
A. E. KENNELLY	H. A. WHEELER
R. H. LANGLEY	L. P. WHEELER
J. O. MAUBORGNE	W. C. WHITE
DONALD McNICOL	L. E. WHITTEMORE

W. WILSON

### Committee on Broadcasting

L. M. HULL, *Chairman*

ARTHUR BATCHELLER  
B. R. CUMMINGS  
P. A. GREENE  
R. GUY  
J. V. L. HOGAN

C. W. HORN  
C. M. JANSKY, JR. (S. L. BAILEY, al-  
ternate)  
R. H. MARRIOTT  
E. L. NELSON

### Committee on Constitution and Laws

R. H. MARRIOTT, *Chairman*

ARTHUR BATCHELLER  
MELVILLE EASTHAM  
W. G. H. FINCH

H. E. HALLBORG  
R. A. HEISING  
G. W. PICKARD

H. A. ZEAMANS

### Committee on Membership

H. C. GAWLER, *Chairman*

W. W. BROWN  
J. M. CLAYTON  
I. S. COGGESHALL  
DAVID GRIMES  
F. A. KOLSTER  
M. B. LONG

S. R. MONTCALM  
A. F. MURRAY  
M. E. PACKMAN  
C. R. ROWE  
J. E. SMITH  
J. C. STROEBEL, JR.

A. M. TROGNER

### Committee on New York Programs

AUSTIN BAILEY, *Chairman*

M. C. BATSEL  
H. C. GAWLER  
L. M. HULL

R. H. RANGER  
L. REYNOLDS  
E. R. SHUTE

H. A. WHEELER

### Committee on Nominations

J. H. DELLINGER, *Chairman*

ARTHUR BATCHELLER  
C. P. EDWARDS

ALFRED N. GOLDSMITH  
J. V. L. HOGAN

L. M. HULL

### Committee on Pub icity

C. E. BUTTERFIELD, *Chairman*

O. H. CALDWELL  
O. E. DUNLAP  
FRED EHLERT  
W. G. H. FINCH

A. H. HALLORAN  
LLOYD JACQUET  
J. F. J. MAHER  
DONALD McNICOL

K. B. WARNER

### Committee on Sections

C. W. HORN, *Chairman*

AUSTIN BAILEY  
W. R. G. BAKER  
L. A. BRIGGS

D. H. GAGE  
V. M. GRAHAM  
R. H. LANGLEY

B. E. SHACKELFORD



## Committee on Standardization

J. W. HORTON, *Chairman*

STUART BALLANTINE  
E. L. BOWLES  
E. L. CHAFFEE  
J. H. DELLINGER  
W. E. DOWNEY  
ALLEN DU MONT  
C. P. EDWARDS  
P. E. EVANS  
MALCOLM FERRIS  
A. N. GOLDSMITH  
F. H. KROGER  
C. M. JANSKY, JR.

H. M. LEWIS  
D. G. LITTLE  
E. L. NELSON  
HARADEN PRATT  
B. E. SHACKELFORD  
J. C. SCHELLENG  
H. M. TURNER  
J. C. WARNER  
K. S. WEAVER  
H. A. WHEELER  
L. E. WHITTEMORE  
R. M. WILMOTTE

W. WILSON



*Underwood and Underwood*

The Sixth Annual Convention of the Institute will be held in Chicago on June 4, 5, and 6, 1931.  
The above picture was taken north of the loop.

## INSTITUTE NEWS AND RADIO NOTES

### March Meeting of the Board of Direction

A meeting of the Board of Direction of the Institute was held on March 4 with the following in attendance: Ray H. Manson, president; Melville Eastham, treasurer; Alfred N. Goldsmith, editor; Arthur Batcheller, J. H. Dellinger, Lloyd Espenschied, J. V. L. Hogan, Harry Houck, L. M. Hull, C. M. Jansky, Jr., R. H. Marriott, A. F. Van Dyck, and H. P. Westman, secretary.

Applications for admission to the grade of Member in the names of J. Groszkowski, M. E. Strieby, F. Wilson, and G. V. Wiltse were approved as were applications by N. D. Cummings, A. Dinsdale, J. J. Long, Jr., and W. W. Mutch for transfer to the Member grade. Applications for the Associate grade of membership totaling one hundred and seventy-nine and fifteen for the Junior grade were approved also.

In view of plans to hold the Sixth Annual Convention of the Institute in Chicago on June 4, 5, and 6, 1931, it was decided to dispense with the regular June meeting of the Institute. It is also probable that no June meeting of the Board of Direction will be held.

The Medal of Honor of the Institute for 1931 will be awarded to General G. Ferrière of Paris, France, for "his pioneer work in the up-building of radio communication in France and the world, his long continued leadership in the communication field, and his outstanding contributions to the organization of international coöperation in radio."

The Morris Liebmann Memorial Prize was awarded to Stuart Ballantine of Boonton, N. J., for "his outstanding theoretical and experimental investigations of numerous radio and acoustic devices."

### American Standard

A new American Standard approved on September 9, 1930, on Specifications for Dry Cells and Batteries has recently been issued in pamphlet form and may be obtained from the American Standards Association, 29 West 39th Street, New York City, at 15 cents per copy. It is the result of the work of the Sectional Committee on Specifications for Dry Cells which was sponsored by the U. S. Bureau of Standards.

### Radio Transmissions of Standard Frequency, April to June, 1931

The Bureau of Standards announces a new and improved service of radio standard frequency transmissions. This service may be used by broadcast and other stations in adjusting their transmitters to exact

frequency, and by the public in calibrating frequency standards and transmitting and receiving apparatus. The signals are transmitted from the Bureau's station WWV, Washington, D.C. They can be heard and utilized by stations equipped for continuous-wave reception at distances up to about 1000 miles from Washington, and some of them at all points in the United States. This improved service is a step in the Bureau's program to provide eventually standard frequencies available at all times and at every place in the country.

Besides the usual monthly transmissions of specific frequencies, the Bureau will add another type of transmission which will be much more accurate than any previous transmissions by the Bureau. This transmission will be by continuous-wave radiotelegraphy on a frequency of 5000 kc, and will consist primarily of a series of very long dashes. The first five minutes of this transmission will consist of the general call (CQ de WWV) and announcement of the frequency. The frequency and the call letters of the station (WWV) will be given every ten minutes thereafter.

Besides this service, the Bureau will also continue the transmissions once a month on scheduled specific frequencies. These are also by continuous-wave radiotelegraphy. A complete frequency transmission includes a "general call," "standard frequency signal," and "announcements." The general call is given at the beginning of each 12-minute period and continues for about 2 minutes. This includes a statement of the frequency. The standard frequency signal is a series of very long dashes with the call letters (WWV) intervening; this signal continues for about 4 minutes. The announcements follow, and contain a statement of the frequency being transmitted and of the next frequency to be transmitted. There is then a 4-minute interval while the transmitting set is adjusted for the next frequency.

Information on how to receive and utilize the signals is given in Bureau of Standards Letter Circular No. 280, which may be obtained by applying to the Bureau of Standards, Washington, D.C. Even though only a few frequencies are received (or even only a single one), persons can obtain as complete a frequency meter calibration as desired by the method of generator harmonics.

The 5000-kilocycle transmissions are from a transmitter of 150 watts power, which may be increased to 1 kilowatt early in the year; they occur every Tuesday except in those weeks in which the monthly transmissions are given. The monthly transmissions are from a transmitter of 1/2 to 1 kilowatt power; they are given on the 20th of every month (with one exception).

5000-Kilocycle Transmissions  
1:30 to 3:30, and 8:00 to 10:00, P.M., Eastern Standard Time.

April	May	June
7	5	2
14	12	9
28	26	16
		30

Time	Monthly Transmissions, Eastern Standard Time		
	April 20	May 20	June 22
10:00 P.M.	1600	4000	550
10:12	1800	4400	600
10:24	2000	4800	700
10:36	2400	5200	800
10:48	2800	5800	1000
11:00	3200	6400	1200
11:12	3600	7000	1400
11:24	4000	7600	1600

The frequencies in the 5000-kilocycle transmission are piezo controlled, and are accurate to a few parts in a million. The frequencies in the monthly transmissions are manually controlled, and are accurate to a few parts in a hundred thousand.

In November, 1930, field intensity measurements were made of the 5000-kilocycle transmissions from (WWV) on 150 watts between Washington and Chicago. The daytime field intensity up to a distance of about 400 miles from Washington was about 100 microvolts per meter, with fading in the ratio 3 to 1. From this distance to Chicago the field intensity gradually decreased to about 10 microvolts per meter peak values with fading the same as above. The evening transmissions had a field intensity of about 200 microvolts per meter with fading similar to that in the daytime. Around 8 P.M. the received intensity was sometimes too low to measure. This happened at distances of from 75 to 150 miles from Washington.

The Bureau of Standards would like to have detailed information on the reception of the 5000-kilocycle transmission, and will appreciate receiving reports from any observers on their reception of these transmissions. Phenomena of particular interest are approximate field intensity, and fading (whether slow or rapid, and approximate time between peaks of signal intensity). The Bureau would also like to receive comments on whether or not the transmissions are satisfactory for purposes of frequency measurement or control. Reports on the reception of the transmissions should be addressed to Bureau of Standards, Washington, D.C.

### Committee Meetings

#### COMMITTEE ON ADMISSIONS

A meeting of the Committee on Admissions was held at 10 A.M. on Wednesday, March 4, at the office of the Institute. The meeting was



attended by C. M. Jansky, Jr., chairman; S. E. Anderson, Arthur Batcheller, H. C. Gawler, R. A. Heising, A. V. Loughren, J. S. Smith, and A. F. Van Dyck. Of five applications for transfer to the grade of Member which were considered, three were approved. Neither of the two applications for admission to the Member grade which were considered were approved.

#### COMMITTEE ON AWARDS

A meeting of the Committee on Awards attended by Alfred N. Goldsmith, chairman; Ralph Bown and Melville Eastham was held at 1:30 P.M. on Wednesday, March 4. The recommendations of this committee were considered by the Board of Direction and the decision reached is included in the report of that meeting.

#### COMMITTEE ON BROADCASTING

A meeting of the committee on Broadcasting was held at 2 P.M. on February 13. The committee members present were: L. M. Hull, chairman; B. R. Cummings, S. L. Bailey, P. A. Greene, Raymond Guy, J. V. L. Hogan, C. W. Horn, C. M. Jansky, Jr., and E. L. Nelson.

Dr. C. B. Jolliffe, chief engineer at the Federal Radio Commission, was present at the meeting to discuss with the committee the problems which confront the Commission and to assist the committee in outlining its future program.

The March meeting of the Committee on Broadcasting was held on the 3rd at 7 P.M., and was attended by L. M. Hull, chairman; Wilson Aull (representing J. V. L. Hogan), S. L. Bailey, B. R. Cummings, P. A. Greene, Raymond Guy, C. W. Horn, C. M. Jansky, Jr., R. H. Manson, R. H. Marriott, and E. L. Nelson.

#### COMMITTEE ON CONVENTION PAPERS

A meeting of the Committee on Convention Papers was held at 1 P.M. on March 4. Those in attendance were: K. S. Van Dyke, chairman; R. H. Ranger and H. P. Westman, secretary.

The committee prepared a tentative program of papers to be presented at the forthcoming Sixth Annual Convention. While it is not possible at this moment to list definitely those papers which will be included in the program, full details will be given in the May issue of the PROCEEDINGS.

#### COMMITTEE ON MEMBERSHIP

A special meeting of the Committee on Membership was held at 5:30 P.M. on Tuesday, February 17, to lay out a program for the opera-

tion of the committee during the year. An analysis of the results of the past year's work in the solicitation of new members was made in order to insure a minimum of waste effort being expended in the future. The meeting was attended by: H. C. Gawler, chairman; I. S. Coggeshall, M. B. Long, S. R. Montcalm, A. M. Trogner, and H. P. Westman, secretary.

The regular monthly meeting of the Committee on Membership was held at 5:30 P.M. on March 4 and was attended by: H. C. Gawler, chairman; I. S. Coggeshall, David Grimes, M. B. Long, S. R. Montcalm, C. R. Rowe, J. E. Smith, and A. M. Trogner.

#### COMMITTEE ON NEW YORK PROGRAMS

At a meeting of the Committee on New York Programs held at 7 P.M. at the office of the Institute on Thursday, February 26, tentative programs covering several forthcoming New York meetings were determined upon. Unfortunately, it is not possible to specify definitely papers recommended by the committee for presentation at New York meetings as definite acceptance by the authors have not been received. Whenever possible the subject matter as well as the date of the forthcoming New York meeting is published on the inside front cover of the PROCEEDINGS.

#### COMMITTEE ON PAPERS

The following were in attendance at a meeting of the Committee on Papers held at 10 A.M. on Wednesday, March 4: William Wilson, chairman; H. A. Affel, J. B. Blanchard (nonmember), W. A. R. Brown (representing R. M. Morris), C. E. Brigham, J. K. Clapp, J. H. Dellinger (nonmember), G. W. Kenrick, R. H. Marriott, R. K. Potter, R. H. Ranger, G. C. Southworth, G. G. Thomas, K. S. Van Dyke, H. A. Wheeler, Irving Wolff, and H. P. Westman, secretary.

An analysis of the past work of the Committee on Papers which was previously known as the Committee on Meetings and Papers indicated the advisability of retaining the present committee structure which divides the field into a number of specialized subjects, each of which is under the care of a specialist in that particular subject.

The report of reader form was revised and it is hoped that the new one will permit placing in the hands of the editors a more concise and accurate estimate of the worth of the papers being considered.

A number of other matters involving the general operation of the committee were discussed.

## STANDARDIZATION

## TECHNICAL COMMITTEE ON RADIO RECEIVERS—ASA

A meeting of the Technical Committee on Radio Receivers operating under the Sectional Committee on Radio of the American Standards Association was held at the office of the Institute on February 16 at 10 A.M. It was attended by Virgil M. Graham, chairman; E. T. Dickey, J. W. Fullmer (representing H. B. Smith), and Leslie Woods (representing W. M. Grimditch).

The committee reviewed the material appearing in the recently approved 1931 Report of the Committee on Standardization of the Institute in so far as it covered matters within the jurisdiction of the committee.

The committee had previously reviewed the report of the Committee on Standardization for 1928 but in view of the many changes made in the 1931 report it was found necessary to go over the new report.

The work of this committee is now practically finished and it is anticipated that its report will be available for submission to the Sectional Committee on Radio in the near future.

## TECHNICAL COMMITTEE ON RADIO TRANSMITTERS AND PARTS—ASA

The March 6 meeting of the Technical Committee on Radio Transmitters and Parts operating under the Sectional Committee on Radio of the American Standards Association was attended by Haraden Pratt, chairman; J. B. Blanchard (nonmember), J. K. Clapp, P. A. Greene, Raymond Guy, E. L. Nelson, William Wilson, and B. Dudley, secretary.

The committee reviewed the definitions relating to transmitters, antennas, and associated subjects which appear in the 1931 Report of the Committee on Standardization of the Institute.

It is anticipated that at the next meeting of the committee material relating to test methods for transmitters will be completed and the report of the committee can be made available to the Sectional Committee on Radio for final approval.

## TECHNICAL COMMITTEE ON RADIO RECEIVERS—IRE

## SUBCOMMITTEE ON HIGH-FREQUENCY RECEIVERS

A meeting of the Subcommittee on High-Frequency Receivers operating under the Technical Committee on Radio Receivers of the Institute was held on March 5 and attended by: C. M. Burrill, chairman; F. A. Polkinghorn, H. O. Peterson, and B. Dudley, secretary.

## **Institute Meetings**

### **BOSTON SECTION**

A meeting of the Boston Section was held on February 13 at Cruft Laboratory, Harvard University, G. W. Pierce, presiding.

The paper of the evening, delivered by Eduard Karplus of the General Radio Company, was on "Communication With Quasi Optical Waves."

The speaker reviewed the possibilities of communication on wavelengths between those of heat waves and ten meters explaining the good and bad points of the various frequencies discussed. He then covered methods of generating oscillations of different wavelengths and the detection methods which could be employed.

The range of wavelengths between one and five meters was considered. The possibilities and weaknesses of these waves for overland communication and a short review of work done by various experimenters followed. The use of Barkhausen oscillation generators for work in the neighborhood of one meter or less using standard American tubes was treated. A considerable quantity of experimental equipment was set up to indicate how these extremely high frequencies might be generated satisfactorily and the methods employed in their measurement.

A number of the one hundred and eighteen members and guests in attendance entered into the discussion of the paper."

### **BUFFALO-NIAGARA SECTION**

A meeting of the Buffalo-Niagara Section was held on February 10 in Edmund Hayes Hall of the University of Buffalo. The meeting was opened by L. G. Hector who explained that A. B. Chamberlain, chairman of the Section, had left the Buffalo Broadcasting Corporation to become associated with the Columbia Broadcasting System. Since Mr. Chamberlain will be located in New York City, his resignation as chairman of the Buffalo-Niagara Section was tendered and accepted. S. W. Brown was elected chairman to succeed Mr. Chamberlain.

The speaker of the evening, Benedict V. K. French of the American Bosch Magneto Corporation presented a paper on "Pentode Tube Development and a General Discussion of Present Day Broadcast Receiver Design."

Mr. French gave a brief history of pentode tube development, explaining why its use has flourished in England and not in the United States.

The advantages and disadvantages of the tube were shown and

variations in the construction of the pentode were examined together with their interlocking variations as reflected in the electrical characteristics of the tube. In addition to the illustrations and diagrams employed in the paper, apparatus was set up to demonstrate by comparison the effectiveness of the pentode as compared with the triode.

After the demonstration, the speaker described an analysis form used by his organization to analyze and compare radio receiving sets.

A general discussion followed which was entered into by Messrs. Brown, Eichman, Hector, Nichols and others of the thirty-nine members and guests in attendance.

#### CINCINNATI SECTION

The sixteenth meeting of the Cincinnati Section was held on February 17 at the Cincinnati Chamber of Commerce and was presided over by Dorman D. Israel, chairman.

The paper of the evening entitled "Radio Factory Engineering" was presented by Edward Austin, factory engineer for the Crosley Radio Corporation.

The speaker briefly outlined the functions of the organization of the factory engineering group as applied to radio manufacturing. The adoption by the radio industry of technical guidance in production matters was discussed. It was shown that the factory section acts as an important liaison unit between the engineering department and the factory, in addition to supervising production testing and handling of associated problems. The selection and management of factory personnel were also discussed.

Messrs. Heina, Kesheimer, Langley, and Nichols of the forty-two members and guests in attendance participated in the discussion of the paper.

#### CLEVELAND SECTION

A meeting of the Cleveland Section was held at the Case School of Applied Science on January 23, G. B. Hamman, presiding.

A paper on "The Practical Design, Engineering, and Operating Aspects of Modern Superheterodynes" was presented by Kendall Clough, chief engineer of Silver-Marshall, Inc.

The author described a method by means of which the oscillator is made to track with the tuned circuits in the preselctor and first detector. The three-coil Meissner oscillating circuit was suggested as being most satisfactory for use as the oscillator of the superheterodyne. Means for keeping the oscillator output constant over the broadcast spectrum were shown. The oscillator was stated to have greater effect on tuning than the combined circuits in the preselector and first detec-



tor. Importance was attached to high gain in the preselector in order to minimize "shot" effect originating in the oscillator.

The paper was discussed by a number of the one hundred and twenty-five members and guests in attendance.

#### DETROIT SECTION

A meeting of the Detroit Section was held at the Detroit News Auditorium on February 20, L. N. Holland, chairman, presiding.

The paper of the evening, "The Thyatron" was presented by Myron Zucker of the engineering division of the Detroit Edison Company. The author traced the early history of the thyatron, the theory of its operation, and some practical considerations in its design and manufacture.

The characteristics of the device and its employment as a control for large power were considered. Some of the uses described covered the use of these tubes in conjunction with "magnetic amplifiers" in which the direct current flowing through the thyatron is employed to saturate the core of a reactor placed in series with an alternating-current load, its application in the field circuit of a motor, permitting the output of a large machine to be controlled by a small portion of the total energy output, the use of transformers to convert heavy currents at low voltages into lighter currents at higher voltages which would be within the operating limitations of the tubes and the use of mechanical relays. In addition, many other uses of the tube were described.

A number of the one hundred members and guests in attendance at the meeting discussed the paper.

#### NEW YORK MEETING

The March 4 New York meeting of the Institute which was held at the Engineering Societies Building was presided over by President Manson.

The paper of the evening on "Current Radio Developments of the Bureau of Standards" is summarized as follows:

"The Bureau of Standards, of the U. S. Department of Commerce, contributes to radio development in the fields of standards, basic research on radio wave phenomena, and applications of radio for special needs of the Government. The most active current developments in these fields are, respectively: (a) The transmission of highly accurate standard frequency signals, which is being expanded with the intention of making it a continuous service; (b) the study of the height of the Kennelly-Heaviside layer, with a view to furnishing an index of transmission conditions at high frequencies; (c) the development of radio aids to air navigation, including a

simultaneous radiotelephone and range beacon system, marker beacons, aids to blind landing, and a collision prevention system."

The meeting was attended by three hundred and twenty-five members and guests.

#### PHILADELPHIA SECTION

The meeting of the Philadelphia Section was held on February 11th at the Engineers' Club, W. R. G. Baker, chairman, presiding.

The paper of the evening was presented by E. J. Sterba of the technical staff, Bell Telephone Laboratories at Deal, New Jersey. Mr. Sterba spoke on "Directive Antennas." His illustrated discussion covered the directive antennas used in the transoceanic and ship-to-shore telephone service as developed by the Bell System.

The meeting was attended by one hundred and thirty-five members and guests many of whom entered into the general discussion of the paper.

#### ROCHESTER SECTION

The February 12 meeting of the Rochester Section was held at the Sagamore Hotel, Harry E. Gordon, chairman, presiding.

The paper of the evening by Paul T. Weeks, chief engineer of the Raytheon Tube Corporation, was on "The Manufacture of Radio Tubes."

The author presented a minute description of each of the various steps in the interesting processes from the collecting of the raw materials to the packing and shipping of the finished tube.

The paper was illustrated by slides and brought out many interesting points regarding the numerous inspections necessary to reduce the number of rejected tubes. It was pointed out that once the elements are sealed in the bulb and the tube evacuated, no correction of any irregularities in the structure could be made and a defective tube can only be rejected. Dr. Weeks indicated that the simple types of tubes in normal production show about ten per cent rejections which value may rise as high as fifty per cent in the case of the more complex structures such as are employed in the screen types of tubes.

Many of the seventy-seven members and guests in attendance entered into the interesting discussion which followed the presentation of the paper.

#### SAN FRANCISCO SECTION

The February 18 meeting of the San Francisco Section was held at the Bellevue Hotel, Walter D. Kellogg, chairman, presiding.

Frederick A. Kolster of the Federal Telegraph Company of Palo Alto presented a paper on "Radio Compass Calibration."

Dr. Kolster opened his talk with a historical story of the early experiments on radio compass work. A step-by-step analysis of radio compass error factors was given together with the mathematical formulas applying thereto. Curves for compass calibration on various ships were shown and the importance of the radio compass aboard ship was pointed out.

Forty-two members and guests attended the meeting and twenty-one of these were present at the informal dinner which preceded it.

#### TORONTO SECTION

A meeting of the Toronto Section was held on Wednesday, January 21, in the Electrical Building of the University of Toronto, J. M. Leslie, chairman, presiding.

A paper on "Operating Characteristics of Light Sensitive Devices" by C. F. Metcalfe of the General Electric Company was presented.

The author pointed out the possibility of determining definitely the operating characteristics of light sensitive devices. Three types of these devices were described. They were the photovoltaic cells wherein the light affects the voltage of the cell, selenium cells, the resistance of which varies with illumination, and photo-electric tubes for use where current variation with illumination is desired.

The use of these various tubes with suitable circuit arrangements was discussed and methods of operation to give maximum voltage, power, or current variations with given illumination were covered.

It was pointed out that within the past few years rapid advances have been made in the design and application of light sensitive devices. Contrary to general belief, the selenium cell has been greatly improved and employed commercially in a number of special applications.

One hundred members and guests were in attendance.

---

#### Personal Mention

Quinton Adams, formerly manager of the Radio Corporation of America in New York, has become manager of the Engineering Products Division of the RCA-Victor Company at Camden.

William F. Allston has been advanced from radio engineer to superintendent of construction of the Tropical Radio Telegraph Company. He is now located in the Boston office, his previous headquarters having been at New Orleans.

Ernest V. Amy has left the Radio Corporation of America to become president of Amy, Aceves, and King, Inc., of New York City.

Formerly a commercial engineer for the Radio Corporation of Amer-

simultaneous radiotelephone and range beacon system, marker beacons, aids to blind landing, and a collision prevention system."

The meeting was attended by three hundred and twenty-five members and guests.

#### PHILADELPHIA SECTION

The meeting of the Philadelphia Section was held on February 11th at the Engineers' Club, W. R. G. Baker, chairman, presiding.

The paper of the evening was presented by E. J. Sterba of the technical staff, Bell Telephone Laboratories at Deal, New Jersey. Mr. Sterba spoke on "Directive Antennas." His illustrated discussion covered the directive antennas used in the transoceanic and ship-to-shore telephone service as developed by the Bell System.

The meeting was attended by one hundred and thirty-five members and guests many of whom entered into the general discussion of the paper.

#### ROCHESTER SECTION

The February 12 meeting of the Rochester Section was held at the Sagamore Hotel, Harry E. Gordon, chairman, presiding.

The paper of the evening by Paul T. Weeks, chief engineer of the Raytheon Tube Corporation, was on "The Manufacture of Radio Tubes."

The author presented a minute description of each of the various steps in the interesting processes from the collecting of the raw materials to the packing and shipping of the finished tube.

The paper was illustrated by slides and brought out many interesting points regarding the numerous inspections necessary to reduce the number of rejected tubes. It was pointed out that once the elements are sealed in the bulb and the tube evacuated, no correction of any irregularities in the structure could be made and a defective tube can only be rejected. Dr. Weeks indicated that the simple types of tubes in normal production show about ten per cent rejections which value may rise as high as fifty per cent in the case of the more complex structures such as are employed in the screen types of tubes.

Many of the seventy-seven members and guests in attendance entered into the interesting discussion which followed the presentation of the paper.

#### SAN FRANCISCO SECTION

The February 18 meeting of the San Francisco Section was held at the Bellevue Hotel, Walter D. Kellogg, chairman, presiding.

Frederick A. Kolster of the Federal Telegraph Company of Palo Alto presented a paper on "Radio Compass Calibration."

Dr. Kolster opened his talk with a historical story of the early experiments on radio compass work. A step-by-step analysis of radio compass error factors was given together with the mathematical formulas applying thereto. Curves for compass calibration on various ships were shown and the importance of the radio compass aboard ship was pointed out.

Forty-two members and guests attended the meeting and twenty-one of these were present at the informal dinner which preceded it.

#### TORONTO SECTION

A meeting of the Toronto Section was held on Wednesday, January 21, in the Electrical Building of the University of Toronto, J. M. Leslie, chairman, presiding.

A paper on "Operating Characteristics of Light Sensitive Devices" by C. F. Metcalfe of the General Electric Company was presented.

The author pointed out the possibility of determining definitely the operating characteristics of light sensitive devices. Three types of these devices were described. They were the photovoltaic cells wherein the light affects the voltage of the cell, selenium cells, the resistance of which varies with illumination, and photo-electric tubes for use where current variation with illumination is desired.

The use of these various tubes with suitable circuit arrangements was discussed and methods of operation to give maximum voltage, power, or current variations with given illumination were covered.

It was pointed out that within the past few years rapid advances have been made in the design and application of light sensitive devices. Contrary to general belief, the selenium cell has been greatly improved and employed commercially in a number of special applications.

One hundred members and guests were in attendance.

---

#### Personal Mention

Quinton Adams, formerly manager of the Radio Corporation of America in New York, has become manager of the Engineering Products Division of the RCA-Victor Company at Camden.

William F. Allston has been advanced from radio engineer to superintendent of construction of the Tropical Radio Telegraph Company. He is now located in the Boston office, his previous headquarters having been at New Orleans.

Ernest V. Amy has left the Radio Corporation of America to become president of Amy, Aceves, and King, Inc., of New York City.

Formerly a commercial engineer for the Radio Corporation of Amer-

ica, Pierson A. Anderson has become assistant to manager of the Engineering Products Division of the RCA-Victor Company at Camden.

Victor J. Andrew has left the Chicopee Falls plant of the Westinghouse Electric and Manufacturing Company to enter the Ryerson Physical Laboratory of the University of Chicago as a graduate student.

Bernard J. Axten has left Kodak, Ltd., to become engineer in charge of the radio laboratory of Standard Telephones and Cables, Ltd., in London, England.

Harold H. Beverage is now chief communications engineer of RCA Communications, Inc., at New York City.

A. Romeyn Bitter has left the engineering staff of the Electric Auto-Lite Company of Toledo, Ohio to become an instructor in radio and electrical engineering at the Woodward High School in Toledo.

Henry L. Bogardus has joined the Engineering Department of the RCA-Victor Company at Camden.

Previously an engineer at the New Brunswick Radio Corporation of America, Victor A. Bohman has joined the Photophone and Applications Division of the RCA-Victor Company at Camden.

Frederick R. Bristow has advanced from supervisor to vice president of the RCA Institutes, Inc., of New York City.

Meade Brunet is now sales manager of the RCA Radiotron Company, Inc., at Harrison, N. J. He was formerly manager of the Radiotron Division of the Radio Corporation of America.

Harvey R. Butt has been transferred from the Norfolk, Va., office to the New York City office of the Radiomarine Corporation of America.

John A. Campbell, formerly managing editor of Metropolitan Electrical News has become editor of the Gage Electrical Encyclopedia in New York City.

E. S. Capron an engineer for Electrical Research Products, Inc., has been transferred from New York City to Detroit.

Louis A. Carazo has become director general of radio for the Costa Rican Government at San Jose, Costa Rica.

From the technical staff of the Marconiphone Company of London, Samuel H. Cohen was transferred to Lissen's, Ltd., of Middlesex, England, as technical assistant.

H. L. Courter has joined the Engineering Department of the Western Electric Company at Hawthorn, Ill. previously being an engineer for the Thordarson Electric Manufacturing Company at Chicago.

Lieutenant Commander T.A.M. Craven has left the U. S. Navy to

do consulting work with headquarters at the National Press Building, Washington, D.C.

Captain Francis C. Curtis of the Royal Signals has left the School of Signals for Staff College at Camberley, Surrey, England.

Formerly with the Westinghouse Electric and Manufacturing Company at East Pittsburgh, Pa., Arthur N. Curtiss has joined the Radio Engineering Department of the RCA-Victor Company at Camden.

Joseph A. Davis has left the Temple Corporation to become chief engineer of E. Toman and Company of Chicago.

Robert J. Davis who was previously with the West India Oil Company at Santiago, Chile, has joined the engineering staff of RCA Communications, Inc., at Rocky Point.

Lee de Forest has recently become president of the Lee de Forest Manufacturing Company of Los Angeles, California.

F. S. Dellenbaugh, Jr., has left the faculty of Massachusetts Institute of Technology to do private consulting work at Cambridge, Mass.

M. Merwin Eells has become communications engineer of the National Air Transport, Inc., of Chicago.

Marcus Glaser has become chief engineer of the United Scientific Laboratories of New York City.

E. F. Hemberger, Jr., has been transferred from the New York office of the Electrical Research Products, Inc., to the Detroit office as staff supervisor.

Alfred H. Hotopp, previously in the transmission department of the Kolster Radio Corporation is now a division engineer on receivers for Wired Radio, Inc., at Ampere, N. J.

Kenneth W. Jarvis, formerly with the King Manufacturing Company is now engineer for the United States Radio and Television Corporation at Marion, Ind.

Samuel M. Kintner, formerly manager of the Research Department of the Westinghouse Electric and Manufacturing Company at East Pittsburgh, Pa., has become assistant vice president of that organization.

Jerome H. Knowles, Jr., previously with the Radio Corporation of America is now standards engineer for the RCA-Victor Company at Camden.

Earl L. Koch, formerly chief engineer of Universal Wireless Com-



munication Company is now doing private consulting work in Chicago, Ill.

Walter T. Lang left the General Electric Company to join the engineering staff of the Bell Telephone Laboratories in New York City.

Walter L. Lawrence is now radio research engineer at the Bell Telephone Laboratories of New York City.

Harry R. Lubeke, formerly assistant director of research of the Crocker Research Laboratory, has become director of experimental broadcasting for Don Lee, Inc., of Los Angeles, Calif.

Formerly with the General Electric Company, Roland A. Lynn has joined the Engineering Department of the RCA-Victor Company at Camden.

Scott A. Magness, formerly assistant inspector of naval material is now a member of the Bell Telephone Laboratories technical staff at New York City.

Jesse Marsten, formerly of Freed-Eisemann Radio Corporation is now chief engineer of the International Resistance Company of Philadelphia.

Ray E. Meyers, previously radio engineer in charge of broadcast station WDEL has joined the Wilkin's Sub-Trans-Polar expedition.

T. E. Nikirk, formerly of the Southern California Edison Company at Alhambra, Calif., has joined the engineering staff of the Transcontinental Western Air, Inc., at Los Angeles.

C. E. Pickett of the National Broadcasting Company has been transferred from New York to the Chicago studios.

William Salt has left the British Wireless Marine Service to join the radio engineering staff of the Edison Swan Electric Company at London, England.

H. Robert Seal previously with the Federal Telegraph Company is now a radio engineer at Hancock Field, Santa Maria, Calif.

Oswald I. Seaverson left the Radio Engineering Department of the Westinghouse Electric and Manufacturing Company to become a transformer and rectifier engineer for the Union Switch and Signal Company at Swissvale, Pa.

David Sonkin is now engineer in charge of receiver design of the Jenkins Television Corporation of Passaic, N. J. He was formerly with Micarta Fabricators, Inc.

Thomas Vanacore, formerly chief radio engineer of the King Manufacturing Company has joined the Radio Engineering Department of the Columbia Radio Corporation of Chicago, Ill.

W. G. Wagener has left the Radio Engineering Department of Heintz and Kaufman, Ltd., of San Francisco, Calif., to join the Radio Engineering Department of the Federal Telegraph Company at Palo Alto, Calif.

Carleton T. Weibler previously chief engineer of The Webster Company has become chief engineer of John E. Fast and Company of Chicago, Ill.





PART II  
TECHNICAL PAPERS



## DIVERSITY RECEIVING SYSTEM OF R.C.A. COMMUNICATIONS, INC., FOR RADIOTELEGRAPHY\*

By

H. H. BEVERAGE AND H. O. PETERSON

(R. C. A. Communications, Inc., New York City)

*Summary*—The early problems confronting the users of short wavelengths for communications are enumerated. Chief of these were fading and noise level. The phenomenon of fading is explained and the known methods of counteracting it are given. The most outstanding of these is the diversity principle. The various forms of this method are described and reasons developed for the choice of the particular form now in common use. The apparatus in general use is described in detail. In this system three spaced antennas are connected to three separate receivers. The output of each is rectified. The d-c outputs of all three receivers are combined in a common resistor, the drop in which is used to actuate means for controlling a locally generated tone which may be transferred to the receiving operator over a wire circuit. Since fading is not simultaneous in all three of the spaced antennas, a material reduction in the effects of fading is obtained.

An aperiodic form of directive receiving antenna is described. Polar diagrams showing its directivity are presented. A series of measurements indicate a gain in signal-to-noise ratio of the order of 32 db for the European circuits as compared to a horizontal doublet.

The effects of echo and cosmic disturbances are briefly discussed.

THE international telegraph circuits of R.C.A. Communications, Inc., were first inaugurated as long-wave radio circuits. By taking advantage of modern technique as made possible by the exchange of patent rights at the formation of the Radio Corporation of America a first-class communication system was built up. This system had, however, several definite limitations. One limitation was the noise level due to atmospherics, forcing the use of fairly slow speeds of operation on some days. Another was the limitation of the amount of communication possible on the thirty of forty kilocycles of frequency spectrum available.

Thus the discovery of the usefulness of the short wavelengths between fifteen and sixty meters was very important to the natural expansion of the radio communications business. In this new part of the spectrum was found space for a great number of channels and at a cost per channel considerably lower than that of long-wave channels. It was, therefore, urgently desirable that these newly discovered possibilities be developed to a serviceable state. The engineering problems manifest at the beginning of this development were as follows:

\* Decimal classification: R140. Original manuscript received by the Institute, November 24, 1930. Presented before December 3, 1930, New York meeting.

*A*—Fading

*B*—Noise level

*C*—Apparatus

*D*—Echo

*E*—Effects of cosmic phenomena (magnetic disturbances)

*A—Fading*

From the very first it was observed that the intensity of a short-wave (high-frequency) signal fluctuated at a comparatively rapid rate over a considerable range. The intensity might change over a ten- or twenty-to-one range from minute to minute or second to second. In some cases the intensity has been observed to fluctuate through several peaks and depressions per second. It was also observed that the diurnal variation of intensity was much greater than for the long-wave (low-frequency) signals. A 20,000-kilocycle signal from Europe might measure over 100 microvolts per meter in the daytime and yet be absolutely inaudible at night. Diurnal variations of certainly over 10,000 to 1 are commonly experienced.

The long period variations of signal strength are probably due to changes of either or both the attenuating or the refracting properties of the medium between transmitter and receiver. The short period fluctuations are quite reasonably explainable if we consider the signal at the receiver as the resultant of a number of components arriving from the transmitter over slightly different paths through space. Then the resultant polarization and phase of the signal field at the receiving antenna will depend upon all of several components. If any one of these components has its path changed, then its phase at the receiving antenna will be changed and the effect will be to change the phase, magnitude, and polarization of the resultant. In this way, fading may result from very slight changes in the medium through which the signal travels.

The diurnal variations of intensity were overcome by the use of more than one frequency channel to carry on a twenty-four hour circuit. An example of this is the Buenos Aires circuit. On this circuit LSE carries the daytime traffic on 20,455 kc and LSD carries it during the night on 8809 kc. On east-west circuits we get conditions of darkness at one end of the circuit while it is still daylight on the other and therefore a more elaborate set of channels is required to give continuous service on a circuit. The selection of frequencies requires a comprehensive study of conditions over an extended period of time.

The short-period fading problem has generally been solved by an application of one or more of the following types of treatment: Limit-

ing, automatic volume control, and diversity receiving methods. Limiting is the method whereby the output of the receiving system is something other than a linear function of the input in such a way that any signal input above a certain minimum level will give an output substantially constant. The British Marconi Company's beam system is an outstanding example of the application of this principle. Here a large and efficient antenna system is used to provide as much signal voltage as possible at the input of the receiver. The receiver has a high gain and is provided with limiters. The result is that even the depressions of strength due to ordinary fading will cause full response in the final stage. Stronger inputs cannot produce more output and consequently the bad effects of fading are pretty well ironed out.

Automatic volume control is another method of counteracting fading. In this method the signal itself is caused to affect the gain of the receiver in such a way that the output remains substantially constant regardless of input signal strength. This treatment is the same as applied to a number of broadcast receivers now on the market. In its application to code the time constant of the control circuit has to be made sufficiently slow so as not to cause much change of gain during the spaces between characters. This is a comparatively simple matter on modern telegraph channels because of the high speeds of sending. Undue change of gain between messages is prevented by that property of the automatic tape transmitters whereby they send dots when no tape is being fed into them.

The other general principle whereby one may mitigate against fading is that of diversity. Diversity is the principle whereby advantage is taken of the fact that fading does not occur simultaneously on: (A) parallel channels of different frequencies; (B) antennas of different polarizations on one frequency; or (C) on spaced antennas of one polarization on one frequency.

Frequency diversity is effective due to the difference of fading times for frequencies differing by as little as several hundred cycles. The simplest form of frequency diversity is obtained by modulating a continuous wave carrier 100 per cent (sine wave form) with a tone of say 500 cycles. This gives two side bands each one-half the amplitude of the carrier and differing from it in frequency by 500 cycles. These parallel channels are all rectified in a common rectifier with limiting applied and the number of drop-outs is reduced by the degree to which one or the other of the two 50 per cent side bands can carry the load when the carrier is faded out. The majority of telegraph transmitters in ordinary use do not lend themselves to sinusoidal modulation and the result is that a great number of side bands are usually present in the



output which is of course an inefficient use of the available frequency spectrum. Furthermore, power distributed over a band of frequencies is not as effective in cutting through interference as an equal amount of power concentrated on one frequency.

In the case of polarization diversity, if the intensities of a signal as received on two differently polarized antennas are plotted against time, it is found that they do not fade in synchronism. Consequently, if we combine energies from differently polarized antennas, we have a means for reducing fading. This method is a good one for places where space for antennas is limited. However, conditions sometime make it preferable to use one definite polarization.

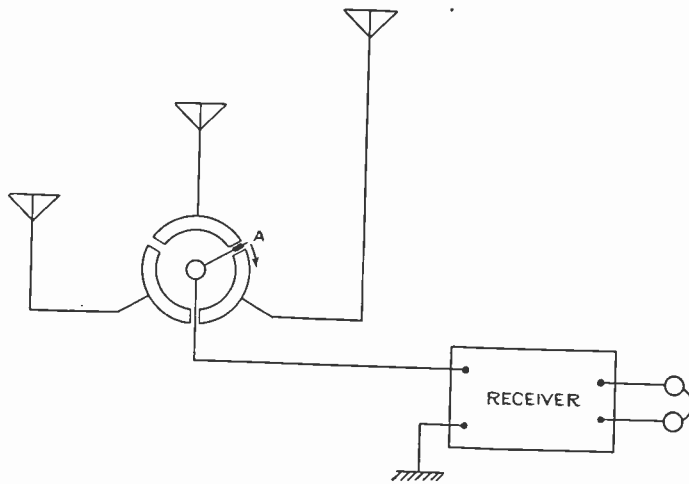

Fig. 1.—Rotating antenna switcher.

Space diversity is that form of diversity reception which combines independently of phase, the effectiveness of several geographically spaced antennas. This is the form of diversity adopted and developed by R.C.A. Communications, Inc. With this form we can concentrate all the power of the transmitter on one frequency and can use two or more of the most preferable types of receiving antennas.

Starting with the basic principle that fading at two spaced points is not simultaneous, our first attempts were to combine in phase the outputs of two antennas separated by about 150 wavelengths. The high frequency was heterodyned to an intermediate frequency by a common oscillator and the outputs from the two antennas were combined through phase-adjusting means. It was found that the adjustment required for cumulative combination was a variable one. This observation was in agreement with the theory that the signal intensity at a point is the vectorial sum of a number of components each of

which varies in phase as its electrical length of path is changed by the medium of transmission.

It was therefore apparent that a diversity system, in order to be effective, must combine the effective output of each antenna irrespective of phase relationship between these respective outputs. A number of ways for doing this were considered and tested out. A most simple application of this type of diversity was to place a heterodyne receiver at each antenna and feed the audible beat notes from these two receivers to a pair of headphones common to both audio-frequency outputs. The phones will respond to both frequencies, which being different, cannot cancel each other for any appreciable length of time. Another alternative of this type is to use a common oscillator to beat the signal from the two antennas in two separate detectors. The beat

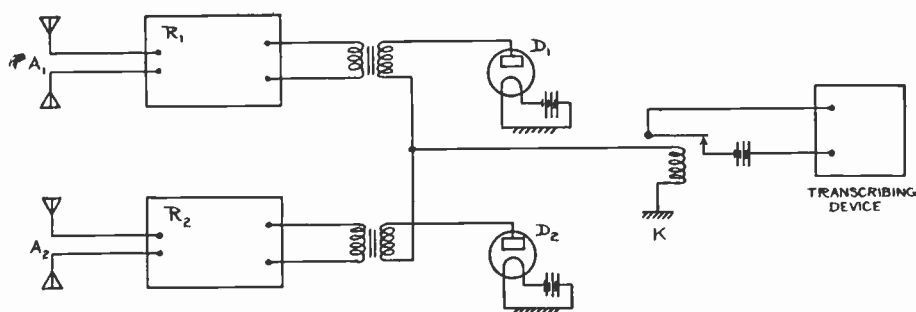

Fig. 2.—Simple two-set diversity system.

notes from the two receivers are connected separately to one of two ear-phones. The operator wears one phone on each ear, thereby listening to the output of one antenna with his left ear and to the other with his right ear. The combination in this case is in the operator's mental processes and is independent of phase.

Another method of getting around the shifting phase relationship of the voltages from several antennas is to use only one of them at a time but to switch from one to another at such a rate as to use each antenna several times during each cycle of the modulating frequency. A simple example of this is a rotating switch arm (Fig. 1) connecting the receiver successively to the several antenna systems as it rotates. Along these same lines is the process whereby the phases of the voltages from several antennas are periodically reversed at different rates. The receiver in this case is connected through to all antennas all the time. Both of these processes can be executed by means of vacuum tube circuits. They are, however, open to the objection that they generate side bands and therefore destroy the selectivity of the receiver unless the selectivity is provided ahead of the switching or reversing means.

Still another alternative is to receive the signal from each antenna on a separate receiver and separately rectify the output of each receiver. The combination of the direct-current outputs of the separate receivers then is a simple matter. Fig. 2 shows a block diagram of the way this system may be set up. In this diagram,  $A_1$  and  $A_2$  are spaced antennas feeding receivers  $R_1$  and  $R_2$ . The a-c outputs of these two receivers are rectified by  $D_1$  and  $D_2$ . These two rectifiers are connected in parallel to the transcribing device  $K$  in such manner that  $K$  receives the sum of the currents passing through  $D_1$  and  $D_2$ . In this case  $K$  is shown as a relay which may operate a sounder, recorder, or other transcribing mechanism. Where the receiving station is remote from

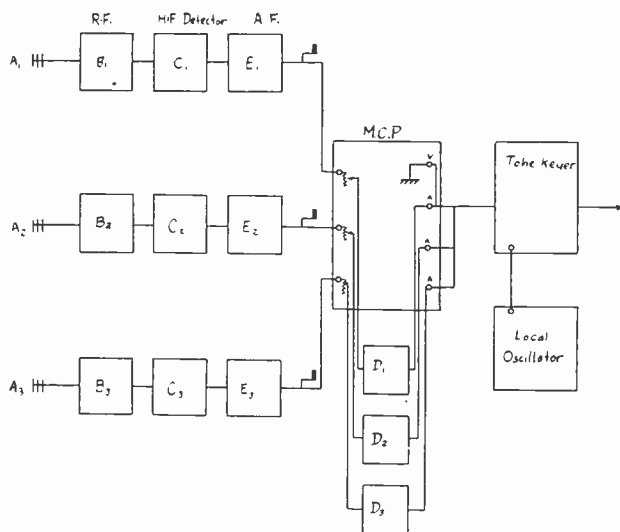

Fig. 3.—Block diagram of space diversity system.

the operator it is common practice to send the output of the receiver over a telephone line as a tone signal. In the above example of diversity combination by addition of rectified currents it would be a simple matter to use the d-c output to key some local source of alternating current suitable for transmission over the line. The simplicity of apparatus and adjustment recommended it for commercial application. Furthermore, in its application, a most efficient use of power and frequency spectrum is possible since the individual receivers can be made as efficient and selective as practicable with any single receiver. After a study of a number of possibilities this system was applied to our commercial services.

A general diagram of the system as now used is shown in Fig. 3. Three spaced antennas are shown feeding three separate receivers through radio-frequency transmission lines. The spacing of these antennas is usually well over ten wavelengths. It has been found that

antennas spaced as little as one wavelength apart sometimes show different fading versus time characteristics but for best results a spacing of at least ten wavelengths seems advisable.

The three receivers consist of tuned radio-frequency amplifiers  $B_1$ ,  $B_2$ , and  $B_3$  feeding heterodyne-detector units  $C_1$ ,  $C_2$ , and  $C_3$ . The audio-frequency outputs of the three heterodyne detector units feed through amplifier units,  $E_1$ ,  $E_2$ , and  $E_3$  into the master control panel

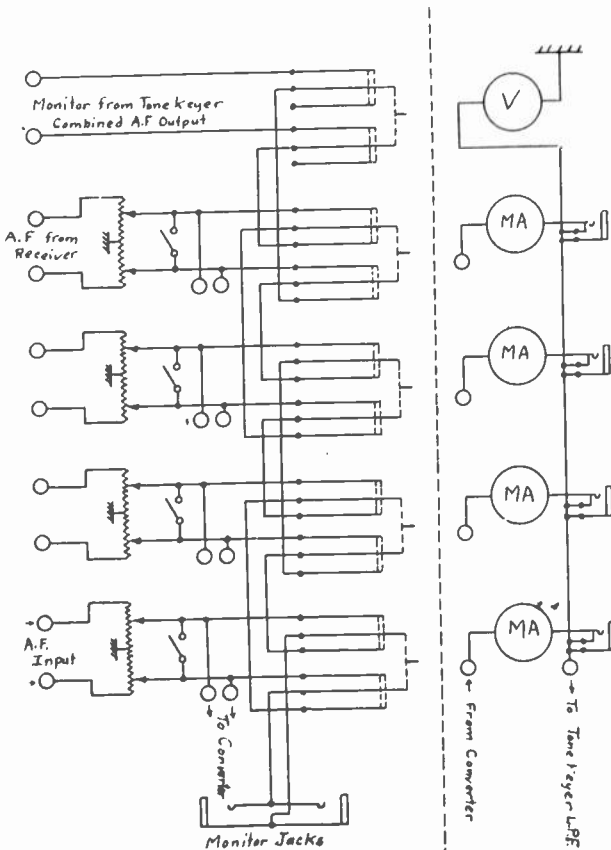

Fig. 4.—Master control panel.

*M.C.P.* In this master control panel are provided means for controlling and monitoring each of the three audio frequencies, Fig. 4. From here the three still separate outputs pass into three converter units,  $D_1$ ,  $D_2$ , and  $D_3$  which still further amplify and then rectify the signal. The direct-current outputs of these three converters pass back to the control panel where they are fed through separate milliammeters into the combining circuit common to all three. In this combining circuit (Fig. 5) the direct current feeds through a low-pass filter, *L.P.F.*, into a common resistor  $R_1$ . The function of the low-pass filter is to remove the ripple from the combined outputs of the rectifiers. The IR drop

in  $R_1$  is fed to the control grid of  $V_1$ . In operation this tube draws plate current through  $R_2$  when no current is flowing in  $R_1$ . This plate current in  $R_2$  causes the amplifier tubes  $V_2$  and  $V_3$  to be biased to cut-off. The

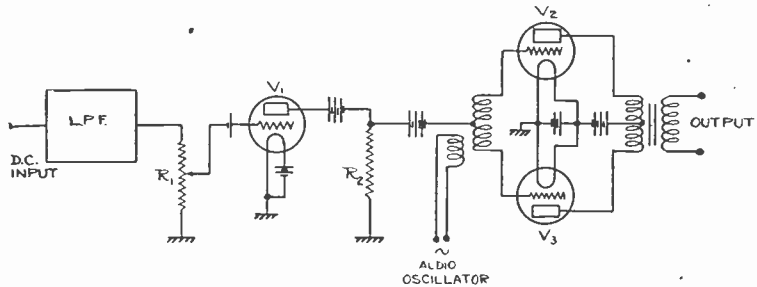

Fig. 5.—Tone keyer—schematic circuit.

result is that no tone output is passed from the local oscillator on to the line feeding the transcribing operator. When a marking element of transmission is received, current flows through  $R_1$  biasing  $V_1$  to cut-off,

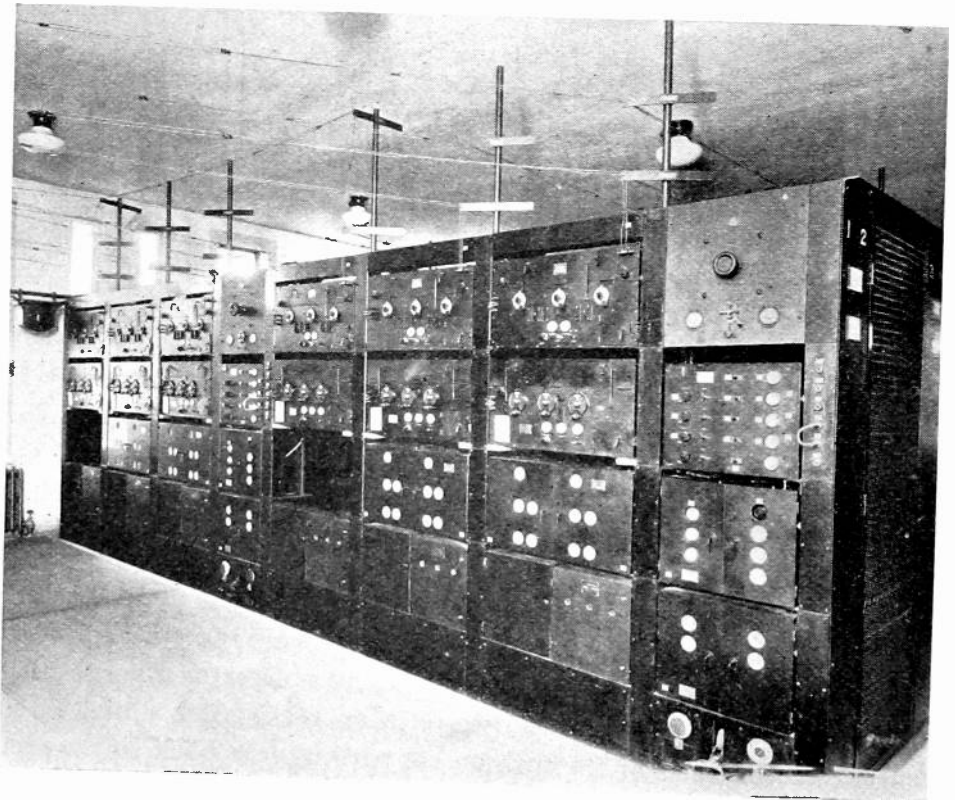

Fig. 6.—Diversity receiver installation.

leaving no IR drop in  $R_2$ . With this condition,  $V_2$  and  $V_3$  act as a push-pull amplifier feeding tone from the oscillator to the line. Provision is made on the monitor panel for monitoring the output of this tone-key-

ing unit. Since the voltage impressed on the grid of  $V_1$  cannot do any more than reduce its plate current to zero, it follows that this tube constitutes a very effective limiting device. The over-all gain of the receiver is ordinarily set so that any signal stronger than the noise level will drive the plate current of  $V_1$  to zero and thereby produce full amplitude response in the output of the  $V_2, V_3$  stage.

A typical rack installation of diversity equipment is shown in Fig. 6. This photograph shows a double rack holding diversity apparatus for two circuits. The Riverhead receiving station of R.C.A. Com-

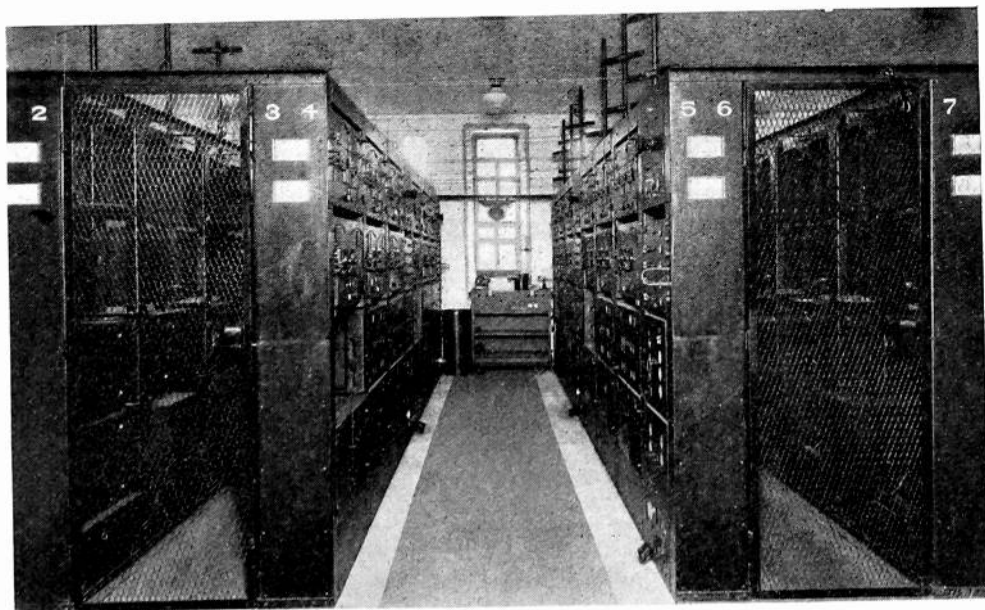

Fig. 7.—Aisle of four complete diversity sets.

munications, Inc., contains twenty such racks which gives facilities for forty circuits. These racks are arranged back to back facing aisles with four circuits per aisle. Ordinarily one man takes care of the circuits in an aisle. Fig. 7 presents the end view of an aisle.

The arrangement of units in a rack is such that the antenna systems feed in overhead. The three principle units of each receiver are placed one above the other. The topmost unit is the radio-frequency amplifier. This amplifier is a tuned radio-frequency cascade amplifier using two screen-grid tubes type UY-224. (See Fig. 8.) These are of the indirectly heated cathode type. The circuits are carefully shielded against radio frequency and the power supply leads are well filtered. A voltage gain of about 100-fold is obtained in these units.

The radio-frequency amplifier unit feeds the tuner unit directly below it. This unit consists of a screen-grid coupling tube followed by

an oscillating detector tube which heterodynes the incoming signal to give an audio-frequency output. (See Fig. 9.) The oscillating detector circuit is coupled loosely to the plate circuit of the coupling tube.

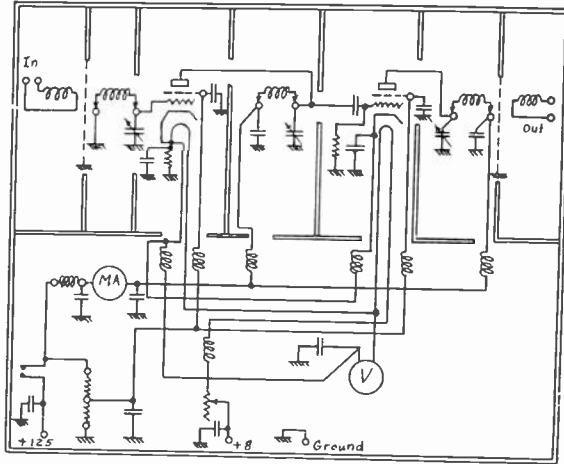

Fig. 8.—Radio-frequency amplifier.

Consequently, very little reaction is experienced between the coupling tube, grid circuit and the oscillator circuit. The tuner unit is well shielded and its supply leads filtered against both radio and audio fre-

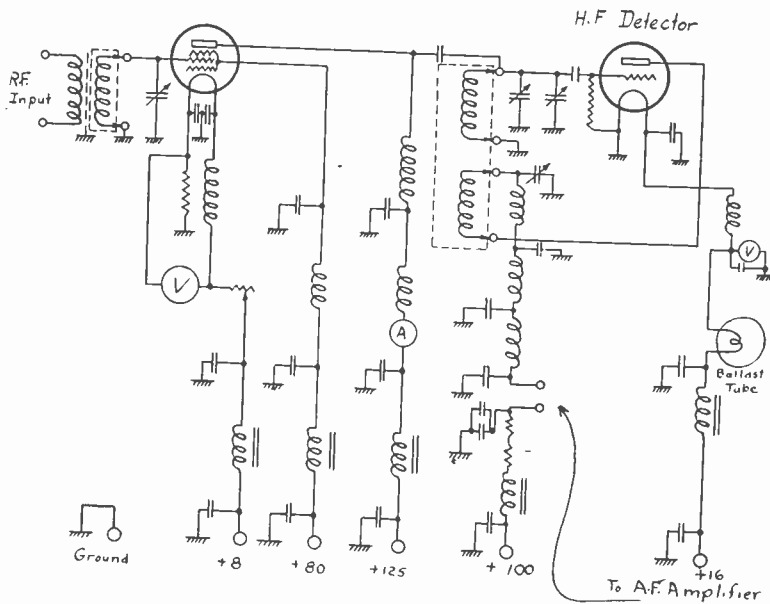

Fig. 9.—Tuner unit.

quency. Extreme care has been exercised to prevent cross-talk between receivers. This is necessary because of the close proximity of the sets. With the apparatus as now developed it is possible to tune in the

same signal on the same antenna without experiencing interference in one receiver from the oscillator of the other.

In high-frequency operation the frequency stability of the high-frequency oscillator is important. The benefits of constant frequency transmitters would be to a large extent lost if the frequency stability of the receiver oscillator were not good. Frequency changes may be due to one or more of the following causes; mechanical vibration, filament voltage change, plate voltage change, and temperature change. The condenser plates are made sufficiently thick to avoid trouble from mechanical vibration of the plates. In addition, to this precaution, the entire tuner unit is mounted on sponge rubber blocks. The mass of the unit is considerable so such mounting on sponge rubber is quite effective in insulating the tuner against mechanical vibration of the racks or floor. The filament voltage is kept practically constant by means of a ballast tube. The oscillator plate voltage for the entire station is supplied by a storage battery operating on a straight discharge basis. This battery carries no other load so its voltage is quite constant over a period of twenty-four hours. The drift of frequency due to change of temperature is the most serious trouble where the temperature is allowed to vary over a considerable range. The receiving station at Riverhead is well insulated to give a fairly good uniformity of ambient temperature. As the frequency requirements become more severe this point will have to be more carefully provided for if the receivers are to be operated with a minimum of manual effort.

The audio-frequency output of the tuner unit is passed on through a conventional two-stage transformer-coupled audio amplifier. The last stage of this amplifier is push-pull. It feeds the potentiometer on the master control panel through a step-down transformer. From there the signal goes to the converter, to be rectified and combined with the outputs of the other receivers, as has been outlined above, and then passed on to the tone lines via the control board, Fig. 27.

In practice, the gain ahead of the tuner is controlled by coupling adjustments on the radio-frequency amplifier and tuner unit so as to give a normal signal at the control panel. The audio-frequency voltage delivered to the converters is then regulated by the potentiometers to give an approximately equal output from all three converters. By means of the potentiometer  $R_1$  in the tone keyer unit (Fig. 5) it is possible to make such an adjustment as to give a minimum of interference in case static or other noise exists. Ordinarily this adjustment is set to provide three or four times as much voltage as is necessary to operate the tone keyer.

Most of the selectivity of the receiver just described is obtained in



the audio-frequency stages. The selectivity ahead of the heterodyne detector is represented by the curve, Fig. 10. By means of low-pass filters in the audio system it has been practical to reduce the effective band width to 6000 cycles. With increasing stability of transmitter frequencies eventually it should be possible to reduce this still further.

Fidelity is another point for consideration in apparatus meant for high speed operation. The standard system is designed to operate at speeds up to 300 words per minute or a keying rate of 120 cycles per

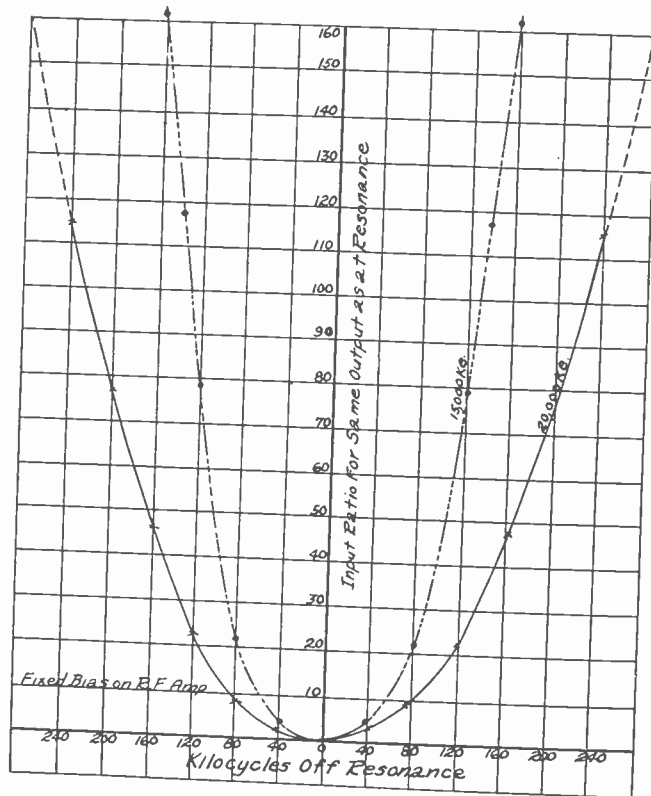

Fig. 10.—Radio-frequency amplifier selectivity.

second without undue distortion of the relative lengths of dots, dashes, and spaces. With some modifications of the circuits, keying rates as high as 800 cycles or 2000 words per minute have been taken. The assistance of J. B. Moore in the development of the combining equipment should be acknowledged.

Some recorder tapes showing the over-all effectiveness of the diversity system are shown in Figs. 11 and 12. It will be noted that the drop-outs recorded by the single receivers are entirely corrected by the combination of the outputs of three receivers. In practice the percentage of the time that all three receivers are simultaneously in a fading depression is much less than that for only one receiver. The tape

presented in Figs. 11 and 12 was taken on a signal from the Portuguese station CUW on 19,180 kc in the middle of the afternoon. The transmitting speed was quite slow, twenty-five words per minute.

The amount of improvement due to the use of the space diversity system is dependent on the range of fading. Thus, if there is no fading

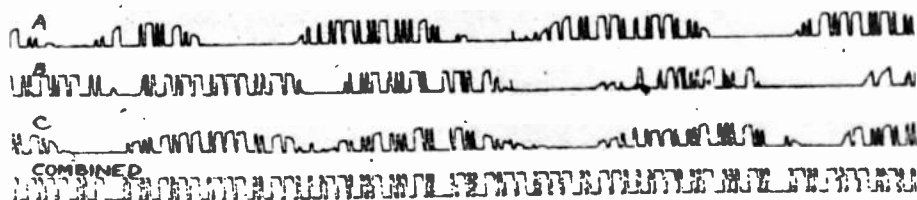
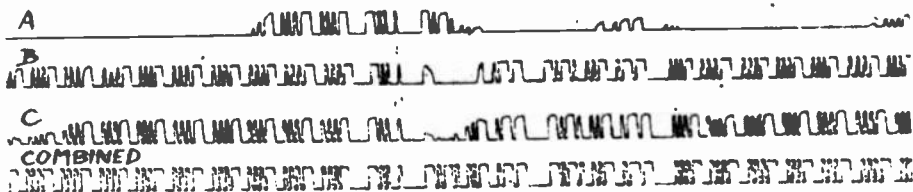

Fig. 11.—Recorder tape showing diversity effect.

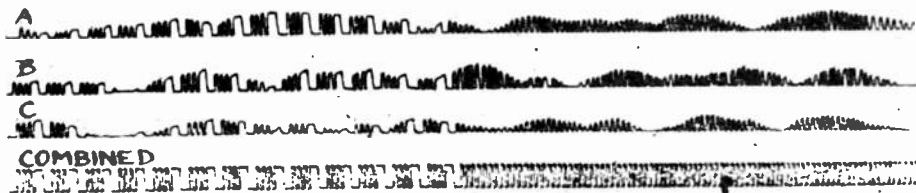
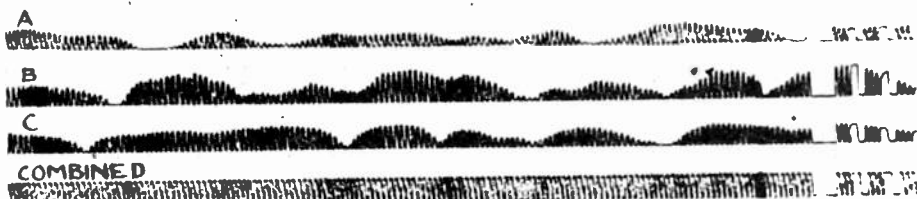

Fig. 12.—Recorder tape showing diversity effect.

one antenna will do as well as three combined. If on the other hand, the signal periodically fades absolutely to zero no amount of gain in a single receiver can give a signal free of drop-outs whilst the diversity system might give perfect output. In average operating conditions the improvement due to diversity comes somewhere between these two extremes. As a general rule a three-spaced-antenna diversity system

will give perfect output with the receiver sensitivity set at a value such that the tone keyer will not operate on the minimum output of any one receiver during the fading cycle of that receiver. The tone keyer is adjusted to just operate at a threshold value somewhat higher than the minimum value reached by the signal in its fades. Reference to Fig. 13 will help in the explanation. Here

$a$  = minimum reached by signal in its fading cycles

$N.a$  = maximum value reached by signal in its fading cycles

$N$  = fading ratio

$b$  = threshold value (adjustment of tone keyer)

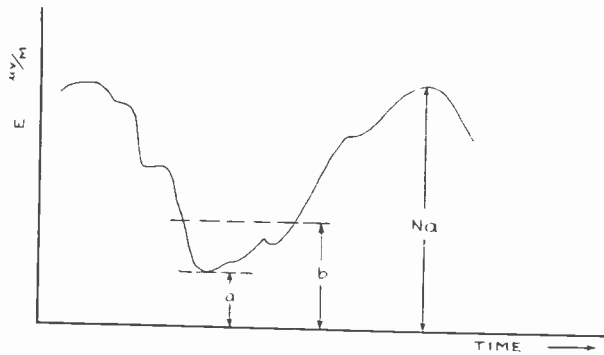

Fig. 13.—Hypothetical fading cycle.

The tone keyer is adjusted to just operate at a value designated as “ $b$ .” It has been observed experimentally that satisfactory results will be obtained if “ $b$ ” is a value 15 per cent up from “ $a$ ” toward “ $N.a$ .”

$$b - a = 0.15(N.a - a)$$

from which

$$b = a(0.15N + 0.85)$$

A single receiver system would have to be adjusted to give output for a level as low as “ $a$ .” The factor  $(0.15N + 0.85)$  is from these considerations the ratio of improvement due to the use of the three-set diversity system as compared to a single receiver system. This factor being dependent on the fading ratio  $N$ , fluctuates over quite a large range. The fading ratio may be anywhere between 5 and 100 for a typical transatlantic circuit. A run of seventy-seven measurements of fading ratios over a period of five days gave an average ratio of 14.5. By an application of the factor  $(0.15N + 0.85)$  we get a value of 3.03 for the magnitude of the improvement we might expect due to the application of diversity. This is equivalent to an improvement of 9.6 db. Operating experiences indicate this estimate is conservative. A

greater number of observations of fading ratio would be desirable for more accurate establishment of the numerical value of this degree of improvement.

It might be of interest to inspect the operation of diversity for some other values of fading ratio. Thus, for a fading ratio of 100 we get an improvement factor of 15.85-fold which is equivalent to 24 db. For a fading ratio of 50, which is quite common, we get an improvement of 8.35-fold or 18.4 db.

Another quality of the diversity system became apparent after it was put in operation. That was the matter of reserve apparatus on one channel. Some of the adjustments of a short-wave receiver are so critical that in making a retune, the signal might be momentarily completely lost due to overshooting of the adjustment or to error of judgment. With three receivers normally carrying the circuit, any two will do quite well at carrying the signal while the receiving engineer makes an adjustment of the third. This enables more continuous operation of the circuit which is important where high traffic capacity is contemplated.

#### *B—Noise Level*

The adoption of short wavelengths as a substitute for the old long-wave channels did not prove a release from the old problem of noise levels. As soon as sensitive receivers were developed the noise problem became apparent. The most troublesome noises are of three classes: Static (atmospherics), local generators of high-frequency disturbances, and noises developed in the tubes and circuits of the receiving system. The noises generated within the tubes and circuits of the receiver proper establish a definite limit to the gain of the receiver. This limit is at present approximately 0.4 microvolt at the input terminals of the receiver. Accordingly, the antenna must deliver to the input of the receiver signals of at least about 0.5 microvolt amplitude. To accomplish this, antenna structures giving considerable output are resorted to. It is desirable to have the antenna contribute the limiting noise level and then make that as small as possible by the use of directivity. Selectivity and directivity seem to be the only effective means for improving the noise level situation. It is well worth while applying as much selectivity as the nature of the circuit will stand, and practical limitations such as frequency drifts and fidelity determine the extent to which this principle can be applied.

Directivity is effective by excluding noises which come from directions other than that of the desired signal. The usual method of obtaining directivity is to combine in phase at a point all the voltages in-

duced in a number of spaced units. This phase relationship will hold only for signals coming from points in the desired direction. A great number of arrangements for obtaining this effect are possible. In practice the elements of an array are usually arranged either along a line perpendicular to the great circle bearing of the transmitting station (broadside arrays) or else along a line coincident with the great circle connecting the transmitting and receiving sites (end-on arrays).<sup>1</sup>

Before the general advent of short-wave technique we had in regular use on our long-wave circuits an efficient form of end-on array, the Beverage wave antenna which has been previously described.<sup>2</sup> This antenna is essentially a horizontal wire along a line coincident with the great circle bearing of the transmitters it is desired to receive. This horizontal wire may be considered as a great number of short horizontal elements placed end to end, thereby forming an end-on array. Each of these elements has a voltage increment induced in it by virtue of the wave-tilt of the advancing wave front. These increments travel along the wire at a velocity slightly lower than the velocity at which the wave front advances through space, thereby adding themselves up substantially in phase as the signal advances toward the end farthest from the transmitter. The antenna is made unidirectional by terminating one end in a resistance equal to the surge impedance of the antenna considered as a transmission line.

This basic form of wave antenna had very early been applied on wavelengths as short as 100 meters. As the wavelength was decreased the physical length of the antenna had to be reduced. This resulted in a reduction of the effective height of the antenna. The vertical down-leads at each end of the antenna had a certain effective height as simple vertical antennas. This nondirective component became a greater proportion of the total as the effective height was reduced, thereby nullifying the directive properties of the antenna. These practical difficulties were overcome in an array suggested by H. O. Peterson. The assistance of M. G. Crosby in the development of this array should be acknowledged.

The theory of operation of this array is very similar to that of the original wave antenna used on long waves. In this array, a two-wire transmission line is extended in the direction of the great circle path between transmitter and receiver. One end of this line terminates in a

<sup>1</sup> A comprehensive treatment of antenna arrays was recently presented before the I.R.E. by G. C. Southworth, "Certain factors affecting the gain of directive antennas," Proc. I.R.E., 18, 1502; September, 1930.

<sup>2</sup> H. H. Beverage, C. W. Rice, and E. W. Kellogg, "The wave antenna," *Trans. A.I.E.E.*, 42, 215.

damping impedance equal to its surge impedance. The other end may be extended to the input terminals of the receiver. As so far described, such a transmission line would have very little signal voltage between the two conductors since the two conductors are electrically symmetrical with respect to ground and spaced very close together. If we now couple to this line at regular intervals along its length a number of antenna elements we have an end-on array. If a sufficient number of antenna elements are coupled to the line per wavelength and if the impedances of these elements are made sufficiently high, the two conductors we started out with retain their characteristics as being simply a transmission line with loading at regular intervals.

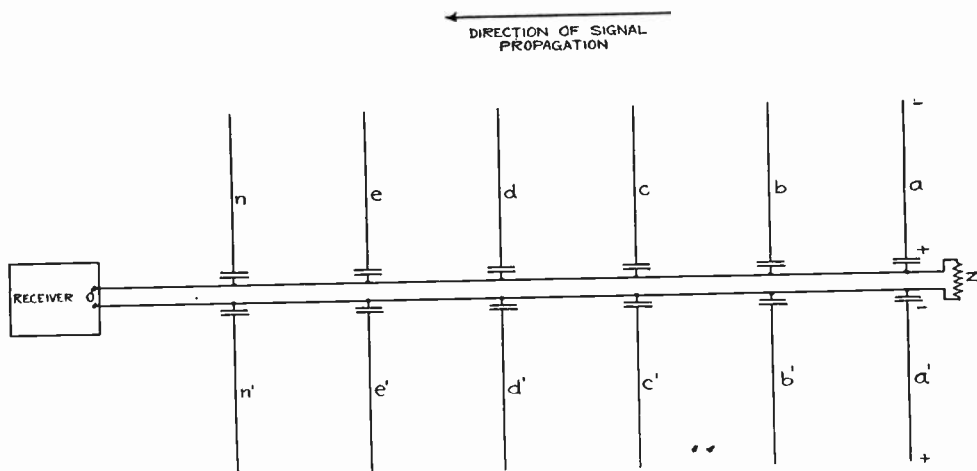

Fig. 14.—Elementary antenna array.

Fig. 14 presents the arrangements of the elements in this array. The elements  $a$  and  $a'$ ,  $b$  and  $b'$ , etc., are untuned lengths of wire. They are coupled to the transmission line through small capacities. Each element adds a small capacitive loading to the transmission line. A slight resistive component is also added by each element. The effect of these loadings is to reduce the phase velocity of the transmission line, and also to reduce its surge impedance. The resistance components will slightly increase its attenuation. The design of the coupling capacities is such as to keep the phase velocity above 90 per cent of the velocity of light.

Referring again to Fig. 14, we shall see that a signal wave front traveling in the direction indicated will first induce voltages in  $a$  and  $a'$ . The instantaneous voltages may be polarized as shown. Thus a potential difference is coupled into the opposite sides of the transmission line. This potential difference will travel from the point of coupling toward the two ends of the transmission line. The component traveling

against the direction of signal propagation is absorbed by the damping resistor  $Z$ . The component traveling toward  $O$  reaches  $b, b'$  only very slightly later than the arrival of the signal wave front at that point. The result is that the potential difference fed to the line by  $b$  and  $b'$  will be added practically in phase to the increment of voltage, just arrived from  $aa'$ . This process continues for the length of the line so that a substantial potential difference accrues between the two conductors of the line at the point  $nn'$  as the signal wave front reaches this point. Signals coming from other directions will not build up appreciable voltages at the output end because increments contributed by the various elements will not accumulate in phase along the line. Signals coming from a direction exactly opposite the bearing of the transmitter for which the

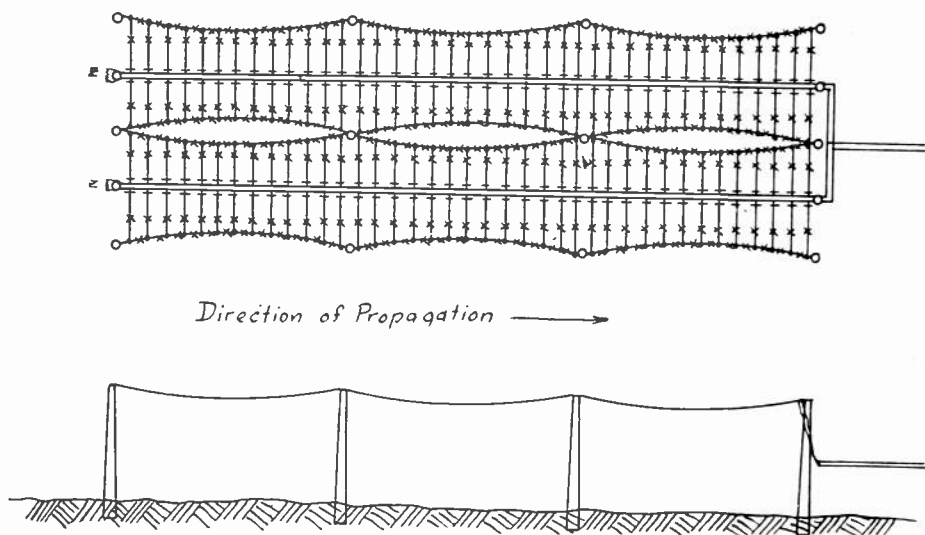

Fig. 15.—Plan and side views of antenna.

antenna was built will cause considerable voltage to accrue at the  $aa'$ . This energy will be dissipated in the damping resistor  $Z$  and hence will not be reflected back to the receiver at  $O$ .

It should be noted from this discussion that none of the elements are tuned to frequencies for which the antenna is designed and none of the phase relationships are dependent on frequency. In short, the antenna is in reality a transmission line, efficient over quite a band of wavelengths. Satisfactory results are obtained with one antenna design over a band of wavelengths from 14 to 25 meters. It is possible, therefore, to connect a number of receivers to the same antenna and obtain quite an economic saving in a large station.

In practice, two of the end-on arrays are usually constructed side by side and connected in parallel to form a broadside of two directive

units, thereby still further improving the directivity. Fig. 15 shows the plan and side elevation views of such a system. Fig. 16 is a photograph of one of the first broadside units erected. Manila rope triatics were

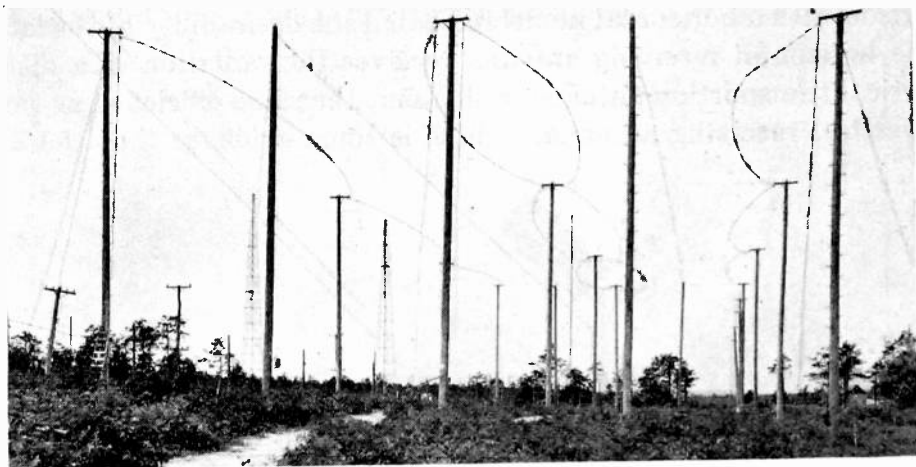

Fig. 16.—Directive antenna, end view.

used in this model. Iron wire rope was later substituted for the manila rope. To avoid the building up of appreciable voltages in these triatics, they were broken up by strain insulators at frequent intervals. This

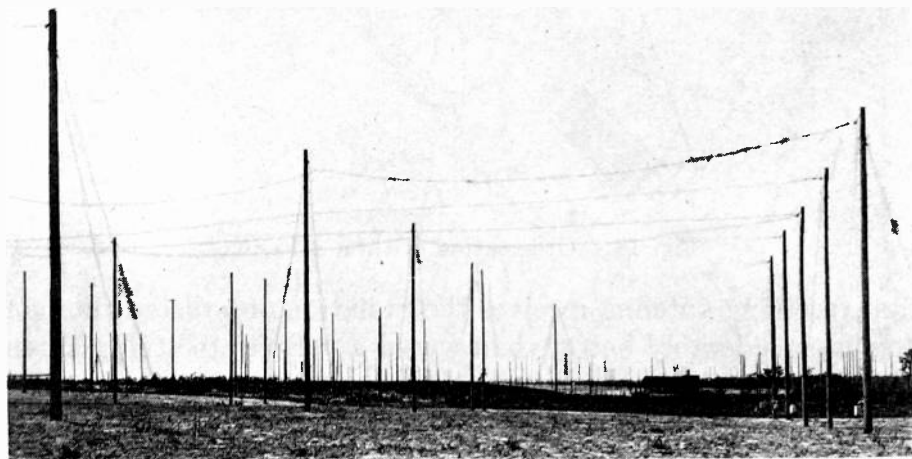

Fig. 17.—Directive antenna, side view.

construction is more clearly illustrated by Fig. 17. This picture was taken at the Riverhead receiving station. The receiving building is shown in the back ground. The antenna is held in tension by a system of counterweights. With the formation of sleet these weights will rise,



relieving to some extent the stress on the structure. A typical orientation of three antennas is presented in Fig. 18.

It will be noted that these antennas are composed of horizontal elements. The first models were built with vertical elements. A comparison with a horizontal model indicated the desirability of the latter. The horizontal receiving antenna receives the radiation of a distant vertical transmitting antenna with about the same efficiency as would a vertical receiving antenna. There is some evidence that the hori-

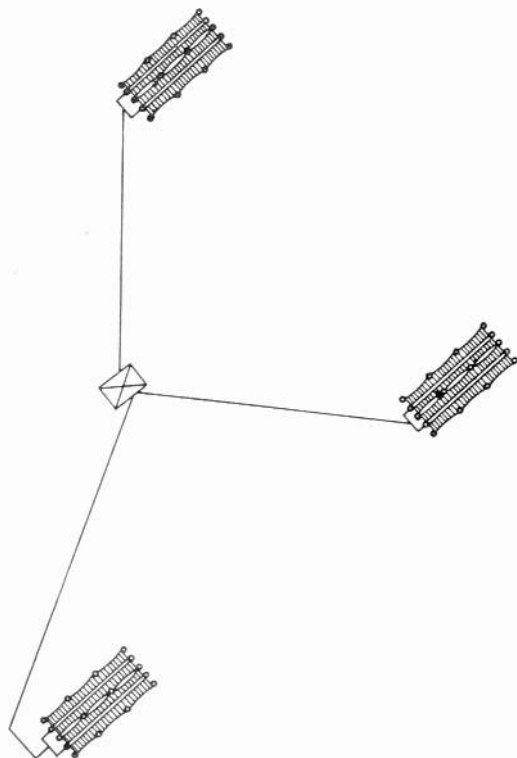

Fig. 18.—Orientation of three antennas.

zontal receiving antenna receives the radiation of a distant horizontal antenna considerably better than would a vertical receiving antenna. Since it was necessary to receive a variety of transmitters on one receiving antenna it seemed most advantageous to standardize on the horizontally polarized type.

Another desirable quality may be attributed to the horizontally polarized receiving antenna. If we have a local source of noise level such as motor car ignition, power line leakage, or commutator sparking, a vertical doublet will usually receive this noise with much greater strength than a horizontal doublet. It seems that most of these locally generated noises are vertically polarized. This is probably due to the

rapid attenuation of the horizontally polarized components as they travel along the surface of the earth. The fact that the horizontal component of a signal coming from a great distance is not similarly discriminated against may be accounted for by the slight elevation above the horizontal along which the signal approaches the receiving antenna.

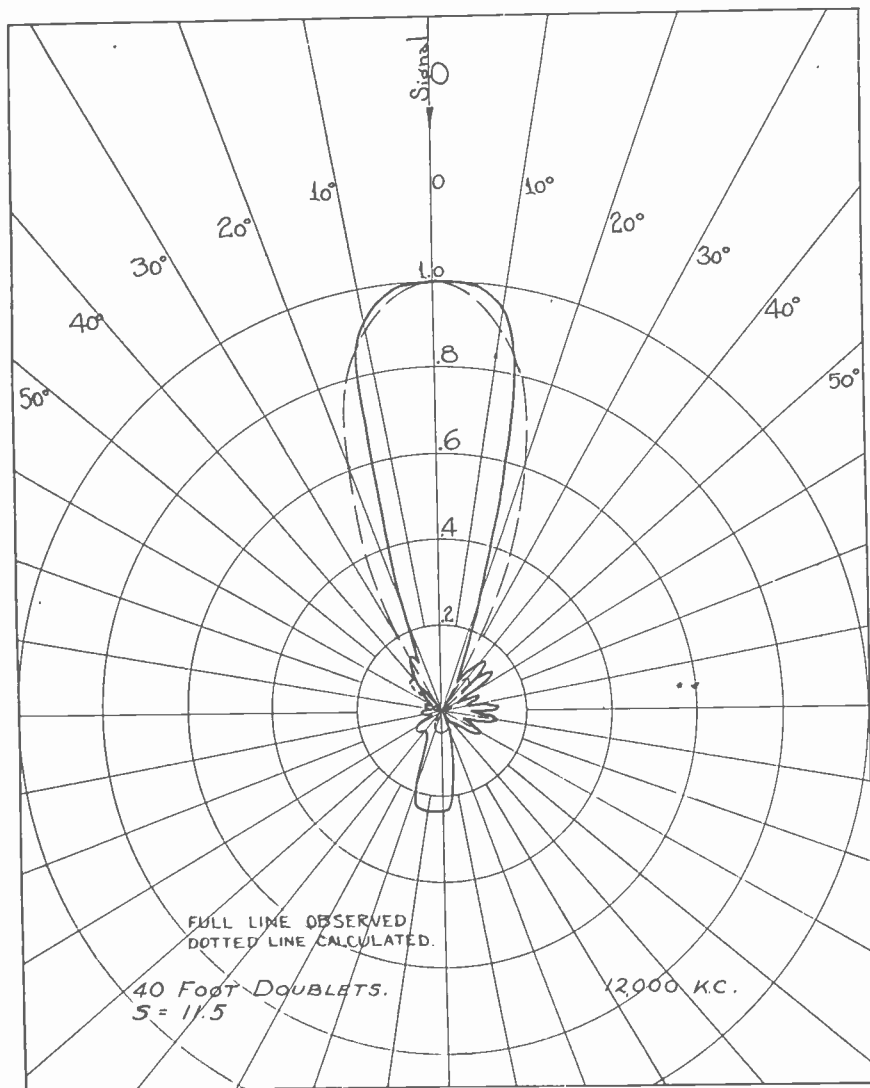

Fig. 19.—Directive diagram of single antenna—12,000 kc.

The antennas, as shown, are mounted on 60-foot poles. These poles are set about seven feet into the ground so the net altitude of the antenna is about 50 feet above the ground. A number of experiments were conducted on wavelengths of 15 to 30 meters with antennas at various altitudes using a kite to raise a small doublet. As the doublet was raised the signal strength increased rapidly for the first 25 or 30

feet. No appreciable gain was observed for altitudes above 50 feet. The use of the lowest structures possible, still retaining good electrical efficiency, is obviously quite preferable. The horizontal type permits lower structures than the vertical.

The polar diagrams of some typical antennas are of interest. Figs.

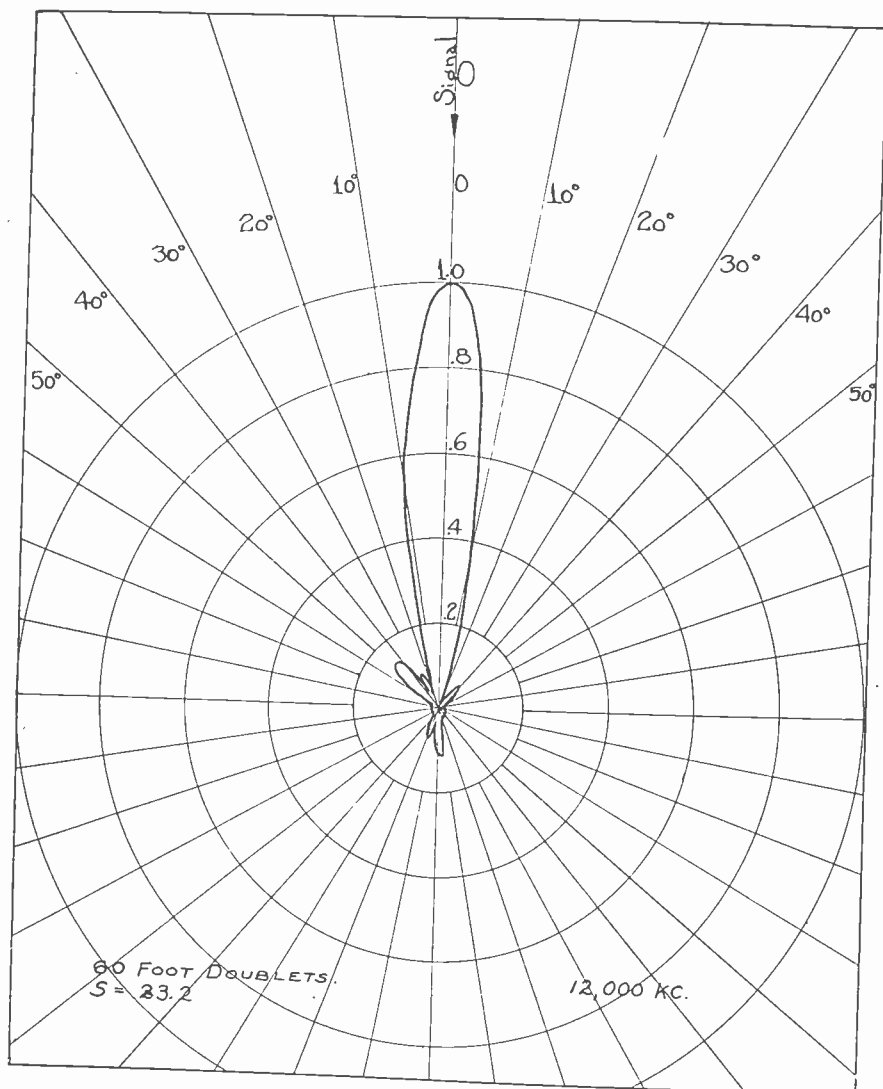

Fig. 20.—Directive diagram of two antennas combined broadside—12,000 kc. 19, 20, and 21 are polar diagrams taken with the aid of an airplane. A small transmitter was mounted in the plane. This transmitter was coupled to a wire three-quarters of a wavelength long. About one-quarter of a wavelength was ineffective as a radiator because of following the fuselage of the plane. The remaining half wavelength was allowed to trail out behind the tail of the ship, substantially horizontal,

tension being supplied at the end by a small drag similar to a sea anchor. The plane was flown along a circle of five miles radius at an altitude of 1200 feet. The radii on the polar diagrams are proportional to voltage delivered to the receiver.

The calculated polar diagram for a single antenna unit is indicated

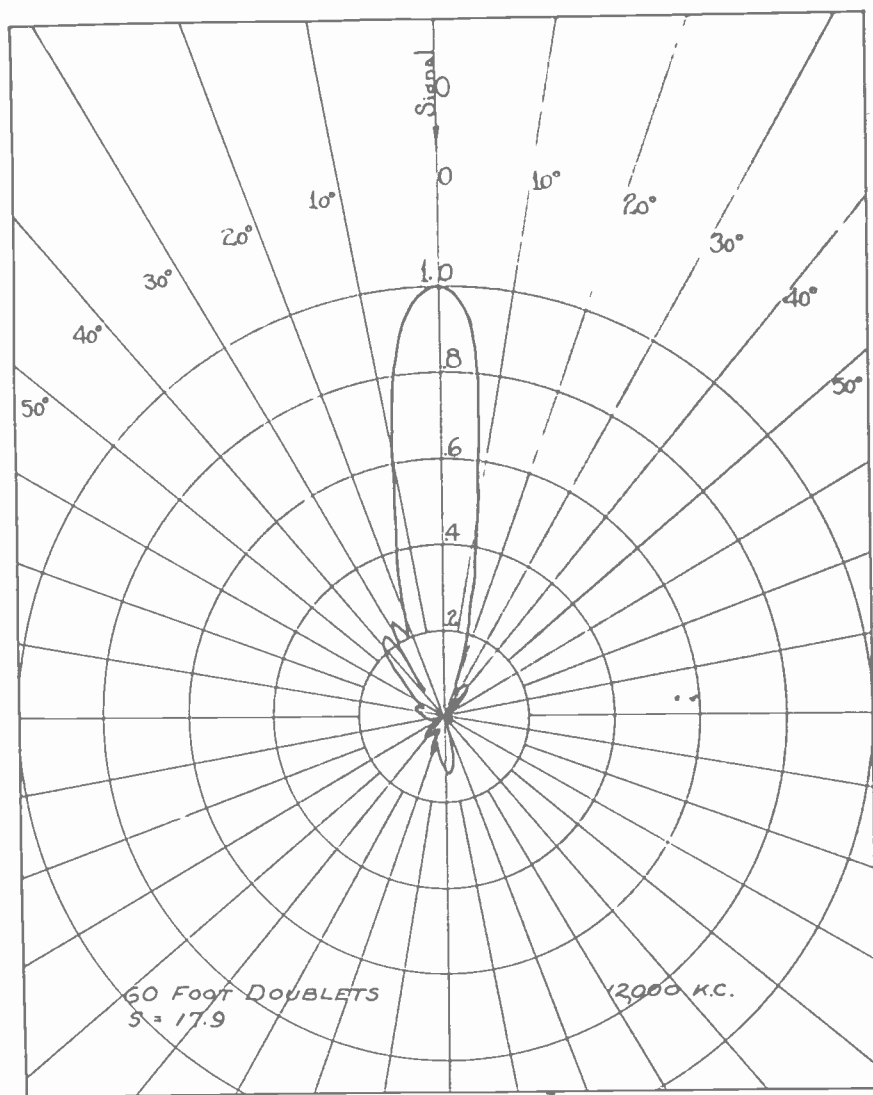

Fig. 21.—Directive diagram of two antennas combined broadside—12,000 kc.

by the dotted curve on Fig. 19. It will be particularly noted that the back-end lobe of the experimental diagram is larger than that of the calculated curve. This difference was probably due to the damping resistor being faulty when the data were taken. These calculations were made on a basis of 93 per cent velocity in the line, zero attenuation, and a length of 3.75 wavelengths.

The area of the polar diagram is a measure of the ability of an antenna to reduce the noise level. On the polar diagrams Figs. 19, 20, and 21 a factor "S" is indicated. This factor is the ratio of the area of the circle whose radius is equal to the greatest radius of the polar diagram to the area of the polar diagrams of the antenna. The factor "S" for the single unit is approximately 11.5. For the broadside combination of Fig. 20, S is 23.2. For the broadside represented by Fig. 21 the value S is 17.9. These values correspond to improvements of 10.6 db, 13.7 db, and 12.5 db, respectively, in the signal-to-noise ratios if we consider the noise sources as being uniformly distributed about the receiving site.

As a matter of fact, the noise source is very seldom evenly distributed about the receiving site. In long-wave operation it was found that most of the static observed at Riverhead came from directions between south and southwest. We have reason to believe that short-wave static likewise comes from the tropical latitudes. Consequently a unidirectional antenna built to receive from Europe, which is northeast of Riverhead, will show a marked discrimination against static from the southerly directions. If we measure the area of the parts of polar diagrams Figs. 20 and 21 lying below the center of the circle we get values very small compared to the area of the entire circle. If we assume all the static to originate within the rear 180 degrees of these antennas, their improvement in signal-to-noise ratio over a nondirective antenna would be 31.2 db and 29 db, respectively. By actual measurement of the signal-to-noise ratio of one of these antennas as compared to a horizontal doublet the average of twenty-nine measurements gave a value of 32.8 db for the improvement due to greater directivity. Both antennas were oriented for reception from Europe. The maximum observed improvement over the doublet was 42 db. The minimum observed improvement was 24.6 db. A horizontal doublet gives a "figure-of-eight" polar diagram which has half the area of the equivalent circle. From the measured ratios it would seem fair to conclude that a majority of our static comes from directions quite different from that of Europe.

By the use of a transmitter on the airplane it was also possible to make some measurements of directivity in the vertical plane. Transmission was obtained from altitudes up to 7000 feet at a distance of three miles, elevation being measured by a transit on the ground. Fig. 22 shows the results of such measurements on one antenna. This diagram is in close agreement with other diagrams made by the same method. The most striking feature about this diagram is the angle above horizontal at which maximum signal strength is received. This

elevation of the effective receiving diagram must be due to the effects of the earth since the antenna itself, if suspended in free space, far away from earth, would have a directive diagram in the vertical plane very similar to that in the horizontal plane (Fig. 19).

The effects of the earth might be either absorption or reflection. If absorption, it might be expected that a distinct improvement in signal strength would result if the receiving were done along the coast at the water's edge so as to have the signal travel over as little land as pos-

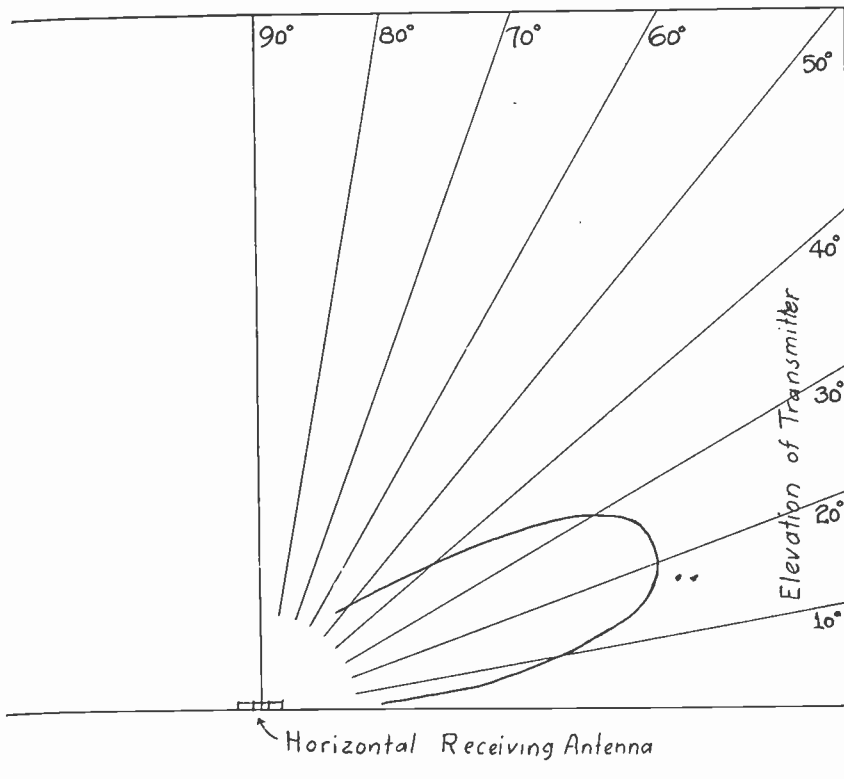

Fig. 22.—Vertical plane directivity of broadside antenna combination.

sible in the immediate vicinity of the receiving site. Some simultaneous measurements of field strength were made with sets at Riverhead and Montauk Point, Long Island, situated about forty-three miles apart. Riverhead is situated about six miles inland. The Montauk site was on a high cliff overlooking the water in the general directions of Europe and South America. The average results obtained at the two places were about equal. It was, however, observed that the very long period fading was not simultaneous at the two places. This kind of fading with a period of from fifteen minutes to one or two hours and occurring at different times at places spaced a considerable number of miles might be called territorial fading.

Directivity is very effective in reducing the troubles from locally generated noises. Besides using directivity an effort should be made to keep these sources under control as much as possible. It is good practice to so locate the antennas that no roads pass in front of them at distances less than 500 feet. Only specially shielded cars should be allowed to come closer than this distance. To have such control of conditions it is usually necessary to purchase an area of several hundred acres for an important receiving station. Rotating machinery and relays at the receiving station are usually silenced by shielding and by filter circuits in the leads. Airplanes have been found to radiate very strong ignition noise levels on some occasions. A plane may cause trouble at distances of one or two miles from the antenna. The use of radio on the planes will encourage the use of ignition shielding which

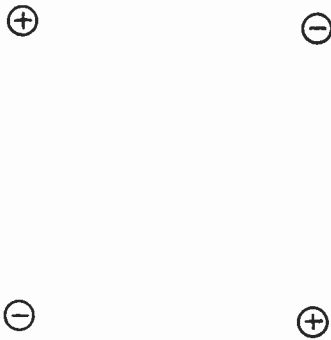

Fig. 23.—Cross section view of four-wire transmission line.

will stop this class of interference. With the advent of a great number of small planes for popular use it may some day be desirable to control their emission of radio-frequency energy by legal regulations.

#### *Transmission Lines*

Transmission lines are used to bring the received energy from the antenna to the receiving building. A satisfactory transmission line must not by itself pick up appreciable signal energy, otherwise the effectiveness of a good directive antenna will be nullified by noises picked up by the transmission line. Furthermore, the line must not attenuate the signal too much. A simple two-wire line was found to have rather too much pick-up for satisfactory operation. This pick-up could be reduced to a low level by bringing the spacing of the wires down to something on the order of a half inch. This spacing would ordinarily be considered quite difficult in practice. A wider spacing could be silenced by a liberal use of transpositions. A transposition every five feet is quite good. A special transposition insulator was de-

veloped for this purpose and has been used in the vertical down-leads of the antenna. The use of so many transpositions in a long line would, however, be quite costly. To meet this situation a four-wire line was developed in which opposite corners are connected in parallel. A cross section view of such a line is shown in Fig. 23. The electrical center of the two sides of such a line are coincident and consequently the pick-up is small. The surge impedance of the antenna is 410 ohms per unit. The impedance of the four-wire line is approximately 200 ohms. Conse-

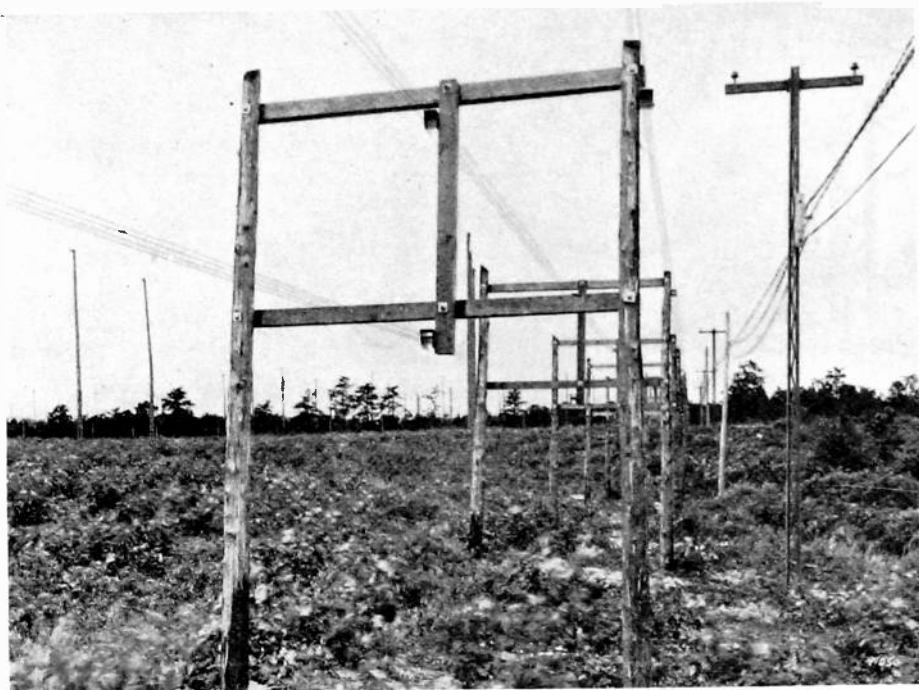

Fig. 24.—Transmission line structure.

quently two antenna units connected in parallel as a broadside combination can be connected directly to the transmission line without the necessity of transformers or impedance matching networks.

Fig. 24 shows an installation of several lines of the four-wire type. The supports are spaced twenty-five feet apart. The wires are threaded through holes in a special isolantite insulator. The small copper can around the insulator serves two purposes. It protects the insulators to some extent against rain and snow and it shields the line against the unbalance that might otherwise result from the proximity of the wooden structure to one side of the line. The four wires pass freely through the holes in the insulators. By means of heavy counterweights at the station end of the line a constant tension is maintained in each



Directivity is very effective in reducing the troubles from locally generated noises. Besides using directivity an effort should be made to keep these sources under control as much as possible. It is good practice to so locate the antennas that no roads pass in front of them at distances less than 500 feet. Only specially shielded cars should be allowed to come closer than this distance. To have such control of conditions it is usually necessary to purchase an area of several hundred acres for an important receiving station. Rotating machinery and relays at the receiving station are usually silenced by shielding and by filter circuits in the leads. Airplanes have been found to radiate very strong ignition noise levels on some occasions. A plane may cause trouble at distances of one or two miles from the antenna. The use of radio on the planes will encourage the use of ignition shielding which

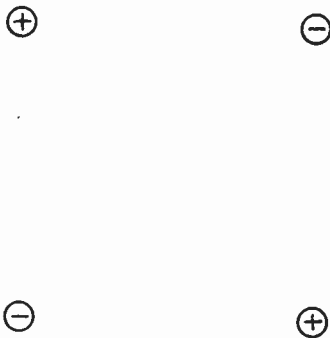

Fig. 23.—Cross section view of four-wire transmission line.

will stop this class of interference. With the advent of a great number of small planes for popular use it may some day be desirable to control their emission of radio-frequency energy by legal regulations.

#### *Transmission Lines*

Transmission lines are used to bring the received energy from the antenna to the receiving building. A satisfactory transmission line must not by itself pick up appreciable signal energy, otherwise the effectiveness of a good directive antenna will be nullified by noises picked up by the transmission line. Furthermore, the line must not attenuate the signal too much. A simple two-wire line was found to have rather too much pick-up for satisfactory operation. This pick-up could be reduced to a low level by bringing the spacing of the wires down to something on the order of a half inch. This spacing would ordinarily be considered quite difficult in practice. A wider spacing could be silenced by a liberal use of transpositions. A transposition every five feet is quite good. A special transposition insulator was de-

veloped for this purpose and has been used in the vertical down-leads of the antenna. The use of so many transpositions in a long line would, however, be quite costly. To meet this situation a four-wire line was developed in which opposite corners are connected in parallel. A cross section view of such a line is shown in Fig. 23. The electrical center of the two sides of such a line are coincident and consequently the pick-up is small. The surge impedance of the antenna is 410 ohms per unit. The impedance of the four-wire line is approximately 200 ohms. Conse-

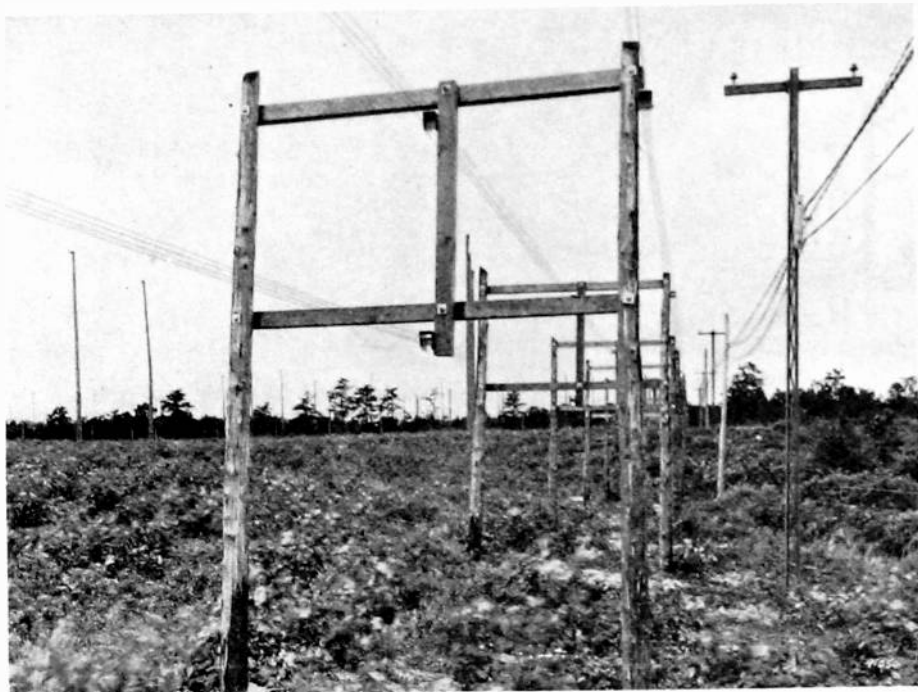

Fig. 24.—Transmission line structure.

quently two antenna units connected in parallel as a broadside combination can be connected directly to the transmission line without the necessity of transformers or impedance matching networks.

Fig. 24 shows an installation of several lines of the four-wire type. The supports are spaced twenty-five feet apart. The wires are threaded through holes in a special isolantite insulator. The small copper can around the insulator serves two purposes. It protects the insulators to some extent against rain and snow and it shields the line against the unbalance that might otherwise result from the proximity of the wooden structure to one side of the line. The four wires pass freely through the holes in the insulators. By means of heavy counterweights at the station end of the line a constant tension is maintained in each

wire. Fig. 25 shows the counterweight systems of some of the lines at the Riverhead station. From the four-wire line the signal passes into the station over transposed rubber-covered lines of close spacing. By making the spacing close it is possible to make the rubber-covered two-

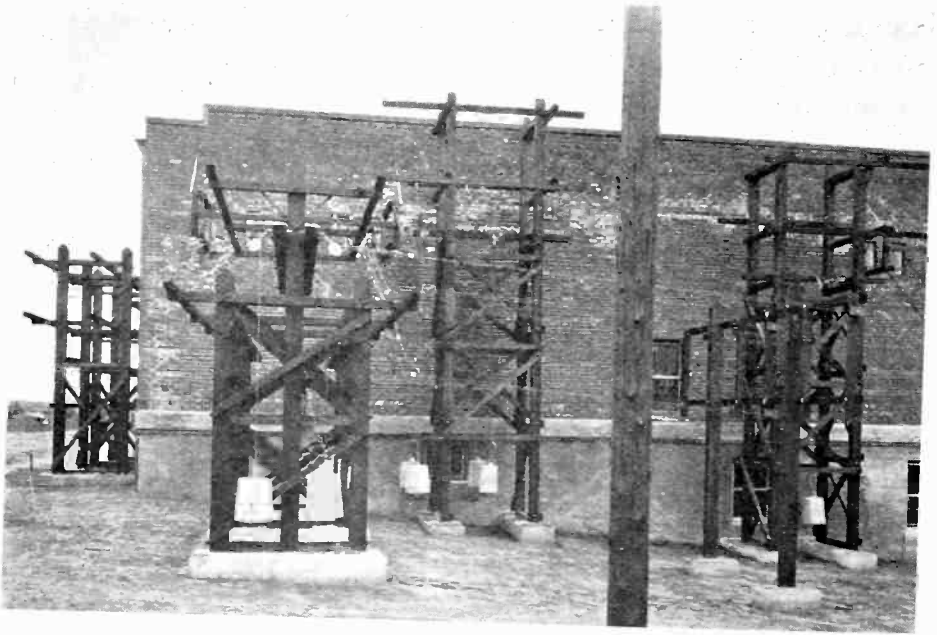

Fig. 25.—Counterweight systems for transmission lines.



Fig. 26.—Riverhead short-wave receiving station.

wire line have practically the same characteristic impedance as the four-wire line. The two wire lines pass into the station through spaced holes in small plate glass windows. Directly inside these windows the lines are connected to neon tube lightning arrestors paralleled by spark

gaps. The radio-frequency impedance of these arrestors is made as high as practicable. From the arrestors the lines continue overhead to the various receivers within the building. As many as five or six receivers may be connected to one transmission line. Fig. 26 shows a front view of the Riverhead station and another view of the transmission line termination. This picture was taken somewhat before the completion of this plant but it shows the general arrangement.

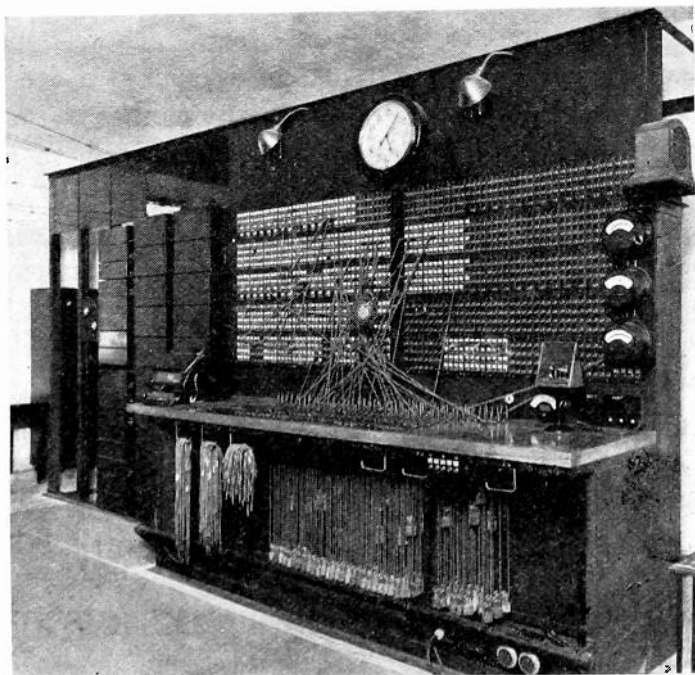

Fig. 27.—Tone line control board.

### *Circuit Conditions*

The phenomena of echo and cosmic disturbances have to some extent harassed the operators of short-wave circuits. Echo is caused by the arrival of the signal at the receiving site over two or more routes of considerably different lengths. Having come over routes of different length, their times of arrival differ. The simplest form of echo results from the signal arriving over the two possible ways around the earth. In receiving from Europe for instance, the main signal energy arrives over the shortest route, i.e., from the northeast. However, under some conditions, a certain amount of energy will travel all the way around over the longest route and arrive from the southwest, considerably behind the main signal. This form of echo was first observed by H. O. Peterson on the Poldhu tests in the summer of 1925. It may cause serious mutilation of the signals at certain times of the day. The use

of unidirectional transmitting and receiving antennas has proved an effective remedy. Another form of echo results when the signal continues on past the receiving site for a complete trip around the world and is registered by the receiving apparatus on its second time of arrival. Proper directivity at both transmitter and receiver will not overcome this interference. Fortunately it is not of common occurrence. When it does occur it is usually possible to reduce the sensitivity of the receiving system to accept the signal on its first arrival but not on its second. Other types of multipath effects become apparent when the circuits are operated at very high speeds such as in facsimile transmission or in television. These effects usually change the marking bias of a telegraph circuit only slightly and therefore have not been so troublesome.

Cosmic disturbances cause changes of the transmission medium which on some occasions may cut off a short-wave channel completely. On other occasions the circuit is considerably attenuated but not cut off completely. These disturbances affect the circuits traveling through polar latitudes more than the circuits crossing the equator. They are coincident with magnetic disturbances and bear a relationship to sun spots. A striking demonstration of the concentration of adverse forces in the polar region may be had by observing a number of circuits at Riverhead when these conditions come on. The first circuit to pass out is the German circuit. The bearing of the German transmitter is N 47 degrees E at Riverhead. The English and French circuits soon follow. Their bearings are N 52 degrees E and N 54 degrees E, respectively. The Italian circuit, N 58 degrees E passes out appreciably later, followed by Madrid, N 66 degrees E. The last circuit to pass out is Lisbon, N 70 degrees E. The South American circuits are very seldom stopped by these conditions. It should be noted that this order of events holds for stations of approximately the same power and frequency.

A great improvement in reliability has been produced by the use of more power and better directive antennas at the transmitters. It is hoped that still further increases in radiated power will be possible. This allows continued operation through periods when the attenuation of the circuit is increased only several fold above normal, the conditions when a weaker transmitter would perhaps be audible, but unreadable.

It has also been found that for many of these times of disturbance, a lower frequency could be used to advantage. During the year 1930 magnetic disturbances have been especially prevalent. It has been noted that on the transatlantic service the higher frequencies around 20,000 kc (15 meters) are the most sensitive to magnetic disturbances

and tend to fade out during even a moderate disturbance. There is some evidence that the magnetic disturbances shift the whole transmission characteristics toward the lower frequencies. Thus the twilight frequencies around 13,500 kc (22 meters) become good daylight frequencies. The night frequencies from 10,000 to 7500 kc take on the characteristics of twilight frequencies, becoming useful early in the afternoon and fading out around midnight. Apparently, frequencies considerably lower than 5000 kc are needed for night transmission after midnight during these disturbed conditions. The old long-wave channels have always held up during these conditions and have proved a valuable reserve.

It is very desirable to have a selection of several strong channels on different wavelengths to carry on a reliable long-distance service. The best possible channel design seems necessary for continuous day in and day out service.

An alternative method of overcoming the troubles from cosmic effects on the European circuits is to route the channel along the two sides of a triangle so as to avoid crossing the polar regions. European stations are, for instance, copied with ease in South America when they are very weak or even inaudible at Riverhead. An automatic relay station could be established at some southerly location and continuity of service insured in that way. This is in reality an application of the space diversity principle on a large scale. Traffic has in some instances been handled over such routings. It is quite general practice for ships in European waters to relay to New York via some of the ships on the Europe-to-South America run. By this method these ships establish a circuit with 200-watt transmitters in spite of abnormal conditions.

The system just described has now been in operation on commercial circuits for a number of years. It has been an important factor in the increased reliability and traffic carrying capacity of these circuits. The encouragement and support of C. H. Taylor in the development of this system should be acknowledged.



## DIVERSITY TELEPHONE RECEIVING SYSTEM OF R. C. A. COMMUNICATIONS, INC.\*

By

H. O. PETERSON, H. H. BEVERAGE, AND J. B. MOORE

(R. C. A. Communications, Inc., New York City)

*Summary*—Difficulties encountered in the reception of high-frequency radio-telephone signals are described: the chief of these being fading and noise. General methods of solving these difficulties are discussed and the most desirable ones pointed out. The utilization of space diversity of fading is then taken up and methods of applying this principle to the reception of telephone signals are discussed. This method chosen is next described, with reasons for the choice and explanation of the circuits and action of the system.

A description of the general features of the equipment is given, and this is followed by a detailed consideration of the individual units comprising the double detection receivers and the combining and control equipment. Over-all characteristics are then given of selectivity and fidelity and a statement of sensitivity and minimum signal strength for commercial service.

Improvement obtained by the use of this system is discussed, and the uses to which it is being put are stated. The latter include international rebroadcasting and transoceanic telephone service.

WITH THE rapid rise of broadcasting came a natural desire to listen not only to programs from stations within our own country, but also to stations in other countries. Tests were made to determine what the possibilities were along these lines. One year in particular, American stations kept silent hours for several days to allow the broadcast listening public opportunity to try picking up foreign stations. On the whole, the results were not very satisfactory and American broadcasters resumed transmitting and have continued to do so ever since then. These tests did, however, result in fair reception up in Maine. A British station 5XX on 1600 meters, and with a good amount of power, came in with fair certainty at our receiving station at Belfast.

Accordingly, special facilities were installed and a few programs actually rebroadcast. The over-all quality of the results was, however, not sufficiently good to warrant their continued use as program material. Their chief merit was their novelty.

Fortunately, the far carrying qualities of short-wave transmission were discovered at about this time. It was soon realized that a short-wave broadcast transmitter of a few kilowatts power might be heard to

Decimal classification: R412. Original manuscript received by the Institute November 24, 1930. Revised manuscript received January 5, 1931. Presented before December 3, 1930, New York Meeting.

the far ends of the earth. But the technique of successfully receiving such broadcasting on short wavelengths was more difficult than on the usual broadcast channels. It was apparent that most satisfactory results might be obtained if a special receiving site were established for picking up these transmission. This receiving station could pass the signals on to the regular networks whence they could be retransmitted on the usual broadcast channels. The American listener could thereby listen to foreign programs with his regular broadcast receiving equipment. The quality of service delivered by such a receiving station must necessarily be of the best possible to make the result acceptable to the listening public. The facilities and technique for doing this are the subject matter of this paper. These facilities naturally constitute a good radiotelephone receiving terminus.

The major problems to be overcome in the establishment of such facilities are similar to those already enumerated for telegraphy in a previous paper.<sup>1</sup> The problems involved were fading, noise level, apparatus details and cosmic disturbances. The noise level situation was met in exactly the same way as in the case of short-wave radiotelegraphy. The receiving site was situated as far as possible from roads, power lines, factories and other sources of man-made interference. In addition to this, highly directive receiving antennas were installed to exclude static and noises coming from directions other than that from which it was desired to receive signals.

Probably the most serious problem was the matter of fading. Fading includes a number of interesting even if not pleasant phenomena. There are numerous ways in which fading might be classified. Thus we might classify it according to its periodicity. If we do, we have the slow fading with a periodicity of from several seconds to several minutes duration. We also have rapid fading with a periodicity of a small fraction of a second. This rapid fading has been called flutter fading on account of the fluttering effect it gives the signal. Flutter fading is as if a low-frequency modulation were superimposed on the transmission. It has a disastrous effect on quality. Fading might be classified further according to its depth. Thus we find it varies from a ratio of 5 or 10 to 1 to 100 or more to 1.

Practically all short-wave fading is accompanied by more or less frequency discrimination.<sup>2</sup> Such fading has generally been called selective fading. This same phenomenon has been discussed in the previous paper where it was called frequency diversity. If we consider the usual

<sup>1</sup> See PROCEEDINGS, this issue, page 531.

<sup>2</sup> R. K. Potter, "Transmission characteristics of a short-wave telephone circuit," *Proc. I.R.E.*, 18, 581; April, 1930.



broadcast transmission we find it consists of a carrier and upper and lower side bands. Thus the transmission occurs on a spectrum of frequencies about 10,000 cycles wide. Study of simultaneously transmitted frequencies in such a spectrum disclosed the fact that fading was not simultaneous on all these frequencies, even the frequencies separated by only a few hundred cycles. Thus, the carrier may fade out leaving the side bands strong; or certain of the side bands might fade out leaving the carrier and other side bands strong. The most objectionable results are obtained when the carrier disappears leaving the side bands in. When this happens the results are similar to what we would get by over modulating a transmitter from several hundred to a few thousand per cent.

This selective fading effect is not strictly confined to short-wave transmission. It may be observed on some of the regular broadcast channels, especially those with a fairly high percentage of modulation. We sometimes get striking examples of it on the regular WJZ broadcast signal as received at Riverhead. When the carrier fades out certain of the side bands still come through with good strength. They beat against each other resulting in a most terrible quality.

The first and most natural thing to do about fading was the application of automatic volume control. As usually applied, automatic volume control consists of rectifying the signal and then passing it through a resistor to get a direct current  $IR$  drop. This  $IR$  drop is fed back to some part of the circuit in such manner that the gain of the receiver is affected. It is so connected that when the signal strength comes up the gain of the receiver is reduced. By its application the output level of the receiver may be maintained practically constant. However, automatic volume control as ordinarily applied will not resupply the carrier if it fades out leaving the side bands. Nor will it improve the signal to noise ratio at times when the signal goes weak. When the signal goes weak the average noise level usually remains fairly constant; the result is that, as the automatic volume control increases the gain of the receiver to take care of the weakened condition of the signal, the noise level in the output is also increased.

It was apparent that the spaced antenna diversity system might be of great help in the reception of broadcast programs and other forms of radiophone signals. The nature of the spaced antenna diversity principle has already been described in the previous paper. Since fading is not simultaneous on a number of spaced antennas, it is natural to conclude that a steadying effect might be obtained by the use of several such antennas.

The problem of bringing together the outputs of several antennas in

such manner as to be independent of phase is more difficult in the case of telephony than in the case of telegraphy because of the higher modulation frequencies involved. The first and simplest method to be tried was the simple mixing of the outputs of several receivers. As usually executed, each of the several receivers had automatic volume control and the several outputs were simply connected together in a common output circuit. In such an arrangement, the noise output of all the receivers are effective in the combined output, even though one or two of them might not at the moment be able to contribute much to the signal level. Furthermore, the phase relationships of the various audio-frequency components are considerably changed in transmission through space, so they do not all add up cumulatively. For this reason, the addition of the audio outputs of several receivers does not give an output of as great volume as might be expected.

In an attempt to dissociate the phase relationship of the various components of the several receivers still more completely, an interesting experiment was conducted. Two receivers on spaced antennas were connected to two loud speakers in a room having considerable reflection from the walls. A microphone was placed in the same room and the combined output observed at a distant point. The output level was considerably stabilized by this process but the quality was somewhat deficient due to the echoes in the combining chamber.

As a rule, at any moment, the antenna with the greatest signal strength might be expected to deliver the best quality at the output of the receiver. It therefore seemed desirable to have a system whereby the loud speaker or transfer line could be rapidly switched from receiver to receiver in such manner as to be associated always with the antenna and receiver having the greatest signal strength. A system of relays was devised whereby the output circuit was always connected to the set having the highest carrier level. The results were quite good and a substantial improvement resulted. This circuit was, however, quite complicated as well as being limited in its speed of operation by the mechanical limits of the relays.

A system involving no mechanical relays, but retaining the advantages of the previously described circuit was evolved. This system is now generally used at the Riverhead station. A block diagram of this system is shown in Fig. 1. In this circuit the signal outputs from each antenna pass through separate superheterodyne receivers to the grids of individual second detectors. The plate circuits of these second detectors are energized by one battery feeding current through a load resistor common to all. As indicated in Fig. 1, this load resistor is connected between the negative end of the plate supply battery and

ground. The audio-frequency output is taken from across this load resistor. The voltage drop across this resistor is also applied, through a time constant circuit, to the control grid bias of the high-frequency amplifier tubes of all sets, thus effecting automatic volume control of all receivers simultaneously.

By this connection, all receivers are kept at substantially equal gain. A strong signal output from any one of the three receivers shown will reduce the gain of all receivers so as to preclude the contribution of noise output by the other two. This is obviously a very desirable con-

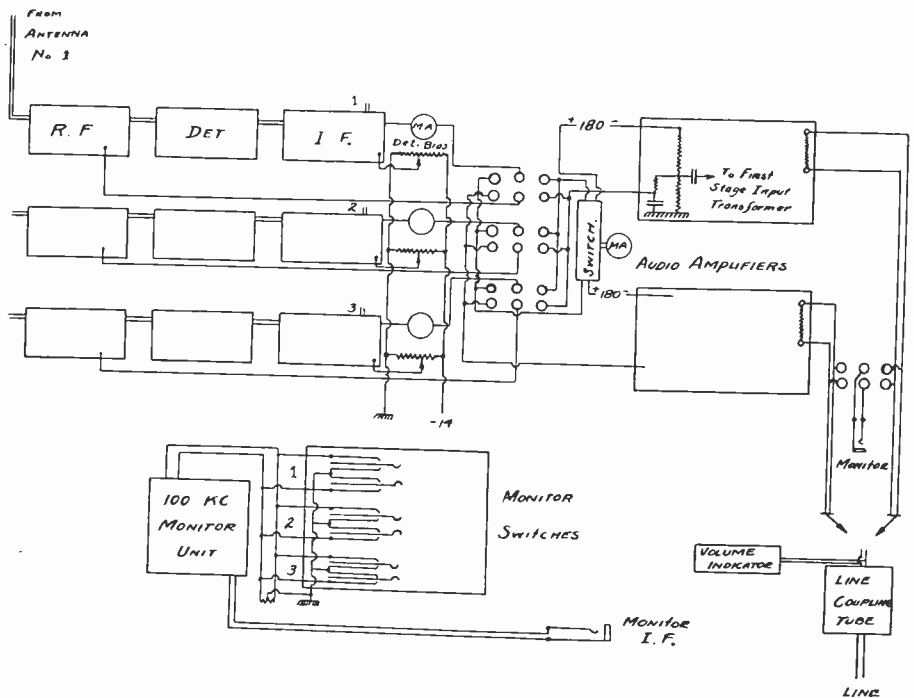

Fig. 1.—Block diagram of telephone receiver.

dition. The choice of time constant of the volume control circuit is largely a matter of compromise. If the time constant is made very low, the automatic control might function to reduce the amplitude of low-frequency modulation of the signal, thereby impairing the fidelity of the receiver. If too great, the control will be unable to respond to the normal rates of fading. There is also a possible case wherein the action of the automatic control lags behind the change of signal strength sufficiently to keep a condition of high gain immediately following a deep fade, with the result that when the signal strength starts to increase, a sudden "burst" of strength results in the output. It is preferable to avoid this condition by making the time constant circuit sufficiently slow so as to not follow the most rapid types of fading. Good re-

sults have usually been obtained with a time constant of from 1/4 to 1/2 second.

The second detectors are UX-841 tubes (high-mu tubes of construction similar to UX-210). They are operated with grids biased considerably negative. In this condition, the output is approximately proportional to the square of the input. From this it follows that the detector having the greatest input will contribute most of the combined output. Thus, if the signal on one antenna is twice as strong as on another, its receiver will contribute four times as much to the combined output as will the other. This constitutes an automatic switching action. When signal strengths on two or three antennas are substantially equal, the combined output is the resultant of mixing the audio outputs of the several receivers. This condition of equality does not exist an appreciable percentage of the time. The switching action just described can function at a high rate of speed and will at times produce an improvement in the fastest types of fading called "flutter fading."

The superheterodyne type of circuit was chosen because of the great selectivity possible. By using high selectivity, the noise level can be substantially reduced. Another advantage derived in the use of the superheterodyne is the simplification of the process of tuning since fewer circuits need have variable adjustments.

The mid-band frequency of the intermediate amplifier is 100 kc. To facilitate the adjustment of the high-frequency oscillator to convert the signal to an intermediate frequency to 100 kc a special monitor unit is provided. This monitor unit is a heterodyne detector unit containing a 100-kc oscillator. A portion of the intermediate-frequency signal from any amplifier may be diverted into the monitor unit. The high-frequency oscillator is then adjusted to produce a zero beat indication in the output of the monitor unit.

It should be noted that a spare audio amplifier is provided. Flexibility of circuits is provided in the master control unit whereby the output of any set can be connected to either amplifier. This enables any receiver to be adjusted without affecting the output of the other two. Or, if desired, two signals may be observed with the apparatus in one rack, feeding one audio amplifier with two sets in diversity combination and the other with the remaining set.

#### EQUIPMENT

The equipment, in its commercial form, is mounted in a steel rack in the arrangement shown by Fig. 2. This is a standard receiver rack used for both the code and phone diversity receiving equipment. Battery supply busses and wiring are concealed in the vertical channels that

separate the bays and constitute the main structural elements of the rack. Each bay is separately fused so that trouble in one receiver will not necessitate shutting down the entire rack. A main power supply switch will be seen at the bottom of the right-hand bay, and in the top section of this same bay a panel which has a main filament supply rheostat and filament and plate supply voltmeters. The main rheostat is for the purpose of keeping the voltage supplied to the units at a predetermined value. To take care of a change in the voltage of the floating filament batteries it is only necessary to adjust the main rheostat to obtain correct voltage at the tubes of all units. Signal lights and keys may also be mounted on this panel when desired.

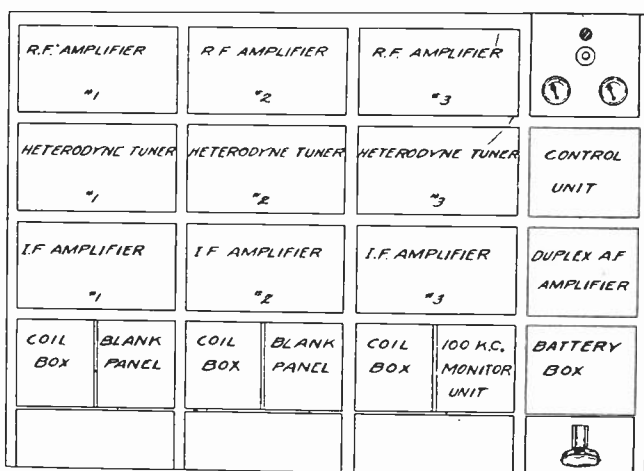

Fig. 2.—Arrangement of telephone receiver in rack.

The equipment consists of three separate receivers mounted in the three main bays as shown. The units containing the control equipment, combining and automatic bias circuits, and audio amplifiers are located in the end bay. The vertical arrangement of each receiver allows antenna transmission lines to be run along above the three bays and the use of short leads down to each of the radio-frequency amplifiers.

Fig. 3 is a photograph of an experimental rack. The general arrangement is the same as that of Fig. 2, the chief difference being in the audio amplifiers and plate batteries which are here seen to be located one above and one below the control panel. The audio- and the intermediate-frequency amplifiers on this particular rack are also of an early experimental design.

The electrical arrangements are such that all switching and monitoring of the three receivers are done from the one control panel in the end bay. Control of the audio output level is in the audio amplifiers located just below the main control panel, and the level of the line

signal is shown by a meter on the control panel. This arrangement provides maximum flexibility and ease of operation.

Auxiliary equipment used for working into local land lines, as used on actual rebroadcast or telephone service, will not be described at this time. It is standard audio-frequency equipment adapted to the needs

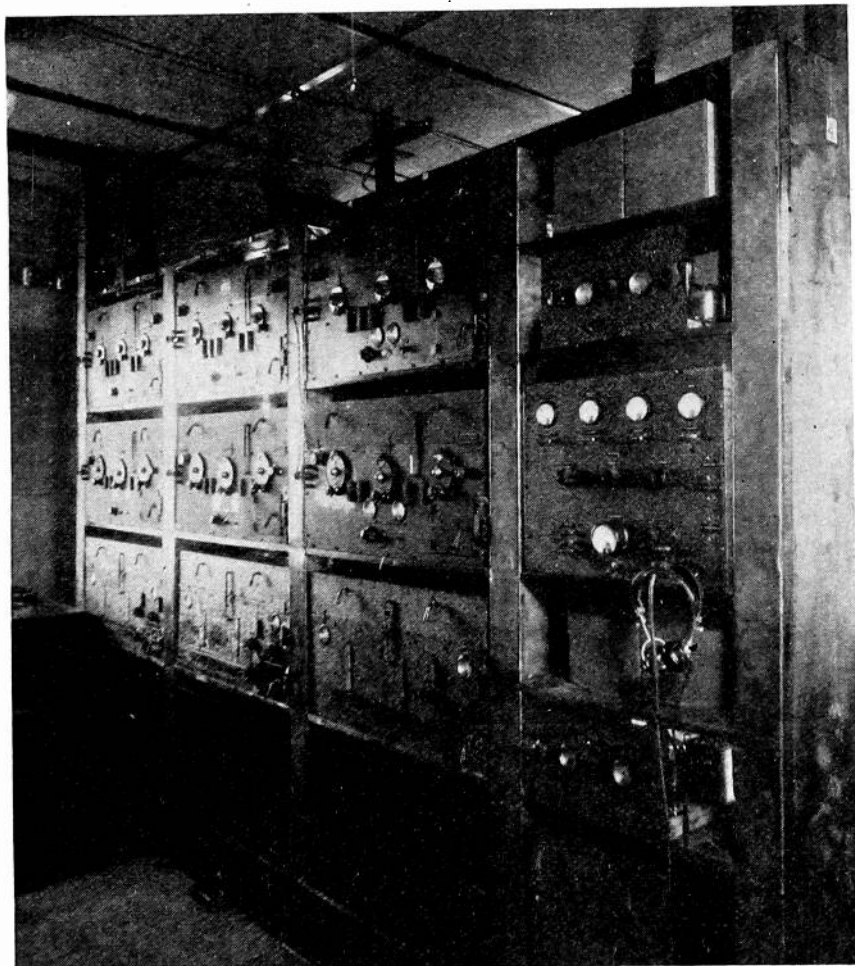

Fig. 3.—Telephone receiver installation in rebroadcast building at Riverhead, L. I.

of the individual installation. A view of the line control board of the Riverhead experimental station is shown in Fig. 4.

As the equipment is intended primarily for use on long-distance circuits, the receivers are supplied with coils to cover the frequency range 5600 kc to 25,000 kc. Additional coils can quite easily be made to cover frequencies down to 1500 kc where this is desired.

### *Radio-Frequency Amplifier*

This contains two tuned stages of radio-frequency amplification utilizing heater type screen-grid tubes. Plug-in coils are used in the three tuned circuits in order to cover the required frequency range. Special attention has been paid to the plug and jack arrangement used for the coils in order to insure a low resistance contact at all times. This is important as measurements have shown that a dirty contact will greatly broaden out the resonance curve of such a tuned high-frequency circuit. If the contact springs have a tendency to weaken with use, this

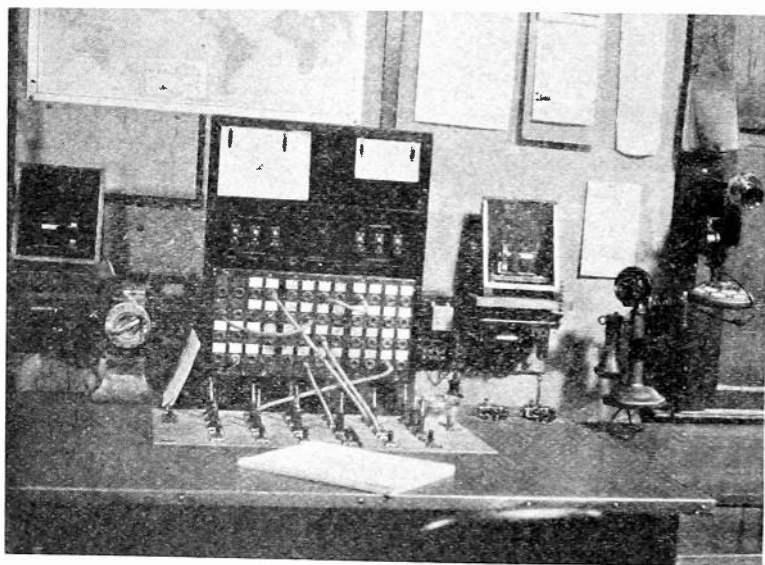

Fig. 4.—Line control board for transferring rebroadcast programs to New York.

condition may develop gradually and be the cause of annoying interference before the trouble is found. A low resistance plug and jack combination was developed to meet these requirements. This is also of especial importance in a double detection receiver where the selectivity of the radio-frequency system must be depended upon to reduce the "image" signal to a negligible level. For the same reason, variable condenser bearing contacts have received equal attention. Another item affecting selectivity, and gain, is the construction of the grid leak used for supplying bias to the second stage. Some types have been found to possess a comparatively high capacity between terminals. When used across an efficient tuned circuit which has only 100 to 150 micro-microfarads total tuning capacity, this small, high-loss condenser increases the effective resistance of the circuit appreciably.

Automatic volume control is accomplished by applying a varying negative bias to the control grids of both stages. Fig. 5 shows the variation of gain with respect to control grid bias and in Fig. 6 is shown an over-all volume control characteristic of one receiver. Second detector plate current is plotted against voltage input to the receiver in micro-

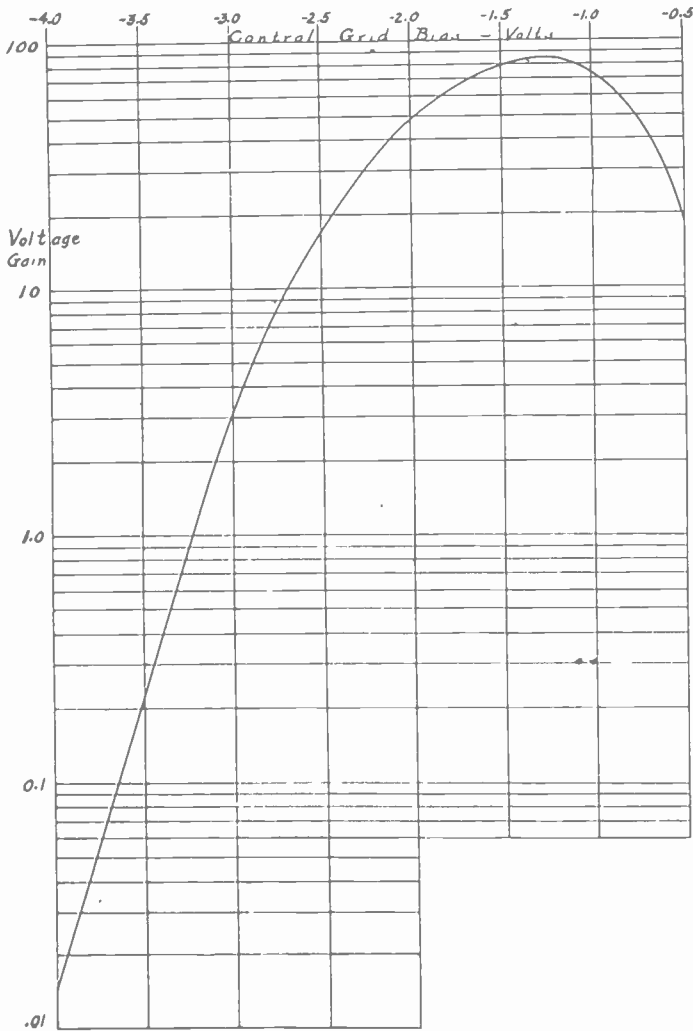

Fig. 5.—Voltage gain versus control-grid bias characteristic of short-wave radio-frequency amplifier at 9560 kc.

volts. In both the 9560-kc and the 18,000-kc runs the sensitivity of the receiver was adjusted to give a rectified output of 0.15 milliamperes with no signal input. This is due to set noise at the condition of approximately maximum gain in the radio-frequency amplifier. It will be seen from the curves that a variation in input signal from 3 microvolts to 3000 microvolts results in a change in the output of less than



2 to 1. The second detector plate current has been plotted as this is normally what is observed. The audio-frequency output voltage, however, is very nearly proportional to this current so the curve shown also represents very closely the change in output signal level.

Manual gain control is also provided in the form of a screen-grid potentiometer which controls the voltage supplied to the screen grids of both stages. This is used both for equalizing the gain of the three receivers and for reducing the gain of the radio-frequency amplifier at high frequencies to a point where it ceases to be unstable.

At these high radio frequencies it is essential to have all tuned circuits and screen-grid tubes effectively shielded from one another and

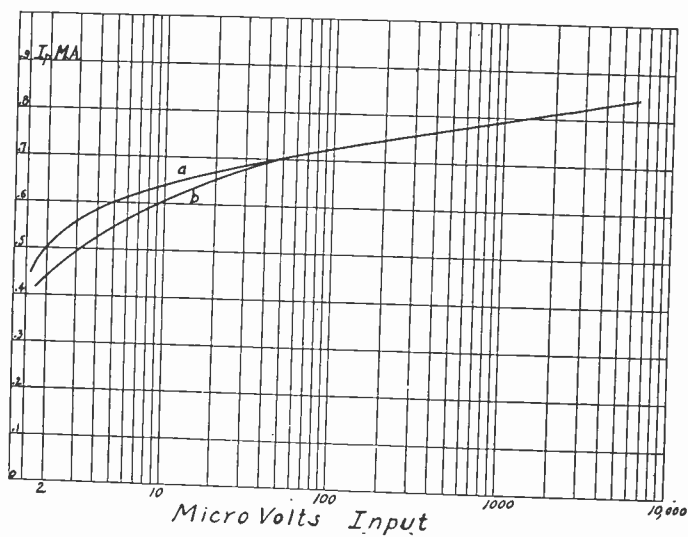

Fig. 6.—Automatic volume control characteristic: Second detector plate current versus signal input to radio-frequency amplifier. Curve a, 9560 kc, curve b, 18,000 kc.

from outside sources. Common battery supply also requires that all leads going to the tuned circuits and tubes be effectively filtered so that feed-back in one unit and cross-feed between units cannot occur by way of the battery busses. This is of major importance in equipment which employs three receivers tuned to the same frequency, and which is intended for operation in the same room with other units of this type. No trace of cross-feed between receivers is experienced in this equipment as it is built and installed.

The tendency of a tuned radio-frequency amplifier to oscillate of its own accord depends upon the amount of feed-back present and upon the gain of the unit. When it is attempted to obtain a voltage gain of much over 15 from control grid to plate, at a frequency of 20,000 kc it is found that feed-back through the tubes themselves is the limiting

factor. If the shunt impedance of the tuned circuits is made high enough to obtain such a voltage gain, it becomes appreciable as compared to the reactance of the plate to control grid capacitance. The voltage across the preceding tuned circuits, due to this feed-back, can easily become sufficiently great to maintain the unit in a state of oscillation. This feed-back action is easily demonstrated by tuning the circuits to exact resonance with a test signal and then feeding the signal backward through the amplifier. It will be found that the signal strength obtained at the "input" terminals is extremely critical to very slight changes in the tuning of the circuits and that removing a control-grid connection from one tube reduces the feed-back to practically zero.

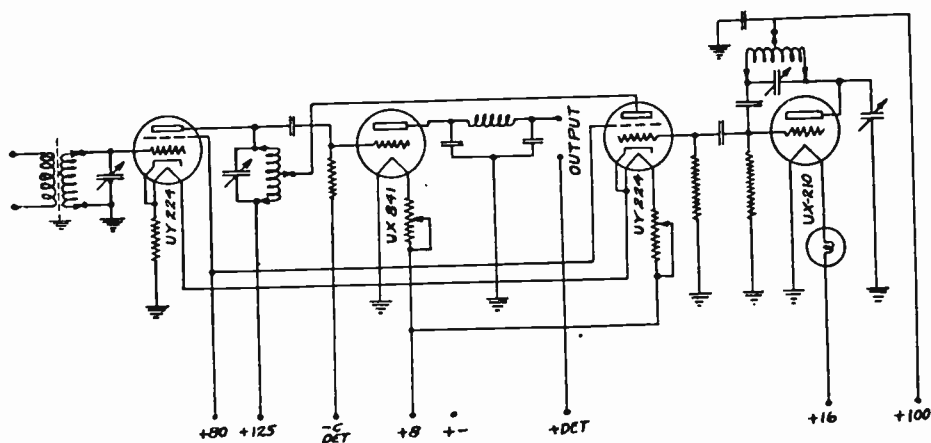

Fig. 7.—Schematic circuit diagram of heterodyne tuner unit.

### Heterodyne-Detector Unit

A schematic circuit diagram of this unit is given in Fig. 7, and a photograph is shown in Fig. 8. It comprises a grid-bias detector, two screen-grid coupling tubes and a high-frequency oscillator. One coupling tube amplifies the signal from the radio-frequency amplifier unit and feeds it to the detector grid. The other feeds voltage from the oscillator to the detector grid. This arrangement prevents the oscillator frequency from being affected either by strong signals or by tuning of the preceding radio-frequency stages. This makes the oscillator adjustment, and beat frequency, independent of any other tuning or gain adjustments in the receiver. From an operating standpoint this feature is a distinct advantage.

Shielding and battery supply filters are not shown in the simplified circuit diagram. These two matters, however, have received as careful consideration as in the case of the radio-frequency amplifier.

Frequency stability of the radio-frequency oscillator, while not of quite so great importance as in the case of a transmitter, should be as

good as can be attained practically. The more stable both transmitters and receiver are, in this respect, the less attention will the receiver require from the operating staff in order to keep the signal properly centered in the pass band of the intermediate-frequency amplifier. To protect the oscillator against changes in the voltage of the floating filament batteries a series ballast lamp is used. Plate supply is obtained from a discharging storage battery; two such batteries being operated on a charge and discharge basis. The only other variable factor having an appreciable effect on the frequency is temperature. Once the receiver is warmed up such slow drift as is caused by temperature

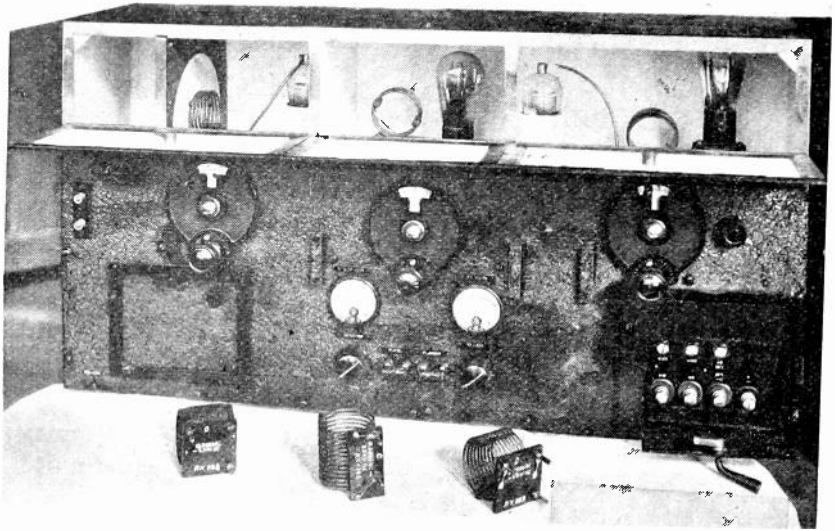

Fig. 8.—Photograph of heterodyne tuner unit.

changes is easily taken care of by the normal attention given the equipment.

The detector output goes through a low-pass filter, and then through shielded leads, to the input of the intermediate-frequency amplifier unit. Stray radio-frequency feed from this point in the circuit is thereby eliminated.

The over-all selectivity of the radio-frequency tunings of the amplifier and detector units is such that, with an intermediate frequency of 100 kc the image signal at a carrier frequency of 15,000 kc is cut down by more than 200 to 1 in voltage (46 db) as compared to the desired signal.

#### *Intermediate-Frequency Amplifier*

A schematic circuit diagram of this unit is given in Fig. 9 and a photograph is shown in Fig. 10. It will be seen to comprise an input

coupling tube feeding the band-pass filter and two stages of broadly tuned amplification, using screen-grid tubes, followed by the second detector. In parallel with the second stage is another screen-grid tube which serves as a coupling tube to supply an intermediate-frequency

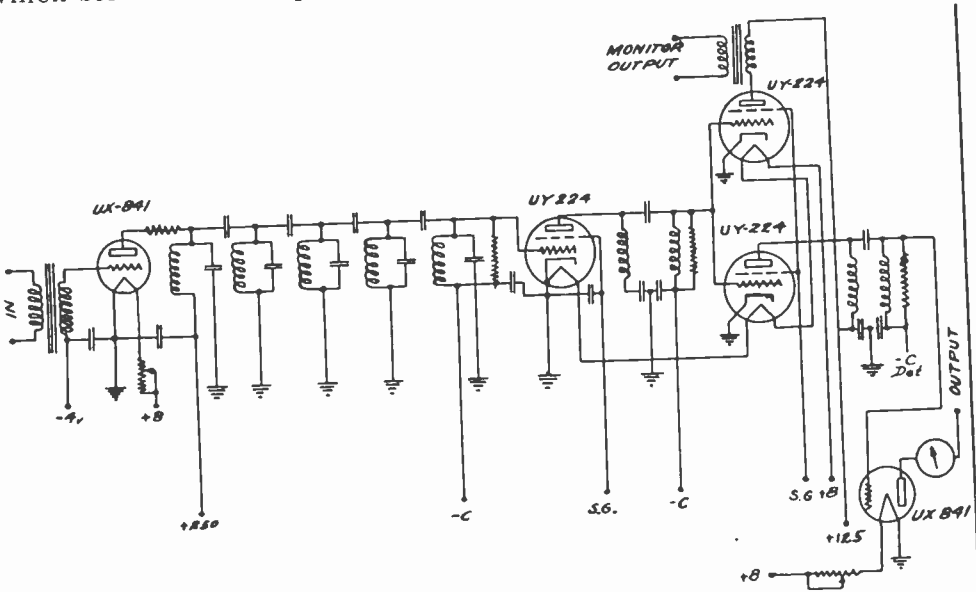

Fig. 9.—Schematic circuit diagram of intermediate-frequency amplifier.

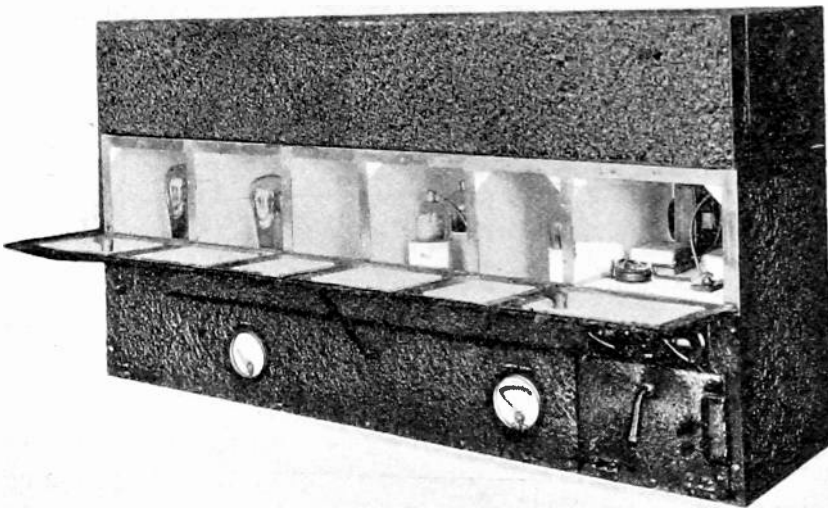

Fig. 10.—Photograph of intermediate-frequency amplifier-detector unit.

signal to the monitoring system. Input, and monitor output, leads are twisted pair shielded to prevent stray pick-up. Before leaving the unit the rectified output goes through a low-pass filter to prevent intermediate-frequency cross-talk between receivers.

The main filter is a four-section one of the band-pass type having three elements per section. This is fed from, and terminated by, a resistance somewhat greater than the nominal mid-band impedance of the filter. The object of this is to obtain some reflection loss around the middle of the pass band and at the same time to obtain a better impedance fit toward the edges of the band. The net result is to flatten out the top of the frequency characteristic. This simple type of mid-shunt equivalent section, with mid-shunt terminations, is admittedly

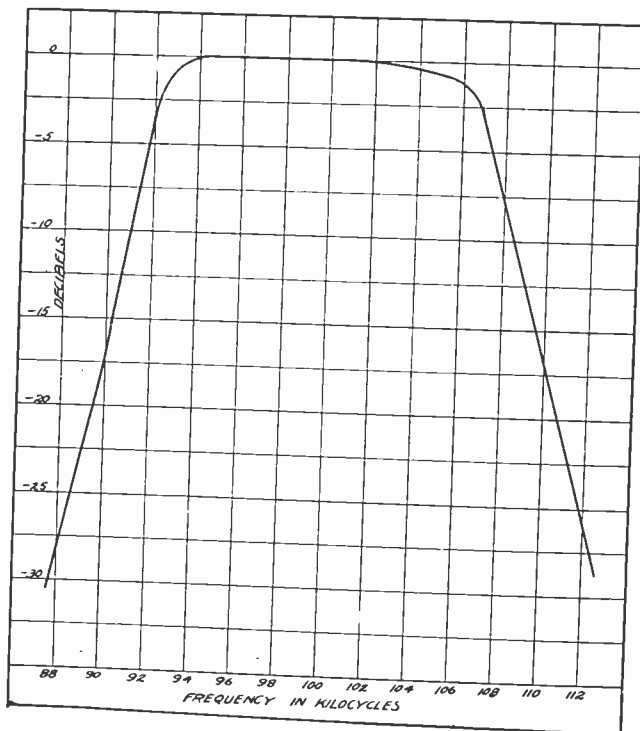

Fig. 11.—Frequency characteristic of intermediate-frequency amplifier.

not the best for obtaining a flat-topped and steep-sided frequency characteristic. It has been chosen, though, for simplicity of manufacture and economy of space. It also simplifies getting plate supply and bias to the input and output tubes, respectively.

Placing all the selectivity at one point ahead of the screen-grid amplifier stages has two advantages. It minimizes the chance of a strong signal, which may be just outside of the band, overloading the early stages; and it also allows the filter to be built up in a single, interchangeable unit. This feature has several advantages. It simplifies manufacture and test; permits of easy replacement of a defective unit and makes it possible to use filter units of the same mid-band frequency but different band widths. In practice the filter unit is bolted on top of the amplifier proper, with input and output leads drop-

ping down through holes provided for them, as shown in Fig. 10. The complete assembly makes a standard 16×30-inch unit which matches the other equipment.

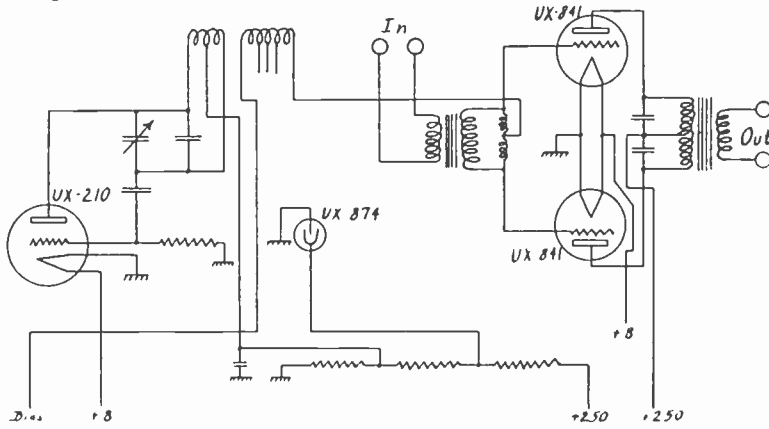

Fig. 12.—Schematic circuit of 100-kc monitor unit.

An over-all frequency characteristic of this amplifier is shown in Fig. 11. The response is practically uniform over a total band of from 12 to 14 kc and is down 30 db at a total width of something less than

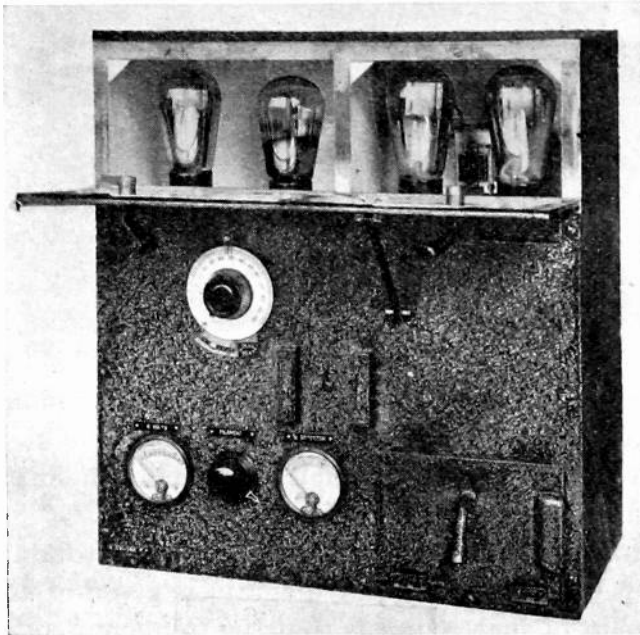

Fig. 13.—Photograph of 100-kc monitor unit.

26 kc. The equipment was designed, primarily, to give high quality broadcast service. The additional width is to allow for variations and drift of the frequency of both transmitter and receiver oscillators. For

special services this band width can be cut down considerably by merely replacing the intermediate-frequency filter unit with a narrower one.

Manual volume control is provided in the form of a potentiometer for screen-grid supply. Shielding and filtering protect the unit from stray pick-up of any sort.

#### *Monitor System*

Fig. 13 is a photograph of the monitor unit. The monitor output from each of the three intermediate-frequency amplifiers is run in shielded twisted pair to a shielded switch compartment on the control

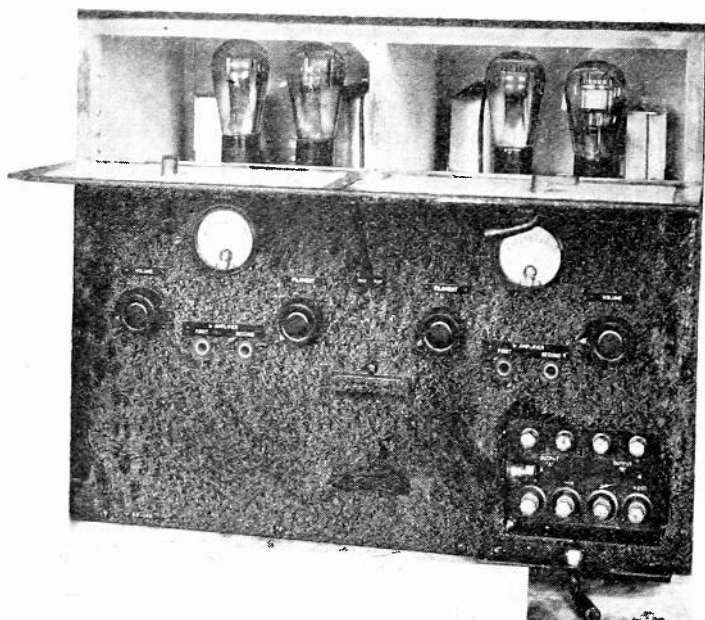

Fig. 14.—Photograph of duplex audio-amplifier unit.

panel. Here any amplifier can be switched on to the monitor unit input, and the audio-frequency beat output is available at jacks on the control panel. The necessity for such a method of monitoring has already been stated.

The monitor unit itself comprises a 100-kc oscillator and a balanced demodulator. A schematic circuit diagram is given in Fig. 12. The chief requirement of such a unit is that the frequency of the oscillator remains constant within something less than 1 per cent regardless of changes in supply voltage and temperature. The latter has necessitated the use of a special mica condenser, in the oscillator circuit, which has a low temperature coefficient of capacity.

#### *Audio Amplifier*

Fig. 14 is a photograph of the duplex audio-amplifier unit. Each

amplifier in the duplex audio unit comprises a two-stage amplifier and a circuit for combining the outputs of the three receivers and obtaining automatic bias for the radio-frequency amplifier units. The amplifier proper is a conventional high quality audio amplifier utilizing resistance coupling between the two stages, and input and output transformers. A constant impedance input potentiometer provides smooth control of the output level. The circuit for combining, and obtaining automatic bias, is shown in simplified form on the general diagram of Fig. 1. By making the resistance in series with the condenser some fifty times as large as that across which this time circuit is shunted, the

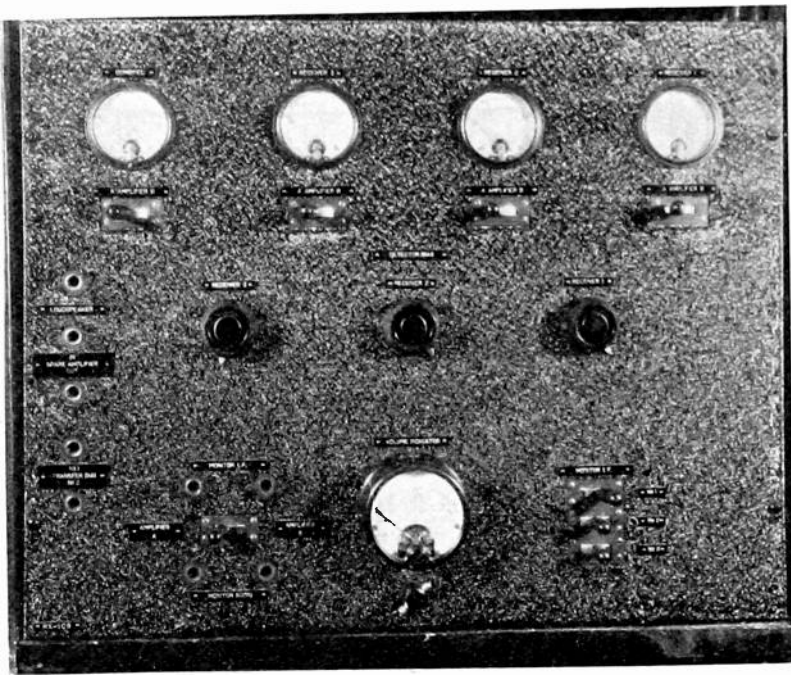

Fig. 15.—Diversity control panel.

effect of this circuit on the audio-frequency characteristic of the unit is negligible. A frequency characteristic of the unit is shown in Fig. 16, curve *a*. The voltage gain of the amplifier proper, from input to a 600-ohm load, is about 20 to 1 or 26 db. It is never necessary to use the full gain to supply normal zero level to a program or telephone line.

#### *Battery Box*

The two separate batteries of 180 volts each that are indicated on the general drawing, Fig. 1, are housed in the battery box shown on the rack arrangement drawing of Fig. 2. These are plate-supply batteries for the second detectors; one being associated with each combining circuit and audio amplifier. As they are at a high audio-frequency



voltage above the ground, the box is arranged to reduce stray capacity between the batteries and case to a minimum.

### Control Panel

This unit is located in the end bay of the rack, as shown in Figs. 2 and 3, at a convenient height. Fig. 15 is a photograph of this unit. From an operating standpoint this is the center of the equipment; all switching and monitoring being done here. On this panel are meters for indicating the plate current of each second detector, and the com-

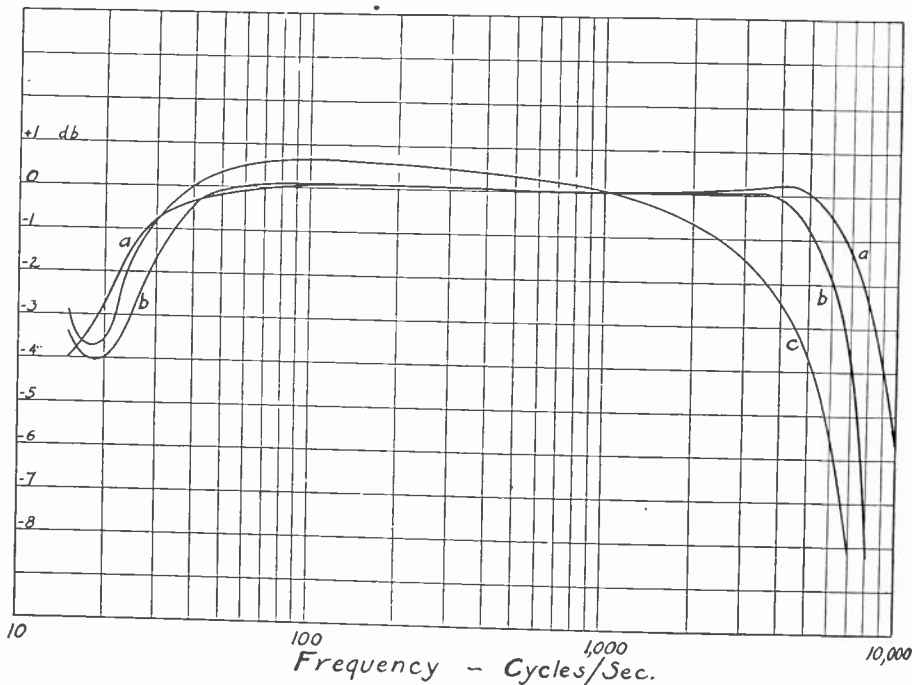

Fig. 16.—Audio-frequency characteristics. Curve *a*, audio amplifier; curve *b*, over-all fidelity of one receiver; curve *c*, over-all fidelity of three receivers and combining circuits.

bined current. Below each meter is a key switch which connects the detector output (and meter) on to either the *A* or *B* audio amplifier, at the same time putting automatic bias from the proper unit on to the radio-frequency amplifier of the set in question. A similar switch connects the totaling meter into either the *A* or *B* combining circuit. Three potentiometers supply bias for the second detectors. Here also are the shielded intermediate-frequency monitor switches and jacks for monitoring either at intermediate-frequency or audio-frequency; the latter being on a key switch for checking either the *A* or *B* amplifier. Due to the arrangement of the second detector output wiring, no cross-talk is heard when both *A* and *B* units are operated at normal output.

The individual output meters show at a glance if the receivers are properly adjusted so that each predominates about the same percentage of the time. For studying transmission of short-wave phone signals the individual meters and totaling meter provide a convenient means for observing rapidity, depth, and diversity of fading.

### *General Characteristics*

Frequency characteristics of the equipment are shown in Fig. 16 where curve (a) is for the audio amplifier alone; curve (b) is the over-all characteristic of one receiver; and curve (c) gives the over-all fidelity of one, two, or three receivers as used in the diversity equipment. Taking 1000 cycles as a reference point the response is down 2 db at 25 cycles and at 3500 cycles, while at 5000 cycles it is down by a little less than 4 db. The reduction of output at high modulation frequencies is due both to the selectivity of the intermediate-frequency amplifier and to the fact that the low-pass output filters of the several intermediate-frequency amplifiers feed in parallel to a common terminating resistance. In the commercial equipment the audio-frequency amplifier will have a slightly rising frequency characteristic which will hold the over-all fidelity more uniform than that shown. The over-all selectivity of the receivers is given by that of the intermediate-frequency amplifier. This is shown in Fig. 11. Some idea of the sensitivity of the equipment can be obtained from the automatic volume control characteristics of Fig. 6.

An audio output of 3 volts across 600 ohms is easily maintained, with normal percentage modulation, over the range of input signal shown. Set noise is, of course, the limiting factor at low values of input. With a negligible outside noise level, a total signal input to the receiver of 4 or 5 microvolts is sufficient to give a commercially usable signal-to-noise ratio. On actual signals, and under average conditions, a minimum signal input of about 10 microvolts is required for satisfactory service. Weaker signals can, of course, be used but the background of noise is then rather high for commercial service.

### *Speech Equipment*

Brief mention might be made, here, of the equipment used between the diversity receiving units and the telephone line to the central telephone exchange or broadcast control room. This is standard speech input equipment, such as used in broadcast systems, modified to suit the needs of the particular installation. Fig. 17 gives an idea of the equipment required, and the general scheme of arrangement. The equipment shown is mounted on a two-bay standard relay rack, with operating shelf. The use of line coupling tubes having a 1-to-1 voltage

gain, and a high impedance input circuit, allows one or more lines to be supplied without affecting the output level. Microphone equipment is for making local announcements and for general service communication.

### Forecasting

In arranging for the rebroadcasting of foreign programs it is highly desirable, and often necessary, to be able to know about what transmission conditions will be on a particular day perhaps three weeks or

3 STAGE MICROPHONE AMPLIFIER	BATTERY FILTER PANEL
	METER PANEL
	MICROPHONE CONTROL PANEL
VOLUME INDICATOR	VOLUME INDICATOR
LINE COUPLING TUBE AMPLIFIER	LINE COUPLING TUBE AMPLIFIER
BATTERY SUPPLY FILTER PANEL	BATTERY SUPPLY FILTER PANEL
JACK PANEL	JACK PANEL
BLANK PANEL	BLANK PANEL

Fig. 17.—Rack arrangement of "speech input" equipment for supplying signals to one or two telephone lines.

more in advance. With this in mind, engineers of the National Broadcasting Company have used reception reports from both United States and European receiving points in carrying on a study of the general question. As the result of their correlation work, there has been developed a method of forecasting with reasonable accuracy what days will be suitable or unsuitable for successful rebroadcasting of a particular signal.

### General Operation and Results

Comparisons have been made between results obtained with one, two, and three receivers, both with and without automatic volume control. Except when transmission conditions are very stable, the use of three receivers with automatic volume control has been found to give results which are sufficiently better to warrant the additional cost

of the equipment. As fading becomes either deeper or more rapid, the benefit obtained from proper utilization of the "diversity" principle increases. There are times when the use of three receivers gives fair quality and intelligibility on an otherwise unintelligible signal. This

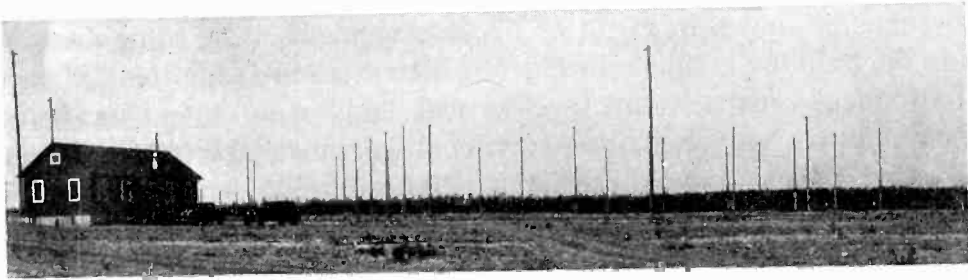

Fig. 18.—Rebroadcast building at Riverhead where rebroadcast programs are picked up, showing north group of antennas in the background.



Fig. 19.—General view of racks in rebroadcast building.

condition is often obtained when rapid and selective fading are being experienced. On deep fading of moderate rapidity the improvement is due to the absence of the characteristic "rushing" noise which is obtained with a single receiver utilizing automatic volume control.

The experimental equipment at Riverhead, Long Island, with which this development work has been carried on has been used for supplying short-wave European broadcast signals to the National Broadcasting Company's networks for rebroadcasting in this country. A general view of the building, and one of the three groups of directive antennas, is shown in Fig. 18. The arrangement of the equipment inside the building is shown in Fig. 19. The racks are experimental ones of wooden construction, the vertical supporting members being sheathed with copper. Three experimental diversity receiving units are installed, the other two racks being used for development work. At the end of the room will be seen one of the monitoring loud speakers, while in the foreground a part of the control table appears.

Programs for which the signal was supplied by this equipment include events such as the London Naval Conference, musical programs and speeches from England, Germany, and Holland, two-way conversation with Rear Admiral Byrd in New Zealand, and two-way conversation with Senatore Marconi on his yacht in Italian waters. This type of receiving equipment will also be used at the Hawaiian end of the San Francisco-Honolulu telephone circuit which is expected to be in commercial operation within a year.

#### *Acknowledgment*

It is desired to acknowledge the assistance of George Rodwin, Benjamin Adler, Elmer F. Bond, and S. H. Simpson in the development of these facilities.

Acknowledgment is also due C. H. Taylor whose guidance and support made it possible to carry on the work to its present state.



## A RADIO BEACON AND RECEIVING SYSTEM FOR BLIND LANDING OF AIRCRAFT\*

BY

H. DIAMOND AND F. W. DUNMORE

(Bureau of Standards, Washington, D. C.)

**Summary**—A radio beacon and receiving system is described for use at airports to permit the blind landing of aircraft under conditions of no visibility. The system comprises three elements to indicate to the pilot the position of the aircraft as it approaches and reaches the instant of landing. Lateral position (that is, landing field runway direction) is given by a small directive beacon of the same type as employed for guidance on the airways, differing only in the use of smaller loop antennas and lower power. Longitudinal position along the runway (that is, approach) is given by a marker beacon. Height is given by an inclined ultra-high-frequency radio beam, used in such a way as to provide a very convenient gliding path for the landing airplane, free of all danger from obstructions.

The same medium-frequency receiving set required for obtaining radiotelephone and radio range beacon service on the airways is utilized for receiving the runway localizing and marker beacon signals. The course indications of the runway localizing beacon are observed on the same vibrating reed indicator as employed on the main radio range beacon, automatic control of receiving set sensitivity being provided to maintain substantially constant reed deflections regardless of the distance between airplane and transmitting station. The marker beacon indications are received aurally. A special high-frequency receiving set is required to receive the landing beam signals. The rectified output current of this set is passed through a d-c microammeter mounted on the instrument board. By keeping the deflection of this microammeter at a fixed value, the pilot directs the airplane along the curved path coinciding with the line of equal intensity of received signal below the axis of the beam. The relative position of the airplane with respect to this convenient landing path is indicated by the rise or fall of the microammeter deflection above the fixed value.

### I. INTRODUCTION

THIS paper describes the research on a radio system for the blind landing of aircraft carried on in the Research Division of the Aeronautics Branch of the Department of Commerce at the National Bureau of Standards, during 1928 to 1930.

The object of the research was to provide a simple and effective radio system which, when combined with the usual navigational instruments, would permit the safe landing of aircraft in fog or any condition of visibility or no visibility. This system was to be adaptable for use in conjunction with the radio navigational aids being provided for point-to-point flying on the civil airways of the United States. In ac-

\* Decimal classification: R526.30. Original manuscript received by the Institute, August 27, 1930. Published by permission of the Director of the Bureau of Standards of the U. S. Department of Commerce.

cordance with the practice already adopted in the development of the navigational aids for the civil airways, all the complicated and expensive parts of the system were to be used on the ground, the equipment required on the aircraft being kept as simple as possible.

The system developed fulfills these requirements. The pilot receives the desired information with a minimum of effort on his part. The additional equipment required on the aircraft (for use of the blind landing aids) is very simple, weighing approximately fifteen pounds.

### 1. The Need for this Development.

The practicability of the use of directional radio as an aid to point-to-point flying has been demonstrated by nearly two years of service given by the radio range beacon system on the fixed airways. By means of this system<sup>1</sup> the pilot can keep accurately on his course, know approximately the points he is flying over, and proceed unerringly to his destination. Scheduled air transport operation is thus immeasurably aided; many flights are made which could not possibly be made without the use of radio direction facilities. Nevertheless, interruption of scheduled flying is still the rule whenever the landing field lies in an area completely enclosed by fog. The results secured by the development of instrument flying and radio navigational aids are then nullified through the lack of means for safe landing at the desired destination, under conditions of poor visibility. The system of radio aids to blind landing described in this paper removes this last great hazard to the reliability of airplane travel, and insures the rigorous maintenance of scheduled flying by day or night.

### 2. Previous Work.

The present development differs from much of the earlier work in this field in its emphasis on directional radio transmission, thereby simplifying the receiving installation on the airplane. A system of blind landing aids must, in general, indicate to the pilot the position of the aircraft in three dimensions as it approaches and reaches the instant of landing. In practically all previous experimentation this problem has been resolved into two separate problems; namely, field localizing and means for securing suitable height indication.

a. *Field Localizers.* The arrangement usually adopted for field localizing has involved the use of "leader cables." Typical installations

<sup>1</sup> J. H. Dellinger, and H. Pratt, "Development of radio aids to air navigation," *Proc. I.R.E.*, 16, 890; July, 1928; H. J. Walls, "The civil airways and their radio facilities," *Proc. I.R.E.*, 17, 2141; December, 1929; J. H. Dellinger, H. Diamond, and F. W. Dunmore, "Development of the visual type radiobeacon system," *Bureau of Standards Jour. of Research*, March, 1930, research paper No. 159; *Proc. I.R.E.*, 18, 796; May, 1930.

are those of the British government at Farnborough<sup>2</sup> and of the French government at Chartres. The British installation employs a complete circuit around the landing field with a visual indicating device on the airplane instrument board. The French installation uses straight cables. The Loth Company of Paris, and several agencies in this country, including the United States Air Corps at Wright Field, Dayton, Ohio, and the Ford Motor Company at Detroit, Michigan, are experimenting with various arrangements employing leader cables.

An obvious disadvantage of the leader cable method of field localizing is its great cost. This method generally involves the burying of cables outside the limits of the landing field, thereby introducing the expense of securing right-of-way, in addition to the actual cost of equipment and installation.

*b. Landing Altimeters.* In several of the leader cable systems, the diminution of intensity of the magnetic field surrounding the cable for increasing distance from the cable is utilized for securing altitude indication. Theoretically, the intensity of the magnetic field varies inversely as the height above the cable. A suitable instrument on the airplane used for measuring the magnetic field intensity, may therefore be calibrated directly in height above ground. Even under optimum operating conditions close equality of the magnetic field intensities at different installations, and practically no distortion of the shape of the magnetic field is required, in order that this instrument have the same calibration for all landing fields.

The problem of securing reliable altitude indication, particularly during the last few hundred feet above the ground, is a difficult one. The barometric altimeter, in common use on aircraft, is inadequate for the purpose since it indicates primarily air pressure and not height above the ground.

Experiments are being undertaken by a number of organizations looking toward the development by several means of altimeters indicating the absolute height above the ground. One is the development of a sonic altimeter.<sup>3</sup> The time taken by sound to reach the ground and return to the airplane is measured. Knowing the velocity of sound, the height of the airplane above ground may be determined. Another device is the capacity altimeter<sup>4</sup> which measures the distance from the ground by detecting the change in the electrical capacity between two plates on the airplane, as the airplane approaches the ground. A third

<sup>2</sup> H. Cooch, *Jour. Royal Aeronautical Society*, 30, 365; 1926.

<sup>3</sup> A. Behm, "Das Behmloch und seine Entwicklung als akustischer Höhenmesser für Luftfahrzeuge," *Jahrbuch der Wissenschaftlichen Gesellschaft für Luftfahrt*, 13, 56; May, 1926.

<sup>4</sup> L. A. Hyland, "True altitude meters," *Aviation*, 25, 1322; October 27, 1928.



method is by the use of direct reflection with radio waves.<sup>5</sup> It is doubtful at the present time whether any of these instruments will be sufficiently sensitive or accurate for making normal landings in dense fog. These instruments, when available, will, however, be exceedingly valuable in maintaining a safe altitude during point-to-point flying, and may prove of some service during landing operations, as will appear below.

## II. RADIO SYSTEM OF BLIND LANDING AIDS—FIRST ARRANGEMENT

The success obtained with the radio range beacon system in its application to point-to-point flying early suggested its possibilities as a field localizer. With the main beacon used for guiding an airplane to a given landing field, a low power beacon with small loop antennas could be employed for marking out the major, or any desirable axis of the landing field. A low power marker beacon could then be used for defining the hazard-free approach to the field (along the axis or runway selected), and for indicating the longitudinal position of the aircraft along that runway. This system offered two outstanding advantages: (1) the same equipment required on the airplane for utilizing the radio navigational aids on the fixed airways was sufficient for the reception of the signals from the runway localizing beacon and marker beacons; (2) the ground equipment was comparatively simple and inexpensive, a transmitter of moderate power for the runway localizing beacon being adequate for marking out a course for a distance range of approximately fifteen miles. The marker beacon power requirements were also very small. In addition, all apparatus could be kept within the confines of the airport.

### 1. Installation at College Park, Maryland.

The Bureau accordingly began the installation of a system of this type at College Park, Maryland, in order to test its practicability. A series of flight tests demonstrated its complete feasibility for landing field localization. The problem of altitude indication still required solution at the time of these early tests.

Fig. 1 illustrates the layout of the ground transmitting equipment in this radio system for field localization. The 2-kw directive radio beacon, with large loop antennas, shown at *A*, is the main radio range beacon of the type provided by the United States Department of Commerce for point-to-point flying on the fixed airways. This beacon is normally located just off the airport (so that the loop antennas may

<sup>5</sup> E. F. W. Alexanderson, "Height of airplane above ground by radio echo," *Radio Engineering*, 9, 34-35; February, 1929.

not constitute an obstruction to flying), and serves to direct an incoming airplane to the vicinity of the airport. Utilizing the zero-signal zone directly over the beacon tower, it is possible to locate this beacon to within 100-1000 feet, depending upon the altitude of the airplane. The drop to zero vibration amplitude of the reeds on his course indicator therefore gives the pilot his exact location with respect to the landing field and also with respect to the course radiated by the low power (200-watt) runway localizing beacon *B*. The localizing beacon, using small loop antennas so that it may be located at one edge of the landing field without constituting an obstruction, directs a course along the major axis of the field. It operates on a radio frequency separated

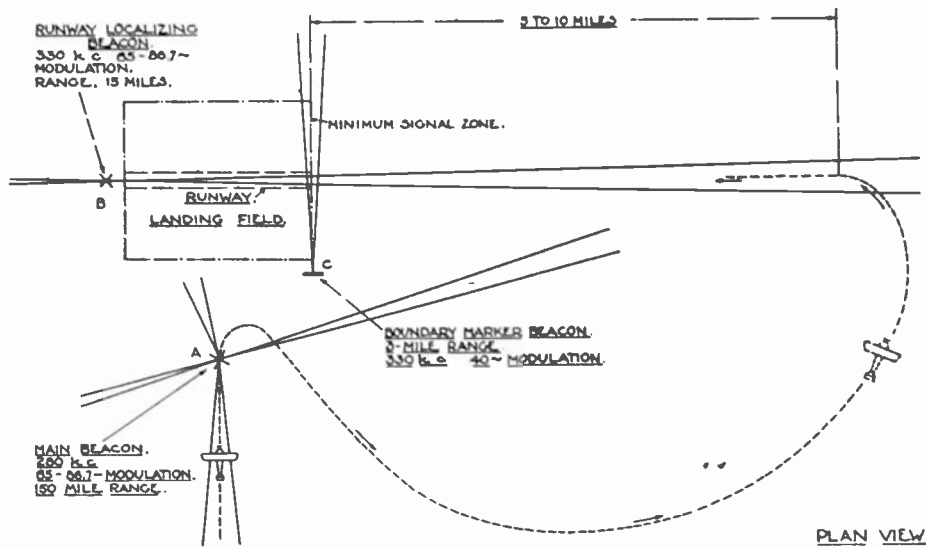

Fig. 1—Layout of ground transmitting equipment for radio system of field localization.

by 50 to 60 kilocycles from that of the main beacon *A*, thereby preventing interference from the main beacon.

Upon receiving the zero-signal indication when directly over the tower of the main beacon, the pilot retunes his receiving set to the frequency of the localizing beacon and through the use of his compass and knowledge of the geography of the field, orients himself along the major axis of the field. The course indications received on the reed indicator greatly facilitate this maneuver. When crossing the boundary of the landing field a signal from the marker beacon *C*, operating on the same radio frequency as the localizing beacon *B*, is obtained.

Summarizing, the complete system provides course and position indication by means of the main beacon *A*, landing field runway direction by means of the localizing beacon *B*, and longitudinal position (that is, approach) along the runway by means of the marker beacon

C. On the airplane a simple receiving set is sufficient to receive all these indications. If accurate indications of the absolute height of the airplane above ground could have been secured in the early tests, the complete information necessary for the blind landing of aircraft (in addition to that obtained from the flight instruments) would have become available.

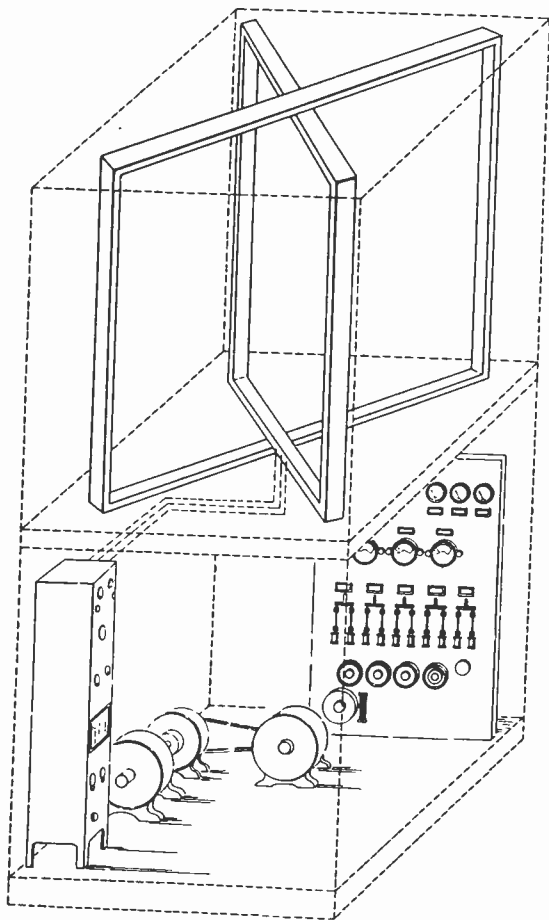

Fig. 2—Runway localizing beacon set-up, showing location of loop antennas, transmitting set and power equipment.

a. *Runway Localizing Beacon.* In the installation at College Park, the main beacon A and the localizing beacon B were of the visual type, the essential difference between the two being the number of beacon courses radiated, the power ratings of the final amplifying stages, and the dimensions of the loop antennas. A description of the visual type beacon is given in the third paper of reference (1). This publication gives full details of the transmitting system for the main radio range beacon. Some idea of the set-up required for the localizing beacon may be had from the three-dimensional view given in Fig. 2. Two loop an-

tennas, crossed at 90 degrees carry currents of the same carrier frequency but modulated to different low frequencies, 65 and 86.7 cycles, respectively. These antennas are so oriented that the vertical plane containing the major axis of the landing field bisects the angle between the two antennas. An airplane flying in this plane therefore receives equal signals from the antennas. On either side of this plane the signal received from one antenna is greater than from the other. On the airplane a visual indicating instrument is employed,<sup>6</sup> consisting of two vibrating reeds mechanically tuned to the two modulation frequencies of the beacon and actuated by small electromagnets connected in the

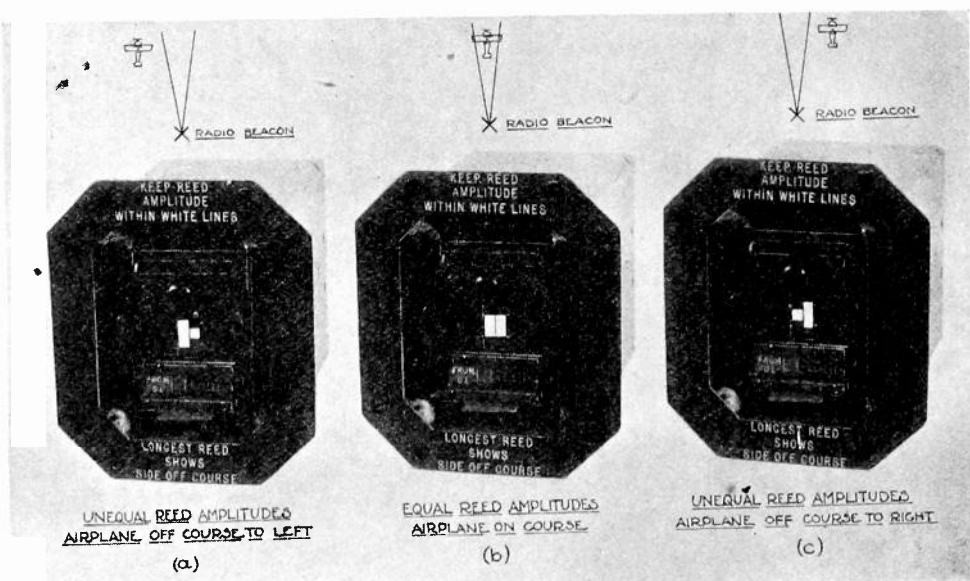

Fig. 3—Course indications as received on vibrating reed course indicator.

output circuit of the receiving set employed. When the beacon signals are received, the two reeds vibrate, comparison of their relative amplitudes of vibration serving to indicate the relative amount of signal received from the two loop antennas. On course (i.e., along the plane bisecting the angle between the two antennas) the reed vibration amplitudes are equal. Off the course they are unequal, the reed vibrating with the greater amplitude being on the side to which the airplane has deviated. Fig. 3 illustrates how the reed indications appear to the pilot, (a) when off the course to the left, (b) when on the course, and (c) when off the course to the right.

By adjusting the time phase displacement between the carrier currents in the two loop antennas, the number of courses provided by the

<sup>6</sup> F. W. Dunmore, "Design of tuned reed course indicators for aircraft radio beacon," *Bureau of Standards Jour. of Research*, 1, No. 5, November, 1928. RP28.

beacon may be made either two or four. The four-course arrangement is more convenient for use on the long range beacons on the fixed airways. The two-course adjustment is, however, more desirable for the localizing beacon, since in coming in for a landing the presence of the courses at right angles to the runway might prove confusing. A polar diagram corresponding to this adjustment, showing the relative deflections of the two reeds comprising the course indicator as a function of angular deviation from the beacon course, is given in Fig. 4.

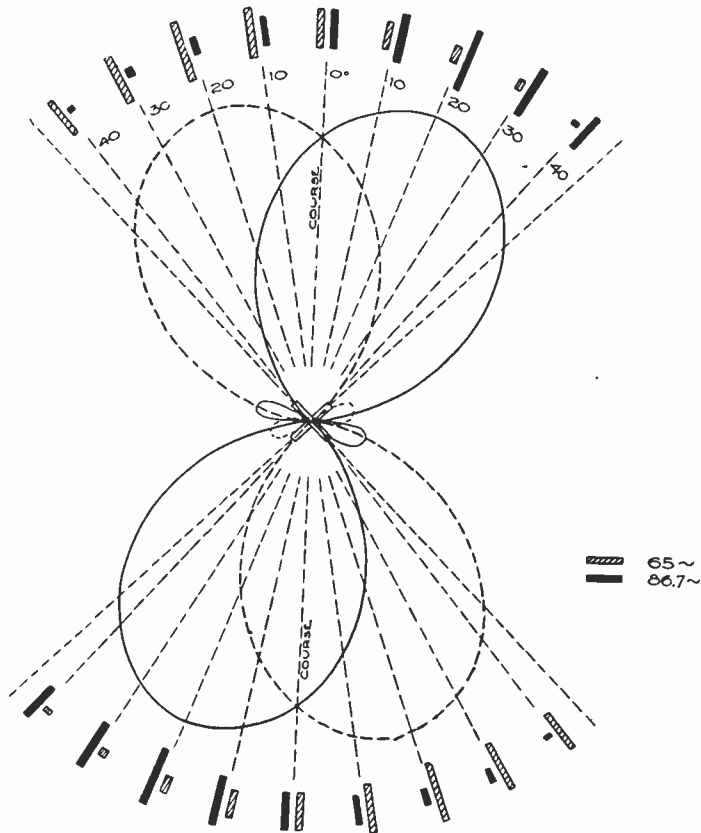

Fig. 4—Polar diagram showing relative reed deflections as a function of angular deviation from the runway localizing beacon course.

*b. Boundary Marker Beacon.* The marker beacon *C* consisted of a 50-watt transmitter feeding a loop antenna, oriented as shown in Fig. 1. Modulation of the radiated wave to the desired frequency, 40 cycles per second, was obtained by supplying the transmitting tube with a plate voltage of 40-cycle frequency. On the airplane a 40-cycle reed indicator, Fig. 5, connected in series with the main course indicator, was employed. The landing field boundary line was thus defined by a zero-signal zone, two or three degrees wide. The pilot observed an increasing deflection of the marker beacon reed as he approached the

edge of the landing field, a decrease to zero deflection as he passed over the boundary line, then an increasing deflection as he came within the landing field area.

## 2. Demonstrations by Guggenheim Fund.

The practicability of the system of field localization outlined above, in application to actual blind landings, was demonstrated by Lieutenant J. H. Doolittle of the Daniel Guggenheim Fund for the Promo-

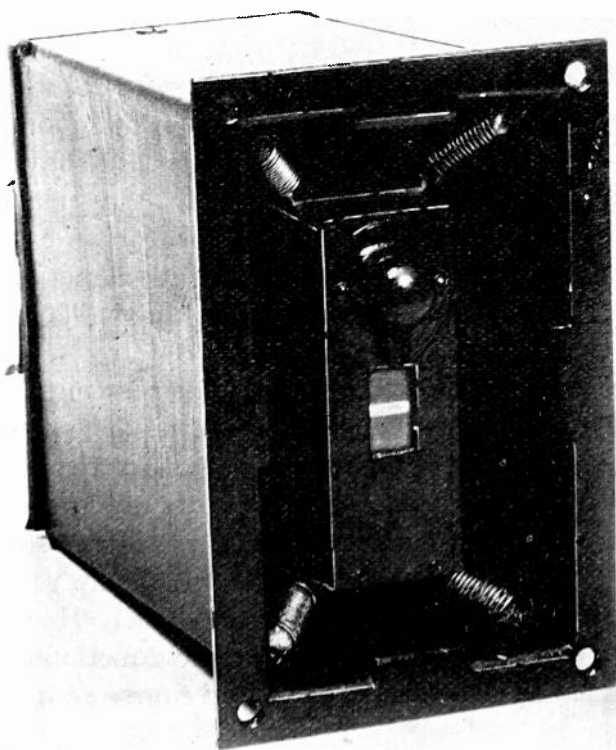

Fig. 5—Marker beacon reed indicator. Reed tuned to 40 cycles.

tion of Aeronautics, in tests carried on at Mitchell Field, Long Island, during July to December, 1929. During the latter part of 1928, the Guggenheim Fund conducted an extensive survey of methods likely to lead to the solution of the problem of landing in fog. The Bureau of Standards submitted a report to the Guggenheim Fund outlining essentially the system described above, and volunteered to make an installation at Mitchell Field similar to the one already under way at College Park. Arrangements for this cooperation were made in January, 1929, the Bureau agreeing to install a runway localizing beacon and a

suitable marker beacon. An aural type beacon, installed by the United States Air Corps, was to serve as the main directive radio beacon.

The installation was completed in July, 1929, and was a material factor in enabling Lieutenant Doolittle, seated in a completely enclosed cockpit, to take off, circle the field, and make a satisfactory landing. A brief description<sup>7</sup> of the method of landing employed is considered of value here, particularly to serve as a basis of requirements for a blind landing system and also as a comparison with the improved system of radio landing aids more recently developed by the Bureau of Standards at College Park, Maryland, and described in section III below.

*a. Special Navigation Instruments—Altitude Indication.* In addition to the means for receiving the directional radio aids outlined, the airplane was equipped with standard engine and navigation instruments, including tachometer, compass, bank-and-turn indicator, air-speed indicator, altimeter, rate-of-climb indicator, and three special instruments,—an artificial horizon instrument, a directional gyroscope, and a sensitive barometric altimeter with a range of 20,000 feet graduated in ten-foot intervals.

The artificial horizon instrument gave at all times the altitude of the airplane with respect to the true horizon. The directional gyroscope was employed to maintain a steady course or to change the course by any desired amount. Lieutenant Doolittle used this instrument as an aid to flying on the localizing beacon course. He observed a natural tendency, when the beacon course narrowed, to fly a zig-zag course, first on one side of the beam and then on the other. He was better able to approximate a straight line by utilizing the directional gyroscope for making the necessary slight changes in the course as indicated by the reed indicator.

The sensitive altimeter was designed to secure height indications of the maximum possible accuracy. Provision was made for adjustment of the altimeter in the air, for any apparent change in ground altitude due to a change in barometric pressure, in accordance with information secured through two-way radio communication with the ground. In spite of these precautions, careful tests on the instrument indicated that a probable error of the order of thirty to forty feet in reading absolute height above the ground was still obtained. The procedure of landing, therefore, resolved itself into maneuvering the airplane into

<sup>7</sup> A complete description is given in the following two pamphlets issued by the Daniel Guggenheim Fund for the Promotion of Aeronautics: (1) Solving the problem of fog flying, 52-page pamphlet, October 9, 1929; (2) Equipment used in experiments to solve the problem of fog flying, 57-page pamphlet, March, 1930.

a glide from a position in space of fixed bearing and altitude with respect to the landing field. The glide continued until contact with the earth was made, the oleo landing gear taking up the shock of contact. The lack of knowledge of the absolute height to the necessary accuracy prevented the usual "flattening-out" in landing.

The lessons learned from these demonstrations were many. Perhaps the most important was that the problem of securing suitable indications of the true height above ground still required attention. The need for two-way communication with the ground in order to correct the altimeter to the proper barometric pressure seemed excessive. In addition, the absolute height could not be determined to the proper accuracy. When developed, it is probable that one of the absolute type

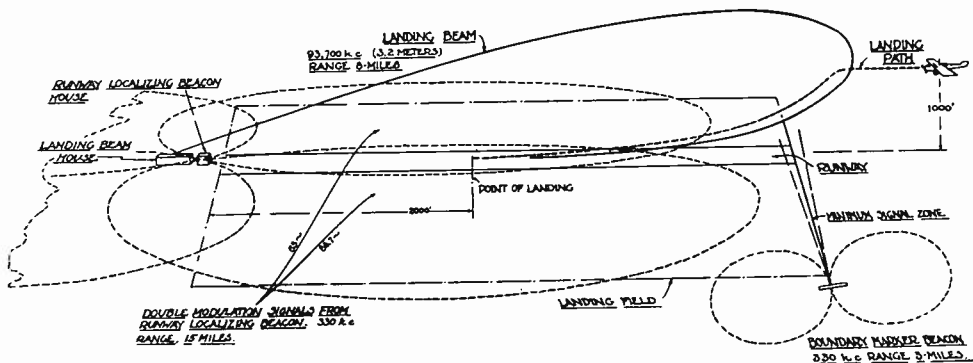

Fig. 6—Three-dimensional view showing improved radio system of blind landing aids.

altimeters, described in section I above, would be preferable to the sensitive barometric altimeter for determining the altitude from which the glide should be started. The accuracy of height indication would probably be increased thereby, and the need for two-way communication with the ground obviated.

### III. RADIO SYSTEM OF BLIND LANDING AIDS— IMPROVED ARRANGEMENT

Meanwhile, in the experiments carried on at College Park, the Bureau of Standards continued to work on improvements to the radio system of aids to blind landing. A general idea of the operation of the improved system developed may be had by reference to the three-dimensional illustration shown in Fig. 6. The main radio range beacon (A in Fig. 1) is still employed, though not shown in Fig. 6. Lateral position (that is, landing field runway direction) is still given by a runway localizing beacon, and longitudinal position (that is, approach) by a landing field boundary marker beacon. Numerous improvements in



the operation and use of these elements have been effected. The major difference from the system illustrated in Fig. 1 consists in the means provided for furnishing to the pilot accurate altitude position of the airplane as it approaches and reaches the instant of landing. A landing beam, utilizing directive transmission from the ground, is employed for this purpose.

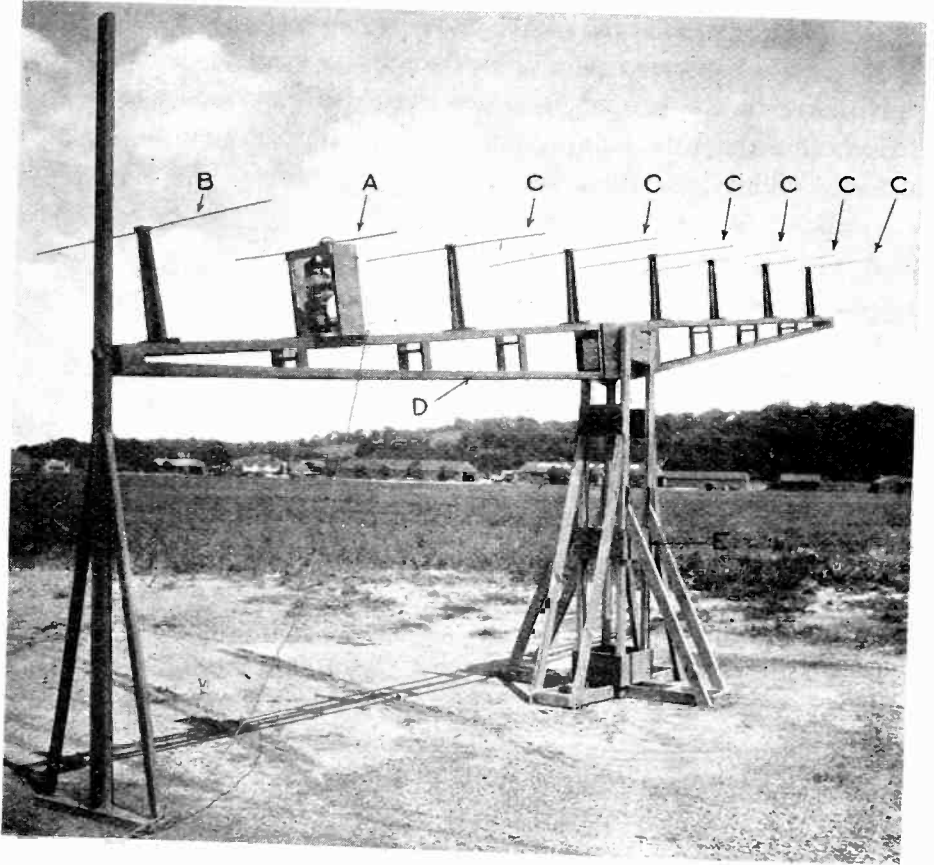

Fig. 7—Landing beam transmitting system, showing electron tube oscillator and directive antenna array.

### 1. Landing Beam.

The landing beam transmitter operates on an ultra high frequency of the order of 100 megacycles. The transmitting system employed, including the directive antenna array, is shown in Fig. 7. The resultant beam is horizontally polarized, requiring the use of a horizontal doublet antenna on the airplane for its reception. (See Fig. 8.) The beam is directed at a small angle above the horizontal, and is used in such a way as to provide a very convenient gliding path for the landing airplane, beginning at any desired elevation (within, say 500 to 5,000 feet) and

at a corresponding distance from the landing field of two to five miles. Sixty-cycle modulation of the landing beam transmitter is provided to facilitate audio-frequency amplification at the receiving end.

On the airplane, a special high-frequency receiving set is used for receiving the landing beam signals. The signal current in the output circuit of the receiving set is rectified and passed through a d-c microammeter mounted on the instrument board. The airplane does not fly on the axis of the beam, but on a curved path under the beam whose curvature diminishes as the ground is approached. The path is the line of equal intensity of received signal below the axis of the beam. The diminution of intensity as the airplane drops below the beam axis



Fig. 8—Bureau of Standards' experimental airplane showing horizontal doublet antenna used for receiving the landing beam signals.

is compensated by the increase of intensity due to approaching the beam transmitter. Thus, by flying the airplane along such a path as to keep the deflection of the microammeter on the instrument board constant, the pilot comes down to ground on a curved line suitable for landing. Fig. 9 shows a photograph of the microammeter used for the landing beam indications. To facilitate its use by the pilot this instrument is mounted on its side so that the pointer moves vertically rather than horizontally. The deflection to be kept constant is chosen at half-scale reading, the instrument pointer being then in a horizontal position. A rise of the pointer above this position indicates that the airplane is above the proper landing path, while the reverse is true if the pointer falls below its horizontal position. The indications of the position of the airplane relative to the landing path are thus made readily comprehensible.

Several important advantages obtain for this method of furnishing altitude indication. The landing path may be so directed as to clear all obstructions. The pilot following the landing path is automatically

kept above obstructions and no longer needs a thorough knowledge of the terrain in order to effect a safe landing. Second, the landing path may be of different shape to suit different landing fields. This is of particular importance in getting into a small field. A third advantage lies in the fact that in the act of following the landing path, the pilot automatically "levels off," thereby facilitating a normal landing. In following the landing path prior to receiving the marker beacon zero-signal zone, the pilot maintains an air speed somewhat above the landing

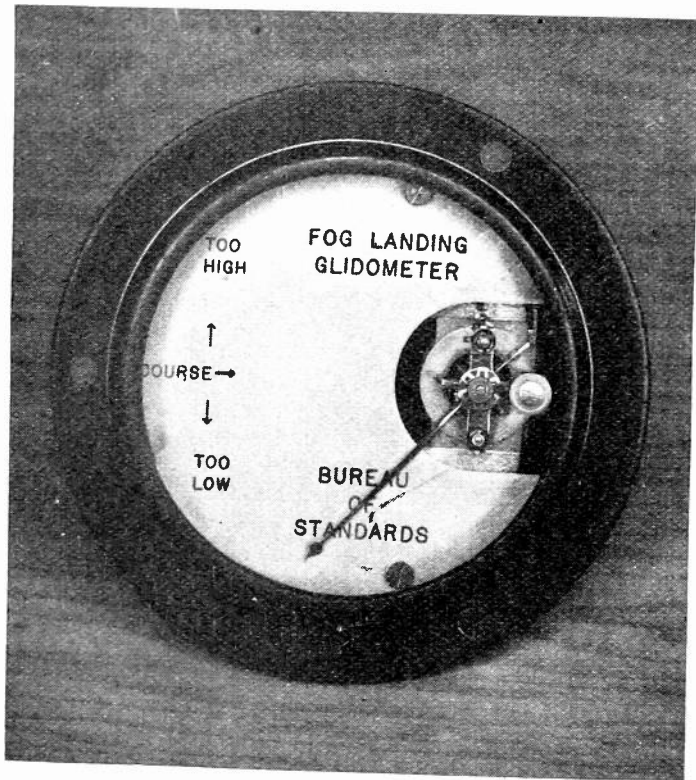

Fig. 9—Landing beam indicator used on the pilot's instrument board to show the relative position of the airplane with respect to the proper landing path.

speed of the airplane, insuring complete controllability with some margin to spare. Upon receiving the marker indication that he is passing over the boundary of the field, the margin over the landing speed may be reduced. The landing is therefore made at a speed more nearly approaching the normal landing speed of the airplane. A fourth advantage is that the landing glide may be begun at any desired altitude, within a rather wide range (say, 500 to 5000 feet). A fifth advantage arises from the ease of using the landing beam indications. No manipulations on the part of the pilot are required. The tuning is fixed. Since

a line of constant field intensity is followed no control of volume is necessary.

## 2. Experiments Leading to Development of Landing Beam.

At this point, it may be of interest to describe the experiments which led to the development of the landing beam. The object of the first experiments along this line, early in 1929, was to mark out an equisignal path in space similar to that obtained with the visual type beacon, but making a constant angle with the horizontal, that is, with the ground. To this end the same transmitting set-up as for the localizing beacon was employed, the two crossed loop antennas being turned over on their sides. This experiment proved unsuccessful because of ground reflection phenomena on the long waves used (about 300 kc).

The next step was to employ directed waves of higher frequencies. Ultra high frequencies, of the order of 60 to 100 megacycles, were chosen in order to reduce the size of the antenna arrays. Two beams were required, both of the same radio frequency but each modulated to a different low frequency, and its axis making a different small angle with the horizontal. The equisignal zone would therefore occur where the two beams intersected, i.e., along a line making an angle with the ground intermediate to the two angles formed by the axes of the two beams and ground. It was recognized that some difficulty would be met in setting up the transmitting circuit arrangement necessary for this system, on the ultra high frequencies considered, since a common master oscillator feeding two balanced amplifier branches, each modulated to a different low frequency, was required. Moreover, making use of the equisignal zone, once it was set up, would add another volume control for the pilot to adjust as he approached the point of landing. The construction of suitable apparatus was, however, begun.

It was at this stage of the development that one of the authors<sup>8</sup> conceived the idea of using only one high-frequency beam in the manner described in section III-1 thereby eliminating the technical difficulties noted and at the same time providing a more suitable gliding path for the landing airplane. The obvious simplification of equipment both on the ground and on the airplane led to the adoption of this idea.

## 3. Other Improvements.

*a. Runway Localizing Beacon.* The runway localizing beacon employed in the improved system of blind landing aids, while still operating on the same principles as previously, has been made considerably easier to use. At the receiving end, some difficulty in following the

<sup>8</sup> F. W. Dunmore.

course was experienced owing to the necessity for adjusting the receiving set sensitivity as the airplane approached the beacon transmitter. Since the beacon signals are followed from a distance of five miles from the transmitter to approximately 2000 feet from the transmitter (the point of landing), variations in the field intensity of the order of 25 to 1 obtain. Continuous adjustment of the receiving set volume control was therefore necessary, in order to keep the reed deflections within scale. The pilot, in making a landing, is, however, concerned with so many things that keeping the necessary close adjustment of the receiving set sensitivity becomes a troublesome task. To overcome this difficulty, an automatic volume control device was developed for maintaining essentially constant receiving set output voltage regardless of the magnitude of the input voltage. The use of the runway localizing beacon thereby resolved itself simply to observing the course indications on the reed indicator and maneuvering the airplane to keep on the course. The automatic volume control device operates through rectification of the alternating voltage across the reed indicator terminals and application of the rectified voltage, after filtering, as a negative biasing voltage on the grids of the radio-frequency amplifying tubes of the receiving set. An increase in the input voltage to the receiving set normally tending to increase the voltage across the indicator terminals is, therefore, accompanied by an increase in the negative bias on the radio-frequency amplifying tubes and, consequently, by a reduction in the receiving set sensitivity such as to maintain substantially constant voltage across the reed indicator.

The provision of this automatic volume control device made possible the addition of an important instrument on the airplane instrument board, giving the pilot information as to his approximate distance from the localizing beacon transmitter. Since increasing input voltage to the receiving set is accompanied by increasing negative biasing voltage on the grids of the radio-frequency amplifying tubes, the deflection of a direct-current milliammeter connected in the plate circuit of these tubes will decrease as the airplane approaches the beacon transmitter. This meter (see Fig. 10) may therefore be calibrated directly in approximate distance from the transmitter. Its calibration will hold roughly on different localizing beacons at different airports, provided these beacons are of approximately the same power ratings. Its chief function is, however, to give the pilot an added check that he is approaching or departing from the landing field and should aid materially in avoiding confusion during blind flight.

*b. Boundary Marker Beacon.* In the first arrangement of blind land-

ing aids, the boundary marker beacon signals were received on the airplane on a special reed indicator connected in series with the vibrating reed course indicator. Several factors combined to point out that aural indication might prove preferable in this case. The pilot, during landing, must focus attention on a number of instruments giving continuous information as to course, altitude of the airplane, air speed, etc. It was felt that he might easily miss the indications given by the marker beacon reed during the short period when he passed over the landing field boundary line. Aural indication would preclude this possibility. The marker beacon modulation was therefore changed to 1000 cycles. Using automatic volume control, it is required to hold the voltage

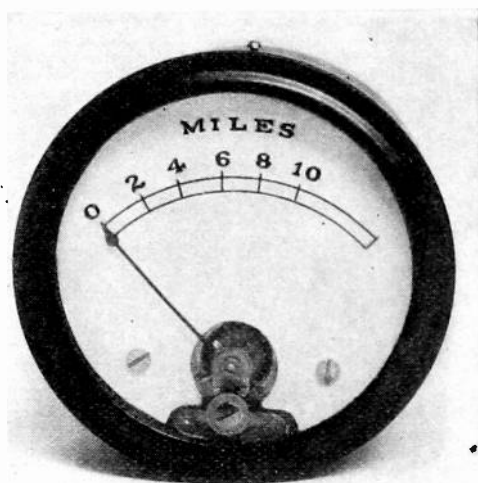

Fig. 10—Rough distance indicator used on the pilot's instrument board to show the approximate distance of the airplane from the runway localizing beacon transmitter.

across the vibrating reed course indicator constant, while the marker beacon signal must be permitted to vary through a minimum. This requirement was met through the use of a filter circuit arrangement connected in the receiving set output which served to direct frequencies below 200 cycles to the reed indicator and frequencies above that value to the head telephones. The automatic volume control device is connected across the reed indicator terminals as before and, consequently, is operated only by the signals from the localizing beacon (no voltage of 1000-cycle frequency appearing across the indicator). The 1000-cycle marker beacon signal heard in the head telephones, since it does not affect the automatic volume control device, is therefore permitted to vary through a minimum, as required.

#### 4. Use of the Improved System.

Having outlined the function of each element of the complete system of blind landing aids, it is desirable at this point to consider the apparatus required on the airplane for making use of these aids. Fig. 11 shows a complete airplane installation. The medium-frequency receiving set *A*, using mast antennas *B*, is normally employed for the reception of the weather broadcast and radio beacon services. This set is also used for receiving signals from the runway localizing and

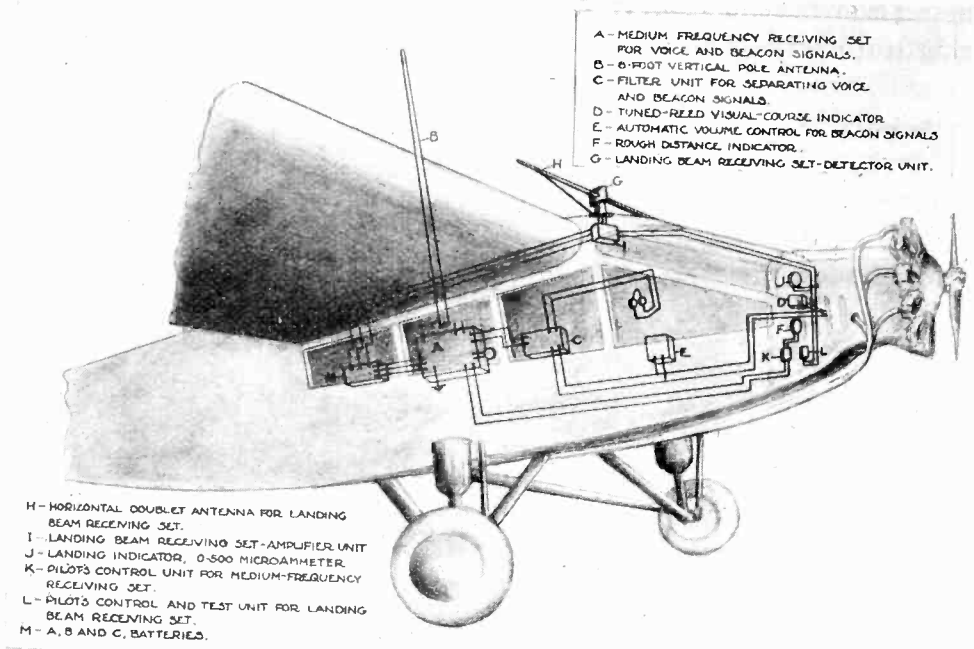

Fig. 11—Complete airplane installation showing radio equipment required to make use of the radio system of blind landing aids. Note that the medium-frequency receiving set is also employed for radiotelephone and radio beacon service on the airways.

marker beacons. To the output of this set is connected the filter unit *C* which directs the main and localizing beacon signals to the reed indicator *D*, and the boundary marker beacon signals to the head telephones. The automatic volume control device *E* is connected across the reed indicator terminals, its operation serving to maintain substantially constant reed deflections and at the same time governing the scale reading of the instrument *F*, which indicates roughly the distance from the beacon transmitter.

The receiving set for the reception of the ultra-high-frequency landing beam signals consists of a detector unit *G* mounted in the stream-

lined housing which supports the receiving dipole antenna structure *H*, and an amplifier-rectifier unit *I*. The rectified output current is fed to the landing beam indicator *J*. The remote control panels for the medium-frequency and ultra-high-frequency sets are shown at *K* and *L*, respectively. *M* contains the batteries necessary for operating these sets.

A photograph of the instrument board on the Bureau's experimen-



Fig. 12—Instrument board on Bureau of Standards' experimental airplane, showing vibrating reed course indicator *A*, landing beam indicator *B*, rough distance indicator *C*, and landing beam runway set control and test panel *D*.

tal airplane is shown in Fig. 12. The reed indicator is shown at *A*, the landing beam indicator at *B*, and the rough distance indicator at *C*. At *D* is shown the control panel for the landing beam receiving set. The control panel for the medium-frequency receiving set is not shown.

Let us now consider the operations required on the part of the pilot in making a blind landing. It is assumed that the information necessary for maintaining the airplane in stable flight is available through the use of suitable flight instruments. The medium-frequency receiving set is tuned to the frequency of the main radio range beacon (say,



280 kc) and indications as to the correct course leading to the vicinity of the airport observed on the reed indicator. Since automatic control of volume is provided, these course indications are available to the pilot without manipulation on his part.

Upon receiving the zero-signal indication when directly over the tower of the main beacon, the pilot retunes the medium-frequency receiving set to the frequency of the localizing beacon (say, 330 kc) and throws a switch which places the landing beam receiving set in operation. These are the only adjustments of radio equipment required of the pilot during the entire landing maneuvers. The reed indicator now furnishes information as to the landing field runway direction, the provision of automatic volume control again relieving the pilot of the necessity for adjusting the receiving set sensitivity for variations in the distance between the airplane and the localizing beacon transmitter. The pilot next orients himself along the major axis of the landing field utilizing his compass indications together with his knowledge of the geography of the field. As noted in connection with Fig. 1, the reed indicator aids considerably in this maneuver. The airplane may be kept at any altitude within, say 500 to 5000 feet. From time to time the pilot glances at the rough distance indicator and endeavors to get on the runway course at a point approximately five miles distant from the landing field. He now directs his airplane along the runway course and in the direction of the landing field, glancing occasionally at the landing beam indicator. When approximately half the distance to the field is covered, the pointer of the landing beam indicator begins to rise to mid-scale or horizontal position. When this position is reached, the pilot knows that he is at a point on the gliding path. To follow the gliding path he must maneuver the airplane to keep the pointer in the horizontal position. A pointer position above the horizontal indicates that the airplane is above the proper landing path, while the reverse is true if the pointer swings below the horizontal position.

It is necessary now that the pilot keep accurately on the runway beacon course, at the same time following down on the landing path. To facilitate this, he may reduce the airplane engine speed so that the air speed indicator registers about five miles above the normal landing speed of the airplane. This also helps during the actual landing, as will appear below. The accuracy to which the runway beacon course should be followed is of the order of  $\pm 3$  degrees. This is necessary in order that the landing beam may be encountered head-on; otherwise, a landing path somewhat steeper than the one desired would be followed. It should not prove difficult, however, to follow the course to the necessary accuracy since a deviation of  $\pm 1$  degree may be observed on the

ceeds. It is felt that after some training a pilot may correct any tendency to fly a zigzag course by flying slightly off-course and gradually bearing in toward the course.

Some distance from the landing field boundary line the pilot begins to hear a 1000-cycle signal from the boundary marker beacon. This signal increases gradually, reaches a maximum, then decreases to zero, and begins to increase again. The instant of zero signal defines the landing field boundary line, and for a given field informs the pilot that he is at a definite distance above ground. Neither point of information is, however, essential to the pilot. The chief function of the boundary marker beacon is to establish a transition period after which the landing beam indications become of primary importance. He may now throttle down his engine to landing speed and maneuver his airplane to follow the landing path accurately to the point of landing.

In the foregoing analysis the direction of the wind has been assumed such as to permit landing along the major runway of the field, and in only one direction along that runway. The system as described, therefore, does not take into account the important factor of wind direction. While it is rare that dense fog is accompanied by a strong wind, blizzards and blinding snowstorms often offer as great limitations to visibility as fog. The factor of wind direction cannot, therefore, be neglected in the general problem of blind landing.

Developments now in progress with a view to making possible landing into the wind regardless of wind direction, will be considered below.

## 5. Further Developments.

In addition to the work on expansion of the system of blind landing aids to take care of wind direction, other experiments are in progress at College Park looking toward still further simplification of the use of the system.

*a. Runway Localizing Beacon.* Since indications of the position of the airplane with respect to the proper landing path are given the pilot by an instrument of the pointer type, it may prove desirable to furnish the localizing beacon course indications on the same type of instrument. An instrument of this type has been developed, and numerous successful flight tests made. The instrument developed is of the zero-center type (see Fig. 13), the movement of the pointer of this instrument from the zero-center position serving to indicate deviation to the left or right of the runway beacon course, as the case may be. The operation of this instrument depends upon the separation of the two frequencies of the double-modulation signal received from the runway localizing beacon (by means of a suitable filter circuit arrangement connected in the

receiving set output), rectification of the separated signals, and the application of the resultant rectified voltages in opposition across the instrument terminals. When the two modulation signals are of equal intensity, as is true on the beacon course, the net voltage applied to the instrument is zero. The instrument pointer then assumes its zero-center position. An increase in relative magnitude of one signal over the other operates to deflect the instrument pointer in one direction or the other, depending upon which signal is the stronger. The direction of

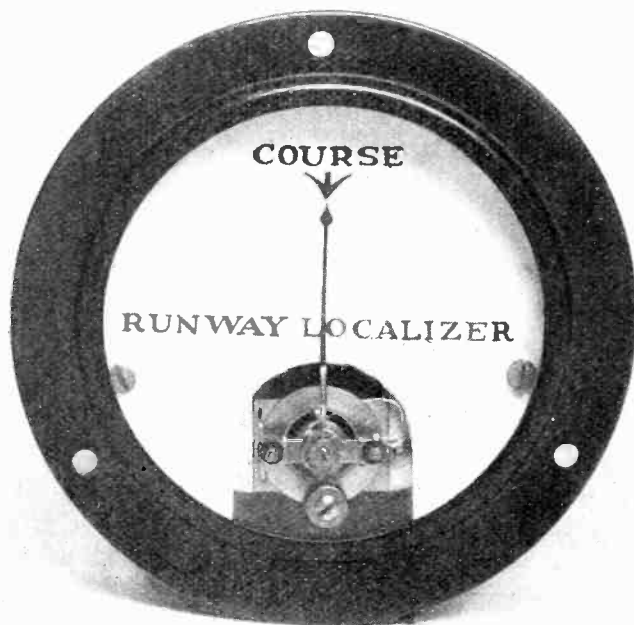

Fig. 13—Pointer type localizing beacon course indicator.

movement of the pointer may be made to correspond to the direction of deviation of the airplane from the runway course

The use of this instrument presents a number of advantages, and also a number of disadvantages, over the use of the reed indicator. Among the advantages is included the fact that the course indications become considerably sharper, a deviation from the course of the order of  $\pm 0.25$  degree being readily detected. A second advantage is that the sharpness of course is adjustable at the receiving end, and may therefore be set at a value found most suitable in actual use. Another advantage is that, since the landing beam and runway localizing beacon indicators are now both of the same type, the two may be combined into a single instrument (see Fig. 14). The resultant simplification is

very similar to that obtained by combining rate of climb and bank indications in the artificial horizon instrument.

Several forms of combined instruments were constructed. Of these the one shown in Fig. 14 proved the most practicable. This instrument consists of two separate microammeters, one corresponding to the landing beam indicator and the other to the zero-center runway course indicator. Two reference lines are provided on the face of the combined instrument, the horizontal line indicating the position of the landing path and the vertical line the position of the runway. The landing beam instrument is so placed that its pointer moves above or below the hori-

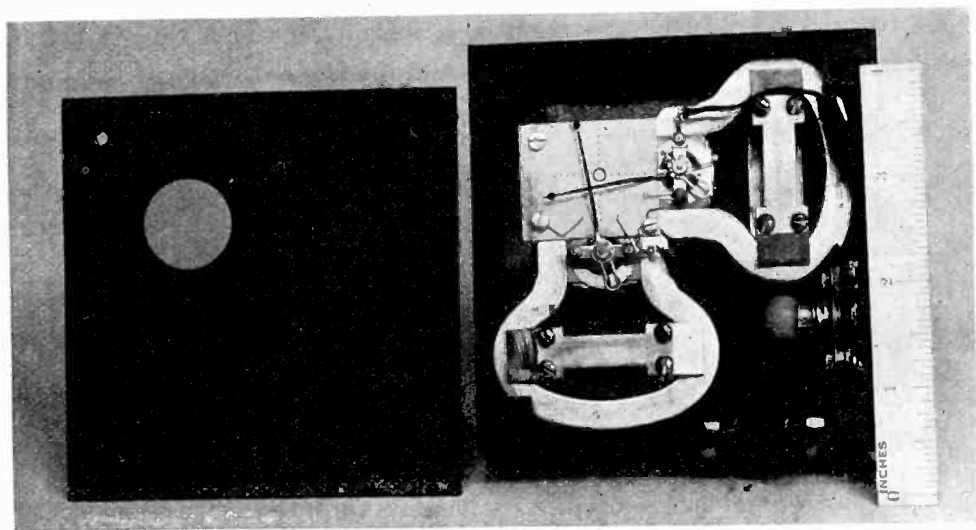

Fig. 14—Combined instrument giving indications of the relative position of the airplane with respect to the runway and also with respect to the high-frequency landing beam path.

zontal reference line, while the pointer of the runway course indicator moves to the right or the left of the vertical reference line. The point of intersection of the two pointers indicates the relative position of the airplane with respect to the proper landing path and the runway. During landing the pilot maneuvers his airplane so that the point of intersection falls on the small circle at the center of the instrument face, as shown at *A*, Fig. 15. Fig. 15 at *B* shows the instrument indication when the airplane is above the proper landing path and to the left of the runway. Fig. 15 at *C* corresponds to the indication obtained when the airplane is below the proper landing path and to the right of the runway.

Among the disadvantages introduced through the use of the pointer type instrument for securing localizing beacon course indications are that the equipment required is somewhat more elaborate than the reed

indicator and, also, a rather delicate instrument as compared with the reed indicator is employed.

b. *Boundary Marker Beacon.* A second field for investigation is the question of the best type of marker beacon signals to be furnished to the pilot. In the first system of blind landing aids, a 40-cycle reed indicator was employed for this purpose. It was later felt that aural indication would be preferable since it would prevent any possibility for the pilot to miss the marker beacon indication during the short period when he passed over the marker. So many factors enter into consideration, however, that it is difficult to arrive at a definite decision as to whether aural indication is entirely satisfactory. With the present trend toward combined passenger and mail transportation, it is not possible to visualize the exact conditions on the airplane of the near

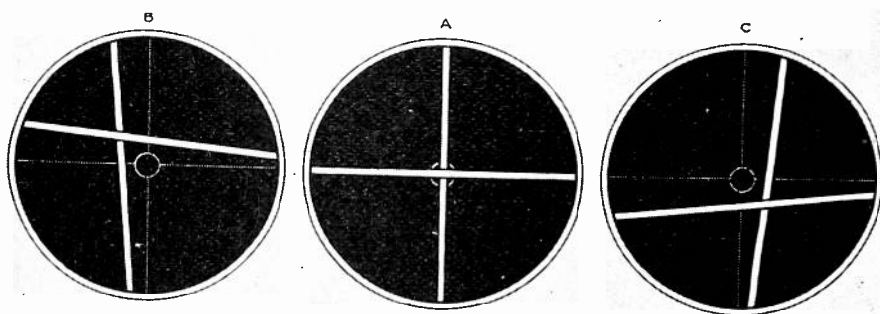

Fig. 15—Combined instrument indications for different positions of airplane.

future. Probably the copilot, who would also be the radio operator, will receive all voice and code messages, including weather reports, while the pilot will use radio only as a navigational aid. In that event, it would be unnecessary for the pilot to use head telephones except if the landing field boundary marker indications were aural. Visual indication, of the nature of a flashing light such that the pilot could not miss the indications, would then perhaps be preferable. The complete system of radio navigational aids would then be furnished the pilot by visual indicating devices only.

c. *Expansion of System to Take Care of Wind Direction.* A number of possible arrangements of the system of blind landing aids outlined above, whereby wind direction may be taken into account, are available. The problem is to determine the most economic arrangement. For example, it has been suggested that the localizing beacon and landing beam transmitters may be buried in the center of the field and oriented into the wind at all times by remote control from the opera-



estimated that the commercial cost of the complete installation would not exceed \$15,000. An obvious advantage is that the equipment once set up remains in permanent adjustment.

Referring to Fig. 16, the beacon arrangement shown is for a three-runway field. Three runway localizing beacons, *A*, *B*, and *C*, and six landing beam transmitters, *D*, *E*, *F*, *G*, *H*, and *I*, are required. Only three boundary marker beacons, *J*, *K*, and *L*, are necessary, since the drop in reed deflections directly over the localizing beacons, *A*, *B*, and *C*, may be used for that purpose in the three remaining positions where marker beacons are required. At any given time but one localizing beacon, one landing beam transmitter, and one boundary marker beacon, are in operation, being so chosen as to require landing into the wind. In practice this system would probably be used in the following manner. The radio operator or reserve pilot on an airplane approaching the field on a course of the main radio range beacon *M*, reports to the traffic control officer at the field (by radio) that the pilot wishes to land. The traffic control officer then informs him of the wind conditions at the field and the direction in which to land. He may also require that the airplane be maintained at a specified altitude in order to permit other airplanes to land. This information is relayed to the pilot, who continues on the main radio beacon course, at the specified altitude, until the drop in deflection of the reed indicator shows that he is passing over the main beacon tower. He then tunes the medium-frequency receiving set to the runway localizing beacon and, knowing the location of the main beacon relative to the field, heads the airplane on the compass course necessary to follow the particular localizing beacon in operation, in accordance with the information received from the traffic control officer. The pilot continues to travel back and forth along this course at the designated altitude, keeping the position of the field in mind by the zero deflection of the reed indicator each time the airplane passes over the localizing beacon transmitter. When orders are received to land, the radio operator relays the message to the pilot, who follows the localizing beacon course until he is about five miles away from the field in the proper direction, makes a 180-degree turn so as to head toward the field, places the landing beam receiver in operation, and proceeds to land in the manner described in section III-4 in connection with the single runway system.

#### IV. DESCRIPTION AND OPERATION OF APPARATUS

In the analysis given above, only such general details of the transmitting and receiving equipment have been introduced as were necessary to the understanding of the system as a whole. In this section the

component parts making up the complete system are described in some detail.

### 1. Runway Localizing Beacon.

This beacon was briefly described in section II above. It is essentially a 200-watt double-modulation beacon, employing small loop antennas so that it may be placed near the landing field without constituting an obstruction to flying. The course indications on the airplane may be obtained either on a reed indicator or on a zero-center pointer type instrument. For the first case the modulation frequencies used at the

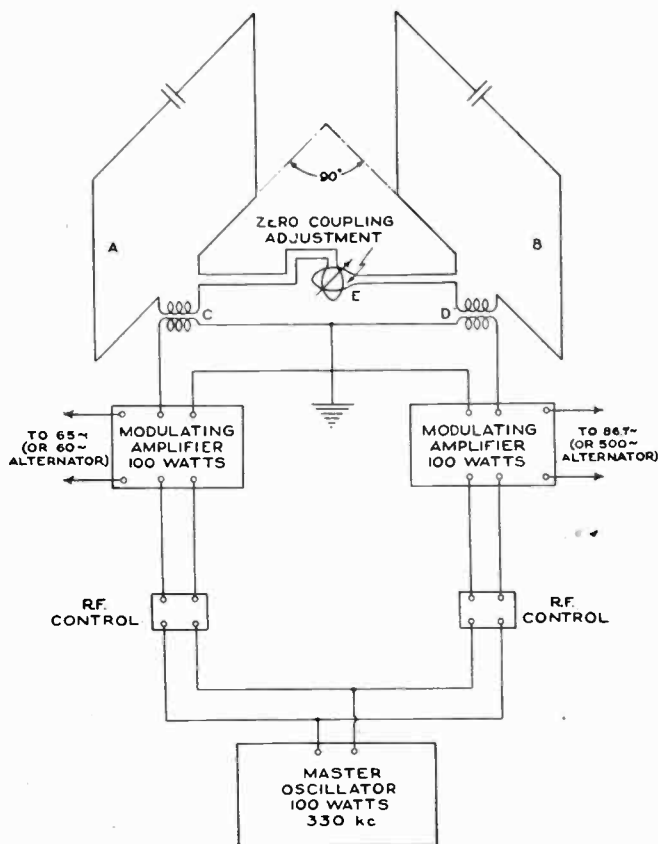

Fig. 17—Transmitting circuit arrangement for runway localizing beacon.

beacon are 65 and 86.7 cycles, respectively; in the second case, 60 and 500 cycles when the electrical filter is used, or 65 and 86.7 cycles when the tuned reed filter is employed. The beacon apparatus is housed in a two-story shed located on the border of the landing field and in line with the runway along which the course is to be directed. (See Fig. 2.) The transmitting set and machinery are shown on the first floor and the transmitting loop antennas on the second floor. These antennas consist of seven turns of wire wound on frames 6 ft.  $\times$  8 ft., the turns being spaced four inches apart.



The transmitter is provided with a 250-watt power amplifier stage in each amplifier branch, but these stages were not used except in the early tests. The actual transmitting circuit arrangement employed is shown in Fig. 17. To simplify apparatus, the transmitter is coupled to the antenna system through two coupling transformers, *C* and *D*, rather than by means of the goniometer employed in the usual radio range beacon set-up. The variometer *E* serves to neutralize any residual inductive coupling between loop antennas *A* and *B*.

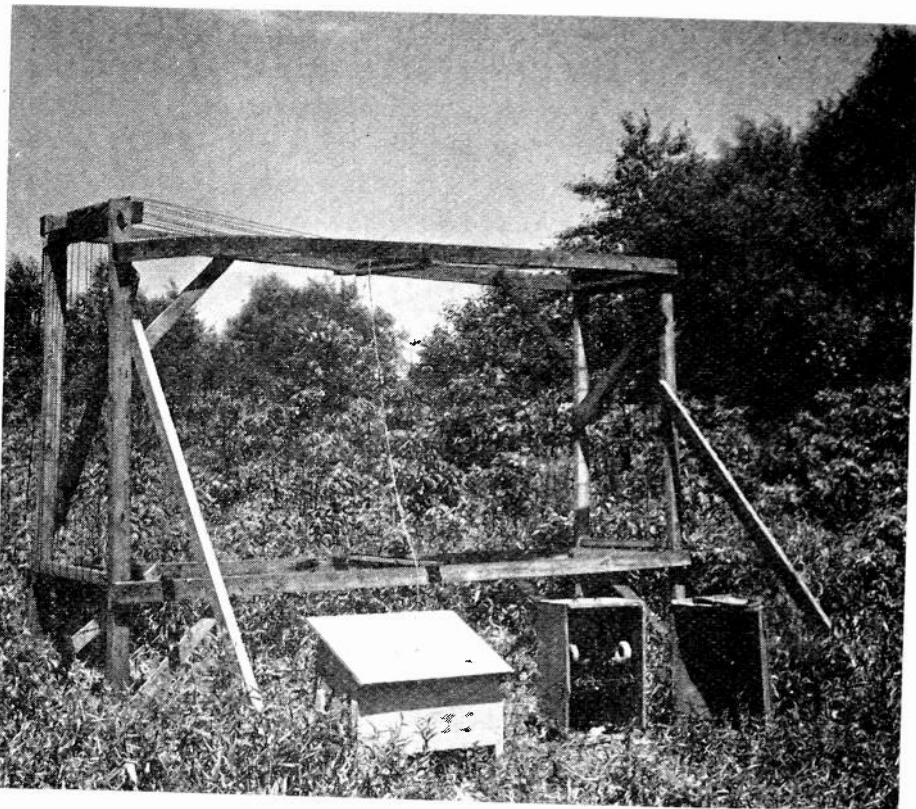

Fig. 18—Transmitting system for airport boundary marker beacon.

## 2. Boundary Marker Beacon.

A photograph of the boundary marker beacon is shown in Fig. 18. The transmitting loop antenna consists of ten turns spaced four inches apart and wound on a wooden frame 6 ft.  $\times$  8 ft., the plane of the antenna being so oriented that the minimum signal zone coincides with the landing field boundary line. In addition to the loop antenna there are two small weatherproof boxes which contain the power supply unit and the transmitting set. The power supply unit is a converter for changing from 60-cycle to 500-cycle supply. The transmitting set employs two 50-watt tubes excited alternately from a 500-cycle plate sup-

ly transformer and feeding a common oscillatory circuit, coupled inductively to the loop antenna. (See Fig. 19.) The tube filaments are also supplied from the 500-cycle source through a suitable winding on the 500-cycle transformer. Due to the alternate excitation of the 50-watt tubes, the resultant modulation has a frequency of 1000 cycles. The boundary marker beacon operates on the same carrier frequency as the runway localizing beacon (330 kc).

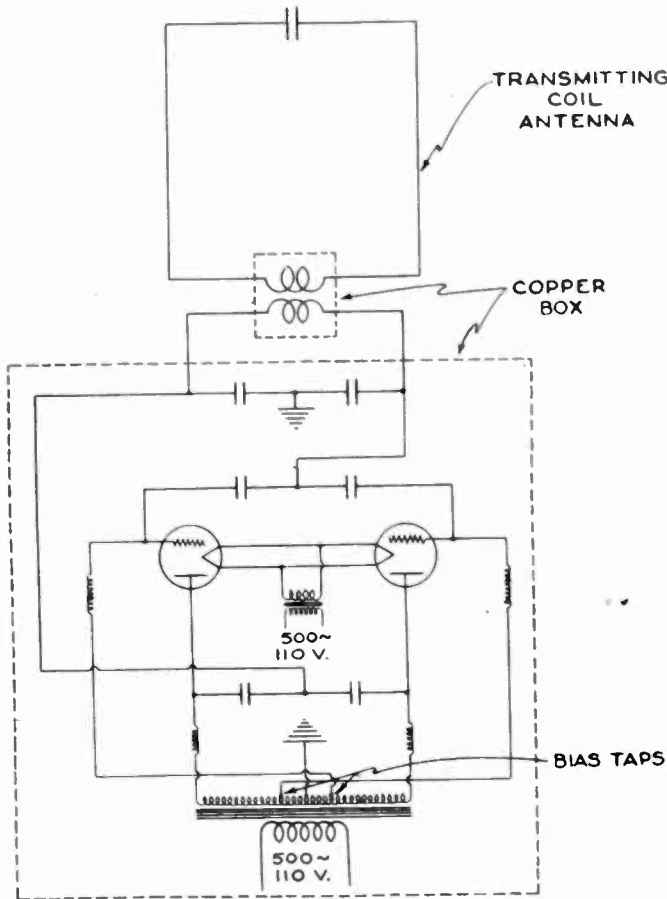

Fig. 19—Transmitting circuit arrangement for airport boundary marker beacon.

### Receiving System for Localizing and Marker Beacon Signals.

When the vibrating reeds are used as the course indicator on the runway localizing beacon, the receiving system on the airplane is as shown in Fig. 20. The filter unit serves to direct the reed frequencies to the reed indicator and the 1000-cycle marker beacon signals to the head telephones. The automatic volume control is connected across the reed indicator terminals and, consequently, is actuated only by the localizing beacon signals. The 1000-cycle marker beacon signal is therefore permitted to vary through a minimum even though the receiving

set output voltage (in so far as the reed indicator is concerned) maintained substantially constant.

The operation of the filter unit is best seen from a study of the graphs in Fig. 21. Graph A shows the variation of the ratio of input

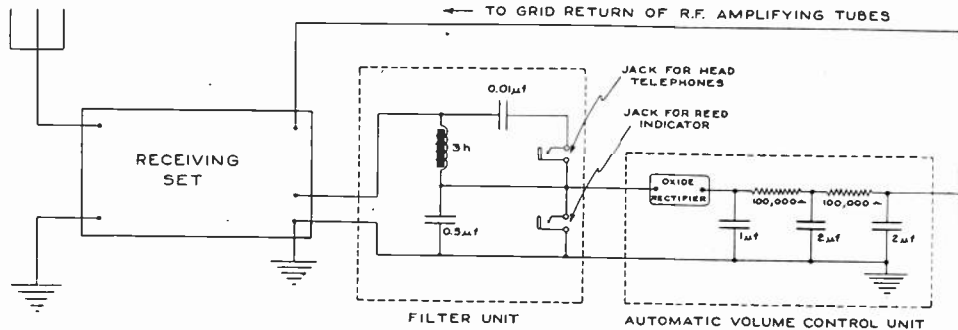

Fig. 20—Circuit arrangement for receiving runway localizing and marker beacon signals when reed indicator is used for runway course indications.

voltage applied to the filter unit to output voltage across the reed indicator as a function of frequency. Cut-off is arbitrarily assumed at a value of 10 to 1 for this ratio, corresponding to 20 decibels. Note that

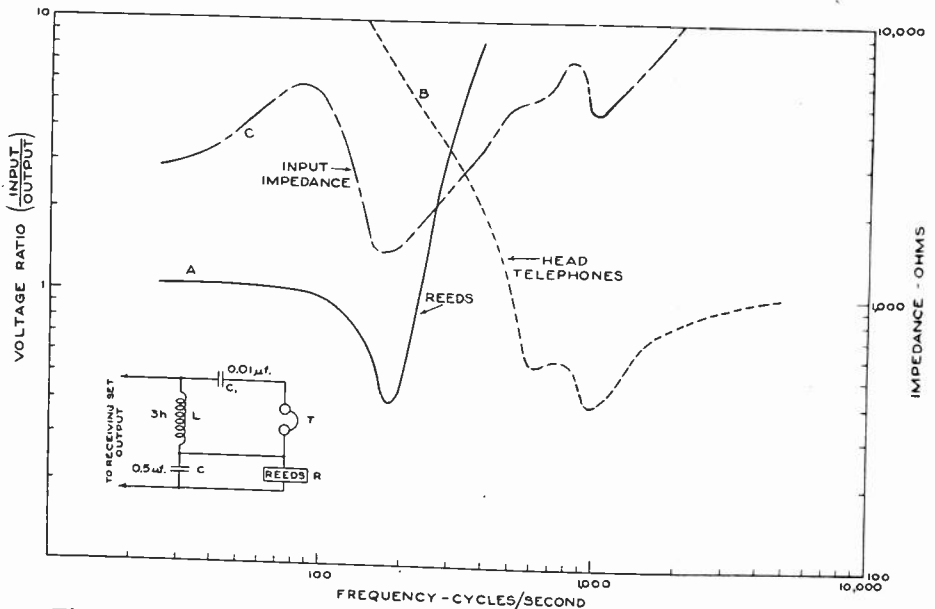

Fig. 21—Graphs showing performance characteristics of filter unit.

cut-off occurs at a frequency of 425 cycles. The 1000-cycle marker beacon signal is therefore excluded from the input circuit of the automatic volume control unit. Graph B shows the variation with frequency of the ratio of input voltage applied to the filter to output voltage across the head telephone. Cut-off occurs at 140 cycles. The low-

frequency reed signals (65 and 86.7 cycles) are therefore not heard in the headphones. The marker beacon signal is, however, received. In addition, code and intelligible speech may be received without adjustment of the filter unit. This is of advantage when the receiving set is used to obtain aural radio range beacon and radio telephone service on the fixed airways. Graph C shows the variation of the input impedance of the filter unit with frequency. This matches quite well the output impedance of the receiving set employed except in the narrow band, 125 to 300 cycles, which is unimportant.

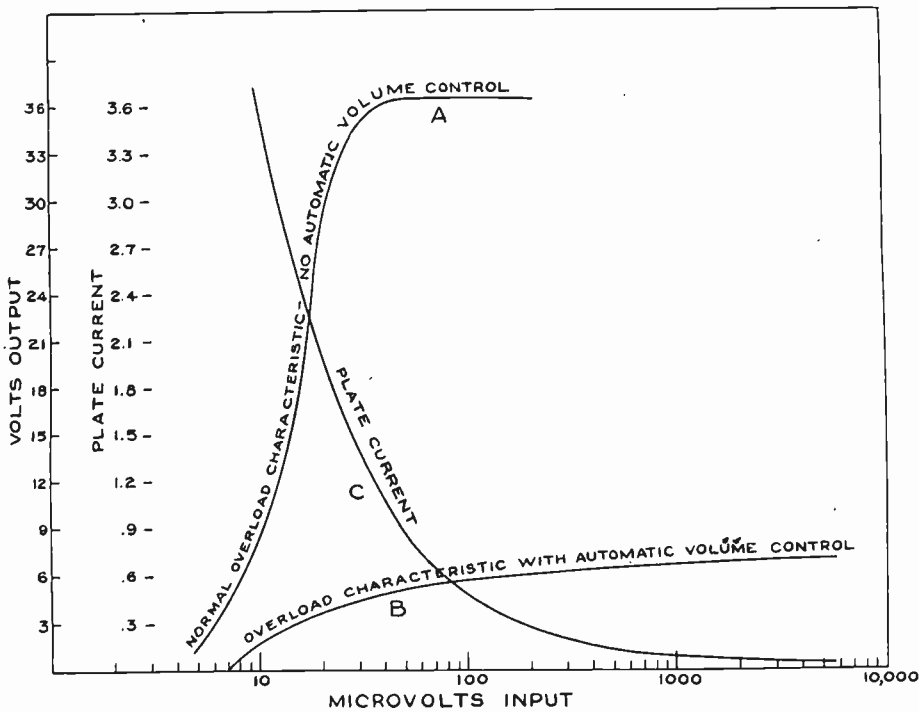

Fig. 22—Graphs showing performance characteristics of automatic volume control unit.

The operation of the automatic volume control unit in conjunction with the particular receiving set used may be obtained from a study of the graphs in Fig. 22. Graph A shows the variation of output voltage across the reed indicator with input voltage to the receiving set when no provisions is made for automatic control of volume. Graph B shows the voltage across the reed indicator as a function of the input voltage to the receiving set, when the automatic volume control connection is used. The variation of the plate current supply to the radio-frequency amplifying tubes as a function of the receiving set input voltage is plotted in graph C. For a beacon station of given power, the instrument reading plate current supply may therefore be calibrated directly in distance.

When the zero-center pointer type instrument is employed as the runway beacon course indicator, a filter-rectifier unit is required at the receiving end for separating the two frequencies of the double-modulation signal received (60 and 500 cycles, respectively), then rectifying the separated signals and applying the resultant rectified voltages in opposition to the instrument terminals. The circuit arrangement for this unit is shown in Fig. 23. The receiving set output signal is fed to terminals *AA* of this unit, the automatic volume control unit being connected across *AA*. Referring to Fig. 23, the double-modulation signal is resolved into its component frequencies through circuit *BC*, voltage of 500-cycle frequency being applied to rectifier *D*, and voltage

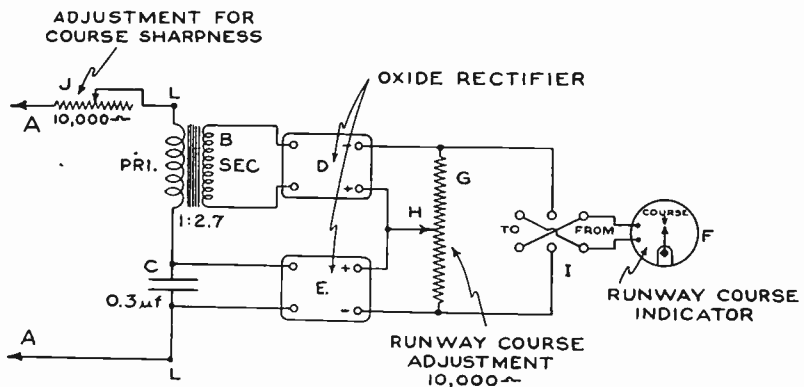

Fig. 23—Circuit arrangement for filter-rectifier unit used with pointer type localizing beacon course indicator.

of 60-cycle frequency to rectifier *E*. The rectified output voltages from *D* and *E* are applied in opposition across instrument *F* by means of the potentiometer *G*, the sliding contact *H* serving to balance the outputs so that the pointer of instrument *F* will be in zero-center position when the two modulation frequencies are of equal intensity. The switch *I* permits the reversal of the instrument terminals, in order that the deflection of the pointer to the left or right of center may correspond to the direction of deviation from the course, whether flying "to" or "from" the beacon. The indicator *F* may be made to give any sharpness of course indication above  $\pm 0.25$  degree, by varying the intensity of the signal delivered to the terminals *LL*. The series resistance *J* is provided for this purpose. This arrangement permits the use of the same automatic volume control and setting (in parallel with *AA*) as is used for the reed indicator when receiving signals from the main radio beacon.

Another form of filter unit developed, which has proved preferable to the arrangement described above, makes use of the selectivity of the tuned-reed indicator. The vibrating reeds are employed to generate

voltages proportional to the reed vibration amplitudes. These voltages are rectified and applied in opposition to the terminals of the zero-center instrument as in the case above.

#### t. Landing Beam.

The use of the landing beam was outlined briefly in section III above. The function of the landing beam is to furnish a pilot with the necessary vertical guidance to permit landing under conditions of no visibility. It consists essentially of a horizontally polarized beam directed at a small angle above the horizontal, this angle and the degree

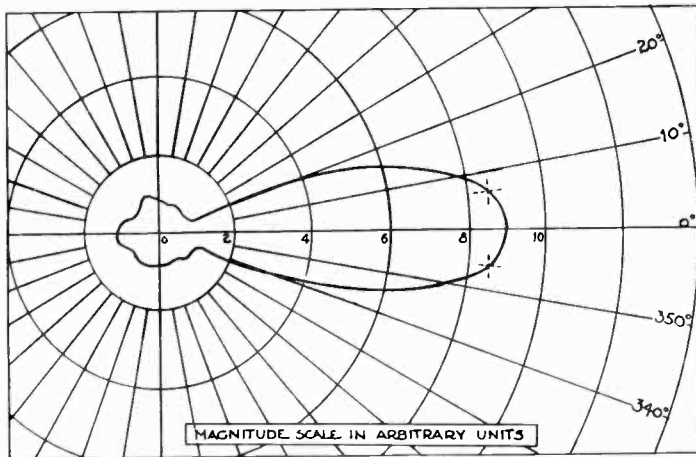

Fig. 24—Horizontal directive characteristic of the 93,700-kc landing beam.

of directivity being so adjusted that a predetermined line of constant field intensity will mark out just the proper gliding path, clearing all obstructions and convenient for landing. In the set-up at College Park, Maryland, the beam is transmitted on a frequency of 93,700 kc (3.2 meters) and is oriented in the same horizontal direction as the course of the runway localizing beacon. The beam transmitting system is shown in Fig. 7 above. On the airplane, a horizontal dipole antenna feeding a detector-amplifier-rectifier unit is employed for receiving the landing beam signal. As will be evident below, the receiving equipment constitutes essentially a vacuum tube voltmeter arrangement for exploring the field intensity in different portions of the landing beam.

*a. Theory of Operation.* The polar diagrams of Figs. 24 and 25 show, respectively, the horizontal and vertical directive characteristics of the landing beam. Referring to Fig. 24, and recalling that an airplane is kept along the axis of the beam (in the horizontal plane) by means of the runway localizing beacon, it will be observed that a deviation from the runway course of  $\pm 6$  degrees will result in but a 5 per cent drop in the

landing beam signals. Since the reed indicator detects a course deviation of  $\pm 1$  degree, it may be concluded that an airplane can readily be directed in a horizontal plane, head-on with the beam. In the analysis which follows it will be assumed at all times that the airplane is along the line of maximum intensity in so far as the horizontal characteristic is concerned.

Consider now the vertical directive characteristic shown in Fig. 25. An airplane flying in a straight line from *B* to *A* directly into the region of maximum field intensity of the beam receives a signal which increases inversely as the distance from the beam transmitter. Such a rate of increase in received signal is of little help in landing. Suppose, however, that the airplane is directed into the beam along the line *OC*, until position *G* is reached, at which point the indicating instrument on the airplane reaches half-scale deflection. At a point directly above *G*, this deflection increases, since the airplane is nearer the line of maxi-

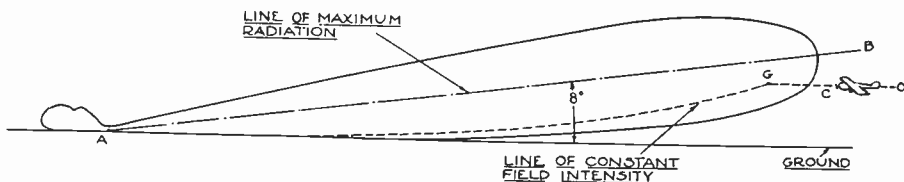

Fig. 25—Vertical directive characteristic of the 93,700-kc landing beam showing landing glide path.

imum intensity of radiation of the beam. At a point directly below *G*, the deflection decreases, the airplane now being farther from the line of maximum intensity of radiation. The instrument deflection thus increases or decreases with any increase or decrease in the altitude of the airplane about the point *G*. If, now, a straight line were followed from *G* to *A*, the indicating instrument pointer would soon go off-scale due to the approach of the receiving system to the transmitting source. However, (and this is the basis of operation of the system) by dropping away from the line of maximum intensity of radiation as *A* is approached, the instrument pointer may be held at the half-scale deflection position at all times, since the increase in signal due to the fact that the airplane is nearing the source *A* is continuously compensated for by a corresponding decrease in signal due to the angular departure of the airplane from the line of maximum intensity of the beam. The path followed by holding the instrument pointer constantly at half-scale deflection is indicated by the dotted line *GA*. Obviously this is a line of constant field intensity of definite magnitude. By properly orienting the beam vertically and giving it the proper degree of direc-

ivity, this line of constant field intensity may be made to coincide with the landing path normally followed by a pilot in clear weather.

This glide curve or landing path may be derived from a proper combination of two graphs, one of which shows the inverse variation of field intensity with distance from the beam transmitter, and the other the polar curve showing the beam directivity in the vertical plane. Referring to Fig. 26 which shows the same vertical characteristic as Fig. 25, the line of maximum intensity of radiation of the beam ( $OK$ ) makes an angle of 8 degrees with the horizontal. Assume that the field intensity at a point located on this line and 2000 feet horizontally distant from the transmitter is 2000 (in arbitrary units<sup>10</sup>). This corresponds to the magnitude  $OK$ . Then the field intensities at points the same

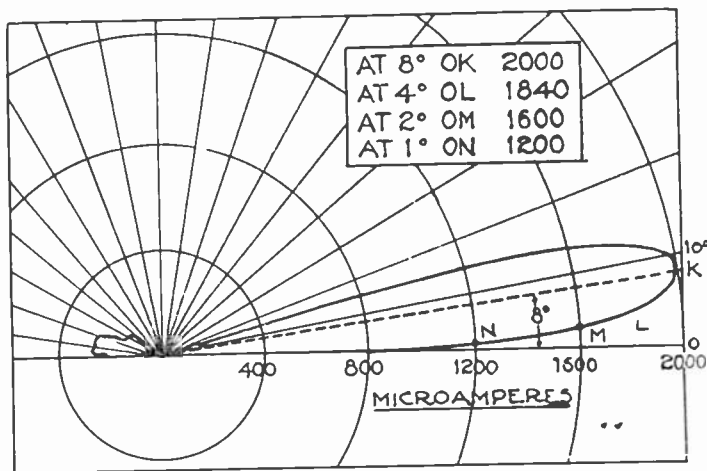

Fig. 26—Vertical directive characteristic of the 93,700-kc landing beam giving experimental data used in the graphical determination of the landing glide path shown in Fig. 29.

horizontal distance from the transmitter but located on lines making, respectively, 4 degrees, 2 degrees, and 1 degree with the horizontal, correspond to the magnitudes  $OL$ ,  $OM$ , and  $ON$ , and are equal to 1840, 1600, and 1200 (in the same arbitrary units). Consider now, the variation of field intensity, along each of the lines considered, for increasing distance from the transmitter. The graphs corresponding to the lines making 8 degrees, 4 degrees, 2 degrees, and 1 degree with the horizontal are shown, respectively, by  $K$ ,  $L$ ,  $M$ , and  $N$  in Fig. 27. In each case the field intensity is an inverse function of the distance. To determine the shape of any line of constant field intensity it is now simply necessary to draw a horizontal line, such as  $ST$  corresponding to the in-

<sup>10</sup> These units are chosen to correspond to the reading of the landing beam-indicating instrument in microamperes. This assumes that the detector-amplifier-rectifier is essentially linear in operation.



tensity desired (250 in this case, half-scale reading of the microammeter used in practice) determining the horizontal distance from the transmitter corresponding to the points of intersection of this line with the

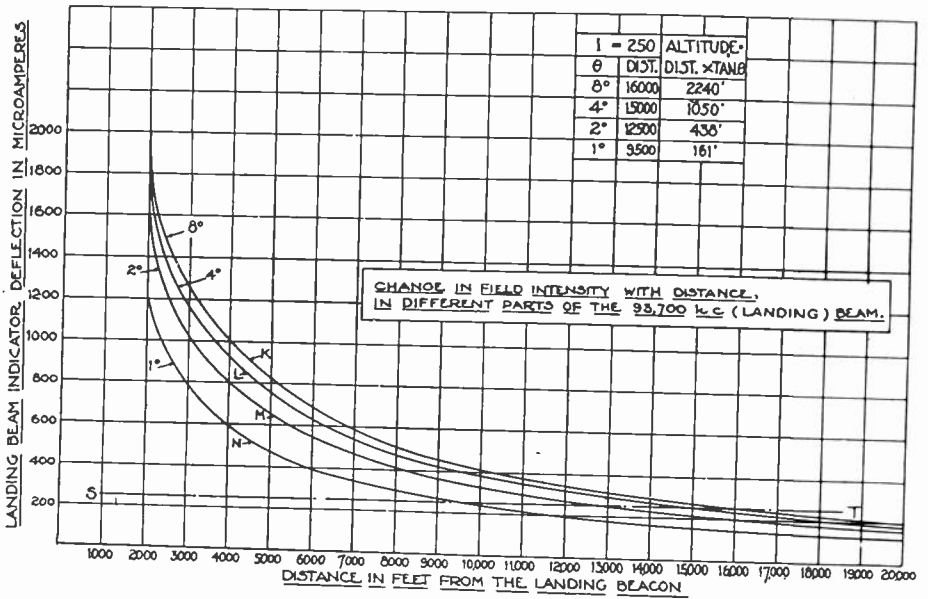

Fig. 27—Graphs showing graphical method of determining landing glide path from the data given in Fig. 27.

graphs K, L, M and N, and computing the height of these points above the ground from the relation

$$h = dx \tan \theta \tag{1}$$

where,

$h$  is the height above ground in feet,

$d$  the horizontal distance from the transmitter in feet,

$\theta$  the angle between the lines  $OK, OL, OM, ON$ , (Fig. 26) and the horizontal.

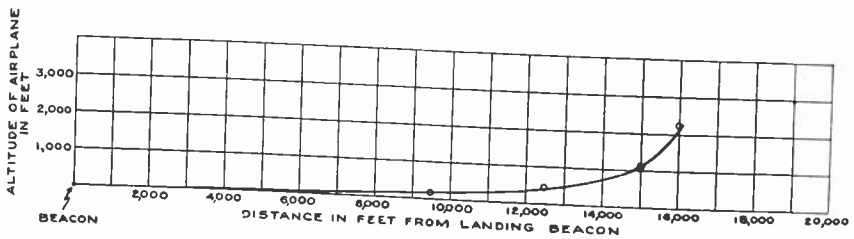
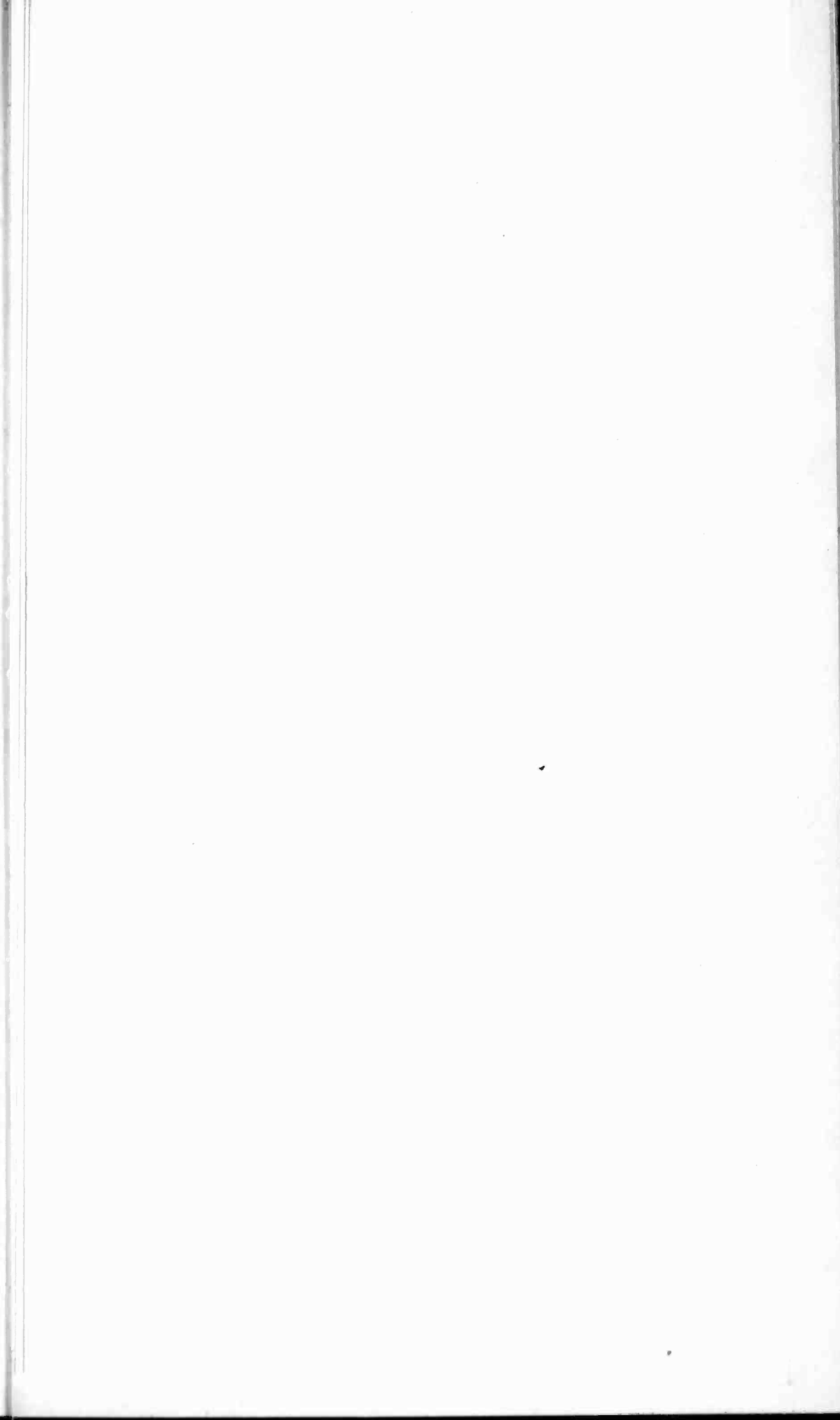
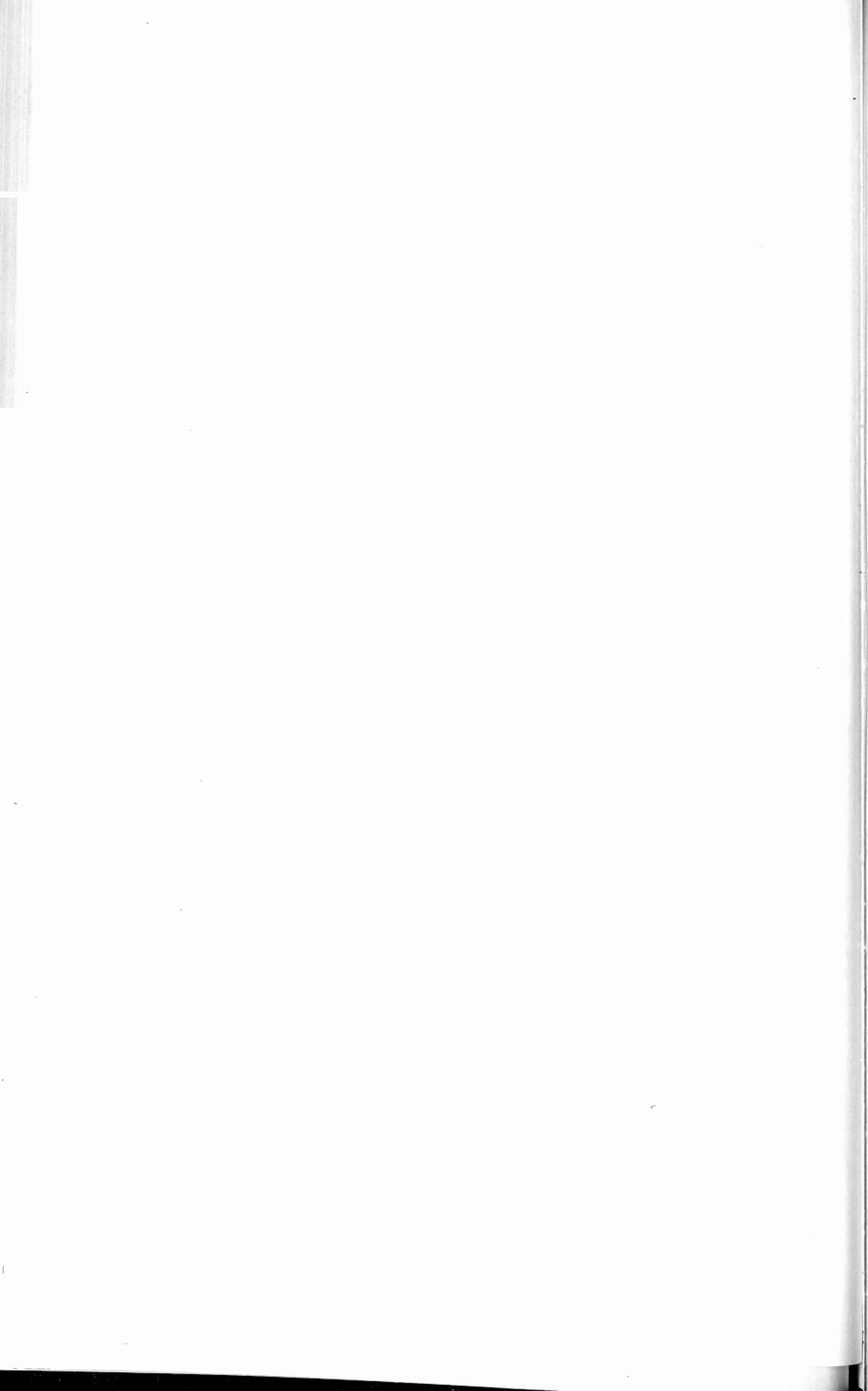

Fig. 28—Landing glide path derived from data given in Fig. 27.

Four points on the graph shown in Fig. 28 are thereby determined. This is the landing path which it was required to find.

A second method for determining the glide curve corresponding to a





given field intensity is indicated in Fig. 29. The field intensities are plotted as abscissas and the altitude of the airplane as ordinates at each 1000 feet of distance from the beam transmitter. The data plotted were obtained experimentally, the field intensity being measured in terms of the deflection of the landing beam indicator. It will be observed that a pilot coming in at an altitude of 1000 feet will observe half-scale deflection of his instrument ( $250 \mu\text{a}$ ) at a distance of approximately 9000 feet from the transmitter. If he then follows the line of constant field intensity corresponding to half-scale deflection on his instrument, he reaches an altitude of 10 feet at a distance of 2000 feet from the beam transmitter. This is actually the point of contact of the airplane with the ground, the receiving antenna being mounted on top of the airplane, 10 feet from the ground.

*b. Directive Transmitting Antenna System.* An ultra high frequency was chosen for the landing beam transmitting system in order to secure the attendant reduction in size and simplicity of equipment. Of a number of directive antenna systems studied, the arrangement developed by Unda and Okabe and described by Yagi,<sup>11</sup> for the production of horizontally polarized directed beams, was considered most suitable. A photograph of the directive antenna array, as set up at College Park, is shown in Fig. 7, above. This was later housed in a shed for protection against weather. The ultra-high-frequency source (93,700 kc) is coupled to the horizontal doublet *A*, (made of one-eighth inch copper tubing) which serves as the radiating antenna and is accurately tuned to the frequency of the source. About 0.8 meter behind the radiating antenna is placed a reflecting antenna *B*, also a horizontal doublet, tuned to a frequency somewhat lower than the frequency of the source. At approximately every meter in front of the radiating antenna, horizontal-doublet directing antennas *C* are placed. These are tuned to a frequency somewhat higher than that of the source. This array of antennas is supported on a horizontal wooden structure *D*, approximately 2.75 meters above the ground, and pivoted on the vertical support *E*. To obtain the vertical directive characteristic shown in Fig. 26 above, the wooden structure *D* was tilted approximately 8 degrees above the horizontal.

*c. The Ultra-High-Frequency Transmitting Circuit Arrangement.* The problem of obtaining sufficient power output on the high frequency used was found to be a rather difficult one. Sufficient radiation was desired to operate a visual indicating device at a distance of five to eight miles from the source with not more than two tubes in the receiving set.

<sup>11</sup> Hidetsugi Yagi, "Beam transmission by ultra short waves, PROC. I.R.E., 16, 715, 1928.

The necessary power output was secured through the use of a 500-watt three-element tube (General Electric ZP-2) used in the oscillatory circuit shown in Fig. 30. This circuit arrangement has the advantage obtained in the customary short-wave two-tube push-pull circuit where the two-tube capacities are in series, thereby halving the total tube capacity in the circuit. In this new oscillatory circuit the second tube is replaced by a small air condenser *E*, with a capacity about equal to the interelectrode grid-to-plate capacity of the tube. The plate inductance *CD* and the grid inductance *AB* are placed between this condenser and the tube, the leads making the shortest possible connections between these elements of the circuit constituting the inductances. Condenser

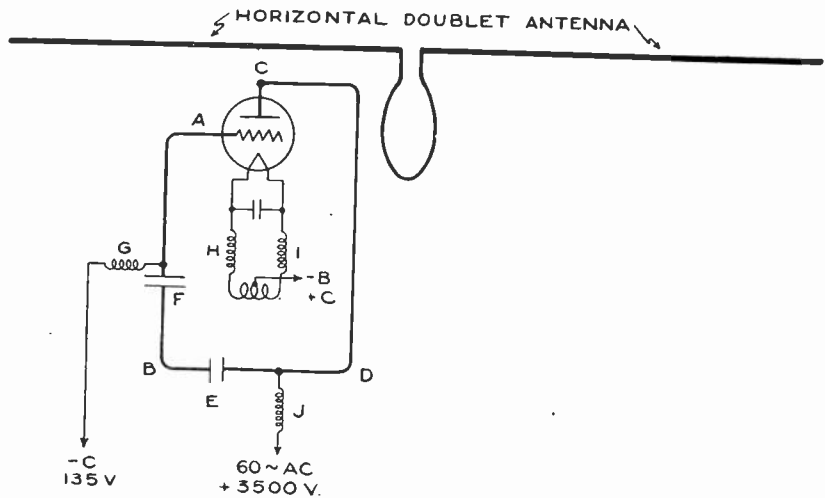

Fig. 30—Circuit diagram of 93,700-ke landing beam oscillator.

*F* is of relative large capacity and is necessary only as a safety measure in case of flashover of condenser *E*. *G*, *H*, *I*, and *J* are suitable choke coils to keep the oscillatory current out of the power supply leads.

Fig. 31 shows the 500-watt tube and associated apparatus including the horizontal doublet radiating antenna. The tube is operated with 3500 volts of 60-cycle frequency on the plate and a negative grid bias of about 135 volts. The tube circuit is tuned to the desired frequency within narrow limits by moving one of the plates of condenser *E* by means of an insulated adjustment screw. The frequency has proved sufficiently stable for use without external means for frequency control, due in part to the fact that but one broadly tuned circuit is used at the receiving end.

*d. The Receiving System.* Considerable time was devoted to the development of a simple and reliable receiving system for giving visual re-

ception of the directed beam up to a distance of five to eight miles. Early in the work it was found that by placing a receiving tube in the center

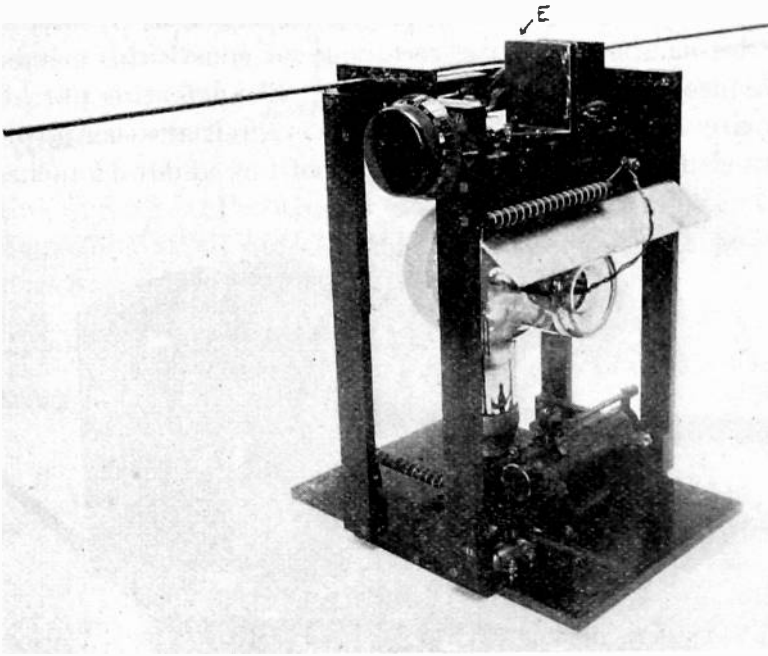

Fig. 31—Electron tube oscillator and radiating antenna for the 93,700-ke landing beam. Shown at A, Fig. 7.

of a horizontal doublet antenna, rather broad tuning was obtained. This was quite desirable since slight changes in the transmitting fre-

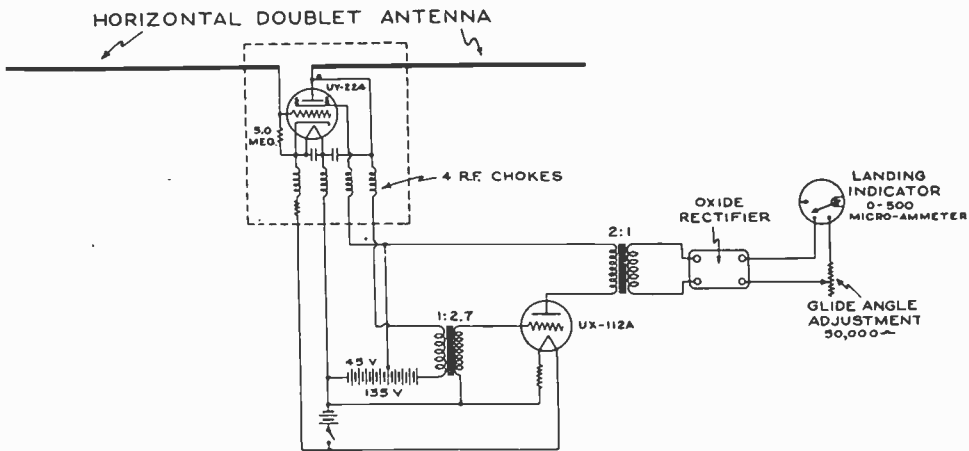

Fig. 32—Circuit diagram of special ultra-high-frequency landing beam receiving set.

quency or receiving antenna constants then had no effect on the deflection of the receiving indicating instrument.

The circuit arrangement finally found to be the most stable and reliable as well as sensitive (see Fig. 32) uses only two tubes without regeneration. This receiving circuit requires no adjustments on the part of the pilot. Even the volume control is dispensed with, since the path followed during the use of the receiving set constitutes a line of constant field intensity of the directed beam. The detecting portion of the receiving circuit (within the dotted lines) is external to the airplane, being mounted in a streamline weatherproof box about 14 inches above

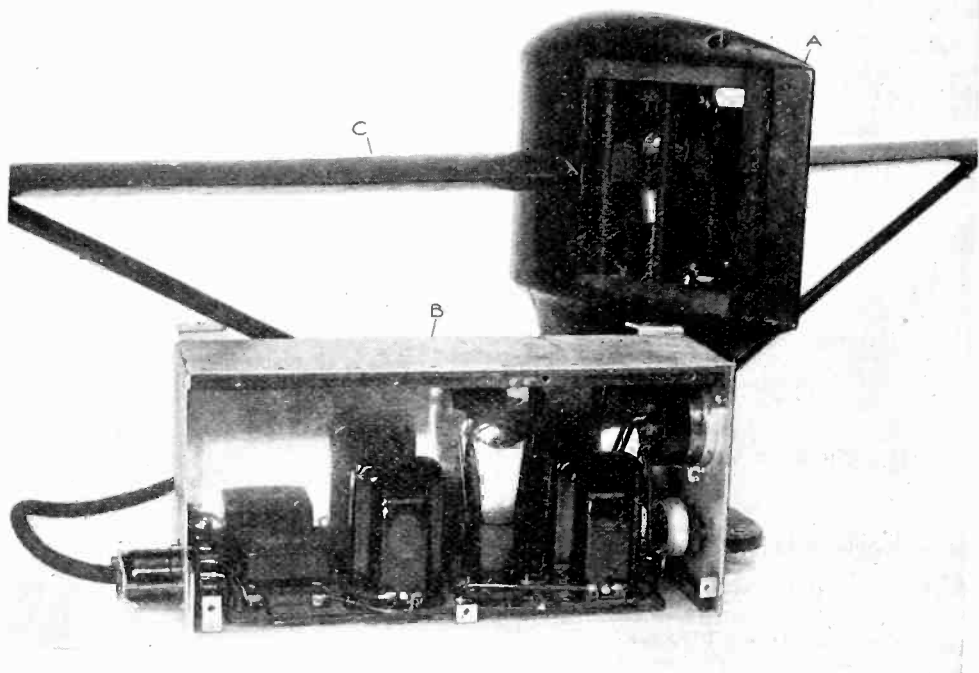

Fig. 33—Special receiving set for receiving landing beam signals. The detector unit is shown at *A* and the amplifier-rectifier unit at *B*, and the horizontal doublet antenna at *C*.

the top wing (see Fig. 8). The doublet antenna is in the form of two copper rods housed in wooden streamlined supports projecting from the streamlined detector box. The rest of the apparatus which includes the audio amplifying tube and transformer, oxide rectifier, *A* and *B* batteries, and indicating instrument, are located within the airplane.

Fig. 33 at *A* shows an inside view of the streamlined detector box. The amplifier-rectifier unit is shown in Fig. 33 at *B*. The oxide rectifier shown eliminates one tube and has been found perfectly stable in its operation at the low frequency employed.

A 224 heater-type screen-grid tube is employed for the detector, to afford the necessary high amplification without undue microphonic

noises. To obtain good efficiency it was found desirable to connect the detector tube directly in the center of the horizontal doublet antenna. The detector tube was, therefore, located about an inch from the center of the antenna. The radio-frequency portion of the circuit is confined to the section above the four radio-frequency chokes. (See Fig. 32.) The four leads running from the lower side of these chokes carry either direct current or the received audio modulation. The streamlined detector box and antenna system is arranged to plug in electrically to the supporting upright on the wing, a five-terminal plug making the necessary connections. The supporting upright also makes a plug connection to a socket in the wing.

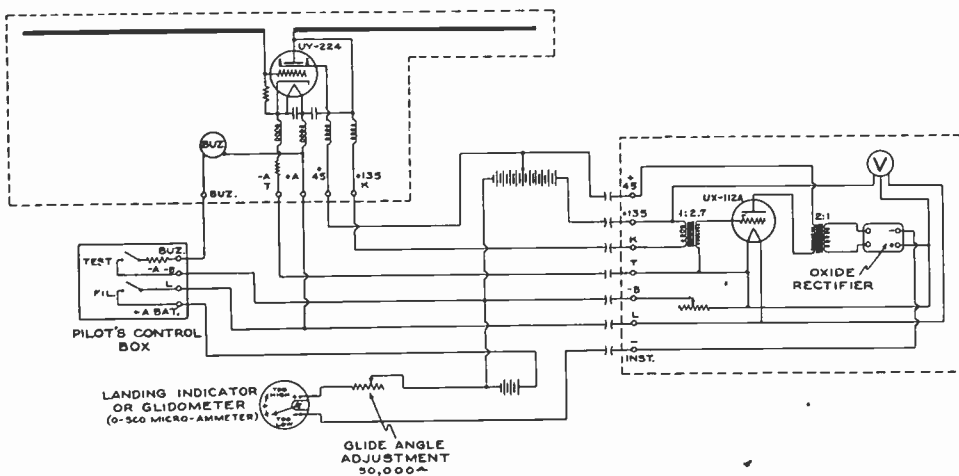

Fig. 34—Complete wiring diagram for the special landing beam receiving set.

Fig. 34 shows the complete wiring diagram for the landing beacon receiver. It will be noted that the pilot has a small control box with a switch for controlling the receiving set filaments and a push button which operates a buzzer mounted in the detector box. The purpose of this buzzer is to produce a signal which operates the microammeter, provided the complete receiver is functioning properly. This button is pressed once before each landing to insure that the receiving set is functioning properly.

## V. PRACTICAL APPLICATIONS

The practicability of the radio system of blind landing aids described has been partially demonstrated in numerous test flights on the Bureau's experimental airplane. No difficulty has been experienced in following both the runway localizing beacon and the landing beam indications simultaneously. These tests have, however, all been made un-



der conditions of good visibility, the Bureau's airplane not being adapted for "blind" flying work. Arrangements are now being made for actual blind landing tests, the results of which, it is felt, will completely demonstrate the feasibility of the system.

Even in its simplest arrangement, (see Fig. 6) which does not take care of wind direction, this system should have numerous applications to scheduled flying. It should successfully prevent practically all interruptions to scheduled service due to dense fog, since fog is rarely accompanied by strong winds. Under special conditions of low visibility (for example, when the airport has a ceiling of 100 feet or more), the system may be used as an aid to landing regardless of wind conditions. A particularly interesting application consists of the use of this system for complete or partial blind landing on seadromes or on airplane carriers, where the landing deck can at all times be oriented into the wind. A large number of conditions exist where a partial use of the system described appears practicable. The runway localizing beacon, in particular, seems to have possibilities of extensive use. This was demonstrated in the tests at Mitchell Field, under the auspices of the Guggenheim Fund, where a special landing altimeter was employed in conjunction with the localizing beacon.

With the expansion of the system to take care of wind direction as shown in Fig. 16, it is felt that the last great obstacle to flying under any conditions of weather is overcome.

#### VI. ACKNOWLEDGMENT

The authors desire to acknowledge the parts played in this development by their coworkers in the Bureau of Standards. Appreciation of valuable contributions is extended to Lieut. D. H. Stuart, airplane pilot, for skillful flight tests of the system, to W. H. Orton for research incident to the operation of the landing transmitting and receiving apparatus, to W. S. Hinman for research in the design and construction of the automatic volume control and filter units, and to F. G. Kear and R. M. Green for field installations and tests. Special acknowledgment is due to Colonel H. H. Blec, Director of Aeronautic Development, Aeronautics Branch, and Dr. J. H. Dellinger, Chief of the Radio Section, Bureau of Standards, for many helpful suggestions during the progress of the work.



## AN ANALYSIS OF A PIEZO-ELECTRIC OSCILLATOR CIRCUIT\*

By

LYNDE P. WHEELER

(Naval Research Laboratory, Bellevue, Anacostia, D. C.)

**Summary**—*In this paper there is presented a mathematical analysis of a crystal "oscillator" circuit based on the suppositions:*

(a) *that the oscillating crystal plate may be replaced by an equivalent electrical network;*

(b) *that the "oscillation characteristic" of the tube may be represented by a three term nonlinear expression.*

*The principal results are contained in an expression giving the resulting a-c plate voltage as a function of the plate tuning capacity, and the tube and circuit parameters. From this equation certain conclusions are drawn as to the suitable values for these parameters.*

*The principal limitations of the analysis are those due to the assumptions:*

(a) *that the internal grid current is negligibly small;*

(b) *that the resistance drop terms in the differential equation may be neglected in comparison with the reactance drop terms.*

*It is pointed out that while the former assumption does not materially affect the results obtained, the latter, by introducing a certain discontinuity which has no physical counterpart, leaves much to be desired in the interpretation of the results for a certain important range of values of the independent variable.*

### INTRODUCTION

THE success of Van Dyke and others<sup>1</sup> in developing an electrical network which is the equivalent of the crystal plate used as a resonator has led naturally to a study of the self-oscillating circuits which result when the equivalent network is substituted for the crystal plate in the familiar Cady and Pierce oscillator circuits.<sup>2</sup> Up to the present time, all of the studies of this nature which have appeared, although yielding important information as to the functioning of these circuits, have been limited as to quantitative results by the (explicit

\* Decimal classification: R191. Original manuscript received by the Institute, October 25, 1930. Presented (in part) before the U.R.S.I. in Washington, D. C., April 25, 1930. An outline of the analysis together with certain conclusions to be drawn from some of the results was presented to the Philadelphia, Boston, and Washington Sections of the I.R.E. on April 1, April 4, and April 10, 1930, respectively.

<sup>1</sup> Van Dyke, K. S., *Phys. Rev.* 25, 895, 1925, and *Proc. I.R.E.*, 16, 742, 1928; van der Pol, Balth, *Gedenboek, Ned. Ver. voor. Radiotelegrafie*, 293, 1926; Dye, D. W. *Proc. Phys. Soc. (London)*, 38, 399, 1928; Watanabe, Y., *Proc. I.R.E.*, 18, 862, 1930.

<sup>2</sup> Terry, E. M., *Proc. I.R.E.*, 16, 1486, 1928; Wright, J. W., *Proc. I.R.E.*, 17, 127, 1929; Vigoureux, J.E.P., *J.I.E.E.*, 68, 265, 1930; Watanabe, *loc. cit.*

or implicit) assumption of a linear "characteristic" for the thermionic vacuum tube. In this paper an attempt is made to remove this restriction. The method of attack is that used by Appleton and van der Pol in their study of the phenomena of "oscillation hysteresis" in the simple tuned plate self-oscillating circuit,<sup>3</sup> and is an adaptation to circuit problems of the "perturbation" methods of mathematical astronomy.

The piezo-electric oscillator circuit to be discussed is that which has come to be used most commonly as the master circuit of crystal controlled transmitters. It is shown schematically in Fig. 1a and with the Van Dyke equivalent network in Fig. 1b. In the latter figure is shown also (in dotted lines) the essential coupling capacity (the internal grid-plate tube capacity) between the grid and plate oscillatory circuits.

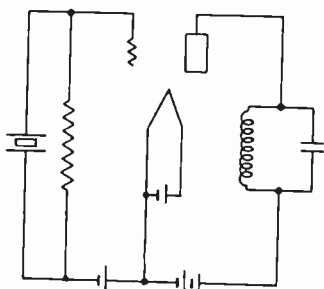

Fig. 1(a)

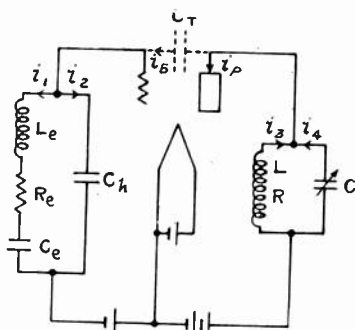

Fig. 1(b)

The other two internal tube capacities are considered to be assimilated into  $C_h$  and  $C$ . No attempt is made to take account of the effect of an air gap which may exist in the crystal holder. To represent this effect adequately another oscillatory circuit coupled to the equivalent crystal circuit would be required, as Dye<sup>4</sup> has pointed out. Although the effect can be taken care of (for frequencies far removed from the supersonic resonant frequency of the air gap) by the device of a third capacity in series with the Van Dyke equivalent network, it has not been thought necessary to add this complication, first because an air gap is not at all necessary for the successful operation of the oscillator, and second, because its presence is immaterial from the standpoint of this investigation whose main interest centers in the effects due to a nonlinear tube characteristic.

#### THE DIFFERENTIAL EQUATION

Referring to Fig. 1b, if we designate by  $e$  and  $v$  the instantaneous a-c voltages on the grid and plate respectively, we have from the Kirchhoff laws,

<sup>3</sup> Appleton and van der Pol, *Phil. Mag.*, 43, 177, 1922.

<sup>4</sup> Dye, *loc. cit.*

$$\begin{aligned}
 i_p + i_5 - i_3 - i_4 &= 0 & \frac{i_5}{C_T} + \frac{i_2}{C_h} + \frac{i_4}{C} &= 0 \\
 i_5 - i_1 - i_2 &= 0 \\
 e &= - \left( L_e p + R_e + \frac{1}{C_e p} \right) i_1 = - \frac{i_2}{C_h p} \\
 v &= - (L_p + R) i_3 = - \frac{i_4}{C_p}
 \end{aligned}$$

where  $p = d/dt$ , and the internal a-c grid current is neglected. This latter limitation radically simplifies the analysis without modifying the results in any essential feature. By reducing the number of loops of current from three to two, the order of the resulting differential equation is reduced from the sixth to the fourth and consequently one possible frequency is ignored. However, consideration of the magnitude of the current corresponding to this frequency which can exist under possible operating conditions leads to the conclusion that nothing of practical significance is overlooked by the simplification which results from leaving this current out of the analysis.

If now we take the a-c plate current  $i_p$  to be any determinate function  $\phi(v)$  of the a-c plate voltage, we obtain on elimination between the Kirchhoff relations, a fourth order differential equation in  $v$  which may be written

$$a_4 p^4 v + a_3 p^3 v + a_2 p^2 v + a_1 p v + a_0 v + a_3' p^3 \phi(v) + a_1' p \phi(v) = 0, \quad (1)$$

with

$$\begin{aligned}
 a_4 &= LL_e C_e (C_h + C_T) \{ C + C_h C_T / (C_h + C_T) \} \\
 a_3 &= (R_e L + RL_e) C_e (C_h + C_T) \{ C + C_h C_T / (C_h + C_T) \} \\
 a_2 &= L \{ C(C_e + C_h + C_T) + C_T(C_e + C_h) \} + L_e C_e (C_h + C_T) \\
 &\quad + R_e R C_e (C_h + C_T) \{ C + C_h C_T / (C_h + C_T) \} \\
 a_1 &= R \{ C(C_e + C_h + C_T) + C_T(C_e + C_h) \} + R_e C_e (C_h + C_T) \\
 a_0 &= C_e + C_h + C_T \quad a_3' = LL_e C_e (C_h + C_T) \quad a_1' = L(C_e + C_h + C_T)
 \end{aligned}$$

where the terms representing a resistance drop have been omitted in comparison with those retained which represent reactance drops. This commonly used approximation<sup>5</sup> does not affect the order of the differential equation although it introduces a nonphysically existent mathematical discontinuity in the dependent variable for that value of the independent variable at which the reactances vanish.

<sup>5</sup> See, e.g., Appleton and van der Pol, *loc. cit.*

If now (1) is divided through by  $C_e + C_h + C_T$  and the abbreviations

$$C_m = \frac{C_h C_T}{C_h + C_T} \quad (2)$$

$$C_e' = \frac{C_e(C_h + C_T)}{C_e + C_h + C_T} \quad (3)$$

$$C_m' = \frac{C_T(C_e + C_h)}{C_e + C_h + C_T} \quad (4)$$

are introduced, it may be written

$$\begin{aligned} [L(C + C_m)L_e C_e' p^4 + \{L(C + C_m') + L_e C_e' \\ + R_e R C_e'(C + C_m)\} p^2 + 1]v = - [(R_e L_e + R L_e)C_e'(C + C_m)p^3 \\ + \{R(C + C_m') + R_e C_e'\} p]v - [L L_e C_e' p^3 + L p]\phi(v). \end{aligned}$$

If further the equation is divided through by  $L(C + C_m)L_e C_e'$  and the added abbreviations

$$\omega_a^2 = \frac{1}{L(C + C_m)} \quad (5)$$

$$\omega_b^2 = \frac{1}{L_e C_e'} \quad (6)$$

$$q = \frac{C + C_m'}{C + C_m} \quad (7)$$

introduced, it may be written

$$\begin{aligned} \left[ p^4 + \left( \omega_a^2 + q\omega_b^2 + \frac{R_e R}{L_e L} \right) p^2 + \omega_a^2 \omega_b^2 \right] v \\ = - \left[ \left( \frac{R_e}{L_e} + \frac{R}{L} \right) p^3 + \left( \frac{R_e}{L_e} \omega_a^2 + \frac{R}{L} q \omega_b^2 \right) p \right] v \\ - L \omega_a^2 (p^3 + \omega_b^2 p) \phi(v). \quad (8) \end{aligned}$$

#### THE GENERAL SOLUTION

Now if the right-hand side of this equation were not a function of the time that side would vanish and the solution of the equation could be written  $v = v_0 \cos \omega t$ , with  $v_0$  a constant (but indeterminate) amplitude and with

$$\omega^2 = \frac{1}{2} \left[ \omega_a^2 + q\omega_b^2 + \frac{R_e R}{L_e L} \pm \sqrt{\left\{ \omega_a^2 + q\omega_b^2 + \frac{R_e R}{L_e L} \right\}^2 - 4\omega_a^2 \omega_b^2} \right]. \quad (9)$$

If we regard the effect of the right-hand side of (8) to be that of an impressed force acting on a system whose free oscillations are determined by the left-hand side, we can retain the same form for the solution by supposing the amplitude to be "perturbed." By this it is meant that the periodic changes in amplitude are very slow compared with the periods of oscillation as given from (9). That is, in evaluating the derivatives of  $v$  we need not retain derivatives of  $v_0$  beyond the first. Thus we have

$$\begin{aligned}pv &= -v_0\omega \sin \omega t + \cos \omega t pv_0, \\p^2v &= -v_0\omega^2 \cos \omega t - 2\omega \sin \omega t pv_0, \\p^3v &= v_0\omega^3 \sin \omega t - 3\omega^2 \cos \omega t pv_0, \\p^4v &= v_0\omega^4 \cos \omega t + 4\omega^3 \sin \omega t pv_0.\end{aligned}\tag{10}$$

Next, if we assume that  $i_p = \phi(v)$  can be expanded in a Fourier series and that the fundamental terms only need be retained (an assumption justified by the known relative weakness of the upper harmonics), we may write

$$\begin{aligned}\phi(v) &= A_0 + A_1 \sin \omega t + B_1 \cos \omega t, \quad \text{with } A_1 = \frac{2}{T} \int_0^T \phi(v) \sin \omega t dt, \\ \text{and } B_1 &= \frac{2}{T} \int_0^T \phi(v) \cos \omega t dt.\end{aligned}$$

The Fourier coefficients can be evaluated by expressing the a-c plate current as a power series in the voltage; that is,

$$i_p = \phi(v) = \sum_1^{\infty} \alpha_n v^n, \quad n = 1, 2, 3, \dots\tag{11}$$

With this definition of  $\phi(v)$  we have  $A_1 = 0$  and

$$B_1 = \sum_1^{\infty} 2 \frac{1 \cdot 3 \cdot 5 \cdots 2n - 1}{2 \cdot 4 \cdot 6 \cdots 2n} \alpha_{2n-1} v_0^{2n-1}.\tag{12}$$

Hence

$$p\phi(v) = -\omega B_1 \sin \omega t \quad \text{and} \quad p^3\phi(v) = \omega^3 B_1 \sin \omega t.\tag{13}^7$$

Substituting (10) and (13) in (8) yields an equation with both sine and cosine terms, and for this to be satisfied by the assumed solution the coefficients of the sine and cosine terms must vanish separately. This gives the two equations

<sup>7</sup> Here the assumption that the perturbation frequency is small enters again.

$$\left[ \omega^4 - \left( \omega_a^2 + q\omega_b^2 + \frac{R_e R}{L_e L} \right) \omega^2 + \omega_a^2 \omega_b^2 \right] v_0 = \left[ \frac{R_e}{L_e} (3\omega^2 - \omega_a^2) - \frac{R}{L} (3\omega^2 - q\omega_b^2) \right] p v_0 \quad (14)$$

$$\left[ 4\omega^2 - 2 \left( \omega_a^2 + q\omega_b^2 + \frac{R_e R}{L_e L} \right) \right] p v_0 = \left[ \frac{R_e}{L_e} (\omega_a^2 - \omega^2) + \frac{R}{L} (q\omega_b^2 - \omega^2) \right] v_0 + L\omega_a^2 B_1 (\omega_b^2 - \omega^2). \quad (15)$$

Hence, oscillations of *constant* amplitude defined by  $v = v_0 \cos \omega t$  are determined as to frequency by (14) with the right-hand side put equal to zero, that is, the frequencies are given by (9); while the magnitudes of the amplitudes are given by (15) with the left-hand side zero. Writing this in the form  $B_1 + Xv_0 = 0$  ( $X$  a function of the circuit constants only) and inserting the value of  $B_1$  from (12), the equation for the amplitudes can be put in the form

$$\sum_1^{\infty} 2 \frac{1 \cdot 3 \cdot 5 \cdots 2n - 1}{2 \cdot 4 \cdot 6 \cdots 2n} \epsilon_{2n-1} v_0^{2n-1} = 0, \quad (16)$$

where  $\epsilon_1 = \alpha_1 + X$ ,  $\epsilon_3 = \alpha_3$ ,  $\epsilon_5 = \alpha_5$ ,  $\dots$ .

To determine the stability of the constant amplitude oscillation of either frequency we proceed in the usual manner to investigate the condition under which a slightly altered amplitude will tend to return to the equilibrium value. This equilibrium value is determined by (15) which may be written, using the integral form of  $B_1$

$$\frac{2}{T} \int_0^T \phi(v_0 \cos \omega t) \cos \omega t dt + Xv_0 + Yp v_0 = 0$$

where  $X$  and  $Y$  are functions of the circuit constants only. Let the altered amplitude be  $v_0 + \delta v_0$ . Then,

$$\frac{2}{T} \int_0^T \phi \{ (v_0 + \delta v_0) \cos \omega t \} \cos \omega t dt + X(v_0 + \delta v_0) + Yp(v_0 + \delta v_0) = 0.$$

Subtracting,

$$\frac{2}{T} \int_0^T [\phi \{ (v_0 + \delta v_0) \cos \omega t \} - \phi(v_0 \cos \omega t)] \cos \omega t dt + X\delta v_0 + Yp\delta v_0 = 0.$$

<sup>8</sup> Carson, J. R., Proc. I.R.E., 7, 187, 1919. This is equivalent to the "oscillation characteristic" of Appelton and van der Pol, *loc. cit.*, and *Phil. Mag.*, 42, 201, 1921. See also van der Pol, *Rad. Rev.* 1, 701, 1920.

But by definition of a derivative, we have

$$\frac{\phi\{v_0 + \delta v_0\} \cos \omega t - \phi(v_0 \cos \omega t)}{\delta(v_0 \cos \omega t)} = \phi'(v_0 \cos \omega t) = \phi'(v).$$

Hence,

$$\left[ \frac{2}{T} \int_0^T \phi'(v) \cos^2 \omega t dt + X + Yp \right] \delta v_0 = 0.$$

Now if the altered amplitude is always to decrease to the equilibrium value, the rate of change of  $\delta v_0$  must be negative or  $p(\delta v_0) < 0$ . Hence, that this may be so,

$$\frac{2}{T} \int_0^T \phi'(v) \cos^2 \omega t dt + X > 0.$$

But from (11),  $\phi'(v) = \sum_1^\infty n \alpha_n v^{n-1}$ , and therefore, the condition of stability becomes

$$\sum_1^\infty 2(2n - 1) \frac{1 \cdot 3 \cdot 5 \cdots 2n - 1}{2 \cdot 4 \cdot 6 \cdots 2n} \epsilon_{2n-1} v_0^{2n-2} > 0 \tag{17}$$

where,

$$\epsilon_1 = \alpha_1 + X, \quad \epsilon_3 = \alpha_3, \quad \epsilon_5 = \alpha_5, \quad \dots$$

To complete the solution it only remains to evaluate the  $\alpha$ 's. If we denote the amplification constant and conductance of the tube by  $\mu$  and  $G$  respectively we may write the expression for the a-c plate current given by Carson<sup>8</sup> in the form

$$i_p = \frac{1}{n!} \frac{\partial^{n-1} G}{\partial E_p^{n-1}} \left( 1 + \mu \frac{e}{v} \right)^n v^n,$$

where  $E_p$  is the plate voltage. Then from (11)

$$\alpha_n = \frac{1}{n!} \frac{\partial^{n-1} G}{\partial E_p^{n-1}} \left( 1 + \mu \frac{e}{v} \right)^n. \tag{18}$$

Thus, on evaluating  $e/v$  from the Kirchhoff relations, the general solution is obtained. That is, the resulting oscillations will be given by  $v = v_0 \cos \omega t$  with  $\omega$  determined from (9), if the condition (16) is satisfied; and the oscillations will be stable provided the condition (17) is fulfilled.

In order to obtain useful results it is necessary to assume a finite number of terms in the series expansions (16) and (17). If we assume



that the conditions under which the tube is operated can be adequately represented by two terms in these expressions, (i.e., a *three-term* oscillation characteristic), these relations become

$$\epsilon_1 v_0 + \frac{3}{4} \epsilon_3 v_0^3 = 0 \quad \text{and} \quad \epsilon_1 + \frac{9}{4} \epsilon_3 v_0^2 > 0.$$

From the first of these relations it follows that there are two possible amplitudes

$$v_{01} = 0 \quad \text{and} \quad v_{02}^2 = \frac{4}{3} \frac{\epsilon_1}{\epsilon_3}.$$

From the second relation it follows that if  $v_0$  is zero,  $\epsilon_1$  must be greater than zero, and that if  $v_0$  is not zero  $\epsilon_1 + 9/4 \epsilon_3 v_0^2 > 0$ , or  $\epsilon_1 < 0$ .

Thus in terms of the  $\alpha$ 's we have for the two possible amplitudes

$$\begin{aligned} v_{01} = 0 & \quad \text{stable when} \quad \left(1 + \frac{X}{\alpha_1}\right) > 0 \\ v_{02}^2 = -\frac{4}{3} \frac{\alpha_1}{\alpha_3} \left(1 + \frac{X}{\alpha_1}\right) & \quad \text{stable when} \quad \left(1 + \frac{X}{\alpha_1}\right) < 0. \end{aligned}$$

Now from (18)

$$\alpha_1 = G \left(1 + \mu \frac{e}{v}\right) \quad \text{and} \quad \alpha_3 = \frac{G''}{6} \left(1 + \mu \frac{e}{v}\right)^3.$$

Hence we have

$$\left. \begin{aligned} v_{01} = 0 & \quad \text{stable when} \quad \frac{X}{G} > - \left(1 + \mu \frac{e}{v}\right) \\ v_{02} = -\frac{8G/G''}{\left(1 + \mu \frac{e}{v}\right)^2} \left[1 + \frac{X/G}{1 + \mu \frac{e}{v}}\right] & \quad \text{stable when} \quad \frac{X}{G} < - \left(1 + \mu \frac{e}{v}\right) \end{aligned} \right\} \quad (19)$$

Although it is possible to so operate the tube that a three-term oscillation characteristic is not a sufficiently close representation of the actual conditions obtaining,<sup>9</sup> we shall not at this time consider any closer approximation, in view of the approximations already made in the establishment of the differential equation.

It remains then to express  $\omega$ ,  $X$ , and  $1 + \mu e/v$  in terms of the circuit and tube constants. As in the operation of the oscillator the tuning is

<sup>9</sup> See Appleton and van der Pol, *loc. cit.*

customarily effected by variation of the plate circuit condenser ( $C$ ), we shall transform the equations to forms explicit in  $C$  (or a simple function of  $C$ ) as the independent variable.

#### TRANSFORMATION TO $C$ AS INDEPENDENT VARIABLE

We first observe that from (2), (3) and (4)

$$C_m' = C_m + C_e' \left( \frac{C_m}{C_h} \right)^2 \quad (20)$$

and that, therefore, (7) may be written

$$q = 1 + \delta_a \frac{\omega_a^2}{\omega_b^2}, \text{ where } \delta_a = \frac{L}{L_e} \left( \frac{C_m}{C_h} \right)^2. \quad (21)$$

This numerical constant  $\delta_a$  has larger values when the equivalent network represents the higher frequency crystals. The largest value it takes on for the highest frequency crystal plates commonly used is, however, only of the order  $10^{-5}$ . Next we write, utilizing (21)

$$\omega_a^2 + q\omega_b^2 + \frac{R_c R}{L_e L} = \Omega_a^2 + \Omega_b^2,$$

where,

$$\Omega_a^2 = \omega_a^2(1 + \delta_a), \quad \Omega_b^2 = \omega_b^2(1 + \delta_b), \quad \text{and } \delta_b = \frac{R_c R}{L_e L \omega_b^2}. \quad (22)$$

$\Omega_a$  and  $\Omega_b$  may be styled *damped* angular frequencies. The numerical constant  $\delta_b$  has larger values when the equivalent network represents the higher frequency crystals. The largest value it takes on for the highest frequency crystals commonly used is, however, only of the order  $10^{-5}$ .

In terms of (22), (9) becomes

$$\omega^2 = \frac{1}{2} \left[ \Omega_a^2 + \Omega_b^2 \pm \sqrt{(\Omega_a^2 + \Omega_b^2)^2 - \frac{4\Omega_a^2\Omega_b^2}{(1 + \delta_a)(1 + \delta_b)}} \right] \quad (23)$$

If for abbreviation we set

$$\delta = (1 + \delta_a)(1 + \delta_b) \quad (24)$$

and introduce the variables

$$y = \omega^2/\Omega_b^2, \text{ and } x = \Omega_b^2/\Omega_a^2 \quad (25)$$

we may write

$$y = \frac{1 + x \pm \sqrt{(1 - x)^2 + 4 \frac{\delta - 1}{\delta} x}}{2x} \quad (26)$$

Since by (25), (22), and (5)

$$x = \frac{\omega_b^2(1 + \delta_b)}{\omega_a^2(1 + \delta_a)} = L\omega_b^2 \frac{1 + \delta_b}{1 + \delta_a} (C + C_m), \quad (27)$$

(26) gives the frequencies in terms of the desired variable. It will be more convenient, however, to use the frequency ratios  $y$  and  $x$  instead

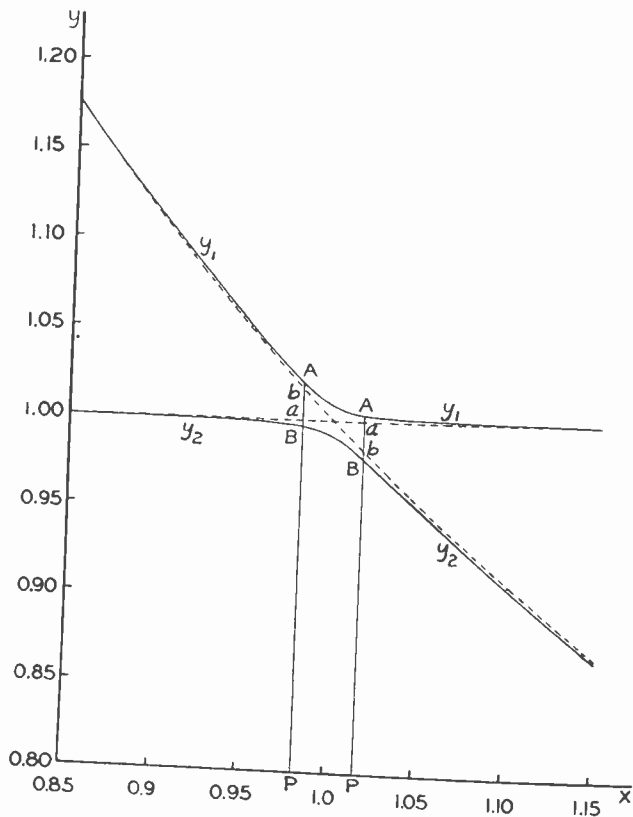

Fig. 2

of the frequencies themselves. A plot of (26) for the region in the neighborhood of  $x = 1$  (which, as will presently appear, is the region in which we are mainly interested) is shown in Fig. 2. The full lines are for a value of  $\delta = 0.000075$  and the dotted lines for  $\delta = 0$ . The curves designated  $y_1$  correspond to the positive and those designated by  $y_2$  to the negative sign in the numerator of (26). The equations of the dotted curves are:

$$y_1 = \frac{1}{x} \quad \text{and} \quad y_2 = 1, \quad \text{valid for } x < 1$$

and,

$$y_1 = 1 \quad \text{and} \quad y_2 = \frac{1}{x}, \quad \text{valid for } x > 1.$$

The question next arises as to which of the two frequencies (or  $y$ 's) given by (26) is effective for a given  $C$ (or  $x$ ). This may be most conveniently answered by a consideration of the magnitude of the effective resistance of the circuit for each frequency when that circuit is viewed as an oscillation transformer, as shown in Fig. 3. That is, we shall suppose the voltages removed from the tube and determine the

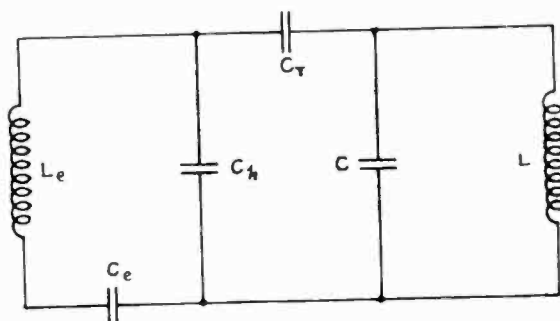

Fig. 3

effective resistance when the circuit is driven from an outside variable frequency source. For this purpose, it will suffice to neglect the d-c resistances of the coils, and we find (by the method of E. Bellini,<sup>10</sup> e.g.) that the resonant "coupling" frequencies are given by

$$(\omega^2 - \omega_1^2)(\omega^2 - \omega_2^2) = k^2 \omega_1^2 \omega_2^2$$

where,

$$\omega_1^2 = \frac{1}{L_e C_1'}, \quad \omega_2^2 = \frac{1}{L C_2'}, \quad C_1' = \frac{C_e'(C + C_m)}{C + C_m'}$$

$$C_2' = C + C_m, \quad k^2 = \left(\frac{C_m}{C_h}\right)^2 \frac{C_1'}{C_2'} = \frac{L}{L_e} \left(\frac{C_m}{C_h}\right)^2 \frac{\omega_2^2}{\omega_1^2}.$$

By (5), (6), (7) and (21) we have

$$\omega_1^2 = q\omega_b^2 = \omega_b^2 + \delta_a \omega_a^2, \quad \omega_2^2 = \omega_a^2, \quad k^2 = \frac{\delta_a \omega_a^2}{\omega_b^2 + \delta_a \omega_a^2}$$

<sup>10</sup> E. Bellini, *La Lumiere Électrique*, 32, 241, 1916.

which yield for the "coupling" frequencies (with the aid of (22))

$$(\omega^2 - \omega_b^2)(\omega^2 - \Omega_a^2) = \delta_a \omega_a^2 \omega_b^2. \quad (23)'$$

Now this is precisely what (23) becomes on setting  $\delta_b = 0$ . Hence, we see that the possible "emitted" frequencies of the circuit as an oscillator are the same as its resonant "coupling" frequencies as a transformer.

The apparent or effective resistance of this transformer is given by

$$R' = R_e + \frac{k^2}{C_1' C_2' \omega^2} \cdot \frac{R_2}{Z_2^2}$$

which becomes to a sufficient approximation

$$\begin{aligned} R' &= \frac{k^2}{C_1' C_2' \omega^2} \cdot \frac{R_2}{X_2^2} = \frac{k^2}{C_1' C_2' \omega^2} \cdot \frac{R C_2'^2 \omega^2 \omega_2^4}{(\omega^2 - \omega_2^2)^2} \\ &= R \frac{C_2'}{C_1'} \cdot \frac{k^2 \omega_2^4}{(\omega^2 - \omega_2^2)^2} = R \frac{L_e}{L} \cdot \frac{\omega^2 - \omega_1^2}{\omega^2 - \omega_2^2}. \end{aligned}$$

On inserting the values of  $\omega_1^2$  and  $\omega_2^2$  we obtain

$$R' = R \frac{L_e}{L} \frac{\omega^2 - \omega_b^2 + \delta_a \omega_a^2}{\omega^2 - \omega_a^2}.$$

This becomes in terms of  $x$  and  $y$  by (25)

$$R' = R \frac{L_e}{L} \frac{(1 + \delta_a)(y - 1) + \delta_a/x}{(1 + \delta_a)y - 1/x}$$

which since  $\delta_a$  is of the same order of magnitude as the  $\delta_b$  which we have already neglected, may be written

$$R' = R \frac{L_e}{L} \frac{y - 1}{y - 1/x}.$$

This equation can be most conveniently interpreted graphically in the manner described by Townsend for the case of the magnetically coupled oscillation transformer.<sup>11</sup> Since in Fig. 2 the dotted curve represents the values of  $1/x$ , we may write the equation in terms of the ordinates of that figure for

$$y = y_1, \quad R' = R \frac{L_e}{L} \frac{PA - Pa}{PA - Pb} = R \frac{L_e}{L} \frac{Aa}{Ab},$$

<sup>11</sup> J. S. Townsend, *Rad. Rev.*, 1, 369, 1920.

and for

$$y = y_2, \quad R' = R \frac{L_e}{L} \frac{PB - Pa}{PB - Pb} = R \frac{L_e}{L} \frac{Ba}{Bb}$$

Therefore,

$$\frac{(R')_{\nu-\nu_1}}{(R')_{\nu-\nu_2}} = \frac{Aa}{Ba} \cdot \frac{Bb}{Ab},$$

and inspection of Fig. 2 shows that

for  $x < 1$ ,  $(R')_{\nu-\nu_1} > (R')_{\nu-\nu_2}$ ; while for  $x > 1$ ,  $(R')_{\nu-\nu_1} < (R')_{\nu-\nu_2}$ .

Hence, for  $x < 1$ ,  $y_2$  gives the effective frequency, while for  $x > 1$  the effective frequency is determined from  $y_1$ . The operating frequency thus follows the  $y_2$  curve as  $x$  (or  $C$ ) is increased until  $x = 1$  when there occurs a sudden discontinuous increase in frequency to the  $y_1$  curve after which the frequency follows the  $y_1$  curve with increasing  $x$ . Factors which have been neglected in this analysis (principally the neglect of the resistance drop terms in the differential equation) will tend to smooth out this discontinuity, and cause the phenomenon to be interpreted experimentally as a small maximum in the frequency-capacity curve.

We next proceed to obtain an expression for  $X$  in terms of  $x$ . From (15) we have for the condition for stationary amplitude, utilizing (21),

$$X = \frac{R}{L^2} \frac{1}{\omega_b^2 - \omega^2} \left[ \frac{R_e L}{R L_e} \frac{\omega_a^2 - \omega^2}{\omega_a^2} + \frac{\omega_b^2 - \omega^2}{\omega_a^2} + \delta_a \right].$$

Setting  $R_e L / R L_e = \rho$  (28), where  $\rho$  is a numerical constant which is in practice of the approximate order  $(10)^{-1}$ , this may be written

$$X = \frac{R}{L^2 \omega_b^2} \frac{1}{1 - \omega^2 / \omega_b^2} \left[ \rho + \delta_a + \frac{\omega_b^2}{\omega_a^2} - \frac{\omega^2}{\omega_a^2} (1 + \rho) \right].$$

Now from (22), (25), and (27) we have

$$\frac{\omega^2}{\omega_b^2} = y(1 + \delta_b), \quad \frac{\omega_5^2}{\omega_a^2} = x \frac{1 + \delta_a}{1 + \delta_b}, \quad \text{and} \quad \frac{\omega^2}{\omega_a^2} = xy(1 + \delta_a).$$

Hence, we may write

$$X = \frac{R}{L^2 \omega_5^2} \cdot F \tag{29}$$

Where,

$$F = \frac{\rho + \delta_a + x \frac{1 + \delta_a}{1 + \delta_b} - xy(1 + \delta_a)(1 + \rho)}{1 - y(1 + \delta_b)} \quad (30)$$

The plot of this equation is shown in Fig. 4. The left-hand branch is obtained with  $y = y_2$  and the right-hand branch with  $y = y_1$ . There is a small discontinuous jump in the value of  $F$  at  $x = 1$  corresponding

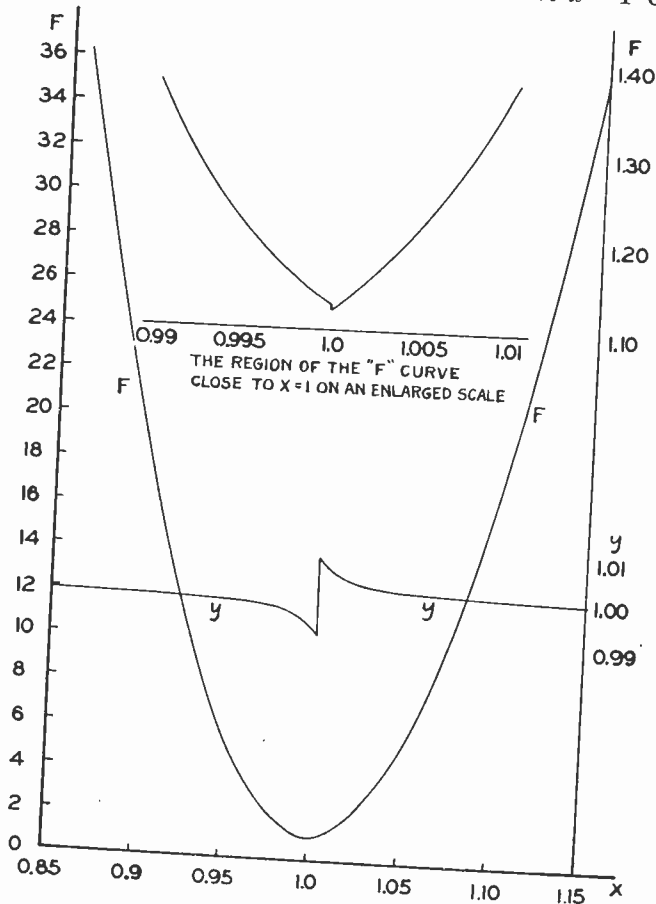

Fig. 4

to the sudden change in frequency at that point. The curve of effective frequencies is repeated in this figure from Fig. 2 to illustrate this point. This discontinuity in  $F$ , like that in the frequency curve would be smoothed out if the neglected factors before mentioned were taken into account.

Lastly we have to express  $1 + \mu e/v$  in terms of  $x$ . From the Kirchhoff relations we obtain with aid of (2) and (3)

$$\frac{e}{v} = \frac{C}{C_h} \frac{i_2}{i_4} = - \frac{C_m}{C_h} \frac{C_e'/C_e + R_e C_e' p + L_e C_e' p^2}{1 + R_e C_e' p + L_e C_e' p^2}$$

etting  $p = j\omega$ , ( $j = \sqrt{-1}$ ), and utilizing (6), we have

$$\frac{e}{v} = - \frac{C_m (C_e'/C_e - \omega^2/\omega_b^2) + jR_e\omega/L_e\omega_b}{C_h (1 - \omega^2/\omega_b^2) + jR_e\omega/L_e\omega_b}$$

Rationalizing and transforming to the polar form of the complex quantity, we get on rejection of the imaginary part

$$\frac{e}{v} = - \frac{C_m (C_e'/C_e - \omega^2/\omega_b^2)(1 - \omega^2/\omega_b^2) + (R_e\omega/L_e\omega_b)^2}{C_h (1 - \omega^2/\omega_b^2)^2 + (R_e\omega/L_e\omega_b)^2}$$

With  $e$  leading  $-v$  by an angle  $\theta$  given by

$$\text{tg}\theta = \frac{(1 - C_e'/C_e)R_e\omega/L_e\omega_b}{(C_e'/C_e - \omega^2/\omega_b^2)(1 - \omega^2/\omega_b^2) + (R_e\omega/L_e\omega_b)^2}$$

Since from (2) and (3)

$$C_e'/C_e = 1 - C_e'C_m/C_T C_h$$

we may write

$$\frac{e}{v} = - \frac{C_m}{C_h} \left[ 1 - \frac{(1 - \omega^2/\omega_b^2)C_e'C_m/C_T C_h}{(1 - \omega^2/\omega_b^2)^2 + (R_e\omega/L_e\omega_b)^2} \right]$$

and

$$\text{tg}\theta = \frac{\frac{R_e C_e' C_m \omega}{L_e C_T C_h \omega_b}}{(1 - \omega^2/\omega_b^2)^2 + (R_e\omega/L_e\omega_b)^2 - (1 - \omega^2/\omega_b^2)C_e'C_m/C_T C_h}$$

Hence, on inserting the value of  $\omega^2/\omega_b^2$ , we obtain

$$1 + \mu \frac{e}{v} = 1 - \mu \frac{C_m}{C_h} (1 - \sigma),$$

where

$$\sigma = \frac{\{1 - y(1 + \delta_b)\} C_e' C_m / C_T C_h}{\{1 - y(1 + \delta_b)\}^2 + (R_e/L_e)^2 y(1 + \delta_b)}, \tag{31}$$

and

$$\text{tg}\theta = \frac{\frac{R_e C_e' C_m}{L_e C_T C_h} \sqrt{y(1 + \delta_b)}}{\{1 - y(1 + \delta_b)\}^2 + (R_e/L_e)^2 y(1 + \delta_b) - \{1 - y(1 + \delta_b)\} C_e' C_m / C_T C_h}$$

Now over the range of values of  $x$  in which we are interested  $\sigma$  is of the order  $10^{-13}$ . Hence, to a very close approximation we may write

$$1 + \mu \frac{e}{v} = 1 - \mu \frac{C_m}{C_h} \tag{31}'$$



To the same approximation  $t_0\theta$  is constant through this range of values of  $x$  and is of the order of  $10^{-8}$ . That is,  $e$  and  $v$  differ (to a very close approximation) by 180 degrees in phase.

Hence, substituting the value of  $X$  from (29) and that of  $1 + \mu e/v$  from (31), in (19), we have for the three-term characteristic

$$\left. \begin{aligned} v_{01} &= 0 && \text{stable when } F > -H \\ v_{02}^2 &= -\frac{8G/G''}{\left[1 - \mu \frac{C_m}{C_h}(1 - \sigma)\right]^2} \left[1 + \frac{F}{H}\right] && \text{stable when } F < -H \end{aligned} \right\} \quad (33)$$

where

$$H = \frac{GL^2\omega_b^2}{R} \left[1 - \mu \frac{C_m}{C_h}(1 - \sigma)\right] \quad (34)$$

#### DISCUSSION

We observe first that since  $F$  is positive, in order for stability condition  $F < -H$  to hold,  $H$  must be negative. As each of the quantities in (34) is essentially positive (for normal use of the tube), this requires that

$$\mu \frac{C_m}{C_h}(1 - \sigma) > 1, \quad (35)$$

which in view of the magnitude of  $\sigma$  becomes for practical purposes

$$\mu \frac{C_m}{C_h} > 1. \quad (36)$$

We next observe that in order for  $v_{02}$  to be real,  $G$  and  $G''$  must have opposite algebraic signs. Now for the normal operation of the tube  $G$  is positive. Hence  $G''$  must be negative. Setting then

$$H_0 = -H = \frac{GL^2\omega_b^2}{R} \left(\mu \frac{C_m}{C_h} - 1\right), \quad G_0'' = -G'',$$

and

$$v_m^2 = \frac{8G/G_0''}{\left(\mu \frac{C_m}{C_h} - 1\right)^2} \quad (37)$$

we have

$$\left. \begin{aligned} v_{01} &= 0 && \text{stable when } F > H_0 \\ v_{02}^2/v_m^2 &= 1 - F/H_0 && \text{stable when } F < H_0 \end{aligned} \right\} \quad (38)$$

The plot of (38) is shown in Fig. 5, where the effective frequency and "F" curves are repeated from Figs. 2 and 4. This shows that as the capacity (or  $x$ ) is increased from very small values, there is no effective voltage in the plate circuit until that value of  $x$  is reached for which  $F=H$ . At this point the voltage rapidly rises to a maximum at  $x=1$  after which it falls off rapidly becoming again zero for the second value of  $x$  corresponding to  $F=H$ . Within these limits  $v_{02}$  is stable,

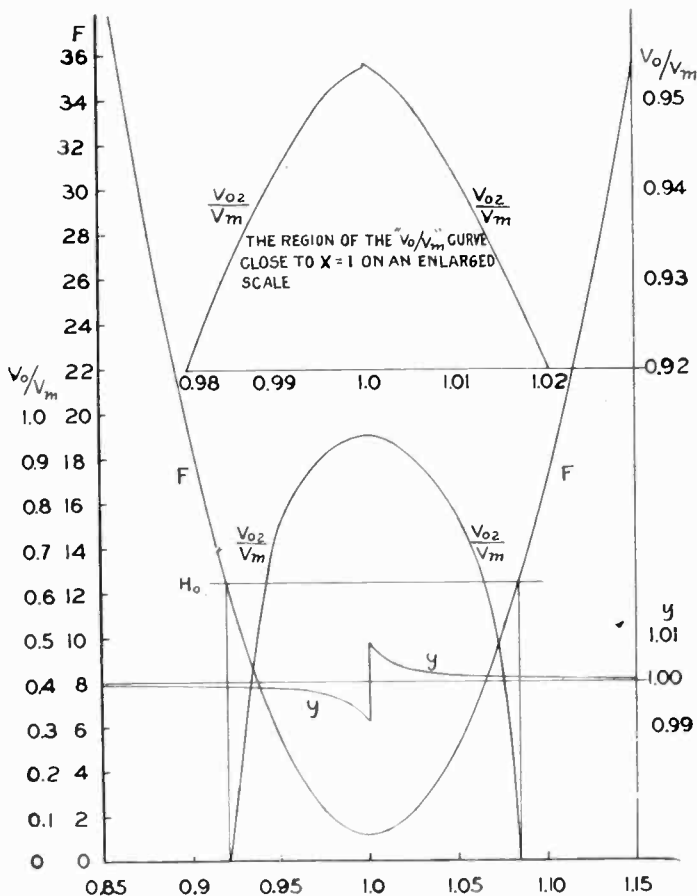

Fig. 5

while outside of them  $v_{01}$  is stable. It will be observed that there is a small discontinuity in the " $v_{02}/v_m$ " curve occurring at  $x=1$ , corresponding to those in the "Y" and "F" curves. As pointed out before it should be understood that these discontinuities do not have a real physical existence, but appear only on account of the approximate nature of the analysis.

To compare in more detail the results of the theory with the experimentally known behavior of the oscillator, the next step would naturally be to deduce the plate, "crystal," and "tank" current curves

from the Kirchhoff relations in terms of the already determined voltage curve. When this is done, it is found that the a-c plate current comes to its maximum at a value of  $x$  less than unity,<sup>12</sup> while the maxima of the other two occur at values of  $x$  very nearly equal to unity. The expressions for the two last named currents depend so markedly on the value of  $y$  that, in view of the fact that the values of this quantity yielded by the present theory in the neighborhood of  $x=1$  cannot be expected to correspond sufficiently closely to reality, it does not seem worth while to reproduce the equations. In so far as it is competent, however, the results of the analysis agree with the experimental facts, first in showing that oscillations exist only over a limited range of variation of the plate tuning condenser, and second that the plate current maximum occurs *before* the maxima of "crystal" or "tank" currents as the tuning condenser is increased in capacity.

We also observe that the range of values of  $x$  for which a stable finite amplitude exists is smaller, the smaller the value of  $H_0$ . Hence, from (37) it is to be concluded that to obtain a "sharp" tuned circuit with a given crystal ( $\omega_b$  fixed), we should (1) use a plate coil having a small  $L/R$  ratio, (2) employ a tube having a low conductance (or reduce the tube conductance by using a reduced plate voltage), and (3) aim to make  $\mu C_m/C_h$  approach the value unity.

For a given tube ( $\mu$  and  $C_T$  fixed), this last condition may be met by an adjustment of the crystal holder capacity to a value a little less than that given by

$$C_h = C_T(\mu - 1).$$

For a given crystal mounting the same considerations give us an indication as to the type of tube to employ. Thus, as for a crystal in the 4-megacycle band,  $C_h$  may be of the order of  $40\mu\mu\text{f}$ , it follows that an oscillator employing a tube of the UX-210 type with  $\mu=8$  and  $C_T=8\mu\mu\text{f}$  will give sharper tuning than one employing a tube of the UX-211 type with a  $\mu=12$  and  $C_T=15\mu\mu\text{f}$ . To make the performance of the two tubes comparable with regard to sharpness of tuning it would be necessary to supply in the latter case an additional capacity in parallel with the crystal. Similarly, for a low-frequency crystal (say 500 kc) where  $C_h$  may be as small as  $10\mu\mu\text{f}$ , we may conclude that the "low- $\mu$ " tubes will in general provide the sharper tuned circuits, and also that a capacity in parallel with the crystal will be more effective in improving the performance in this respect than in the case of the high-frequency crystals.

<sup>12</sup> For the values assumed in obtaining the curves given in the figures, this maximum occurs at a value of  $x$  which is approximately equal to 0.96.

Two precautions should be borne in mind, however, in adjusting the holder capacity to give improved sharpness of tuning. First, it *may* be necessary in some cases to introduce series capacity. This will occur for tubes having both  $\mu$  and  $C_T$  so small that  $(\mu - 1) C_T$  is less than  $C_h$ . And second, the added parallel capacity must not be great enough to affect appreciably the excitation voltage at the grid, or oscillations will cease. With these limitations it is found that the above mentioned indications of the theory are fulfilled in practice, at least qualitatively. The same is true with respect to the theoretical predictions as to the effects of the magnitude of the plate inductance and the tube conductance.

A more important consideration is the frequency stability to be expected. Before this can be discussed, we must arrive at an acceptable definition of this quantity. If, as seems natural, it is defined by

$$S = \frac{d\omega/\omega}{dC/(C + C_m)} = \frac{1}{2} \frac{dy/y}{dx/x},$$

we are confronted with the necessity of selecting some particular value of  $x$  at which to specify it, as  $S$  is obviously a function of  $x$ . From practical considerations the points which it would be natural to select would be either the value of  $x$  which makes the "crystal" current a maximum, or the value yielding a maximum "tank" current. Now, unfortunately, as has been pointed out above, both of these maxima occur in the region of values of  $x$  where the present approximate analysis gives values of the dependant variables which cannot correspond to reality. That however the present theory, in so far as it is competent, is in accord with experiment, is indicated by the values of  $S$  found for values of  $x$  more remote from  $x = 1$ . Thus for  $x = 0.96$  (the approximate position for the maximum of a-c plate current in the example chosen for the figures) we find  $S = 0.02$ . That is, if with  $C$  set to give this maximum, we increase it by one part in a thousand, the frequency will be decreased by two parts in one hundred thousand; a change both in direction and magnitude which agrees with experimental experience.

To sum up: It seems fair to conclude that Van Dyke equivalent network is capable of giving an adequate representation of the crystal oscillator considered, when a nonlinear tube characteristic is taken into account. While this conclusion is qualitatively certain, it does not appear to be possible to complete the picture quantitatively except by the inclusion in the differential equation of those resistance drop terms which are customarily neglected. While the solution of the equation with these terms included is by no means an impossible task, it will be nevertheless a laborious one algebraically, and hence, although the

author hopes that before long he will be able to present the more complete solution, yet in view of the uncertainties attending the command of sufficient leisure for the purpose, he ventures to hope that the present incomplete picture may not be without value.



## ALTERNATING-CURRENT MEASURING INSTRUMENTS AS DISCRIMINATORS AGAINST HARMONICS\*

BY

IRVING WOLFF

(RCA-Victor Company, Camden, N. J.)

*Summary*—Alternating-current measuring instruments are classified and a brief description of a method for obtaining each one of them is given. They are then discussed from the standpoint of the increase in reading which can be caused by harmonics added to the pure tones. It is shown that, under certain conditions, the linear detector may be superior to other forms of alternating-current instruments in that the increase due to harmonics is the smallest, whereas the full-wave square-law detector or energy measuring device has the unique superiority of having an increase which is independent of the phase relations between the fundamental and the harmonics and between the harmonics themselves.

WHEN making many alternating-current measurements, if a simple harmonic input is introduced into a system where a certain amount of amplitude distortion takes place, or if the attainment of a sufficiently pure input is inconvenient, it is more important to know the amount of fundamental which is produced than the total output. If the measuring instrument discriminates sufficiently against the harmonics it will not be necessary to purify the output. It is the purpose of this discussion to determine the extent to which some of the alternating electrical measuring instruments commonly in use do this.

### CLASSIFICATION OF ALTERNATING-CURRENT MEASURING INSTRUMENTS

We shall limit ourselves in this study to the following instruments:

- (1) Square-law detector (energy measuring device).
- (2) Half-wave square-law detector (output proportional to square of input for all positive values—zero for all negative values).
- (3) Linear detector (output proportional to input for all positive values—zero or proportional to input with a different factor for all negative values).
- (4) Peak reading voltmeter.

Thermal meters, in which the resistance remains essentially constant up to the peak current value, come under class (1). A vacuum tube detector will come under this class, if the entire part of the characteristic swept over by the alternating current gives a response of the

\* Decimal classification: R389. Original manuscript received by the Institute, May 24, 1930. Presented before U. R. S. E., April 25, 1930, Washington, D. C.

form  $I_p = A + Be + Ce^2$  where  $A$ ,  $B$ , and  $C$  are constants and  $e$  is the instantaneous value of the alternating potential to be measured. A grid-bias detector in which the bias is not made negative enough so that the negative swing reaches the neighborhood of the plate current cut-off point illustrates this type.

The grid-bias detector as ordinarily used approximates class (2). The negative  $c$  bias is sufficient to reduce the plate current almost to zero, while on the positive part of the swing it is almost proportional to the square of the input potential. The operating range of this instrument is limited to the maximum value of the alternating current for which the grid becomes positive.

Several methods have been suggested for constructing a linear detector with the use of vacuum tubes. In one type, the tube is used as a two-element device. In another type, the plate potential on the tube is made small, and sufficient amplification is used ahead of the detector so that the voltage impressed will keep the grid positive over the larger part of one-half of the current cycle. The insertion of the proper resistance in series with the grid then gives a practically linear characteristic.

The peak reading voltmeter is illustrated by a vacuum tube device in which the grid bias is first adjusted so that the plate current is almost zero, and then, after the alternating current is impressed on it, this bias is again adjusted so that the plate current reads the same as it did previously. The additional negative voltage, which it was necessary to impress on the grid, gives the peak voltage of the impressed alternating current.

#### THE DETECTION OF IMPURE WAVES

A calculation of the power available in an alternating current shows that it is proportional to  $\sum_{i=1}^{i=n} A_i^2$  where  $A_i$  is the amplitude of any harmonic, the subscript 1 being used for the fundamental. This expression contains merely the amplitudes and not the phase relations of the components. The deflection of a true square-law detector is, therefore, independent of these phase relations and only dependent on the magnitude of the harmonic components.

The square-law detector will usually be calibrated to read on a scale which is proportional to the square root of the energy. Using the same notation as in the last paragraph, the output for a pure tone is proportional to  $A_1$  and for an impure tone will be proportional to  $\sqrt{A_1^2 + A_2^2 + \dots + A_n^2}$ . When the total harmonic content is not too large, that is, when the square root of the sum of the squares of the harmonic

amplitudes is not greater than one-half that of the fundamental amplitude, the fractional increase due to the harmonics is nearly equal to  $\frac{1}{2} (A_2^2 \cdots A_n^2) / A_1^2$ .

The half-wave square-law detector measures the available power on only one side of the zero current axis. For a simple harmonic wave this is the same on both sides. For a complex wave it may be different, and the detector may, therefore, give a changed reading for reversed input terminals. The average of the readings with terminals reversed will, however, be proportional to the total power available, since the sum of the powers available on both sides of the zero-current axis must equal the total power. Since the power on one side of the zero-current axis is not independent of the phase relations between the harmonic components, the deflection of the half-wave square-law detector is also

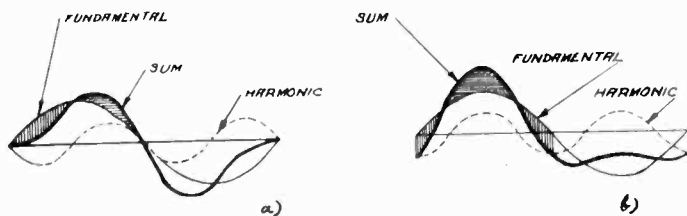

Fig. 1—Linear detection of fundamental, plus 50 per cent second harmonic.  
 (a) Phase of harmonic adjusted to cause minimum change in reading.  
 (b) Phase of harmonic adjusted to cause maximum change in reading.

dependent on these phase relations, and cannot be used to give a true reading of the amplitude of the components.

The linear detector measures the average value of the amplitude on one side of the zero axis. Since for an alternating current the total positive current must equal the total negative current the average negative and positive currents must be the same and the deflection of this detector is independent of reversed input terminals. A shift in phase of harmonics may, however, cause a shift in output. This can readily be seen if a second harmonic is added to the fundamental, first so that both have zero values at the same time, and then so that the harmonic is a maximum when the fundamental is zero.

In Fig. 1 (a), a fundamental and 50 per cent second harmonic are shown. The horizontal and vertical shaded portions represent the amounts added and subtracted from the fundamental when the second harmonic is added. The two areas must be equal, and, therefore, the area above the zero current axis is unchanged when the harmonic is added. Fig. 1 (b) shows the same fundamental with a 90-degree phase-shift in the harmonic. Again the vertical shaded and horizontal shaded portions are equal. The linear detector, however, measures only the



area above the zero-current axis. Above the axis the horizontal shaded portion is greater than that vertically shaded and the area above the axis is, therefore, increased by the addition of the harmonic. A consideration of the second half of the fundamental cycle shows that it never causes a flow of positive current so that the whole change has already been included. It is, therefore, evident that the shift in phase of the second harmonic causes a change in the reading of the detector.

In Fig. 2, a fundamental and 33 per cent third harmonic are shown. In the diagram on the left, the phases are arranged so that the fundamental and harmonic are 180 degrees out of phase at the beginning of the cycle. A consideration of this figure shows that two areas equal to the area contained in one-half cycle of the harmonic are subtracted while one of the same extent is added, resulting in a decrease in area equal to the one-half-cycle area of the harmonic. In the figure on the

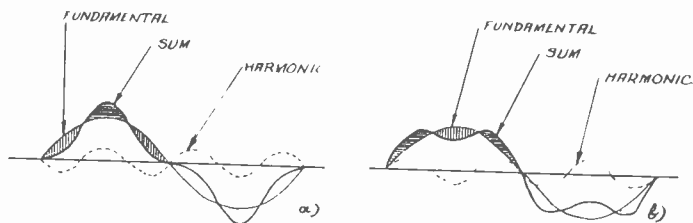

Fig. 2—Linear detection of fundamental, plus 33 per cent third harmonic.  
 (a) Phase of harmonic adjusted to cause maximum decrease in reading.  
 (b) Phase of harmonic adjusted to cause maximum increase in reading.

right, conditions are reversed and an increase in area of the same magnitude takes place.

These curves illustrate the effects which may be caused by a single harmonic when linear detection is employed. Before drawing general conclusions as to the maximum effects which can be caused by specific harmonics on the linear detector, it will be interesting to make a few calculations to determine the magnitude of the increase in reading, which is caused by either a 50 per cent second or third harmonic. The increase due to the second harmonic is shown on Fig. 3. It is also interesting to compare these values with the same values obtained for the square-law and half-wave square-law detector. In both Figs. 3 and 4, the error due to the harmonic in per cent is given as a function of an angle which expresses the phase difference between the harmonic and a zero position, where the harmonic is 180 degrees out of phase with the fundamental at the beginning of the cycle.

It will be noticed in Fig. 3 that the error caused by the second harmonic varies between zero and 10 per cent in the case of the linear detector. Thus, for all positions the error is less than when using a square-

law detector, which is approximately 12 per cent. The maximum value in the case of the half-wave square-law device is by far the worst and runs up as high as 27 per cent.

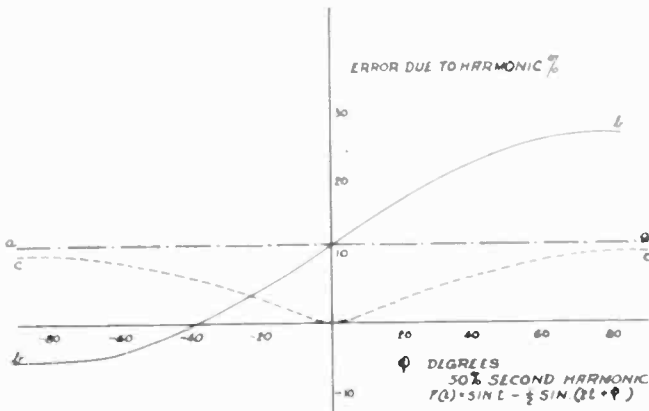

Fig. 3—Per cent increase in reading due to 50 per cent second harmonic, as the phase of the harmonic with respect to the fundamental is changed.  
 (a) Square-law detector.  
 (b) Half-wave square-law detector.  
 (c) Linear detector.

In the case of the third harmonic the error caused by the 50 per cent harmonic varies between -10 per cent and +16 per cent for the linear detector, as shown in Fig. 4. In this case, the error caused by the square-law detector is again 12 per cent, and, due to the fact that

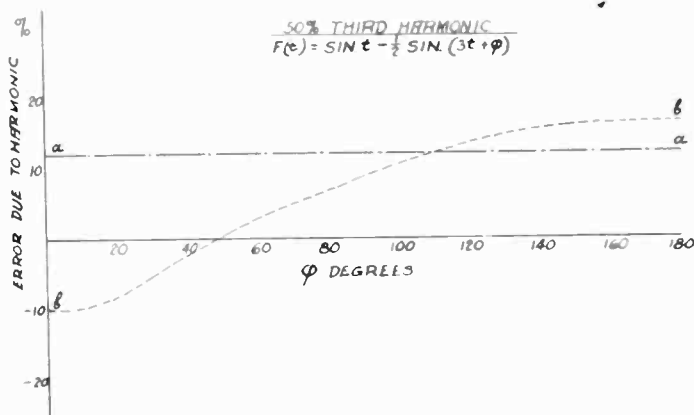

Fig. 4—Per cent increase in reading due to 50 per cent third harmonic, as the phase of the harmonic with respect to the fundamental is changed.  
 (a) Square-law detector and half-wave square-law detector.  
 (b) Linear detector.

an odd harmonic gives a wave-form, which is symmetrical for negative and positive values, the per cent error when using a half-wave square-law device will be the same. The construction of a few diagrams like this shows that the error caused by more complex harmonics on a linear

detecting device is a rather complicated function of the harmonics. In certain measurements, however, it is known that one harmonic of a certain frequency is preponderant so that a determination of the effect which is caused by a single harmonic will be useful. Only harmonics up to 50 per cent of the fundamental amplitude will be considered.

We have already seen that for an odd harmonic, an increase or decrease equal to the area of a single half cycle of the harmonic may be obtained. In the case of the even harmonic, the increase will vary between zero and some maximum value, which will now be determined. An upper limit to the error, which can be caused by the even harmonic, may be determined as shown in Fig. 5. *ABC* represents one cycle of the fundamental. The lines *DE* and *FG* are drawn through the maximum, positive, and negative values of the harmonic, respectively. The dotted curves show the minimum values which can be assumed by the sum in

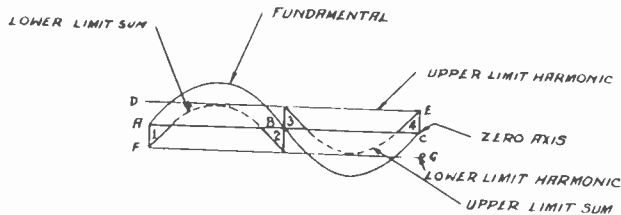

Fig. 5—Linear detection of fundamental, plus 50 per cent harmonic of high order.

the positive half cycle and the maximum values which can be assumed by the sum in the negative half cycle as the phase of the harmonic takes on all possible values. Since the algebraic integral must be the same for each half cycle as it was before the addition of the harmonic, the sum of the areas 1 and 2 represent the maximum increase which can take place in this half cycle. The sum of areas 3 and 4 represent the maximum possible area above the zero axis in the second half cycle. The maximum increase which can be caused by an even harmonic is, therefore, equal to the sum of areas 1, 2, 3, and 4.

It is possible to show that not more than one-half of this area can be occupied. For harmonics of the order of magnitude chosen, each one of these small figures is approximately triangular in shape. If  $r$  is the ratio of the amplitude of the harmonic to that of the fundamental, the altitude of each one of the triangles is equal to  $r \times A_1$  and the length is equal to  $r$ . The area of each one of the figures is, therefore,  $\frac{1}{2} A_1 r^2$ , and the area included in all of them is  $2 A_1 r^2$ . The maximum fractional change which can be caused by a single even harmonic, is therefore,  $A_1 r^2 / 2 A_1$  or  $\frac{1}{2} r^2$ , this being the ratio of the increase in area to the original area above the zero axis. In the case of a very high even

harmonic less than  $1/\pi$  of the area of the figures can be occupied, so that the maximum increase is  $r^2/\pi$ .

We have already seen that in the case of an odd harmonic an increase or decrease in area equal to the area included under one-half cycle of the harmonic may be obtained. Using the same notation, this means that a fractional increase in area equal to  $r/n$  may be obtained. It may also be shown by using a similar method to that employed for the even harmonic, that a fractional increase in area equal to  $\frac{1}{2} r^2$  can be obtained, due to the sum crossing the zero axis. The maximum possible increase in fractional area is determined by the greater of these two quantities.

The peak reading voltmeter measures the maximum value in one-half cycle of the curve. It is, therefore, evident that its reading will depend on the phase of the harmonic with respect to the fundamental and may vary when the wave is turned over. As in the cases of the linear and half-wave square-law detectors the computation of the increased reading due to a complex system of harmonics is not simple. For a single harmonic, however, the maximum fractional increase is equal to  $r$ .

SUMMARY

A summary of the results which have been obtained is shown in Table I. It is evident that both the full-wave, square-law, and linear detectors have advantages over the other types. Due to the fact that the

TABLE I  
Effect of Harmonics on Alternating-Current Detecting Instruments

	Square Law	Half-Wave Square Law	Linear	Peak
Phase Effect	No	Yes—May change when wave is inverted	Yes—No change when wave is inverted	Yes—May change when wave is inverted
50 per cent Second Harmonic	12 per cent	-6 to +27 per cent	0 to 10 per cent	-25 to +50 per cent
50 per cent Third Harmonic	12 per cent	12 per cent	-10 to +16 per cent	8 to +50 per cent
Up to 50 per cent Single Even Harmonic	$\frac{1}{2}r^2$	Maximum $> \frac{1}{2}r^2$	Maximum $< \frac{1}{2}r^2$	Maximum = $r$
Up to 50 per cent Single Odd Harmonic	$\frac{1}{2}r^2$	$\frac{1}{2}r^2$	Maximum less than the greater of $\begin{cases} r \\ \frac{1}{n} \end{cases}$	Maximum = $r$
Up to 50 per cent High Harmonics	$\frac{1}{2}r^2$	Approximately $\frac{1}{2}r^2$	Approximately $\frac{1}{\pi}r^2$	Approximately $r$

full-wave square-law detector gives a deflection which is independent of the phase of the harmonic, a correction is possible if only the size of the harmonics are known. If it is known that a single even harmonic is preponderant the linear detector will give a maximum increase in read-

ing which is somewhat less than that of the square-law instrument, and an average increase in reading which is about one-half that of the square-law instrument. For a very high harmonic or disturbing frequency the linear detector gives an increase which is approximately in the ratio  $2/\pi$  as great as that of the square-law instrument. In the case of an odd harmonic, it is necessary to find the greater of the quantities  $r/n$  and  $\frac{1}{2} r^2$  to determine whether the linear or the square-law detectors will give the smaller increase in reading.



IMPROVEMENT OF THIN FILM CAESIUM  
PHOTO-ELECTRIC TUBES\*

BY

S. ASAO AND M. SUZUKI

(Tokyo Electric Company, Tokyo, Japan)

*Summary*—The photo-electric sensitivity of thin films of caesium deposited on silver oxide with silver as a base metal was studied by L. R. Koller. Photo-electric tubes with sensitive surfaces made in this manner have a maximum sensitivity in the short-wave range and also a second maximum in the red, with the long wavelength limit moving out into the infra-red. We have found that if a thin film of silver or gold is deposited on the above sensitive cathode surface and afterwards baked, it becomes very much more sensitive and shows displacements of the long wavelength limit still further in the infra-red. By this new method, which will be described below, sensitivities as high as 40 and even 48 microamperes per lumen have been obtained. This is several times better than for the caesium on silver oxide tubes and about thirty times better than potassium hydride tubes. The new sensitive surface or cathode thus formed may be considered to have a thin film of caesium, over which is deposited, as a final layer, a thin film of silver. The sensitivity as reported was measured with a gas-filled tungsten lamp operating at 2700 deg. K.

## INTRODUCTION

RECENTLY the photo-electric effect of thin films has been studied by many persons, including H. Ives,<sup>1</sup> N. Campbell,<sup>2</sup> and L. R. Koller.<sup>3</sup> Special mention is to be made of Koller's results in which, by depositing caesium on oxidized silver, he has produced greatly increased sensitivity in the red and infra-red. Photo-electric tubes produced by this method are three times or more as sensitive as potassium hydride tubes, using a tungsten lamp as the source of light. A sensitive surface made by Koller's method has been successfully coated with an additional thin layer of silver or gold. When tubes made in this manner are heat treated, they become even more sensitive, especially in the infra-red.

## PROCESS OF MAKING THE TUBE

A soda glass bulb  $6\frac{1}{2}$  cm in diameter is silvered by evaporation of silver from a small tungsten filament located in the exhausted bulb.

\* Decimal classification: 535.38. Original manuscript received by the Institute, November 28, 1930.

<sup>1</sup> H. E. Ives, *Astrophys. Jour.* **60**, 209 and 231, 1924; **62**, 309, 1925; **64**, 128, 1926; *Jour. Opt. Soc. (America)*, **12**, 486, 1926.

<sup>2</sup> N. R. Campbell, *Phil. Mag.*, **6**, 633, 1928.

<sup>3</sup> L. R. Koller, *General Electric Review*, **31**, 476, 1928; *Jour. Opt. Soc. (America)*, **19**, 135, 1929.

The silver layer is then oxidized and caesium, obtained by treating caesium chloride with calcium, is introduced into the bulb from a side tube. The whole bulb is then baked at 250 degrees C, causing a thin

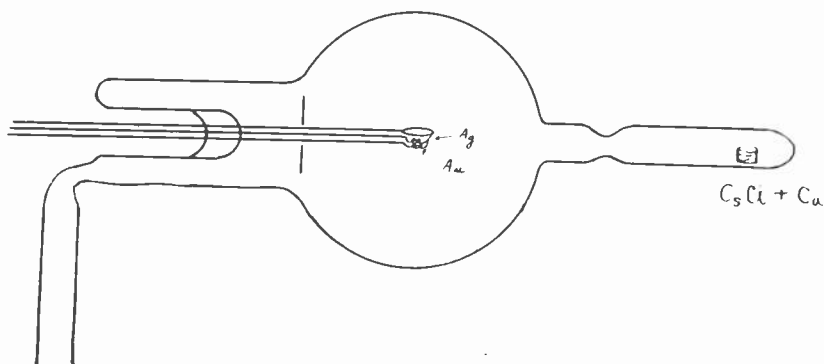

Fig. 1—Photo-electric tube used in experiment.

film of caesium to be coated over the oxidized silver layer. When this is completed, silver or gold is evaporated and allowed to deposit over the

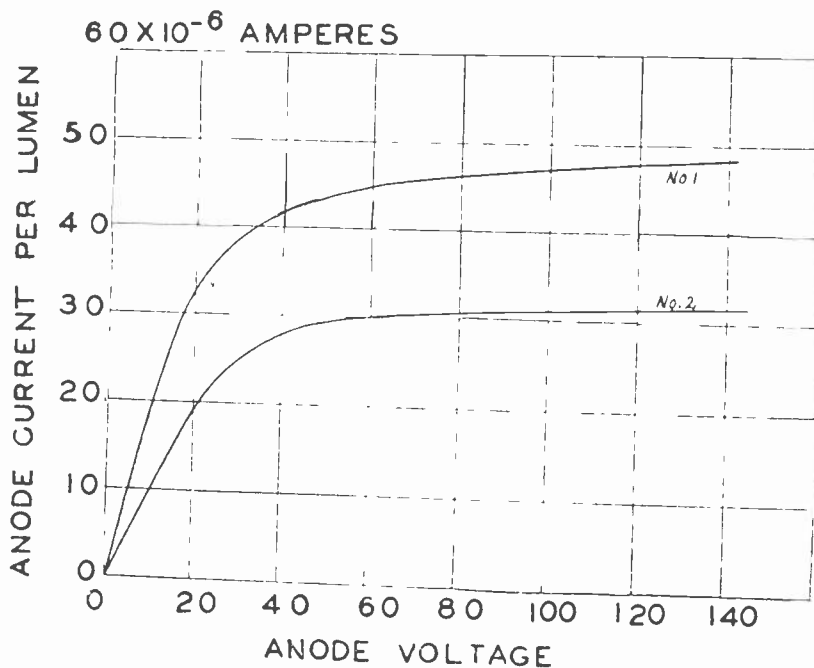

Fig. 2—Anode voltage-anode current characteristics of photo-electric tubes treated with Ag.

caesium. This final film of silver or gold must be very thin, but need not be so thin as an atomic layer. As a final step, the tube is again baked at 250 degrees C.

## APPARATUS

For testing the color sensitivity, a quartz monochromator of the constant deviation type was used and its calibration extended to 9000  $\text{A}^\circ$ . The light source was a ribbon filament tungsten lamp. The

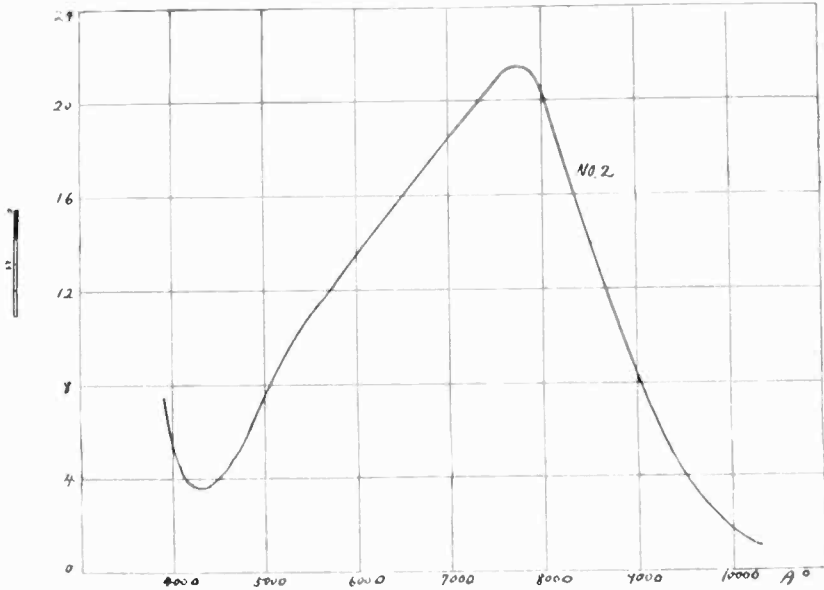

Fig. 3—Color sensitivity curve. (Same tube used as No. 2 in Fig. 2) Cs-Ag-CsO-Ag.

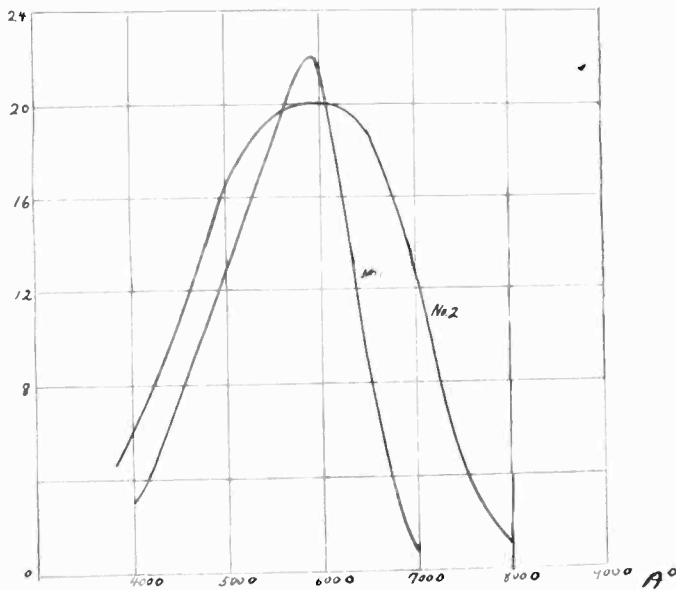

Fig. 4—Color sensitivity curve. Cs-CsO-Ag.

photo-electric currents were measured by a Leeds and Northrup galvanometer of sensitivity  $10^{-10}$  ampere and the radiant energy applied to the photo-electric tube was measured with a Leeds and Northrup



galvanometer of sensitivity  $10^{-8}$  ampere. The thermopiles, made by the Adam Hilger Company, had ten elements with a total resistance of 13 ohms.

#### RESULTS OF THE EXTRA SILVER COATING

The voltage-current curves on two vacuum tubes made by the new method are shown in Fig. 2. The light source used was a gas-filled tungsten lamp operating at 2700 degrees K.

The color sensitivity curve of one sample of vacuum tube made according to the new method is shown in Fig. 3, while curves of two

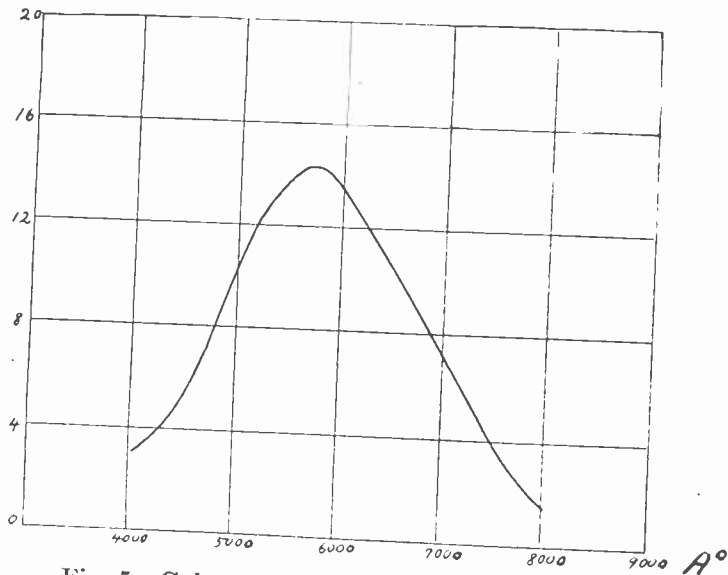

Fig. 5—Color sensitivity curve. Cs-Au-CsO-Au.

samples made without the extra silver coating are shown in Fig. 4. The latter have peaks at about 6000 A° and the former (Fig. 2) peaks at about 7500 A°, indicating considerably greater displacement of the long wavelength limit.

#### RESULTS OF AN EXTRA GOLD COATING

Gold was tried instead of silver in the method already described. In this case the photo-electric sensitivity was not so great as with the silver treated surface, although greater than when no extra coating was used. The color sensitivity of a tube treated with gold is shown in Fig. 5.

#### ACKNOWLEDGMENT

The authors' thanks are due to M. Nagashima and Y. Hata for assisting in these experiments.

## DIRECT-READING FREQUENCY METER\*

BY

F. GUARNASCHELLI AND F. VECCHIACCHI

**Summary**—The frequency meter described functions over the whole scale of acoustic frequencies from 20 to 10,000 cycles per second, and in addition constitutes a static equivalent of the vibrating reed apparatus used for precise comparisons of a capacity with a resistance and a time.

A condenser is charged at a given voltage  $E_0$  across a triode in a half period and discharged across another triode in the successive half period; for this two grid circuits are controlled by opposite phases of the periodic voltage variations obtained from the two secondaries of a single transformer whose primary is supplied with the frequency to be measured. If the continuous voltage supply  $E_0$  is kept constant, the frequency may be read directly on the calibrated scale of a milliammeter. It is possible to attain an almost complete independence of the triode characteristics and of the form and value of the voltage of the applied oscillation, within very wide limits.

The frequency meter may also serve for the measurement of very small capacities.

### PRINCIPLE OF OPERATION

THE principle of operation of this device may be most readily explained by reference to Fig. 1, which gives a schematic of the circuit in its simplest form. The circuit is so arranged that a condenser  $C$  may be charged to the potential  $E_0$  by making the plate-filament circuit of the triode  $T_2$  conductive; similarly, it may be discharged by making the plate-filament circuit of triode  $T_1$  conductive. The grid circuits of these two triodes have negative biasing potentials  $P_1$  and  $P_2$ , of sufficient magnitude to reduce the plate current to zero when no other grid voltages are present, and provided the plate potential does not exceed  $E_0$ . A transformer having two independent secondary windings is so connected that a voltage impressed on its input terminals causes voltages of equal amplitude but of opposite phase to be set up in the grid circuits of the two triodes.

With this circuit arrangement it is apparent that whenever the induced voltages are of such sign that the potential on the grid of the triode  $T_2$  is made less negative than the biasing potential  $P_2$  the plate-filament path becomes conducting and the condenser charges. At such times the induced voltage on the shunt-connected triode  $T_1$  is made even more negative than the biasing potential, hence the plate-filament path remains nonconducting. When the signs of the secondary induced voltages are reversed, the plate-filament path of the shunt connected triode  $T_1$  becomes conducting, permitting the condenser to discharge.

\* Decimal classification: R384. Original manuscript received by the Institute, May 21, 1930. Translation received by the Institute, July 15, 1930.

If the secondary induced voltages,  $V_1$  and  $V_2$ , are sufficiently large, and if the capacity of the condenser,  $C$ , is of suitable magnitude, both charge and discharge will be practically complete.

Each charge of the condenser is of the magnitude  $Q = CE_0$ . Hence if there are  $f$  charges per second, the average current drawn from the plate battery will be  $I = CE_0f$ . As  $C$  and  $E_0$  are both constant, it follows that there is a definite relation between the frequency,  $f$ , of the voltage impressed on the transformer and the current drawn from the plate battery. This current may be conveniently indicated by a milliammeter in series with the battery.

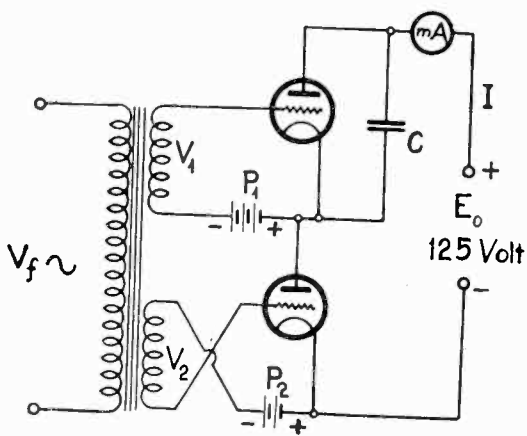

~ Fig. 1 ~

Fig. 1

#### CONSTANTS OF THE DEVICE

A schematic of the complete circuit is given in Fig. 2. It will be noted that the elementary circuit of Fig. 1 is preceded by two stages of amplification. These in turn are preceded by an attenuator. By this arrangement it is possible to obtain an instrument having considerable sensitivity and sufficient control to permit operation over a wide range of voltage amplitudes.

In practice, two sets of transformers are used; one for the frequency range between 20 and 300 cycles per second; the other for the frequency range between 200 and 10,000 cycles per second. This choice has been made as a matter of convenience, and it is obvious that other arrangements may be made readily if found more desirable.

#### LIMITS OF OPERATION

##### (a) Limits Imposed by the Transformer

Due to the presence of transformers there are obviously definite limits to the frequency ranges above and below which the secondary

voltages will be insufficient to charge and discharge the condenser completely.

(b) *Effect of Value of Capacity*

For a given frequency range there is a limiting maximum value to the capacity of the condenser  $C$ . It will be understood that for a specified frequency there will be a limiting maximum value to the time constant of the circuit, consisting of the plate-filament path of the tubes and the condenser  $C$ , such that the condenser is prevented from becoming fully charged. This fact is definitely evidenced by observed deviations of the instrument reading from values of frequency derived by other methods.

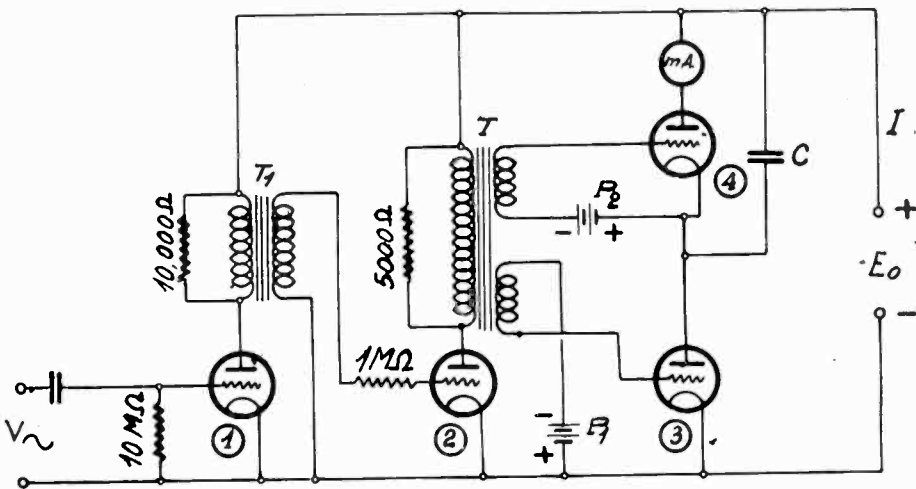

Fig. 2

(c) *Effect of Voltage and of Wave-Form*

Within the limits noted above, the calibration of the device coincides closely with that given by the formula  $I = CEf$ . This condition is obtained by capacity of about 0.05 microfarad for the frequency range between 20 and 300 cycles per second, and for a capacity of 0.003 microfarad for frequencies up to 10,000 cycles per second. In cases where the frequency range is more definitely restricted, it is possible to select a more suitable value of capacity. In this case the amplitude of the voltage, the frequency of which is to be measured, may vary from one to several hundred volts without producing any appreciable variation in the indication. The effect of wave-form, which is related to that of voltage is also negligible, provided that any harmonics are of insufficient amplitude to cause more than two reversals in the sign of the grid potential during each cycle of the fundamental period. It should also be noted that incorrect indications may result if the two half cy-

cles are of markedly different duration. In the first case, the indications will be considerably above the true value. In the second case, the condenser may have insufficient time for completely charging or discharging.

(d) *Frequency Limitation of the Device*

Although models of this apparatus have not been built for ranges exceeding those mentioned above, it is probable that, provided with suitable control and suitable interstage transformers, the range may be extended appreciably in either direction. It is predicted that the method can be extended to some tens of kilocycles.

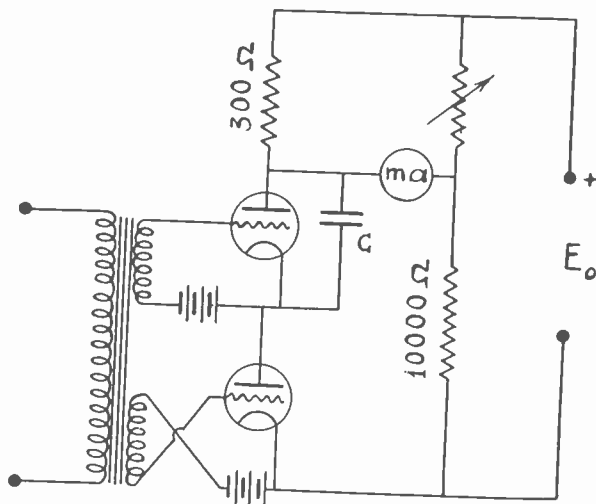

Fig. 3

#### SPECIAL ADJUSTMENT

By the use of a circuit as shown schematically in Fig. 3, it is possible to compensate the reading of the milliammeter in such a way that high sensitivity is obtained for small frequency variations. For example, it is readily possible with frequencies of the order of 50 cycles per second to adjust the device so that measurements may be made to 0.01 cycle per second.

In order to make the apparatus independent within certain limits of the value of the plate potential  $E_0$ , the milliammeter may be replaced by an ohmmeter. If this is done it is possible to operate the instrument on alternating current by using a suitable rectifier.

#### CALIBRATION

Provided it is possible, the calibration curve given by the formula  $f = I/CE_0$  should be checked by reference to frequencies of known

value. In general practice it is advantageous to use either an electrically driven tuning fork or a piezo-electric oscillator with an auxiliary interpolating oscillator. As distinguished from the customary bridge type of frequency meter and from the heterodyne frequency meter the meter here described is direct-reading, and hence facilitates the determination of frequency.

A useful application is in connection with the determination of the frequency of radio transmitting stations which may be done by determining the beat note between the frequency of the transmitter and the frequency of a monitoring piezo-electric oscillator. It should be pointed out that frequency measurements are possible with this device, even if the wave is modulated or damped, provided modulation is not complete. In case it is desired to determine the values of a beat frequency, care must be taken to eliminate completely all higher frequencies as these may readily produce false indications.

By using an audio frequency obtained by heterodyning two frequencies of considerably higher magnitude, the direct-reading frequency meter may be used for the measurement of small capacities, as for instance, capacities of the value of one-hundredth of a micromicrofarad or less. The change in the heterodyne frequency resulting when the capacity of one of the high-frequency oscillators is altered by an amount equal to the unknown capacity is determined by the direct-reading frequency meter. From this measured change in frequency the magnitude of the change in capacity may be computed. This method has been successfully used in the measurement of interelectrode capacity of vacuum tubes.



## A SYSTEM FOR SUPPRESSING HUM BY A NEW FILTER ARRANGEMENT\*

BY

PALMER H. CRAIG

(Consulting Physicist, Cincinnati, Ohio)

*Summary*—A new system for filtering the output of rectifiers or the commutator ripple from generators is discussed, giving the mathematical design and showing the superiority in practical results as compared with standard systems. The system is based on the superposition of a current which has been shifted in phase by means of a wave-filter with one not displaced in phase. The method is also applicable to frequency doubling.

THE filter system to be described was designed chiefly to produce better filtration from rectified and commutator generator sources than existing types of filters with the same amount of inductance and capacity, or to produce equal filtration with less inductance and capacity.

The familiar curve for the output of an ideal full-wave rectifier is that shown by the full line curve of Fig. 1. A similar curve for a cur-

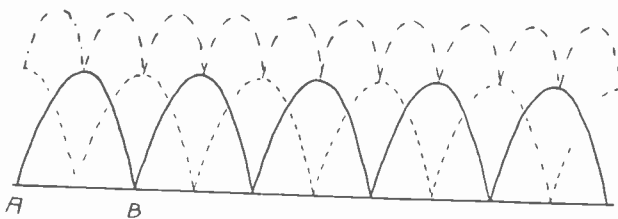

Fig. 1

rent displaced in phase by an angle corresponding to 90 degrees for the input alternating current or 180 degrees for the essential "ripple" frequency of the rectified output would be that shown by the dotted line curve of Fig. 1.

Now if the current which has been displaced in phase is superimposed upon the current not displaced in such a way as to retain the electrical identity of the circuits producing these phase conditions, the resulting output is a ripple following the dash-dot curve of Fig. 1. This ripple has double the frequency of the ripple in either full-wave rectified wave, and the amplitude of its alternating-current component has obviously been decidedly reduced.

\* Decimal classification: R386. Original manuscript received by the Institute, December 29, 1930. Presented at the December 16, 1930, meeting of the Cincinnati Section of the Institute of Radio Engineers.

The most obvious way of shifting phase is by means of inductive or capacitive reactance. It is theoretically possible to use inductive reactances to produce phase displacement, such currents being combined with another not displaced in phase provided these two circuits are separate. For example, the theoretical arrangement of Fig. 2 may be considered to illustrate the point. Here the output of one full-wave rectifier is fed through inductive reactance  $X_L$  to resistor  $R_1$ , whereas the alternating-current component of the output of another full-wave rectifier is fed through capacitive reactance  $X_C$  to resistor  $R_2$ , the superimposed output being obtained across  $R_1$  and  $R_2$  in series. This arrangement would theoretically produce 180 degrees phase displacement

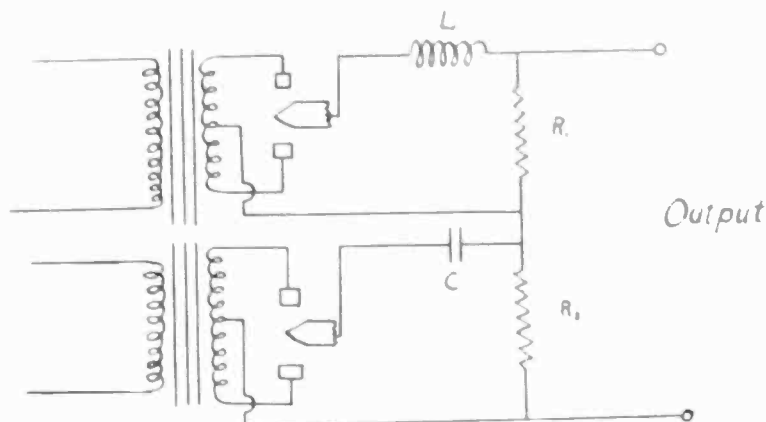

Fig. 2

in resistor  $R_1$  as compared with  $R_2$ , referring of course, to the ripple frequency. This system is impractical for radio receiver power supplies due to the duplication in rectifiers. It would also be possible to use inductive reactance in series with the primary circuit of one transformer feeding a rectifier, and no phase displacement in the primary circuit of another transformer feeding another rectifier, the output current of the two rectifiers being then superimposed. In this case a phase displacement of only 90 degrees would be required, since this corresponds to a phase shift of 180 degrees for the frequency of the full-wave rectified ripple.

The obvious difficulty, however, with any system employing reactance alone for phase displacement is that of obtaining sufficient reactance to produce the necessary displacement, this reactance being required of course, to carry its share of the output current. Thus, in any practical case where the reactance also has direct-current resistance, the value of the reactance necessary to produce 90-degree phase displacement is infinite, and even that required to produce slightly less than 90 degrees is very large.



A better method of accomplishing phase shift is by means of electric wave filters. The low-pass type of filter is the one most obviously adaptable due to the fact that its series arms which must pass the load current comprise inductance and its shunt arms capacity. Obviously, also, the band-pass and band-elimination types are also adaptable.

The main practical difference between the system about to be described and ordinary filtration is that in the phase-displacement arrangement a properly designed filter of relatively high cut-off frequency is used instead of simply using one having practically as large values of inductance and capacity as possible.

Considering the simple case of the  $T$ -section, constant- $K$  type low-pass filter, we know that the phase displacement per section varies from zero to  $\pi$  radians in the pass region and is constant at  $\pi$  radians for all frequencies above the cut-off frequency. For the series derived and shunt derived  $M$ -type sections the same characteristics hold except that there is no phase shift for frequencies above the frequency of theoretically infinite attenuation. For the case of the shunt derived  $M$ -type high-pass filter, there is no phase shift between zero frequency and the frequency of infinite attenuation, while between this latter frequency and the cut-off frequency the displacement is  $-\pi$  radians. Above the cut-off frequency the phase shift varies from  $-\pi$  radians at the cut-off frequency to zero at infinite frequency. In a ladder-type filter in which the series impedances are represented by the reference characters  $Z_1$  and the shunt impedances by the reference characters  $Z_2$ , the propagation constant per section,  $\gamma$ , is given by the following equation:

$$\cosh \gamma = 1 + \frac{1}{2} Z_1 / Z_2 \text{ where } Z_1 \text{ and } Z_2 \text{ are pure reactances}$$

$$\gamma = \alpha + j\beta \text{ where } \begin{cases} \alpha = \text{attenuation constant per section} \\ \beta = \text{phase shift in radians} \end{cases}$$

Within a pass band,  $\alpha = 0$  and  $\beta \neq 0$

Within a stop band,  $\alpha \neq 0$  and  $\beta = 0$

Hence for phase shift purposes, the frequency in use lies within a pass band of the filter.

For a low-pass filter shown in Fig. 3a,

$$Z_1 = j\omega L \text{ and } Z_2 = \frac{1}{j\omega C}$$

$$\cosh \gamma = 1 + \frac{1}{2} \frac{j\omega L}{\frac{1}{j\omega C}} = 1 - \frac{1}{2} \omega^2 LC$$

$$\cosh \gamma = \cosh \alpha \cos \beta + j \sinh \alpha \sin \beta.$$

Since  $\cosh \gamma$  is real, the last term vanishes and

$$\cosh \gamma = \cosh \alpha \cos \beta.$$

For the pass band  $\alpha=0$ , and  $\cosh \alpha=1$

Therefore,  $\cosh \gamma = \cos \beta = 1 - \frac{1}{2}\omega^2 LC$

where  $\omega = 2\pi f$ ; where  $f$  = frequency of ripple.

By proper choice of the product  $LC$ ,  $\beta$ , the phase shift per section, may be made any angle desired from 0 to 180 degrees. The values

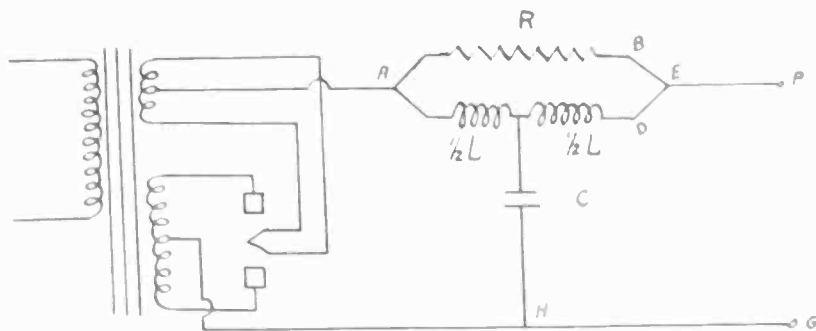

Fig. 3a

of  $L$  and  $C$  are not quite arbitrary, however, since to avoid reflection the characteristic impedance of the filter should match the equivalent load resistance.

Considering a simple practical case, the circuit arrangement of which is shown in Fig. 3a, of a low-pass,  $T$ -section, constant- $K$  type filter, it can be shown mathematically that there is less 120-cycle cur-

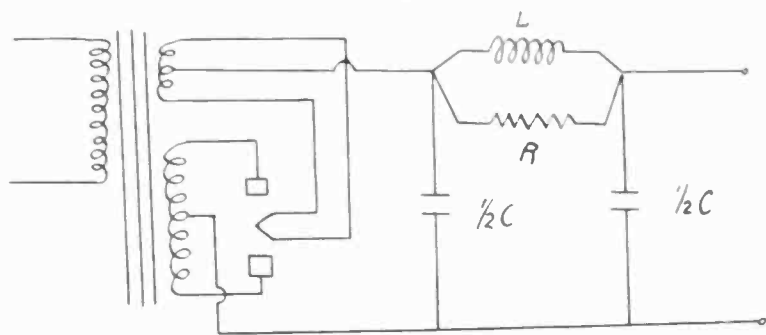

Fig. 3b

rent and a larger direct-current component flowing in the load when the resistive branch is connected as shown in Fig. 3a than when the resistive branch is left open and the filter is operating alone.

Analyzing the ideal output of a full-wave rectifier having a peak e.m.f. of one volt, which analysis applies to one wave of the full-line curve of Fig. 1 between successive cusps, we have the following expression:

$$f(x) = \sin \frac{x}{2} = a_0 + a_1 \cos x + a_2 \cos 2x + \dots$$

The sine terms being absent since  $f(x)$  is an even function.

$$A_0 = \frac{1}{2\pi} \int_0^{2\pi} f(x) dx = \frac{1}{2\pi} \int_0^{2\pi} \sin \frac{x}{2} dx = -\frac{1}{\pi} \cos \frac{x}{2} \Big|_0^{2\pi} = \frac{2}{\pi}$$

$$\begin{aligned} A_n &= \frac{1}{\pi} \int_0^{2\pi} \sin \frac{x}{2} \cos nx dx = \frac{1}{2\pi} \int_0^{2\pi} [\sin (n + \frac{1}{2})x - \sin (n - \frac{1}{2})x] dx \\ &= \frac{1}{2\pi} \left[ -\frac{1}{n + \frac{1}{2}} \cos (n + \frac{1}{2})x + \frac{1}{n - \frac{1}{2}} \cos (n - \frac{1}{2})x \right]_0^{2\pi} \\ &= \frac{2}{2\pi} \left[ \frac{1}{n + \frac{1}{2}} - \frac{1}{n - \frac{1}{2}} \right] = \frac{1}{\pi} \left[ \frac{-1}{n^2 - \frac{1}{4}} \right] = -\frac{4}{\pi(4n^2 - 1)} \end{aligned}$$

From the above the value of  $a$  at any frequency can be calculated and is as follows:

For the zero order, i.e., for the d-c component,  $a = 0.637$ .

For the first order, i.e., for the 120-cycle component,  $a = -0.425$ .

For the second order, i.e., for the 240-cycle component,  $a = -0.085$ , and so forth.

Calculating the transfer impedance of Fig. 5a,

$$\begin{aligned} \left[ I + \frac{I(R + jX_L)}{-jX_C} \right] jX_L + I(R + jX_L) &= E \\ I[(R + jX_L - jX_C)jX_L - jX_C(R + jX_L)] &= E(-jX_C) \\ I[j(R + jX_L)(X_L - X_C) + X_C X_L] &= E(-jX_C) \\ I[X_C X_L + X_C X_L - X_L^2 + jR(X_L - X_C)] &= E(-jX_C) \\ \frac{R(X_C - X_L)}{X_C} + j \frac{X_L(2X_C - X_L)}{X_C} &= \frac{E}{I} \end{aligned}$$

which is the transfer impedance.

To obtain the value of the current through the load for two practical cases, one of which illustrates the use of a filter which produces only about 70-degree phase displacement, and the other employing a filter which causes a phase displacement of about 150 degrees, which is closer to the "ideal" condition of 180 degrees, let us use the following practical filter constants:

Case 1:  $L = 3.98$  (whence the inductance associated with  $X_L$  in a T-section is half this value, i.e., 1.99 h.)

$C = 0.637\mu\text{f}$ .  $R = 2500\omega$ . Parallel resistance branch =  $2500\omega$ .

Cut-off frequency of filter = 200 cycles.

The constants of case 1 are those given in Figs. 5a, 5b, and 5c.

Case 2:  $\frac{1}{2}L = 3.185$  henries.  $C = 1.02\mu\text{f}$ .

$R = 2500\omega$ . Parallel resistance branch =  $2500\omega$ .

Cut-off frequency of filter = 125 cycles.

The shunting resistance in case 2 is made greater than that of case 1 by the square root of the ratios of the inductances.

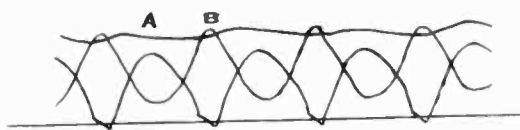

Fig. 4

The calculation of the 120-cycle component of the current through the load for cases 1 and 2 is contained in Table I which refers, of course, to the circuit arrangement not containing the resistive branch

TABLE I

	$X_L$	$X_C$	$X_C - X_L$	$2X_C - X_L$	$\frac{R(X_C - X_L)}{X_C}$	$\frac{X_L(2X_C - X_L)}{X_C}$	$Z_t = \sqrt{A^2 + B^2}$	$I = \frac{A_n}{Z_t}$
Case 1	1500	2080	580	2660	"A" 697	"B" 1920	2040	$\frac{10^3}{208}$
Case 2	2400	1300	-1100	200	-2120	369	2150	198

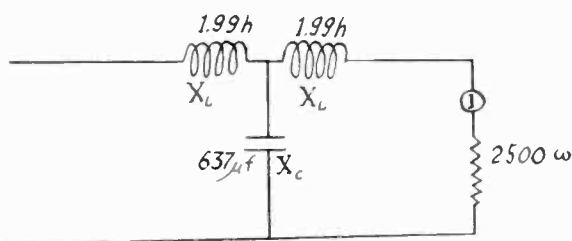

Fig. 5a

When the resistive branch is included as shown in Fig. 5b the transfer impedance is calculated as follows, by replacing the Y at P, Fig. 5b, with a  $\Delta$  according to Fig. 5c: ( $R_1$  refers to the parallel resistive branch and  $R_2$  to the load.)

$$Z_1 = \frac{(jX_L)(jX_L) + (jX_L)(-jX_C) + (jX_L)(-jX_C)}{-jX_C}$$

$$\begin{aligned}
 &= j \frac{(2X_C - X_L)X_L}{X_C} \\
 Z_2 &= \frac{(jX_L)(jX_L) + (jX_L)(-jX_C) + (jX_L)(-jX_C)}{jX_L} \\
 &= j(X_L - 2X_C). \\
 IR_2 + \left( \frac{RZ_1}{R + Z_1} \right) \left( I + \frac{IR}{Z_2} \right) &= E = I \left[ R + \frac{RZ_1}{R + Z_1} \cdot \frac{R + Z_2}{Z_2} \right] \\
 E &= I \left[ \frac{R_1Z_1(R_2 + Z_2) + R_2Z_2(R_1 + Z_1)}{(R_1 + Z_1)Z_2} \right] \\
 \frac{E}{I} &= \left[ \frac{R_1Z_1(R_2 + Z_2) + R_2Z_2(R_1 + Z_1)}{(R_1 + Z_1)Z_2} \right]
 \end{aligned}$$

which is the transfer impedance.

Substituting the constants for cases 1 and 2, the data of Table II are obtained. It is apparent from Table II that the resistive branch decreases the 120-cycle component of the output current from 208 to

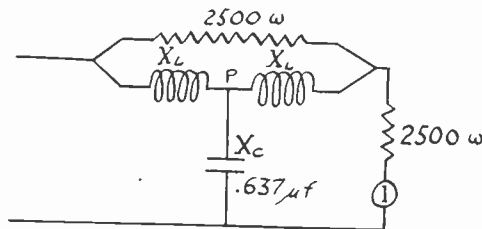

Fig. 5b

137 microamperes per volt in case 1, with a corresponding decrease in case 2. In fact, the efficiency of this system as regards phase superposition is somewhat better in case 1 than in case 2 despite the fact that the

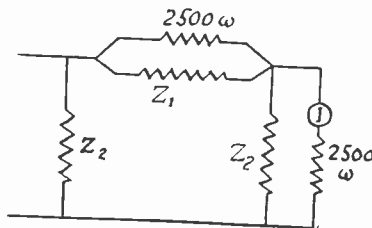

Fig. 5c

phase displacement is nearer 180 degrees in the second case, the reason for this being that the ordinary filtration is considerably increased in the second case and this effect is lessened by the shunt resistive branch.

An "optimum" condition can be reached in practice where these two effects are both taken into consideration for the best filtration. This condition can be very roughly arrived at theoretically by plotting a curve for efficiency vs. degree of phase displacement having at least three points on each side of the peak value of efficiency, and prolonging these curves until they meet.

The objection might be raised that it is unfair to compare the phase superposition system with the attenuation of an ordinary filter to a frequency in its pass region, but in practice it is found that the cut-off frequency of such filters is not sharp and that they exhibit appreciable

TABLE II

	$Z_1 = \frac{j(2X_C - X_L)X_L}{X_C}$	$Z_1 = j(X_L - 2X_C)$	$R_1 Z_1 (R_1 + Z_1) \times 10^3$	$R_1 Z_1 (R_1 + Z_1) \times 10^3$	$C = A + B \times 10^3$	$(R_1 + Z_1) Z_1 \times 10^6$	$Z_t = \frac{C}{D}$ Polar	$l = \frac{a_n}{Z_t}$
80	j1920	-j2660	"A" 12.77 + j16.62	"B" 12.77 + j12.00	25.54 + j28.62	5.11 - j6.65	3100	137
100	j369	-j200	0.184 - j1.59	0.235 + j2.94	0.499 × j1.35	0.0738 - j0.636	3150	135

attenuation to frequencies below their cut-off frequency. This is due, of course, to their relatively high direct-current resistance, to the difficulty of adjusting the inductance of iron-core reactances carrying direct-current to the ideal value, and to the high equivalent series resistance exhibited by the electrolytic condensers often used. That the comparison given is permissible is shown by the actual hum measurements taken as a comparison between a phase-superposition arrangement (comprising a wave filter of relatively high cut-off frequency and a parallel resistance path) and an ordinary filter of very low cut-off frequency. These results are given toward the end of this paper.

The value of parallel resistance branch equal to the load resistance should not be taken as the ideal one for practical cases, since the value of this resistor should be equal to the impedance of the filter for the frequency considered, taking into account the direct-current resistance and the reactance of the filter, the latter being present in the pass band due to its departure from the ideal nondissipative case.

It is obvious that the presence of the resistive branch increases the direct-current component in the load due to the fact that this parallel branch decreases the total direct-current filter resistance.

The higher harmonics do not ordinarily cause trouble due to the high capacity usually shunted across the load as will be explained further in the equalizer analysis to follow. In an actual case this capacity amounted to 8μf so that this capacitative reactance for the next harmonic, 240 cycles, was only 83 ohms as compared with the resistance

of the part of the voltage divider associated with the detector tube, namely 150,000 ohms, so that practically none of this component reaches the detector, and only about 1/30th of the total load current at this frequency flows through the complete 2500-ohm divider system shunted by all tubes in use. Still more of the current of the higher harmonics will be shunted by the output condenser.

The saving in sizes of inductance and capacity used in the above system, case 1, is roughly apparent from the increase in the cut-off frequency from 4.68 cycles (which is the value for a "pi" section with  $L=30$  henries;  $\frac{1}{2}C=2\mu f$ ) to 200 cycles, recalling that the formula for cut-off frequency of a low-pass filter of this kind is  $f_c = 1/\pi\sqrt{LC}$ . Added to this economy is the fact that in the system described herewith the inductive branches carry only a part of the direct-current output, and can therefore be made of smaller wire, and their cores can be reduced in cross section.

Another way this general system of hum suppression may be used is to employ several filter sections in one branch with a parallel resistive branch, each filter section contributing its share to the total phase displacement. In this way the cut-off frequency of each section can be made quite high and still obtain the requisite phase shift from the sum of the displacements of the several sections. An example of this arrangement in practice would be illustrated in Fig. 3a by the addition of a condenser between points *A* and *H* and another between *E* and *H*, which would be the ordinary arrangement because of the advantage of employing an input condenser to maintain the voltage of the rectifier tube, and an output condenser for by-passing and equalizer purposes. Then this system could be considered as two "pi" sections, each contributing half of the total phase shift. Another method is to use filter sections in both parallel branches, and adjusting them so as to produce the desired difference of phase between them.

To ascertain the relative efficiency between ordinary filtration and this phase-displacement system, the arrangement of Fig. 3a was connected to the voltage divider of a standard radio receiver through the field winding of its dynamic speaker and with an 8- $\mu f$  electrolytic condenser across the voltage divider to provide additional filtration. The constants were approximately those of case 2. The cut-off frequency is made such as to pass the fundamental ripple frequency of 120 cycles but to suppress its harmonics, since the filter constants would not produce the proper phase displacement with the higher frequencies. With this arrangement oscillograph elements were placed between *B* and *E*, between *D* and *E*, and between *F* and *G* (see Fig. 3a). Fig. 4 is the oscillogram obtained, the curve which extends to the zero axis being that

for the current through  $R$ , and the other approximately sinusoidal curve representing the current through the filter branch. The output between points  $F$  and  $G$  when the circuit arrangement of Fig. 3a is completed and the currents of differing phase are superimposed is represented by the upper curve of Fig. 4, showing a very slight ripple. The superiority of the filtration in the topmost curve of Fig. 4 as compared with the filter branch curve of that figure illustrates the advantage gained with this system.

Figs. 6a and 6b are the oscillograms of the two parallel currents and superimposed output, respectively, obtained with another receiver having different constants throughout.

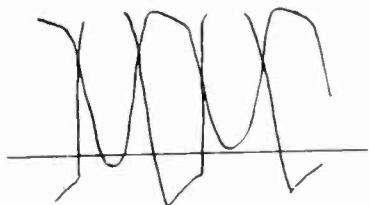

Fig. 6a

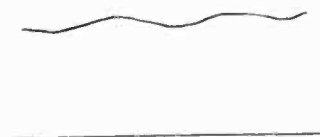

Fig. 6b

The actual hum measurements for the set-up corresponding to Fig. 4, taken with a copper-oxide voltmeter across the primary of the output push-pull transformer were as follows: Without the resistive branch (using the wave-filter as an ordinary type), with the given values of inductance and capacity the hum was 0.28 volt. With the resistive branch connected, but with no other changes the hum was reduced to 0.162 volt, a reduction in hum to about 58 per cent of the original value. Using the standard filter of the same set, employing a 10-henry choke and three electrolytic condenser sections, the hum was 0.23 volt, so that the phase-shifting arrangement was considerably better than the standard system at a decided saving in the sizes of inductance and capacity used. The impedance of the voltmeter used to measure this hum was about 4000 ohms, matching roughly the impedance of the output circuit of the set.

Since the resistive branch carries an appreciable part of total load current, the size of the wire and core of the inductances can be materially reduced, producing an additional saving.

It should be noted that the wave-form of the output current formed by superposition can be varied between wide limits by adjusting the amplitude and wave-form of the component currents. For example, part  $A$  of Fig. 4 can be raised by increasing the relative current through the resistive branch, and part  $B$  of Fig. 4 may be increased in amplitude by increasing the current through the filter branch, the relative pro-



portions of current flowing through filter and resistive branches being controlled, of course, by the magnitude of their respective impedances. The wave-form of the current through the filter branch may be somewhat changed by varying the filter constants.

In some cases, especially where the harmonics of the chief ripple frequency are of interest, it is desirable to use filters in both branches, using however, more sections in one branch than another or sections of differing phase displacement in the two branches. Obviously, also, more than two branches may be employed, their phase displacements being so adjusted as to produce the least ripple after superposition, as for example by using three branches, one being resistive, another producing 120-degree phase displacement and the third having enough sections to produce 240-degree shift.

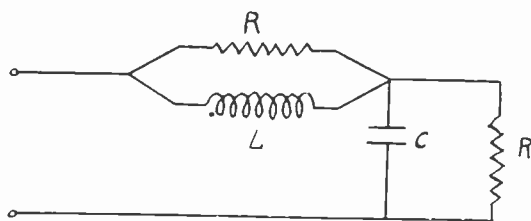

Fig. 7

Low-pass filters have been discussed because they represent a simple case. Other types, notably the shunt-derived  $M$ -type high-pass filter, are applicable to frequency doubling where the d-c component is not of interest, and in the case of radio frequencies other types of high-pass filters are also indicated. Combinations thereof, such as band-pass and band-elimination filters may be employed in special applications. Half sections of any type may be used to obtain half the phase shift experienced in a corresponding full section.

Fig. 3 illustrates a "pi" section, low-pass filter in this general arrangement.

Due to the fact that highly inductive or capacitive loads may cause serious reflection losses in the filter, the equalizer system of Fig. 7 may be used to eliminate this difficulty. The impedance looking into the system of Fig. 7 is given by the following expression, where  $X_1$  refers to capacitive reactance and  $X_2$  refers to inductive reactance:

$$\begin{aligned}
 Z &= \frac{R_2 j X_2}{R_2 + j X_2} + \frac{R_1 j X_1}{R_1 + j X_1} \\
 &= \frac{-R_2 X_1 X_2 + j R_1 R_2 X_2 - R_1 X_1 X_2 + j R_1 R_2 X_1}{(R_1 + j X_1)(R_2 + j X_2)}
 \end{aligned}$$

$$= \frac{-X_1 X_2 (R_1 + R_2) + j R_1 R_2 (X_1 + X_2)}{R_1 R_2 + j (X_1 R_2 + X_2 R_1) - X_1 X_2}$$

If  $R_1 = R_2 = R$ , this reduces to

$$Z = \frac{-X_1 X_2 2R + j R^2 (X_1 + X_2)}{R^2 + j R (X_1 + X_2) - X_1 X_2}$$

If  $X_1 = X_2 = -R^2$  this simplifies to

$$Z = \frac{2R^3 + j R^2 (X_1 + X_2)}{2R^2 + j R (X_1 + X_2)} = R + j0$$

If  $X_1 = -1/\omega C$  and  $X_2 = \omega L$

$$X_1 X_2 = -\frac{\omega L}{\omega C} = -\frac{L}{C} = -R^2$$

Therefore,

$$L/C = R^2$$

This indicates that if there is normally a large inductance in the load, as is the case when the field winding of a dynamic speaker is included in the load, it is possible to compensate for this inductance and give the load the characteristics of a pure resistance for all frequencies by introducing a capacity across the voltage divider and shunting the inductance with a resistor, these values being given by the above equation. Similarly, if the load were highly capacitive, it could be compensated for by shunting the capacity with a resistor and adding an inductance shunted with a resistor according to the same equation. This equalizer system is applicable to any filter system and is not limited to this system wherein a shunt resistive branch is used.

In conclusion, the author wishes to express his appreciation of the coöperation of Professor W. C. Osterbrock of the University of Cincinnati in the preparation of the mathematical analysis.



## NEGATIVE CIRCUIT CONSTANTS\*

BY

LAL C. VERMAN

(Cornell University, Ithaca, N. Y.)

**Summary**—A brief review of literature on devices furnishing negative resistance is made and further possibilities of development indicated. New names are suggested for negative circuit constants. It is shown that for transient states the negative inductances and negative capacitances respond as would be expected of true negative circuit constants. External circuits are suggested to vary the negative resistance of a given vacuum tube system. A system of circuits is described by means of which it is possible to obtain impedances proportional to  $\pm(j\omega)^n$ , where  $n$  is any positive or negative integer.

IT IS possible to construct circuits in various ways that will offer negative resistance to an applied electromotive force. The electric arc has long been known to possess this property. However, with the advent of the thermionic vacuum tubes, other devices much more stable than the arc have come into use for this purpose. The dynatron of A. W. Hull<sup>1</sup> offers negative resistance by virtue of the secondary electrons emitted from the surface of the plate due to its bombardment by the primary electrons from the filament. Ordinary triodes as well as screen-grid tubes<sup>2,3,4</sup> could be used as dynatrons. The author's experience shows, however, that the negative resistance thus obtained with commercial radio tubes does not stay constant over long periods of time. The circuit, of course, is quite stable. It may be highly desirable, therefore, in constructing dynatrons to give special attention to the surface emitting secondary electrons.

J. Scott-Taggart<sup>5</sup> developed a two-plate tube, called "negatron," that does not depend on the secondary emission of electrons for its negative resistance property. A difficulty with this tube, however, is that the part of the current-voltage characteristic that corresponds to negative resistance, does not pass through zero value of current. This feature makes the negatron undesirable for a-c circuit applications.

\* Decimal classification: R140. Original manuscript received by the Institute, June, 12, 1930.

<sup>1</sup> A. W. Hull, "Dynatron, a tube possessing negative resistance," Proc. I.R.E., 6, 5; February, 1918.

<sup>2</sup> J. J. Dowling, "A new method of using resistance amplification with screened grid valves," *Exp. Wireless and Wireless Eng.*, 5, No. 53; February, 1928.

<sup>3</sup> Hajime Iinuma, "A method of measuring the radio-frequency resistance of an oscillatory circuit," Proc. I.R.E., 18, 537; March 1930.

<sup>4</sup> C. E. Worthen, "The dynatron," *The General Radio Experimenter*, 4, May, 1930.

<sup>5</sup> J. Scott-Taggart, *Radio Review*, 11, 598, 1921.

Scott-Taggart also proposed a two-tube circuit, which the author has found, in preliminary experiments, to be rather unstable on alternating e.m.fs.

It is clear, therefore, that a good deal of work could be done in the development of stable negative resistances that would stay constant over long periods and at the same time be applicable to a-c circuits. It seems that the progress in this direction has been rather slow, chiefly due to the fact that convenient alternative means are available for accomplishing the chief purposes for which the negative resistance might be used; for example, oscillators, voltage and current amplifiers, etc. The number of possible applications, however, has been considerably increased by the suggestion of negative inductance and negative capacitance,<sup>6,7</sup> so that now we have at our disposal, at least theoretically, all the three fundamental circuit constants with negative as well as positive values. It is the purpose of this paper to discuss some new possible applications of these negative impedances to accomplish novel results.

The question of stability of the circuits containing negative resistances is of prime importance in connection with a-c work. A theoretical as well as an experimental study of the problem is quite worth while; this the author intends to undertake at a later date. In this paper, however, it is implicitly assumed that the circuits considered are stable.

#### NOMENCLATURE

It is quite likely that the use of negative circuit impedances will increase with time. It may, therefore, be worth while to introduce appropriate names for them in order to facilitate discussion. The author suggests the names *Nesistance*, *Ninductance*, and *Napacitance* for negative resistance, negative inductance, and negative capacitance, respectively. The corresponding conventional units of measurements may be retained to express these quantities, i.e., ohms, henries, and farads.

#### TRANSIENT STATES

In the papers of Bartlett and van der Pol, to which reference has been made above, the negative circuit elements were considered only with reference to steady state conditions. It is, however, shown in the following that they also respond exactly like true negative impedances for transient states.

<sup>6</sup> A. C. Bartlett, "Boucherot's constant-current networks and their relation to electric wave filters," *Jour. I.E.E.* (London), 65, 373, 1927.

<sup>7</sup> van der Pol, "A new transformation in alternating-current theory and an application to the theory of audition," *Proc. I.R.E.*, 18, 221; February, 1930.

Consider the circuit of Fig. 1(a) which is equivalent, for steady state considerations, to the circuit of Fig. 1(b) in which an e.m.f.  $e$  is suddenly applied to a ninductance of  $-R^2C$  henries. If the circuits were exactly alike for transient states as well as for steady states, the differential equation for current in the two circuits would be identical.

For the circuit of Fig. 1(b), we simply have

$$L \frac{di}{dt} = -R^2C \frac{di}{dt} = e \quad (1)$$

Whereas for the circuit of Fig. 1(a), we have three equations:

$$\left. \begin{aligned} i_1 + i_2 &= i \\ Ri + Ri_2 + \frac{\int i_2 dt}{C} &= e \\ Ri_1 + Ri_2 + \frac{\int i_2 dt}{C} &= 0 \end{aligned} \right\} \quad (2)$$

whence, solving for  $i$ , equation (1) directly follows. For any kind of applied e.m.f.  $e$  and any initial conditions, the solutions of (1) are identical

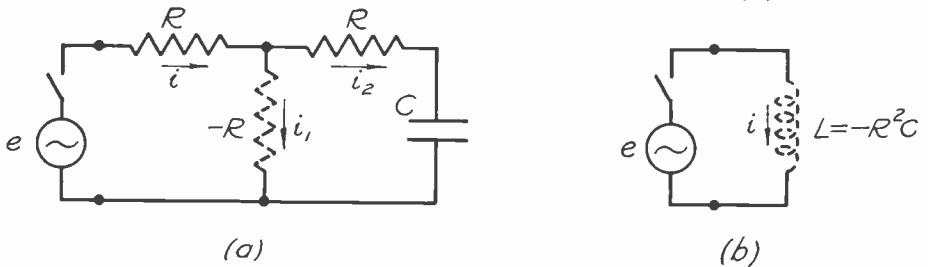

Fig. 1

(except for algebraic sign) with the solutions of the corresponding differential equation involving positive inductance under similar conditions. In case we had in series with the above ninductance another impedance of some other type, the differential equation for  $i$  could be simply written as for an ordinary circuit, except that the ninductance would be considered as a true negative inductance.

The same arguments apply to the circuits of Fig. 2(a) and 2(b), where we have an e.m.f.  $e$  applied to a ncapacitance.

Consider next a circuit which contains any combination of the six circuit elements. It is clear that the differential equations for the currents in this circuit can now be directly written just as in the conventional circuits of positive circuit constants with their correct algebraic signs. Furthermore, the same theory applies to the solution of these equations as before. In a like manner the sign of the expression

$R^2C^2 - 4LC$  determines whether the circuit is oscillatory, critically damped, or overdamped, where  $R$ ,  $L$ , and  $C$  represent the aggregate equivalent values of the corresponding circuit constants.

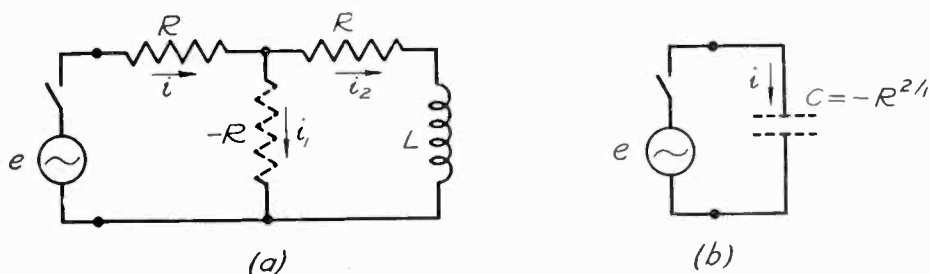

Fig. 2

VARIABLE RESISTANCE CIRCUITS

It is often difficult to vary the negative resistance of a given vacuum tube system beyond certain limits. External circuits, however, enable one to accomplish variations beyond these limits. Fig. 3 shows three circuits devised for this purpose. Circuit (a) in this figure serves to cut down the absolute value of the given resistance  $r_n$ , circuit (b) to increase it, whereas circuit (c) may be used to accomplish either. The

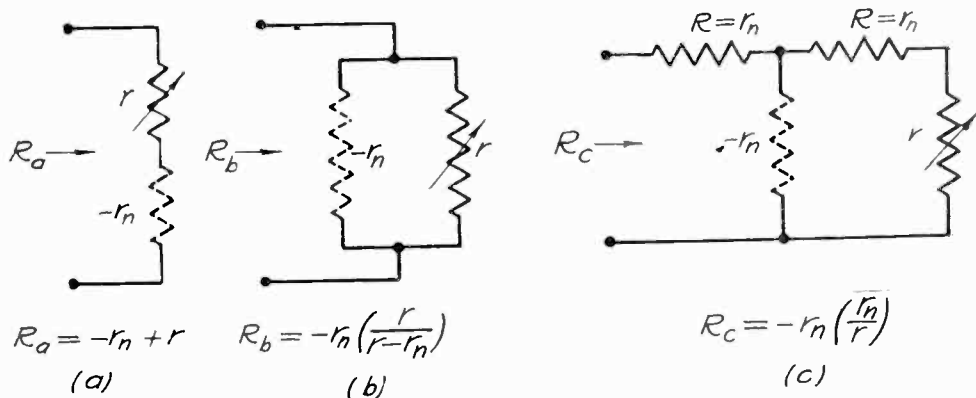

Fig. 3

curves in Fig. 4 illustrate the equivalent resistance obtained from these circuits for various values of the variable resistance  $r$ . It must be borne in mind that these circuits can be employed only under specialized conditions depending largely on the characteristics of the particular negative resistance circuit used.

IMPEDANCES PROPORTIONAL TO HIGHER POWERS OF FREQUENCY

With the conventional circuit constants at hand one has available only the means to get impedances directly or inversely proportional to the first power of the impressed frequency, such as  $j\omega L$ ,  $1/j\omega C$ , and their

various combinations. Fig. 5 shows what may be accomplished by means of negative circuit elements.

Circuit (a) of Fig. 5 yields an impedance directly proportional to the square of the frequency. It may be made positive or negative according as  $r$  is positive or negative. Similarly (b) gives positive or negative impedance inversely proportional to the square of the applied frequency.

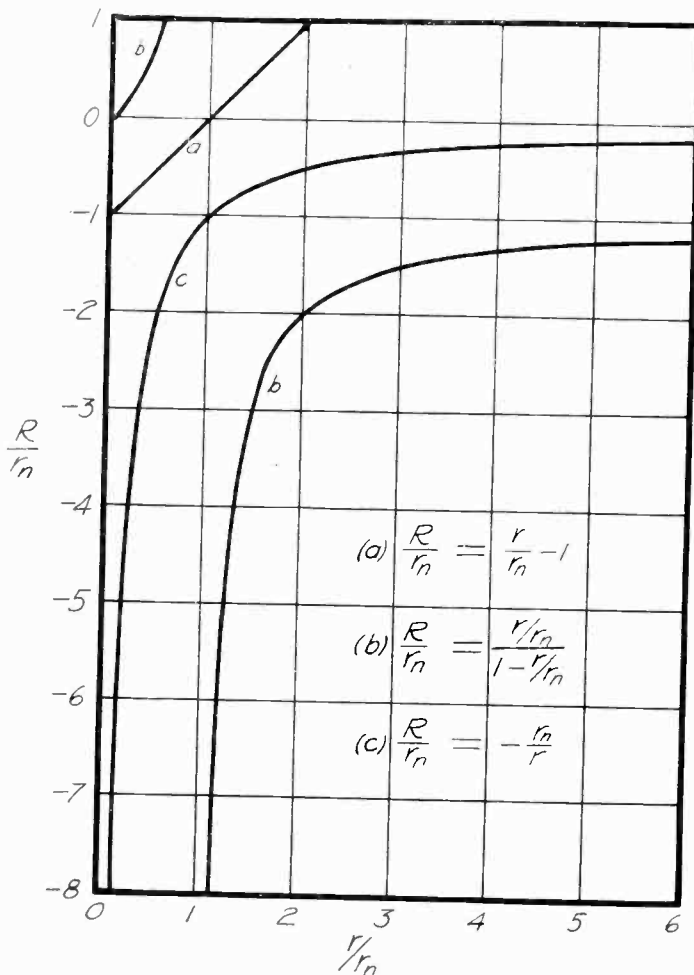

Fig. 4

By replacing  $\pm r$  by  $\pm C$  and  $\pm L$  we get similar impedances directly and inversely proportional to the 3rd power of the frequency (Fig. 5(c) and (d)). The impedances of the type  $Z_a$  and  $Z_b$  may be called *dissipative*, when they are positive, since they consume energy, and *antidissipative*, when negative, since in that case they feed energy back into the source. On the other hand the impedances of the type  $Z_c$  and  $Z_d$  neither consume nor furnish energy but serve as phase shifters only and, hence, may be called *nondissipative* types of impedances.

Now let us construct circuits of the same general form as those shown in Fig. 5, by using as individual elements not only the six elementary types of circuit constants but also employing the impedances of the types  $Z_a$ ,  $Z_b$ ,  $Z_c$ , and  $Z_d$  as individual branches. The equivalent

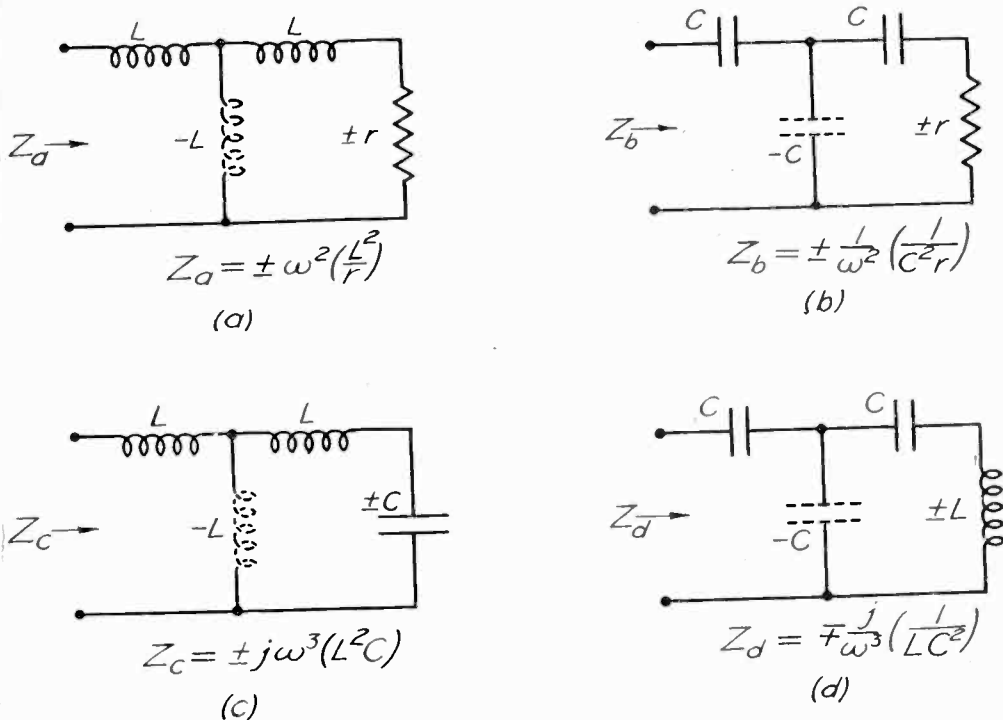

Fig. 5

impedances of such circuits will evidently involve higher powers of frequency from the 4th up to the 9th. An example of such a circuit is shown in Fig. 6, where we have a nondissipative type of impedance directly proportional to the 9th power of frequency. This process of

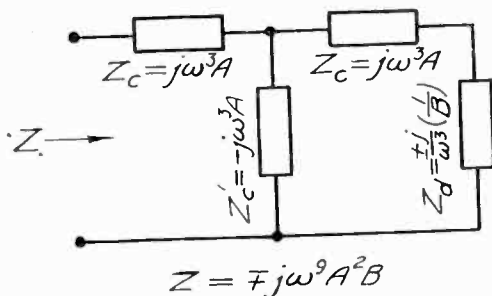

Fig. 6

constructing structures by substitution of previously obtained impedances may be carried on indefinitely, so that we may say that, in general, impedances proportional to  $\pm(j\omega)^n$  are possible, where  $n$  may be any integer positive, negative, or zero. Again it might be stated that odd values of  $n$  will give nondissipative impedances and even values will lead to either dissipative or antidissipative type of impedances.



## CORRECTIONS

### POLYPHASE RECTIFICATION SPECIAL CONNECTIONS

Mr. R. W. Armstrong has brought to the attention of the editorial staff of the PROCEEDINGS a number of corrections to his paper "Polyphase Rectification Special Connections" which appeared on Page 78 of the January, 1931, issue of the PROCEEDINGS. They are as follows:

Page 81, Table IB, 3d column of figures:

"Transformer secondary voltage per leg" should read "(half leg 0.493)" instead of "(half leg 4.93)."

"Transformer primary kva" should read "1.05" instead of "1.21."

"Average of primary and secondary kva" should read "1.38" instead of "1.46."

Page 81, Table IB, 4th column of figures:

"Ripple peaks with reference to average d.c. as axis" negative value should read "0.093" instead of "0.930."

Page 89, 6th line of text should read:

"The average of primary and secondary kva equals 1.50 *GJ*, which is only very slightly larger than the value 1.38 for the 3-phase broken star 3-transformer circuit."

Page 89, 8th line from bottom should read:

"The T-connection forms a convenient method of getting 4-phase from a 3-phase supply and would have an application where three tubes of standard size will not quite give the required current output, but 4 tubes will."

Page 94, twelve lines from bottom should read:

"of the product of condenser capacity and load resistance."

Page 95, add to caption of figure 6:

"Curves are for 60 cycles; for other frequencies use  $CRf/60$  for abscissas instead of  $CR$ ."

### CALCULATION OF ELECTRIC AND MAGNETIC FIELD STRENGTHS OF ANY OSCILLATING STRAIGHT CONDUCTORS

The author, Mr. R. Bechmann, makes the following correction to the above paper, which appeared in the March, 1931, issue of the PROCEEDINGS.

On page 461, footnote 1 should read:

B. van der Pol, Jr., Jahrbuch der drahtl. Telegr., 13, 217, 1917.

## BOOK REVIEW

Acoustics by G. W. Stewart and R. B. Lindsay. D. Van Nostrand Co., New York City.

This book supplies a valuable addition, both as a text for instruction and as a reference source, to the literature on applied acoustics. Subjects included are: fundamental properties of acoustic waves, properties of acoustic elements, such as resonators, orifices and tubes, a number of chapters on acoustic transmission phenomena, acoustic filter theory, acoustic measurement and instruments, physiological and architectural acoustics, and chapters on the transmission of signals under water and through the atmosphere. Problems are provided at the end of each chapter based on the material which has been developed.

The chapters on acoustic transmission are particularly valuable and contain a wealth of material which has not been presented elsewhere in book form. The theory of acoustic filters, to which one of the authors has made numerous original contributions, is given in detail. The chapter on subaqueous signaling is useful as one of the most complete expositions of the subject which has appeared in the English literature. The other chapters follow conventional lines. The material is essentially in the field of acoustics and no attempt is made to give a treatment of the electrical part of electro-acoustic apparatus.

The authors are to be commended on their purpose of making acoustic transmission theory stand on its own feet without numerous references to electrical analogies. Their viewpoint is expressed in the following quotation:

"It is well to suggest that the apparent practical gain in the use of analogous electrical equations may prove a detriment to the most rapid progress in anyone's appreciation of acoustic phenomena. The corresponding electrical phenomena are in reality much less concrete. Acoustics deals with gross matter and can be visualized more readily, and the physical action in acoustics is much better understood. Therefore an acoustician might profitably endeavor to think in acoustic terms rather than electrical. The electrical analogies may sometimes be advantageous in mathematical procedure, but in the long run, not in physical interpretation."

A good knowledge of fundamental classical physics and differential equations is required to follow the treatment readily and obtain the maximum of use from the book.

IRVING WOLFF\*  
January 30, 1931

\* RCA-Victor Co., Camden, N. J.

## REFERENCES TO CURRENT RADIO LITERATURE

THIS is a monthly list of references prepared by the Bureau of Standards, and is intended to cover the more important papers of interest to the professional radio engineer which have recently appeared in periodicals, books, etc. The number at the left of each reference classifies the reference by subject, in accordance with the "Classification of radio subjects: An extension of the Dewey Decimal System," Bureau of Standards Circular No. 385, which appeared in full on pp. 1433-56 of the August, 1930, issue of the PROCEEDINGS of the Institute of Radio Engineers. The classification numbers are in some instances different from those used in the earlier version of this system used in the issues of the PROCEEDINGS of the Institute of Radio Engineers before the October, 1930, issue.

The articles listed are not obtainable from the Government or the Institute of Radio Engineers, except when publications thereof. The various periodicals can be secured from their publishers and can be consulted at large public libraries.

### R000. RADIO

- R000 Liston, J. Developments in the electrical industry during 1930. *Gen. Elec. Rev.*, 34, 6-82; January, 1931.

This résumé includes vacuum tubes, radio (pp. 44-58) and television, among other items.

- R000 Gerth, F. Der derzeitige Stand der Entwicklung der ultra-kurzen  
×R423.5 Wellen unter Berücksichtigung ihrer Verwendungsmöglichkeiten für Rundfunkzwecke. (The present development of ultra-high frequencies with special reference to their possible application in broadcasting.) *Elek. Nach. Tech.*, 8, 39-42; January, 1931.

A brief historical résumé is followed by a description of the present development of the art and its future possibilities.

### R100. RADIO PRINCIPLES

- R113 Elias, G. J. Das Verhalten elektromagnetischer Wellen bei räumliche veränderlichen elektrischen Eigenschaften. (The behavior of electromagnetic waves in space with varying electrical properties.) *Elek. Nach. Tech.*, 8, 4-22; January, 1931.

A mathematical study of the reflection of electromagnetic waves: (1) when the dielectric constant, (2) when the conductivity, and (3) the dielectric when both constant and the conductivity vary in any direction according to a definite exponential law.

- R113 Quäck, E. Versagen der kurzen Wellen auf der Linie Europa-Nordamerika in der Zeit vom 8 bis 12 August, 1930. (Failure of the high-frequency circuit, Europe-North America during the period from August 8-12, 1930.) *Elek. Nach. Tech.*, 8, 46-48; January, 1931.

Observations on several long range circuits during the disturbance period are given and possible causes of the failure of the Europe-North American circuit are discussed.

- R113 Merritt, E. The optics of radio transmission. *Jour. Opt. Soc. of Am.* 21, 90-100; February, 1931.

A popular discussion of radio wave phenomena and how their explanation is based on ordinary optical principles.

- R113.6 Kenrick, G. W., Taylor, A. H., Young, L. C. Note on high-frequency transmission during the summer of 1930. *Proc. I.R.E.*, 19, 252-255; February, 1931.
- The results of observations of echo signals at Cheltenham, Md., on 20 and 25 megacycles during the summer of 1930 are presented. A notable absence of strong echoes during this period is noted and marked abnormalities in their time of occurrence (as compared with previously reported results) are found. A comparison with field strength observations on GBU (18.62 mc) is included and a discussion of possible causes of the abnormalities is given. The close correlation between the intensity of echoes and the intensity of the reception at Bellevue of the high-frequency signals, from Rocky Point, is also emphasized.
- R113.6 Appleton, E. V. and Childs, E. C. On some radio-frequency properties of ionized air. *Phil. Mag.*, 10, 969-994; December, 1930.
- A report on the results of experiments which support the theory that the refractive deviation of radio waves in the upper atmosphere is due to the influence of free electrons.
- R113.62 Appleton, E. V. The timing of wireless echoes. *Wireless World and Radio Review*, 28, 2-4; January 4, 1931; 43-44; January 14, 1931.
- A discussion is given of alternative theories of the Heaviside layer and methods used to determine the layer's effective height.
- R120 Bechmann, R. Berechnung der Strahlungscharakteristiken und Strahlungswiderstände von Antennensystemen. (Calculation of the radiation characteristics and radiation resistance of antenna systems.) *Zeits. f. Hochfrequenz.*, 36, 182-188; November, 1930; 201-208; December, 1930.
- Formulas applying to directive antenna arrays are derived and discussed.
- R120 Glas, E. T. Über den Wirkungsgrad von Rundfunk-Sendeantennen. (The efficiency of broadcasting transmitting antennas). *Zeits. f. Hochfrequenz.*, 36, 8-12, January, 1931.
- The optimum dimensions and characteristics for broadcast antennas are discussed in the light of exhaustive experimental data.
- R125.1  
×R270 Gothe, A. Neuere Messungen an Kurzwellen-Richtantennen. (Measurements on short wave directional antennas.) *Elek. Nach. Tech.*, 7, 494-501; December, 1930.
- An account of the procedure and results of field intensity measurements made on the Telefunken directive antennas at Nauhen.
- R130 Barclay, W. A. The alignment representation of valve data. *Exp. Wireless and Wireless Engr.*, 8, 75-82, February, 1931.
- The inverse use of the alignment principle and its utility in the analysis of vacuum tube performance is explained.
- R132  
×R361.2 Sowerby, A. L. M. The intermediate-frequency amplifier of the superheterodyne. *Wireless World and Radio Review*, 27, 689-692; December 17, 1930; 712-715, December 24, 1930.
- Design problems are discussed, especially the causes and prevention of distortion.
- R133  
×R355.5 Stwolin, A. P. Die Phasenverteilung in einem zusammengesetzten Röhrengenerator für ultrakurze Wellen. (Phase relations existing in a multi-tube ultra-high-frequency vacuum tube generator). *Zeits. f. Hochfrequenz.*, 37, 18-21; January, 1931.
- A study of the phase relations obtaining in a parallel arrangement of vacuum tubes oscillating at  $\lambda = 89$  cm.

- R133      New ultra-high-frequency oscillator—The Pierret circuit. *Wireless*  
 ×R355.5    *World and Radio Review*, 28, 81; January 28, 1931.  
 Using copper disks sliding along the grid and plate leads to limit the part of the circuit in which oscillating currents flow, Barkhausen-Kurz oscillations of the order of  $\lambda = 0.12$  meter were attained. Satisfactory communication up to 9 km was established at  $\lambda = 0.17$  meter).
- R133      Hagen, C. Über Gitterschwinglinien. (On grid swing curves). *Zeits. f. Hochfrequenz.*, 36, 1-7; January, 1931.  
 A method is given for solving the alternating-current problems connected with the analysis of vacuum tube oscillators, especially those employing close coupling.
- R133      Ito, Y. Zur Theorie des Dynatrons. (The theory of dynatrons.) *Elek. Nach. Tech.*, 8, 23-30; January, 1931.  
 An equivalent electrical circuit analysis of the dynatron yields an explanation of its action.
- R135      Below, F. and Kallmann, H. E. Anwendung von Raumladegitterröhren zur Amplituden-Modulation. (Amplitude modulation by means of screen grid tubes.) *Zeits. f. Hochfrequenz.*, 36, 209-211; December, 1930.  
 A modulating method is described in which the modulating frequency is impressed on the screen grid of a four-element amplifier tube.
- R140      Turner, H. M. An experimental method of studying transient phenomena. *Proc. I.R.E.*, 19, 268-281; February, 1931.  
 The description is given of an experimental method of studying transient phenomena which, by repeating the phenomena synchronously, enables one to observe it on the screen of an oscillograph as long as desired.
- R140      Flegler, E. Spule and Wanderwelle. (Transient waves in coils.) *Archiv. f. Electrotechnik*, 25, 35-72; January, 1931.  
 The results of a comprehensive oscillographic study of coil transients are given.
- R140      Windred, G. Early developments in a-c circuit theory. *Phil. Mag.*,  
 ×537.1    10, 905-916; November, 1930.  
 A brief historical résumé, with some notes on the application of complex methods in the solution of a-c circuit problems, and an extensive bibliography.
- R145.5    Zakarias, E. Übersetzungsverhältnis bei kapazitiver Spannungstransformation. (Voltage transformation by capacitive means.) *Elek. Nach. Tech.* 8, 42-45; January, 1931.  
 An analysis of the so-called "capacity transformer" is given.
- R149      Stierstadt, O. Zur Theorie eines Gleichrichters mit fallender hyperbelförmiger Kennlinie. (The theory of a rectifier having a falling hyperbolic characteristic.) *Elek. Nach. Tech.*, 8, 31-38; January, 1931.  
 The use of a falling characteristic (such as that of the electric arc) for rectification is investigated and the rectification characteristics, stability, and efficiency of such a device are discussed.
- R165      Barclay, W. A. Loud-speaker impedance. *Wireless World and Radio Review*, 27, 627-30; December 3, 1930; 662-666; December 10, 1930.  
 The use of alignment charts in solving loud speaker impedance problems is illustrated.
- R165      McLachlan, N. W. Modern views on the moving coil speaker. *Wireless World and Radio Review*, 28, 52-54; January 21, 1931; 100-102; January 28, 1931.  
 A study of the factors which adversely affect frequency response.

## R200. RADIO MEASUREMENTS AND STANDARDIZATION

- R211.1 Piesch, H. Ein einfacher Frequenzmesser hoher Genauigkeit. (A simple frequency meter of high accuracy.) *Zeits. f. Hochfrequenz.*, 36, 211-217; December, 1930.  
After considering several important types of frequency meters, the author discusses the "absorption type" and shows that the usual disadvantages encountered in this type may be eliminated.
- R214 Mögel, H. Some methods of measuring the frequency of short waves. *PROC. I.R.E.*, 19, 195-213; February, 1931.  
Four methods are given for practical frequency measurements on short waves (10-50 meters, 30,000-6000 kc) with an absolute accuracy of  $\pm 0.01$  per cent to  $\pm 0.001$  per cent and a relative accuracy of  $\pm 0.0001$  per cent. Harmonic overtones are used in each method.
- R241 Black, D. H. Die Messung des Wechselstromwiderstandes flüssiger Dielektrika. (Measurement of the a-c resistance of fluid dielectrics.) *Zeits. f. Hochfrequenz.*, 36, 217-219; December, 1930.  
A method is presented, for measuring the specific a-c resistance of an isolated liquid.
- R254 Runge, W. Untersuchungen an amplituden und frequenz-modulierten Sendern. (Tests on amplitude and frequency modulated transmitters.) *Elek. Nach. Tech.*, 7, 488-494; December, 1930.  
A method and an apparatus for making measurements on transmitters having either amplitude or frequency modulation.
- R262 Bull, C. S. Testing radio valves. *Experimental Wireless and Wireless Engr.*, 8, 70-74; February, 1931.  
A discussion of the accuracy and speed of various methods of test indicates that the a-c bridge method is probably the quickest and most useful. An a-c bridge test board is described.
- R264  
×R381 Ross, H. Characteristics of dry-electrolyte condensers. *Radio Engineering*, 10, 27-48; December, 1930.  
Laboratory tests show that electrolytic condensers may be advantageously employed in the construction of radio receiving sets.
- R270  
×R113.1 Green, A. L. Some notes on field intensity measurements. *Experimental Wireless and Wireless Engr.*, 8, 61-69; February, 1931.  
During the course of "fading" observations at Radio Research Station, Peterborough, it was realized that the absolute strength of atmospherically returned wireless waves could be calculated from the knowledge of (a) the field strength of the steady ground wave in daylight and (b) any "fading" curve taken at night. The following notes are a record of some attempts made at Peterborough to measure field strengths as low as 0.5 millivolts per meter, with simple unshielded apparatus. A high standard of accuracy has not, so far, been attempted, but the results already obtained indicate a useful field for development.
- R282 Black, D. H. and Nisbet, R. H. The conduction of electricity in liquid dielectrics. *Phil. Mag.*, 10, 842-862; November, 1930.  
The possibility of applying the theory of conduction in gases to conduction in liquid dielectrics is investigated and experimental results show that the gas theory is better able to account for observed facts than are other theories.

## R300. RADIO APPARATUS AND EQUIPMENT

- R355.7 Aceves, J. G. Audio compensated amplifier for broadcasting and recording studios. *Radio Eng.*, 11, 37-38; January, 1931.  
An audio amplifier system which permits of compensating for improper room acoustics and for loud speaker deficiencies, is described.

- R356.3 Osborn, R. H. Mercury arc rectifiers for radio transmitters. *Elec. Jour.*, 28, 123-124; February, 1931.  
A three-phase mercury arc rectifier of the mercury pool type, designed for KDKA's new broadcast station and rated at 7500V-30A, is described.
- R361 Gill, A. G. and McDonald, A. G. Developments in broadcast radio receiving apparatus. *P. O. Elec. Engrs. Jour.*, 23, 216-219; October, 1930; 311-324; February, 1931.  
A brief discussion is given of some of the more recent developments in broadcast receiving sets and their components, with special reference to the apparatus exhibited at the annual British Radio Show of 1930.
- R361 Nason, C. H. W. Modulated cw and the Stenode radiostat. *Radio Eng.*, 11, 19-21; January, 1931.  
An engineering discussion of the theory of this new receiving system recently demonstrated in New York.
- R361.2 Tanner, R. W. A superheterodyne receiving set for short waves. *Radio Eng.*, 11, 22-23; January, 1931.  
The description of an oscillator tuned system for stable high-frequency radio reception is given.
- R361.3  
×R162 Binneweg, A. Short wave receiving set design. *Radio Eng.*, 11, 26-27; January, 1931.  
Some of the more technical aspects of regenerative, high-frequency receiving set design, are considered, together with experimental results.
- R365.2 Edelman, P. E. Condenser loud-speaker with flexible electrodes. *Proc. I.R.E.*, 19, 256-267; February, 1931.  
Condenser loud-speakers employing flexible electrodes are described together with their uses as the input to an amplifier or for reproducing from the output of an amplifier unit. One electrode diaphragm utilizes an impregnated cloth carrying a conductive coating. The cooperating electrode is also flexible and air-permeable. Textile threads at spaced distances are used to maintain the separation between the operating electrodes and to reduce backlash rattle noises. The improvement in response, fidelity, and efficiency, as well as durability, are set forth, accompanied by examples of suitable operating circuits. It is pointed out that such condenser speakers operate most favorably with an amplifier arranged to compensate for their characteristics.
- R365.3 Robinson, G. D. Wide range scales for fading records by electrical means. *Proc. I.R.E.*, 19, 247-251; February, 1931.  
The electrical means discussed in this paper are two in number. Relatively small modifications of the response characteristics of the recording system may be obtained by the use of a combination of plate detection and grid detection in which the latter becomes active only for strong signals. Great modifications of the response characteristics are produced by circuit arrangements of the type used for "automatic volume control." Curves are given showing typical results. These show the possibility of obtaining greatly increased scale ranges and also of obtaining scales in which the recorder response is roughly proportional to the logarithm of the strength of the carrier wave. The response to side bands is stated to be small.
- R380 Goodwin, W. N. Rectifier type instruments. *Radio Eng.*, 10, 34-35; December, 1930.  
A discussion of the sources of error that may occur in this type of instrument, which finds its principal use in the measurement of small a-c currents.
- R381 Dunn, W. L. Electrolytic condensers. *Radio Eng.*, 11, 31-33; January, 1931.  
The characteristics of electrolytic condensers are discussed as well as their action and performance in radio receiving sets.
- R382.1 Wigge, H. Die verzerrungsfreie Leistungsübertragung auf einen Lautsprecher durch den Ausgangs-transformator. (The transfer of

power through an output transformer to the loud-speaker without distortion.) *Zeits. f. Hochfrequenz.*, 37, 16-17; January, 1931.

Presenting an analysis of the problem and a convenient method of determining optimum constants for the transformer.

- R390 Lautermann, W. F. The design of attenuation networks, *Electronics*, 2, 508-509; February, 1931.

Formulas and tables for both the *H*- and *T*-type networks are presented in the most useful form for practical design application.

- R390 Holcomb, R. T. Electrical delay circuits for radiotelephony. *Bell Lab. Record.* 9, 229-239; January, 1931.

A brief analysis of the improved delay circuits used with the transatlantic radiotelephone.

- R390 Smack, J. C. Mechanical remote tuning controls for radio receiving sets. *Radio Eng.*, 11, 28-30; January, 1931.

Several types of mechanical control which have found recent favor are described.

#### R400. RADIO COMMUNICATION SYSTEMS

- R423 von Ardenne, M. Über eine Methode zur Schaffung guter empfangsverhältnisse in der Grossstadt. (A method of improving broadcast reception in large urban centers.) *Elek. Nach. Tech.*, 7, 463-476; December, 1930.

The method consists essentially of an aperiodic receiving set and an aperiodic transmitter, both of which are designed to pass the entire broadcast spectrum and which are linked together by a wire line or a short wave channel. The receiving set is located beyond the outskirts of the city (where disturbances are a minimum) while the transmitter having an output of 0.5 to 1 kw is located in the center of the city. Thus, within the urban district, the field intensities of distant broadcast transmitters are increased to the level of local stations. Experiments are described in which an ultra-high-frequency carrier is modulated with several voice modulated r.f. carriers.

- R423.5  
×R148 von Ardenne, M. Zur Technik des Sendens und Empfangens von Ultrakurzwellen, die mit mehreren modulierten Hochfrequenzen moduliert sind. (The transmission and reception of ultra-high frequencies, which are modulated with several voice-modulated radio frequencies.) *Zeits. f. Hochfrequenz.*, 27, 12-15; January, 1931.

The author describes the apparatus used, the results of experiments and the future possibilities of ultra-high-frequency carrier channels.

- R450 Espenschied, L. and Wilson, W. Overseas radio extensions to wire telephone networks. *Proc. I.R.E.*, 19, 282-303; February, 1931.

There is given first, a sketch of the wire telephone networks and the interconnecting links as they exist today, second, a picture of the transmission results which are being obtained in the operation of some of the overseas links, and finally a discussion of the more important phenomena and problems involved in the radio transmitting medium.

#### R500. APPLICATIONS OF RADIO

- R520 Radio aboard the DO-X. *Radio News*, 12, 781; March, 1931.

A brief description of the radio equipment carried by the DO-X.

- R550  
×R612.1 Eckersley, P. P. On the simultaneous operation of different broadcast stations on the same channel. *Proc. I.R.E.*, 19, 175-194; February, 1931.

This paper gives a detailed account of experiments in the operation of general radio broadcast stations on a common frequency, conducted in England. The theory involved in synchronous transmission is set forth as well as accounts of tests. Three different methods of common-frequency operation were tried. The results are discussed at length giving the relative advantages and disadvantages of each.



- R583 Ives, H. E. Progress in two-way television. *Bell Lab. Record*, 9, 262-264; February, 1931.

A brief description of improvements in television apparatus including a new neon tube.

- R592 Clarke, C. W. Signal Corps motorized radio equipment. *Radio Eng.*, 11, 17-18; January, 1931.

The description is given of a four-ton, four-wheel-drive truck equipped with radio transmitting and receiving equipment, and a three-ton, gas-electric truck which is equipped to supply power to the transmitter.

## R600. RADIO STATIONS

- R612.1 Semm, A. Der Grossrundfunksender Mühlacker. (The Mühlacker high power broadcast transmitter.) *Tel. and Fernsprech Tech.*, 19, 367-374; December, 1930.

A detailed description of the completed installation is given.

- R614 Mögel, H. Betriebskontrolle von Kurzwellensenders. (Monitoring the operation of short-wave transmitters.) *Elek. Nach. Tech.*, 7, 334-348; September, 1930. *PROC. I.R.E.*; 19, 214-232; February, 1931.

Abstracted in December, 1930, issue of PROCEEDINGS of the Institute of Radio Engineers.

## R800. NONRADIO SUBJECTS

- 530 Regener, E. Durchdringende Hohenstrahlung: UltraStrahlung und Kosmiches Geschehen. (Cosmic rays and the Cosmos.) *Elek. Nach. Tech.*, 7, 451-462; December, 1930. *Electrotech. Zeitschrift*, 52, 97-102; January 22, 1931.

A discussion of the results of recent discoveries in the field of cosmic radiation.

- 537.65 The crystal clock. *Wireless World and Radio Rev.*, 28, 69-70; January 21, 1931.

An interesting application of the piezo oscillator to the measurement of time.

- 538 Williams, S. R. and Sanderson, R. A. Changes in electrical resistance due to magnetism and hardness. *Phys. Rev.*, 27, 309-314; February 1, 1931.

A series of nickel rods, to which had been imparted different degrees of hardness, had their resistance measured when subjected to a longitudinal magnetic field. In each case the magnetic field caused increased resistance, the increase varying for different degrees of hardness.

- 621.313.7 Sahagen, J. The use of the copper-oxide rectifier for instrument purposes. *PROC. I.R.E.*, 19, 233-246; February, 1931.

After discussing the possibilities and limitations of half-wave rectification, an analysis is made of the copper-oxide full-wave instrument rectifier. Characteristics of this rectifier and of rectifier instruments under varying conditions of current, temperature, frequency, and wave form are discussed.

- 621.319.2 Arnold, J. W. and Bechberger, P. F. Sinusoidal currents in linearly tapered loaded transmission lines. *PROC. I.R.E.*, 19, 304-310; February, 1931.

Working formulas for the calculation of input impedances and attenuation are obtained for a transmission line in which the resistance and inductance per unit length are linear functions of distance, and in which the capacitance and leakage are constant. Generalized functions depending on the initial constants and the rate of taper are introduced, in such a way that the formulas and the functions are analogous to the usual formulas and hyperbolic functions. The latter are secured as special cases of the former. The theory is applicable to the tapered loaded submarine cable. Propagation in such a transmission line as distinguished from that in the smooth uniform line is characterized by the fact that the current attenuation is, in general, different from the voltage attenuation.

- 621.375.1 Kearsley, W. K. A vacuum-tube time switch. *Gen. Elec. Rev.*, 34, 128-129; February, 1931.

A precision time switch employing three vacuum tubes is described.

- 621.385.91 Leconte, R. A. Circuit equipment for program distribution. *Bell Lab. Record*, 9, 233-237; January, 1931.

A brief discussion of problems encountered in designing repeater equipment and loading for program circuits is given.

- 621.385.91 Timmis, A. C. and Beer, C. A. Underground circuits for the transmission of broadcast programs. *P. O. Elec. Engrs. Jour.*, 23, 315-321; January, 1931.

A description of the network of land lines and repeater circuits which link the studios of the British Broadcasting Company, and a discussion of the electrical characteristics of these lines is given.

- 621.385.95 Sivian, L. J. Absolute calibration of condenser transmitters. *Bell Sys. Tech. Jour.*, 10, 96-115; January, 1931.

Several methods have been used or proposed for the calibration of the Wentz condenser transmitter. The methods falling under the two classifications conveniently designated "constant pressure" or "pressure" calibration and "constant field" or "field" calibration are most useful and amenable to measurement. Which of these two calibrations is more significant depends on the particular use made of the transmitter. In the following pages the methods now used or proposed are reviewed and the advantages or disadvantages of each from the standpoint of transmitter application are discussed.

- 621.385.96 Livadary, J. P. Frequency characteristics of optical slits. *Electronics*, 2, 512-513; February, 1931.

A treatment is given of the relative efficiency of different optical slits, and their frequency characteristics in connection with sound recording and reproduction.



## CONTRIBUTORS TO THIS ISSUE

**Asao, S.:** Born December 29, 1898 at Toyama, Japan. Studied physics, Tokyo Imperial University, 1920-1923. Tokyo Electric Company, Kawasaki, 1923 to date. Nonmember, Institute of Radio Engineers.

**Beverage, Harold H.:** Born October 14, 1893 at North Haven, Maine. Received B.S. degree in E.E., University of Maine, 1915. Testman, General Electric Company, 1915-1916. Assistant in Alexanderson's radio laboratory at Schenectady, 1916-1920. In charge of communication receiver laboratory, Radio Corporation of America, 1920-1929, chief communications engineer, R.C.A. Communications, Inc., 1930 to date. Received Liebmann Memorial Prize, 1923. Associate member, Institute of Radio Engineers, 1915; Member, 1926; Fellow, 1928.

**Craig, P. H.:** Born January 10, 1901 at Cincinnati, Ohio. Received A.B. degree, University of Cincinnati, 1923; M.A. degree, 1924; Ph.D. degree, 1926. Professor of physics, Mercer University, 1926-1927. Research physicist, Premier Laboratory, Inc., New York City, 1927. Research physicist with Harris Hammond, 1928-1930. Vice President, Crason Corporation, 1931. Member, American Physical Society, A.I.E.E. Associate member, Institute of Radio Engineers, 1925.

**Diamond, H.:** Born February 12, 1900 at Quincy, Massachusetts. Received B.S. degree, Massachusetts Institute of Technology, 1922; M.S. degree, Lehigh University, 1925. Engaged in research work in mechanical engineering with General Electric Company, 1922-1923; instructor in electrical engineering, Lehigh University, 1923-1927; summer work, General Electric, B. F. Sturtevant, and Boston Elevated Companies. Associate radio engineer, Bureau of Standards, 1927-1928; radio engineer in charge of development of radio aids to air navigation, Bureau of Standards, 1928 to date. Member, A.I.E.E. Associate member, Institute of Radio Engineers, 1926; Member, 1930.

**Dunmore, F. W.:** Born February 24, 1891 at Haverhill, Massachusetts. Commercial radio operator, summers, 1911-1913. Received B.S. degree, Pennsylvania State College, 1915. Student engineering course, General Electric Company, 1915-1917; research department, American Radio and Research Corporation, 1918; radio laboratory staff, Bureau of Standards, 1918 to date, specializing in research work in radio direction finder, directional transmission and radio aids to air navigation. Nonmember, Institute of Radio Engineers.

**Guarnaschelli, Ferruccio:** Born November 8, 1900 at Pavia, Italy. Specialized electrotechnics and radio communications, Naval Electrotechnical and Communications Institute, Livorno, 1926; assistant, Naval Electrotechnical and communications Institute, 1927 to date. Nonmember, Institute of Radio Engineers.

**Moore, John B.:** Born October 13, 1900 at Alden, New York. Received B.S. degree in E.E., Carnegie Institute of Technology, 1922. Engineering department, Radio Corporation of America and R.C.A. Communications, Inc., since 1922; operating division, 1922-1928; design of receiving methods and equipment, 1928 to date. Associate member, Institute of Radio Engineers, 1926.

**Peterson, Harold O.:** Born November 3, 1899 at Blair, Nebraska. Received B.S. degree in E.E., University of Nebraska, 1921. Testman, General Electric Company, 1921-1922. Engaged in development of radio communications equipment with Radio Corporation of America, 1922-1929; in charge of communication receiver development laboratory, R.C.A. Communications, Inc., 1929 to date. Associate member, Institute of Radio Engineers, 1922.

**Suzuki, M.:** Born January 26, 1906 at Nakakubiki, Niigata, Japan. Studied at Denki Gakko, Kanda, Japan, 1922-1925. Research assistant in development of photoelectric tubes, potassium hydride tubes, and caesium tubes, Tokyo Electric Company, 1927 to date. Nonmember, Institute of Radio Engineers.

**Vecchiacchi, Francesco:** Born October 9, 1902 at Lucca, Italy. Received Doctor of Physics degree, University of Pisa, 1925. Specialized electrotechnics and radio engineering, Livorno Naval Electrotechnical and Communications Institute. Assistant professor, Institute of Physics, University of Pisa, 1926-1927; assistant, Naval Electrotechnical and Communications Institute, 1927 to date; professor, radio communications and member, National Council of Researches, Radiotelegraphic Committee (Italy). Associate member, Italian Electrotechnical Association, Italian Society of Physics. Nonmember, Institute of Radio Engineers.

**Verman, Lal C.:** Born October 2, 1902 at Amritsar, India. Received B.S. degree in E.E., University of Michigan, 1927; M.S. degree, Cornell University, 1928; Ph.D. degree in physics, 1930. Research assistant in engineering research department, sound division, University of Michigan, 1925-1927; Donovan Scholar, University of Michigan, 1925-1927; Charles A. Coffin Fellow (General Electric Company), Cornell University, 1927-1930. Associate member, A.I.E.E. Associate member, Institute of Radio Engineers, 1928.

**Wheeler, L. P.:** Born July 27, 1874 at Bridgeport, Connecticut. Received Ph.B. degree, Yale University, 1894; Ph.D. degree, 1902; Laboratory assistant in physics, Sheffield Scientific School, Yale University, 1895-1897; assistant, 1897-1901; instructor, 1901-1906; assistant professor, 1906-1923; associate professor, 1923-1926. Physicist, U. S. Naval Research Laboratory, 1926 to date. Fellow, Institute of Radio Engineers, 1928.

**Wolff, Irving:** Received B.S. degree, Dartmouth College, 1916; nontechnical work, 1916-1919; instructor, Iowa State College, 1919-1920; instructor, Cornell University, 1920-1923; Ph.D. degree, Cornell University, 1923; research on polarization capacity for Heckscher Research Council, 1923-1924; research on electro-acoustics, Radio Corporation of America, 1924-1929; RCA-Victor Company, 1930 to date. Fellow, American Association for Advancement of Science and Acoustical Society of America, Member, American Physical Society; member, Sigma Xi and Phi Kappa Phi. Associate member, Institute of Radio Engineers, 1927.





# ENGINEERS AVAILABLE

Advertisements on this page are available only to members of the Institute of Radio Engineers. For rates and further information address the Secretary, The Institute of Radio Engineers, 33 West 39th Street, New York, N.Y.

**Manufacturers** and others seeking radio engineers are invited to address replies to these advertisements at the Box number indicated, care the Institute of Radio Engineers. All replies will be forwarded direct to the advertiser.

---

**INSTRUCTOR IN PHYSICS AND RADIO COMMUNICATION**, is interested in securing position with broadcast station in any capacity, or with radio manufacturer offering opportunity to do radio research. Has had experience in construction and design of broadcast stations as well as in station management. College graduate. Age 27. Box 50.

---

**COLLEGE GRADUATE**, having several years experience with design of public address and centralized radio systems and talking picture equipment desires position with opportunity for doing design, development and research in audio systems or radio equipment. Now employed. Age 25. Box 54.

---

**YOUNG MAN**, with some college education, desires position where past experience may be most advantageously used. Has had seven years experience in design and development of radio receivers and loud speakers and other audio equipment. Age 25. Box 55.

---

**YOUNG WOMAN**, holding commercial operator's license is interested in position in radio field, particularly with some broadcast station. Has had high school education as well as course in radio. Pianist and typist. Also has some experience servicing radio receivers. Age 18. Box 56.

# RADIO'S FOREMOST NOW MADE EVEN BETTER BY THE NEW TYPE "K" METALLIZED

**L**AST month we announced Type "K" *Metallized* Filament. The statement was made that it was this company's greatest contribution to the radio and vacuum tube industries since the introduction of *Metallized* Resistors.

In support of this assertion we now present facts taken from a few of the tests conducted over a period of eighteen months of intensive research.

The results of these tests have been confirmed by several of our larger customers in their own laboratories. They will interest every set manufacturer, every distributor of radio supplies, and every serviceman—for without question they stamp Type "K" *Metallized* Filament as the most advanced resistance unit available to the Radio industry today.

**IRC**

*Metallized*

*When writing to advertisers mention of the PROCEEDINGS will be mutually helpful.*

# RESISTOR FILAMENT

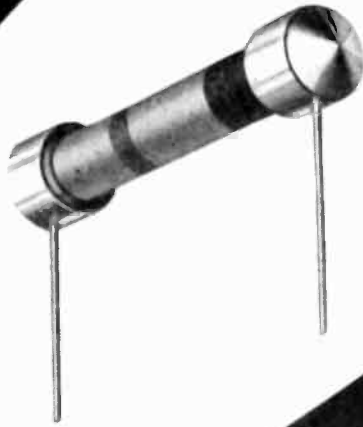

## Permanent

Type "K" *Metallized* Resistors, placed under intermittent rated wattage, show small change in resistance, the units always returning to their original values.

## High Safety Factor

With 100 per cent overload applied to type "K" *Metallized* Resistors, the change in resistance is not greater than 10 per cent. These units also return to within 2 per cent of their initial values.

## Moisture Proof

Type "K" *Metallized* Resistors will be found to be nearly impervious to moisture. Hot moisture and cold moisture tests, applied to these units, show a change in resistance of less than 10 per cent. The units return to their original values after these severe tests.

## INTERNATIONAL RESISTANCE CO., PHILADELPHIA

In Canada, International Resistance Co., Ltd.,  
74 Wellington St., Toronto

## Noiseless

Type "K" *Metallized* Resistors, under test, show extremely low noise level.

## Ruggedness

Type "K" *Metallized* Resistors are extremely strong. When a load of sixty-five pounds was placed across a resistor it showed no failure. Type "K" units will readily withstand abuses to which resistors are subject in production or shipment.

## Voltage Coefficient

Test voltages applied on Type "K" *Metallized* Resistors from 0 to 350 volts show a maximum change of 2 per cent from original resistance value.

Write for your Folder

Folders showing curves and data bearing on these and other tests have been forwarded to our customers. If you have not received yours, write and a copy will be mailed.

# RESISTORS

## Also Precision Wire Wound Resistors

When writing to advertisers mention of the PROCEEDINGS will be mutually helpful.



# AMERTRAN SOUND SYSTEM PANELS

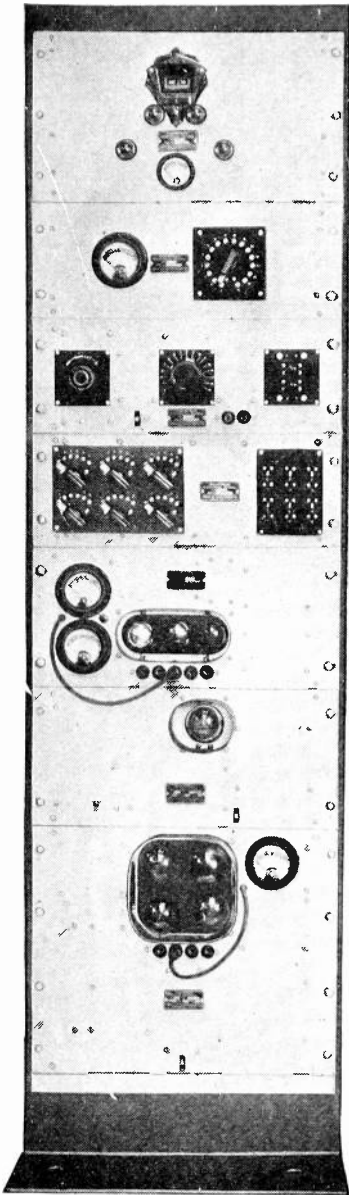

Suggested Panel Layout No. 2  
(For Undistorted Outputs of 12.5 Watts)

Long recognized as typifying the "Standard of Excellence" in audio products, the Amertran line now includes a wide assortment of standard panels designed to fill every requirement for complete sound systems.

Amertran panels are so constructed that they may be assembled on racks in various combinations for every purpose. They are the best that engineering genius can produce with the finest of materials and workmanship.

Before placing these Sound Systems on the market, months of research were spent in perfecting them, and thousands of panels were built for special applications—tested for true fidelity and satisfactory service, both in the laboratory and in actual installations.

Bulletin 1200 gives complete information and illustrations of Standard Amertran Panels. Write for it on your business stationery, and send specifications of your particular problem. Our engineering staff is at your service.

**AMERICAN TRANSFORMER COMPANY**  
179 Emmet Street, Newark, N. J.

*Representatives in following cities*

Atlanta • Boston • Chicago • Knoxville • Minneapolis  
Montreal • Philadelphia • San Francisco • St. Louis



# AMERTRAN

*When writing to advertisers mention of the PROCEEDINGS will be mutually helpful.*

# You Don't Need A Can

With The

## ELKON Non-Aqueous Hi-Volt Condenser!

**Specify Elkon  
Without  
the Can and  
Reduce Your  
Condenser  
Cost**

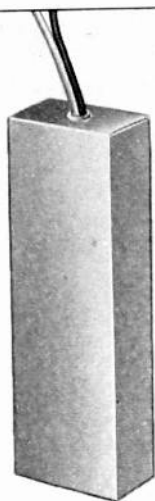

The sturdy, wax-dipped cardboard carton used on Elkon condensers is ample protection to insure efficient operation.

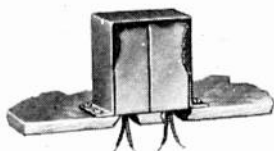

If your set is already designed for condensers on top of the chassis, the Elkon condensers may be placed under an inexpensive drawn metal cover.

otherwise—



—the condensers may be mounted directly to the under side of the chassis.

There's Nothing to Spill » » »  
Nothing to Leak » » »

**E**LKON alone offers this opportunity to reduce your condenser costs by eliminating the can. The sturdy, wax-sealed cardboard container used on Elkon condensers is ample protection to insure efficient operation. The other features of the Elkon condenser also show why many leading set and instrument manufacturers have adopted the Elkon condenser as standard equipment:

- 1 Highest Filtering Capacity of any electrolytic condenser.
- 2 High Working Voltage: 450 volts—withstands without injury transient peaks in excess of 575 volts.
- 3 Absolutely Dry: A condenser from which all water is eliminated.
- 4 Low Leakage: Normal rated leakage 0.1 mil per mfd. (After operating short period the leakage is 0.025 mils per mfd.)
- 5 Impervious to Low Temperatures: Operates efficiently from minus 40° F to 125° F.
- 6 Long Life: To reduce replacements and interrupted service periods to a minimum.
- 7 Self Healing: Transient peaks in excess of 575 volts do not injure the Elkon condenser.
- 8 Compactness: Smallest cubical volume per microfarad of any condenser on the market.
- 9 Stability in Operation: To guard against mechanical and electrical variation that would affect action of the circuit.
- 10 Low Cost Per Microfarad Per Voltage Rating: A large safety factor in volt rating for the same cost as lower voltage condensers.

Samples built to your specifications will be sent to all recognized manufacturers (metal cans will, of course, be supplied if desired).

Send for booklet giving complete technical data and general descriptions.

**ELKON DIVISION**  
P. R. Mallory & Company, Incorporated  
Indianapolis, Indiana

When writing to advertisers mention of the PROCEEDINGS will be mutually helpful.

# THERE IS A DIFFERENCE

A little change here, a little cut there—the letter of your specifications may have been met—yet the finished job may not produce the expected results if the manufacturer has failed to interpret your intention. Then what? Who gets the headache?

Take, for example, CARDWELL manufactured-to-specification instruments and apparatus. Built with scrupulous exactness, no product of the CARDWELL factory has failed to meet the requirements of a most discriminating clientele, composed of the foremost engineering organizations in the country and various departments of the government. The headaches, if any, have been ours.



*Aircraft  
Transmitter,  
Built for U. S. Navy*



CARDWELL condensers, too, insure that quality of performance desired and expected by the engineer or designer, and the great variety of types and sizes available in the CARDWELL line affords an opportunity to choose *exactly* the *right* condenser for the *right* place in any circuit.

*May we serve you?*

**CARDWELL CONDENSERS**  
*(Variable and Fixed)*

**AND**

**MANUFACTURING SERVICE**

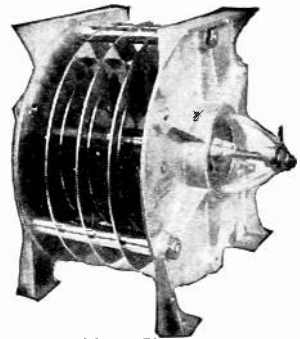

*High Voltage  
Fixed Condenser*



**THE ALLEN D. CARDWELL MFG.  
CORPN.**

93 Prospect Street, Brooklyn, N.Y.

“THE STANDARD OF COMPARISON”

*When writing to advertisers mention of the PROCEEDINGS will be mutually helpful.*



The new RCA 235 is not interchangeable with any other RCA Radiotron and must be used in circuits especially designed for its characteristics.

# Announcing the New Super- Control Screen- Grid Amplifier

THE RCA Radiotron Company, Inc., is pleased to announce a screen grid radio frequency amplifier, designed especially for reducing cross-modulation and modulation distortion. Furthermore, its design is such as to permit easy control of a large range of signal voltages without the use of local-distance switches or antenna potentiometers. This feature makes the tube adaptable to automatic volume control design. It is designed for AC operation, and employs a cathode of the quick heater type.

Tentative ratings and characteristics of the RCA 235 are:

Filament Voltage . . . . .	2.5 Volts.
Filament Current . . . . .	1.75 Amps.
Plate Voltage (Recommended) . . . . .	180 Volts.
Screen Voltage (Recommended) . . . . .	75 Volts.
Grid Voltage . . . . .	-1.5 Volts.
Plate Current . . . . .	9 Milliampes.
Screen Current . . . . .	Not over 1/4 of plate current.
Plate Resistance . . . . .	200,000 Ohms (Approx.)
Mutual Conductance . . . . .	1100 Micromhos.
Effective Grid-Plate Capacitance . . . . .	0.010 uuf. Max.

RCA RADIOTRON COMPANY, INC. — HARRISON, N. J.

*A Radio Corporation of America Subsidiary*

# RCA RADIOTRONS

« « *The Heart of Your Radio* » »

*When writing to advertisers mention of the PROCEEDINGS will be mutually helpful.*



## "Here's a New SPRAGUE INVERTED CONDENSER that does the work"

Metal enclosed  
vent

One piece  
anode

One hole  
mounting

Can—dull  
nickel finish

Small space—  
high capacity

High voltage—  
self-healing

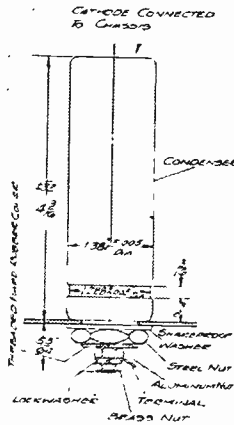

RADIO engineers of 1931 receiving sets will receive with unqualified approval this announcement of a Sprague Electrolytic Condenser that helps materially in their problems to make the new radio receivers as simple as possible, more efficient than ever before—and at the same time conserve time, space and expense.

Only an organization like SPRAGUE, with superb modern manufacturing facilities, highly developed research laboratories, an engineering department devoted to the problems of the set manufacturer, and a highly trained personnel could produce the tremendous improvement represented by this new SPRAGUE INVERTED ELECTROLYTIC CONDENSER in tremendous quantities with unqualified UNIFORMITY.

Send for illustrated booklet, diagrams, etc. Address Dept. 13K

SPRAGUE SPECIALTIES COMPANY  
North Adams, Mass.

# SPRAGUE

## Electrolytic CONDENSERS

When writing to advertisers mention of the PROCEEDINGS will be mutually helpful.



**It's  
Adjustable**

Additional clips  
easily added or re-  
moved as required  
—an Exclusive  
Truvolt Feature

U. S. Pat.  
1670869 and  
Pats. Pend.

# **TRUVOLT—The Most Easily Adaptable of All RESISTORS**

**N**OT only outstanding quality, but *convenience* as well should be a prime requisite in selecting resistors.

The unique patented winding of TRUVOLTS makes for exact values and long life. The resistance element is fully exposed for air cooling. The tubular fire-clay base further aids ventilation.

In addition, TRUVOLTS are the only resistors providing for adjustable clips. They may be added or taken off at will, or shifted to any position to obtain exact values.

Think what that feature means in convenience, saving of time and lower service costs. With TRUVOLTS, fewer units are required in the serviceman's kit.

TRUVOLTS are made in single and multiple units in all usual resistance values and voltage ratings. Also 22 stock sizes with adjustable knob control.

*Let Electrad cooperate in solving  
your resistor problems.*

# **ELECTRAD**

INC.

ELECTRAD, INC., Dept. PE-4, 175 Varick  
St., New York, N.Y.

Please send me FREE new, complete 36-  
page Electrad Catalog of all products.

Name .....

Address .....

*When writing to advertisers mention of the PROCEEDINGS will be mutually helpful.*

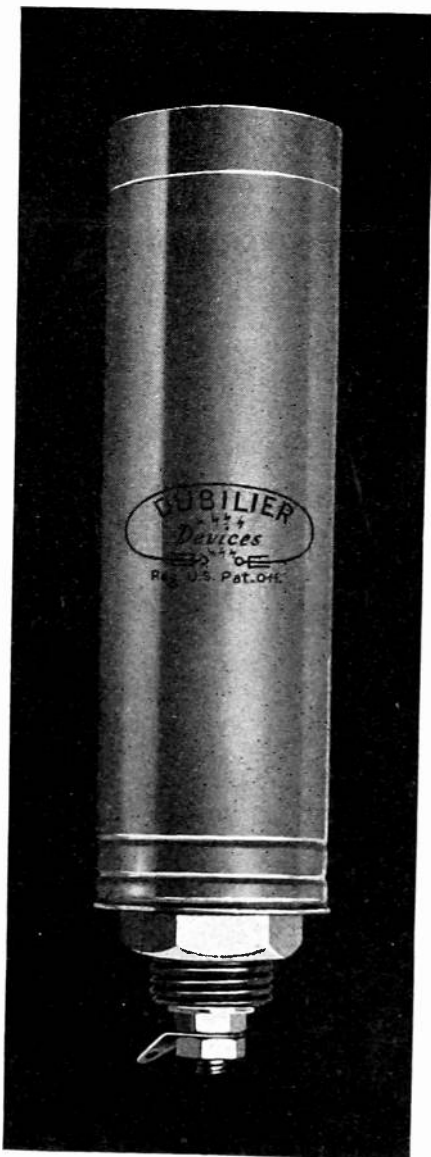

The original research and development work of Dubilier engineers in the electrolytic condenser field is now at your disposal. Do not hesitate to place your condenser problems before us. Details and samples of Dubilier Hi-Mike Condensers will be cheerfully submitted.

## DUBILIER INVERTED TYPE HI-MIKE CON- DENSER

For sub-panel wiring jobs, the Dubilier engineers have developed the Dubilier Inverted Type Hi-Mike Condenser—a fitting companion for the standard type, with the same general characteristics:

1. Aluminum can  $4\frac{1}{2}$  by  $1\frac{3}{8}$  inches, interchangeable with other standard electrolytic units.
2. Standard capacity of 8 mfd., with highest percentage of effective capacity.
3. Working voltage conservatively rated at 400, peak of 430, and capable of withstanding 500 for short periods.
4. Fully self-healing, reforming faster than any other electrolytic condenser.
5. Lowest leakage at high voltages—approximately 0.2 milliamperes at 430 volts peak, after 100 hours.
6. Power factor less than 10%.
7. Life expectancy in excess of requirements of usual radio assembly.
8. Compact, clean, non-spillable, efficient, inexpensive, self-healing, reliable.

**DUBILIER**  
CONDENSER CORPORATION  
4377 BRONX BOULEVARD · · · NEW YORK CITY

*When writing to advertisers mention of the PROCEEDINGS will be mutually helpful.*

# FROST-RADIO

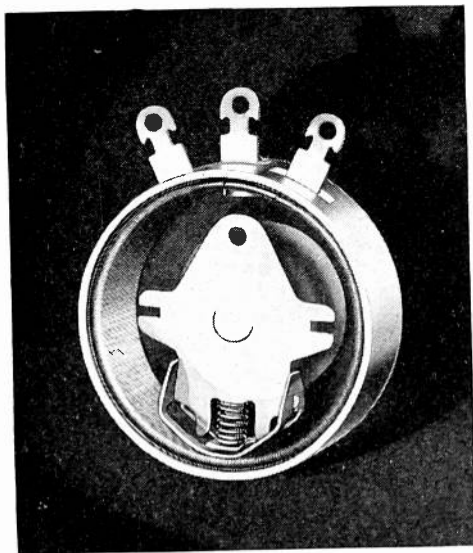

## Amazingly noiseless—

Frost-Radio engineers have been amazingly successful in removing the cause of noise from wire-wound volume controls. In the new Frost-Radio No. 20 Series noise is entirely absent. The operation of these controls is velvety smooth and silent to a degree heretofore believed

impossible in wire-wound units. This is accomplished by using a specially designed variable contactor which makes two separate and distinct line contacts with the resistance element, each contact being  $\frac{3}{32}$ " in length, a total line contact of  $\frac{3}{16}$ ". Frost-Radio construction makes it possible to employ more turns and larger wire. Space between turns has been successfully reduced to one ten-thousandth of an inch. Contact pressure has been greatly reduced, and danger of cutting and scoring practically eliminated. Nor can dirt, fragments of metal, etc., prevent the runner from making positive, continuous contact with the resistance element. Most amazing of all, fatigue tests have shown that our No. 20 Series Volume Controls can be depended on for 1,000,000 complete rotating operations without trouble of any kind developing . . . Engineers are invited to send us specifications of their volume control requirements.



No. 20 Series  
Single  
Control

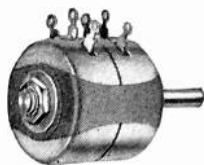

No. 20 Series  
Tandem Unit

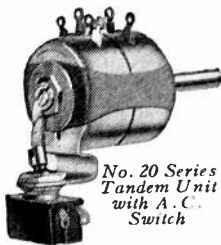

No. 20 Series  
Tandem Unit  
with A. C.  
Switch

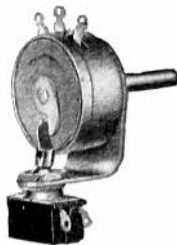

No. 20 Series  
Single Control  
with A. C.  
Switch

CHICAGO TELEPHONE SUPPLY CO.

HERBERT H. FROST, Inc.  
SALES DIVISION

General Offices ELKHART, INDIANA and Plant

When writing to advertisers mention of the PROCEEDINGS will be mutually helpful.



# VARITOR

[small fixed—variable capacitor]

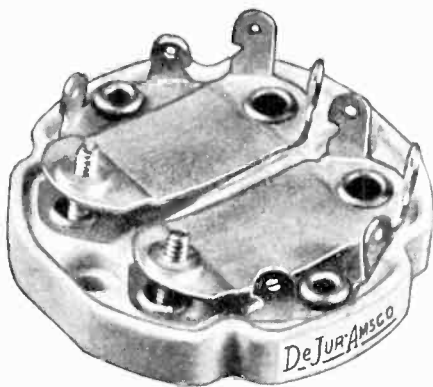

**A DEFINITE  
CONTRIBUTION  
TO THE  
ECONOMICAL  
PRODUCTION  
OF RADIO  
APPARATUS**

As radio research engineers for the past ten years and the leading makers of manufacturer's parts, we developed and introduced the DeJur-Amsco Single and Duplex Varitors. Leading radio engineers throughout the industry acclaim this new unit as a definite contribution to the economical production of radio apparatus.

The use of an isolantite base and the finest grade of mica as a dielectric insures a condenser of the highest electrical efficiency. Cadmium plated phosphor bronze plates eliminate the possibility of corrosion or oxidation with eventual microphonic variations.

*Write for circular giving complete specifications and Varitor's many uses in modern radio frequency circuits.*

## **MULTIPLE VARIABLE CONDENSERS FOR STANDARD AND MIDGET RECEIVERS**

Each size made in one capacity. Available in 2, 3, 4 and 5 gang units.

*Write for engineering data and working drawings. Send us your specifications and let us quote.*

*Samples on request.*

**We Also Make Special Condensers  
for Automobile Radios and  
Portable Receivers**

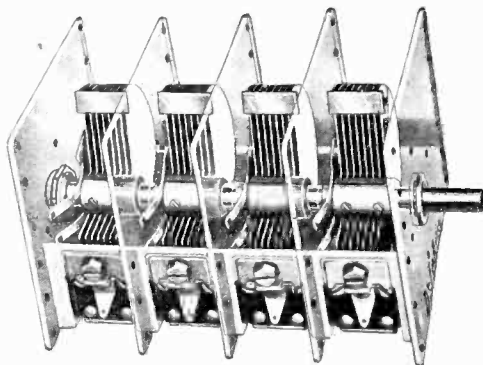

## **FRONT DRIVE DIALS**

*Write for circular showing complete line of DeJur-Amsco Front Drive Dials.*

# DeJur-Amsco Corporation

*Varitors—Variable Condensers—Power Rheostats—Front Drive Dials*

**95 MORTON ST., NEW YORK CITY**

*When writing to advertisers mention of the PROCEEDINGS will be mutually helpful.*

# A NEW Talking Point That Will Help Your Dealers **SELL**

**T**OO many radio "talking points" are common to *all* radio, as motors are common to all automobiles. But just as synchro-mesh transmissions, free-wheeling and front-wheel drives distinguish certain motor cars from the common herd, AMPERITE Line Voltage Control is lifting radio to a higher level of quality and performance.

AMPERITE in a radio is something to talk about—something *worth* talking about.

Dealers are talking about AMPERITE and wishing the sets they sell were equipped with it. A recent survey proves it overwhelmingly.

More than 82 percent of the dealers who answered our questionnaire state that *AMPERITE would help them sell radio and greatly reduce their service problems.*

AMPERITE corrects line-voltage irregularities—improves tone—reduces noise—increases tube efficiency—prevents strains on filter equipment—makes radio work according to laboratory standards, regardless of line-voltage fluctuations between 100 and 140 volts.

AMPERITE may be provided for in any electric radio without chassis changes or increase in chassis cost.



*Mail Coupon  
for Technical Data*

**AMPERITE Corporation**

Dept. PE-4 561 BROADWAY. NEW YORK

Please send Amperite Set Chart, installation instructions and technical data to

Name .....

Address .....

.....

## **AMPERITE**

*Self-Adjusting*  
**LINE VOLTAGE CONTROL**

*When writing to advertisers mention of the PROCEEDINGS will be mutually helpful.*

• **TECHNICALLY SPEAKING** •  
 “THESE FEATURES MAKE THE  
**RECORDOVOX SUPERIOR!**”



**LIST  
 PRICE  
 \$25.00**

*less microphone  
 Microphone as illus-  
 trated. \$10 additional*

**E**LECTRICALLY and mechanically, the  
 PACENT RECORDOVOX is as fine an  
 instrument as you could find even in the profes-  
 sional recording laboratories.

Every possible angle has been taken into con-  
 sideration in the design of the RECORDOVOX.  
 Supplied with 3 adjustable weights, it can be  
 used with motors that lack sufficient torque to  
 operate the turntable when the head is fully  
 weighted. Like the well-known PHONOVOX,  
 the RECORDOVOX, as the result of careful de-  
 sign, possesses excellent frequency characteristics.

Designed for pre-grooved type of records only.  
 List Price \$25.00. Microphone \$10.00 list extra.

*Write for information on special types and models  
 to meet your specifications.*

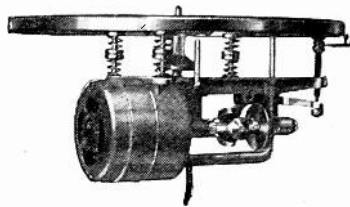

**ELECTRIC  
 PHONOGRAPH  
 MOTOR, CATALOG  
 NO. 140**

Meets every require-  
 ment of radio-phono-  
 graph use. Has suffi-  
 cient torque to cut  
 even 10" records. List  
 Price \$25.00.

**Manufacturers  
 PACENT ELECTRIC CO., INC., 91 SEVENTH AVE., NEW YORK**

Pioneers in Radio and Electric Reproduction for Over 20 Years  
 Licensee for Canada: White Radio, Ltd., Hamilton, Ontario.

**PACENT**

*When writing to advertisers mention of the PROCEEDINGS will be mutually helpful.*

---

LOCAL TELEPHONE SERVICE ONCE COST

\$ 240 A YEAR

---



---

IN 1879, the New York telephone directory was a card listing 252 names. There were no telephone numbers, nor any need for them. When you telephoned, you gave the operator the name of the person you wanted. Service was slow, inadequate and limited principally to people of wealth. The cost of a single telephone was as high as \$240 a year.

Today, you can talk to any one of hundreds of thousands of telephone users for a fraction of what it then cost for connection with less than three hundred. Every new installation increases the scope and value of the telephones in your home or office.

Twenty-four hours of every day, the telephone stands ready to serve you in the ordinary affairs of life and in emergencies. In the dead of night, it will summon a physician to the

bedside of a sick child. Men transact a great part of their business over it. Women use it constantly to save steps and time in social and household duties. In an increasing number of ways, it helps to make this a united, more active, more efficient nation.

Simply by lifting the receiver you become part of a nation-wide communication system that uses 80,000,000 miles of wire, and represents an investment of more than \$4,000,000,000. Yet the cost of local service is only a few cents a day.

Subscribers who look back over the month and consider what the telephone has meant to them in convenience, security and achievement are quick to appreciate its indispensable value and reasonable price.

Often you hear it said—"The telephone gives you a lot for your money."

---

★ AMERICAN TELEPHONE AND TELEGRAPH COMPANY ★



*When writing to advertisers mention of the PROCEEDINGS will be mutually helpful.*

---

**This unusual coil experience  
is at your command  
USE IT!**

---

Dudlo, Rome, and the other companies united in General Cable, form a reservoir of coil experience, research and knowledge that is unusually broad and deep.

That reservoir can and should be of great value to the progressive radio manufacturer. To draw from it whatever service may be of benefit in the design and production of your sets, call for a General Cable Coil Engineer. Let him apply to your coil requirements every modern coil ad-

vantage known to General Cable.

Such service may merely confirm the correctness of your present coil specifications. On the other hand it may, and often does, result in improvements or economies that might otherwise have been missed.

This service is at your command at any time. Use it.

If you do not know the address of the General Cable district office nearest you, write to headquarters in New York.

---

**GENERAL CABLE CORPORATION**

420 LEXINGTON AVENUE, NEW YORK • OFFICES IN PRINCIPAL CITIES



---

*When writing to advertisers mention of the PROCEEDINGS will be mutually helpful.*

# RCA

## New laboratory and test instruments

Beat Frequency Oscillators . . . R. F. Filters  
 Direct Capacitance Meter . . . Signal Generators  
 GM & RP Meter . . . Microphonic Test Set  
 Magnetic Prop Test Set



**Harmonic Analyzer**  
*type VE 14*

Measures quickly the voltage and frequency components of complex waves within frequency range of 60-2000 cycles above 0.25 millivolts. Accuracy of calibration within 2%. Standard signal included for checking calibration.

Is invaluable for analysis and study of complex waves. Filter design, distortion measurements of audio amplifiers, vacuum tube distortion, hum, etc.

*Special laboratory and production test equipment designed to your particular requirements. Information and prices on request.*

## ENGINEERING PRODUCTS DIVISION

RCA Victor Co., Inc., Camden, N. J.

Chicago—100 W. Monroe St.

San Francisco—225 Montgomery St.

*Please writing to above addresses mention the Engineering Division and be sure to specify model.*

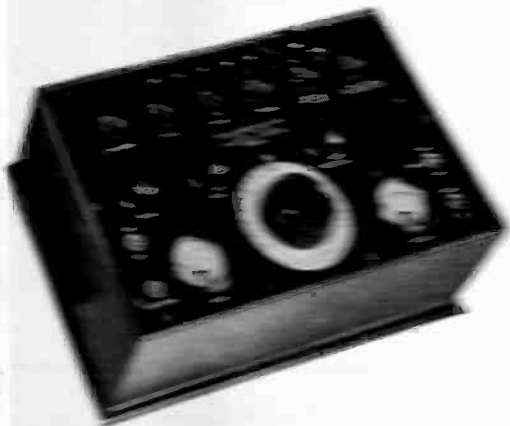

**Manual Conductance**  
*Meter type VE 9*

Measures manual conductance of all power types receiving tubes.

Accuracy within 2% of actual value with manual conductance power 200, microamp.

Test reading from a calibrated dial.

# AEROVOX

**BUILT BETTER**  
CONDENSERS AND RESISTORS

## The Aerovox Hi-Farad Dry Electrolytic Condenser

Low Cost  
Self-Healing  
High Capacity  
500 Volts Peak

**DRY!**



Universal mounting ring permits mounting of condensers in any position, upright or inverted.

**Free!**

This Book Giving the Latest and Most Complete Information on All Electrolytic Condensers Sent Free on Request.

Aerovox Wireless Corporation  
80 Washington Street  
Brooklyn, N. Y.

Please send me, without charge or obligation, a copy of your book, "The Hi-Farad DRY Electrolytic Condenser."

Name .....

Address .....

City..... State.....



**AEROVOX WIRELESS CORP.**

80 Washington Street, Brooklyn, N. Y.

**PRODUCTS THAT ENDURE**



When writing to advertisers mention of the PROCEEDINGS will be mutually helpful.

# The Institute of Radio Engineers

Incorporated

33 West 39th Street, New York, N. Y.

## APPLICATION FOR ASSOCIATE MEMBERSHIP

(Application forms for other grades of membership are obtainable from the Institute)

To the Board of Direction  
Gentlemen:

I hereby make application for Associate membership in the Institute.

I certify that the statements made in the record of my training and professional experience are correct, and agree if elected, that I will be governed by the constitution of the Institute as long as I continue a member. I furthermore agree to promote the objects of the Institute so far as shall be in my power, and if my membership shall be discontinued will return my membership badge.

Yours respectfully,

.....  
(Sign with pen)

.....  
(Address for mail)

.....  
(Date)

.....  
(City and State)

### References:

(Signature of references not required here)

Mr. .... Mr. ....

Address ..... Address .....

Mr. .... Mr. ....

Address ..... Address .....

Mr. ....

Address .....

The following extracts from the Constitution govern applications for admission to the Institute in the Associate grade:

### ARTICLE II—MEMBERSHIP

Sec. 1: The membership of the Institute shall consist of: \* \* \* (d) Associates, who shall be entitled to all the rights and privileges of the Institute except the right to hold the office of President, Vice-president and Editor. \* \* \*

Sec. 5: An Associate shall be not less than twenty-one years of age and shall be: (a) A radio engineer by profession; (b) A teacher of radio subjects; (c) A person who is interested in and connected with the study or application of radio science or the radio arts.

### ARTICLE III—ADMISSION

Sec. 2: \* \* \* Applicants shall give references to members of the Institute as follows: \* \* \* for the grade of Associate, to five Fellows, Members, or Associates; \* \* \* Each application for admission \* \* \* shall embody a concise statement, with dates, of the candidate's training and experience.

The requirements of the foregoing paragraph may be waived in whole or in part where the application is for Associate grade. An applicant who is so situated as not to be personally known to the required number of members may supply the names of non-members who are personally familiar with his radio interest.





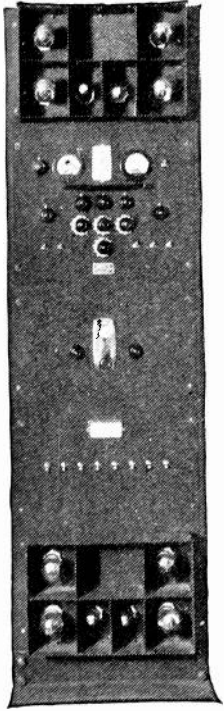

# *Better* AMPLIFICATION

*With this Better  
Amplifying Equipment*

The New Ferranti Type D Rack Amplifying Equipment goes beyond ordinarily satisfactory standards in securing faithful reproduction of voice and music . . . especially where heavy amplification is required.

## UNIT ASSEMBLY PRINCIPLE

*Makes for Speed and Convenience*

Any desired combination may be supplied from stock units. Additions are made without disturbing existing equipment. New units are quickly installed. Plug connections top and bottom, permit interchanging at will without disturbance of wiring.

## **Ferranti No. 245-A2 Commercial Type Amplifier**

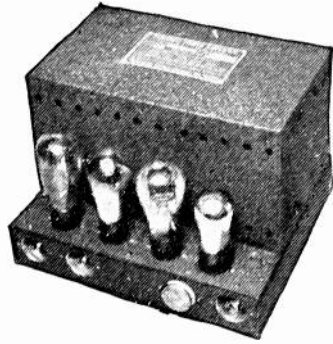

## SPECIAL AUDIO and OUTPUT TRANSFORMERS

Built in the U.S.A., these transformers, wound for special requirements, can now be shipped within 48 hours.

*Write for quotation and full particulars.*

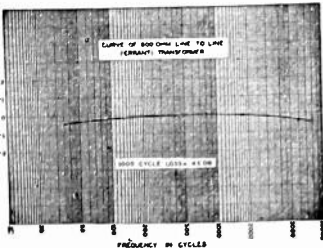

Graph shows curve typical of this newly developed series of Ferranti Transformers.

**FERRANTI, Inc.** 130 West 42nd St.  
New York

*When writing to advertisers mention of the PROCEEDINGS will be mutually helpful.*

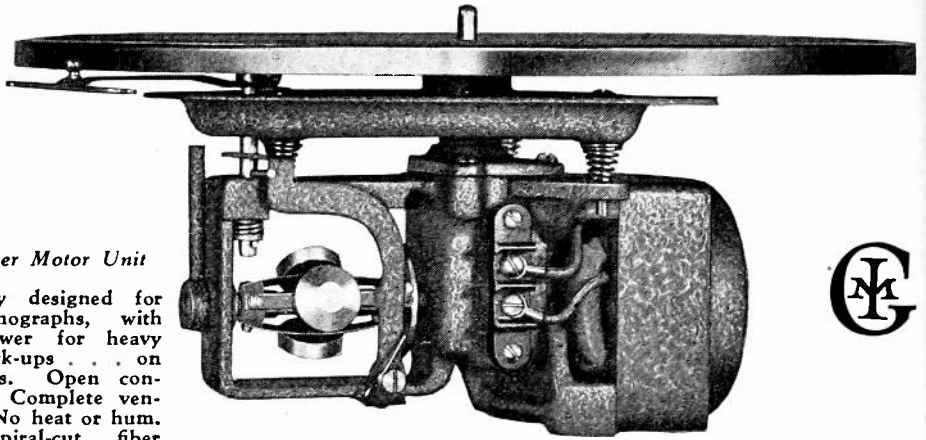

*Blue Flyer Motor Unit*

Specially designed for Radio-Phonographs, with ample power for heavy electric pick-ups . . . on all records. Open construction. Complete ventilation. No heat or hum. Silent, spiral-cut fiber gears; long oversize bearings. Operates on all voltages and frequencies. Automatic stop optional. Complete with mounting plate, turn-table and speed regulator.

*Responsibly  
Guaranteed*



Ontario Hydro-  
Electric Power  
Commission  
Approval No.  
2685.

# Flyer Electrics

## do a job to perfection..

**L** EADING engineers called the first Flyer Electric a good job. That was over two years ago. Every since then the Flyers have consistently won the same enthusiasm and respect from everybody. The popular motors for radio-phonographs. Doing a job to perfection.

Their advantages in simplicity of design and balanced co-ordination are as distinct today as ever. Wherever installed the Blue Flyer or the smaller Green Flyer proves it. Thanks not only to superior design. Thanks fully as much to 15 years of Flyer Motor experience in supplying power in over 5,000,000 quality phonographs. Thanks fully as much to a quarter century of similar success in electrical manufacturing by the same organization and plant.

Self starting, amply powerful, supplying uniform speed to perfection, and uninterrupted service. For all voltages and frequencies. Also the Green Flyer for direct current, either 110 or 220 volts.

*In ordering  
samples, please  
give voltage  
and frequency.*

## The GENERAL INDUSTRIES CO.

3146 Taylor Street, Elyria, Ohio

*When writing to advertisers mention of the PROCEEDINGS will be mutually helpful.*

# Shakeproof

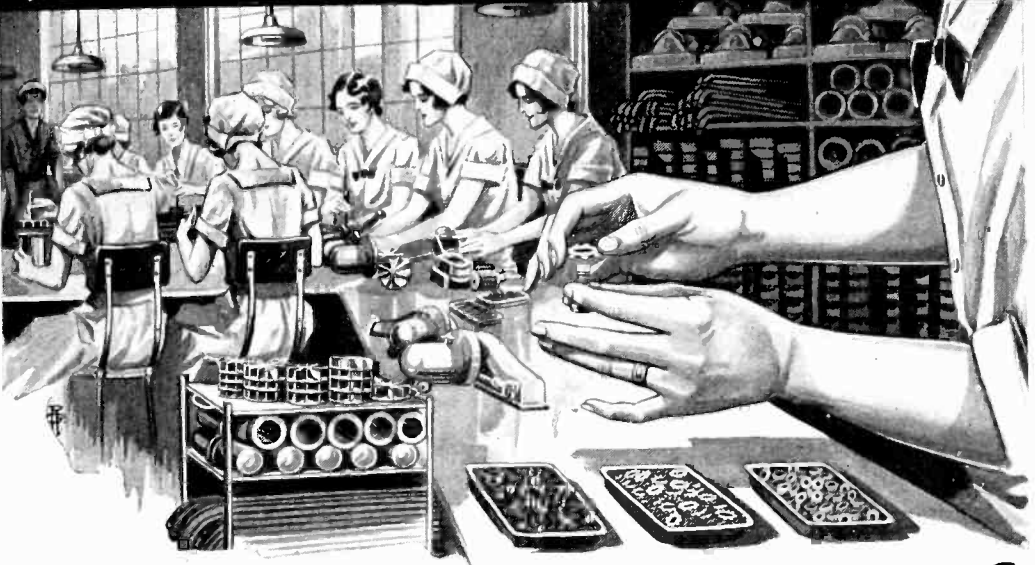

## the Tangleproof ≡ Lock-Washer!

**M**INUTES are dollars on any production job and that's why progressive manufacturers in hundreds of industries have turned to Shakeproof. Being made in a complete circle, this modern lock washer never tangles. In fact, there is no possible way to tangle Shakeproof—regardless of the amount of handling from the stock-room to the assembly line.

The Shakeproof Lock Washer not only saves time and money but improves performance, too. Its twisted steel teeth bite into both the nut and work surfaces and only applied force can release their hold. Give Shakeproof a trial on your assembly line—see how it speeds up production and makes neater work possible. We will gladly furnish free samples in any size desired—write for yours today!

## SHAKEPROOF Lock Washer Company

U. S. Patents  
1,419,564  
1,604,122  
1,697,954  
1,782,387  
Other patents  
pending.  
Foreign patents

(Division of Illinois Tool Works)

2529 N. Keeler Avenue, Chicago, Ill.

"It's the  
Twisted  
Teeth  
that LOCK"

Shakeproof representatives are located in the following cities:  
New York City · Philadelphia · Boston · Pittsburgh · Schenectady · Cleveland  
Detroit · Toledo · Cincinnati · Birmingham, Ala. · Dallas, Texas · Mil-  
waukee · Los Angeles · Seattle · San Francisco · Toronto, Ontario, Canada

When writing to advertisers mention of the PROCEEDINGS will be mutually helpful.



Type 12. Internal  
For  
S. A. E. and Standard  
Machine Screws



Type 11. External  
For Standard Bolts  
and Nuts



Type 15. Countersunk  
For all Countersunk  
Screws



Type 20  
Locking Terminals  
For Radio  
and Electrical Work

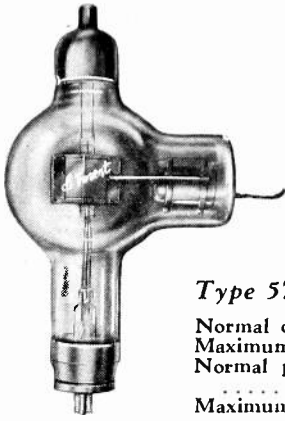

# Two New DeForest Transmitting Tubes

TYPE 571 is, in short, a 561 without a screen or again a big 552. It is the highest power ultra-high-frequency Audion of the air-cooled class now available. Tubes of this type have been employed with unusual success at frequencies greater than 100 M.C. Although we recommend Audion 561 for frequencies less than 7 M.C., we believe that the increased efficiency to be gained by using Audion 571 at highest frequencies far outweighs the inconvenience of neutralizing when this Audion is employed as an amplifier. Internal capacity is so unusually low and the stability so great that neutralizing is not a problem. NET PRICE: \$200.00.

### Type 571 Audion Rating

Normal output . . . 500 Watts  
 Maximum output .750 Watts  
 Normal plate voltage . . . . .  
 . . . . . 3000 Volts  
 Maximum plate voltage . . . . .  
 . . . . . 4000 Volts  
 Maximum plate current . . . . .  
 . . . . . 0.350 Ampere  
 Maximum plate dissipation . . . . .  
 . . . . . 500 Watts  
 Filament Voltage . . . 11 Volts  
 Filament Current 10 Amperes  
 Average Amplification Factor . . . . . 16  
 Average Plate Resistance 5000  
 Average Mutual Conductance . . . . . 3200  
 Negative Grid Bias (Class B) . . . . . -250 Volts  
 Negative Grid Bias (Class C) . . . . . -400 Volts

TYPE 575 fills a long-felt need for a power rectifier between the 572 and 569 classes. It is rated at 15,000-volt inverse peak and 2.5 amperes peak current. The design of this Audion is such as to make it readily usable in standard 572 power units when increased output voltage is required. Overall length approximately one inch greater than Type 572. Standard 50-watt base. This Audion was developed for use in DeForest standard transmitters but has received such popular support that it is definitely offered to the radio public at a price that makes it a most exceptional buy. NET PRICE: \$30.00.

### Type 575 Audion Rating

Filament Voltage . . 5 Volts  
 Filament Current . . . . .  
 . . . . . 12.5 Amperes  
 Maximum Peak Inverse Voltage . . . . 15,000 Volts  
 Maximum Peak Plate Current . . . . . 2.5 Amperes  
 Approximate Tube Voltage Drop . . . . . 12 Volts

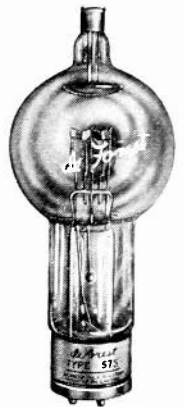

*After all, There's No Substitute for 25 Years' Experience*

De Forest Radio Company, Passaic, N.J.  
 Export Department, 304 E. 45th Street, New York City, N.Y., U.S.A.

**de Forest**  
 (AUDIONS)

RECEIVING  
 AND  
 TRANSMITTING **TUBES**

*When writing to advertisers mention of the PROCEEDINGS will be mutually helpful.*

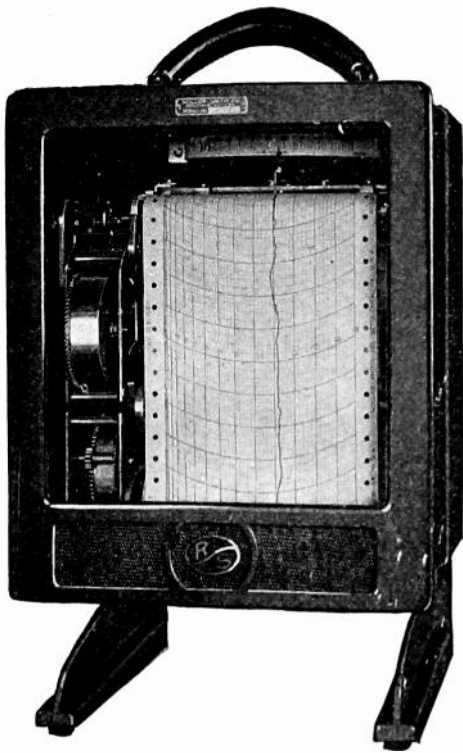

## ROLLER-SMITH

### Graphics

Need No "Coddling"



The powerful clock runs evenly—without coaxing.

The mechanisms, sturdy efficient and sensitive, are not easily damaged by abuse or overload.

The 5" chart moves along smoothly without jerking or buckling.

The chart rolls are as easy to install as a new film in a Kodak.

The ink flows freely irrespective of temperature, humidity or how long the instrument has been idle.

The ink well is so easy to fill that a child could do it.

The case is made of light but strong aluminum which does not easily crack or break.

And when servicing is required everything is not only accessible but get-at-able—there is a world of difference.

ROLLER-SMITH GRAPHICS are made for direct and alternating current; switchboard, wall and portable models and as ammeters, voltmeters, single and polyphase wattmeters and power factor meters. Either clock or synchronous motor drive is available. Send for Bulletin K-830 for further details or, better still, get in touch with the R-S office nearest you. There is one in every important City in the U.S.A. and Canada.

*Forty year's instrument experience is back of*

## ROLLER-SMITH COMPANY

Electrical Measuring and Protective Apparatus

Main Office:  
2134 Woolworth Bldg.  
NEW YORK



Works:  
Bethlehem,  
Pennsylvania

Offices in principal cities in U. S. A. and Canada

*When writing to advertisers mention of the PROCEEDINGS will be mutually helpful.*



---

We Have Doubled Plant  
Facilities to Meet the Demand for

**THE**  
**ACRACON\***  
**ELECTROLYTIC**  
**CONDENSER**

Sales tell the story of Acracon leadership in the condenser field more eloquently than any advertisement could.

Since its introduction, an ever increasing demand for the Acracon electrolytic unit has taxed our production department to such an extent that we have been forced to double our plant facilities. Now, we are equipped to supply the entire industry.

Follow the leaders in the industry. Specify Acracon Electrolytic Condensers. Also By-pass, Wax Impregnated, Oil Impregnated, Power and Transmitting types.

*Write Today, Enclosing Specifications!*

*\*All Acracon Features Are Protected by Patents Pending*

**Condenser Corporation of America**  
259-271 Cornelson Ave. Jersey City, N. J.

Chicago  
Cincinnati

*Factory Representatives in:*  
St. Louis  
San Francisco  
and other Principal Cities

Los Angeles  
Toronto

---

*When writing to advertisers mention of the PROCEEDINGS will be mutually helpful.*

SELECTIVITY SELLS SETS



Listening to Your  
Favorite Radio Program  
Unmolested by Inter-  
ference from Competing  
Programs

## Textolite Safeguards Selectivity

**P**ROGRAMS that once quarreled their way through now flow in with satisfying clarity — where the insulation is right. That's why some of the most prominent radio manufacturers have intrusted the right insulation of their receivers to laminated Textolite.

Here is a superior material that emerged fully tested from one of the greatest research laboratories in the world. It has proved its ability to preserve the original precision of tuning with unflagging fidelity. It possesses a practically constant power-factor under varying conditions.

Don't hesitate to request information on Textolite — in sheets, rods, or tubes — from the eastern or western fabricators, or from the Textolite specialist in the General Electric office of your vicinity.

General Fabricating Co.  
37 East 18th Street  
New York City

Electrical Insulation Corp.  
308 W. Washington St.  
Chicago, Ill.

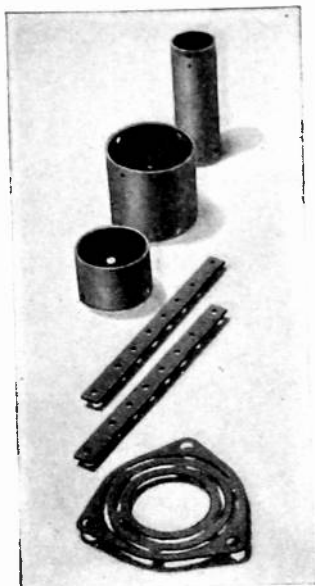

GENERAL



ELECTRIC

885-51D

When writing to advertisers mention of the PROCEEDINGS will be mutually helpful.





# CHANGE IN MAILING ADDRESS OR BUSINESS TITLE

Members of the Institute are asked to use this form for notifying the Institute office of a change in their mailing address or any change in the listing of their company affiliation or title for the Year Book membership list.

The Secretary,  
THE INSTITUTE OF RADIO ENGINEERS,  
33 West 39th Street,  
New York, N.Y.

Dear Sir:

Effective ..... please note change in my address  
(date)  
for mail as follows:

FROM

.....  
(Name)

.....  
(Street Address)

.....  
(City and State)

TO NEW ADDRESS

.....  
(Street Address)

.....  
(City and State)

Also for the membership list for next year's Year Book note change in my business address (or title) as follows, this <sup>is</sup> ~~is not~~ my mailing address:

.....  
(Title)

.....  
(Company Name)

.....  
(Address: Street, City and State)

PLEASE FILL IN, DETACH, AND POST TO THE  
INSTITUTE PROMPTLY

# Back Numbers of the Proceedings, Indexes, and Year Books Available

**M**EMBERS of the Institute will find that back issues of the Proceedings are becoming increasingly valuable, and scarce. For the benefit of those desiring to complete their file of back numbers there is printed below a list of all complete volumes (bound and unbound) and miscellaneous copies on hand for sale by the Institute.

The contents of each issue can be found in the 1914-1926 Index and in the 1929 Year Book (for the years 1927-28).

## BOUND VOLUMES:

Vols. 10 and 14 (1922-1926), \$8.75 per volume to members  
Vols. 17 and 18 (1929-1930), \$9.50 to members

## UNBOUND VOLUMES:

Vols. 6, 8, 9, 10, 11, 14, and 16 (1918-1920-1921-1922-1923-1926-1928),  
\$6.75 per volume (year) to members

## MISCELLANEOUS COPIES:

Vol. 1 (1913) July and December  
Vol. 2 (1914) June  
Vol. 3 (1915) December  
Vol. 4 (1916) June and August  
Vol. 5 (1917) April, June, August, October and December  
Vol. 7 (1919) February, April and December  
Vol. 12 (1924) August, October and December  
Vol. 13 (1925) April, June, August, October and December  
Vol. 15 (1927) April, May, June, July, August, October, November  
and December  
Vol. 17 (1929) January, February, March, April, May, June, July, August,  
September, November and December.  
Vol. 18 (1930) April, May, June, July, August, September, October, No-  
vember and December.

These single copies are priced at \$1.13 each to members to the January 1927 issue. Subsequent to that number the price is \$0.75 each. Prior to January 1927 the Proceedings was published bimonthly, beginning with the February issue and ending with December. Since January 1927 it has been published monthly.

**M**EMBERS will also find that our index and Year Book supplies are becoming limited. The following are now available:

## FOURTEEN YEAR INDEX

The Proceedings Index for the years 1909-1926 inclusive is available to members at \$1.00 per copy. This index is extensively cross indexed.

## YEAR BOOK

The 1931 Year Book is available to members at \$1.00 per copy. This Year Book includes the 1930 Standardization Report,—an "up to the minute" report on the most recent standardization information available.

Make remittances payable to the Institute of Radio Engineers and send orders to:

**THE INSTITUTE OF RADIO ENGINEERS**

33 West 39th Street

NEW YORK CITY, N. Y.

# Cornell

TRADE MARK REG.

## CARBONIZED RESISTORS

Temperature Co-efficient of Resistance  
Less than Three-quarters of One Percent  
for Every 10° Centigrade Rise in Temperature

Cornell Carbonized Resistors are absolutely noiseless and conservatively rated. Resistances are independent of voltage within normal wattage rating.

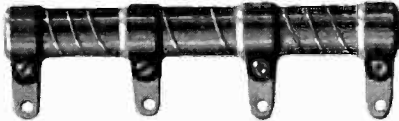

Terminal Type A.  
2 Tap Unit  
 $\frac{3}{8}$ " dia. x 3" long  
2½ Watts overall

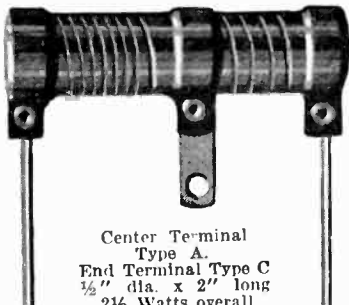

Center Terminal  
Type A.  
End Terminal Type C  
 $\frac{1}{2}$ " dia. x 2" long  
2½ Watts overall

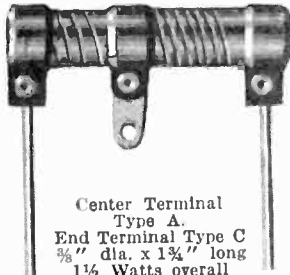

Center Terminal  
Type A.  
End Terminal Type C  
 $\frac{3}{8}$ " dia. x 1½" long  
1½ Watts overall

Cornell Carbonized Resistors can be made in values from 200 ohms to 5 megohms and are available in wattages from ¼th to 6 Watts. They can be made to as close as 5% resistance tolerance.

Any of the units shown here, except the ¼th Watt resistor can be furnished with leads or lugs as desired.

Tapped units can be supplied in any of the above mentioned ranges, with as many as four taps on a single tube.

Cornell Carbonized Resistors have been designed to give the extreme accuracy demanded in modern radio receivers, broadcasting stations, sound recording and reproducing equipment and other electrical appliances.

*Write for samples and let us know your requirements. We shall be glad to send you full particulars.*

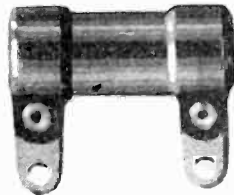

Terminal Type A  
 $\frac{3}{8}$ " dia. x 1" long  
1 Watt overall



Midget Type  
 $\frac{3}{16}$ " dia. x  $\frac{3}{4}$ " long  
¼th Watt overall

## Cornell Electric Mfg. Co., Inc.

Filter and By-Pass Condensers, Interference Filters and  
All Types of Paper Dielectric Condensers

LONG ISLAND CITY, NEW YORK

When writing to advertisers mention of the PROCEEDINGS will be mutually helpful.

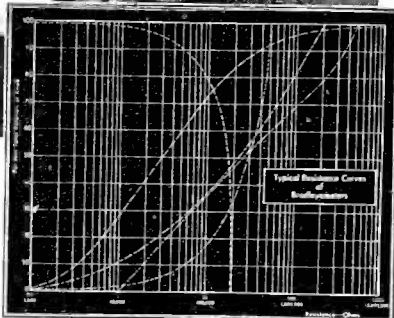
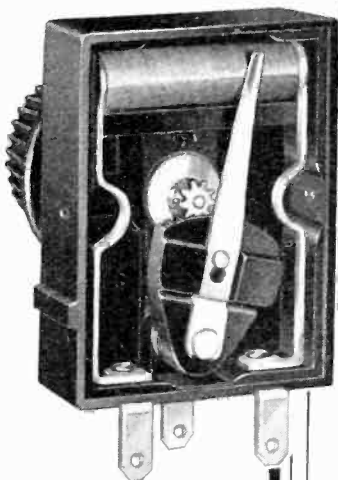

**Other Allen-Bradley  
Radio Products**

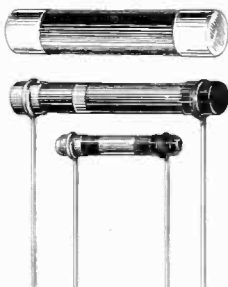

Bradleymeters are solid molded resistors, made in five sizes with or without tinned leads. They are color coded to meet any manufacturer's specifications.



Bradley Suppressors for radio equipped cars are used by leading car manufacturers and make shielded ignition cables unnecessary for good reception.

# The Bradleymeter

**Assembled by automatic machinery to produce any performance curve!**

Manufacturing facilities in the Allen-Bradley plant keep pace with the rapidly increasing demand for the new Bradleymeter.

The Bradleymeter is a "stepped" potentiometer of about fifty steps and comprises a series of resistance disks. The resistance value of each step is separately controlled and the total number of disks are assembled by automatic machinery to conform with the Resistance-Rotation curve as specified by any manufacturer.

Bradleymeters are used extensively for volume controls, tone controls, mixer controls, attenuators, and in connection with telephone equipment, public address systems, radio receivers, phonographs, etc. Write for technical data today.



Type A Single Bradleymeter



Type AA Double Bradleymeter



Type AAA Trip Bradleymeter

Allen-Bradley Co.  
116 W. Greenfield Ave. Milwaukee, Wisconsin



# ALLEN-BRADLEY RESISTORS

Produced by the makers of Allen-Bradley Control Apparatus

*When writing to advertisers mention of the PROCEEDINGS will be mutually helpful.*



# ANNOUNCES A NEW POWER TUBE SOCKET

GLAZED  
ISOLAN-  
TITE  
INSULA-  
TION

NOVEL  
FEATURES

LONG LIFE

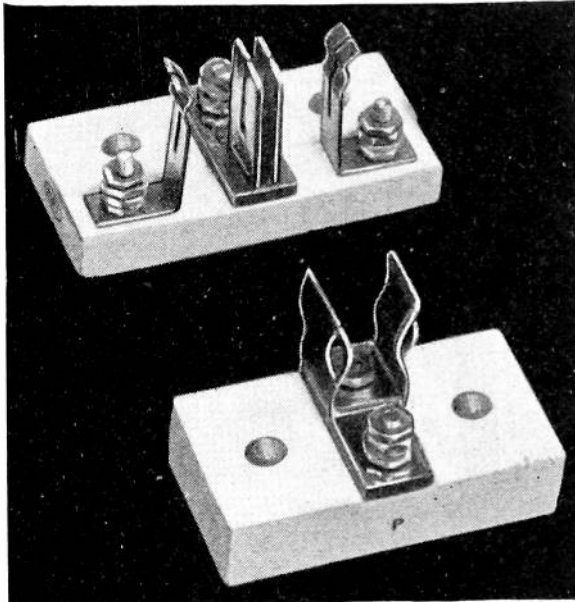

POSITIVE  
UNDER ALL  
CONDI-  
TIONS

RUGGED  
CONTACT

ECONOM-  
ICAL

CAT. NO. 128

The REL Cat. #128 tube socket is a necessity finally realized. The bases are **GLAZED ISOLANTITE**, the insulator approved by the U. S. Navy. It cannot be effected by moisture. This socket is ideal for use with all standard double-ended power tubes in any type of circuit. The extra rugged contacts are positive under all conditions. For use with type 04-A, 49, 51, 61 and all other similar tubes.

Cat. #128 tube sockets are ready for immediate delivery. Attention Dealers—Write for prices or else send your orders direct. Price per pair—\$4.75



MANUFACTURES A COMPLETE LINE OF  
APPARATUS FOR SHORT WAVE TRANS-  
MISSION AND RECEPTION.

## Radio Engineering Laboratories, Inc.

100 Wilbur Ave.

Long Island City, N.Y., U.S.A.

*When writing to advertisers mention of the PROCEEDINGS will be mutually helpful.*



**V**  
**THE NEW**

## VARIABLE - MU TUBE

New in Design . . . Advanced in Principle  
Efficient in Performance

**E**VERY set manufacturer, every radio engineer, the entire trade, will be vitally interested in this newest invention—the Arcturus Type 551 Variable-Mu Tube.

Seldom, in the rapidly changing radio industry, has one tube embodied so many advantages and presented to set manufacturers such splendid merchandising and economic possibilities for 1931 receivers—with practically no changes in existing circuits.

By shaping the plate current-grid voltage characteristic so as to minimize the higher order curvature over an extended range of control grid voltage, the Type 551

1. Reduces cross-talk by a factor of several hundred times and eliminates modulation distortion and receiver "hiss"
2. Eliminates distortion of signals from high-power stations caused by the non-linear relation between the r. f. output voltage and the r. f. input voltage;
3. Minimizes hum in a-c receivers due to modulation of the carrier by low-frequency hum voltages inadvertently present in the control grid circuit;
4. Obviates the use of antenna potentiometers, local-long distance switches, double pre-selectors, etc.

These features are of important significance to manufacturers in designing 1931 sets where production costs and performance are paramount considerations.

A special technical bulletin on the Arcturus Type 551 Variable-Mu Tube will be sent upon request.

ARCTURUS RADIO TUBE COMPANY  
Newark, New Jersey

# ARCTURUS

## RADIO TUBES

**WITH THE LIFE-LIKE TONE**

*Arcturus' quick-action is another feature of the 551.*

*Licensed under  
patent applica-  
tions of Boonton  
Research Corp.*

**"THE TUBE**



ARCTURUS  
(No. 551)

*When writing to advertisers mention of the PROCEEDINGS will be mutually helpful.*

You  
have a  
design  
problem  
or need insulators  
of special  
character . . . . .

remember that for 16 years the name Stupakoff has been foremost in the design and manufacture of refractory insulators. We are always ready to work in confidence with manufacturers. Write us.

## STUPAKOFF INSULATORS

STUPAKOFF  
LABORATORIES, Inc.  
6619 Hamilton Ave.  
Pittsburgh, Penna.

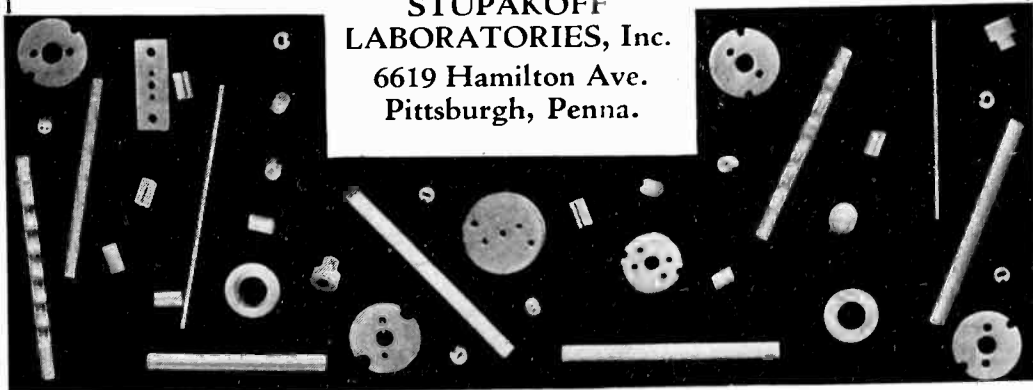

*When writing to advertisers mention of the PROCEEDINGS will be mutually helpful.*



# ESCO Motor-Generators

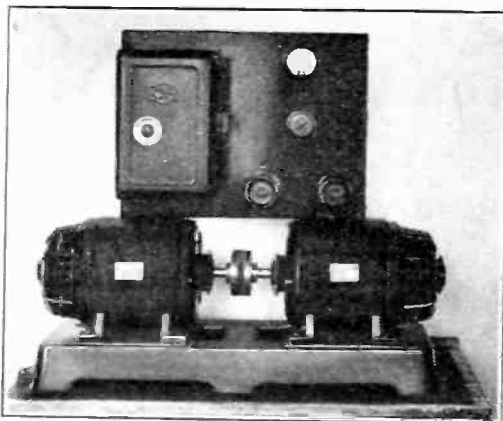

“Fit” the application

“Fit” the power supply

Motors—Generators—Dynamotors—Rotary Converters

*Designed · Developed · Manufactured*

*Quick Delivery · Low Priced*

“ESCO” is a company where “Special” does not mean “soak ‘em” or “Let ‘em wait.” Because for twenty years “ESCO” has specialized in the “Special.” “Special” voltages, frequency, speed, and mechanical design is the objective of our equipment and organization. OUR EXPERIENCE IS BROAD. Below is a list of some of the special applications of our motors and generators, manufactured during this last December.

Telegraph  
Airplane dynamotors  
Wind driven generators  
Portable gasoline units  
Radio beacons  
Radio transmitters  
Television  
Talkies  
Radio receivers  
Automobile radio  
Valve control  
Water tight doors  
Pianos  
Electric indicators

Speed reducers  
Ventilators  
Telechron reseters  
Automatic chucks  
Recording instruments  
Elevator door control  
Elevators  
Flexible shafts  
Riveters  
Gasoline pumps  
Bottle washers  
Phase shifters  
Frequency changers  
Hair dryers

Arc lamps  
Anti-corrosion  
Oil burners  
Automatic whistle  
Ore-vibrators  
Organ generators  
Hoists  
Freight trucks  
Temperature control  
Polishers  
Stock quotations  
Sun lamps  
Bookkeeping unit  
Forced draft

Knitting mills  
Printing press  
Electro plating  
Remote control  
Movie cameras  
Aerial cameras  
Cloth cutting  
Coin counters  
Pneumatic Valves  
Valve grinders  
Theater dimmers  
Cup vending  
Refrigerator  
Automatic stoker  
Wearing

Why not profit by our long experience? Up to date equipment and practical engineering talent. They are all at your disposal. Write us for bulletins or information.

**ELECTRIC**  **SPECIALTY**  
**COMPANY**

300 South St.

Stamford, Conn.

*Manufacturers of motors, generators, dynamotors and rotary converters.*

*When writing to advertisers mention of the PROCEEDINGS will be mutually helpful.*

# Continental Resistors

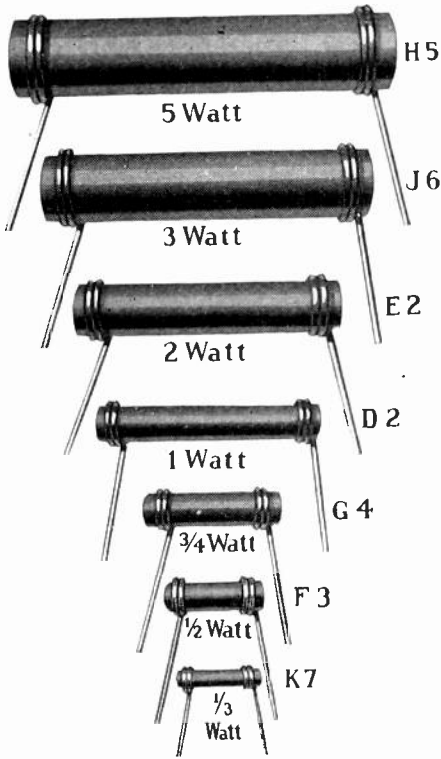

## RESISTOR CHARACTERISTICS:

NOISELESS  
RESISTANCE CONSTANT  
SMALL TEMPERATURE  
COEFFICIENT  
RUGGED  
FIRMLY SOLDERED TERMINALS  
DEPENDABLE  
COLOR CODED

UNITS SHOWN HALF SIZE

## CONTINENTAL SUPPRESSORS

*For Radio-Equipped Cars*

Stop ignition noise in the automobile radio set when used with suitable by-pass condensers. The distributed capacity is extremely small. The resistors are enclosed in a tough ceramic tube of high crushing and tensile strength, of low coefficient of expansion and of high dielectric strength. They are hermetically sealed in the tube and this renders the suppressors moisture proof.

Suppressors shown full size

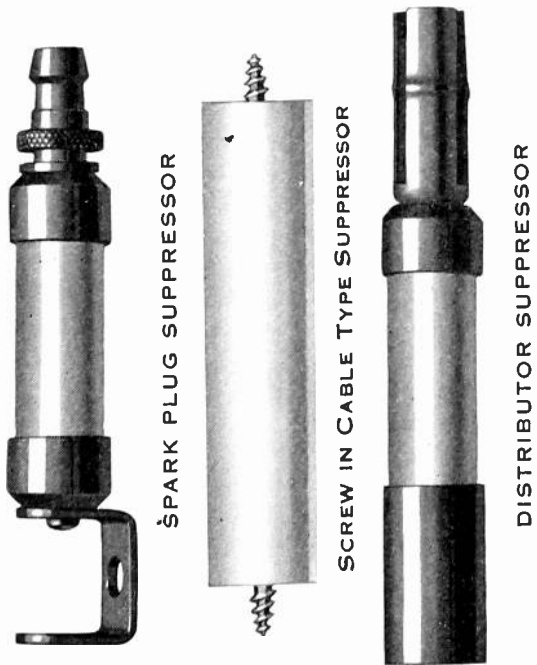

SPARK PLUG SUPPRESSOR

SCREW IN CABLE TYPE SUPPRESSOR

DISTRIBUTOR SUPPRESSOR



### Curtis Electro Chemical Condenser

*Essential Characteristics*

- Full capacity at all voltages
- Uniform capacity at all frequencies
- Low freezing point
- Low internal resistance
- Low leakage
- No nipples, new breather principle
- One hole mounting terminal at bottom

For Further Particulars Write to  
**Curtis Continental Corp.**  
13900 Lorain Ave.,  
Cleveland, O.

Write for Information and Prices  
**CONTINENTAL CARBON INC.**

13900 Lorain Ave.  
WEST PARK, CLEVELAND, O.

*When writing to advertisers mention of the PROCEEDINGS will be mutually helpful.*

# “Centralab Preferred”

*for those who can't afford to gamble!*

**I**N these hectic days when everyone is stock market conscious even the man on the street considers himself an expert on “guessing the market.”

Whether this or that stock is up or down is a matter of popular information. Those who feel the urge to gamble play hunches and tips. Those who can't, stay with the old reliable, time-tried and time-proven stocks. Radio engineers, radio manufacturers and radio servicemen who can't afford to gamble with inferior parts play “CENTRALAB PREFERRED.”

More than twenty million Centralab Volume Controls have taken the gamble out of the volume control market. Hunches give way to accurate scientific engineering standards and tips are represented by the scores of successful manufacturers whose quality products are made even better by the introduction of Centralab Volume Controls.

# Centralab

## Volume Controls

---

MAIL COUPON NOW

---

CENTRAL RADIO LABORATORIES  
942 Keefe Ave., Milwaukee, Wis.

Enclosed find 25c for which send me new  
VOLUME CONTROL GUIDE.

Name .....

Address .....

City ..... State.....

I.R.E.

*When writing to advertisers mention of the PROCEEDINGS will be mutually helpful.*

# FANSTEEL RARE METAL

## Wire and Sheet for Vacuum Tubes

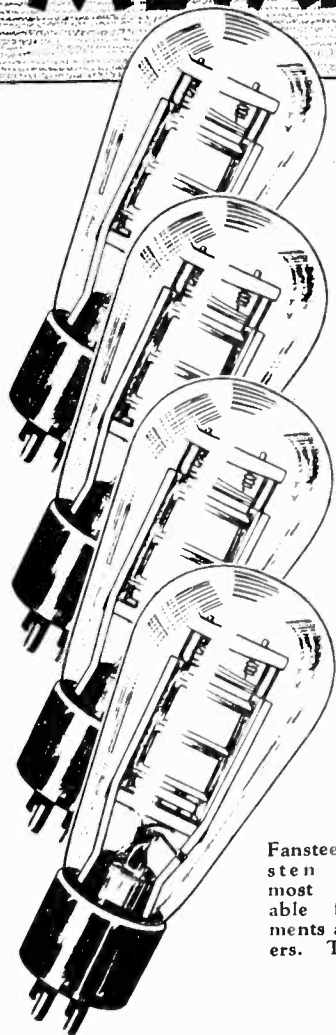

Fansteel Tungsten Wire—most dependable for filaments and heaters. Try it!

Standardization on Fansteel Metals often results in reduced shrinkage and waste, while making better and more uniform tubes.

This is because Fansteel metals are made specifically for use in tubes. Beginning with the refining of ores and basic salts, every process is carried out under the careful direction of *men who know tubes*. In the Fansteel research laboratory, various types of tubes are made and tested, and here much important development work has been done.

Fansteel Rare Metals and Alloys are pure, uniform, dependable—chemically, physically, electrically. Ample stocks of standard dimension wire and sheet are kept on hand, ready for immediate shipment. Wide assortments of “specials” are stocked, too, and those which are not stocked can be quickly made to order.

Write for samples and prices; or, if interested in receiving suggestions on some development problem relating to metals, write the Fansteel research staff.

**FANSTEEL PRODUCTS COMPANY, Inc.**  
North Chicago, Ill.

TANTALUM · TUNGSTEN · MOLYBDENUM · RARE METAL ALLOYS

*When writing to advertisers mention of the PROCEEDINGS will be mutually helpful.*

# Piezo Electric Crystals

*"The Standard of Comparison"*



When in the market for Accurately Ground Piezo Electric Crystals suitable for POWER USE, write us stating your requirements and our *seven years* of experience in this specialized field will be at your disposal.

Our prices for grinding these crystals are not the cheapest, but we believe our product to be *second to none* considering output and accuracy of frequency.



*"A Trial Will Convince You"*



## Scientific Radio Service

*"The Crystal Specialists"*

P.O. Box 86

Mount Rainier, Maryland

*When writing to advertisers mention of the PROCEEDINGS will be mutually helpful.*



Depend on » »  
**FORMICA**  
for Your *punched*  
& *fabricated parts*

**F**ORMICA is prepared to make necessary dies for punching your insulating parts in its own tool room, and to punch those parts promptly in its own factory.

Formica has the largest fabricating equipment for these purposes in the country.

For many years the Formica organization has served the leading electrical organizations with sheets, tubes and rods and with fabricated parts ready for assembly.

Send your blue prints for estimates.

THE FORMICA INSULATION CO.  
4654 Spring Grove Avenue  
Cincinnati, Ohio

**FORMICA**  
Made from Anhydrous Bakelite Resins  
SHEETS TUBES RODS

---

*When writing to advertisers mention of the PROCEEDINGS will be mutually helpful.*



*For direct*

**WESTON**  
Model 576

## *reading of* **MUTUAL CONDUCTANCE OF RADIO TUBES**

**T**HIS new Weston model 576 Mutual Conductance Tester reads the mutual conductance of all type A.C. and D.C. radio receiving tubes, having an amplification factor between 3.5 and 42, and screen grid tubes.

Radio tube manufacturers, set manufacturers with tube problems, large radio distributors and service organizations will find immediate use for this new and additional means to better check radio tubes.

Model 576 employs a newly developed copper oxide rectifier circuit. The meter is  $7\frac{1}{4}$  inches in diameter—made for flush panel mounting. It is accompanied by a

"Compensator", a separate rectangular unit arranged for surface mounting on the panel, adjacent to the instrument. The "Compensator", by means of a dial switch, permits an easy changeover from one type tube to another.

The operation of Weston model 576 is based on the application of a signal voltage of one volt A.C. 60 cycles to the grid. The other elements of the tube are energized with their standard rated voltages.

Weston Mutual Conductance Testers can also be supplied in smaller sizes, without the "Compensator", for use in a production line devoted to a single type of tube.

*Write for Complete Details*

**WESTON ELECTRICAL INSTRUMENT CORPORATION**  
589 Frelinghuysen Avenue  
Newark, N. J.

*When writing to advertisers mention of the PROCEEDINGS will be mutually helpful.*

*Just published!*

The most important  
radio book of the year

# The RADIO HANDBOOK

Over 875 pages  
of latest data on:

- modern transmitters and receivers
- Piezo crystal
- 100% modulation
- short wave receivers and transmitters
- Kennelly-Heaviside layer
- marine radio equipment
- auto a'arm
- automobile radio sets
- vacuum tubes
- photo-electric cells
- television
- sound motion pictures
- radio tubes in industry
- testing equipment and methods
- etc., etc.

Including Television  
and Sound Motion Pictures

By JAMES A. MOYER  
and JOHN F. WOSTREL

Both of the Massachusetts Department of Education; Authors of *Radio Receiving Tubes, Practical Radio Construction and Repairing*, etc.

HERE at last is a handbook that meets the need for a complete digest of authoritative radio data, both theoretical and practical, in one logically arranged and thoroughly indexed volume of the standard of McGraw-Hill Handbooks in other fields of engineering. From the fundamentals of electricity, magnetism and electron theory right down to full details on latest commercial and industrial applications, this book covers the whole field of radio, with description, definitions, design data, practical methods, tables and illustrations in profusion.

See this book 10 days FREE  
Send this coupon

McGRAW-HILL FREE EXAMINATION COUPON

McGRAW-HILL BOOK CO., Inc., 370 Seventh Ave., N. Y. C.

Send me Moyer and Wostrel's *Radio Handbook*, postpaid for ten days' free examination. I agree to send \$5.00 within ten days of receipt or to return the book.

Name .....

Address .....

City and State.....

Firm .....

Position .....

IRE-4-31

When writing to advertisers mention of the PROCEEDINGS will be mutually helpful.



*Self-Re-cycling*

# TIME DELAY RELAY

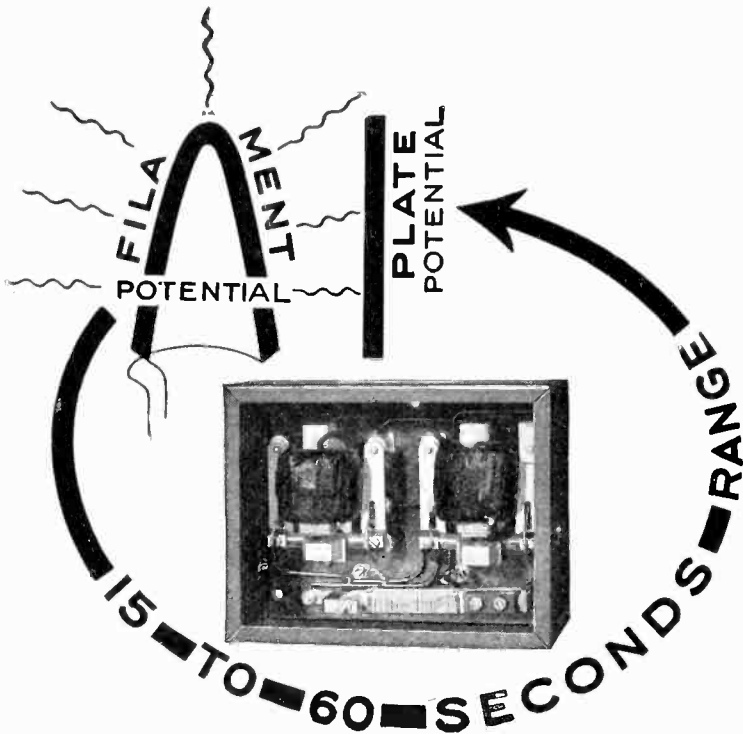

- SET the time delay . . . .  
for example . . . at 30 seconds
- CLOSE the circuit . . . .  
starting the cycle of operations
- OPEN the circuit . . . .  
before the 30 seconds has elapsed . . .  
stopping the cycle of operations
- RESTART . . . and the original setting  
of 30 seconds has not been shortened

*Send for information on this  
and other Ward Leonard relays.*

**WARD LEONARD ELECTRIC CO.**  
MOUNT VERNON, N. Y.

*When writing to advertisers mention of the PROCEEDINGS will be mutually helpful.*

# PROFESSIONAL ENGINEERING DIRECTORY

For Consultants in Radio and Allied Engineering Fields

## THE MAGNAVOX COMPANY

155 East Ohio Street, Chicago, Ill.

*PIONEERS AND SPECIALISTS  
IN THE ART OF  
SOUND REPRODUCTION.  
DYNAMIC SPEAKERS SINCE  
1911.*

## ELECTRICAL TESTING LABORATORIES

Tests of Inductances.  
Condensers. Transform-  
ers etc. Life and charac-  
teristics of Radio Tubes

80th. Street and East End Ave.  
• • NEW YORK, N.Y. • •

### REPRESENTATIVES WANTED MICROPHONES

Double button carbon type

### DIAPHRAGMS

Gold-plated duralumin for any make  
microphone

### REPAIRS

Twenty-four hour service on any car-  
bon microphone

THE ELECTRO-VOICE  
MANUFACTURING COMPANY, INC.  
South Bend, Indiana

For Export of Material Manufactured  
by:

American Transformer Co.  
Allen D. Cardwell Mfg. Co.  
Corning Glass Works  
Dubilier Condenser Corp.  
P. R. Mallory  
Radio Engineering Labs.  
Universal Microphone Co., Ltd.  
Ward Leonard Electric Co.  
Weston Elec. Inst. Co.

*Apply to*

AD. AURIEMA, INCORPORATED  
116 Broad St.  
New York City, N.Y.

## Radio Engineers

If you want the 8,000 most important  
and influential radio men of the day to  
know of your services, be sure that your  
card appears on this professional card  
page.

Per insertion . . . . . \$10.00

## The J. G. White Engineering Corporation

Engineers—Constructors

*Builders of New York Radio  
Central*

43 Exchange Place New York

## JENKINS & ADAIR, INC.

*Engineers*

Designers and manufacturers of appara-  
tus essential to broadcasting, sound re-  
cording and sound measurement work.

3333 Belmont Ave., Chicago, U.S.A.

Cable Address: *Jenkadair*

Telephones: Keystone 2130

### TEN DOLLARS DOES IT!

You can directly acquaint over  
8,000 of the most influential and  
authoritative radio men of the day  
with your services each month  
through this Professional Card  
Page.

Per insertion . . . . . \$10.00

*When writing to advertisers mention of the PROCEEDINGS will be mutually helpful.*

---

---

## Alphabetical Index to Advertisements

### A

Aerovox Wireless Corp.....XXXII  
Allen-Bradley Co.....XLVI  
American Tel. & Tel. Co.....XXIX  
American Transformer Co.....XVIII  
Amperite Corp. ....XXVII  
Arcturus Radio Tube Co.....XLVIII

### C

Capitol Radio Institute.....LXI  
Cardwell, Allen D. Mfg. Corp.....XX  
Central Radio Laboratories.....LII  
Chicago Transformer Co.....  
.....Inside Back Cover  
Condenser Corp. of America.....XL  
Continental Carbon, Inc.....LI  
Cornell Electric Mfg. Co.....XLV  
Cornish Wire Co.....LXIII

### D

DeForest Radio Co.....XXXVIII  
DeJur-Amsco Corp.....XXVI  
Dubilier Condenser Corp.....XXIV

### E

Electrad, Inc.....XXIII  
Electric Specialty Co.....L  
Elkon, Inc.....XIX  
Engineers Available.....XV

### F

Fansteel Products Co., Inc.....LIII  
Ferranti, Inc. ....XXXV  
Formica Insulation Co.....LV  
Frost, H. H., Inc.....XXV

### G

General Cable Corp.....XXX  
General Electric.....XLI  
General Industries Co.... XXXVI  
General Radio Co..Outside Back Cover  
Gilby Wire Co.....LXIV

### H

Hammarlund Mfg. Co.....LXII

### I

International Resistance Co.XVI, XVII  
I.R.E.....XXXIII, XXXIV,  
XLIII, XLIV

### M

Mallory, P. R.....XIX  
McGraw-Hill Book Co.....LVII

### P

Pacent Electric Co., Inc.....XXVIII  
Professional Eng. Directory.....LIX

### R

Radio Engineering Labs.....XLVII  
RCA Radiotron Co., Inc.....XXI  
RCA Victor Co.....XXXI  
Roller-Smith Co.....XXXIX

### S

Scientific Radio Service.....LIV  
Scovill Mfg. Co.....XLII  
Shakeproof Lock Washer Co.XXXVII  
Sprague Specialties Co.....XXII  
Stupakoff Labs., Inc.....XLIX

### W

Ward Leonard Electric Co.....LVIII  
Weston Elec. Instrument Corp....LVI

---

---

*When writing to advertisers mention of the PROCEEDINGS will be mutually helpful.*



E. H. RIETZKE, PRESIDENT

E. B. Redington, of Savannah, N. Y., associated with radio since 1910, writes,

*"I'm surely glad you dropped me a line about your course when I joined the I.R.E. From my viewpoint it is a good tie-up between the theory I was supposed to assimilate when in College and a good practical viewpoint."*

**IF**

You are an experienced radioman;  
You are ambitious to get ahead rapidly in radio;  
You realize the necessity of a directed training in the engineering principles of radio but are unable to take advantage of college training,—

**Then—**

send in the coupon for our new illustrated book, "Modern Radio." It will give you complete details of an advanced home study course in Practical Radio Engineering WRITTEN FOR THE EXPERIENCED RADIOMAN.

**Capitol Radio Engineering Institute, Inc.  
3166 Mt. Pleasant St., N.W., Washington, D. C.**

Please send me, without obligation, your new 1931 issue of "Modern Radio" explaining your advanced course in Practical Radio Engineering.

Name .....

Address .....

Position .....

IRE-April '31.

When writing to advertisers mention of the PROCEEDINGS will be mutually helpful.

This New  
**HAMMARLUND**  
**MIDGET** is  
*Vibration Proof!*

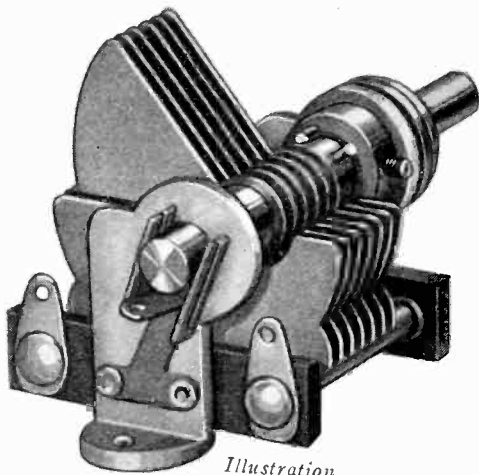

*Illustration*

**W**ITHOUT nuts or screws (*everything rivetted*) this new Hammarlund Midget Condenser is ideal for airplane or automobile receivers, or for any other use where vibration has heretofore been difficult to overcome.

High capacity and wide range—20 to 325 mmf. Soldered brass plates, rugged frame, accurately fitted bearings, double four-point bronze wiping contact. Parmica insulation.

Adjustment screw works in a groove—cannot burr the shaft. Straight line or “Midline” tuning curve. Baseboard or one-hole mounting.

Ideal for tuning Short-Wave Receivers.

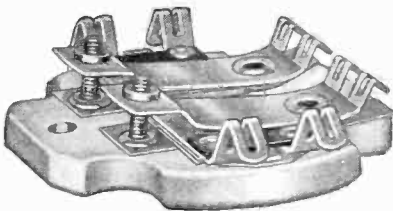

*For Tuning*  
**INTERMEDIATE**  
**TRANSFORMERS**

Insulantite base mounts inside transformer shield.

Self-aligning phosphor-bronze adjustable spring plates, double rivetted. Mica insulation.

Proved design—will not change in resistance or capacity from humidity, temperature or vibration.

Three ranges in single or double models—10 to 70 mmf.  
 —70 to 140 mmf.—140 to 220 mmf.

*Mail coupon for sample and quotations*

**H** For Better Radio  
**Hammarlund**  
 PRECISION  
**PRODUCTS**

HAMMARLUND MFG. CO.,  
 424-438 W. 33rd St., New York

Please send  sample of Intermediate Frequency Transformer  Intermediate Frequency Midget and quotations.  
 Name .....  
 Address .....  
 PE-4

*When writing to advertisers mention of the PROCEEDINGS will be mutually helpful.*



# PARALAC

The Moisture Proof Hook-up Wire With  
the Slide Back Feature

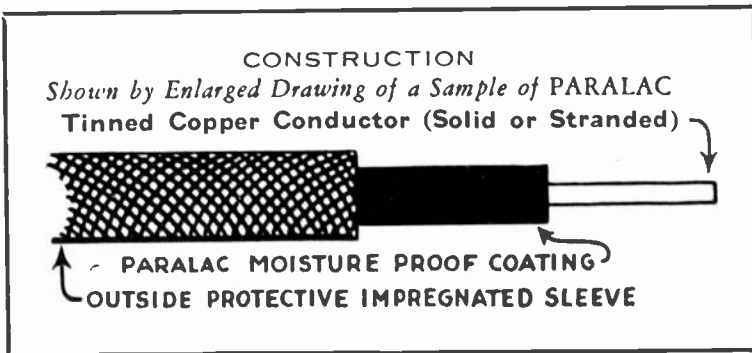

**THE ENGINEER** needs a high voltage hook-up wire with the slide-back feature, the product also possessing high and constant insulation resistance values.

**THE PRODUCTION MANAGER** requires a hook-up wire easy to work with, thus saving time in assembly without sacrificing quality.

**THE PURCHASING AGENT** wants a hook-up wire possessing these characteristics that can be brought within the range of present-day commercial costs.

To fulfill these requirements our engineers have designed **PARALAC**. Recent tests made at the Electrical Testing Laboratories, New York City, show conclusively that **PARALAC** meets all these requirements.

*We have copies of these tests on file awaiting your request but—better still, write for a sample of PARALAC and verify our contentions in your own factory.*

PARALAC is made with both solid and stranded core in assorted colors from 12 to 24 gauge. Prices on request.

**CORNISH WIRE CO., Inc. 30 Church Street, New York**

*"MADE BY ENGINEERS FOR ENGINEERS"*



*When writing to advertisers mention of the PROCEEDINGS will be mutually helpful.*

# GILBY RADIO FILAMENT

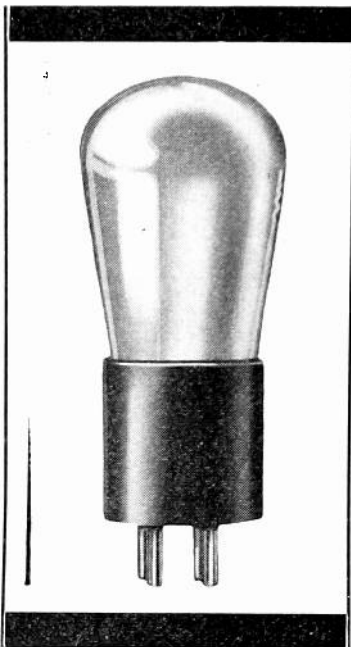

**G**ILBY WIRE COMPANY has been THE reliable source for radio tube filament, and today stands foremost in the opinions of radio tube engineers.

Our engineering department has done and is doing considerable research to produce the best filament obtainable. By development of materials together with

real metallurgical control and precision measurement we are able to produce a filament which is uniform and of stable characteristics.

We are able to supply material to strict specifications, thereby cutting down shrinkage, so essential at all times.

Gilby—a real dependable source of supply for filament.

## GILBY WIRE COMPANY *Wilbur B. Driver, President* NEWARK, NEW JERSEY

Manufacturers of Nickel Chrome Resistance Wire, Copper Nickel Resistance Wire. Nickel Wire and Sheet. Gilby Processed Carbonized Nickel for Plates. Gilby Patented Salvage Mesh.

*When writing to advertisers mention of the PROCEEDINGS will be mutually helpful.*

---

**From Transformer**

**Headquarters**

---

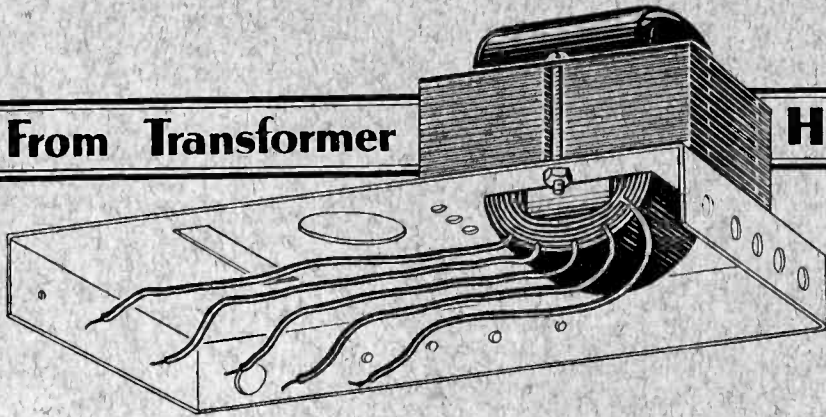

This specialized transformer design provides very compact mounting and saves one end cover plate. The leads are connected directly to chassis parts, eliminating soldering to terminal lugs.

## Laminations in Stock All Types — All Sizes For Any Transformer

Quick service to transformer users calls for two things:

1. A wide range of standard laminations to meet almost every need, and the facilities for making any special lamination design needed.
2. Ample facilities, such as automatic presses, winding machines, and impregnating equipment for assembling one or a thousand transformers to meet your specifications on short notice.

C. T. C. transformers are made entirely under one roof. Laminations, housings, coils, terminal blocks—every component part is a C. T. C. product.

Let C. T. C. engineers quote on your transformer requirements. Mail us your specifications today.



---

# CHICAGO TRANSFORMERS

CHICAGO TRANSFORMER CORP., 2622 WASHINGTON BLVD., CHICAGO, U. S. A.

---



## TRANSMISSION-LOSS MEASUREMENTS

**T**HE transmission loss-frequency characteristics of a wire line conveys an immense amount of valuable information to the engineers responsible for the design and operation of auxiliary equipment. With the right instruments and with a knowledge of how to go about it, the determination of the attenuation characteristic of any line is easily obtained—so easily in fact that there is no need for any engineer to deny himself full knowledge about his wire circuits.

An interesting description of these line measurements is contained in an article published in the *General Radio Experimenter* for February, 1931. The article tells what instruments are needed and how to use them. A request on your business letterhead will bring you the article and a copy of the *General Radio* catalog describing the necessary instruments in more detail.

### GENERAL RADIO COMPANY

OFFICES    ::    LABORATORIES    ::    FACTORY  
CAMBRIDGE A, MASSACHUSETTS