

VOLUME 18

AUGUST, 1930

NUMBER 8

PROCEEDINGS  
*of*  
**The Institute of Radio  
Engineers**



Form for Change of Mailing Address or Business Title on Page XLIX

---

# Institute of Radio Engineers

## Forthcoming Meetings

---

**NEW YORK MEETING**

September 3, 1930

---

**WASHINGTON SECTION**

September 10, 1930

---

**PITTSBURGH SECTION**

September 16, 1930

---

PROCEEDINGS OF  
**The Institute of Radio Engineers**

Volume 18

August, 1930

Number 8

Board of Editors

ALFRED N. GOLDSMITH, *Chairman*

STUART BALLANTINE

G. W. PICKARD

RALPH BATCHER

L. E. WHITTEMORE

J. W. HORTON

W. WILSON

CONTENTS

PART I

	Page
Frontispiece, John Stone Stone, President of the Institute, 1915.....	1276
Institute News and Radio Notes.....	1277
Radio Signal Transmissions of Standard Frequency.....	1277
Institute Meetings.....	1277
Personal Mention.....	1280
Proposed Standard Tests of Broadcast Radio Receivers.....	1282

PART II

*Technical Papers*

Properties and Applications of Mycalex to Radio Apparatus W. W. BROWN	1306
From Broadcasting to Audible Pictures..... P. H. EVANS	1316
Problems Involved in the Design and Use of Apparatus for Testing Radio Receivers..... P. O. FARNHAM AND A. W. BARBER	1338
Engineering Control of Radio-Receiver Production..... V. M. GRAHAM AND BENJ. OLNEY	1351
Dry Electrochemical Condensers..... P. E. EDELMAN	1366
War Department Message Center..... F. E. STONER	1372
Fluctuation Noise in Radio Receivers..... STUART BALLANTINE	1377
A Screen-Grid Voltmeter and its Application as a Resonance Indicator..... RONOLD KING	1388
Reflection of Radio Waves from the Surface of the Earth. L. C. VERMAN	1396
Coöperation Committee Program..... A. E. KENNELLY	1430
Classification of Radio Subjects; An Extension of the Dewey Decimal System..... BUREAU OF STANDARDS	1433
Book Review.....	1457
Booklets, Catalogs and Pamphlets Received.....	1458
Monthly List of References to Current Radio Literature.....	1459
Contributors to this Issue.....	1463

*Copyright, 1930, by the Institute of Radio Engineers*

# The Institute of Radio Engineers

## GENERAL INFORMATION

The PROCEEDINGS of the Institute is published monthly and contains papers and discussions thereon submitted for publication or for presentation before meetings of the Institute or its Sections. Payment of the annual dues by a member entitles him to one copy of each number of the PROCEEDINGS issued during the period of his membership.

Subscription rates to the PROCEEDINGS for the current year are received from non-members at the rate of \$1.00 per copy or \$10.00 per year. To foreign countries the rates are \$1.10 per copy or \$11.00 per year.

Back issues are available in unbound form for the years 1918, 1920, 1921, 1922, and 1926 at \$9.00 per volume (six issues) or \$1.50 per single issue. For the years 1913, 1914, 1915, 1916, 1917, 1919, 1923, 1924, and 1925 miscellaneous copies (incomplete unbound volumes) can be purchased for \$1.50 each; for 1927, 1928, and 1929 at \$1.00 each. The Secretary of the Institute should be addressed for a list of these.

Discount of twenty-five per cent is allowed on all unbound volumes or copies to members of the Institute, libraries, booksellers, and subscription agencies.

Bound volumes are available as follows: for the years 1922 and 1926 to members of the Institute, libraries, booksellers, and subscription agencies at \$8.75 per volume in blue buckram binding and \$10.25 in morocco leather binding; to all others the prices are \$11.00 and \$12.50, respectively. For the year 1929 the bound volume prices are: to members of the Institute, libraries, booksellers, and subscription agencies, \$9.50 in blue buckram binding; to all others, \$12.00. Foreign postage on all bound volumes is one dollar, and on single copies is ten cents.

The 1930 Year Book, containing general information, the Constitution and By-Laws, catalog of membership, etc., is available to members at \$1.00; to non-members, \$1.50.

Contributors to the PROCEEDINGS are referred to the following page for suggestions as to approved methods of preparing manuscripts for publication in the PROCEEDINGS.

Advertising rates for the PROCEEDINGS will be supplied by the Institute's Advertising Department, Room 802, 33 West 39th Street, New York, N.Y.

Changes of address to affect a particular issue must be received at the Institute office not later than the 15th of the month preceding date of issue. That is, a change in mailing address to be effective with the October issue of the PROCEEDINGS must be received by not later than September 15th. Members of the Institute are requested to advise the Secretary of any change in their business connection or title irrespective of change in their mailing address, for the purpose of keeping the Year Book membership catalog up to date.

The right to reprint portions or abstracts of the papers, discussions, or editorial notes in the PROCEEDINGS is granted on the express condition that specific reference shall be made to the source of such material. Diagrams and photographs published in the PROCEEDINGS may not be reproduced without making special arrangements with the Institute through the Secretary.

It is understood that the statements and opinions given in the PROCEEDINGS are views of the individual members to whom they are credited, and are not binding on the membership of the Institute as a whole.

All correspondence should be addressed to the Institute of Radio Engineers, 33 West 39th Street, New York, N.Y., U.S.A.

Entered as second class matter at the Post Office at Menasha, Wisconsin.

Acceptance for mailing at special rate of postage provided for in the Act of February 28, 1925, embodied in paragraph 4, Section 412, P. L. and R. Authorized October 26, 1927.

Published monthly by

**THE INSTITUTE OF RADIO ENGINEERS, INC.**

Publication office, 450-454 Ahnaip Street, Menasha, Wis.

BUSINESS, EDITORIAL, AND ADVERTISING OFFICES,

Harold P. Westman, *Secretary*

33 West 39th St., New York, N.Y.

# SUGGESTIONS FOR CONTRIBUTORS TO THE "PROCEEDINGS"

## Preparation of Paper

**Form**—Manuscripts may be submitted by member and non-member contributors from any country. To be acceptable for publication, manuscripts should be in English, in final form for publication, and accompanied by a summary of from 100 to 300 words. Papers should be typed double space with consecutive numbering of pages. Footnote references should be consecutively numbered and should appear at the foot of their respective pages. Each reference should contain author's name, title of article, name of journal, volume, page, month, and year. Generally, the sequence of presentation should be as follows: statement of problem; review of the subject in which the scope, object, and conclusions of previous investigations in the same field are covered; main body describing the apparatus, experiments, theoretical work, and results used in reaching the conclusions and their relation to present theory and practice; bibliography. The above pertains to the usual type of paper. To whatever type a contribution may belong, a close conformity to the spirit of these suggestions is recommended.

**Illustrations**—Use only jet black ink on white paper or tracing cloth. Cross-section paper used for graphs should not have more than four lines per inch. If finer ruled paper is used, the major division lines should be drawn in with black ink, omitting the finer divisions. In the latter case, only blue-lined paper can be accepted. Photographs must be very distinct, and must be printed on glossy white paper. Blueprinted illustrations of any kind cannot be used. All lettering should be 3/16 in. high for an 8 x 10 in. figure. Legends for figures should be tabulated on a separate sheet, not lettered on the illustrations.

**Mathematics**—Fractions should be indicated by a slanting line. Use standard symbols. Decimals not preceded by whole numbers should be preceded by zero, as 0.016. Equations may be written in ink with subscript numbers, radicals, etc., in the desired proportion.

**Abbreviations**—Write a.c. and d.c. (a-c and d-c as adjectives), kc,  $\mu$ f,  $\mu\mu$ f, e.m.f., mh,  $\mu$ h henries, abscissas, antennas. Refer to figures as Fig. 1, Figs. 3 and 4, and to equations as (5). Number equations on the right in parentheses.

**Summary**—The summary should contain a statement of major conclusions reached, since summaries in many cases constitute the only source of information used in compiling scientific reference indexes. Abstracts printed in other journals, especially foreign, in most cases consist of summaries from published papers. The summary should explain as adequately as possible the major conclusions to a non-specialist in the subject. The summary should contain from 100 to 300 words, depending on the length of the paper.

## Publication of Paper

**Disposition**—All manuscripts should be addressed to the Institute of Radio Engineers, 88 West 39th Street, New York City. They will be examined by the Committee on Meetings and Papers and by the Editor. Authors are advised as promptly as possible of the action taken, usually within one month.

**Proofs**—Galley proof is sent to the author. Only necessary corrections in typography should be made. *No new material is to be added.* Corrected proofs should be returned *promptly* to the Institute of Radio Engineers, 88 West 39th Street, New York City.

**Reprints**—With the galley proof a reprint order form is sent to the author. Orders for reprints must be forwarded promptly as type is not held after publication.

## INSTITUTE SECTIONS

<i>Chairmen</i>	<i>Secretaries</i>
H. F. Dobbs <i>Acting Chairman</i>	<b>ATLANTA</b> Philip C. Bangs, 23 Kensington Rd. Avondale Estates, Ga.
George W. Pierce	<b>BOSTON</b> Melville Eastham, 30 State St., Cambridge, Mass.
A. B. Chamberlain	<b>BUFFALO-NIAGARA</b> E. C. Waud, 235 Huntington Ave., Buffalo, N. Y.
H. E. Kranz	<b>CHICAGO</b> J. H. Miller, Jewell Electrical Inst. Co., 1650 Walnut St., Chicago, Ill.
R. H. Langley	<b>CINCINNATI</b> W. W. Boes, Radio Products, Co., 5th and Norwood Sts., Dayton, Ohio
D. Schregardus	<b>CLEVELAND</b> C. H. Shipman, 14805 Ardenall Ave., East Cleveland, Ohio
Q. A. Brackett	<b>CONNECTICUT VALLEY</b> F. C. Beekley, 96 S. Main St., W. Hartford, Conn.
A. B. Buchanan	<b>DETROIT</b> W. R. Hoffman, 615 West Lafayette Blvd., Detroit, Mich.
T. C. Bowles	<b>LOS ANGELES</b> Charles S. Breeding, 1187 N. Normandie Ave., Hollywood, Calif.
Pendleton E. Lehde	<b>NEW ORLEANS</b> Anton A. Schiele, 1812 Masonic Temple, New Orleans, La.
W. R. G. Baker	<b>PHILADELPHIA</b> <i>Acting Secretary</i> G. C. Blackwood, 243 E. Upsal St., Mt. Airy, Philadelphia, Pa.
A. J. Buzzard	<b>PITTSBURGH</b> C. F. Donbar, 233 South Starr Ave., Bellevue, Penna.
E. C. Karker	<b>ROCHESTER</b> A. R. Barfield, Valley Appliances, Inc., Rochester, N. Y.
Walter D. Kellogg	<b>SAN FRANCISCO</b> Paul R. Fenner Custom House, San Francisco, Calif.,
Austin V. Eastman	<b>SEATTLE</b> Abner R. Willson, 8055—14th Ave., N. E., Seattle, Wash.
J. M. Leslie	<b>TORONTO</b> G. E. Pipe, 90 Chestnut St., Toronto, Canada
C. B. Jolliffe	<b>WASHINGTON</b> J. B. Brady, Ouray Bldg., Washington, D. C.

## GEOGRAPHICAL LOCATION OF MEMBERS ELECTED JULY 2, 1930

### Elected to the Associate grade

Arkansas	Blytheville, 105 E. Main St.	Marsh, W. Paul
California	Alhambra, 25 East Valley Blvd., Apt. 10	MacDowell, K. P.
	Glendale, 2404 Sylvan Lane	Murray, R. W.
	Inglewood, 608 Hilldale St.	Brittain, L. B.
	Los Angeles, 1117 N. Commonwealth Ave.	Reiter, F. P.
	Newman, P. O. Box No. 246	Beall, E. J.
	Oakland, 5318 Princeton St.	Jordan, Chester H.
	Oakland, 1061-62nd St.	Summers, J. W.
	Palo Alto, 620 Gilman St., Apt. 2	Wiskeman, Max
	San Diego, c/o U.S.S. Medusa	Jorgenson, A. A.
Connecticut	Hartford, 42 Brownell Ave.	Coe, R. S.
	Hartford, 1711 Park St.	Parmenter, R. B.
Illinois	Chicago, 6245 S. Sacramento Ave.	Burkhart, V. S.
	Chicago, 520 N. Michigan Ave.	Gruskin, George
	Chicago, 1138 N. Waller Ave.	Harrower, J. C.
	Chicago, 2639 N. Fairfield Ave.	Helman, A. R.
	Chicago, 5944 S. California Ave.	Hemingway, Bert
	Chicago, 4750 Kenmore Ave.	Herdrich, H. E.
	Chicago, 806 N. Lockwood Ave.	Hungerford, N. C.
	Chicago, 4940 East End Ave.	Miller, D. H.
	Chicago, 2119 East 67th St.	Tighe, J. V.
Indiana	Elkhart, 124 S. Vine St.	Haselwood, W. E.
Iowa	Council Bluffs, 542 Benton St.	Fisher, H. R.
	Waterloo, 227 Cortlandt St.	Palmer, P. M.
Kansas	Milford	Miller, J. C.
Kentucky	Owensboro, 323 W. 8th St.	Kirk, W. C.
Louisiana	New Orleans, 521 Bienville St.	Veasy, J. J.
Maryland	Laurel, Montgomery Ave.	Harrison, Lee
Massachusetts	Wollaston, 125 West Elm Ave.	Waite, A. H., Jr.
Michigan	Ann Arbor, 216 Packard St.	Fuller, L. D.
	Jackson, 1507 E. North St.	Bailey, Neil
	South Haven, 312 Michigan Ave.	Bennett, M. C.
	St. Paul, 995 Winslow Ave.	Coil, N. B.
Missouri	Kansas City, 1806-41st St.	Willing, J. P., Jr.
New Jersey	Audubon, 740 White Horse Pike	Harris, W. A.
	Camden, R.C.A.-Victor Co., Bldg. 5, Room 603	Johnson, E. E.
	Camden, 2823 Hayes Ave.	Troxell, G. W.
	Deal, American Tel. and Tel. Co., Box No. 122	Leeds, L. M.
	East Orange, 85 South Arlington St.	Woods, W. A.
	Long Branch, 688 Broadway	Spittle, S. E.
	Maplewood, 99 Tuscan Road	Poppele, J. R.
	Newark, 108 Schofield St.	Meyer, H. E.
	New Brunswick, c/o National Air Transport, Inc., Hadley Field	Barker, F. C.
	Orange, 651 Lincoln Ave., Apt. 305	Maul, G. E.
	Passaic, 50 Park Ave.	Webster, R. G.
New York	Brooklyn, 25 Billings Pl.	Sobel, A. D.
	Brooklyn, U. S. Naval Radio Station, Navy Yard	Tallman, Clare Le Roy
	Buffalo, 345 Shirley Ave.	Cameron, Richard
	Buffalo, 401 Forest Ave.	Meek, D. A.
	Elmhurst, L. I., 8642-57th Road	Content, E. J.
	Kenmore, 171 W. Girard Ave.	Sheets, H. M.
	New Rochelle, 29 Burling Lane	Cantor, A. B.
	New York City, 138 E. 38th St.	Bylander, J. C.
	New York City, Century Hotel, 111 W. 46th St.	Conley, S. D.
	New York City, Bell Tel. Labs., 463 West St.	Custer, C. J.
	New York City, 17 W. 60th St., Room 1101	Haldane-Duncan, B.
	New York City, USS Saratoga, c/o Postmaster	Honeycutt, V. C.
	New York City, 26 Broadway, SS A. S. Bradford, c/o Standard Shipping Co.	McCarroll, G. M.
	New York City, 67 Broad St., c/o Mackay Radio Telegraph Co., Inc.	Miles, P. D.
	New York City, 152 West 42nd St., c/o S. S. White Dental Mfg. Co.	Smack, J. C.
	New York City, 326 East 155th St.	Speed, R. B.
	New York City, 865 East 167th St.	Weintraub, D. H.
	New York City, 18 East 3rd St.	Wood, R. C.
	Pelham Manor, 1333 Manor Circle	Lewis, F. W., Jr.
	Rochester, 822 University Ave.	Proctor, Benj., 3rd.
	Rocky Point, Radio Corporation of America	Wooldridge, A. C.
	Scarsdale, 85 Alkamont Ave.	Weis, E. M.
Ohio	Schenectady, 6 Jackson Place	Rohner, A. J.
	Akron, 59 Hawthorne Ave.	Myers, W. H.
	Cleveland, National Air Transport, Municipal Air- port	Clemans, H. L.

*Geographical Location of Members Elected July 2, 1930*

Ohio (cont.)	Cleveland, National Air Transport.....	Costa, Humbert
	Columbus, 111 West 11th Ave.....	Newhouse, R. C.
	East Cleveland, 15987 Nelamere Road.....	Williams, H. R.
	Medina.....	Kohli, H. J.
Oklahoma	Oklahoma City, 1110 West 2nd St.....	Spooner, A. J.
Oregon	Eugene, 492 West Broadway.....	Du Sair, P. E.
Pennsylvania	Philadelphia, 1817 Fulmer St.....	Berrien, P. H.
	Philadelphia, 1624 E. Eyre St.....	Bloom, Walter
	Philadelphia, 128 S. Salford St.....	Podolsky, Leon
	Philadelphia, 4910 Stenton Ave.....	Williams, A. J., Jr.
	Pittsburgh, 929 Penn Ave.....	Clary, Howard L.
	Upper Darby, 264 Wembley Road.....	Lenhart, G. R., Jr.
	Wilmerding, Faller Bldg., Apt. 25.....	Irlam, William
Rhode Island	Providence, 204 Bowen St.....	Huddy, Franklin S.
Texas	Brownsville, Cia. Mexicana de Aviacion, S. A.....	Fernandez, Manuel
	Dallas, Box No. 1151.....	Eilert, E. F.
	Dallas, Box No. 181, S. M. U.....	Tucker, D. J.
Washington	Everett, 2511 East Grand.....	Malmstrom, W. H.
Wisconsin	Milwaukee, 672 Van Buren St.....	Gebhart, B. R.
	Platteville, R. R. No. 1.....	Bentz, C. F.
	Sauk City.....	Schmitz, A. J.
Canada	Kenora, Ont., Box No. 135.....	Doan, G. F.
	Montreal, Que., 173 William St.....	Bailey, F. A. A.
	Montreal, Que., 637 Craig St., West.....	Higgins, H. H.
	Montreal, Que., 4922 Sherbrooke St., West.....	White, W. E.
	Ste. Therese, Que., Box No. 111.....	Farmer, E. W.
Canal Zone	Coco Solo, U. S. Naval Air Station.....	Pritchard, C. A.
Colombia	Cúcuta, Estación Inalambrica.....	Caicedo, A. D.
England	Colchester, Essex, 13 Salisbury Ave.....	Wyborn, R. B.
	Liverpool, 86 Canning St.....	Worall, E. J. B.
	London, W. C. 1, Faraday House, 62 Southampton Row.....	Gunawardane, S. T. D.
	London, 599 High Ro Leyton.....	Summers, R. H. J.
	Sale, Nr. Manchester, 17 Hulme Road.....	Critchley, W. H.
	Thornton Heath, Surrey, 89 Parchmore Road.....	Hall, R. C.
	Thornton Heath, Surrey, 66 Ingram Road.....	Thomas, L. H.
Philippine Islands	Manila, c/o Radio Division, Bureau of Posts.....	Soriano, Alfonso
Scotland	Edinburgh, 22 Walker St.....	Kerr, John
South Africa	Umbilio, Durban, Natal, 23 Francois Road.....	Thomson, H. J.
<b>Elected to the Junior grade</b>		
Illinois	Chicago, 801 S. Marshfield Ave.....	Nichols, L. R.
Michigan	Flint, 2208 Cadillac St.....	Blanford, E. K.
Ohio	Akron, 188 Gale St.....	Branch, G. E.
Canada	Toronto, Ont., 345 Adelaide St., West.....	Blackburn, Wesley
	Winnipeg, Man., 205 Cambridge St.....	Sinclair, D. B.





## APPLICATIONS FOR MEMBERSHIP

Applications for transfer or election to the various grades of membership have been received from the persons listed below, and have been approved by the Committee on Admissions. Members objecting to transfer or election of any of these applicants should communicate with the Secretary on or before August 31, 1930. These applicants will be considered by the Board of Direction at its September 3rd meeting.

### For Transfer to the Member grade

New Jersey	Haddon Heights, 306 White Horse Pike.....	Burrill, C. M.
New York	Astoria, L. I., 32-35-38th St.....	Gunther, Frank A.
Canada	Toronto, 358 Bay St.....	Mullen, J. G.

### For Election to the Member grade

New Jersey	Camden, RCA-Victor Co. Inc.....	Ogloblinsky, Gregory
New York	New York City, 3rd Naval District.....	Clark, C. R.
England	Wigan, Mining & Technical College.....	Das, M. M.

### For Election to the Associate grade

Arizona	Kingman, P. O. Box No. 451.....	Wallace, P. H.
California	Alameda, 808 Taylor Ave.....	Montin, J. R. T.
	Oakland, R.F.D. No. 1, Box No. 1737.....	Mangelsdorf, F. B. E.
	Los Angeles, 1749 Magnolia Ave.....	Metcalf, D. E.
	San Bruno, Box No. 547.....	McAulay, W. H.
	San Diego, U. S. Naval Radio School.....	Riddle, G. E.
	San Francisco, RCA Photophone, Inc., Russ Bldg.....	Smith, M. O.
	San Francisco, 1509½ Dolores St.....	Walther, O. P.
	San Francisco, c/o Heintz and Kaufman.....	Wells, H. W.
	San Jose, 399 S. 14th St.....	Brown, O. H.
Connecticut	New Haven, c/o Tad Jones & Co., S. S. Edward Peirce.....	Ennis, J. B., Jr
Dist. of Columbia	Bellevue-Anacostia, U. S. Naval Research Laboratory.....	Overton, G. P.
	Washington, 4609-15th St., N. W.....	Neely, G. M.
Florida	Clearwater, 1604 Sunset Drive.....	Mitchell, J. H.
	Jacksonville, 106 E. Forsyth St.....	Weiss, Glover
	St. Petersburg, 2435 First Ave., So.....	Napper, C. J.
Illinois	Chicago, 553 N. Central Ave.....	Drobish, W. M.
	Chicago, 130 N. Parkside Ave.....	Elliot, P. T.
	Chicago, 5309 Potomac Ave.....	Huffman, K. C.
	Chicago, 5132 S. Wells St.....	Kara, A. R.
	Chicago, 1330 N. Parkside Ave.....	Vitellaro, F. L.
	Cicero, 2341 S. 53d Ave.....	Bennett, G. T.
	Riverside, 49 Forest Ave.....	Durham, J. B.
	Westmont, 325 S. Grant St.....	Keim, J. A.
	Wilmette, 735 Prairie Ave.....	Burrows, F. A.
Iowa	Marshalltown, 532 N. First St.....	Davis, S. S.
	Sioux City, 1225 Nebraska St.....	Morris, T. J.
	Tipton.....	Huber, L. R.
Kansas	Winfield, Box No. 520.....	Baden, M. W.
Maryland	Annapolis, c/o P. G. School, U. S. Naval Academy.....	Neimo, P. J.
	Baltimore, 1701 E. Lanvale St.....	Goldstein, M. K.
Massachusetts	Atlantic, 14 Hovey St.....	O'Donnell, E. T.
	Cambridge, c/o Mr. C. K. Jen, Cruft Lab.....	Eoyang, T. T.
	Cambridge, c/o Mr. C. K. Jen, Cruft Lab.....	Mao, C. S.
	Springfield, 77 Monrovia St.....	Moatz, D. R.
	Worcester, 87 Malden St.....	Cohen, Monte
Michigan	Lansing, 123 Elm St.....	Barnwell, J. W.
Minnesota	Minneapolis, 946-19th Ave., N. E.....	McLaughlin, H. J.
Mississippi	Greenwood, Box No. 120.....	Barnett, H. B.
New Jersey	Ampere, c/o Wired Radio, Inc.....	Goshaw, I. R.
	Haddon Heights, 1601 Sycamore St.....	Caller, J. M.
	Harrison, RCA Radiotron Co.....	Burnap, R. S.
	Newark, Brunswick, 30 Washington St.....	Hull, C. E.
	Woodbridge, 251½ Valley Blvd.....	Pratt, D. R.
New York	Bronx, 1473 Fulton Ave.....	Bouclis, S. A.
	Brooklyn, 7708 Bay Parkway.....	Bernstein, Julius
	Brooklyn, 5 Margaret Court.....	Coke, C. B.
	Brooklyn, 806 Ocean Ave.....	Lowander, R. W.
	Buffalo, 463 Colvin Ave.....	Rains, J. A.
	New York City, c/o Tropical Radio Tel. Co. Pier No. 9, N. R.....	Davis, M. F.
	New York City, 54 Dey St.....	Hatch, R. D.
	New York City, 315 Central Park West.....	Silberstein, R.
	Mitchell Field, L. I.....	Allen, F. G.
	Mt. Vernon, 60 Broad St.....	Fletcher, L. DuB., Jr.
	Schenectady, 429 McClellan St.....	Craig, R. B.
	Schenectady, 11 Hampton Ave.....	Hall, W. N.

## Applications for Membership

New York (cont.)	Schenectady, 1062 Baker Ave. ....	Rossman, D. V. O.	
	Scotia, 311 Pleasant View Ave. ....	Eldridge, F. B.	
North Carolina	Scotia, 122 James St. ....	Risinger, Paul	
	Marion, Box No. 154. ....	Martin, H. C.	
Ohio	Delaware, 169 N. Liberty St. ....	Johnston, G. D.	
	Portsmouth, 822 Gay St. ....	Feyler, H. C.	
Oklahoma	Fort Sill, First F. A. ....	Beckley, S. A.	
	Oklahoma City, Box No. 298, Y.M.C.A. ....	Knittle, T. M.	
Oregon	Woodward, 819 Main St. ....	Shircliff, E.	
	Boardman. ....	Howell, J. P.	
Pennsylvania	Allentown, 315 N. Franklin St. ....	Grammes, C. W.	
	Bellevue, 27 E. Orchard Ave. ....	Bucher, J. P.	
Tennessee	Bethlehem, 240 W. Packer Ave. ....	Stein, Victor	
	North Braddock, 1422 Ridge Ave. ....	Berhalter, J. J.	
	Philadelphia, 2953 N. 25th St. ....	Brown, H. C.	
	Philadelphia, 3424 N. Dillman St. ....	Eskuchen, F. G.	
	Philadelphia, 2438 N. 54th St. ....	Korson, Sol	
	Philadelphia, 1458 E. Lycoming St. ....	Stroud, R. J.	
	Wilmerding, 416 Welsh Ave. ....	Simpson, E. H.	
	Chattanooga, 42 Rosemont Drive. ....	Eiselein, J. E.	
	Memphis, c/o O. K. Hauck Co., 103 S. Main St. ....	Roach, J. F.	
	Corpus Christi, 316 Indiana St. ....	Nelson, C. L.	
	Texas	Dallas, 3506 Lindenwood Ave. ....	Hayes, T. P.
		Dallas, 2302 Poplar St. ....	Wilks, E. L.
Virginia	Houston, KTUE, Texas State Hotel. ....	Meyer, J. M.	
	Bristol, West & 21st St. ....	Jellicorse, H. L.	
Washington	Seattle, 7412 Dayton Ave. ....	Baker, E. W.	
	Seattle, 1430 First Ave. ....	Hoke, V. L.	
Wisconsin	Milwaukee, 471 Marshall St. ....	Borek, J. J.	
Australia	Melbourne, N. 3, Victoria. ....	Munro, G. H.	
	Melbourne, Victoria, Research Section, P.G.M.'s Dept., 360 P. O. Pl. ....	Wright, E. P.	
	Sydney, N. S. W., 24 Bond St. ....	Mingay, O. F.	
	Toronto, Ont., 43 Pacific Ave. ....	McCardle, Henry	
	Winnipeg, 60 Brock St. ....	McLaughlin, H. R.	
	Hong Kong, Electrical Dept., P. W. D. ....	Summerhayes, R. A.	
	Burnley-Lanes, 120 Padiham Rd. ....	Mallinson, W.	
	Chelmsford, Essex, 47 Vicarage Rd. ....	Evans, E. H.	
	Cheltenham, 40 Albert St., St. Pauls. ....	Swain, F. A.	
	Haslemere, Surrey, The Homestead, St. Pauls. ....	Hutchinson, G. A.	
	London, Enfield Town, "Cyldon" Works, Sarnesfield Rd. ....	Bird, S. S.	
	London, W.C.L., c/o Int. Marine Radio Co., Connaught Howe. ....	Jarratt, G. H.	
Much Hadham, Herts., The Vineyard. ....	Gausden, P.		
Newcastle-on-Tyne, The Governor's House, Royal Victoria Infirmary. ....	Dunstan, A. S.		
North Harrow, Middlesex, 47 Blenheim Rd. ....	Lawson, C. J. F.		
Japan	Tokyo, 18, 2-chome, Marunouchi. ....	Iyoki, O.	
New Zealand	Tokyo, 18, 2-chome, Marunouchi. ....	Morita, M.	
	Wellington, Dist. Tel. Engineer. ....	Baggs, A. D.	
South Africa	Wellington, P. O. Box No. 830. ....	Webster, Allan	
	Johannesburg, Box No. 1077. ....	Nicholas, W. H.	
Switzerland	Johannesburg, c/o S. A. G. E., Box No. 1905. ....	Rose, H. H.	
	Zurich, Klossbachstrasse. ....	Guggenheim, Sigmund	
For Election to the Junior grade			
Michigan	Jackson, 611 Fourth St. ....	Pampel, F. L.	
New York	White Plains, 75 Robertson Ave. ....	Arcand, W.	
Wisconsin	Milwaukee, Central Y. M. C. A. ....	Almberg, C. H.	
England	Swindon, Wilts., 14 Victoria Rd. ....	Cross, A.	



## OFFICERS AND BOARD OF DIRECTION, 1930

(Terms expire January 1, 1931, except as otherwise noted)

### *President*

LEE DE FOREST

### *Vice-President*

A. G. LEE

### *Treasurer*

MELVILLE EASTHAM

### *Secretary*

HAROLD P. WESTMAN

### *Editor*

ALFRED N. GOLDSMITH

### *Managers*

J. H. DELLINGER

L. M. HULL

A. F. VAN DYCK

R. A. HEISING

R. H. MANSON

ARTHUR BATCHELLER

(Serving until Jan. 1, 1932)

C. M. JANSKY, JR.

J. V. L. HOGAN

(Serving until Jan. 1, 1932)

(Serving until Jan. 1, 1933)

R. H. MARRIOTT

(Serving until Jan. 1, 1933)

---

### *Junior Past Presidents*

ALFRED N. GOLDSMITH

A. HOYT TAYLOR

---

### Board of Editors

ALFRED N. GOLDSMITH, *Chairman*

STUART BALLANTINE

G. W. PICKARD

RALPH BATCHER

L. E. WHITTEMORE

J. W. HORTON

W. WILSON



JOHN STONE STONE  
President of the Institute, 1915

John Stone Stone, fourth president of the Institute, was born at Dover, Virginia, in 1869.

After spending two years at Columbia University and two additional years at Johns Hopkins University, he joined the Research and Development Laboratory of the American Bell Telephone Company at Boston, Massachusetts, in 1890, continuing this connection until 1900. During that period he invented the Stone common battery system and the carrier current system of transmission over wires. Among other of his inventions at that period was the system of uniformly loading telephone cables with inductance. He was a special lecturer on electrical oscillations at the Massachusetts Institute of Technology for a number of years during this period and later.

From 1902 to 1908 he was director, vice president, and chief engineer of the Stone Telephone and Telegraph Company, becoming president in 1908 to 1910. From 1910 to 1921 he practiced as a consulting electrical engineer and expert in patent causes, then joining as an associate engineer at large, the Department of Development and Research of the American Telephone and Telegraph Company.

He has been granted a large number of patents for inventions relating to improvements in telephony and telegraphy, both wire and radio.

He was awarded the Edward Longstreth Medal of the Franklin Institute in 1913 and the Medal of Honor of the Institute of Radio Engineers in 1923.

He is a Fellow of the American Academy of Arts and Sciences, American Association for the Advancement of Science, a member of the Franklin Institute, American Electrochemical Society, American Institute of Electrical Engineers, American Defense Society, and Academy of Political Science.

He was president of the Society of Wireless Telegraph Engineers, from 1906 to 1909. This organization together with the Wireless Institute became the Institute of Radio Engineers in 1912.

A member of the Board of Direction of the Institute from 1912 to 1917, he became vice president for 1913 and 1914, and president during 1915. He was made a Fellow of the Institute in 1915.

## INSTITUTE NEWS AND RADIO NOTES

### Associate Application form

For the benefit of members who desire to have available each month an application form for Associate membership, there is printed in the PROCEEDINGS a condensed Associate form. In this issue this application will be found on page XXXIII of the advertising section.

Application forms for the Member or Fellow grades may be obtained upon application to the Institute office.

The Committee on Membership asks that members of the Institute bring the aims and activities of the Institute to the attention of desirable and eligible nonmembers. The condensed form in the advertising section of the PROCEEDINGS each month may be helpful.

### Radio Signal Transmissions of Standard Frequency July to December 1930

The following is a schedule of radio signals of standard frequencies for use by the public in calibrating frequency standards and transmitting and receiving apparatus as transmitted from station WWV of the Bureau of Standards, Washington, D. C.

Further information regarding these schedules and how to utilize the transmissions can be found on pages 10 and 11 of the January, 1930 issue of the PROCEEDINGS, and in the Bureau of Standards Letter Circular No. 171, which may be obtained by applying to the Bureau of Standards, Washington, D. C.

Eastern Standard Time	Aug. 20	Sept. 22	Oct. 20	Nov. 20	Dec. 22
10:00 P.M.	4000	550	1600	4000	550
10:12	4400	600	1800	4400	600
10:24	4800	700	2000	4800	700
10:36	5200	800	2400	5200	800
10:48	5800	1000	2800	5800	1000
11:00	6400	1200	3200	6400	1200
11:12	7000	1400	3600	7000	1400
11:24	7600	1500	4000	7600	1500

### Institute Meetings

#### JUNE MEETING

A joint meeting of the Institute and the Radio Manufacturers' Association was held in Atlantic City June 3, 1930, during the convention of the Radio Manufacturers' Association, Dr. Lee deForest, presiding.

The morning session was devoted to a general discussion on loud-speaker testing methods and a considerable number of those present contributed to it.

Three papers were presented during the afternoon session and are as follows:

"Problems Involved in the Design and Use of Apparatus for Testing of Radio Receivers," by P. O. Farnham and A. W. Barber.

"Engineering Control of Radio-Receiver Production," by Virgil M. Graham and Benjamin Olney.

"Essential Tests for Component Parts of Electric Radio Receivers" by H. E. Kranz.

As the first two papers of the afternoon session are being published in this issue, there is no need of their being abstracted here.

Approximately four hundred attended the meetings.

#### BUFFALO-NIAGARA SECTION

The May meeting of the Buffalo-Niagara Section was held on the 21st of the month at the University of Buffalo, L. Grant Hector, chairman, presiding.

A paper by J. M. Thomson, radio engineer of the Ferranti Electrical Company of Toronto, Ontario, Canada on "Output Transformer Design and Application," was presented.

Twenty members and guests attended the meeting.

The June 26th meeting of the Buffalo-Niagara Section was held at Edmund Hayes Hall of the University of Buffalo, L. Grant Hector, chairman, presiding.

E. J. T. Moore of the Stromberg-Carlson Telephone Manufacturing Company, delivered a paper on "Laboratory Equipment Used for Determining Characteristics of Broadcast Receivers." Messrs. Burns, Chamberlain, Hector, and Waud entered into the discussion.

At the annual election which was held, the following officers were elected: A. B. Chamberlain, chairman; L. Shapiro, vice chairman; and E. C. Waud, secretary-treasurer.

Twenty members and guests were in attendance.

#### LOS ANGELES SECTION

The Los Angeles Section held its meeting on the 19th of the month at the Engineers Club, T. F. McDonough, acting chairman, presiding.

A paper by John K. Hilliard, chief transmission engineer of the United Artists Studio Corporation presented a paper on "Problems in Transmission Engineering as Applied to Sound Recording." The

paper covered the calculation of line pads, volume indicators, audio amplifiers, gain controls, mixing units, and other apparatus used in radio, audio systems, and sound recording.

The discussion which followed was participated in by Messrs. Breeding, Fox, Silent, Willey and others.

One hundred and sixty-nine members and guests attended the meeting.

#### PHILADELPHIA SECTION

At the June 11th meeting of the Philadelphia Section, held in the Hall of the Franklin Institute, presided over by R. L. Snyder, William F. Diehl, division engineer in charge of testing at the RCA-Victor Company plant in Camden, delivered a paper on "Radio Test Methods and Equipment." Many of the seventy-five members and guests present entered into the general discussion which followed the presentation of the paper.

Officers for the coming year were elected and are as follows: W. R. G. Baker, chairman; C. D. Haigis, vice chairman; G. C. Blackwood, secretary-treasurer.

#### PITTSBURGH SECTION

On May 20th a meeting of the Pittsburgh Section was held at the Fort Pitt Hotel, vice chairman J. G. Allen, presiding.

A paper on "Construction of the Vacuum Tube and Recent Developments of the A-C Pentode Tube" was delivered by F. S. Huddy of the Ceco Manufacturing Company of Providence, R. I.

Discussion of the paper was entered into by Messrs. Allan, Hitchcock, Mag, Roese, and Sunnergren.

Thirty-eight members and friends attended the meeting.

#### SAN FRANCISCO SECTION

The April meeting of the San Francisco Section was held on the 28th of the month at the Engineers Club, Donald K. Lippincott, presiding.

A paper on the "Design of High-Power Antennas by the Use of Models" was delivered by C. H. Suydam.

A number of the forty-five members and guests attending the meeting participated in the discussion.

The May 28th meeting of the San Francisco Section was held in the Telephone Auditorium, D. K. Lippincott, chairman, presiding.

A paper by Howard F. Mason, radio engineer on the Byrd Antarctic Expedition on "Radio as an Essential to the Byrd Antarctic Expedition" was presented.

One hundred and fifty-three members and guests were present.

A paper on "Electrical Discharge Through Gases at Low Pressure" was presented by Herbert E. Metcalf at the June 25th meeting of the San Francisco Section held at the Engineers Club, D. K. Lippincott and W. D. Kellogg, presiding.

The annual election of officers was also held and Walter D. Kellogg was elected chairman; C. H. Suydam, vice chairman; and Paul R. Fenner, secretary-treasurer.

Thirty-four members and guests attended the meeting.

#### SEATTLE SECTION

On May 23, a meeting of the Seattle Section was held in the Engineering Hall, University of Washington, Austin V. Eastman, presiding.

A paper by T. M. Libby on "The Action of Vacuum-Tube Modulators and Detectors" was presented and, as part of the paper, the action of vacuum-tube modulators and detectors was demonstrated. A physical demonstration of the amplitudes of the several products of modulation was given.

Eighty-seven members and guests attended the meeting.

---

#### Personal Mention

Howard F. Mason until recently engineer-operator with the Byrd Antarctic Expedition, has joined the Engineering Department of Heintz and Kaufman, at San Francisco, Cal.

Erwin Aymar, formerly of the Engineering Department of the Western Union Telegraph Company is now service engineer for Electrical Resistance Products, Inc., of New York City.

J. R. Bain is now a sound picture engineer in the Research Products Engineering Department of the Northern Electric Company at Montreal. He was formerly with the Canadian Westinghouse Company at Hamilton.

J. H. Barron, Jr. has recently joined the engineering staff of the Federal Radio Commission, leaving his former position as U. S. Radio Inspector in the Radio Division at Washington, D. C.

I. Dale Ball has left the office of the Supervisor of Radio in Detroit to become a junior radio inspector at the U. S. Constant Frequency Monitoring Station at Grand Island, Nebr.

J. F. Church, formerly manager of the Radio Division of the Kodel



Electric and Manufacturing Company at Cincinnati is now connected with the Jensen Manufacturing Company of Chicago.

J. M. Clayton, previously secretary of the Institute of Radio Engineers, is now Manager of Operations of Heintz and Kaufmann at San Francisco, Cal.

Elmer L. Brown is now engineer in the Special Equipment Division of the RCA-Victor Company at Camden, having formerly been a member of the Engineering Department of the Radio Corporation of America at Camden.

Maurice Artzt has left the Radio Test Department of the General Electric Company to join the Engineering Staff of the RCA-Victor Company at Camden.

Previously chief engineer of Brunner Engineering Company of New York, C. M. Norberg has joined the Electrical Engineering Staff of Electrical Research Products, Inc.

Robert H. Noyes, formerly of the Naval Research Laboratory has joined the Engineering Staff of the U. S. Army Signal Corps at Wright Field, Dayton, Ohio.

Donald K. Oram, previously general manager of Harold Herbert, Inc., of New York City is now engineer for the Hammarlund Manufacturing Company.

L. M. Perkins has left the Delco Remy Corporation to become an engineer for the General Motors Corporation of Dayton, Ohio.

Albert R. Pettit has become an engineer in the Photophone and Applications Division of the RCA-Victor Company at Camden.

John Poppleton of Cleethorpes, England is now acting in a consulting capacity as a radio engineer.

John A. Russ, formerly radio inspector at Detroit, Michigan has become assistant radio inspector at the Monitoring Station at Grand Island, Nebraska.

Harry Sadenwater is now sales engineer for the RCA-Victor Company at Camden, previously being connected with the technical operation of broadcast stations of the General Electric Company at Schenectady, N. Y.

B. E. Shackelford, formerly head of the radio and illuminating engineering department of the Westinghouse Lamp Company is now chief engineer of RCA Radiotrons, Inc., of Harrison, N. J.

Saul I. Salter is now chief engineer of the Ergon Electric Corporation of Brooklyn, N. Y. previously being an engineer for the Gold Seal Electric Company of Newark, N. J.

Oliver Smith has become district transmission engineer of the Pacific Telephone and Telegraph Company at Spokane, Wash.

E. P. Schultz has joined the Engineering Department of RCA Photophone Inc. of New York City.

## PROPOSED STANDARD TESTS OF BROADCAST RADIO RECEIVERS

### Introduction

**D**URING the past year and a half, the Committee on Standardization of the Institute of Radio Engineers, and the four Technical Committees of the Committee on Standardization have been busily engaged in bringing the past standardization reports of the Institute up to date by adding new material and by making such alterations in the past reports as have become desirable. The committees have based their work principally upon the "Report of the Committee on Standardization for 1928" as published in the 1929 Year Book of the Institute of Radio Engineers.

The four Technical Committees, under the Committee on Standardization, have been engaged in the more technical and specialized work of enlarging and modernizing the "Report of the Committee on Standardization for 1928." When necessary, subcommittees of the Technical Committees have been appointed to work out even more specialized definitions than are originated by the Technical Committees. The work of the subcommittees and the Technical Committees has been practically completed and their reports are being forwarded to the Committee on Standardization for its approval, or revision if this is necessary.

The Committee on Standardization is concerned with the matter of correlating the reports of the Technical Committees to make sure that the recommended definitions, nomenclature, and test methods will not be duplicated in the various sections of the 1930 standardization report; of making all definitions consistent in grammatical structure; of securing comments, criticism, and suggestions concerning the reports of the Technical Committees, and of recommending to the Board of Direction of the Institute that its own report be adopted and published as the "Report of the Committee on Standardization for 1930."

There are forty-five members of the Committee on Standardization of the Institute of Radio Engineers under the chairmanship of J. H. Dellinger to whom the responsibility of working out a satisfactory standardization report is delegated. The members of this Committee are scattered throughout the United States, Canada, England, Germany, France, Japan, and Italy.

The following report of the "Proposed Standard Tests of Broadcast Radio Receivers" by the Technical Committee on Radio Receivers and its subcommittees is being circulated for comment and criticism before

being brought before the Committee on Standardization. Comments, criticisms, and suggestions from members of the Institute concerning this report will be appreciated so that any new or important ideas on the subject may be considered by the Committee on Standardization. Communications should be addressed to the Secretary, Committee on Standardization, Institute of Radio Engineers, 33 West 39th St., New York City.

## I. General

The purpose of the standard tests here proposed is to provide by general agreement a basis upon which the complete normal performance of any broadcast radio receiver may be reasonably predicted. It is believed that no simple "figure of merit" can properly be derived that will by itself give an index of complete performance. This follows from the varying weights that may be applied at different times and in different services, to the fundamental properties of Sensitivity, Selectivity, and Fidelity. Consequently it is believed to be essential to define and to provide for the separate measurement of each of these fundamental properties. Such information is of somewhat too highly technical nature to appeal directly to the average user of broadcast radio receivers, but is thought to be useful to radio distributors and dealers in guiding their selection of apparatus for specific service conditions, and to engineers and manufacturers in aiding the comparison and improvement of their products.

It is recognized that the tests do not comprehend the entire range of service conditions that may be met in practice, and that peculiarities of design not reflected in the test data may in special cases affect the deductions to be made properly from the test results. It is also recognized that the three basic properties of Sensitivity, Selectivity, and Fidelity are in some radio receivers dependent upon adjustments that will change the relative prominence of each, and consequently the three factors should be invariably measured at the same settings of the radio receiver adjustments. Nevertheless, it is thought that acceptance of the procedure outlined, together with proper interpretation and correlation of the results obtained by the tests, will serve to permit a standard comparison of normal radio receiver performance.

## II. Definition of Terms

A. **Sensitivity**—Sensitivity is that property of a radio receiver which enables it to respond to a small input voltage of the frequency to which it is tuned. It is measured quantitatively in terms of the input voltage required to give a standard output.

**B. Selectivity**—Selectivity is that property of a radio receiver which enables it to differentiate between the desired signal and signals of other carrier frequencies. This characteristic is not expressible by a single numerical value, but requires one or more graphs for its expression.

**C. Fidelity.**—Fidelity is that property of a system, or a portion of a system, which enables it to reproduce accurately at its output the signal which is impressed upon it. As applied to a radio receiver, fidelity is measured by the accuracy of reproduction at the output terminals of the modulation of the received wave.

**D. Normal Test Output**—As applied to the testing of a broadcast radio receiver, the term represents an audio-frequency power of 0.05 watt in a noninductive resistor arranged to carry alternating current only and connected across the output terminals of the radio receiver (usually the loud-speaker terminals), the resistance of the resistor having been adjusted to that value recommended by the tube manufacturer to give maximum undistorted output power for the type of vacuum tube intended to be used in the output of the radio receiver, with normal adjustments of this vacuum tube. If the radio receiver is not arranged to filter out direct current from its output circuit, then an external filter system shall be employed, of such character as to introduce negligible resistance to direct current, to have negligible loss and to have negligible shunt admittance and negligible series impedance relative to the output resistor.

**E. Normal Radio Input Voltage**—As applied to the testing of a broadcast radio receiver, this term represents the r.m.s. voltage of a received signal, modulated 30 per cent at 400 cycles per sec., which results in Normal Test Output (definition D, section II) at resonance. If the radio receiver does not include a self-contained antenna, then the signal is to be impressed on a real or artificial Standard Antenna\* (see definition F, section II).

For data on various methods of measuring the percentage modulation, the reader is referred to "The use of the electron tube peak voltmeter for the measurement of modulation" by C. B. Jolliffe, Proc. I.R.E., 17, 660-669; April, 1929. The method described in this article has much to recommend it from the point of view of simplicity, and with proper care the method is sufficiently accurate and reliable for general use. The method involves calculation of the percentage modulation from measured values of the peak voltage of the radio-frequency

\* Experience has indicated that with some radio receivers, an artificial antenna adversely affects the stability. In such cases it is necessary to employ a real antenna.

oscillator output under modulated and unmodulated conditions. The voltage measurements are made with a vacuum-tube peak voltmeter. The paper indicates that this method is capable of giving results accurate to within about 5 per cent. For use in calibrating the percentage modulation of a radio-frequency oscillator for radio receiver measurement work, however, this accuracy is generally sufficient.

**F. Standard Antenna.** (Real or Artificial)—As applied to the testing of a broadcast radio receiver not having a self-contained antenna, this term represents an artificial antenna having in series a capacity of 200  $\mu\mu\text{f}$ , a self-inductance of 20  $\mu\text{h}$ , and a resistance of 25 ohms.

**G. Standard Test Frequencies.**—In the testing of a broadcast radio receiver, the five standard carrier frequencies are 600, 800, 1000, 1200, and 1400 kc per sec. When tests are required at only three carrier frequencies, the values 600, 1000, and 1400 kc per sec. are recommended.

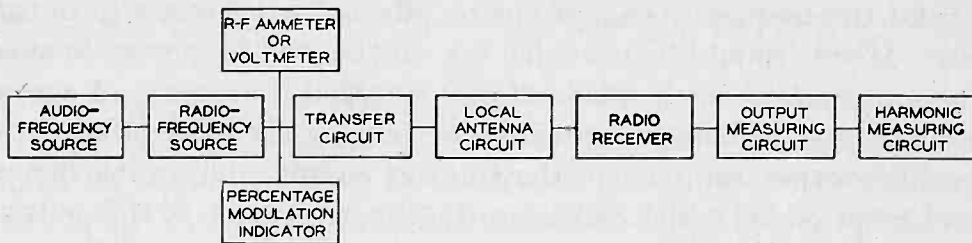

Fig. 1—Schematic arrangement of apparatus used in tests of radio receivers.

### III. Requirements and Characteristics of Testing Apparatus

The apparatus employed in testing radio receivers should be as simple as is consistent with accurate performance of the necessary functions. As far as possible, the same apparatus should be used in the different tests. The values of the electrical quantities and the calibrations should not change with time, or if some change is unavoidable, means for checking should be provided.

The required apparatus for Tests of Sensitivity, Selectivity, and Fidelity, is indicated schematically in Fig. 1. Both frequency sources should be calibrated so that separate measurement of frequency is not needed. The requirements of the separate elements are stated in the following paragraphs.

#### A. Audio-Frequency Source.

For Sensitivity and Selectivity Tests this may be a mechanical oscillator of fixed frequency (400 cycles per sec.), but a vacuum tube oscillator having a frequency range at least from 40 to 10,000 cycles per sec. is preferred and for the Fidelity Test is necessary. The total

harmonic content in the output of this oscillator should not exceed 5 per cent. The audio-frequency oscillator is arranged to modulate the radio-frequency oscillator by a known amount and preferably should furnish the same degree of modulation without readjustment at all carrier frequencies and all modulation frequencies. Means should be provided for adjusting the degree of modulation for at least the normal value of 30 per cent.

### **B. Radio-Frequency Source.**

This consists of a vacuum tube oscillator supplied preferably from batteries, either fully shielded in itself or so shielded from the radio receiver under test that there is no direct radiation to the receiver. If the power supply is external to the shielding system which encloses the oscillator all ungrounded leads to the oscillator should pass through shielded low-pass filters. The frequency should be adjustable by an external control to any desired value between 500 and 1500 kc per sec., and the frequency should not be affected by changes in output power. Means should be provided for varying the frequency in small steps immediately on each side of any specified frequency. A second external control should be provided for varying the modulated radio-frequency output supplied to the transfer circuit, and an instrument should be provided which indicates the effective value of this output. The oscillator in conjunction with the transfer system used (see part C below) should be capable of supplying in series with the receiving antenna system at least 200,000  $\mu$ v at all carrier frequencies.

### **C. Transfer Circuit.**

The radio receiver under test is provided with a local antenna circuit consisting of either a loop antenna (which may be self-contained) or an artificial antenna. In determining the significant characteristics, as outlined in the preceding sections, modulated radio-frequency voltages of known value are impressed in the local antenna circuit through the transfer circuit which should assume one of two forms as follows:

1. A coupling coil fed from the radio source and mounted in inductive relation with the loop antenna or with the 20- $\mu$ h inductance coil of the artificial antenna. In the latter case the coupling coil is used as the primary of a calibrated mutual inductor, the secondary of which is the 20- $\mu$ h coil.
2. A calibrated attenuator of the resistance type terminating in a low impedance of known value (usually a resistance of about one ohm) which may be inserted in series with the artificial or loop antenna. This attenuator should be so constructed that all attenuation ratios are substantially independent of frequency within the broadcast band.

It is preferably made variable in steps with additional provision for continuous variation between the steps. As an alternative to continuous variation within the attenuation network, provision may be made for continuously varying the measured current or voltage supplied from the source to the attenuator over a sufficient range to cover all values of receiver input voltage which lie between the steps of the attenuator. Design details of attenuators fulfilling these requirements are available in the literature. The combined range of ratios on the attenuator and variable currents from the source should be such as to allow a range of voltage across the terminal unit which feeds the receiving set of  $1 \mu\text{v}$  to  $200,000 \mu\text{v}$ .

#### D. Output Measuring Circuit.

The components of the output measuring circuit should be as follows:

1. A noninductive load resistor adjustable to any desired value between 1 and 20,000 ohms and capable of dissipating 10 watts at any setting.

2. An output filter to be used with radio receivers normally having direct current in their outputs. This filter should fulfill the requirements given under definition D, section II, and a recommended form consists of an inductance of not less than 100 h (with 50 ma direct current in the winding) and a capacitance of not less than  $8 \mu\text{f}$  arranged as shown in Fig. 5.

3. A vacuum-tube voltmeter or an equivalent device which will accurately measure the r.m.s. values of output voltage. At Normal Test Output the voltage is of the order of from 10 to 20 volts for ordinary output vacuum tubes. For the Sensitivity and Selectivity Tests the output meter need be calibrated only at these values. For the Fidelity Test continuous calibration is required, and for Overload Level Test calibration for much higher values is needed.

### IV. Test Procedures

#### A. Preliminary.

The present-day radio receivers vary so greatly in their manner of operation that it is difficult to set down a single test procedure for each fundamental characteristic and have the procedure include all the allowances that should be made for the peculiarities of different sets. It is simpler to describe in general the test set-ups and adjustments of input and output; the operating conditions; and the radio receiver adjustments as applied to any type of receiver. Then standard procedures for measuring Sensitivity, Selectivity, and Fidelity, can be outlined.

## B. Input Measurements.

### 1. RADIO RECEIVER WITHOUT A SELF-CONTAINED ANTENNA

Standard input circuits are shown in Figs. 2 and 3. Either circuit may be used depending on whether an impedance device or a mutual inductance (see section III) is used to attenuate and introduce the radio-frequency voltage in the artificial antenna circuit.

The mutual inductor is used as shown in Fig. 2. The input to the receiving set is controlled by adjustment of either the coupling be-

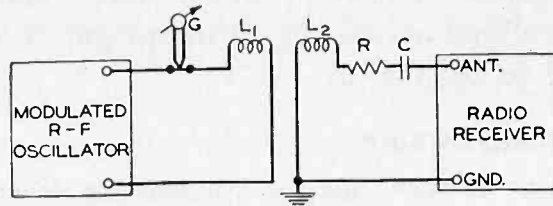

Artificial antenna

$L_2 = 20 \mu\text{h}$

$C = 200 \mu\mu\text{f}$

$R = 25 \text{ ohms}$

Fig. 2—Standard input circuit—mutual inductive coupling.

tween coils  $L_1$  and  $L_2$  or the current through  $L_1$ . The value of radio-frequency voltage impressed on the artificial antenna is determined

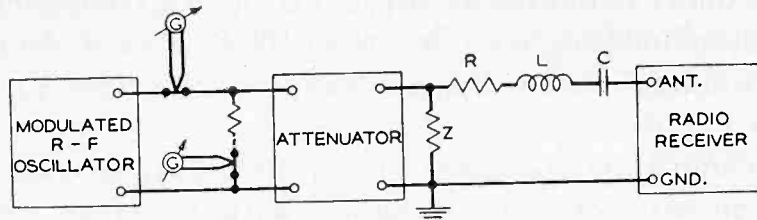

Artificial antenna

$L = 20 \mu\text{h}$

$C = 200 \mu\mu\text{f}$

$R + \text{Resistance component of } L = 25 \text{ ohms}$

$Z = \text{Coupling Impedance}$

Fig. 3—Standard input circuit—impedance coupling.

from the formula,

$$E = 2\pi fMI \quad (1)$$

where

$E$  is the radio-frequency input voltage in microvolts

$f$  is the carrier frequency in kilocycles per sec.

$M$  is the mutual inductance between  $L_1$  and  $L_2$  in millihenries

$I$  is the current through  $L_1$  in microamperes.

The circuit for use with an impedance coupling device is shown in Fig. 3. The voltage impressed in series with the artificial antenna is brought to the desired value by selecting the proper degree of attenuation and accurately adjusting either the current or the voltage input to



the attenuator. The value of  $Z$  should be small compared with that of the circuit to be connected to it. If the attenuator is calibrated in terms of current, the radio-frequency voltage impressed on the artificial antenna may be expressed as

$$E = KZI \quad (2)$$

where

$E$  is the radio-frequency input voltage in microvolts

$K$  is the attenuation factor

$Z$  is the impedance of the coupling device in ohms

$I$  is the measured value of current fed to the attenuator in microamperes.

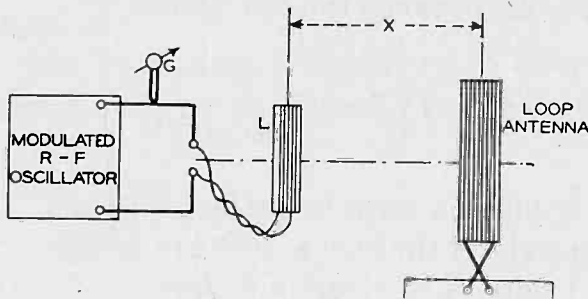

Fig. 4—Radio receiver with loop antenna.

If the attenuator is calibrated in terms of voltage and includes the impedance  $Z$ , then

$$E = KV \quad (3)$$

where

$E$  is the radio-frequency input voltage in microvolts

$K$  is the attenuation factor

$V$  is the measured input voltage in microvolts.

## 2. RADIO RECEIVER WITH A LOOP ANTENNA

There are two methods by which such receivers may be measured. The first method consists of inducing a known voltage in the loop antenna, while the second method introduces the known voltage in series with loop antenna.

a. For the first of these methods an arrangement of apparatus as shown in Fig. 4 is suggested. The voltage induced in the loop antenna is

$$E = \mathcal{E}Q \quad (4)$$

where

$E$  is the voltage induced in the loop antenna in microvolts

$\mathcal{E}$  is the field strength in microvolts per meter at the loop antenna

$Q$  is the effective height of the loop antenna.

The values of  $\mathcal{E}$  and  $Q$  may be calculated as follows:

$$\mathcal{E} = \frac{18850N_1A^2I}{(A^2 + X^2)^{3/2}} \cos B \quad (5)$$

where

$N_1$  is the number of turns in the coupling coil  $L$

$A$  is the radius of the coupling coil in centimeters

$I$  is the ammeter reading in microamperes

$X$  is the distance in centimeters between the center of the coupling coil and the center of the loop antenna

$B$  is the angle, if any, between the axis of the loop antenna and the line between the coil centers

and

$$Q = 2N_2h \sin \frac{fs}{300,000} \quad (6)$$

where

$N_2$  is the number of turns in the loop antenna

$h$  is the height of the loop antenna in meters

$s$  is the length of the loop in meters

$f$  is the frequency in kilocycles per second.

The induced voltage in the loop antenna may be adjusted by varying the distance  $X$  and the current through the coil  $L$ . The distance  $X$  should always be large as compared with the dimensions of the loop antenna. The axis of the coupling coil  $L$  should always pass through the center of the loop antenna. Equation (6) applies only to rectangular loops.

b. In the second method of test, the radio-frequency voltage may be introduced in the loop antenna by inserting the terminal impedance of a resistance type attenuator in series with the loop at a point of ground potential in a manner similar to that shown for an artificial antenna in Fig. 3. In this case the loop takes the place of the artificial antenna and the radio-frequency voltage is measured across the impedance which should be kept low in comparison with the impedance of the loop.

### C. Output Measurements.

#### 1. RADIO RECEIVER WITH DIRECT CURRENT IN ITS OUTPUT

If the radio receiver is not equipped to filter direct current from its output, the circuit which should be used in making output measurements is shown in Fig. 5. The specifications for the components of the above circuit are given in section III.

The value for  $R$  is dependent on the operating conditions of the output tubes used in the radio receiver. Its value is arbitrarily taken

(from the specifications of the tube manufacturer) as that resistance which gives the maximum undistorted power output under the given operating conditions.

In the case of a radio receiver having an output transformer, the load resistance  $R_L$  to be used across the output terminals is taken as the transferred value of the resistance  $R$  as specified above. That is,

$$R_L = \frac{R}{A^2} \quad (7)$$

where

$R_L$  is the load resistance actually connected across the output terminals

$R$  is the load resistance recommended by the manufacturer for maximum undistorted output. (In the case of push-pull operation, this value is the sum of the resistances for the individual tubes.)

$A$  is the transformer ratio of the total primary-to-secondary turns. The voltage across  $R$  for Normal Test Output is

$$V = \sqrt{0.05R}.$$

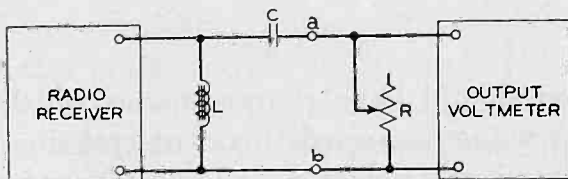

Fig. 5—Radio receiver with direct current in its output.

## 2. RADIO RECEIVER WITH NO DIRECT CURRENT IN OUTPUT

If the radio receiver has a device eliminating direct current from its output, (referring to the circuit of Fig. 5)  $L$  and  $C$  are removed and the points  $a$  and  $b$  connected directly to the output terminals of the receiver.

## 3. RADIO RECEIVER WITH EXTRANEIOUS VOLTAGES IN THE OUTPUT

The voltages due to a-c hum, tube noises, etc., that may exist across the output of some radio receivers must be considered where the output voltage to be measured is small. For example, if these voltages are comparable with the Normal Test Output Voltage, let the voltage across the resistor  $R$  for Normal Test Output be,

$$V_i = \sqrt{V_1^2 + V_2^2}, \quad (8)$$

where

$V_1$  is the r.m.s. voltage due to extraneous effects

$V_2$  is the value for Normal Test Output Voltage which gives 0.05 watt power in  $R$ .

In any case, if the extraneous voltage is appreciable, the measured voltage across  $R$  (see Fig. 5.) should be considered as the vector sum of the extraneous voltage and that due to the desired signal.

#### D. Operating Conditions.

##### 1. BATTERY OPERATED RADIO RECEIVERS

The "A" and "B" battery voltages supplied to the radio receiver should be held constant at the values specified for the receiver. If a battery cable is not furnished with the receiver, the leads to the batteries should be as short as possible. The batteries used should be in good condition.

##### 2. SOCKET-POWERED AND ELECTRIC RADIO RECEIVERS

The a-c or d-c voltage input to the radio receiver should be held constant at the value specified for the set or at 115 volts. If the receiver is provided with adjustments for reducing hum or ripple in the output, such adjustments should be made.

##### 3. TUBES

The tubes used should have characteristics which represent the arithmetical mean value as regards filament emission, plate current, plate resistance, amplification factor, and mutual conductance for that type of tube.

#### E. Radio Receiver Adjustment.

##### 1. GENERAL

The Test Frequency adjustment is normally obtained by adjusting all the external tuning and volume controls, with which a radio receiver is equipped, until maximum response is had at its output for a given signal impressed on its input.

##### 2. REGENERATIVE RADIO RECEIVERS

All tests should be made for each of the following conditions:

- a. With the radio receiver adjusted as in part 1 without causing oscillation at radio or audio frequencies to occur within the receiver.
- b. With the receiver adjusted as in part 1 with the minimum of regeneration that can be obtained by adjustment of the external controls only.

### 3. STABILIZED RADIO RECEIVERS

If a radio receiver is provided with external stabilization controls that are to be used in the normal operation of the receiver, it should be tested as a regenerative receiver. No other modifications of the general instructions of part 1 are necessary for the testing of stabilized radio receivers.

### 4. SUPER-HETERODYNE RADIO RECEIVERS

If a super-heterodyne radio receiver has a separate control of its oscillator frequency all tests should be made with the oscillator adjusted to the higher frequency above the signal, unless the instructions accompanying the receiver specify other conditions for operation. Selectivity tests should include the response at the lower frequency. In making selectivity tests the radio-frequency oscillator should be moved over twice the intermediate frequency. If this falls outside the broadcast band it should not be ignored. Otherwise, tests are to be in accordance with part 1.

## F. Sensitivity and Tuning Range Tests.

### 1. SENSITIVITY TEST

The sensitivity is determined by impressing a radio-frequency voltage, with 400 cycles, 30 per cent modulation, in series with a standard antenna (definition F, section II), or by inducing a known radio-frequency voltage in the self-contained antenna, if the radio receiver is so provided, and adjusting the intensity of the input voltage until Normal Test Output is had under conditions stated in D and E, section II, for carrier frequencies between 550 and 1500 kc per sec.

A graph is plotted with Normal Radio Input Voltage as ordinates and carrier frequency as abscissas. A uniform scale should be used for the abscissas and either a uniform or logarithmic scale may be used for ordinates.

### 2. TUNING RANGE TEST

In conjunction with the Sensitivity Test it is convenient to make a test of the tuning range of the radio receiver. Using the same test conditions as for the Sensitivity Test, the radio receiver tuning adjustment should be set for the lowest carrier frequency it is capable of receiving under normal operation. The radio-frequency oscillator is then adjusted in frequency until it is at that frequency which gives maximum output in the output meter. The output signal used should be approximately Normal Test Output, to avoid inaccuracies due to over-loading. The radio-frequency setting of the oscillator is then

recorded as the lower frequency limit of the tuning range. If the radio-frequency oscillator is incapable of reaching the low-frequency limit of the receiver, the oscillator should be set at its minimum frequency and the receiver tuned to it. The dial scale reading of the radio receiver is then recorded for that frequency. The process is then repeated at the high-frequency limit of the range. The maximum and minimum frequency settings of the tuning control will generally correspond to the maximum and minimum dial scale markings. If they do not, the dial settings corresponding to the limit frequency settings should be recorded.

If a calibration of dial setting versus carrier frequency is desired, it can be obtained by adding to the limit values, a set of readings of the dial settings for each of the Standard Test Frequencies used in the Sensitivity Test. The dial calibration is plotted in the form of a graph with carrier frequency as abscissas and dial setting as ordinates, both to a linear scale.

#### **G. Selectivity Test.**

The selectivity is determined by tuning the radio receiver to each Standard Test Frequency (definition G, section II) in succession, with the receiver in the same condition as in the Sensitivity Test, and measuring the radio-frequency input voltage necessary to give Normal Test Output at a series of carrier frequencies in steps not greater than 10 kc per sec. at least up to 100 kc per sec. on either side of resonance, or until the radio input voltage has increased to at least 1000 times its value at resonance (and preferably 10,000 times or more if the measuring equipment permits).

The conditions of modulation of the radio-frequency oscillator are to be the same as given under the definition for Normal Radio Input Voltage (definition E, section II). For each Standard Test Frequency a graph is plotted with carrier frequency as abscissas and the ratio of input off resonance to the input at resonance, as ordinates. The scale of ordinates should be logarithmic and the most accurate representation is secured by plotting the graphs for selectivity with separate enlarged frequency scales, which should be uniform and alike.

On some receivers the volume control setting has an effect on the selectivity, and this fact should be considered when making this test. (See, Effect of Volume Control on Selectivity, section V, for outline of test for this performance characteristic.)

#### **H. Fidelity Test.**

This is determined by tuning the radio receiver to each Standard Test Frequency (definition G, section II) in succession, with the re-

ceiver in the same condition as in the Sensitivity and Selectivity Tests, adjusting the impressed voltage to the Normal Radio Input Voltage, (definition E, section II) and then varying the modulation frequency from 40 to 10,000 cycles per sec. at 30 per cent modulation and constant radio-frequency input voltage throughout, taking readings of relative output voltage at convenient modulation frequencies. For each Standard Test Frequency, a graph is plotted with modulation frequency as abscissa, and as ordinate, the ratio of the output voltage at the modulation frequency of measurement to the output voltage at the modulation frequency of 400 cycles per sec. A logarithmic scale should be used for the abscissas and a uniform scale for the ordinates.

It is often useful to make Fidelity Tests at output levels higher than Normal Test Output. The output levels to be used are left to the discretion of the test engineer and should be stated in the results.

Certain types of volume controls have an effect upon the fidelity of the receiver and this fact should be considered when making this test. (See Effect of Volume Control on Fidelity, part B, section V, for outline of test for this characteristic.)

#### V. Additional Tests

The tests outlined in this section are to be regarded as tentative only. They are included for the purpose of bringing before the industry the need for tests of certain other factors of performance, in addition to major radio receiver tests which have been outlined in the preceding sections.

In some of the following tests, limits have been set in a somewhat arbitrary manner for the purpose of providing a basis for experimentation and further development. After some general experience has been had in making these additional tests, it is intended that definite standards for procedure in investigating these factors of radio receiver performance shall be drawn up. The Committee will be greatly assisted to this end if those laboratories finding a use for such tests will try out the methods outlined, and send in their comments and criticisms.

The tests which have appeared necessary thus far under this heading include:

- A. Tests of radio receivers at high output levels.\*
- B. Tests for volume controls of radio receivers.
- C. Tests for hum produced in radio receivers.

\* In the opinion of the Committee, tests at high output levels are considered worthy of a place among the preceding standard tests, but it is felt that there has not been sufficient experience with this test by various laboratories to warrant the setting up of a definite standard test for this characteristic of radio receivers. The following paragraphs on "Tests at High Output Levels" are therefore placed in the section on "Additional Tests," pending the collection of further data. It is expected that the material will be revised in further editions of this report.

## A. Tests of Radio Receivers at High Output Levels.

### 1. OVERLOADING OF RADIO RECEIVERS

It is conceded that the effect of distortion on the human ear is highly variable, and dependent upon many conditions which cannot be specified in any manner which shall be standard practice for any length of time. There is a basis on which overloading can be defined from the technical viewpoint, however, that may be used for the purpose of comparing radio receivers with respect to this factor of performance. A radio receiver can be said to be overloaded when distortion is manifested in the output, i.e., when the electrical output differs in wave form from the electrical input by a specified amount. The output of the radio receiver should be tested for the introduction of spurious frequencies, that is, those not present in the input.

The test apparatus will be that used for the Fidelity Test, except that a harmonic measuring instrument is to be connected across the standard output load, and this instrument so chosen as to constants, that it exerts negligible effect on the load circuit. For this purpose the instrument described in "The alternating current bridge as a harmonic analyzer"\* is recommended.

The radio-frequency input (with modulation adjusted to 30 per cent at 400 cycles) is to be increased in steps until a value is reached which causes the output voltage to contain 10 per cent of total harmonics.

When this input value has been reached, the output voltage is to be measured (as in Fidelity Test) and the power in the output circuit calculated. The overload level of the radio receiver shall then be considered to be that value of power output.

### 2. OVERLOAD CURVES

Curves showing the radio-frequency input in microvolts as abscissas, and the corresponding audio-frequency output in watts, as ordinates, furnish valuable data on the overloading of a radio receiver, especially if taken at lower percentage of modulation, as well as at 30 per cent. The same arrangement of apparatus can be used as in measuring the overload level. Observations at 30 and 10 per cent modulation at 400 cycles are usually sufficient, although other values may be used at the discretion of the test engineer. It is suggested that the test be made at 1000 kc although other Test Frequencies may be used if desired. The radio frequency and percentage modulation should be designated on each curve. Logarithmic scales should be used for both ordinates and abscissas.

\* Irving Wolff, "Alternating current bridge as a harmonic analyzer" *Jour. Opt. Soc. Am. and Rev. of Sci. Inst.*, 15, No. 3, 163-170; September 1927.



### 3. SENSITIVITY AT MAXIMUM UNDISTORTED POWER OUTPUT

In view of the output power capabilities of present-day broadcast receivers, it is felt desirable to have a test for sensitivity at an output power greater than the Normal Test Output. For this purpose it is suggested that the input radio-frequency voltage necessary to produce maximum undistorted output in the load resistor be determined. The value of output may be determined as described in the preceding section on Overloading of Radio Receivers, or if it is not desired to make this test, that value may be used which is given by the tube manufacturer for the particular output tube and voltage conditions in the receiver. It is realized that this output may not be the maximum undistorted output as defined in part 1 above, but it is felt that some useful information will, nevertheless, be obtained by such a test.

The data obtainable from these measurements should be plotted in the same form as for sensitivity measurements except that the ordinate values should be the radio-frequency input voltages for maximum undistorted output instead of the normal radio-frequency input voltages, and the power output obtained should be noted on the graph sheet.

In cases where the power output varies for the different carrier frequencies, note of this should also be made.

### B. Volume Control Tests of Radio Receivers.

Briefly, the most important of these are:

1. Tests of the effect of the volume control on the sensitivity, selectivity, and fidelity of the radio receiver.
2. Tests of the effect of the radio-frequency field to which the radio receiver is exposed (input signal not subject to the volume control adjustment).

#### 1. TESTS OF THE EFFECT OF THE VOLUME CONTROL ON THE SENSITIVITY, SELECTIVITY, AND FIDELITY OF THE RADIO RECEIVER

##### a. Effect of Volume Control on Sensitivity.

The radio input voltage required to produce Normal Test Output should be measured at various volume control settings. These can be plotted in the form of a graph using percentage of maximum setting of volume control as abscissa, and Normal Radio Input Voltage in microvolts as ordinate. This graph can be plotted on the same type of paper used for selectivity graphs with the logarithmic axis as ordinate. The graph should be taken all the way to the minimum end of

the volume control unless this is impossible with the equipment available. In the latter case the graph should be taken to a radio-frequency input of at least 200,000  $\mu\text{v}$ . This graph can be taken at any one or more of the Standard Test Frequency settings desired, and enough points should be taken to show the graph shape accurately.

b. Effect of Volume Control on Selectivity.

In addition to the usual inverse resonance graphs, a selectivity graph should be taken with a radio-frequency input at resonance of 5000  $\mu\text{v}$ . This signal is to be reduced by means of the volume control until it gives Normal Test Output at the receiver output. One or more such selectivity graphs should be taken at reduced volume control as required in the opinion of the test engineer, and in cases of apparent erratic behavior of the volume control, graphs may be taken at higher values of radio-frequency input voltage.

c. Effect of Volume Control on Fidelity.

In addition to the usual Fidelity graphs, one should be taken with a radio-frequency input of 50,000  $\mu\text{v}$ , with the radio receiver output reduced by means of the volume control to give Normal Test Output at 400 cycles. Such curves should be taken at 600 and 1400 kc, and at other standard test carrier frequencies if thought desirable.

d. Test of Automatic Volume Control Characteristics.

Curves of audio-frequency output against radio-frequency input voltages, modulated 30 per cent at 400 cycles, are taken for several settings of the manual volume control. The radio-frequency input voltages should be varied over a range of at least 100 to 1. The audio-frequency output voltages or currents are plotted as ordinates and the radio-frequency input voltages as abscissas. Logarithmic scales should be used for both ordinates and abscissas.

2. TESTS OF THE EFFECT OF THE RADIO-FREQUENCY FIELD  
TO WHICH THE RADIO RECEIVER IS EXPOSED (INPUT  
SIGNAL NOT SUBJECT TO THE VOLUME-  
CONTROL ADJUSTMENT)

It is intended that this test evaluate the pickup by the radio receiver circuit, of radio-frequency fields through unshielded or poorly shielded coils or wires within the radio receiver, and through the power line in the case of radio receivers deriving part or all of their power supply from that source, under conditions where the volume control is set at minimum. Such a test appears desirable, but the Committee knows of no satisfactory way of making such a test quantitatively at the present time, and recommends that the various labora-

tories keep in mind the need for such a test. If a method is later developed which permits results of a useful quantitative nature to be obtained, it is requested that this be brought to the attention of the Technical Committee on Radio Receivers.

### **C. Test for Hum Produced in Radio Receivers.**

Radio receivers of the type which derive their power from an a-c supply generally produce in the output circuit a certain amount of audio-frequency voltage composed of a combination of various harmonics of the a-c supply frequency and occasionally containing the fundamental. This voltage is commonly called the a-c hum voltage, and this section is intended to outline certain tests for evaluating it.

A measure of the r.m.s. hum voltage across the output terminals of the radio receiver is not an indication of its quantitative effect on the ear, since the audio response characteristics of audio-frequency amplifiers and loud speakers, and of the human ear, cause the higher harmonics of the a-c power supply to result in more sound response from the loud speaker than do the lower harmonics or the fundamental. Therefore it is desirable to evaluate the various harmonic components of the hum voltage in order to obtain a useful conception of the degree of unpleasantness which the hum from a particular radio receiver will create. A simple way of doing this would be to construct a filter network having an attenuation characteristic which would take account of the dropping off in loud speaker response and ear response below 1500 cycles. (It is felt that frequencies above 1500 cycles can be disregarded in the hum measurement.) This network should be connected between the radio receiver output and the output voltmeter. If the voltmeter is calibrated in r.m.s. volts it will then measure the square root of the sum of the squares of the various hum harmonic voltages, each harmonic being attenuated to a percentage of its actual value corresponding to its importance from the point of view of the loud speaker and ear response characteristics. Thus, a single voltage measurement is made to give a measure of the degree of unpleasantness which the hum from a particular radio receiver would create with an average loud speaker. From this voltage measurement and the value of the radio receiver output resistance the hum power should be calculated.

While the ear characteristic is fairly well known, the preparation of a network which would include the response characteristic of an average loud speaker would, of course, necessitate the measurement of all the loud speakers upon the market at the present time and for some time past. It would also require the use of sound measuring equip-

ment and measurement conditions whose absolute accuracy has been proved. These requirements are impossible of complete realization at the present time, but it is felt that some valuable experience in the field of hum measurement can be obtained by the adoption of an arbitrary network, having characteristics which appear, in light of present

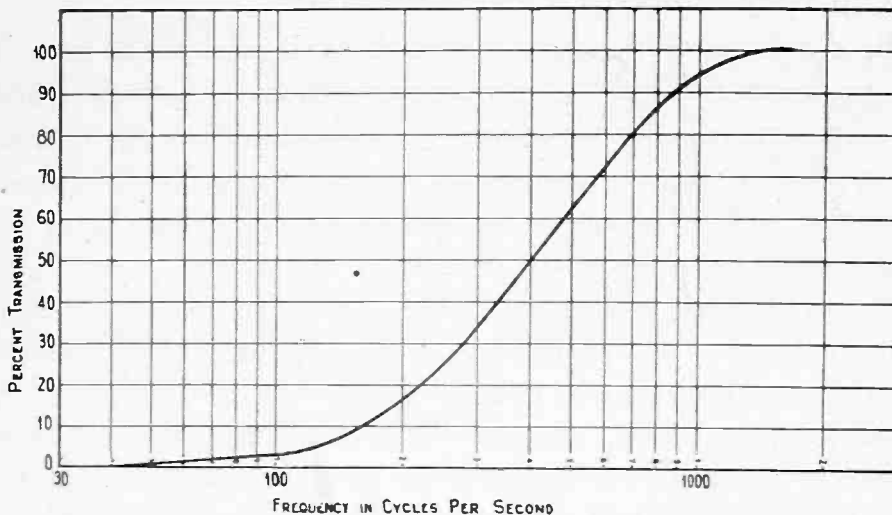
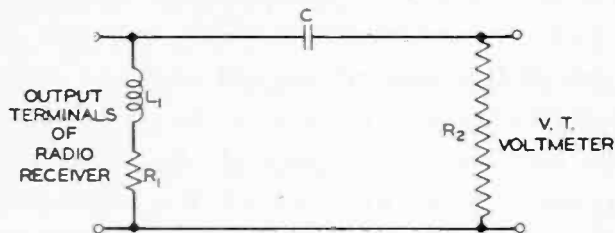

Fig. 6—Possible attenuation characteristic of arbitrary network for use in hum measurement.

knowledge, to be of the general order of magnitude of the frequency attenuation factors involved, and to approximate an average loud-speaker characteristic. A possible attenuation characteristic for such a network is shown in Fig. 6, and a network having approximately this characteristic is shown in Fig. 7.



$$\begin{aligned}
 L_1 &= 0.9 \\
 R_1 &= 180 \text{ ohms (including } R_{eff.} \text{ of } L_1) \\
 R_2 &= R_p \text{ of output tube} \\
 C &= 0.045 \mu\text{f for } 5000 \text{ ohm } R_2 \\
 C &= 0.065 \mu\text{f for } 2000 \text{ ohm } R_2
 \end{aligned}$$

Fig. 7—Network intended to approximate an average loud-speaker characteristic.

It should be emphasized that the graph of Fig. 6 is not intended to include an accurate representation of an average loud speaker frequency response characteristic. The network characteristic is only tentative, and has been prepared as a guide for those desiring to make investigations in the field of hum measurement.

Other conditions which must be considered in connection with the measurement of hum from a radio receiver are:

1. Use of an a-c power supply having known and definitely limited harmonic characteristics.

2. Adjustment of any devices provided on the receiver for hum regulation, such as filament mid-tap potentiometers, for minimum hum.

In connection with condition 1 above, it is suggested that use be made of the differential distortion factor circuit, which has been used in the past in the electrical art in evaluating the harmonic content of

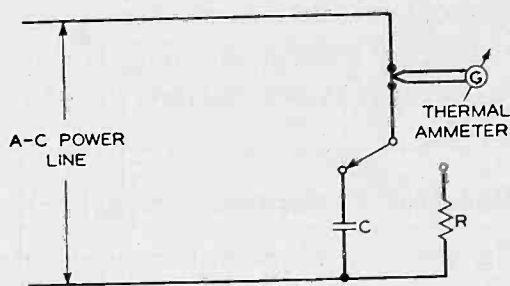

Fig. 8—Differential distortion factor circuit.

a-c power supplies. The circuit is shown in Fig. 8. The constants of the circuit are governed by the relation

$$R = \frac{1}{2\pi fC} \quad (9)$$

where  $f$  is the fundamental frequency of the a-c line. The value of  $R$  can be chosen to suit the particular thermocouple meter available. The resistance of the thermocouple should be, of course, small compared with  $R$ .

The differential distortion factor is then given by the following relation

$$d.d.f. = \frac{I_c}{I_r} \quad (10)$$

where  $I_c$  is current through the condenser and  $I_r$  is current through the resistor.

It is recommended tentatively, in making measurements of hum on a-c radio receivers, that the power supply have a differential distortion factor not greater than 1.05.

It should be noted that in some radio receivers, more hum will be produced when a carrier is tuned in. On this account it is necessary to measure the hum under two conditions of the radio receiver unless only the value of the worst hum condition is desired, in which case that one of the following receiver adjustment conditions should be used which gives the greater hum:

a. No incoming carrier frequency and no other voltages such as static, induction, etc., in the output circuit. In radio receivers where the position of the volume control does not affect the hum (with no incoming carrier), the last condition may be most easily complied with by setting the volume control to zero.

b. With an incoming unmodulated carrier having a radio-frequency input of 50,000  $\mu$ v impressed on the radio receiver input circuit, and with the volume control so set that, were the incoming carrier to be modulated 30 per cent at 400 cycles, it would give normal output power in the radio receiver output circuit. Here, as in condition a, static and induction voltages in the output voltage should be reduced to a negligible percentage.

## VI. Receiver Performance Graph Sheets

In an engineering analysis of general trends in receiver design and performance, it is necessary to consider data on a large number of receiver designs, and on a large number of particular receivers of each design, for it is well known that the performance of a random sample of a type of receiver may be far from representative of the type as a whole. In order to facilitate such analyses, and to aid in the evaluation of a particular design relative to the field, the Receiver Performance Graph Sheets to be described below were developed. They have been found so helpful by those who have used them in experimental forms that in more finished form, as prepared by the I.R.E. Technical Committee on Radio Receivers, they are here published for the information of the membership. It is hoped that they will be found useful and freely used. The Committee will welcome any comments or suggestions of the members relative to their improvement.

Great accuracy is not usually justified in plotting typical or average characteristic curves, for large probable errors are inherent in a determination of what is typical or average from the relatively small quantity of data which are usually available. And furthermore, the usefulness of the sheet as a summary for frequent reference would be decreased by including too much detail. Therefore, in the form shown in Fig. 9, advantage has been taken of these facts by making the sheet small—standard Lefax size,  $3\frac{3}{4}$  in.  $\times$   $6\frac{3}{4}$  in.—thus gaining the utmost in compactness without sacrifice of needed accuracy.

Curves plotted on this sheet may be easily read to an accuracy of 5 per cent, which should prove sufficient for the original record of many receiver tests which are made with test equipment not of the highest order of accuracy, or which are rapidly made when great accuracy is not required. However, this small sheet has been designed with the

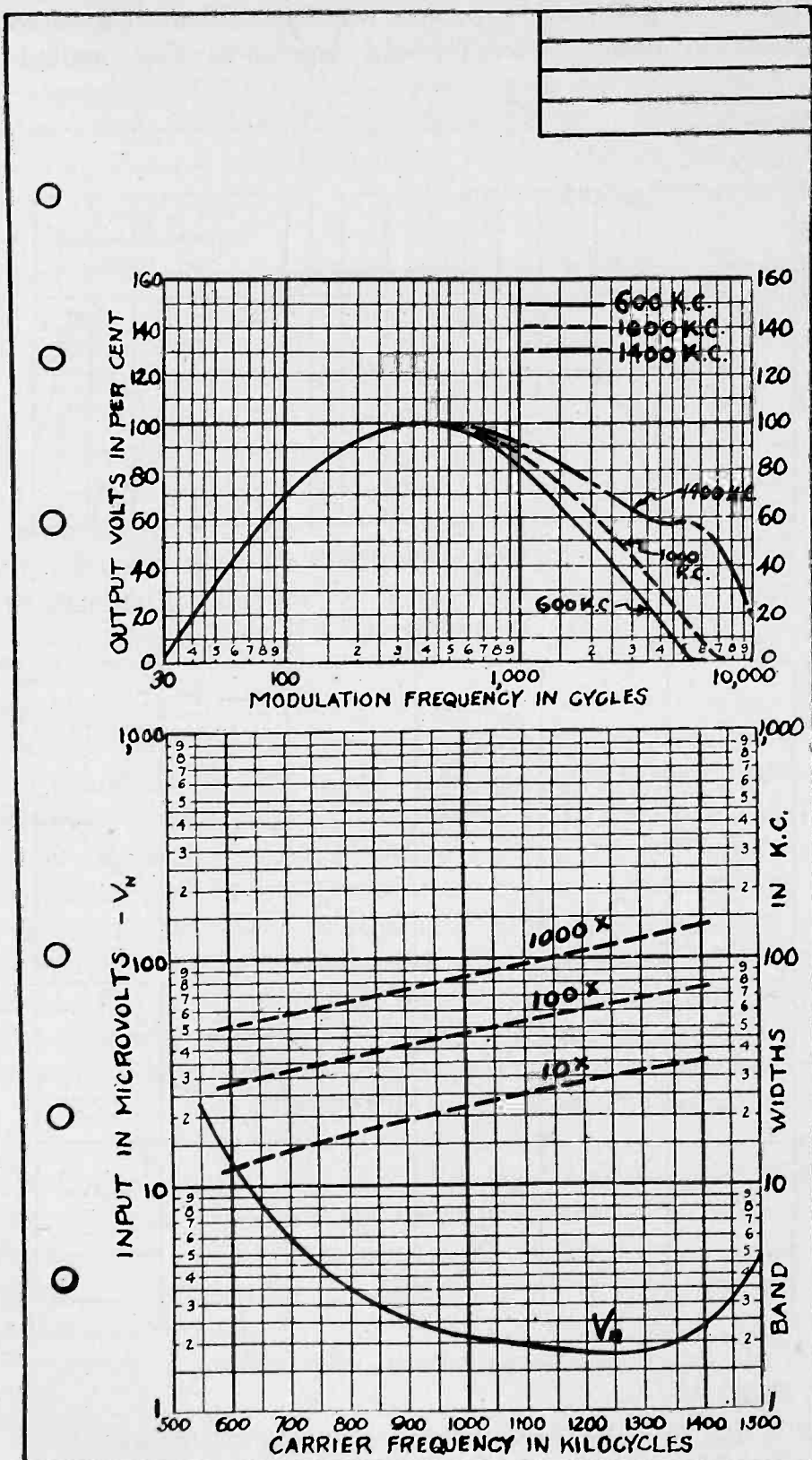

Fig. 9—Receiver performance graph sheet. (Full size)

principal object in view of providing a means of recording average or typical data in summary form for ready reference. Tests made to dis-

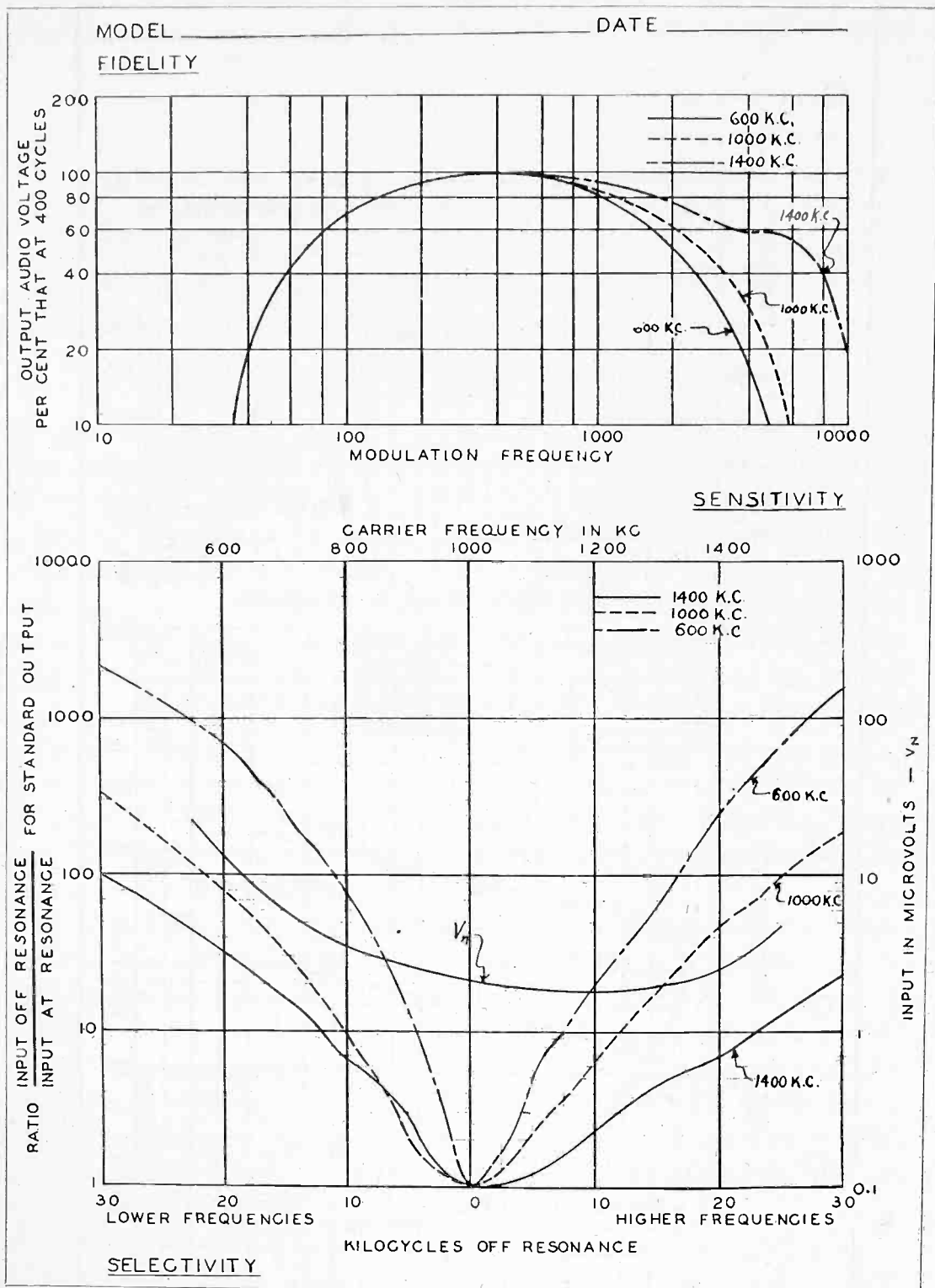

Fig. 10—Receiver performance graph sheet. (Half size)

close small differences in individual receivers, or to discover errors or defects, should be recorded in other ways more suitable for such tests.



The sheet consists of two ruled sections, one with logarithmic abscissas and linear ordinates, for fidelity curves, and the other with linear abscissas and logarithmic ordinates, upon which may be recorded sensitivity and band-width (selectivity) curves. The scales are all properly marked and are so chosen as to be universal, that is, they will be suitable for practically any present or contemplated broadcast receiver, without change.

The use of universal scales is considered essential so that different receivers may be compared at a glance by noting the shape and location of their characteristic curves on the standard sheet, without the necessity of translating the curves back into figures. This requirement necessitates—if undue loss of accuracy is to be avoided—the plotting of the selectivity characteristic by means of the band width, derived from the inverse resonance curves (or measured directly) instead of the inverse resonance curves. It is obvious that to cover all types of receivers, a logarithmic scale for sensitivity and band width is required. Linear ordinates for the fidelity curves are chosen because, on a small sheet, they indicate with greater accuracy the essential fidelity characteristics.

Space has been left at the top of the sheet for a title and any general memoranda which may be desirable. The standard Lefax index ruling may be included in the upper right-hand corner of the sheet, if desired, subject to any legal restrictions there may be to the use of this ruling. The figure shows the proposed sheet, full size, upon which have been plotted, for the purpose of illustration, the basic characteristics of a receiver; sensitivity; band widths at 10, 100, and 1000 times Normal Radio Input Voltage at resonance; and fidelity, measured at the three standard test frequencies of 600, 1000 and 1400 kc per sec.

For those who prefer to plot complete selectivity curves, instead of band-width data, a different form has been prepared, and is shown in Fig. 10. This form is designed for standard letter size paper,  $8\frac{1}{2}$  in.  $\times$  11 in.

The lower part of the form provides for plotting complete selectivity curves, and also provides for a sensitivity curve. As in the smaller form, the upper section of the form is for fidelity curves. Logarithmic ordinates are provided for the fidelity curves, as many engineers consider these show the fidelity more nearly as it sounds.

The curves plotted on Fig. 10 are from the same data as those on Fig. 9.

These forms have been prepared in accordance with the revision of the Standard Tests of Broadcast Radio Receivers, as found on the preceding pages.

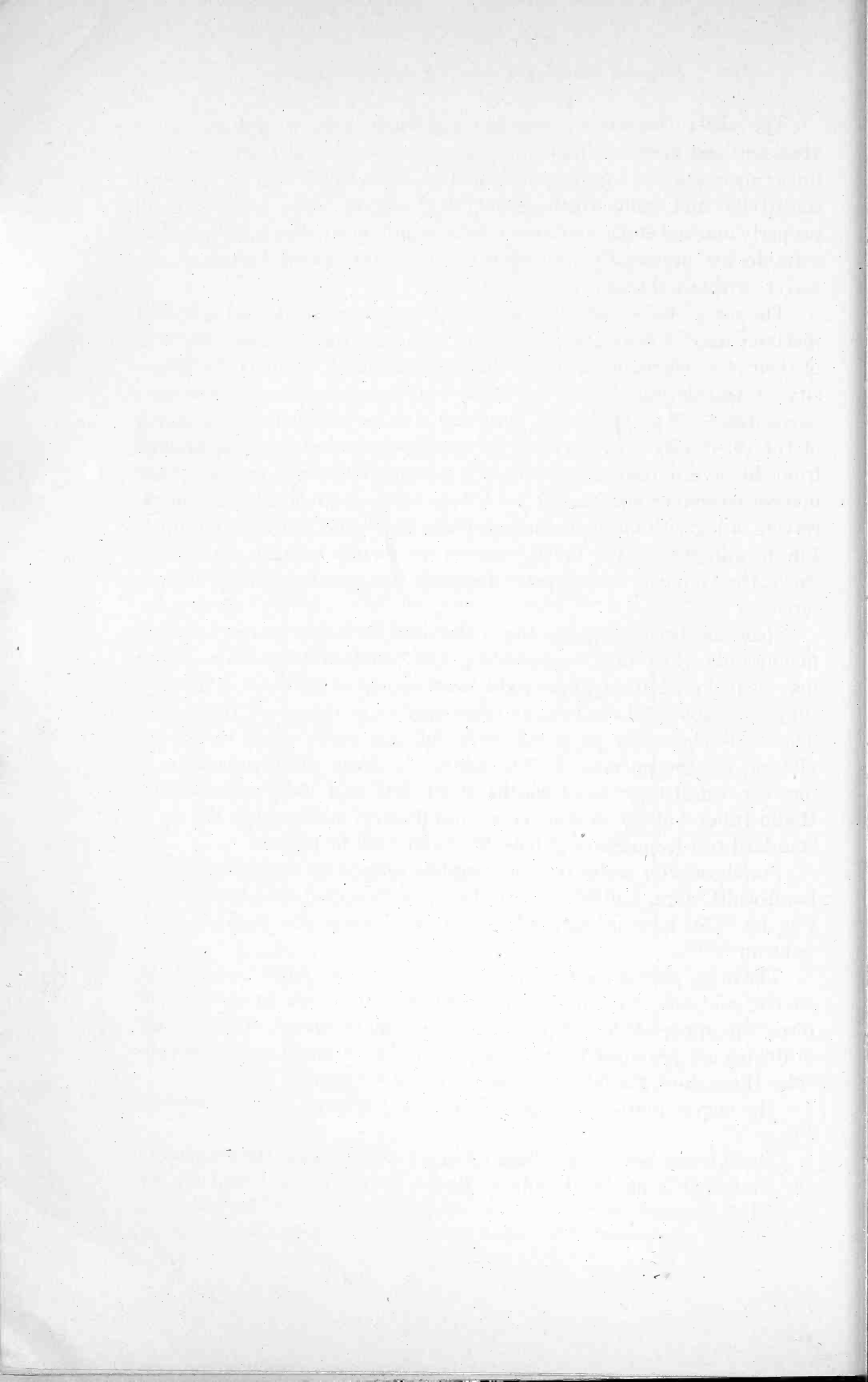

PART II

TECHNICAL PAPERS

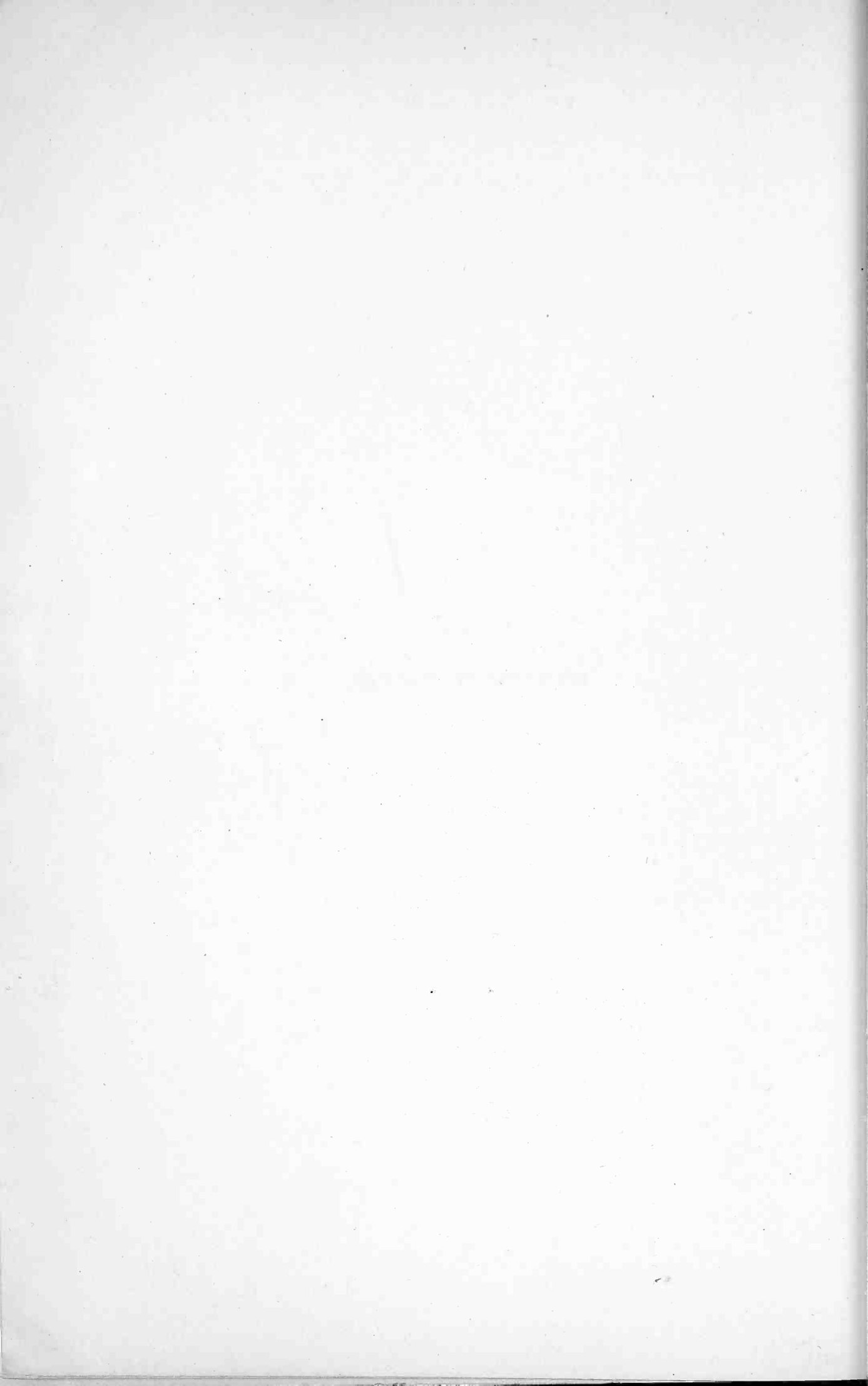

## PROPERTIES AND APPLICATIONS OF MYCALEX TO RADIO APPARATUS\*

BY

W. W. BROWN

(General Electric Company, Schenectady, N. Y.)

### Materials and Processes

**M**YCALEX is a molded insulation having properties which make it particularly suitable for radio applications.

The materials from which it is formed are ground mica and lead borate. The mixture is heated to the softening point of lead borate (approximately 675 deg. C), and the mass compressed while plastic. The moldings are cooled under compression and removed when the lead-borate binder has solidified and firmly cemented the mass together.

The material is molded under pressure of approximately 10,000 pounds per square inch. This high pressure, combined with the high molding temperature (approximately 500 deg. C) requires relatively complicated and expensive molds. For these reasons, the moldings available are of such sizes and shapes that they may be used in a wide range of applications. Moldings used to greatest extent for general applications are:

Slabs—2 1/4 in. wide, 12 in. long, and any thickness between 1/4 and 1 in.

Slabs—1 in. wide, 12 in. long, and any thickness between 1/8 and 1 in.

Rods—octagonal, 7/8 in. diameter by 12 in. long.

Rods—octagonal, 1 3/8 in. diameter by 12 in. long.

Special sizes and shapes are obtained either by machining standard moldings or by special molds. To produce from standard moldings, the material may be sawed, turned, drilled, ground, or polished. Carborundum wheels are used for sawing and grinding and tungsten-carbide alloy tools for turning and drilling. Although the material may be machined by methods similar to machining marble, using ordinary tool steel, these operations are greatly improved by the use of harder tools. Special and intricate moldings are produced in special molds when the quantity required justifies the cost of the molds.

### Properties

The table shown in Fig. 1 shows comparative properties of Mycalex porcelain, fused quartz, and glass.

\* Dewey decimal classification: R281.2. Original manuscript received by the Institute, February 19, 1930.

The properties of mycalex which make it particularly suitable for radio application are low dielectric loss, high dielectric strength, high tensile strength, and high resiliency.

These properties, in combination, are found in Mycalex in a higher degree than in any other one material. This accounts for the rapid increase in applications of this material in radio apparatus, particularly transmitters.

FIG. 1—PROPERTIES OF DIELECTRICS

ELECTRICAL	Electrical Glass	Transparent Fused Quartz	Porcelain	Mycalex
Dielectric Constant (K) (ASTM) Test Method 100,000 cycles	5.7	4.2	7.0	8.0
Power Factor % (ASTM) Test Method 100,000 Cycles	.4	.02	.7	.2
Phase Angle—Minutes	130	6.9	240	69
Loss Factor—Power Factor $\times K$	220	.084	4.9	1.6
Dielectric Strength—Volts: Thickness $\frac{1}{2}$ inch, Electrodes —1", spherical Frequency 60 cycles		100,000	90,000	120,000
MECHANICAL				
Compressive Strength—lbs./sq. in.		200,000	55,000	25,000
Tensile Strength—lbs./sq. in.		8,000	6,000	8,000
Transverse Strength (Modulus of Capture)			11,000	16,000
Resistance to Impact (ASTM) Test Method			.23	.48

The relatively low dielectric loss, (Fig. 1), which was measured at 100,000 cycles, was found to exist in practically the same relations at 6,000,000 cycles. This is shown by heating data. (Fig.2.) This lowloss factor is one of the main advantages of the material for radio applications.

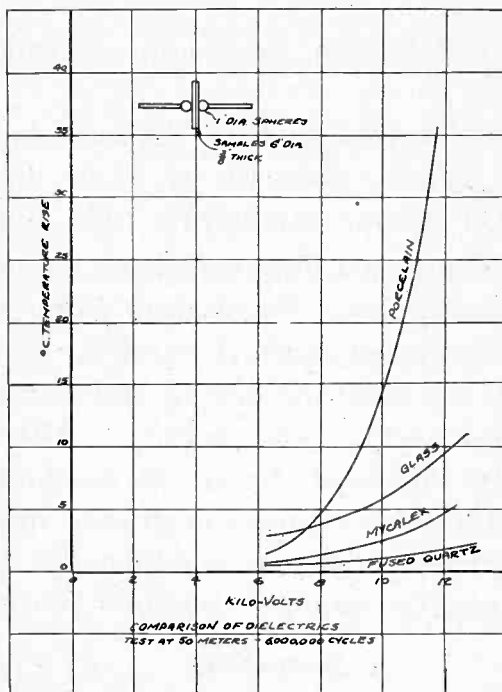

Fig. 2

The high transverse strength and exceptionally high resiliency enable the using of proportions for radio insulators far more advantageous than is possible with any other available material. It is essential in proportioning insulators for radio frequencies to provide

low flux density in the dielectric. This requires insulators long and slender and also in some cases electrostatic shields. Rods 3/4 in. in diameter and 12 in. long approach the ideal in electrical respects and mechanically are entirely practical. There is no other known material that would provide these features to the same degree.

The surface of Mycalex is highly resistant to arcing. Continued arcing along the surface produces a path of fused lead borate, similar in appearance to glass. This path is only on the surface and when scraped off leaves the surface without permanent injury. The material does not crack or burn beneath the surface as most other available insulating materials do.

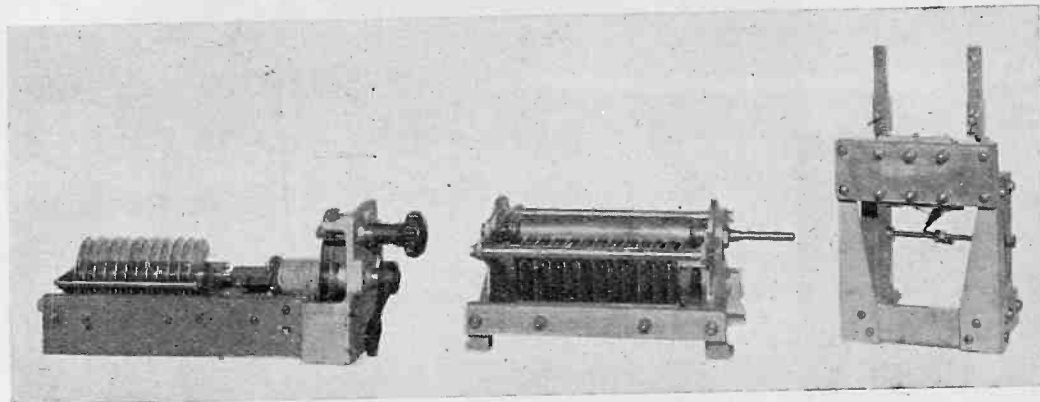

Fig. 3—Mycalex applications.

Although the material is practically nonhygroscopic, the surface as molded is not as smooth as glaze on porcelain. For outdoor applications, therefore, the moldings are ground or otherwise polished, producing a surface comparable with glaze. The surface as molded is entirely satisfactory for indoor application.

#### Indoor Applications

Figs. 3 to 8 inclusive show Mycalex as used in typical component units of transmitters.

Figs. 9 to 12 inclusive show applications in assembled sets.

#### Outdoor Applications

Fig. 13 shows three sizes of antenna insulators used extensively for short-wave antennas. The small, 3/4-in. diameter, insulators are tested in tension at 2000 pounds. Flashover dry of the short insulator is 50 kv at 60 cycles and of the long insulator, 82 kv. The large, 1 1/4 in. diameter, insulator is tested in tension at 5000 pounds and flashover is 70 kv.

These insulators in appreciable quantities have been in use for several years at the developmental radio stations of the General Electric Company at South Schenectady, N. Y., and Oakland, Calif. Although the surface appearance of the insulators has changed slightly

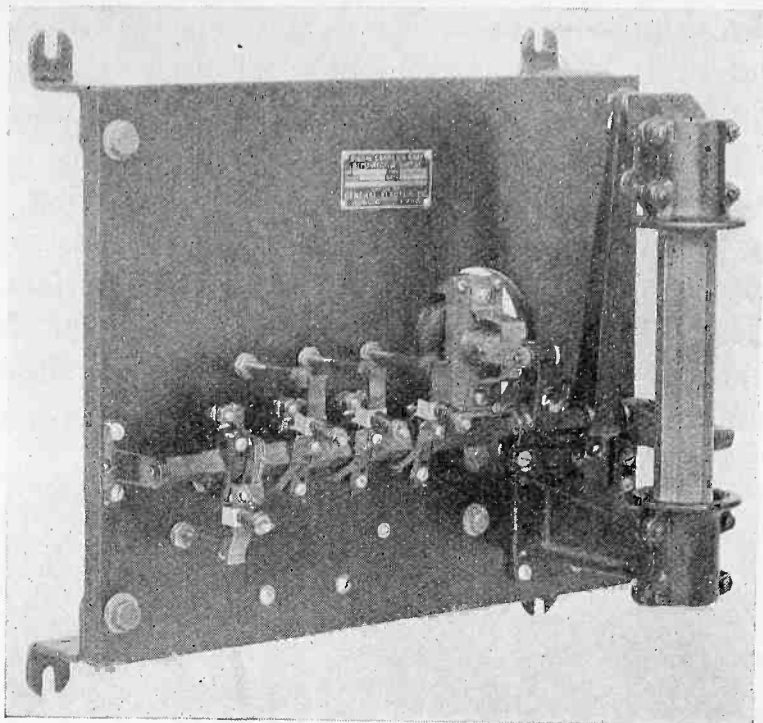

Fig. 4.—Magnetic send receive switch.

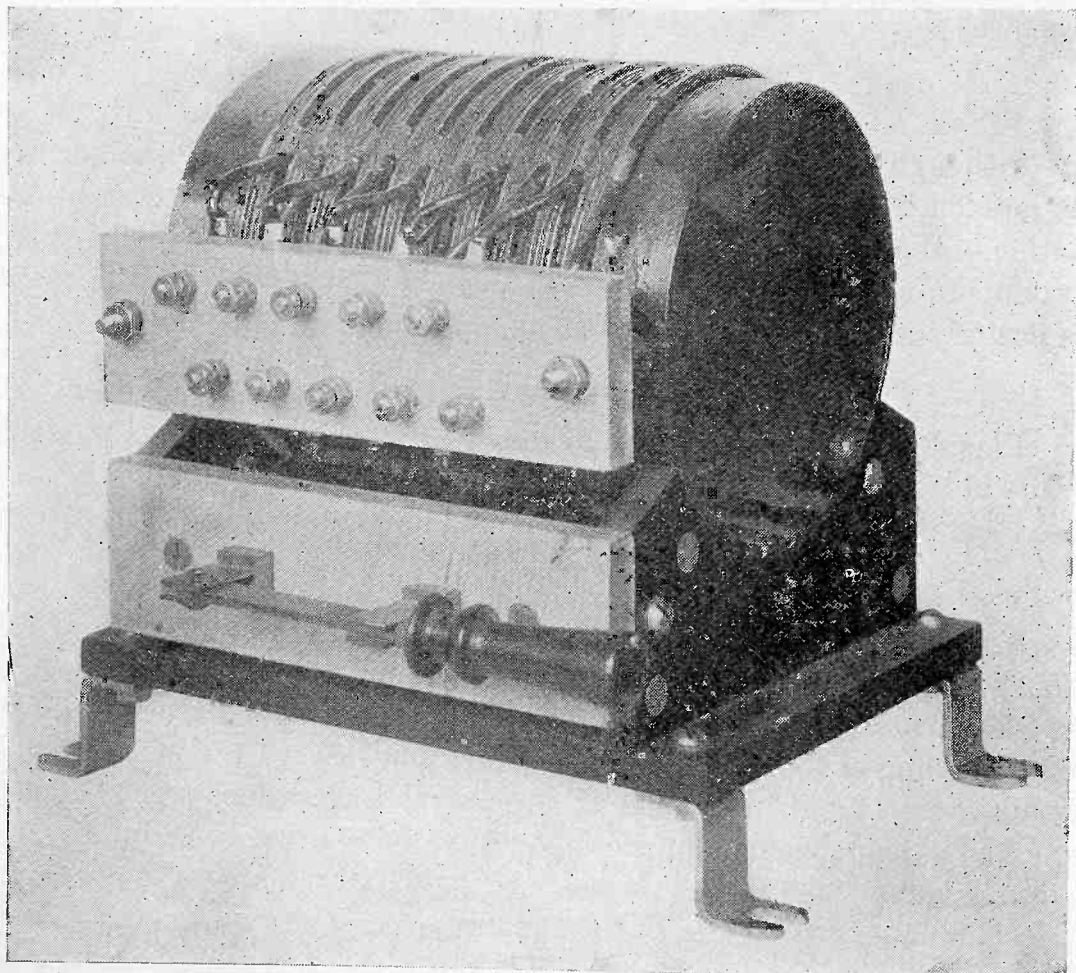

Fig. 5.—Loading coil.



during this period, on account of weathering effects, their properties apparently have not changed as they are still performing in an entirely satisfactory manner.

### Performance

Mycalex is being widely used by the Radio Corporation of America and the United States government in their various departments, mainly in transmitters, and to a less extent in antenna insulation. These applications include practically all classes and sizes of trans-

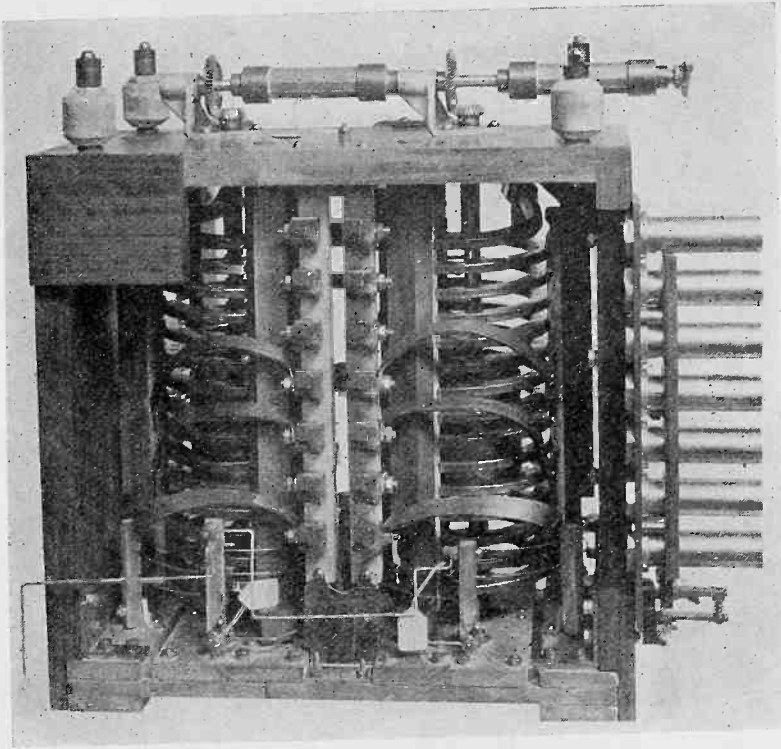

Fig. 6—Power-amplifier-tank inductor for 5-kw transmitter type. Side view showing plug-in switch mechanism.

mitters, and cover practically the entire range of operating frequencies. The material has proved uniformly satisfactory in these applications.

### Relative Costs

Although the cost per pound of Mycalex is considerably higher than the cost of porcelain, the smaller quantity which may be used for a given insulator brings the unit costs to a comparable basis. This condition is further brought about by the fact that the fittings may be molded in or around the Mycalex, thereby avoiding the additional expense of cementing or otherwise attaching the fittings to porcelain and similar insulators.

### Conclusions

Since 1925, when this insulating material became available for general use in radio transmitters, its application has rapidly increased to very considerable proportions. This has resulted in improving trans-

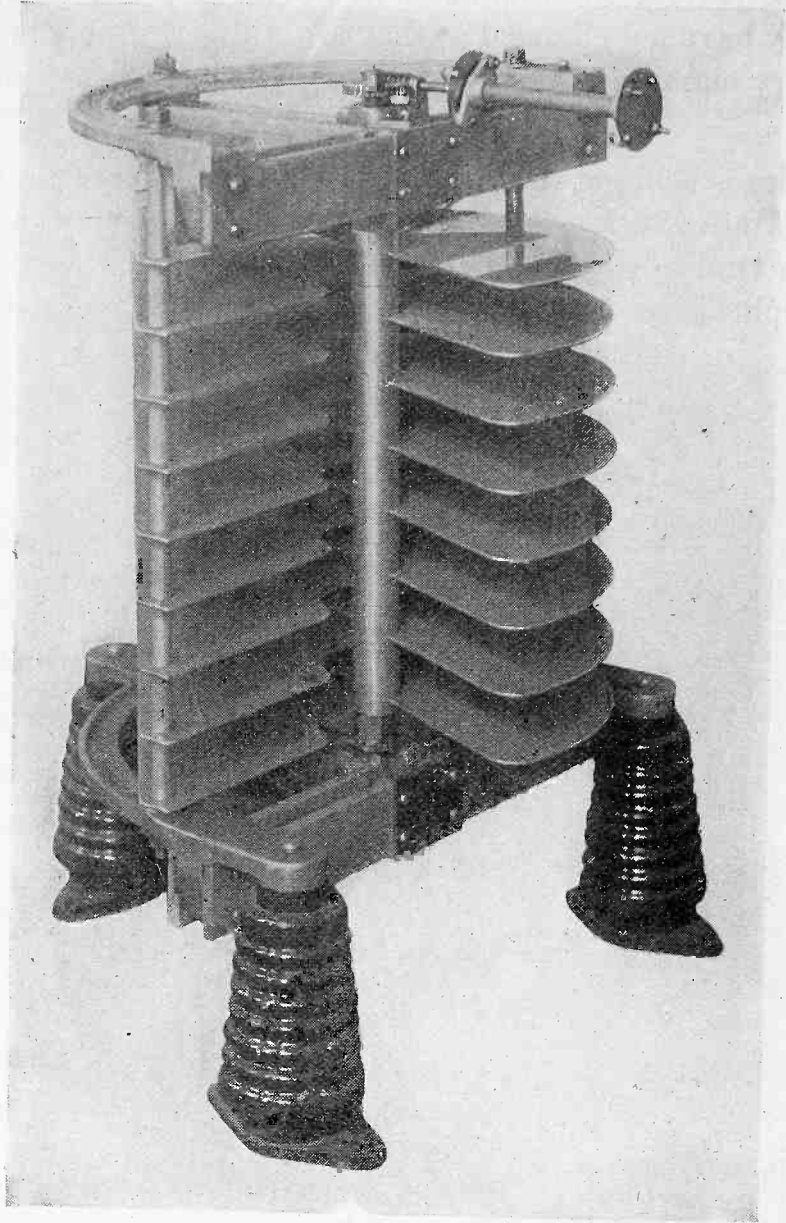

Fig. 7—Motor operated variable condenser.

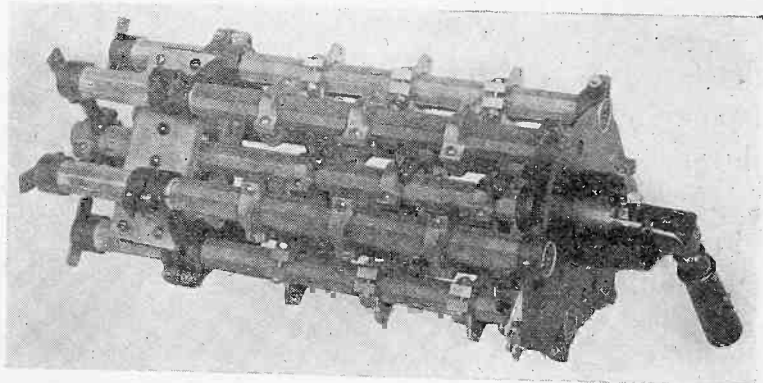

Fig. 8—High-frequency gang switch.

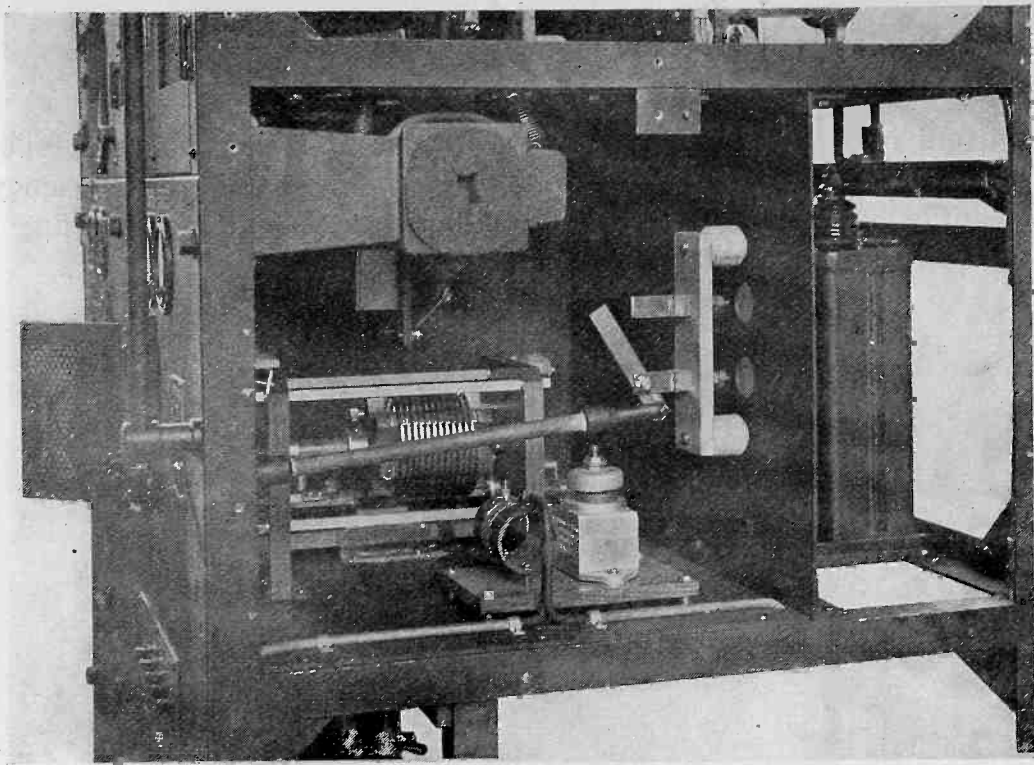

Fig. 9—Mycalex applications.

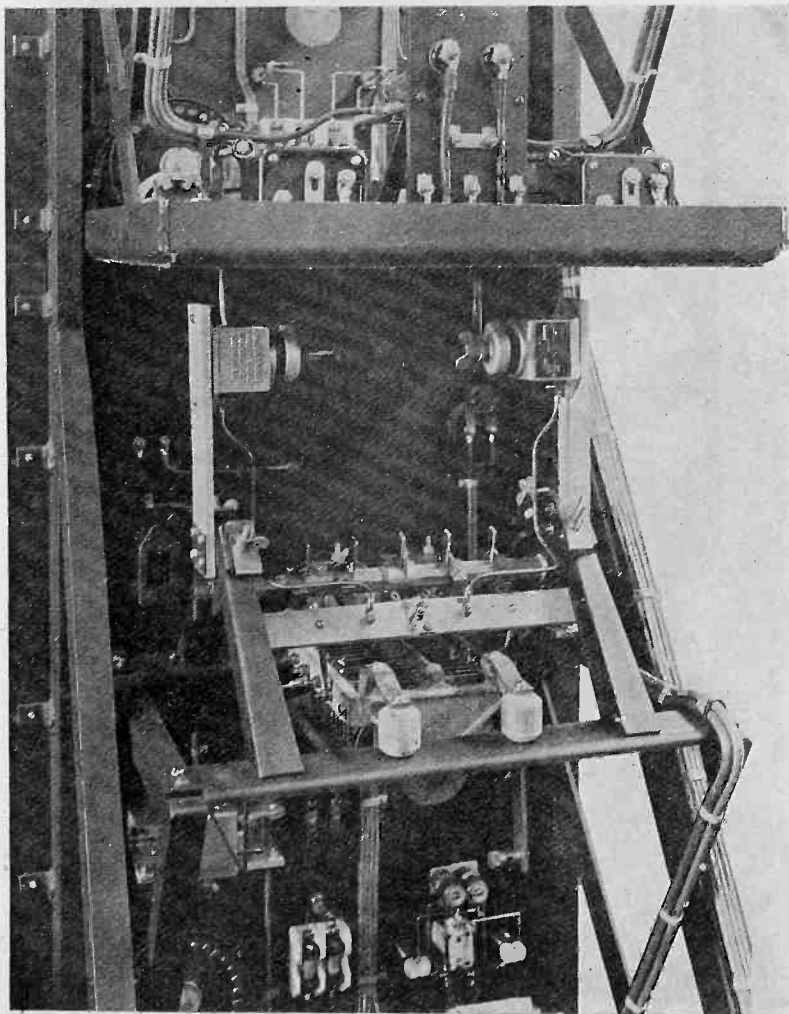

Fig. 10—Mycalex applications.

mitters in general, particularly broadcast and short-wave sets by reducing the internal losses and thereby increasing the efficiency. Possibly of greater importance is the improvement of providing a

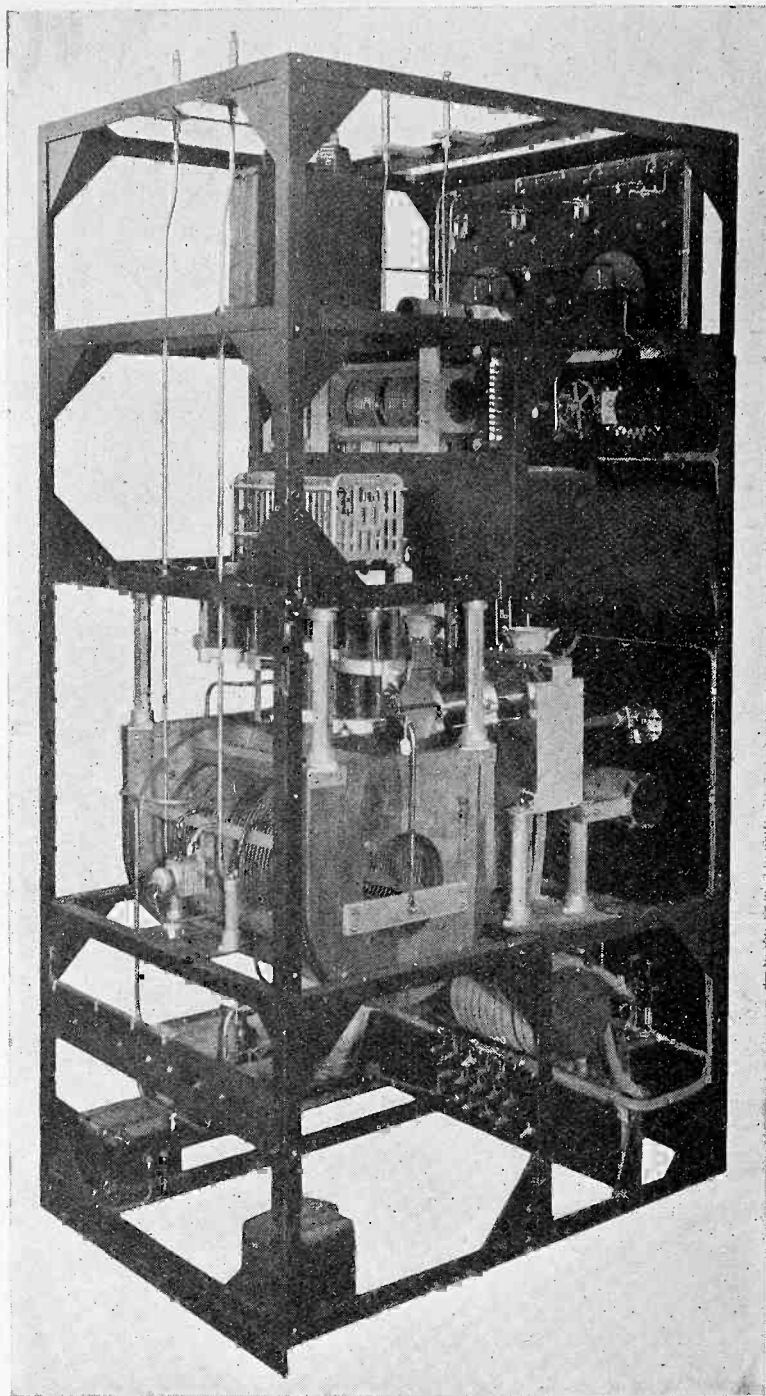

Fig. 11—Intermediate power amplifier.

dependable insulation. Interruptions of service due to failure of Mycalex are practically negligible.

The writer is indebted to L. J. Cavanaugh of the Insulation Engineering Department of the General Electric Company for data on properties of dielectrics included in this article.

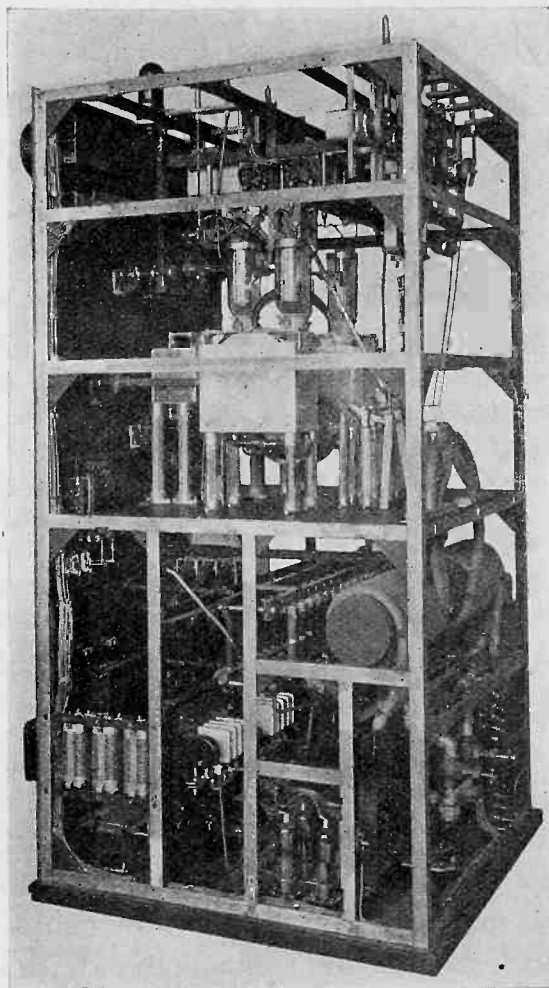

Fig. 12—Power amplifier, shield removed. Side view.

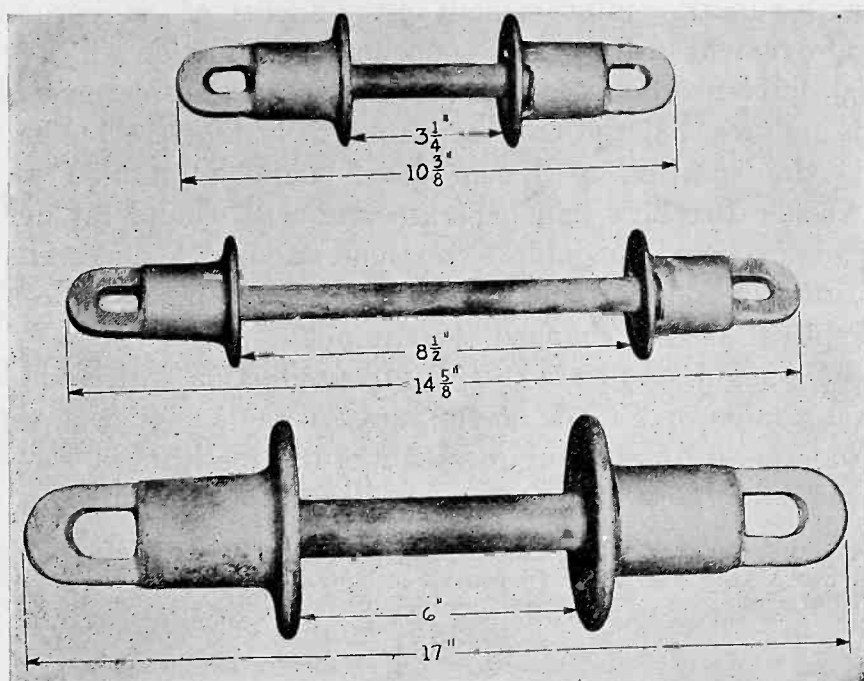

Fig. 13—Mycalex antenna insulators with aluminum alloy and fittings.

## A COMPARISON OF THE ENGINEERING PROBLEMS IN BROADCASTING AND AUDIBLE PICTURES\*

BY

PORTER H. EVANS

(Chief Engineer, Eastern Studios, Warner Brothers-Vitaphone Corporation, Brooklyn, N. Y.)

*Summary*—Attention is called to the principal difference between the present success of audible pictures and the failures which preceded it. The similarities and differences between broadcasting and audible pictures are pointed out. This includes a comparison of the installations, a comparison of the pickup and reproduction conditions, etc. Some of the advantages of disk recording are pointed out. Measurements of the acoustical characteristics of recording stages and theaters are given, as well as system frequency characteristics. The factors limiting the frequency range on disk recording are discussed. Some of the problems in sound editing are mentioned and the elements in greatest need of improvement are pointed out.

### INTRODUCTION

WHEN Warner Brothers decided to experiment with audible pictures, it was very doubtful whether the public would welcome the innovation. Those who experimented with the idea in the laboratory were fascinated and intrigued by the possibilities it seemed to open up. But for forty years everyone who attempted to interest the public in them had lost large sums of money. With the development of the vacuum tube, the vacuum-tube amplifier, a new type of microphone and a better loud speaker, sounds could be picked up and reproduced with a marked improvement in the fidelity of the reproduction. This improvement in the quality of sound reproduction which was the principal difference between this attempt at talking pictures and the previous failures, led the engineers to believe that the public would welcome the addition of synchronized sound to motion pictures. After Warner Brothers had experimented with sound for over two years, had developed the public's reactions, and had demonstrated that the addition of sound would be welcome, the other producers who were skeptical at first changed their minds.

In the general stampede to get into production with audible pictures many raids were made on the ranks of radio engineers, with the result that we now find many members of the Institute in the picture business and doubtless many more considering the change. As a result

\* Dewey decimal classification: 621.385. Original manuscript received by the Institute March 29, 1930. Presented at New York meeting of the Institute, April 2, 1930.

it seems quite appropriate that the Institute should consider some of the problems of the sound engineer in the picture business.

Comparing broadcasting with audible pictures, one notes many striking similarities and many outstanding differences in the equipment used and the practices followed.

In both, the sound is picked up in an acoustically-treated room and converted into electric currents of audio frequency by microphones whose outputs are blended together and then amplified for transmission on a carrier in an inaudible form. At the receiving end, after being restored to electric currents of audio frequency, the results are amplified and then converted back into sound and projected by means of loud speakers.

If it were not for the motion-picture camera the principal difference between the two would be in the carrier and hence in the time of transmission. In the case of broadcasting the sound is carried from the broadcast studio to the home by an electromagnetic wave. In the case of audible pictures it is carried from the picture studio to the theatre by a phonograph disk or a film sound track. In the former case the transmission is almost instantaneous; in the latter case it may be stored anywhere from a few hours to many years, or generations.

Fig. 1 illustrates diagrammatically the two transmission systems. In addition to the similarities and differences noted above, it will be observed that the modulator in the broadcasting transmitter has been replaced by the recorder on the recording machine, and the detector in the radio receiver has its counter part in the reproducer in the projection booth. In other words, broadcast and audible-picture systems are very similar if we substitute for the radio part of the broadcast system, the recording and reproducing part of the audible-picture system.

The motion-picture camera, however, creates enormous differences in the pickup and the reproduction conditions. In the picture studio the microphone must be kept out of the camera field and the camera noise must be kept away from the microphone. This greatly complicates the pickup problem. In the theater the sound must be reproduced synchronously with the picture. This imposes a synchronizing problem on the recording. In other words, the camera and recording machine in the studio must progress together in identically the same manner as the turntable and projector in the projection booth. In order to give maximum flexibility and mobility to the camera an electrical interlock is used in recording. It is then a simple problem to add more cameras and recording machines. The addition of the former permits photographing at several different camera angles without the loss of syn-

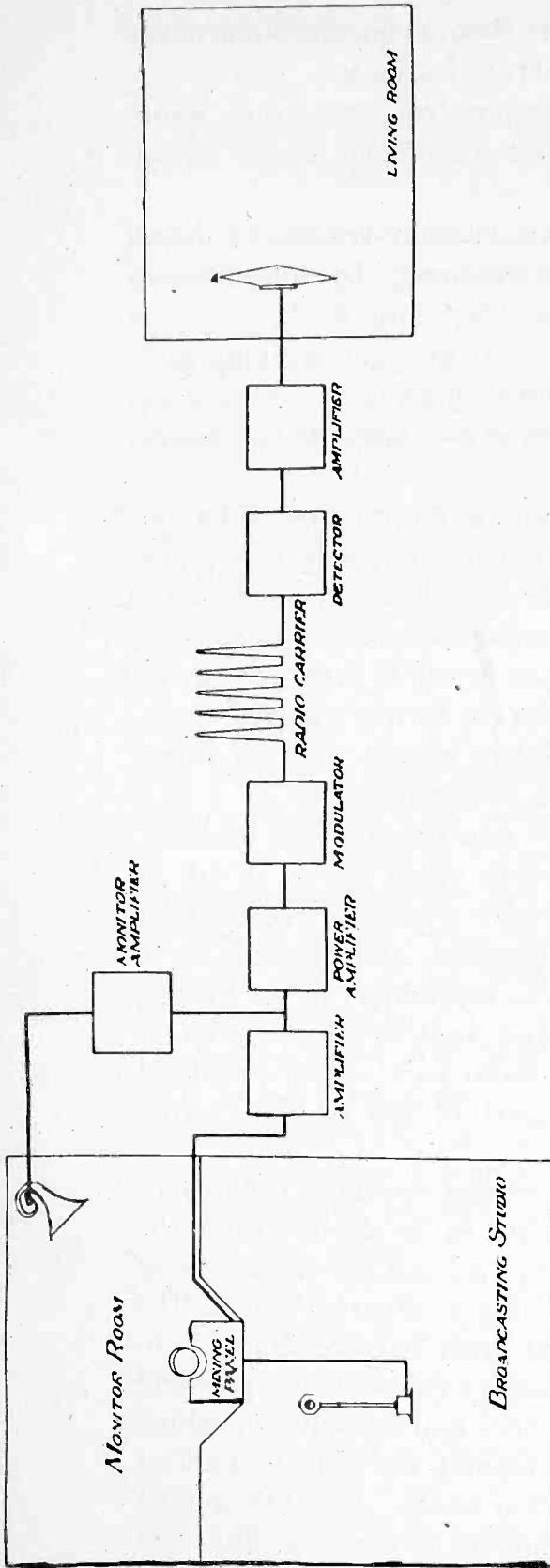

*RADIO BROADCASTING SYSTEM*

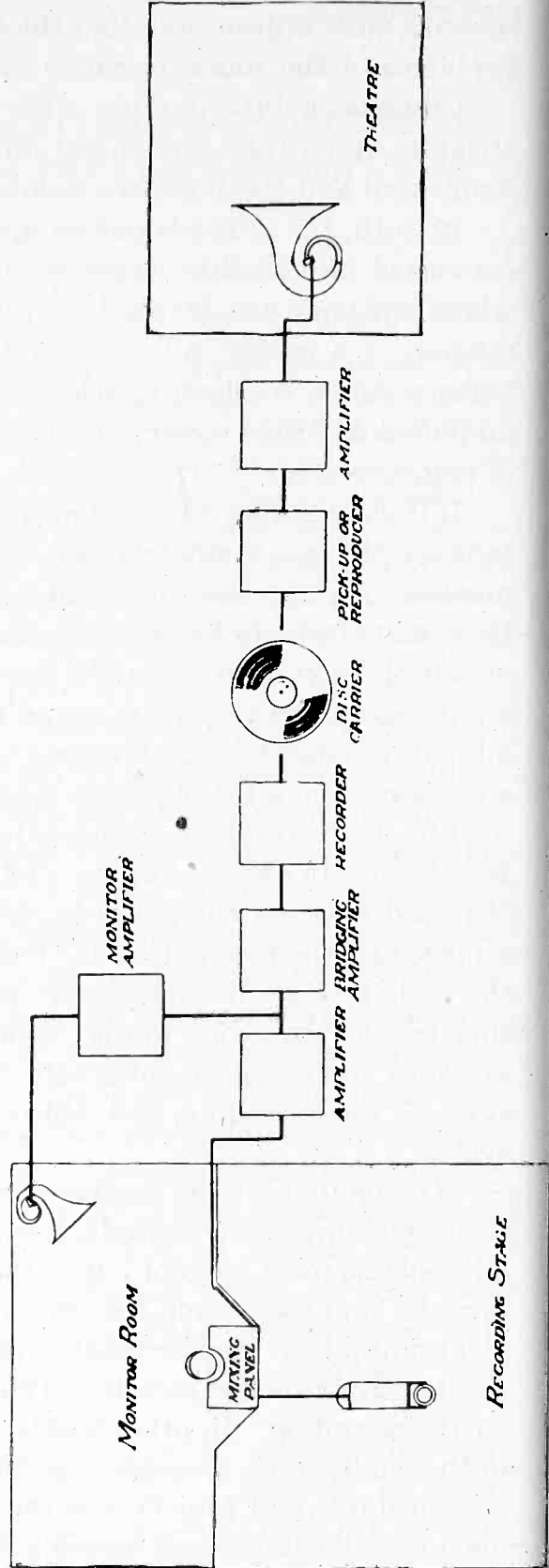



chronization or the necessity of stopping and repeating the action, and the addition of recording machines permits the making of duplicate records, one for a play-back, one for release, and one as insurance against loss. It also permits simultaneous recording on film and wax.

In the projection booth a mechanical interlock is used as there is no hardship in placing the turntable and projector adjacent to each other and there is never any need for more than one of each being used at the same time.

In recording sound for talking pictures, the Vitaphone Corporation uses Western Electric sound-recording equipment. Inasmuch as most of this equipment has been described by representatives of companies affiliated with them in a series of papers which have been presented before various engineering and scientific societies we shall not consume time here in detailed discussion of this equipment. The equipment we use is essentially the same as that used by all other producers recording under Western Electric licenses and does not permit of much variation or originality in its installation.

On the reproducing end, however, there is a wide variety of equipment. Much originality has been shown by the large number of companies who have been attracted to this business by the inability of exhibitors to secure prompt delivery on reproducing equipment. But here again we shall refrain from detailed discussion of apparatus, leaving that to the various manufacturers concerned, and confine ourselves to the operating problems which face the producer and exhibitor,—that is, to the problem of transmitting the best possible sound with the equipment available at present—and in addition, pointing out some of the things that are badly in need of improvement.

Before proceeding with that part of the paper let us point out that next to a good frequency characteristic the most difficult problem is the maintenance of a sufficiently uniform speed in recording and reproducing, that is, the elimination of hunting in the motor, speed irregularities due to gears, and the variation of load caused by the intermittent motion which advances the film in the camera and projector.

In the recording and reproduction of music any change in speed will affect the pitch of the musical tones, and when these changes are sudden or follow each other in rapid succession they are particularly noticeable and objectionable. To musicians, who have what is known as an absolute pitch ear, changes in speed of less than 1/2 of one per cent are readily noticed. Fluctuation in speed of 1/10 of one per cent or less seem to be satisfactory, however. When audible pictures were first exhibited, the public seemed to think that synchronism be-

tween sound and pictures was the key to success. This, however, was one of the easiest problems.

The difficult problem and the thing that distinguishes previous failures from the present success has been pleasing reproduction which involves a good frequency characteristic and exceptionally uniform speed. The latter still requires improvement in film reproduction.

#### INSTALLATION

Let us now briefly consider the installation problem. Here we find little difference between the requirements for broadcasting and sound pictures. In fact, the installation of recording and reproducing amplifiers and of all speech wiring follows precisely the practice developed for broadcasting. The amplifiers are mounted on relay racks and connected by twin lead wire pulled in rigid conduit. The former is required to give electrostatic shielding, the latter for mechanical protection. While the latter gives a magnetic shielding where required, it is not a satisfactory electrostatic shield.

The author describes here some of the salient characteristics of the recording installation at Warner's Eastern Studio.

In order to simplify installation and operation, we have departed from the practice originally suggested of installing all amplifying equipment at one central point and have adopted in its place the practice of locating the bridging amplifiers in the recording room and associating them thru normal jacks with specific recording machines. These amplifiers are driven from a bus, known as the recording bus, which is energized in turn by the stage amplifiers where the pickup occurs. This recording bus is operated at approximately zero level.

All amplifiers ahead of the bridging bus as well as all monitoring amplifiers are located in the monitor booth under the control of the monitor man.

No duplicate or stand-by amplifying channels are provided in the monitoring booth. Trunk circuits are provided between the monitoring booth and the electrical test room. These were installed in order to provide means for check tests on the amplifying system. They could be used, however, for connecting amplifiers located in the electrical test room or in the other monitor rooms in place of those in trouble but they have never been used for that purpose in a year and a half of operation. It has been found that by having only one amplifying channel conveniently available, greater care has been exercised in its maintenance than would be the case if more than one channel were available for use. Occasional delays in production have occurred

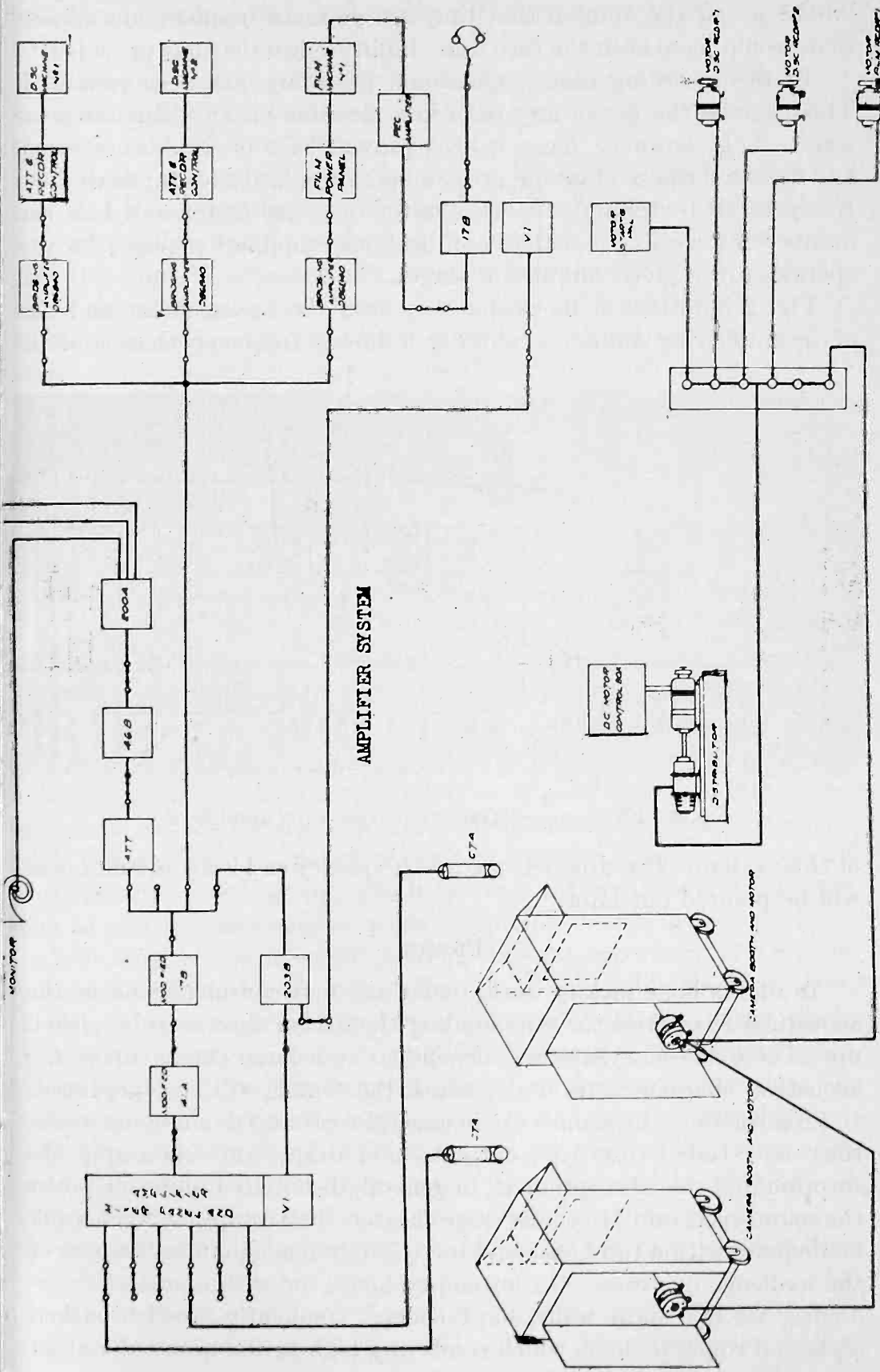

Fig. 2—Skeleton schematic of recording system.

but we are of the opinion that they are no more frequent nor serious than would have been the case were duplicate installations provided.

In the recording rooms, maximum flexibility has been provided. This permits the use of any recording machine on any distributor or stage. This, however, has not been provided for break-down service, but for the purpose of giving greater operating latitude and flexibility. It is possible by taking advantage of the diversity factor to reduce the number of recording machines and bridging amplifiers required for the operation of a given number of stages.

Fig. 2 indicates in block diagram form the arrangement and use of the amplifying equipment and Fig. 3 shows a frequency characteristic

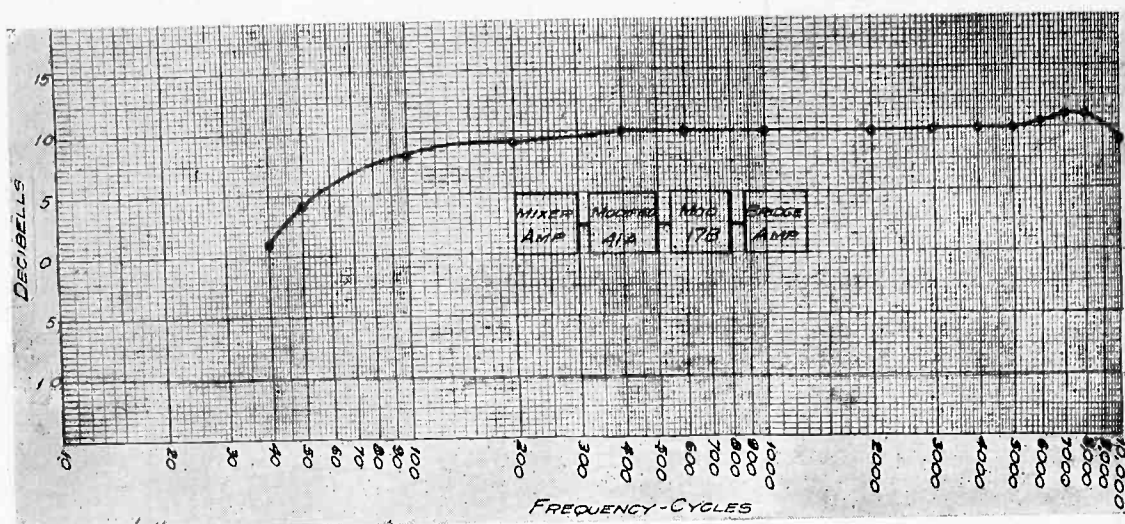

Fig. 3—Frequency-characteristic recording amplifiers.

of this system. The droop at the low frequency end is an advantage as will be pointed out later.

### PICKUP

In microphone pickup work, one of the first considerations is the acoustical characteristics surrounding the action that is to be picked up. These characteristics are dependent to a large extent upon the acoustical characteristics under which the sounds will be reproduced. In broadcasting, the sounds are in general reproduced in a home where rugs, overstuffed furniture, curtains, and drapes provide ample absorption and this absorption is, in general, distributed uniformly over the sound spectrum. In the average theater, the absorption is generally inadequate with a full house and increasingly inadequate as the size of the audience decreases. In an empty house, or with a scattered audience, we find hard walls, hard ceiling, frequently wooden-backed seats and concrete floors which result in a high period of reverberation

which changes in a marked degree with frequency as will be noted later.

From the pickup point of view, this means that a broadcast studio should be fairly live acoustically, while in the case of sound recording, the studio should be relatively dead.

Another point of difference between the two studios is found in the fact that there is nothing in the operation of a broadcast studio which will materially affect its acoustical characteristics. Its characteristics can, therefore, be adjusted until it is felt that the optimum results are being obtained and it can then be left alone. In the case of the picture studio, sets are built to represent or simulate the circumstances pictorially and acoustically surrounding the action which is being photographed and recorded. These sets are constantly being changed to represent new scenes and hence the acoustical characteristics under which recording is done rarely remains the same for more than a few minutes of recording time at any one time.

These sets generally consist of two or three side walls only. They never have the fourth side as this space is occupied by the cameras photographing the action. A top is rarely provided as it seldom comes within the range of the camera field. In order to keep the expense of the set construction down, it is desirable to build them of easily workable material. Unless specially requested from an acoustical standpoint, these side walls are built of thin material such as compo-board which will reflect sounds of the higher frequencies and transmit the sounds of lower frequencies. The construction of sets on the recording stage, therefore, has the effect of increasing the period of reverberation at the high frequencies. It, therefore, seems desirable in providing sound treatment for the stage to make it as dead as practical and to use the sets to enliven the acoustics when required.

The ideal condition would be to have the reverberation of a recording stage uniform for all frequencies. It is impossible to obtain this, however, without providing acoustic material, many inches thick. Sound treatment, an inch or two thick, absorbs a bigger percentage of the sounds at the high frequencies than at the low frequencies. On the other hand, as pointed out above, the sets are considerably more active in reflecting sounds of high frequencies than at low frequencies with the result that very satisfactory recording can be obtained on stages treated with an inch or two of sound treatment.

Fig. 4 shows the variation of the absorption and reverberation time with frequency on one of our recording stages.

One of the most striking differences between broadcasting and talking pictures comes in microphone placement. The broadcaster has no

restrictions placed on his microphone placement since he can arrange his artists and microphone to suit himself and can adjust his set-up until the optimum condition is obtained. On a sound stage, however, the pickup man is not so fortunate. The arrangement of the actors and artists is dictated by pictorial considerations and after the cameras have been placed the sound men must then find a location for their microphones outside of the camera field. Furthermore, in order to sustain interest in the picture, action on the part of the participants is essential. In the early days of sound pickup several microphones were placed about the set, some were hung in different locations outside of the camera field, others were hidden behind hand props, tables, chairs,

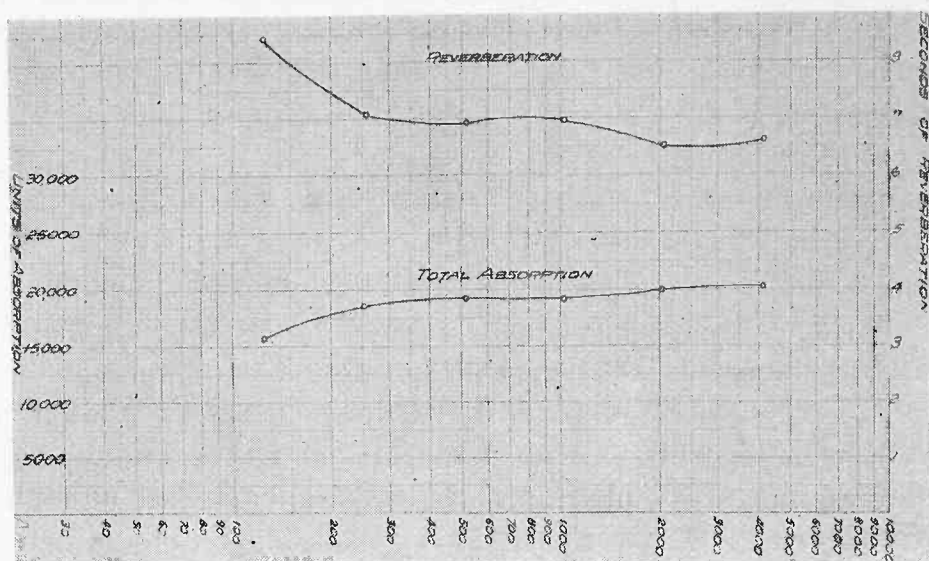

Fig. 4—Reverberation-absorption characteristic. Stage No. 2 empty, 267,000 cubic feet.

pillows, etc., on the set. Such arrangements required exceptional dexterity on the part of the pickup man to switch on the proper microphone at the proper time. Generally, rehearsals did not help the situation much as the actors were prone to change their lines between the rehearsals and a take. It was impossible to keep all the microphones turned on all the time as this produces very objectionable effects. In addition to the difficulty of having the proper microphone turned on at the proper time, there were marked and abrupt changes in quality.

It has been suggested many times that the microphones be placed approximately the same distance from the action as the camera. Some people claim that satisfactory results can be obtained in this way if the sets are given the proper acoustical characteristics. It has been our experience, however, that when the microphone is placed at any distance from the action, the noise level is greatly increased by com-

parison with the sound, and a great deal of detail in the speech or music is lost, and a blurring effect is introduced.

Fig. 5 shows an oscillogram of sound pickup at two and forty-five feet from the sound source. This illustrates in an exaggerated manner the effect to which I refer.

We feel that the best results are obtained by using the minimum number of microphones possible, preferably one suspended from a long cord and swung above the set by an operator who follows the action with the microphone, maintaining as nearly as possible a uniform and relatively short distance from the sound source. In order that the

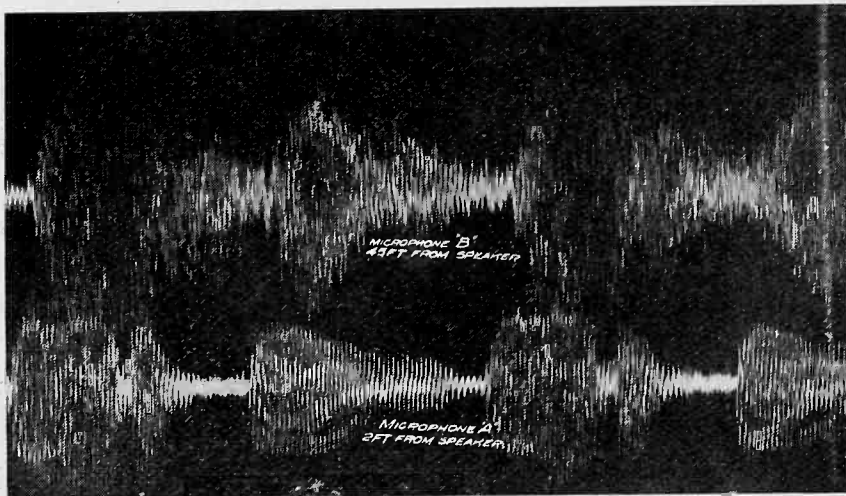

Fig. 5—Oscillogram of pickup on stage No. 1 before correct acoustic treatment was applied.

distance from the microphone to the sound source may be kept as small as possible, photographing at the time of the recording is restricted to the close-up and medium shot, the long shot being made later, either being shot wild, that is, without any sound being recorded or being photographed while the original recording is being played back.

### THE SOUND RECORD

There are three common forms for the sound record; first, a phonograph disk; second, sound film using variable-density constant-width sound track; third, sound film using variable-width constant-density sound track. At the present time, Vitaphone releases only by the first method. The other Western Electric licensees release by both the first and second methods, and the General Electric and R.C.A. licensees release by the first and third methods.

At the time the making of audible pictures was started there was only the one process commercially available for recording, namely, the

phonograph disk. Prior to this time, several interests were endeavoring to develop the photographic process of recording sound, but public demonstrations established the fact that this process was not commercial at that time.

Records had been produced commercially for some twenty-five years and as a result the galvano and pressing processes had reached a high degree of perfection. Experience had been accumulating for several years on the use of electric-recording equipment and as a result the technique of cutting waxes by the electric process was well understood, and no difficulties were encountered with this part of the work.

Later photographic recording of sound was used and under laboratory conditions we have been successful in obtaining very satisfactory results, but we have as yet been unable to produce as satisfactory results on film as we have on disk under commercial conditions. If, at some future date, the results commercially obtainable with film become equal to those obtained with disk, we may change to film. If the results become superior to those obtainable with disk, we are certain to change, as quality with us is of prime importance.

There are many things to be considered in comparing the relative merits of disk and film. In some, the advantages lie with film, in others the advantages lie with disk. It might be well for us to look at one or two of the factors to be considered.

When the sound track is placed on the film alongside of the picture, it is necessary to replace the entire print whenever a new sound record is needed. Inasmuch as a thousand-foot release print costs many times that of a disk, it is only natural that there is a marked reluctance to retiring a print before it is absolutely necessary. As a result, sound film is frequently retained in service long after it would be desirable from the sound standpoint to retire it. Very little information is available on the life of film containing sound track and what is available is not reliable because there are no established standards for determining when the useful life of a sound track has been passed. With disk recording, additional records are furnished to replace the records in service whenever there is a noticeable depreciation in the quality of the reproduction, the exhibitor being advised not to play one record over twenty or thirty times.

It is frequently stated that a better result can be obtained with film than with disk recording. This statement seems to be based on tests made in the laboratory where every step in the recording, developing, printing, and reproduction is done by expert engineers or where the disk record has been made by rerecording from film to disk and, therefore, has in addition to its own limitations, the limitations of the



original film record. In practice, however, where film must be developed and exhibited in large quantities, it is difficult to secure the expert handling which is required to obtain satisfactory results. This is especially true on the exhibition end.

From the standpoint of the equipment, a disk reproducer is simplicity itself. The only attention the reproducer requires in the projection booth is the insertion of a new needle for each new disk. If anything goes wrong with the reproducer a new one may be installed quickly, easily, and cheaply. On the other hand, the film reproducer is complicated by comparison. There are a number of adjustments which must be made with a high degree of precision in order to obtain satisfactory

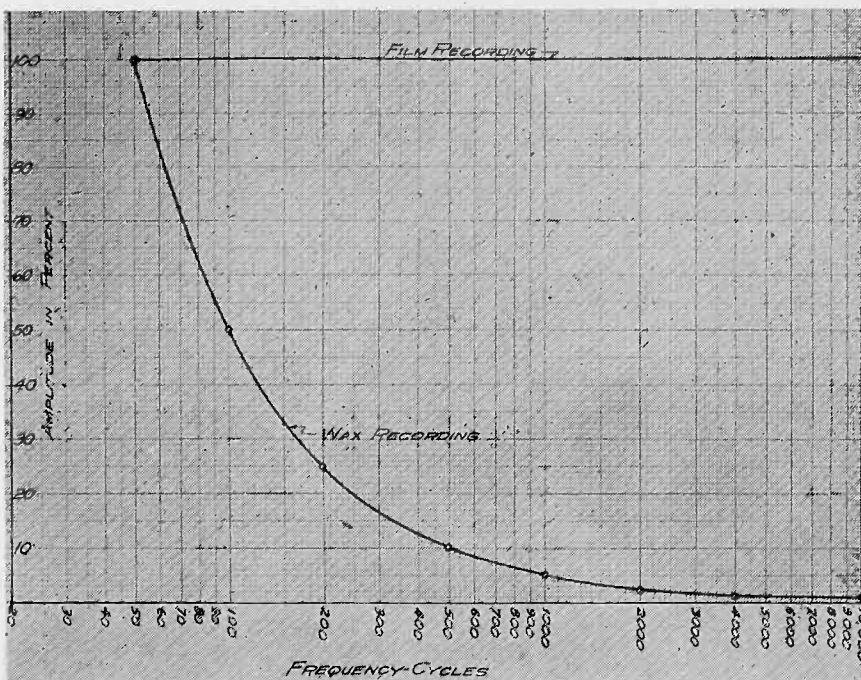

Fig. 6—Frequency-amplitude relations wax and film recording  
—constant output level.

results. Two additional stages of amplification are required in which the energy level is extremely low and, therefore, the problem of excluding extraneous noises is very difficult. As the projectionists in the booth become more familiar with the handling of sound track and more expert in the maintenance of the sound-track reproducer we may expect the results in the theater to improve.

On the surface there appears to be a marked advantage in the use of sound film in the editing process. In practice, however, this operation is not as simple as it appears at first. While sound film has its use in editing it also has its limitations as will be seen later.

It is interesting to compare the film and disk record of the same

sound. As the wave form of a photographic record is more evident in the variable-width method than in the variable-density method, we shall make a comparison between the disk and the variable-width method.

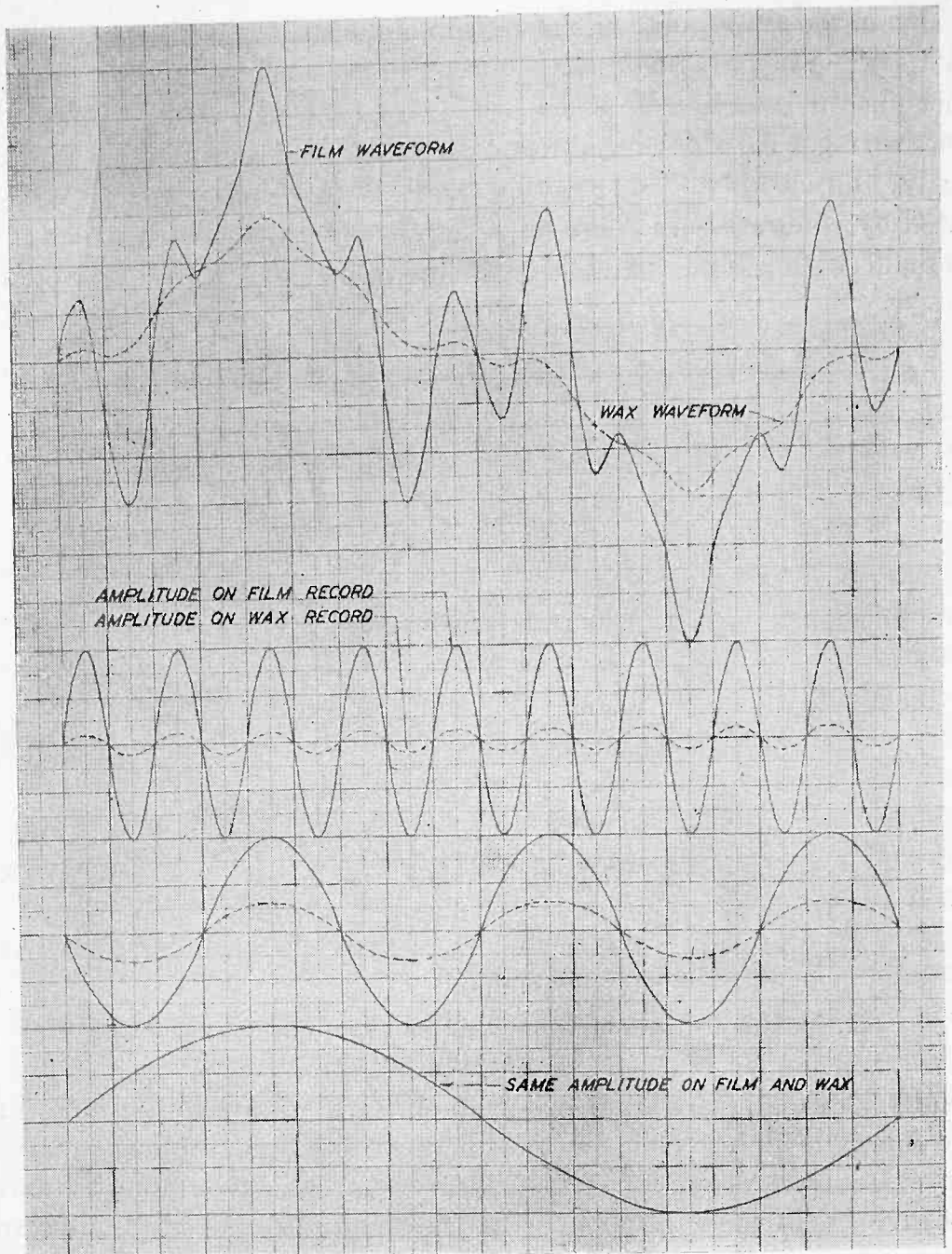

Fig. 7—Wave form for given sound; wax vs. film recording.

In a disk reproducer the induced voltage is proportional to the transverse needle velocity. This means, then, that for uniform output level the amplitude of the sound track on a disk record is inversely proportional to the frequency.

In a photoelectric cell, the current output is directly proportional to the instantaneous value of the light entering the cell. In other words, the amplitude of a photographic record for constant output is independent of the frequency.

Fig. 6 illustrates the effect of frequency upon amplitude in the two types of recording. It will be noted that in disk recording the amplitude at 5000 cycles is only one per cent of the amplitude at 50 cycles for the same output level, while in the case of film recording the amplitude is the same at both frequencies for the same output level.

To illustrate this effect a little further we have imagined a base violin, a cello, and a violin playing simultaneously at equal volumes. To simplify this illustration further we have assumed that the instruments produce sinusoidal waves bearing a frequency ratio of 1, 3, and 9 and have shown the resulting wave form that would be obtained on the film and disk record. Fig. 7 is very interesting. The high frequencies are scarcely evident on the disk record by comparison with the film record. An inspection of Figs. 6 and 7 illustrates why the presence of high frequencies need not be considered in establishing the level for wax recording while they must be considered in establishing the level for film recording.

It will be observed that if the level of the low frequency sounds are kept within the prescribed limits on wax recording that the monitor man need not pay much attention to the high frequency sounds. In film recording, however, it is essential that the sounds of single frequency be recorded at a relatively low level in order to prevent overloading when complex sounds occur.

When we observe the relatively low amplitudes which are involved in recording high frequencies, it is easy to understand why it is difficult to eliminate surface noise from disk recording and why this surface noise is high pitched. It is extremely difficult to obtain a surface on the wall of the groove which is free from slight irregularities. If these irregularities occur at frequent intervals they need only be of molecular proportions in order to produce relatively large volumes of sound.

It is interesting to note what the limiting factors are in extending the frequency range beyond that in current use. In this connection a study of the wavelength of the recorded sounds is valuable. In order to keep the length of one reel of film long enough to be practical, it was necessary to lengthen materially the playing time of the commercial phonograph record. This was accomplished by increasing the diameter of the disk and by reducing the speed of rotation. Commercial records rotate at 78 r.p.m., while Vitaphone records rotate at 33 1/3 r.p.m. It will be evident that this change in speed will materially

affect the wavelength of the recorded sound. Fig. 8 shows the variation in wavelength with frequency for grooves of various diameters on the Vitaphone records.

It is obvious that if the radius of curvature of the recorded sound becomes less than the radius of the reproducer needle, it will be impossible for the needle to follow the sound wave. It is also evident that for a given wavelength the radius of curvature decreases as the

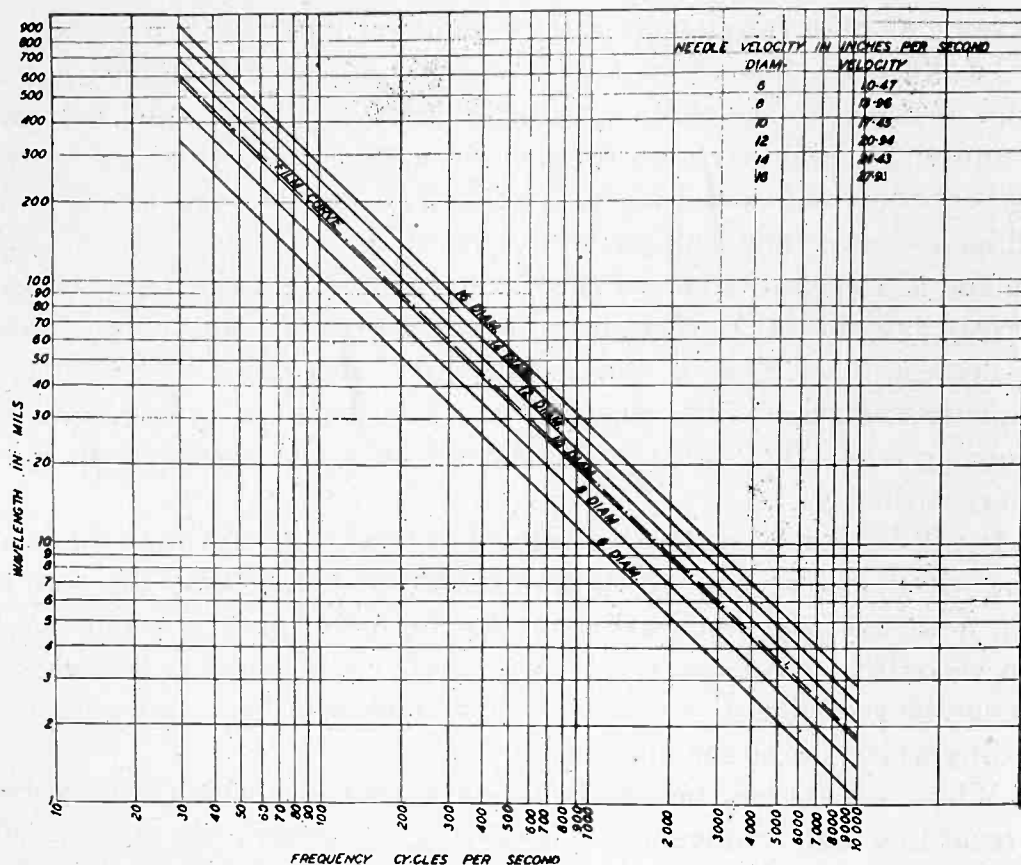

Fig. 8—Wavelength vs. frequency for different diameter spirals.— $33\frac{1}{3}$  r.p.m.

amplitude increases and, therefore, for wavelengths corresponding in magnitude to the diameter of the reproducer needle there will be a limit to the amplitude which it is capable of reproducing. In addition, there is an effect in reproducing these frequencies which is analogous to overloading in an amplifier or radio transmitter. As this effect is usually confined to the last octave, the harmonics generated fall outside the range of the loud speakers and produce no objectionable sounds.

In order to determine whether it was the frequency characteristic of the reproducer or the wavelength phenomena, which is at present limiting the frequency range of reproduction, a laboratory reproducer was constructed and used in playing a standard frequency record of constant velocity. Curve A in Fig. 9 is the result obtained. The speed

of the record was then approximately doubled with the frequencies corrected to correspond with the new speed. Curve *B* shows the results of this test and indicates that the reproducer which we used had no resonant peaks below 8000 cycles. Therefore, the decrease in output with increase in frequency in *A* must be the result of the wavelength phenomena. It is to be expected that if the recording level on the constant-velocity standard-frequency record was reduced that the breaking point on *A* would be shifted to the right more and more as the recording level was reduced. As the normal amplitude of sounds above 3000 or 4000 cycles is ordinarily very much below the amplitude of

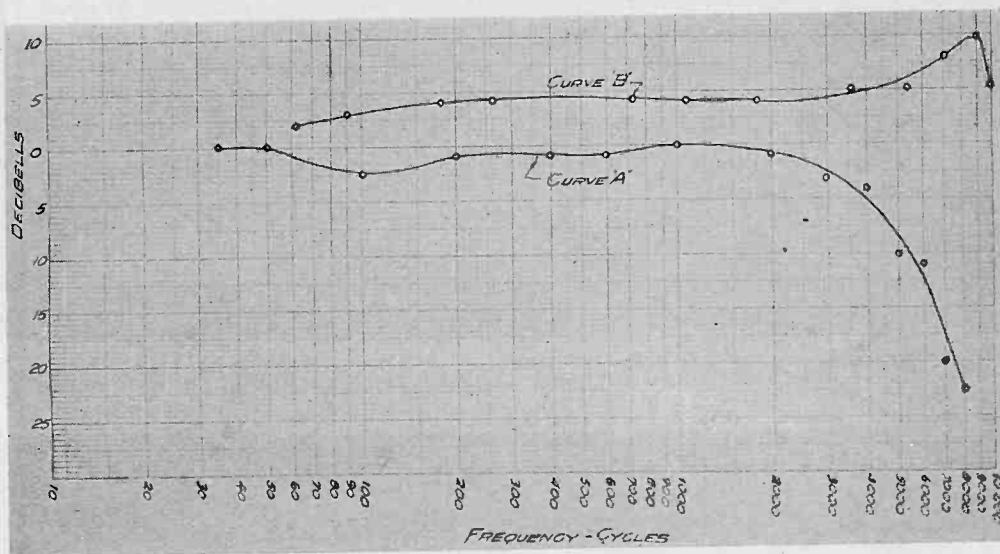

Fig. 9—Frequency characteristic—experimental dynamic reproducer.

low-frequency sounds, it is doubtful whether the wavelength phenomena would be an obstacle in attempting to add another octave to the present frequency range.

As pointed out above, a study of Fig. 6 indicates that the amplitude of the low frequencies is a limiting factor in disk recording. By reducing the amplitude of these frequencies the high frequencies can be recorded at a considerably higher level and, therefore, the ratio between the recorded sound and the surface noise is increased. When this was done it was found in reproducing these sounds in the theater that the results were more pleasing than when the low frequencies were recorded and reproduced in their true proportion. At first, this was baffling but the explanation can be found in the study of the theater acoustics. Fig. 10 illustrates the way in which the sound absorption in the average theater varies with frequency, and indicates that reverberation at the lower frequencies is much more objectionable than at the higher

frequencies. From this it is evident that a smaller amount of energy is required to produce a given volume of sound in the theater in the first two octaves than in the last two. It, therefore, results that a

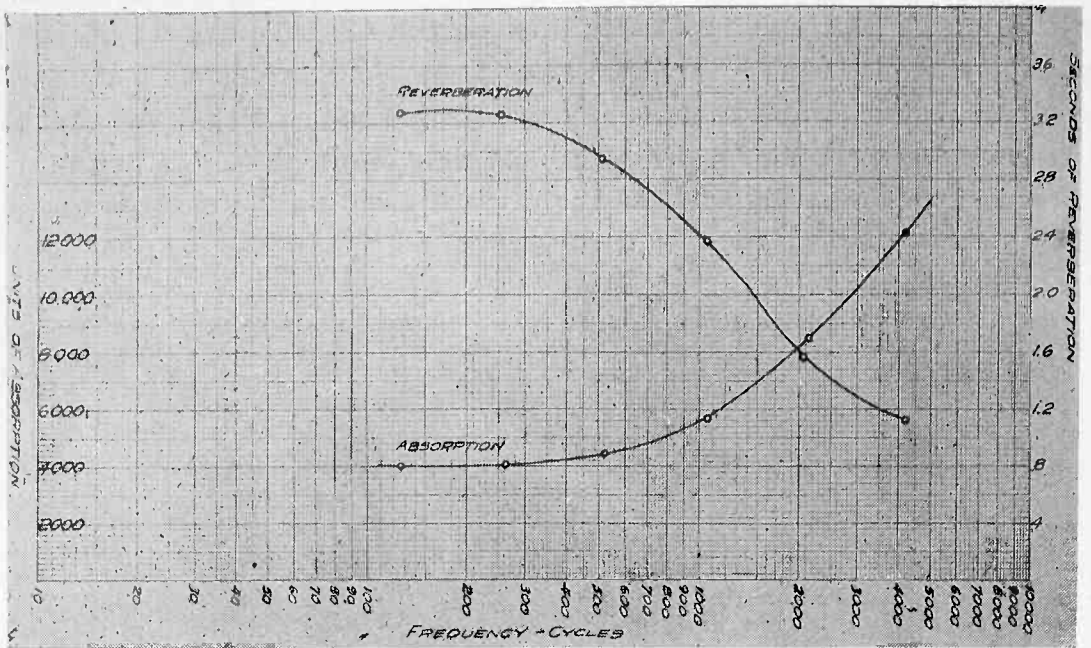

Fig. 10—Reverberation-absorption characteristics; typical theater curve.

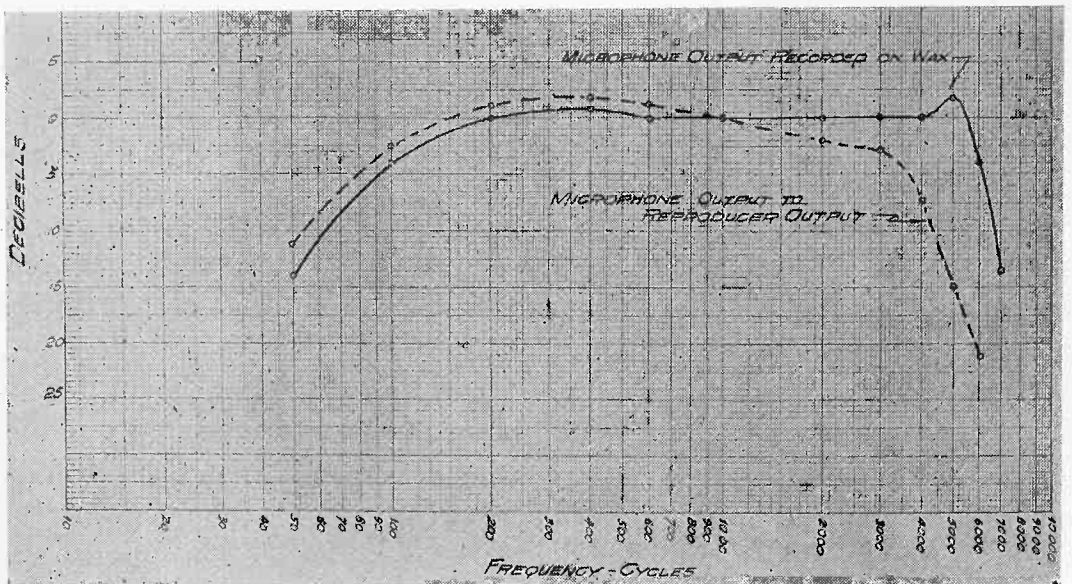

Fig. 11—Over-all frequency characteristics.

modification in the frequency characteristic which is advantageous from a recording standpoint is also advantageous from the standpoint of theater reproduction.

One curve on Fig. 11 shows the frequency characteristic of the recording system from C.T.A. output as far as the wax, and the other

extends it to include the effect of reproduction. It is interesting to note that records made with this frequency characteristic sound better in the average theater than do records in which the low frequencies are recorded more nearly in their true proportions, while they do not sound as well in rooms having uniform sound absorption as those having more bass. As time goes on and the acoustical characteristics of the theater are improved it will undoubtedly be found desirable to modify this recording frequency characteristic.

### SOUND EDITING

A paper on audible pictures cannot be presented without some reference to sound editing, an operation which has no counterpart in broadcasting.

In the beginning it was necessary to shoot a complete reel of picture and sound without stopping. This seriously limited the entertainment scope of audible pictures as it is virtually impossible to shift the scene of the action during a take. It was once attempted by constructing three sets side by side and locating cameras in front of each set. When the action on the first set had been completed the lights were turned out and the actors hurriedly shifted to the second scene whereupon the lights were turned on and the action continued. This proved to be entirely impractical. It was decided, therefore, to attempt re-recording, an operation which those versed in the phonograph business stated could not be done without ruinous effect upon the quality of the recorded sound. A few experiments in this direction proved, however, that the difficulties anticipated could be overcome, with the result that very few reels are now continuous or original recordings. Once it was discovered that re-recording was practical a great many other reasons for its use were discovered besides the necessity of shifting scenes. It enabled the directors to break up their action into short sequences, and thus make it unnecessary for the actors to memorize and rehearse long scenes at a time. It also permits the addition of sound effects and music recorded at other times and in other places and in case of a breakdown either on the part of the actors, in the photography or in the recording, it is unnecessary to repeat any action which preceded the breakdown, provided it was satisfactory. It also enables the director to eliminate, during the editing of the film, entire scenes, sentences or even words which were recorded at the time the picture was made. In the case of censorship it permits the elimination of any material to which there are objections.

In order to edit the sound a number of turntables are driven by motors which are electrically interlocked with the motors on the re-

ording machines. The records containing the sequences which are to be patched together are placed on different turntables. The reproducers from the different turntables are connected to separate potentiometers on a mixing table. The reproducers are placed on the proper start mark on the records containing the initial action and after the reproducing and recording system has been started up the records containing subsequent action are released in accordance with predetermined cues. These cues, which are given to the nearest tenth of a turntable revolution, are obtained by measuring the film and determining the distance between the start marks of the various sequences.

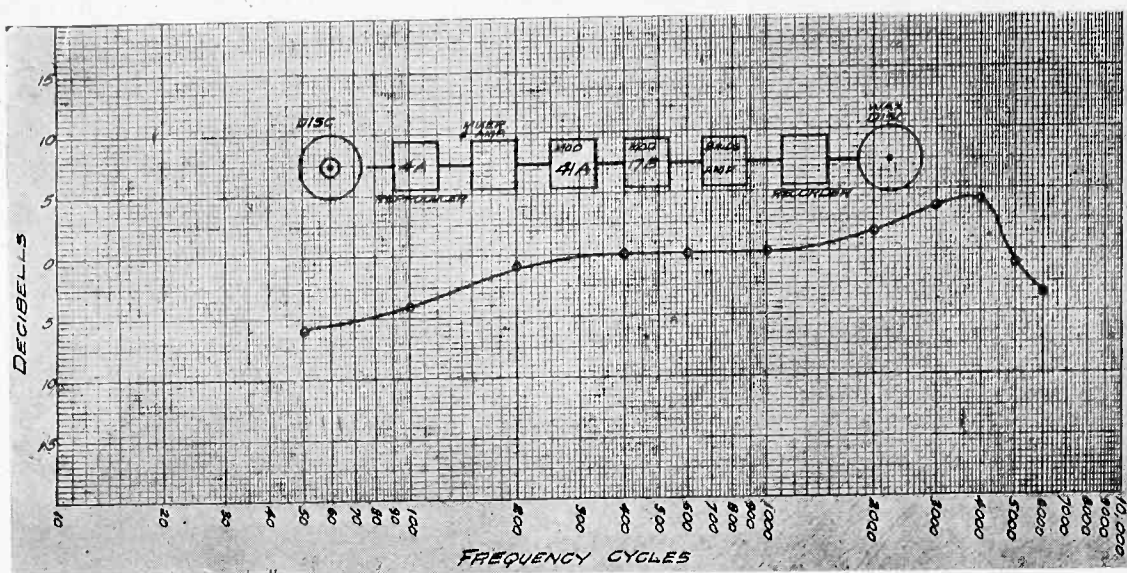

Fig. 12—Rerecording frequency characteristic.

After a little practice, it is found that the various records can be released accurately to within a few frames and these slight deviations from correct synchronism can be corrected by a check cutting of the picture film.

In rerecording it is obviously undesirable to modify the frequency characteristic of the original recording. It has been found that by selection of the proper type of equalizers it is possible to compensate for the frequency characteristic of the reproducers, amplifiers, and recorders. Where this is done it is difficult for experts to distinguish any difference between the original recording and the re-recording. Fig. 12 gives a frequency characteristic of our rerecording system. It was obtained by rerecording our constant-velocity standard-frequency record and measuring the levels recorded on the wax.

From the standpoint of the cutter and director there is a marked advantage in the use of sound on film. The cutter can join up the sound track at the same time he cuts the picture. The director, therefore,



can judge the length of the waits between sequences and the effect of the changes of sequences on the continuity without having to wait for the sound department to rerecord the reel.

From the sound department's standpoint, however, there is little or no advantage in editing with film. The majority of pictures call for the addition of sound effects or background music not contained in the original record. As a result the original sound-track negative cannot be used in printing where the sound is released on film. Before sound film can be rerecorded a matched print must be made, that is, a print from the negative after it has been matched to the cutting print. This requires time and if used in re-recording on wax it would merely delay the operation. As a result we have found the most practical procedure to be to supply the cutters with sound track for their use and when the production has the director's approval, to make the release records by re-recording from disks.

#### IMPROVEMENTS DESIRED

No loud speaker characteristics are included in this paper but judging from those published by others their response does not extend much, if any, outside of the range of reproduction shown in Fig. 11. In practice, therefore, under the best conditions it is doubtful whether any sounds having frequency much above 5000 cycles or much below 100 cycles ever reaches the audience from either disk or film recording. If this range of frequencies is faithfully reproduced under good acoustical conditions the results are pleasing and quite satisfactory. But anyone who has observed a given picture in a number of different theaters has undoubtedly noted a very wide variation in the fidelity of the reproduction in the different theaters. In some theaters the results are excellent, in others the results are only fair and in some, speech is scarcely understandable even though the same type of reproducing equipment is used in each case. A number of factors may contribute to this, but it is my belief that in the majority of cases this variation in the results is due to the difference in the acoustical characteristics of the theaters. In addition to the variation of absorption with frequency noted above there is the added difficulty resulting from reflection which may be evident in the form of echoes or interference patterns. At the present time, therefore, we are forced to the conclusion that the weakest link in the chains connecting the actor and the audience is the acoustics of the theater.

We should all use our influence to persuade the exhibitor to have his theater treated acoustically. There are several organizations that are prepared to furnish expert advice on this question. Referring to Fig.

10 it is evident that we must emphasize the importance of the octaves centering around 128 and 256 cycles as it is in this range that the average male voice lies. Many of the acoustical materials available at present provide little or no absorption in this range. The salesmen for these materials state that this range is not important. As this is not the case, it is better to look for advice to those who are not interested in the sale of any particular material.

It is generally agreed that recording frequencies above 4000 or 5000 cycles does not materially contribute to the articulation of the reproduction but the addition of another octave would certainly improve the naturalness of the reproduction. A little progress has been made in that direction. Recorders which will respond to higher frequencies can be obtained but there are no reproducers commercially available which will reproduce them and even if there were, there are no loud speakers which will project them. The incentive to improve these elements is retarded by the knowledge that increased frequency range would result in increased surface noise, and until a new record material is available which will reproduce the higher frequencies without increasing the surface noise there would be little use for the improved reproducer and loud speaker.

The importance of developing or discovering a new and better record material cannot be overemphasized. Many people are working on this problem and we hope that someone will soon get the answer.

From the studio standpoint a silent camera which need not be enclosed in a sound-proof camera booth would be a great aid. A microphone which could be placed at a greater distance from the action and which could be focused on the set like the camera and collect the sounds equally well from a restricted angle would be invaluable.

The newer type amplifiers available are adequate for handling another octave but they are about the only thing that is.

#### CONCLUSIONS

The acoustics of the theater appear to be the limiting factor in realizing the maximum possible results obtainable with the present equipment.

In attempting to increase the frequency range by another octave, the present amplifiers will be found satisfactory, but there are several other items which are not. The most important of these in the disk method of recording appear to be:

- (A) The frequency-response characteristic of the loud speaker.
- (B) The frequency-response characteristic of the reproducer.
- (C) The surface noise of the record.

In the film method of recording the most important limiting factors appear to be:

- (A) The frequency-response characteristic of the loud speaker.
- (B) The frequency-response characteristic of the light valve.
- (C) The frequency-response characteristic of the sound-track reproducer
- (D) The elimination of speed variation in the sound-track reproducer

There are two other improvements which would be of great importance to the producing organizations:

- (A) A silent camera which need not be enclosed in a sound-proof booth.
- (B) A microphone which could be placed at a greater distance from the action and which could be focused on the set in the same manner that a camera is focused on a set and which would collect the sound equally well from a restricted angle.

The author hopes that this description of present practices and problems of the producer, and some of the history of the development leading up to them has proved interesting, and that this recitation of the limitations of the present equipment may stimulate an improvement in the art and thus add to the enjoyment which may be derived from audible pictures. They are thoroughly commercial and relatively satisfactory at present but we, as engineers, will never rest contented until our part in the picture business has reached perfection.

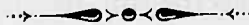

## PROBLEMS INVOLVED IN THE DESIGN AND USE OF APPARATUS FOR TESTING RADIO RECEIVERS\*

BY

PAUL O. FARNHAM AND ALFRED W. BARBER

(Radio Frequency Laboratories, Inc., Boonton, N. J.)

*Summary*—This paper deals briefly with (1) the desirable characteristics of measuring equipment employed in making the usual tests of radio receiver performance and (2) a description of apparatus and technique used in carrying out several special tests. Measuring equipment and methods are discussed with reference to the elements of the receiver, after which are remarks on the usual tests of sensitivity, selectivity, and fidelity. Under special tests is a discussion of measurements on hum, tube and circuit noise, modulation distortion, intermodulation, audio harmonic analysis, and volume control. Some specimen curves showing results obtained on model receivers are presented.

### I. Introduction

IN THE space of a few years the testing of radio receivers has evolved from the simple method of making qualitative listening tests on overall performance, through relatively simple quantitative measurements on sensitivity, selectivity, and fidelity, until at the present time it involves a fairly complete investigation of all the factors which measure the performance and the worth of the receiver. The equipment necessary for making these quantitative measurements has thus been added to and improved from time to time, not only in view of the growing numbers of tests, but also because of the progress which has marked the development of the receivers themselves. It is thought that a brief exposition of the problems of design of suitable measuring equipment and of some of the methods used in receiver testing as followed at the Radio Frequency Laboratories may be of interest.

### II. Laboratory Development of Receivers

The equipment necessary for the development of a model receiver in the laboratory is, of course, more complicated and extensive than that used in the checking and inspection of receivers from the factory production line. For this reason it seems pertinent to discuss briefly the methods of testing the various elements making up the receivers before going on to the matter of over-all characteristics.

\* Dewey decimal classification: R201. Original manuscript received by the Institute, May 17, 1930. Preprinted and presented at a joint meeting of the Institute of Radio Engineers and the Radio Manufacturers' Association, Atlantic City, N. J., June 3, 1930.

In order to study the performance of the single r-f amplifier stage, a relatively simple outfit is used comprising an r-f oscillator of variable frequency with a calibrated attenuator system of low impedance at its output, a stage gain panel with tuned input and output circuits arranged to take various types of tubes, and a vacuum-tube voltmeter of special low-loss construction for connection to the input and output of the stage. For a measurement of stage gain the voltmeter is first connected to read the voltage supplied across the tuned input circuit with the tube grid disconnected and no attenuation at the oscillator output. It is then connected across the tuned output circuit (the grid of the tube connected to the input) and the attenuation on the oscillator output set to give the same voltmeter reading as before, when both input and output circuits are tuned for maximum output. The gain of the stage is hence given by the attenuator setting. The repeater gain of the stage is measured in a similar fashion except that the tuned input circuit is not used and the low impedance oscillator output is connected directly to the grid of the tube.

The selectivity of the single stage may be measured by readings of attenuation for constant output as the oscillator frequency is varied by small amounts on either side of the resonant frequency of the stage.

The characteristics of an antenna coupling system, as well as other forms of radio-amplifier stages, may also be studied advantageously with the same oscillator and tube voltmeter.

Detector circuits are investigated by using the stage gain oscillator with a modulation system added as well as a linear radio amplifier for supplying high carrier voltages at the detector grid. The modulation frequency may be varied continuously over the audio range by means of a beat-frequency audio oscillator in order to determine the audio fidelity of the detector and its associated plate load. A special metering system makes possible a direct setting of the percentage modulation.

The voltage gain of audio amplifiers over the useful range of audio frequencies is obtained directly from a beat-frequency oscillator and a vacuum-tube voltmeter. A slide-wire and attenuator built in with the beat oscillator makes possible the same technique as was described in measuring radio stage gain.

### III. Over-All Characteristics of Laboratory Models

We may continue now to a discussion of the apparatus used for measuring the performance of the receiver as a unit after it has been constructed according to the information obtained from tests on the separate elements.

Fig. 1 is a functional diagram illustrating the equipment necessary for making such over-all measurements.

The frequency of the audio oscillator is conveniently adjustable in fixed steps from 50 to 7000 cycles on a single dial with a compensating arrangement to give an output voltage that is constant with frequency. Plate modulation of the radio oscillator is used, with a metering system in the r-f oscillator for adjusting the percentage modulation over a range from 2.5 to 70 per cent. It is important to adjust the constants of the audio oscillator so that the harmonic audio output is low. When special measurements are to be made on the introduction of audio harmonics in the receiver under test it is convenient to have a filter between the audio oscillator and modulation system which suppresses the audio harmonic output.

The operation of the r-f oscillator and attenuator deserves special mention in regard to the following factors.

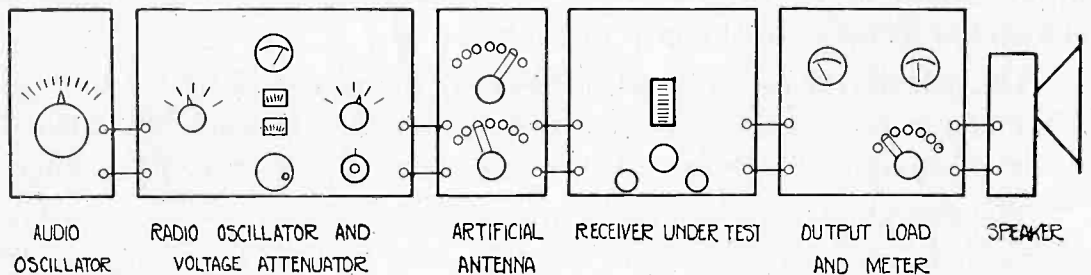

Fig. 1—Illustrating the arrangement of apparatus for making over-all receiver measurements.

(a) The frequency should not vary more than about 200 cycles when an amplitude modulation of 30 per cent is impressed at any carrier frequency. Incorrect over-all selectivity measurements will result if a frequency modulation appreciably greater than this is used when testing modern receivers of high selectivity.

(b) The r-f voltage at the attenuator output should be constant with frequency.

(c) The modulation system should introduce no frequencies in the oscillator output other than  $\omega \pm a$  where  $\omega$  = carrier frequency and  $a$  = audio frequency.

(d) The actual percentage modulation should be constant for a given setting over a range of audio frequencies up to 7000 cycles.

(e) The output impedance of the attenuator system should not vary more than 1 or 2 ohms for various output levels.

(f) An adjustment for varying the carrier frequency in small steps up to at least 30 kc on each side of three standard test frequencies should be provided.

(g) The maximum voltage output of the oscillator should be of the order of 0.5 volt.

(h) The shielding of the oscillator and method of wiring the attenuator should be such as to keep the stray signal well below one microvolt when the attenuator is set for zero output.

(i) In some locations it is necessary to use a shielded booth for housing the r-f oscillator and receiver under test to suppress effects

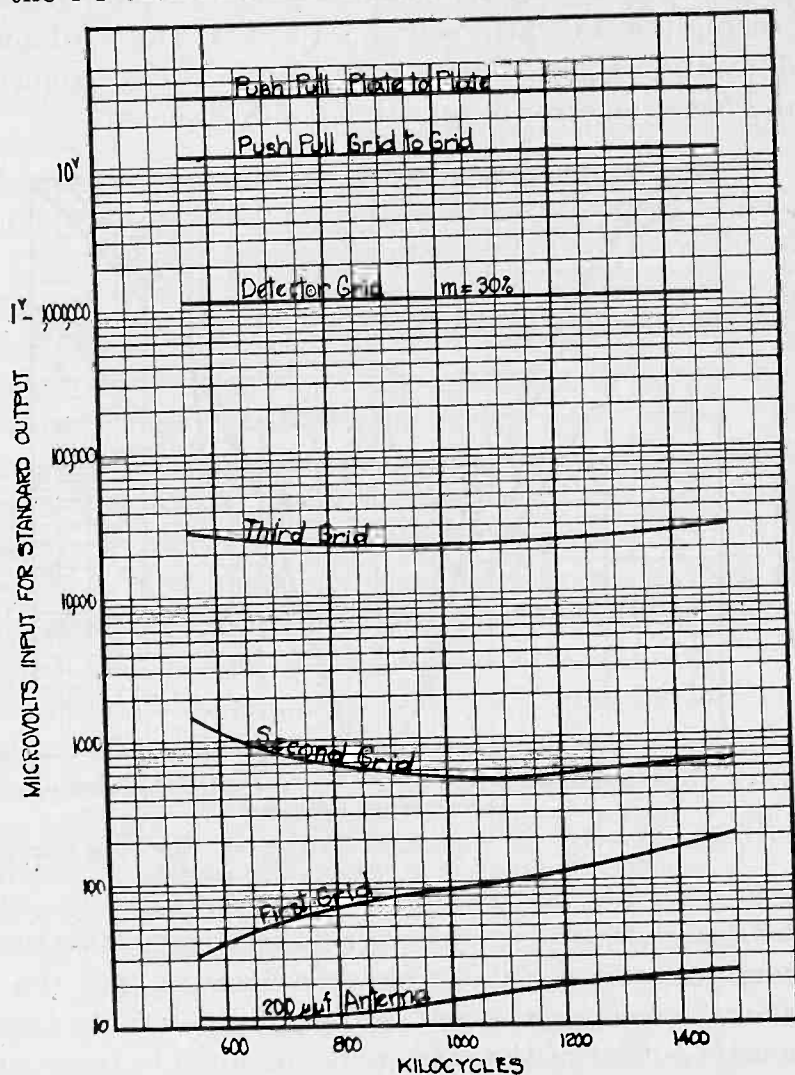

Fig. 2—Sensitivity analysis of an experimental receiver.

from undesired stray fields. The supply leads to the measuring equipment should be filtered carefully against r-f currents.

(j) The attenuation system should give consistent operation over the range of carrier frequencies used.

Between the attenuator output and the receiver under test there is inserted an artificial antenna which is preferably adjustable as to resistance and capacity so that the behavior of the input circuit on the

receiver may be studied with regard to these constants. Since the output impedance of the attenuator is low, of the order of 1 or 2 ohms, any capacity between the supply leads to the artificial antenna, such as might be obtained by twisting them, causes practically no decrease in the voltage introduced by the attenuator into the artificial antenna. It is important, however, to keep the leads between the artificial antenna and the set as short as possible since this part of the circuit is highly susceptible to static pickup. Further, any load across this circuit will result in a more serious reduction in voltage applied to the receiver and hence an error in sensitivity measurements.

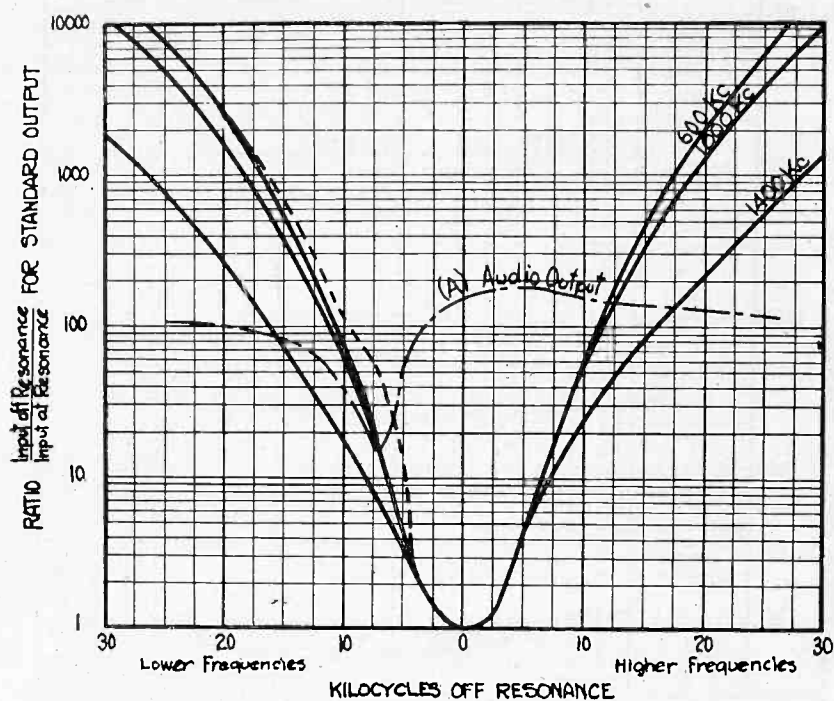

Fig. 3—Selectivity curves of an experimental receiver showing effects of frequency modulation in the voltage source.

The electrical output of the receiver is measured with a system of thermal ammeters and variable resistance loads so that the correct impedance for the receiver's output load may be determined and used.

The acoustic output of the receiver is measured in terms of sound pressures by apparatus including a calibrated microphone,<sup>1</sup> amplifier, and meter. The type of sound chamber in which the measurements are made is under control and may be arranged for practically complete absorption in all directions as a limiting case.

After this rather brief summary of desirable and necessary features with regard to the measuring equipment we may consider the methods followed in testing a model receiver.

<sup>1</sup> See Ballantine, "Effect of diffraction around the microphone in sound measurements," Contributions from Radio Frequency Laboratories, No. 9, 1929.



Fig. 2 shows a sensitivity analysis of one model receiver. The voltage input required for standard output level of 100 mw is shown for various carrier frequencies using a signal modulated 30 per cent at 400 cycles. By connecting the output of the attenuator system through a large capacity to the successive grids of the amplifier, the amplification of the several stages is determined. Audio voltage levels at various points in the detector and audio system are read by a tube voltmeter.

Selectivity curves of this receiver, obtained in the conventional way by maintaining constant audio output, are shown for three carrier frequencies in Fig. 3. The dotted selectivity curve for 600 kc is included to show the spurious characteristic which may be obtained with a highly selective receiver when frequency modulation is present in the r-f source. If selectivity curves are taken by holding constant carrier voltage on the detector grid they would not thus indicate the presence of frequency modulation. A plot of audio output taken at the same time, however, shows the effect of the frequency modulation in a striking fashion as depicted in curve A of Fig. 3.

These effects of frequency modulation as shown in Fig. 3 may be explained as follows. When the frequency of the impressed r-f signal is somewhat removed from the resonant frequency of the r-f amplifier in the receiver, any change in impressed frequency will result in a change in carrier voltage reaching the detector. The effect, so far as the detector is concerned, is thus equivalent to an amplitude modulation. If now, we have the usual amplitude modulation present in the impressed r-f voltage, this additional amplitude modulation due to the change in carrier frequency will augment the desired amplitude modulation on one side of the resonant frequency of the amplifier and decrease it on the other side.

It is while making these selectivity measurements on a model receiver that evidence of any radio-frequency feed back in the chassis will appear in the form of (1) an excessive sharpening or broadening of the curve in the immediate region of resonance, (2) a kink or double resonance effect. Misalignment of the tuned circuits in the receiver will often result in unsymmetrical selectivity curves. It is quite possible to have the presence of frequency modulation in the r-f source and interstage or over-all feed back in the receiver working in opposite directions and to obtain a symmetrical selectivity curve as a result. In order to study defects in the receiver it is therefore quite necessary to have no frequency modulation in the r-f oscillator.

Curves of electrical fidelity are taken in the usual manner by setting the audio level at a given value for 400-cycle modulation and, with the input carrier voltage held constant, varying the modulation

frequency to obtain the corresponding audio outputs. These fidelity curves are taken at the same carrier frequencies as the selectivity curves and in the higher audio-frequency regions may be correlated with the sharpness of the selectivity curves near resonance. The shape of the fidelity curves will in general depend upon the signal level at which the detector is being worked, owing to the effect of a change in detector plate resistance.

Fig. 4 shows curves of electrical fidelity on one model receiver and also the improvement in fidelity obtained by working at a higher signal level.

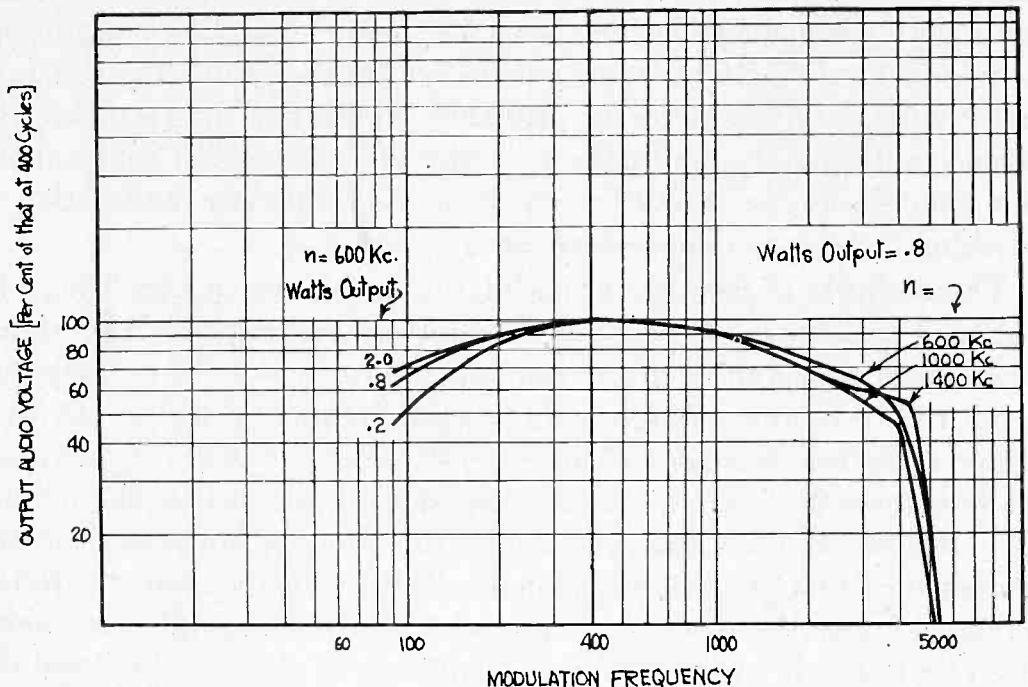

Fig. 4—Electrical fidelity of a receiver showing effects of various output levels and various carrier frequencies, Modulation = 30 per cent.

The overload characteristic of a receiver is an important index of performance. Fig. 5 shows the audio-output current for different radio inputs at three percentages of modulation. It is, of course, desirable that the audio output should hold up for a considerable range of carrier input before dropping off so that in tuning the receiver through a strong signal the effect of maximum output at two places on the dial will not be obtained. This falling off in audio output is most likely to occur with low percentages of modulation, for in such instances the usual detector circuit will overload before the output tubes. In fact, by going to very small percentages of modulation the carrier voltage at which the detector overloads may be determined.

The measurement of automatic volume control receivers brings up several points of considerable interest. These receivers, whatever type

of control is used, have in general a means for setting the output level at a given value. For each receiver there is a definite region of low carrier input which does not operate the automatic control. The operation of the control should be practically independent of the percentage modulation in order to avoid distortion of the audio output. Sensitivity measurements are taken in the usual manner with the output level control set at maximum. Selectivity curves are likewise obtained with the output control set at maximum and at a value of audio output small enough to preclude the possibility of action of the automatic control.

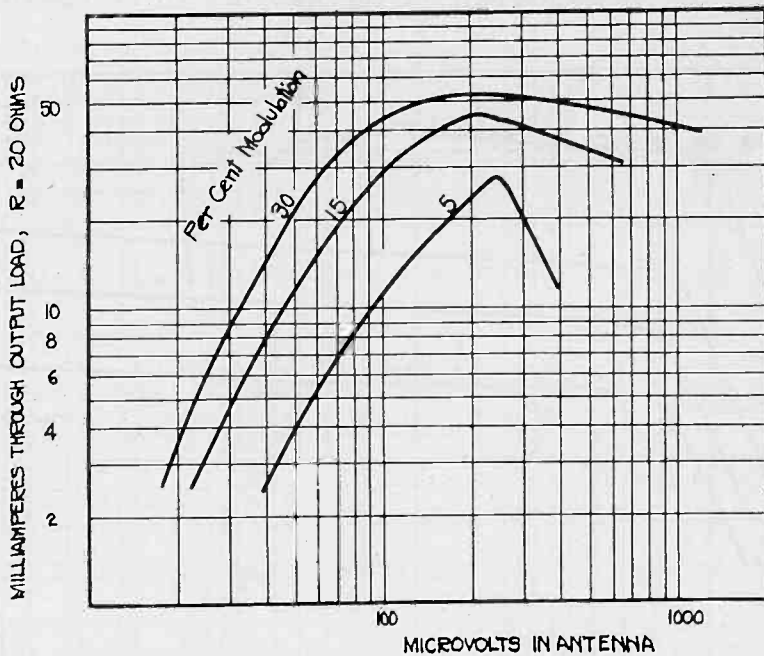

Fig. 5—Overload characteristics of an experimental receiver for three percentages of modulation at 400 cycles.

The action of the automatic control may be obtained by plotting a characteristic similar to that of overload described for the manually volume-controlled receiver. This control characteristic is observed for various settings of output level as shown in Fig. 6. The sensitivity of control should be noted, that is, the value of carrier input at which the automatic control begins to operate, as well as the sharpness of control, that is, the range of carrier input required to obtain a substantially flat output level.

#### IV. Special Measurements

In addition to these measurements just outlined there are several others of considerable interest which require in some instances more extensive measuring equipment than has been described.

Receivers operating from an a-c line supply generally give rise to so-called hum voltages at their output as an undesirable effect. A

measurement of this hum voltage should take into account the frequency response characteristic of the loud speaker and of the ear. To furnish results which do measure the true disturbing effect would require a rather lengthy study.<sup>2</sup>

A good idea of this effect for purposes of comparison between receivers, and for studying the effects of applied carrier and volume control upon hum output can be obtained by the use of a network of the type shown in the Year Book of the Institute of Radio Engineers.<sup>3</sup>

If apparatus for the measurement of sound pressure is available, the transmission characteristic of the network to be inserted in the

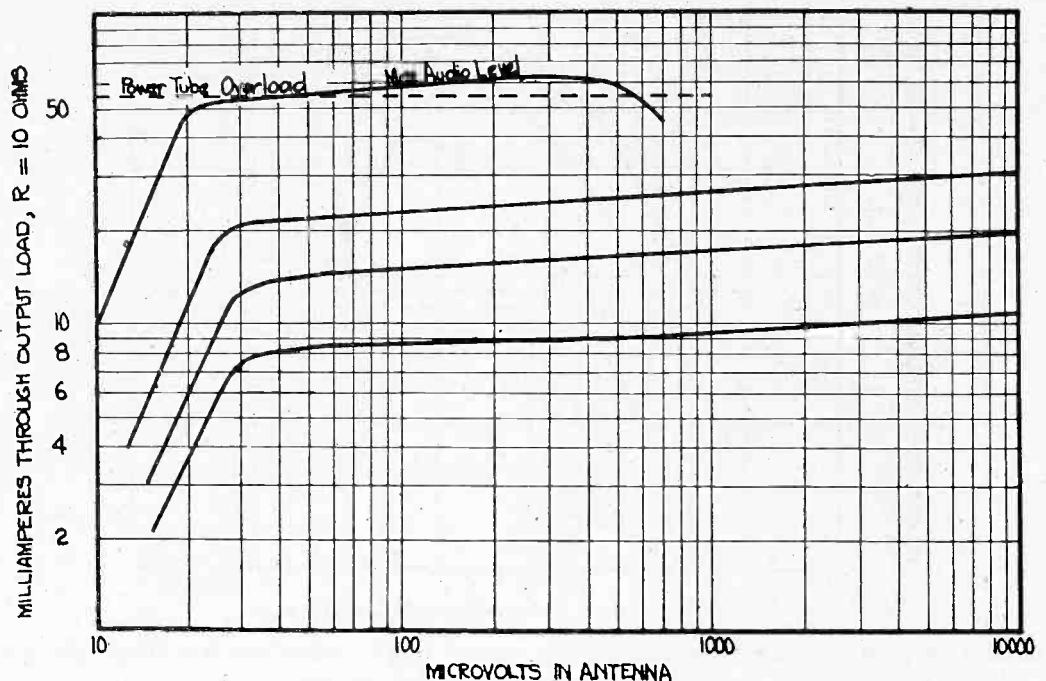

Fig. 6—Automatic volume control characteristic for various audio output levels. Modulation = 30 per cent.

circuit can take account of the frequency response relations in the ear only. The hum output of a receiver may be expressed as an equivalent 400-cycle modulation, a useful conception due to Ballantine.

Another undesirable effect in the output of a receiver is due to the presence of noise generated in the r-f amplifier tubes and circuits. This noise may be considered as coming mostly from the first tube and input circuits and originates from any or all of the following causes<sup>4</sup>: thermal agitation in the conductors of the input circuit, and in the tube, shot effect, and thermal agitation in the tube plate resistance. The frequency of this noise is distributed over a wide range, a band

<sup>2</sup> Fletcher, "Speech and Hearing", Part III.

<sup>3</sup> YEAR BOOK I.R.E., 123-126, 1929.

<sup>4</sup> F. B. Llewellyn, PROC. I. R. E., 18, 243; February, 1930.

of which comes through the r-f amplifier. It gives demodulation products with the carrier at the detector, and appears at the audio outputs as the familiar hiss. Without going into detail as to the factors affecting the ratio of this hiss to signal, the amount of the hiss may be measured with a thermocouple and expressed in the

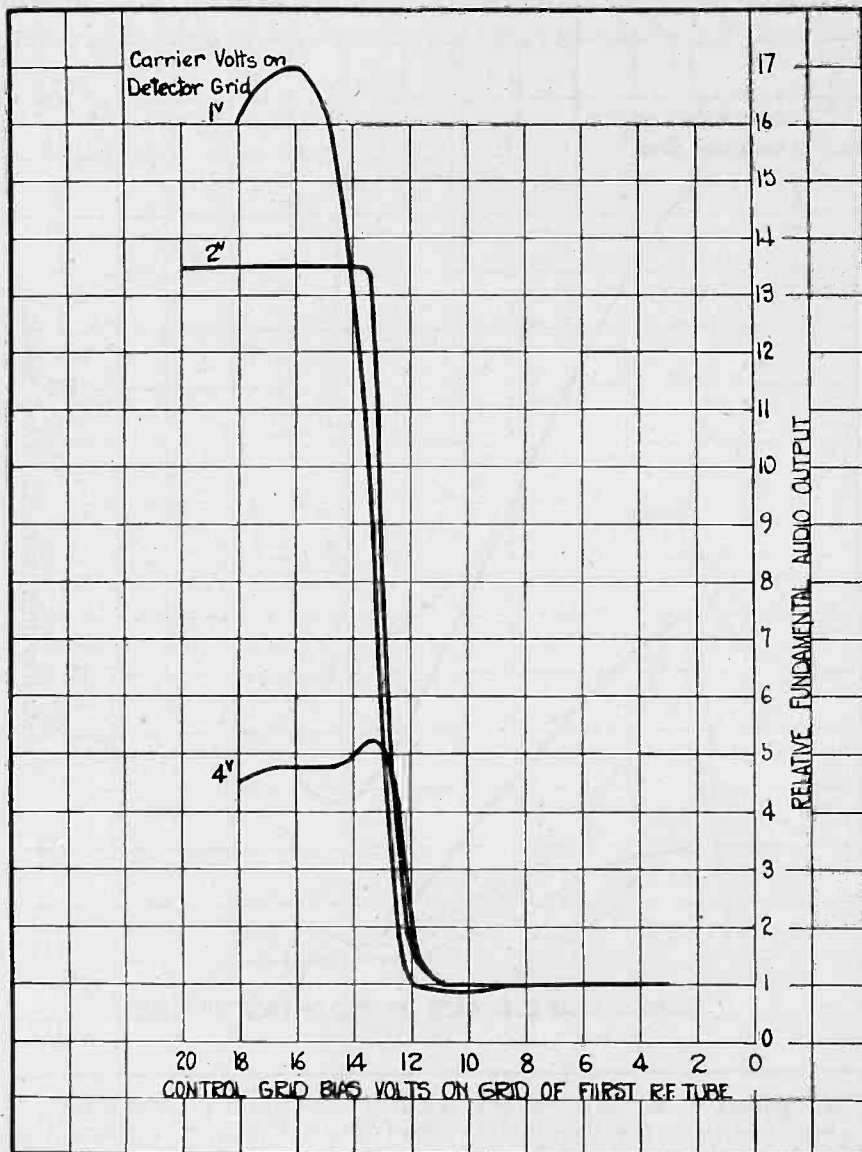

Fig. 7—Illustrating the increase in effective modulation as shown by fundamental audio output when operating over certain regions of control-grid bias on the first radio amplifier tube.

form of an equivalent 400-cycle modulation percentage. The peak factor of noise voltage is so high as to cause erroneous results if measured by a square-law vacuum-tube voltmeter. From measurements made on this noise voltage it appears that in receivers of high sensitivity requiring in the order of  $30 \mu\text{v}$  at the grid of the first tube

for standard signal output the noise output will be equivalent to about a one per cent modulation at 400 cycles.

The method of volume control of radio amplifiers by means of control-grid bias or screen-grid potential generally gives rise to conditions under which distortion of the modulated carrier voltage occurs. Two effects are then likely to happen, (1) an increase in effective modulation

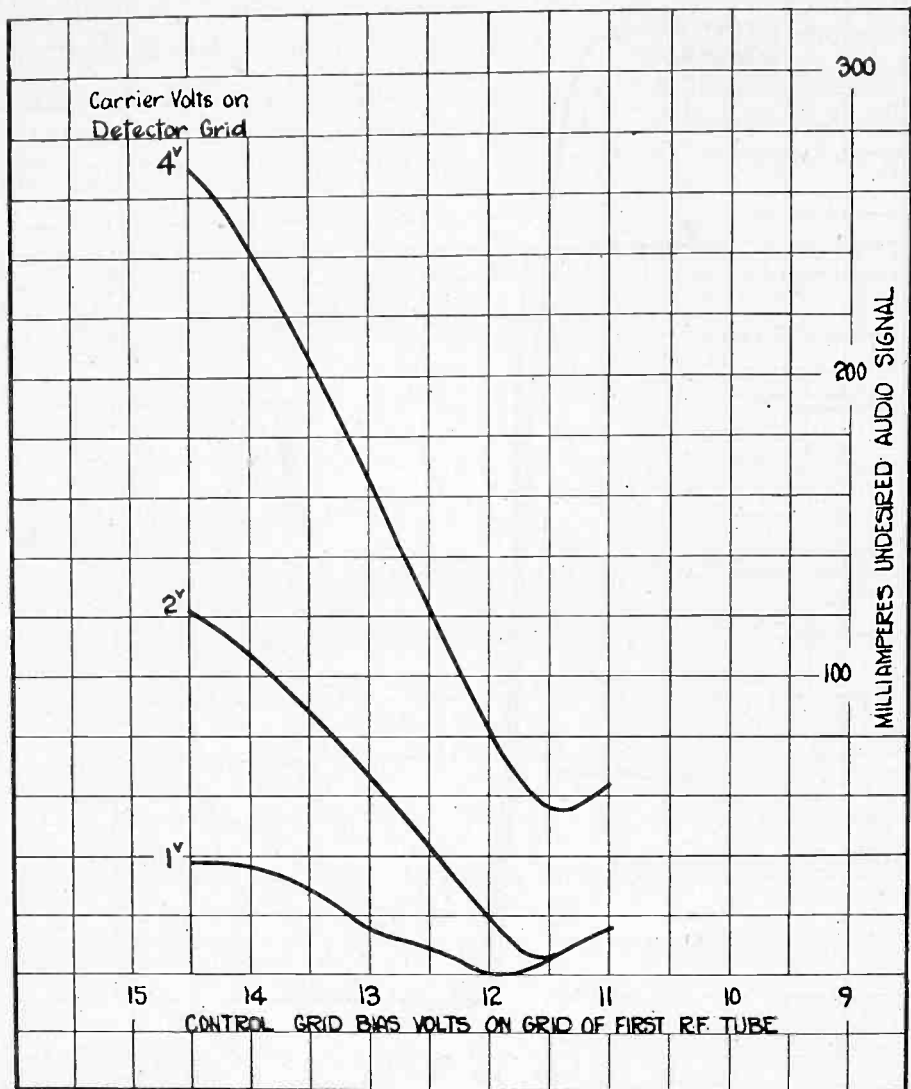

Fig. 8—Effect of volume control by grid bias upon intermodulation in the first r-f amplifier tube for various levels of desired carrier voltage at detector grid. Receiver tuned to desired carrier at 700 kc, modulation = 0. Undesired carrier at 715 kc,  $m = 30$  per cent. UY-224 r-f amplifier tubes.

percentage at the fundamental modulation frequency together with the introduction of harmonics of the modulation frequency, and (2) the possibility of intermodulation from any undesired signal voltage reaching the grid of the first tube. These effects may be measured in the laboratory with some additional equipment. The increase in effective percentage modulation at the fundamental modulation frequency may be observed by applying a large value of modulated

carrier at the input of the receiver with reduced volume control so as to hold the carrier voltage on the detector grid at a constant level. The audio output at the fundamental modulation frequency is then measured for various values of carrier input and compared with the output obtained with a carrier input corresponding to maximum r-f amplification. Fig. 7 shows the increase in fundamental audio output with control-grid bias on the first tube for various carrier levels at the detector grid.

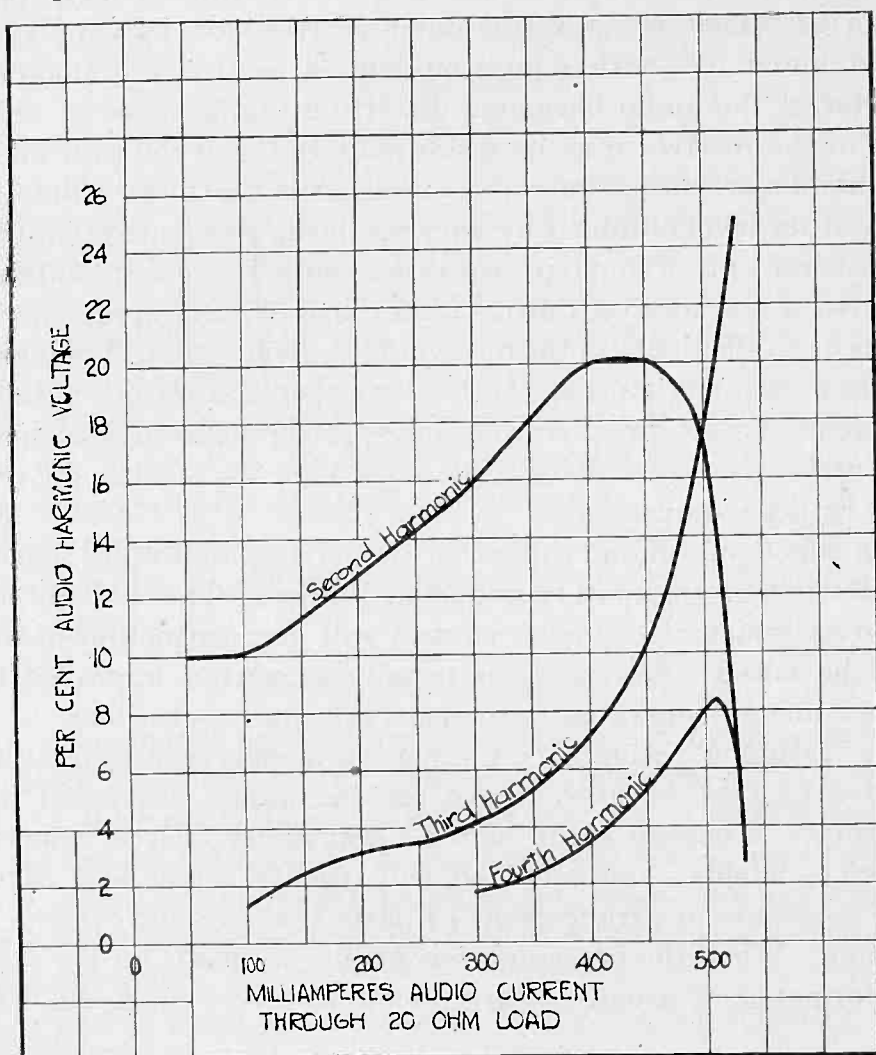

Fig. 9—Overall audio harmonic distortion in an experimental receiver for various output levels. Modulation = 30 per cent. Volume control on r-f amplifier set for maximum sensitivity.

Intermodulation may be measured by supplying the receiver under test from two oscillators of different carrier frequencies and different modulation frequencies. With the receiver tuned to one oscillator and with an appropriate audio selector in the output the amount of undesired audio output may be observed for various values of control-grid bias, setting the carrier input of the desired frequency to obtain a constant carrier voltage on the detector grid. In Fig. 8 are shown

curves of undesired output as a function of control-grid bias on the first r-f tube for various levels of carrier on detector grid.

The problem of measuring audio harmonic distortion due to volume controlling in the radio amplifier as well as that due to the process of detection and audio amplification brings up another special form of apparatus known as a harmonic audio analyzer. This instrument is capable of analyzing a complex wave to give the voltages at the several harmonic frequencies in per cent of the fundamental voltage. Such an instrument is a powerful tool in analysis, for, by supplying the receiver under test with a pure modulated carrier, the amount and character of the audio harmonic distortion taking place at different points in the receiver may be measured. In Fig. 9 the over-all audio harmonic distortion for one model receiver is shown as a function of audio output level obtained by varying the applied carrier input.

Measurements of sound pressures delivered by a given loud speaker connected to the receiver output for a range of audio frequencies give the true over-all fidelity of the receiver for a given sound chamber. The frequency characteristics of the loud speaker and output tube alone are in general quite irregular and unless some means of averaging the sound pressures over a small band of frequencies is used, the process will be rather tedious.<sup>5</sup>

The effects of volume control in the r-f amplifier upon sensitivity and selectivity form another important subject. The limits of carrier input over which the volume control will give extinction of output should be noted. Selectivity is usually somewhat improved if the volume control is operated to increase the control-grid bias.

The testing of preliminary production models is in general not so extensive as that outlined above for the model developed in the laboratory. A careful check of the usual items such as sensitivity, selectivity, fidelity, and overload will usually reveal any faults in circuit constants or arrangement of parts that are not evident upon inspection. When the necessary corrections are made on the receiver its performance is, usually, nearly identical with that of the original model.

Although the subject dealt with in the present paper would require considerably more space for a detailed treatment, it is felt that an outline including special and less well-known features of receiver testing should be of interest. In conclusion the authors wish to acknowledge contributions and suggestions from members of the engineering staff of the Radio Frequency Laboratories.

<sup>5</sup> A forthcoming paper by Stuart Ballantine will deal extensively with the apparatus and technique used in measurements of sound pressure.



## ENGINEERING CONTROL OF RADIO RECEIVER PRODUCTION\*

BY

VIRGIL M. GRAHAM AND BENJAMIN OLNEY

(Stromberg-Carlson Telephone Manufacturing Company, Rochester, N. Y.)

### INTRODUCTION

THE PURPOSE of this paper is to discuss briefly a system of radio receiver production testing and inspection, backed up by "proving" inspections and engineering laboratory checks, which gives close control of production quality to the radio engineering department. It is obviously very advantageous to have the engineering department in close touch with production and inspection, as by this contact the product can be held to the high standards set by the engineers. These high standards are continuously maintained giving uniformity of product, since any tendency of any characteristic to change is immediately detected and corrected.

The experience in precision testing of telephone equipment over a number of years is used advantageously in the inspection and testing of radio equipment.

### INSPECTION OF COMPONENTS

All components used in the construction of radio receivers are completely inspected and in most cases are given special operating tests. In order not to lengthen this paper with the description of routine tests which are made by all radio manufacturers, only two of the tests of component parts will be discussed. These two are selected as being typical of the method employed and illustrative of the type of equipment used.

The first of these tests so selected is the one for detecting shorted turns in small transformer solenoids. This equipment has been recently designed and placed in operation. It is an induction balance and has the advantage of being capable of testing any of the several solenoids used without altering the apparatus. This test is shown in Fig. 1. The box at the left contains an amplifier, and the one at the right is the test itself. The solenoid under test is slipped on the iron core pro-

\* Dewey decimal classification: R700.6. Original manuscript received by the Institute, May 19, 1930. Preprinted and presented at a joint meeting of the Institute of Radio Engineers and the Radio Manufacturers' Association, Atlantic City, N. J., June 3, 1930.

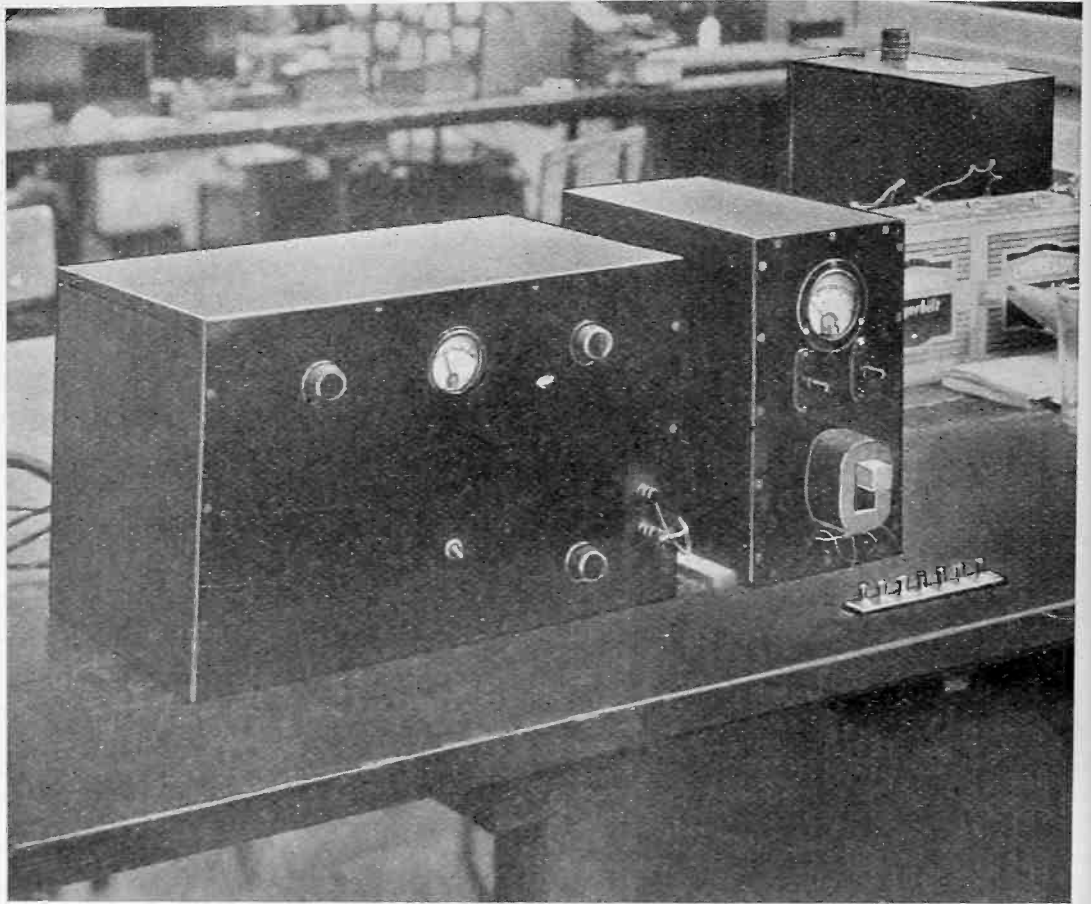

Fig. 1—Equipment for testing solenoids for shorted turns.

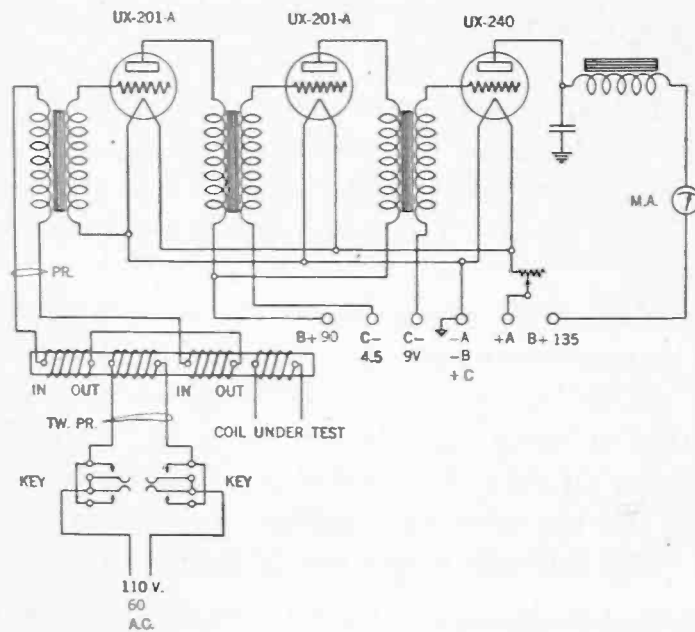

Fig. 2—Circuit of apparatus for testing solenoids for shorted turns.

ecting from the front panel. Then a key, also on the panel, is operated and the reading taken from the meter. When there are no shorted turns in the solenoid the pointer does not deflect. When shorted turns are present the pointer deflects in proportion to their number. Fig. 2 is the schematic circuit of this equipment.

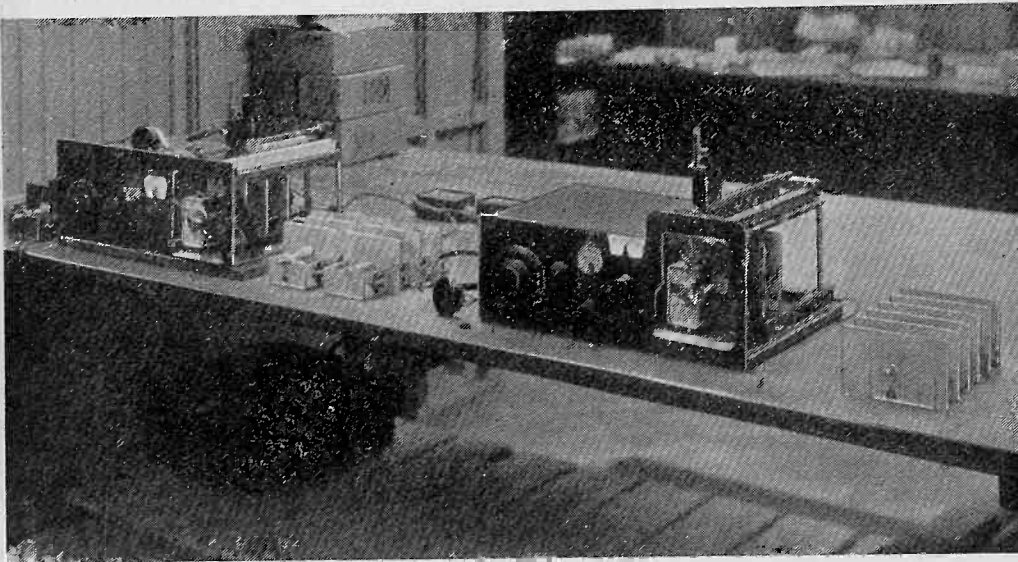

Fig. 3—Two of the testing instruments for measuring the uniformity among the units of the gang capacitors.

The other test is that for checking the uniformity of the units in the five gang tuning capacitor. Two such test equipments are shown in Fig. 3. The method employed uses the first unit of the gang capacitor as the reference, and the variation of the other units with respect to

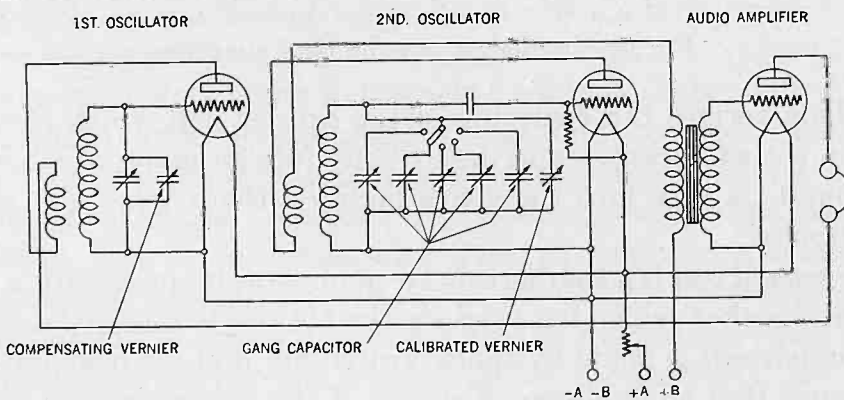

Fig. 4—Circuit of gang capacitor testing equipment.

the first is quickly obtained. The capacitors are checked at three dial settings. The circuits employed have been described in detail in the PROCEEDINGS.<sup>1</sup> This method of testing gang capacitors has given very

<sup>1</sup> Virgil M. Graham, "A gang capacitor testing device," Proc. I. R. E., 16, 1401; October, 1928.

satisfactory service for over two years, and has proved so accurate that the suppliers adopted it for their final inspection.

### PRODUCTION AND TESTING OF LOUD SPEAKERS

Electrodynamic loud-speaker assemblies are subjected to two separate operating tests before installation in the radio receiver cabinet. These tests are conducted in small rooms which are partially sound insulated to limit disturbing noises. The first test, shown in Fig. 5, consists in driving the loud speaker over the audio-frequency range by means of a beat-frequency oscillator of ample output power capacity and listening for any rattles or other evidences of sub-standard opera-

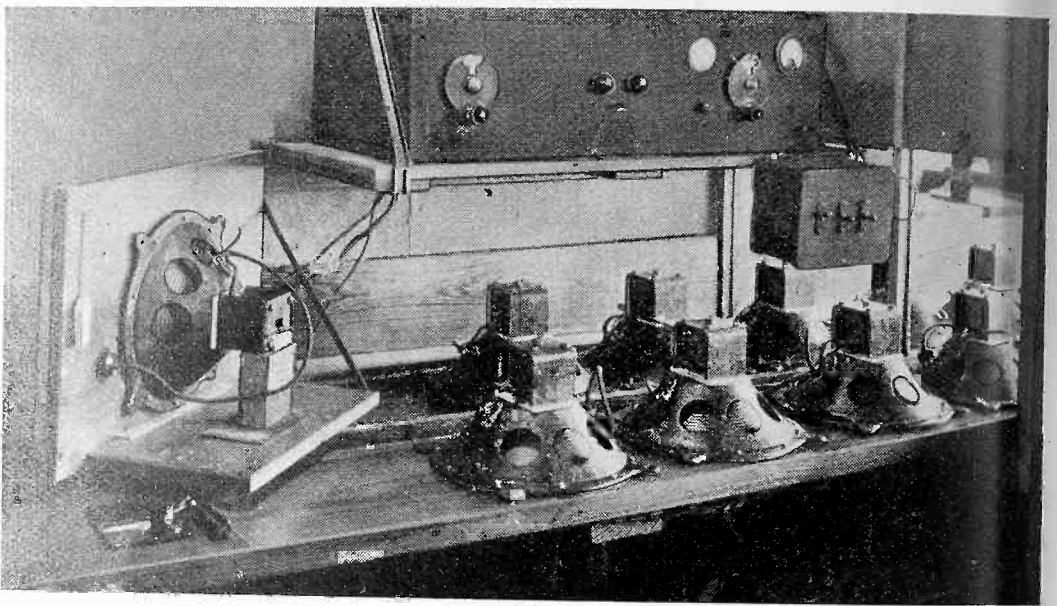

Fig. 5—Oscillator test for loud speakers.

tion. This verifies the centering of the driving coil which previously has been set with gauges and detects any foreign material which may have found its way into the space between the driving coil and the magnet poles.

The second test is a comparison on phonograph music with a standard loud speaker which has been checked in the acoustical laboratory. This comparison is made by quick switching, and its primary object is to insure that the volume efficiency of the test speaker is equal to or better than that of the standard. Tests are made at two volume levels, low and high, the test set being provided with a key with which to select the pre-set levels. Other keys are provided to adapt the outfit for testing magnetic armature speakers of various impedances.

Apparatus which will supplant the above test is under development. In this new equipment the speaker will be driven by a band-

quency oscillator, the sound being picked up by a condenser microphone and the resultant voltage compared with that appearing across the output of a fixed attenuator fed from the same oscillator that drives the speaker.

In order to insure that production speakers shall fulfill the expectations of the engineering department, it has been the practice to carry out in the acoustical laboratory the design of important shop fixtures required for the assembly of the moving systems of speakers. Before starting actual factory production on a new model, experimental production of such assemblies is carried on in the laboratory and the resulting speakers given careful tests for efficiency and uniformity of performance. When factory production starts, an engineer from the acoustical laboratory follows through the processes, sees that the assembly fixtures are properly installed and used and aids in the instruction of operators performing the more delicate and important parts of the work. This engineer spends most of his time in the factory until it is found that the usual initial difficulties have been overcome and that the production of a satisfactory quality of apparatus can continuously be maintained.

#### TEST AND INSPECTION OF RECEIVER CHASSIS

The radio receiver chassis are assembled and wired on a "line." In this process, one operator puts on certain apparatus, or does certain wiring, and passes the chassis on to the next operator. This continues until the chassis reaches the preliminary electrical inspection.

Just as much as the wiring connections are made in groups, these groups or sections of the receiver are given a mechanical inspection and continuity test before going to the next position. This method makes the procedure more specialized, so that one operator, instead of making all the connections in a chassis, only solders a few and becomes expert at those. Likewise, the inspectors inspecting only a few connections, etc., are accurate with those items and the tendency to miss unsoldered joints, loose nuts, and such things, is not present as it would be if the inspector looks over all the points in the chassis. This system allows inspectors at frequent intervals along the assembly line.

After the chassis has been completely assembled, wired, and inspected as above described, it goes to a final continuity test and then to the preliminary electrical test. In this latter test the voltages at all the sockets are measured and breakdown tests applied. The purpose of this procedure is to locate any wiring or other electrical faults before sending the chassis to the aligning and calibrating operators.

The next operation is that of aligning and calibrating the receivers.

satisfactory service for over two years, and has proved so accurate that the suppliers adopted it for their final inspection.

### PRODUCTION AND TESTING OF LOUD SPEAKERS

Electrodynamic loud-speaker assemblies are subjected to two separate operating tests before installation in the radio receiver cabinet. These tests are conducted in small rooms which are partially sound insulated to limit disturbing noises. The first test, shown in Fig. 5, consists in driving the loud speaker over the audio-frequency range by means of a beat-frequency oscillator of ample output power capacity and listening for any rattles or other evidences of sub-standard opera-

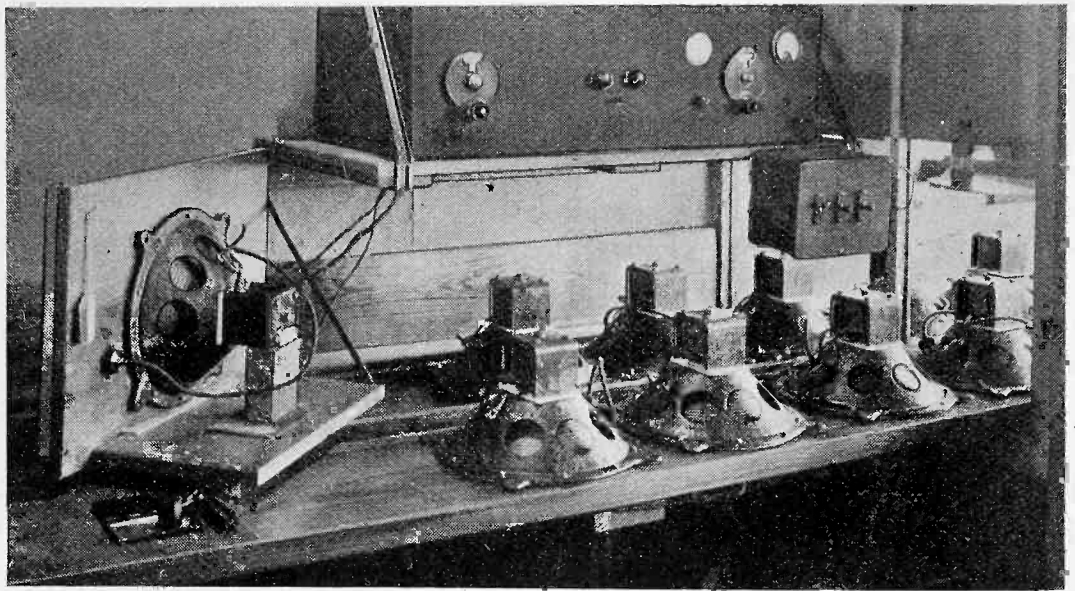

Fig. 5—Oscillator test for loud speakers.

tion. This verifies the centering of the driving coil which previously has been set with gauges and detects any foreign material which may have found its way into the space between the driving coil and the magnet poles.

The second test is a comparison on phonograph music with a standard loud speaker which has been checked in the acoustical laboratory. This comparison is made by quick switching, and its primary object is to insure that the volume efficiency of the test speaker is equal to or better than that of the standard. Tests are made at two volume levels, low and high, the test set being provided with a key with which to select the pre-set levels. Other keys are provided to adapt the outfit for testing magnetic armature speakers of various impedances.

Apparatus which will supplant the above test is under development. In this new equipment the speaker will be driven by a band-

frequency oscillator, the sound being picked up by a condenser microphone and the resultant voltage compared with that appearing across the output of a fixed attenuator fed from the same oscillator that drives the speaker.

In order to insure that production speakers shall fulfill the expectations of the engineering department, it has been the practice to carry out in the acoustical laboratory the design of important shop fixtures required for the assembly of the moving systems of speakers. Before starting actual factory production on a new model, experimental production of such assemblies is carried on in the laboratory and the resulting speakers given careful tests for efficiency and uniformity of performance. When factory production starts, an engineer from the acoustical laboratory follows through the processes, sees that the assembly fixtures are properly installed and used and aids in the instruction of operators performing the more delicate and important parts of the work. This engineer spends most of his time in the factory until it is found that the usual initial difficulties have been overcome and that the production of a satisfactory quality of apparatus can continuously be maintained.

#### TEST AND INSPECTION OF RECEIVER CHASSIS

The radio receiver chassis are assembled and wired on a "line." That is, one operator puts on certain apparatus, or does certain wiring, and passes the chassis on to the next operator. This continues until the chassis reaches the preliminary electrical inspection.

Inasmuch as the wiring connections are made in groups, these groups or sections of the receiver are given a mechanical inspection and continuity test before going to the next position. This method makes the procedure more specialized, so that one operator, instead of soldering all the connections in a chassis, only solders a few and becomes expert at those. Likewise, the inspectors inspecting only a few connections, etc., are accurate with those items and the tendency to miss unsoldered joints, loose nuts, and such things, is not present as it is if the inspector looks over all the points in the chassis. This system places inspectors at frequent intervals along the assembly line.

After the chassis has been completely assembled, wired, and inspected as above described, it goes to a final continuity test and then to the preliminary electrical test. In this latter test the voltages at all the sockets are measured and breakdown tests applied. The purpose of this procedure is to locate any wiring or other electrical faults before sending the chassis to the aligning and calibrating operators.

The next operation is that of aligning and calibrating the receivers.

This is done in a room provided with a number of positions, each one equipped with an individual testing set-up. Such a set-up consists of amplifiers (supplied from common crystal oscillators), signal strength control, and the proper dummy antennas. Voltmeters are also supplied to each position, so that the operator can check and locate any trouble that was not detected in preliminary tests.

The chassis is first aligned at 1500 kc with the dial set to the proper marking. The alignment and dial readings are then checked at 550 kc.

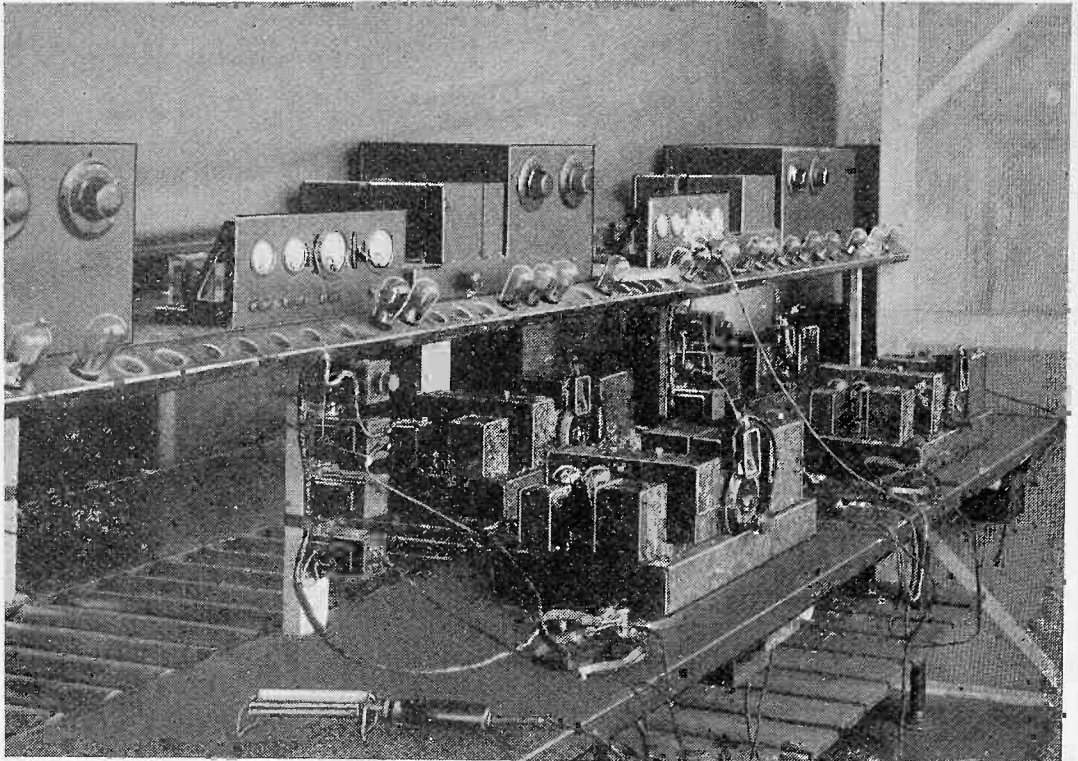

Fig. 6—Two positions in the test room where the receiver chassis are aligned and calibrated.

This check obviously necessitates resetting the alignment for 1500 kc, and this is accordingly done. The test is completed by checking the dial calibration in the middle of the broadcast range, and testing the operation of the pickup switch and jack circuits.

These tests are watched very closely by the radio engineers, to see that the equipment is kept functioning properly and that close limits are maintained. The operators in this test room are skilled men and are, of course, thoroughly acquainted with the circuits of the receivers. These men are given instruction by the radio engineering department in circuits and operation of new receivers before production is started. All the tests of the chassis mentioned above are conducted by the manufacturing group. The chassis are not considered to be completed



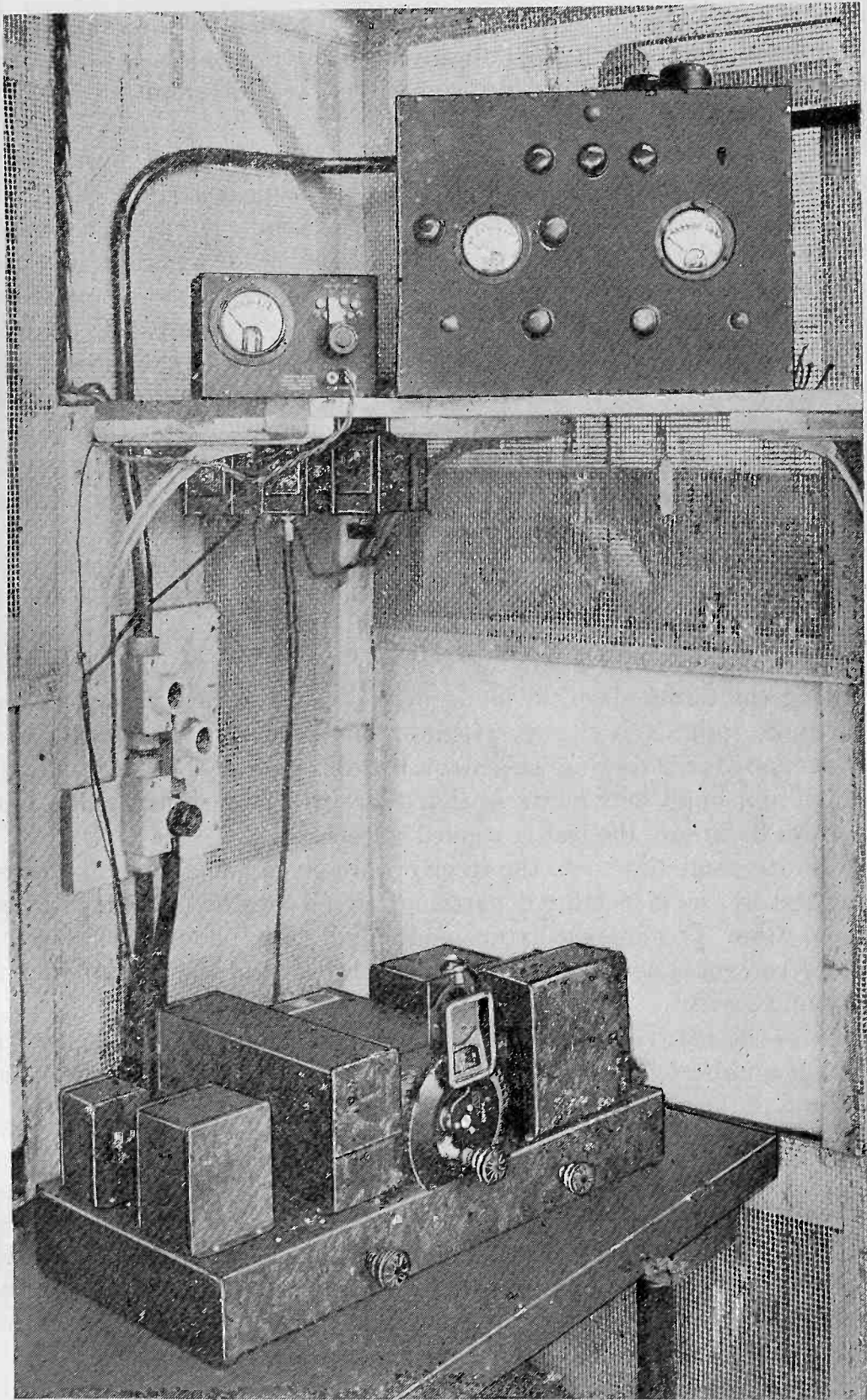

Fig. 7—View of equipment for performance test in shielded room.

until they are aligned and calibrated. Therefore, after this is done the completed unit is delivered to the inspection department for performance test. This procedure consists of tests for sensitivity, selectivity, fidelity, and hum.

The equipment used is set up in a shielded booth, and consists of a standard signal generator with proper controls for measuring the three characteristics at important points of the various curves. The sensitivity is measured at three frequencies in the broadcast range, and the selectivity is measured at these same three points at 10 kc both sides of the resonant frequencies. As the frequency is changed to the off-resonance values, the input to the receiver is increased a hundredfold.

The fidelity is checked at three carefully selected audio frequencies at each of the above mentioned radio frequencies. After the chassis have been passed through these tests by the inspection department, they are delivered back to the manufacturing organization for placing in the cabinets along with the loud speakers.

The completed receivers are taken into a quiet room where two more tests are applied. The first of these is for rattles, which might occur when the loud speaker is operated at high volume. For this a beat-frequency audio oscillator with an amplifier is coupled to the moving-coil terminals of the loud speaker. The oscillator is tuned over the audio range and if any rattles or vibrations are detected in the cabinet or chassis they are taken out. Of course, every effort is made to design and build both units so that there will be no such faults, but in order to be sure the test is applied to each set.

In this same test room the receivers are given a final overall operation test by the inspection department. This consists of tuning in the signal from a small oscillator modulated with phonograph music. Every control is checked for normal operation and the pickup circuit is again tested.

Now the receiver is ready to be packed and shipped. At this time a certain number of receivers are selected to be tested by the proving division of the radio engineering department.

#### "PROVING" TESTS OF RECEIVERS

This proving division is equipped with complete laboratory equipment for measuring receiver characteristics, all necessary meter equipment and generators supplying direct current and various frequencies of alternating current. This division takes a number of receivers daily just before packing and puts them through first a rigid mechanical and electrical inspection, taking complete sensitivity, selectivity, and fidelity curves as well as measuring maximum power output and hum.

A portion of the chassis of these receivers are put on a "bumping" test for a time, and then put through the complete procedure again. Other receivers are shipped to branch offices and returned without being unpacked to determine if any damage occurs in shipment.

The head of the proving division reports directly to the engineer in charge of the radio engineering department, so that information on the quality of the product is continuously supplied to that department and immediate action can be taken if any change in characteristics is noted.

All the inspection and proving tests are backed up by frequency checks by the laboratories of the radio engineering department and the acoustical laboratory. These laboratories carry on the experimental and design work on chassis and loud speakers.

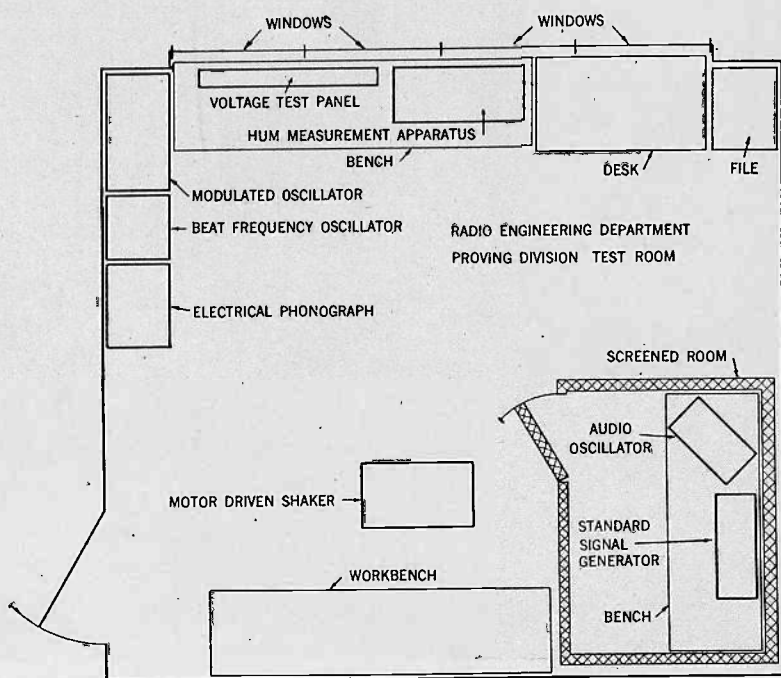

Fig. 8—Plan of test room of proving division of radio engineering department.

The radio laboratories are equipped with standard receiver measuring apparatus and much special equipment has been and is being constructed. One engineer is assigned to the problem of keeping all such apparatus up-to-date and of building new instruments.

The acoustical laboratory is completely equipped with modern measuring instruments for testing loud speakers and magnetic pickups. This apparatus is being revised from time to time as the art advances.

There are certain types of tests on loud speakers which, because of the amount of apparatus and time required, are impracticable for factory use. The primary use of such tests is in development work,

but they are also of great practical value in checking a limited portion of the factory product. Response measurements fall in this class.

The purpose of a response measurement is to determine, over the audio-frequency range, a relation between the sound power delivered by the loud speaker under specified acoustic conditions, and the available electric power in the input circuit. Measurements made on the same loud speaker under different acoustic conditions may show widely differing results. The best conditions are out of doors and remote from reflecting surfaces, but practical necessity makes indoor measure-

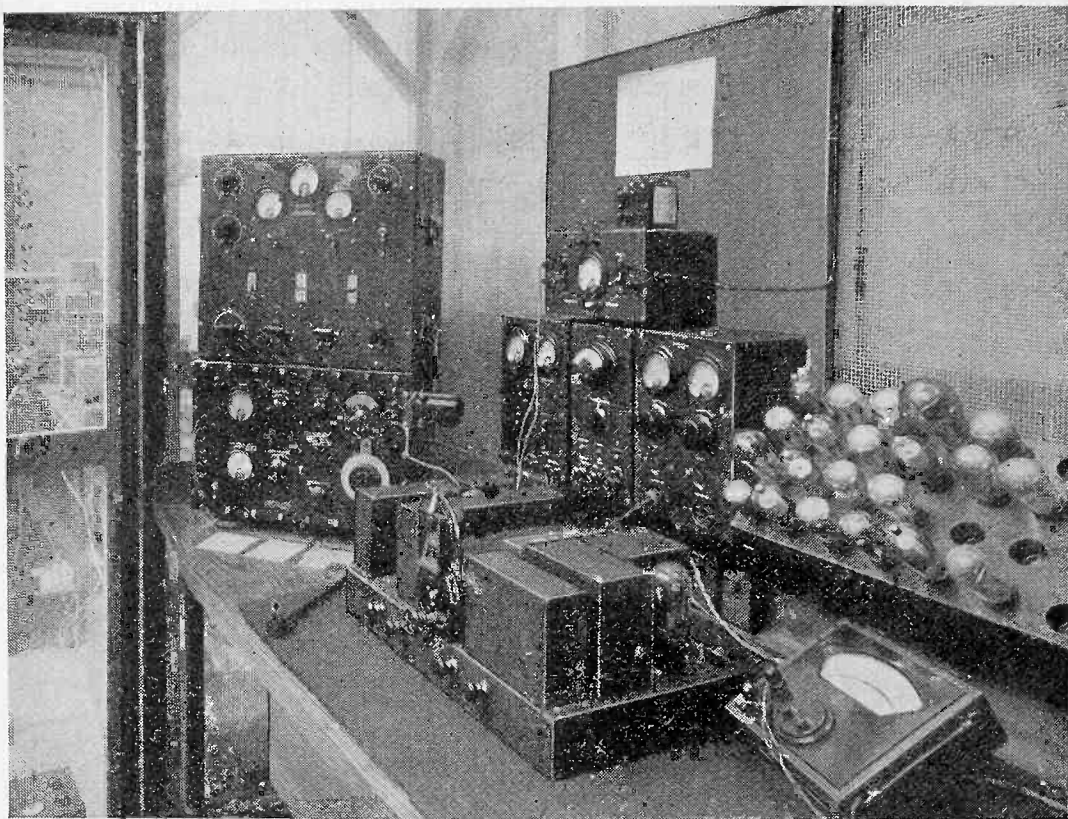

Fig. 9—View of one of the laboratory shielded rooms with receiver measuring equipment.

ments desirable. The obtaining of the proper acoustic conditions indoors constitutes the major problem in such loud-speaker measurements.

An excellent measuring system has been described by L. G. Bostwick.<sup>2</sup> This method possesses the important advantage that measurements may be repeated over long periods of time because the system virtually is calibrated at every frequency point taken.

The apparatus set-up for the above system as employed by the authors is shown in Fig. 10. It is mounted on a truck so as to be readily portable when it is desired to make outdoor measurements.

<sup>2</sup> L. G. Bostwick, "Acoustic considerations involved in steady state loud speaker measurements," *Bell Sys. Tech. Jour.*, January, 1929.

Indoor measurements are made in the room shown in Fig. 11. This room is built with double celotex walls and ceiling on separate studs and joist and all of its interior surfaces are covered with one-inch hair felt. Strips of the latter material also are suspended from the ceiling in the manner shown in the photograph, the object of the large amount of sound absorbent material being to reduce reflection from the bounding surfaces. The arrangement of the strips on the ceiling and the irregular twists in the wall drapes are for the purpose of diffusely

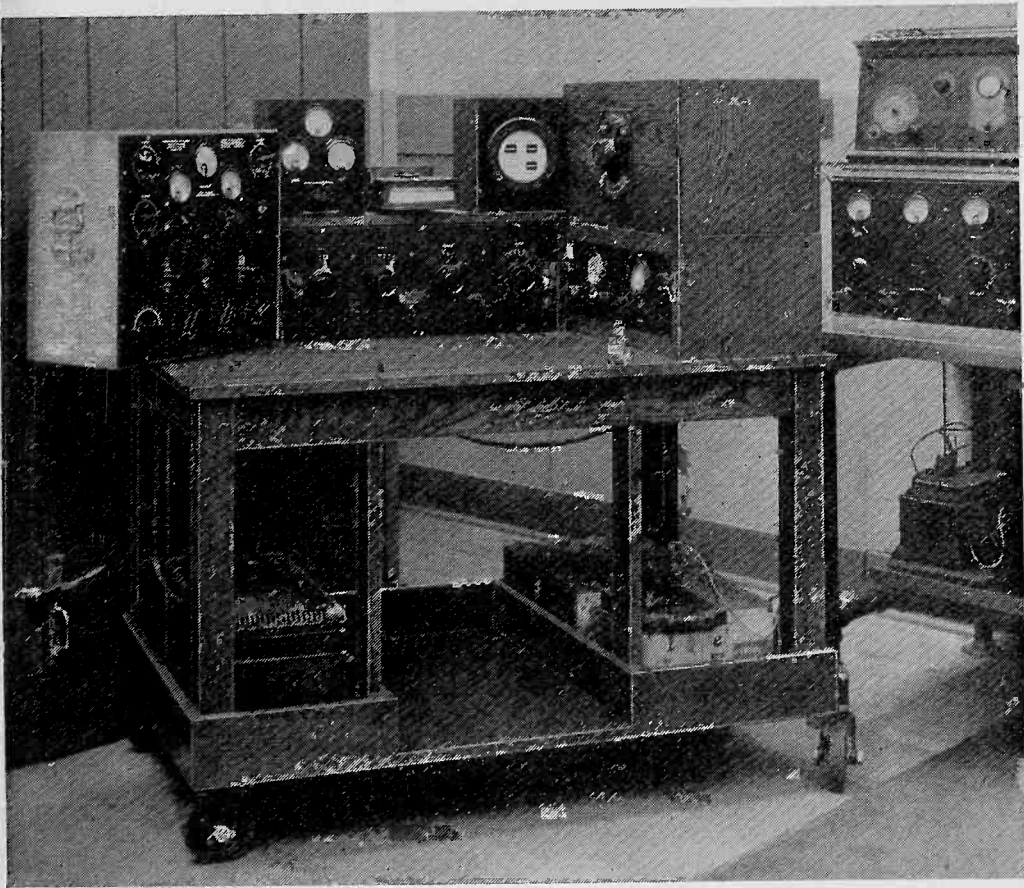

Fig. 10—Loud-speaker response measuring apparatus.

reflecting sound waves in the lower frequency region where the absorption coefficient of the felt is relatively small. This results in a more random distribution of sound in the room. The size of the measuring room is 15 ft. by 22 ft. by 11 ft. high.

The sound is picked up by a calibrated condenser microphone which, with its associated first-stage amplifier, is mounted in a spherical housing on the end of the rotating arm shown in the reproduction of the photograph. This arm carries the microphone around an 8-ft. diameter circular orbit at the rate of about 27 r.p.m., a mechanical arrangement being employed for keeping the microphone axis always

parallel to that of the loud speaker. The thermocouple and meter which form the indicating portion of the electrical system are sufficiently slow to permit a fairly steady reading to be obtained when the

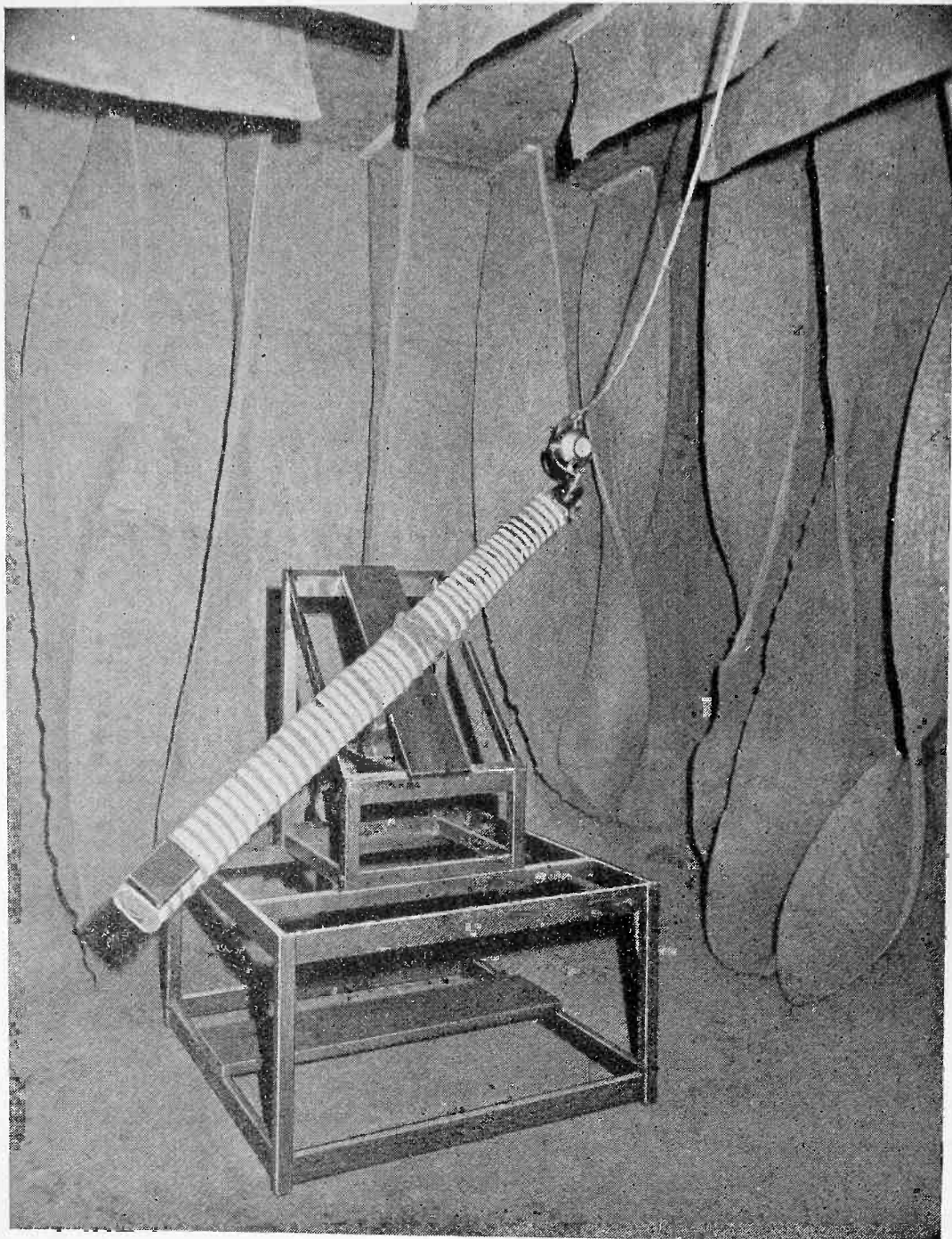

Fig. 11—Microphone rotator in loud-speaker response measuring room.

condenser microphone is passing through the varying sound pressures due to the standing wave system in the room. This arrangement causes the meter deflection to be proportional to the average of the squares of the sound pressures around the microphone path and, over the

reater part of the frequency range, reduces the effect of reflections in the measuring room so that outdoor conditions are approached.

By means of the above apparatus, periodic checks are made on production loud speakers in order to detect any marked departures from the average response curve. The sensitivity of the method is such that differences which are too small to be heard may readily be measured. The over-all characteristics of radio receivers are also obtained by combining the results of electrical measurements of the radio

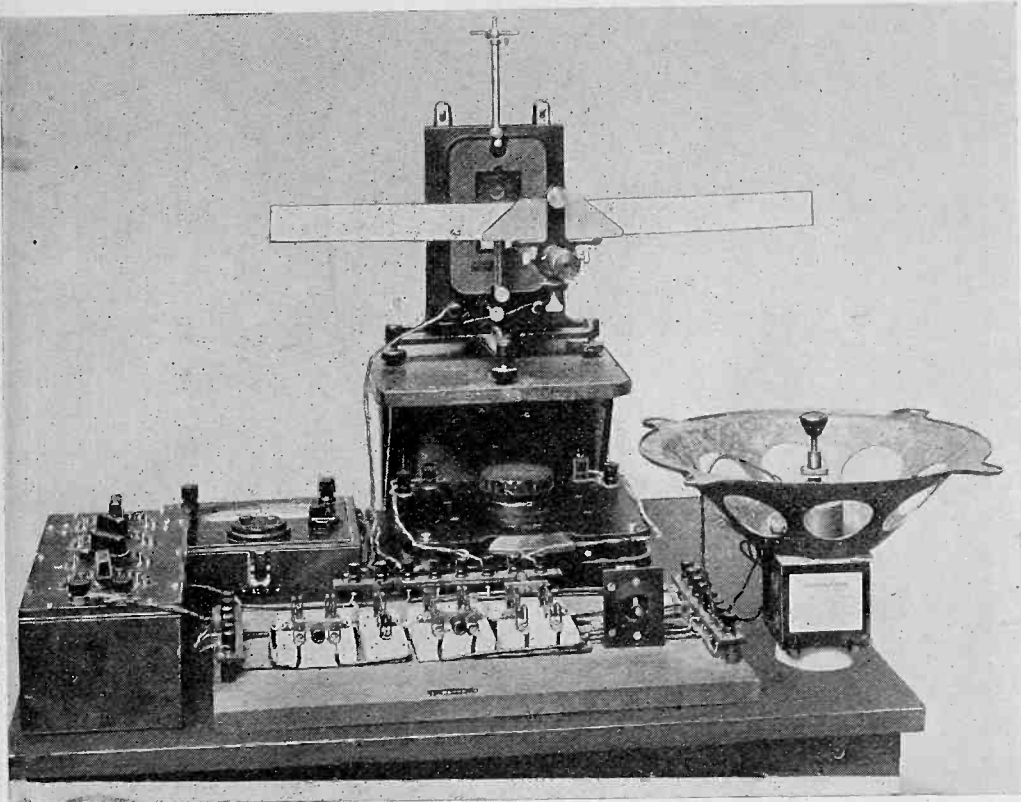

Fig. 12—Apparatus for measuring gap flux density in electrodynamic loud speakers.

receiver chassis and response measurements of the loud speaker mounted in the proper cabinet.

Another type of laboratory measurement which is very useful in checking production speakers is the determination of the magnetic flux density in the air-gap in which the driving coil moves. This is an important factor, as the efficiency of the speaker over the working range is proportional to the gap density. This quantity may be affected by variations in the magnetic quality of the iron parts, by variations in their dimensions and method of assembly and also by variations in field coils. The stock for the iron parts is received in such forms that the preparation of regular magnetic test samples is a difficult matter,

so that it is much more convenient to check such materials by measurement of the gap density of loud-speaker field structures in which parts made from them are assembled, together with other parts of known, standard quality.

A convenient assembly of apparatus for making gap density measurements is shown in Fig. 12. A fluxmeter-type reflecting gal-

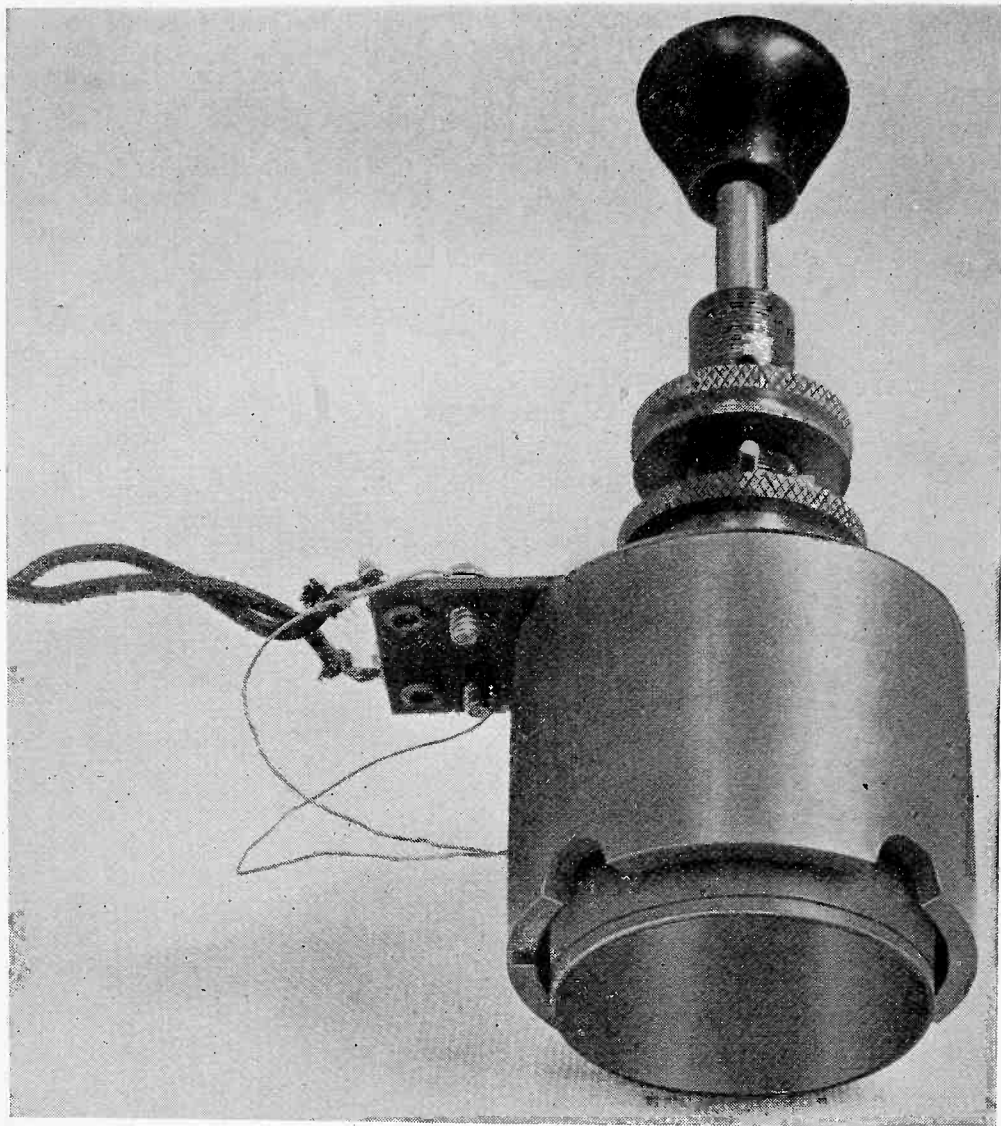

Fig. 13—Detail view of search coil fixture used in measuring gap flux density of electrodynamic loud speakers.

vanometer is used and is calibrated by reversing a measured current through the primary of the mutual inductometer shown. To measure the gap density a single-turn search coil, whose diameter is the mean diameter of the gap and whose terminals are connected to the galvanometer, is moved over the axial length of the gap. If desired,



the galvanometer may be so calibrated that it indicates the flux density directly in gaussses.

In order to make accurate measurements, it is necessary that the search coil motion be rectilinear and that its limits be definitely set. These requirements are met by the use of the fixture shown in Fig. 13. The single-turn search coil of fine wire lies in a groove near the end of a tube of insulating material. This tube is attached to a plunger which slides in a long, well-fitted bearing and whose motion may definitely be limited by adjustment of the two nuts on the stem. This bearing is carried by a brass cup which houses the search coil tube and whose lower end is faced off parallel with the search coil. In use, the fixture is placed with the brass cup resting on the front plate of the speaker field structure and with the search coil in the air-gap, the stop nuts being so adjusted that when the plunger is drawn out, the search coil is moved over the width of the pole faces.

Accelerated life tests are made on loud speakers by driving them to the limits of motion of their vibrating systems at a frequency near fundamental resonance. This affords a valuable check on the quality of materials used in such parts as suspensions and driving coil leads.

In this manner both the radio and acoustical engineers keep in close personal touch with every inspection and test in the factory, in order to maintain high standards of production quality.

While not strictly within the scope of this paper, it may be well to mention some other activities of the radio engineering department in connection with broadcast receivers. These include field tests of preliminary models, coöperation with various engineering and research laboratories, preparation of engineering data books on new receivers, holding of technical schools for both factory men and dealers' men, and the preparation of data for the sales department.



## DRY ELECTROCHEMICAL CONDENSERS\*

BY

P. E. EDELMAN

(Electrical Engineer, Chicago, Ill.)

**Summary**—Operating characteristics of compact, dry, electrochemical, high-voltage filter condensers, comprising a dielectric plated sheet electrode contacting with a gummed spacer rolled with an untreated electrode sheet, show that such condensers are in all respects suitable for power-pack filter service and effect large reduction in costs.

Commercial condensers of this type have working voltages up to 700 volts d-c. The leakage current, which determines the merit of an electrochemical condenser, is extremely small in the case of the gum condenser and affords a very long operating life. Gum condensers are operable in the extreme temperature range from  $-30$  deg. F through  $+250$  deg. F.

A RELIABLE filter condenser of low cost is afforded by a polarized couple structure employing two thin aluminum sheets separated by a thin gummed-fabric spacer, wherein one of the aluminum sheets is plated with a dielectric coating. Fig. 1 shows a diagram of this couple.<sup>1</sup> A commercial aluminum sheet 0.006 in. thick is used for the electrodes, the negative electrode being untreated and the positive electrode being coated with a permanent dielectric film. The spacer employed is a porous fabric approximately 0.009 in. thick impregnated with an organic gum.<sup>2</sup> The relative thermal masses of this structure, as used in compact roll form are such that the metal mass predominates and tends to dissipate any heat which occurs internally. The normal operation of the gum condenser is accordingly not accompanied by a rise in temperature.

This gum condenser has a high capacity of permanent value in a small bulk and has a low energy loss. It is substantially free from surge breakdown and merely suffers temporary increase in leakage current at the time an abnormally high voltage is applied thereto. With the heat generated by such overload dissipated, the condenser returns to its normal low leakage at its rated voltage limit. No reforming operation is required for this restoration of the overloaded condenser.

\* Dewey decimal classification: R381. Original manuscript received by the Institute, April 26, 1930.

<sup>1</sup> U. S. Patent No. 1,730,725 issued, Oct. 8, 1929, on gum electrolyte; U. S. Patent No. 1,753,920 issued April 8, 1930, on dry-type condenser.

<sup>2</sup> The gum used commercially is purified gum arabic, prepared in a saturated syrup.

The principal factors which determine the merit of this condenser are a very low leakage current under normal operating conditions and an ability to withstand overload peaks. This result is attained by a dielectric film coating on the positive electrode, characterized by permanance and ruggedness. Whereas polarized condensers generally tend to have an increased current leakage after being idle for a period of time, the hardness of the gum condenser coated electrode reduces

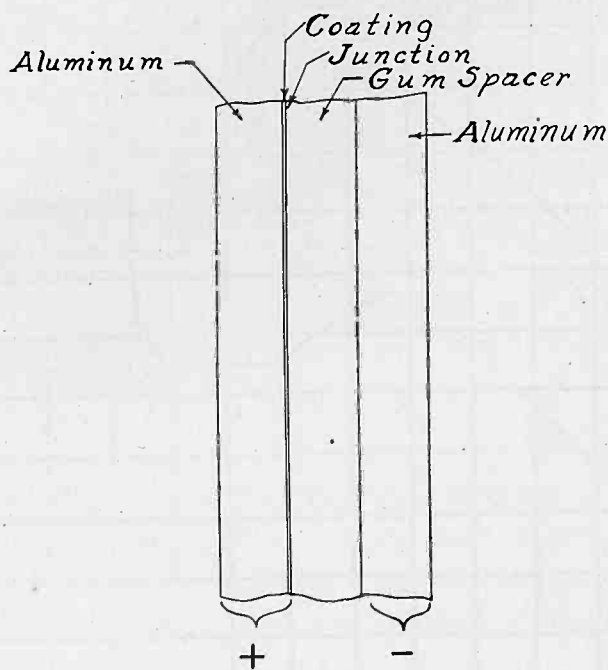

Fig. 1

such current leakage increase. The coated electrodes do not lose their dielectric film, even after long standing.

#### DIELECTRIC COATING

Referring to Fig. 1, the dielectric coating is plated to cover the positive electrode entirely. This coating is hard, does not flake off upon bending of the electrode sheet, and is exceedingly thin. It is applied electrolytically at a temperature of 90 deg. C by connecting the aluminum sheet as anode in a molybdate plating solution operated at 460 volts d-c. The plating time varies according to the size of the electrode, a 2  $\mu$ f anode requiring but 40 minutes plating time while an 8  $\mu$ f anode requires 150 minutes. The plated anodes are air-dried and may be used in assembly the same day or at any future time as long as a year later because the coating does not deteriorate upon standing.

## LOW LEAKAGE CURRENT

The assembly of coated electrodes with the negative untreated sheet and the gummed spacer strip is completed by a simple winding operation, after which the assembled sections are tested, sealed, and grouped for usual canning and terminal mounting. The gum con-

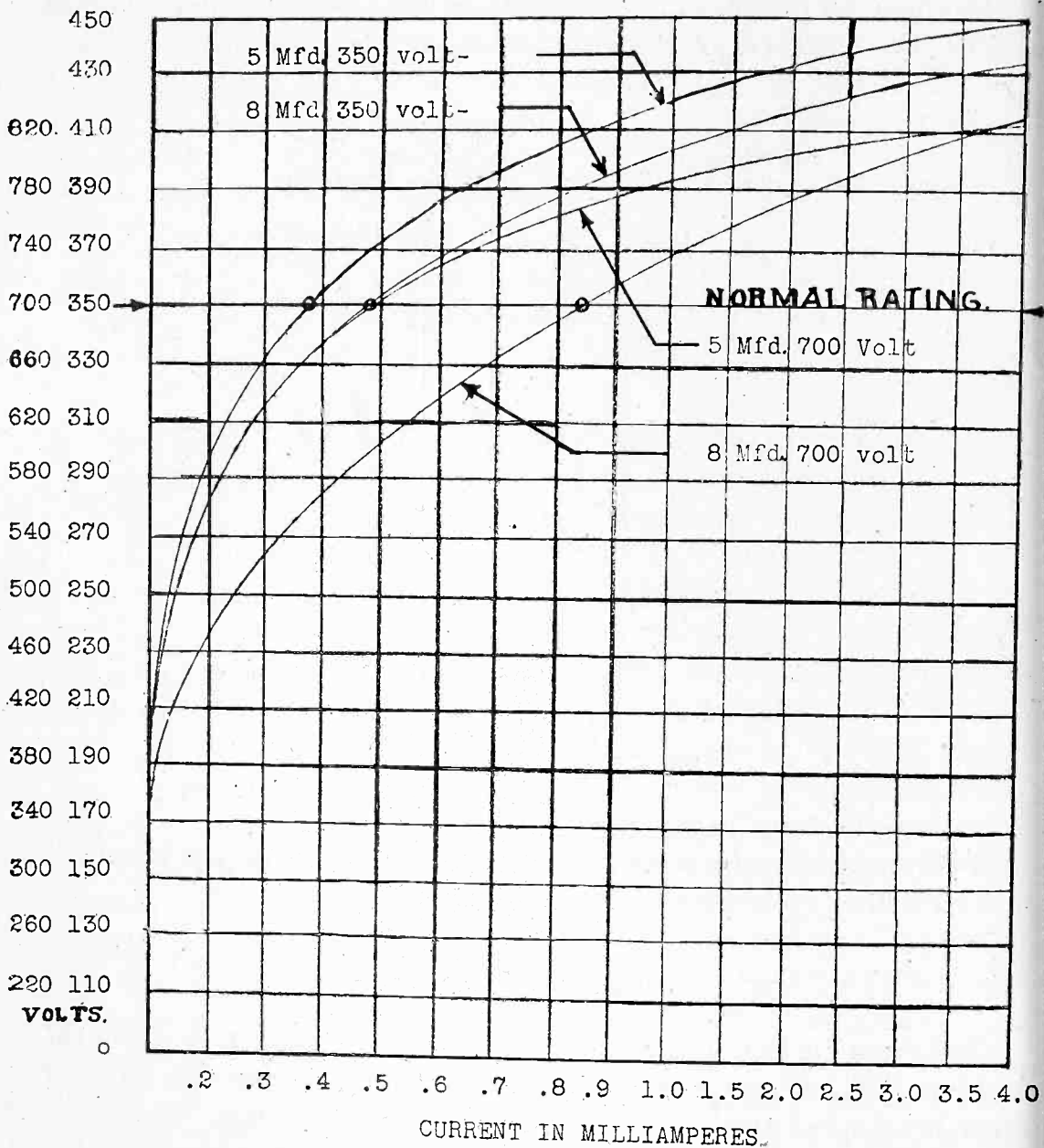

Fig. 2

densers can be used in any position in any desired mounting shape. The merit of a condenser is determined by its leakage current, which is very low. Considering an 8- $\mu$ f section rated at 350 volts for normal operation limit, the leakage current at 350 volts will not exceed 1/2 ma for the 8  $\mu$ f or 1/16th ma per  $\mu$ f at rated voltage. At lower volt-

ge the leakage will be still less. Curves for both 5- and 8  $\mu\text{f}$  gum condensers in both 350 volt and 700 volt rated types are shown in Fig. 2. These leakage currents are negligibly small and insure long operating life. In fact, gum condensers have been in continuous service over a period of three years and are still in excellent condition.

#### NO HUM LEAKAGE CURRENT

As shown in Fig. 3, the gum condensers are normally used in any standard filter circuit interchangeable with and/or replacing paper-

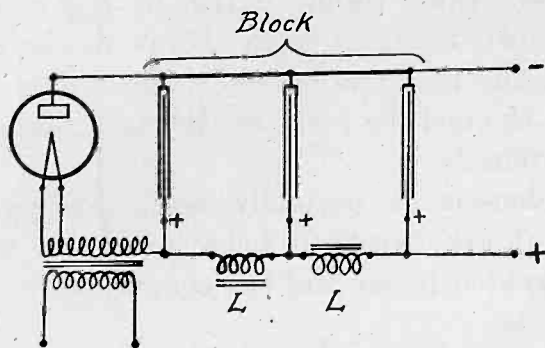

Fig. 3

type condensers. Each condenser section is isolated from its neighboring section electrically so that there is no hum current leakage across the filter choke coil. Dimensions of a commercial condenser block of this kind are shown in Fig. 4. The costs of such blocks range at a small

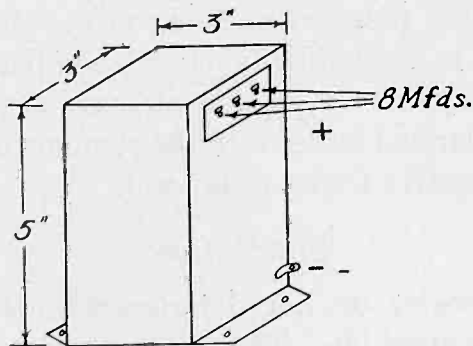

Fig. 4

fraction of the equivalent paper condenser. Some blocks are made with small by-pass condensers sealed in the same can.

#### HIGH CAPACITY PER UNIT AREA

The high capacity per unit area of the order of one  $\mu\text{f}$  per 4 sq. in., attained by the contact action at the junction of the gum and the anode coating affords very compact assemblies of large capacity. Commercial capacity sizes range from 1  $\mu\text{f}$  up to 5000  $\mu\text{f}$ . Owing to the

extreme operating range from  $-30$  deg. F up thru  $+250$  deg. F there is no possibility of freezing damage nor evaporation loss.

#### EFFECT OF TEMPERATURE

This brings out the interesting fact that the gum condenser is not harmed by extremes of operating temperature or shipping temperature in winter or in summer. It may be remarked that when the condenser is operated above normal operating temperatures, the leakage current will be increased, but that in all cases this leakage current will return to the normal small value it originally had at return to normal temperature. In tests made to verify this point the specimen did not break down until the temperature was increased in an electric oven up to  $160$  deg. C, the melting point of the sealing wax used to support the condenser terminals.

The gum condensers are normally sealed nonhygroscopically and in this as well as in other respects behave in many ways like a high-grade wax-impregnated paper and foil condenser.

#### USES

Aside from increasing use of such condensers in power pack and filter circuits there are a large number of general uses in the electrical arts. Operation on pure a-c supplies where a rectified component is absent is not permissible except for brief periods of time, such as in the case of the starting of a condenser-type induction motor. Its wide temperature operating range extends the use of the condenser to outdoor mounting or to assembly in closed compartments with other current consuming apparatus. This condenser should always be connected in correct polarized sense, with the common or negative terminal connected to the negative feeder conductor.

#### SHELF LIFE

The gum condensers do not deteriorate during long periods of idleness or standing shelf life. The dielectric coating is not dissolved nor lost on standing, so reforming is not required before use. The normal charging time ranges between 5 sec. and 15 sec., according to the size of the condenser. The time required for the condenser to stabilize at normal operation is invariably less than the time required for the heater tubes in a radio chassis to warm up to normal temperature. Specimen samples checked at various periods of idleness, after remaining unused for periods of 4 months, 8 months, 13 months, 18 months, and 25 months showed the longest charging time to be 85 sec. in the last case.

## EFFECT OF CONTINUED OPERATION

On the other hand, invariably, and for a large group of specimens, the effect of continued operation is observed to show a continued reduction in current leakage with time up to the 41st day of continuous operation at which time a minimum leakage ranging on an average only 10 per cent of the normal leakage on intermittent operating service is attained. The conclusion reached is that, for a given operating voltage there is an irreducible minimum leakage current. This may be due, however small, to molecular pores in the lattice structure of the anode coating. For all practical purposes the leakage currents are negligibly small.



## WAR DEPARTMENT MESSAGE CENTER\*

By

FRANK E. STONER

(Signal Corps, War Department, Washington, D. C.)

WITH THE completion of a new short-wave transmitting station at Fort Myer, Virginia, the Signal Corps of the War Department is introducing the beam-transmission system of radio communication in handling radio traffic for the 55 Government bureaus now utilizing the facilities of the War Department Message Center. This

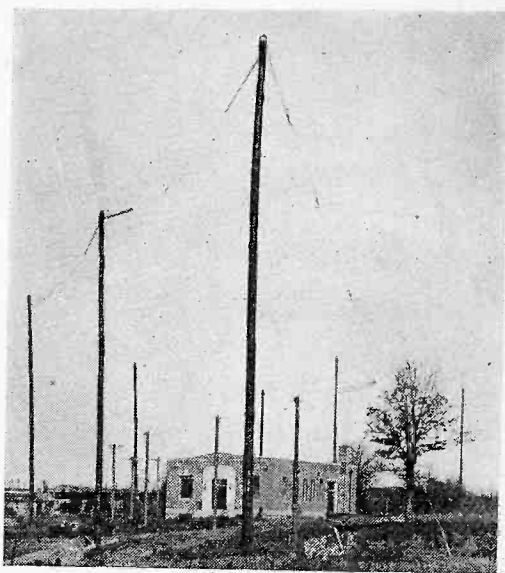

Fig. 1—War Department radio-transmitting station WAR showing complete antenna system.

departure means that directional short waves will carry messages to the far-flung corners of continental United States and our insular possessions, the electric energy being concentrated in a given direction instead of being diffused in all directions. The directional effect is achieved by use of reflectors which catch and reflect back the radio waves in a manner not dissimilar to the mirror of a searchlight in catching and reflecting rays of light.

The new radio installation at Fort Myer is comprised of three groups of transmitting sets; one 10,000-watt, two 1000-watt, and three 500-watt high-frequency transmitters. Their frequency range is extensive, from 4000 to 18,000 kc, and the six sending sets have been

\* Dewey decimal classification: R560. Original manuscript received by the Institute April 4, 1930.



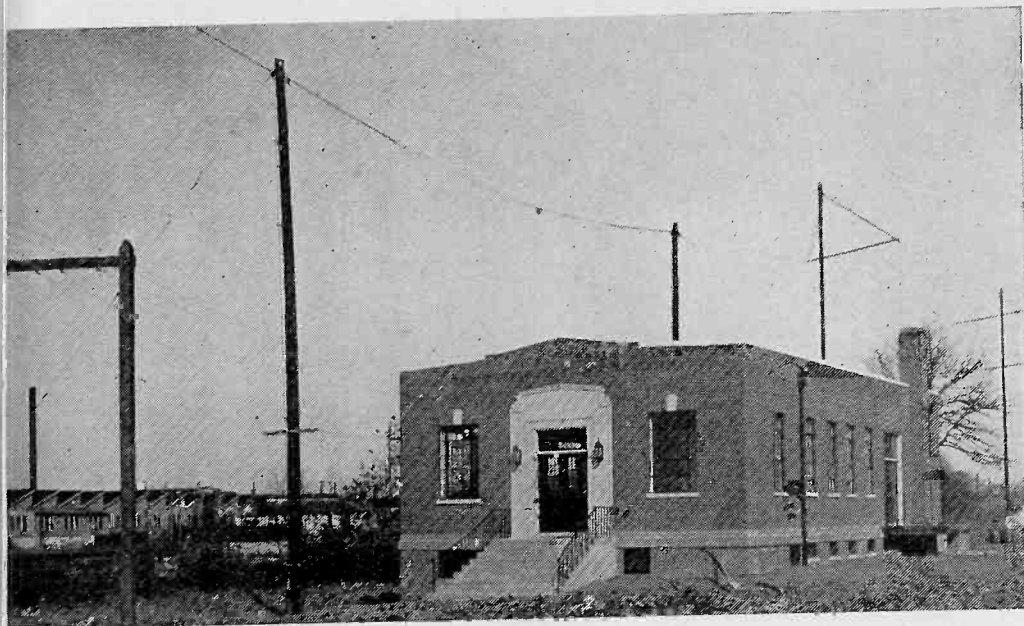

Fig. 2—Close-up of War Department transmitting station WAR showing doublet transmitting antenna and 12,000- and 16,000-kc beam antennas.

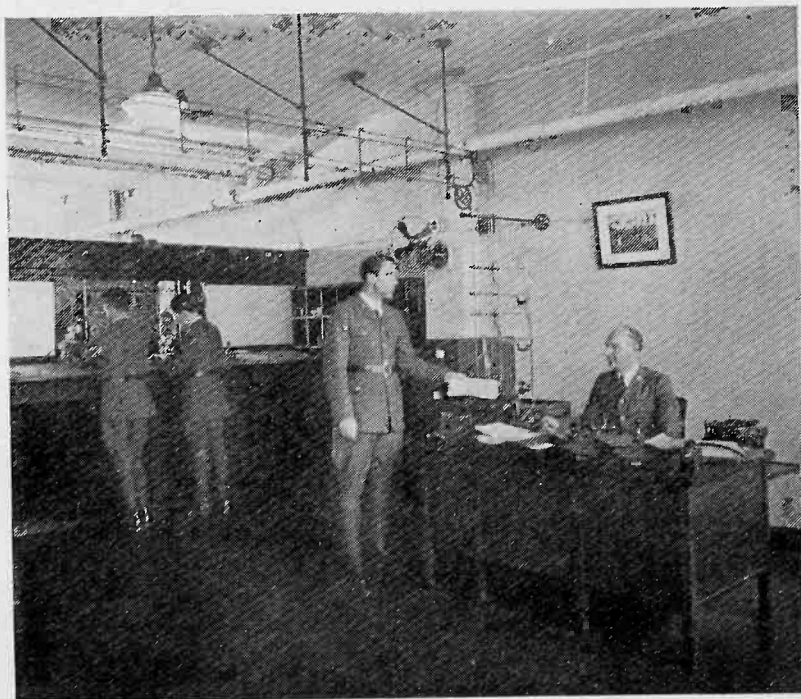

Fig. 3—Radio receiving desk and routing desk with message carrier facilities to Radio-Cable and Telegraph Sections. An average of 1500 messages daily are routed from this desk.

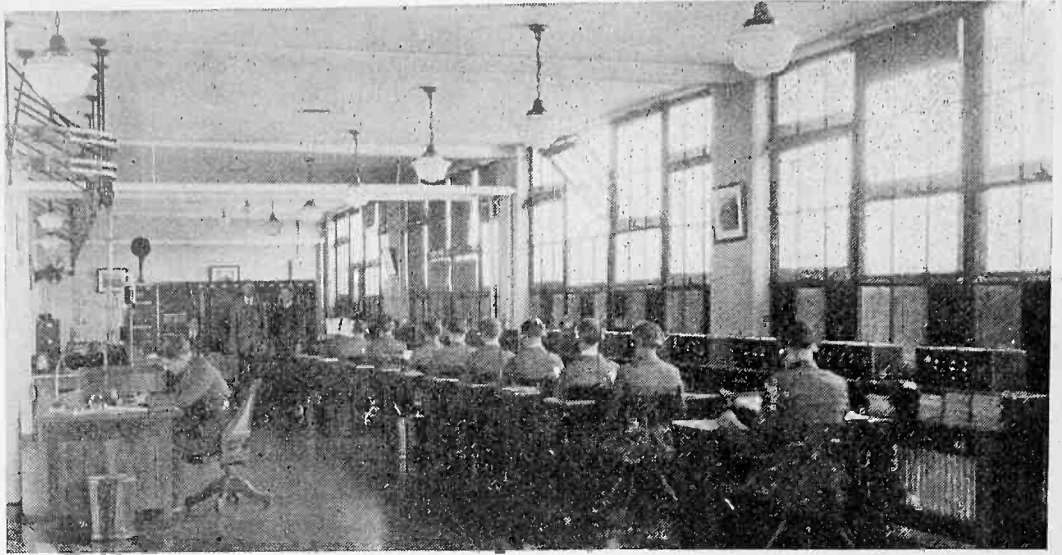

Fig. 4—A general view of the Radio Section consisting of twelve high-frequency positions, and two intermediate-frequency positions. Radio routing desk at the left with automatic message carrier system connected with the main Message Center routing desk.

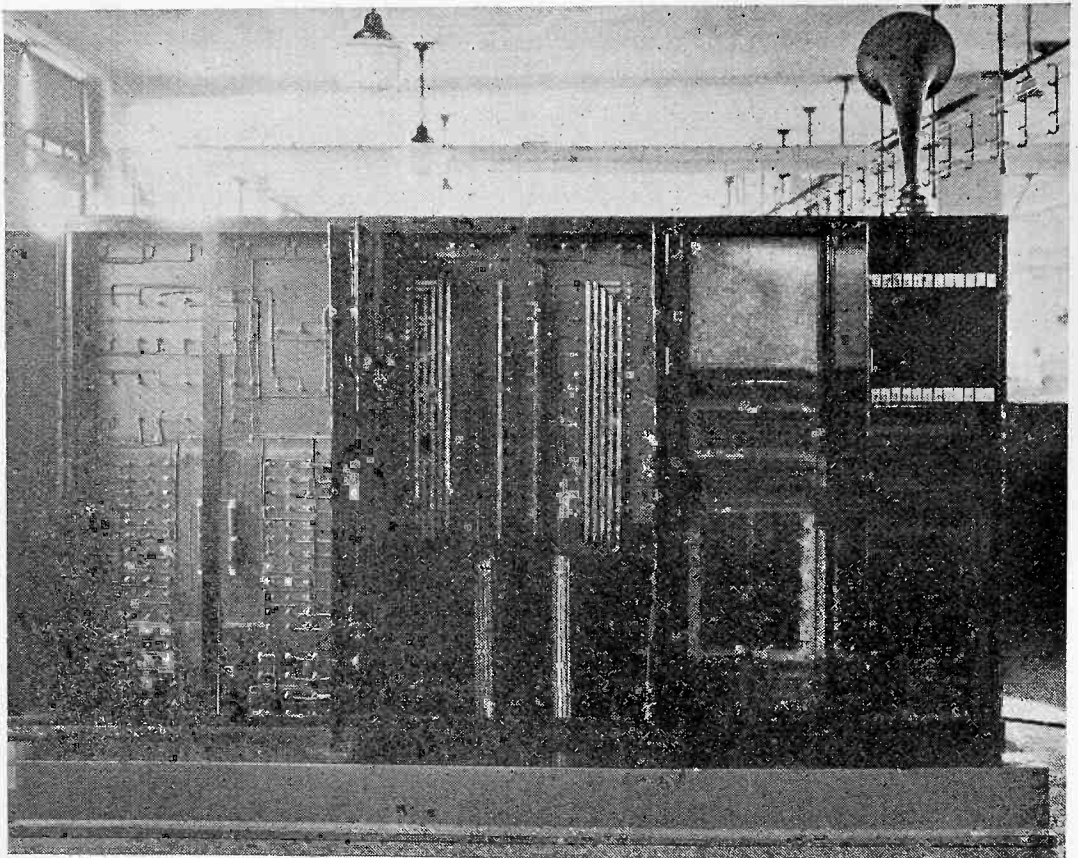

Fig. 5—Rear view from left to right: Battery-charging panel, battery-distributing panel, and switchboard. Extreme left: Battery cabinet made of heavy galvanized iron and containing compartments for all "A" and "B" batteries. A galvanized-iron trench houses all cable connections between the switchboard and all receiving positions.

so installed as to afford maximum flexibility in the selection of any one or group of frequencies. Beam transmission—the first attempt to handle traffic out of Washington by directional waves—will be effected on the 16,000- and 12,000-kc bands. The signals on both beams have a spread of approximately 60 deg., thus insuring coverage of the entire United States from north to south. The directional antenna system is

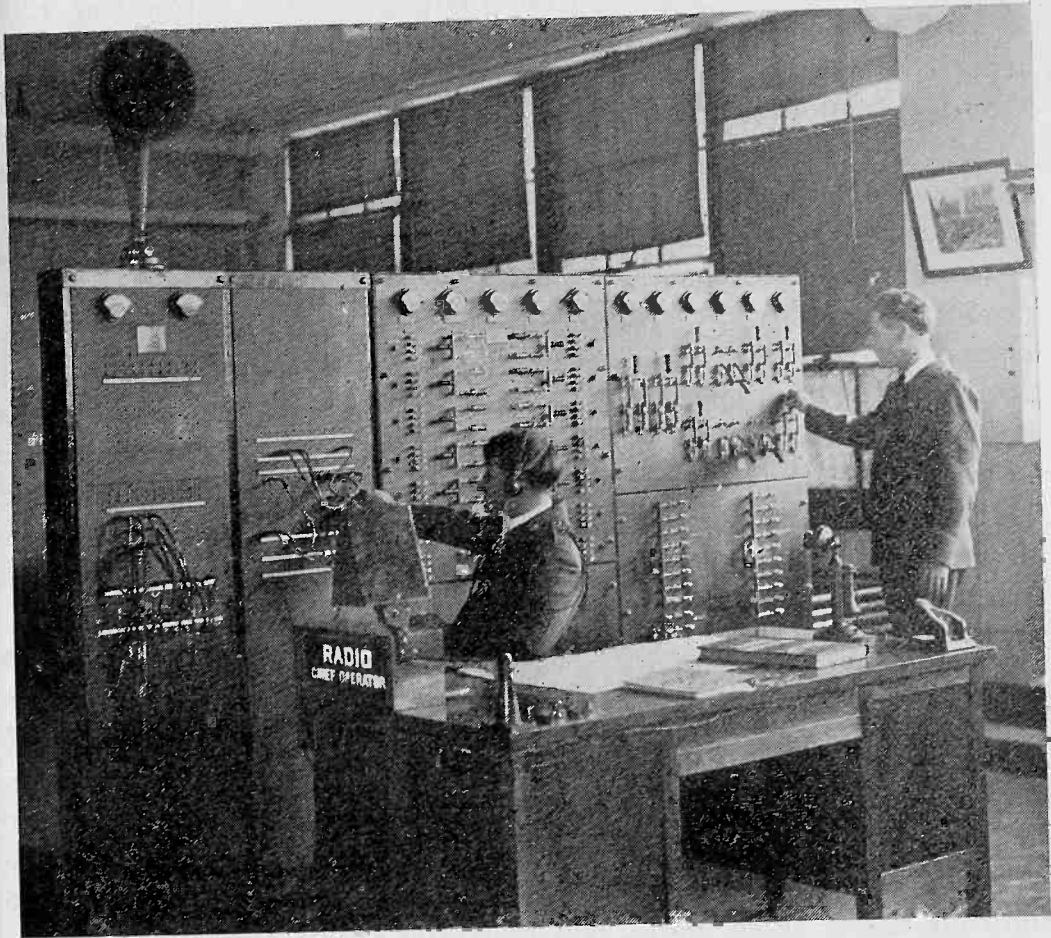

Fig. 6—Chief Operator's desk. From left to right: switchboard, battery-distributing panel, and battery-charging panel. This system is equipped for either individual or common "A" and "B" batteries on all receiving positions. One interesting feature about the switchboard is that seven transmitters, each operating on different frequencies can be plugged in on any one position; thus simultaneous sending on all frequencies and all transmitters by one operator is accomplished.

not cramped, as there is virtually unlimited room for expansion around the Fort Myer station.

This transmitting station, literally lifted out of a basement and given occupancy in a new 40-by 70-ft. building, is to operate on a 24-hour schedule. Hourly, day and night, it will be in direct radio communication with the following points: Seattle, Washington;

San Francisco, California; Manila, Philippine Islands; Hawaii, Hawaiian Islands; Panama, Canal Zone; San Antonio, Texas; Omaha, Nebraska; Chicago, Illinois; Atlanta, Georgia; Columbus, Ohio; and Boston, Massachusetts. In addition to establishing communication with the above-mentioned land stations, these high-frequency transmitters will have ethereal contact with United States Army transports at sea. The traffic at present from Washington alone varies from 1200 to 1500 messages a day; the short-wave transmitters at Fort Myer being controlled and keyed remotely by enlisted radio operators in Message Center, located in the Munitions Building.

If not by design then a happy coincidence, simultaneous with the completion of the new transmitting station at Fort Myer, is the occupancy of new and larger quarters by the Message Center of the Signal Corps. Formerly divided by a passageway and so cramped as to be elbowing for room, the author and his staff of 52 assistants are now located in a spacious room, 60 by 100 ft., on the third floor, rear, of the Munitions Building. With a single file of 14 radio operating desks and with a radio routing desk at the left, associated with an automatic message carrier system leading to the main Message Center routing desk, the system in handling a traffic of 1500 messages per day is bereft of any confusion and without that bustle that you might expect in a radio operating room of such wide ramifications.

In truth, this is a globe-girdling communication system. While its direct radio communication is limited to continental United States, its reach is not circumscribed; by interlinking this radio net with the telegraph and cable companies, domestic and transoceanic telephones, and international short-wave radio circuits, a message originating here could as easily find its destination in Patagonia as in Boston. The radio receiving and routing desk, for instance, is at present directing into the channels of cable, radio, and telegraph approximately 1500 messages each day.

The enlarged and constantly expanding facilities of the Message Center of the War Department are the results of the efforts of George S. Gibbs, Chief Signal Officer, and the author, actively in charge. With the Federal Farm Board and the Census Bureau as recent users of this radio system, a total of 55 Government bureaus now draft upon this communication net, and without cost to the respective branches of the Federal Government. Eventually, the large Government departments are to be associated with the Message Center by teletype circuits, thus eliminating messengers for delivering messages to and from the Message Center.

## FLUCTUATION NOISE IN RADIO RECEIVERS\*

BY

STUART BALLANTINE

(President, Boonton Research Corporation, Boonton, N. J.)

**Summary**—This paper discusses fluctuation noise in radio receivers due to shot and thermal effects (Schottky) in the radio-frequency circuits. The r-f noise components beat with the carrier when a signal is being received and are transformed to audio components which are heard as a hissing noise.

The mathematical theory for a receiver employing a square-law detector is given, and it is shown that the deflection of a meter measuring the average square of voltage or current due to the noise is proportional to the area under the curve representing the square of the over-all transmission against frequency. The over-all transmission is somewhat analogous to the over-all fidelity of the receiver. This result is similar to the well-known laws for simple linear networks without frequency transformation.

The method of calculating the noise due to the shot and thermal effects is discussed.

Finally a convenient method of measuring the specific noise (noise per frequency interval) in a radio receiver is described, and results for several typical commercial receivers are given. The method consists in comparing the noise, as referred to the antenna circuit, with the amplitudes of the side bands,  $mE_0$ , in a standard modulated signal.

ON ACCOUNT of the atomistic structure and nature of the universe many of the quantities with which we are concerned in macroscopic physical measurements do not in reality possess that steadiness with which we often associate them, but are in reality fluctuating quantities of which our ordinary measurements furnish merely average or statistical values. The fundamentally fluctuating nature of such quantities may often be brought into evidence by measurements of sufficient delicacy. The term "fluctuation" has been proposed † as a generic characterization of these phenomena, of which the following examples may be cited by way of illustration: fluctuation of pressure due to rain falling upon an object of finite size, such as a bounded flat surface; fluctuation of pressure upon the walls of a vessel containing a gas which arises from the random impacts of the molecules in consequence of their thermal agitation; Brownian movement of small particles in a gas or liquid brought about by random impacts of the molecules of the gas or liquid; fluctuation of current in an electrical conductor in consequence of the thermal agitation of its ions

\* Dewey decimal classification: R170. Original manuscript received by the Institute May 26, 1930.

† R. Fürth, *Schwankungerscheinungen in der Physik*. T. C. Fry, "Probability and Its Engineering Uses," Ch. 11, p. 389, (New York, 1928).

and electrons (Schottky temperature effect); fluctuations of the photoelectric emission of electrons from metals in consequence of the random impact of light quanta; fluctuation in the thermionic emission; fluctuation in the saturation current carried by the electrons in a thermionic tube as a result of this random emission (Schottky "shot effect"); fluctuation in the e.m.f. of an electrolytic cell due to random motion of ions; fluctuations in the rate of magnetization of magnetic materials (Barkhausen effect); fluctuation of space-charge limited currents in a thermionic tube due to ionization of residual gas, evaporation of positive ions, etc.; fluctuation of thermionic emission due to statistical disturbances in surface conditions, or work function, (Johnson-Schottky "flicker effect"). These examples of the statistical character of natural phenomena may be multiplied endlessly.

Attention was drawn to certain electrical fluctuation phenomena by W. Schottky<sup>1</sup> in 1918. Among the more important effects to which he drew attention were: (1) the fluctuation of current in ordinary electrical conductors as a consequence of the ordinary thermal agitation of the conducting particles; (2) the fluctuation of current in a tube carrying voltage-saturated thermionic current as a consequence of the random emission (and flow) of electrons. The first effect he called the "temperature effect," and the second the "schrot" (small-shot or shot) effect. Both effects are of some technical significance since the noise, or other disturbances produced by them, sets a definite limit upon the electrical amplification which may be usefully employed.

In a normal radio receiver the chief sources of fluctuation noise reside in the thermal agitation of electricity in the conductors (coils, antenna, etc.) and in the shot effect in the first tube. Naturally the contribution of noise from any source depends upon the amplification following it, so that if the amplification per r-f stage is reasonably high only the antenna-coupling circuits, first tube and its output circuit contribute significantly to the noise production.

Schottky's original theory of these disturbances was a statistical one based upon the general statistical relation  $\bar{n}^2 = N\tau$ . In this theory the time-form of the individual disturbances is not considered, and the results are therefore correct only when the duration of the disturbance is vanishingly short; however, in both thermal and shot effects the duration is actually so short that for the frequency regions of practical interest, Schottky's theory is quite adequate.

<sup>1</sup> W. Schottky, "On spontaneous current fluctuations in various electrical conductors," *Annalen der Physik*, 18, 541, 1918.

The author has recently<sup>2</sup> published an alternative theory based upon Rayleigh's theorem which possesses some mathematical interest and is of slightly greater generality. In this theory the elementary disturbance is analyzed by Fourier's theorem to determine its spectral distribution characteristics. The total effect of one disturbance is obtained by integrating, over the frequency range, the product of the energy-per-frequency interval and the square of the transmission. Then, by Rayleigh's theorem, the average effect of a number of disturbances occurring at random at the rate of  $n$  per second is precisely equal to  $n$  times that of a single disturbance, and has the same frequency distribution.

In the pure shot effect the elementary disturbance, or event, is the pulse of current due to the passage of a single electron from cathode to anode; in the thermal effect it is the pulse of current occasioned by the flight of an electrified particle between collisions.

If the duration of the elementary disturbance be sufficiently short its spectrum will contain components of *all frequencies of equal amplitudes*. In this case, as in the case of heat radiation, we may not speak of the amplitude of a single component of a definite frequency, but must speak of an *amplitude-per-frequency interval*. In spectral distribution the fluctuation effects due to elementary disturbances of durations which are short compared with the reciprocal of the frequencies in the range under consideration are analogous to perfectly white light.

In a conventional radio receiver comprising a radio-frequency amplifier, detector, and audio-frequency amplifier, the disturbance components originating in the first r-f stage and its associated circuits are of radio frequency and are transmitted by the r-f amplifier to the detector, where by beating with each other, they are transferred to audio-frequency disturbances which are heard as a hissing noise. When a carrier is present at the detector the r-f noise components also beat with the carrier, forming audible noise components. In a radio receiver of average sensitivity ( $10\mu\text{v}$ ) with a square-law detector the audio noise due to beating of the r-f noise components among themselves in the absence of a carrier is usually too weak to be detected. When a carrier is present, however, the audio noise produced by beating of the r-f noise components with the carrier is proportional to the carrier and may become quite noticeable. The hissing noise ordinarily heard during reception is predominantly of this latter type and we shall consider it exclusively in this discussion.

<sup>2</sup> Stuart Ballantine, "Shot effect in high frequency circuits," *Cont. from the Radio Frequency Laboratories*, No. 7, 1928; *Jour. Frank. Inst.*, 206, 159, 1928.

## II

THEORY OF AUDIO-NOISE PRODUCTION IN A RECEIVER  
EMPLOYING A SQUARE-LAW DETECTOR

The theory of fluctuation effects has been worked out for the case in which a linear transmission network connects the branch of the circuit in which the disturbance originates and the instrument employed for measuring  $\bar{e}^2$  or  $\bar{i}^2$  (time average of voltage- or current-squared).

In a radio receiver the situation is somewhat more complicated. The disturbances originate in the r-f circuits. We are not interested in the noise at the output terminals of the r-f amplifier, as given by the ordinary theory, but in the audio-frequency noise which appears after detection and audio amplification. The extension of the theory to this more complicated case is not difficult.

We may note that when in the case of a square-law detector the carrier is large compared with the noise components each r-f component of frequency  $f$  is transmitted through the system with a change of frequency  $f - f_0$  ( $f_0 =$  carrier frequency) and of amplitude; also the principle of superposition holds since if  $E_0 \gg E$  the beating of the noise components among themselves is negligible compared with their beating with the carrier. The system then possesses a sort of quasi linearity and the ordinary theory is applicable.

Let us assume that the audio noise is measured at the output terminals of the audio amplifier by an instrument capable of indicating the time average of  $\bar{e}^2$ . Let us assume that the disturbance is a current pulse originating in a r-f branch of the receiver circuit.

In the form in which we shall use it the Rayleigh-Schuster<sup>3</sup> theorem may be stated as follows:

*Rayleigh-Schuster Theorem:*

Let  $E_j(t)$  represent the output voltage produced in mesh,  $j$  by the current  $I_k(t)$  in mesh  $k$  acting through a linear network; let a quantity  $Z_{jk}(f)$ , called the transimpedance, be defined as

$$Z_{jk} = E_j / I_k$$

when

$$e_j(t) = E_j e^{i2\pi f t} \text{ and } i_k = I_k e^{i2\pi f t}. \text{ Then} \quad (a)$$

$$\int_0^\infty e_j^2(t) dt = 2 \int_0^\infty |Z_{jk}(f)|^2 I_k^2(f) \cdot df \quad (b)$$

<sup>3</sup> Rayleigh, *Phil. Mag.*, 27, 466, 1889. A. Schuster, *Phil. Mag.*, 37, 509, 1894, "Theory of Optics," 2nd Ed., p. 399, (London, 1909). J. R. Carson, "Electrical Circuit Theory and Operational Calculus," p. 185, (New York, 1926).



where

$$I_k^2(f) = \left[ \int_{-\infty}^{\infty} i_k(t) \cos 2\pi ft \cdot dt \right]^2 + \left[ \int_{-\infty}^{\infty} i_k(t) \sin 2\pi ft \cdot dt \right]^2, \quad (c)$$

and if  $i_k(t)$  represents a disturbance recurring at random intervals at the average rate of  $n$  times per second, then

$$\bar{e}_j^2(t) = n \int_0^{\infty} e_j^2(t) \cdot dt = 2n \int_0^{\infty} E_k^2(f) \cdot df \quad (d)$$

$$= 2n \int_0^{\infty} |Z_{jk}(f)|^2 I_k^2(f) \cdot df \quad (e)$$

or in other words the frequency distribution of the square of the total disturbance is equal to  $n$  times that of a single disturbance and is precisely of the same form as a function of frequency.

In the above equations  $|Z|$  denotes, as usual, the absolute value, or amplitude, of the complex impedance  $Z$ .

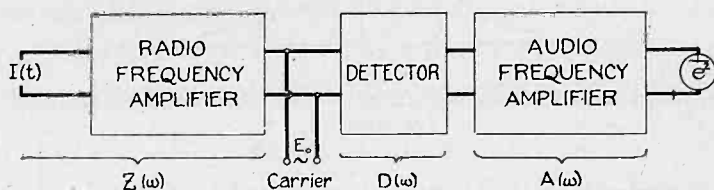

Fig. 1—Scheme of conventional radio receiver under discussion.

In the case of a radio receiver (Fig. 1) let  $Z(f)$  represent the transimpedance between the mesh of the circuit in which the disturbance  $i(t)$  originates and the output of the r-f amplifier,  $E_0$  the carrier voltage at the detector,  $D$ , the detection factor, defined in terms of output voltage, and  $A(f)$  the transmission of the audio amplifier (ratio of output voltage to input voltage). Then, remembering that an r-f component of frequency  $f$  is transformed to one of audio frequency  $f - f_0$

$$Z_{jk}(f) = Z(f)E_0D(f - f_0)A(f - f_0). \quad (1)$$

$Z_{jk}$  is of the nature of an over-all transimpedance, being proportional to the product of the transmissions of the detector and radio amplifier and the transimpedance of the r-f amplifier. The component factors are roughly suggested in Fig. 2.  $Z_{jk}$  is readily measured by impressing a carrier voltage  $E_0$  on the detector, a current of variable radio frequency in the branch of the r-f amplifier in which the fluctuation effect has its origin and measuring the output voltage as a function of the radio frequency,  $f$ .

In view of (1) the Rayleigh-Schuster theorem gives for the total noise as measured by  $\bar{e}^2$ .

$$\bar{e}^2 = 2n \int_0^{\infty} I^2(f) |Z(f)E_0D(f, f - f_0)A(f - f_0)|^2 df \quad (2)$$

where  $I^2(f)$  is given by (c). In the case of most disturbances the duration of  $i(t)$  is so small compared with  $1/f_0$  that  $I^2(f)$  (equation c) is given very approximately by

$$I^2(f) = \left[ \int_{-\infty}^{\infty} i(t) \cdot dt \right]^2 \quad (3)$$

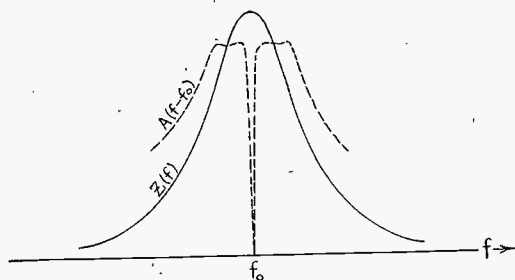

Fig. 2—Radio- and audio-transmission curves as functions of frequency;  $f_0$  = carrier frequency.

which is independent of frequency and equal to the square of the total electric charge transferred by the current pulse. In this case

$$\bar{e}^2 = 2n \left[ \int_{-\infty}^{\infty} i(t) \cdot dt \right]^2 \int_0^{\infty} |Z(f)E_0D(f, f - f_0)A(f - f_0)|^2 \cdot df. \quad (4)$$

This result may be expressed as follows:

1. In a radio receiver employing a square-law detector, and with a carrier voltage impressed upon the detector, the audio-frequency noise, as measured by an instrument indicating the average value of the square of voltage (or current), is proportional to the area under the curve representing the square of the over-all transimpedance (or of the transmission) from the r-f branch in which the disturbance originates to the measuring instrument as a function of frequency, and proportional to the square of the carrier voltage.

2. When the disturbance is a current pulse  $i(t)$  of short duration  $\tau$ , such that  $\tau f_0 \ll 1$ , recurring at random intervals at the average rate of  $n$  per second, the noise is proportional to the product of  $n$  and the square of the time integral of  $i(t)$  or to the square of the total electric charge conveyed by the pulse.

## SHOT NOISE

The author has considered the calculation of  $I^2(f)$  for the shot effect elsewhere.† For a pure electronic shot effect the time of passage of an electron from cathode to anode is of the order of  $10^{-9}$  sec. and at ordinary frequencies (3) is sufficiently accurate. The equivalent shot circuit is shown in Fig. 3.

In calculating transimpedance from the plate circuit it is often convenient to replace the impressed current  $i(t)$ , Fig. 3b, by its equivalent series e.m.f., Fig. 3c. (Thevenin's theorem). This puts the shot-

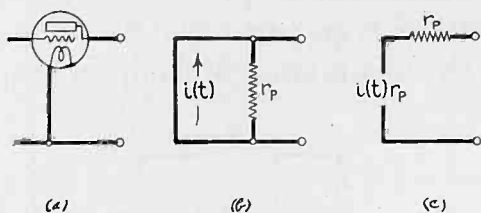

Fig. 3—Equivalent circuits for calculation of shot effect;  $i(t)$  represents elementary current pulse due to passage of one electron.

noise source on the same footing as the signal e.m.f. and is convenient in making comparisons of them. If  $e$  is the electronic charge and if  $I_s$  denotes the saturation component of current through the tube then

$$nI^2(f) = ne^2 = I_s e \quad (5)$$

which is the well-known result.

The shot noise is then given by (4) and (5) as

$$\bar{e}^2 = 2I_s e \int_0^{\infty} |Z(f)E_0 D(f_1 f - f_0) A(f - f_0)|^2 df. \quad (6)$$

A further detailed discussion of the shot noise generation in vacuum tubes is reserved for a separate paper now in preparation.<sup>4</sup>

## THERMAL NOISE

In electrical conductors in which the mean-free-path of the conducting particles is short the energy acquired by these particles from the electric field is small compared with that due to ordinary thermal agitation and the shot-effect merges into a thermal agitation effect. An ordinary inductance coil wound with copper wire or a high-resistance unit (e.g., one megohm) at room temperature are examples of such

† See footnote 2.

<sup>4</sup> Since the present paper was written a discussion of the noise production, in tubes and their associated circuits has been published by F. B. Llewellyn, *Proc. I.R.E.*, 18, 243; February, 1930. Since the present paper is confined to general theory, and matters not considered by Dr. Llewellyn, it has not been considered necessary to make any changes in its original form.

conductors. In these the conducting particles fly in all directions between collisions and constitute a fluctuating electric current. The "elementary event," corresponding to the flight of one electron from the cathode to anode in a vacuum tube in the case of the shot effect, is now the flight of an electron between collisions. If the mechanism of conduction were sufficiently well known the  $i(t)$  corresponding to the elementary event and the spectral distribution could be calculated. In the absence of such detailed information, we are obliged to calculate the thermal effect in a more general fashion.

Such a general calculation of the frequency distribution of energy in the thermal effect has been performed by Nyquist<sup>5</sup> for a system in equilibrium. Upon the assumption of equipartition of energy and em-

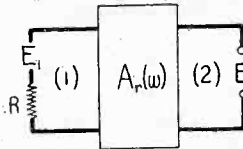

Fig. 4—Thermal noise circuit.

ploying the principle of detailed balancing Nyquist showed that the energy per frequency interval is

$$e^2 df = 4kTR(f)df \quad (7)$$

where  $k$  = Boltzmann's constant =  $1.372 \times 10^{-23}$  watts/dyne;  $\tau$  = absolute temperature;  $R(f)$  = effective resistance of the source of the noise.

In Fig. 4 the noise is generated in the resistance  $R$  in branch 1 of a network. If we denote by  $A_r(f)$  the voltage produced across the terminals of the detector by a sinusoidal e.m.f. of unit amplitude in series with  $R$ , then the audio-noise output may be expressed as follows:

$$\begin{aligned} \bar{e}^2 &= 4kT \int_0^\infty R(f) |A_r(f) E_0 D(f, f - f_0) A_a(f - f_0)|^2 df \\ &= 5.48 \times 10^{-23} T \int_0^\infty \text{etc.} \quad (\text{degrees K, ohms}). \end{aligned} \quad (8)$$

If there are several sources

$$\bar{e}^2 = 4k \int_0^\infty \left\{ \sum_k T_k R_k(f) |A_r(f)|^2 \right\} |E_0 D(f, f - f_0) A_a(f - f_0)|^2 \cdot df. \quad (9)$$

In the thermal effect the spectral distribution function  $I^2(f)$  of the elementary current pulse  $i(t)$  thus equals  $2kT/R$ .

<sup>5</sup> H. Nyquist: *Phys. Rev.*, 32, 110, 1928.

## III

## MEASUREMENT OF RECEIVER NOISE

When the external noise level is low the fluctuation noise generated in the receiver will limit the sensitivity that may usefully be employed; this factor is therefore an important one in the performance rating of the receiver. Other factors, such as selectivity, sensitivity, fidelity, etc., of receiver performance have become the subject of standardized measurement and it seems desirable to standardize a suitable technique for noise measurement. The following procedure, which the author has found convenient, may be of interest in this connection.

If the "noise" is measured by the deflection of a meter indicating  $E^2$  or  $I^2$  it will, as we have seen, depend upon the electrical "fidelity" of the receiver. A receiver of good fidelity will be noisier than one of poor fidelity. Hence we cannot use the over-all noise alone as a basis of comparison. Just what audio-transmission range should be provided

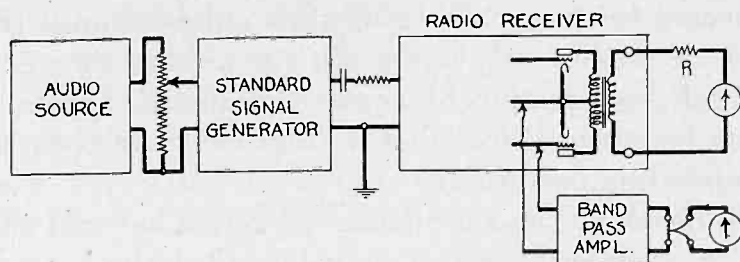

Fig. 5—Apparatus for measurement of specific noise in a radio receiver in terms of side-band amplitude in standard modulated signal.

in a receiver, in view of the presence of noise, is a matter of judgment and the decision depends upon many factors. In view of this it has seemed to me preferable to measure, instead of the total noise as given by (4), the *specific noise*, which is defined as the *noise per frequency interval*. This is the quantity which, multiplied by the transmission-squared and integrated over the frequency range, gives the total noise. The use of this quantity effectively divorces the question of noise generation from that of fidelity and permits a direct comparison to be made of the inherent noise generation in two receivers.

The experimental arrangement employed for this measurement is shown in Fig. 5. The scheme here is to single out a band of frequencies, wide enough to give a measurable deflection due to noise, but narrow enough to avoid troubles due to hum in a-c receivers on the low-frequency side and to avoid variations in the fidelity of the receiver on the higher-frequency side. The band-pass amplifier is designed to transmit frequencies from 300 to 1500 cycles. Its actual transmission curve is ascertained and a correction factor calculated

by mechanical integration. For better accuracy the fidelity curve of the receiver is combined with the transmission of the filter before integration.

The noise is compared with the amplitude of the side bands in a standard symmetrically modulated signal of the type  $e = E_0(1 + m \sin at) \sin \omega t$ , and expressed in terms of  $mE_0$  (side-band amplitude). A measurement is made as follows:

The resistance  $R$  is that giving maximum output at 400 cycles and is that ordinarily used in measurements of the sensitivity by the standard method. The receiver sensitivity is adjusted to its maximum value and the standard signal generator (S.S.G.) input is adjusted for standard output in  $R$  at 400 cycles with 30 per cent modulation. After setting the signal and receiver in this fashion the 400-cycle modulation is cut off the S.S.G. (carrier remains) and the band-pass amplifier gain is adjusted until a readable deflection *due to noise* is obtained. The 400-cycle modulation voltage is then reduced to a very low value and reconnected to the S.S.G. being then adjusted until the reading of the noise meter is exactly doubled. The noise is then expressed as the value of  $mE_0$  required for this equality of side-band signal and noise.

This may be repeated for other settings of the receiver sensitivity, and other operating conditions.

It should be noted that the "noise," measured in terms of  $mE_0$  is not  $\bar{e}^2$  but  $(\bar{e}^2)^{1/2}$ , a quantity which may be called the *noise amplitude*.

The deflection due to the modulation is

$$\text{Def.} = k(E_0^2 A_r^2 m D A_a)^2 \quad (10)$$

where  $E_0$  is the input carrier voltage,  $A_r$  and  $A_a$  are respectively the transmissions of radio and audio amplifiers,  $D$  is the detection factor,  $m$  is the degree of modulation, and  $k$  is a factor expressing the transmission of the band-pass amplifier and meter at 400 cycles.

Throughout the range covered by the band-pass amplifier the transmissions from the various sources of noise to the detector are approximately uniform with respect to frequency so that very approximately the deflection due to the noise will be

$$\text{Def.} = k A_r^2 E_0^2 N^2 \int_0^\infty |A_r'(f) D(f) A_a(f)|^2 |K(f)|^2 df. \quad (11)$$

$K(f)$  represents the transmission of the BP amplifier (400 cycles = 100 per cent. If the deflections are equal:

$$E_0 m = N A_r' / A_r \times \sqrt{M} \quad (12)$$

where  $M$  is a correction factor which expresses the effect of nonuniformity in the transmission over the frequency range. We see that  $E_{om}$  does not actually measure the specific noise  $N$  at its source since  $A$  (the radio transmission from antenna to detector) does not in general equal  $A_r'$  (radio transmission from source of noise to detector) but it expresses the noise-signal ratio, or the noise due to all sources as referred to the antenna circuit. This is really the quantity of fundamental significance from the point of view of over-all performance. For design work other methods are available for the analysis of the several sources of noise.

One or two precautions may be mentioned. Since the amplitude of the noise is usually low difficulty may often be encountered in a-c receivers due to hum. The contribution of the hum to the noise deflection should be carefully ascertained in such cases. The suppression of all frequencies up to 300 cycles by means of the band-pass amplifier is usually sufficiently effective in avoiding this embarrassment. As to the measuring instrument, the author has found the use of ordinary vacuum-tube voltmeters unsatisfactory for the measurement of fluctuation effects. This is due to the fact that the amplitudes fluctuate considerably so that the instrument is actually overloaded, as far as the peaks are concerned, long before a sufficient deflection has been obtained. The same difficulty has been observed by A. W. Hull.<sup>6</sup> The use of a thermocouple completely avoids this difficulty and is much to be preferred. A detailed report of measurements of receiver noise will be given elsewhere, but a few sample results may be given here in conclusion.

TABLE I  
RELATIVE SPECIFIC FLUCTUATION NOISE (REFERRED TO THE ANTENNA) IN A GROUP OF RFL BROADCAST RECEIVERS

Receiver	Relative Noise
A1	2.3
A2	2.75
B	1.4
C	1.0
D	5.7
E1	3.2
E2	3.0

The above measurements relate to a group of broadcast receivers designed for licensees of the Radio Frequency Laboratories and illustrate typical variations among various receivers. The results refer to a common sensitivity to which all receivers were adjusted.

<sup>6</sup> A. W. Hull, *Phys. Rev.*, 25, 172. 1925.

## A SCREEN-GRID VOLTMETER AND ITS APPLICATION AS A RESONANCE INDICATOR\*

BY

RONOLD KING

(Physics Department, Cornell University, Ithaca, N. Y.)

*Summary*—A screen-grid voltmeter of high sensitivity is described and compared with a triode voltmeter. At low frequencies, using either the 222 or the 224 tube, it effectively covers a range of from 0.1 to 10 volts, r.m.s. At frequencies of the order of  $10^8$  cycles per sec., it serves as a supersensitive indicator for a Lecher wire system. For this purpose a tuned input is used.

IN ORDER to investigate the shape of resonance curves on Lecher wires, a sensitive current or voltage indicator is imperative. Ideally such a device should have an impedance of zero for reading current, or of infinity for reading potential difference; and in either case it is desirable that deflections should reach their maxima with as little lag as possible. Vacuum thermocouples were not found entirely satisfactory; and an ordinary voltmeter of the vacuum-tube type, using a triode and grid-leak detection, responded but little better to the extremely small potential differences induced in the parallel wires by a loosely coupled 201-A oscillator operating near its upper frequency limit. At frequencies of the order of  $10^8$  cycles per sec., tube capacities were relatively too large to permit effective operation as a voltmeter proper. By substituting a tuned input circuit for the usual blocking condenser and grid leak, the relatively high-resonance voltage across the grid-filament capacity of the tube was utilized, and very much greater sensitivity obtained. By further introducing a screen-grid tube operating at a sensitive point on its plate-current screen-grid voltage characteristic, the sensitivity was effectively trebled. Readings were, moreover, practically instantaneous.

Although developed primarily for use as a resonance indicator, the screen-grid voltmeter, when used as a voltmeter proper, compares well in both sensitivity and range with other types of vacuum-tube voltmeters. For this reason it seems desirable to discuss its operation and general properties first, and then to turn to consideration of its special use as a resonance indicator.

### CHARACTERISTICS OF THE SCREEN-GRID VOLTMETER

Examination of the upper diagram of Fig. 1 reveals that the circuit of the screen-grid voltmeter differs from that of the conventional

\* Dewey decimal classification: R261. Original manuscript received by the Institute May 22, 1930.



leaky-grid detector only in an added screen grid and a potentiometer to govern its voltage. Hence, in order to understand the operation of a voltmeter of this type, as distinct from the corresponding triode device, it is necessary to examine the characteristics of the screen-grid tube. As is well known, leaky-grid detection depends upon a greater increase in the electron current to a neutral or slightly positive grid during its positive half-cycle, than a corresponding decrease during the negative half-cycle. The resulting negative bias decreases the current flow to the plate. A suitably chosen grid leak allows this accumulated charge to leak off rapidly compared with the time of input voltage variations, but slowly compared with its alternations.

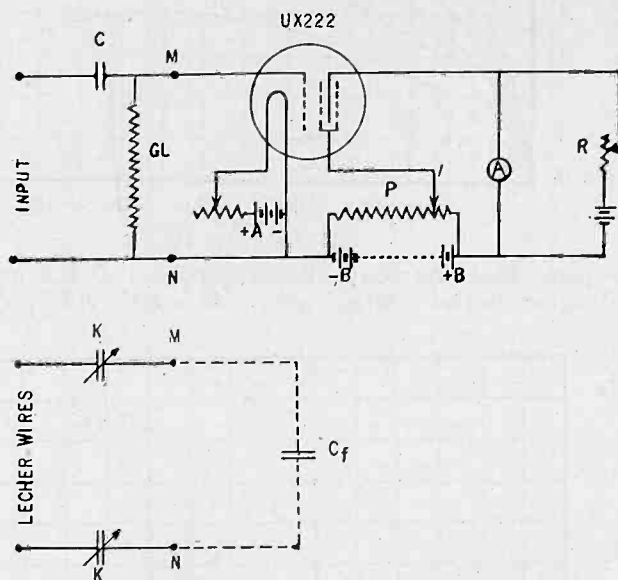

Fig. 1—Circuit diagram of screen-grid voltmeter showing input connections for use as a voltmeter (above), and for use as a resonance indicator.

By selecting an operating point on a straight part of the plate-current plate-voltage characteristic, this decrease in plate current due to grid rectification very much exceeds any increase due to plate rectification. The net effect is a curve such as *B* in Fig. 4, which shows the decrease in the plate current of a 201-A tube as the 60-cycle input voltage is increased. The circuit, in this case, is exactly as that represented in Fig. 1, but with the extra grid and the potentiometer absent.

In the case of the screen-grid tube, the operation is precisely as described above, except that the plate current depends as well upon the screen-grid voltage as upon the negative bias of the control grid. In Fig. 2 are shown a group of curves plotted for a 222 tube at constant plate voltage and with a series of different negative biases applied to the control grid. The curves show the effect upon the plate current of a progressive increase in screen-grid voltage from zero to a value equal

to the plate potential. It is seen that the plate current rises to a maximum, and then decreases as the screen voltage approaches that of the plate. It is further clear, that a particular negative bias of the

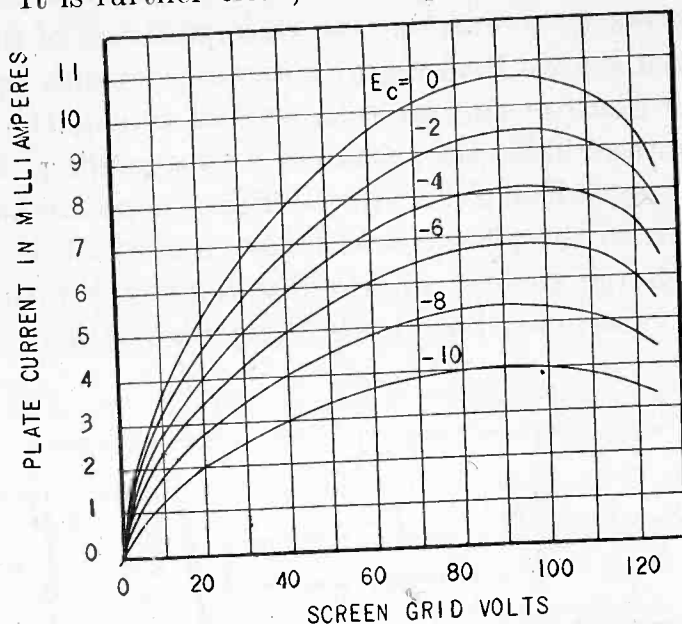

Fig. 2—Screen-voltage plate-current characteristics of 222 at different negative bias voltages on the control grid.  $E_p = 125$  volts,  $I_f = 0.11$  ampere.

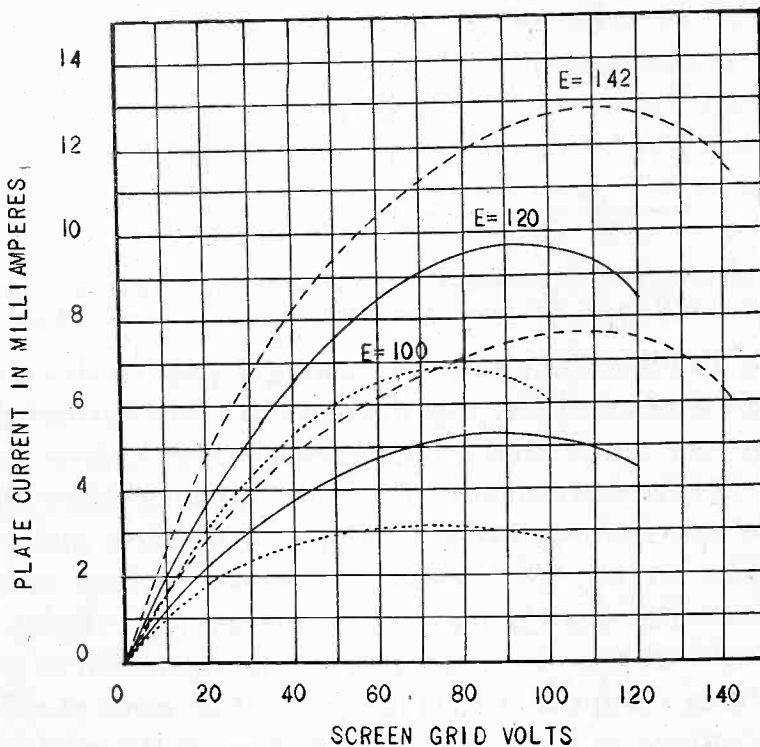

Fig. 3—Screen-voltage plate-current characteristics of 222 at different plate voltages with and without input.  $E_c = 0$ ,  $I_f = 0.11$  ampere.

control grid, is most effective in decreasing the plate current when the screen-grid voltage is such as to make the plate current a maximum. But this is not a sensitive adjustment; the decrease is very nearly the

same over a considerable range of screen voltages near this point. The upper curves of Fig. 3 show the same characteristic at three different plate voltages with the control grid at zero bias. The lower three curves were recorded simultaneously, respectively, with the upper ones, but with a constant high-frequency input to the control grid. The difference between the ordinates of each pair of curves is, then, a measure of the sensitivity at the particular plate and screen voltages. Here, as in Fig. 2, it is clear that the sensitivity is a maximum when the screen

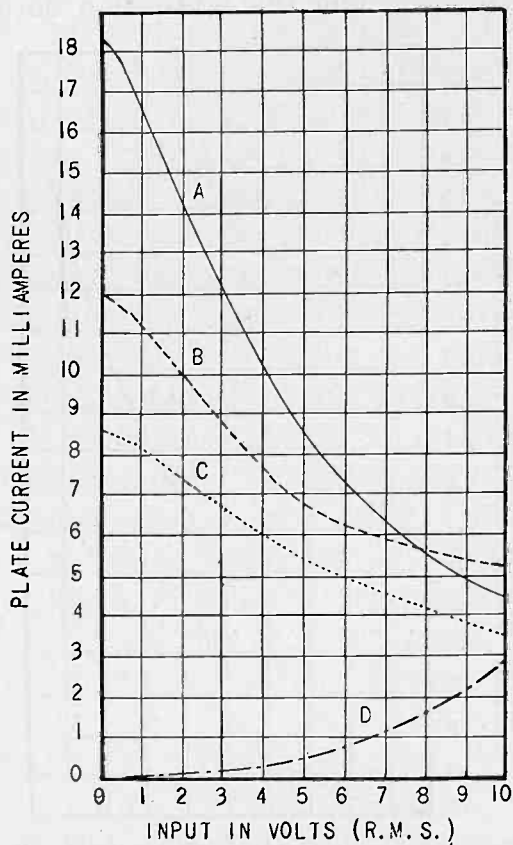

Fig. 4—Calibration curves of different tubes: curve A, 224 at  $E_p = 180$ ,  $E_s = 125$  volts; curve B, 201-A grid rectification at  $E_p = 135$  volts,  $I_f = 0.22$  ampere; curve C, 222 at  $E_p = 120$  volts,  $I_f = 0.10$  ampere; curve D, 201-A plate rectification,  $I_f = 0.25$  ampere.

voltage is adjusted to the value which will give the largest plate current. But again, this adjustment is not critical. The curves of Fig. 3 also show a marked increase in sensitivity as the plate voltage is raised. In a similar way variation in filament current affects the plate current, but within a considerable range of adjustment, such variation has little effect on the sensitivity.

Calibration curves A and C of Fig. 4 were recorded, respectively, for a 224 and 222 tube. In each case the screen voltage was adjusted to give maximum plate current. At 60 cycles the blocking condenser

C, (Fig. 1) was necessarily large— $8\mu\text{f.}$ ; a grid leak of 0.75 megohm proved satisfactory. The sensitivity was slightly increased with a higher resistance leak, but at this frequency the response to decreasing input voltages became somewhat sluggish. At higher frequencies different leak and condenser values are, of course, necessary; and at extremely high frequencies there is usually sufficient leakage without a grid leak to permit satisfactory operation as a detector. Fig. 5 shows a lower voltage range of the same three calibration curves as shown in Fig. 4. In obtaining the calibration data the 224 and the

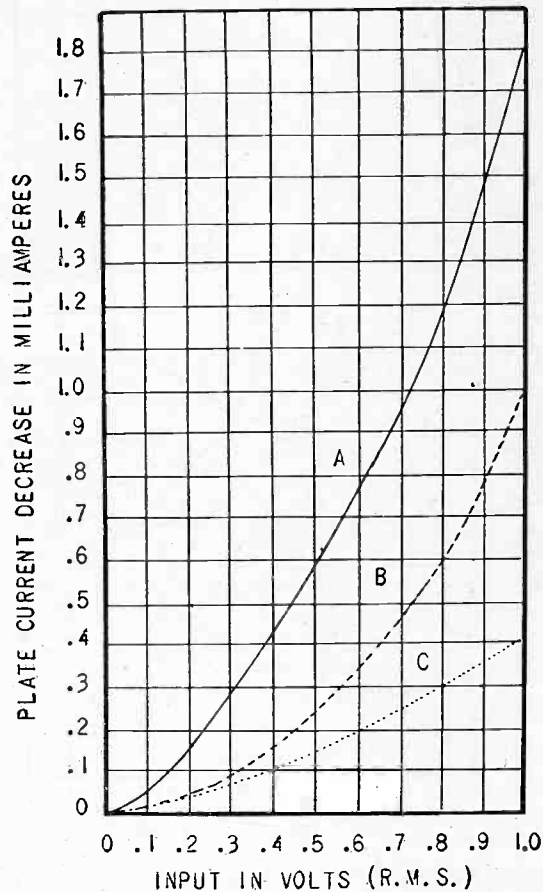

Fig. 5—The low-voltage range of Fig. 4 plotted from a common zero.

201-A tube were operated at maximum rated voltages. In the case of the 222, the data were taken for plate-voltages and filament-current values—both considerably below rated maxima—at which the tube had been operated for entire afternoons during many weeks as a resonance indicator.

The adjustment and manipulation of the screen-grid voltmeter is extremely simple, and its operation is very stable. In the range from one to ten volts, or when used as a resonance indicator, any milliammeter reading from zero to ten may be used as the plate-current and deflection-indicating instrument A, (Fig. 1). No precautions regarding

an accurate control of fluctuations in filament current or balancing current are necessary, since small variations in these do not affect a zero setting on the milliammeter. This is a great advantage over voltmeters reading in microamperes, where only slight fluctuations produce an unsteady pointer. The control resistance  $R$  of the balancer should, of course, be large compared with the resistance of the meter used. A screen-grid vacuum-tube balancer may be used to good advantage, current adjustments in this case being readily made by varying the screen voltage. With the meter connected to show a decrease for increasing plate current, and the balancer adjusted to keep the pointer on the scale, the screen voltage is increased until a definite minimum deflection is reached. This shows a maximum plate-current flow. With the pointer finally adjusted to zero on the scale by means of the balancer, any input to the grid will cause positive deflections. It is of no mean significance, in this connection, that, with balancing current and deflections of the same order of magnitude, a broken circuit or burned-out tube does not cause injurious currents to flow through the meter. In fact, after the zero setting has been made, the normal plate current is instantly obtained by turning off the tube.

In conclusion, it may be said that the screen-grid voltmeter equals or exceeds the triode leaky-grid voltmeter in range and sensitivity. The calibration characteristic is practically a straight line over a large part of the range, which is effectively from 0.1 to 10 volts r.m.s. To be sure, the sensitivity rapidly decreases for input voltages much above ten volts, but beyond this value plate rectification voltmeters, in particular the excellent reflex circuit,<sup>1</sup> become useful.

#### THE SCREEN-GRID VOLTMETER AS A RESONANCE INDICATOR

Returning now to the application of the leaky-grid voltmeter, and especially of the screen-grid voltmeter to detecting high-frequency resonance currents, the circuit need be modified only to the extent of removing grid leak and blocking condenser, and inserting two small variable condensers. For a frequency of the order of  $10^8$  cycles per sec., seven-plate midget condensers with two of the three variable plates removed, serve admirably. This modified circuit is shown in the lower diagram of Fig. 1. The dotted part to the right of the points  $MN$  diagrammatically represents the circuit completed through the control-grid-filament capacity  $C_f$  of the tube. By varying the condensers  $K$ , the input circuit may be tuned to the frequency induced in the

<sup>1</sup> W. B. Medlam and U. A. Oswald, *Exp. Wireless and Wireless Eng.*, 3, 670; November, 1926.

Lecher wires. At resonance the potential across  $C_f$  is  $E_c = I/\omega C_f$ , where  $I$  is the resonance current flowing. In other words, the smaller the capacity  $C_f$  of the tube, the higher will be the resonance potential across it. It is this resonance potential which produces the negative bias that controls the plate-current decrease. Evidently, what corresponds to a current loop in the Lecher system has been established across the tube filament and control grid, and the device has become a current indicator, at least in so far as the Lecher wires are concerned. As would be expected, the tuning of the input circuit by the condensers  $K$  is delicate. But since an increase in the capacities of the condensers

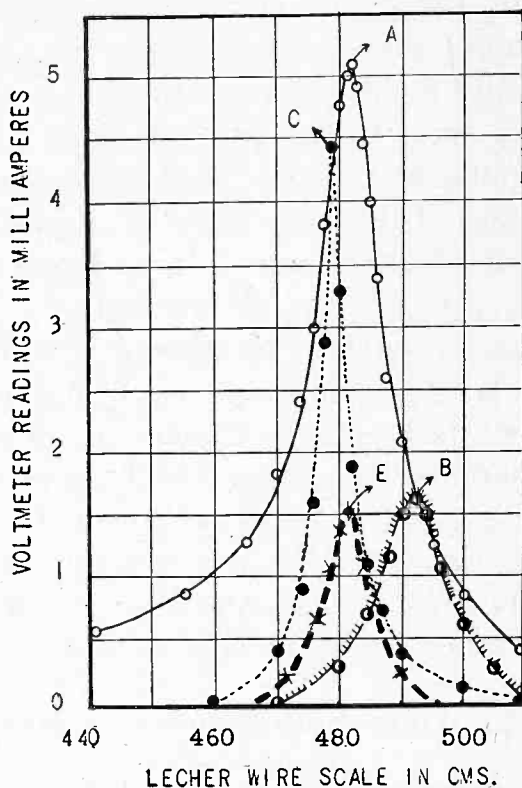

Fig. 6—A resonance curve taken with different tubes operated respectively at maximum rated voltages: curve A—224, curve B—201-A, curve C—222, curve D—199. Using a thermocouple indicator the maximum deflection for the same resonance peak was 25 microamperes.

$K$  or of the tube  $C_f$  effectively shortens the line by moving the resonance points nearer the condensers, any approximate setting will allow the device to function.

At low frequencies the sensitivity of the device was shown to depend upon the plate-current control-grid characteristic. At high frequencies using a tuned input, the sensitivity depends in addition upon the filament control-grid capacity  $C_f$  of the tube. Fig. 6 shows a single resonance peak plotted from voltmeter deflections using four different tubes with carefully tuned input. In each case the points were obtained by moving a conductor bridge along the wires; the in-

indicator was fixed at one end (to the right in the figure). The oscillator was coupled to the wires at a point near the indicator where it could induce maximum energy,<sup>2</sup> and the remote end of the wires was adjusted so that the total length was a quarter wavelength more than a length for which the entire system would resonate.<sup>3</sup> The curves of Fig. 6 show that the order of sensitivity shown in Fig. 4 has changed. The two screen-grid tubes are very much more sensitive than the 201-A tube. This is due to the high  $C_f$  of the latter. Even the small 199 tube operated at only 90 volts is practically as sensitive as the 201-A at this frequency, namely  $0.75 \times 10^8$  cycles per sec. The reason is again the higher  $C_f$  of the 201-A. Rated values for these two tubes are  $5.6 \mu\mu\text{f}$  for the 201-A and  $3.8 \mu\mu\text{f}$  for the 199.

The relative capacities of the four tubes are shown by the positions of the maxima. The higher capacity of the 201-A has moved the resonance peak nearer the indicator. The capacity of the 224 seems to be identical with that of the 199, and that of the 222 somewhat lower. (It must not be forgotten that in speaking of capacities in this connection, the filament-control-grid capacity and not the plate-filament capacity is referred to). Quantitatively these conclusions concerning the relative capacities may be roughly checked by assuming the calibration curves of Fig. 4 applicable at high frequencies, provided the input is tuned to resonance. Thus, corresponding to its resonance deflection of 1.6 ma. in Fig. 6, Fig. 4 shows an input of 1.7 volts for the 201-A tube. Taking its capacity as  $5.6 \mu\mu\text{f}$  the resonance current  $I$  may be evaluated from the relation  $I = E_c C_f \omega = 0.45$  ma at a frequency of  $0.75 \times 10^8$ . Noting that for a deflection of 5.1 ma (Fig. 6), the 224 should have an input of 2.5 volts, and using the calculated value of 0.45 ma. as resonance current, the capacity of the 224 is given by  $C_f = I / E_c \omega = 3.8 \mu\mu\text{f}$ . This is exactly the value assigned to the 199, and since the resonance peaks of the 224 and 199 are at the same point, their capacities should be equal.

Thus the combination of high sensitivity to variations in control-grid bias, plus a low filament-control-grid capacity, makes the screen-grid tubes peculiarly adapted to high-frequency resonance indicators. No doubt the isolated lead-in of the control grid contributes to the low capacity. In any case, the superiority of the tuned input resonance indicator with regard to sensitivity, stability of operation, and economy in construction and use, over other types of indicators seems beyond dispute. Either the 222 or the 224 gives good results, the one allowing greater portability, the other a greater range.

<sup>2</sup> R. King, *Rev. Sci. Inst.*, 1, 172; March, 1930.

<sup>3</sup> The significance of end effects in affecting the shape of resonance curves will be taken up in a later paper. One aspect of the problem has been discussed by Takagishi, *Proc. I.R.E.*, 18, 513; March, 1930.

## REFLECTION OF RADIO WAVES FROM THE SURFACE OF THE EARTH\*

BY

LAL C. VERMAN

(Physics Department, Cornell University, Ithaca, N. Y.)

*Summary*—The reflection of an elliptically polarized electromagnetic wave from partially conducting and perfectly conducting surfaces is studied in detail. It is shown that in either case the interference of incident and reflected waves gives rise to a pseudo-stationary wave field above the surface of the reflector. This field is bodily propagated along the horizontal projection of the direction of the incoming wave with a velocity greater than that of light, i. e.,  $c/\sin \alpha$  where  $\alpha$  is the angle of incidence. The resultant field at any given point lies in a plane whose orientation varies with height. This fact is made the basis of experimental measurements.

It is found that the 43-meter wave from WIZ, located at New Brunswick, N. J., holds its polarization and angle of incidence constant during morning hours at Ithaca, N. Y. The rapid fading that accompanies the signal is attributed to purely amplitude fluctuations. Observations on this station are analyzed, and it is shown on the basis of the above theory how it is possible to obtain the angle of incidence as well as complete information regarding the polarization of the incoming wave.

Measurements on almost all other stations ranging from 25- to 50-meters wavelength show highly erratic conditions.

### INTRODUCTION

**S**TUDIES pertaining to the propagation of radio waves through the atmosphere and around the earth have led various investigators to problems concerning the possible paths a radio wave may take and the possible states of polarization through which it may pass during its travel from the sending station to the receiver. Theoretical studies of Nichols and Schelleng<sup>1</sup> as well as those of Pedersen<sup>2</sup> show that, due to the magnetic field of the earth and the presence of charged particles in the upper atmosphere, an electromagnetic wave undergoes double refraction and that its plane of polarization suffers a rotation. The two effects, in general, occur simultaneously when the direction of propagation makes an arbitrary angle with the earth's magnetic field. Thus one may expect to find any state of elliptical polarization at the receiver including the special cases of circular and

\* Dewey decimal classification: R113.6. Original manuscript received by the Institute, March 7, 1930.

\* A Thesis presented to the faculty of Cornell University for the degree of Ph.D.

<sup>1</sup> H. W. Nichols and J. C. Shelleng, "Propagation of Electric Waves Over the Earth," *Bell Sys. Tech. Jour.*, 4, No. 2; April, 1925.

<sup>2</sup> P. O. Pedersen, "Propagation of Radio Waves along the Surface of the Earth and in the Atmosphere," Chap. VII, Copenhagen, 1927.



plane polarization. Experiments of Pickard,<sup>3</sup> Appleton,<sup>4</sup> Hollingworth and Naismith<sup>5</sup> seem to verify such a belief. Alexanderson<sup>6</sup> obtains particularly systematic results, but theoretically they still stand unexplained. In the attempted explanations of all these measurements, the effect of the ground as a reflector has not been taken into account, except in Appleton's work.<sup>4</sup> Even there, the soil is considered to be a perfect reflector, which is only an approximation.

The problem of radio reception as affected by the reflection from the earth was first attacked by Bouthillon,<sup>7</sup> who made an excellent study of several special cases of reception of plane polarized waves by linear antennas and loops at the surface of the earth. His work, however, neither includes the general case of elliptically polarized incoming wave nor discusses reception as a function of height from the reflecting soil. Pedersen<sup>8</sup> has computed complex coefficients of reflection for various wavelengths and for four types of reflectors—sea water, fresh water, wet soil, and dry soil. In a recent article by Glas,<sup>9</sup> it is assumed that the incident beam is plane polarized and reflected from an imperfectly reflecting ground. The reflected beam interferes with the incident and produces a complicated pattern of electromagnetic wave field above the surface of the reflector. Glas pictures this field as composed of two *field ellipses*<sup>10</sup> for each of the electric and magnetic vectors. One of these ellipses lies in the plane of incidence and the other in a vertical plane at right angles to the plane of incidence. He computes a few of these ellipses for three discrete heights. It will be shown in the present paper that the resultant field need not be considered as being composed of two discrete field ellipses lying in two different planes. It can simply be represented by one ellipse whose plane as well as shape and size vary continuously with height. The above mentioned theoretical studies are very valuable, but do not lend themselves directly to an experimental check due to the fact that under actual

<sup>3</sup> G. W. Pickard, "Polarization of radio waves," *Proc. I.R.E.*, 14, 205; April, 1926.

<sup>4</sup> E. V. Appleton, "The study of signal fading," (Abstract), *Exp. Wireless and Wireless Eng.*, 5, 267; May, 1928.

<sup>5</sup> J. Hollingworth and R. Naismith, "Polarization of radio waves," *Nature*, 121, 171; February 4, 1928.

<sup>6</sup> E. F. W. Alexanderson, "Polarization of radio waves," *Jour. A. I. E. E.*, 65, 1926.

<sup>7</sup> L. Bouthillon, "Influence du sol et de l'angle d'incidence des ondes électromagnétiques sur le fonctionnement des antennes et des cadres de réception," *Jour. de l'École Polytech.*, 21<sup>es</sup>. 25<sup>e</sup> cahier, pp. 151-190, 1925.

<sup>8</sup> Footnote 2; Chap. VIII.

<sup>9</sup> E. T. Glas, "On the effect of the ground on the downcoming plane space-waves," *Exp. Wireless and Wireless Eng.*, 6, 663; December, 1929.

<sup>10</sup> *Field ellipse* is a term applied to the elliptical locus described by a field vector.

working conditions the state of polarization and the angle of incidence are beyond our control.

It is the object of this paper to develop a general theory of reflection in terms of directly measurable quantities, and to endeavour to apply it to the experimental results obtained, with a view to gain information regarding the structure of the incoming wave.

From optics it is well known that light waves reflected from an approximately perfect reflector interfere with the incident beam to give rise to a stationary wave system with parallel planes of brightness and darkness. It was with this principle in mind that the experimental work, described later, was undertaken. It was soon found, however,

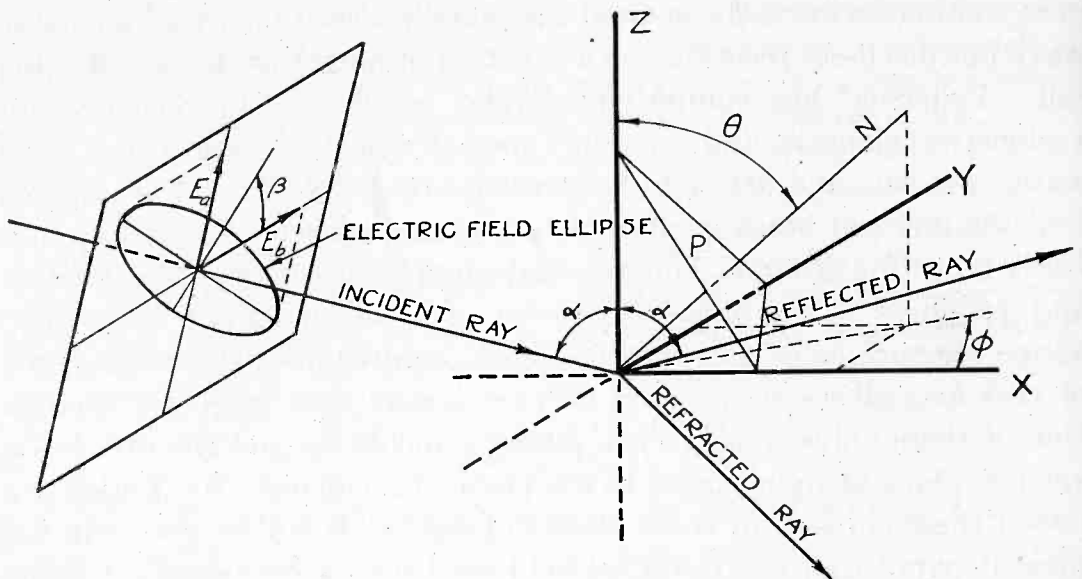

Fig. 1—Disposition of axes,  $xy$  in the plane of the earth,  $xz$  in the plane of incidence. Plane  $P$  contains the resultant magnetic field and  $N$  is the normal to  $P$ .  $\theta$  is the angle of tip and  $\phi$  the angle of orientation.

that the simple theory of optical standing waves from a perfect reflector was not sufficient to explain the results and that a more complex theory was necessary.

## THEORY OF REFLECTION<sup>11</sup>

### I. General Case

Let us assume the earth to be a plane reflector whose conductivity is  $\sigma$ , dielectric constant  $\epsilon$ , and permeability  $\mu = 1$ . For air we shall take the usual values of electric constants, that is

$$\sigma = 0, \quad \epsilon = 1, \quad \text{and} \quad \mu = 1.$$

<sup>11</sup> Due to limitation of space, theoretical discussion is confined to absolute essentials. For details, the reader is referred to the original thesis at Cornell University Library, Ithaca, N. Y.

Choose a right-handed set of rectangular axes, so that the  $x$  axis is along the projection in the plane of the earth of the incoming ray; let the  $z$  axis be normal to the earth. (See Fig. 1.) Let an elliptically polarized wave be incident at an angle  $\alpha$  with the normal to the earth's surface. This implicitly assumes a simple harmonic wave, probably a very close approximation to the actual conditions. Call the angle between the  $y$  axis and one of the axes of the electric field ellipse  $\beta$ .

The elliptically polarized wave may now be resolved into two plane polarized components, one whose electric vector lies in the plane of incidence and the other whose electric vector lies at right angles to this plane. Let the amplitude of the first be  $a$  and the second be  $b$ . These components will generally be out of phase with each other. Call this phase difference  $\psi$ . Then the field ellipse is defined by two vector equations

$$E_a = E_x + E_z = a \cos \omega t \tag{1}$$

and

$$E_b = E_y = b \cos (\omega t + \psi) \tag{2}$$

where  $\omega$  is the angular frequency and  $t$  the time. Thus  $\beta$  and  $\psi$  are related by the equation.

$$\tan 2\beta = \frac{2ab}{b^2 - a^2} \cos \psi. \tag{3}$$

If we denote the semi-axes of the ellipse by  $a'$  and  $b'$ , then it can be shown easily that

$$(a')^2 = \frac{a^2 b^2 \sin^2 \psi}{b^2 \sin^2 \beta + a^2 \cos^2 \beta - 2ab \cos \psi \sin \beta \cos \beta} \tag{4}$$

and

$$(b')^2 = \frac{a^2 b^2 \sin^2 \psi}{a^2 \sin^2 \beta + b^2 \cos^2 \beta + 2ab \cos \psi \sin \beta \cos \beta} \tag{5}$$

Whether  $a'$  or  $b'$  is the semi-major axis will be determined by the magnitude of their values computed from (4) and (5).

For convenience let us now define the quantities

$$n = (x \sin \alpha - z \cos \alpha) \omega / c \tag{6}$$

and

$$m = (x \sin \alpha + z \cos \alpha) \omega / c. \tag{7}$$

For simplicity we shall employ complex notation, and consider only the real parts of the complex expressions as significant for our problem. Furthermore we shall employ the Gaussian system of units in which all electric quantities are measured in absolute c.g.s. electrostatic units, and all magnetic quantities in absolute c.g.s. electromagnetic units. Thus denoting the components of the incident beam with subscript  $i$ , we obtain

$$\left. \begin{aligned} E_{xi} &= a \cos \alpha e^{j(\omega t - n)} \\ E_{yi} &= b e^{j(\omega t - n + \psi)} \\ E_{zi} &= a \sin \alpha e^{j(\omega t - n)} \\ H_{xi} &= b \cos \alpha e^{j(\omega t - n + \psi)} \\ H_{yi} &= -a e^{j(\omega t - n)} \\ H_{zi} &= b \sin \alpha e^{j(\omega t - n + \psi)} \end{aligned} \right\} \quad (8)$$

In general the incident beam is partially reflected, and partially transmitted into the earth. The reflected beam is superimposed on the incident, thus forming the complicated standing wave system which is our object of study; whereas the refracted beam that penetrates the earth is lost in the form of heat produced by the induced currents. Some writers<sup>12</sup> believe that these induced currents give rise to an additional field above the earth's surface. This is an erroneous conception. It must be remembered that in computing the reflected and refracted beams, one endeavours to satisfy Maxwell's field equations in both the mediums as well as at the boundary surface. If, besides the reflected field, there had existed an additional field above the earth, it would automatically have shown up in the solution of the field equations. The reflected field itself, however, may be thought of as being produced by the induced currents in the soil. Hence we can justifiably neglect the refracted beam entirely and confine ourselves to the reflected and the incident fields.

The components of the reflected field are obtained by satisfying the necessary boundary conditions at the surface of reflection. Thus for the reflected beam we get

$$\left. \begin{aligned} E_{xr} &= (A + jB)a \cos \alpha e^{j(\omega t - m)} \\ E_{yr} &= (C + jD)b e^{j(\omega t - m + \psi)} \\ E_{zr} &= -(A + jB)a \sin \alpha e^{j(\omega t - m)} \\ H_{xr} &= -(C + jD)b \cos \alpha e^{j(\omega t - m + \psi)} \\ H_{yr} &= (A + jB)a e^{j(\omega t - m)} \\ H_{zr} &= (C + jD)b \sin \alpha e^{j(\omega t - m + \psi)} \end{aligned} \right\} \quad (9)$$

<sup>12</sup> For example, Glas, p. 664, footnote 9.

where  $A, B, C,$  and  $D$  are real and are defined by the following equations

$$A + jB = \frac{\sqrt{(\sin^2 \alpha - \epsilon) + j2\sigma c\lambda} - (2\sigma c\lambda + j\epsilon) \cos \alpha}{\sqrt{(\sin^2 \alpha - \epsilon) + j2\sigma c\lambda} + (2\sigma c\lambda + j\epsilon) \cos \alpha}, \quad (10)$$

$$C + jD = \frac{-\sqrt{(\sin^2 \alpha - \epsilon) + j2\sigma c\lambda} + j \cos \alpha}{\sqrt{(\sin^2 \alpha - \epsilon) + j2\sigma c\lambda} + j \cos \alpha}. \quad (11)$$

Equations (8) and (9) represent conditions existing simultaneously in space above the earth. The corresponding components may be, therefore, directly added together to give a composite electromagnetic field as follows

$$\left. \begin{aligned} E_x &= a \cos \alpha (J + jK) e^{j\omega(t-x\sin\alpha/c)} \\ E_y &= b(L + jM) e^{j\omega(t-x\sin\alpha/c)+j\psi} \\ E_z &= a \sin \alpha (Q + jR) e^{j\omega(t-x\sin\alpha/c)} \\ H_x &= b \cos \alpha (S + jT) e^{j\omega(t-x\sin\alpha/c)+j\psi} \\ H_y &= -a(Q + jR) e^{j\omega(t-x\sin\alpha/c)} \\ H_z &= b \sin \alpha (L + jM) e^{j\omega(t-x\sin\alpha/c)+j\psi} \end{aligned} \right\} \quad (12)$$

where  $J, K, L, M, Q, R, S,$  and  $T,$  are all real and are given by the following equations

$$\left. \begin{aligned} J &= (1 + A) \cos s + B \sin s \\ K &= B \cos s + (1 - A) \sin s \\ L &= (1 + C) \cos s + D \sin s \\ M &= D \cos s + (1 - C) \sin s \\ Q &= (1 - A) \cos s - B \sin s \\ R &= -B \cos s + (1 + A) \sin s \\ S &= (1 - C) \cos s - D \sin s \\ T &= -D \cos s + (1 + C) \sin s \end{aligned} \right\} \quad (13)$$

where

$$s = \frac{\omega z \cos \alpha}{c}. \quad (14)$$

On examining (12) and (13) carefully, one finds that the amplitudes of all the components are complicated periodically varying functions of the height  $z$ . The same is true of the phases. For a given height, however, all the amplitudes and their relative phases remain constant. Each component is being propagated in the positive  $x$  direction with

the same velocity  $c/\sin \alpha$ —a velocity, in general, greater than that of light. Thus the whole field may be considered as a *pseudostationary wave system* in the vertical direction  $z$ , being bodily propagated along the  $x$  axis with a velocity  $c/\sin \alpha$ .

Computing absolute values of the amplitudes of the various components, we obtain

$$\left. \begin{aligned} |E_x| &= a \cos \alpha \sqrt{(A^2 + B^2 + 1) + 2\sqrt{A^2 + B^2} \sin\left(2s + \arctan \frac{A}{B}\right)} \\ |E_y| &= b \sqrt{(C^2 + D^2 + 1) + 2\sqrt{C^2 + D^2} \sin\left(2s + \arctan \frac{C}{D}\right)} \\ |E_z| &= a \sin \alpha \sqrt{(A^2 + B^2 + 1) - 2\sqrt{A^2 + B^2} \sin\left(2s + \arctan \frac{A}{B}\right)} \\ |H_x| &= b \cos \alpha \sqrt{(C^2 + D^2 + 1) - 2\sqrt{C^2 + D^2} \sin\left(2s + \arctan \frac{C}{D}\right)} \\ |H_y| &= a \sqrt{(A^2 + B^2 + 1) - 2\sqrt{A^2 + B^2} \sin\left(2s + \arctan \frac{A}{B}\right)} \\ |H_z| &= b \sin \alpha \sqrt{(C^2 + D^2 + 1) + 2\sqrt{C^2 + D^2} \sin\left(2s + \arctan \frac{C}{D}\right)} \end{aligned} \right\} \quad (15)$$

It is clear from (15) that the absolute amplitudes are all periodic functions of  $s$  and have the same period  $\pi$ . Since  $s$  is a linear function of  $z$ , amplitudes are also periodic in terms of  $z$ . Calling this period  $h_a$ , we have

$$h_a = \left\{ \begin{array}{l} \pi \text{ radians, in terms of } s, \\ \frac{\lambda}{2 \cos \alpha} \text{ meters, in terms of } z, \end{array} \right\} \quad (16)$$

if  $\lambda$  is given in meters.

Furthermore, none of the amplitudes vanishes<sup>13</sup> at any height (for  $0 < \alpha < \pi/2$ ) unless the reflecting surface is perfectly conducting.

For experimental application, the following two inferences are of great value:

1.  $|E_x|$  goes through maximum values,  $|E_z|$  and  $|H_y|$  go through minimum values,  $E_x$  and  $E_z$  are in phase, and  $H_y$  is 180 deg. out of phase

<sup>13</sup> The special cases, when  $\alpha = 0$  or  $\pi/2$ , are omitted from this statement. Under these conditions certain components identically vanish for all heights.

with  $E_x$  and  $E_z$  at the same heights above the reflecting surface. Furthermore the first such height  $z_I$  is given by

$$z_I = \frac{c}{2\omega \cos \alpha} \cdot 2s_I = \frac{c}{2\omega \cos \alpha} \text{arc tan } B/A. \quad (17)$$

The other values of height  $z$ , where all the above mentioned relationships simultaneously hold, are periodically repeated at intervals given by (16).

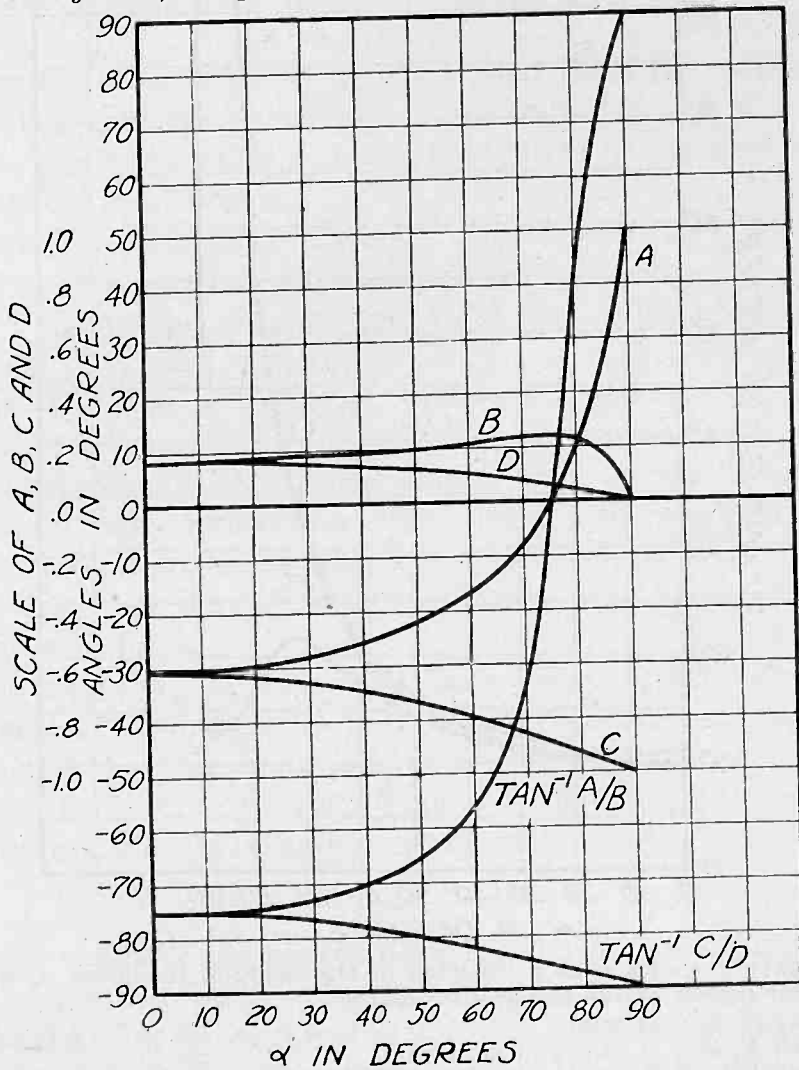

Fig. 2—Elements A, B, C, and D of reflection factors, given by (10) and (11), as functions of the angle of incidence  $\alpha$ ; for  $\lambda=43$  meters,  $\sigma=5 \times 10^{-14}$  e.m.u., and  $\epsilon=8$ .

2.  $|E_y|$  and  $|H_z|$  go through maximum values,  $|H_x|$  goes through minimum values, and  $E_y$ ,  $H_x$ , and  $H_z$  are all in phase at the same heights above the reflecting surface. Furthermore the first such height  $z_{II}$  is given by

$$z_{II} = \frac{c}{2\omega \cos \alpha} \cdot 2s_{II} = \frac{c}{2\omega \cos \alpha} \text{arc tan } D/C. \quad (18)$$

The other values of height  $z$ , where the above mentioned relationships simultaneously hold, are periodically repeated at intervals given by (16).

It is clear that the first statement applies to the components of the partial wave whose electric vector lies in the plane of incidence, and the

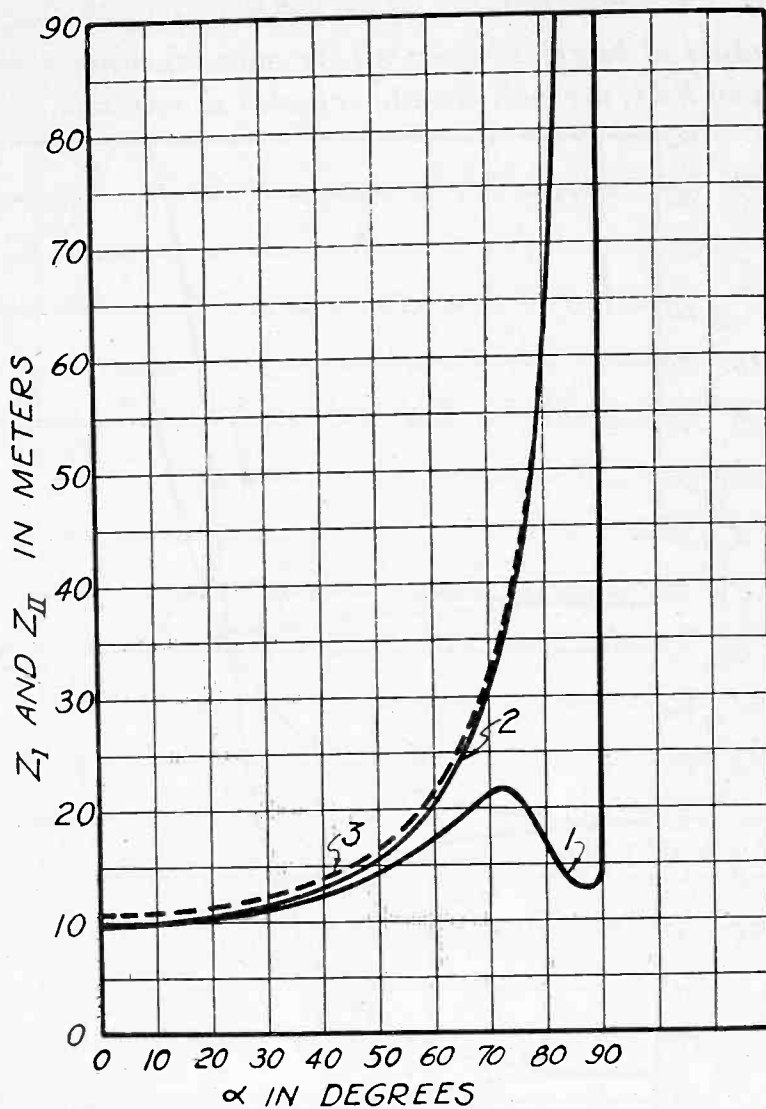

Fig. 3—Curve 1 shows  $z_1$  as a function of the angle of incidence  $\alpha$ ,  $z_1$  denotes the first height above the ground where

- $E_x$  is maximum
- $E_z$  and  $H_y$  are minimum, and
- $E_x$  and  $E_z$  are in phase and  $H_y$  180 deg. out of phase with them.

Curve 2 shows  $z_{II}$  as a function of the angle of incidence  $\alpha$ ,  $z_{II}$  denotes the first height above the ground where

- $E_y$  and  $H_x$  are maximum,
- $H_z$  is minimum, and
- $E_y$ ,  $H_x$  and  $H_z$  are all in phase.

Curves 1 and 2 apply to the case where  $\sigma = 5 \times 10^{-14}$  e.m.u.,  $\epsilon = 8$ , and  $\lambda = 43$  meters.

Curve 3 shows both  $z_1$  and  $z_{II}$  for perfect reflection, i.e., when  $\sigma \rightarrow \infty$ , for  $\lambda = 43$  meters.

second to the components of the wave whose electric vector lies at right angles to this plane.



Most of the experimental work that is described later was done on a wavelength of 43 meters. The soil from which the reflections were studied was generally quite wet. Soil constants are assumed as used by Pedersen<sup>14</sup> for wet soil, i.e.,

$$\text{and } \left. \begin{aligned} \sigma &= 5 \times 10^{-14} \text{ e.m.u.} \\ \epsilon &= 8 \end{aligned} \right\} \quad (19)$$

Under these assumptions, the following curves were computed and plotted.

The values of the elements (A, B, C, and D) of the reflection factors as well as those of the reflection phase shifts (arc tan A/B and arc tan C/D), as given by (10) and (11), are plotted in Fig. 2 as functions of the angle of incidence  $\alpha$ .

In Fig. 3 are plotted the values of  $z_I$  and  $z_{II}$  given by (17) and (18), as functions of  $\alpha$ , based on the reflection factors of Fig. 2.

Fig. 4 shows the absolute values of the resultant amplitudes,  $|E_x|/a$ ,  $|E_y|/b$ ,  $|E_z|/a$ ,  $|H_x|/b$ ,  $|H_y|/a$ , and  $|H_z|/b$ , plotted as functions of  $s$  from (15), for four values of the angle of incidence,  $\alpha = 0$  deg., 45 deg., 75 deg., and 85 deg. For convenience, there are plotted four straight lines in the same figure, which, in connection with the top scale, give values of the height  $z$  corresponding to any  $s$  for the various angles of incidence mentioned above. These lines are also drawn in the following two figures that show phase-angle variations with height

Phase angles of all components are referred to the electric vector of the incident beam that lies in the plane of incidence (see (1)): To avoid complexity, the phase angles of the various components are designated by  $\angle E_x$ ,  $\angle E_y$ , etc. Thus if  $U$  be any component of the resultant field, it could be simply expressed as

$$U = |U| e^{j\omega(t-z \text{ in } \alpha/c) + \angle U}$$

Computed values of the phase angles are shown in full line curves in Figs. 5 and 6, as functions of  $s$ , and  $s$  in turn is plotted as a function of the height  $z$ , for the angles of incidence,  $\alpha = 0$  deg., 45 deg., 75 deg., and 85 deg. It is clear that the period of these curves is twice the period of the absolute values of the amplitudes shown in Fig. 4. Calling this period  $h_p$ , we have

$$h_p = \left\{ \begin{aligned} &2\pi \text{ radians, in terms of } s, \\ &\frac{\lambda}{\cos \alpha} \text{ meters, in terms of } z, \end{aligned} \right\} \quad (20)$$

where  $\lambda$  is in meters.

<sup>14</sup> See footnote 2.

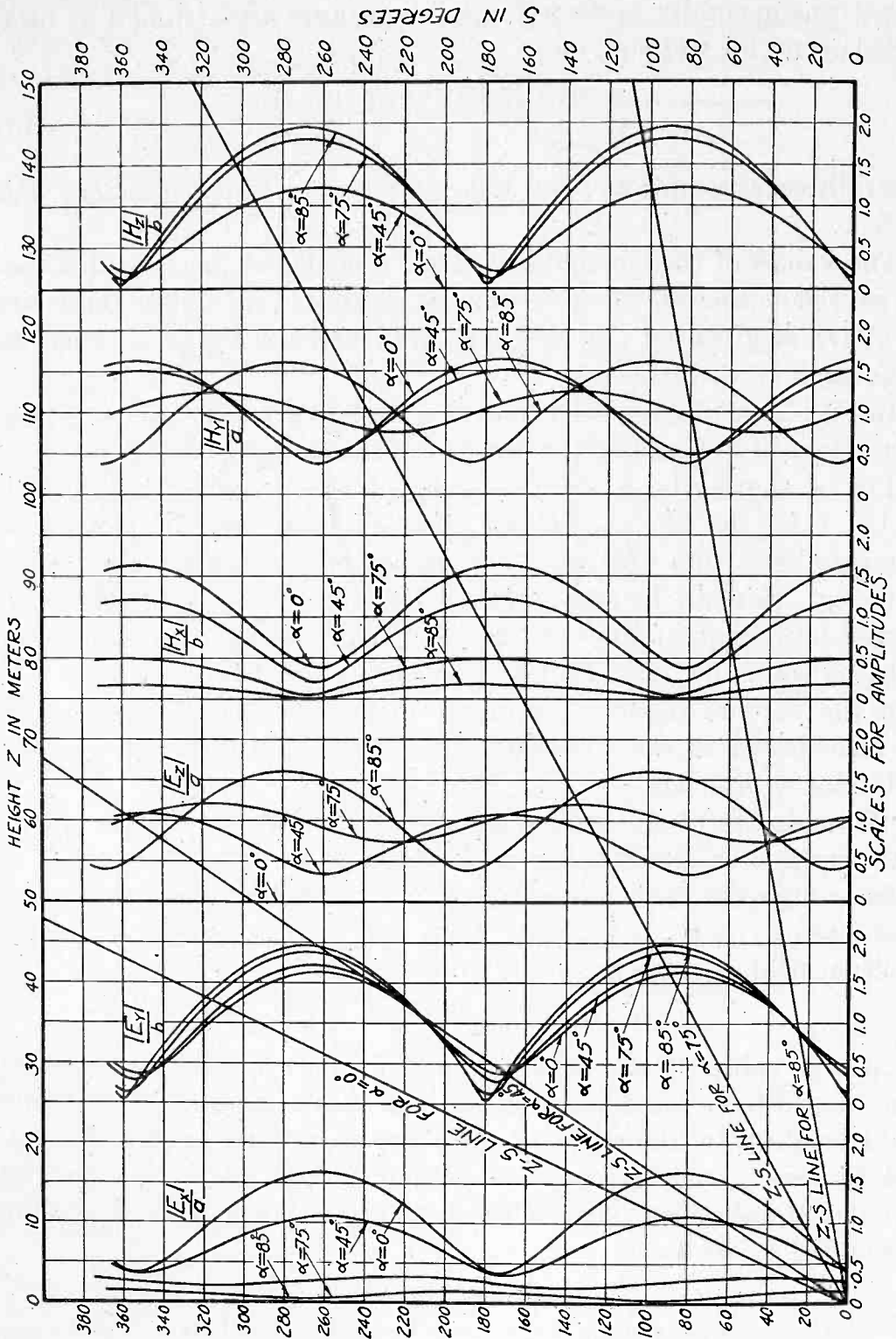

Fig. 4—Absolute values of resultant amplitudes as functions of  $s$ , and  $s$  as a function of height  $z$ , for angles of incidence  $\alpha = 0$  deg., 45 deg., 75 deg., and 85 deg.;  $\sigma = 5 \times 10^{-14}$  e.m.u.,  $\epsilon = 8$ , and  $\lambda = 43$  meters.



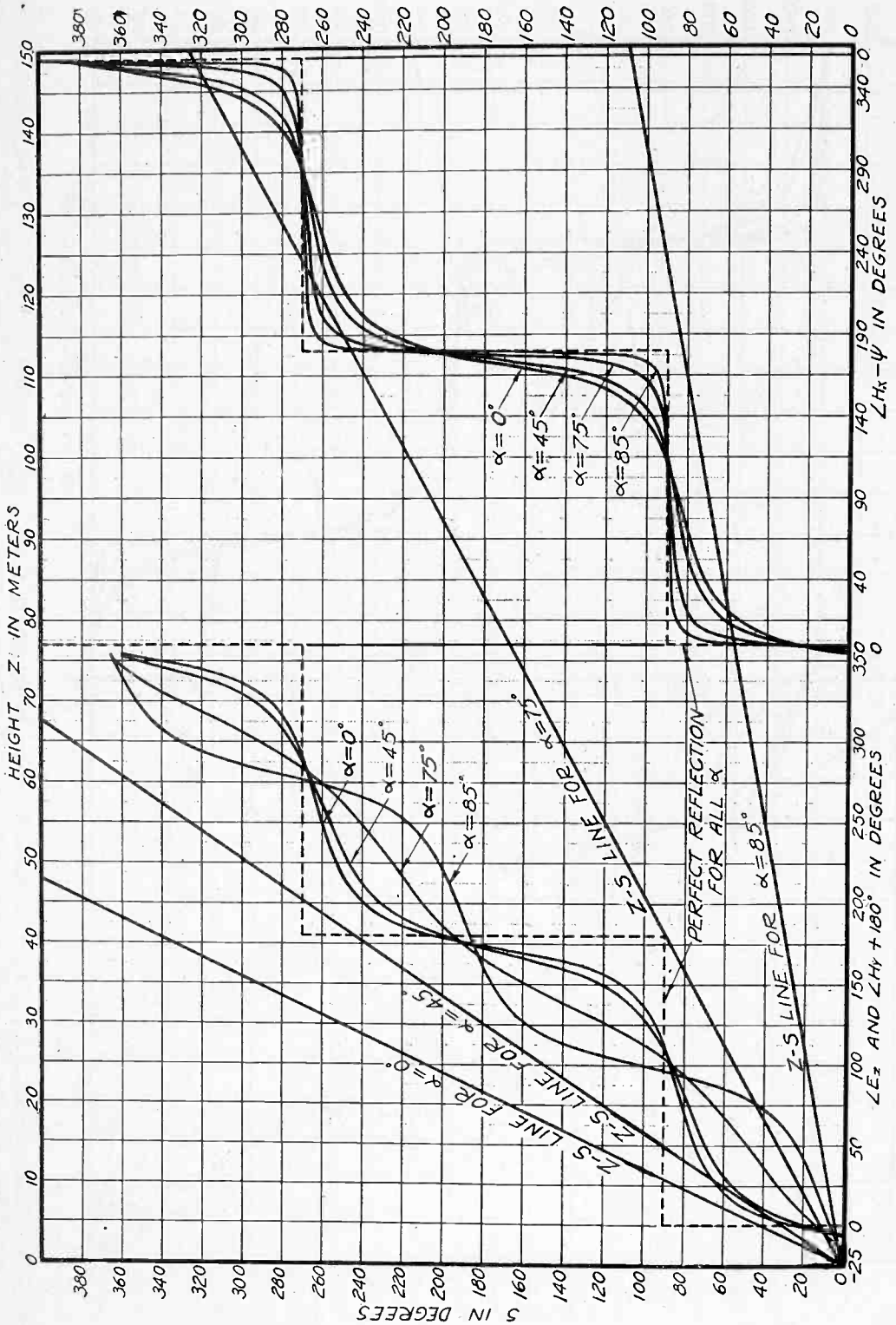

Fig. 6—Phase angles  $\angle E_z$ ,  $H_\nu$  and  $\angle H_z - \psi$  as functions of  $s$ , and  $s$  as a function of height  $z$ , for angles of incidence.  $\alpha = 0$  deg., 45 deg., 75 deg., and 85 deg. Full line curves apply to the case where  $\sigma = 5 \times 10^{-14}$  e.m.u.,  $\epsilon = 8$ , and  $\lambda = 43$  meters. Dotted line curves apply to perfect reflection where  $\sigma = \infty$ , for all  $\alpha$  and all wavelengths.

We have shown so far that an elliptically polarized incident beam gives rise to a resultant field above the ground which may be considered as a pseudostationary wave field. The curves of Figs. 2 to 6 clearly illustrate that, at any given height, all the six components of the electric and magnetic force field exist, and bear a definite phase and amplitude relationship to each other. Each set of the three components of the electric and magnetic fields may be shown to give rise to field ellipses whose size, shape, and plane vary continuously with the height from the ground. We are, however, chiefly interested in the plane in which the ellipses lie. The reasons for this will be evident later. Calling  $p$ ,  $q$ , and  $r$  the direction numbers of the normal to the plane containing the resultant magnetic field ellipse, it can be shown that

$$\left. \begin{aligned} p &= |H_y| |H_z| \sin(\angle H_y - \angle H_z) \\ q &= |H_z| |H_x| \sin(\angle H_z - \angle H_x) \\ r &= |H_x| |H_y| \sin(\angle H_x - \angle H_y) \end{aligned} \right\} \quad (21)$$

Experimentally, however, it is convenient and sufficient to measure two angles  $\phi$  and  $\theta$  (see Fig. 1) to determine the position of this plane. In Fig. 1,  $N$  is the normal to the plane  $P$  containing, say, the magnetic field ellipse. The angle between  $N$  and the  $z$  axis is called  $\theta$  or the *angle of tip*, whereas the angle between the  $x$  axis and the projection of  $N$  on the  $xy$  plane is called  $\phi$  or the *angle of orientation* or the *azimuth angle*.  $\phi$  and  $\theta$  may be expressed as

$$\left. \begin{aligned} \phi &= \arctan q/p \\ \pm \theta &= \arccos \frac{r}{\sqrt{p^2 + q^2 + r^2}} \end{aligned} \right\} \quad (22)$$

Similar expressions will apply to the electric field ellipse. It was found simpler and more convenient to work with a loop antenna to determine the plane of the magnetic field rather than to use a linear resonator to determine the plane of the electric field.

### II. A Special Case

Let us now consider the case where the conductivity of the reflecting surface approaches infinity. This is a fair approximation for long wavelength reflection from the earth. Our interest, however, lies in observing how far the results deviate from the general case.

From (10) and (11), we find that when  $\sigma \rightarrow \infty$ , then

$$\text{and } \left. \begin{aligned} A &= -1, & B &= 0 \\ C &= -1, & D &= 0. \end{aligned} \right\} \quad (23)$$

Hence from (12) and (13), we obtain the resultant field equations

$$\left. \begin{aligned} E_x &= 2ja \cos \alpha \sin s e^{j\omega(t-xs\sin\alpha/c)} \\ E_y &= 2jb \sin s e^{j\omega(t-xs\sin\alpha/c)+j\psi} \\ E_z &= 2a \sin \alpha \cos s e^{j\omega(t-xs\sin\alpha/c)} \\ H_x &= 2b \cos \alpha \cos s e^{j\omega(t-xs\sin\alpha/c)+j\psi} \\ H_y &= -2a \cos s e^{j\omega(t-xs\sin\alpha/c)} \\ H_z &= 2jb \sin \alpha \sin s e^{j\omega(t-xs\sin\alpha/c)+j\psi} \end{aligned} \right\} \quad (24)$$

In Fig. 7 are plotted the absolute values of the amplitudes as functions of  $s$  from (24). These curves now apply to any wave length. In determining the height corresponding to any  $s$ , however, we have to make use of the wavelength involved. It is clear that now we get perfect nodes and anti-nodes, i.e., the amplitudes actually vanish at periodic intervals. As a matter of fact they obey a very simple law of trigonometric sines and cosines. Curve 3 of Fig. 3 shows the position of the first nodes and anti-nodes in meters above the ground as function of the angle of incidence for  $\lambda = 43$  meters. Phase angles as functions of  $s$  are plotted in dotted lines on Figs. 5 and 6.

It is possible in this case to find simple expressions for  $\phi$  and  $\theta$  directly in terms of the constants of the incident wave. Thus

$$\phi = \arctan \frac{b \cos \alpha \sin 2s}{a \cos \psi \sin 2s} \quad (25)$$

and

$$\pm \theta = \arccos$$

$$\frac{-\cos \alpha \cos s \sin \psi}{\sqrt{(\sin \alpha \sin s \cos \Psi)^2 + (\cos \alpha \cos s \sin \psi)^2 + \left(\frac{b}{2a} \sin 2\alpha \sin s\right)^2}} \quad (26)$$

In (25), we cannot cancel out  $\sin 2s$  from the numerator and the denominator, for as  $s$  passes through 90 deg.,  $\sin 2s$  changes sign, which makes  $\phi$  shift through an angle of 180 deg. Otherwise  $\phi$  remains constant for all heights.

Consider now a highly specialized case of a *plane* polarized beam being *perfectly* reflected. Hence  $a$  and  $b$  both have values different from zero and  $\psi$  is zero. We then find that  $\theta$  becomes  $\pm 90$  deg. and  $\phi$  simply a constant shifting by 180 deg. at certain heights. This means that the field ellipse lies in the same vertical plane at all heights, the orientation of the plane being given by (25). This ellipse has one axis

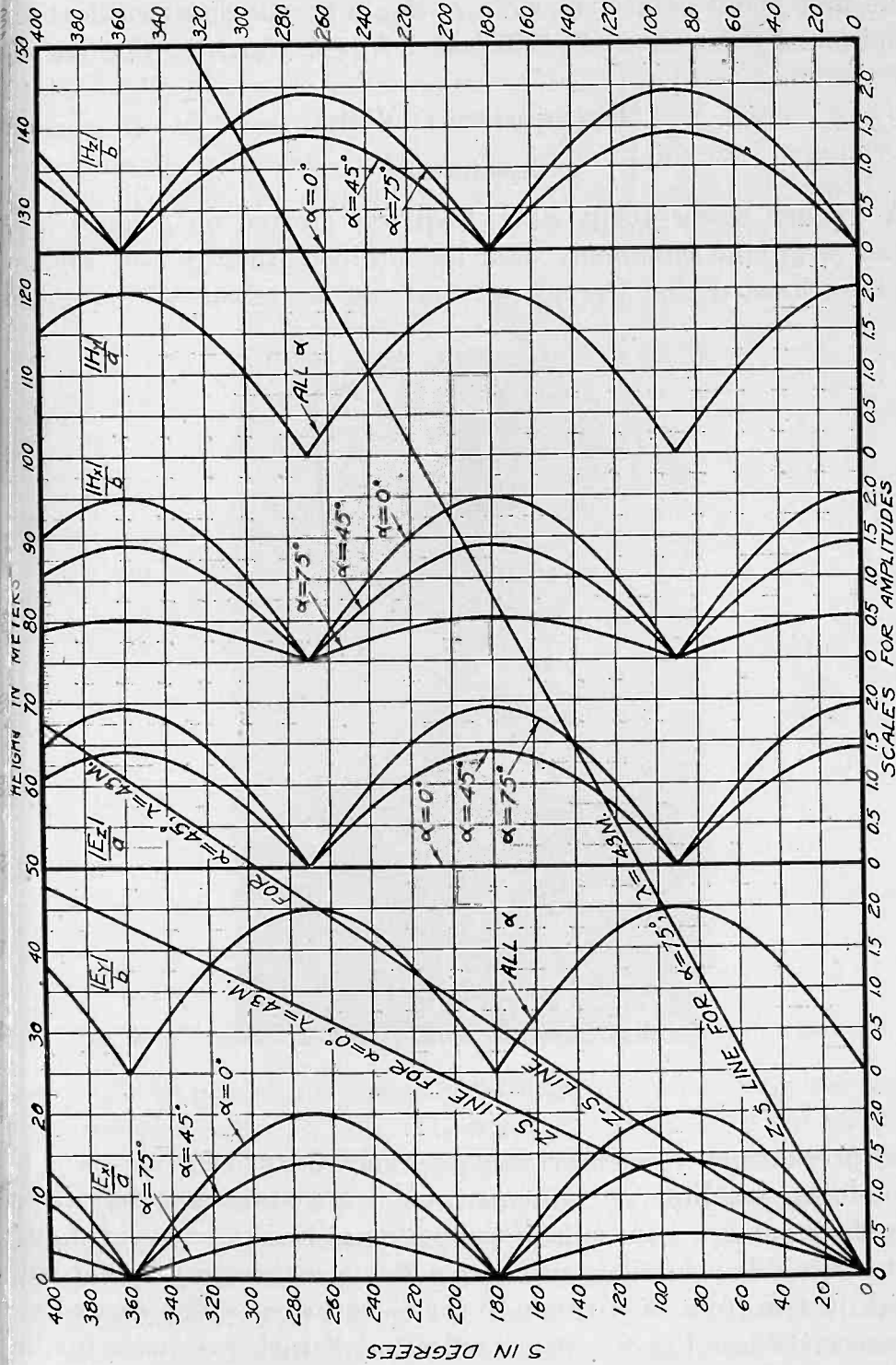

Fig. 7.—Absolute values of resultant amplitudes as functions of  $s$  for perfect reflection, i.e.,  $\sigma = \infty$  and for all wavelengths; and  $s$  as a function of height  $z$  for  $\lambda = 43$  meters. For values of the angle of incidence  $\alpha = 0$  deg.,  $45$  deg., and  $75$  deg.

that is parallel to the vertical axis  $z$ , and the other parallel to the horizontal plane. The ellipse degenerates into a line that is vertical at the first nodal point (i.e.,  $|H_x| = |H_y| = 0$ ) and horizontal at the second nodal point (i.e.,  $|H_z| = 0$  and  $\angle H_x = \angle H_y$ ), etc. (See Fig. 7.)

## EXPERIMENTAL WORK

### Apparatus

A wooden tower about 50 ft. high was erected on a fairly level stretch of ground commonly used for outdoor athletics (see Fig. 8). It was so located that the nearest building was about 650 ft. away.



Fig. 8—The tower.

These precautions were necessary to avoid disturbances caused by the building, machinery, equipment, etc. The stray reflections from the metal structure and walls of the buildings had to be avoided also. On the east side near the south corner was constructed a ladder with a track just in front of it to guide the elevator car which carried the radio receiver (see Fig. 9). Stray reflection disturbances were further minimized by having the power cable that supplied the elevator buried in the ground and by installing the elevator machinery at the bottom of the tower instead of at the top.



The general arrangement of the receiver that was mounted on the elevator car is shown diagrammatically in Fig. 10. The receiver consisted of a screen-grid radio-frequency amplifier (UX-222), an oscillating autodyne detector (UX-201-A), and two transformer coupled audio stages (UX-201-A and UX-112-A). Dry batteries were employed for all tubes. A single-turn loop about 13 in. square was used as the receiving antenna. It was mounted on a universal arrangement (see Fig. 11) with two divided circles, so that it could be turned in any desired direction and the direction of the normal to the plane of the

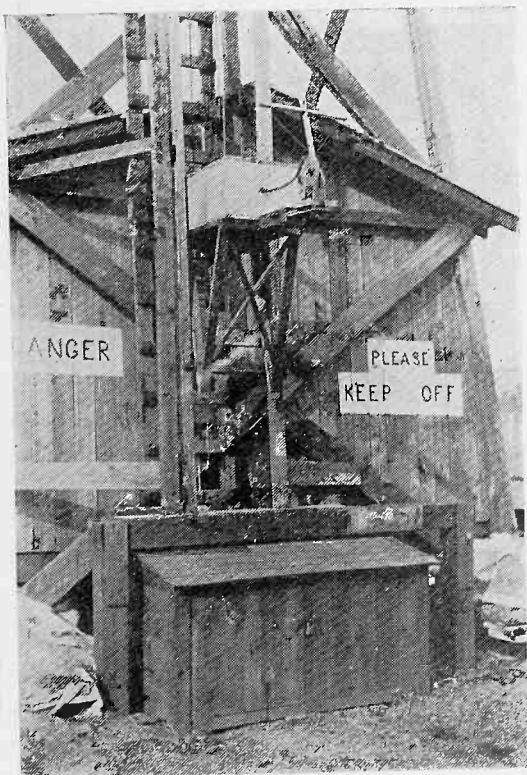

Fig. 9—Close-up view of the receiving equipment, elevator car, etc.

loop could be read directly from the two protractors. The horizontally mounted protractor  $P_1$  (Fig. 11) read the direction of the projection of the normal in the horizontal plane, measured positively from the north to the west. This angle was called  $\phi'$ . Angle  $\phi$  or the actual azimuth angle can be directly computed from  $\phi'$ , by making correction for the direction in which the transmitting station is located. The vertically mounted protractor  $P_2$  read the tip of the normal from the vertical, thus giving  $\theta$  directly. This was reckoned positive when the normal moved towards the north while  $\phi'$  was kept zero. The values of  $\phi$  and  $\theta$  thus determined correspond directly to the theoretical values given by (22).

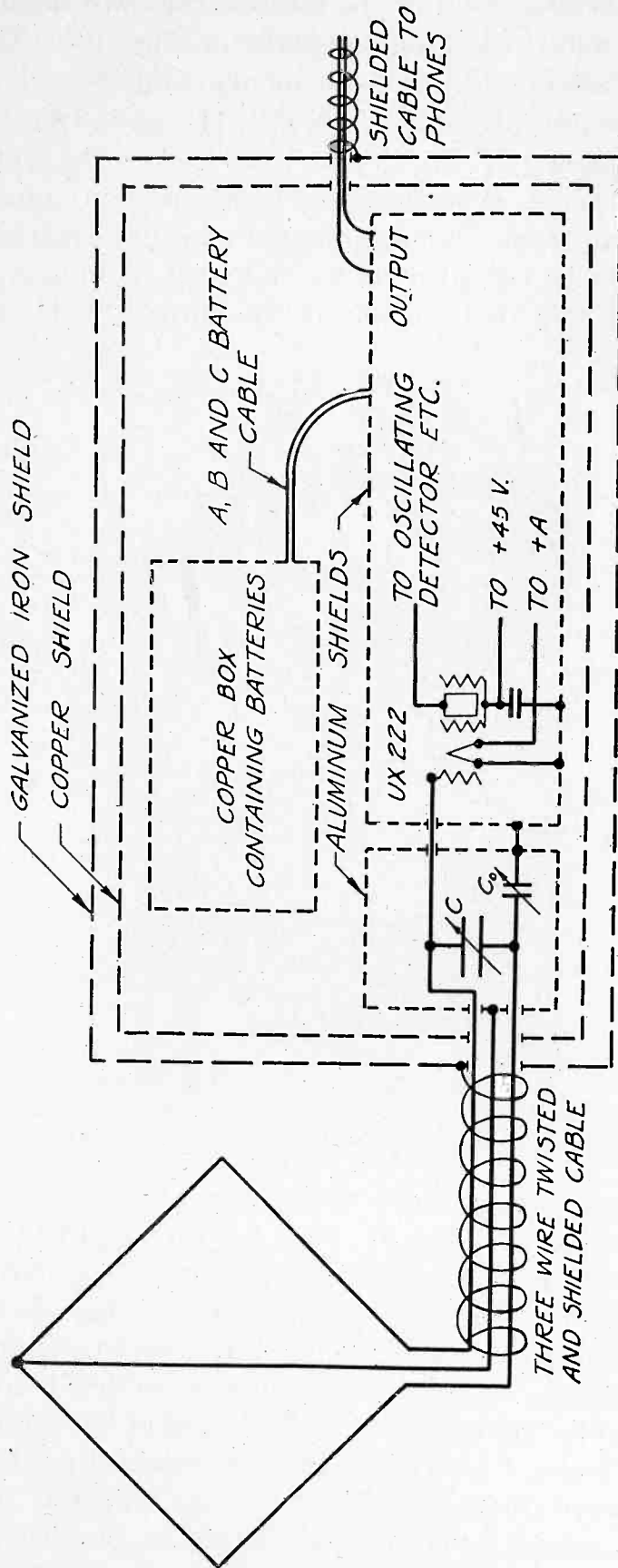

Fig. 10—General arrangement of the receiving circuit.

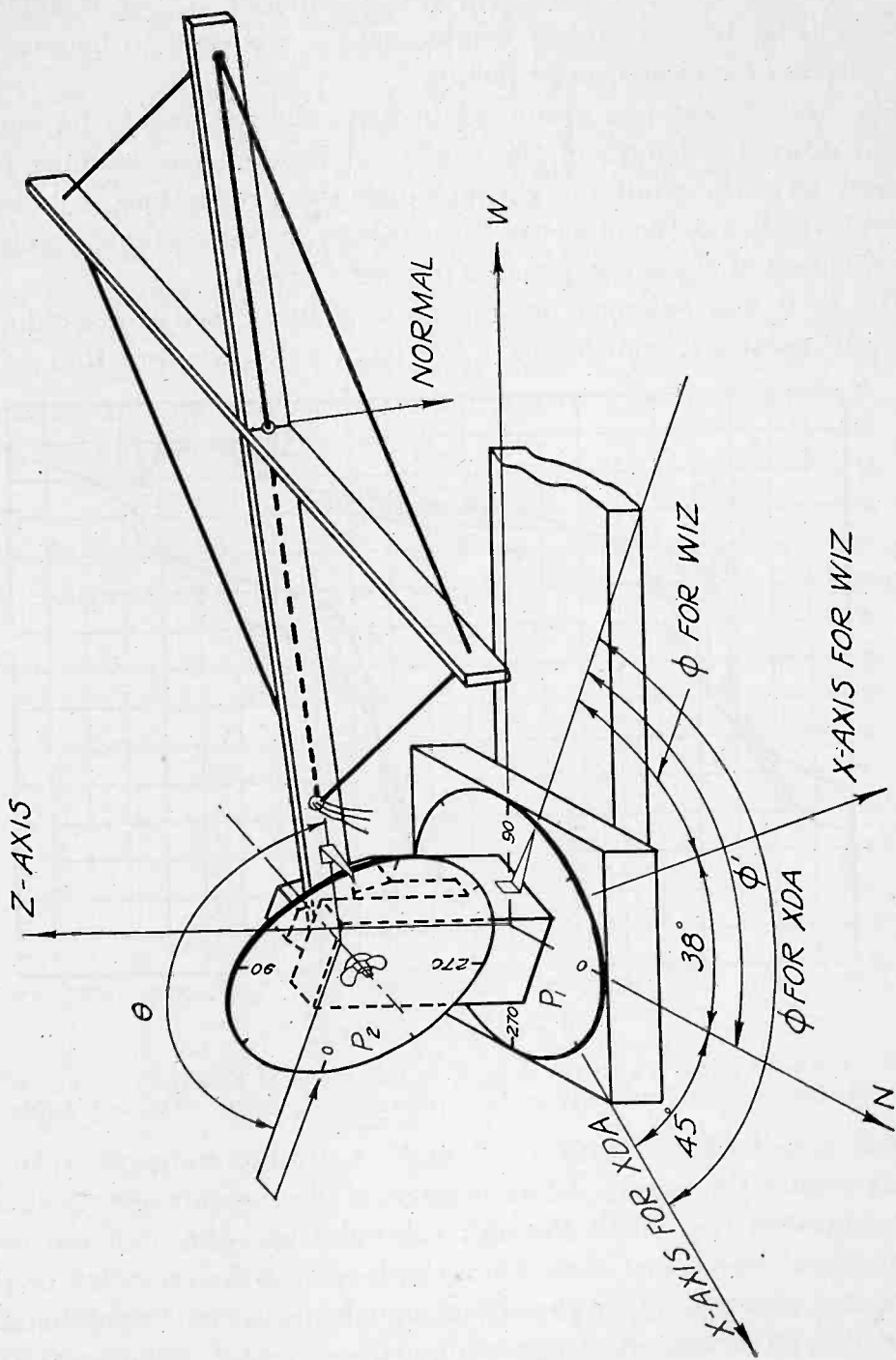

Fig. 11—The universally mounted loop antenna.

The three leads from the loop were interwoven and shielded with a sheath of copper braid to reduce the magnetic and static stray pickup. The loop was tuned with a variable condenser,  $C$ , of  $0.00025 \mu\text{f}$  capacity (Fig. 10). A midget condenser,  $C_0$ , was used to balance the loop antenna for electrostatic pickup.

The system was not grounded because the set had to be moved up and down the length of the tower. A ground lead running from the receiver to the ground might introduce stray reflections and distort the field which was the object of these measurements. Hence an elaborate shielding of the set was necessary (see Fig. 10).

The loop was balanced by means of a local oscillator sending a vertically polarized continuous wave from a known direction. The

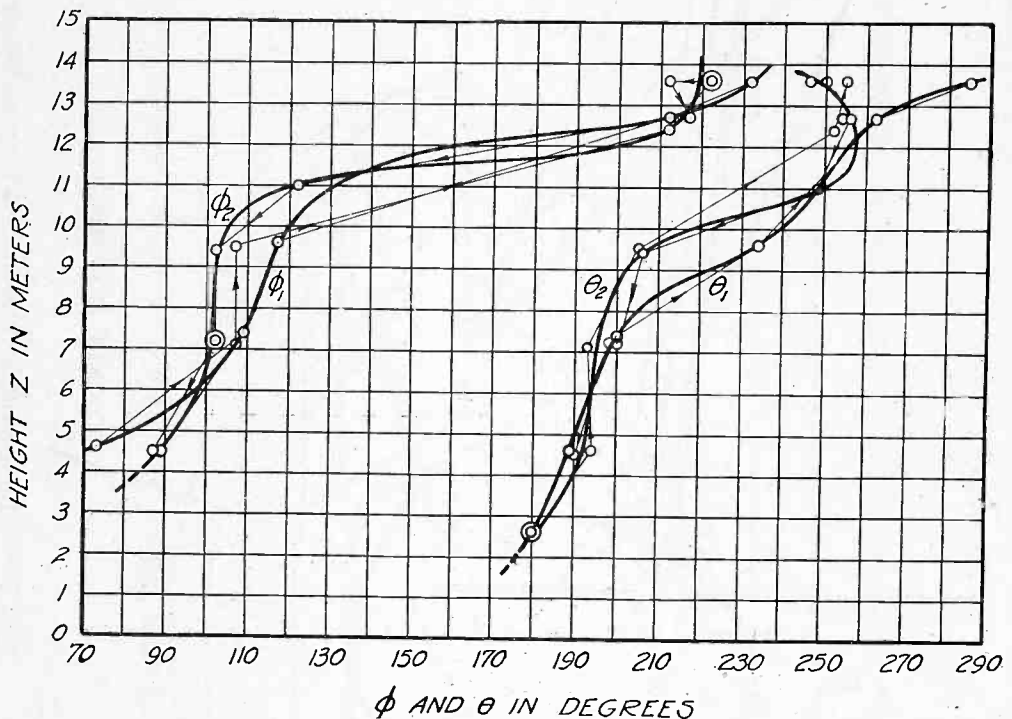

Fig. 12—Azimuth angle  $\phi$  and tip angle  $\theta$  as functions of height  $z$ , station WIZ,  $\lambda = 43$  meters, 10:02 to 10:47 A.M., September 18, 1929. (Data of Table I).

loop was thus balanced within  $\pm 5$  deg. A ground connection would possibly reduce this error. Another cause of discrepancy was the signal that penetrated the shield through the holes and the door crevices. A faint signal was heard even when the loop was disconnected or the condenser  $C$  shorted. Since the actual signals measured were generally very erratic, no further effort was made to improve the receiving system.

### Procedure

The procedure of measurements was as follows. The set was tuned to the desired station when at the bottom of the tower. The orientation and tip angles of the loop were so adjusted that the signal became

zero or minimum. In general, zero reception was rare, because of the energy penetration through the shielding. The values of  $\phi'$ ,  $\theta$ , and the time of observation were recorded. The receiver was then raised to greater heights and similar readings taken at various distances from the ground. Having reached the top, observations were repeated on a downward trip. If the two sets of observations fell on the same curves, it was assumed that the conditions during both sets of observations were steady with regard to polarization and angle of incidence; otherwise the sets of data were disregarded.

In spite of the felt padding, the radio receiver was sometimes detuned on account of the vibrations and jars of the elevator car. A spring suspension was tried, which made the conditions still worse. The set was, therefore, tuned every time it was necessary. It took about half an hour on the average to make two sets of readings covering an upward and downward trip.

### Observations

Most short-wave stations fade tremendously, and it will appear at first thought that a set of observations of this nature would be almost

TABLE I  
OBSERVATIONS ON STATION WIZ,  $\lambda = 43$  METERS, TIME A.M., SEPTEMBER 18, 1929, SOIL VERY WET

Z	$\phi$	$\theta$	Time	Remarks
2.6	All	0	10:02	Group 1
4.6	73	9	10:04	
7.4	109	20	10:06	
9.6	117	54	10:16	
12.7	212	82	10:18	
13.6	232	105	10:21	
13.6	217	110	10:22	
13.6	212	105	10:23	
13.6	202	100	10:24	
13.6	222	73	10:25	
13.6	222	66	10:27	Transition
13.6	212	70	10:27.5	
13.6	217	76	10:28	
12.7	212	74	10:29	
11.0	122	68	10:31	
9.4	102	26	10:32	
7.2	102	20	10:34	
7.2	102	18	10:35	
4.5	87	10	10:36	
2.6	All	0	10:37	
4.6	89	14	10:38	Group 2
7.1	107	13	10:39	
9.5	107	25	10:43	
12.4	212	72	10:44	
13.6	222	75	10:47	

impossible to obtain. It was found, however, that the 43-meter station WIZ, located in New Brunswick, New Jersey, held fairly steady, but only during the morning hours. This conclusion is based on the fact that a constant set of values for  $\phi$  and  $\theta$  were obtained over a long period of time, showing that the polarization and the angle of incidence remained constant during that period. The rapid, irregular fading

that accompanied these observations can, therefore, be attributed to purely amplitude fluctuations. Almost all other stations received here, ranging from 25- to 50-meter wavelength, were found to be highly erratic. The readings shifted continuously even when taken at a fixed height.

One typical set of observations on WIZ is given in Table I and plotted in Fig. 12. In plotting the points, the sequence of observation is shown by joining them with arrowhead lines. The data of Table I seem to be divided into two distinct parts. Starting from the bottom of the tower, the points lie on fairly smooth curves  $\phi_1$  and  $\theta_1$ , until the top of the tower is reached. At the top, however, the readings became variable for about five minutes and then settled down to steady values. The observations were then started on a downward trip and

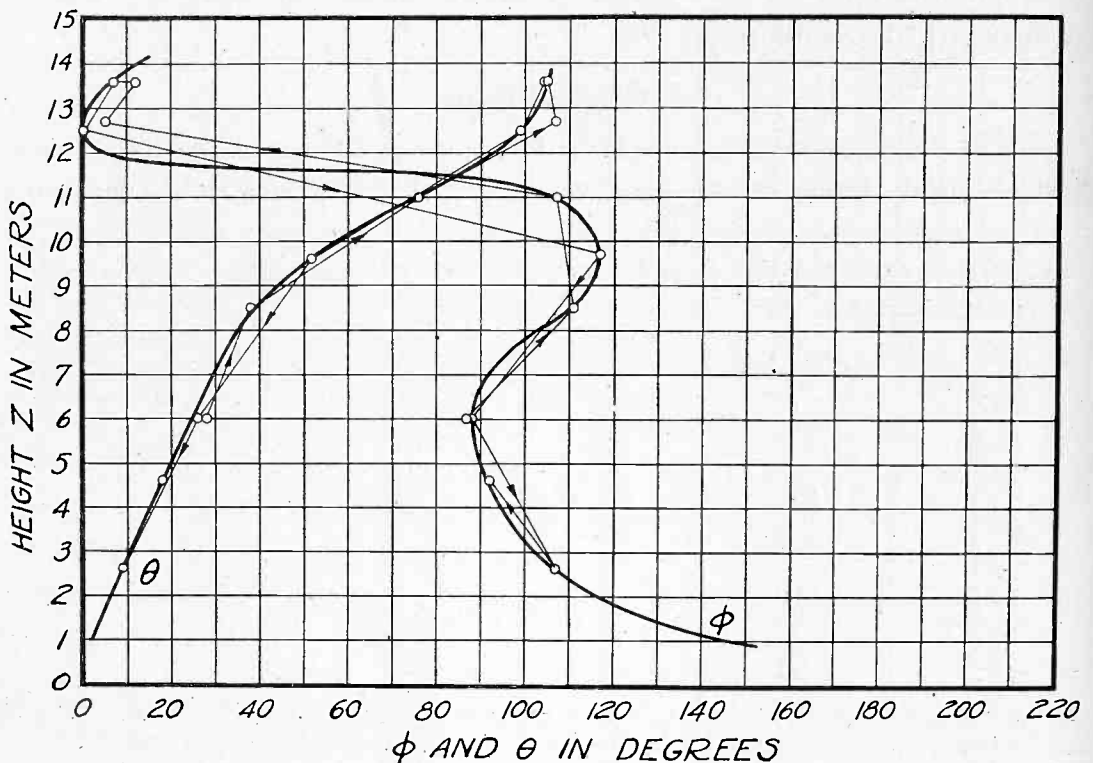

Fig. 13—Azimuth angle  $\phi$  and tip angle  $\theta$  as functions of height  $z$ , Station WIZ,  $\lambda=43$  meters, 10:40 to 11:00 A.M., September 24, 1929.

again repeated going up. The points obtained in the last two trips lie on the same curves  $\phi_2$  and  $\theta_2$  of Fig. 12. This indicates that during the above five-minute period, the signal from WIZ, arriving at Ithaca went through a transition of some sort. The character of this transition will be discussed in the next section on 'Analysis.' Curves  $\phi_1$  and  $\theta_1$  possibly do not correspond to any given set of conditions of polarization and incidence, but curves  $\phi_2$  and  $\theta_2$  certainly do, since the latter were determined by two sets of observations.

In Fig. 13, is plotted another set of data on the same station. The points lie surprisingly well on smooth curves.

Fig. 14 shows another typical set of observations on the same station. These curves are plotted for three sets of data obtained in three trips (up, down, and up) during the course of about 50 minutes. It is needless to say, the steadiness of polarization and angle of incidence is beyond usual expectations.

TABLE II

OBSERVATIONS ON STATION XDA,  $\lambda=44$  METERS, TIME A.M. SEPTEMBER 12, 1929, SOIL WET

Z	$\phi$	$\theta$	Time
2.4	All	0	10:46
6.0	67	18	10:47
9.5	63	34	10:49
13.6	40	5	10:51
2.4	All	0	10:53

Table II and Fig. 15 show the only data obtained on station XDA, a 44-meter station located in Chapultepec, Mexico. The check, regarding the steadiness of conditions, consists only of one repeated observation at the bottom of the tower.

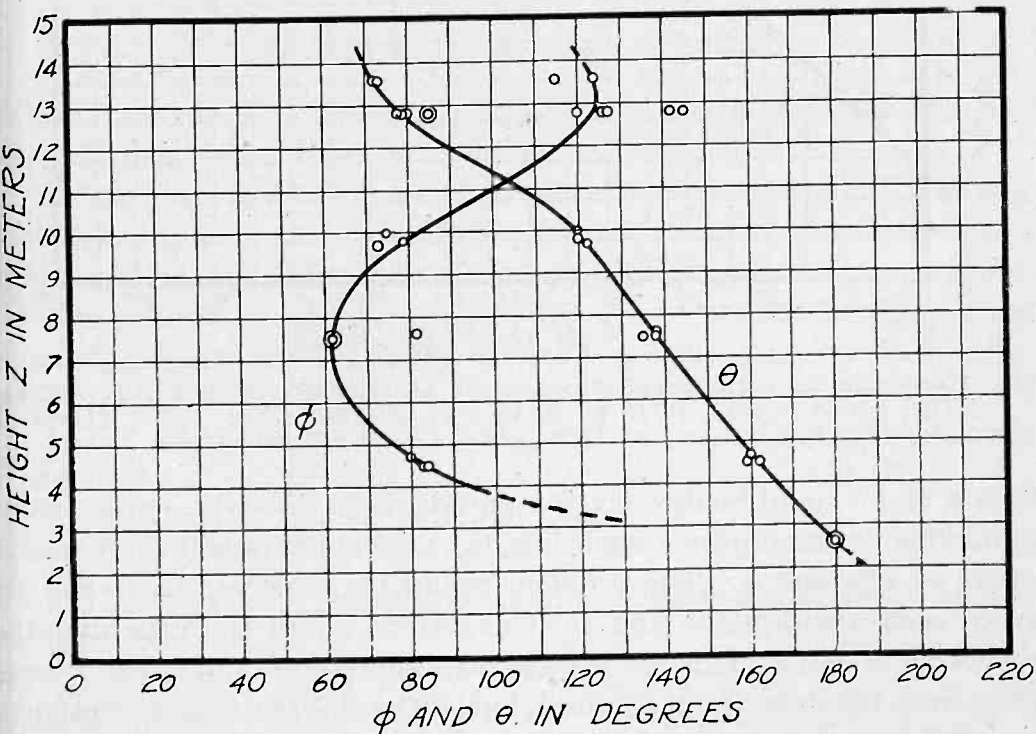

Fig. 14—Azimuth angle  $\phi$  and tip angle  $\theta$  as functions of height  $z$ , station WIZ,  $\lambda=43$  meters, 9:20 to 10:10 A.M., September 16, 1929.

Further observations are now in progress with a view to find out how conditions vary over 24 hours of the day and from one day to the next.

## THEORETICAL ANALYSIS AND CHECK OF EXPERIMENTAL CURVES

In the observation of  $\phi$  and  $\theta$ , there is an inherent ambiguity of 180 deg., hence the value of an observed angle may be regarded as itself or as 180 deg. larger or smaller. Of course when the value of one point on the curve is chosen, the rest of the curve is definitely fixed.

Under the assumption of the values for  $\sigma$  and  $\epsilon$  for the earth as given by (19), the various characteristics of the resultant field have been computed and plotted above. Now if we further assume or otherwise obtain the values of the angle of incidence  $\alpha$ , the ratio  $a/b$  and the angle  $\psi$ , we shall have completely determined the problem and

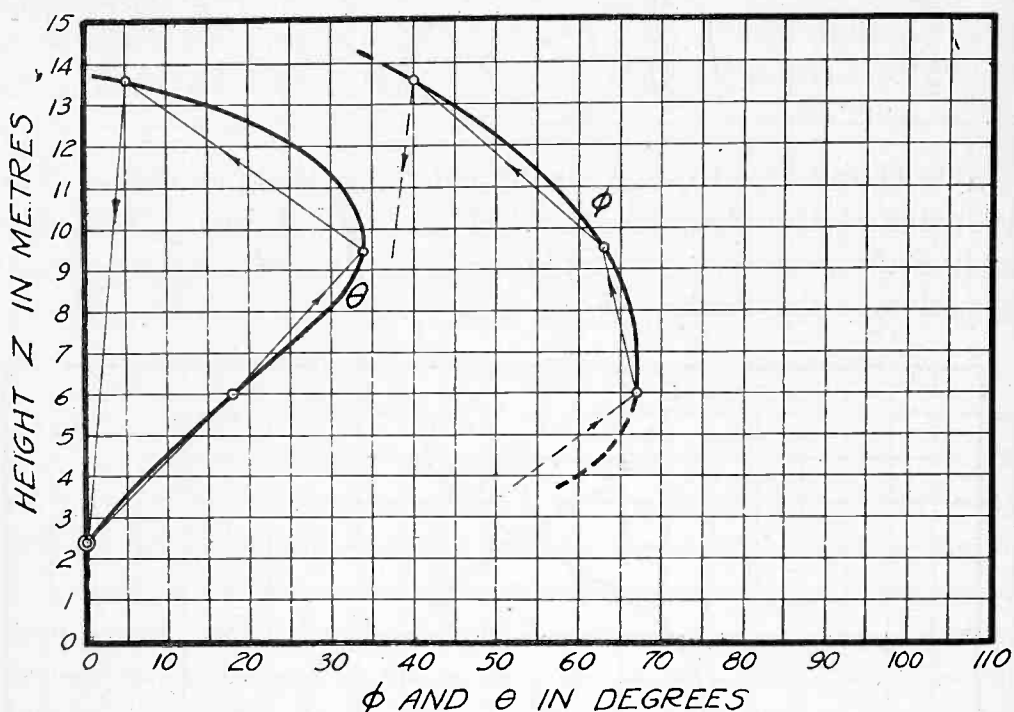

Fig. 15—Azimuth angle  $\phi$  and tip angle  $\theta$  as functions of height  $z$ , station XDA,  $\lambda=44$  meters, 10:45 to 10:55 A.M., September 12, 1929. (Data of Table II).

then  $\phi$  and  $\theta$  could be directly computed. It is, however, unnecessary to make any assumptions regarding the above mentioned three quantities,  $\alpha$ ,  $a/b$ , and  $\psi$ . The problem would be hopeless, if one had to make such assumptions and then expect to check the experimental curves for  $\phi$  and  $\theta$ . It is not always possible to determine these quantities from the data at our disposal, but, if the observations were carried to a sufficient height above the ground, the values of these unknowns could be determined by the method outlined below.

Let us, at first, confine our attention to the curves  $\phi_2$  and  $\theta_2$  of Fig. 12. One notices that  $\phi_2=180$  deg. at  $z=11.7$  metres. From Fig. 1, it is evident that when  $\phi$  is 180 deg. or 0 deg., the loop cuts the  $xz$



plane at right angles. Hence the field ellipse, that lies in the plane of the loop, may be thought of as being composed of two vectors, one in the  $xz$  plane and the other parallel to the  $y$  axis. Whence one directly concludes that  $H_x$  and  $H_z$  must be in phase or 180 deg. out of phase with each other to produce a resultant line vector in the  $xz$  plane. But from Figs. 5 and 6, it is clear that they can never be 180 deg. out of phase at any given height, hence they must be in phase. One may directly arrive at the same conclusion by substituting  $\phi = 180$  deg. in the first of equations (22), whence  $q = 0$ . From the second of equations (21), since  $|H_x|$  and  $|H_z|$  are not zero, we find that  $\angle H_x$  must be equal to  $\angle H_z$ . Now going back to curve 2 of Fig. 3, we find that, in order that  $H_x$  and  $H_z$  be in phase at  $z = 11.7$  meters, the angle of incidence  $\alpha$  must be 31 deg. Notice that curve  $\phi_2$  in Fig. 12 is rather flat in the neighborhood of 180 deg., hence the determination of  $\alpha$  is quite accurate, provided our underlying assumptions regarding conductivity and dielectric constant of the earth were accurate.

Now at this same height when  $\phi = 180$  deg.,  $\theta = 256$  deg. (or 76 deg.). Knowing  $\alpha$  and  $z$ , we find that the corresponding  $s$  is 84 deg. From Fig. 4 corresponding to this value of  $s$ , we find by interpolation that

$$H_x/b = 0.29 \text{ and } H_z/b = 0.87.$$

Whence we compute  $\theta$  to be 72 deg., which checks with the observed value 76 deg. well within the experimental error.

To compute  $a/b$  and  $\psi$ , we make use of the point where  $\phi_2 = 90$  deg. and  $\theta_2 = 193$  deg. At this point  $z = 4.7$  meters and the corresponding  $s$  becomes 34 deg. Here the normal to the loop lies in the  $yz$  plane, hence  $H_y$  and  $H_z$  are in phase or 180 deg. out of phase. But from Figs. 5 and 6, it is evident that they cannot be in phase at any one height, hence they are 180 deg. out of phase. Furthermore the resultant of  $H_y$  and  $H_z$  makes an angle of 77 deg. with the  $z$  axis, since  $\theta = 193$  deg. Hence

$$H_y/H_z = \tan 77 \text{ deg.} = 4.3.$$

From Fig. 4, we find, by interpolation, that when  $\alpha = 31$  deg., and  $s = 34$  deg., then

$$H_z/b = 0.6 \text{ and } H_y/a = 1.2,$$

whence

$$a/b = 2.15.$$

Similarly for  $\alpha = 31$  deg. and  $s = 34$  deg., we find from Figs. 5 and 6 that

$$\angle H_z - \psi = 72 \text{ deg. and } \angle H_y = -176 \text{ deg.},$$

whence we obtain

$$\psi = -68 \text{ deg.}$$

Now assuming these values of  $\alpha$ ,  $a/b$ , and  $\psi$ , i.e.,

$$\alpha = 31 \text{ deg.}$$

$$a/b = 2.15,$$

and

$$\psi = -68 \text{ deg.},$$

values of  $\phi$  and  $\theta$  are computed from (20) and (21), by interpolation of the curves in Figs. 4, 5, and 6. These are plotted as  $\phi_i$  and  $\theta_i$  in Fig. 16, where curves  $\phi_2$  and  $\theta_2$  are also reproduced from Fig. 12.  $\theta_i$  and  $\theta_2$  check fairly well, whereas  $\phi_i$  and  $\phi_2$  do not show so close an agreement.

Now supposing the earth was a perfect reflector, i.e.,  $\sigma = \infty$ , we can compute another set of curve for  $\phi$  and  $\theta$ . But in this case we cannot take the same values of  $\alpha$ ,  $a/b$ , and  $\psi$  as we used above; for they were gotten from the experimental curves on the assumption of imperfect reflection with values of soil constants as given by (19). Let us assume then that the turning point of  $\phi$  as given by (25), at  $s=90$  deg., lies at the same height  $z=11.7$  meters, and draw our theoretical  $\phi$  curve (designated in Fig. 16 by  $\phi_p$ ) symmetrical about the  $\phi_2$  curve. This leads to the value of  $\alpha$  as being 23 deg. and  $\phi_p$  being 70 deg. for  $s < 90$  deg. Substituting this value of  $\phi_p$  in (25), we have

$$b/a = 3.0 \cos \psi. \quad (27)$$

By making the corresponding theoretical  $\theta_p$  curve coincide  $\theta_2$  curve at some one point, independent values of  $b/a$  and  $\psi$  can be obtained. Thus let us choose the point where  $\theta_2=206$  deg. (or 26 deg.). Then the corresponding  $z=9.4$  meters and  $s=72$  deg. Substituting in (26) this value of  $s$  and appropriate value of  $\alpha$ , and solving it simultaneously with (37), we get

$$a/b = 2.75 \text{ and } \psi = -83 \text{ deg.}$$

$\theta_p$  is now computed on the basis of these values of  $\alpha$ ,  $a/b$ , and  $\psi$ , and the results plotted in Fig. 16.

In general the computed and experimental  $\phi$  and  $\theta$  curves of Fig. 16 seem to have the same characteristics, except at the lower part near the ground. Here  $\phi_2$  deviates considerably and shows a curvature opposed to that of the theoretical curve  $\phi_i$ . This discrepancy may be attributed to the possible disturbance introduced by stray reflections

from the cabin at the bottom of the tower and possibly the motor and its housing. As the distance from the ground increases this extraneous disturbing effect is lessened. This view is further substantiated by the fact that the observed value of  $\theta$  is zero (i.e., the loop exactly horizontal) at a height  $z=2.6$  meters. This holds true for the curves of Fig. 14 and 15 as well. Very rarely a value of  $\theta$  different from zero is observed at this height, as in Fig. 14. This means that  $H_z$  vanishes whenever  $\theta$  vanishes. But theoretically we have proved that no component ever vanishes at any height. From Fig. 4 we see that  $H_z$ ,

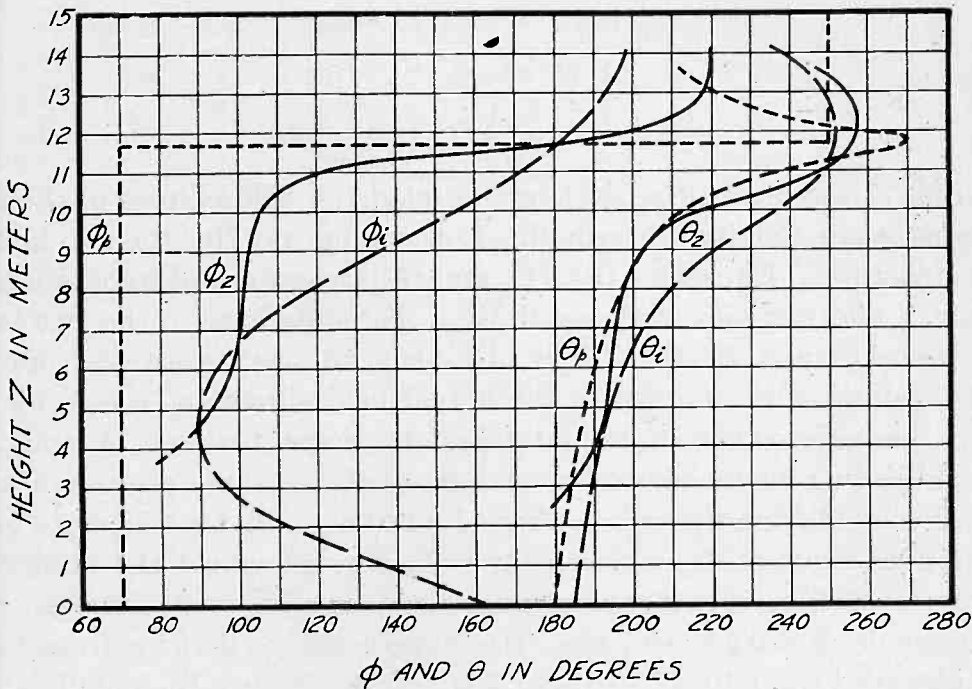

Fig. 16—Theoretical check of the experimental curves  $\phi_2$  and  $\theta_2$  of Fig. 12, on the basis of perfect and imperfect reflections:

- $\phi_p$  and  $\theta_p$ —perfect reflection  
 $\alpha = 23$  deg.,  $\psi = -83$  deg.,  $a/b = 2.75$ .
- $\phi_i$  and  $\theta_i$ —imperfect reflection  $\alpha = 31$  deg.,  $\psi = -68$  deg.,  
 $a/b = 2.15$ .

in the neighborhood of ground, assumes a minimum value only at  $z=0$ . So that there appears to be no possible theoretical reason for  $H_z$  to vanish at a height of 2.6 meters, in most of the observations. We can only attribute this to the disturbance from the nearby objects.

Furthermore we notice from Fig. 16 that the experimental curves lie midway between the computed curves based on the two assumptions of perfect and imperfect reflection. Notice the gradation in the flatness of the  $\phi$  curves and gradual sharpening of the peaks of the  $\theta$  curves as one passes from the imperfect reflection to the perfect reflection case. This conclusively shows that the conductivity of the soil, as assumed

in (19), was not high enough for the soil responsible for reflection, and that if one were to measure the conductivity and the dielectric constant at the same time that the reflection observations are taken, the theoretical and experimental curves would show a better check and at the same time lead to more accurate information regarding the incoming wave.

The actual structure of the incoming wave may, therefore, be regraded as lying somewhere midway between the two structures derived above on the basis of the two assumptions, i.e.,

$$31 \text{ deg.} > \alpha > 23 \text{ deg.}$$

$$2.15 < a/b < 2.75$$

$$- 68 \text{ deg.} > \psi > - 83 \text{ deg.}$$

In Fig. 17 are drawn the electric and magnetic field ellipses of the incoming wave, looking towards the downcoming ray, for the two limiting structures. Equations (3), (4), and (5) are employed to obtain the angle  $\beta$ , and the axes of these ellipses. The difference in the two sets of ellipses *A* and *B* (Fig. 17) is obviously not very great and one is quite safe in concluding that the actual field ellipses of the incident wave had somewhat of an intermediate shape between *A* and *B*.

Subjecting curves  $\phi_1$  and  $\theta_1$  of Fig. 12 to the same process of analysis we find from the point, where  $\phi = 180$  deg., that  $\alpha = 35$  deg. The computed value of  $\theta_1$  at this point is 74 deg. as against the observed value of 76 deg. Furthermore from the point where  $\phi = 90$  deg., we obtain  $a/b = 3$  and  $\psi = -67$  deg. Hence we conclude that the transition we observed from 10 :22 to 10 :27 A.M., on September 18, 1929 (Table I) in the signal from WIZ, consisted mainly in a variation in the value of  $a/b$  from 3 to 2, i.e., the field ellipses became fatter. The variation in  $\alpha$  from 35 deg. to 31 deg. and that in  $\psi$  from  $-68$  deg. to  $-67$  deg. are very small and can be safely neglected as being within the error of observation and the error due to the approximate assumptions.

When the curves of Fig. 13 are subjected to analysis, we find, from the point where  $\phi = 0$  deg. that  $\alpha = 36.5$  deg. and the computed value of  $\theta$  is 101 deg. as compared to the observed value 99 deg. However, instead of one set of values for  $a/b$  and  $\psi$ , we obtain four sets—three sets from the three points where  $\phi = 90$  deg. and one from the point where  $\theta = 90$  deg. These are tabulated in Table III. Its explanation is yet uncertain, but it may be attributed to the presence of two waves coming down from the ionized layer of the upper atmosphere.

In Fig. 14, we have a typical case of large angles of incidence. The angle of incidence is so large that the first nodal point, where  $\phi = 0$  deg.

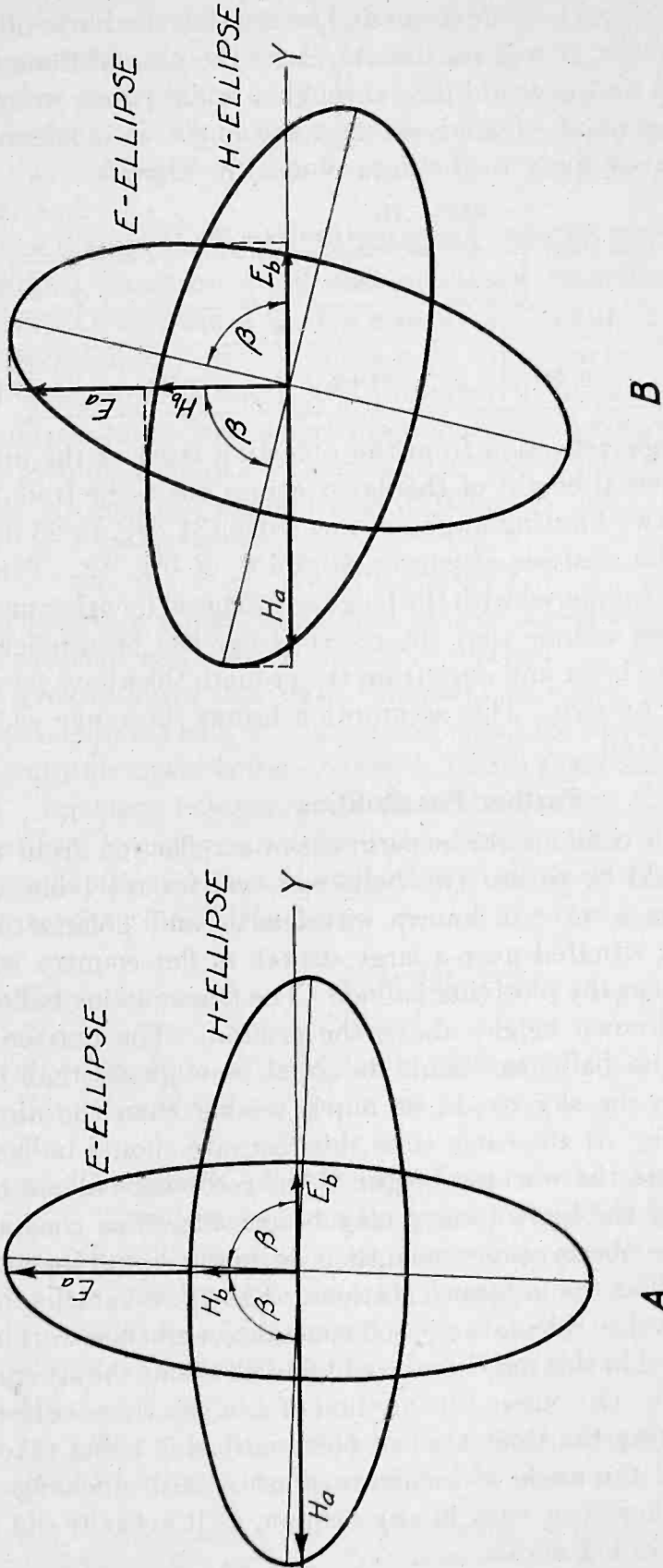

Fig. 17—Incident field ellipses (drawn looking towards the downcoming wave) corresponding to the two analyses of the curves  $\phi_2$  and  $\theta_2$  of Fig. 12 based on perfect and imperfect reflection:

- A—Perfect reflection  
 $\alpha = 23$  deg.,  $\psi = -83$  deg.,  $a/b = 2.75$ ,  $\beta = 87$  deg.
- B—Imperfect reflection  
 $\alpha = 31$  deg.,  $\psi = -68$  deg.,  $a/b = 2.15$ ,  $\beta = 76$  deg.

or 180 deg., is out of reach of the tower and we are thus unable to obtain its value. If, however, it was possible to carry the observations to a sufficient height so that  $\phi$  would pass through a nodal point, we could obtain the starting point of analysis, i.e., the angle of incidence  $\alpha$ .

The same remarks apply to the data plotted in Fig. 15.

TABLE III  
COMPUTED VALUES OF  $a/b$  AND  $\psi$  FROM CURVES OF FIG. 13

From	$\phi = 90^\circ$			$\theta = 90^\circ$
Z =	11.4	6.7	5.0	11.8
a/b =	0.25	1.4	1.5	2.3
$\psi =$	-17 deg.	-63 deg.	-65 deg.	22 deg.

Assuming a single reflection from the reflecting layer of the upper atmosphere, the virtual height of this layer comes out to be from 380 to 760 km for the two limiting angles of incidence (31 deg. to 23 deg.) that follow from the analysis of curves  $\phi$  and  $\theta$  of Fig. 12. This is a bit too high when compared with the heights measured by other methods. However, if we assume that the received ray has been reflected twice from the upper layer and once from the ground, the above figures have to be divided by two. This assumption brings the range within limits already observed.

#### Further Possibilities

An ideal way to conduct the experiments on reflection from the earth's surface would be to use two balloons—one for receiving and one for transmitting a wave of known wavelength and polarization, both balloons being situated over a large stretch of flat country with fairly uniform soil near the receiving balloon. The transmitting balloon may be held at a known height above the ground. The horizontal distance between the balloons should be small enough so that the wave reflected from the sky would be much weaker than the direct wave at the receiver. At the same time this distance should be large enough so that within the working height of the receiving balloon the angle of incidence of the known wave may be considered as constant for all heights. The observations may then be made simultaneously on the known as well as the unknown stations. The known station observations may be used to calculate the soil constants, and then working backwards as outlined in this paper one could find all about the structure of the incoming wave. Of course, this method of analysis relies entirely on the fact that during the time a set of observations is being taken, the polarization and the angle of incidence must remain unchanged. Its amplitude may, however, vary in any fashion, as it actually did in the observations recorded above.

In case the configuration of the earth's surface is fairly uniform for large stretches, the method of Smith-Rose and Barfield<sup>15</sup> may be employed to measure the conductivity of the soil. This consists in measuring the tilt angle of the ground wave in the vicinity of a vertically polarized wave radiator. It, however, does not yield the dielectric constant of the soil.

The theory may easily be extended to cover the case of broadcast reception, where an additional vertically polarized ground wave is present. Observations in this case would have to be carried to much greater heights.

Furthermore it might be of interest to extend the theory as well as analysis to the case where more than one sky wave is present. This may give us a clue as to whether the ambiguous case of Fig. 14 and Table III could be explained on this basis.

### Acknowledgment

The author is highly indebted to Prof. Ernest Merritt for suggesting this problem and for his continual interest and valuable suggestions that greatly aided this work. Author's thanks are also due to W. E. Bostwick for his help in reading the code. He further wishes to express his gratitude towards the Charles A. Coffin Foundation of Schenectady, N.Y., for their fellowship grants of 1927-28 and 1928-29, which enabled him to carry on studies in connection with this work and to the Heckscher Foundation of Cornell University for the use of the tower built by their Grant No. 140.

### NOMENCLATURE

- |    |   |   |
|----|---|---|
| A  | }   | Elements of complex reflection factors as defined by (10) and (11). |
| B  |   |   |
| C  |   |   |
| D  |   |   |
| a  | Amplitude of the component of the electric vector of the incident beam in the plane of incidence, expressed in e.s.u.                 |   |
| b  | Amplitude of the component of the electric vector of the incident beam at right angles to the plane of incidence, expressed in e.s.u. |   |
| a' | }   | Semi-axes of the incident electric and magnetic field ellipses.     |
| b' |   |   |
| c  | The velocity of electromagnetic radiation, $3 \times 10^{10}$ cm per sec.   |   |
| E  | Electric field vector expressed in e.s.u.   |   |

<sup>15</sup> R. L. Smith-Rose and R. H. Barfield, "Direction of forces of wireless waves at the earth's surface," *Proc. Roy. Soc.*, (A), 107, 586-601, 1925.

$E_{xi}$	}	Orthogonal components of incident electric field.
$E_{yi}$		
$E_{zi}$		
$E_{xr}$	}	Orthogonal components of reflected electric field.
$E_{yr}$		
$E_{zr}$		
$E_x$	}	Orthogonal components of resultant electric field.
$E_y$		
$E_z$		
$H$		Magnetic field vector expressed in e.m.u.
$H_{xi}$	}	Orthogonal components of incident magnetic field.
$H_{yi}$		
$H_{zi}$		
$H_{xr}$	}	Orthogonal components of reflected magnetic field.
$H_{yr}$		
$H_{zr}$		
$H_x$	}	Orthogonal components of resultant magnetic field.
$H_y$		
$H_z$		
$e$		Naperian base.
$h_a$		Period of resultant field amplitudes considered as functions of height.
$h_p$		Period of the phases of the resultant field components, considered as functions of height.
$J$	}	Elements of the complex coefficients of the resultant field components as defined by (13).
$K$		
$L$		
$M$		
$Q$		
$R$		
$S$		
$T$		
$j$		$= \sqrt{-1}$
$N$		Normal to the plane containing the resultant magnetic field ellipse.
$n$		Defined as in (6).
$m$		Defined as in (7).
$P$		Plane containing the resultant magnetic-field ellipse.
$p$	}	Direction numbers of the normal to the plane $P$ containing the resultant magnetic field.
$q$		
$r$		
$s$		Defined as in (14).



- $t$  Time in seconds.
- $U$  Any component of the resultant field.
- $x, y, z$  Coördinate axes,  $x$  and  $y$  in the plane of the earth with  $x$  along the horizontal direction of propagation and  $z$  normal to the earth (see Fig. 1).
- $z_I, z_{II}$  See caption under Fig. 3.
- $\alpha$  Angle of incidence.
- $\beta$  Angle between one of the axes of the electric field ellipse of the incident beam and a horizontal line parallel to the  $y$  axis (see Fig. 1).
- $\epsilon$  Dielectric constant of the earth.
- $\theta$  Angle of tip—the angle between the  $z$  axis and the normal  $N$  to the plane  $P$  containing the resultant magnetic field (see Fig. 1).
- $\theta_i$  Theoretical  $\theta$  computed on the basis of imperfect reflection.
- $\theta_p$  Theoretical  $\theta$  computed on the basis of perfect reflection.
- $\lambda$  Wavelength in meters.
- $\sigma$  Conductivity of the earth in e.m.u.
- $\phi$  Angle of orientation—the angle between the  $x$  axis and the horizontal projection of the normal  $N$  to the plane  $P$  containing the resultant magnetic field.
- $\phi_i$  Theoretical  $\phi$  computed on the basis of imperfect reflection.
- $\phi_p$  Theoretical  $\phi$  computed on the basis of perfect reflection.
- $\psi$  Phase difference between the components of the electric vector in the plane of incidence and the one at right angles to this plane.
- $\omega = 2\pi f$  or  $2\pi c/\lambda$ , where  $f$  is the frequency of the signal.



## THE COÖPERATION COMMITTEE PROGRAM\*

BY

A. E. KENNELLY

*Summary*—The following is a communication to the meeting of the American Section, International Scientific Radio Union, Washington D. C., April 25, 1930, in which present daily schedules and future plans for the international exchange of radio-cosmic information are outlined.

THE COMMITTEE on Coöperation of the American Section, International Scientific Radio Union (URSI), aims to serve as a channel of information concerning the activities and progress of scientific organizations engaged in research upon cosmic phenomena affecting the propagation of radio waves.

The intensity of electromagnetic wave signals received from distant parts of the world is known to be affected by a number of cosmic influences which may be divided, for convenience, into four groups:

I. Influences, at or beneath the earth's surface, such as physical or chemical influences attending geological and topographical distributions of surface material.

II. Meteorological influences in the lower atmosphere or troposphere, including atmospheric electric disturbances.

III. Upper atmospheric influences, of ionized gases forming absorbing, reflecting, or refracting layers, including auroras.

IV. Influences outside of the earth's atmosphere, such as solar activities.

The science of radio-wave propagation aims at securing quantitative knowledge of the effects of each and all of these groups of cosmic influences. In the present state of our knowledge, we must obtain statistical information concerning observed effects of variations in cosmic phenomena upon observed radio-signal intensities.

As offering facilities for such variational observations, the French Government inaugurated, December 1, 1928, a system of radio-cosmic bulletin broadcasts, at 11.20 A.M. daily, G.M.T., from the Eiffel Tower Station (FLE) at Paris, following the regular meteorological bulletin broadcast at that hour, on a wavelength of 1445 meters, or a frequency of 207.5 kc per sec.

This daily radio-cosmic bulletin includes information on the following particulars:

\* Dewey decimal classification: R 009. Original manuscript received by the Institute, May 1, 1930. Delivered at a meeting of the American Section, International Scientific Radio Union, Washington, D. C., April 25, 1930.

- (a) Steadiness or disturbance of the earth's magnetic field.
- (b) Steadiness or disturbance of the atmospheric electric field.
- (c) Apparent activity of the solar surface, as regards both sunspots and faculae.

This information is communicated in plain French, i.e., not in code.

It will be observed that (a) and (b) are geophysical data, while (c) relates to astrophysical data. These data are contributed by the Physical Institute of the Globe (l'Institut de Physique du Globe) of Paris, the National Meteorological Office, and the Astronomical Observatory at Meudon near Paris. The data concerning atmospheric electric fields relate to both steadiness of the field, and to the gradient of atmospheric potential. These are reported from continuous records made at the Val Joyeux Observatory in Seine-et-Oise, a few kilometers beyond Versailles from Paris.

Information concerning the operation of this daily radio-cosmic broadcast service was received in March, 1929, by the American Coöperation Committee from President Ferrie of the URSI. This information was speedily distributed to the American Section of the URSI and also to the Liaison Committee of the International URSI.

In April, 1929, an informal meeting of scientists interested in coöperation on cosmical researches, was held at the National Academy of Sciences, in Washington, D. C. It was decided that it would be desirable both in the interests of radio science, and of other cosmical sciences, to develop a daily radio-cosmic broadcast bulletin service from U. S. Government coastal radio stations, following the lines of the daily Eiffel Tower bulletins. It was also suggested that it would be helpful to American observers, if the Eiffel Tower daily radio-cosmic bulletins could be repeated daily from the powerful French radio station Lafayette (FYL) near Bordeaux, which has a long wave (18,900 meters or frequency 15.9 kc.).

The French Government authorities, on being informed of this desire, very courteously complied. Since February 1, 1930, they have repeated daily the Eiffel Tower (FLE) radio-cosmic bulletins, simultaneously, from two radio stations, one having a long and the other a short wave, at about 20.20 G. M. T., or 15.20 E. S. T. (75th Meridian). The former is the Lafayette Station (FYL), frequency 15.9 kc or 18,900 meters. The latter is Issy-les-Moulineaux, near Paris, ( $f=9230$  kc or  $\lambda 32.5$  meters).

Information has been received that these radio-cosmic bulletins are daily copied by various American radio observers, including some

who keep statistical records; but the total number of such records is not known; nor is it yet known over what range of area in the United States these signals can be read and recorded.

An informal committee of scientists in Washington, D. C., interested in cosmic researches, has taken up consideration of effective means for collecting radio-cosmic data and of issuing a daily broadcast bulletin. It is hoped that such a radio-cosmic bulletin service may shortly be put in operation from American coastal stations.

Eventually, we may hope that such radio-cosmic bulletins will be issued by the leading nations of the world, exchanging their daily observations in simple international code form, commencing with a small number of cosmic data and gradually increasing the number and precision of the scientific data exchanged. In this way, a prediction of the behavior of radio waves may not only be facilitated; but various other world phenomena, meteorological or otherwise, may be elucidated, both from the basic and applied science standpoints.



## CLASSIFICATION OF RADIO SUBJECTS: AN EXTENSION OF THE DEWEY DECIMAL SYSTEM.\*

*Summary*—A systematic scheme of classification of subjects in radio science and engineering is necessary in classifying references to current radio publications and also for classifying all sorts of other radio material, such as reports, reprints, drawings, books, apparatus, etc. In an effort to fill the need for a radio classification this extension of the Dewey decimal system was prepared.

Since the publication of the first edition of this circular, in 1923, the subject classification it presents has been used extensively by many radio research workers and engineers as well as by the radio section of the Bureau of Standards. The present edition brings the classification up to date and makes a few changes which use has shown to be necessary.

### I. INTRODUCTION

SINCE the publication of the first edition of this circular, in 1923, the subject classification it presents has been used extensively by many radio research workers and engineers as well as by the radio section of the Bureau of Standards. The present edition brings the classification up to date and makes a few changes which use has shown to be necessary.

A systematic scheme of classification of subjects in radio science and engineering is necessary in classifying references to current radio publications and also for classifying all sorts of other radio material, such as reports, reprints, drawings, books, apparatus, etc. In an effort to fill the need for a radio classification this extension of the Dewey decimal system was prepared.

Such a system makes it easy to place books on related subjects near together on the shelves, or to file references on the same subject all in the same group and not by the order of their addition to the collection or file. If a classification is to be of the most use, any part of it must be capable of expansion, or it must be possible to disregard any part of the classification without interfering with the usefulness of the remaining parts. These requirements are met.

### II. THE DEWEY DECIMAL SYSTEM OF CLASSIFICATION

Under the Dewey decimal system,<sup>1</sup> of which the present classification is an extension, classification is by subject, numbers being used to

\* Dewey decimal classification: R050. Original manuscript received by the Institute May 26, 1930. First edition prepared by L. E. Whittemore and R. S. Ould; 2nd edition prepared by J. H. Dellinger and C. B. Jolliffe.

<sup>1</sup> The first edition of this circular was based on the 10th edition, 1919, of "Decimal classification and relative index for libraries, clipping notes, etc.," by M. Dewey, published by the Forrest Press, Lake Placid Club, N. Y. Success-

show the relative positions of the books, cards, or other material. The numbers, therefore, show both what the material is (that is, its subject matter), and where the material is (that is, its location on the shelves or in the files). In the classification list the indentation and the figures prefixed to each item show the rank of each subject in the classification.

Accompanying the extended classification table used in the Bureau of Standards' files is an alphabetical index.<sup>2</sup> The index is used in determining the number to assign to a given item or material, or to learn where to place it in the files. The index is also used by any person desiring to locate the material covering a given subject. The reference number tells immediately where all material on that and on related subjects can be found.

#### a. Outline of Classification

The whole subject of radio is given the number 621.384 in the Dewey classification. The relation of this place to the general field of knowledge is shown by the following table.

Class 600	Useful arts
20	Engineering
1.	Mechanical
.300	Electrical
.080	Communication
.004	Radio

In a strictly radio library or office it is convenient to represent the figure 621.384 by "R" and this abbreviation is used below in the further classification of radio. Thus, R211 indicates 621.384.211.

While some of the details of the Dewey system itself seem to be illogical (for example, electrical engineering a subdivision of mechanical engineering), the system has been widely adopted, and confusion would result from attempts to change it into a more logical form.

The Dewey system has some general features which are found especially advantageous. For example, all general material under a given class is put under the class itself (usually having a final figure 0). The ninth division under any class is usually reserved for miscellaneous

---

sive revisions of Dewey's book appeared, and the 12th edition, 1927, is the basis of the present edition of this circular. Attention is also called to an elaboration of the Dewey system of decimal classification made by the International Institute of Bibliography (Published in "Classification Decimale Universelle", by Institut International de Bibliographie, Bruxelles, 1905; 2d edition, 1929). The American Dewey and the International Institute expanded tables are similar in general plan, but differ in detail. For example, in the American Dewey tables radio-communication is found at 621.384, as explained below, while in the International Institute tables it is found at 621.396.

<sup>2</sup> By neglecting detailed numbers this index can be applied to the classification Table given in III b.

tems which are as yet of too small importance to classify separately; this should not be confused with the first item (0) under each class which is used for general material pertaining to many or all of the subdivisions under it. The ninth division should be used sparingly, i.e., effort should always be made to find a more specific classification. This sometimes requires an extension to be made to the classification at some point.

#### b. Detailed Form Classification

The Dewey classification as well as the extension for radio is mainly by subject or content, regardless of form. For material covering a general field, special form subdivision of the subject is found practically useful. For classification as to form the following set of numbers may be used in connection with the number corresponding to any subject covered.

- 001 Statistics
- 002 Quantities; cost
- 003 Contracts; specifications
- 004 Designs; drawings
- 005 Executive; administrative; rules
- 006 Working; maintenance
- 007 Laws; regulations
- 008 Patents
- 009 Reports of tests; bulletins
- 01 Theory; methods; programs
- 02 Textbooks; outlines; manuals
- 03 Cyclopedias; dictionaries
- 04 Essays; addresses; lectures; letters; papers
- 05 Periodicals; magazines; reviews; bibliography; publications
- 06 Societies; associations; transactions; exhibitions
- 07 Education; training; museums
- 08 Tables; calculations; charts; maps
- 09 History; progress; development, biographical

The sequence of figures constituting the form number is simply placed to the right of the sequence of figures constituting the class number.<sup>3</sup> Thus a periodical on any subject has the subject number followed by 05.

Examples:

- R500.05 Periodicals on applications of radio
- R510.05 Periodicals on applications of radio to navigation

<sup>3</sup> In the previous edition, Circular 138, the following statement was made "If the class number already ends in one or two zeros, as 500 or 510, these zeros are disregarded in making up the combined number." This practice has been abandoned and all zeros should be included except under R000.

R526.105 Periodicals on radio beacon systems

R526.100.7 Laws regarding radio beacons

Thus the classification of any subject may be expanded to meet the needs of an individual file. The complete number gives in a condensed form an indication of what the material is, as well as its location in the files.

### III. CLASSIFICATION OF RADIO SUBJECTS

#### a. Details of Use

In the classification of radio subjects the main features of the Dewey system as to subject and form classification are retained.

The class (R800) is anomalous. This space in the classification is actually used for nonradio matter. Such material should, however, be given its regular class number according to the Dewey system. If it were arranged in strictly numerical order, some of this material would come before radio and some after radio. By choosing arbitrarily to use the space denoted by R800 for this purpose it is possible to arrange the nonradio material in classified order, but to keep it subordinate to a larger volume of radio material. Accordingly, a number of nonradio items are included where R800 comes in the list under Section IV below but are given their number according to the complete classification.

In filing a specific paper under a given class or subdivision, a convenient file number for it can readily be made by using its subject classification number plus a small letter; the order chosen for the letters used for subsequent papers can be according to author, chronological order of accession, or any other consideration depending on the circumstances.

In a card file of references to periodical literature, it is convenient to arrange the cards under each final class or subdivision either in chronological order or in alphabetical order by the names of authors. Cross references may be made conveniently in such a card file by preparing two or more cards and marking each card, after the file number, "X——." For example, suppose an article on fading (R113.1) includes a method of measuring field intensity by radio-frequency comparison method (R273); two cards should be made out, one marked R113.1, X R273 and the other R273, X R113.1. Each of these should be filed under the first number.

The needs of individual collections of files vary widely, and expansions of the system can be made by any person using the system. The following classification table is given as a classification which in itself meets the needs of small collections or files. Persons interested in a



particular subject or subjects will find it advantageous to expand the parts in which they are interested, and to use the classification as given for those parts in which they have only a general interest.

In Section V below there is given a detailed extension of this classification which has been evolved to meet the filing needs of the Radio Section of the Bureau of Standards. In that table there will be found examples of detailed extensions to meet particular circumstances.

In cases where files of an organization are numbered according to an extended system and are made available to another organization using a less extended system, the detailed portion of the classification numbers can be removed. An example of this is the monthly lists of References to Current Radio Literature published by the Bureau of Standards.<sup>4</sup> The reference numbers in the Bureau's own files are according to the table given in Section V, e.g., an article on radio beacon systems for aircraft (visual type) is filed under R526.12. This may be filed in a less extended file under R520 (aircraft radio), R526 (radio as navigation aid), or R526.1 (beacon systems for aircraft), depending on how brief a system is being used.

## b. Classification Table

### R000 Radio

(Material of a general nature for which no specific classification can be used and which relates to the field as a whole.)

### R100 Radio Principles

(Material having to do with underlying theory.)

#### R110 Radio waves.

(Transmission phenomena and theory; atmospheric.)

#### R120 Antennas.

#### R130 Vacuum Tubes.

#### R140 Circuit theory and effects.

#### R150 Generating (transmitting) apparatus (except vacuum tubes; see R130)

#### R160 Receiving apparatus.

#### R170 Interference.

#### R190 Other radio principles.

### R200 Radio Measurements and Standardization

(Methods of, and apparatus for, measurement.)

#### R210 Frequency.

#### R220 Capacity.

#### R230 Inductance.

#### R240 Resistance; current; voltage.

#### R250 Generating (transmitting) apparatus.

#### R260 Receiving apparatus.

#### R270 Intensity (field intensity, signal intensity, noise, etc.)

<sup>4</sup> PROC. I.R.E.

R526.105 Periodicals on radio beacon systems

R526.100.7 Laws regarding radio beacons

Thus the classification of any subject may be expanded to meet the needs of an individual file. The complete number gives in a condensed form an indication of what the material is, as well as its location in the files.

### III. CLASSIFICATION OF RADIO SUBJECTS

#### a. Details of Use

In the classification of radio subjects the main features of the Dewey system as to subject and form classification are retained.

The class (R800) is anomalous. This space in the classification is actually used for nonradio matter. Such material should, however, be given its regular class number according to the Dewey system. If it were arranged in strictly numerical order, some of this material would come before radio and some after radio. By choosing arbitrarily to use the space denoted by R800 for this purpose it is possible to arrange the nonradio material in classified order, but to keep it subordinate to a larger volume of radio material. Accordingly, a number of nonradio items are included where R800 comes in the list under Section IV below but are given their number according to the complete classification.

In filing a specific paper under a given class or subdivision, a convenient file number for it can readily be made by using its subject classification number plus a small letter; the order chosen for the letters used for subsequent papers can be according to author, chronological order of accession, or any other consideration depending on the circumstances.

In a card file of references to periodical literature, it is convenient to arrange the cards under each final class or subdivision either in chronological order or in alphabetical order by the names of authors. Cross references may be made conveniently in such a card file by preparing two or more cards and marking each card, after the file number, "X—." For example, suppose an article on fading (R113.1) includes a method of measuring field intensity by radio-frequency comparison method (R273); two cards should be made out, one marked R113.1, X R273 and the other R273, X R113.1. Each of these should be filed under the first number.

The needs of individual collections of files vary widely, and expansions of the system can be made by any person using the system. The following classification table is given as a classification which in itself meets the needs of small collections or files. Persons interested in a

particular subject or subjects will find it advantageous to expand the parts in which they are interested, and to use the classification as given for those parts in which they have only a general interest.

In Section V below there is given a detailed extension of this classification which has been evolved to meet the filing needs of the Radio Section of the Bureau of Standards. In that table there will be found examples of detailed extensions to meet particular circumstances.

In cases where files of an organization are numbered according to an extended system and are made available to another organization using a less extended system, the detailed portion of the classification numbers can be removed. An example of this is the monthly lists of References to Current Radio Literature published by the Bureau of Standards.<sup>4</sup> The reference numbers in the Bureau's own files are according to the table given in Section V, e.g., an article on radio beacon systems for aircraft (visual type) is filed under R526.12. This may be filed in a less extended file under R520 (aircraft radio), R526 (radio as navigation aid), or R526.1 (beacon systems for aircraft), depending on how brief a system is being used.

## b. Classification Table

### R000 Radio

(Material of a general nature for which no specific classification can be used and which relates to the field as a whole.)

### R100 Radio Principles

(Material having to do with underlying theory.)

#### R110 Radio waves.

(Transmission phenomena and theory; atmospheric.)

#### R120 Antennas.

#### R130 Vacuum Tubes.

#### R140 Circuit theory and effects.

#### R150 Generating (transmitting) apparatus (except vacuum tubes; see R130)

#### R160 Receiving apparatus.

#### R170 Interference.

#### R190 Other radio principles.

### R200 Radio Measurements and Standardization

(Methods of, and apparatus for, measurement.)

#### R210 Frequency.

#### R220 Capacity.

#### R230 Inductance.

#### R240 Resistance; current; voltage.

#### R250 Generating (transmitting) apparatus.

#### R260 Receiving apparatus.

#### R270 Intensity (field intensity, signal intensity, noise, etc.)

<sup>4</sup> PROC. I.R.E.

- R280 Properties of materials.  
R290 Other radio measurements.
- R300 Radio Apparatus and Equipment**  
(Component parts of apparatus, not complete communication systems.)
- R320 Antennas.  
R330 Vacuum tubes.  
R350 Generating (transmitting) apparatus.  
R360 Receiving apparatus.  
R380 Parts; instruments.  
R390 Other radio apparatus and equipment.
- R400 Radio Communication Systems**  
(Complete communication systems, or parts of a system which are considered in relation to the complete system.)
- R410 Modulated-wave systems.  
R420 Continuous-wave systems.  
R430 Interference elimination.  
R440 Remote control (by wire).  
R450 Connection of radio systems to wire systems.  
R460 Duplex and multiplex systems.  
R470 Radio-frequency carrier wire systems.  
R480 Radio relay systems.  
R490 Other systems.
- R500 Application of Radio**  
(Radio as an instrument in other arts, industries, etc.)
- R510 Marine applications.  
R520 Aeronautic applications.  
R530 Commercial and special services (commercial communications, press, railroads, mining, etc.).  
R540 Private.  
R550 Broadcasting.  
R560 Military.  
R570 Remote control by radio.  
R580 Picture transmission; television.  
R590 Other applications.
- R600 Radio Stations**  
(Equipment, operation, and management.)
- R610 Equipment.  
R620 Operation and management.
- R700 Radio Manufacturing**
- R710 Factories.  
R720 Processes.  
R740 Sales.
- (R800) Nonradio Subjects**  
(Material of interest but not a part of radio. Give complete numbers according to the Dewey system; see part V.)

**R900 Miscellaneous Radio**

(Material which has no specific place. See also R000.)

This is in substantial agreement with the classification as given in the first edition, with the exception of changes in R240, R250, R260, R340, R580, and R590, mostly made for the sake of consistency between parts of the classification.

**IV. EXTENSIONS OF RADIO CLASSIFICATION**

For larger collections and files a still more detailed extension might be required. The form classification (Sec. II b) is very useful for detailed extensions, and may be used under any item in the classification, as occasion requires.

The following extension of the subject classification has been developed for filing material in the Radio Section, Bureau of Standards. Form classifications (see Sec. II b) are not given in the table except under R000, but, as already stated, may be made anywhere in the classification. Radio reference lists and other material published by the Bureau are classified according to this table.

**V. EXTENDED CLASSIFICATION TABLE USED  
IN BUREAU OF STANDARDS FILES**

R000	Radio
R001	Statistics.
R004	Design.
R005	Executive; administrative; personnel.
R007	Laws; regulation.
R007.9	International conferences; treaties.
R009	Reports; bulletins.
R010	Research.
R020	Textbooks. (See also R050.)
R030	Terminology; symbols.
R040	Lectures.
R050	Publications.
R051	Books. (See also R020.)
R053	Periodicals.
R055	Bibliographies.
R060	Societies; meetings.
R070	Education; training.
R080	Collections; tables; miscellanies.
R081	Tables.
R082	Nomograms.
R083	Humor.
R084	Maps and charts.
R090	History.
R091	Radio telegraphy.
R094	Radio telephony.
R097	Biographical.

- R100     **Radio Principles**
- R110     Radio waves.
- R111     Theory.
- R111.1    Velocity of radio waves.
- R111.2    Radiation.
- R111.6    Reception.
- R113     Radio-wave transmission phenomena.
- R113.1    Fading.
- R113.2    Daily variations; seasonal variations.
- R113.3    Direction variations.
- R113.5    Meteorological, geophysical, and cosmical effects.
- R113.55   Eclipses.
- R113.6    Reflection; refraction; diffraction; absorption; polarization.
- R113.61   Kennelly-Heaviside layer.
- R113.62   Multiple signals.
- R113.63   Wave front angle.
- R113.7    Transmission formulas; range.
- R114     Atmospheric disturbances; strays.
- R115     Directional properties.
- R116     Waves on wires.
- R120     Antennas.
- R121     Condenser-type antennas (ordinary elevated type) with ground or counterpoise.
- R125     Directional antennas (transmitting in, or receiving from, a particular direction.)
- R125.1    Beam antennas.
- R125.2    Wave antennas.
- R125.3    Coil antennas.
- R125.31    Direction finding.
- R125.4    Adcock antennas.
- R126     Ground connections.
- R129     Other types of antennas.
- R129.1    Multiple tuned antennas.
- R130     Vacuum tubes.
- R131     General properties; characteristic curves.
- R132     Amplifying action.
- R133     Generating action.
- R134     Detector action.
- R135     Modulating action.
- R138     Electron emission; ionization.
- R139     Other vacuum-tube principles.
- R140     Circuit theory and effects.
- R141     Simple radio circuits.
- R141.1    Frequency.
- R141.2    Resonance.
- R141.3    Impulse excitation.
- R142     Coupled circuits.
- R142.1    Direct coupling.
- R142.3    Inductive coupling.
- R142.5    Capacitive coupling.
- R143     Filters.

- R144 Radio-frequency resistance.
- R144.1 Damping; decrement.
- R145 Reactance.
- R145.3 Inductance.
- R145.5 Capacity.
- R146 Harmonics.
- R146.1 Harmonic amplification.
- R146.2 Multivibrator.
- R147 Beats.
- R148 Modulation.
- R148.1 Distortion.
- R149 Rectification.
- R150 Generating (transmitting) apparatus (except vacuum tubes; see R133).
- R152 Spark.
- R153 Arc.
- R154 Alternator.
- R160 Receiving apparatus.
- R161 Receiving sets.
- R161.1 Selectivity.
- R161.2 Sensitivity.
- F161.3 Fidelity.
- R161.4 Normal output.
- R161.5 Interference output.
- R162 Receiving-set circuit arrangements.
- R163 Heterodyne reception.
- R165 Telephone receivers. (See also 621.385.97.)
- R170 Interference.
- R171 Beat interference.
- R190 Other radio principles.
- R191 Principles of piezo electricity applied to radio.
  
- R200 **Radio Measurements and Standardization**
- R201 General methods and apparatus.
- R201.5 Shielding and grounding.
- R201.7 Use of cathode-ray oscillograph.
- R202 Resonance methods.
- R203 Harmonic methods.
- R204 Null methods.
- R205 Substitution methods.
- R206 Use of beat notes in measurements.
- R206.1 Beat indicators.
- R207 High-frequency bridge methods.
- R210 Frequency.
- R211 Circuit resonance methods.
- R211.1 Frequency meters.
- R212 Parallel wire methods.
- R213 Harmonic methods.
- R213.1 Harmonic amplifiers.
- R213.2 Multivibrators.
- R214 Piezo-electric standards.

- R220 Capacity.
- R220.1 Capacity meters.
- R223 Dielectric constant.
- R225 Capacity of coils.
- R230 Inductance.
- R231 Self inductance.
- R232 Mutual inductance.
- R240 Resistance; current; voltage.
- R241 Resistance; power factor.
- R241.1 Resistance-variation method.
- R241.2 Reactance-variation method.
- R241.3 Substitution method.
- R241.4 Calorimeter methods. (See also 536.)
- R241.5 Bridge methods.
- R242 Current.
- R242.1 Ammeters.
- R242.11 Hot-wire.
- R242.12 Thermoelement.
- R242.13 Current transformer.
- R242.14 Electro-dynamometer.
- R242.15 Einthoven galvanometer.
- R242.16 Bolometer bridge.
- R243 Voltage.
- R243.1 Vacuum-tube voltmeters.
- R243.2 Sparking distance.
- R243.3 Electrostatic voltmeters.
- R250 Generating (transmitting) apparatus
- R251 Power rating.
- R253 Transmitting vacuum tubes.
- R254 Modulation.
- R255 Power amplifiers.
- R256 Microphones.
- R260 Receiving apparatus.
- R261 Receiving sets.
- R261.1 Selectivity.
- R261.2 Sensitivity.
- R261.3 Fidelity.
- R261.4 Normal output.
- R261.5 Interference output.
- R261.6 Power supply.
- R262 Receiving vacuum tubes.
- R261.1 Characteristic curves.
- R262.2 Grid conductance.
- R262.3 Plate conductance; plate resistance.
- R262.4 Amplification factor.
- R262.5 Mutual conductance.
- R262.6 Internal capacities.
- R262.7 Life tests.
- R262.8 Power output.
- R262.9 Other vacuum-tube measurements.
- R263 Amplifying apparatus.



- R264 Component parts.
  - R264.1 Condensers.
  - R264.2 Coils.
  - R264.3 Transformers.
- R265 Telephone receivers. (See also 621.385.97.)
- R265.1 Telephones.
- R265.2 Loud speakers.
- R270 Intensity (field intensity, signal intensity, noise, etc.).
- R271 Shunted telephone method.
- R272 Audio-frequency comparison method.
- R273 Radio-frequency comparison method.
- R280 Properties of materials.
  - R281 Electrical insulating materials. (See also R223, R241.)
  - R282 Electrical conducting materials.
    - R282.1 Metallic conductors.
    - R282.2 Electrolytes.
    - R282.3 Magnetic materials.
- R290 Other radio measurements.
  
- R300 **Radio Apparatus and Equipment**
  - R320 Antennas.
    - R320.6 Antenna switches.
    - R320.8 Towers.
  - R321 Condenser type antennas (ordinary elevated type) with ground or counterpoise.
  - R325 Directional antennas (transmitting in, or receiving from, a particular direction.)
    - R325.1 Beam antennas.
    - R325.2 Wave antennas.
    - R325.3 Coil antennas.
    - R325.31 Direction finders.
    - R325.4 Adcock antennas.
  - R326 Ground connections.
  - R327 Artificial antennas.
  - R329 Other types of antennas. (For airplane antennas see R525.)
  - R329.1 Multiple tuned antennas.
- R330 Vacuum tubes.
  - R331 Construction; evacuation. (See also vacuum pumps, 533.85.)
  - R332 Two-electrode.
  - R333 Three-electrode.
  - R334 Four-electrode.
  - R335 Five-electrode.
  - R336 Alternating-current tubes.
    - R336.1 Directly-heated cathode.
    - R336.2 Indirectly-heated cathode.
  - R337 Rectifier tubes.
  - R338 Regulator tubes.
  - R339 Special types of tubes.
- R350 Generating apparatus; transmitters.
  - R352 Spark.
  - R353 Arc.

- R354 Radio-frequency alternators.
- R355 Vacuum-tube transmitters.
  - R355.1 Low frequency (10–100 kc).
  - R355.2 Medium frequency (100–1500 kc).
  - R355.21 Broadcast frequency (550–1500 kc).
  - R355.3 Medium-high frequency (1500–6000 kc).
  - R355.4 High frequency (6000–30,000 kc).
  - R355.5 Very high frequency (above 30,000 kc).
  - R355.6 Frequency control.
    - R355.65 Piezo oscillators.
  - R355.7 Power amplifiers.
  - R355.8 Modulators.
  - R355.9 Generating sets for special purposes.
- R356 Power supply.
  - R356.1 Direct current.
  - R356.2 Alternating current.
  - R356.3 Rectifiers.
- R357 Frequency changers; harmonic amplifiers; multivibrators.
- R358 Protective devices.
- R359 Automatic transmitters.
- R360 Receiving apparatus.
- R361 Receiving sets.
  - R361.1 Tuned radio frequency.
  - R361.2 Superheterodyne.
  - R361.3 Regenerative.
- R362 Detectors.
  - R362.1 Crystal.
  - R362.2 Vacuum tube.
  - R362.9 Other types.
- R363 Amplifiers.
  - R363.1 Radio frequency.
  - R363.2 Audio frequency.
- R365 Telephone receivers. (See also 621.385.97.)
  - R365.1 Telephones.
  - R365.2 Loud speakers.
  - R365.3 Automatic recorders.
- R366 Power supply.
  - R366.1 Direct current.
  - R366.2 Alternating current.
  - R366.3 Rectifiers.
- R380 Parts; instruments.
  - R381 Condensers.
  - R382 Inductors.
    - R382.1 Transformers.
  - R383 Resistors.
    - R383.1 Grid leaks.
  - R384 Frequency meters.
    - R384.1 Radio.
    - R384.2 Audio.
    - R384.5 Decremeters.
- R385 Modulation and keying devices.

- R385.1 Keys.
- R385.2 Buzzers.
- R385.3 Interrupters; tone wheels; choppers. (See also R427.)
- R385.5 Microphone.
- R386 Filters.
- R387 Protective equipment.
- R387.1 Shields.
- R387.5 Grounds.
- R387.7 Insulators.
- R388 Cathode-ray oscillograph.
- R389 Electrical indicating instruments.
- R390 Other radio apparatus and equipment.

**R400 Radio Communication Systems**

- R410 Modulated-wave systems.
  - R411 Spark.
  - R412 Telephone.
  - R413 Audio-frequency modulation.
  - R414 Radio-frequency modulation.
- R420 Continuous-wave systems.
  - R421 High-frequency alternator.
  - R422 Arc.
  - R423 Vacuum tube.
    - R423.1 Low frequency (10-100 kc).
    - R423.2 Medium frequency (100-1500 kc).
    - R423.21 Broadcast frequency (550-1500 kc).
    - R423.3 Medium high frequency (1500-6000 kc).
    - R423.4 High frequency (6000-30,000 kc).
    - R423.5 Very high frequencies (above 30,000 kc).
  - R424 Timed spark.
  - R425 Impulse excitation.
  - R426 Beat reception.
  - R427 Use of receiving interrupters and tone wheels.
  - R429 Other continuous-wave systems.
- R430 Interference elimination.
- R440 Remote control (by wire).
- R450 Connection of radio systems to wire system.
- R460 Duplex and multiplex systems.
- R470 Radio-frequency carrier wire systems.
- R480 Radio relay stations.
- R490 Other systems.

**R500 Applications of radio**

- R510 Marine applications.
  - R511 Distress signals.
  - R512 Position finding.
    - R512.1 Radio beacon; radio range.
    - R512.2 Fog signaling.
    - R512.3 Radio compass.
  - R515 Submarine.
  - R516 Life-saving service.

- R520 Aeronautic applications.
- R521 Receiving on aircraft.
- R521.1 Receiving sets.
- R521.2 Ignition shielding.
- R522 Transmitting from aircraft.
- R522.1 Transmitters.
- R522.2 Bonding.
- R523 Receiving from aircraft.
- R524 Transmitting to aircraft.
- R525 Antennas.
- R526 Radio as navigation aid to aircraft.
- R526.1 Beacon systems; radio range.
- R526.11 Aural.
- R526.12 Visual.
- R526.2 Direction finders; radio compass.
- R526.3 Field localizers; landing aids.
- R526.4 Altimeters.
- R527 Automatic control of aircraft.
- R530 Commercial and special services.
- R531 Traffic.
- R531.1 Codes and ciphers.
- R531.2 Station call letters.
- R531.3 Abbreviations.
- R531.4 Alphabets, Morse and Continental (international).
- R531.5 Relations with land lines.
- R531.6 Relations with cables.
- R531.7 Rates.
- R532 Press.
- R533 Railroad.
- R534 Agriculture.
- R535 Forestry.
- R536 Mining; geophysical prospecting.
- R537 Power-transmission lines.
- R540 Private.
- R545 Amateur.
- R550 Broadcasting.
- R551 Time signals.
- R551.1 Longitude determinations.
- R553 Meteorological signals.
- R554 Entertainment.
- R555 Standard-frequency signals.
- R556 Market reports.
- R560 Military.
- R561 Army.
- R565 Navy.
- R570 Remote control by radio.
- R580 Picture transmission; television.
- R581 Facsimile; photographs.
- R582 Motion pictures.
- R583 Television.
- R590 Other applications.

- R591 Transmission of power by radio.
- R592 Radio on automobiles.
- R594 Therapeutics.
- R595 Radio toys.

R600 **Radio Stations**

- R610 Equipment.
  - R611 Low frequency (10-100 kc).
  - R612 Medium frequency (100-1500 kc).
  - R612.1 Broadcast frequency (550-1500 kc).
  - R613 Medium high frequency (1500-6000 kc).
  - R614 High frequency (6000-30,000 kc).
  - R615 Very high frequency (above 30,000 kc).
  - R616 Ship stations.
  - R617 Direction-finding stations.
  - R620 Operation and management.

R700 **Radio Manufacturing**

- R710 Factories.
- R720 Processes.
- R740 Sales.

(R800)<sup>6</sup> **Nonradio Subjects**

- 347.7 Patent practice.
- 353.821\* Bureau of Standards.
- 383 Postal service, Air Mail service. (See also Aero-nautics, 629.13.)
- 510 Mathematics.
- 520 Astronomy.
- 526 Geodesy.
- 526.8 Map projections.
- 530 Physics.
  - 531 Mechanics.
  - 532 Hydrostatics.
  - 533 Pneumatics.
    - 533.95 Vacuum apparatus.
  - 534 Sound.
    - 534.3 Tuning forks.
    - 534.83 Signals in navigation.
  - 535 Light. (For light signaling, see 623.731.)
    - 535.3 Photoelectric phenomena.
      - 535.38\* Photoelectric tubes.
  - 536 Heat.
    - 536.33 Radiation; general theory.
    - 536.83 Heating by induction.
  - 537 Electricity.
    - 537.1 Theory of electricity.
    - 537.23 Electrostatic generators.

<sup>6</sup> The numbers marked with an asterisk are not found in the Dewey Decimal Classification but are inserted here for convenience.

- 537.26\* Corona discharge.
- 537.4 Lightning.
- 537.6 Electrodynamicis.
- 537.65\* Piezo-electric phenomena (See R191, R214, and R355.65).
- 537.67\* Experimental plotting of electrical fields.
- 537.7 Wave form analysis.
- 537.87 Physiological electrical phenomena.
- 538 Magnetism.
- 538.11\* Magnetostriction.
- 539 Molecular physics; atomic physics.
- 539.7 Radioactivity
- 540 Chemistry.
- 541.3 Physical chemistry.
- 550 Geology.
- 551.5 Weather; meteorology.
- 621 Mechanical engineering.
- 621.3 Electrical engineering.
- 621.313 Electric generators; electric motors.
- 621.313.2 Direct-current machinery.
- 621.313.23 Direct-current generators.
- 621.313.24 Direct-current motors.
- 621.313.25 Motor generators.
- 621.313.26 Dynamotors.
- 621.313.3 Alternating-current machinery.
- 621.313.7 Rectifiers.
- 621.314.3 Transformers.
- 621.314.6 Choke coils.
- 621.314.7 Induction coils.
- 621.317 Switchboards.
- 621.317.3 Switches.
- 621.317.4 Rheostats.
- 621.319.2 Transmission lines.
- 621.325 Incandescent arcs.
- 621.326 Incandescent filament lamps.
- 621.327.4 Mercury vapor tubes (lamps).
- 621.327.7 X-ray tubes.
- 621.353 Batteries, primary.
- 621.354 Batteries, secondary (storage).
- 621.354.7 Battery charging devices.
- 621.374.2 Wheatstone bridges.
- 621.374.3 Voltmeters.
- 621.374.33\* Electrometers.
- 621.374.41\* Ammeters.
- 621.374.45\* Galvanometers.
- 621.374.6 Wattmeters.
- 621.374.63\* Electrodynamometers.
- 621.374.7 Oscillographs.
- 621.375.1\* Vacuum tubes, special applications other than radio.
- 621.38 Electric communication.
- 621.382 Telegraphy.

- 621.382.4 High-speed telegraphy.  
 621.382.7 Picture transmission, facsimile (by wire).  
 (See also R581.)  
 621.382.8 Submarine cable.  
 621.382.92\* Ground telegraphy.  
 621.382.94 Induction signaling.  
 621.383.21 Relays.  
 621.385 Telephony.  
 621.385.91\* Program distribution.  
 621.385.95\* Condenser transmitters.  
 621.385.96\* Talking motion pictures.  
 621.385.97\* Electro-acoustic devices. (See also R265 and  
 R365.)  
 621.385.971\* Electric phonograph.  
 621.388 Television (by wire). (See also R583.)  
 621.39 Other applications of electricity.  
 623.731 Light signals.  
 623.8 Steamships.  
 629.13 Aeronautics. (See also R520.)  
 629.145 Aerial navigation.  
 629.18 Airplane construction.  
 658 Business methods.

## R900 Miscellaneous Radio

## VI. INDEX TO RADIO CLASSIFICATION

This index applies specifically to Sec. IV, viz., the Bureau of Standards extended classification. It may be used to find the classification number of a subject, or to find the location of information in files or on shelves.

To use the index, find the subject desired in its alphabetical place. The number after it is its classification number, and thus gives the places where the topic will be found on shelves or in files or subject catalogs. Labels on shelves or drawer fronts may be used to guide readily to the classification number sought. Under the classification number will be found the resources of the library or files on the subject desired.

## A

- Abbreviations, radio traffic, R531.3  
 Absorption of radio waves, R113.6  
 Adcock antennas, R125.4, R325.4  
 Administrative, radio, R005  
 Aerial navigation, 629.145, (see also R520)  
 Aerials, R320  
 Aeronautics, (see also R520), 629.13  
 Aeronautics, applications of radio to, R520  
 Agriculture, applications of radio to, R534  
 Aids for landing aircraft, radio, R526.3  
 Aircraft, applications of radio to, R520  
 Aircraft, automatic control of, R527  
 Aircraft, receiving from, R523  
 Aircraft, receiving on, R521  
 Aircraft receivers, R521.1  
 Aircraft transmitters, R522.1  
 Aircraft, transmitting from, R522  
 Aircraft, transmitting to, R524  
 Air mail service, (see also Aeronautics, 629.13),  
 383  
 Airplane construction, 629.18  
 Airport receivers, R523  
 Airport transmitters, R524  
 Alphabets, Morse and Continental (international)  
 R531.4  
 Alternating-current machinery, 621.313.3  
 Alternating-current power supply, receiving  
 sets, R366.2  
 Alternating-current power supply, transmitters,  
 R356.2  
 Alternating-current tubes, R336  
 Alternators, radio-frequency, R154, R354, R421  
 Altimeters, R526.4  
 Amateur radio, R545

Ammeters, 621.374.41  
 Ammeters, hot-wire, R242.11  
 Ammeters, radio, R242.1  
 Amplification factor, receiving vacuum tubes, measurement, R262.4  
 Amplification, harmonic, R146.1  
 Amplifiers, R363  
 Amplifiers, audio-frequency, R363.2  
 Amplifiers, harmonic, R357  
 Amplifier, harmonic, use in frequency measurements, R213.1  
 Amplifiers, power, R255, R355.7  
 Amplifiers, radio-frequency, R363.1  
 Amplifiers, vacuum-tube, principles, R132  
 Amplifying action of vacuum tubes, R132  
 Amplifying apparatus, measurement, R263  
 Analysis of wave form, 537.7  
 Angle of wave front, R113.63  
 Anode, vacuum tubes, (see Plate)  
 Antennas, R120, R320  
 Antennas, Adcock, R125.4, R325.4  
 Antennas, airplane, R525  
 Antennas, artificial, R327  
 Antennas, beam, R125.1, R325.1  
 Antennas, coil, R125.3, R325.3  
 Antennas, condenser type, with ground or counterpoise, R121, R321  
 Antennas, counterpoise, R321  
 Antennas, directional (transmitting in, or receiving from, a particular direction), R125, R325  
 Antennas, multiple tuned, R129.1, R329.1  
 Antennas, other types of, R129, R329  
 Antennas, wave, R125.2, R325.2  
 Antenna switches, R320.6  
 Apparatus, radio, R300  
 Apparatus, receiving, R360  
 Apparatus, transmitting, R350  
 Applications, radio, R500  
 Arc, transmitters, R153, R353  
 Arcs, incandescent, 621.325  
 Arc systems, R422  
 Arrays, antenna, R125.1  
 Artificial antennas, R327  
 Army, applications of radio, R561  
 Astronomy, 520  
 Atmospheric disturbances, R114  
 Atmospherics, elimination of, R430  
 Atomic physics, 539  
 Attenuation formulas, radio waves, R113.7  
 Audions, (see Vacuum tubes)  
 Audio-frequency amplifiers, R363.2  
 Audio-frequency comparison method, signal intensity, measurement R272  
 Audio-frequency modulation systems, R413  
 Aurora, effect on radio waves, R113.5  
 Automatic control of aircraft, R527  
 Automatic recorders, R365.3  
 Automatic transmitters, R359  
 Automobiles, radio on, R592  
 Austin-Cohen formula, R113.7  
 Aviation, applications of radio to, R520

## B

Balloons, use of radio on, R520  
 Batteries, primary, 621.353  
 Batteries, secondary, (storage), 621.354  
 Battery-charging devices, 621.354.7  
 Beacon, radio, marine applications, R512.1  
 Beacon systems, aeronautic, R526.1  
 Beacon systems, aural, aeronautic, R526.11  
 Beacon systems, visual, aeronautic, R526.12  
 Beam antennas, R125.1, R325.1  
 Beat indicators, R206.1  
 Beat interference, R171  
 Beat notes, use of in measurements, R206  
 Beat reception systems, R426  
 Beats, principles, R147  
 Beverage antennas, R125.2, R325.2  
 Bibliographies, radio, R055  
 Biographical, radio, R097  
 Bolometer bridge, R242.16  
 Bonding of aircraft, R522.2

Books, radio, (see also R020), R051  
 Books, text, radio, (see also R051), R020  
 Braun tube, R388  
 Bridge, bolometer, R242.16  
 Bridge, Wheatstone, 621.374.2  
 Bridge methods, high-frequency, R207  
 Bridge methods for measuring resistance, R241.5  
 Broadcast frequency communications systems, vacuum tube, (550-1500 kc), R423.21  
 Broadcast frequency vacuum-tube transmitters, (550-1500 kc), R355.21  
 Broadcast station descriptions, (550-1500 kc), R612.1  
 Broadcasting, entertainment, R554  
 Broadcasting, radio, R550  
 Bulletins, radio, R009  
 Business methods, 658  
 Bureau of Standards, 353.821  
 Buzzers, R385.2

## C

Cables, relations with radio traffic, R531.6  
 Cables, submarine, 621.382.8  
 Call letters, station, R531.2  
 Calorimeter methods for measuring resistance, R241.4 (see also 536)  
 Capacitance, (see Capacity)  
 Capacitive coupling, principles, R142.5  
 Capacity, internal, receiving vacuum tubes, measurement, R262.6  
 Capacity, measurement, R220  
 Capacity, principles, R145.5  
 Capacity meters, R220.1  
 Capacity of coils, measurement, R225  
 Carrier-frequency systems, radio, R470  
 Carrier wave telephony, R116  
 Cathode-ray oscillograph, R388  
 Cathode-ray oscillograph, use in radio measurements, R201.7  
 Changers, frequency, R357  
 Characteristic curves of receiving vacuum tubes, R262.1  
 Characteristic curves of transmitting vacuum tubes, R253  
 Characteristic curves, vacuum tubes, principles, R131  
 Chargers, battery, 621.354.7  
 Charts, R084  
 Chemistry, 540  
 Choke coils, 621.314.6  
 Choppers, R385.3, (see also R427)  
 Cipher, R531.1  
 Circuit arrangements, receiving set, principles, R162  
 Circuit resonance methods in radio measurements, R211  
 Circuit theory and effects, R140  
 Circuits, coupled, principles, R142  
 Circuits, simple radio, principles, R141  
 Codes and ciphers, R531.1  
 Codes, Morse and Continental, R531.4  
 Coil antennas, R125.3, R325.3  
 Coils, choke, 621.314.6  
 Coils, inductance, R382  
 Coils, induction, 621.314.7  
 Coils, measurement, R264.2  
 Coils, measurement of capacity of, R225  
 Coils, measurement of self inductance of, R231  
 Collections, radio, R080  
 Commercial and special services, radio, R530  
 Communication, electric, 621.38  
 Communication, radio, R000  
 Communication radio systems, R400  
 Comparison method, audio-frequency, signal intensity, R272  
 Comparison method, radio-frequency, signal intensity, R273  
 Compass, radio, aeronautic applications, R526.2  
 Compass, radio, marine applications, R512.3  
 Component parts, receiving apparatus, measurement, R264  
 Condenser antennas with ground or counterpoise, R121, R321



Condenser transmitters, 621.385.95  
 Condensers, construction and design, R381  
 Condensers, measurement, R264.1  
 Conductance, grid, receiving vacuum tubes, measurement, R262.2  
 Conductance, mutual, receiving vacuum tubes, measurement, R262.5  
 Conductance, plate, receiving vacuum tubes, measurement, R262.3  
 Conducting materials, electrical properties of, R282  
 Conductors, metallic, R282.1  
 Conferences, international, radio, R007.9  
 Constant, dielectric, measurement, R223  
 Construction of vacuum tubes, R331  
 Continental code, R531.4  
 Control, remote, by radio, R570  
 Control, remote, by wire, R440  
 Converters, arc, R353  
 Converters, frequency, R357  
 Continuous-wave communication systems, other, R429  
 Continuous-wave systems, R420  
 Continuous-wave systems, alternator, R421  
 Continuous-wave systems, arc, R422  
 Continuous-wave systems, impulse excitation, R425  
 Continuous-wave systems, timed spark, R424  
 Continuous-wave systems, vacuum tube, R423  
 Corona discharge, 537.26  
 Cosmic effects on radio waves, R113.5  
 Counterpoise, R121, R321  
 Coupled circuits, principles, R142  
 Coupling, capacitive, principles, R142.5  
 Coupling, direct, principles, R142.1  
 Coupling, inductive, principles, R142.3  
 Courses of study, radio, R070  
 Crystal detectors, R362.1  
 Current, measurement, R242  
 Current transformer, R242.13  
 Curves, characteristic, of vacuum tubes, R131  
 Curves, characteristic, receiving vacuum tubes, R262.1

D

Daily variations (of radio waves), R113.2  
 Damping, radio circuit, R144.1  
 Decrement, R144.1  
 Decremeters, R384.5  
 Design, radio, R004  
 Detector action of vacuum tubes, principles, R134  
 Detectors, R362  
 Detectors, crystal, R362.1  
 Detectors, other types, R362.9  
 Detectors, vacuum tube, R134, R362.2  
 Dielectric constant, measurement, R223  
 Diffraction of radio waves, R113.6  
 Diode, R332  
 Direct coupling, principles, R142.1  
 Direct-current machinery, 621.313.2  
 Direct-current power supply for receiving sets, R366.1  
 Direct-current power supply for transmitters, R356.1  
 Direction finders, R125.31, R325.31  
 Direction finders, aeronautic applications, R526.2  
 Direction-finding stations, descriptions, R617  
 Direction variations (of radio waves), R113.3  
 Directional antennas, R125, R325  
 Directional properties (radio waves), R115  
 Directly-heated cathode, a-c tubes, R336.1  
 Discharge, corona, 537.26  
 Distant control by radio, R570  
 Distortion, principles, R148.1  
 Distress signals, R511  
 Distribution, program, 621.385.91  
 Disturbances, atmospheric, R114  
 Doublers, frequency, R357  
 Dry batteries, 621.353  
 Dummy antennas, R327  
 Duplex systems, R460  
 Dynamotors, 621.313.26

E

Earth connections, R326  
 Echo signals, R113.62  
 Eclipses, (effect on radio waves), R113.55  
 Education, radio, R070  
 Einthoven galvanometer, R242.15  
 Electric communication, 621.38  
 Electric furnaces, high-frequency, 536.11  
 Electric phonograph, 621.385.971  
 Electrical conducting materials, properties of, R282  
 Electrical engineering, 621.3  
 Electrical indicating instruments, R389  
 Electrical insulating materials, properties of, R281  
 Electricity, 537  
 Electricity, other applications of, 621.39  
 Electricity, theory of, 537.1  
 Electro-acoustic devices, 621.385.97, (see also R265 and R365)  
 Electrodynamicometers, 621.374.63  
 Electrodynamicometer in radio measurements, R242.14  
 Electrolytes, properties of, R282.2  
 Electrolytic rectifiers, 621.313.7  
 Electromagnetic theory, R111  
 Electrometers, 621.374.33  
 Electrostatic generators, 537.23  
 Electrostatic voltmeters, R243.3  
 Elevated antenna with ground or counterpoise, R121, R321  
 Elimination of interference, R430  
 Elimination of ignition interference on aircraft, R521.2  
 Engineering, electrical, 621.3  
 Engineering, mechanical, 621  
 Entertainment, broadcasting, R554  
 Equipment, radio, R300  
 Equipment of radio stations, R610  
 Evacuation of vacuum tubes, R331  
 Excitation, impulse, R425  
 Excitation, impulse, of circuits, principles, R141.3  
 Executive, radio, R005

F

Facsimile transmission by radio, R581, (see also 621.382.7)  
 Facsimile transmission by wire, 621.382.7, (see also R581)  
 Factories, radio, R710  
 Fading, (of radio waves), R113.1  
 Federal Radio Commission, R005  
 Fidelity of receiving sets, measurement, R261.3  
 Fidelity of receiving sets, principles, R161.3  
 Field-intensity measurements, R270  
 Field localizers, R526.3  
 Fields, electrical, experimental plotting of, 537.67  
 Filters, R143, R386  
 Finding of position, by radio, (marine), R512  
 Five-electrode vacuum tubes, R335  
 Fog signaling by radio, marine applications, R512.2  
 Forestry, applications of radio, R535  
 Formulas, transmission, R113.7  
 Four-electrode vacuum tubes, R334  
 Frame antennas, R325.3  
 Frequency, measurement, R210  
 Frequency, of circuits, principles, R141.1  
 Frequency assignment, R007  
 Frequency changers, R357  
 Frequency control of vacuum-tube transmitters, R355.6  
 Frequency meters, measurement, R211.1  
 Frequency meters, description, construction, R384  
 Frequency meters, audio, R384.2  
 Frequency meters, radio, R384.1  
 Frequency signals, standard, R555  
 Furnaces, high-frequency, 536.83

## G

Galena detector, R362.1  
 Galvanometer, Einthoven, R242.15  
 Galvanometers, 621.374.45  
 Gaps, spark, R152, R352  
 General properties of vacuum tubes, R131  
 Generating action of vacuum tubes, R133  
 Generating apparatus, (except vacuum tubes),  
 see R133, R150, R350  
 Generating apparatus, measurement, R250  
 Generating sets for special purposes, R355.9  
 Generators, direct-current, 621.313.23  
 Generators, electric, 621.313  
 Generators, vacuum tube, principles, R133  
 Geodesy, 526  
 Geology, 550  
 Geophysical, effects on radio waves, R113.5  
 Geophysical prospecting, R536  
 Goldschmidt alternators, R354  
 Goniometer, radio, R325.31  
 Goniometer, radio, marine applications, R512.3  
 Goniometry, R125.31  
 Grid conductance, receiving vacuum tubes,  
 measurement, R262.2  
 Grid leaks, R383.1  
 Ground connections, R126, R326  
 Ground telegraphy, 621.382.92  
 Grounding in radio measurements, R201.5  
 Grounds, protective, R387.5  
 Guided-wave telephony, R470

## H

Harmonic amplification, principles, R146.1  
 Harmonic amplifiers, R357  
 Harmonic amplifier, use in frequency measure-  
 ments, R213.1  
 Harmonic analysis, 537.7  
 Harmonic methods of measuring frequency,  
 R213  
 Harmonic methods, in radio measurements, R203  
 Harmonics, principles, R146  
 Heat, 536  
 Heating by induction, 536.83  
 Heaviside layer, R113.61  
 Heterodyne reception, principles, R163  
 High-frequency alternator systems, R421  
 High-frequency bridge methods, R207  
 High-frequency communication system, vacuum  
 tube (6000-30,000 kc) R423.4  
 High-frequency electric furnaces, 536.83  
 High-frequency station descriptions (6000-30,000  
 kc), R614  
 High-frequency vacuum-tube transmitters (6000-  
 30,000 kc), R355.4  
 High-speed telegraphy, 621.382.4  
 History, radio, R090  
 Hot-wire ammeters, R242.11  
 Humor, radio, R083  
 Hydrostatics, 532

## I

Ignition shielding on aircraft, R521.2  
 Impedance, input, of receiving vacuum tubes,  
 R262.2  
 Impedance, output, of receiving vacuum tubes,  
 R262.3  
 Impulse excitation, of circuits, principles,  
 R141.3  
 Impulse excitation systems, R425  
 Incandescent filament lamps, 621.326  
 Indicating instruments, electrical, R389  
 Indicators, beat, R206.1  
 Indirectly-heated cathode, a-c tubes, R336.2  
 Inductance, principles, R145.3  
 Inductance, measurements, R230  
 Inductance, mutual, measurement, R232  
 Inductance, self, measurement, R231  
 Induction coils, 621.314.7  
 Induction heating, 536.83  
 Induction signaling, 621.382.94  
 Inductive coupling, principles, R142.3  
 Inductors, R382

Infra-red signaling, 623.731  
 Input impedance of vacuum-tube receivers,  
 R262.2  
 Instruments radio, construction and design,  
 R380  
 Insulating materials, electrical properties, R281  
 Insulation, properties of, R281  
 Insulators, R387.7  
 Intensity, (field intensity, signal intensity, noise,  
 etc.), measurement, R270  
 Intensity variation of radio waves, (fading),  
 R113.1  
 Interference, atmospheric, R114  
 Interference elimination, R430  
 Interference, ignition (aircraft), R521.2  
 Interference output of receiving sets, measure-  
 ments, R261.5  
 Interference output of receiving sets, principles,  
 R161.5  
 Interference, principles, R170  
 Interference, beat, principles, R171  
 Internal capacities, receiving vacuum tubes,  
 measurement, R262.6  
 International conferences, radio, R007.9  
 Interrupters, R385.3  
 Interrupters, receiving, use of, R427

## J

## K

Kennelly-Heaviside layer, R113.61  
 Kenotrons, R332  
 Keying devices, R385  
 Keys, R385.1

## L

Land lines, relations with radio traffic, R531.5  
 Landing aids for aircraft, R526.3  
 Laws, radio, R007  
 Layer, Kennelly-Heaviside, R113.61  
 Leader cables, R526.3  
 Lectures, radio, R040  
 Legislation, radio, R007  
 Life-saving service, applications of radio to,  
 R516  
 Life tests, receiving vacuum tubes, R262.7  
 Light, 535. (For light signaling, see 623.731.)  
 Light signals, 623.731  
 Lightning, 537.4  
 Lissajous figures, R201.7  
 Localizers, field, R526.3  
 Longitude determinations by radio, R551.1  
 Loop antennas, principles, R125.3  
 Loud speakers, R165, R365.2  
 Loud speakers, measurement, R265.2  
 Low-frequency communication system, vacuum  
 tube (10-100 kc), R423.1  
 Low-frequency modulating systems, R413  
 Low-frequency stations, descriptions, (10-100  
 kc), R611  
 Low-frequency vacuum-tube transmitters (10-100  
 kc), R355.1

## M

Magnetic materials, R282.3  
 Magnetic storms, effect on radio waves, R113.5  
 Magnetism, 538  
 Magneto interference, elimination on aircraft,  
 R521.2  
 Magnetostriction, 538.11  
 Management of radio stations, R620  
 Manufacturing, radio, R700  
 Map projections, geodesy, 526.8  
 Maps, R084  
 Marine applications of radio, R510  
 Market reports, radio broadcasting, R556  
 Masts, R320.8  
 Materials, magnetic, R282.3  
 Materials, properties of, R280  
 Mathematics, 510  
 Measurements, radio, R200

Mechanical engineering, 621  
 Mechanics, 531  
 Medicine, applications of radio to, R594  
 Medium frequency communication systems,  
     vacuum tubes, R423.2  
 Medium frequency station descriptions, (100-  
 1500 kc), R612  
 Medium frequency vacuum-tube transmitters,  
     (100-1500 kc), R355.2  
 Medium high frequency communication systems,  
     vacuum tubes, (1500-6000 kc), R423.3  
 Medium high frequency station descriptions,  
     (1500-6000 kc), R613  
 Medium high frequency vacuum tube trans-  
 mitters (1500-6000 kc), R355.3  
 Meetings, radio, R060  
 Mercury vapor rectifiers, 621.313.7  
 Mercury vapor tubes (lamps), 621.327.4  
 Metallic conductors, R282.1  
 Metals, properties of, R282.1  
 Meteorological effects, radio waves, R113.5  
 Meteorological signals, radio broadcasting,  
     R553  
 Meteorology, 551.5  
 Meters, capacity, R220.1  
 Meters, frequency, R211.1  
 Microphones, R335.5  
 Microphones, measurement, R256  
 Military, applications of radio, R560  
 Mining, applications of radio, R536  
 Miscellaneous, R900  
 Miscellanies, radio, R080  
 Modulated-wave systems, R410  
 Modulated-wave systems, audio-frequency, R413  
 Modulated-wave systems, radio-frequency, R414  
 Modulated-wave systems, spark, R411  
 Modulated-wave systems, telephone, R412  
 Modulating action of vacuum tubes, R135  
 Modulation, measurement, R254  
 Modulation, radio principles, R148  
 Modulation and keying devices, R385  
 Modulators, vacuum tube, R135, R355.8  
 Molded insulating materials, properties of,  
     R281  
 Molecular physics, 539  
 Morse code, R531.4  
 Motion pictures, talking, 621.385.96  
 Motion pictures, transmission by radio, R582,  
     (see also 621.388)  
 Motors, direct-current, 621.313.24  
 Motors, electric, 621.313  
 Motor generators, 621.313.25  
 Multiple signals, R113.62  
 Multiple tuned antennas, R129.1, R329.1  
 Multiplex systems, R460  
 Multivibrators, R146.2, R357  
 Multivibrator, use in measurements, R213.2  
 Mutual conductance, receiving vacuum tubes,  
     measurement, R262.5  
 Mutual inductance, measurement, R232

N

Naval applications of radio, R565  
 Navigation, aerial, 629.145, (see also R520)  
 Navigation, aerial, radio as aid to, R526  
 Navigation, sound signals in, 534.83  
 Noise intensity measurements, R270  
 Nomenclature, radio, R030  
 Nograms, R082  
 Nonradio subjects, R800  
 Normal output of receiving sets, measurement,  
     R261.4  
 Normal output of receiving sets, principles,  
     R161.4  
 All methods in radio measurements, R204

O

Operation and management of radio stations,  
     R620  
 Operation of radio stations, R600  
 Oscillographs, 621.374.7  
 Oscillograph, cathode-ray, R388

Oscillograph, cathode-ray, use in radio measure-  
 ments, R201.7  
 Output impedance of receiving vacuum tubes,  
     R262.3  
 Output, interference, of receiving sets, measure-  
 ment, R261.5  
 Output, interference, of receiving sets, principles,  
     R161.5  
 Output, normal, of receiving sets, measurements,  
     R261.4  
 Output, normal, of receiving sets, principles,  
     R161.4  
 Output, power, receiving vacuum tubes, measure-  
 ment, R262.8  
 Oxide rectifiers, 621.313.7

P

Parallel wire methods in radio measurements,  
     R212  
 Parts, component, receiving apparatus, measure-  
 ment, R264  
 Parts of circuits, R380  
 Patent practice, 347.7  
 Pentode, R335  
 Periodicals, radio, R053  
 Personnel, radio, R005  
 Phase difference, measurement, R241  
 Phones, R365.1  
 Phonograph, electric, 621.385.97  
 Phonograph recorder, R365.3  
 Photoelectric phenomena, 535.3  
 Photoelectric tubes, 535.38  
 Photographic recorder, R365.3  
 Photographs, transmission of by radio, R581,  
     (see also 621.382.7)  
 Physical chemistry, 541.3  
 Physics, 530  
 Physics, atomic, 539  
 Physics, molecular, 539  
 Physiological electrical phenomena, 537.87  
 Pickup, electric phonograph, 621.385.971  
 Picture transmission by wire, 621.382.7, (see  
     also R581)  
 Picture transmission by radio, R581, (see also  
     621.382.7)  
 Piezo-electric phenomena, 537.65, (see R191,  
     R355.65 and R214)  
 Piezo-electric standards, R214  
 Piezo-electricity applied to radio, principles,  
     R191  
 Piezo oscillators, for frequency control of trans-  
 mitters, R355.65  
 Plate conductance, receiving vacuum tubes,  
     measurement, R262.3  
 Plate resistance, receiving vacuum tubes, meas-  
 urement, R262.3  
 Pliotrons, (see Vacuum tubes)  
 Plotting of electrical fields, 537.67  
 Pneumatics, 533  
 Polarization of radio waves, R113.6  
 Position finders, R325.31  
 Position finding, principles, R125.31  
 Position finding by radio (marine), R512  
 Postal service, Air Mail service, 383, (see also  
     Aeronautics, 629.13.)  
 Power, transmission of by radio, R591  
 Power amplifiers, R355.7  
 Power amplifiers, measurement of, R255  
 Power factor, radio, measurement, R241  
 Power output, receiving vacuum tubes, R262.8  
 Power rating of transmitting apparatus, R251  
 Power supply, receiving sets, R366  
 Power supply, receiving sets, measurement,  
     R261.6  
 Power supply, transmitters, R356  
 Power supply, alternating current, receiving  
     sets, R366.2  
 Power supply, alternating current, transmit-  
     ters, R356.2  
 Power supply, direct current, receiving sets,  
     R366.1  
 Power supply, direct current, transmitters,  
     R356.1

Power transmission lines, use of radio in connection with, R537  
 Press, application of radio, R532  
 Primary batteries, 621.353  
 Principles, radio, R100  
 Printing recorder, automatic, R365.3  
 Private applications of radio, R540  
 Processes, radio manufacturing, R720  
 Program distribution, 621.385.91  
 Programs for research, R010  
 Properties of materials, R280  
 Prospecting, geophysical, R536  
 Protective devices, generating apparatus, R358  
 Protective equipment, R387  
 Publications, radio, R050  
 Pumps, vacuum, 533.85

## Q

Quartz, properties of, R281

## R

Radiation, of radio waves, principles, R111.2  
 Radiation, heat, theory, 536.33  
 Radio, R000  
 Radio, applications of, R500  
 Radio aids for landing aircraft, R526.3  
 Radio and wire lines connection, R450  
 Radio apparatus and equipment, R300  
 Radio as navigation aid to aircraft, R526  
 Radio beacons, marine applications, R512.1  
 Radio circuits, simple, principles, R141  
 Radio communication systems, R400  
 Radio compass, marine use, R512.3  
 Radio compass, aeronautic applications, R526.2  
 Radio-frequency alternators, R354  
 Radio-frequency amplifiers, R363.1  
 Radio-frequency carrier wire systems, R470  
 Radio-frequency comparison method, signal intensity measurements, R273  
 Radio-frequency modulation communication systems, R414  
 Radio-frequency resistance, principles, R144  
 Radio manufacturing, R700  
 Radio measurements and standardization, R200  
 Radio principles, R100  
 Radio range, aeronautic, R526.1  
 Radio range, marine application, R512.1  
 Radio relay stations, R480  
 Radio research programs, R010  
 Radio stations; equipment, operation and management, R600  
 Radiotelegraphy, history, R091  
 Radiotelephone systems, R412  
 Radiotelephony, history, R094  
 Radio toys, R595  
 Radio wave theory, R111  
 Radio wave phenomena, R113  
 Radio waves, R110  
 Radio waves, velocity of, R111.1  
 Radioactivity, 539.7  
 Radiogoniometer, (see Direction finder)  
 Radiofrons, (see vacuum tubes)  
 Railroad, applications of radio, R533  
 Range, radio, aural, aeronautic, R526.11  
 Range, radio, marine application, R512.1  
 Range, radio systems, aeronautic, R526.1  
 Range, radio, visual, aeronautic, R526.12  
 Range of transmission, R113.7  
 Rates, radio traffic, R531.7  
 Rating, power, of transmitting apparatus, R251  
 Reactance, principles, R145  
 Reactance-variation method for measuring resistance, R241.2  
 Receivers, telephone, R165, R365  
 Receivers, telephone, measurements, R265  
 Receiving apparatus, R160, R360  
 Receiving apparatus, measurements, R260  
 Receiving interrupters, use of, R427  
 Receiving on aircraft, R521  
 Receiving from aircraft, R523  
 Receiving set circuit arrangements, principles, R162

Receiving sets, R161, R361  
 Receiving sets, measurements, R261  
 Receiving sets, regenerative, R361.3  
 Receiving sets, superheterodyne, R361.2  
 Receiving sets, tuned radio frequency, R361.1  
 Receiving vacuum tubes, measurements, R262  
 Reception, of radio waves, R111.6  
 Reception, heterodyne, principles, R163  
 Recorders, automatic, R365.3  
 Rectifiers, 621.313.7  
 Rectifiers for receiving sets, R366.3  
 Rectifiers for transmitters, R356.3  
 Rectifier tubes, R337  
 Rectification, radio, principles, R149  
 Reference lists, radio, R055  
 Reflection of radio waves, R113.6  
 Refraction of radio waves, R113.6  
 Regenerative receiving sets, R361.3  
 Regulations, radio, R007  
 Regulator tubes, R338  
 Relations of radio traffic with cables, R531.6  
 Relations of radio traffic with land lines, R531.5  
 Relay, electron, (see vacuum tubes)  
 Relay stations, radio, R480  
 Relays, 621.383.21  
 Remote control by radio, R570  
 Remote control of stations, by wire, R440  
 Reports, radio, R009  
 Research, radio, R010  
 Resistance, measurement, R241  
 Resistance, plate, receiving vacuum tubes, measurements, R262.3  
 Resistance, radio-frequency, principles, R144  
 Resistance-variation method for measuring resistance, R241.1  
 Resistors, R383  
 Resonance methods, frequency measurements, R211  
 Resonance methods, in radio measurements, R202  
 Resonance, of radio circuits, principles, R141.2  
 Rheostats, 621.317.4  
 Round the world signals, R113.62

## S

Sales, radio, R740  
 Schools, radio, R070  
 Screen-grid vacuum tubes, R334  
 Seasonal variations, (of radio waves), R113.2  
 Secondary batteries, 621.354  
 Secondary standards (classify under appropriate item in radio measurements and standardization)  
 Selectivity of receiving sets, measurement, R261.1  
 Selectivity of receiving sets, principles, R161.1  
 Self inductance measurement, R231  
 Sensitivity of receiving sets, measurement, R261.2  
 Sensitivity of receiving sets, principles, R161.2  
 Service, commercial, radio, R530  
 Sets, receiving, R361  
 Sets, receiving, for aircraft, R521.1  
 Sets, transmitting, R350  
 Shielding, ignition, on aircraft, R521.2  
 Shielding in radio measurements, R201.5  
 Shields, R387.1  
 Ship stations, descriptions, R616  
 Ships, application of radio to, R510  
 Short wave, (see High frequency)  
 Shunted telephone method, signal intensity, measurement, R271  
 Signal corps, applications of radio, R561  
 Signal intensity, measurement, R270  
 Signaling, fog, by radio, marine applications, R512.2  
 Signaling, induction, 621.382.94  
 Signals, distress, R511  
 Signals, multiple, R113.62  
 Skin effect (high-frequency resistance), R144  
 Societies, radio, R060  
 Sound, 534  
 Sound signals in navigation, 534.83  
 Spark gaps, R352

Spark systems, R411  
 Spark, timed, systems, R424  
 Spark transmitters, R152, R352  
 Sparking distance, voltage measurement, R243.2  
 Speakers, measurement, R265.2  
 Speakers, principles, R165  
 Special applications of vacuum tubes, other than radio, 621.375.1  
 Specialservice, radio, R530  
 Speech distortion, principles, R148.1  
 Speech transmission, radio, R412  
 Speed, code reception, R531.15  
 Standard frequency signals, R555  
 Standardization, radio, R200  
 Standards, Bureau of, 353.821  
 Standards, piezo-electric, R214  
 Standing waves on wires, R116  
 Static (radio), R114  
 Static, elimination of, R430  
 Static machines, 537.23  
 Station call letters, R531.2  
 Station descriptions (10-100 kc), R611  
 Station descriptions (broadcast), (550-1500 kc), R612.1  
 Station descriptions (1500-6000 kc), R613  
 Station descriptions (6000-30,000 kc), R614  
 Station descriptions (above 30,000 kc), R615  
 Station descriptions (ship), R616  
 Station descriptions, direction finding, R617  
 Station equipment, R610  
 Station interference elimination, R430  
 Stations, radio; equipment, operation, and management, R600  
 Stations, remote control by wire, R440  
 Statistics, radio, R001  
 Steamships, 623.823  
 Storage batteries, 621.354  
 Strays, R114  
 Strays, elimination of, R430  
 Strength of signals, measurement, R270  
 Submarine, applications of radio to, R515  
 Submarine cable, 621.382.8  
 Submarine sound signals, 534.83  
 Substitution methods, in radio measurements, R205  
 Substitution method for measuring resistance, R241.3  
 Sun spots, effect on radio waves, R113.5  
 Superheterodyne receiving sets, R361.2  
 Swinging (of radio signals), R113.1  
 Switchboards, 621.317  
 Switches, 621.317.3  
 Switches, antenna, R320.6  
 Symbols, radio, R030  
 Systems, radio communication, R400

T

Tables, radio, R081  
 Talking motion pictures, 621.385.96  
 Telegraphy, 621.382  
 Telegraphy, ground, 621.382.92  
 Telegraphy, high-speed, 621.382.4  
 Telegraphy, radio, history, R091  
 Telephone radio systems, R412  
 Telephone receivers, R165, R365  
 Telephone receivers, measurement, R265  
 Telephone receivers, loud speaking, R365.2  
 Telephones, R365.1  
 Telephones, measurement, R265.1  
 Telephony, 621.385  
 Telephony, radio, history, R094  
 Television, by radio, R583, (see also 621.388)  
 Television, by wire, 621.388, (see also R583)  
 Terminology, radio, R030  
 Tesla coils, 621.314.7  
 Testing (Index under apparatus tested)  
 Textbooks, radio, R020, (see also R050)  
 Theory, circuit, R140  
 Theory of electricity, 537.1  
 Theory, electromagnetic, R111  
 Therapeutics, applications of radio to, R594  
 Thermal ammeters (hot-wire), R242.11  
 Thermal ammeters (thermoelement), R242.12

Thermoelement, R242.12  
 Thermogalvanometers, R242.12  
 Three-electrode vacuum tubes, R333  
 Timed spark system, R424  
 Time signals, by radio, R551  
 Tone wheels, R385.3. (See also R427.)  
 Tone wheels, use of, R427  
 Towers, antenna, R320.8  
 Toys, radio, R595  
 Traffic, radio, R531  
 Training, radio, R070  
 Transformers, 621.314.3  
 Transformers, current, R242.13  
 Transformers for receiving sets, R382.1  
 Transformers, measurement, R264.3  
 Transformers, measurement of mutual inductance of, R232  
 Transmission of photographs by radio, R581, (see also 621.382.7)  
 Transmission of power by radio, R591  
 Transmission formulas, R113.7  
 Transmission-lines, 621.319.2  
 Transmission phenomena, R115  
 Transmission, remote control, R440  
 Transmitters, R350  
 Transmitters, arc, R353  
 Transmitters, automatic, R359  
 Transmitters, broadcast frequency, (550-1500 kc), R355.21  
 Transmitters, condenser, 621.385.95  
 Transmitters, spark, R352  
 Transmitters, vacuum tube, R355  
 Transmitters, vacuum tube, high frequency (6000-30,000 kc), R355.4  
 Transmitters, vacuum tube, low frequency (10-100 kc), R355.1  
 Transmitters, vacuum tube, medium frequency (100-1500 kc), R355.2  
 Transmitters, vacuum tube, medium high frequency (1500-6000 kc), R355.3  
 Transmitters, vacuum tube, very high frequency (above 30,000 kc), R355.5  
 Transmitters, on aircraft, R522.1  
 Transmitting apparatus, R350  
 Transmitting apparatus, measurement, R250  
 Transmitting from aircraft, R522  
 Transmitting to aircraft, R524  
 Transmitting sets, telephone, (see Vacuum-tube transmitters)  
 Transmitting vacuum tubes, measurement, R253  
 Treaties, radio, R007.9  
 Triode, R333  
 Triodes, (see Vacuum tubes)  
 Tubes, (see Vacuum tubes)  
 Tubes, electron, (see Vacuum tubes)  
 Tubes, vacuum, R130, R330  
 Tuned antennas, multiple, principles, R129.1  
 Tuned radio frequency, receiving sets, R361.1  
 Tuning forks, 534.3  
 Tuning, principles, R141.2  
 Two-electrode vacuum tubes, R332

U

Undamped wave systems, R420  
 Ultra-violet signaling, 623.731  
 United States laws and regulations, R007  
 United States radio inspection service, R005

V

Vacuum apparatus, 533.85  
 Vacuum tube communication systems, R423  
 Vacuum tube communication systems, broadcast frequency (550-1500 kc), R423.21  
 Vacuum tube communication systems, high frequency (6000-30,000 kc), R423.4  
 Vacuum tube communication systems, low frequency (10-100 kc), R423.1  
 Vacuum tube communication systems, medium frequency (100-1500 kc), R423.2  
 Vacuum tube communication systems, medium high frequency (1500-6000 kc), R423.3

- Vacuum tube communication systems, very high frequencies, (above 30,000 kc), R423.5  
 Vacuum tube detectors, R362.2  
 Vacuum tube modulators, R355.8  
 Vacuum tube transmitters, R355  
 Vacuum tube voltmeters, R243.1  
 Vacuum tubes, R130, R330  
 Vacuum tubes, alternating-current, R336  
 Vacuum tubes, a-c directly-heated cathode, R336.1  
 Vacuum tubes, a-c indirectly-heated cathode, R336.2  
 Vacuum tubes, amplifying action, R132  
 Vacuum tubes, characteristic curves, R131  
 Vacuum tubes, detector action, principles, R134  
 Vacuum tubes, five-electrode, R335  
 Vacuum tubes, four-electrode, R334  
 Vacuum tubes, general properties of, R131  
 Vacuum tubes, generating action, principles, R133  
 Vacuum tubes, modulating action, R135  
 Vacuum tubes, receiving, measurement, R262  
 Vacuum tubes, special applications other than radio, 621.375.1  
 Vacuum tubes, special types, R339  
 Vacuum tubes, three-electrode, R333  
 Vacuum tubes, transmitting, measurement, R253  
 Vacuum tubes, two-electrode, R332  
 Valves, (see Vacuum tubes)  
 Variations, daily, of radio waves, R113.2  
 Variations, directional, of radio waves, R113.3  
 Variations, seasonal, of radio waves, R113.2  
 Variometers, R382  
 Velocity of radio waves, R111.1  
 Very high frequency communication systems, vacuum tube (above 30,000 kc), R423.5  
 Very high frequency stations, description (above 30,000 kc), R615  
 Very high frequency transmitters (above 30,000 kc), R355.5  
 Vibration galvanometers, 621.374.45  
 Visual signaling, 623.731  
 Voltage, measurement, R243  
 Voltmeters, 623.374.3  
 Voltmeters, electrostatic, R243.3  
 Voltmeters, vacuum tube, R243.1
- W
- Wattmeters, 621.374.6  
 Wave antennas, R125.2, R325.2  
 Wave form analysis, 537.7  
 Wave front angle, R113.63  
 Wavelength, (see Frequency)  
 Wavelength assignment, R007  
 Wave phenomena, radio, R113  
 Waves on wires, R116  
 Waves, radio, R110  
 Waves, radio, velocity of, R111.1  
 Waves, standard, transmission of, R555  
 Weather, effect on radio waves, R113.5  
 Weather, meteorology, 551.5  
 Weather signals, radio broadcasting, R553  
 Wheatstone bridge, 621.374.2  
 Wire and radio systems, connections, R450  
 Wired radio, R470  
 Wires radio, principles, R116  
 Wireless, (see radio)  
 Wires, waves on, R116  
 Working of radio stations, R620
- X
- X-ray tubes, 621.327.7  
 X's (radio transmission), R114  
 X's, elimination of, R430



## BOOK REVIEW

Report of the Radio Research Board for the Period ended 31st March 1929.  
Published by His Majesty's Stationery Office, London. 166 pages unbound.  
Price 3s 6d net.

This report is a detailed review of the investigations of the British Research Board on wave propagation, directional wireless, atmospherics, radio-frequency standards and precision measurements, antennas, performance of amplifiers, measurement of interference of transmitting stations, preliminary work on high frequencies (more than 30 megacycles) and several miscellaneous subjects. A brief summary of the report follows:

The height of the Kennelly-Heaviside layer was determined by varying the frequency of a transmitter and counting the resulting interference fringes at receiver caused by the changing phase relations of reflected and ground waves. In addition to the above method fading was studied at these frequencies (about 750 kc) by comparing reception of loop and vertical antennas and also by a combination of loop and vertical antennas which eliminated the ground wave. Some similar work was done at about 3000 kc. At low frequencies measurements were made of the intensity of the various components of the downcoming and ground waves and their polarization and phase difference.

The conductivity of the ground was determined in various locations by measuring the forward tilt of the wave front. From field intensity surveys the absorption of radio waves over land was studied and the results compared with those deduced from Sommerfeld's theory of propagation.

The causes of deviations of bearings of direction finders, especially night errors, were investigated. A rotating radio beacon was designed as an aid to marine and air navigation. A high-frequency closed-coil direction finder was developed. Direction-finding apparatus employing an Adcock antenna was designed to eliminate errors due to downcoming waves and a direct-reading cathode-ray direction finder was developed.

A cathode-ray direction finder for atmospherics was developed and observations made of the direction of the source of atmospherics. The wave forms of individual atmospherics were determined with the cathode-ray oscillograph. The energy spectrum of atmospherics was studied with a radio telegraphic spectrometer. The effective disturbing range of atmospherics and the meteorological aspects of atmospherics were also investigated.

The development of the N.P.L. multivibrator frequency meter, and the investigations of piezo-electric resonators and oscillators are reviewed. An interferometer method of examining the modes of vibration of quartz plates has been developed.

Work has been done on methods of measuring effective resistance, inductance, capacitance, impedance, and current at radio frequencies. International comparisons of radio standards and measurements, particularly of frequency, have been made. The current distribution, effective height, and radiation distribution of antennas have been considered.

S. S. KIRBY\*

\* Bureau of Standards, Washington, D. C.

## BOOKLETS, CATALOGS, AND PAMPHLETS RECEIVED

The Supreme Instruments Corporation, of Greenwood, Miss., has recently published a 10-page catalog listing testing equipment of interest to the service man. The catalog describes various portable and bench test panels, ohmmeters, and tube characteristic test sets. A small leaflet describing their Model 90 set analyzer is also available for distribution, upon request.

The International Resistance Co., 2006 Chestnut St., Philadelphia, Pa., has for distribution a data sheet describing several varieties of resistors for use in radio receivers.

High-capacity electrolytic condensers for use in receiving circuits are described in a folder issued by the Sprague Specialites Co. of Quincy, Mass.

From the Readrite Meter Works, Blufton, Ohio, may be obtained a 12-page catalog listing metered test equipment and electrical meters for radio purposes.

"AC Set Protection With Vitrohm Line Voltage Reducer" is the title of a folder describing line voltage resistors. A copy may be obtained from the Ward Leonard Electric Co., Mount Vernon, N. Y.

"Radio Materials" is the title of a 10-page booklet listing the various wires and products manufactured for the radio industry by the Gilby Wire Co., of Newark, N. J.

A copy of "Inside Facts" which shows the construction of Eveready batteries will be mailed upon request to the National Carbon Company, Inc., New York, N. Y.

The Racon Electric Co., 18 Washington Place, New York, has for distribution a four-page folder describing horns for public address and theatre use.

The Allen-Bradley Co., of Milwaukee, Wisc., has recently issued a folder describing various fixed and adjustable resistors for radio purposes, and a new high-resistance potentiometer.

Catalog Supplement F-200, of the General Radio Co., describes their Type 404 test-signal generator. This generator is a shielded portable oscillator for checking the sensitivity of broadcast receivers. A copy of the supplement will be mailed to those requesting a copy from the General Radio Co., 30 State St., Cambridge, Mass.





## REFERENCES TO CURRENT RADIO LITERATURE

THIS IS a monthly list of references prepared by the Bureau of Standards and is intended to cover the more important papers of interest to the professional radio engineers which have recently appeared in periodicals, books, etc. The number at the left of each reference classifies the reference by subject, in accordance with the scheme presented in "A Decimal Classification of Radio Subjects—An Extension of the Dewey System," Bureau of Standards Circular No. 138, a copy of which may be obtained for 10 cents from the Superintendent of Documents, Government Printing Office, Washington, D. C. The various articles listed below are not obtainable from the Government. The various periodicals can be secured from their publishers and can be consulted at large public libraries.

### R000. RADIO COMMUNICATION

- R007 Segal, P. The radio engineer and the law. *Proc. I.R.E.*, 18, 1038-43; June, 1930.

The difficulties inherent in the development of a body of law for radio are presented. It is pointed out that that body of law must be based upon sound scientific principles as presented by radio engineers. The radio engineer as an expert witness may be able to avoid the difficulties encountered by experts of other classes and take advantage of important opportunities for the education of courts and commissions. As legislative advisors the members of the engineering profession have tasks of great responsibility. Radio engineers can bring about a healthy growth of law through cooperative effort and group consciousness.

### R100. RADIO PRINCIPLES

- R112.1 Colebrook, F. M. The physical reality of side-bands. *Nature* (London), 125, 726-727; May 10, 1930.

Experimental evidence is presented of the physical reality of the added radio frequencies attributed to the modulation of a carrier wave. Resonance curves are presented showing peaks at the carrier frequency and other peaks at frequencies corresponding to the carrier frequency plus and minus the modulating frequency. The method used in obtaining the curves is outlined.

- R113.5 Yokoyama, E. and Nakai, T. Meteorological influences on long-distance long-wave reception. *Proc. I.R.E.*, 18, 1075-83; June, 1930.

The results of an analytic study of a series of measurements of the field intensity of several distant long-wave stations are given. The field intensities of both daylight and night reception were found to vary inversely with changes of atmospheric temperature and absolute humidity at the receiver end of the transmission path. The intensity-pressure relation and the influences of weather were found to be more complex and less clear.

- R113.5 Stratton, J. A. The effect of rain and fog on the propagation of very short radio waves. *Proc. I.R.E.*, 18, 1064-74; June, 1930.

The effect of rain, fog or clouds on the propagation of short radio waves is investigated theoretically. The theory of the propagation of electromagnetic waves in a medium in which are suspended particles of an arbitrary material is first reviewed. The available physical data on fog and rain is then referred to. The conclusion is arrived at that for waves greater than 5 cm in length, the effect of ordinary rain or fog on the absorption is negligible.

- R127 Bechmann, R. Zur Theorie der Strahlungskopplung von Kurzwellen-Antennen Systemen. (On the theory of the radiation coupling of short wave antenna systems). *Annalen der Physik*, 4, 829-62; No. 7; 1930.

The dipole radiation theory of Abraham is extended and applied to various antenna systems. Mathematical developments are given for the natural frequency, radiation resistance, and efficiency of multi-wire antenna arrays.

- R131 Terman, F. E. and Cook, A. L. Note on variations in the amplification factor of triodes. *Proc. I.R.E.*, 18, 1044-1046; June, 1930.

It is pointed out that variations in the amplification factor of triodes are due to different portions of the tube having different values of  $\mu$ . The resulting  $\mu$  variations over the operating range of the tube characteristic are very considerable in commercial tubes, and give numerous undesirable operating features.

- R132 Vermes, N. Eine allgemeine Behandlung der Verstärkung und Gleichrichtung von Elektronenröhren. (A universal treatment of the amplification and rectification of electron tubes.) *Annalen der Physik*, 4, 943-970; No. 7, 1930.

The relations between tube parameters and circuit constants in a vacuum-tube circuit are treated theoretically. A considerable amount of experimental data is given to show the applicability of the theory to actual circuit problems.

- R133 Bergmann, L. Zur Frage der Erzeugung kurzer elektrischer Wellen mit Elektronenröhren. (On the question of the production of short electric waves with electron tubes). *Zeits. für Hochfreq.*, 35, 148-149; April, 1930.

It is shown that in a radio-frequency generator the leakage of high frequency energy along the power leads to the tube may be eliminated by putting a parallel resonant circuit in series with each filament lead and by making the plate and grid voltage connections to nodes of the high-frequency circuit.

- R133 Mallett, E. Frequency stabilization of valve oscillators. *Jour. I.E.E.* (London), 68, 578-82; May, 1930.

It is shown that the addition of a series inductance of suitable value to the plate circuit of a vacuum-tube radio-frequency generator makes the frequency of the oscillations generated independent of fluctuations in the tube constants.

- R140 Purington, E. S. Single- and coupled-circuit systems. *Proc. I.R.E.*, 18, 983-1016; June, 1930.

Networks based upon singly-tuned circuits and upon coupled circuits with primary and secondary both resonant to the same frequency are discussed. Transmission equations are derived for both types, the coupled circuit curve shapes being developed from the single circuit curves by a multiplication process, or by a vector difference process. Complex networks are handled by equivalent circuit methods. Applications to circuit design of the principles and properties noted are pointed out.

- R140 Reed, M. Electrical wave filters (continued from May, 1930 issue). *Exp. Wireless and W. Engr.* (London), 7, 315-322; June, 1930.

Wave filters using mutual inductance are discussed in general. A low-pass filter containing negative inductance and a band-pass filter containing mutual inductance are treated in detail, the attenuation and phase constant characteristics being derived for each. (to be continued.)

- R145 Barclay, W. A. Applications of the method of alignment to reactance computations and simple filter theory (continued from May, 1930 issue). *Exp. Wireless and W. Engr.* (London), 7, 309-314; June, 1930.

An alignment chart for various types of symmetrical T-filter used with an inductive load is given. The method of using the chart to determine readily the filter reactance of each type for various loads at different values of frequency is explained and illustrated. The types treated are the high-pass, low-pass, band-pass and band-stop filters. The effect of resistance on the response curves is discussed. (to be concluded.)

- R160 Pistor, W. Ueber den Empfang ultrakurzer elektrischer Wellen mittels Elektronenschwingungen. (On the reception of very short waves by means of regeneration). *Zeits. für Hochfreq.*, 35, 136-148; April, 1930.

The construction of a transmitter for generating waves of less than 1 meter wavelength is explained. The problems of short wave reception are outlined. Experiments with receiving sets of several types are described and it is concluded that both regeneration and super-regeneration are possible at high frequencies, the former being practicable and an improvement over the ordinary Barkhausen receiving method.

## R200. RADIO MEASUREMENTS AND STANDARDIZATION

- R200 Barnes, E. J. Measurement of the performance of loudspeakers (concluded from May, 1930 issue). *Exp. Wireless and W. Engr.* (London), 7, 301-308; June, 1930.

Apparatus employed to record the frequency response curve of a loudspeaker is described. An outline is given of the procedure used in loudspeaker tests and typical characteristic curves obtained with various commercial speakers are reproduced and discussed.

- R201.7 Fortescue, C. L. and Ralph F. An instrument for projecting and recording the response curve of electrical circuits. *Jour. I.E.E.*, (London), 68, 583-86; May, 1930.

There is described a combination of a projection oscillograph, a special amplifier, and a variable condenser coupled to the rocking mirror of the oscillograph, by means of which response curves may be thrown on a screen for observation or may be recorded photographically. The amplifier may be used with the oscillograph in the ordinary manner for low frequency observations, the amplifier then functioning as a special form of vacuum-tube voltmeter giving an output suitable for operating the oscillograph.

- R210 Namba, Y. The establishment of the Japanese radio-frequency standard. *PROC. I.R.E.*, 18, 1017-27; June, 1930.

The standard frequency equipment established at the Electrotechnical Lab., Ministry of Communications, Tokio, Japan is described. A vacuum-tube maintained tuning fork is the working standard, the mean frequency of which is 999.770 cycles per second at 36°C. The important characteristics of its frequency variation have been measured and the adjustments made to minimize the variations are noted. Constancy of maintenance is a few parts in one million. The frequency multiplying equipment consists of two stages of multivibrators. The method of calibration which gives an accuracy of one part in several hundred thousand is outlined.

- R251.1 Fortescue, C. L. and Moxon, L. A. An ammeter for very high frequencies. *Jour. I.E.E.* (London), 68, 556-559; May, 1930.

The construction and theory of a simple form of hot-wire ammeter intended for use at any frequency up to 100,000,000 cycles per second are described. A cylindrical form is adopted in order that the correction factors for various frequencies may be calculated with certainty. Figures are given for an instrument as actually constructed.

- R251.4 Moullin, E. B. The development of a precision ammeter for very high frequencies. *Jour. I.E.E.*, (London), 68, 544-555; May, 1930.

The principles and development of an ammeter for measuring currents of very high frequencies are described. The instrument is of the dynamometer type and has a geometrical form for which all the changes of current distribution can be calculated. Methods are given for checking calculated correction factors. In addition measurements are described of the high frequency resistance and of the inductance and terminal capacity. The ammeter can be made to carry unshunted a current of any magnitude.

### R300. RADIO APPARATUS AND EQUIPMENT

- R343 Walter, R. Verzerrungsempfänger als Uebersteuerungsanzeiger beim Rundfunk. (A receiving set for detecting over-modulation of a broadcast transmitter). *Zeits. für Hochfreq.* 35, 149-150; April, 1930.

A simple receiving circuit is given for the detection of distorted signals. The set is designed for use at broadcast frequencies.

- R343 Okabe, K. The amplification and detection of ultra-short electric waves. *PROC. I.R.E.*, 18, 1028-37; June, 1930.

Experimental results and theoretical considerations are discussed which concern the amplification and detection of electric waves shorter than 1 meter in length in a system wherein diodes and triodes are connected so as to produce oscillations of the Barkhausen and Kurz type. A simple theory of the electronic effect in the detector action is given. In some of the circuits use is made of a magnetic field applied in the direction of the axis of the electrodes within the tube.

### R400. RADIO COMMUNICATION SYSTEMS

- R402 Uda, S. Telegraphie und Telephonie mittels kurzer Wellen von  $\frac{1}{2}$  m. Wellenlänge. (Telegraphy and telephony with short waves of  $\frac{1}{2}$  meter wavelength). *Zeits. für Hochfreq.*, 35, 129-135; April, 1930.

Circuits and apparatus are described by means of which directed telephone communication was accomplished on 50 centimeter waves up to a distance of 20 miles. A generator producing oscillations of the Barkhausen type and the Yagi directive system are features of the transmitting apparatus.

- R402 Uda, S. Radiotelegraphy and radiotelephony on half-meter waves. *PROC. I.R.E.*, 18, 1047-63; June, 1930.

Communication tests in radiotelegraphy and radiotelephony on  $\frac{1}{2}$  meter waves are described. A description is given of a new type of receiver for 40-80 cm waves. Experimental results are given to show its operation. It is pointed out that a sort of regenerative amplifying accompanies the detection of such extremely short waves and this action is briefly explained. The results of experiments on a  $\frac{1}{2}$  meter transmitter are set forth with special regard to the modulation system. Actual tests of communication to the distances from 10 to 30 km are described. The possible application of the wave collecting system to direction finding with such extremely short waves is pointed out.

- R412 Schelleng, J. C. Some problems in short-wave telephone transmission. *PROC. I.R.E.*, 18, 913-38; June, 1930.

Short-wave telephony from the standpoint of transmission is discussed. The phases of the subject treated include the requirements and limitations of the transmitting antenna, the reasonably expected gain of arrays, the phenomenon of non-synchronous fading, and the directional properties of the transmitting medium. High-power transmitting equipment is discussed with special emphasis on the following requirements: stability of operation flexibility, and freedom from amplitude distortion and phase and frequency modulation. Experimental data obtained in a large number of transatlantic tests are used to illustrate problems involved in the discussion.

### R500. APPLICATIONS OF RADIO

- R526.1 Diamond, H. and Kear, F. G. A 12-course radio range for guiding aircraft with tuned-reed visual indicator. *PROC. I.R.E.*, 18, 939-62; June, 1930.

There is described a radio directive beacon of the visual indicating type developed by the Bureau of Standards to provide radio marked courses at air terminals where more than four airways converge. The beacon provides 12-equisignal zones which may be oriented within rather wide limits and made to coincide with converging airways. Circuit features of the transmitter are treated in detail.

- R526.1 Dunmore, F. W. A tuned-reed course indicator for the 4 and 12 course aircraft radio range. *PROC. I.R.E.*, 18, 963-982; June, 1930.

Tuned-reed indicators for the 4- and 12-course aircraft radio ranges are described. Details of design and operating characteristics are given. A shutter and color system are explained which enable the pilot to know which of the various courses of the range he is flying on and in which direction.

- R550 Eckersley, P. P. A wireless broadcasting transmitting station for dual programme service. *Exp. Wireless and W. Engr.* (London), 7, 324-27; June, 1930.

Abstract of paper read before Wireless Section, Institution of Electrical Engineers, London, May 7, 1930.

### R800. NONRADIO SUBJECTS

- 621.39 Sutton, G. W. Some notes on the design of a gramophone pick-up. *Jour. I.E.E.* (London), 68, 566-77; May, 1930.

An account is given of an experimental investigation of the performance of certain types of commercial phonograph pick-up. Experiments are described on the mode of vibration of a pick-up armature and on other factors affecting the performance of the instrument. A theoretical treatment based on the results of the experiments is given and a new design is evolved.



## CONTRIBUTORS TO THIS ISSUE

**Ballantine, Stuart:** See PROCEEDINGS for July, 1930.

**Barber, A. W.:** Born July 24, 1906 at Portsmouth, New Hampshire. Received B.S. degree, Electrical Communication Engineering, Harvard, 1928. Radio receiver design and testing, Browning-Drake Corporation, 1926-1928; installation and service, Electrical Research Products, Inc., 1928-1929; Radio Frequency Laboratories, Inc., 1930 to date. Non-member, Institute of Radio Engineers.

**Brown, William W.:** Born November 11, 1889 at Hambleton, West Virginia. Received E.E. degree, I. C. S. Electrical construction and repair, Davis Coal & Coke Co., 1907-1910; electrical construction and repair and power station engineer, United Railways and Electric Co., 1910-1913; electric testing, 1913-1915; design and development of high power radio equipment since 1915; in charge of development and design, Alexanderson Alternators, and associated apparatus. Member, Institute of Radio Engineers, 1918.

**Edelman, Philip E.:** Born July 16, 1894. Received B.S. in Engineering, 1916, E.E., 1917, University of Minnesota; Fellow, 1917, Research Corporation. Anti-submarine development, Naval Experiment Station, New London, Conn., 1918; perfected and received basic patents, automatic chemical control, 1919-1920; developed electrical, chemical, radio, and labor saving improvements, 1921-1925; perfected devices for radio power supply, electro-plating, acoustic condensers, and production processing, 1926-1930. Associate member, Institute of Radio Engineers, 1914.

**Evans, Porter H.:** Born January 11, 1891 at Erie, Pennsylvania. Received E.E. degree, University of Michigan, 1914; M.S. degree, University of Michigan, 1920. Instructor in electrical engineering communication courses, University of Michigan, 1915-1920; engineering and development work on public address and power line carrier and radio equipments, the latter including broadcasting, airplane radio, radio beacons, and radio transmission measurements, Bell Telephone Laboratories, 1920-1928; chief engineer, eastern studios, Warner Brothers-Vitaphone Corporation, 1928 to date. Member, Institute of Radio Engineers, 1923.

**Farnham, Ralph E.:** See Proceedings for February, 1930.

**Graham, Virgil M.:** Born January 22, 1902 at Rochester, New York. Attended University of Rochester, 1920-1923; radio engineering work, Stromberg-Carlson Telephone Manufacturing Company, 1923 to date; for the past six years in charge of the radio engineering department. Chairman, Rochester Section, Institute of Radio Engineers, 1927; Secretary, Rochester Engineering Society; vice-chairman and secretary RMA Standardization Committee on Receivers and Power Supply; editor, RMA Standards Handbook; member, Standardization Subcommittees, A. S. A. and Institute of Radio Engineers; Associate member, A. I. E. E.; Associate member, Institute of Radio Engineers, 1924; Member, 1927.

**Kennelly, Arthur E.:** Born December 17, 1861 at Bombay, East Indies. Attended schools in England, Scotland, France, Belgium; received honorary Sci.D., University of Pittsburgh, 1895; Hon. A.M. degree, Harvard Univer-

sity, 1906; Hon. Sci.D. degree, University of Toulouse, 1923. Assistant secretary, I.E.E.; English Telegraph Company, 1876-1886; assistant to Thomas A. Edison, 1887-1892; Houston and Kennelly, construction engineers, 1894-1901; professor electrical engineering, Harvard University, 1902; professor electrical engineering, Massachusetts Institute of Technology, 1913; exchange professor to France, 1922-1923; construction electrical engineer. Past president, A.I.E.E., 1893-1900; president Illinois Engineering Society, 1911; past president Institute of Radio Engineers, 1916; honorary member, I.E.E., Great Britain. Associate member, Institute of Radio Engineers, 1912; Member, 1913; Fellow, 1928.

**King, Ronald:**

**Olney, Benjamin:** Manufacturing, plant engineering, and maintenance work, 1904-1920; in charge, electrical laboratory, Stromberg-Carlson Telephone Manufacturing Company, 1920 to date; designed audio transformers and amplifying systems, later designed one of the pioneer program service systems for giving loud speaker service over telephone lines; in charge, Stromberg-Carlson acoustical laboratory, 1926 to date. Non-member, Institute of Radio Engineers.

**Stoner, Frank E.:** Officer in charge, War Department Message Center, and War Department Net Control Station WAR. Non-member, Institute of Radio Engineers.

**Verman, Lal C.:** Born October 2, 1902 at Amritsar, India. Received B.S. degree in Electrical Engineering, University of Michigan, 1927; M.S. degree, Cornell University, 1928; Ph.D. degree in Physics, Cornell University, 1930. Research assistant in Engineering Research Department, Sound Division, University of Michigan, 1925-1927; Donovan Scholar, University of Michigan, 1925-1927; Charles A. Coffin Fellow (General Electric Company), Cornell University, 1927-1930. Associate member, A.I.E.E. Associate member, Institute of Radio Engineers, 1928.



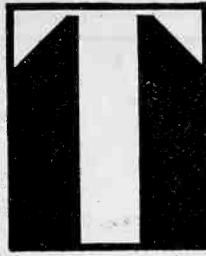

*Do think of*  
**TRANSFORMERS**

*is to think of*  
**THORDARSON**

**TRANSFORMER SPECIALISTS**  
*Since 1895* / / / / / /

Microphone Transformers ● Line  
to Tube, Tube to Line, Line to Line ●  
Mixing Transformers ● Coupling  
Reactors ● Filter Chokes ● Audio  
Transformers ● Impedance Matching  
Transformers ● Power Compacts ●  
Speaker Coupling Transformers ●  
Complete Amplifiers . . . . .

*Catalog of new Replacement Power and Audio  
Transformers will be sent upon request*

**THORDARSON ELECTRIC MFG. CO.**  
**Huron, Kingsbury and Larrabee Sts., Chicago, Ill., U. S. A.**

*When writing to advertisers mention of the PROCEEDINGS will be mutually helpful.*

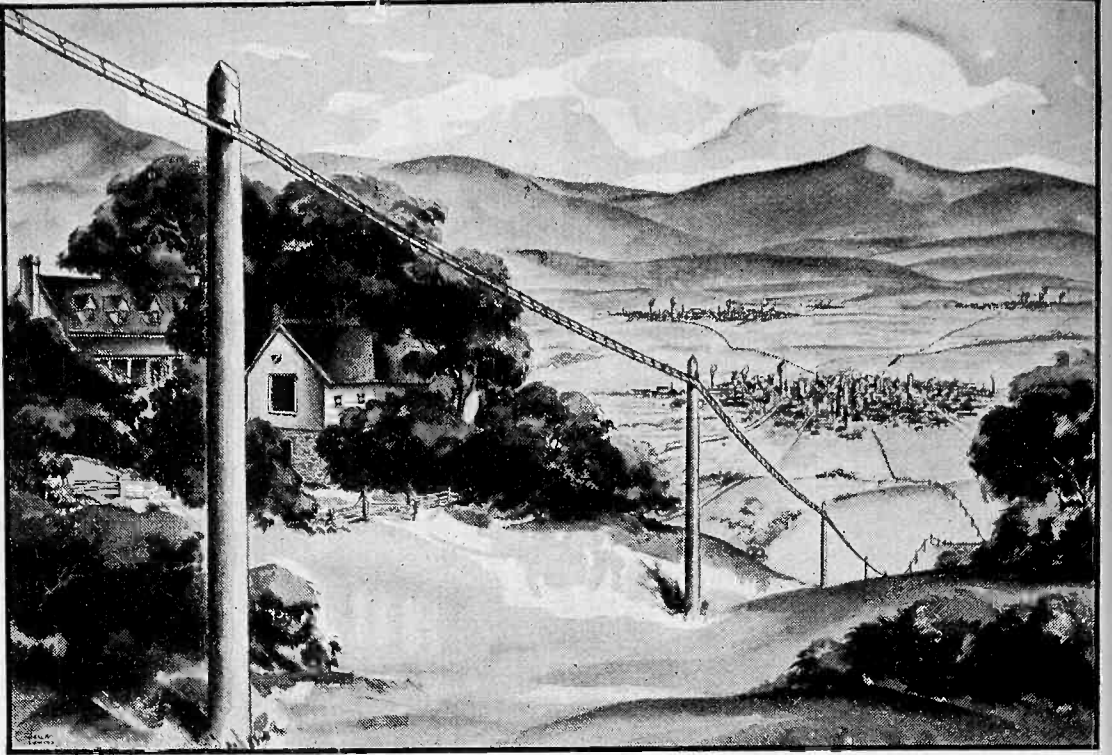

AN INTER-CITY CABLE, PART OF THE BELL SYSTEM NETWORK THAT UNIFIES THE NATION

## Vast, to serve the nation . . . personal, to serve you

*An Advertisement of the American Telephone and Telegraph Company*

So THAT YOU may telephone from house to house in a Southern village, from farm to farm in the Middle West, or from the Pacific to the Atlantic Coast—the Bell Telephone System *must* be large. Its work is to give adequate telephone service to one of the world's busiest and most widespread nations. There is 4000 million dollars' worth of telephone plant and equipment in the Bell System, any part of which is subject to your call day or night.

Every resource of this system is directed to the end that you may have quick, clear and convenient telephone service.

In order to meet the telephone needs of the country most effectively, the operation of the Bell System is carried on by 24 Associated Companies, each attuned to the area it serves. Working with these companies is

the staff of the American Telephone and Telegraph Company, giving them the benefit of its development of better methods. The Bell Laboratories and the Western Electric Company utilize the talents of thousands of scientists for constant research and improvement in the material means of telephony. Western Electric, with its great plants and warehouses in every part of the country, contributes its specialized ability for the precise and economical manufacture of equipment of the highest quality for the entire system.

The Bell System is vigorously carrying forward its work of improving the telephone service of the country. It is building for today and tomorrow—for the benefit of every one who lives and works in America.



*When writing to advertisers mention of the PROCEEDINGS will be mutually helpful.*



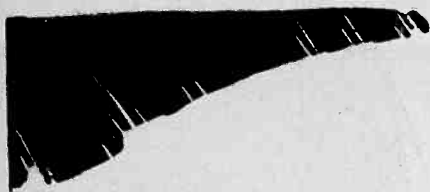

# Bring the Studio to your Home

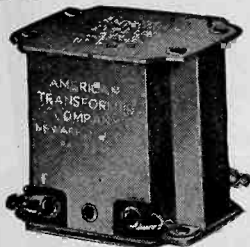

*AmerTran De Luxe  
Audio Transformer—  
List Price \$8.00. Type  
151—Between one in-  
put and two output  
tubes—List Price \$12.00*

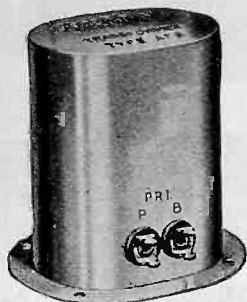

*Type AF-8 Audio Trans-  
former—Either 1st or 2nd  
stage audio. Turn ratio  
3 1/2—List Price \$5.00*

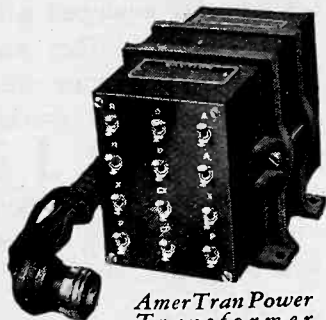

*AmerTran Power  
Transformer  
Type PF-245A—  
List Price \$22.00*

There is no excuse for imperfect radio reception. But even today, receiving sets fail to reproduce music and the speaking voice in true tone identical with the range of pitch and the rich fulness of sound quality as broadcast in the studio.

The weak point in most receiving sets is in the audio system.

AmerTran Audio Transformers and Power Transformers shown here perfect the audio system and bring the programs into your home exactly as they go over the air through the microphone. For further descriptions of these and thirty-odd products in the field of radio reproduction that have attained the perfection necessary to AmerTran Standard of Excellence, write for Bulletin 1065.

The facilities of our engineering department are at the service of everyone interested in better radio reproduction.

## AMERTRAN

TRADE MARK REG. U.S. PAT. OFF.



QUALITY RADIO PRODUCTS

AMERICAN TRANSFORMER COMPANY  
178 EMMET STREET, NEWARK, N. J.

Transformer Builders for over 29 years

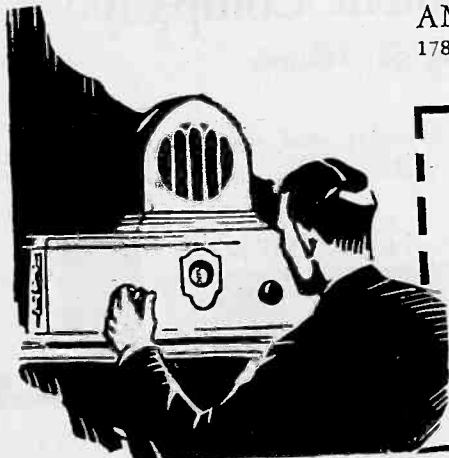

AMERICAN TRANSFORMER CO.  
178 Emmet St., Newark, N. J.

Please send me Bulletin 1065 containing complete information on AmerTran Transformers, for better radio reception.

Name .....

Address .....

IRE 8-30

*When writing to advertisers mention of the PROCEEDINGS will be mutually helpful.*

# Accurate and Rapid Checking of Circuits and Resistances



THE JEWELL Pattern 89 Ohmmeter provides a degree of convenience and accuracy for checking resistance and testing circuits not found in other instruments of comparable price.

A 1½ volt cell mounted inside the case makes the Pattern 89 entirely independent of outside sources of energy. Convenient adjustment is provided through a magnetic shunt to compensate for variations in cell voltage. Since this adjustment may be made before each series of tests, very accurate resistance readings are assured.

The current draw is so low that the cell

will last several months in ordinary service, and it is easily replaced. In testing, the resistance of the section under test is indicated directly on the ohmmeter scale. As a result no calculations are necessary.

Every radio factory, laboratory or repair shop should be thoroughly equipped with Jewell Pattern 89 Ohmmeters. They save so much time, contribute to accurate measurements so effectively that they quickly pay for themselves.

Available with 0-1000, 0-3000, 0-10000, or 0-30000 ohm ranges. List price, including battery and test leads, \$18.50.

## Jewell Electrical Instrument Company

1642-D Walnut St., Chicago, Illinois

*Manufacturers of a complete line of portable and switchboard instruments and an extensive line of radio service equipment.*

30 YEARS MAKING GOOD INSTRUMENTS  
**JEWELL**

*When writing to advertisers mention of the PROCEEDINGS will be mutually helpful.*

Use Roller-Smith Apparatus for  
INDICATION REGISTRATION PROTECTION

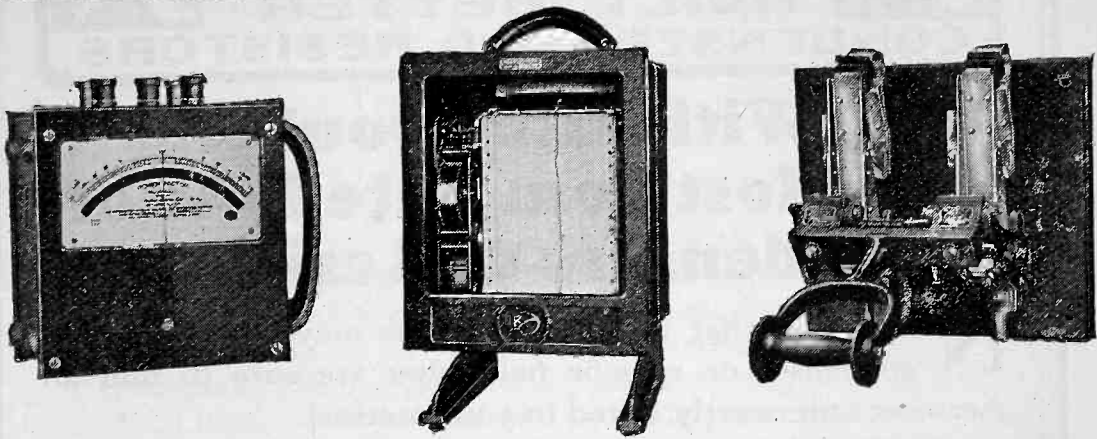

SATISFACTION is Always the Result



## Products

*Comprise complete lines of*

**ELECTRICAL INSTRUMENTS**

*Indicating and Graphic*

**CIRCUIT BREAKERS**

*Air and Oil*

**RELAYS**

Bulletins covering the various devices will be sent on request.

*Over thirty-five years' instrument experience is back of*

**ROLLER-SMITH COMPANY**  
Electrical Measuring and Protective Apparatus

Main Office:  
2134 Woolworth Bldg.  
NEW YORK



Works:  
Bethlehem,  
Pennsylvania

*Offices in principal cities of U. S. A. and Canada.*

*When writing to advertisers mention of the PROCEEDINGS will be mutually helpful.*

# AEROVOX

**BUILT BETTER**  
CONDENSERS AND RESISTORS

## Without A Doubt The Most Complete Line of Condensers & Resistors

**N**O matter what your requirements may be in the fixed condenser or resistor field, you are sure to find an Aerovox unit—exactly suited to your needs.

Dry Electrolytic Condensers  
Filter Condenser Blocks  
Buffer Condenser Blocks  
Socket Power Condensers  
High Voltage Condensers  
Transmitting Condensers  
Bypass Condensers  
"A" Power Condensers  
Bakelite Moulded Mica  
Condensers

Pyrohm Heavy Duty Resistors  
Edison Base Pyrohm Resistors  
Tapped Pyrohm Resistors  
Wire Wound Resistor Units  
Grid Suppressor Resistors  
Center-tapped Resistor Units  
Non-Inductive Lavite Resistors  
Grid Leak Resistors  
Resistor Mountings  
Interference Filters

In addition to the large number of stock sizes of condensers and resistors, the Aerovox Wireless Corporation is equipped to supply to manufacturers special types and sizes of condensers, filter blocks and resistors in all fixed and tapped combinations on short notice.

### SEND FOR COMPLETE CATALOG

Complete specifications of all Aerovox units, including insulation specifications of condensers, carrying capacities of resistors and all physical dimensions, electrical characteristics and list prices of condensers and resistors, are contained in a complete 1929-30 catalog which will be sent gladly on request.



The Aerovox Research Worker is a free monthly publication that will keep you abreast of the latest developments in radio. Your name will be put on the mailing list free of charge on request.

## AEROVOX WIRELESS CORP.

80 Washington Street, Brooklyn, N. Y.

**PRODUCTS THAT ENDURE**



*When writing to advertisers mention of the PROCEEDINGS will be mutually helpful.*

# Piezo Electric Crystals and Constant Temperature Equipment

## *Piezo Electric Crystals:*

We are prepared to grind Piezo Electric Crystals for POWER use to your assigned frequency in the 550 to 1500 KC band, *accurate to plus or minus 500 cycles* for \$55.00 fully mounted. Crystals for use in the HIGH FREQUENCY BROADCAST BAND (4000 to 6000 KC) for POWER use, accurate to plus or minus .03% of your assigned frequency, fully mounted, \$85.00. In ordering please specify type of tube used, plate voltage and operating temperature. All crystals guaranteed with respect to output and accuracy of frequency. Deliveries can be made within three days after receipt of order.

## *Constant Temperature Equipment*

In order to maintain the frequency of your crystal controlled transmitter to a high degree of constancy, a high grade temperature control unit is required to keep the temperature of the crystal constant. Our unit is solving the problem of keeping the frequency within the 50 cycle variation limits. Our heater unit maintains the temperature of the crystals constant to **BETTER THAN A TENTH OF ONE DEGREE CENTIGRADE**; is made of the finest materials known for each specific purpose and is absolutely guaranteed. Price \$300.00. Further details sent upon request.

## *Low Frequency Standards:*

We have a limited quantity of material for grinding low frequency standard crystals. We can grind them as low as *15,000 cycles*. These crystals will be ground to your specified frequency accurate to **ONE HUNDREDTH OF ONE PER CENT**. Prices quoted upon receipt of your specifications.

## Scientific Radio Service

*"The crystal specialists"*

P. O. Box 86

Dept. R6

Mount Rainier, Md.

# A SAFE GUIDE

in the selection of insulation for Radio Transmitting and Receiving Sets

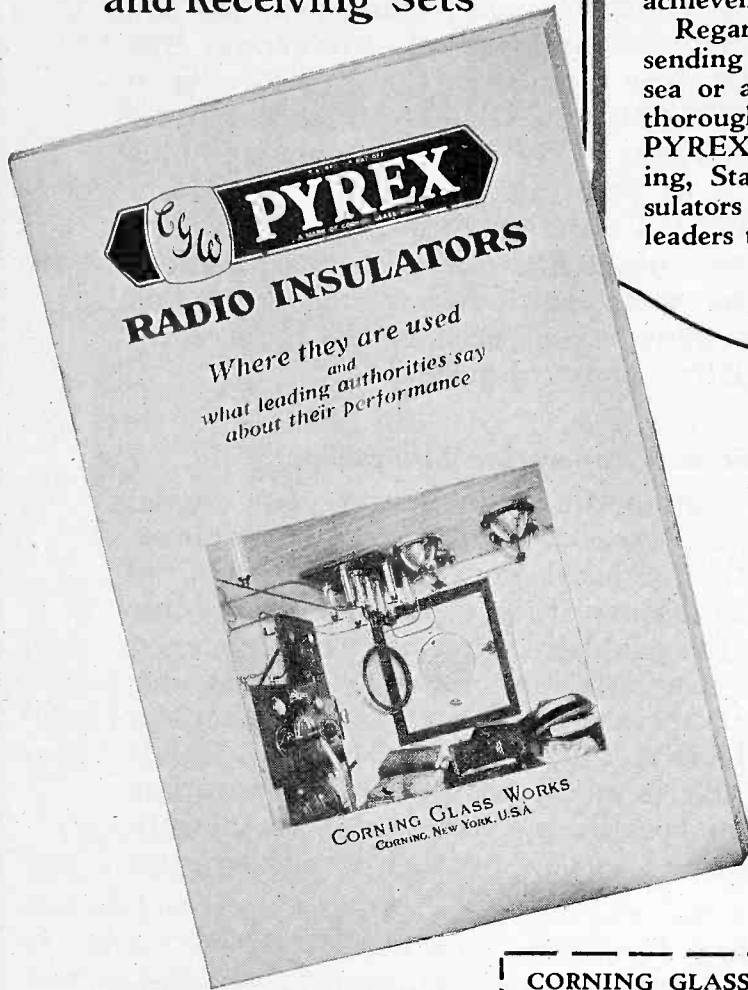

OVER 300 broadcasting stations, leading radio telegraph systems, the United States Army, Navy, Air Mail, Coast Guard and Ice Patrol Services, explorers like Commander Byrd, and exacting amateurs everywhere have utilized PYREX Insulators in many spectacular achievements.

Regardless of whether you are sending or receiving—on land, sea or airplane—you should be thoroughly familiar with the PYREX Antenna, Strain, Entering, Stand-off and Bus-bar Insulators that are helping these leaders to make radio history.

The new PYREX Radio Insulator booklet lists all types and sizes with data that you will want for ready reference.

Return the coupon for your copy, and if you want further advice on any insulation problem, our Technical Staff will answer your questions promptly.

CORNING GLASS WORKS, Corning, N. Y.

Send copy of your new bulletin on Radio Insulators

Name .....

Address .....

I. R. E. 8-30

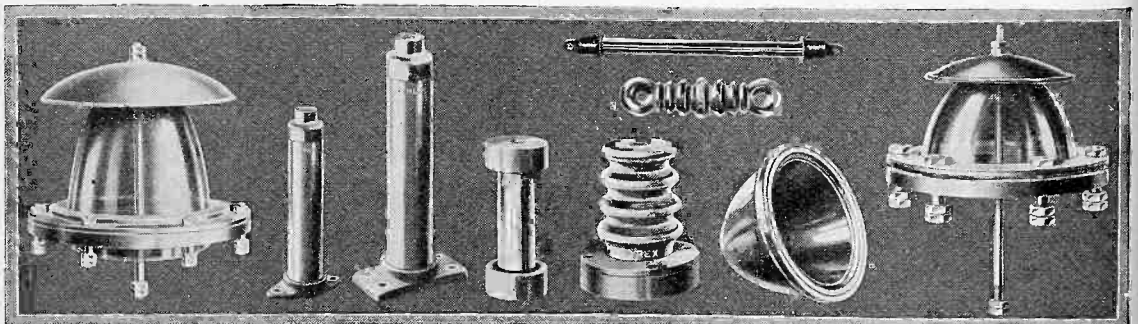

When writing to advertisers mention of the PROCEEDINGS will be mutually helpful.

# The New ELECTRAD Constant Impedance Super-TONATROL

Licensed  
under U.S.  
Pats.  
Pend.  
and issued  
Canadian  
Pats.  
281172-  
286778

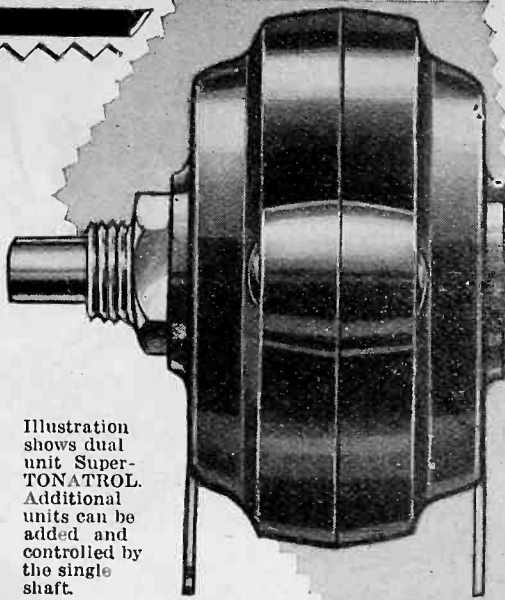

tilt the **DURATROL** Patented Principle  
ADJUSTABLE RESISTORS

Illustration shows dual unit Super-TONATROL. Additional units can be added and controlled by the single shaft.

The EFFICIENT Volume Control for Microphones Phonographs and Talking Picture Amplifiers

## New in Principle Unequaled in Performance

THE new ELECTRAD Super-TONATROL Constant Impedance "T" Pad and "L" Pad controls offer designers of electrical sound reproducing apparatus, phonographs, talking picture and similar equipment an effective solution to their volume control problems.

Efficient volume control between pickup and amplifier is now made possible without unbalancing the impedance of the circuits.

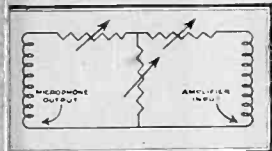

Showing Super-TONATROL "T" Pad installed.

Built on the newly-perfected DURATROL patented principle, these resistors assure absolutely smooth, noiseless variation—and unusually long life.

These Stock Sizes Now Available Special Units Made to Your Specifications Super-TONATROL "T" Pads—3 gang units of Duratrol Construction

Impedance of Line	Impedance of "T" Pad	Type
200 ohms	200 ohms	TS 200
500 "	500 "	TS 500
3,000 "	3,000 "	TS 3,000
5,000 "	5,000 "	TS 5,000

Super-TONATROL "L" Type—Dual Control		
200 ohms	200 ohms	LS 200
500 "	500 "	LS 500
3,000 "	3,000 "	LS 3,000
5,000 "	5,000 "	LS 5,000

Also made with the famous ROYALTY Type Unit, for use with lower voltages

Impedance	Type
15 ohms	TR 15
200 "	TR 200
500 "	TR 500
3,000 "	TR 3,000
5,000 "	TR 5,000

### Quotations on Request

The Duratrol Principle is especially suitable for graduating light changes of stage lights, illuminated fountains, advertising displays and for any other purpose requiring smooth, stepless variation of voltage. Any number of units with different resistance curves can be operated on one shaft.

Varick St., New York, N.Y.  
**ELECTRAD**  
INC.

Smooth  
Stepless  
Variation  
With  
Longer  
Life

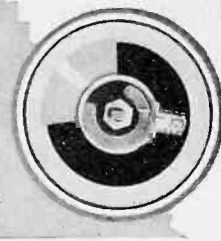

Electrad DURATROL Adjustable Resistors have many distinctive features.

The long-wearing resistance element is permanently fused to a vitreous enameled metal plate—over which floats a specially developed pure silver contact, with delightful smoothness. Metal plate aids rapid heat dissipation. Duratrol units can be secured in high and special high resistance values.

Super-TONATROL Units, for radio volume controls are available in 2 types, with 3 and 5 watt ratings. Also dual and three-gang units in 3-watt size.

MAIL COUPON FOR SUPER-TONATROL CIRCULAR  
ELECTRAD, Inc., Dept. PE-8, 175 Varick St., New York  
Please send circular covering the Constant Impedance Super-TONATROL and other DURATROL Resistors.

Name .....  
Address .....  
City .....  
State .....

When writing to advertisers mention of the PROCEEDINGS will be mutually helpful.

# the Coils the thing!

In every radio hook-up an ideal coil is specified for each function in the set.

Each Dudlo coil is backed by its reputation as the utmost in coil perfection, and though tucked away in the chassis of a set . . . forgotten, yet depended upon . . . will give years of faithful performance.

Continuous performance is *assumed*. Tubes may come and tubes may go . . . condensers may break down . . . but the coils must go on forever.

Dudlo coils are superbly engineered, and constructed by experts to fit individual requirements . . . no matter how complex or difficult.

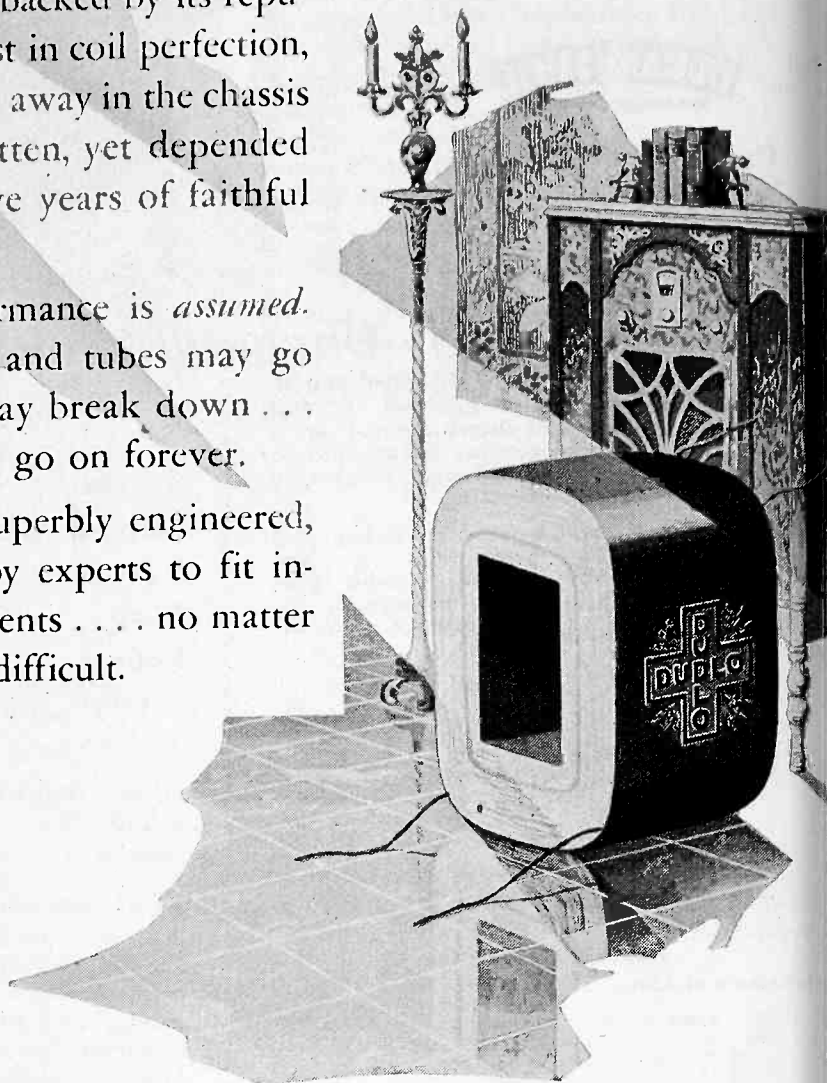

# DUDLO

DUDLO MANUFACTURING COMPANY, FORT WAYNE, INDIANA  
*Division of General Cable Corporation*

*When writing to advertisers mention of the PROCEEDINGS will be mutually helpful.*



Products  
Produits  
Productos

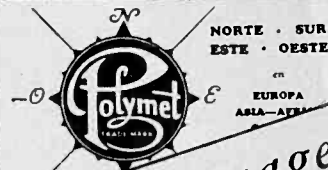
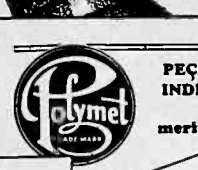
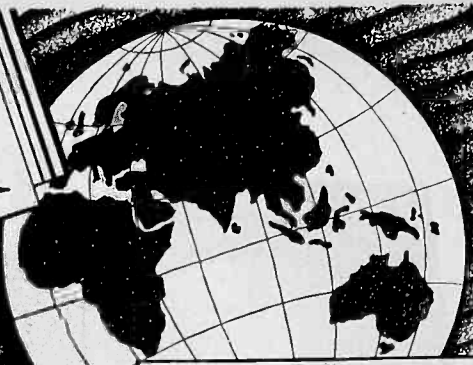

**PRODUITS**



Condensateurs de mica, bobines, transformateurs, etc.

Trois énormes usines modernes sont situées au travail fabriquant les fameux articles Polymet qui emploient 80% des principaux fabricants de T. S. F. de l'Amérique.

**PRODUCTOS**



Condensadores de papel y de mica, enrollamientos de bobina, artículos para la radiofonia, alambre magnético esmaltado, transformadores, resistencias.

Tres gigantescas plantas industriales se encuentran siempre trabajando, produciendo estos artículos Polymet usados por el 80% de los principales fabricantes de aparatos de radio de los EE. UU. Escriba en solicitud de catálogos, precios y descuentos.

**SEGUROS**

POLYMET MANUFACTURING CORPORATION  
134th Street, New York City, U. S. A.  
Directores: ARLAB—Croydon, London.

**POLYMET**

**POLYMET advertisements** which have been running in Journals reaching radio men throughout the world.

but in every language  
**POLYMET** stands for  
Quality Radio Essentials

Wherever radio has penetrated—  
and few places exist today where  
its wonders are not known—  
there you will find Polymet  
Products.

The reason is the same which  
impels 80% of the great American  
radio manufacturers to  
employ Polymet Products—  
dependable Condensers,  
Coils, Resistances, Trans-  
formers, Magnet Wire.

Catalogs and prices will be furnished  
promptly on request.

**POLYMET**  
Manufacturing Corporation  
829 East 134th Street  
New York City

Canadian Representative  
**WHITE RADIO**  
LIMITED

41 West Avenue

North Hamilton, Canada

Representative for the British Isles

**A. H. HUNT**  
LIMITED

Tunstal Road, Croydon, Surrey, England

When writing to advertisers mention of the PROCEEDINGS will be mutually helpful.



**PACENT  
MASTER  
PHONOVOX**

Model 107

**\$15.00**

*Slightly higher west of the  
Rockies and Canada*

**12 months' research have perfected  
12 improvements in the  
NEW MASTER PHONOVOX**

The results from the new Pacent Master Phonovox more than justify the time and effort put forth to produce this improved pickup. These are the features which assure the continuance of Pacent leadership in the pickup field:

- |  |   |
|--|---|
| <ol style="list-style-type: none"> <li>1 Improved frequency characteristics through scientific placement of weight.</li> <li>2 Greater range of reproduction — more bass — more highs!</li> <li>3 Low center of gravity—better record tracking. Lateral play of armature exceeds lateral cut of record grooves.</li> <li>4 Built-in volume control.</li> <li>5 Built-in radio-record change-over switch — go from one to the other in an instant.</li> <li>6 Full swing back head for easy needle changing.</li> </ol> | <ol style="list-style-type: none"> <li>7 Special Cobalt magnets.</li> <li>8 Pole pieces specially milled, heat treated and precision ground.</li> <li>9 All parts in the Master Phonovox precision adjusted to insure a new degree of pickup performance.</li> <li>10 Correct needle pressure applied through scientific design of head.</li> <li>11 Ball-bearing swivel tone-arm.</li> <li>12 Beautiful—modernistic, golden bronze finish, delicately embossed.</li> </ol> |
|--|---|

*Write for literature*

**PACENT ELECTRIC CO., Inc., 91 Seventh Ave., New York, N. Y.**

*Manufacturing Licensee for Great Britain and Ireland*

**IGRANIC ELECTRIC CO., Ltd., Bedford, England**

*Licensee for Canada: White Radio Ltd., Hamilton, Ont.*

*When writing to advertisers mention of the PROCEEDINGS will be mutually helpful.*

Fused Pure Silica  
**Vitreosil**

## THE IDEAL INSULATION

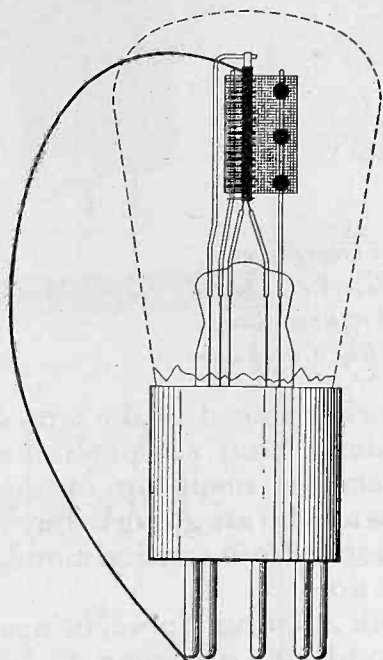

**P**ROGRESSIVE manufacturers, making the better kind of AC heater-type radio tubes use Vitreosil insulation for its freedom from gas and uniform wall which produces even heat distribution. It easily meets the thermal conditions of sudden heating and cooling, is mechanically strong, and available at low cost in single or multibore styles, and twin bore in either oval or circular cross section.

*You can identify this Vitreosil product, illustrated herewith, by its smooth satin finish.*

*Let us send samples and quote on your requirements.*

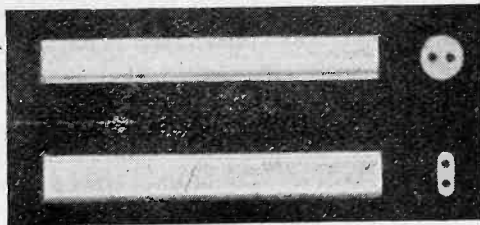

**THE THERMAL SYNDICATE, Ltd.**

1716 Atlantic Avenue

Brooklyn, New York

*When writing to advertisers mention of the PROCEEDINGS will be mutually helpful.*

Little things  
like this help  
make your  
set a  
headliner

*by George Lewis,  
Vice-President,  
Arcturus Radio  
Tube Company*

**D**AILY dramas are being staged in the stores of your local dealers. Your set plays the leading role. The audience is made up of the Joneses or Smiths or Browns who are going to buy a radio, and like all audiences they're in a critical mood.

Snap the switch—let's go!

Your set, equipped with Arcturus Tubes, brings in the program in 7 seconds. No annoying 40-50 second wait, while live prospects fidget.

The music is clear, true, and free from hum; sure to be satisfying.

Another Arcturus feature—long life—keeps up the good first impression. Critical engineers know that sets equipped with Arcturus Tubes require minimum servicing.

In these three ways Arcturus Tubes help make sure of a perfect performance every time your set is in the spotlight. Each point is important, for a slight edge over competition often swings the sale your way. When you use Arcturus Blue Tubes for standard equipment, you're liable to get the kind of demonstrations that make your dividends grow.

ARCTURUS RADIO TUBE COMPANY, Newark, N. J.

# ARCTURUS

*Quick Acting*

## RADIO TUBES

*When writing to advertisers mention of the PROCEEDINGS will be mutually helpful.*

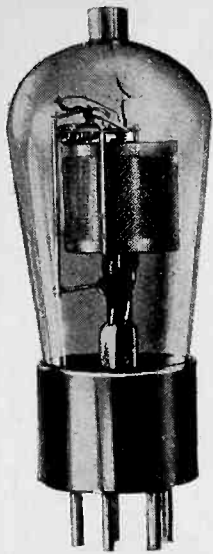

## GILBY PRODUCTS



Filament Wire

Plain Nickel Mesh

Gilby Selvage Mesh  
(Pat. applied for)

Support Wire

Nickel Ribbon-Plain  
and Carbonized

Seamless Tubing

Grid Wire



# GILBY . . .

moves hand in hand  
with electron tube de-  
velopment . . .

**G**ILBY experience in the production and application of special wire and wire products is available to manufacturers and engineers who are developing new uses of the electron tube. You are invited to use this experience freely—to consult with Gilby on your problems involving tube wire, screens, and resistance wire.

Gilby offers wire, ribbon and sheets in the highest purity of nickel, free from cobalt for such uses as plates, cathodes, support wires, etc. Manufacturers express their confidence in Gilby Pure Nickel Filament wire by accepting it as standard. Gilby Resistance material, too, in wire, sheet and strip-bare, enameled, cotton or silk covered is recognized standard.

Special alloys are also available for special needs. Write for full information.

**GILBY WIRE COMPANY**  
*Wilbur B. Driver, President*  
**NEWARK, NEW JERSEY**

*Gilby will gladly send samples of its products to responsible manufacturers. We invite an opportunity to cooperate with you.*

*When writing to advertisers mention of the PROCEEDINGS will be mutually helpful.*



# in Radio... Success rests on Quality

*And Quality is An Engineering Achievement*

**T**HE most successful radio set manufacturers are those whose products give the listener the best broadcast reception. And for perfect reception nothing can take the place of quality in the set.

The perfection of radio—the in-building of quality—is an engineering achievement. It has involved the close cooperation of research engineer, parts manufacturer and set maker.

In this development Scovill is proud to have been a pioneer. Scovill electrical, metallurgical and mechanical engineers,

Scovill laboratories, research workers and craftsmen have worked from the beginning of the industry to give the set maker better condensers and metal parts.

Today, Scovill radio condensers are recognized as leaders in quality. Scovill manufacturing service is known for being a step ahead. And Scovill enjoys the patronage of radio's famous manufacturers. If you are one of the few who are not now using Scovill parts there is a representative at the nearest Scovill office who will be glad to talk with you.

# SCOVILL

Established 1802

## MANUFACTURING COMPANY

· WATERBURY · CONNECTICUT ·

BOSTON  
ATLANTA  
CHICAGO

PROVIDENCE  
CLEVELAND  
LOS ANGELES

NEW YORK  
DETROIT  
SAN FRANCISCO

PHILADELPHIA  
CINCINNATI



*In Europe—THE HAGUE, HOLLAND*

*When writing to advertisers mention of the PROCEEDINGS will be mutually helpful.*

# A Still Finer MULTIPLE CONDENSER by Hammarlund

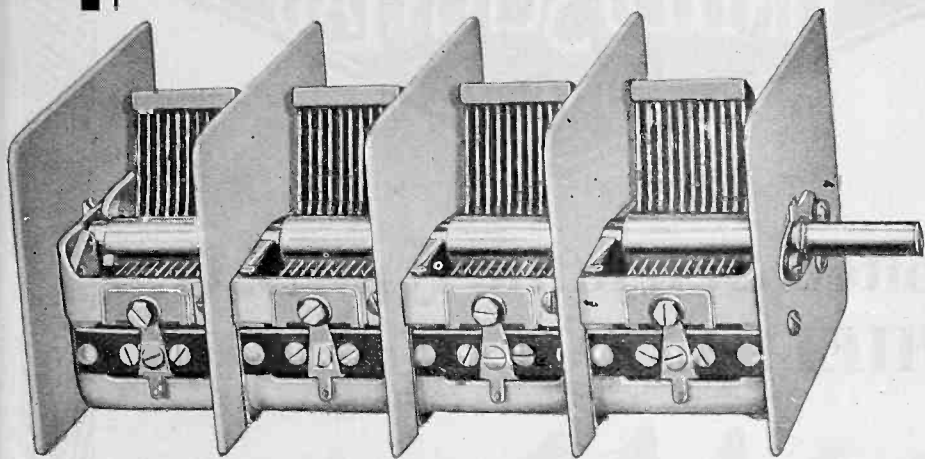

Completely  
Shielded

## Two, Three and Four-Gang Models

**E**NGINEERS who have seen this new condenser development pronounce it "still finer" than the many superb condenser types that have steadily maintained Hammarlund leadership since the birth of radio.

It offers superior constructional features and extremely high electrical efficiency.

Completely shielded with rigid  $\frac{1}{16}$ " aluminum shields, which may be easily removed if not required.

A rib-reinforced, die-cast aluminum frame gives maximum strength with light weight.

Insulated with the new Hammarlund dielectric, "Parmica," which has but 10 percent of the usual insulation losses. Hence, low R. F. resistance and increased sensitivity and selectivity.

Permanently aligned aluminum plates with tie-bars. Individual bronze wiping contacts for each section. Sections matched to plus or minus  $\frac{1}{2}$  of 1 percent and each section has its own trimming condenser.

Write for further details, and prices. They will interest you. Use the convenient coupon.

HAMMARLUND MFG. CO.  
424-438 W. 33rd St., New York

For Better Radio  
**Hammarlund**  
PRECISION  
PRODUCTS

MAIL COUPON FOR FULL PARTICULARS

HAMMARLUND MANUFACTURING CO., Dept. PE8  
424-438 W. 33rd St., New York

Please send information on "M" Condensers.

Name .....

Address .....

When writing to advertisers mention of the PROCEEDINGS will be mutually helpful.



## United Scientific type S. G. SHIELDED CONDENSER

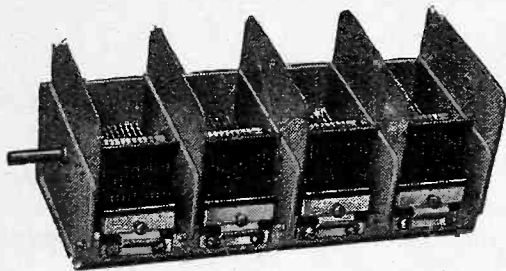

*Solves  
Your  
Tuning  
Problem*

*Improves  
Mechanical  
Appearance  
of Receiver*

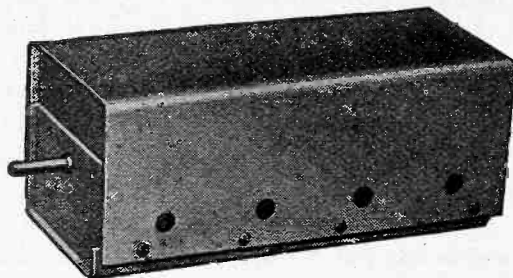

Completely shielded stators; individually grounded contacts; extra heavy steel frame; minimum compensators of novel construction; smooth rotor action; bosses arranged for either bottom or side mounting; heavily cadmium plated metal parts; dust proof cover enclosing entire unit; uniform precision spacing of rotors and stators. These are a few of the many features of our new type S.G. Shielded Condenser.

*Complete Specifications, Full Information,  
Sample and Prices Sent on Request.*

**UNITED SCIENTIFIC LABORATORIES, Inc.**  
115-C Fourth Avenue, New York City

*Branch Offices for Your Convenience in*

St. Louis  
Chicago  
Boston  
Minneapolis  
Cincinnati

Los Angeles  
Philadelphia  
San Francisco  
London, Ontario



*When writing to advertisers mention of the PROCEEDINGS will be mutually helpful.*



---

# AFTER ALL . . .

THE real worth of any condenser to the set manufacturer should be measured by its electrical efficiency and the speed with which it can be assembled. Consider these two characteristics above all others when specifying condensers.

Complete information regarding the new "ACRACON" Electrolytic and By-Pass Condensers, including charts showing electrical characteristics will gladly be furnished on request. Enclose your specifications and let our engineers solve your condenser problems.

**Write Today!**

**CONDENSER CORPORATION OF AMERICA**  
259-271 Cornelison Ave. Jersey City, N. J.

CHICAGO  
CINCINNATI

Factory Branches in:

LOS ANGELES  
TORONTO

---

*When writing to advertisers mention of the PROCEEDINGS will be mutually helpful.*



## Have You Tested **SHAKEPROOF** Lock Washers on Your Product

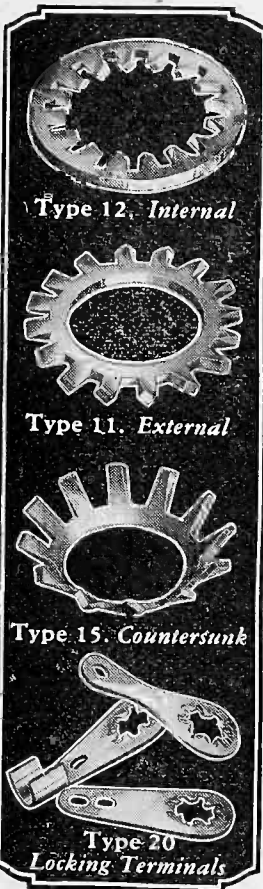

U. S. Patents 1,419,564  
1,604,122 — 1,697,954  
Other patents pending.  
Foreign patents.

**T**HERE'S a real surprise waiting for you when Shakeproof Lock Washers are given a trial in your shop. This new locking method employs a principle that is totally different from the ordinary washer. The results are different, too—in fact so different that you will be amazed at what you see.

Each twisted tooth of the Shakeproof Lock Washer forms a double lock—biting into both the nut and the work surface. Then, multiply this powerful action by the number of teeth on the washer and you can realize its tremendous holding strength.

Next, expose it to intense vibration—far greater than you ever expect your product to experience. You will see the teeth dig in deeper—never slipping or spreading and always holding the nut or screw absolutely tight. Make this test on your product now and see for yourself. Free samples will be furnished on request.

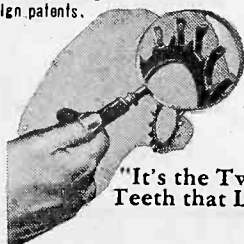

"It's the Twisted  
Teeth that LOCK"

# SHAKEPROOF Lock Washer Company

{Division of Illinois Tool Works}  
2529 North Keeler Ave., Chicago, Illinois

When writing to advertisers mention of the PROCEEDINGS will be mutually helpful.

# Key to the market



— TONE QUALITY

*is the magic key that finally  
opens the purse and closes the sale*

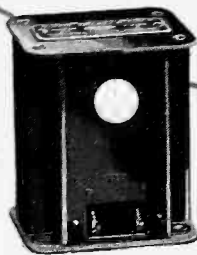

Today, Mr. Everyman and his brother who make up the radio market are *tone-conscious*. Critical ears now pass judgment on your set and if you would win popular approval you must look to the "audio end." Tone quality is the key to the radio market.

There is no such thing as "saving money" on transformers. You only place another hurdle in the path of your sales force. The buying public judges the price of your set by its tone quality.

Transformer building is an exact science—best left to an organization like Sangamo, whose research experience and precision manufacturing facilities guarantee results. Sangamo "A" Line Transformers are for custom set makers or manufacturers who want a "tone" advantage over competition. They cost a little more but the cost of selling your set is reduced.

**SANGAMO ELECTRIC CO.**

SPRINGFIELD, ILLINOIS, U. S. A.

*Manufacturers of Precision Electrical Apparatus for 30 years*

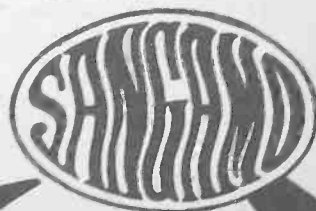

See Reverse  
Side

# "A" Line Transformers

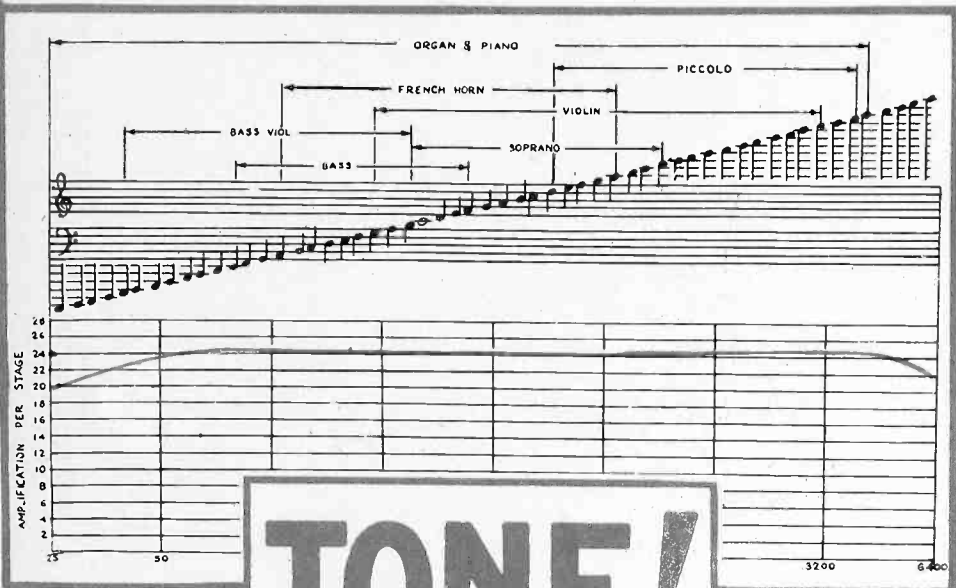

**TONE!**

*Curve of Type "A" Sangamo Straight Audio Transformer showing uniformity of amplification at all audible frequencies.*

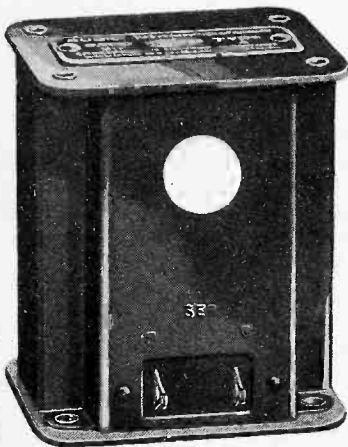

Type "A" straight audio amplification. List price.....\$10.00

Type "B" Push-pull Input Transformer for all tubes. List price \$12.00

Type C-171 Push-pull Output, for 171, 245 or 250 type power tubes with cone speaker. List price \$12.00

Type D-210, same as C, except for 210 and 112 power tubes. List price .....\$12.00

Type H-171, Push-pull Output for 171, 245, or 250 power tubes for Dynamic Speaker. List price \$12.00

Type G-210, same as type H, except for 210 and 112 power tubes. List price .....\$12.00

Type F Plate Impedance for use as a choke to prevent oscillation and for impedance coupled amplifiers. List price.....\$5.00

PRINT THIS TO YOUR LETTERHEAD AND MAIL

SANGAMO ELECTRIC CO.  
Springfield, Illinois, U. S. A., Dept. U-9

(For manufacturers) I am interested in engineering data regarding your transformers and condensers.

(For set builders) Please send circulars describing your apparatus and latest audio hook-ups. I enclose 10c to cover cost of mailing.

Name.....

Address.....

*Unusual facilities for furnishing transformers with or without cases ready for mounting and quick assembly with the receiver. Prices on application.*

## Type "A" Condenser



Every sound characteristic affected by the quality of fixed condensers in a set. Sangamo builds accurate mica condensers, molded within an overall enclosure of genuine bakelite with only the terminals brought outside. Moisture, heat, shocks or jars will not alter their characteristics nor affect operation after the set leaves the factory.

## Sangamo "Illini" Condensers

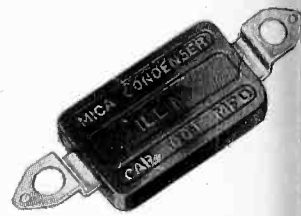

"Illini" Condensers are standard with those manufacturers who insist on ratings being actually what the specification call for. Manufactured by exclusively designed equipment held to the tolerances your engineering department demand. Sangamo Condensers will reduce to a negligible quantity inspection department rejects and "reassembly" losses in production.

## Sangamo High Voltage Condensers

Tested at 5000 volts D. C. and 3500 A. C. and built to Sangamo standards, known throughout the radio world, amateur commercial men and manufacturers have learned to depend on Sangamo High Voltage Condensers. Accurately rated and adequately tested—these condensers offer the maximum protection in high voltage, high frequency circuits.

*Prices on request*

# The Institute of Radio Engineers

Incorporated

33 West 39th Street, New York, N. Y.

## APPLICATION FOR ASSOCIATE MEMBERSHIP

(Application forms for other grades of membership are obtainable from the Institute)

To the Board of Direction  
Gentlemen:

I hereby make application for Associate membership in the Institute.

I certify that the statements made in the record of my training and professional experience are correct, and agree if elected, that I will be governed by the constitution of the Institute as long as I continue a member. I furthermore agree to promote the objects of the Institute so far as shall be in my power, and if membership shall be discontinued will return my membership badge.

Yours respectfully,

.....  
(Sign with pen)

.....  
(Address for mail)

.....  
(Date)

.....  
(City and State)

### References:

(Signature of references not required here)

Mr. .... Mr. ....

Address ..... Address .....

Mr. .... Mr. ....

Address ..... Address .....

Mr. ....

Address .....

The following extracts from the Constitution govern applications for admission to the Institute in the Associate grade:

### ARTICLE II—MEMBERSHIP

Sec. 1: The membership of the Institute shall consist of: \* \* \* (d) Associates, who shall be entitled to all the rights and privileges of the Institute except the right to hold the office of President, Vice-president and Editor. \* \* \*

Sec. 5: An Associate shall be not less than twenty-one years of age and shall be: (a) A radio engineer by profession; (b) A teacher of radio subjects; (c) A person who is interested in and connected with the study or application of radio science or the radio arts.

### ARTICLE III—ADMISSION

Sec. 2: \* \* \* Applicants shall give references to members of the Institute as follows: \* \* \* for the grade of Associate, to five Fellows, Members, or Associates; \* \* \* Each application for admission \* \* \* shall embody a concise statement, with dates, of the candidate's training and experience.

The requirements of the foregoing paragraph may be waived in whole or in part where the application is for Associate grade. An applicant who is so situated as not to be personally known to the required number of members may supply the names of non-members who are personally familiar with his radio interest.

(Typewriting preferred in filling in this form) No.....

### RECORD OF TRAINING AND PROFESSIONAL EXPERIENCE

1 Name .....  
(Give full name, last name first)

2 Present Occupation.....  
(Title and name of concern)

3 Permanent Home Address.....

4 Business Address .....

5 Place of Birth..... Date of Birth.....Age.....

6 Education .....

7 Degree ..... (college) ..... (date received)

8 Training and Professional experience to date.....

NOTE: 1. Give location and dates. 2. In applying for admission to the grade of Associate, give briefly record of radio experience and present employment.

DATES HERE

9 Specialty, if any.....

Receipt Acknowledged..... Elected..... Deferred.....  
Grade..... Advised of Election..... This Record Filed.....

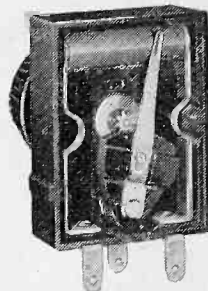
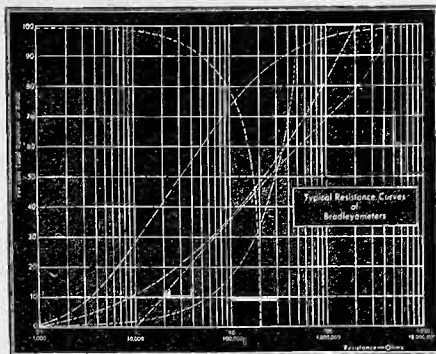

## A NEW POTENTIOMETER ... BUILT ON A NEW PRINCIPLE

THE Bradleyometer is a distinctly new type of potentiometer, unusual in design and marvelous in performance. Approximately fifty solid resistance discs are interleaved between thin metal discs. A contact arm moves from one end of the resistance column to the other.

The resistance value of each disc is separately controlled and the total number of discs can be arranged in accordance with any resistance-rotation curve desired. No other type of resistor offers such flexibility in the variation of resistance so essential in modern electronic tube circuits.



Type AA  
Double  
Bradleyometer



Type AAA  
Triple  
Bradleyometer

One or more Bradleyometers can be arranged to operate with one knob. Each Bradleyometer has its own resistance characteristic as shown in the diagram above. In this manner, mixer controls, T-pad and H-pad attenuators and other complex controls can be provided.

The extraordinary performance of the new Bradleyometer, its silent operation, and its unlimited adaptability can be appreciated only by installing a Bradleyometer in a test circuit. Samples will be gladly furnished to set manufacturers.

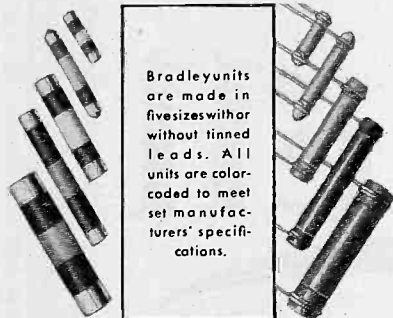

Bradleyunits are made in five sizes with or without tinned leads. All units are color-coded to meet set manufacturers' specifications.

### BRADLEYUNIT RESISTORS FOR ALL APPLICATIONS

Bradleyunits are solid molded resistors unaffected by temperature, moisture or age. Their accurate calibration, great mechanical strength and permanence make them ideal for providing correct C-bias, plate voltage, screen grid voltage and for use as gridleaks and as fixed resistors in resistance coupled circuits.

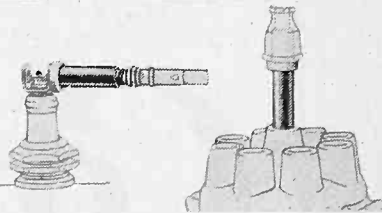

### BRADLEY SUPPRESSORS FOR RADIO-EQUIPPED CARS

These special solid molded resistors are now used by prominent car manufacturers to provide individual resistors for each spark plug and for the common cable to the distributor on radio-equipped cars. They increase the resistance of the high tension ignition system and minimize the disturbing oscillations in the ignition circuit which interfere with the radio receiver in the car. When used with suitable by-pass condensers in other parts of the circuit, shielded ignition cables are unnecessary. They do not affect the operation of the motor.

For complete information on Allen-Bradley Resistors address

ALLEN-BRADLEY CO.  
282 Greenfield Avenue Milwaukee, Wisconsin

# ALLEN-BRADLEY RESISTORS

Produced by the makers of Allen-Bradley Control Apparatus

When writing to advertisers mention of the PROCEEDINGS will be mutually helpful.

Cornell

Cornell

# NEW DeLUXE «CUB» CONDENSER

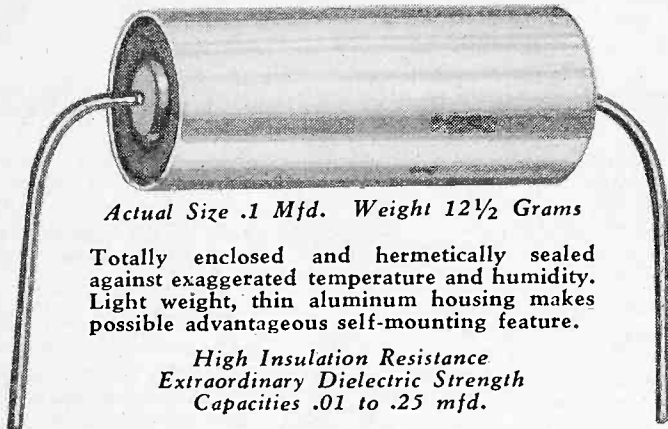

*Actual Size .1 Mfd. Weight 12½ Grams*

Totally enclosed and hermetically sealed against exaggerated temperature and humidity. Light weight, thin aluminum housing makes possible advantageous self-mounting feature.

*High Insulation Resistance  
Extraordinary Dielectric Strength  
Capacities .01 to .25 mfd.*

These new DeLuxe «Cub» condensers are compact, light in weight and of attractive appearance. They cut labor operations and cost from 20% to 50% less. *Write for sample.*

# Cornell

FILTER CONDENSERS  
BY-PASS CONDENSERS  
RADIO INTERFERENCE FILTERS  
POWER FACTOR CORRECTION BANKS  
UNIFORMLY HIGH INSULATION RESISTANCE  
PAPER DIELECTRIC CONDENSERS (All Types)

*Write for Sample DeLuxe «Cub» Condenser and Catalog of Complete Line of Cornell Products.*

## Cornell Electric Mfg. Co., Inc.

LONG ISLAND CITY, NEW YORK

Cornell

Cornell

*When writing to advertisers mention of the PROCEEDINGS will be mutually helpful.*



# THERMO COUPLES *in* VACUUM

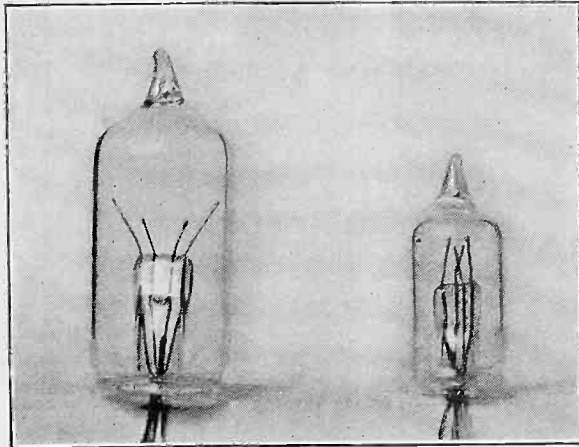

Illustrations full size

### *Points of Superiority*

- 1—Small Physical Size
- 2—No Reversal on Direct Current
- 3—Calibration Remains Constant

*and finally*

- 4—Prompt Deliveries

Ratings—5 to 500 Milliamperes  
Write for Bulletin 3130

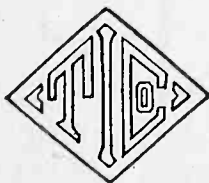

## THERMAL INSTRUMENT CO.

38 Woods Avenue

Somerville, Mass.

*When writing to advertisers mention of the PROCEEDINGS will be mutually helpful.*

# Continental Resistors

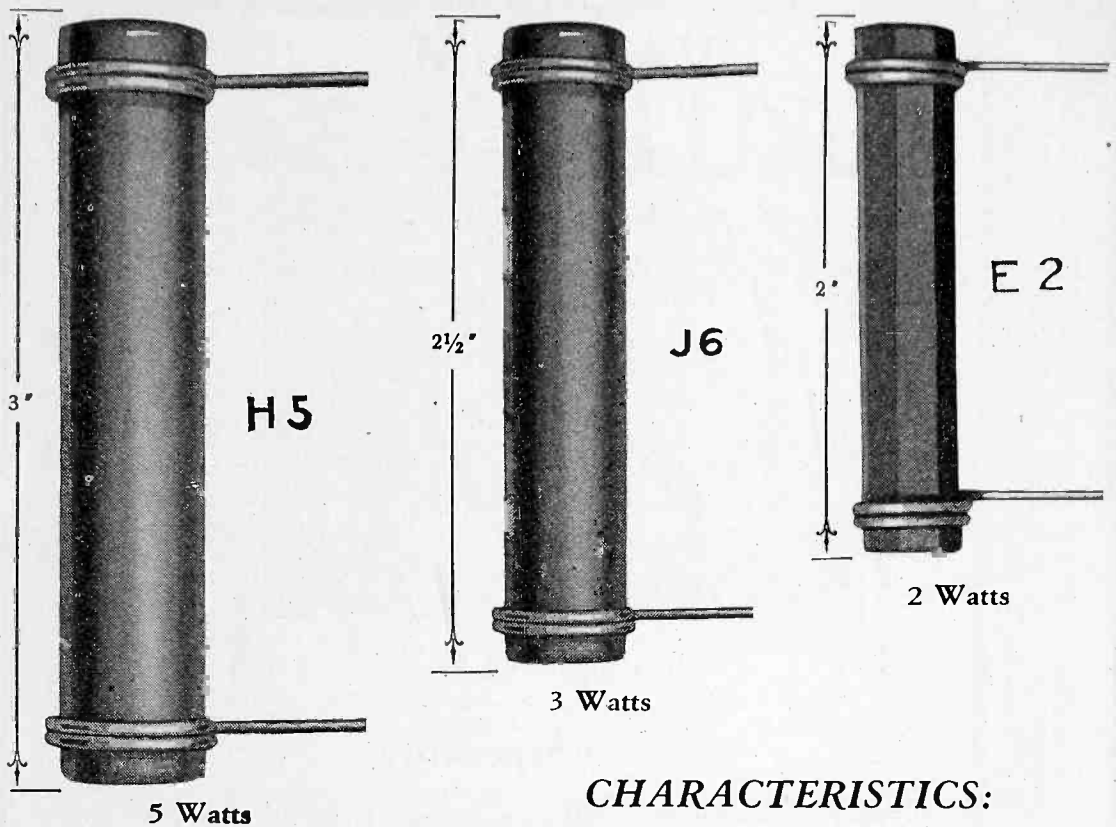

## CHARACTERISTICS:

NOISELESS  
RESISTANCE CONSTANT  
SMALL TEMPERATURE COEFFICIENT  
RUGGED  
FIRMLY SOLDERED TERMINALS  
DEPENDABLE  
COLOR CODED

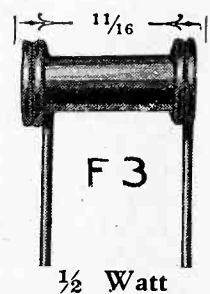
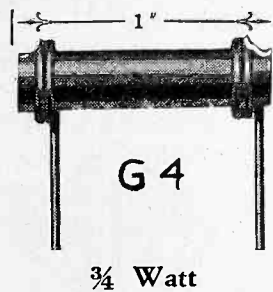
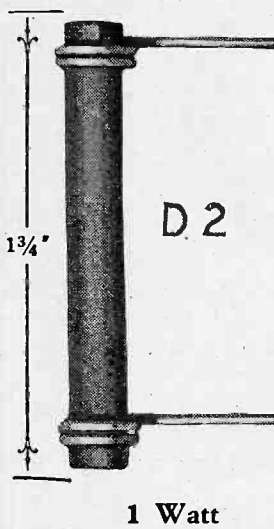

*Write for Information and Prices*

**CONTINENTAL CARBON INC.**  
WEST PARK, CLEVELAND, OHIO

*When writing to advertisers mention of the PROCEEDINGS will be mutually helpful.*

# Take Your Choice

Every member of the Institute of Radio Engineers will want to wear one of these three attractive emblems. All of these emblems are appropriately colored to indicate the various grades of membership and each emblem is approximately the size of the following illustrations.



The **Lapel Button** is of 14k gold, with background enameled in the membership color, and with the lettering in gold. The screw-back on the back of this button fastens it securely to your coat.

\$2.75 postpaid—any grade.



The **Pin** is also of 14k gold. It is provided with a safety catch and is appropriately colored for the various grades of membership.

\$3.00 postpaid—any grade.



The **Watch Charm**, handsomely finished on both sides, is also of 14k gold. This charm is equipped with a suspension ring for attaching to a watch fob or chain.

\$5.00 postpaid—any grade.

*Orders, accompanied by checks made payable to the Institute of Radio Engineers, should be addressed to*

**THE INSTITUTE OF RADIO ENGINEERS**

33 West 39th Street

NEW YORK CITY, N. Y.

*Send in your order now!*

*When writing to advertisers mention of the PROCEEDINGS will be mutually helpful.*

# ENGINEERS AVAILABLE

Advertisements on this page are available only to members of the Institute of Radio Engineers. For rates and further information address the Secretary, The Institute of Radio Engineers, 33 West 39th Street, New York, N.Y.

**MANUFACTURERS** and others seeking radio engineers are invited to address replies to these advertisements at the Box number indicated, care the Institute of Radio Engineers. All replies will be forwarded direct to the advertiser.

---

**SERVICE MANAGER**, having general experience in the development, testing, and inspection, on radio appliances in both field and laboratory is interested in development or servicing of radio equipment or sound reproducing systems. Has had three years' experience in managing service laboratory, three years' experience on carrier current and other communication problems of power company, and two years in charge of general development laboratory of Westinghouse. Two years' college training. Age 39. Box 30.

---

**RADIO ENGINEER, E.E. and M.E.**, three years with concern of the highest standing in radio research work. Considerable experience in the design of screen grid receivers and precision laboratory equipment for r.f. measurements. Wishes larger responsibilities. Box 31.

---

**RADIO ENGINEER**, course in applied electricity at Pratt Institute (1917) and at Sorbonne University, Paris, desires position in communication engineering or office administration in similar field where experience is most useful. Assistant Supervisor of Radio, for nine years, first in charge

of examinations and issuance of licenses, and later engineering and legal administrative work for Department of Commerce. Field engineer for radio communication concern locating sites for commercial receiving stations, and working on design of transmitting equipment, 1929-30. Instructor in radio course for two and a half years. Age 35. Member, I.R.E. Box 32.

---

**RADIO OPERATOR**, having five years' varied experience in commercial and broadcast radio operation, desires position with some reliable broadcasting station. Has held amateur license since 1921, and commercial license since 1924. Experience with General Electric and Western Electric broadcast transmitters with power up to 50 kw. Age 30. Box 33.

---

**MAN** with four years' technical training, 1927-29 with radio manufacturer in service engineering, test foreman, sub-foreman test equipment laboratory; May 1929—December 1929, in charge of design and construction of all test equipment for large receiving set manufacturer; desires position in research, laboratory or test equipment work. Box 4.

*When writing to advertisers mention of the PROCEEDINGS will be mutually helpful.*

# CONDENSERS OF DEPENDABILITY

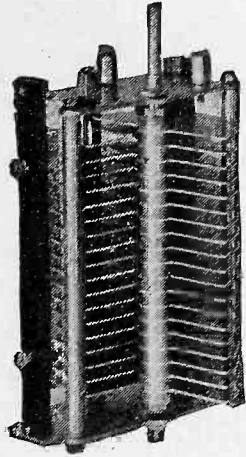

Construction solid and sturdy—design scientifically correct—fit for any service a variable condenser may be expected to withstand and proved worthy by rigorous tests, under all conditions, literally, from Pole to Pole.

*Made for transmitting and receiving—fixed and variable.*

*Literature will be sent on request.*

## CARDWELL CONDENSERS

THE ALLEN D. CARDWELL  
MFG. CORPN.  
81 PROSPECT ST.      BROOKLYN, N.Y.

*Since Broadcasting Began*  
“THE STANDARD OF COMPARISON”

*When writing to advertisers mention of the PROCEEDINGS will be mutually helpful.*

Standard Types  
**MERSHON**  
 ELECTROLYTIC  
 Filter Condenser



Single Anode  
 Inverted



Single Anode  
 Upright



Multiple Anode  
 Upright

# THIS COMPLETE TREATISE

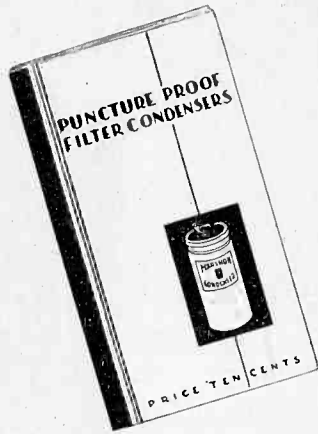

## ON THE ELECTROLYTIC FILTER CONDENSER

Perhaps the first ever published, contains live up-to-date information that should be in the file of every active radio engineer.

In successive chapters it deals with the various condenser problems and their solutions. Voltage surge effects, condenser life limits, moisture, safety-valve action, cost and size, are carefully and completely analyzed.

It is replete with diagrams and photographs illustrating the important points, and contains a complete description of the latest developments of Mershon Electrolytic Condensers, showing in detail their construction and characteristics.

You will find it profitably interesting reading. Write, today, for a complimentary copy.

**THE AMRAD CORPORATION**  
 315 COLLEGE AVENUE  
 MEDFORD HILLSIDE, MASS.

*(Sole Manufacturers of the Mershon Condenser)*

*When writing to advertisers mention of the PROCEEDINGS will be mutually helpful.*

# TWO WAY RADIO LINK NEVER INTERRUPTED!!!

## CAPT. YANCEY'S RADIO MAKES NEW RECORDS—

*Here's the story behind these headlines.*

The Yancey plane (ESCO equipped) in its non-stop flight to Bermuda, maintained direct two way communication with New York. Darkness forced the plane down a little short of its goal. The plane, floating on the sea, remained in communication with New York.

Later, on its "Good Will" flight to South America, the Yancey plane, on the ground at the Canal Zone maintained two way communication with New York. Zeh Bouck, radio operator, said—"I believe this is without doubt a record for airplane transmission, and it shows very clearly what we could have done had we been forced down in some of the jungle over which we have flown during the last few weeks."

On July 1st this last record was broken. The Yancey plane, on the ground at Buenos Aires, communicated uninterruptedly for more than an hour with the New York Times station 5,838 miles away.

The Yancey plane was equipped with an "ESCO" wind driven generator to supply radio power while flying, and with a battery operated "ESCO" dynamotor for ground work.



*Type NA Aircraft Generator*

Low wind resistance, light weight, non-corroding parts, ball bearings, tool steel shafts, steel shells, cast steel pole pieces, weather proof construction, many sizes to choose from, high voltage and low voltage windings to suit individual requirements, are a few of the many reasons for "ESCO" generators or dynamotors being the first choice.

"ESCO" has a very complete line of wind driven generators, and dynamotors for airplane service. Let "ESCO" Engineers help you with your power supply for communications.

**ELECTRIC**  **SPECIALTY**  
**COMPANY**

300 SOUTH ST., STAMFORD, CONN.

*Manufacturers of motors, generators, dynamotors and rotary converters.*

*When writing to advertisers mention of the PROCEEDINGS will be mutually helpful.*

# ENGINEERS AVAILABLE

Advertisements on this page are available only to members of the Institute of Radio Engineers. For rates and further information address the Secretary, The Institute of Radio Engineers, 33 West 39th Street, New York, N.Y.

**MANUFACTURERS** and others seeking radio engineers are invited to address replies to these advertisements at the Box number indicated, care the Institute of Radio Engineers. All replies will be forwarded direct to the advertiser.

---

**SERVICE MANAGER**, having general experience in the development, testing, and inspection, on radio appliances in both field and laboratory is interested in development or servicing of radio equipment or sound reproducing systems. Has had three years' experience in managing service laboratory, three years' experience on carrier current and other communication problems of power company, and two years in charge of general development laboratory of Westinghouse. Two years' college training. Age 39. Box 30.

---

**RADIO ENGINEER, E.E. and M.E.**, three years with concern of the highest standing in radio research work. Considerable experience in the design of screen grid receivers and precision laboratory equipment for r.f. measurements. Wishes larger responsibilities. Box 31.

---

**RADIO ENGINEER**, course in applied electricity at Pratt Institute (1917) and at Sorbonne University, Paris, desires position in communication engineering or office administration in similar field where experience is most useful. Assistant Supervisor of Radio, for nine years, first in charge

of examinations and issuance of licenses, and later engineering and legal administrative work for Department of Commerce. Field engineer for radio communication concern locating sites for commercial receiving stations, and working on design of transmitting equipment, 1929-30. Instructor in radio course for two and a half years. Age 35. Member, I.R.E. Box 32.

---

**RADIO OPERATOR**, having five years' varied experience in commercial and broadcast radio operation, desires position with some reliable broadcasting station. Has held amateur license since 1921, and commercial license since 1924. Experience with General Electric and Western Electric broadcast transmitters with power up to 50 kw. Age 30. Box 33.

---

**MAN** with four years' technical training, 1927-29 with radio manufacturer in service engineering, test foreman, sub-foreman test equipment laboratory; May 1929—December 1929, in charge of design and construction of all test equipment for large receiving set manufacturer; desires position in research, laboratory or test equipment work. Box 4.

*When writing to advertisers mention of the PROCEEDINGS will be mutually helpful.*



# CONDENSERS OF DEPENDABILITY

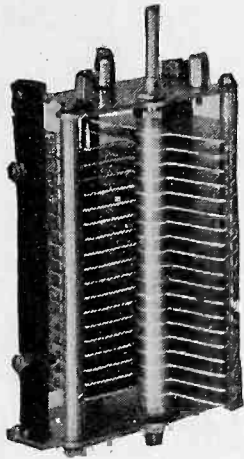

Construction solid and sturdy—design scientifically correct—fit for any service a variable condenser may be expected to withstand and proved worthy by rigorous tests, under all conditions, literally, from Pole to Pole.

*Made for transmitting and receiving—fixed and variable.*

*Literature will be sent on request.*

## CARDWELL CONDENSERS

THE ALLEN D. CARDWELL  
MFG. CORPN.

81 PROSPECT ST.      BROOKLYN, N.Y.

*Since Broadcasting Began*

**“THE STANDARD OF COMPARISON”**

*When writing to advertisers mention of the PROCEEDINGS will be mutually helpful.*

Standard Types  
**MERSHON**  
 ELECTROLYTIC  
 Filter Condenser



Single Anode  
 Inverted



Single Anode  
 Upright



Multiple Anode  
 Upright

# THIS COMPLETE TREATISE



## ON THE ELECTROLYTIC FILTER CONDENSER

Perhaps the first ever published, contains live up-to-date information that should be in the file of every active radio engineer.

In successive chapters it deals with the various condenser problems and their solutions. Voltage surge effects, condenser life limits, moisture, safety-valve action, cost and size, are carefully and completely analyzed.

It is replete with diagrams and photographs illustrating the important points, and contains a complete description of the latest developments of Mershon Electrolytic Condensers, showing in detail their construction and characteristics.

You will find it profitably interesting reading. Write, today, for a complimentary copy.

**THE AMRAD CORPORATION**  
 315 COLLEGE AVENUE  
 MEDFORD HILLSIDE, MASS.

*(Sole Manufacturers of the Mershon Condenser)*

*When writing to advertisers mention of the PROCEEDINGS will be mutually helpful.*

# TWO WAY RADIO LINK NEVER INTERRUPTED!!!

## CAPT. YANCEY'S RADIO MAKES NEW RECORDS—

*Here's the story behind these headlines.*

The Yancey plane (ESCO equipped) in its non-stop flight to Bermuda, maintained direct two way communication with New York. Darkness forced the plane down a little short of its goal. The plane, floating on the sea, remained in communication with New York.

Later, on its "Good Will" flight to South America, the Yancey plane, on the ground at the Canal Zone maintained two way communication with New York. Zeh Bouck, radio operator, said—"I believe this is without doubt a record for airplane transmission, and it shows very clearly what we could have done had we been forced down in some of the jungle over which we have flown during the last few weeks."

On July 1st this last record was broken. The Yancey plane, on the ground at Buenos Aires, communicated uninterruptedly for more than an hour with the New York Times station 5,838 miles away.

The Yancey plane was equipped with an "ESCO" wind driven generator to supply radio power while flying, and with a battery operated "ESCO" dynamotor for ground work.



*Type NA Aircraft Generator*

Low wind resistance, light weight, non-corroding parts, ball bearings, tool steel shafts, steel shells, cast steel pole pieces, weather proof construction, many sizes to choose from, high voltage and low voltage windings to suit individual requirements, are a few of the many reasons for "ESCO" generators or dynamotors being the first choice.

"ESCO" has a very complete line of wind driven generators, and dynamotors for airplane service. Let "ESCO" Engineers help you with your power supply for communications.

**ELECTRIC**  **SPECIALTY**  
**COMPANY**

300 SOUTH ST., STAMFORD, CONN.

*Manufacturers of motors, generators, dynamotors and rotary converters.*

*When writing to advertisers mention of the PROCEEDINGS will be mutually helpful.*

---

---

# Refractory, Wire and Enamel

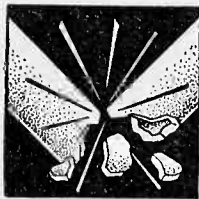

Each W. L. refractory is tested for minimum strength. You benefit.

**M**OST engineers in the Electrical Industry know how we manufacture our resistors\*, and buy them.

Yet more is purchased than refractory, wire, and enamel when VITROHM RESISTORS are specified. Added to the physical components and processes—each the finest possible—is the intangible leaven of experience gained during the past 39 years through the zeal of men determined to make the best. This is protection when you SPECIFY VITROHM RESISTORS.

\*Vitrohm Resistors are made by winding resistance wire of low temperature coefficient of resistivity upon a refractory tube. The resistance wire and terminal connections are then entirely surrounded by and completely protected with a fused-on coating of vitreous enamel.

## WARD LEONARD ELECTRIC CO.

Mount Vernon, New York

*resistor specialists for more than 39 years*

---

---

*When writing to advertisers mention of the PROCEEDINGS will be mutually helpful.*

# FANSTEEL

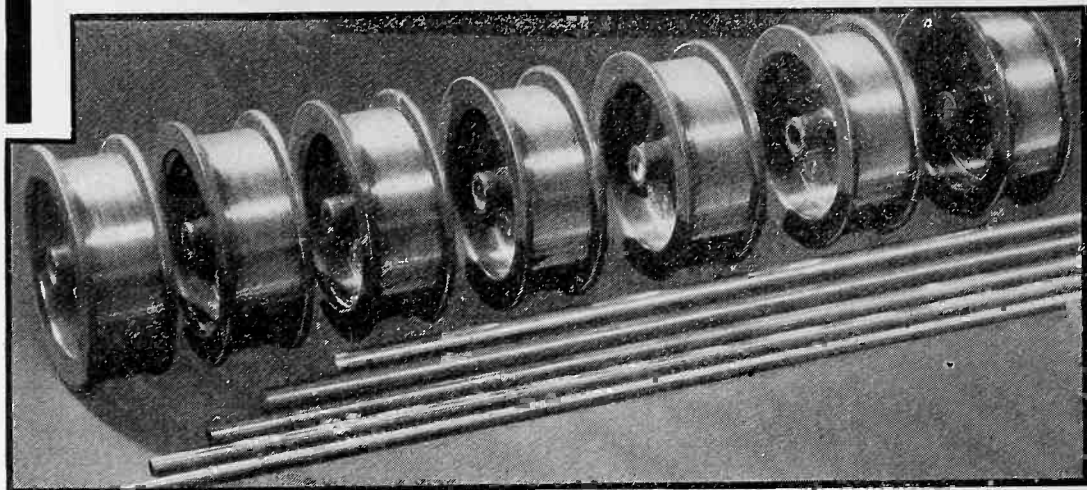

## BEST SOURCE OF SUPPLY FOR RADIO WIRE AND METALS

Since 1918, even before the beginning of radio as we know it today, the tube industry has looked to Fansteel for high quality metals and alloys, refined especially for vacuum tube parts.

**MOLYBDENUM (99.95% PURE)**—An exceptionally high grade product, refined by exclusive Fansteel process which assures unusual purity and uniformity.

**DUCTILE MOLYBDENUM ROD**—Workable up to 5/16" diameter; a new product now being made by special Fansteel process. Much used by producers of large power tubes.

**MOLY "B" AND MOLY "X"**—Two carefully compounded hardened Molybdenum alloys, excellent for heaters, springs, hooks, and support members, each alloy possessed of special characteristics that make it best for certain purposes.

**TANTALUM (99.9+% PURE)**—A superior metal of extremely low vapor pressure, great gas absorbing properties and ability to withstand high temperatures. Ideal for plates and grids.

**"TAW" METAL**—A Tantalum alloy of exceptional elasticity—excellent for springs, hooks and tension members. Does not anneal at temperatures ordinarily reached in vacuum tubes.

**CAESIUM and RUBIDIUM**—Pure metals and salts for photo cells.

All Fansteel metals are made in the Fansteel plant, under strict laboratory control. Supplied in all standard commercial forms.

*Write for full information and prices.*

## FANSTEEL PRODUCTS COMPANY, INC.

North Chicago, Illinois

*When writing to advertisers mention of the PROCEEDINGS will be mutually helpful.*

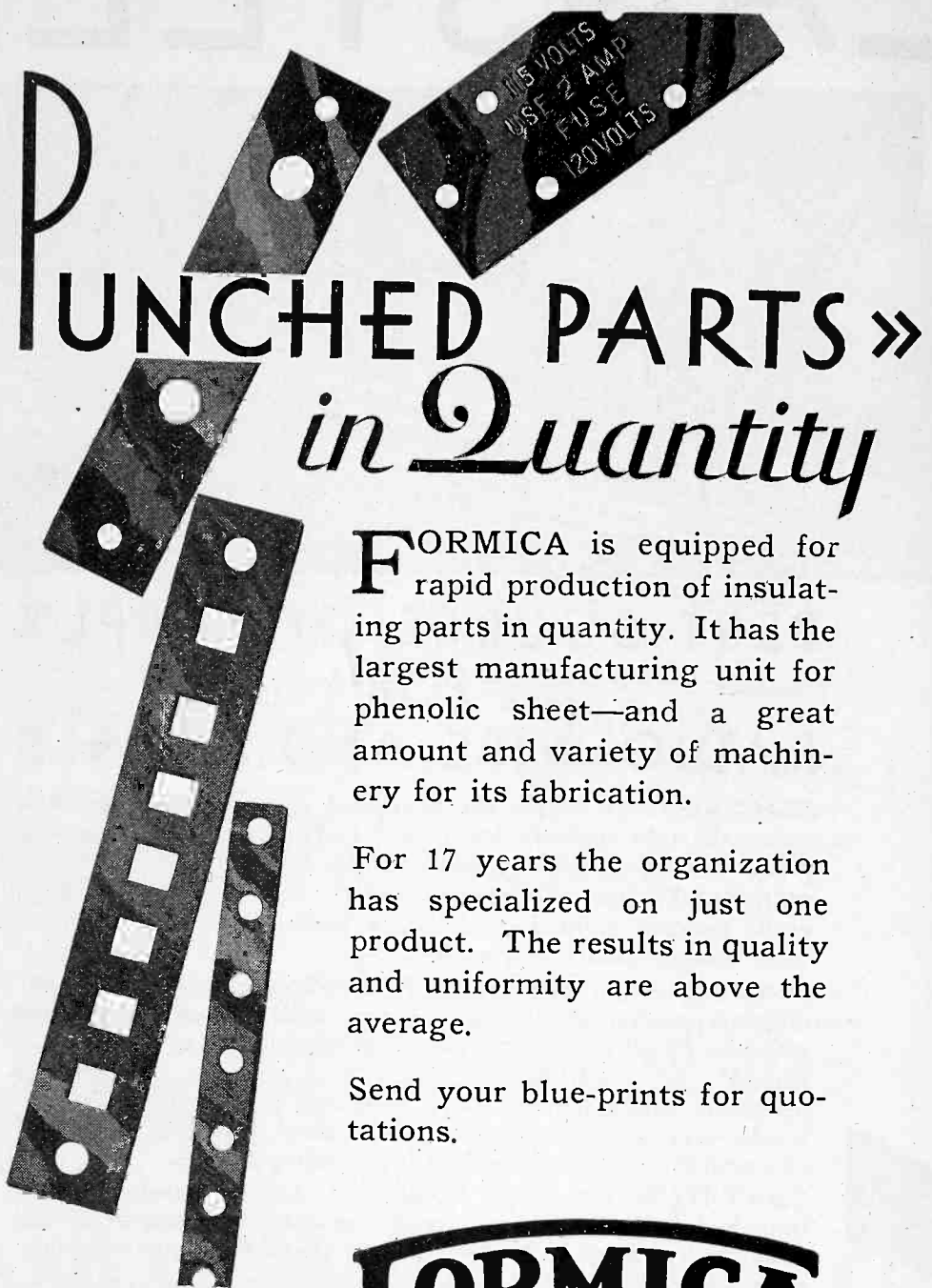

**F**ORMICA is equipped for rapid production of insulating parts in quantity. It has the largest manufacturing unit for phenolic sheet—and a great amount and variety of machinery for its fabrication.

For 17 years the organization has specialized on just one product. The results in quality and uniformity are above the average.

Send your blue-prints for quotations.

**FORMICA**  
Made from Anhydrous Bakelite Resins  
**SHEETS TUBES RODS**

THE FORMICA INSULATION COMPANY

4626 Spring Grove Avenue  
Cincinnati, Ohio.

---

*When writing to advertisers mention of the PROCEEDINGS will be mutually helpful.*

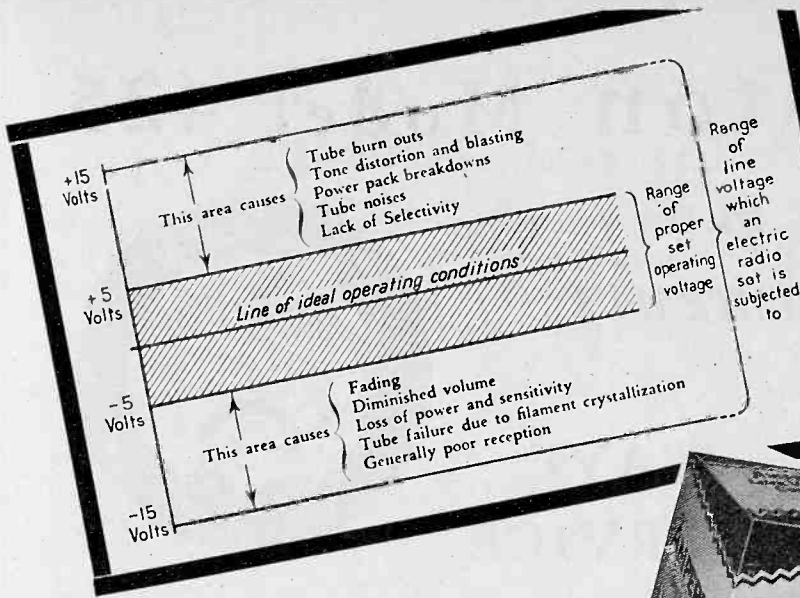

**INSURES**  
Perfect Operation  
of A.C.  
Receivers, Re-  
gardless of Line  
Voltage Varia-  
tions

# SOLVES Radio's Most Annoying Problem



**T**HE AMPERITE Self-Adjusting Line Voltage Control automatically irons out line voltage fluctuations (between 95 and 135 watts) so that modern A.C. Receivers operate uniformly and consistently with laboratory quality.

There is no other practical means of controlling fluctuating line voltages with as perfect accuracy, simplicity and low-wattage as with AMPERITE.

The slightest line variation, up or down, is instantly checked by AMPERITE—thus maintaining steady volume, preventing damage to tubes and filter equipment, and greatly reducing servicing costs.

There's an AMPERITE for every receiver voltage requirement.

The circuit connection is shown in the diagram.

The type AMPERITE used depends on the current drain of the set.

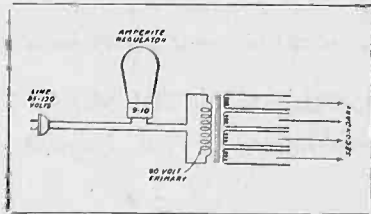

Does Not  
Add to Chas-  
sis Cost

**AMPERITE Corporation**  
561 BROADWAY, NEW YORK  
**AMPERITE**  
Self-Adjusting  
LINE VOLTAGE CONTROL

**MAIL COUPON FOR TECHNICAL DATA**

AMPERITE CORPORATION, Dept. PE8,  
561 Broadway, New York.  
Please send technical data on the AMPERITE  
Self-Adjusting Line Voltage Control.

Name .....  
Manufacturer .....  
City .....  
State .....

When writing to advertisers mention of the PROCEEDINGS will be mutually helpful.

# Weston Model 425

*Thermo  
instruments  
for*

**SHORT WAVE  
RADIO SERVICE**

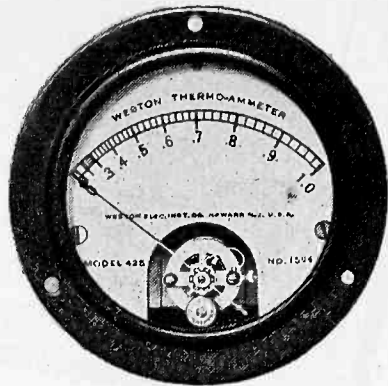

**T**HE public is as yet little aware of the functions of short wave radio which occur in that mystic band below 200 meters where the middle man of distribution—the broadcasting station—is seldom required. But science and engineering know and appreciate its multitudinous services.

In aviation—for weather reports and beacon signals; in the marine—for land and sea communication; in railways—for long freight hauls in government service—for coast guard boats, tugs and tenders; for police alarms and for all manner of civil and commercial uses where quick and unlimited conversational contact is essential, two-way short wave communication is now in universal vogue.

For the operation of short wave transmitters it is necessary to employ a radio frequency ammeter to accurately gauge the amount of energy imparted to the antenna. In industry, also where radio frequency currents are used, such as in bombarding of tubes, and induction furnaces, the same type of instrument is required. It is used in telephony, in television, by manufacturers of a variety of radio apparatus such as crystal control equipment and, of course, by amateur transmitters the world over.

For all these services the preferred testing equipment consists of the Weston Model 425 thermo instruments made as ammeters, milliammeters and galvanometers, together with accompanying voltmeters—Model 301 for D.C., and Model 476 for A.C. service. All instruments are matched in size and appearance— $3\frac{1}{4}$  inch diameter—for flush panel mounting.

*For complete descriptions and prices write for Circular JJ.*

**WESTON ELECTRICAL INSTRUMENT CORPORATION**

589 Frelinghuysen Ave., Newark, N. J.



*When writing to advertisers mention of the PROCEEDINGS will be mutually helpful.*



# CHANGE IN MAILING ADDRESS OR BUSINESS TITLE

Members of the Institute are asked to use this form for notifying the Institute office of a change in their mailing address or any change in the listing of their company affiliation or title for the Year Book membership list.

The Secretary,  
THE INSTITUTE OF RADIO ENGINEERS,  
33 West 39th Street,  
New York, N.Y.

Dear Sir:

Effective ..... please note change in my address  
(date)  
for mail as follows:

FROM

.....  
(Name)

.....  
(Street Address)

.....  
(City and State)

TO NEW ADDRESS

.....  
(Street Address)

.....  
(City and State)

Also for the membership list for next year's Year Book note change in my business address (or title) as follows, this <sup>is</sup> my mailing address: <sub>is not</sub>

.....  
(Title)

.....  
(Company Name)

.....  
(Address: Street, City and State)

PLEASE FILL IN, DETACH, AND POST TO THE  
INSTITUTE PROMPTLY

# Back Numbers of the Proceedings, Indexes, and Year Books Available

**M**EMBERS of the Institute will find that back issues of the Proceedings are becoming increasingly valuable, and scarce. For the benefit of those desiring to complete their file of back numbers there is printed below a list of all complete volumes (bound and unbound) and miscellaneous copies on hand for sale by the Institute.

The contents of each issue can be found in the 1914-1926 Index and in the 1929 Year Book (for the years 1927-28).

#### BOUND VOLUMES:

Vols. 10 and 14 (1922-1926), \$8.75 per volume to members  
Vol. 17 (1929), \$9.50 to members

#### UNBOUND VOLUMES:

Vols. 6, 8, 9, 10, 11 and 14 (1918-1920-1921-1922-1923-1926), \$6.75 per volume (year) to members

#### MISCELLANEOUS COPIES:

Vol. 1 (1913) July and December  
Vol. 2 (1914) June  
Vol. 3 (1915) December  
Vol. 4 (1916) June and August  
Vol. 5 (1917) April, June, August, October and December  
Vol. 7 (1919) February, April and December  
Vol. 12 (1924) August, October and December  
Vol. 13 (1925) April, June, August, October and December  
Vol. 15 (1927) April, May, June, July, August, October, November and December  
Vol. 17 (1929) April, May, June, July, August, September, November and December

These single copies are priced at \$1.13 each to members to the January 1927 issue. Subsequent to that number the price is \$0.75 each. Prior to January 1927 the Proceedings was published bimonthly, beginning with the February issue and ending with December. Since January 1927 it has been published monthly.

**M**EMBERS will also find that our index and Year Book supplies are becoming limited. The following are now available:

### FOURTEEN YEAR INDEX

The Proceedings Index for the years 1909-1926 inclusive is available to members at \$1.00 per copy. This index is extensively cross indexed.

### YEAR BOOK

The 1929 and 1930 Year Books are available to members at \$1.00 per copy. The 1929 Year Book includes the report of the 1928 committee on Standardization and the 1930 Year Book includes Standardization information pertaining to allied communication arts.

Make remittances payable to the Institute of Radio Engineers and send orders to:

## THE INSTITUTE OF RADIO ENGINEERS

33 West 39th Street  
NEW YORK CITY, N. Y.

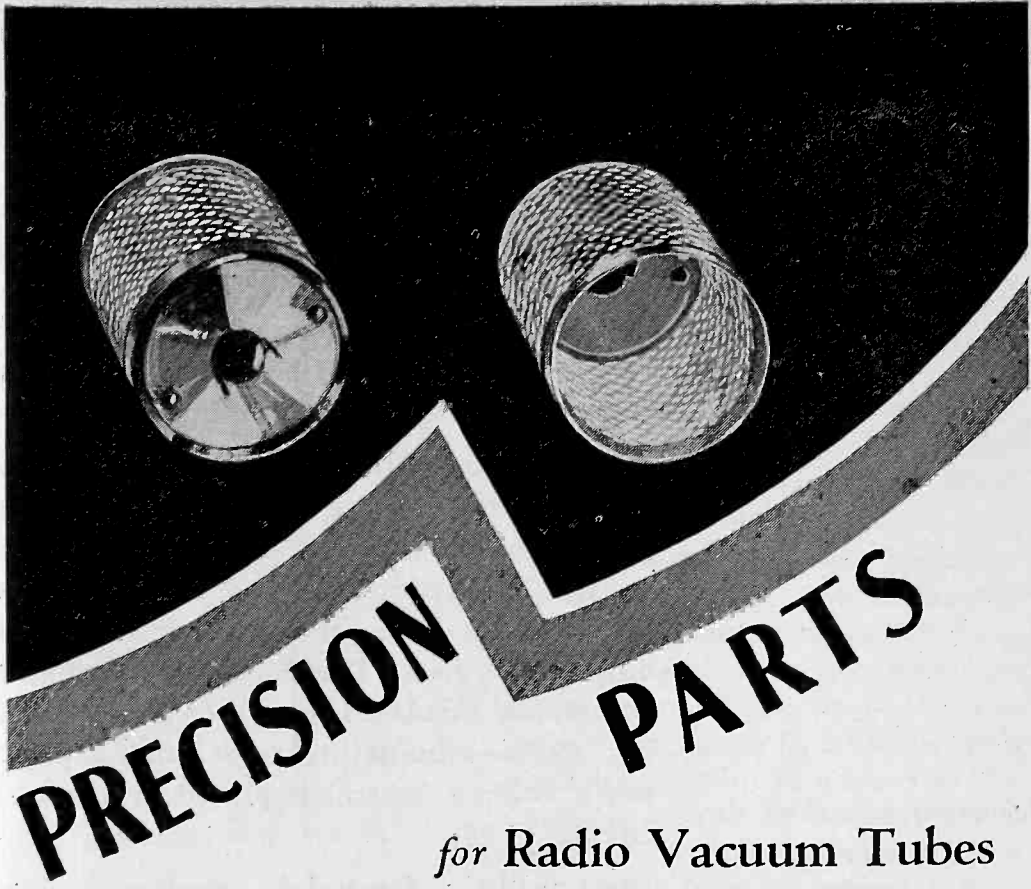

# PRECISION PARTS

## *for Radio Vacuum Tubes*

(Above) Screen grid (224) Assemblies. Sold complete ready for mounting. Supplied in varied weaves and widths of mesh. Accurately made.

(Below) Screen Grid (224) Plates. Uniform in all dimensions.

Write for Portfolio of Blue Prints of Precision Tube Parts.



A PRODUCT OF  
**SIGMUND COHN**

44 Gold Street  
New York

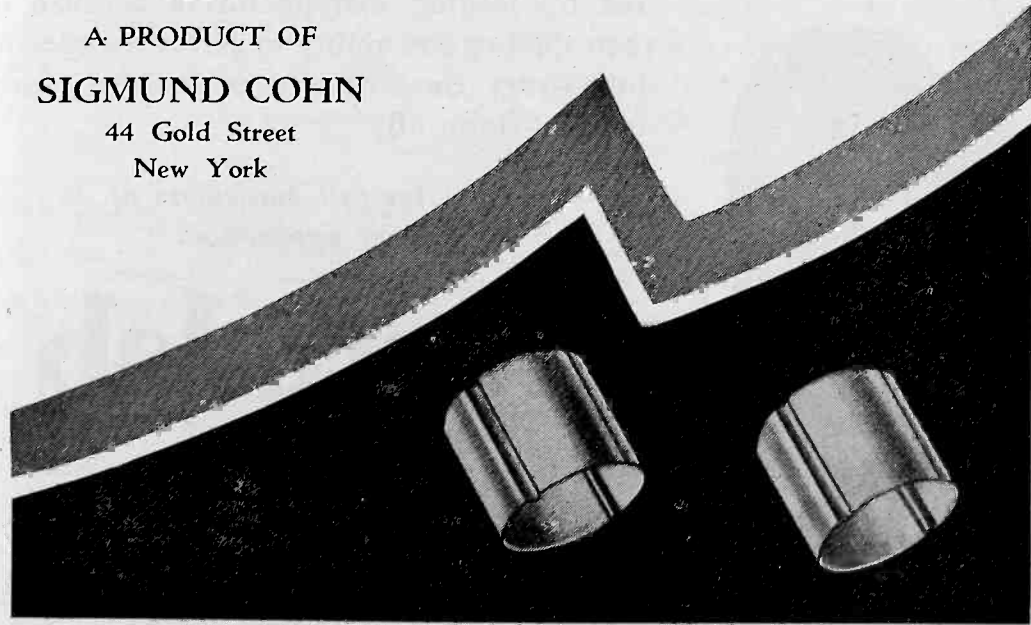

*When writing to advertisers mention of the PROCEEDINGS will be mutually helpful.*

---

# Volume Controls

**T**O vary the intensity of the faithful reproduction built into radio receivers without introducing noise or distortion, can only be accomplished by a careful and complete consideration of both mechanical and electrical features of the volume control.

**Mechanically**—The Centralab exclusive and patented rocking disc contact precludes any possibility of wear on the resistance material. This feature adds to the smoothness of operation since the contact shoes ride only on the disc. The shaft and bushing are completely insulated from the current carrying parts—eliminating any hand capacity when volume control is placed in a critical circuit.

**Electrically** — Centralab engineers have evolved tapers of resistance that produce a smooth and gradual variation of volume. These tapers have been thoroughly tried and tested for each specific application for current carrying capacity and power dissipation.

Centralab volume controls have been specified by leading manufacturers because of their quality and ability to perform a specific duty—vary the intensity of faithful reproduction—faithfully.

*Manufactured in three sizes*

*Standard*

*Junior*

*Midget*

*Also Double Standard  
and Double Junior*

*Special Combination  
Wire Wound and  
Graphite Control*

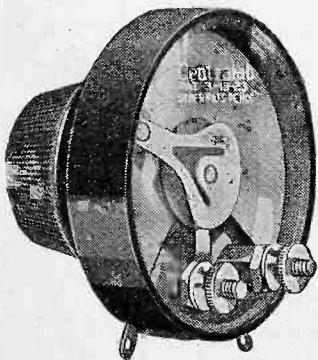

*Write for full particulars of  
specific application.*

**Centralab**  
CENTRAL RADIO  LABORATORIES

36 Keefe Ave.

Milwaukee, Wis.

**A CENTRALAB VOLUME CONTROL IMPROVES THE RADIO SET**

---

*When writing to advertisers mention of the PROCEEDINGS will be mutually helpful.*

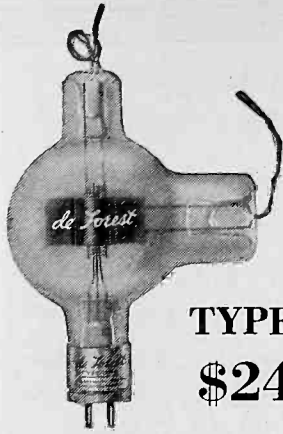

**TYPE 552**  
**\$24.25**

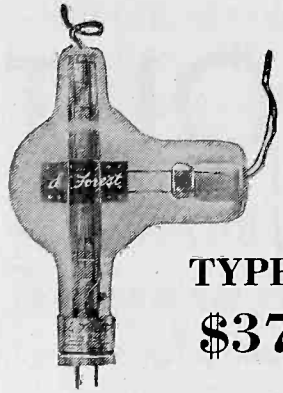

**TYPE 560**  
**\$37.50**

**These are net prices on  
de Forest Transmitting Tubes**

510	—15 Watt Oscillator.....	\$ 9.00
503-A	—50 Watt Oscillator and R. F. Power Amplifier.....	30.00
511	—50 Watt Oscillator, A. F. Ampli- fier, Modulator or R. F. Power Amplifier.....	30.00
545	—50 Watt A. F. Amplifier and Modulator.....	33.75
552	—75 Watt Oscillator and R. F. Amplifier.....	24.25
504-A	—250 Watt Oscillator, Modulator or R. F. Power Amplifier.....	105.00
504	—A Heavy duty 250 watt oscillator or R. F. Power Amplifier, tungsten filament.....	105.00
500	—500 Watt Special Oscillator.....	97.50
520-B	—5000 Watt Oscillator, R. F. Ampli- fier and modulator water cooled.....	187.50
565	—7½ Watt Screen Grid R. F. Amplifier.....	16.50
560	—75 Watt Screen Grid R. F. Amplifier.....	37.50
561	—500 Watt Screen Grid R. F. Amplifier.....	292.50
566	—Half wave hot cathode, mercury vapor rectifier.....	9.00
572	—Half wave hot cathode, mercury vapor rectifier.....	22.50

## Two 75 watters designed primarily for operation on 3 to 30 megacycles

These two de Forest 75 watters may be used as oscillators and radio frequency power amplifiers. They are particularly suited for stable r. f. amplification at either low or high frequencies.

In operating on very high frequencies leakage due to insufficient or improper insulation, and inter-electrode capacity are factors that unless properly controlled will result in failures when operating within this band of frequencies—3 to 30 megacycles—especially on the upper band. In these de Forest transmitting Audions the construction reduces inter-electrode capacity to a minimum, and the high quality and scientific placement of the insulation reduces high frequency current leakage to the lowest possible point.

In the Type 560 75-watter, the extremely low control grid to plate capacity, which is inherent, makes neutralizing unnecessary—this is taken care of by the internal shielding.

*For further information consult  
your local dealer or address*

**DE FOREST RADIO COMPANY**  
**PASSAIC, N. J.**

**Export Department, 304 E. 45th Street**  
**New York City, N. Y., U. S. A.**

**de Forest**  
**(AUDIONS)**

RECEIVING  
AND  
TRANSMITTING **TUBES**

*When writing to advertisers mention of the PROCEEDINGS will be mutually helpful.*

---

---

# FACT STANDS OUT

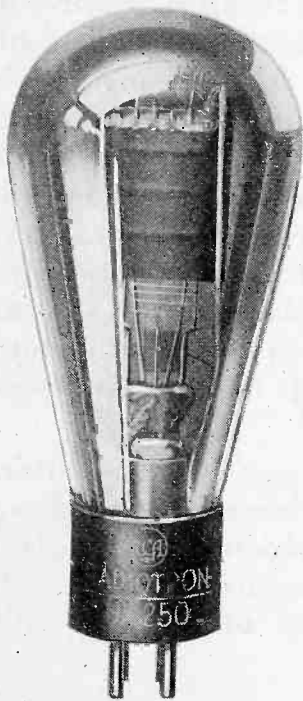

... and that is, RCA Radiotrons have been the standard in the tube industry for years. Only by making a product of unsurpassable quality did the RCA Radiotron Company attain and hold this position of leadership. Make your product the best by designing it around RCA Radiotron standards. Years of experience and careful study are behind every RCA Radiotron.

RCA RADIOTRON COMPANY, Inc., HARRISON, N. J.

## RCA Radiotrons

« « The Heart of Your Radio Set » »

---

---

*When writing to advertisers mention of the PROCEEDINGS will be mutually helpful.*

## PROFESSIONAL ENGINEERING DIRECTORY

For Consultants in Radio and Allied Engineering Fields

### THE MAGNAVOX COMPANY

Oakland, Calif. & Chicago, Ill.

**PIONEERS AND SPECIALISTS  
IN THE ART OF  
SOUND PRODUCTION.**

**DYNAMIC SPEAKERS SINCE  
1911.**

### ELECTRICAL TESTING LABORATORIES

Tests of Inductances.  
Condensers. Transform-  
ers etc. Life and charac-  
teristics of Radio Tubes

80th Street and East End Ave.  
• • NEW YORK, N. Y. • •

### PATENTS

WM. G. H. FINCH

Patent Attorney

(Registered U. S. & Canada)

Mem. I. R. E. Mem. A. I. E. E.

303 Fifth Ave. New York  
Caledonia 5331

Radio and Television Patents  
Bought and Sold. Applications,  
Searches, Reports.

H. R. VAN DEVENTER

Consulting Engineer and Patent  
Attorney

342 Madison Ave.,  
New York City, N. Y.

The J. G. White  
Engineering Corporation

Engineers—Constructors

Builders of New York Radio  
Central

43 Exchange Place New York

### RADIO ENGINEERS

Ten dollars will introduce you  
directly to over 8,000 technical  
men, executives, and others with  
important radio interests. For  
details write to

Advertising Dept., I.R.E.

## Radio Engineers

If you want the 8,000 most important and influential radio men  
of the day to know of your services, be sure that your card  
appears on this professional card page.

Per Issue—\$10.00

When writing to advertisers mention of the PROCEEDINGS will be mutually helpful.

# Alphabetical Index to Advertisements

## A

Aerovox Wireless Corp.....XVI  
 Allen-Bradley Co.....XXXV  
 American Tel. & Tel. Co.....XII  
 American Transformer Co.....XIII  
 Amperite Corp.....XLVII  
 Amrad Corp.....XLII  
 Arcturus Radio Tube Co.....XXIV

## C

Cardwell, Allen D., Mfg. Corp....XLI  
 Central Radio Laboratories.....LII  
 Cohn, Sigmund.....LI  
 Condenser Corp. of America....XXIX  
 Continental Carbon Inc.....XXXVIII  
 Cornell Electric Mfg. Co.....XXXVI  
 Corning Glass Works.....XVIII

## D

DeForest Radio Co.....LIII  
 Dudlo Manufacturing Co.....XX

## E

Electrad, Inc.....XIX  
 Electric Specialty Co.....XLIII  
 Engineers Available.....XL

## F

Fansteel Products Co., Inc.....XLV  
 Formica Insulation Co.....XLVI  
 Frost, H. H., Inc.....LVIII

## G

General Radio Co., Outside Back Cover  
 Gilby Wire Co.....XXV  
 Grebe, A. H., and Co., Inc.....  
 .....Inside Back Cover

## H

Hammarlund Mfg. Co.....XXVII

## I

International Resistance Co.....LX  
 I.R.E. ....XXXIII,  
 XXXIV, XXXIX, XLIX, L

## J

Jewell Electrical Instrument Co...XIV

## N

National Carbon Co.....LIX

## P

Pacent Electric Co.....XXII  
 Polymet Manufacturing Corp....XXI  
 Professional Engineering Directory  
 .....LV

## R

R.C.A. Radiotron Co., Inc.....LIV  
 Roller-Smith Co.....XV

## S

Sangamo Electric Co...XXXI, XXXII  
 Scientific Radio Service.....XVII  
 Scovill Manufacturing Co.....XXVI  
 Shakeproof Lock Washer Co....XXX  
 Sprague Specialties Co.....LVII

## T

Thermal Instrument Co.....XXXVII  
 Thermal Syndicate, Ltd.....XXIII  
 Thordarson Electric Co.....XI

## U

United Scientific Labs.....XXVIII

## W

Ward Leonard Electric Co.....XLIV  
 Weston Elec. Instrument Co...XLVIII

*When writing to advertisers mention of the PROCEEDINGS will be mutually helpful.*





# Here's the Solution of Your Condenser Troubles!

**D**ON'T worry about condenser problems. If they involve 8 MFD or more—let the Sprague electrolytic condenser take care of them. For this new, perfected condenser is the most adaptable and efficient unit you ever saw. Only  $1\frac{3}{8}$ " in diameter and only 5" height overall. Yet it rates 8 MFD capacity with peak voltage of 430 DC.

It has an exclusive, one-piece, round-edged anode without a single soldered or welded joint anywhere. The individual screw socket mounting makes it easily adaptable to use in any set.

And because of the Sprague standardized unit construction—you buy just the amount of capacity you require, without paying a premium for useless excess or for "special built" jobs.

Write for illustrated folder on the Sprague electrolytic condenser.

**SPRAGUE SPECIALTIES COMPANY**  
QUINCY, MASS.

Manufacturers also of the well-known  
SPRAGUE PAPER CONDENSER

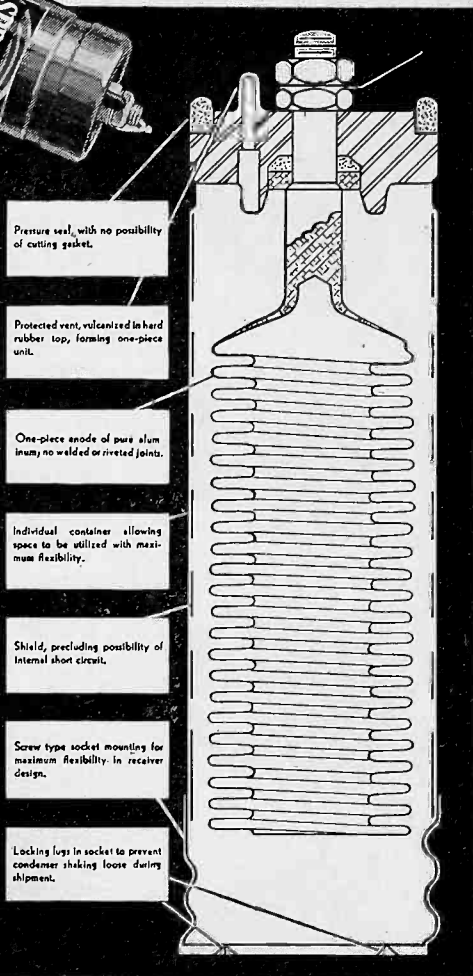

# SPRAGUE *Electrolytic* CONDENSER

*Capacity 8 MFD  
Peak Voltage 430 DC  
Can Negative*

*When writing to advertisers mention of the PROCEEDINGS will be mutually helpful.*

# FROST-RADIO

engineers have  
banished *noise* from  
wire-wound volume controls!

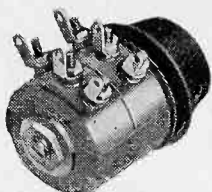

No. 590—590

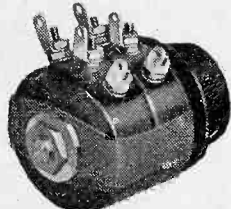

No. 2880—2880

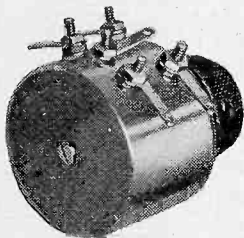

No. 890

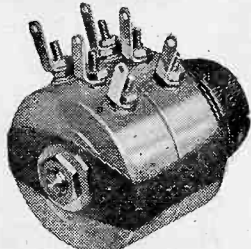

No. 280—280

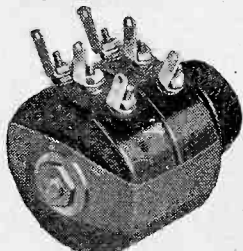

No. 1880—1880

The necessary use of wire-wound Volume Controls in high gain Radio Receivers has presented fresh problems to the manufacturer of potentiometers and rheostats. Previous standards and methods of manufacture having proved to be wholly inadequate, radically new and different materials and processes were required, and it remained for FROST-RADIO Engineers to develop these.

They have perfected an automatic device for rounding and polishing the contacting edge of the wire. This process so perfectly forms the wire edges that there is not one ten-thousandth of an inch difference in height between any adjacent wires. A velvet smooth contacting surface is thus provided.

They have proven that the new FROST-RADIO Volume Controls will withstand a fatigue test of two hundred thousand half-cycles, at a speed of thirty per minute, without evidence of wear on wire edge or contact arm, *and that they are as perfectly noiseless at the completion of test as before being subjected to fatigue.*

A complete treatise on the subject of volume controls has been prepared by our research laboratory. We will be glad to send a copy to any interested engineer.

**HERBERT H. FROST, Inc.**  
Main Offices and Factory: ELKHART, IND.  
160 North La Salle Street, Chicago

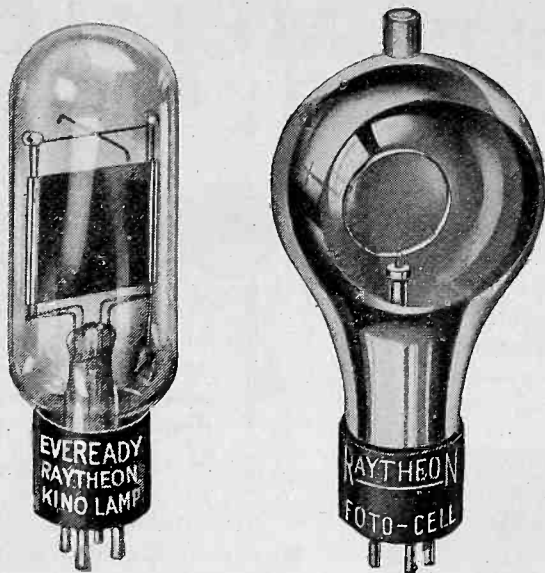

## EVEREADY RAYTHEON TUBES FOR TALKING PICTURES, TELEVISION AND ALL INDUSTRIAL PURPOSES

These tubes have a firmly established position in the fields of talking pictures, television and industrial usage.

The Eveready Raytheon Foto-Cell is a long-life transmitting tube for talking pictures and television. It is also finding new industrial uses every day, such as paper testing, color matching, automatic counting, control of illumination and many others. It comes in several standard types, or can be made to specification.

The Eveready Raytheon Kino-Lamp, for television reception, has uniform glow over the entire plate, and its reproductive qualities are perfect without the need of mirrors or ground glass.

Write, if you are interested in talking pictures, television or Foto-Cell applications of any kind. Free—Eveready Raytheon Technical Bulletin No. 1, dealing with the Kino-Lamp, and No. 2, covering the Foto-Cell.

*The Eveready Hour, radio's oldest commercial feature, is broadcast every Tuesday evening at nine (New York time) from WEAJ over a nation-wide N.B.C. network of 31 stations.*

NATIONAL CARBON CO., INC., General Offices: New York, N. Y.

Branches: Chicago Kansas City New York San Francisco

Unit of Union Carbide



and Carbon Corporation



TRADE-MARKS

*When writing to advertisers mention of the PROCEEDINGS will be mutually helpful.*

## STANDARDIZE ON METALLIZED RESISTORS

*The Resistor which is standardized upon by the nation's radio loaders.*

No skin effect but a virtually uniform resistance to either AC or DC on account of the metallized coating on a glass filament, —thoroughly seasoned and fully stabilized.

# METALLIZED RESISTORS



Metallized resistors, due to their electrical characteristics, are ideally adapted to Superhetro-dyne sets.

Metallized resistors are used by the largest radio manufacturers because of their accuracy and dependability.

Due to the precision with which they are made, the quality of all materials, Metallized resistors are accurately rated, maintain their tolerance and are noted for rugged strength and quietness.

*All types, 50 ohms to 100 meg ohms.*

VISIT OUR EXHIBIT AT THE  
TORONTO CONVENTION

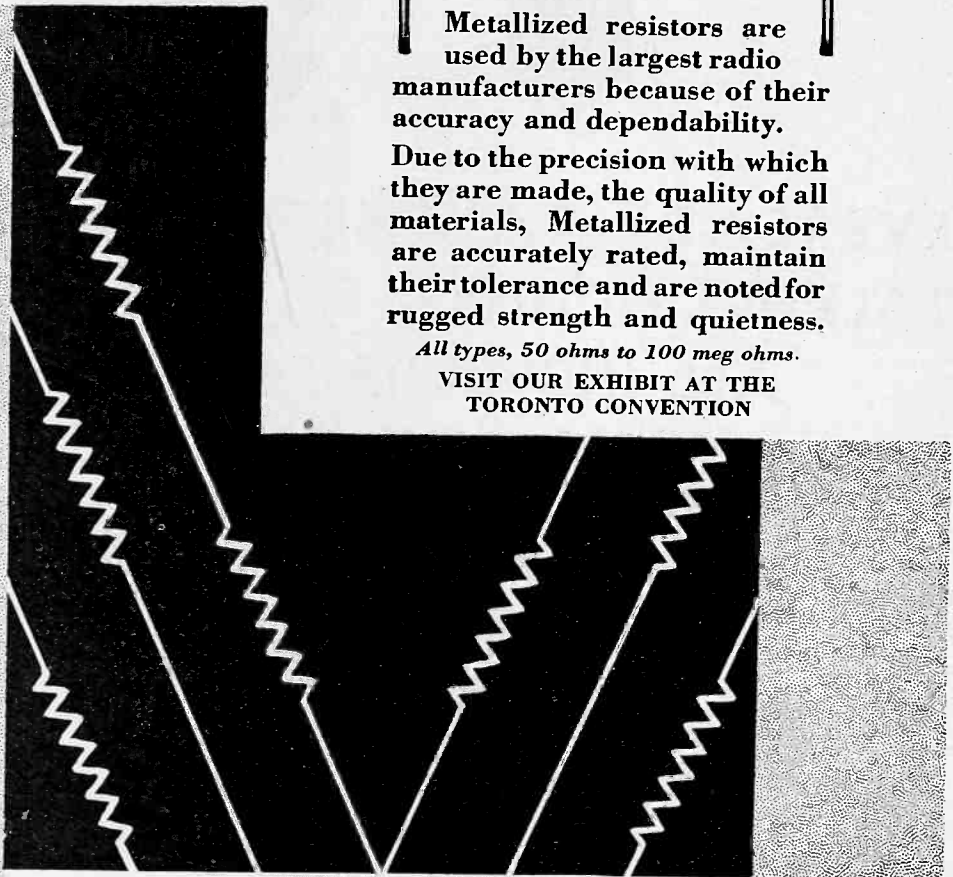

**DURHAM**

*Metallized*  
**RESISTORS**

**INTERNATIONAL RESISTANCE COMPANY**  
2006 Chestnut Street Philadelphia, Pa.

*"No other Resistor has all of Metallized's Advantages."*

*When writing to advertisers mention of the PROCEEDINGS will be mutually helpful.*

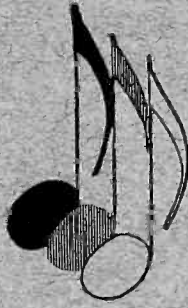

**A.H.GREBE & CO., Inc.**

RICHMOND HILL, NEW YORK

**Grebe  
radio**

SUPER-SYNCHROPHASE 

WESTERN BRANCH

443 South San Pedro Street

Los Angeles, California

**MAKERS OF QUALITY RADIO SINCE 1909**

# SINCE 1915

General Radio Company has been designing and manufacturing electrical measuring instruments for use at communication frequencies (0 to several million cycles per second). A list of the most important items in the line is given below. Many of them have application outside the laboratory.

Frequency Standards and Measuring Devices — Magnetostriction Oscillators — Piezo-Electric (Quartz) Oscillators — Wavemeters.  
Vacuum-tube Oscillators — Radio-Frequencies — Audio-Frequencies  
Bridges for Measuring — Resistance, Inductance, Capacitance —  
Vacuum-tube Characteristics

Resistance Boxes

Precision Condensers

Calibrated Inductors

Attenuation Networks and Voltage Dividers

String Oscillograph

A-C Voltmeters — Vacuum-tube Type — Oxide-rectifier Type

Standard-Signal Generator (for radio-frequency voltage measurements)

Galvanometer Shunts

Transformers

Relays

Miscellaneous Accessories — Vacuum-tube Sockets — Rheostats and Potentiometers — Switches — Plugs, Jacks, Plug-in Mounting Bases

Our Engineering Department publishes a monthly magazine, *The General Radio Experimenter*, for free distribution to anyone interested in technical developments in communication engineering and allied fields. A memorandum with your name, mailing address, and business affiliation will place you on the mailing list.



## GENERAL RADIO COMPANY

CAMBRIDGE A, MASSACHUSETTS