

VOLUME 18

FEBRUARY, 1930

NUMBER 2

PROCEEDINGS
of
The Institute of Radio
Engineers



Form for Change of Mailing Address or Business Title on Page XLIX

Institute of Radio Engineers

Forthcoming Meetings

CINCINNATI SECTION

Cincinnati, Ohio, February 20, 1930

NEW YORK MEETING

New York, N. Y., March 5, 1930

TORONTO SECTION

Toronto, Canada, February 12, 1930

SAN FRANCISCO SECTION

San Francisco, Calif., February 19, 1930

WASHINGTON SECTION

Washington, D. C., February 13, 1930

PROCEEDINGS OF

The Institute of Radio Engineers

Volume 18

February, 1930

Number 2

Board of Editors, 1930

ALFRED N. GOLDSMITH, *Chairman*
 STUART BALLANTINE G. W. PICKARD
 RALPH BATCHER W. C. WHITE
 J. W. HORTON L. E. WHITTEMORE
 W. WILSON

CONTENTS

PART I

	Page
Frontispiece, Lee de Forest, President of the Institute, 1930.....	208
Institute News and Radio Notes.....	209
January Meeting of Board of Direction.....	209
Radio Signal Transmissions of Standard Frequency.....	210
Committee Work.....	211
Report of 1929 Activities of Committee on Standardization.....	212
Institute Meetings.....	215

PART II

Technical Papers

A New Transformation in Alternating-Current Theory with an Application to the Theory of Audition.....	221
BALTH. VAN DER POL	
The Accurate Testing of Audio Amplifiers in Production.....	231
ARTHUR E. THIESSEN	
A Study of Noise in Vacuum Tubes and Attached Circuits.....	243
F. B. LLEWELLYN	
A Study of the Output Power Obtained from Vacuum Tubes of Different Types.....	266
H. A. PIDGEON AND J. O. McNALLY	
The Equivalent Generator Theorem.....	294
V. D. LANDON	
Filament Supply for Radio Receiver from Rectified 25-Kilocycle Current.....	298
HUGH A. BROWN AND LLOYD P. MORRIS	
Quartz Control for Frequency Stabilization in Short-Wave Circuits.....	307
P. VON HANDEL, K. KRUGER, AND H. PLENDL	
A Broadcast Receiver for Use in Automobiles.....	321
PAUL O. FARNHAM	
Some Remarks on the Multivibrator.....	327
YASUSI WATANABE	
Production Testing of Vacuum Tubes.....	336
K. S. WEAVER AND W. J. JONES	
Cross Modulation in R-F Amplifiers.....	350
SYLVAN HARRIS	
Book Review, "Report of the Royal Commission on Broadcasting".....	355
C. H. STARR	
Booklets, Catalogs, and Pamphlets Received.....	356
Monthly List of References to Current Radio Literature.....	357
Contributors to This Issue.....	360

Copyright, 1930, by the Institute of Radio Engineers

The Institute of Radio Engineers

GENERAL INFORMATION

The PROCEEDINGS of the Institute is published monthly and contains papers and discussions thereon submitted for publication or for presentation before meetings of the Institute or its Sections. Payment of the annual dues by a member entitles him to one copy of each number of the PROCEEDINGS issued during the period of his membership.

Subscription rates to the PROCEEDINGS for the current year are received from non-members at the rate of \$1.00 per copy or \$10.00 per year. To foreign countries the rates are \$1.10 per copy or \$11.00 per year.

Back issues are available in unbound form for the years 1918, 1920, 1921, 1922, and 1926 at \$9.00 per volume (six issues) or \$1.50 per single issue. For the years 1913, 1914, 1915, 1916, 1917, 1918, 1924, and 1925 miscellaneous copies (incomplete unbound volumes) can be purchased for \$1.50 each; for 1927, 1928, and 1929 at \$1.00 each. The Secretary of the Institute should be addressed for a list of these.

Discount of twenty-five per cent on all unbound volumes or copies is allowed to members of the Institute, libraries, booksellers, and subscription agencies.

Bound volumes are available as follows: for the years 1920, 1921, 1922, and 1926 to members of the Institute, libraries, booksellers, and subscription agencies at \$8.75 per volume in blue buckram binding and \$10.25 in morocco leather binding; to all others the prices are \$11.00 and \$12.50, respectively. For the years 1928 and 1929 the bound volume prices are: to members of the Institute, libraries, booksellers, and subscription agencies, \$9.50 in blue buckram binding and \$11.00 in morocco leather binding; to all others, \$12.00 and \$13.50, respectively. Foreign postage on all bound volumes is one dollar, and on single copies is ten cents.

Year Books for 1926, 1927, and 1928, containing general information, the Constitution and By-Laws, catalog of membership, etc., are priced at seventy-five cents per copy per year. The 1929 Year Book is available to members at \$1.00; to non-members, \$1.50.

Contributors to the PROCEEDINGS are referred to the following page for suggestions as to approved methods of preparing manuscripts for publication in the PROCEEDINGS.

Advertising rates for the PROCEEDINGS will be supplied by the Institute's Advertising Department, Room 802, 33 West 39th Street, New York, N. Y.

Changes of address to affect a particular issue must be received at the Institute office not later than the 15th of the month preceding date of issue. That is, a change in mailing address to be effective with the October issue of the PROCEEDINGS must be received by not later than September 15th. Members of the Institute are requested to advise the Secretary of any change in their business connection or title irrespective of change in their mailing address, for the purpose of keeping the Year Book membership catalog up to date.

The right to reprint limited portions or abstracts of the papers, discussions, or editorial notes in the PROCEEDINGS is granted on the express condition that specific reference shall be made to the source of such material. Diagrams and photographs published in the PROCEEDINGS may not be reproduced without making special arrangements with the Institute through the Secretary.

It is understood that the statements and opinions given in the PROCEEDINGS are views of the individual members to whom they are credited, and are not binding on the membership of the Institute as a whole.

All correspondence should be addressed to the Institute of Radio Engineers, 33 West 39th Street, New York, N. Y., U. S. A.

Entered as second class matter at the Post Office at Menasha, Wisconsin.

Acceptance for mailing at special rate of postage provided for in the Act of February 28, 1925, embodied in paragraph 4, Section 412, P. L. and R. Authorized October 26, 1927.

Published monthly by

THE INSTITUTE OF RADIO ENGINEERS, INC.

Publication office, 450-454 Ahnaip Street, Menasha, Wis.

BUSINESS, EDITORIAL, AND ADVERTISING OFFICES,

33 West 39th St., New York, N. Y.

SUGGESTIONS FOR CONTRIBUTORS TO THE PROCEEDINGS

Preparation of Paper

Form—Manuscripts may be submitted by member and non-member contributors from any country.

To be acceptable for publication manuscripts should be in English, in final form for publication, and accompanied by a summary of from 100 to 300 words. Papers should be typed double space with consecutive numbering of pages. Footnote references should be consecutively numbered and should appear at the foot of their respective pages. Each reference should contain author's name, title of article, name of journal, volume, page, month, and year. Generally, the sequence of presentation should be as follows: statement of problem; review of the subject in which the scope, object, and conclusions of previous investigations in the same field are covered; main body describing the apparatus, experiments, theoretical work, and results used in reaching the conclusions and their relation to present theory and practice; bibliography. The above pertains to the usual type of paper. To whatever type a contribution may belong, a close conformity to the spirit of these suggestions is recommended.

Illustrations—Use only jet black ink on white paper or tracing cloth. Cross-section paper used for graphs should not have more than four lines per inch. If finer ruled paper is used, the major division lines should be drawn in with black ink, omitting the finer divisions. In the latter case, only blue-lined paper can be accepted. Photographs must be very distinct, and must be printed on glossy white paper. Blueprinted illustrations of any kind cannot be used. All lettering should be $\frac{3}{16}$ in. high for an 8 x 10 in. figure. Legends for figures should be tabulated on a separate sheet, not lettered on the illustrations.

Mathematics—Fractions should be indicated by a slanting line. Use standard symbols. Decimals not preceded by whole numbers should be preceded by zero, as 0.016. Equations may be written in ink with subscript numbers, radicals, etc., in the desired proportion.

Abbreviations—Write a.c. and d.c., (a-c and d-c as adjectives), kc, μf , $\mu\mu f$, e.m.f., mh, μh , henries, abscissas, antennas. Refer to figures as Fig. 1, Figs. 3 and 4, and to equations as (5). Number equations on the right in parentheses.

Summary—The summary should contain a statement of major conclusions reached, since summaries in many cases constitute the only source of information used in compiling scientific reference indexes. Abstracts printed in other journals, especially foreign, in most cases consist of summaries from published papers. The summary should explain as adequately as possible the major conclusions to a non-specialist in the subject. The summary should contain from 100 to 300 words, depending on the length of the paper.

Publication of Paper

Disposition—All manuscripts should be addressed to the Institute of Radio Engineers, 33 West 39th Street, New York City. They will be examined by the Committee on Meetings and Papers and by the Editor. Authors are advised as promptly as possible of the action taken, usually within one month.

Proofs—Galley proof is sent to the author. Only necessary corrections in typography should be made. *No new material is to be added.* Corrected proofs should be returned *promptly* to the Institute of Radio Engineers, 33 West 39th Street, New York City.

Reprints—With the galley proof a reprint order form is sent to the author. Orders for reprints must be forwarded promptly as type is not held after publication.

INSTITUTE SECTIONS

<i>Chairman</i>	<i>Secretaries</i>
H. P. Thornton	ATLANTA Philip C. Bangs, 23 Kensington Rd., Avondale Estates, Ga.
George W. Pierce	BOSTON Melville Eastham, 30 State St., Cambridge, Mass.
L. Grant Hector	BUFFALO-NIAGARA E. C. Waud, 235 Huntington Ave., Buffalo, N. Y.
H. E. Kranz	CHICAGO J. H. Miller, Jewell Electrical Inst. Co., 1650 Walnut St., Chicago, Ill.
R. H. Langley	CINCINNATI W. W. Boes, 622 Broadway, Cincinnati, Ohio
D. Schregardus	CLEVELAND C. H. Shipman, 14805 Ardenall Ave., East Cleveland, Ohio
Q. A. Brackett	CONNECTICUT VALLEY F. C. Beekley, 96 S. Main St., W. Hartford, Conn.
A. B. Buchanan	DETROIT W. R. Hoffman, 615 West Lafayette Blvd., Detroit, Mich.
T. C. Bowles	LOS ANGELES Charles S. Breeding, Aero Radio Corp., 5927 Franklin Ave., Hollywood, Calif.
Pendleton E. Lehde	NEW ORLEANS Anton A. Schiele, 1812 Masonic Temple, New Orleans, La.
J. C. Van Horn	PHILADELPHIA <i>Acting Secretary</i> E. T. Darlington, 2848 Idaho Road, Camden, N. J.
L. A. Terven	PITTSBURGH T. D. Cunningham, 1310 Hay St., Wilksburg, Pa.
E. C. Karker	ROCHESTER A. R. Barfield, Valley Appliances, Inc., Rochester, N. Y.
Donald K. Lippincott	SAN FRANCISCO Paul R. Fenner Custom House, San Francisco, Calif.
Austin V. Eastman	SEATTLE Abner R. Willson, 8055—14th Ave., N. E., Seattle, Wash.
V. G. Smith	TORONTO G. E. Pipe, 90 Chestnut St., Toronto, Canada
C. B. Jolliffe	WASHINGTON J. B. Brady, Ouray Bldg., Washington, D. C.

GEOGRAPHICAL LOCATION OF MEMBERS ELECTED JANUARY 8, 1930

Elected to the Fellow grade

Germany	Berlin, Ludende, Karlstrasse 4	Fassbender, Heinrieh
---------	--------------------------------	----------------------

Transferred to the Member grade

Massachusetts	Cambridge, General Radio Co., 30 State St.	Thiessen, Arthur E.
Pennsylvania	Irwin, 728 Grant St.	Marsteller, L. O.
Canada	Toronto, 45 Jarvis St.	Meredith, C. C.
France	Asnieres (Seine), 16 Rue de Chateaudun	Kraemer, G. I.

Elected to the Member grade

California	San Pedro, c/o Postmaster, <i>USS West Virginia</i>	Cooper, Lowell
Massachusetts	Springfield, 120 Ardmore St.	Lavallee, J. A.
	Springfield, 72 Princeton St.	Fortier, Ralph L.
New Jersey	Upper Montclair, 9 Bradford Parkway	DuMont, Allen B.
New York	New York City, c/o Radio Corporation of America,	
	233 Broadway	Grover, Harry G.
Ohio	Cleveland, Nela Park, Cleveland Vacuum Tube Works of G. E.	Ritter, E. W.
Pennsylvania	Pittsburgh, 5529 Bryant St.	Roth, Albert
	Wilksburg, 584 Lenox Ave.	Carlisle, Richard W
Siam	Bangkok, Post and Telegraph Dept.	Prakit, Phya

Elected to the Associate grade

California	Berkeley, 1524 Scenic Ave.	Dempster, Everitt R.
	El Centro, 864 Olive St.	Irey, Earl R.
	Glendale, 1211 Winchester Ave.	Klingensmith, W. B.
	Hollywood, 4909 Sunset Boulevard	Brockway, Don C.
	Hollywood, 2144 Beachwood Drive	Heinemann, John T.
	Los Angeles, 1136 So. New Hampshire Ave.	Bilkie, W.
	Los Angeles, 1129 4th Ave.	Brown, Cutler
	Los Angeles, 1023 1/2 Blaine St.	Flickinger, J. H.
	Napa, P. O. Box 86	Streich, Robert J.
	Oakland, 1741 Seminary Ave.	Weaver, Chester E.
	Palo Alto, 151 Church Ave.	Boyson, Carl V.
	Palo Alto, 213 Fulton St.	Green, Irving L.
	Pasadena, 3209 E. Colorado St.	Craft, Walter C.
	San Francisco, 140 New Montgomery St.	Franklin, Lyman T.
	San Francisco, c/o San Francisco Examiner, Station KUP	Martin, Ronald G.
	San Jose 87 E. San Antonio St.	Cooper, Charles A.
	Venice, 806 Marco Place	DuVall, Charles
Connecticut	Hartford, 52 Beacon St.	Grammer, George
	Naugatuck, Field St., R. F. D. #1	Wood, William Forrest
Dist. of Columbia	Waterbury, 50 Hewlett St.	Buckley, Francis P.
	Bellevue, Naval Research Laboratory	Kosar, William S.
	Takoma Park, P. O. Box 4253	Aurynger, John J.
	Washington, 911 Barr Bldg.	Codel, Martin
	Washington, 928 Madison St. N. W.	Dawson, William B.
	Washington, 226 8th St. S. E.	Guthrie, Robert C.
	Washington, 3333 P St. N. W.	Keough, Bayard Cole
	Washington, 3217 Brother's Place S. E.	Link, John C.
	Washington, 1319 F St. N. W.	Pierce, James F.
	Washington, 2807 Connecticut Ave.	Reynolds, George E.
	Washington, 214 17th St. N. E.	Shepherd, Henry Clayton
	Washington, 663 F St. N. E.	Taylor, Kenneth B.
	Washington, Navy Yard, Radio Test Shop	Tinsley, W. M.
	Hialeah, c/o Tropical Radio Telegraph Co., Pox 488	Corrigan, C. J.
	Florida	Tampa, 907 Florida Ave.
Illinois	Argo, 7806 W. 65 Place	O'Connor, James M.
	Chicago, 2543 S. Avera Ave.	Burger, Emil S.
	Chicago, 4614 N. Paulina Ave.	Elliott, John S.
	Chicago, 6800 Hilldale Ave.	Erwood, John
	Chicago, 656 W. Washington Boulevard	Huntley, Wilfred Eliot
	Chicago, 1305 S. St. Louis Ave.	Lyon, Alex
	Chicago, Radio Station WENR.	McCluer, Paul
	Chicago, c/o Electrical Research Products Co., 910 S. Michigan Blvd.	Manchester, Raymond Mark
	Chicago, 3333 N. Marshfield Ave.	Menor, Geoffrey J.
	Chicago, 7712 Emerald Ave.	Mower, Irving F.
Chicago, 3942 Lake Park Ave.	Rulison, Earl Wm.	

Geographical Location of Members Elected January 8, 1930

Illinois (cont'd)	Chicago, Electrical Research Products Co., 910 S. Michigan Blvd.	Sterling, M. F.
	Chicago, 4742 W. Adams St.	Stokes, Howard S.
	Chicago, 1329 N. Wells St.	Thineman, Edward H.
	Chicago, 2715 S. Komensky Ave.	Tomas, Charles Frank, Jr.
	Elmhurst, 633 Spring Road	Walter, L. B.
	Glenview, Radio Station WBBM	Frisk, Caleb C.
	La Grange, 541 S. Kensington Ave.	Beckley, John G.
	Plainfield	Barch, Henry Stefan
	Plainfield, Universal Wireless Comm. Co.	Graham, Maxwell S.
	Plano	Littlepage, Orvale Herbert
Indiana	Valparaiso, 305 Monroe St.	Hays, Clarence W.
	Valparaiso, Box 301	Heaton, George C.
	Valparaiso, 458 1/2 S. Locust Ave.	Terrill, Jeannette
Iowa	Blairstown	Schultz, Harvey R.
	Neodesha, 912 Indiana St.	Crimmel, Henry W.
Kansas	New Orleans, 2430 Gen. Taylor St.	Labe, Henry, Jr.
	New Orleans, 859 Roosevelt Place	Lurry, Thomas M.
Louisiana	Annapolis, 69 Fifth St.	Howard, David G.
	Baltimore, 2111 W. Baltimore St.	Anderson, John H.
	Baltimore, 1233 W. Baltimore St.	Berman, Henry O.
	Baltimore, 3818 Old Frederick Ave.	Garvey, Joseph M.
	Baltimore, 223 N. Curley St.	Vacek, George John
Massachusetts	Boston, Electrical Research Products, Inc., 20 Providence St.	Compton, G. Edwin
	Boston, c/o J. H. Burke Co., 221 Columbus Ave.	O'Donnell, Edward Francis
Michigan	Boston, c/o R. C. A. Institutes, Inc., 899 Boylston St.	Serreze, Victor C.
	Brighton, 103 Antwerp St.	Yurt, F. X.
	Chicopee Falls, 18 Arlington St.	Gough, John Henry
	East Springfield, 26 Prentice St.	Robbins, Lynn R.
	Haverhill, Ward Hill Section	Phinney, Harold
	Maynard, 8 Elm Court	Stuckert, E. M.
	Melrose Highlands, 283 Vinton St.	Jewett, Raymond Bryce
	Quincy, 1511 Hancock St.	Dunleavy, Frank S.
	Quincy, 10 Empire St.	Steer, J. Ralph
	Seekonk	Stackpole, Nelson B.
	Springfield, 59 Olmstead Drive	Boyd, Bruce
	Springfield, 97 Orleans St.	Cameron, J. A.
	Springfield, 46 Osborne Terrace	Valentine, Francis B.
	Watertown, 29 Oakley Road	Anderson, Homer G.
	West Springfield, 60 Armstrong St.	Sutherland, Edgar F.
	Detroit, 1936 Sharon	Grote, Ernest A.
	Detroit, 2909 David Stott Bldg.	Russ, John A.
	Detroit, 2800 Fisher Bldg.	Jones, Clarence Wm.
	Detroit, 1518 Pennsylvania, Apt. 21	Keller, John C.
	Detroit, 7-218 General Motors Bldg.	Lesinsky, Frank
Detroit, Marine P. O., SS Alpena	MacCormack, Edwin A.	
Jackson, 3000 Francis St.	Adams, Eugene C.	
Lansing, 417 Oak Ave.	Aman, Bernard H.	
Port Huron, 1107 Center Ave.	Fountain, J. Clarence	
South Haven, 242 Hubbard St.	Hollands, L. C.	
South Haven, 341 Park Ave.	Klein, Albert G.	
Missouri	Columbia Radio Station KFRU	White, Robert F.
	Jefferson City, Radio Station WOS	Wilson, W. W.
Montana	Kansas City, 3143 Cleveland Ave.	Cox, Everett E.
	Butte, 117 Hamilton St.	Setterquist, Charles Ragnar
Nebraska	Great Falls, P. O. Box 1054	Van Blaricom, S.
	Lincoln, University of Nebraska, Dept. of Elec. Engr.	Norris, Ferris W.
New Jersey	Lincoln, 2511 R St.	Spencer, Herbert Logan
	Arlington, 573 Elm St.	Gelardin, Benjamin
New Jersey	Bergenfield, 16 S. Summit St.	Munzer, Louis F.
	Bergenfield, 3 S. Washington Ave.	Sonberg, Kenneth T.
	Bloomfield, 17 Floyd Ave.	Bryan, Oscar F.
	Bloomfield, 89 Watessing Ave.	Hansen, Rolf Krohn
	Bogota, 110 Queen Anne Road	Bisbee, Robert Hause
	Caldwell, 35 Gould Place	Winans, Roswell R.
	Deal, Box 122	Smith, Phillip H.
	East Orange, 106 N. Grove St.	Bagnall, Vernon B.
	East Orange, 106 N. Walnut St.	Bohner, Chance E.
	East Orange, 18 Girard Ave.	Green, Ralph W.
	East Orange, 526 Park Ave.	Grossvendt, Carl
	East Orange, 54 Glenwood Ave.	Mabey, Charles A.
	East Orange, 293 N. Oraton Parkway	Salmons, George C.
	East Orange, 59 Ampere Parkway	Vermillion, Charles O.
	East Orange, 5 S. Maple Ave.	Wallace, Milton W.
	East Orange, 141 Park Ave.	Walter, John C.
	Long Branch, 130 Second Ave.	McCollum, Harry J.
	Maplewood, 20 Colonial Terrace	Brown, Bayne
Merchantville, 2431 Merchantville Ave.	Swanson, Milton A.	
Mount Ephraim, P. O. Box 206, King's Highway	Williams, Ernest R.	
Mountain Lakes, 23 Howell Road	Currie, Alexander	

Geographical Location of Members Elected January 8, 1930

New Jersey (cont'd)	Newark, 65 Wakeman Ave.	Cavanaugh, John D.
	Newark, 476 S. Eighteenth St.	Penk, Charles, Jr.
	Verona, 128 Sunset Ave.	Paret, F. Murray
New York	Weehawken Heights, 480 Palisade Ave.	Spinner, Robert F., Jr.
	Whippany, Bell Telephone Laboratories	Hensel, W. G.
	Brooklyn, 651 Wythe Ave.	Amendolara, Patrick
	Brooklyn, 2337 85th St.	Camarda, Frank
	Brooklyn, 274-A Ninth St.	Evans, Nicholas O.
	Brooklyn, 1502 E. 9th St.	Kay, Samuel Robert
	Brooklyn, 2220 Pacific St.	Kovacs, S.
	Brooklyn, 902 Avenue C.	Love, Nathan
	Brooklyn, 55 Hanson Place	Pierce, Norman J.
	Brooklyn, 124 E. 3rd St.	Seekamp, Walter J.
	Brooklyn, 548 Clinton St.	Simeone, Frank
	Brooklyn, 1305 Foster Ave.	Traeger, Sam Harry
	Buffalo, 55 Harvard Place	Burns, Homer M.
	Buffalo, 374 High St.	Jennings, Russell G.
	Buffalo, 224 Jersey St.	Showalter, John L. E.
	Buffalo, 245 Highgate Ave.	Walls, Norman F.
	Elmira, 405 E. Church St.	Beyer, Raymond G.
	Ithaca, Cornell University, Rockefeller Hall	Minging, Charles R.
	Kenmore, 66 Legion Drive	Thomas, Lawrence F.
	New York City, 2486 Grand Ave., Brcnx	Bennett, Don
	New York City, 44 Seaman Ave.	Beyer, Haim
	New York City, 600 W. 178th St.	Blaufox, Jos. David
	New York City, 506 W. 163rd St.	Bohmann, Louis
	New York City, 162 E. Broadway	Brave, Harry J.
	New York City, 463 West St.	Budenbom, H. T.
	New York City, c/o Mr. C. Y. Hsu, 500 Riverside Drive	Chung, C. F.
	New York City, 463 West St.	Dale, George V.
	New York City, Pier 27, E. River	Ellis, T. H.
	New York City, International Comm. Lab., 89 Broad St.	Harris, Charles S.
	New York City, c/o Bell Tel. Labs., 463 West St.	Hartmann, Albert
	New York City, c/o R. C. A. Institute, 326 Broadway	Horman, Frederick L.
	New York City, 300 W. 107th St.	Kott, Herman
New York City, International House, 500 Riverside Drive	Kruse, Sigurd	
New York City, Bell Tel. Labs., 463 West St.	Lindsay, Maxwell H. A.	
New York City, 152 W. 72nd St.	Mix, Charles L.	
New York City, 204 W. 106th St.	Ornstein, Eugene	
New York City, 212 E. 18th St.	Schanz, John A.	
New York City, c/o Radiomarine Corp. of America, 326 Broadway	Shandy, G. P.	
New York City, 133 W. 71st St.	Simpson, S. H. Jr.	
New York City, c/o Mr. C. Y. Hsu, 500 Riverside Drive	Ward, Zangwill	
North Pelham, 129 Second Ave.	Seibert, George William, Jr.	
Queens Village, L. I., 104-16 223rd St.	Sypher, Edgar L., Jr.	
Rochester, 62 Minnesota St.	Albright, Gordon E.	
Rochester, 634 Lexington Ave.	White, J. W.	
Rocky Point, L. I., c/o R. C. A. Communications, Inc.	Peterson, Lloyd E.	
Rocky Point, L. I., c/o R. C. A.	Russell, H. J.	
Rocky Point, L. I., c/o R. C. A.	White, W. L.	
Scotia, Spring Road, R. D. #2	Batchelor, Harold	
Skaneateles, 65 Genesee Street	Roberts, Edward	
Southampton, L. I., c/o Mackay Radio	Hayward, Walter	
Syracuse, 747 James St.	Turner, Walter V.	
Troy, D. K. E. House	Hadley, Raymond F.	
Ulster Park	Wickery, John B.	
White Plains, 20 Trenton Ave.	Bayne, James W.	
North Dakota	Mandan, 708 W. Main St.	Templeman, E. J.
Ohio	Cincinnati, 3027 Feltz Ave.	Platts, George F.
	Cincinnati, 3353 Wabash Ave.	Winget, Donald N., Jr.
Oklahoma	Clayton	Jones, Carl C.
	Cleveland, Allerton Club, Room 1203	Pierce, R. Morris
	Lakewood, 14415 Delaware Ave.	Cooper, William H.
	Norwood, 4810 Beech St.	Boerstler, Loren L.
	Norman, 221 E. Main St.	Coston, E. G.
Oregon	Oklahoma City, 2904 N. Robinson St.	Ehret, Kenneth Marion
	Shawnee, 309 S. Penn Ave.	Barron, Arthur Joseph
	Elgin, P. O. Box 206	Bussear, Lilliam M.
Pennsylvania	East Pittsburgh, Research Dept., Westinghouse E. & M. Co.	Kilgore, G. Ross
	East Pittsburgh, Radio Operation Dept., Westinghouse E. & M. Co.	McKeel, P. D.
	East Pittsburgh, Research Bldg., Westinghouse E. & M. Co.	Osbon, W. O.
	East Pittsburgh, Radio Eng. Dept., Westinghouse E. & M. Co.	Reifsteck, C. N.
	East Pittsburgh, Westinghouse E. & M. Co.	Upp, Charles B.
	Emporium, Sylvania Products Co.	Kronenwetter, Harold G.
	Erie, 1119 W. 4th St.	Persio, Louis N.
	Johnsburg, c/o Johnsonburg Radio Corp.	Carson, W. G.

Geographical Location of Members Elected January 8, 1930

Pennsylvania (cont'd)	Philadelphia, 243 E. Upsal St., Mt. Airy	Blackwood, George Campbell
	Philadelphia, 251 S. 38th St.	Chambers, Carl C.
	Philadelphia, 3422 Barclay St., E. Falls	Gerhard, Charles E.
	Philadelphia, 756 N. Preston St.	Guzik, N. J.
	Philadelphia, 1816 W. Sulis St.	Hertrich, John H.
	Philadelphia, 3846 Lancaster Ave.	McCloskey, George W.
	Philadelphia, 1635 Poplar St.	Miller, George Anthony
	Philadelphia, 2651 S. Fairhill St.	Moss, Stanley Allen
	Philadelphia, 4636 Hazel Ave.	Prow, Albert H.
	Philadelphia, The Gladstone, 11th and Pine Sts.	Somerville, Harry V.
	Philadelphia, 1121 Spruce St.	Stanton, Russell S.
	Pittsburgh, 340 Rochelle St.	Curtiss, A. N.
	Pittsburgh, 5550 Beacon St.	Green, M. L.
	Pittsburgh, (21), 817 Rebecca Ave.	Harness, L. R.
	Pittsburgh, 306 Live Stock Exchange Bldg., Herr's Island.	Thompson, R. G.
	St. Mary's Speer Carbon Co.	Abbott, Harold W.
	Turtle Creek, 131 Grant St.	Walker, M. C.
	Uniontown, Box 802	Vincent, Charles William
	Wilkinsburg, 309 Penwood Ave.	Bokovoy, Sam A.
	Wilkinsburg, 412 Ross Ave.	Furth, Ernest L.
Wilkinsburg, 707 Lamar Ave.	Miller, Horace G.	
Wilkinsburg, 584 Celeron St.	Mitkewich, W.	
Wilkinsburg, 1139 Franklin Ave.	Tiedje, J. Q.	
Wilkinsburg, 723 Whitney Ave.	Whitelock, L. D.	
Wilkinsburg, 1666 Laketon Road	Wilson, Arthur C.	
Lennox, Box 332	Van Bockern, John H.	
Watertown	Sigelman, S. S.	
Memphis, 1221 Jefferson St.	Shafer, Arthur B.	
Amarillo, Amarillo Inn.	Chini, Carl J.	
Amarillo, 140 Wayside Drive	Martin, J. Laurance	
Tyler, Tyler Commercial College	Daniel, Charles L.	
Wichita Falls, 2213 9th St.	Drollinger, Kyle M.	
Winchester, 440 National Ave.	Smalts, Franklin W.	
Seattle, 904 E. Pike St.	Gable, M.	
Gilman, P. O. Box 207	Lowitz, W. V.	
Milwaukee, 543 Jefferson St., Apt. 37	Osterloo, John D.	
Eyak, Mile 7	Brightman, R. B.	
Juneau, U. S. Naval Radio Compass Station, Soapstone Point	Derry, F. R.	
Argentina	Buenos Aires, Navarro 4159, V. Devoto	Acuna, Segundo P.
Buenos Aires, c/o Transradio 329, San Martin	Noizeux, Pierre	
Australia	New South Wales, North Road, Eastwood	Craggs, Herbert Harold
Victoria, 157 Raglan St., Preston N 18	Skelton, Thomas H.	
Austria	Vienna 18, Währingerstrasse 123	Ehrlich, Karl
Canada	Halifax, N. S., Acadian Hotel	Howard, William B.
Hamilton, Ont., 72 Ontario Ave.	Olson, E.	
Montreal, P. Q., Northern Elec. Co., Ltd., 637 Craig St.	James, Cliff C.	
Toronto 9, Ont., 549 Indian Road	Cronk, Harold W.	
Toronto, Ont., 886 Danforth Ave.	Dix, George	
Toronto, Ont., 192 Pape Ave.	Grant, Ingol M.	
Toronto, Ont., 91 St. George St.	Irwin, L. D.	
Toronto 6, Ont., 686 Broadview Ave.	McKichan, Donald Brandon	
Toronto, Ont., Canadian National Carbon Co., Ltd., 805 Davenport Road	Potter, N. M.	
Toronto, Ont., c/o Sangamo Electric Co. of Canada, 183 George St.	Waite, Griffin Grant	
Toronto, Ont., 131 Lawrence Ave. W.	Hawes, Isaac E.	
Toronto 3, Ont., 12 Ellis Ave.	Tran, T. A.	
Winnipeg, Man., 399 Beaverbrook St.	Young, M. D.	
Havana, P. O. Box 1368	Sebasco, Jorgeh Gourafer	
Cuba	Cambridge, Downing College	Vedy, Louis George
England	Sidecup, Kent, Sidecup Hill, "Uplands"	Robertson, N. C.
Lancaster, Lancashire, 5, Coverdale Road	Salt, William	
Cleethorpes, Lincolnshire, 39, St. Peter's Ave.	Poppleton, John	
Liverpool, Bootle, 28, Middlesex Road	Hughes, William Morris	
London N 7, Tufnell Park, 67, Carleton Road	Graham, C.	
London NW 2, Dollis Hill Ave., 3, Hill Close	Horn, C. O.	
Norwich, Thorpe Hamlet, 34, Cedar Road	Cooper, G. R.	
Hawaii	Hilo, Moses Stationery Co., Ltd.	Hill, Otis
Honolulu, Box 3287	Jackson, N. H.	
Italy	Rome, 24 Lungotevere Mellini	Gabriello, Giannini
Rome, Viale Mazzini 6	Marino, Algeri	
Japan	Tokyo, Azabuku, Banchi, Amishiroco -1	Akamatsu, Kaworu
Tokyo, Marunouchi, Japan Wireless Telegraph Co.	Kiyota, Y.	
Tokyo, Marunouchi 2 Chome, Japan Wireless Telegraph Co.	Mizuhashi, Tosaku	
Tokyo, Marunouchi 2 Chome, Japan Wireless Telegraph Co.	Nakagami, Minoru	
Tokyo, 419 Ikebukuro (near Tokyo)	Takeuchi, H.	
New Zealand	Christchurch, c/o District Telegraph Engineer	Rubenstein, S. J.
Dannevirke, Rawhiti St.	Claridge, R.	

Geographical Location of Members Elected January 8, 1930

New Zealand (cont'd)	Queensland, S. Brisbane, Annerley, Rose St.	Bauer, A. T.
North Ireland	Belfast, 128 University Ave.	Waite, D.
Philippine Islands	Cebu, Cebu, P. O. Box 525	Rivera, T. L.
Scotland	Aberdeen, 102 Stanley St.	Wilkie, J. McKenzie
	Edinburgh, 6 ^a Royal Circus	Gee, Harry L.
South Africa	Beaufort West, Telegraph Repeater Room	Hendry, J. S.
	Northern Rhodesia, c/o N'Changa Copper Mines, via Ndola	Yule, T. M.
South Australia	Rosewater, Margaret Terrace	Sawford, L. F.
Elected to the Junior grade		
California	San Francisco, 625 Bush St.	Simpson, Charlotte Frances
Georgia	Atlanta, P. O. Box 742	Barker, Howard J.
Illinois	Chicago, 5509 Everett Ave.	Palmer, James
Indiana	Valparaiso	Gallinger, Lester E.
	Valparaiso, 401 E. Monroe	Gunnaugson, Jacob
	Valparaiso	Jones, W. R.
	Vincennes, Terre Haute Road	Kopp, Clarence
Iowa	Douds	Greenfield, Daniel C.
Massachusetts	Cambridge, M. I. T. Dorm '93	Dyer, John Newton
	Cambridge, M. I. T. Dorm, Room 93-508	Hollywood, John M.
	Gloucester, 13 Beauport Ave.	Hoyt, Edward C.
	Hannibal, 1030 Church St.	Cox, T. Alfred
Missouri	Carleton	Damm, Fred
Nebraska	Passaic, 330 Gregory Ave.	Mercer, Ira G., Jr.
New Jersey	Weehawken, 62 Liberty Place	Pollack, Dale
	Brooklyn, 2977 W. 3rd St.	Daniels, Murray
	Brooklyn, 441 Eastern Parkway	Hartley, John Harrison
	Brooklyn, 839 Monroe St.	Salvante, Louis Eugene
	New York City, 1575 Grand Concourse, Bronx	Sheffield, Berthold
	Schenectady, Union College, Delta Phi House	Peck, Caid H.
Ohio	Skaneateles, 65 Genesee St.	Roberts, Edward
	Lakewood, 15104 Detroit Ave.	Hoff, Henry B.
	Westerville, R. R. #1, Box 9-A	Nafzger, Lester H.
Pennsylvania	Scranton, 323 Madison Ave.	Richards, Jack E.
Texas	San Antonio, 205 E. Locust	James, Vir N.
Canada	Toronto, Ont., 48 Albermarle Ave.	Morton, Howard J.
New Zealand	Dunedin, Northeast Valley, 30 Calder Ave.	Collett, William George
Peru	Lima, All American Cables, Inc., Radio Staff	Shaw, Sydney Coates



APPLICATIONS FOR MEMBERSHIP

Applications for transfer or election to the various grades of membership have been received from the persons listed below, and have been approved by the Committee on Admissions. Members objecting to transfer or election of any of these applicants should communicate with the Secretary on or before February 28, 1930. These applicants will be considered by the Board of Direction at its March 5th meeting.

For Transfer to the Member grade		
Dist. of Columbia	Washington, 3221 Connecticut Ave.	Diamond, Harry
Australia	Brisbane, Queensland, Broadcasting Station 4QG	Bardin, W. F.
England	London EC4, 123/5 Queen Victoria St.	Gambrell, H. W.
South Africa	Natal, Durban, Durban Broadcasting Station, Municipal Building.	Allaway, G. N. P.
For Election to the Member grade		
New York	New York City, 106 Seventh Avenue.	Cohn, Hugo
Ohio	Cincinnati, 1027 Valley Lane, Avondale.	Church, John F.
Pennsylvania	Swissvale, 7333 Whipple St.	Zworykin, V. K.
Virginia	Quantico, Marine Barracks.	Moriarty, James F.
England	North Wembley, Middlesex, Shrublands, 7 Paxford Rd.	Lane, C. F.
For Election to the Associate grade		
California	Los Angeles, 708 N. Kenmore Rd.	Alford, Andrew
	Los Angeles, 820 W. 30th St.	Berkoll, G. F.
	Los Angeles, 1653-3rd Ave.	Day, Ralph P.
	Oakland, 596-58th St.	Zimmer, H. F.
Connecticut	New Haven, 280 Whalley Ave., Apt. 3.	Messer, H. G.
	Torrington, 85 Prescott St.	Alexas, Joseph
Dist. of Columbia	Washington, 1745-18th St., N. W.	McNallan, Wilbur T.
	Washington, 1300 Gee St., N. W.	Roberts, Matthew H.
Florida	Jacksonville, Radio Station WJAX.	Canepa, John M.
Illinois	Chicago, 1735 Washburne Ave.	Carney, Louis P.
	Chicago, 2625 N. Rockwell St.	Smith, Paul S.
	St. Louis, 3015 Regent Pl.	Reiss, Paul E.
Indiana	Albion, 115 N. Elm St.	Ravenscroft, Carl E.
Iowa	Shenandoah.	Rapp, John C.
Louisiana	Bastrop, Moeller's Radio Shop.	Moeller, Jerome H.
Maine	Bangor, 64 Ohio St.	Mullaney, John R.
Massachusetts	Gloucester, 91 Main St.	Adams, John C.
	New Bedford, 77 Jouvette St.	Blanchet, Ovila J.
	Somerville, 34 Flint St.	Balderson, James R.
Michigan	Watertown, 60 Church St.	Salvini, David K.
	Ann Arbor, 1020 Olivia Ave.	Williams, N. H.
	Detroit, 1820 Helen Ave.	Howey, Wm. J.
	Flint, 614 Pierson St.	Raab, Edwin F.
	Grand Rapids, 16½ Hall St., S. E.	Blett, E. B.
	Muskegon, 119 Irwin Ave.	Retzlaff, K. C.
Minnesota	Sault Ste Marie, 600 South St.	Smith, Rex B.
	Minneapolis, 3832 Elliot Ave.	Braum, Cyril M.
	Minneapolis, 531 Walnut St., S. E.	Kallio, Wilho
Nebraska	Omaha, 3071 S. 32nd St.	Veverka, R. E.
New Jersey	Bloomfield, 200 Franklin St.	Briggs, T. H. IV
	Cliffwood, Bell Telephone Labs., Box #31.	Beck, Alfred C.
	Camden, 2222 46th St.	Greene, Warren L.
	East Orange, 25 Lawton St.	Coxey, E. J.
	Irvington, 1010 Clinton Ave.	Newton, Oscar A.
	Newark, 32 Third Ave.	Erstad, A. J.
	Newark, 68 Astor St.	Kurlbaum, Georg
	Newark, 329 Walnut St.	Golden, Frank
	Newark, 459 High St., Apt. 43-R50.	Tasker, J. M.
	Penna Grove, 28 Ziegler Trust.	Douglass, Wm. A.
	Plainfield, 318 Central Ave.	Allcutt, E. B.
	Raton.	Schulze, R. L.
New Mexico	Buffalo, 318 Elm St.	Hayes, Wilber A.
New York	Buffalo, 740 S. Division St.	Windrath, M. B.
	Buffalo, 740 S. Division St.	Windrath, R. V.
	Jackson Hts., L. I., 41-40-77th St.	Beisel, Keith
	Jamaica, L. I., 146-59-107th St.	Roth, Louis H.
	New York City, 2 S. Pinehurst Ave.	Brainson, Wm.
	New York City, 463 West St.	Coles, Francis A.
	New York City, 463 West St.	Plummer, W. E.
	New York City, 3120 Hull Ave.	Roth, Wm.
	New York City, 20 West 40th St.	Sperry, A. T.
	Rochester, 3 Stebbins St.	Hartmetz, F. P.
	Rochester, 25 Bernard St.	Haas, Paul
	Rochester, 311 Wilkins St.	Kimmel, K. A.
	Troy, 24 Cortlandt St.	Herman, S. P.

Applications for Membership

New York (cont.)	Utica, 2814 Dearborn Pl.	Gray, John E.
	Utica, 11 Clark Pl.	Steates, E. F.
Ohio	Woodside, L. I., 50-06 Bliss St.	Carreau, E. L.
	Ashtabula, 13 Orchard Ave.	Cornell, James F.
	Cleveland, 947 Leader Building	Sponagle, C. E.
	Dayton, 615 West Circle Drive	Mohn, Olaf
	Dayton, 30 W. Beechwood Ave.	Retter, C. T.
	Norwood, 5210 Warren Ave.	Willging, L. F.
	Portsmouth, Wheeling Steel Corp.	Byers, James C.
	Springfield, United Reproducers Corp.	Kesheimer, E. V.
Oklahoma	Hugo, 402 E. Lowery St.	Wright, A. J., Jr.
	Oklahoma City, 706 W. Second	Roberts, C. E.
Pennsylvania	Erie, 1853 East Lake Rd.	Metzner, M. W.
	Philadelphia, 4447 Baker St., Manayunk	Merman, J. C.
	Philadelphia, 5553 N. Lawrence St.	Nagle, John F.
	West Philadelphia, 5006 Willows Ave.	Caulton, C. O.
	Reading, 940 Elm St.	Liesman, F. J.
	Trooper	Zern, R. T.
Tennessee	Memphis, 2190 Harbert Ave.	Montgomery, Wm. C., Jr.
Texas	Corpus Christi, Radio Sta. KGFI, Plaza Hotel Studio	Lockhart, Hildred B.
	Dallas, 317 W. 8th St.	Childers, Horace W.
	Dallas, 612 S. Willomet St.	Howard, G. M.
	Dallas, 5647 East Side Ave.	Mitchell, John P.
	El Paso, Box #73, Station A	Talbott, E. P.
	Houston, P. O. Box #1705	Van Orsdale, A. A.
Vermont	Rutland, 127 Lincoln Ave.	Westeren, S. E.
Virginia	Dumbarton, R. F. D. #1, Box #204, Wilson Ave.	Eubank, R. N.
	Richmond, 2315 Third Ave.	Woods, David C.
Washington	Spokane, 515 E. Ermina Ave.	Rankin, R. C.
Wisconsin	Shorewood, 367 Newton Ave.	Gellerup, D. W.
	Stevens Point, 228 McCulloch St.	Spindler, E. R.
Alaska	Cordova, U. S. Naval Radio Station	McGarry, John
Argentina	Buenos Aires, Cia. Internacional de Radio, Avenida Ro-	
	que Saenz, Pena 501.	O'Reilly, C.
Australia	Sydney, N. S. W., So. Radio Eng. Co., 363 rd Oxford St.	Israel, B. F.
Canada	Edmonton, Alberta, 10434-69th Ave.	Field, George S.
	Edmonton, Alberta, 10434-69th Ave.	Field, Percy A.
	Kingston, Ont., 262 Frontenac St.	Little, Willis C.
	Montreal, Que., 4221 Decarie Blvd.	Kelly, F. J.
	Montreal, Que., 986 Cote des Neiges Road.	Zavitz, R. D.
	Toronto, Ont., 15 Churchill Ave.	Killem, Morris
China	Hongkong, Sam Cheung Co., 40 Wing On St.	Wu, F. T. S.
England	Bradford, Yorks, 57 Whitehall Road	Sykes, Wm. E.
	Epping, Essex, 26 Bury Road	Wilecock, A. E.
	London, Aldwych, Internat. Standard Elec. Corp., Con-	
	naught House	Baskett, Fred. J.
	London, Aldwych W. C. 1, Internat. Standard Elec. Corp.	
	Connaught House	Hamilton, D.
	London, Aldwych W. C. 2, Internat. Tel. and Tel. Labs.	
	Inc., Connaught House	Pedersen, G. V. C.
	London, "Castelnau," 189 Gunnersbury Lane, Acton W.	
	3	Burgess, A. G.
	Sheffield, 286 Handsworth Road.	Booler, Ernest
	Wembley, Middlesex, "Cottrell" 3 Georgian Court	Hawkeswood, A. E.
Guam	Naval Station, M. B.	Francis, O. T.
Hawaii	Honolulu, Box #2993	Macartney, A. Roy
Japan	Sapporo, Hosokyoku Tsukisappu Hosojou	Wataru, Sugiyama
For Election to the Junior grade		
Illinois	Springfield, 1844 S. 15th St.	Numrick, Fred
Indiana	Kendallville, 533 N. Wood St.	Jones, R. P.
Iowa	Monticello	Burrichter, D. E.
Massachusetts	Lowell, 482 Westford St.	Marte, Chas. W.
	Somerville, 96 Temple Road	MacInnis, James R.
Missouri	Kansas City, 3821 Michigan	Joyce, G. B.
Nebraska	Lincoln, 1844 Washington	Kleinkauf, J. D.
Ohio	Cleveland, 1973 W. 52nd St.	Lyle, Chas. F.
New York	Utica, 303 Richardson Ave.	Hart, Herbert
New Jersey	Whippany, Bell Telephone Labs	Bradford, C. I.



OFFICERS AND BOARD OF DIRECTION, 1930

(Terms expire January 1, 1931, except as otherwise noted)

President

LEE DE FOREST

Vice-President

A. G. LEE

Treasurer

MELVILLE EASTHAM

Secretary

JOHN M. CLAYTON

Editor

ALFRED N. GOLDSMITH

Managers

J. H. DELLINGER

L. M. HULL

A. F. VAN DYCK

R. A. HEISING

R. H. MANSON

ARTHUR BATCHELLER

(Serving until Jan. 1, 1932)

C. M. JANSKY, JR.

J. V. L. HOGAN

(Serving until Jan. 1, 1932)

(Serving until Jan. 1, 1933)

R. H. MARRIOTT

(Serving until Jan. 1, 1933)

Junior Past Presidents

ALFRED N. GOLDSMITH

A. HOYT TAYLOR

Board of Editors, 1930

ALFRED N. GOLDSMITH, *Chairman*

STUART BALLANTINE

G. W. PICKARD

RALPH BATCHER

W. C. WHITE

J. W. HORTON

L. E. WHITTEMORE

W. WILSON

COMMITTEES OF THE INSTITUTE OF RADIO ENGINEERS, 1930

Committee on Meetings and Papers

J. W. HORTON, *Chairman*

Theory, Circuit and General

L. M. HULL

Generating Apparatus and Theory

L. P. WHEELER

Receiving Apparatus and Theory

H. A. WHEELER

Transmission through Space

G. W. KENRICK

Measurements and Standards

C. B. JOLLIFFE

Vacuum Tubes and Thermionics

W. C. WHITE

Aerials and Aerial Systems

G. C. SOUTHWORTH

Acoustics and Audio Frequencies

IRVING WOLFF

Aircraft and Directional Radio

F. M. RYAN

Stations and Operation, Broadcasting

R. M. MORRIS

Television

DELBERT E. REPLOGLE

Picture Transmission

R. H. RANGER

Wire Telephony and Telegraphy

H. A. AFFEL

Miscellaneous Technical Papers

K. S. VAN DYKE

Historical, Book Reviews, Bibliographies, S. S. KIRBY

Radio Communication Systems

T. A. M. CRAVEN

Radio Manufacturing

G. G. THOMAS

Members at Large

ELLERY W. STONE

HARRY SADENWATER

Committees of the Institute—(Continued)

Committee on Admissions

R. A. HEISING, *Chairman*

C. N. ANDERSON
ARTHUR BATCHELLER
C. M. JANSKY, JR.
A. G. LEE
GEORGE LEWIS

R. H. MARRIOTT
E. R. SHUTE
J. S. SMITH
A. F. VAN DYCK
Chairman of each Section, *ex officio*

Committee on Institute Awards

W. G. CADY, *Chairman*

STUART BALLANTINE
RALPH BOWN

ALFRED N. GOLDSMITH
A. HOYT TAYLOR

Committee on Bibliography

B. E. SHACKELFORD, *Chairman*

M. C. BATSEL
W. G. CADY
J. H. DELLINGER
MELVILLE EASTHAM
G. W. GIBBS
C. B. JOLLIFFE
F. H. KROGER
R. H. LANGLEY
R. H. MANSON
J. O. MAUBORGNE

DONALD McNICOL
G. W. PICKARD
E. R. SHUTE
H. M. TURNER
A. F. VAN DYCK
H. A. WHEELER
L. P. WHEELER
W. C. WHITE
L. E. WHITTEMORE
W. WILSON

Committee on Broadcasting

L. M. HULL, *Chairman*

ARTHUR BATCHELLER
PAUL A. GREENE
RAYMOND GUY
J. V. L. HOGAN

C. W. HORN
R. H. MARRIOTT
E. L. NELSON

Committee on Constitution and Laws

R. H. MARRIOTT, *Chairman*

ARTHUR BATCHELLER
MELVILLE EASTHAM
W. G. H. FINCH
H. E. HALLBORG

R. A. HEISING
G. W. PICKARD
HAROLD A. ZEAMANS

Committee on Membership

I. S. COGGESHALL, *Chairman*

W. H. BELTZ
F. R. BRICK
W. W. BROWN
BEVERLY DUDLEY
H. C. GAWLER
F. A. KOLSTER
S. R. MONTCALM

A. F. MURRAY
M. E. PACKMAN
C. R. ROWE
J. E. SMITH
JOHN C. STROEBEL, JR.
A. M. TROGNER
Secretary of each Section, *ex officio*

Committee on New York Programs

R. H. RANGER, *Chairman*

AUSTIN BAILEY
H. C. GAWLER

F. M. RYAN
E. R. SHUTE

Committees of the Institute—(Continued)

Committee on Nominations

ALFRED N. GOLDSMITH, *Chairman*

ARTHUR BATCHELLER
W. G. CADY
MELVILLE EASTHAM

R. H. MANSON
DONALD McNICOL

Committee on Publicity

W. G. H. FINCH, *Chairman*

H. W. BAUKAT
ZEH BOUCK
C. E. BUTTERFIELD
ORRIN E. DUNLAP
FRED EHLERT
A. H. HALLORAN
R. D. HEINL

LOYD JACQUET
ARTHUR H. LYNCH
J. F. J. MAHER
A. H. MORSE
U. B. ROSS
J. G. UZMANN
WILLIS K. WING

Committee on Sections

AUSTIN BAILEY, *Chairman*

L. A. BRIGGS
D. H. GAGE
VIRGIL M. GRAHAM
C. W. HORN
R. H. LANGLEY

A. F. MURRAY
A. M. PATIENCE
B. E. SHACKELFORD
Chairman of each Section, *ex officio*

Committee on Standardization

J. H. DELLINGER, *Chairman*

WILSON AULL
M. C. BATSEL
W. R. BLAIR
E. L. BOWLES
C. E. BRIGHAM
E. L. CHAFFEE
L. M. CLEMENT
T. A. M. CRAVEN
T. McL. DAVIS
E. T. DICKEY
CARL DREHER
H. W. DREYER
ALLEN DU MONT
C. P. EDWARDS
S. W. EDWARDS
P. H. EVANS
GENERAL FERRIE
H. A. FREDERICK
ALFRED N. GOLDSMITH
W. E. HOLLAND
C. B. JOLLIFFE
GEORGE LEWIS

R. H. MANSON
ALEXANDER MEISSNER
C. B. MIRICK
GINO MONTEFINALE
R. M. MORRIS
E. L. NELSON
L. G. PACENT
HARADEN PRATT
D. E. REPLOGLE
J. L. REYNOLDS
H. B. RICHMOND
C. E. RICKARD
A. F. ROSE
H. N. SLAUGHTER
H. M. TURNER
K. B. WARNER
W. C. WHITE
DONALD WHITING
L. E. WHITTEMORE
C. E. WILLIAMS
HIDETSUGU YAGI





©Underwood & Underwood

LEE DE FOREST

President of the Institute, 1930

Lee de Forest was born at Council Bluffs, Iowa, August 26, 1873. He was graduated from Sheffield Scientific School of Yale University in 1896 with the B.S. degree. In 1899 he received the Ph.D. degree and in 1926 the D.Sc. Degree, from Yale University. During the Spanish American War he was a member of Battery A, First Artillery Company, Connecticut National Guard.

Since 1901 Dr. de Forest has been identified with the development of radio communication. In 1906 he patented the audion or three-element vacuum tube. In the years that followed he has been an active worker in the application of the vacuum tube in its various uses.

He has been the recipient of many honors, among them the Gold Medal of the St. Louis Exposition in 1904, for work in wireless telegraphy, and the Gold Medal of the San Francisco Exposition in 1915 for his work in radiotelephony. He has the cross of the Legion of Honor from France, the Elliott Cresson Medal from the Franklin Institute, the Medal of Honor from the Institute of Radio Engineers, and the John Scott Medal from the City of Philadelphia.

Dr. de Forest is a Fellow in the Institute of Radio Engineers and the American Institute of Electrical Engineers.

He was elected by the membership to the Presidency of the Institute of Radio Engineers on January 8, 1930.

INSTITUTE NEWS AND RADIO NOTES

January Meeting of the Board of Direction

At the January 8, 1930 meeting of the Board of Direction, held in the office of the Institute, 33 West 39th Street, New York City, at 2 P.M. the following Board members were present: A. Hoyt Taylor, president; Melville Eastham, treasurer; Lee de Forest, president-elect; Alfred N. Goldsmith, junior past president; Arthur Batcheller, J. H. Dellinger, R. A. Heising, R. H. Manson, R. H. Marriott, and John M. Clayton, secretary.

The official count of the Committee of Tellers, appointed to ascertain the vote of the membership for officers and Board members for this year was certified, the results of the ballot being as follows: president, Lee de Forest; vice president, Colonel A. G. Lee; managers with terms to January 1, 1933—J.V.L. Hogan and R. H. Marriott.

R. A. Heising, L. M. Hull, and A. F. Van Dyck were appointed members of the Board for 1930. Melville Eastham was reappointed treasurer of the Institute and John M. Clayton, secretary.

The following were transferred and elected to the grades of membership indicated.

Transferred to the Fellow grade: H. Barkhausen.

Transferred to the Member grade: Edward Austin, C. A. Boddie, Burke Bradbury, A. W. Kispagh, C. C. Meredith, and Arthur E. Thiessen.

Elected to the Fellow grade: H. Fassbender.

Elected to the Member grade: R. W. Carlisle, Lieut. Comm. Lowell Cooper, Allen B. DuMont, Ralph Fortier, Harry G. Grover, G. Israel Kraemer, J. A. Lavallee, L. O. Marsteller, Phya Prakt, E. W. Ritter, and Albert Roth.

Three hundred and seven Associate members and twenty Junior members were elected.

F. M. Ryan was appointed the Institute's representative on the Committee on Aeronautical Radio Research, Department of Commerce.

Alfred N. Goldsmith was appointed Editor of the PROCEEDINGS to succeed W. G. Cady, resigned.

J. C. Jensen, of Nebraska-Wesleyan University, was appointed the Institute's representative on the Council of the American Association for the Advancement of Science.

R. H. Marriott was appointed the Institute's representative on the Executive Committee of the American Section, International Scientific Radio Union.

It was announced that the final paid membership of the Institute as of December 31, 1929, was 5,695, an increase of 848 during the year.

Associate Application Form

For the convenience of members of the Institute who may want to present an application form for Associate membership to their eligible non-member friends or associates, there appears each month in the advertising section of the PROCEEDINGS a condensed Associate application blank.

Application forms for membership in other grades may be obtained from the Institute upon application.

Radio Signal Transmissions of Standard Frequency

FEBRUARY TO JUNE, 1930

The following is a schedule of radio signals of standard frequencies for use by the public in calibrating frequency standards and transmitting and receiving apparatus as transmitted from station WWV of the Bureau of Standards, Washington, D.C.

Further information regarding these schedules and how to utilize the transmissions can be found on pages 10 and 11 of the January, 1930, issue of the PROCEEDINGS and in the Bureau of Standards Letter Circular No. 171 which may be obtained by applying to the Bureau of Standards, Washington, D.C.

Eastern Standard Time	Feb. 20	Mar. 20	Apr. 21	May 20	June 20
10 00 PM	4000	550	1600	4000	550
10 12	4400	600	1800	4400	600
10 24	4800	700	2000	4800	700
10 36	5200	800	2400	5200	800
10 48	5800	1000	2800	5800	1000
11 00	6400	1200	3200	6400	1200
11 12	7000	1400	3600	7000	1400
11 24	7600	1500	4000	7600	1500

1929 Bound Volumes

A limited number of bound volumes of the PROCEEDINGS for the year 1929 are available. These are bound in a substantial blue buckram binding and are complete with the annual index. To members of the Institute the price is \$9.50 per volume; to others, \$12.00 per volume.

Committee Work

COMMITTEE ON ADMISSIONS

A meeting of the Committee on Admissions was held on January 3rd in the office of the Institute, 33 West 39th Street, at 10:00 A.M. Members present were R. A. Heising, chairman; Arthur Batcheller, J. S. Smith, and A. F. Van Dyck.

The Committee considered seventeen applications for transfer or election to the Member grade in the Institute. Nine of these applications were approved.

SUBCOMMITTEE ON RECEIVERS AND PARTS

A meeting of the Subcommittee on Radio Receivers and Parts of the Institute's Committee on Standardization was held at 10 A.M. on January 7th in the office of the Institute. Members of the subcommittee were present as follows: E. T. Dickey, chairman; George Crom, C. E. Dean (representing W. A. McDonald), Malcolm Ferris, E. J. T. Moore (representing V. M. Graham), and H. P. Westman, secretary.

COMMITTEE ON BROADCASTING

The Committee on Broadcasting met at 10 A.M. on January 8th. Members present included R. H. Marriott, acting chairman; R. F. Guy, Paul A. Greene, E. L. Nelson, and Arthur Batcheller.

COMMITTEE ON MEMBERSHIP

In the office of the Institute at 5:30 P.M. on Wednesday, January 8th, a meeting of the Committee on Membership was held. Those present were I. S. Coggeshall, chairman; H. B. Coxhead, F. R. Brick, R. S. Kruse, H. C. Gawler, J. E. Smith, and A. M. Trogner.

SUBCOMMITTEE ON VACUUM TUBES

A meeting of the Subcommittee on Vacuum Tubes of the Standardization Committee of the Institute was held at 10 A.M. January 9th in the office of the Institute. Those present were C. B. Jolliffe, chairman; Stuart Ballantine, E. L. Chaffee, H. F. Dart, D. E. Harnett, J. W. Horton, George Lewis, W. C. White, J. C. Warner, and H. P. Westman, secretary.

TECHNICAL COMMITTEE ON ELECTRO-ACOUSTIC DEVICES

The Technical Committee on Electro-Acoustic Devices of the American Standards Association met at 2:00 P.M. on January 9, 1930, in the Institute office in New York City. Members present were as

follows: Irving Wolff, chairman; Austin Armer, L. G. Bostwick, E. D. Cook, H. A. Frederick, J. W. Horton, C. L. Farrand, E. W. Kellogg, Benjamin Olney, L. J. Sivian, H. B. Smith, J. E. Volkmann, J. D. Phyfe, and H. P. Westman, secretary.

Report of 1929 Activities of Committee on Standardization

The Committee on Standardization inaugurated the vigorous expansion of the Institute's standardization work decided upon by the Board of Direction in its June 5th resolution. Most of the time of the assistant secretary of the Institute is devoted to the work of this committee and of the A.S.A. Sectional Committee on Radio, of which the Institute is a sponsor. He acts as secretary of this committee and of all its subcommittees. The committee has set up four subcommittees which carry on most of the work. Two of the subcommittees have organized parts of their work in sub-subcommittees.

The committee is making a special point of working in collaboration with other organizations in similar fields. There are included in the committee's membership officially designated representatives of the A.I.E.E., R.M.A., and N.E.M.A. There is similarly a representative of the R.M.A. and of the N.E.M.A. on each subcommittee.

An executive committee of eight was organized, consisting of the chairman and secretary, the representatives of the R.M.A. and N.E.M.A., and the four subcommittee chairmen. This executive committee considers matters of organization, coordination, and cooperation. The Standardization Committee as a whole passes upon the reports of the subcommittees and in addition deals with technical matters not handled by any subcommittee.

The committee has been assisted by a number of comments on the 1928 Standardization Report, which have been received from members and others. The R.M.A. suggested revisions of some of the provisions of the radio receiver testing standards, and drew attention to the need of testing methods for radio-frequency transformers and for loud speakers.

A number of standards of interest to radio engineers have been selected from the published standards of the A.S.A. and A.I.E.E. for publication in the 1930 Year Book. These will be given simply for the information of the Institute members, no action on them having been taken by the Institute or its Standardization Committee.

The reports of three of the four subcommittees follow. The other subcommittee, on electro-acoustics, has work in progress or in prospect on the following subjects: Review of the portions of 1928 Standard-

ization Report dealing with electro-acoustic matters to consider any suitable for submission to the A.S.A. Sectional Committee on Radio as tentative American standards.

Review of definitions of types of loud speakers.

Methods of measuring sound output of loud speakers as a function of frequency.

Methods of measuring loud-speaker overload and sensitivity.

Respectfully submitted,

J. H. DELLINGER, *Chairman*

SUBCOMMITTEE ON RADIO RECEIVERS

Work Done and in Progress

Review of the comments on the section on Radio Receivers which have been received since the publication of the 1928 Standardization Report.

Review of the sections of the 1928 Standardization Report dealing with radio receivers for the purpose of deciding upon those which are suitable for submission to the Sectional Committee on Radio of the American Standards Association as tentative American standards.

Formation of three sub-subcommittees of the Subcommittee on Radio Receivers to handle the work in connection with drawing up standards for high-frequency receivers, aircraft receivers, commercial marine receivers, and direction finders.

Problems for Future Work

Preparation of a test outline for determining the distortion caused in radio reception by the detector.

Preparation of definitions for new terms such as "linear detector" and "power detector."

Preparation of a test outline for measurement of automatic volume controls.

Study of the present graph plotting methods for the purpose of revising them if such action seems desirable.

Preparation of test outlines for measurement of component parts of a radio receiver.

E. T. DICKEY, *Chairman*

Subcommittee on Radio Receivers

SUBCOMMITTEE ON RADIO TRANSMITTERS AND ANTENNAS

Work Done and in Progress

The subcommittee has reviewed the portions of 1928 Standardization Report coming within its scope and has prepared some tentative revisions.

Three sub-subcommittees have been appointed to deal with the following subjects: (1) nomenclature, symbols and definitions; (2) methods of testing apparatus, equipment, devices, and materials, used in radio transmitters and antennas; (3) establishment of provisions for safety of operating and other personnel in relation to radio transmitting equipment.

Problems for Future Work

Additional definitions on antennas.

Methods of test for safety provisions.

Definitions relating to the general external effects produced by transmitting apparatus. Owing to the small contact of the general public with transmitting apparatus itself, and the relatively small number of manufacturers, each of whom have their own specifications as to materials, etc., the general opinion seems to be that our work should be primarily confined to the effects the equipment produces, which is the point of contact between the equipment itself and the general public. To this end, it is proposed to discuss and adopt all desirable pertinent matters arrived at by the American Delegation, as embodied in its recommendations to the C.C.I.R. meeting at The Hague this year.

HARADEN PRATT, *Chairman*

Subcommittee on Radio Transmitters and Antennas

SUBCOMMITTEE ON VACUUM TUBES

Work Done and in Progress

Review of the comments on section on Vacuum Tubes of 1928 Standardization Report received since publication.

Revision and amplification of some definitions to make them applicable to vacuum tubes having any number of electrodes.

Problems for Future Work

Study of vacuum-tube letter symbols and formulation of a new standard system.

Review of section on vacuum tubes of 1928 Standardization Report with view to selecting material for submission to Sectional Committee on Radio of the American Standards Association as tentative American standards.

Review of section on Standard Methods of Measuring Important Characteristics of Vacuum Tubes to consider applicability of these methods to new types of vacuum tubes.

C. B. JOLLIFFE, *Chairman*

Subcommittee on Vacuum Tubes

Photographs of Delegates to the Eastern Great Lakes District Convention

Members of the Institute who were present at the Eastern Great Lakes District Convention and did not secure a photograph of the delegates taken at Valley Appliances, Inc., may receive one copy of the photograph, gratis, by addressing John W. Dodson, Valley Appliances, Inc., P. O. Box 105, Rochester, N. Y.

Institute Meetings

ATLANTA SECTION

The December, 1929, meeting of the Atlanta Section of the Institute was held in the Hurt Building, Atlanta, on the 26th of the month.

H. P. Thornton, chairman of the section, presided. K. A. Pitt, of the Electrical Research Laboratories, presented a demonstration of the Western Electric sound system.

A. Hoyt Taylor, president of the Institute, was the guest of honor. Dr. Taylor addressed the section on the activities of the Institute, reviewing the work accomplished during the year.

Philip C. Bangs was elected secretary-treasurer of the section to fill the vacancy caused by the resignation of J. H. McKinney, removed to Dallas, Tex.

Forty-seven members of the section and their guests attended this meeting.

BUFFALO-NIAGARA SECTION

A meeting of the Buffalo-Niagara Section was held on December 18th in Edmund Hayes Hall, University of Buffalo. L. Grant Hector, chairman of the section, presided.

C. G. Miller, of the Weston Electrical Instrument Corporation, presented a paper on "Electrical Measuring Instruments" and S. W. Brown, of Cumberland-Young, Inc., read a paper, "Vacuum Tubes Employing both Space-Charge and Screen Grids."

The Buffalo-Niagara Section met on January 2, 1930, in Room 239, Edmund Hayes Hall, University of Buffalo. L. Grant Hector, chairman of the section, presided.

H. N. Kozaowski, of the Department of Physics, University of Michigan, presented a paper, "Quartz Crystals and their Application to Radio."

A general discussion on the part of the twenty-two members and guests followed the presentation of this paper

CINCINNATI SECTION

The Cincinnati Section met December 19th in the Cincinnati Chamber of Commerce. R. H. Langley, chairman of the section, presided.

Mr. Langley reported on the meeting of the Committee on Sections held in New York on December 5, 1929, and Mr. Loftis discussed three of the papers which were presented at the Eastern Great Lakes District Convention.

Twenty-six members and guests attended the meeting.

CLEVELAND SECTION

A meeting of the Cleveland Section was held on December 20, 1929, in the studios of Station WTAM. B. W. David, chairman of the section, presided.

Three speakers discussed the construction of the new WTAM studios and station as follows: S. E. Leonard, "The New Studio"; F. E. Rutzen, "The New Station"; and G. Deitz, "The New Antenna System." All of the talks were illustrated with lantern slides.

A special program of WTAM artists was put on and dedicated to the local I.R.E. Section. This feature was broadcasted.

1930 officers of the section were elected at this meeting as follows: D. Schregardus, chairman; S. E. Leonard, vice chairman; C. H. Shipman, secretary-treasurer. Chairmen of two of the committees were appointed as follows: J. R. Martin, program committee, and E. L. Gove, membership committee.

Forty-five members of the section attended this meeting.

NEW YORK MEETING

The New York meeting for January was held on the 8th of the month in the Engineering Societies Building, 33 West 39th Street. A. Hoyt Taylor, retiring president, presented a short summary of the activities of the Institute during the year and introduced Lee de Forest, president-elect, who made a short inaugural address. Two papers were presented as follows: "Summary of Developments in Frequency Standardization," by J. H. Dellinger and C. B. Jolliffe, both of the Radio Section, Bureau of Standards, Washington, D. C., and "Summary of Progress in the Study of Radio Wave Propagation Phenomena" by G. W. Kenrick, Tufts College, Mass., and G. W. Pickard, consulting engineer, Wireless Specialty Apparatus Co. The former paper was presented by Dr. Jolliffe and is summarized as follows:

The steadily increasing requirements of accuracy in frequency measurements were given new impetus by the decisions of the Inter-

national Consulting Committee on Radio Communication, which met at The Hague in September, 1929. The spectrum of radio frequencies is to be used more efficiently in the future, largely through closer regulation of the frequencies of transmitting stations. In some parts of the spectrum, it will not be long until stations will be required to remain within 1 part in 10,000 of the assigned frequency. Station standards must be capable of ten times this accuracy and the national primary standard one hundred times. The paper shows that these requirements are reasonable and that means will be available whereby they can be readily attained."

The second paper, presented by Dr. Kenrick, is summarized as follows:

"Recent progress in the study of radio wave propagation phenomena is surveyed in the light of the history of the art. The paper is divided into three parts: (A) an historical review; (B) recent developments; and (C) conclusions and outlook for future development. Part A, The historical development of the art from its inception to 1927 is considered. The discussion includes an outline of early isolated sphere hypotheses, their limitations, and the development of the modern Kennelly-Heaviside layer theory of radio transmission. Early experimental progress, echo signals, magnetic correlations, and the relations of the science of radio direction finding are also considered. Part B, (On recent advances) reviews the progress of the last year or 18 months and includes a discussion of publications on the Störmer-van der Pol echoes and their theoretical interpretation. Progress in Kennelly-Heaviside layer height determinations and experimental studies in transmission and magnetic and solar correlations are also considered. Part C, The rapidity of the advance during the last year is noted, but the need of further consistent observations and other means of investigation before anything approaching a complete satisfactory theory of radio transmission can be evolved is pointed out. A bibliography of 100 references is also included."

It is believed that both of these papers will be published in forthcoming issues of the PROCEEDINGS.

Four hundred and fifty members of the Institute and their guests attended this meeting.

PHILADELPHIA SECTION

A meeting of the Philadelphia Section of the Institute was held in the Franklin Institute, Philadelphia, on January 7, 1930. J. C. Van Horn, chairman of the section, presided.

J. C. Schelleng, Bell Telephone Laboratories, presented a paper, "Some Problems in Short-Wave Telephone Transmission." It is expected that this paper will be published in a forthcoming issue of the PROCEEDINGS.

R. H. Goddard, Department of Physics, Clark University, presented a paper on "The Development of a Rocket for the Investigation of the Upper Atmosphere." The paper included a popular but accurate

discussion of the problems entering into the design of a rocket for reaching very high altitudes, and indicated the importance of such a device in connection with transmission and studies of the Kennelly-Heaviside layer. The author believes the rocket, equipped with camera and other recording instruments, will penetrate to a distance of 472 miles by means of repeated explosive chambers. Rockets already perfected in his laboratories at Worcester, Mass., will travel to 43 miles, it was stated, at approximately 7,000 feet a second. An automatic parachute is made a part of each rocket. A motion picture showing the ascent of the rocket through the 60-foot iron tower was shown.

One hundred and twenty members and guests attended the meeting which was preceded by an informal dinner at Green's Hotel.

PITTSBURGH SECTION

On December 17, 1929, a meeting of the Pittsburgh Section was held in Utility Hall, Duquesne Light Company, Pittsburgh. L. A. Terven, chairman of the section, presided.

J. R. Harrison, of the University of Pittsburgh, presented a paper, "Characteristics and Uses of Piezo-Electric Crystals."

Messrs. Hitchcock, Terven, Koch, McArthur, Mag, Wallace, Allen, and Haller discussed the paper.

Twenty-eight members of the section were present at this meeting.

SAN FRANCISCO SECTION

On December 18, 1929, a meeting of the San Francisco Section was held in the Engineers' Club, 206 Sansome Street, San Francisco. Donald K. Lippincott, chairman of the section, presided.

Harry R. Lubcke, assistant director of research, Television Laboratories, Inc., presented a paper on "Band Pass Filters." Mr. Lubcke presented the results of an analysis of band pass filters as used in radio receivers and described their practical significance.

Thirty-two members of the section attended this meeting.

SEATTLE SECTION

A meeting of the Seattle Section was held on December 20, 1929, in Philosophy Hall, University of Washington. Austin V. Eastman, chairman of the section, presided.

Captain Robert M. Shaw, of the Signal Corps, U. S. Army, presented a talk on "Radio in the Signal Corps." The paper included a history of the Signal Corps communication system. The talk was illustrated by a display of several portable transmitters and receivers. Captain Shaw explained in detail the experiences of the Signal Corps during the war.

Twenty-five members of the section were present.

WASHINGTON SECTION

On December 11, 1929, a meeting of the Washington Section was held in the Continental Hotel, Washington, D. C. C. B. Jolliffe, chairman of the section, presided.

A symposium on early days of radio was conducted by Dr. L. W. Austin, General George O. Squier, Dr. Louis Cohen, and Dr. A. Hoyt Taylor.

Forty-eight members of the section attended the meeting.

Errata

The following corrections have just been received to the paper entitled "The Piezo-Electric Resonator and Its Equivalent Network," by K. S. Van Dyke, published in the Vol. 16, No. 6 issue of the PROCEEDINGS, pages 742-764:

Page 748, line 10, delete $P =$.

" 752, " 31, formula should be $g = \pi^2 A' G / 2l'$.

" 757 " 23, *Eqs.* (7) should read *Eqs.* (13).

" 25, $C_1 = 1.0 \mu\mu\text{f}$ should read $C_1 = 9.4 \mu\mu\text{f}$.

" 759, footnote, third line, *ten* should read *three*.

" 762, lines 15 and 16, (b) and (a) should be interchanged.

In the paper by Yuziro Kusunose, entitled "Calculation of Characteristics and the Design of Triodes" and published in the Vol. 17, No. 10 issue of the PROCEEDINGS, pages 1706-1749, two errors in mathematics have been found, as follows:

Page 1712, Example 3. The equation in the third line of the calculations should read:

$$G = 2.33 \times 34.2 / 0.25 \times 0.68 \times 10^{-6} = 0.469 \times 10^{-3}.$$

" 1726, Example 11. The first dimension, given as $x_o = 1.15$ should read $x_a = 1.15$.





PART II
TECHNICAL PAPERS

A NEW TRANSFORMATION IN ALTERNATING-CURRENT THEORY WITH AN APPLICATION TO THE THEORY OF AUDITION*

BY

BALTH. VAN DER POL

(Physical Laboratory, Philips Incandescent Lamp Works, Eindhoven, Holland)

Summary—A mathematical transformation of the elements of an impedance, called a j -transformation is considered whereby the complex impedance of each of the constituents is multiplied by j , j^2 and j^3 and thereupon the physical meaning of such a transformed system is investigated. Thus new circuits can be derived from known circuits and special properties of the former are transformed into new special properties of the latter. Further negative capacities and negative inductances are considered which are independent of frequency.

Next several a-c circuits are described having the property that the modulus of their impedances is independent of frequency. Hence a complicated "wave" form, such as speech, retains in such a circuit all its higher harmonics with their former amplitudes, though the phases of these harmonics are shifted. Oscillograms of vowels thus obviously show a very marked distortion, though the ear is unable to detect this phase distortion. The experiments confirm the well-known acoustical law of Ohm stating that within limits the ear is not able to detect phase shifts of the components of a complicated sound.

IN ordinary linear a-c theory an inductive reactance is usually represented by $+j\omega L$, while a capacitive reactance is denoted by $-j/\omega C$. Therefore the *imaginary part* of an impedance may have a positive or negative sign. As long as positive resistances only were known the *real part* of an impedance was always positive (independent of the constitution of the network considered). But with the advent of negative resistances (such e.g., as the arc, the dynatron, or the triode with retroaction) the real part of an impedance, like the imaginary part, may have either sign.

The transformations to be considered here (and which may be called j -transformations) consist of multiplying all complex impedances of a network by j , j^2 , j^3 and j^4 , respectively, where $j = \sqrt{-1}$. Though *mathematically* these transformations obviously represent only a turning of the impedance vectors by angles $\pi/2$, π , $3/2\pi$ and 2π respectively, the *physical* interpretation of these transformations may lead to some new circuits or at first sight to unexpected relations between circuits with well-known properties.

Obviously the j^4 -transformation transforms the circuit into itself and therefore does not yield anything new. On the other hand the

* Dewey decimal classification: 530. Paper read at the U. R. S. I. meeting, Brussels, Belgium, September, 1928.

j^2 -transformation implies the multiplication of any circuit element by -1 . This means that in the network considered every positive resistance is to be replaced by a negative resistance of the same absolute value and vice versa. Moreover every positive inductance must be replaced by a negative inductance and vice versa, and also every positive capacity by a negative capacity and vice versa. With this physical interpretation of the j -transformation any network thus transformed retains its impedances (but multiplied by -1) for all frequencies. The necessity of constructing *negative inductances* and *negative capacities* does not (at least on paper) yield any difficulties, now that negative resistances are at hand. Fig. 1b has the equivalent network of Fig. 1a, as can be easily verified.

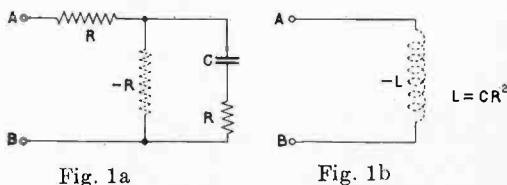

We can therefore with the aid of two positive and one negative resistances and a capacity construct a negative inductance which is independent of frequency. The circuit of Fig. 1a thus behaves exactly as if between the terminals $A - B$ a negative inductance were inserted of value $L = CR^2$.

Similarly a negative capacity (again independent of frequency) may be obtained as shown in Fig. 2, which speaks for itself¹. Thus the network of Fig. 2a is equivalent to a negative capacity of value $C = LR^{-2}$ (Fig. 2b), as is easily verified. Of course instabilities often arise in circuits comprising a-c negative resistances. The stability of such a circuit can, however, be calculated. We therefore imagine with Barkhausen² a small inductance inserted in series with an arc, and a small capacity shunted across a dynatron or triode. This system can then be further investigated with the aid of the Hurwitz determinants, giving the conditions that the real part of all the roots of an equation are negative.³

Coming now to the j -transformation and the j^3 -transformation it will be clear that the latter can be derived from the former by a j^2 -transformation so that we can further limit ourselves to the consideration of the j -transformation only.

¹ See Bartlett, *Jour. I. E. E.*, London, 65, 373, 1927. Also British Patent 278036.

² H. Barkhausen: *Phys. Zeit.*, 27, 43, 1926.

³ I found that these determinants can be considerably simplified and hope to report on this subject shortly.

As the reactance of a self-inductance and of a capacity depends upon the angular frequency ω of the impressed e.m.f. the j -transformation can be used only for one given frequency at a time so that when a different frequency is considered the physical and numerical results of the j -transformation are also different. In applying the j -transformation every positive resistance R in the network, through the multiplication by j , becomes jR and this has to be interpreted physically as $j\omega L'$, i.e., every positive resistance R is transformed into an inductance L' , of amount $L' = R\omega^{-1}$. Similarly every negative resistance $-R$ has to be replaced by a capacity C' such that $C' = (\omega R)^{-1}$. Further

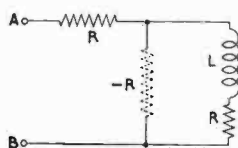

Fig. 2a

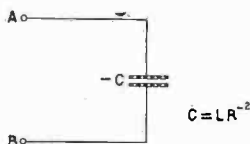

Fig. 2b

every impedance $j\omega L$ becomes $jj\omega L = -\omega L = -R'$, i.e., every inductance L has to be replaced by a negative resistance $-R'$ of an amount $R' = (\omega L)^{-1}$. Finally every capacitive reactance $1/j\omega C$ becomes $j/j\omega C = (\omega C)^{-1}$. This expression is real and positive, hence every capacity (of value C) has to be replaced by a resistance R' , where $R' = (\omega C)^{-1}$.

It will be clear that in ordinary vectorial representation the j -transformation simply means revolving a vector diagram as a whole through 90 deg. and then inquiring into the physical meaning of the revolved diagram. The j -transformation could obviously be extended to transformations such as a j^3 -transformation, meaning a rotation over an angle $\pi/4$. However, we will limit ourselves here to integral powers of j only.

Consider for example a series connection of L , C , $+R_1$ and $-R_2$. Upon this linear system let an e.m.f. be impressed of angular frequency ω . By varying L or C we can bring the system into *reactance-resonance*. When, as in a wireless receiver with retroaction, we thereupon make R_2 as nearly as possible equal to R_1 (i.e. adjust the retroaction to the critical point), we do the same thing over again, but only after one j -transformation, and one could say in a broad sense that adjusting the total resistance near zero value means bringing the system into *resistance-resonance*.

We will now consider some simple a-c circuits having special properties and inquire as to what becomes of them after a j -transformation.

Example 1.

Consider Fig. 3a, representing a well-known circuit, such as often

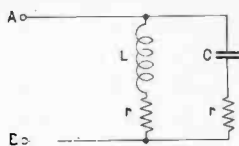

Fig. 3a

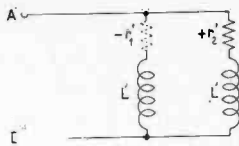

Fig. 3b

used, for example in a triode amplifier.

This circuit has the property that for resonance, i.e., for

$$j\omega L = -\frac{1}{j\omega C} \quad (1)$$

the equivalent impedance Z_{AB} between the points $A - B$ is

$$Z_{AB} = \frac{\frac{L}{C} + R^2}{2R} \quad (2)$$

and is therefore real, i.e., a pure resistance. After one j -transformation Fig. 3a is changed into Fig. 3b such that

$$\begin{aligned} j\omega L &= -R_1', \\ \frac{1}{j\omega C} &= +R_2', \\ R &= j\omega L', \\ R &= j\omega L' \end{aligned}$$

Thus the condition (1) becomes

$$R_1' = R_2' \quad (1')$$

i.e., in the derived circuit the equality of the moduli of the two resistances corresponds to the resonance condition of the original circuit. Moreover, the special property (2) of the original circuit becomes after our j -transformation

$$Z'_{A'B'} = \frac{-R_1'R_2' - \omega^2 L'^2}{2j\omega L'} = j\omega L' \cdot \frac{\omega^2 L'^2 + R'^2}{2\omega^2 L'^2} \quad (2')$$

or, in words, the system of Fig. 3b behaves as a pure inductance when the numerical values of $-R_1'^1$ and $R_2'^1$ are made equal.

Example 2.

The circuit of Fig. 4a has the property that when $j\omega L = -1/j\omega C$ i.e., in resonance, the current i_z through the arbitrary impedance Z is independent of this impedance, viz.

$$i_z = \frac{E}{j\omega L} \tag{3}$$

After the application of the j -transformation Fig. 4a becomes Fig. 4b. Here again the resonance condition of Fig. 4a is changed into the equality of the numerical values of the two resistances $-R'$ and R'

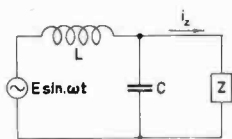

Fig. 4a

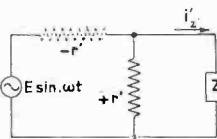

Fig. 4b

in Fig. 4b. The arbitrary impedance Z of Fig. 4a is transformed into another arbitrary impedance Z' of Fig. 4b. Again (3) changes into

$$i'_{z'} = -\frac{E}{R'} \tag{3'}$$

or in words, the current through Z' is independent of the impedance Z' itself, so that, when instead of $E \sin \omega t$ an e.m.f. is applied of arbitrary wave form, the current through Z' is an exact image in amplitudes as well as in phases of the applied e.m.f.⁴

Example 3.

Let a given current i be flowing between the terminals A and B of Fig. 5a. It is easy to show that for resonance the p.d. E_z developed across the impedance Z will be

$$E_z = \frac{i}{j\omega C}$$

and therefore does *not* depend upon the value or constitution of Z .

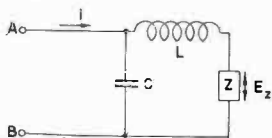

Fig. 5a

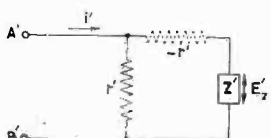

Fig. 5b

⁴ This property of Fig. 4b has already been derived by Bartlett, l. c.

The j -transformation of Fig. 5a is shown in Fig. 5b. If in the latter the negative resistance $-R'$ is numerically made equal to the positive resistance R' then the p.d. developed across the arbitrary impedance Z' is an exact image of the current i' entering the system, independent of its wave form.

Example 4. (Application to the theory of audition).

Consider the circuit of Fig. 6a. For an impressed e.m.f. of a frequency ω given by

$$\omega^2 = \frac{1}{2ZC} \quad (4)$$

the impedance Z_{AB} between the terminals AB is given by

$$Z_{AB} = j\omega L \cdot \frac{1 - j\omega CR}{1 + j\omega CR} = j\omega L \cdot e^{-2j\theta} \quad (5)$$

where

$$\tan \theta = \omega CR \quad (6)$$

We therefore see that for the specific frequency given by (4) the modulus of the impedance between the points A and B of Fig. 6a does

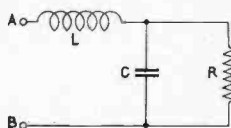

Fig. 6a

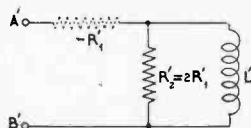

Fig. 6

not vary with the value of R . If, therefore, an alternating e.m.f. of constant amplitude and of frequency $\omega^2 = (2LC)^{-1}$ is maintained between the terminals $A - B$, the amplitude of the current through the L branch is unaffected by the value of R , but its phase is affected. This is a very valuable property for measurement purposes as we can vary the phase over 180 deg. without affecting the amplitude.

When we now apply again the j -transformation to the system of Fig. 6a, Fig. 6b is obtained.

The frequency condition (4) of the former circuit, which can be written

$$j\omega L = \frac{-1}{2j\omega C}$$

now becomes

$$R_2' = 2R_1'$$

and does *not* depend upon the frequency. The impedance $Z'_{A'B'}$ now becomes

$$Z'_{A'B'} = -R_1' \cdot \frac{R_2' - j\omega L'}{R_2' + j\omega L'} = -R_1' \cdot e^{-2i\theta'} \tag{5'}$$

where

$$\tan \theta' = \frac{\omega L'}{R_2'} \tag{6'}$$

Our circuit of Fig. 6b has therefore the following properties: *the modulus of the impedance of the network between the points A' and B' is the same for all frequencies and does not depend upon the value of L'. The phase however does depend upon the value of L'. If we therefore apply an e.m.f. of any complicated wave form to the terminals A'B' all the amplitudes of the various harmonic components of the current entering at A' will be exactly proportional to the corresponding amplitudes of the harmonics of the e.m.f. The phases of the currents however are shifted relatively to the phases of the e.m.f., and by an amount depending upon the frequency.*

The limiting cases can be recognized directly. For a very low frequency the L' branch forms a short circuit in parallel to the R₂' branch. Hence for a very low frequency the impedance Z'_{A'B'} approaches -R₁'. For a very high frequency on the other hand the branch L' (in parallel to the R₂' branch) can be ignored, thus leaving a total impedance Z'_{A'B'} = -R₁' + R₂' = -R₁' + 2R₁' = R₁'. Thus the total possible phase change is 180 deg.

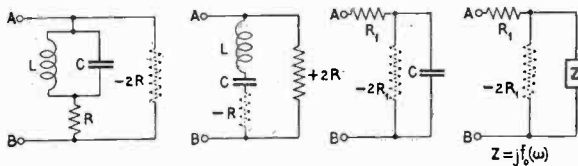

Fig. 7

Several circuits possessing the above properties can be designed. Some other examples are given in Fig. 7. (By $Z = jf_0(\omega)$ is meant any impedance consisting of inductances and capacities only.)

For all those circuits having the above property the impedance Z can be expressed as

$$Z = R \cdot \frac{f_e(\omega) - jf_o(\omega)}{f_e(\omega) + jf_o(\omega)} = R \cdot e^{-2i\theta}$$

where $f_e(\omega)$ and $f_o(\omega)$ represent an even and an odd function of ω , respectively, and where

$$\tan \theta = \frac{(f_o\omega)}{f_e(\omega)}$$

and R represents an ohmic resistance.

It may be remarked that the circuits considered are quite different from the circuit of Fig. 8, described by Möller⁵, where the ampli-

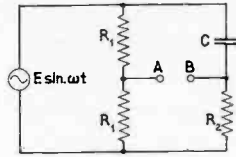

Fig. 8

tude of the potential between $A.B$ is independent of the frequency of the source $E \sin \omega t$, while the phase is also independent. However, this is only true as long as the internal resistance of the source $E \sin \omega t$ is zero which is difficult to realize in practice with triodes.

The property described of leaving the amplitudes of all the constituent harmonics untouched but changing only their phases gives us a means of verifying experimentally the well-known acoustical law of Ohm which states that our ear perceives from a complicated sound the amplitudes of the various components only and cannot recognize the phases of those components. Therefore arbitrary changes made in the phases of the components do not affect our perception of a sound as long as the amplitudes are left unaltered.

Now in order to test this law the circuit of Fig. 9 was used.

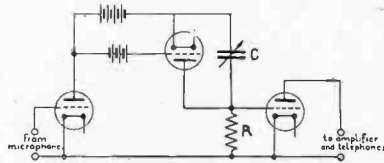

Fig. 9

The first triode acts as an amplifier, while the second triode is used as a dynatron providing the negative resistance. This circuit is essentially equivalent to the circuit of Fig. 10. The current through R

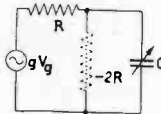

Fig. 10

represents an exact amplitude image (not phase image) of the grid potential of the first triode. The potential variations across R are the grid potential variations of the third triode.

⁵ H. G. Möller, "Schwingungsaufgaben," p. 43 (Hirzel: Leipzig 1928).

If the circuit of Fig. 9 is properly adjusted, the amplitudes of the various components of the sound spoken in the microphone are unaffected by a change of C , but their phases are affected. If now one listened to a loud speaker connected to the output side of the circuit of Fig. 9 while someone else spoke into the microphone set up in a different room, not the slightest difference could be observed after a pronounced change (up to 180 deg. and, with an L inserted in series with the C , even 360 deg.) of the phases of the components. This fact was verified by several persons so that the above law of Ohm was found to be true for phase changes up to 360 deg. Obviously the microphone and the amplifier produced some phase changes themselves. The fact, however, that the phases of the higher components could be advanced as well as retarded makes the above conclusion justified.

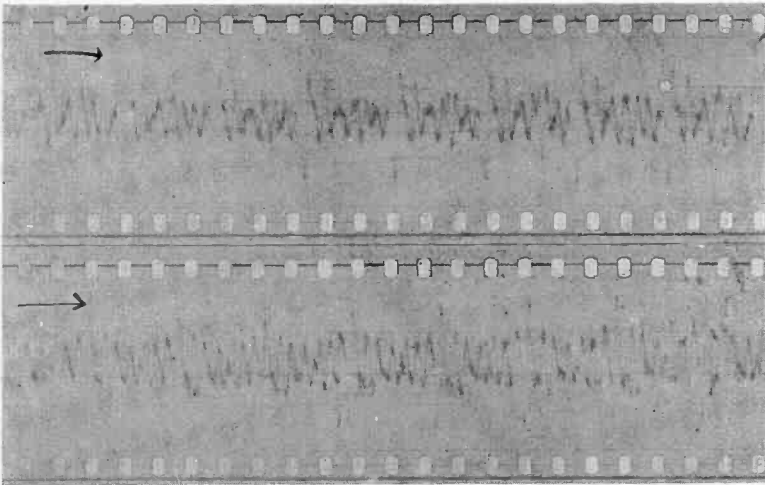

Fig. 11

For *non-periodic* sounds such as the spoken language, phase retardation may be conceived of any amount extending beyond 360 deg. For instance at the receiving end of a long telephone cable the time of arrival of the higher speech components may be considerably different from that of the lower components; this relative retardation may obviously amount to several periods. One cannot expect the ear to be absolutely insensitive to such long relative retardations, and practice with cables bears this out.

For *periodic* sounds (such as vowels) and normal amplitudes, however, the above experiments conclusively confirm the classical acoustical law of Ohm, which was also found to be valid for unperiodic

sounds (the spoken word) as long as the relative phase retardation between the high and low components was not greater than 360 deg. of the high components.

Finally oscillograms were taken of various vowels with and without changes of the relative phases and the curves for the vowel *a* (the pronunciation in the Dutch language for the vowel is quite near that of the English *a* in the word "father") is given in Fig. 11, where the bottom oscillogram gives the vowel undistorted while the top one is phase distorted (fundamental frequency = 140 sec.^{-1}). It is curious to note that though the wave form of the two oscillograms is quite different there is not the slightest difference audible. This oscillogram was taken by Mr. Van der Mark of this laboratory, who in another article describes the technique of these experiments (where also further instances of vowel oscillograms will be found).



THE ACCURATE TESTING OF AUDIO AMPLIFIERS IN PRODUCTION*

By

ARTHUR E. THIESSEN

(General Radio Company, Cambridge, Massachusetts)

Summary—The necessity for a means to obtain a quantitative check on radio receivers, as they are produced in considerable quantities, is becoming more and more apparent. This paper deals with a method for quickly comparing the voice frequency amplifying system of receivers, particularly those for use in broadcast reception, with a predetermined standard.

The test is made on the two most important characteristics of the performance of an audio amplifier, namely the amplification within the band of audio frequencies, and the undistorted power output that it will deliver.

THE audio-frequency amplifier has become a very vital part of the modern broadcast receiver, since its performance determines in large part the quality of output of the receiver. There has been quite a concentration of effort recently in the development of satisfactory amplifiers, but no adequate means has been described for comparing the performance of the amplifiers produced in considerable quantities with the standard model from which they are made.

It is the purpose of the equipment herein described to provide a method that permits the rapid and accurate comparison of audio amplifiers with a fixed and unvarying standard. It is entirely self-contained, operates from an alternating-current source, and is simple enough to be operated by an inspector with no special training.

The two most important criteria of the performance of an audio-frequency amplifier such as is used in a broadcast receiver are its amplification—or gain—over the useful range of voice frequencies and the level at which it will deliver power into its output circuit without overloading.

DEFINITION OF AMPLIFICATION

Transmission efficiency, of which amplification or gain is one form, refers to the amount of power transferred across a junction from a generator to a load impedance. In Fig. 1-A, assume as a reference condition that the load or output impedance R_L is connected directly to the generator. In this case, the generator voltage acts in series with the generator and load impedances. The transmission efficiency of any network which may be inserted at the junction between R_G and R_L is

* Dewey decimal classification: R342.7.

expressed in terms of the ratio of the power delivered to R_L from this network to the power delivered at the reference condition.

It can be shown that the maximum amount of energy is delivered across a junction when the generator and load impedances are equal.¹ When they are unequal, impedance-matching transformers are employed to improve the efficiency. An ideal impedance-matching transformer, such as is shown in Fig. 1-B, is one in which the apparent impedance of the primary winding is equal to R_G when the secondary

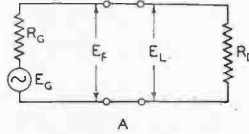

Fig. 1A—Junction of a generator and load impedance. Reference condition for transmission efficiency.

winding is connected to R_L . Consequently, the generator delivers to the primary terminals of the transformer the maximum amount of power which it can deliver to any circuit. Since there is no gain or loss of power in an ideal transformer, all of this power is transferred to the secondary load. In other words, the ratio of the power output to the power input is unity. For the measurement of amplification, this arrangement is taken as the reference condition. If the ideal

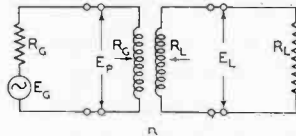

Fig. 1B—Generator and load joined by ideal transformer.

transformer is removed and an amplifier, for example, put in its place, the input and output impedances of which match R_G and R_L , respectively, some increase in power in R_L will be noted. The gain of the amplifier is the ratio of the power output measured at R_L to the power output which would have been obtained with an ideal transformer in the circuit.

The most direct method of determining the gain on the basis of the above definition is to measure the output and input powers, the ratio of these being the gain of the amplifier. This may be expressed as a logarithmic function in decibels as:

¹ K. S. Johnson, "Transmission Circuits for Telephonic Communication," (New York: D. Van Nostrand Co., 1925), Chapter III.

$$\text{db} = 10 \log \frac{\text{output power}}{\text{input power}}$$

There are several reasons why it is not practical to measure the gain of an audio amplifier by such a direct method. One is that there are no wattmeters available which will operate over the frequency range necessary or at the usual power levels. If the voltmeter-ammeter method were attempted instead, using, for instance, a thermionic voltmeter and a thermocouple, the complications resulting from the use of the additional instruments would be a serious handicap in an instrument to be used for production testing. The gain may, however, be determined by simply measuring the input and output voltages, provided due account is taken of the impedances across which they appear.

Referring again to Fig. 1-B, it is apparent that if the input and output impedances of the ideal transformer, or of the amplifier substituted in its place, are equal, the ratio of the power output to power input is equal to the square root of the voltage ratios. That is:

$$\text{db} = 10 \log \frac{P_{OUT}}{P_{IN}} = 10 \log \frac{E_P^2}{E_G^2} = 20 \log \frac{E_P}{E_G}$$

Usually, however, amplifiers do not have the same input and output impedances, and so if the gain, or increase in power level, is to be found by simple voltage measurements, a correction must be included to take care of the difference of impedances across which the voltages are measured.

In Fig. 1-B, let

P_{IN} = power into the network

P_{OUT} = power out of the network

E_G = generator voltages

E_P = voltage across primary of ideal transformer

R_G = generator resistance

E_L = voltage across secondary and load

R_L = load resistance

The ideal transformer, by definition, has primary and secondary impedances which match R_G and R_L , respectively.

Then

$$E_P = \frac{1}{2} E_G$$

$$P_{IN} = \frac{E_P^2}{R_G} = \frac{E_G^2}{4R_G}$$

$$P_{OUT} = \frac{E_L^2}{R_L}$$

Since no power is gained or lost

$$P_{IN} = P_{OUT}$$

$$\frac{E_P^2}{R_G} = \frac{E_L^2}{R_L}$$

thus

$$\frac{E_L^2}{E_P^2} = \frac{R_L}{R_G}$$

$$\frac{E_L}{E_P} = \sqrt{\frac{R_L}{R_G}}$$

$$\frac{E_L}{E_P} \times \sqrt{\frac{R_G}{R_L}} = 1.$$

If the input and output impedances are matched, the ratio of E_L/E_P is unity. If they are not matched, then the ratio E_L/E_P must be multiplied by $\sqrt{R_G/R_L}$ in order to return to the reference condition.

For working between matched impedances the gain of an amplifier, referred to an ideal transformer, is

$$\text{db} = 20 \log \frac{E_L}{E_P}$$

For mis-matched impedances, multiplying by $\sqrt{R_G/R_L}$

$$\text{db} = 20 \log \frac{E_L}{E_P} + 20 \log \sqrt{R_G/R_L}$$

$$\text{db} = 20 \log \frac{E_L}{E_P} + 10 \log \frac{R_G}{R_L} \quad (1)$$

Thus, by using the correction to be applied as indicated by the last equation, it is entirely practicable to measure relative power levels by observing only relative voltages.

A serious difficulty encountered in measuring the gain of the average audio-frequency amplifier is the extremely low level of power or voltage at the input. Fig. 2 shows one simple and well-known way to measure gain, in which the necessity of measuring the very small power at the input to the amplifier is avoided. A resistance of proper value has been substituted in place of the loud speaker load in

order that its characteristics shall not enter into the measurements. An attenuation network which is variable in known steps and which has a constant terminal impedance at all values of loss is inserted between the amplifier and the oscillator or power source. This attenuation network and the load resistance have values such that the amplifier input and output impedances are properly matched. When the power into the network is equal to the power at the output of the amplifier, the loss caused by the network is numerically equal to the gain of the amplifier. This is the method used for gain measuring with the test equipment described in this paper. It will be noticed that instead of attempting to measure the power directly, the voltages across the known input and output resistances are used for the indication. By use of a vacuum-tube voltmeter it is possible to do this without disturbing the circuit in any way.

The impedance Z of Fig. 2 has a value that matches the input impedance of the attenuator. If, then, the voltage across the actual

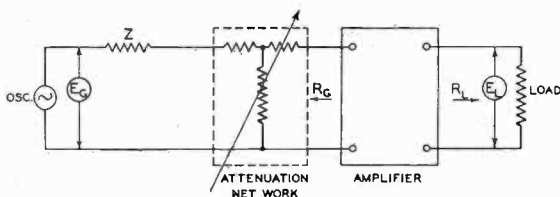

Fig. 2—Simple method of measuring amplifier gain.

generator is maintained constant, the effect is the same as though the attenuator were connected to its own impedance in series with a zero impedance generator, having the measured voltage across its output terminals. This allows for perfect matching between the generator and the attenuation network. This assumption is shown to be true by Thevenin's theorem. This states that an electromotive force acting through any network will produce the same current in any terminal impedance to which the network is connected as will a voltage equal to the open circuit voltage of the network, acting in series with an impedance equal to that measured at the output terminals of the network.

As it has become customary to speak of the gain or loss of a network in terms of decibels, it is convenient to calibrate the attenuation network of Fig. 2 in this way.

When the input voltage to the attenuator is equal to the output voltage of the amplifier, the attenuator loss equals the amplifier gain in decibels provided that the input and output terminal impedances are equal. When the impedances are not matched, the correction factor involving the impedances indicated by (1) must be considered.

COMPARISON OF AMPLIFIERS

Referring again to Fig. 2, assume that an amplifier which is known to be standard is put into the circuit. By proper adjustment of the attenuator, a certain voltage reading will be observed across the output load which is the same as the input voltage to the attenuator. The standard amplifier is now removed and another amplifier whose gain is unknown is put in its place, absolutely no other changes being made in the circuit adjustments. If the output voltmeter reads the same as it did with the standard amplifier, then the gain of the second amplifier is definitely known to be equal to the gain of the standard.

When it is necessary or desirable, as is usually the case, to measure the gain of the amplifiers at several different frequencies, a slight modification of the scheme is necessary in that the oscillator must deliver a number of frequencies at the same voltage. Since the gain is probably not the same at each of these, the reading of the output voltmeter will be different for every frequency.

Speed, which means a lack of complication in operating, is one of the most important features of this instrument. It was noted above that if an amplifier is measured at several widely separated frequencies, its gain will probably not be the same at all of them. If the value of loss in the attenuator is changed simultaneously with the frequency by an amount equal to the change in the gain of the amplifier, then the power transferred from the generator to the amplifier output load through the attenuator and amplifier will be the same at all of the testing frequencies. This, of course, means that there will be no change of the output voltmeter reading at any frequency setting of the generator.

For the measurement of the audio amplifier in broadcast receivers, for example, several frequencies extending from 50 cycles to 5,000 cycles are selected. The gain of the standard amplifier is found at each of these. The attenuator which is made variable is ganged by a common switch to the frequency control. The attenuation values are set at each of the selected frequencies to be the same as the amplification of the standard at these frequencies. Then all that is necessary is to insert the amplifier to be tested in the circuit and to turn the switch which varies simultaneously the frequency and the attenuator loss. By observing whether or not the output voltmeter deviates from a fixed standard reading, it may be immediately determined whether or not the tested amplifier has the same gain-frequency characteristics as the standard. These networks which compensate for the change in amplifier gain have been given the name of "compensation networks."

The operation is thus reduced to such simplicity that it may be performed by anyone with no special training whatever.

It is, of course, not necessary to restrict the apparatus to the measurement of only one type of amplifier. The compensation networks may be made interchangeable for the purpose of testing any amplifiers having gains which vary within wide limits, provided only that a standard of comparison is available.

It will be noted that the instrument is not intended to actually measure the gain of audio-frequency amplifiers, but is used to compare the gain-frequency curves of a number of amplifiers with a known and unvarying standard. This is the aim of production testing, to determine by a quantitative method how closely the product of manufacture compares with the engineering model from which it is constructed.

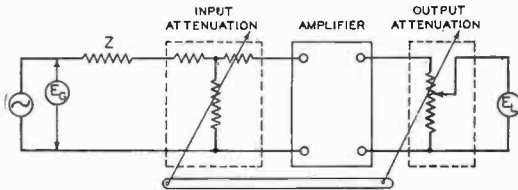

Fig. 3—Method used to determine overload level of amplifier.

DETERMINATION OF OVERLOAD LEVEL

Once the gain of a given amplifier is determined, it is usually important to know whether or not it will deliver the required amount of power to the output load without overloading and consequent distortion.

The method chosen for determining the overload level of the amplifier under test is shown schematically in Fig. 3.

The oscillator voltage is applied in this case to the amplifier through a network which introduces a known loss. This loss is variable in small steps so that a constantly increasing power is applied to the input of the amplifier as the attenuation of the network is reduced, provided that the oscillator voltage remains constant. Until the overload level is reached, increases in the input power should produce proportional increases in the output power. For simplicity, so that the meter reading of the output voltage of the amplifier shall not fluctuate with changes in the adjustment of the input network, another variable network is inserted between the amplifier output and the voltmeter. This need only be a potentiometer with a resistance equal to the impedance into which the amplifier is intended to work, tapped so that each step will change the voltage into the meter by the same

amount, but in the opposite direction, as the voltage applied to the amplifier through the attenuator.

The circuit is arranged so that as attenuation is removed between the generator and the amplifier the same amount of attenuation is inserted between the amplifier and the output voltmeter. Thus by turning one switch, the power to the amplifier is increased in uniform amounts with each step, with no change in the voltage read on the output meter until the overload level is reached. At this point, the amplifier no longer delivers power in proportion to the input power and the reading of the voltmeter begins to drop. The curve of Fig. 4 shows the order of magnitude of this drop. The ratio of power output to power input of an average two-stage amplifier with a UX-245 tube in the last stage is plotted against output power.

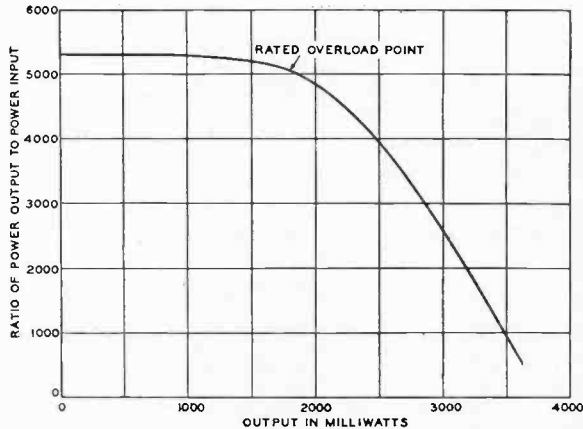

Fig. 4—Curve showing ratio of output to input power plotted against power output of a two-stage audio amplifier. One UX-245 used as output tube.

This method of measuring the overload level is a remarkably sensitive and simple operation. The attenuators are calibrated in decibels. The reading at which overload occurs indicates the power level in decibels above the reference power level. This may be selected at any value, for example, the I.R.E. reference standard of 50 milliwatts.

The arrangement of all of the essential circuit elements for the complete checking of audio amplifiers as regards their gain-frequency and overload characteristics is shown in Fig. 5.

For the sake of simplicity in this figure, the impedances of all of the networks and the amplifier input are assumed to be matched. It is not, however, always convenient to do this. When it is necessary to connect two mis-matched networks together so that each has its proper terminating impedance, a special type of network is used. This

is called an impedance tapering network or "taper pad," and consists simply of an L type network with the horizontal arm pointing in the direction of the largest impedance. Such a network always introduces some loss in the circuit which must be taken into account when calculating the total losses of all of the networks.

Since the impedance matching, the compensation, and the overload testing networks are used in series, the total of their attenuations must be made equal to the amplifier gain. The graph below the diagram in Fig. 5 indicates the power level at the various points in the circuit.

Leads to the voltmeter are provided across the oscillator output in order that the oscillator amplitude may be set to the correct ref-

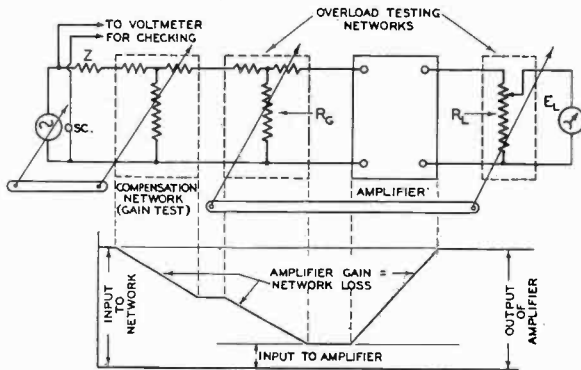

Fig. 5—Schematic diagram showing essential units for determining both gain-frequency and overload characteristics of amplifiers.

erence value at each frequency, and that it may be occasionally checked during operation to make certain that no change has occurred.

There are two main controls brought out on the panel of the equipment. One is to make the gain-frequency test, the other for the determination of the overload level.

In testing an amplifier under working conditions, it is only necessary to connect it to the test equipment with a pair of flexible leads. With the overload-level switch set at zero, the gain test is made at each of the frequencies. The next step is to set the frequency-control switch at any frequency and to advance the overload-level switch until the voltmeter reading begins to drop. The setting of the switch where this occurs indicates in decibels the overload level of the amplifier above the reference level. The overload level of the standard amplifier is known, thus the one being tested can immediately be classified for overload rating with the standard for comparison.

When made in production quantities, amplifiers cannot, unless constructed with extreme care, be made to have exactly the same gain-frequency curve as the standard. Whatever tolerance is to be allowed may be indicated on the scale of the output voltmeter.

VACUUM-TUBE VOLTMETER

The circuit of the alternating-current operated vacuum-tube voltmeter used in this equipment is shown in Fig. 6. The grid bias is variable and is obtained from a section of the voltage divider. It is of sufficient value to make the tube operate on the lower section of its grid-voltage, plate-current curve where it acts as an efficient detector. The small residual plate current is balanced out by an opposing current also taken from the voltage divider. This permits the use of an ammeter reading from 0 to 200 μ a for the indicator which is

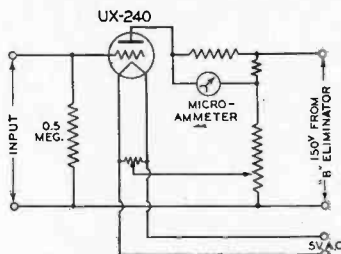

Fig. 6—Circuit of vacuum-tube voltmeter used.

exceedingly responsive to the incremental changes in plate current resulting from small changes of the grid potential. The microammeter is set at zero by adjusting the variable grid-bias potential. Since this voltmeter is only used to indicate deviations from a standard reading, it does not have to be calibrated. With an average UX-240 tube in the circuit, the microammeter reads full scale with approximately two volts r.m.s. applied to the grid.

COMPLETE EQUIPMENT

A number of these instruments have been made for the Audio Vision Appliance Company for checking the audio-amplifying system of the Victor-Radio receivers. Fig. 7 shows the front and rear views of one of the completed panels.

The large hand-wheel at the left of the front panel is used for the test of the frequency-gain characteristics. This switch has three separate sections. One to bring the necessary oscillator coils and capacities into the circuit for the several frequencies; the second to change the value of feed-back resistances in order to maintain the amplitude

of oscillation constant; and the third to change the attenuations of the compensation networks by the same amount as the gain of the standard amplifier changes over the frequency band. The central hand-wheel controls the values of the networks for the determination of the overload level. It is calibrated from 0–20 db so that the value of overload above the reference level, as indicated by the decrease in voltmeter reading, can be found at any point within this range.

The circuit diagram of this panel, Fig. 8, indicates the details of the wiring. The lower half shows the connections to the multiple

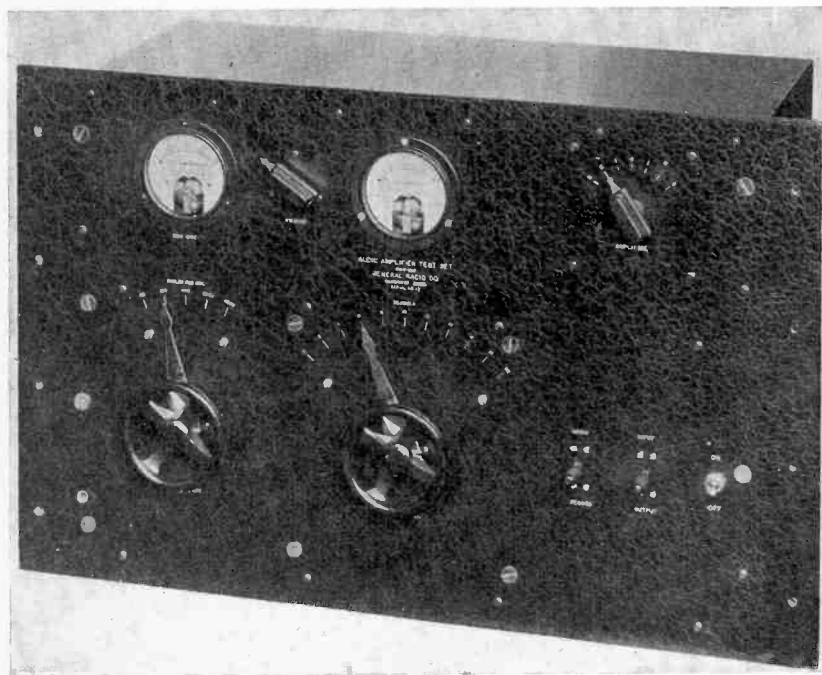

Fig. 7-A—Front view of a complete testing panel used by the Audio Vision Appliance Company of Camden, N. J.

switches which operate from the two hand-wheels on the front panel. On the upper half of the drawing is indicated the oscillator tube which is directly coupled to an amplifier tube. The output of this circuit is coupled by means of a transformer to the networks in the lower section. The UX-240 tube is used in the vacuum-tube voltmeter circuit. It is provided with a switch on its input so that it may be transferred from the output of the amplifier under test to the oscillator output whenever necessary. At the upper right-hand of the

diagram is the power-supply unit with the familiar standard "B-eliminator" circuit.

CONCLUSION

The performance of this instrument has been found to be very satisfactory under actual operating conditions. The speed of operation is remarkably high, something less than two minutes being required for the complete testing of the gain-frequency and overload-level characteristics of an amplifier. Because of its flexibility and the ease with which the various networks may be made interchangeable, the

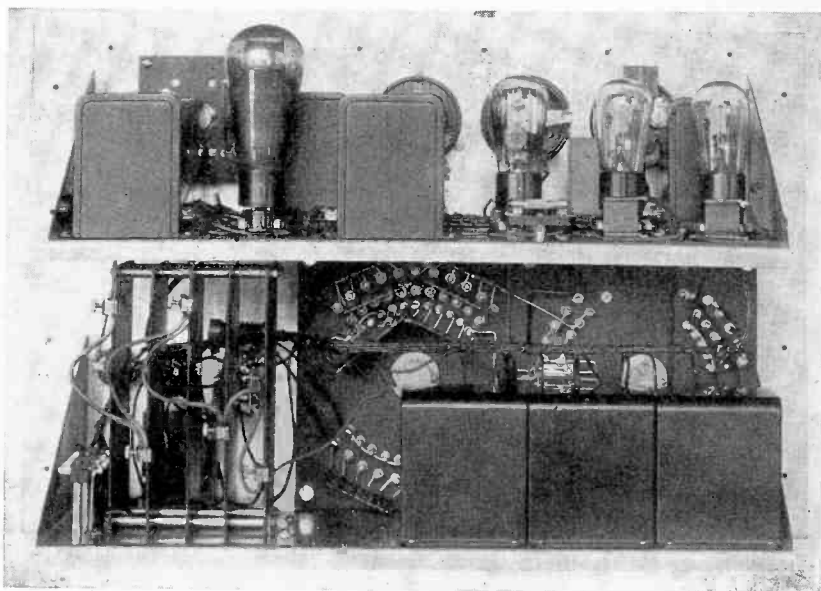

Fig. 7-B—Rear view of a complete testing panel used by the Audio Vision Appliance Company of Camden, N. J.

instrument is adapted for use in plants manufacturing a fairly large variety of amplifiers, as well as in plants where the output is restricted to but one type.

ACKNOWLEDGMENT

The author wishes to express his great appreciation to J. W. Horton, chief engineer, General Radio Company, for his assistance in the preparation of this paper. Also it is wished to acknowledge with thanks the suggestions and help extended by the engineers of the Audio Vision Appliance Company, Camden, N. J., during the development of this testing equipment.

A STUDY OF NOISE IN VACUUM TUBES AND ATTACHED CIRCUITS*

By

F. B. LLEWELLYN

(Bell Telephone Laboratories, New York, N. Y.)

Summary—The noises originating in vacuum tubes and the attached circuits are investigated theoretically and experimentally under three headings: (1) shot effect with space charge, (2) thermal agitation of electricity in conductors, (3) noise from ions and secondary electrons produced within the tube.

A theoretical explanation of the shot effect in the presence of space charge is given which agrees with experiment insofar as a direct determination is possible. It is shown that the tubes used should be capable of operating at full temperature saturation of the filament in order to reduce the shot effect.

In the computation of the thermal noise originating on the plate side of a vacuum tube, the internal plate resistance of the tube is to be regarded as having the same temperature as the filament.

Noise produced by ions within the tube increases as the grid is made more negative.

With tubes properly designed to operate at temperature saturation it is possible to reduce the noise on the plate side to such an extent that the high impedance circuits employed on the grid side of the first tube of a high gain receiving system contribute practically all of the noise by virtue of the thermal agitation phenomenon.

INTRODUCTORY

IT has long been realized that there is a limit to the amount of amplification which may usefully be employed in a circuit containing vacuum tubes, and that in the absence of static this limit depends upon noises which arise in the circuit itself. Of these noises, those which come from run-down batteries, poor connections, vibration, and microphonic effects, either within the vacuum tubes or in some part of the external circuit, will not be discussed here since their remedy, although not always easy, is obvious. With these eliminated from consideration, there remain several distinct ways in which noise occurs in the circuit.

In the first way noise is produced by irregularities in the stream of electrons from the filament to the plate of the vacuum tube. In the absence of space charge this noise has been termed by Schottky the "schroteffekt," or "small shot effect," from the analogy which the flight of electrons from the filament to the plate of a vacuum tube bears to the spattering of small shot fired from a shot gun. The simple term "shot effect" will be used in this paper to denote this noise either with or without space charge.

* Dewey decimal classification: R170.

In the second way noise is produced by the thermal agitation of electric charges within the conductors of the circuit. This noise is discussed from a theoretical viewpoint in a paper by Dr. H. Nyquist¹ and from an experimental standpoint in a paper by its discoverer, Dr. J. B. Johnson.² In Part II of the present paper the importance of this noise, which will be termed "thermal noise," in high-frequency radio receiving circuit design will be discussed.

In still other ways, noise may be produced by agencies operating within the tube, such as the ionization of gas molecules, the production of secondary electrons and ions by bombardment of the grid or the plate, and by evaporation of ions from the filament. These and similar agencies may conveniently be grouped in a third general source of noise within vacuum tubes and their associated circuits, which will be discussed in Part III.

Part I

SHOT EFFECT

For the theory of the shot effect in the absence of space charge the reader is referred to a paper by Dr. T. C. Fry.³ A partial picture of its mechanism may be obtained by considering what happens when a single electron is transferred from the filament to the plate of the vacuum tube. Since the time of flight of the electron is brief in comparison with the periods even of the highest of the frequencies with which we have at present to deal, the effect of the electron on the circuit is equivalent to that of suddenly placing a charge, e , equal to the charge of the electron, on the plate. This charge is dissipated in the circuit, producing current in the ordinary manner. The total space current is the resultant of all the currents produced individually by the electrons as they arrive at the plate.

If the electrons were to arrive in a uniform stream, that is, if the time between successive electron arrivals were a constant, then the resulting space current could be represented by a Fourier's series, of which the constant term would represent the average value of the space current. Moreover, the term representing the fundamental frequency would have a period equal to the time between successive electron arrivals so that *the lowest frequency present in the resulting current would be that corresponding to the total number of electrons which arrive per second*. Such a frequency is far greater than any to which present day radio apparatus is responsive. It is, therefore, apparent that in

¹ "Thermal agitation of electric charge in conductors," *Phys. Rev.*, 32, (110) 1928.

² "Thermal agitation of electricity in conductors," *Phys. Rev.*, 32, (97), 1928.

³ "The theory of the schroteffekt," *Jour. of the Franklin Inst.*, 199, No. 2 February, 1925.

order for irregularities to become manifest, it is necessary that they occur in the rate of arrival of the electrons. The stream constituting the space current may be pictured as a moving fluid, of gaseous nature, but of varying density. The effect of the variations on the measuring or the recording device, which in speech receivers is ultimately the human ear, is limited to those frequencies to which the complete system, including the measuring device, is responsive.

The theory of the shot effect has been investigated experimentally by several workers.^{4,5} This theory is not, however, directly applicable to radio tube circuit use. The theory is based upon lack of space charge, and only so long as a vacuum tube is operated under such conditions can the noise be thus computed.

In practice the vacuum tube requires the presence of space charge in order to function properly as an amplifier or a detector. Under these conditions Fry's formula does not hold. Johnson showed that as the filament current is increased from zero the noise at first increases rapidly as predicted by Fry's formula; next, however, it goes through a maximum as the space charge comes into play, and then decreases to a value which is nearly independent of filament current. It is in the last named region that vacuum tubes are usually operated.

To see why the noise decreases in the presence of space charge it is necessary to review the assumptions underlying Fry's formula. First, it is assumed that the electrons are emitted from the filament independently of one another. By means of this assumption the effect of the variation in the rate of electron emission can be calculated. Secondly, it is assumed that all electrons emitted by the filament are drawn over to the plate, and consequently that variations in the filament emission are transferred to the plate without change.

The presence of space charge obviously does not affect the first assumption. The filament continues to emit electrons in a manner dependent upon its temperature. The second assumption, however, does not hold when space charge comes into play. In fact, if a curve be drawn showing the relation between filament temperature and rate of arrival of electrons on the plate (see Fig. 1) it becomes evident that at the higher temperatures a lower percentage of the emitted electrons reach the plate. To the right of the point *A* in Fig. 1 a change in filament emission, resulting from a change in filament temperature, produces no change in the rate of arrival of electrons at the plate. Since the shot effect has been shown to result from changes in the den-

⁴ J. B. Johnson, "The Schottky effect in low frequency circuits," *Phys. Rev.* 26, No. 1, July, 1925.

⁵ A. W. Hull and N. H. Williams, *Science*, p. 100, Aug. 1, 1924; *Phys. Rev.*, 25, 147, February, 1925.

sity of the electron stream from filament to plate it may be inferred that when the filament has reached full temperature saturation, as shown by the flat portion of the curve to the right of the point A then small fluctuations in the density of the stream emitted by the filament are all smoothed out in the space charge region, and the current reaching the plate contains no variations which result from changes in the filament emission. *Shot effect, as such, is zero in the region of temperature saturation of the filament.*

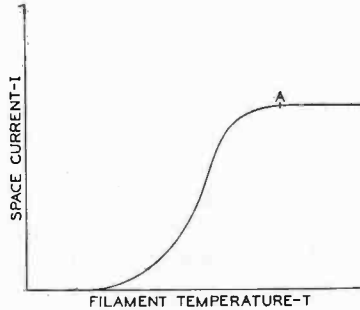

Fig. 1—Variation of space current with filament temperature.

The mathematical formulation for this effect, together with computation formulas for the shot effect at various degrees of partial temperature saturation is given in Notes 1 and 2, to be found at the end of the present paper. Difficulties inherent in obtaining complete experimental verification are discussed in Part IV.

The first requirement for a noiseless circuit is thus seen to be that the vacuum tubes employed contain filaments capable of operating at full temperature saturation, so that the shot effect noise is reduced to zero. The remaining noises must then come from ionization of gas within the tube, from the production of secondary electrons or ions, or from thermal agitation of electricity. This latter effect predominates in high vacuum tubes, and is discussed in the following paragraphs.

Part II

THERMAL NOISE

The noise which arises from the thermal agitation of electricity in conductors is of such recent discovery, and may prove to have such important consequences that a general description of it is given here, even though it entails some repetition of what already has been published by Drs. Johnson² and Nyquist.¹ The phenomenon is described in the words of Johnson as follows:

"The electric charges in a conductor are found to be in a state of thermal agitation, in thermodynamic equilibrium with the heat motion of the atoms of the conductor. The manifestation of the phenomenon is a fluctuation of potential difference between the terminals of the conductor which can be measured by suitable instruments."

In radio-frequency receiving systems a tuned input circuit is usually connected to the grid of the first vacuum tube. Together with the heat motion of the atoms within the conductors which compose this circuit, the electric charges within the conductors are in a state of thermal agitation.* This agitation causes energy to be transferred to and fro between the various parts of the circuit. Although the resultant energy is always a constant, the haphazard surging of charges causes small varying potential differences to appear between any two points located on the conductors of the circuit. These potential variations are amplified and cause a dissipation of energy in a receiving or measuring device located at the terminus of the amplifier. The frequencies present in the measuring device are determined by the frequency characteristics of the receiving system in a way analogous to that in which the frequencies characteristic of shot effect or of long range static depend upon the circuits in which the effects act rather than upon frequencies inherent in the effects themselves. The thermal agitation of charges in conductors will then yield a steady hiss type of sound similar to long range static and to the shot effect.

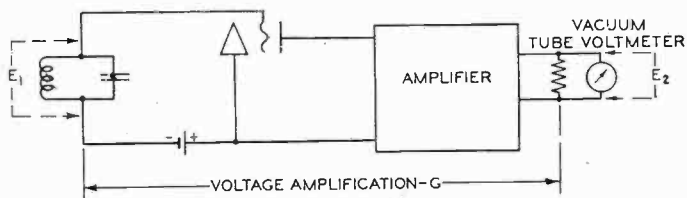

Fig. 2—Circuit to illustrate method of detecting or measuring noise from the thermal agitation of electricity in conductors.

In the system shown in Fig. 2, varying potential differences across the grid of the first tube are produced by thermal agitation of charges within the conductors of the input circuit. These varying potential differences are amplified by the system and produce an energy dissipation in the measuring device or receiver at the end of the diagram. The mean square voltage across the measuring device is given by the expression, developed by Nyquist:

* Whether or not Maxwellian equilibrium exists between the motions of atoms and electrons, the resulting voltage fluctuations are calculable from the thermal agitations of the atoms alone, at the atomic temperature.

$$\overline{E^2} = \frac{2}{\pi} kT \int_0^{\infty} R |G|^2 d\omega \quad (1)$$

where

- k = Boltzmann's constant
 = 1.372×10^{-23} joules per degree
 T = temperature, degrees Kelvin
 R = resistance component of the impedance
 measured across the input circuit.
 G = gain of the amplifier attached to the circuit,
 i.e., the ratio of E_2 to E_1 (see Fig. 2).

This expression shows that, with a given band width in the amplifier, the effect depends only upon the *resistive component* of the input circuit impedance and upon the *absolute temperature* of that circuit. Thus, if all other noises in the amplifier were eliminated, this effect would represent a limit beyond which further reduction of noise is impossible, since the material composing the input circuit has absolutely no influence either upon the character or magnitude of the noise.

For amplifiers employed in radio, it is possible to design tubes such that the level of the noise produced by the high-impedance circuit on the grid side is raised by the amplification of the tube to a point where it masks the noise produced on the plate side. However, it is important to investigate the noise on the plate side in order to determine the amplification necessary to bring about this result, and also in order to deal with those special cases where it may be desirable to operate the high gain amplifier from a low-impedance input circuit. Suppose, then, that the system shown in Fig. 2 is operated with the grid of the first tube effectively short-circuited to ground for the radio frequencies. Thermal noise from the grid side of that tube is thus eliminated. Also suppose that the filament of the first tube operates at full temperature saturation so that there is no shot effect noise. Experiment shows that under these circumstances a considerable amount of noise still arises in the first tube and its circuits. This residual noise is mostly thermal noise from the resistive component of the impedance measured across from plate to ground of the first tube. This impedance includes the internal resistance of the vacuum tube, and brings forth the following question:

What is the effective temperature as regards production of thermal noise of the internal plate resistance of a vacuum tube?

This question is discussed in Note 3, where it is shown that the plate resistance must be taken at the filament, or cathode, temperature. Since this temperature ranges between 1000 degrees Kelvin and 2000 degrees Kelvin for the tubes in general use today, it is evident that a

fairly large portion of the noise may be contributed by the plate resistance. Equation (1) gives the mean square value of the thermal e.m.f. resulting from a single resistance. From this it is easy to deduce, (see Note 4), that the mean square e.m.f. resulting from the plate resistance at filament temperature in parallel with an external impedance at room temperature T_0 and having a phase angle whose tangent is ϕ , is given by:

$$\overline{E} = \frac{2kT_0}{\pi} \int_0^\infty R \left(\frac{ab(1+\phi^2)+1}{(1+b)^2+b^2\phi^2} \right) |G|^2 d\omega \quad (2)$$

where

R = resistive component of external impedance.

b = ratio of external resistance R to internal tube resistance, r_p .

a = ratio of cathode temperature to room temperature.

T_0 = room temperature, Kelvin.

$\phi = X/R$, where X is the reactive component of the external impedance.

G = gain of that portion of the amplifier which follows the tube under measurement.

For the important case where the external impedance is resistive, only, so that $\phi=0$, equation (2) may be written in the simpler form:

$$\overline{E}^2 = \frac{2kT_0}{\pi} \int_0^\infty R \left(\frac{ab+1}{(1+b)^2} \right) |G|^2 d\omega. \quad (3)$$

The form of this equation for the thermal noise from a tube is shown graphically by the solid line curves of Fig. 3, where the values of $b = R/r_p$

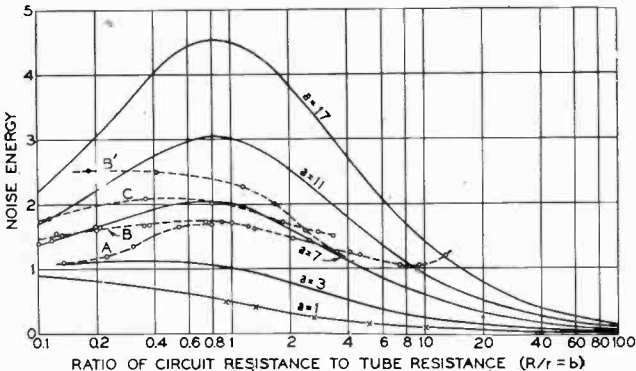

Fig. 3—Noise from thermal agitation in the plate circuit when the plate resistance is varied. The various curves are for different values of filament temperature.

$$\text{Noise Energy} \propto \frac{1+ab}{(1+b)^2}$$

where a = ratio of filament to room temperature, $b = R/r_p$ = ratio of circuit resistance to tube resistance.

The dotted curves are from experimental data.

are plotted as abscissas, and of noise energy as ordinates. A separate curve is shown for each of several values of filament temperature ranging from room temperature to seventeen times that temperature. Ordinary tubes should show thermal noise values lying between the isothermals for three and seven times room temperature.

Actually, as shown by experiments described in Part IV, and illustrated by the dotted curves on Fig. 3, the tubes gave values lying considerably above the computed curves, even when it was ascertained that the contribution of shot effect, as described in Part I, was negligible. This residual noise is ascribed to ions and to the emission of secondaries from the grid, screen, or plate, as a result of bombardment by the primary electrons. Part III is devoted to a discussion of such effects.

Part III

NOISE PRODUCED BY IONIZATION AND SECONDARY EFFECTS

In general, this type of noise is responsible for the difference between the thermal noise and the total noise under the desired condition that the filaments of the tubes operate at temperature saturation. A direct calculation or measurement of the effect of the several possible contributing agencies has never been made, and there will be attempted here only a short discussion of the more obvious contributing agencies.

The general theory of shot effect and of thermal noise takes account of all noise produced by the random emission of electrons from the filament and from their random movements in thermal agitation. Moreover, if the filament operates at temperature saturation, any kind of variation which may occur in the rate of emission from the filament produces no effect upon the space current. However, in actual operation, many electrons and positive ions are produced in the space charge region by collisions with gas molecules in the tube or by bombardment of the plate or grid.

Electrons produced in such a manner by ionization of the gas in the tube or by bombardment of the grid are drawn to the plate and produce noise in a manner similar to those electrons emitted by the filament when there is no space charge. It is therefore possible to form a rough estimate of the probable magnitude of the noise from the electrons from gas ionizations on the basis of plausible assumptions and the shot effect formula. Such an estimate indicates that in rather extreme cases, such as when the plate resistance is quite high and the gas pressure within the tube somewhat above normal, the noise from the ionization electrons may amount to a noticeable fraction of the thermal noise. Under ordinary conditions, however, noise from these electrons should be negligible.

When the positive ions which result from the ionization of gas or from bombardment of the electrodes are considered, the result is quite different. Instead of being drawn off by the plate, these are attracted into the space-charge region where small disturbances in equilibrium cause comparatively large changes in the space current. It is therefore to be expected that nearly all of the residual noise in vacuum tubes may be attributed to disturbances set up in the space-charge region by the entrance of positive ions liberated either from gas molecules, from bombardment of the elements, or by recombination of electrons in the space-charge region with ions evaporated from the filament itself.

Certain data to be discussed in the following section indicate that the plate is the most fruitful source of these disturbing ions, or at least that ions from the plate exert a more significant effect upon the noise than do those from filament or grid, but a much more searching investigation than was here attempted will be necessary before the exact role played by ions and secondary electrons in noise production may be determined.

Thus far, neither experiment nor theory has been successful in isolating the ionization and secondary effects enumerated above. It is therefore impossible to say that all of the noise sources have been included in this discussion. Nevertheless, the difference between the measured noise and the noise from thermal agitation and residual shot effect is of the probable order of magnitude of these effects, and no other sources of sufficient importance to warrant consideration have thus far been discovered. For the present, then, we turn our attention to the experimental results which show the comparative importance of the several effects, and demonstrate how they vary under different conditions of operation.

Part IV

EXPERIMENTAL RESULTS

In the introduction, noise sources discussed in the foregoing paragraphs were grouped under the three general headings:

1. Shot effect
2. Thermal agitation
3. Ions and secondary electrons

The scope of the first two groups is fairly well defined, and at high frequencies magnitudes may be estimated for the ideal case from the theoretical formulas given in the notes at the end of this paper. The third heading presents more difficulties, especially in the assignment of the relative importance of the several agencies which produce secondaries. The measurements to be described deal with noise produced on the plate side of the tube, since the noise produced on the grid side,

in the absence of direct grid current, results entirely from thermal agitation, and has been discussed experimentally by Johnson.¹ In the experimental investigation of noise produced on the plate side, care was taken to keep the impedance between grid and ground so low that noise on the grid side might be neglected.

An amplifier with a voltage amplification of a millionfold was employed. This amplifier terminated in a vacuum-tube voltmeter, of the "negative C" type, which was operated only in the region where its response curve followed a square law to within ten per cent. The mean square noise voltage on the grid of the voltmeter was thus directly proportional to the deflection of the meter.

Two types of amplifiers were used. The first was a straight radio-frequency amplifier employing screen-grid tubes, with which measurements could be made over a range of frequencies from 700 to 1500 kc. The band width of this amplifier was about 4000 cycles. The other amplifier consisted of two stages of high-frequency amplification covering a frequency range from 2 to 20 megacycles, which was followed by a heterodyne oscillator-detector and a 300-kc, intermediate-frequency amplifier, with a band width of approximately 12,000 cycles. Screen-grid tubes were employed in both the high and intermediate-frequency stages.

Both amplifiers were carefully shielded against outside influences, and against "pickup" of the amplified noise from the latter stages, which, it was found, could become troublesome. The final measurements were made in a completely shielded room.

In order to avoid the necessity of determining the amplification of the amplifiers with each set of data the thermal noise from an anti-resonant circuit of known characteristics was used as a reference. Large error incident to a measurement of the large amplification at high frequencies was thus eliminated.

The two amplifiers were used to check the various noise sources until it was determined that nothing in the range covered, 700 kc to 20 megacycles, depended upon the frequency. Some preliminary work showed that at 300 kc the results were still in line with those at the higher frequencies.

It may be concluded that no source of noise not included in the theoretical discussion in Parts I, II, and III, and which depends upon frequency, is present in appreciable amount between 300 and 20,000 kc, although Johnson⁴ has shown that at low frequencies, and especially below 1 kc, the frequency becomes effective in determining the noise. This he ascribes to time changes of the activity of the filament or to the behavior of the factor $\partial I/\partial J$ (see Note 1) at low frequencies. For radio

frequencies these effects disappear with full temperature saturation of the filament, and hence above 10 kc the frequency at which the measurements are made is of no consequence when the full space-charge condition of temperature saturation holds. This statement would be expected to apply even in the region of very high frequencies above 40 megacycles discussed by Ballantine,⁶ with the exception that secondaries from the grid may be expected to produce somewhat less noise when the time consumed in their passage to the plate is comparable with the time of a cycle of the frequency under measurement.

With the question of frequency disposed of, we may investigate the effect of the tube upon the noise by means of the arrangement shown in Fig. 4. In this connection the noise from the tube and the anti-reso-

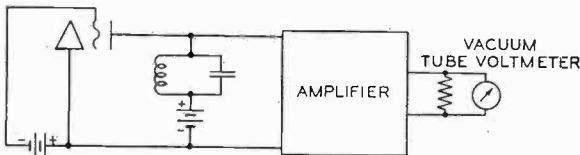

Fig. 4—Circuit for measuring noise on the plate side of a vacuum tube.

nant circuit is measured as the filament temperature of the tube is gradually raised.

An example of the kind of result to be expected from such a procedure is given in Fig. 5-a, where the abscissas represent the power expended in heating the filament and the ordinates represent the resulting noise energies. When the filament is cold, the measured noise is that from the anti-resonant circuit alone. As the filament is heated so that electron emission commences, the noise curve mounts rapidly because of the shot effect. However, the space charge soon comes into play and causes the noise curve to bend over, while at the same time the lowered resistance of the vacuum tube contributes still further to the bending over of the noise curve.

The characteristic behavior of only the shot-effect component of the noise is shown in Fig. 5-b. The noise starts up along a curve proportional to the space current. Somewhere near the point *A* in the figure, the space charge begins to show its influence and the curve accordingly bends over toward the right. When the full space-charge condition has been reached, so that a change in filament emission does not change the space current, the pure shot-effect noise falls to zero, as shown at the point *B* in the figure.

⁶ "Schrot-effect in high frequency circuits," *Jour. Franklin Inst.*, 126, No. 2, p. 159.

Meanwhile, there are two separate agencies operating on the part of the noise that comes from the thermal effect. First, the reduction in the plate resistance decreases the impedance between the plate and filament and so tends to reduce the noise, while secondly, the increase in the filament temperature produces a corresponding increase in the effective temperature of the plate resistance which tends to increase the noise.

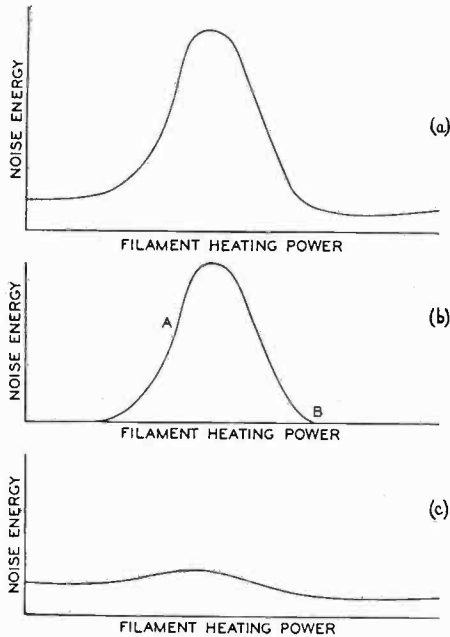

Fig. 5-a—Total noise energy from ideal tube with no ions and secondaries as a function of filament heating power.

Fig. 5-b—Noise energy from shot effect only as a function of filament heating power.

Fig. 5-c—Noise energy from thermal agitation only as a function of filament heating power.

The form of only the thermal noise curve is shown in Fig. 5-c. When the filament is cold the noise is taken as unity, so that the noise energy scale refers to the noise from the resistive component of the circuit impedance external to the vacuum tube. As the filament is progressively made hotter, the corresponding increase in temperature of the plate resistance at first produces an effect which preponderates over the decrease in the impedance produced by the decreasing value of the plate resistance. The noise curve accordingly rises somewhat above the unity value of the external circuit alone. The decreasing value of the plate resistance finally shows its influence by decreasing the noise, so

that in tubes with low plate resistances the thermal noise with the filament hot may actually be less than with the filament cold.

Figs. 6 and 7 show these effects as calculated from experimental data. The dotted curve *B* represents the thermal noise as calculated by the method outlined in Part II and illustrated in Fig. 3. The dash line curve *C* shows the calculated shot-effect noise, while the solid line curve *D* is the sum of the calculated shot and thermal noises, and should therefore equal the measured noise in an ideal case where the effect of secondaries and ions is zero. Actually, the measured noise as shown by curve *A* fell below the calculated noise in the shot effect region. The reason for this must be looked for in the method of calculating the shot effect.

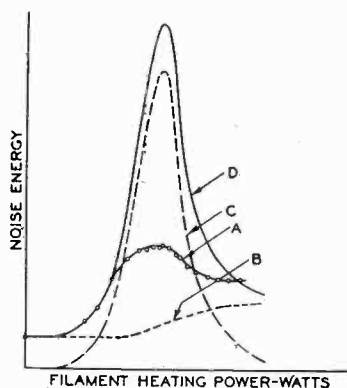

Fig. 6—Variation of noise with filament heating power for a three-electrode tube with tungsten filament.

Curve *A* shows the total measured noise.

Curve *B* shows the calculated thermal noise.

Curve *C* shows the calculated shot noise.

Curve $D = B + C$, shows the calculated thermal and shot noise.

Such a calculation involves a determination of the saturation current from the filament, and also of the rate of change of the actual space current with saturation current. A small error in the determination of the saturation current may therefore be expected to produce a very large error in the computed result, and this was found to be the case. The difficulties inherent in the measurement of the saturation current result primarily from two causes, although other things such as end cooling of the filament, occluded gases, and the potential drop along the filament also complicate the problem.

The first of the primary difficulties is the Schottky variation of saturation current with the applied electric field. The theory requires the evaluation of the saturation current at the operating plate potential. Therefore the attempt was made to find its value by the following

procedure: The actual space current was plotted as a function of the filament heating current. When plotted on a power emission chart* the resulting curve approaches a straight line for very low values of heating power, but departs considerably for higher values of heating. The straight line portion of the curve was continued as a straight line up into the region of higher values of heating power. This straight line was taken as the saturation current. It may readily be realized that a small error in drawing the straight line may result in large errors in values for the saturation current.

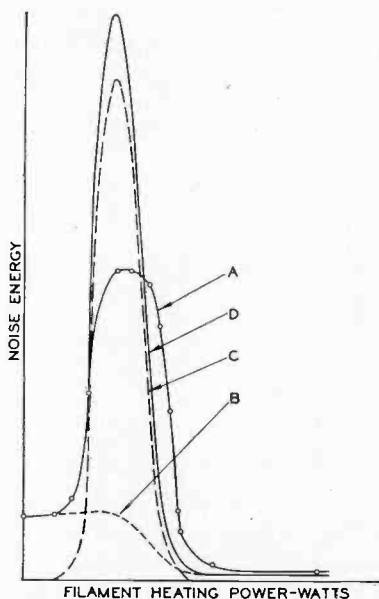

Fig. 7—Variation of noise with filament heating power for a two-element tube with oxide-coated filament.

Curve A shows the total measured noise.

Curve B shows the calculated thermal noise.

Curve C shows the calculated shot noise.

Curve $D = B + C$, shows the calculated shot and thermal noise.

The second of the primary difficulties in the determination of the saturation current results from the fact that immediately after a change has been made in the filament temperature, the saturation current continues to vary over a considerable length of time^{7,8} when coated fila-

* A power emission chart is a system of curvilinear coordinates designed by Dr. C. Davisson of these Laboratories. If the current obeys Richardson's equation and the cooling follows the Stefan-Boltzmann law, then the result when plotted on the chart gives a straight line.

⁷ Davisson and Germer, "The thermionic work function of tungsten," *Phys. Rev.*, 20, 300, 1922.

⁸ Davisson and Germer, "The thermionic work function of oxide coated platinum," *Phys. Rev.*, 24, December, 1924.

ments are used. When pure tungsten is employed, there is reason to believe that the same kind of an effect occurs, but in so short a time that ordinarily it cannot be separated from the time taken for the actual temperature change of the filament to become established. In the calculation of the shot effect, the "dynamic" value of $\partial I/\partial J$ is required. In view of the time variation mentioned above, no method of measuring this has been found. Accordingly the "static" values were used; that is, the final values reached by the currents after sufficient time had elapsed for steady state conditions to be reached.

When all of these computations were carried out, the result gave the curves shown in dashed lines on Figs. 6 and 7. It is seen that in both instances the results are too large. This was to be expected from the difference between the dynamic and static values of $\partial I/\partial J$. However, the important thing is that despite the complicated processes of measurement and estimate employed to arrive at the result, the curves are of the proper shape, and their maxima fall at very nearly the correct positions. Again, while the absolute values of the ordinates are too large, they are nevertheless of the same order of magnitude as the measured ones, and this fact lends support to the theory.

The curves of Fig. 6 refer to a tube having a tungsten filament and operated with 100 volts on the plate and -23 volts bias on the grid. The large grid bias was necessary for this tube in order to secure temperature saturation at normal filament temperatures.

Fig. 7 refers to a tube with an oxide-coated filament connected as a rectifier, with the plate and grid tied together. This was done to determine whether any new and fundamentally different effects were introduced by the different mode of operation. From several such curves as compared with those from the same and from different tubes with the ordinary three-electrode connection, it was ascertained that no unexpected results are attendant upon the mode of connection of the tube into the circuit.

Fig. 3 has been mentioned in Part II where it was pointed out that the solid lines represent the thermal noise calculated for the plate and its associated circuits. With filaments operating at temperature saturation, noise data on a number of tubes were taken. A few of these are representative of the entire number, and are shown connected by the dotted line curves in the figure. Curves *A*, *B*, and *B'* were for tubes with oxide-coated filaments operating at about 1000 deg. K. Curves *B* and *B'* represent the same tube, but in *B* the plate resistance was varied by means of the plate-battery potential, while in *B'* the grid-biasing battery was used to vary the plate resistance. It is seen that large values of negative grid bias produce a marked increase in the noise.

This evidence gives weight to the view that the difference between the actual noise and the thermal noise is mostly the result of positive ions which move into the space-charge region. The more negative the grid is made, the more pronounced is its effect in drawing the ions into the space-charge region.

Curve *C* shows data taken with a tube having a thoriated tungsten filament operating at approximately 2000 deg. K under the same experimental conditions that were used in obtaining curve *B*. As was to be expected, *C* lies higher than *B* by virtue of its higher temperature. Curve *A* was made for a tube with oxide-coated filament at 1000 deg. K. The amplification factor of this tube was 30 as compared with 6 for the tubes corresponding to curves *B* and *C*. For low values of plate potential curve *A* approaches the theoretical curve very closely.

A significant set of data from a practical standpoint is shown in Fig. 8. These data are the result of tests made upon a number of tubes

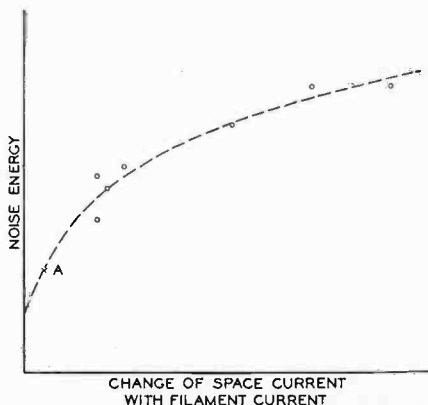

Fig. 8—Slope of a space current—filament heating power curve plotted against noise for a number of different tubes of the same type. Point *A* refers to a tube of another type having good filament temperature saturation.

all of the same type and show the effect of non-saturation of the filament upon the noise. The tubes were operated with the values of plate and grid potentials and filament temperature recommended by the designer. Under these conditions it was found that the filaments were in very imperfect temperature saturation. For the purpose of the experiment it was fortunate that the degree of temperature saturation was quite different for the different tubes so that a relation between the degree of saturation and amount of noise could be obtained. In this way, a rough though significant curve was secured which shows that the more complete the saturation the less was the noise. In the same figure, point *A* shows the same measurement made upon a tube of another

type, having about the same values of plate resistance and amplification factor, but having quite perfect temperature saturation.

Tests for gas were made on a number of tubes, but no correlation between the gas pressure and the residual noise was found for any of the high-vacuum tubes in use today. Therefore, ionization by direct collision is thought to be of sufficiently rare occurrence to produce a negligible amount of noise.

A special study was made of the noise in the four-electrode type of tube commonly known as the screen-grid tube. In general, these tubes were found to have rather poor temperature saturation of the filament, and as a result showed a high noise level. The filaments saturated better and the noise level was much lower with 45 volts on the screen than with 67 volts. In rating these tubes for noise, it must be remembered that their high-plate impedance keeps the noise level quite high, so that an erroneous impression may be gained that they are too noisy for use where quietness is essential. Such is not the case. The signal is amplified to such an extent that the ratio of signal to noise ranks about the same as with other tubes having the same degree of filament saturation. There is room for a decided improvement in the degree of temperature saturation in all kinds of these tubes which have been tested, including those with the heater type of cathode.

Part V

GENERAL CONCLUSIONS

In the practical application of the foregoing theoretical and experimental study of the noise inherent in vacuum tubes and their associated circuits, there is one important fact to be borne in mind above all others. This fact is that the first stage of a radio receiving apparatus usually has a high impedance circuit attached to the grid of the tube. The thermal noise from such a circuit masks the noise from the plate side provided that the tube is operating as a detector or amplifier with temperature saturation of the filament. In this case, then, all that need concern the radio technician is the ratio of signal to noise in the input circuit.

When this is not the case the filament is nearly always responsible for the excess noise by exhibiting only a low degree of temperature saturation.

In order to be prepared to deal with those special cases or circuits where the input circuit impedance is sufficiently low to allow noise from the plate side to come into prominence, the more detailed investigation was undertaken. Here, again, it is found that with tubes properly designed to operate at temperature saturation, the major portion of the

noise comes from thermal agitation in the plate circuit, with the internal plate resistance of the tube acting at the filament temperature. There is thus an advantage in tubes having saturation at low values of filament temperature.

The question of the shot effect in the presence of space charge has been dealt with theoretically. It is thought that the explanation here given may be subjected to a mathematical treatment sufficiently rigorous to supplement the experimental tests, which are, for reasons explained, somewhat unsatisfactory. The practical criterion is theoretically predicted and experimentally established that perfect temperature saturation of the filament under operating conditions results in a reduction of the noise.

The exact effect of ions and secondary electrons upon the noise is not determined. It is certain that they contribute a measurable amount, but a more definite statement at the present time seems to be impossible just as an accurate determination of their effect upon the space current itself has never been made. It is found, however, that a large negative bias on the grid is harmful.

In conclusion the writer wishes to thank the many members of the technical staff of the Bell Telephone Laboratories who by their aid and suggestions have contributed to these noise studies.

Note 1

SHOT EFFECT IN THE PRESENCE OF SPACE CHARGE

The total space current of a given vacuum tube is dependent only upon the plate and grid potentials and upon the total electron emission from the filament, provided that thermal effects are neglected. Thus

$$I = I(E_p, E_g, J) \quad (1)$$

where

I is total space current

E_p is the plate potential

E_g is the grid potential

J is the total current emitted by the filament.

From (1)

$$\delta I = \frac{\partial I}{\partial E_p} \delta E_p + \frac{\partial I}{\partial E_g} \delta E_g + \frac{\partial I}{\partial J} \delta J \quad (2)$$

In this expression δJ may be interpreted as the change in the current emitted by the filament. Since no current ordinarily flows in the external grid circuit, δE_g may be taken as zero. Then, since by convention

$$\frac{\partial I}{\partial E_p} = \frac{1}{r_p}$$

equation (2) becomes

$$\delta I = \frac{\delta E_p}{r_p} + \frac{\partial I}{\partial J} \delta J. \quad (3)$$

Imagine an impedance to be placed in the external plate circuit, and consider a frequency range between ω and $\omega + d\omega$. We may write

$$Z(\omega) \delta I(\omega) = -\delta E_p(\omega) \quad (4)$$

where $Z(\omega)$ is the impedance in the external plate circuit at frequencies between ω and $\omega + d\omega$.

From (3) and (4)

$$-\delta E_p(\omega) = \frac{\partial I}{\partial J} Z_0(\omega) \delta J(\omega) \quad (5)$$

where

$$\frac{1}{Z_0(\omega)} = \frac{1}{r_p} + \frac{1}{Z(\omega)} \quad (6)$$

so that $Z_0(\omega)$ is the impedance at frequencies between ω and $\omega + d\omega$ of the parallel combination of r_p and $Z(\omega)$. If an amplifier whose voltage step-up is given by the gain, $G(\omega)$, is arranged to amplify the voltage given by (5), then the voltage across the terminating impedance of the amplifier is

$$e(\omega) = \frac{\partial I}{\partial J} Z_0(\omega) G(\omega) \delta J(\omega). \quad (7)$$

But the right-hand side of this expression is merely the fraction $\partial I/\partial J$, multiplied by the voltage that would be produced if there were no space charge. The mean square value of this latter may be written, from Fry's formula:

$$\overline{V^2} = \frac{\epsilon J}{\pi} \int_0^\infty |Z_0(\omega)|^2 |G(\omega)|^2 d\omega \quad (8)$$

where ϵ is the electron charge, $= 1.59 \times 10^{-19}$ coulomb. Hence, the shot effect mean square voltage, with or without space charge, becomes

$$\overline{e^2} = \left(\frac{\partial I}{\partial J} \right)^2 \frac{\epsilon J}{\pi} \int_0^\infty |Z_0(\omega)|^2 |G(\omega)|^2 d\omega. \quad (9)$$

Note 2

EVALUATION OF $\partial I/\partial J$ FOR IDEAL CASE

In order to evaluate the fraction $\partial I/\partial J$, we note that it is the rate of change of the actual space current with the total current emitted by the filament, under the restriction that the values of plate and grid

potentials are constant. Fig. 9 shows the manner in which I varies with filament temperature for various values of the plate potential. We may write

$$\frac{\partial I}{\partial J} = \left(\frac{\partial I}{\partial T} \right) \left(\frac{\partial T}{\partial J} \right).$$

From Fig. 9, the slope of the space current curve for a given value of plate potential, say 100 volts, is equal to $\partial I/\partial T$. Therefore, for the

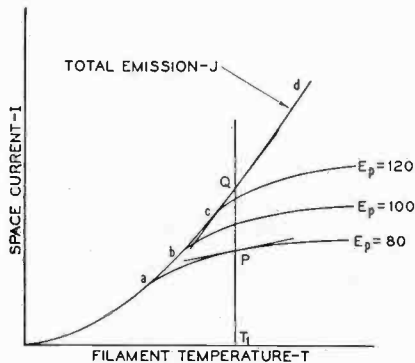

Fig. 9—Ideal variation of space current with filament temperature for various values of plate potential. The curve $Oabcd$ represents J , the total current emitted by the filament.

temperature T_1 , the value of $\partial I/\partial T$ is given by the slope at P , as shown. Irrespective of the plate potential, the value of $\partial J/\partial T$ is given by the slope of the J curve at the point Q , corresponding to the temperature T_1 .

For actual computation work it is convenient to plot the actual current I as a function of the saturation current J so that $\partial I/\partial J$ may be found directly.

Note 3

WHAT IS THE EFFECTIVE TEMPERATURE AS REGARDS PRODUCTION OF THERMAL NOISE OF THE INTERNAL PLATE RESISTANCE OF A VACUUM TUBE?

The difficulty in answering this question lies in the fact that the internal resistance of a vacuum tube is not a physical piece of apparatus but is a mathematical concept which measures the energy dissipated within the tube by a small variable current component through it. It is known from the kinetic theory of gases that the temperature of the electron cloud emitted by the filament is the same as the temperature of the filament itself. An analogous example is found in the case of boiling water, where the steam and water are at the same temperature. The

electron cloud does not in itself, however, constitute the internal resistance of the tube. The electrons from the cloud are constantly being drawn off by the plate and resupplied by the filament. They acquire kinetic energy on their way to the plate. This energy does not affect the cloud temperature because it is coordinated energy, while the energy by which temperature is measured is the average random uncoordinated energy. Upon striking the plate the electrons dissipate energy. Here, then, is an attribute of resistance; namely the dissipation of energy when the electrons strike the plate. The coordinated kinetic energy which the electrons have acquired on their way to the plate is transformed into the random motions of heat energy of the material composing the plate.

Without, however, entering into a more detailed study of how the energy dissipation takes place, we may obtain the answer to our question by the following thermodynamic argument:

Refer to Fig. 10. This figure shows a vacuum tube composed of cathode, anode and grid, together with the d-c generators necessary to

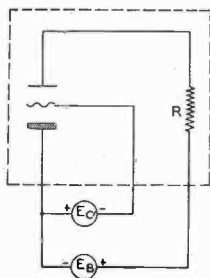

Fig. 10—Diagram to illustrate explanation of the effective temperature of the internal resistance of a vacuum tube.

supply a positive potential to the plate and a negative potential to the grid. A resistance R is connected in the external plate circuit. The resistance R and the tube are placed in an oven where both are maintained at the same temperature T , which is taken to be high enough to insure a copious emission of electrons from the cathode. The cathode may be imagined to be oxide-coated, whereas the grid and anode are composed of a material which does not emit electrons. Moreover, the grid potential is adjusted so that a change in electron emission by the cathode does not change the space current. The absence of any shot effect is thus provided for, so that no energy other than that needed to maintain a perfectly steady space current is supplied by the generators.

Under these circumstances, the thermal agitation of electricity within the resistance R will cause varying currents to flow through the tube,

supplying power to the internal resistance r_p of the tube. Therefore, the second law of thermodynamics requires that the internal resistance r_p must supply exactly the same power to the external resistance R . Suppose the two resistances to be equal in magnitude. Nyquist's formula tells us the mean square value of the thermal e.m.f. within R at the temperature T . Therefore, the mean square value of the e.m.f. within r_p must be exactly the same.

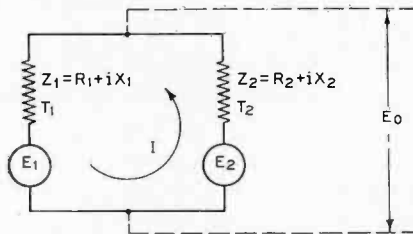

Fig. 11—Diagram to illustrate derivation of the expression for thermal noise from two impedances at different temperatures, T_1 and T_2 .

But the temperature T is the cathode temperature. If the anode is cooled by circulating water, the energy relations between R and r_p are still undisturbed, since R is powerless to deliver electromagnetic energy to the cooling water.

The conclusion follows, therefore, that the effective temperature of the internal resistance of a vacuum tube is equal to the cathode temperature.

Note 4

THERMAL NOISE FROM TWO CIRCUIT ELEMENTS IN PARALLEL BUT AT DIFFERENT TEMPERATURES*

From the method of derivation of equation (1), the mean square value of the effective e.m.f. acting within an impedance of resistive component $R(\omega)$ and between the frequencies given by ω and $\omega + d\omega$ is

$$\overline{E^2}d\omega = \frac{2kT}{\pi}R(\omega)d\omega. \quad (1)$$

Consider the circuit shown in Fig. 10. The thermal electromotive forces acting in Z_1 and Z_2 are represented by E_1 and E_2 , respectively, and the two impedances are at the different temperatures, T_1 and T_2 . For the present, consideration is limited to those frequencies lying between ω and $\omega + d\omega$.

* The modification of the formula for thermal noise which is here presented was derived by both Nyquist and Johnson independently of the writer, and at a previous time.

From the figure:

$$I = \frac{E_1 + E_2}{Z_1 + Z_2}$$

Hence, the voltage E_0 is:

$$\begin{aligned} E_0 &= E_1 - I_1 Z_1 \\ &= E_1 \frac{Z_2}{Z_1 + Z_2} - E_2 \frac{Z_1}{Z_1 + Z_2} \end{aligned}$$

The mean square value of E_0 is therefore

$$\overline{E_0^2} = \overline{E_1^2} \left| \frac{Z_2}{Z_1 + Z_2} \right|^2 + \overline{E_2^2} \left| \frac{Z_1}{Z_1 + Z_2} \right|^2 \quad (2)$$

From (1) the mean square values of E_1 and E_2 may be obtained. When these are substituted in (2) there results:

$$\overline{E_0^2} d\omega = \frac{2k}{\pi} \left(\frac{T_1 R_1 |Z_2|^2 + T_2 R_2 |Z_1|^2}{|Z_1 + Z_2|^2} \right) d\omega$$

or, by integration over all frequencies

$$\overline{E_0^2} = \frac{2k}{\pi} \int_0^\infty \left(\frac{T_1 R_1 |Z_2|^2 + T_2 R_2 |Z_1|^2}{|Z_1 + Z_2|^2} \right) d\omega \quad (3)$$

which may be put into the form used in the text by ordinary algebraic manipulation.



A STUDY OF THE OUTPUT POWER OBTAINED FROM VACUUM TUBES OF DIFFERENT TYPES*

BY

H. A. PIDGEON AND J. O. McNALLY

(Bell Telephone Laboratories, New York City)

Summary—Economical operation of the large number of tubes involved in the Bell System makes necessary the adoption of common supply voltages. This requires that repeater tubes of various types be designed to operate at a fixed plate voltage. For this reason the design of amplifier tubes to give as large a power output as possible at the operating plate voltage is of considerable importance.

In the case of three-electrode tubes it is possible from theoretical considerations to compute, approximately, the electrical parameters a tube must have in order to give the maximum output power of a given quality obtainable under fixed operating conditions.

The electrical characteristics and output of fundamental, second, and third harmonics of two of the more common telephone repeater tubes are given.

It is of considerable interest to determine whether greater power output of comparable quality can be obtained from tubes containing more than one grid. Since no sufficiently exact theoretical analysis of multi-grid tubes is yet available to permit the determination of the parameters of optimum tubes, a comparative experimental investigation of a number of such structures has been undertaken. The electrical characteristics and output of fundamental, second, and third harmonics of several such experimental tubes are given. The power output of multi-grid tubes and of three element tubes is compared. The reasons for the comparatively large power output of certain types of multi-grid tubes are discussed.

IN the design of amplifier tubes for use in the Bell System certain controlling factors must be taken into account, based upon considerations of plant economy and the character of the service required. Economical operation of the large number of tubes involved makes necessary the adoption of common supply voltages. These are 130 volts for plate and 24 volts for filament supply. This requires that tubes of various types be designed to operate at this plate voltage, and with filament voltages so chosen that a number of tubes can be operated in series on the common filament supply. Four filaments are usually operated in series so that, allowing for the normal battery voltage fluctuations and for certain auxiliary apparatus in the filament circuit, the maximum filament voltage is fixed at 5.0 volts.

It is necessary to consider the stability of gain with variations in the operating voltages in the design of such tubes. The gain variation introduced by fluctuations in filament battery voltage is particularly important. In fact, the useful life of repeater tubes is determined by the

* Dewey decimal classification: R131.

period over which the gain variation remains less than a specified value for a given change in filament current.

Another important factor is reliability of service. This requires that the average life of tubes shall be relatively long in order to reduce, as far as possible, impairment or interruption of service by tube failures. This is particularly important in the long-distance lines where a large number of tubes are involved in the operation of any given talking circuit. Tubes used in this service have an average life of not less than 10,000 hours, while some of the types used have an average life greater than 25,000 hours. Furthermore, repeater tubes must be uniform in their characteristics in order to be interchangeable; and they must maintain this uniformity throughout their useful life in order to keep the transmission characteristics of the telephone lines within the limits required. Similar considerations apply to the quality of output. In general, it is necessary to operate the tubes into impedances matching their own plate-filament resistance in order to reduce reflection effects; and in carrier circuits, where the harmonics must be reduced to very low levels, the tubes are used in push-pull or balanced arrangement to suppress the second harmonic as far as possible.

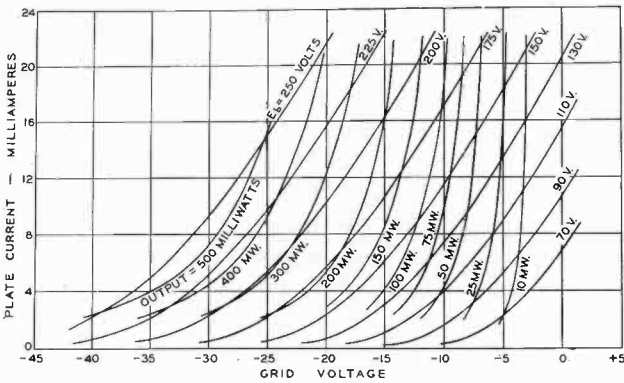

Fig. 1—Type 101-D tube. Characteristic curves and fundamental output power for a sinusoidal input voltage whose peak value, v , is equal to the grid potential, E_c , at all points. The load resistance, R , is equal to the plate resistance, R_p .

These requirements and other factors lead to more conservative tube design than is necessary for many other types of service. Particularly is this true with respect to the filament. More electron emission and, consequently, greater filament area are provided than is necessary in many other tube applications.

CHARACTERISTICS OF TELEPHONE REPEATER TUBES

In use as amplifier and modulator tubes in the telephone plant are the types 101-D¹ and 104-D tubes. Both tubes operate at a filament current of 0.97 ampere and a filament voltage of 4.4 volts. Characteristic curves for the 101-D tube are shown in Fig. 1. It normally operates at a grid bias of -9.0 volts and at a plate current of about 8 milliamperes. Under these conditions the average amplification factor, μ , is 5.9 and the average plate resistance is about 6000 ohms.

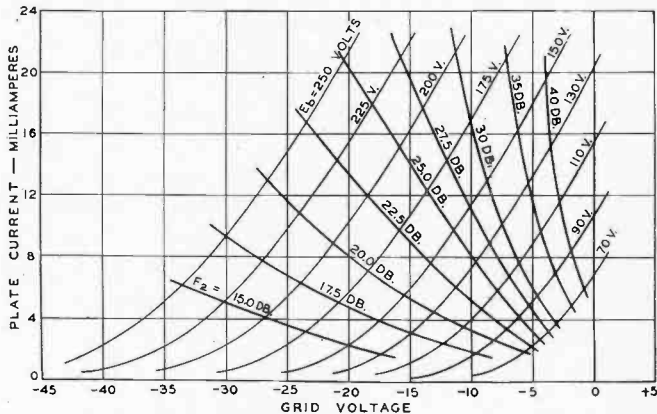

Fig. 2—Type 101-D tube. Second harmonic, F_2 , in decibels below the fundamental, F_1 . $v = E_c$; $R = R_p$.

Projected across the characteristic curves of Fig. 1 are isometric curves of fundamental output power. In Figs. 2 and 3, in a similar manner, isometric curves are shown for constant ratios of the second and third harmonics, respectively, to the fundamental output. These ratios are expressed in decibels. The data shown, the method of measuring which will be described later, were obtained under the following conditions: an external load resistance was adjusted at all points to have a value equal to the plate resistance of the tube; a sinusoidal, audio-frequency input was applied, the peak value of which at all points was adjusted to equal the grid-bias voltage. Consequently, the values of output power shown are the largest that can be obtained without carrying the grid positive.

The output power for smaller values of input voltage may be computed readily since the power is proportional to the square of the

¹ The type 101-D tube has been largely replaced in voice frequency repeaters by the type 101-F tube, which operates at a filament current of 0.485 ampere and a filament voltage of about 4.0 volts. Otherwise its characteristics are very similar to those of the 101-D tube described in this paper.

input voltage. Likewise, the corresponding ratios of the second and third harmonic currents to the fundamental may be computed since these ratios are approximately proportional, respectively, to the first and second power of the input voltage.

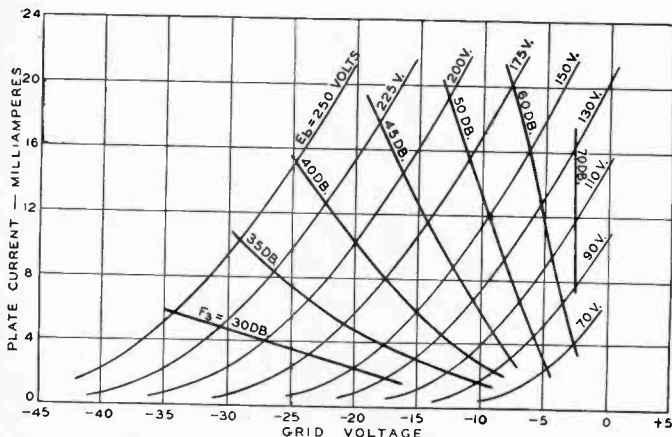

Fig. 3—Type 101-D tube. Third harmonic, F_3 , in decibels below the fundamental, F_1 . $v = E_c$; $R = R_p$.

Or, expressed in decibels we may write,

$$F_2 = F_{2m} + 20 \log_{10} \frac{e_m}{e} \tag{1}$$

in which F_{2m} is the level of the second harmonic current below the fundamental in decibels when the peak-input voltage has the value e_m which just carries the grid to zero; and F_2 is the corresponding level of second harmonic for any lesser value of peak input e . Similarly, for the third harmonic,

$$F_3 = F_{3m} + 40 \log_{10} \frac{e_m}{e} \tag{2}$$

It is seen from the figures that the output power of the 101-D tube at the normal operating point is about 60 mw with the second and third harmonics 26.3 and 48 db below the fundamental, respectively. The power output can be very much increased by operating the tube at more negative grid potentials, although the quality is not as good. For example, with the grid potential at -13 volts the output is increased to 85 mw with the second harmonic 20 db below the fundamental.

Similar data are shown in Figs. 4 and 5 for the 104-D tube, which is also widely used in the Bell System particularly in carrier circuit

apparatus. At a plate potential of 130 volts, and a grid potential of -20 volts the plate current is 23 ma. Under these conditions the amplification factor is 2.5 and the plate resistance 2000 ohms. The

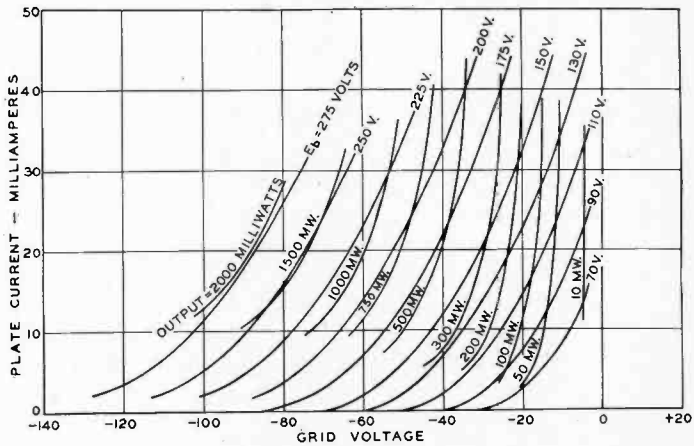

Fig. 4—Type 104-D tube. Characteristics and fundamental output power. $v = E_c$; $R = R_p$.

output power is 160 mw with the second harmonic 25 db below the fundamental. At -32 volts grid potential the power output is increased to 265 mw with the second harmonic 20 db below the funda-

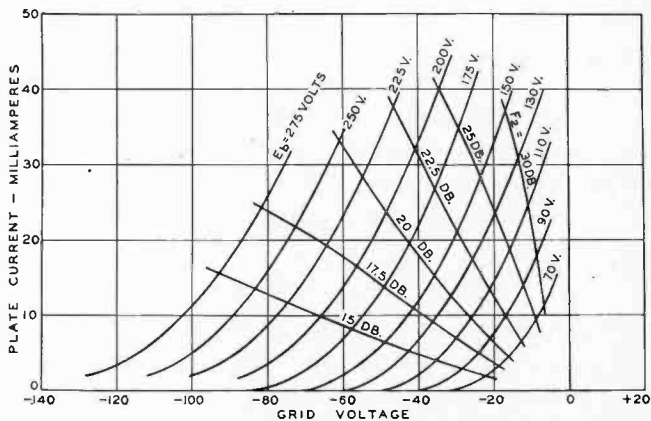

Fig. 5—Type 104-D tube. Second harmonic, F_2 , in decibels below the fundamental, F_1 . $v = E_c$; $R = R_p$.

mental. By operating at still more negative grid potentials the output power may be further increased, although the quality rapidly grows worse.

It has become a common practice to collect such data as are shown in Figs. 1 to 5 as part of the standard information on tubes used in the telephone system. This information includes, for several ratios of external plate circuit resistance to the plate resistance of the tube, the gain, output power, and the relative levels of second and third harmonics; also similar charts show the plate resistance and amplification factor, μ , over the entire operating range of the tube. Such diagrams form a compact compilation of data useful in determining the best operating conditions for any particular application of tubes as amplifiers, and they also afford an accurate basis for the comparison of tubes of different types.

METHOD OF MEASURING THE HARMONIC OUTPUT OF VACUUM TUBES

In measuring the harmonic output of tubes use is made of a current analyzer similar in design to that developed by J. W. Horton and F. Mohr.² It will suffice to state here that it is a high gain amplifier with highly selective circuits such that, when tuned to the frequency of the current to be measured, the magnitude of the current is indicated by the reading of a meter in the output circuit. The slight unsteadiness in gain inherent in such apparatus makes the permanent calibration of the output in terms of the input impracticable. It is the usual practice, therefore, to make such measurements by a method of substitution in which the harmonic current of unknown magnitude from the tube (or apparatus) under test, is replaced in the analyzer system by a measured current of the same frequency from a standard oscillator adjusted to produce the same response in the indicating meter placed in the output circuit of the analyzer.

For rapid work a modification of this method has been successfully used employing the circuit shown schematically in Fig. 6. The input to the tube under test is supplied by the input oscillator and measured by the thermocouple *B*. An input frequency of 1900 cycles per second has been used in most of the work. A suitable low-pass filter system between the oscillator and the tube suppresses all harmonics in the oscillator output to values well below those produced by modulation in the tube under test. With the switch *S* thrown to the position 2, the output current of the tube is passed through the attenuation network into the analyzer. With the switch in position 1 the analyzer and attenuator are connected to the standard oscillator, the output current of which is indicated by the thermocouple *A*.

² J. W. Horton, "The empirical analysis of complex electric waves," *Trans. A. I. E. E.*, 46, 535-541; May, 1927. A. G. Landeen, "Analyzer for complex electric waves," *Bell Sys. Tech. Jour.*, 6, 230-247; 1927.

In practice the procedure is as follows: after tuning the analyzer to the frequency of the harmonic it is desired to measure, the standard oscillator is connected and also adjusted to this frequency. The reading of the indicating meter *D* is then noted for some convenient value of input current to the analyzer smaller than the harmonic current to be measured. This gives the necessary calibration. The output circuit of the tube under test is then connected to the analyzer, and the attenuator adjusted until the same reading is obtained in the meter *D*. A simple calculation gives the value of the harmonic current. Provided the plate and filament voltages on the analyzer are suffi-

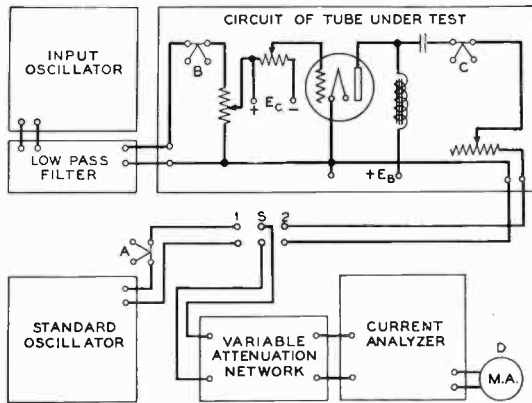

Fig. 6—Schematic diagram of circuit for the measurement of the harmonic output currents from vacuum tubes.

ciently constant, it is possible to make a number of measurements before readjusting the calibration. The thermocouple *C* in the plate circuit of the tube under test gives the fundamental current with an error of less than 2 per cent for cases when the greatest harmonic level is 14 db or more below the fundamental, and when the other harmonics are progressively smaller in about the same ratio. For cases where this method produces appreciable error the fundamental current may be measured in the same way as the other components of output current, but this is obviously unnecessary in most cases.

Having available an experimental method by which the output of fundamental and other harmonics can be measured readily and with a fairly high degree of precision, it becomes a problem of considerable interest to determine whether greater output of a given quality can be obtained from other types of structure than from three-electrode tubes *when limited to the same plate voltage and space current.*

The primary object of this paper is to present the results of such an experimental study of tubes containing two grids, one of which is held at some fixed positive potential; and to compare the output power obtained from them with the maximum obtainable from comparable three-electrode tubes. For at least most of the applications we are concerned with, it is a necessary condition that the tube work into an impedance equal to its own plate resistance; therefore, the study is limited to this condition. It is also limited to 130 volts plate potential and to a total space current equal to that of the 104-D tube, viz., 20 to 25 ma.

OPTIMUM THREE-ELECTRODE TUBES

In the case of three-electrode tubes a sufficiently exact theoretical analysis is possible to permit the design of structures closely approximating the optimum obtainable from the standpoint of giving the maximum output power of a given quality available at any given plate voltage and plate current. Space does not permit presenting such an analysis here, although it is hoped that it shall be given at a later time.

Such computations show that no very substantial increase in output power of like quality could be obtained by a change in design, over that now obtained from the 101-D and 104-D tubes under the given operating conditions. The gain, however, could be increased without sacrifice of output power or quality. With the second harmonic fixed at 20 db below the fundamental, similar computations show that the output power could be greatly increased. For example, with the plate current fixed at 23 ma, by a change in design, an output power of about 450 mw could be obtained as compared with 265 mw from the 104-D tube. Data obtained from such a tube will be shown later.

TWO-GRID TUBES—POSITIVE INNER GRID

Tubes containing two grids spaced at unequal distances from the filament, one of which is held at some fixed positive potential, were extensively studied and described by W. Schottky.³ He found that tubes with the inner grid positive are particularly effective in giving high amplification at low plate voltages. The basic idea of this arrangement is that the field due to space charge near the filament, which limits the flow of electrons, is partially neutralized by the field of the positive grid. A larger percentage of the total number of electrons emitted by the filament is thus utilized in space current, the plate resistance lowered thereby and the amplification correspondingly increased.

³ W. Schottky, "Über Hochvakuumverstärker," *Archiv. für Elektrotechnik*, 8, 299-328; 1919.

Although such tubes have been studied in this country, they have not come into general use, due chiefly, perhaps, to the following reasons. They are somewhat wasteful of space current, since the positive grid collects a considerable fraction of the total current. And for power amplifiers, with high-voltage plate batteries readily available, it has been found economical and more in accord with the general trend in tube design to meet the demand for increased output power by increasing the operating plate voltage rather than by increasing the plate current and, consequently, the electron supply from the filament, to the extent that would otherwise be necessary. It does not follow, however, that with a definitely fixed plate voltage available, as there is in the telephone plant, it might not be economical to apply this principle.

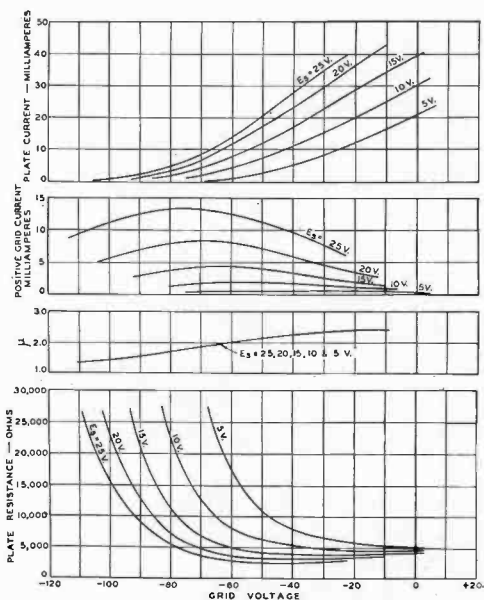

Fig. 7—Two-grid tube with inner grid positive. Characteristics for 130 volts plate potential and for various values of positive grid voltage, E_g . Plate spacing = $5/16$ inch; outer grid spacing = 0.200 inch; inner grid spacing = 0.105 inch; diameter of lateral wires = 0.008 inch, and turns per inch = 10 for both grids.

The work of Schottky was mainly concerned with the amplification obtainable under the most favorable conditions. But neither his work nor any other available data, so far as the authors are aware, permits the direct comparison of the output of a given quality that may be obtained from such tubes with that obtainable from three-electrode tubes when limited to the same voltage and space current.

Unfortunately, in the case of multiple grid tubes, particularly when one of them is held at a positive potential, there is no sufficiently, exact theoretical analysis yet available to permit the determination of the parameters of optimum tubes, as there is in the case of three-electrode tubes. It has been necessary, therefore, to follow qualitative considerations largely in the design of such tubes, and to cover experimentally fairly wide variations in structural parameters.

Flat type structures are the only ones well adapted to the use of filament having the characteristics desired for telephone use. Consequently, this study was limited to structures of flattened cylindrical form containing the usual type of wound grids that are readily made commercially. A number of variations were made in the spacing of the plates and grids, and in the size, number, and arrangement of the lateral wires in each grid.

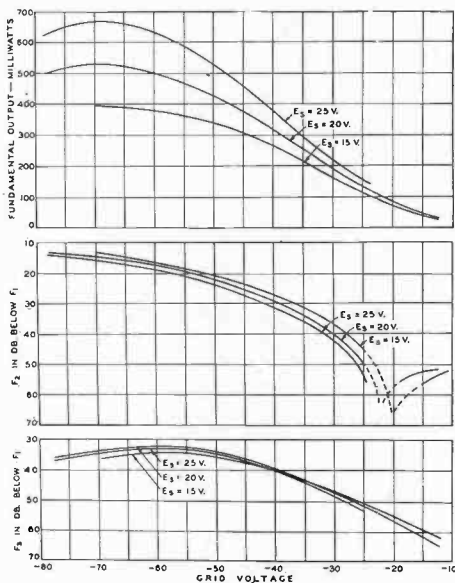

Fig. 8—Output power; second and third harmonic levels, expressed in db below the fundamental, F_1 , for positive inner grid tube whose characteristics are shown in Fig. 7. $E_b = 130$ volts; $v = E_c$; $R = R_p$.

In Figs. 7 and 8 curves are shown for one of the best structures found. It contains the same filament and is therefore capable of operating at the same total space current as the 104-D tube. In Fig. 7 the plate current, positive grid current, amplification factor, and plate resistance are plotted as functions of the control-grid voltage for several values of potential on the positive space-charge grid. In Fig. 8

power output, second and third harmonic levels are shown in a similar manner. As in the cases of the 101-D and 104-D tubes, the values of power, second, and third harmonics are for sinusoidal input voltages the peak values of which are equal to E_c at every point.

Now the available output power will depend on the quality specified. Without attempting to define the quality required, let us arbitrarily adopt as a basis of comparison the criterion that the percentage of second harmonic cannot be greater than that corresponding to 20 db below the fundamental. This is a higher percentage than could be permitted in many cases, and perhaps is as high as could be tolerated in almost any practical application.

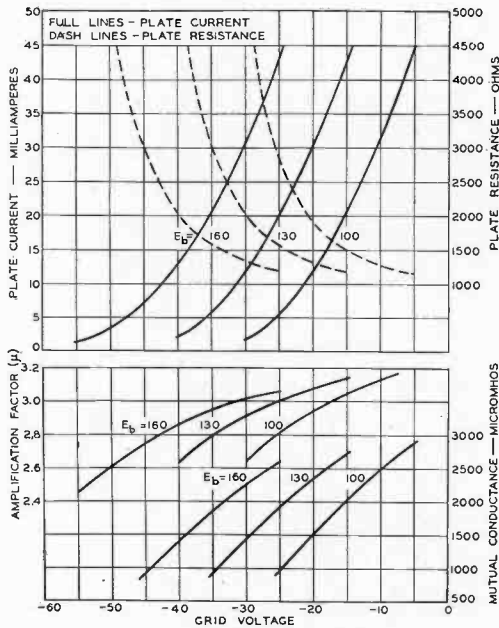

Fig. 9—Characteristics of optimum three-electrode tube. Constructed to give maximum output power with second harmonic 20 db below the fundamental, for $E_b = 130$ volts and $I_b = 23$ ma.

For the tube considered, the 20-db limit is reached at a grid potential of -54 volts and at a positive grid potential E_g of 20 volts, which is about as high a value of the latter as could be chosen without exceeding the space-current limitation. Under this condition the sum of plate and positive grid currents is 22.5 ma, which is within the proper range for the filament of the 104-D tube. The plate resistance is 3300 ohms and the value of μ is 2.1. The output power under these conditions is 460 mw. The gain is 22.7 db, determined under the standard

conditions for repeater tubes. These conditions, which apply to all of the values of gain given in this paper, are that the tube work into a resistance load, R , equal to its own plate-flament resistance, R_p , and that the input circuit have a resistance of 600,000 ohms.

Let us compare this output power with that from an optimum three-electrode tube designed to operate at a plate potential of 130 volts, a plate current of 23 ma, and giving the maximum output power obtainable with the second harmonic 20 db below the fundamental. As previously indicated, the computed output power of such a tube is about 450 mw.

The characteristics of a tube very close to the optimum in output power under these conditions are shown in Figs. 9 and 10. The plate and grid spacing were made as small as practicable in tubes the electrical characteristics of which must be maintained within the relatively close limits required in telephone repeater tubes. This tube operates at the proper level of second harmonic with the grid at -25.3 volts, at which point the power output is 440 mw. The gain under this condition is 29 db. Comparison with the results obtained for the space-charge-grid tube shows that the power output is nearly the same for the two structures, although the gain obtained with the optimum three-electrode tube is 6.3 db higher. Therefore, so far as the results from this positive grid tube are indicative, there would seem to be no advantage in tubes of this type.

From theoretical considerations and also from the work of Schottky and D. C. Prince,⁴ it appears that perhaps some advantage might be gained by the construction of space-charge-grid tubes of circular section and having as great a degree of symmetry as possible. Under ideal conditions such tubes would transfer the zone of effective space charge from a small sheath about the filament to a very much larger cylindrical sheath at a position between the two grids determined by the potentials on the plate and grids. The density of space charge and, consequently, the impedance of the tube would be correspondingly reduced. The distortion of the field by the grids, particularly if this distortion is non-symmetrical, prevents the realization of this ideal condition by introducing an element of turbulence into the flow of electrons. From this standpoint, there might be some advantage also in using longitudinal lateral wires in one of the grids, thus making the lateral wires in the two grids perpendicular to each other as employed by Prince and also suggested by F. Below.⁵

⁴ D. C. Prince, "Four-element tube characteristics as affecting efficiency," *Proc. I. R. E.*, 16, 805-821; June, 1928.

⁵ F. Below, "Zur Theorie der Raumladegitterröhren," *Zeits. für Fernmelde-technik*, 9, 113-118, August, 1928; 136-143, September, 1928.

While it is possible that some improvement might be obtained by a change in electrical parameters from those of the tube the characteristics of which are shown, or by structural changes such as those discussed above, it is not believed that any very substantial increase in output power of like quality can be obtained by such means, at least under the imposed limitations of space current and plate voltage. Confirmation of this view is had in the results obtained with certain variations in structures tried. Experiments were made on three groups of tubes constructed as follows: in the first group the lateral wires of the control grid were arranged directly behind those

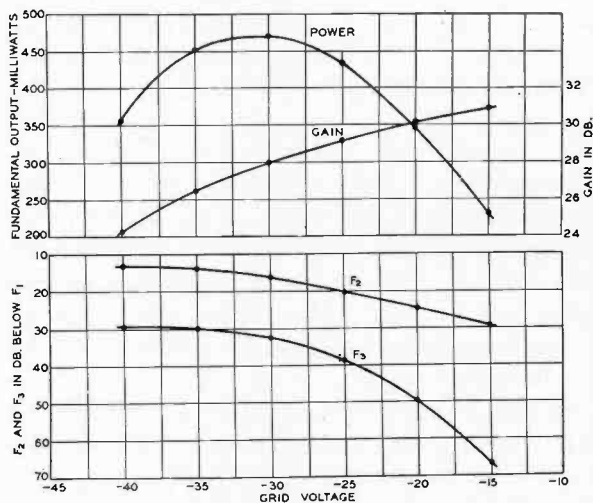

Fig. 10—Output power, gain, second and third harmonic levels for the optimum tube whose characteristics are shown in Fig. 9. $E_b = 130$ volts; $v = E_c$; $R = R_p$.

of the positive grid. In the second group the lateral wires of the control grid were directly opposite the mid-points in the interstices between the grid wires of the positive grid. The characteristics of one of these tubes are shown in Figs. 7 and 8. In the third group the inner (positive) grid was identical with that in the other groups; the outer or control grid was constructed with longitudinal lateral wires having the same diameter and spacing as in the other groups. In all other details than those described the structure of the tubes in the three groups was identical. If turbulence is effective in limiting the output power from this type of structure, then there should be a marked difference in the results obtained from the tubes in these three groups. As a matter of fact the characteristics and output were practically identical.

The results of these and other experiments lead to the conclusion that there is a more fundamental reason for the limitation in output power from such tubes. They are essentially low-voltage high space-current tubes, and are not particularly efficacious at the voltage and comparatively low space currents considered here. Over a limited range of operation they have a low impedance and, consequently, are capable of giving a high gain. When tubes of this type are designed to operate over a wider range, as they must be for large output power, they are much less efficient. Under this condition the effective plate resistance increases and the positive grid is of little service or may even render the tube less effective than a well-designed three-electrode tube. Better results were obtained with a type of structure described later, which is essentially free from these limitations; consequently, tubes of this particular type were not studied further.

TWO-GRID TUBES WITH OUTER GRID POSITIVE

Another possibility in the application of two-grid tubes lies in the operation of specially designed structures with the outer grid positive, which also was suggested by W. Schottky.⁶ The arrangement is similar to that in the well-known screen-grid tube, but the grids are made much coarser in order to reduce greatly the tube resistance. With such tubes it is possible to obtain fairly large values of output power within the specified limits of quality and space current, and at extraordinarily high gain. Although comparatively high in plate resistance, they have an advantage in the reciprocal effect that the plate current, throughout the permissible operating range, varies much less with plate voltage than in either of the other types previously considered. This would permit the consumption of a greater percentage of the total plate voltage in useful potential drop across the load impedance were it not for one very serious restriction. This is due to the well-known fact that, for plate potentials equal to or less than that of the positive grid, the tube characteristics are greatly distorted by secondary electrons liberated from the plate and collected by the positive grid. This at once places the limitation on the operation of the tube, that the instantaneous values of the plate potential can never be less than that of the positive grid if prohibitive distortion of the output current is to be avoided. This requires the operating plate voltage to be so high as to exclude such tubes from consideration at the limited voltage considered here, and in any case to handicap seriously their efficient operation so far as the economical use of plate battery is concerned.

⁶ W. Schottky, *loc. cit.*

A means of practically eliminating the effects due to secondary electrons from the plate has been found in an additional grid placed between the plate and positive grid. It is held at some potential (usually near that of the filament) lower than that ever reached by the plate thus preventing secondary electrons from the plate escaping to the positive grid. This permits operation with the plate at potentials only a little higher or even equal to that of the positive grid. Such tubes have found practical application in England under the name "pentodes".

However, the percentage of second harmonic in the output of such tubes is high, caused by the combination of comparatively large current components of like sign produced by the curvature of the plate-current plate-voltage characteristic, and by relatively large variations in μ . For this reason we may dismiss such tubes from further consideration so far as this study is concerned. In any case the inherent high resistance of such structures makes them compare unfavorably with other structures so far as output power is concerned, although a moderate output power combined with the extraordinarily high gain of which they are capable makes them attractive for certain special applications.

CHARACTERISTICS OF CO-PLANAR GRID TUBES

Another arrangement that has been found to be particularly effective in the utilization of a positive grid to reduce space-charge effects, is to place it so that its lateral wires lie in the same plane as those of the negative control grid and alternate with them. So far as the authors are aware no data on such structures have hitherto been published.

Here, as in the case of other types of tubes with positive grids, it has been necessary to follow qualitative considerations in their design, so that the structural parameters necessary for the best design are not as yet very well defined. In agreement with theoretical considerations, the tube resistance and, consequently, μ should be low for large power output. At the same time there seems to be an advantage in having the lateral wires of the negative control grid shield those of the positive grid as well as possible when the former swings to large negative potentials. These opposing requirements cannot be wholly satisfied, but obviously are the most nearly so by the use of small diameter lateral wires fairly closely spaced. On the other hand it is necessary to use lateral wires large enough to maintain the grid form. The arrangement of the grids and other elements in these tubes is shown in the sketches of Fig. 11. The narrower grid is used as the

control grid since a larger current is collected by the unshielded portion of the positive grid if the arrangement is reversed.

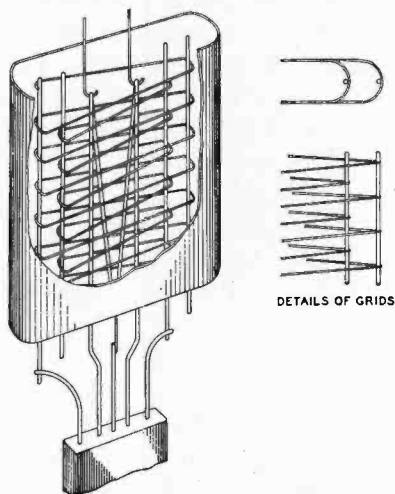

Fig. 11—Schematic diagram of co-planar grid tube.

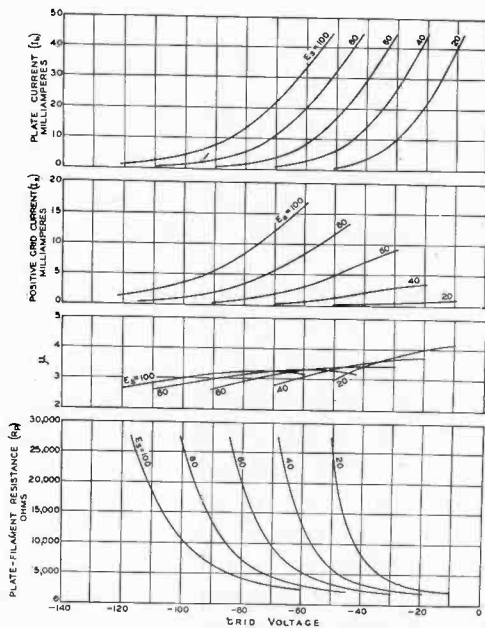

Fig. 12—Characteristics of co-planar grid tube for various values of positive grid potential, E_g ; $E_b = 130$ volts. Plate spacing = 0.200 inch; grid spacing = 0.090 inch; diameter of lateral wires = 0.005 inch, and turns per inch = 12.9 for each grid.

Static characteristics for a typical tube of this type, which we will refer to as a co-planar grid tube, are shown in Figs. 12 and 13. The plate spacing in this particular tube is 0.200 inch, and the spacing of the grids 0.090 inch. The lateral wires in both grids are 0.005 inch in diameter, wound with 12.9 turns per inch. The curves of Fig. 12 are analogous in all respects to those shown in Fig. 7 for a tube with positive inner grid. In Fig. 13 are shown families of plate current and positive grid-current curves as functions of E_c with the positive grid

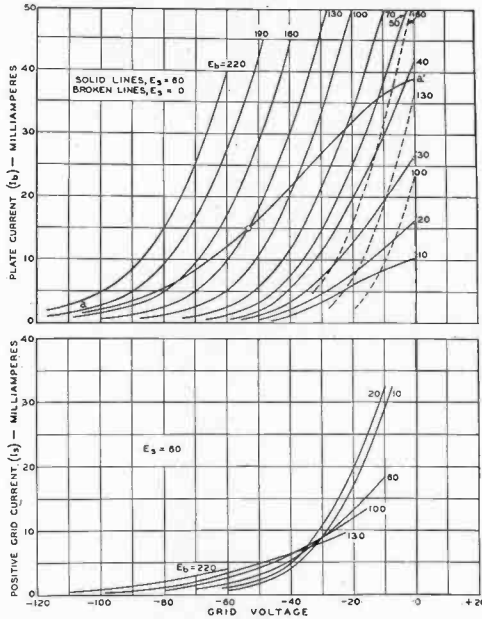

Fig. 13—Characteristics of co-planar grid tube for various values of plate potential, E_b . $E_s = 0$ and 60 volts.

voltage E_s fixed at zero and 60 volts as parameters. It is apparent from these curves that one of the chief effects of increasing the positive grid voltage is to move the families of plate current characteristics to the left. This displacement is equivalent in effect to an increase in plate voltage and is roughly proportional to the increase in E_s . This approximation is closer if we consider the total space current to both the plate and positive grid rather than that to the plate alone.

In fact we may write as a rough approximation of the characteristics over a considerable portion of their range,

$$I_t = I_b + I_s = K(E_b + \mu_s E_s - \mu E_c)^n \tag{3}$$

in which I_t is the total space current, that is, the sum of the plate and

positive grid currents, I_b and I_s , respectively; K is a constant depending on the values of μ_s , μ and the dimensions of the tube; μ is the usual amplification factor pertaining to the control grid, and μ_s a similar factor pertaining to the positive grid. In a tube in which the two grids are symmetrical one might expect that μ_s and μ would be equal, but such is not the case although at the higher values of E_s , at least, the ratio of μ_s to μ is nearly constant when I_t is held constant. The variations in μ_s and μ are complex in character and space does not permit a detailed discussion of them here. In general, μ decreases and μ_s increases with decreasing values of I_t ; but the magnitude of these variations, at least when E_b is greater than E_s , does not seem to be greater than in ordinary three-electrode tubes.

Obviously, this equation does not take into consideration the distribution of the total current I_t between the plate and positive grid, which it would be necessary to do in order to formulate the characteristics with sufficient accuracy to permit the computation of the harmonic output; and, unfortunately, no satisfactory means are now available for computing the current to a positive grid. However, some of the characteristics of the tube are made clearer by reference to the above equation. For example, if the operating plate voltage E_b and the total space current I_t are fixed, then as larger values of positive grid voltage E_s are chosen the corresponding values of control-grid voltage E_c must be made proportionately more negative. We have already seen from the curves of Figs. 12 and 13 that this is the case, qualitatively at any rate. Computation shows that it also holds quantitatively to a fair approximation if the variations in μ and μ_s are taken into consideration. Since the peak value of the allowable input voltage increases with the absolute value of E_c the output power should, therefore, increase with E_s .

Or, so far as total space current is concerned, we might regard equation (3) as that of an equivalent three-electrode tube in which the plate voltage E_b is replaced by the effective plate voltage $E_b + \mu_s E_s$, an increase proportional to E_s as was indicated above.

Looked at from a slightly different angle, there is another reason why one should expect such a structure to give a greater power output than can be obtained from ordinary three-electrode tubes under comparable conditions. Under the limitation that the grid shall not be carried positive the latter are low in efficiency as power converters from the standpoint of the ratio of useful output power to that dissipated in the plate when no input is applied. One reason for this is, that at the instant when the grid is at zero potential, a large portion of the available voltage in the plate circuit must be consumed in draw-

ing the peak current from the tube, only the remainder being available as the peak value of useful voltage across the load resistance. That is,

$$E_b = E_{p0} + iR = E_{p0} + (I_{p0} - I_b)R \tag{4}$$

in which E_{p0} and I_{p0} are respectively the values of plate potential and plate current at the instant when the grid is at zero potential. E_{p0} is always a very considerable fraction of E_b .

Now in the co-planar grid tube the fixed component $\mu_s E_s$ of equivalent plate voltage contributes a large portion of the potential across the tube (corresponding to E_{p0}) necessary to draw the required current at the instant when the grid potential is zero. Consequently a larger proportion of E_b is available as useful voltage-drop across the load resistance than in three-electrode tubes. This means increased output power.

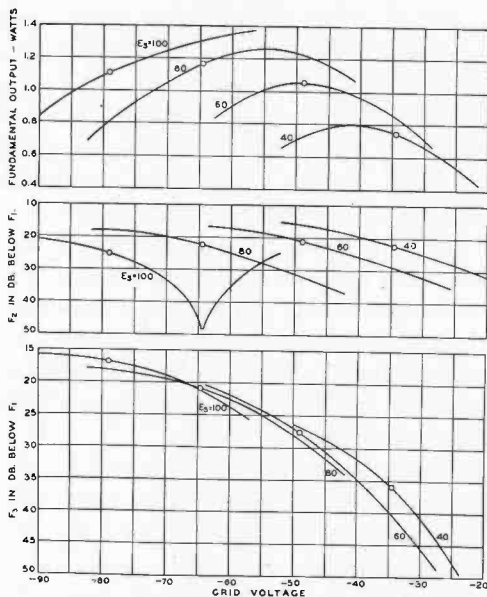

Fig. 14—Co-planar grid tube. $E_b = 130$ volts. Output power, second and third harmonics as functions of grid voltage. $v = E_c$, $R = R_p$.

On the other hand, there is no way of telling definitely from the curves as to what the relative levels of harmonics may be. The plate-current characteristics of Fig. 13 show a marked flattening or even a dropping off for values of E_b lower than E_s as E_c approaches zero. This is due to the larger fraction of the total current collected by the positive grid under these conditions. This also produces a flattening out of the

dynamic characteristic in this region, as is shown by the curve *a a'* which is a dynamic characteristic drawn through the operating point, $E_b = 130$ volts, $E_s = 60$ volts and $E_c = -53$ volts, for a resistance load equal to the plate resistance of the tube. The effect of this flattening of the dynamic characteristic is to reduce the second harmonic although the third may be increased relatively.

These conclusions are quite well confirmed by the curves of Fig. 14 in which the fundamental output power, second and third harmonics are plotted as functions of the control-grid voltage E_c . These data were obtained under the same conditions as those previously given for other tubes. The points on the curves marked by circles represent conditions for which the total space current, $I_b + I_s$, is 23 ma, so that

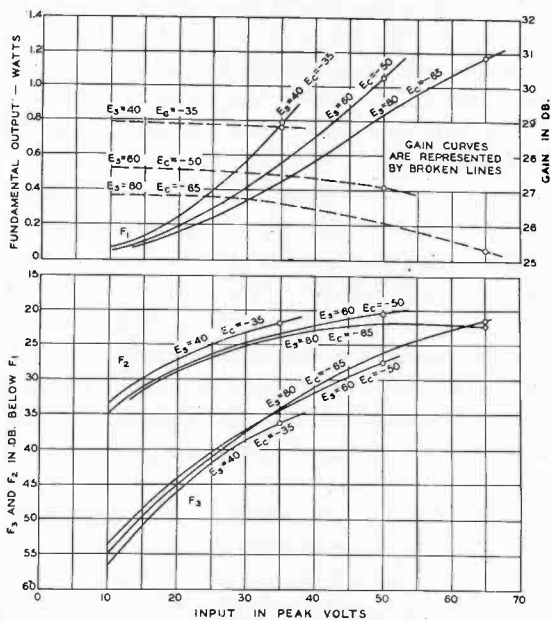

Fig. 15—Co-planar grid tube. $E_b = 130$ volts. Output power, gain, second and third harmonics as functions of peak input voltage.

values at these points are directly comparable with those previously considered for other tubes. In Fig. 15 some of the same data are plotted as functions of peak input voltage with E_s 80, 60, and 40 volts as parameters, and for selected values of E_c such that the total space current I_t (at zero input) is very nearly 23 ma. Gain curves for the same conditions are also included.

With E_s at 100 volts the total space current I_t reaches 23 ma at a grid voltage of -79 volts. At this point the output power is 1.11 watts

with the level of the second harmonic 25 db below that of the fundamental. On the other hand the third harmonic is only 17 db below the fundamental. So that, if we extend our criterion of the lowest permissible quality to include the condition that the third as well as the second harmonic must be limited to 20 db below the fundamental, this condition of operation must be rejected. The reason for the relatively high level of the third harmonic as compared with the second is found in the peculiar form of the characteristics as discussed above. With E_s at 80 volts the output power is 1.17 watts with the second and third harmonics 22.5 and 21.0 db below the fundamental, respectively. The gain under this condition is 25.3 db. The output power and third harmonic are progressively lower at the 23 ma points on the curves for lower values of E_s , while the second harmonic remains at about 22 db. Under the same limitation as to second harmonic the output power obtainable from this tube is about 2.5 times that from either the optimum three-electrode tube or from the tube with positive inner grid. On the other hand the third harmonic is considerably higher than for either of the other tubes.

Now suppose a three-element tube be designed to give the maximum possible output power with a plate current of 23 ma and without regard to quality. Computations show that such a tube would have a power output of about 850 mw with the second harmonic about 16 db below the fundamental. Hence, it is clear that this co-planar grid tube, which it cannot be assumed represents an optimum, gives a larger output power at a lower level of second harmonic (although not of third) than is possible in any three-electrode tube of the ordinary type, subject to the imposed limitations as to grid swing and space current.

Let us consider the output power of the co-planar grid tube at a level of second harmonic comparable with that of the 104-D tube when working under the conditions previously given. The output, as we have seen (Figs. 4 and 5), is 160 mw with the second harmonic 25 db below the fundamental. Under this condition the third harmonic is very low, of the order 55 db below the fundamental,⁷ and also extremely variable from tube to tube. This is caused by a partial balance of components of opposite phase due to curvature of the plate-current characteristics and to variations in μ . From the curves of Fig. 15 it is found that, with E_s at 40 volts, E_c at -35 volts and with a peak input of 25 volts the co-planar grid tube gives a power output of 400 mw with the second and third harmonics respectively 25 and 42 db below the fundamental. This value of output power is 2.5 times

⁷ Data not shown.

that of the 104-D tube under comparable conditions. By a redesign it might be possible, in a tube similar to the 104-D tube, to increase the output power to about 200 mw, but even so the co-planar grid tube would deliver twice as much power under comparable conditions.

Let us now remove the restrictions as to plate potential and plate current that have thus far applied in this study, and consider the output power from the co-planar grid tube at higher plate voltages and plate currents. The frequently used conditions will be assumed to apply, that the load resistance be made equal to twice the plate resistance of the tube and that the second harmonic be limited to five

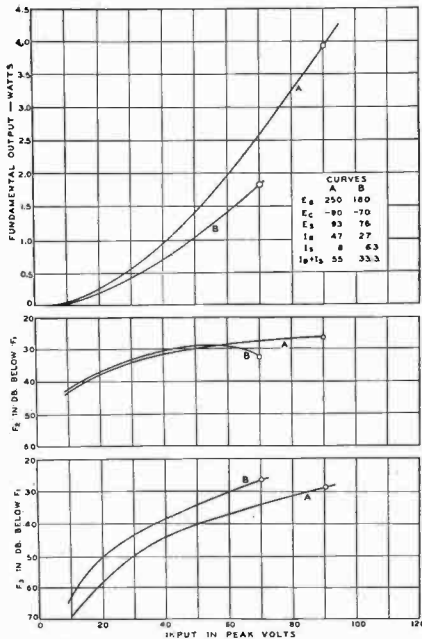

Fig. 16—Co-planar grid tube. $E_b = 180$ and 250 volts. Output power, second and third harmonics as functions of peak input voltage.

per cent, that is 26 db below the fundamental. Curves giving the output power and harmonics as functions of peak-input voltage are shown in Fig. 16. The curves marked (A) are for a plate potential of 250 volts and for a total space current of 55 ma. The maximum output power, (indicated by circle) determined by a peak-input voltage equal to E_c , is 3.95 watts with the second and third harmonics respectively 26.5 and 29 db below the fundamental. It will be observed that the second harmonic falls off very slowly with decreasing input, while the third harmonic falls off quite rapidly.

The curves marked (B) show similar results for a plate potential of 180 volts and a total space current of 33.3 ma. The maximum output power in this case is 1.8 watts with the second and third harmonics respectively 32 and 26 db below the fundamental. Here the percentage of second harmonic actually increases for a time with decreasing input, reaching a maximum of 29 db. The reason for this and also for the relatively high value of third harmonic, as previously explained, is found in the bending over of the dynamic characteristic at low values of grid voltage. (See Fig. 13.) The plate voltages, at which the above values of output power are obtained, are 60 to 70 per cent of the plate voltages necessary in three-electrode tubes to give the same power output at the same space currents and the same levels of second harmonic. The third harmonic is higher in the co-planar grid tube, however, for reasons given.

To facilitate ready comparison, data have been compiled in Table I for the tubes considered in this study under various operating conditions. Although above the normal operating voltage, data are included for the 101-D and 104-D tubes at 200 volts to illustrate the effect of increase in plate voltage on the output power of a given quality.

In this study the output power of tubes has been considered entirely independently of the application of the tubes in particular circuits. Consequently, in the comparisons made the relative magnitudes of the input voltage required to load the various tubes completely have not been taken into consideration. However, it is recognized that this factor would necessarily have to be taken into account in determining the comparative merits of tubes for application in various amplifier systems.

SECONDARY ELECTRONS

Some of the reasons for the comparatively large output power from the co-planar grid tube have already been discussed. But it also has some other features that are of interest. One of these is the phenomenon of secondary electron emission. One might expect the situation to be similar to that in tubes with the outer grid positive in which, as we have seen, the range of operation is seriously restricted by secondary electrons from the plate to the positive grid when the potential of the former is less than that of the latter. That this restriction does not apply in this case is evident from the curves of Fig. 17a in which plate current is plotted against plate potential for $E_s = 60$ volts and for several values of E_c . There is no apparent distortion as the plate potential passes through a value equal to that of the positive grid, i.e., 60 volts. For the lower grid voltages there is some distortion

at plate potentials between 15 and 20 volts. This point will be discussed later. That the plate does emit a copious number of secondary electrons is shown by the curves of Figs. 17b and 17c. In this case both grids are held at the same positive potential and the filament current adjusted to limit the total space current to approximately 30 ma. Here the effects of secondary electrons are very pronounced, the plate current falling off very greatly as the decreasing plate potential passes through a value equal to that of the positive grids. The

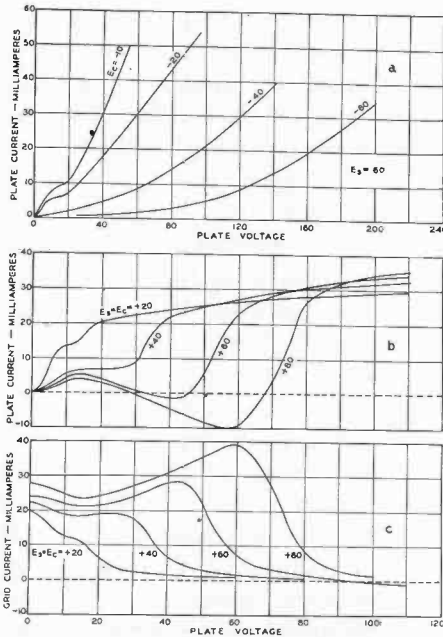

Fig. 17—Secondary electron effects in co-planar grid tube.

- (a) Plate characteristic curves for various values of E_c . $E_s = 60$ volts.
- (b) Plate characteristics with total space current limited to approximately 30 ma. Both grids held at the same positive potentials.
- (c) Current to the positive grids under the same conditions as in (b).

complementary character of the corresponding curves of Fig. 17c giving the current to the positive grids shows that the secondary electrons emitted from the plate are collected by them.

The reason for the small number of secondaries from the plate to the positive grid under normal conditions is evidently due to the shielding of the latter by the field of the negative control grid. This may be illustrated as follows: suppose the plate to be at a potential of 30 volts, the positive grid at 60 volts, and the negative control grid at -40 volts. Then one may think of the resultant electric field between

the grid plane and the plate as that produced by the superposition of two components, one directed toward the plate due to the 30 volts difference between the plate and positive grid, and an oppositely directed component due to the 70 volts difference between the negative grid and the plate. Obviously the latter must prevail and electrons from the plate find themselves in an opposing field. At low plate potentials, with the negative control-grid potential approaching zero and with high potentials on the positive grid, the shielding of the latter is so much reduced that it may collect secondary electrons from the plate. This condition accounts for the humps on the curves of Fig. 17a at plate potentials between 12 and 20 volts. This effect may reduce the net plate current somewhat in this region but not enough to impair the functioning of the tube. The effect increases somewhat with increasing values of positive grid potential.

OTHER ADVANTAGEOUS FEATURES OF THE CO-PLANAR GRID TUBE

Another advantageous feature of the co-planar grid tube is that by placing the two grids in the same plane the necessary spacing between the filament and the plate is reduced to a distance comparable with that in three-electrode tubes, which is effective in reducing the tube resistance; and at the same time it eliminates a region between the two grids affected by space charge or excessive turbulence in the flow of electrons. In space-charge-grid tubes with the inner grid positive (as usually operated at any rate), a relatively large space current is drawn from the filament at all times. Part of this stream of electrons is collected by the positive grid; a varying proportion of the remaining stream which flows through the positive grid, depending on the instantaneous potential of the negative control grid, passes through the latter to the plate; the remaining electrons are turned back by the control grid eventually to be collected by the positive grid. The latter thus collects not only the stream of electrons flowing directly to it, but also a reverse stream which increases as the control grid reduces the current to the plate.

While in the co-planar grid tube a positive grid is provided, as in other tubes containing space-charge grids, to partially neutralize the opposing field due to space charge near the filament, yet this effect is limited by the varying potential of the negative control grid in the same plane. By this dual control of the space-charge effect the action of the positive grid, when the tube is in operation, is neutralized by the field of the control grid when the latter is near the most negative point in its swing and but little space current is drawn away from the

filament. As the control grid approaches zero potential, the field of the positive grid becomes more effective in reducing the space-charge field near the filament during that portion of the cycle when a large space current is required. Consequently, at any time only that number of electrons is drawn away from the filament that is necessary to supply the currents flowing directly to the plate and positive grid at the particular instant. In this case there are no reversed currents to the positive grid. It would seem, therefore, that in comparable structures the co-planar grid tube should require somewhat smaller average values of space current than positive inner grid tubes, a fact reasonably well established by experiment.

TABLE I

Type of Tube	E_b	E_s	E_c	$I_t = I_b + I_s$ (Space Current)	R_p	$\frac{R}{R_p}$	μ	Gain (db)	Power (mw)	F_2	F_3	Input, v (Peak Volts)
101-D	130	—	-9	8	6000	1	5.9	29.5	60	26.3	48	$v = E_c$
"	130	—	-13	4.5	7500	1	5.7	28.0	85	20	40	"
"	200	—	-21	9	5800	1	5.8	28.9	280	20	38	"
104-D	130	—	-20	23	2000	1	2.5	26.8	160	25	50-55	"
"	130	—	-32	12	2900	1	2.3	24.8	265	20	40-50	"
"	200	—	-49	23	2300	1	2.3	25.7	750	20	40-50	"
Optimum Three-Electrode Tube	130	—	-25.3	19.5	1600	1	3.0	29.0	440	20	38	"
"	130	—	-30	12	2000	1	2.9	28.0	470	16	32	"
Positive Inner Grid	130	20	-54	22.5	3300	1	2.1	22.7	460	20	32	"
"	130	15	-42	19.5	4000	1	2.25	22.8	280	26	39	"
Co-planar Grid Tube	130	80	-64.5	23	3700	1	3.3	25.3	1170	22.5	21	"
"	130	60	-49	23	3300	1	3.25	27.1	1060	21	27.5	"
"	130	40	-34.5	23	2700	1	3.6	28.8	740	22	36	"
"	130	40	-35	23	2700	1	3.6	28.9	400	25	42	25 volts
"	250	93	-90	55	2175	2	3.35	27.7	3950	26.5	29	$v = E_c$
"	180	76	-70	33.3	2780	2	3.3	26.4	1800	32	26	"

Another possible application of the co-planar grid tube is in the use of both grids as a means of dual control. It has been found that, under suitable conditions of operation, the input impedance to the positive grid is sufficiently high to make this feasible for some applications at least. In this case the μ action of the two grids could be made approximately equal, which is impracticable with two-grid tubes of either of the other types.

Other mechanical arrangements are possible, of course, in these tubes, such as altering the relative number of turns in the two grids and varying the diameter of the lateral wires in one grid from those in the other. No particular advantage has been found in the latter alternative, although it cannot be said definitely that there is no arrangement of the sort for which there is an advantage.

Structurally, the co-planar grid tube has the disadvantage of being more difficult to construct than other two-grid tubes. This

might prove to be somewhat of a handicap to its commercial application. But little attention has been given to such difficulties since this study has been limited to a consideration of some of the more important electrical properties. However, a method of satisfactory fabrication could doubtless be found. It is believed that some of the advantageous electrical features of the co-planar grid tube outweigh any difficulties in fabrication and that for some uses, at least, it may find practical commercial application.

Supplementary References

- G. W. O. Howe, "Double-grid tubes," *Radio Rev.*, 2, 337-340; July, 1921.
- John G. Frayne, "The unilateral dynamic characteristics of three-electrode vacuum tubes," *Phys. Rev.*, 19, 629-651; June, 1922.
- W. J. Brown, "Maximum power output from tubes with linear characteristics"; discussion, symposium on loud speakers, *Proc. Phys. Soc. of London*, 36, 218-224; 1924.
- E. W. Kellogg, "Design of non-distorting power amplifiers," *Jour. A.I.E.E.*, 44, 490-498; May, 1925, (abridged); discussion, 645-647, June, 1925; *Trans. A.I.E.E.*, 44, 302-313; discussion, 313-315; 1925.
- W. P. Radt, "Über Maximalleistungen von Verstärkerröhren," *Elect. Nach. Tech.*, 3, 21-27; 1926.
- E. Alberti, "Untersuchungen an Raumladegitterröhren," *E.N.T.*, 3, 149-154; April, 1926.
- F. B. Llewellyn, "Operation of thermionic vacuum tube circuits," *Bell Sys. Tech. Jour.*, 5, 433-462; July, 1926.
- F. C. Willis and L. E. Melhuish, "Load carrying capacity of amplifiers," *Bell Sys. Tech. Jour.*, 5, 573-592; October, 1926.
- J. C. Warner, A. V. Loughren, "The output characteristics of amplifier tubes," *Proc. I.R.E.*, 14, 735-757; December, 1926.
- A. Clavier and I. Podliasky, "Sur les amplificateurs de puissance sans distorsion," *L'Onde Electrique*, 6, 71-81; February, 1927.
- E. Peterson and H. P. Evans, "Modulation in vacuum tubes used as amplifiers," *Bell Sys. Tech. Jour.*, 6, 442-460; July, 1927.
- A. Forstmann and E. Schramm, "Über Arbeitskennlinien und die Bestimmung des günstigsten Durchgriffes von Verstärkerröhren," *Jahrb. d. draht. T.u.T.*, 30, 89-95; September, 1927.
- Manfred von Ardenne, "On the theory of power amplification," *Proc. I.R.E.*, 16, 193-207; February, 1928.
- A. Forstmann, "Über unverzerrte Leistungsabgabe durch Elektronenröhren," *Jahrb. d. draht. T.u.T.*, 31, 45-50; February, 1928.
- B. C. Brain, "The approximate theory of the screen-grid valve," *Exp. Wireless and Wireless Eng.*, 5, 179-183; April, 1928.
- C. R. Hanna, L. Sutherlin, and C. B. Upp, "Development of a new power amplifier tube," *Proc. I.R.E.*, 16, 462-475; April, 1928.
- B. D. H. Tellegen, "Endverstärkerprobleme," *Jahrb. d. draht. T.u.T.*, 31, 183-190; June, 1928.
- J. Dantscher, "Untersuchungen an der Doppelgitterröhre in Raumladungsnetzschaltung," *Archiv. für Elektrotechnik*, 20, 333-345; August, 1928.

A. Forstmann and E. Schramm, "Ueber Maximalleistungen von Verstärker-
röhren," *Jahrb. d. draht. T.u.T.*, 32, 195-199; December, 1928.

H. Bartels, "Über die Höchstleistungen und Verzerrungen bei Endverstär-
kern," *E.N.T.*, 6, 9-17; January, 1929.

L. G. A. Sims, "The pentode and power amplification," *Wireless World*,
24, 60-64; January 16, 1929.

B. C. Brain, "Output characteristics of thermionic amplifiers," *Exp. Wire-
less and Wireless Eng.*, 6, 119-127; March, 1929.

J. G. Brainerd, "Mathematical theory of the four-electrode tube," *Proc.*
I.R.E., 17, 1006-1020; June, 1929.



THE EQUIVALENT GENERATOR THEOREM*

BY

V. D. LANDON

(Radio Engineering Department, Westinghouse Elec. & Mfg. Co., East Pittsburgh, Penna.)

Summary—It is proved that any electrical network with two output terminals may be replaced by a generator and a series impedance without changing the current in an externally connected load. The voltage of the generator is the no-load voltage of the output terminals. The value of the series impedance is the impedance of the unloaded network looking into the output terminals. The use of the theorem is illustrated, and it is pointed out that it is valid for transient as well as steady state conditions.

THE theorem which is formulated below has been found useful in simplifying the solution of many kinds of networks. While the theory involved is not new,¹ it seems that the acceptance and use of the proposition are not as widespread as its merits warrant. Hence it is believed that the following exposition is justified.

Theorem: In an electrical network with two output terminals, the same current will flow in an external load circuit if the whole system, exclusive of load, is replaced by a suitable generator and impedance in series with the load; the generator voltage being the no-load voltage of the output terminals and the impedance being that of the unloaded network looking into the output terminals.²

Stated in another way:

Given a network including a zero impedance generator. Let any mesh of the network be open-circuited and the voltage measured across the break. If a second generator having a voltage equal to the measured voltage is placed across the break, and if the first generator is then short-circuited, the same currents and voltages will appear as before, in that portion of the network which was rendered inactive by the break in the circuit.

* Dewey decimal classification: 537.1.

¹ Thevenin's theorem as stated by K. S. Johnson in "Transmission circuits for telephonic communication" is the practical equivalent to the theorem stated here. However, he limits its application to the case of a generator of simple harmonic voltage. The present paper shows how its use may be extended by means of operational calculus to the case where the output of the generator is a transient, or any other desired function of the time.

However, the primary purpose of this paper is to extend the use of Figs. 1a, 1b, and 1c.

Anyone employed in vacuum-tube circuit work should find daily use for this simplification of conception. Nevertheless, it is believed that their use at present is quite limited.

With no desire to detract from the credit due the originator, it is believed that the descriptive name used here is more easily remembered and hence more desirable.

² The rigorous application of this theorem is limited to electrical networks in which the values of the circuit elements do not change with the amplitude of the applied voltage.

Proof: If the second generator is reversed so as to oppose the voltage across the break, then no current will flow through this generator and conditions are unchanged by its addition to the circuit.

However, a well-known and generally accepted theorem of electrical networks is that that current due to each generator in a circuit may be calculated separately and the results added.

Hence, the currents that would occur in the inactive portion of the network with the first generator shorted are equal and opposite to the currents that would occur with the second generator shorted.

Therefore, shorting the first generator and again reversing the second (to the connection stated in the theorem) gives the original current distribution in that portion of the circuit which was rendered inactive by the initial break.

Although this proof is rigorous it leaves a doubt in the minds of many. This should be cleared up by the following:

The simplest case where the theorem is applicable is shown in Figs. 1A and 1B, Fig. 1A being the original and Fig. 1B the equivalent circuit. The proof of equivalence is accomplished by showing that the current in Z_3 is the same in each case, being equal to

$$\frac{E_1 Z_2}{Z_1 Z_2 + Z_1 Z_3 + Z_2 Z_3}$$

Fig. 1C is another useful equivalent.

Accepting the validity of the theorem for Fig. 1B, its validity for Fig. 2 follows at once, since by the use of Fig. 1B the generator may be shifted around the network at will as shown by the various equivalents, Figs. 2B, 2C, and 2D.

However, this method of proof cannot be used for the generalized unbalanced bridge circuit of Fig. 3. The generalized proof originally given must suffice for this circuit.

An excellent example of the usefulness of this proposition is obtained in the above circuit. Let it be required to find the current in Z_6 . It is an exceedingly difficult thing to get at by ordinary methods. By using this theorem it is rendered a straightforward (though perhaps tedious) problem.

It is only necessary to solve for E_b , the voltage across the break with Z_6 open, and the I_s current in a wire used to short-circuit Z_6 . Then $I_6 = E_b / [Z_6 + (E_b / I_s)]$.

It should be noted that the theorem is true, not only where the original voltage and equivalent-generator voltage are direct current or steady state alternating current, but also where either voltage is any desired function of time. That is, it applies equally well for transient conditions. The following will illustrate this:

In the circuit of Fig. 4A let the applied voltage be $E_1=f(t)$, the voltage across the condenser being required.

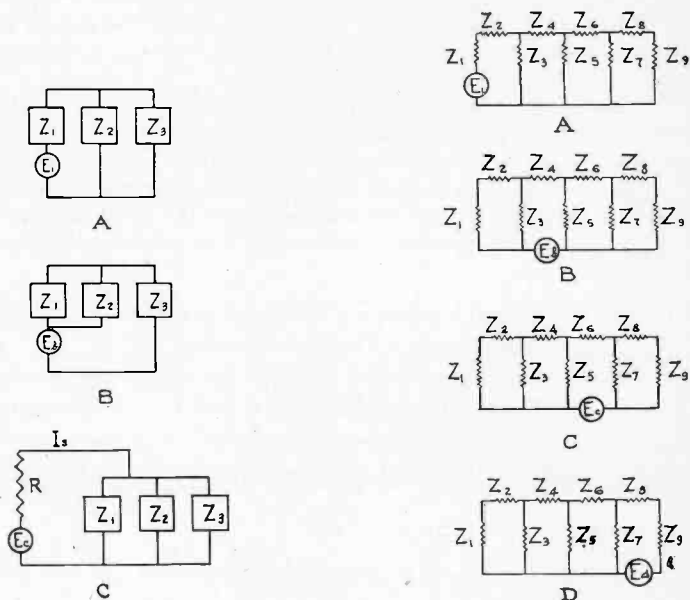

Fig. 1— $E_b = \frac{E_1 Z_2}{Z_1 + Z_2}$
 $E_c = R I_s$
 $R = \infty$
 $I_s = \frac{E_1}{Z_1}$

Fig. 2—Each of above circuits has same value of current in Z_3
 E_b = voltage across Z_3 if Z_4 is opened in circuit A
 E_c = voltage across Z_6 if Z_6 is opened in circuit A or B
 E_d = voltage across Z_7 if Z_8 is opened in circuit A, B, or C.

Then in operational terminology

$$E_c = E_1 \frac{1}{R + \frac{1}{(1/Lp) + Cp}} = \frac{E_1 Lp}{R + RLCp^2 + Lp}$$

or from Fig. 4B

$$E_c = E_b \frac{1/Cp}{\frac{1}{(1/R) + (1/Lp)} + 1/Cp} = E \frac{R + Lp}{R + RLCp^2 + Lp}$$

substituting $E_b = E_1 Lp / R + Lp$

$$E_b = E_1 \frac{Lp}{R + Lp}$$

$$E_c = \frac{E_1 L p}{R + R L C p^2 + L p}$$

Thus the same operational solution is obtained by both methods.

In the above illustration the use of the theorem did not particularly simplify the problem. It was used simply to show the applicability to transient conditions.

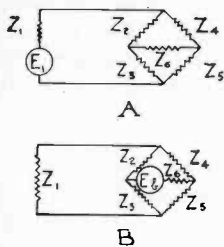

Fig. 3— $E_b = E_3 - E_5$ (Z_6 open)
 $I_s = I_2 - I_3$ (Z_6 shorted)
 $Z_b = E_b / I_s$
 $I_6 = \frac{E_b}{Z_6 + Z_b}$

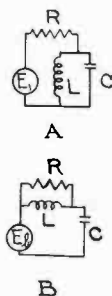

Fig. 4— $E_b = \frac{E_1 L p}{R + L p}$

In general the use of the theorem changes the requirements from the solution of one problem to the solution of three, namely the calculation of the new generator voltage and impedance and then the calculation of the unknown using these values.

These three operations may or may not be less difficult than solving for the unknown directly. This depends on the conditions of the problem and the point chosen for making the break.

If the circuit is of the form of Fig. 1A, then Fig. 2B is always a simplification when Z_2 has the same power factor as Z_1 .



FILAMENT SUPPLY FOR RADIO RECEIVER FROM RECTIFIED 25-KILOCYCLE CURRENT*

BY

HUGH A. BROWN AND LLOYD P. MORRIS

(University of Illinois, Urbana, Ill.)

Summary—A method of generating, rectifying, and filtering 25-kc current for supplying filament power to ordinary d-c amplifier tubes in radio receivers is described. The oscillator used to generate the 25-kc current was of a special design and contained one or more UX-210 power tubes. The dry contact type rectifier unit was used, and cathode-ray oscillograms of the output current were taken. Operating tests were made of the performance of radio receivers.

INTRODUCTION

THE problem of heating the filaments of the amplifier and detector tubes of a receiving set with radio-frequency currents was undertaken in this laboratory two years ago. Efforts to develop a practical system utilizing currents of frequencies above those to be tuned in by the radio receiver itself were mostly unsuccessful. Among the difficulties encountered were interactions between frequencies in the incoming tuned circuits and the frequency of the filament current. Another peculiar difficulty is the tendency for a detector tube to block when radio-frequency current passes through its filament. After considerable work a combination of adjustments could be obtained which would permit operation of a radio receiver, but frequent readjustment was required. The writers understand that operation of filaments at frequencies above 3,000 kc has been accomplished with results which were pronounced successful. The writers worked with frequencies from 3,000 kc to 12,000 kc, however, without obtaining encouraging results.

Rectification of the 3,000-kc currents was considered, and it was realized that only a thermionic rectifier, with the attendant high resistance and large loss, could be used. A low-voltage electrolytic or oxide film rectifier with its high electrostatic capacity would completely short-circuit the radio-frequency current. Another possibility consisted of using current at a frequency about twice the upper limit of the audible range, in the region of 20 to 30 kc. If efficient rectification at this frequency could be obtained, a simple filter would easily smooth out the pulsations of the output. The remainder of this paper describes the means developed for accomplishing the generation and rectification of 20–25-kc current, with sufficient precautions to make it successfully operate a standard radio receiver.

* Dewey decimal classification: R343.7.

RECTIFICATION OF 25-KC CURRENT

Two types of rectifiers were considered and examined by obtaining oscillograms of the current flowing through the rectifier unit. Fig. 1a shows the current flowing through a contact cartridge rectifier of the electrolytic type. For the samples tested, the rectification was not complete. In some cases no rectification was noticeable for a few minutes after voltage was applied.

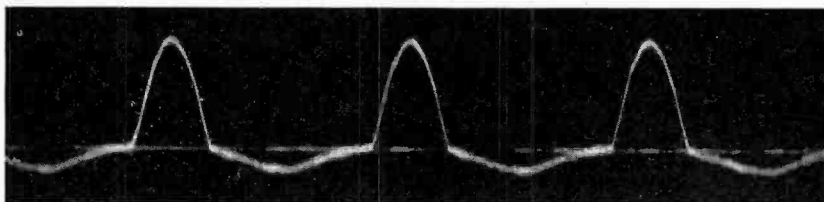

Fig. 1a

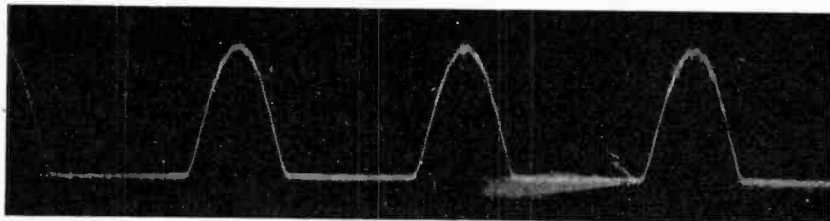

Fig. 1b

Oscillograms of rectified current of contact rectifiers.

Fig. 1b shows a record of the charging current through a load circuit for a dry contact oxide-film rectifier. This rectifier seems to possess the most desirable characteristics for the rectification of intermediate-frequency current, and was therefore used as hereinafter described. The oscillographic records were both obtained for normal rated load current passing and for normal rated voltage (6 volts) across the load resistance.

DESIGN OF THE 25-KC GENERATOR

The standard type of audio-frequency vacuum-tube oscillator comprising the tuned oscillating element in the plate circuit and possessing a grid tickler coil was selected because it seemed to possess very stable characteristics when closely coupled with a low-impedance load. In order that harmonic frequencies generated by the oscillators might be prevented from causing interference in the radio receiver, it was necessary not only to place the apparatus in a copper box, but also to use an arrangement of circuits which allowed all incoming and outgoing leads to be by-passed to ground with large capacitances. After con-

siderable experimenting with circuit arrangements, the oscillator was connected as shown schematically in Fig. 2. Rectifier units for full-wave rectification were connected in series with coils L_1 and L_2 , and closely coupled to L_0 . The oscillating element C_0L_0 was placed next to the plate terminal of the tube so that a by-pass condenser might be used across the d-c plate-voltage supply. The copper box container was also connected to the points indicated with a "ground connection."

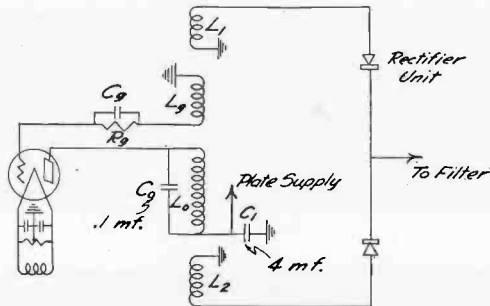

Fig. 2—Oscillator circuit.

The forms of the inductance coils and the coupling coils and their dimensions were worked out partly by calculation and partly by trial, and merit some description. A compact form of air-cored coil was selected. Iron-cored coils were tried out, but iron losses and harmonics due to permeability characteristics made them less desirable than a proper type of air-cored coil. The design adopted is shown in Fig. 3. The coils are designated as in Fig. 2, and are shown mounted on a bakelite tube, so that the coupling to the load may be varied. An optimum value of coupling L_2 and L_1 with L_0 was found, and was about as shown. These coils were approximately of the maximum inductance shape factor, and, although they appear to possess considerable effective resistance, operation seemed quite satisfactory from the standpoint of power output obtained. The coils were bank wound and taped in places to make them self-supporting. Their sizes were as shown in Fig. 3. Compact paper filter condensers were used.

A condition that gave trouble with several oscillator circuits tried was that of instability. The oscillator would cease to function when the load was changed considerably or when the circuit constants or coupling were changed. The type of oscillator described above was the only one of a number tried out that would continue oscillating when the output from the rectifier was short-circuited. Oscillation prevailed with extremely close coupling, in fact, with as close coupling as could be obtained with the coils shown. Such close coupling, how-

ever, did not give maximum power output, and hence the coupling was used about as shown in Figs. 3 and 4. The oscillator was stable for considerable changes in plate voltage and filament voltage.

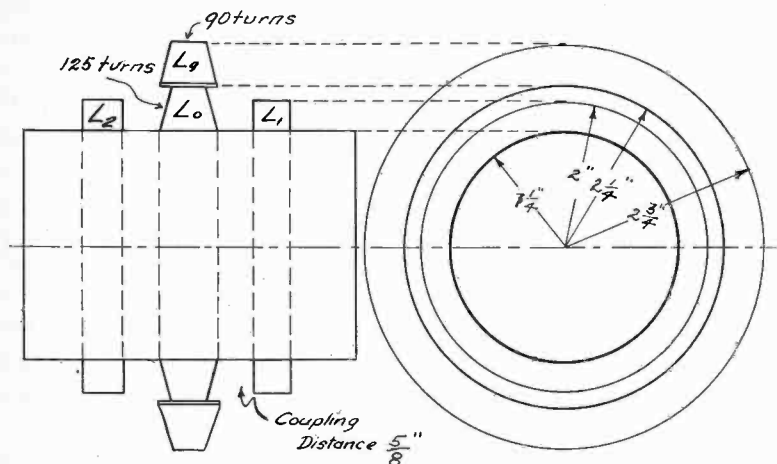

Fig. 3—Arrangement of oscillator coils and pickup coils.

In regard to the tubes required for the oscillator, and their rating should be mentioned that the best results were obtained with two

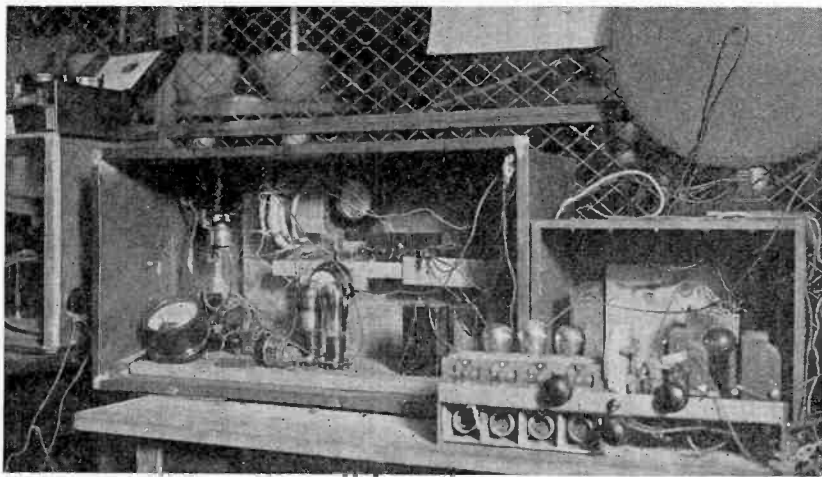

Fig. 4—Photograph of oscillator, filter, and receiver setup.

UX-210 tubes in parallel. More output was obtained in the rectifier circuit with less total plate current in such a setup, than in one using one such tube. On one test it was found that an output of about 5.5

watts was obtained with one UX-210 tube in the oscillator. This was, however, the maximum output obtained. The one tube oscillator supplied power for the filaments of radio receivers using up to 4 tubes, fairly well, but did not provide much reserve power under average operating conditions. The 6-tube receiver shown in Fig. 4 was operated completely from the oscillator using two UX-210 tubes on several occasions, but in general no attempt was made to light the audio-frequency amplifier tube filaments in the receivers because this was not thought necessary owing to the present development of audio amplifiers using a-c supply. Several complete two- and three-tube tuned radio-frequency sets with audio amplifiers were used with excellent results. Listeners could not tell the difference when the filament supply was changed from the rectified 25-kc supply to a storage-battery filament supply. The most satisfactory arrangement was obtained by operating the six-tube receiver so that the three radio-frequency tubes and detector tube received filament power from the oscillator-rectifier.

CAPACITY OF POWER SUPPLY

In passing, the power supply for the oscillator used should be mentioned. This power supply was of the conventional type using half-wave rectification, with filter chokes of 50 and 10 h, and condensers of 2, 2, and 4 μf . The rectifier tube used was the mercury-vapor type UX-866, and gave excellent results. It is necessary to use not less than a 2- μf condenser preceding the first filter choke if best results are to be obtained. It is necessary that the power supply be capable of furnishing about 100 ma at 350 to 400 volts to the oscillator. The plate-voltage supply for the receiving set proper may be incorporated in the same equipment.

COMPLETE ASSEMBLY OF TEST EQUIPMENT

The complete oscillator-rectifier assembly used in these tests is shown in Fig. 4. The complete circuit diagram is shown in Fig. 5. The power supply, oscillator, and filter are shown shielded in individual copper containers. The leads from one container to the other were run through short lengths of metallic-covered wire which served to connect the shields as well as to shield the lead wires. In the case of multi-tube sets that had a tendency to oscillate, care in shielding had to be used in order to obtain absolute freedom from heterodyne effects. A closer view of the oscillator-rectifier outfit used for these sets is shown in Fig. 6. As may be seen, no attempt was made to arrange the parts in the most compact form; and it may be noted that the parts comprising the oscillator and rectifier may be condensed into a small space, say about 8 in. by 4 in. wide, by 5 in. high.

FILTERING THE RECTIFIED 25-KC CURRENT

The presence of high harmonics in the oscillator current wave and especially in the rectified wave presented a serious problem. If these harmonics were present they would make the device under discussion im-

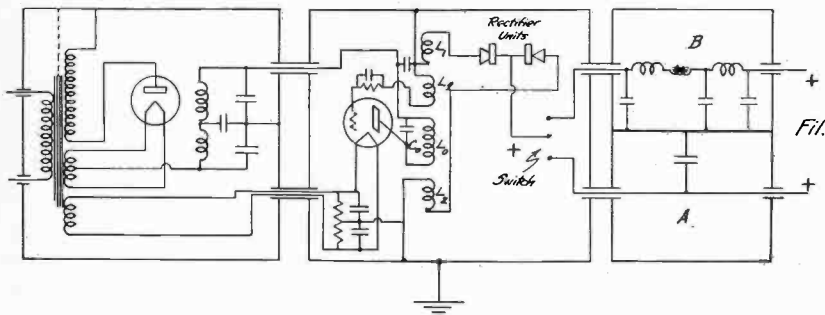

Fig. 5—Power supply, oscillator, and filter circuits of rectifier system.

possible for radio reception, hence steps were taken to surmount such difficulties. The cathode-ray oscilloscope proved to be very helpful in studying the behavior of the output of the rectifier, and with its help satisfactory operating adjustments were made. Fig. 7a is a picture of

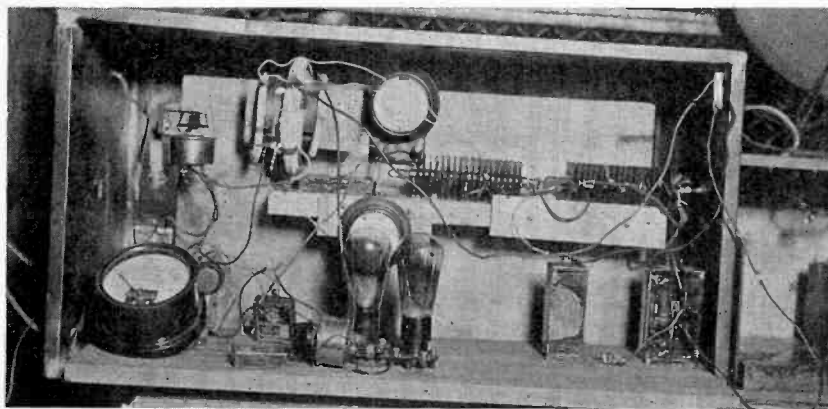

Fig. 6—Close view of oscillator.

the voltage wave produced by the oscillator at 25 kc and loaded with a resistance only. The wave appears to be almost a pure sine wave. When the rectifiers and their load (a resistance) were coupled to the oscillator, as when it was operating a radio receiver, the voltage across the coupled pickup coils was badly distorted as is shown in Fig. 7b.

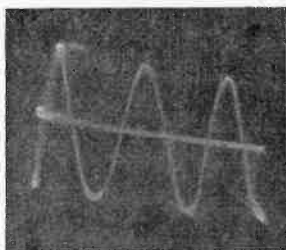

Fig. 7a



Fig. 7b

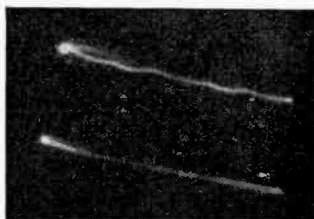

Fig. 7c

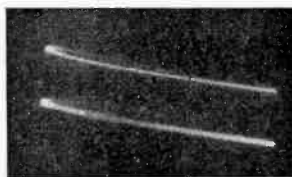

Fig. 7d

Oscillograms of 25-kc voltage and current.

The rather high capacitance of the rectifier units short-circuits some of the highest harmonics so that the current delivered to a resistance load has the form of Fig. 7c. In this figure the smooth line is the zero line and the other the rectified and partially filtered current. The filtering action is almost complete. Fig. 7d shows the result of placing

a high capacitance between the output lead and ground as shown at *A*, Fig. 5. The elimination of any noticeable harmonic in the direct current is thus accomplished. This made the operation of radio receivers very satisfactory.

Attempts were made to design a "low-pass" filter to function between the rectifier connection and the "*A*(+)" lead to the set, as shown at *B*, Fig. 5. Since the impedance must be of the order of 15 to 30 ohms, such a filter is very hard to design, and in fact heterodyne reception of a broadcast wave could not be entirely prevented with any sort of low-pass filter in the low impedance circuit.

COMPARISON TESTS

The operation of the setup of Fig. 4 was tested on several types of radio receivers. For such operation the negative filament terminals of the radio receiver were grounded as were the negative supply voltage terminal and the metal container of the filament supply system under discussion. The positive lead of the latter was then connected to the positive "*A*" battery lead of the radio receiver. One-, three-, and six-tube sets were used to test reception by this means, all the radio receivers being of the well-known "d-c tube" or battery type. Type 201-A tubes were used as detectors and amplifiers except for the last audio stage in all the receivers. The operating tests were made over a period of five months. Most of the tests were made with a six-tube neutrodyne radio receiver, operating the three radio-frequency amplifier tubes and the detector tube filaments from the rectifying system. In listening tests which were made from time to time, comparisons were made of the performance of the radio receiver when operating as above, and when operating with storage-battery filament current supply. These tests were qualitative, of course, but showed that the receiver functioned as well on the rectified filament current as on the battery supply. For the operation of the tube filaments of four or five tubes, the 25-kc oscillator drew 100 ma at 400 v on the plate, using two UX-210 tubes in parallel. This power may be a part of the "*B*" supply for the radio receiver tubes. One UX-210 would operate the filaments of three tubes satisfactorily.

Regarding comparative efficiencies, the system herein described compares favorably with the rectified 60-cycle filament supply system, requiring from 50 to 80 watts input to the power tube of the 25-kc oscillator. However, it is less efficient than the straight a-c filament supply system. The above statements concern only the output-input power efficiency. If comparisons are made of the initial costs and maintenance costs of a-c and d-c tubes and other equipment

necessary, it is believed that the rectified 25-kc current supply will prove as practical as any other type now in use.

CONCLUSIONS

A method of rectifying 25-kc current for supplying the filaments of a group of storage-battery amplifier tubes in parallel in radio receivers was developed and found to operate very successfully. The type of oscillator supplying the power must be correctly designed for stable operation. Cathode-ray oscillograms showed that the d-c output of the oscillator-rectifier filter was free from high- or low-frequency pulsations.

Chief among the advantages of this system over the a-c filament supply are:

- (1) Use of an inexpensive long-life d-c amplifier tube for all radio-frequency stages and for the detector.
- (2) Instant response of the radio receiver when the current is turned on.
- (3) Absence of any hum due to 60 cycles or any of the harmonics of this frequency. Quietness of battery performance obtained without the vexations of battery maintenance.



QUARTZ CONTROL FOR FREQUENCY STABILIZATION IN SHORT-WAVE RECEIVERS*

BY

P. VON HANDEL, K. KRÜGER, AND H. PLENDL

(German Research Laboratory for Aeronautics, Berlin-Adlershof, Germany)

Summary—For the purpose of stabilizing short-wave reception, experiments were made using quartz control in receivers. It was found that the use of a crystal which produces audible beats with the frequency of the transmitter quartz is practically impossible. In fact, the quartz-controlled oscillating detector caused too great a decrease in the tone volume, while in the case where a separate quartz-controlled heterodyne was used, the effect of temperature on the frequency of the crystals caused disturbances.

In order to solve this problem, a method is described in which the superposition of the frequencies of the transmitter quartz and the receiver quartz produces an oscillation of high frequency. This intermediate frequency corresponds to a long wave and is made audible in a normal oscillating detector.

THE German Research Laboratory for Aeronautics in publications¹ during recent years has repeatedly pointed out the suitability of short waves for communication with aircraft. It was found that in cases where quartz-controlled telegraph transmitters were used for communication from aircraft to ground, relatively very small power was required, for example, 2 watts for continuous communication up to about 600 or 800 km. It appeared to be immaterial in such cases whether the aircraft, provided with a fixed dipole antenna, transmitted from an arbitrary altitude, from the ground before starting, or from the ground after landing. Owing to quartz control the emitted waves were independent of vibrations of any kind which, in principle, cannot be avoided in aircraft, especially in airplanes. In fact, at the receiving station no criterion whatever was available to tell whether the airplane was on the ground with its motor stopped or running, or whether it was in the air with its motor running full speed as neither the volume nor the clearness of the tone received indicated the momentary condition of motion or rest of the airplane.

* Dewey decimal classification: R343. Communication of the Deutschen Versuchsanstalt für Luftfahrt, Division for Radio and Electrical Engineering, Berlin-Adlershof, Germany.

¹ H. Fassbender, K. Krüger, and H. Plendl, *Naturwissenschaften* 15, 357, 1927. H. Plendl, *Zeitschr. f. techn. Physik*, 11, 456, 1927. H. Fassbender, *Luftfahrtforschung*, 1, 121, 1928. K. Krüger and H. Plendl, *Jahrb. d. drahtl. Tel.*, 31, 169, 1928. K. Krüger and H. Plendl, *Jahrb. d. drahtl. Tel.*, 33, 85; 1929. K. Krüger and H. Plendl, *Proc. I. R. E.*, 17, 1296; August, 1929. Also: "Kurzwellenversuche bei der Amerikafahrt des Luftschiffes *Graf Zeppelin*" *ETZ* 50, S. 16, 1929.

When an airplane while flying received communications from a transmitter on the ground, however, conditions were different. Although the reception of short-wave signals was not entirely impossible in this case, as had been previously thought and stated by others, there appeared to be a number of factors having a more or less disturbing influence on clear reception: noises and disturbances caused by the ignition and vibrations.

The question was now to find means of reducing as much as possible the effect of these sources of disturbance on the reception.

The best remedy against these noises,² which are so difficult to eliminate, appeared to be the increase of the signal intensity to above the limit of sensitivity of the ear, for example by the addition of another low-frequency amplification stage. So far as the disturbances caused by the ignition system of the motor were concerned, it appeared that in metal airplanes such as were mainly used for these experiments, these disturbances generally had but little effect on reception. The purer the superimposed frequency produced by a quartz-controlled transmitter in the receiver, the greater the clearness with which the signals were heard above the level of disturbances caused by the ignition system.

The influence of vibrations, however, appeared to be a source of disturbance which was difficult to eliminate. Even with the most careful suspension of the receiver by rubber cords, there was always, during flight, more or less serious impairment of the audible frequency which prevented faultless reception. The receivers investigated showed this phenomenon of tone impairment in different degrees.

When used in the airplane, the apparatus characterized on the ground by constancy and sensitivity usually gave signals with a rough note due to modulation by vibrators, or even gave signals whose tone quality had been entirely destroyed and which rose barely above the level of the disturbances. Other receivers which were less sensitive, that is, which gave a smaller volume of signal, usually appeared to be less subject to impairment of tone.

It was found by repeated experiments that the vibrations were transmitted not only by the means used in the suspension of the apparatus, but also by the air. Several receivers, for instance, appeared to give a distinct microphone effect; in a head set connected with them one could understand without difficulty words spoken against the housing. Evidently, very minute vibrations were able to affect the reception in a disturbing manner. If such a receiver was placed in a

² H. Fassbender and K. Krüger, "Geräuschmessungen in Flugzeugen." *Zeitschr. f. techn. Physik.*, 8, S. 277; 1927.

housing whose walls were made of lead or copper, these disturbances at once decreased considerably; however, this resulted in such a heavy weight for the equipment that it could not be tolerated for an airplane receiver.

The only remaining solution, therefore, was to decrease the sensitivity to vibrations as far as possible by careful construction, selection of stable component parts, and the avoidance of movable conductors. In this manner improvements were actually made, but the phenomena in question were so difficult to overcome that one of two receivers of exactly the same construction was liable to behave in an entirely different manner from the other as far as sensitivity to vibration was concerned.

It was observed furthermore that a receiver became worse in the course of time, that is, it became more sensitive to vibrations. In another case, a very good set suddenly showed the phenomenon of tone impairment to an extremely strong degree, after a minor change in the connections that affected only the wave range.

In addition, in most cases there was still another phenomenon affecting the quality of reception. If a receiver known to be of good quality was tuned to a transmitter in the absence of vibrations, the superposed tone would begin to fluctuate according to the rhythm of the motion of the apparatus, when the latter was moved a little up and down in its suspension. This phenomenon, like that mentioned above, occurred to a varying extent in the several receivers and was difficult to eliminate. In many cases, grounding the metal housing of the apparatus cured the evil, but usually this remedy was insufficient for eliminating the sensitivity to fluctuations.

Therefore, as the problem of the short-wave transmitter for airplanes could be considered as having been solved to a large extent, the development of a suitable short-wave receiver for airplanes was still in its initial phase.

Evidently, the elimination of the sensitivity to vibrations not only required stabilization of the frequency in the transmitter, but also at the receiving end. If this could be done successfully, then the vibrations produced would no longer be able to exert such a damaging influence on the quality of reception; for the impairment of the tone was caused exclusively by the changes in frequency produced by the vibrations. With stabilized frequency, the beat note must necessarily remain pure, from a musical standpoint, and could still be subject to a variation in amplitude, which variation could not be expected to have a detrimental effect.

An obvious step now was to stabilize the frequency of the receiver

by quartz control. For this purpose, it seemed necessary first to develop a method permitting changing the beat frequency of the receiver either gradually or in steps without essentially decreasing the ability of the quartz control to stabilize the frequency. It is, in fact, useful to be able to adjust the pitch of the beat frequency at will. Moreover, the beat frequency gradually changes, owing to changes in temperature³ or in the position of the quartz crystal in its mounting so that it may rise even above the limit of audibility. The difficulty in grinding two or more crystals with such accuracy as to have them superimpose their frequencies under identical conditions, as well as the difficulty in providing a suitable means for keeping the temperature of the two quartzes constant should be avoided if at all possible.⁴

STABILIZATION OF THE FREQUENCY BY MEANS OF BEATING QUARTZ CRYSTALS

The condition for the behavior of quartz-controlled oscillations mentioned above can be fulfilled to a certain extent by providing additional regeneration.

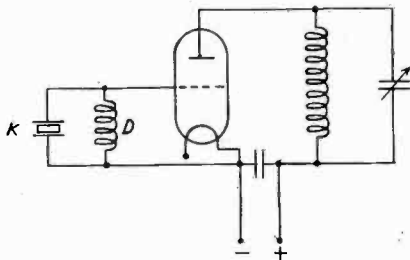

Fig. 1—Wiring diagram of a quartz-controlled transmitter.

The simple diagram of a quartz-controlled transmitter in which the regeneration is supplied exclusively by the crystal itself and the internal tube capacity between grid and anode, is shown in Figs. 1 to 3. In this circuit the quartz crystal is located immediately between grid and cathode. The choke D in Figs. 1 to 3 serves only for the removal of the direct grid current and must present a very high impedance to high frequency; it therefore need not be taken into account when considering the oscillations. Fig. 1 represents the crystal K in the usual manner; Fig. 2 contains the electric equivalent diagram of the crystal; Fig. 3 shows the resultant reactance and resistance

³ See: F. Gerth and H. Rochow, "Die Temperaturabhängigkeit der Frequenz des Quarzresonators," *ENT*, 5, 549-551; 1928. Additional literature is also given there.

⁴ A large number of quartz crystals were prepared by the Loewe-Radio Co. and made available for the experiments under discussion.

of the crystal, which are necessary to make stable oscillations possible. It will be seen that in Fig. 3 the circuit can be reduced to the well-known Huth-Kühn circuit.⁵

The additional regeneration consists in connecting an additional voltage of the same or slightly different phase in series with the voltage impressed on the quartz crystal by the oscillation circuit via the grid-anode capacity. This can be done in circuits such as Figs. 4 or 5, both of which are of equal value with regard to quartz control.

These two circuits indicate the two possible solutions. Fig. 4 represents a quartz-controlled oscillating audion with autodyne action. Fig. 5 represents a quartz-controlled separate heterodyne which must be imagined as acting on an undamped audion. These two methods are dealt with separately in the following, in sections (1) and (2).

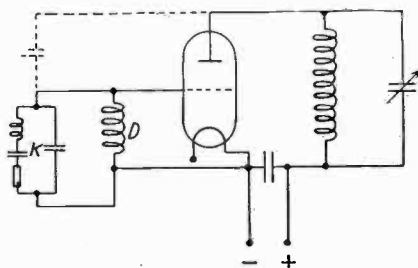

Fig. 2—Quartz-controlled transmitter. Equivalent circuit diagram of the quartz crystal.

In the diagrams according to Figs. 4 and 5, the coupling coil L transforms the alternating potential from the anode oscillating circuit at the grid, or from the grid oscillating circuit at the anode. In this case, the oscillations have an action which is different in many respects from that in the diagram according to Figs. 1 to 3. When the tuning condenser C is varied, the oscillations are produced more easily than in Figs. 1 to 3, and moreover they can be carried, within certain limits, above the resonance point proper of the oscillation circuit, the frequency changing by a few hundred cycles, until the oscillations suddenly cease.

In addition to this, another phenomenon is observed. It is known that even crystals connected according to Figs. 1 to 3 have a single frequency only if they are carefully ground and selected. If not, there will often occur a number of oscillations, either close together or separated by several kilocycles, a situation which often greatly impaired the development of quartz-controlled transmitters. However, it was

⁵ An exact investigation of the oscillation phenomena in crystal-controlled transmitters will be published in a later article.

also found that crystals which have a single frequency in Figs. 1 to 3, and which therefore are very suitable for transmitting purposes, give rise to the generation of several frequencies if there is an additional feed back of sufficient strength, while such waves are not produced in the absence of such feed back. In general, these frequencies are quite close to the main frequency and often do not differ from each other by more than a few hundred cycles. This manifests itself in such a manner that if the tuning condenser C is turned, there is produced first a wave which, as described above, can be carried along several hundred cycles, until with a jump the next wave begins and produces a different tone. This process may be made audible by a constant receiver which is adjusted once and then remains unchanged. When the condenser is turned back, the last wave remains at first and then

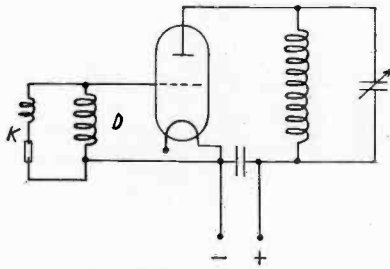

Fig. 3—Quartz-controlled transmitter. Representation of the impedance of the quartz crystal.

gradually changes again, in most cases by a few hundred cycles, until, with a jump, the first wave begins again. If the tuning condenser is turned through a larger range, several of such oscillations, changing by jumps, may usually be observed. However, in such a case, the receiver circuit must often be readjusted, since frequently the next wave gives a beat frequency which lies above the limit of audibility.

In rotating the tuning condenser, there is also found to be a considerable range over which no oscillations occur. The latter do not appear again until the condenser has reached a more remote position, and usually there follow then, in the immediate vicinity of the latter, a number of other adjustable oscillations. It was thus possible, for example, in the case of a crystal with the nominal wavelength of 46.28 m, to observe about 5 waves between 46 and 47 meters, and again about as many between 40 and 41 meters.

(1) Quartz-Controlled Oscillating Audion

The quartz-controlled oscillating audion represents, as discussed above, one of the two possible solutions of the quartz-controlled

heterodyne reception with feed back. Its function was discussed in detail in reference to Fig. 4 which shows the wiring diagram. In this diagram, it was possible, for all of the numerous quartz crystals investigated, to generate a number of successive quartz waves by different tuning. If quartz crystals whose nominal waves were close together were used for transmission and reception it was possible, in general, to produce one or more quartz waves in the receiver which gave heterodyne reception with the transmitter wave. The beat frequency remained perfectly pure and constant, even when the receiver was subject to strong mechanical and acoustic vibrations, as for example in a flying airplane. However, a number of detrimental phenomena were observed.

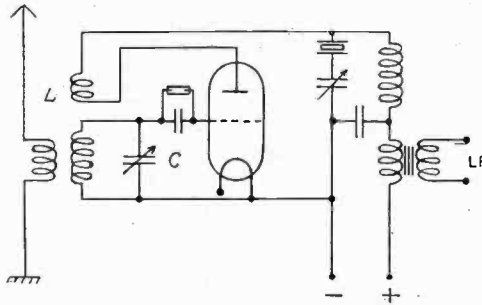

Fig. 4—Quartz-controlled oscillating audion with additional feed back.

In the first place, it appeared that the tone volume which could be obtained was considerably less than in the case of reception without a crystal, and that it was not sufficient for practical operation. Investigations of this problem showed that the amplitudes of the natural oscillations of the quartz-controlled receiver according to the diagram of Fig. 4 were considerably larger than the amplitudes of an ordinary audion oscillating at the starting point of the oscillations. In fact, either the quartz crystal did not get into action at all, or it started at once with a high amplitude, a condition causing a great decrease in intensity of the audion effect, as the latter must function at a characteristic point and in a feedback condition where the oscillations are very weak or indifferent. The crystal in the vicinity of its resonance point, determined by the resonance of the magnitudes L , C , R , in the equivalent diagram (Fig. 6), offer a considerable ohmic resistance. The latter is defined by the equation:

$$R = \frac{\pi^2 \rho Q}{8 \epsilon_{11}^2} \cdot \frac{d}{F} \cdot 9 \cdot 10^{11} \Omega = 1.39 \cdot 10^5 \frac{d}{F} \Omega$$

in which ρ is the density, Q the "viscosity," ϵ_{11} the piezo-electric con-

stant, d the thickness, and F the area of the quartz crystal. For example the ohmic resistance computed on the basis of this equation, for a crystal with a wavelength of 50 m and an area of 4 cm², is about 1700 Ω at resonance.⁵

Consequently, the crystal must represent a high resultant inductivity in series with this ohmic resistance in order to take care that the feed back thus formed, in series with the additional feedback of coil L , be sufficient for the generation of the oscillations. Otherwise the latter, hampered by the ohmic resistance of the crystal, would never be able to get into action. The situation may be reproduced by placing a corresponding ohmic resistance in series with a choke coil, instead of the crystal, in which case the element of frequency stabilization

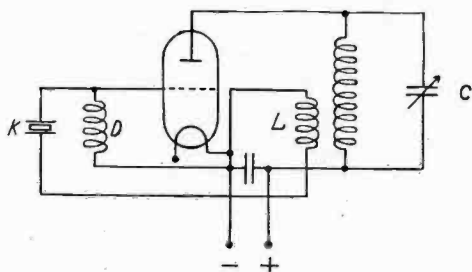

Fig. 5—Quartz-controlled transmitter (separate heterodyne) with additional feed back.

through the crystal is of course eliminated. It is thus seen that the tone volume in the telephone is reduced, as compared to that of ordinary reception, in a similar manner as if the receiver without a crystal or equivalent elements had been given a very strong feed back. In the latter case also, the amplitude of the natural oscillations of the receiver is, of course, considerably increased, while the tone volume is considerably reduced.

Finally, attention must be called to a phenomenon which was, it is true, less disturbing than the decrease in tone volume, but which nevertheless had also a disadvantageous effect. Although the quartz-controlled receiver produced a pure constant heterodyne tone, it had become strongly amplitude-sensitive to intense vibrations, a fact which was noticeable through a dull roaring noise in the telephone receiver. Evidently, while the frequency of the oscillating audion is kept constant to a high degree by the quartz control, strong vibrations of the receiver housing or of the conductors detune to such an extent that with practically constant natural frequency the amplitudes vary with the rhythm of the vibrations, and the otherwise pure heterodyne tone is modulated in its amplitude by these vibrations.

(2) Quartz-Controlled Separate Heterodyne

The drawbacks described above make it necessary to abandon the principle discussed in section (1), and to adopt the other possible solution, namely that of the quartz-controlled separate heterodyne. For this purpose, a transmitter according to the diagram in Fig. 5 was given so strong an additional feed back that there was produced the phenomenon of the appearance of several quartz frequencies as described above. An ordinary audion was placed beside it as receiver (that is no quartz crystal was used) and the damping was reduced by the feed back up to the limit where natural oscillations begin to appear. The quartz-controlled transmitter acted then as a separate heterodyne, while the receiver functioned as undamped audion. The coupling between the two apparatus could be adjusted by regulation of the amplitude of the separate heterodyne and by suitable variation of the distance between the two apparatus. The expected result by

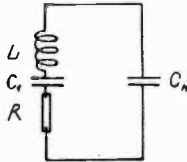

Fig. 6—Equivalent circuit diagram of the quartz crystal.

the use of a separate heterodyne was immediately obtained. Reception with a pure tone of constant frequency could also be obtained in the flying (that is the vibrating) machine, the reception being about equivalent, as to tone volume, with that obtained by means of the ordinary receiver. With suitably adjusted coupling between separate heterodyne and audion no amplitude-sensitivity was then noticed.

However, with regard to the frequency stabilization, the behavior of the main wave appeared to be different from that of the secondary waves of the heterodyne crystal. When the main wave was used the tone was nearly as sensitive with respect to vibrations as without quartz control, as the use of the additional feed back strongly reduces the frequency-stabilizing action of the quartz crystal. This property did not appear to be inherent in the secondary waves of the crystal which could be generated by the additional feed back; these waves were perfectly stable and insensitive to vibrations.

However, there arose a new difficulty in this respect; the natural frequency of quartz crystals is, as is well-known, dependent upon their temperature. The latter is governed by the internal heating due to losses, and by the outside temperature. The internal heat depends on the load on the crystal. Once a frequency with good audibility has

been obtained by generating a secondary wave, the temperature of the crystal will soon change because of its being under load and because of the outside temperature in the airplane. This made itself felt by a constant change in pitch, which finally led to a rise in the tone to above the limit of audibility, although no change was made in the adjustment of the receiver. It was possible to readjust the pitch within certain limits by means of the procedure mentioned above by varying the frequency with an additional feed back in circuit. However, as the crystal frequency was gradually changing in the same direction, this measure could be used for a short while only. Consequently, the next secondary wave of the crystal had to be generated as soon as the beat frequency of the first secondary wave had become too high. In the most favorable case, a new audible frequency was at once obtained in this manner. In general, however, this new crystal frequency produced a beat note which still remained outside the limit of audibility and no immediate reception could be obtained. If the entire apparatus was left unchanged for a while, the beat frequency of this second secondary wave finally became audible, at first with a very high pitch, gradually becoming lower and louder. In general, the same course of events took place with regard to this second secondary wave, as previously with the first wave.

It was therefore found that as a result of the relation between quartz frequencies and temperature, the separate secondary waves which could be generated by the crystal should not be more than a few thousand cycles apart, corresponding to the range of good audibility, if constant reception is to be possible. This was not the case, however, with the numerous quartz crystals used in these experiments. Suitable reception by this method could be reached only if the temperature of the transmitter and receiver crystals remained constant. The influence of the outside temperature could well be taken care of by suitable thermostats into which the crystal was inserted with its mounting, although with regard to space required and simplicity this solution is not ideal in those cases where the apparatus must be kept as compact and simple as possible, as in the airplane. However, the establishment of a means of compensating for the internal heating of the quartz crystals, an effect which cannot be avoided in cases where the principle described is applied, is subject to much greater difficulties. In fact, it is unavoidable in this method that the additional feedback and the changed tuning, which generate the several secondary waves of the crystal, put the quartz under different voltages so that the quartz when in operation is subject to a constant change in temperature. For these reasons, consequently, it is impossible to get a

condition of reliable operation using simple means, even if reception with separate heterodyne within the range of audibility is applied.

FREQUENCY STABILIZATION BY MEANS OF QUARTZ CRYSTALS GIVING HIGH-FREQUENCY BEATS

The quartz-controlled beat reception with additional feed back, functioning within the range of audibility, leads in practice, as shown above, to difficulties if the autodyne or separate heterodyne principle is applied. The main drawback consists in the fact that there is no practical remedy for the continuous rise of the beat frequency above the level of audibility.

The problem presented in the beginning of this article, of stabilizing on the one hand the natural frequency of the receiver and on the other hand to be able to adjust and readjust at will the tone of the reception, must therefore be solved in another way. The solution is not found by trying to obtain the fulfilment of both of these conditions by suitable performance of the quartz crystal; in the method described in the following, the quartz crystal rather works merely as frequency stabilizer, whereas the requirement of adjustability of the pitch of the observed tone is taken care of by other independent means.

The quartz frequency waves of transmitter and receiver are so selected as to beat at high frequency. This beat frequency corresponds to a long wave and must be considered here as an intermediate frequency which is made audible by means of a long-wave audion. Reception of a long wave with a pure tone does not present any difficulties, however. With this principle, the natural frequency of the receiver in the short wave is stabilized by the quartz crystal, and the pitch of the observed tone can be adjusted and readjusted at will by the long-wave audion. In order to try out this principle, the following experimental arrangement was used.

The ground station consisted, exactly as in the experiments described above, of a quartz-controlled transmitter with constant frequency. At the reception end in the airplane there was used an arrangement as shown in Fig. 7. The short-wave audion⁶ did not function in the oscillating condition, but, in a strongly damped condition, quite close to the starting point of the oscillations, and was tuned to the transmitted wave. The intermediate frequency generated by the quartz-controlled separate heterodyne⁷ had a wavelength of about 2000 m. The coupling between the short-wave audion and the quartz-controlled separate heterodyne could be adjusted at will. The output

⁶ For this purpose use was made, among other things, of the push-pull audion of the short-wave receiver "Telefunken Gr. 98."

⁷ A set built in the laboratory was used here.

of the short-wave audion was inductively coupled with the grid circuit of a long-wave audion⁸ which was tuned to the intermediate frequency (2000 m). Two to three low-frequency amplification stages⁹ were connected in series with the tube for the intermediate frequency.

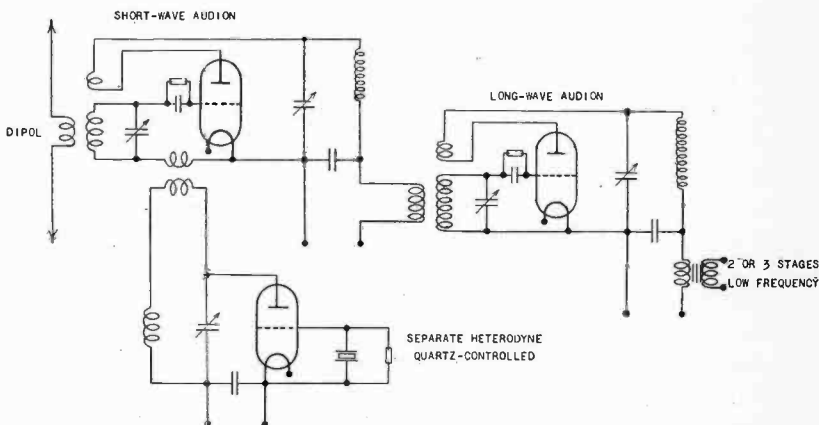

Fig. 7—Quartz-controlled short-wave receiver with intermediate frequency.

The arrangement in this case also is not sensitive to vibrations, because of the quartz control of the short-wave stage. The quartz-controlled separate heterodyne functions here without an additional feedback, so that the crystal can vibrate with its main wave only and can be given only a light load. Moreover, this load is constant as, contrary to the situation described previously, the adjustment of this apparatus remains unchanged during operation. As a result of this, the internal heating effect of the crystal is small and after a certain lapse of time a condition of equilibrium is reached so that the variations in frequency are essentially dependent exclusively on the changes in the outside temperature.

These frequency variations of transmitter and receiver are therefore considerably smaller in this case than in the arrangements referred to above, and disappear in general as soon as a stable condition is reached. In the intermediate frequency, they occur with the same absolute value as in the quartz. However, it is now possible to follow these variations by a slight correction in the tuning of the audion for the intermediate frequency, and thus to obtain any tone desired. For these reasons, the crystals need not answer special requirements with regard to accurate maintenance of their wavelengths. Further-

⁸ The set "Telefunken E. 266" was used here.

⁹ The low-frequency stages of Gr. 98 were used here.

more, arrangements for keeping the temperature constant, such as thermostats and vacuum mountings, become superfluous.

From the above explanation, it will be clear that the intermediate frequency obtained at the long-wave audion is perfectly constant, provided we disregard a very slow, minute shift which occurs only during a certain period of time after tuning in, and whose influence on the pitch of the reception tone can easily be balanced. The only further requirement for obtaining a note of constant pitch is then that the natural frequency of the long-wave audion also be constant. Experience has shown that this may be accomplished without difficulty, since, with long waves, a slight vibration of the parts conducting the current does not exert any appreciable influence on the frequency.

The result of numerous experiments carried out with the arrangement described agreed entirely with the state of affairs discussed above. A reception tone with perfect purity and constant frequency could be obtained even under the most intense mechanical and acoustical vibrations in the airplane (motor at full speed, starting and landing). The pitch could be adjusted at will by means of the audion for the intermediate frequency, and the tone volume was at least of the same quality as with normal reception, although no amplification stages were used for the intermediate frequency.

The arrangement described functions with a non-oscillating short-wave audion, and therefore also with a non-oscillating receiving antenna. Consequently conductor systems in the neighborhood cannot cause induction. The varying contact resistance of such conductors can no longer produce a reaction disturbing reception.

The disturbing noises which often occur due to the above causes in cases where an oscillating antenna is used are therefore eliminated here. As shown by experience, this is particularly important for movable stations on ships or in aircraft where it is impossible, in general, to avoid the mechanical action of metal parts on each other.

In the case of short-wave reception with intermediate frequency, the simplest solution is to work with two tuned oscillating circuits, one of the short-wave audion, and one of the long-wave audion. If the resonance curves of these two circuits are compared, it appears that the range of transmission (expressed in cycles) in the audion with intermediate frequency is but a fraction of that in the short-wave audion, assuming that the damping is equal. This has a practical significance for the suppression of reception disturbances. If, for example, the latter act with constant amplitude throughout the entire range of transmission frequency of the short-wave circuit, the total disturbance-spectrum corresponding to this range of frequency im-

pairs the reception if no intermediate frequency is used. However, if intermediate frequency is used, the disturbing band of short waves is reduced to the considerably narrower transmission range of the long-wave circuit. The decrease in disturbance is proportional to the ratio of the transmission ranges, which, for equal decrements,¹⁰ are proportional to the frequencies of the two circuits.

The decrease in the influence of the disturbance as observed in the experiments was very considerable, although the ratio between the wavelengths was not very high (47 m and 2000 m). Therefore, the use of an intermediate frequency is of particular importance for short-wave radio receivers in aircraft, as in this case the disturbances caused by the electric ignition equipment of the internal combustion engines can impair the reception to a large extent.

The arrangement described also makes it possible to increase the loudness of reception by the addition of intermediate amplification stages for the frequency. The range of frequencies of the intermediate-frequency arrangement as a whole can be kept very small, since the heterodyne wave is determined by the receiver quartz.

Of course, it is also possible to use any long-wave receiver for the intermediate frequency. If a long-wave set, for example, a direction-finding set, is already available at the station in question, then an additional set consisting of an audion and a quartz-controlled separate heterodyne may suitably be used for short-wave reception. This saving in sets is of particular importance for aircraft.

¹⁰ For a long-wave receiver of good quality, the decrement of the oscillating circuit has a value of about 1.5 per cent. For short-wave receivers, a value of about 0.5 per cent may be adopted.



A BROADCAST RECEIVER FOR USE IN AUTOMOBILES*

BY

PAUL O. FARNHAM

(Radio Frequency Laboratories, Inc., Boonton, N. J.)

Summary—*The purpose of this paper is to present several important features affecting the design of a broadcast receiver for use in automobiles. The design of the receiver is carried along step by step with special reference to (1) type of collector, (2) ignition shielding, (3) electrical characteristics of receiver, (4) physical structure of receiver, (5) power supply.*

From measurements made on an experimental receiver installed in an automobile the ignition interference is found to be greatest at the higher frequencies in the tuning range. Observations made during a road test of the receiver indicate a normal service range of from 50 to 100 miles on such stations as WJZ, WOR, and WEA. The severe fluctuation of the signal encountered in travel through hilly country indicates the desirability of some form of automatic volume control.

SINCE the design of a broadcast receiver for use in automobiles presents problems not encountered in the ordinary broadcast receiver for entertainment purposes, an outline of these problems and their solution may be of interest. As a starting point let us consider the limitations imposed by the type of collector suited for use on an automobile and by the interference produced by the ignition system.

1. **Type of Collector.** Of the two types of collector which might be used on an automobile, the capacity antenna is better suited for the reception of broadcast stations than is the loop antenna by reason of the directional effects and physical size of the latter. The capacity antenna will not, however, have a large effective height due to the fact that the collector wires are preferably not extended vertically higher than the car roof for the sake of appearance and clearances. Such a collector will thus require a sensitive receiver which will again require a rather high degree of ignition shielding. The effective height of the antenna as installed on a car is of the order of 1 meter. In order to obtain standard signal output for field intensities of $100 \mu\text{v}$ per meter the receiver sensitivity must therefore be at least $100 \mu\text{v}$. Let us now consider the question of ignition interference.

2. **Ignition Shielding.** Referring to Fig. 1 we shall designate V_1 as the modulated carrier voltage received on the antenna useful in producing the desired signal, and V_2 as the voltage received on the antenna from the ignition system effective in producing noise. In order that

* Dewey decimal classification: R360.

the noise from the ignition voltage V_2 shall not interfere with the received signal V_1 we may write the relation $V_1 > kV_2$.

The voltage V_2 produced by the ignition is in reality a spectrum of voltages of various frequencies so that in Fig. 2 the effective V_2 for the various frequencies to which the receiver may be tuned is shown as the bottom curve increasing with frequency. The height of this curve depends upon the effective height of the antenna and upon the degree of ignition shielding.

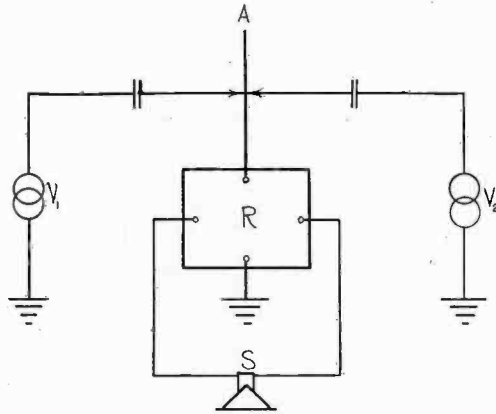

Fig. 1.—Pertaining to ignition interference. V_1 =modulated carrier station voltage, V_2 =ignition interference voltage, A =capacity antenna, R =receiver, S =loud speaker.

Above this curve and with the same slope is drawn kV_2 . This represents a limit below which the received effective station voltage V_1 must not fall if the ignition interference is to be just inaudible. The ideal sensitivity characteristic of the receiver in the presence of such ignition disturbance may now be drawn as V_1' , which represents the microvolts input required at various frequencies to give a satisfactory volume level from the loud speaker. If the actual receiver sensitivity characteristic, say V_1 , falls below V_1' at any frequency the volume control of the receiver must be operated so as to make the receiver less sensitive to the extent indicated by the cross-hatched region. The ideal sensitivity characteristic for such a receiver is thus seen to have a positive slope with respect to frequency equal to the slope of the ignition interference characteristic. The actual useful sensitivity of the receiver will then depend directly upon the degree of ignition shielding.

An experimental shielding of the ignition system of an Essex sedan was tried, employing copper shields over the high-tension leads, the high-tension coil, the distributor, spark plugs, and the low-tension

leads. The shielding of the low-tension leads running up to the instrument board was found to be particularly important. With this rather complete shielding the ignition interference was reduced to such a level that the receiver could be operated at $10\text{-}\mu\text{v}$ sensitivity at 1500 kc with the ignition noise just inaudible.

The improvement brought about by this type of shielding is illustrated by a comparison between the curve V_2 , which represents

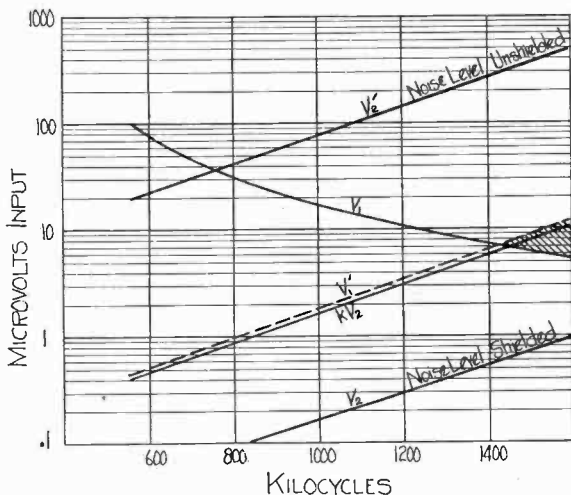

Fig. 2—The relation between useful receiver sensitivity and ignition interference level. V_2 = microvolts input for nearly complete shielding, V_2' = microvolts input for no shielding, V_1' = ideal sensitivity characteristic for receiver, V_1 = common sensitivity characteristic of a receiver.

the noise level with complete shielding as described above, and the curve V_2' , which represents the noise level in the absence of shielding.

3. Electrical Characteristics of Receiver. Having decided upon the degree of ignition shielding which will be economically possible from actual ignition interference measurements and from the desired receiver sensitivity, the design of the actual receiver may be undertaken.

The division of amplification in the receiver may be considered as a first step. Since the receiver will be subjected to rather severe shocks in use it appears desirable to use a rather low order of audio-frequency amplification so that microphonic noise may be minimized. The necessary high radio gain may be advantageously secured by the use of the shielded tetrode so that by supplying the detector tube with a rather high radio input voltage the detector may be made to operate directly

into the output tube.¹ Battery tubes such as the UX-222 appear to be undesirable since the filament structure is not sturdy enough to withstand the severe shocks.

In Fig. 3 is shown an amplification analysis of an early model of the RFL automobile receiver. The radio amplifier comprises an untuned

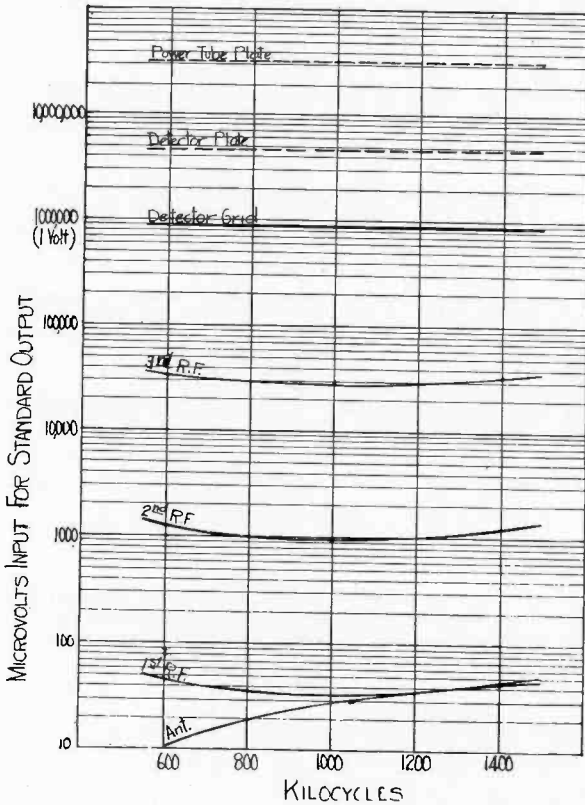

Fig. 3—Analysis of sensitivity in automobile receiver.

input circuit, three UY-224 tubes with three condenser-tuned circuits feeding a UY-224 detector. The detector and output tube are connected by resistance coupling. A moving-armature speaker having an impedance approximately equal to the output impedance of the power tube is used. The radio-frequency amplification from the grid of the

¹ Stuart Ballantine, *Proc. I. R. E.*, 17, 1176; July, 1929; *Cont. from RFL.*, No. 11, June, 1929. P. O. Farnham, "Report on Design of High-Voltage Detectors Employing the UY-227 Triode and the UY-224 Tetrode," *Cont. from RFL.*, No. 12, July 15, 1929.

first tube to the grid of the detector is approximately 45,000 at 1000 kc. The voltage detection factor (plate rectification) for 30 per cent modulation is about 6. By proper design of the input circuit the overall sensitivity characteristic of the receiver is given a positive slope with respect to frequency in order to obtain as closely as possible the ideal characteristic V_1' shown in Fig. 2.

Since the interior of the usual automobile constitutes a sound chamber with relatively high attenuation of the higher audio frequencies due to the reflection characteristics of the upholstery, it will be advantageous to use a loud speaker giving considerably greater response at the high frequencies than at the low.

4. Physical Structure. Limitations on the space available for installing the receiver in the car made it desirable to keep the dimension from front to back rather short. This permits the receiver to be placed below and behind the instrument board of the car. The short dimension was obtained by placing the three tuning condensers with their shafts parallel to each other and perpendicular to the face of the receiver, rather than arranging them on the same shaft, as is the usual practice. The three shafts carry pulleys with wire belts and are driven from a direct tuning control mechanism acting on the central shaft. Some consideration was given to the use of a three-gang variometer for tuning the circuits, but the principal objections to its use lie in the difficulty of matching the inductance of the molded type, which would be necessary to cover the frequency range, and the poor selectivity of the circuits at the high frequencies.

Shielding between the radio amplifier tubes is obtained by mounting the by-pass condensers associated with each tube in a rather long thin metal box, and placing this condenser unit between the tubes as an electrostatic shield.

The dimensions of one model of the RFL receiver are 11 in. long, 7 in. high, and 6 in. deep. With tubes, cable, and volume control the weight is ten pounds, two ounces. The volume control knob appears on the instrument board and operates to vary the control grid bias on the radio amplifier tubes.

5. Power Supply. The heater supply for the tubes is obtained from the 6-volt storage battery in the automobile. The four UY-224 heaters are wired in series-parallel with the 5-volt filament of the 112-A output tube bridged across them giving a total current consumption of 3.75 amperes. Plate and screen voltage supply is obtained from a 180-volt "B" battery and a "C" battery is used to bias the output tube.

6. **Results of Road Tests.** The original model of this receiver was installed on an Essex sedan at Boonton, N. J. Observations were taken during a daylight trip to Springfield, Mass. on three broadcast stations, WJZ, WOR, and WEAF. The location of the car, the time, and the character of the surrounding country were noted, and the type of reception noted at various points along the route. Most noticeable was the effect of travel through hilly country in reducing the general level of the output which could be obtained from the receiver and the rapid fluctuations of the signal as the car progressed. Strong reception, as indicated by overloading of the output tube before full receiver sensitivity was used, was obtained up to distances of between 50 and 100 miles from the three stations previously mentioned.

The problem of signal fluctuation seems serious enough to warrant the use on this type of receiver of the automatic volume control developed here and now employed in other RFL broadcast receivers.

It is desired to acknowledge the contribution of W. D. Loughlin embodied in the design of the receiver, and the assistance of F. H. Drake in connection with the experimental work on the ignition shielding.



SOME REMARKS ON THE MULTIVIBRATOR*

By

YASUJI WATANABE

(Professor of Electrical Engineering, Tohoku Imperial University, Sendai, Japan)

Summary—The author proposes to treat theoretically the production of oscillations by means of the multivibrator, and to formulate expressions for the period of these oscillations.

I

SINCE Abraham and Bloch¹ in 1919 invented the multivibrator as a means of obtaining a wave, rich in harmonics, for the calibration of wavemeters, it has been one of the important pieces of apparatus in high-frequency laboratories. Although the phenomenon resulting in the production of sustained oscillations was explained clearly by Armagnat and Brillouin,² the period of this oscillation has not been definitely formulated so far as the author knows. The first objective of the present paper is to derive as accurate a formula as possible for the period of the multivibrator oscillations.

As is well-known, the multivibrator is a symmetrically connected regenerative two-stage resistance-capacity amplifier, the circuit arrangement being similar to that shown in Fig. 1. In this circuit, the capacity C_1 is considered as being negligibly small.

An approximate formula for the period has been given as follows:²

$$T \doteq C_2 R_2 + C_2' R_2' . \quad (1)$$

Recently B. van der Pol^{3,4} has investigated the oscillations produced by a multivibrator from the standpoint of his theory of the "Relaxationsschwingung," (*relaxation oscillation*) and has given the following approximate formula for its period, assuming that $C_2 R_2 = C_2' R_2'$

$$T \doteq \frac{\pi}{2} C_2 R_2 . \quad (2)$$

Friedlaender,⁵ on the other hand, has contended that the oscillations of the multivibrator must be one type of "Kippschwingung." Unfortunately for us, however, he has not definitely formulated his theory.

* Dewey decimal classification: R133.

¹ H. Abraham and E. Bloch, *Ann. de Phys.* 12, 237, 1919.

² H. Armagnat and L. Brillouin, "Les Mesures en Haute Frequence" pp. 73-78 (1924).

³ B. van der Pol, *J.d.D.T.*, 28, 178, 1926.

⁴ B. van der Pol, *J.d.D.T.*, 29, 114, 1927.

⁵ E. Friedlaender, *Arch. f. Elektr.*, 20, 158, 1928.

Other important papers to which we must refer regarding the theory of the multivibrator are those by Heegner.^{6,7} He states that a main reason for the maintenance of periodic changes of current consists in the existence of a falling characteristic which, as is well known, is a property of a two-stage regenerative resistance-coupled amplifier.^{8,9,10}

Fig. 2 represents the circuit used by Heegner for obtaining the characteristic curves. This depends to a considerable degree upon the value of the anode coupling resistance.

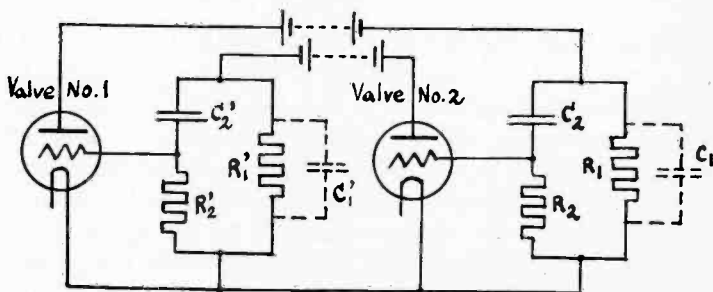

Fig. 1—Connections of a multivibrator.

Fig. 3 shows results obtained experimentally by Heegner for the case where the grid voltage of one tube is varied, and that of the second is held constant. He states in his paper that if the battery E_0 is replaced by a condenser C_2 , the anode current will vary periodically along the path $a b c d a \dots$, which has two jumping points, a and c . According to him, this explanation is directly applicable to the multivibrator.

II

The author believes that it may be useful to publish the results of his consideration of the theory of multivibrators, particularly since the above mentioned theories do not seem to him entirely correct. It is his intention, therefore, in the following to consider the multivibrator shown in Fig. 1. The assumptions to be made are:

- (1) The value of the anode-cathode capacity C_1 is negligibly small;
- (2) The circuit constants are symmetrical with regard to the two tubes; that is, the operating characteristics of the tubes are identical. Also $R_2 = R_2'$, $C_2 = C_2'$, and $R_1 = R_1'$;
- (3) The resistance R_1 in the anode circuit is much less than the grid-coupling resistance R_2 as is the case in practice.

⁶ K. Heegner, *Zeits. f. Phys.*, 42, 773, 1927.

⁷ K. Heegner, *J.d.D.T.*, 29, 151, 1927.

⁸ F. Schirl, *Arch. f. Elekt.*, 20, 346, 1928.

⁹ E. Friedlaender, *Arch. f. Elektr.*, 17, 103, 1926.

¹⁰ Y. Watanabe, *J.d.D.T.*, 32, 77, 1928.

Let us imagine first that an increment, having a value A , takes place suddenly in the anode current of the first tube. This results in a sudden increase, AR_1 , in the negative voltage-drop across the resistance R_1 .

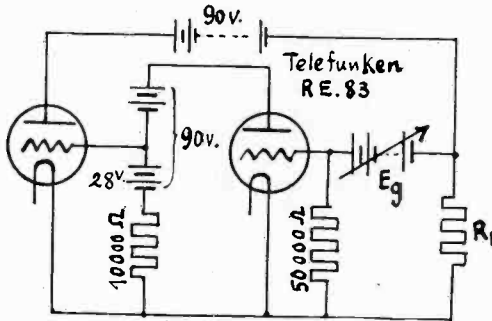

Fig. 2—Circuitual arrangement for obtaining characteristic of regenerative resistance amplifier (Heegner).

To a very quick change in current the condenser C_2 acts as a short circuit, thereby causing a sudden negative voltage drop of AR_1 across the resistance R_2 . This sudden decrease in the grid voltage of the second tube causes its anode current to decrease by a value A' , with the consequent result that the grid voltage of the first tube, which is equal to the voltage drop across the resistance R_2' , receives a positive increment having the value $A'R_1$.

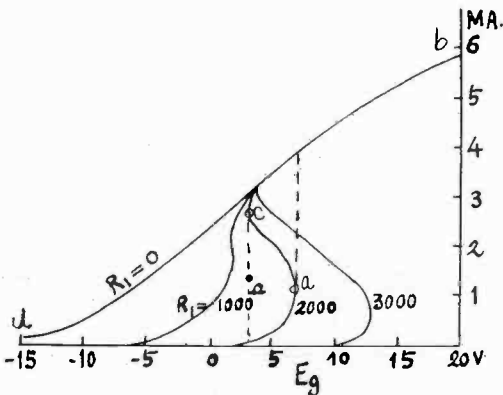

Fig. 3—Heegner's experimental result.

Let us now consider the transient phenomena taking place after this jump. It is evident that a charging of one condenser, C_2 , through the resistance R_2 , and a discharging of the other condenser, C_2' , through the resistance R_2' occur simultaneously. Consequently, the variation

in the grid voltages of the two tubes may be represented by the curves shown in Fig. 4, in which we see that $e_g = -e_g'$, because from the symmetry of the circuit $AR_1 = A'R_1'$ and $R_2C_2 = R_2'C_2'$.

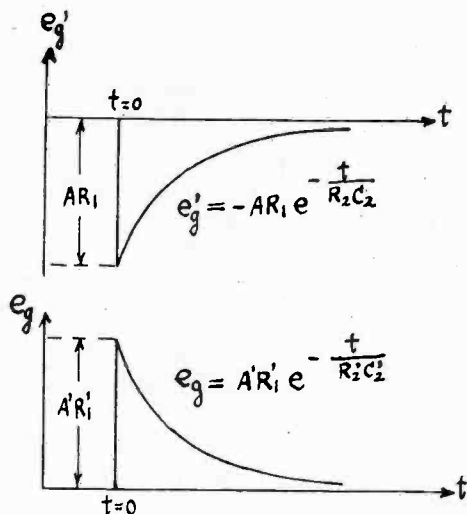

Fig. 4—Variations in grid voltages.

This property is important, since it permits us to employ the following static method of obtaining the characteristic curve of a multivibrator along which the anode current must change during a charging or discharging period for the capacity C_2 or C_2' . Fig. 5 shows a circuit

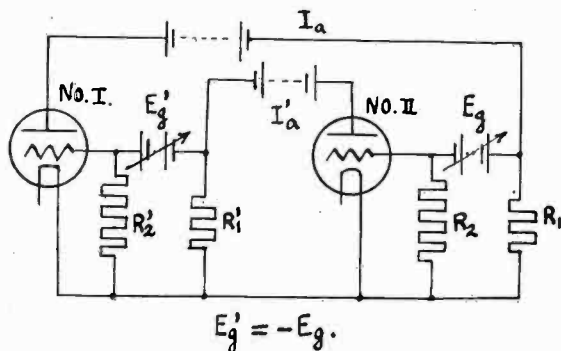

Fig. 5—Circuit for obtaining characteristics of a multivibrator.

whereby this desired characteristic curve may be obtained. In this arrangement E_g is always equal to $-E_g'$. We may, however, easily obtain this characteristic curve by means of the following graphical method. The curve I of Fig. 6 represents an ordinary anode-current

stant grid bias, $E_{g_0'}$, of the second tube. There is, however, a turning point, c , on the characteristic curve. At this point c the anode current, I_a' , of the second tube must jump to a maximum value, while that of the first tube decreases suddenly from the point c' to zero. At this jumping instant an abrupt change, having a value $E_1 = I_a R_1$, occurs in the grid voltages. The resultant values correspond to the point e' (negative maximum) for the first tube and to e (positive maximum) for the second tube. Subsequently, the condenser C_2 discharges through R_2 and the second condenser C_2' is simultaneously charged through R_2' , with the result that the grid voltage e_g increases. At the

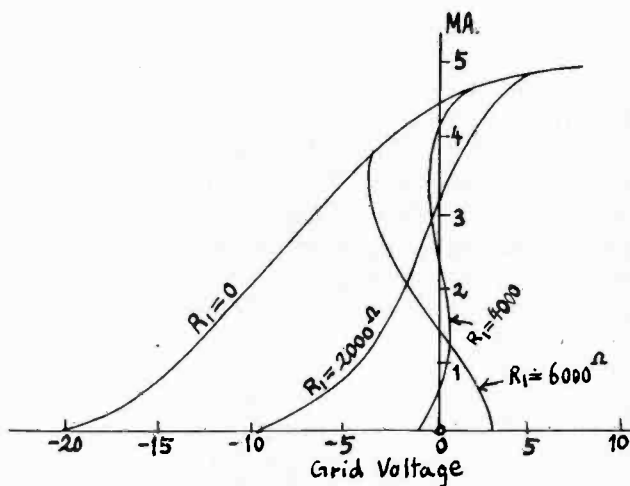

Fig. 7—Relation between characteristics and coupling resistances.

instant when e_g reaches the value e_c corresponding to the point f' , another sudden increment occurs in the anode current, I_a , causing an abrupt decrement in I_a' . This sequence repeats itself, thus maintaining the self-excited oscillations. The variations in the anode currents are represented in Fig. 8B. The time from c to e , required for these sudden increments to occur is usually negligibly small compared with the time required for charging the condensers so that the performance of a multivibrator as a producer of self-excited oscillations may be represented as in Fig. 9.

In order that self-excited oscillations may be produced by means of an apparatus such as a multivibrator or a neon-tube oscillator, it is a necessary condition that there be no point of equilibrium with respect to the direct current. Although the point P in Fig. 8A may appear to be a point of equilibrium for the second tube, it is unstable

because there is a turning point f' of the other tube between P and e , hence the two-tube system cannot have stable equilibrium. It is easily conceived that an abrupt change of an anode current is an important condition for the maintenance of oscillations. Notwithstanding the fact that a falling characteristic may be a favorable condition for a

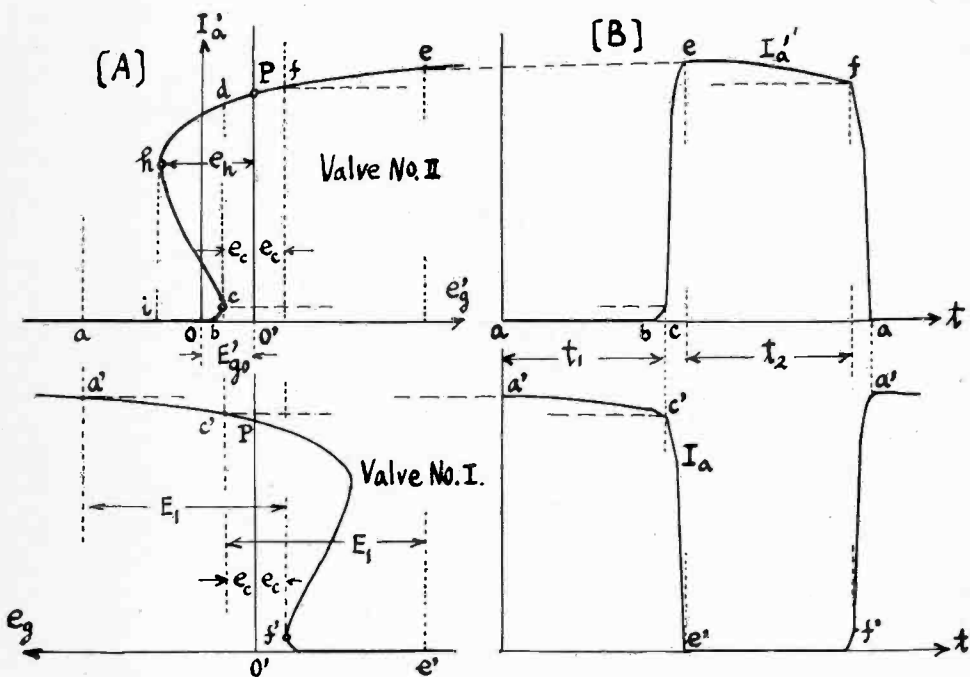

Fig. 8—Diagrams showing the oscillation cycle.

rapid change in anode current at the instant of jumping, we must, however, notice that this falling characteristic is not always a necessary condition. A characteristic such as shown in Fig. 10 may be useful also in order to excite oscillations. Taking these facts in to consideration, we may give the following condition for the production of oscillations:

$$E_1 - e_c > e_h > e_c, \tag{3}$$

and

$$E_{g0}' > e_c,$$

where $E_1 = I_a R_1$ is the change in the voltage-drop across the resistance R_1 at the jumping instant. I_a is approximately equal to the saturation value of the anode current.

From the symmetry of the circuit it is evident, in Fig. 9, that $t_1 = t_2$ and

$$t_1 = t_2 = C_2 R_2 \log_e \frac{E_1 - e_c}{e_c} \quad (4)$$

Consequently the period of the oscillation may be represented as follows:

$$T = t_1 + t_2 = 2C_2 R_2 \log_e \frac{E_1 - e_c}{e_c} \quad (5)$$

We have seen that the turning point c , or f' , in A of Fig. 8 is of great importance in determining the period, while the other turning

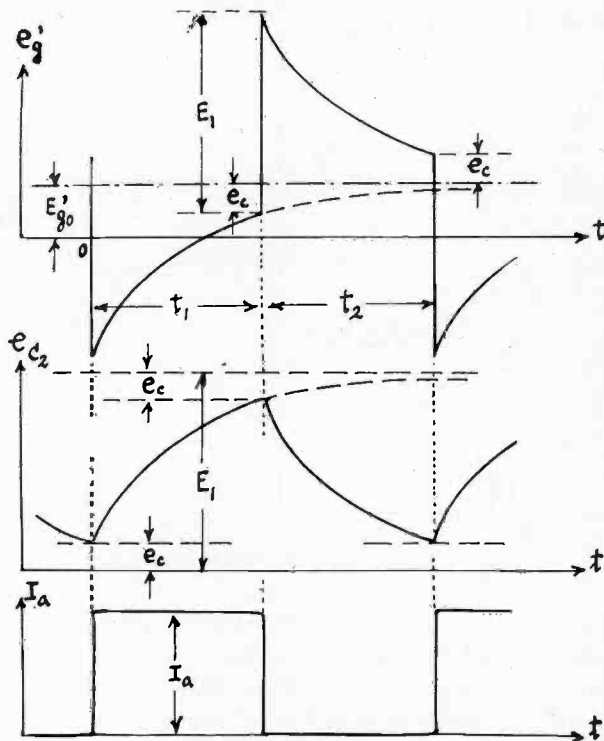

Fig. 9—Variations of grid and condenser voltages and anode current.

point, h , has no relation to it. When the resistance R_2 is much higher than R_1 it has no influence on the values of E_1 or of e_c . Consequently, the period is always proportional to the product $C_2 R_2$, as previously shown by many experiments. Both the resistance R_1 and the operating condition of the tube may give an appreciable variation in the period. Moreover, it must be noted that the point e must be on the saturated part of the characteristic curve in order to make the production of oscillations effective.

III

The author would like to add the following observation. The circuit arrangement shown in Fig. 1, assuming C_1 to have a given value,

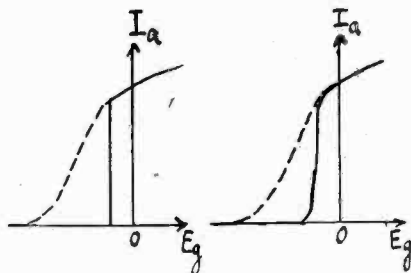

Fig. 10—Non-falling characteristics.

may produce sinusoidal oscillations under the following condition:

$$g_m = \frac{1}{R_P} + \frac{1}{R_1} + \frac{1}{R_2} \left(1 + \frac{C_1}{C_2} \right) \quad (6)$$

where g_m and R_P are respectively the mutual conductance and the internal anode resistance. The angular velocity of the vector representing this sinusoidal oscillation is

$$\omega^2 = \frac{1}{R_2 C_2} \cdot \frac{1}{C_1} \left(\frac{1}{R_P} + \frac{1}{R_1} \right). \quad (7)$$

When this system functions as a producer of sinusoidal oscillations the operating condition of the tube must be so adjusted as to give the maximum value of mutual conductance; that is, the point of equilibrium with respect to direct current must be nearly in the middle of the characteristic curve. It is an interesting fact that we may produce either a sinusoidal oscillation or a "kippschwingung" by means of the two-tube system shown in Fig. 1 by varying the value of anode capacity C_1 .



PRODUCTION TESTING OF VACUUM TUBES*

BY

K. S. WEAVER AND W. J. JONES

(Westinghouse Lamp Company, Bloomfield, N. J.)

Summary—The factory testing of vacuum tubes is becoming more specialized every year. In the early days of broadcasting a few tubes served many purposes and actual performance in its relation to tube characteristics was not as widely studied and understood as it is today.

Increasing knowledge of the how and why of tube and set operation has led to the development of many more or less special tubes designed for a specific function in the set. The increasing use of accurate set measuring equipment has enabled designers to work out the optimum circuit arrangements for the use of these specially designed tubes in the various stages.

As a result of this growth of the industry the testing of vacuum tubes has required more and more attention to set operation, a constant elaboration of test methods and equipment being necessary in order to exercise the necessary control over tube characteristics.

Organization of Test Procedure

FACTORY TEST

Electrical Inspection

ELECTRICAL test limits are established by the Characteristics Committee which is made up of engineering, manufacturing, and commercial representatives. The setting of the limits is naturally governed by the operation of the tube in a receiving set extended over a certain period of time known as the life of the tube.

All tubes are designed for certain characteristics and must be within limits on each of these design characteristics; therefore, all tube parts before and after assembly are carefully inspected and measured so that theoretically all tubes reaching final factory inspection should be within limits for all characteristics. However, during the various processes through which the tube must pass in its manufacture something may happen to change the characteristics and throw them outside test limits.

Every tube is tested by the factory for those characteristics affecting the performance of the tube, the characteristics tested for depending upon the type and purpose of the tube.

Many of the tubes are tested by hand on individual test sets, each of which is designed for the type of tube to be tested. The test set operator inspects each tube for the above-mentioned characteristics

* Dewey decimal classification: R330.

and also for any physical defects. Production on each of these test sets ranges from one to two hundred tubes per hour.

High production tubes are tested on automatic test machines. The same characteristics are tested for by these machines as on hand testers but with greater speed and more accuracy due to the fact that the tubes are inserted automatically into the socket, tested and ejected, thus eliminating the human element entirely.

These automatic testing machines function at a speed of approximately five thousand tubes per hour. The testing for the various characteristics is accomplished as follows:

The various voltages are applied to the sockets on a rotating head by means of pick-up brushes. As the head rotates the tubes are passed or rejected by means of a series of relays which are set for limits on each of the different characteristics. Good tubes are eased from the socket to a belt conveyor by means of a cam. When a tube which is outside limits passes around the automatic test machine the relay energizes a solenoid coil, the plunger of which ejects the defective tube from the socket to a belt conveyor. For instance, five of these belt conveyors may be connected to an automatic tester as follows:

1. Dead bad tubes or "duds"
2. Gassy tubes
3. Low emission tubes
4. High or low plate current tubes
5. Good tubes which have passed all electrical tests.

Tubes from belts one to four inclusive are then held and analyzed for correction of manufacturing process.

Good tubes on belt five are conveyed on through the belt inspection to automatic wrapping and packing machines.

Belt Inspection

Belt inspection is an inspection made in the factory by factory operators on tubes which have passed all factory inspection, is under the direct supervision of the Engineering Department, and functions as follows:

Approximately a 6-8 per cent selection from every package is inspected by the belt inspectors for electrical and mechanical defects. The finding of defective tubes by belt inspectors is followed up by an additional inspection on the same lot of tubes. If more of the same defects are found on this reinspection the entire product is reinspected by the factory. This reinspection continues until the belt inspector finds the product free from defects. This inspection is on a scoring basis.

ENGINEERING DEPARTMENT INSPECTION AND TEST

Engineering department inspection is made for the purposes of obtaining engineering information and data. This inspection is made by traveling inspectors using the same standards and electrical limits in each of the manufacturing divisions. A small percentage of tubes per day of each type being manufactured are selected at random after final factory inspection in the packing department. These tubes are measured for all electrical characteristics, physical defects, and various special features.

This inspection is also on a scoring basis and the results are used to detect drifts in manufacture, to obtain design information, and to keep electrical characteristics of the various manufacturing divisions within limits and as closely centered as possible.

The traveling inspectors also make a selection daily from the factory product for the commercial testing laboratories. These sample tubes are selected in the same manner as mentioned above, the cartons being sealed and dated immediately after selection.

WAREHOUSE INSPECTIONS

The purpose of the warehouse inspection is to detect any variations in manufacture which may cause defects to develop on standing, such as gas, glass cracks, etc.

A number of tubes of each type manufactured are selected by the belt inspector weekly, selections being made daily from the factory production. These tubes are inspected, then held for a period of seven days, and then reinspected and results noted. These tubes are again held for a period of thirty days and again reinspected. This inspection is also on a scoring basis.

STRENGTH TEST

The purpose of this test is to detect structural weakness due to faulty assembly or manufacture. Approximately 50 tubes per type are selected monthly from current factory product which have passed all electrical tests and are free from physical defects. These tubes are numbered and the plate current readings are noted. Tubes are then repacked in cartons and placed in cardboard inner containers and subjected to a drop test which consists of dropping the package six times from the height of 42 inches. Tubes are then unpacked, reinspected for physical defects and plate current readings again noted. Any abnormal results are investigated by the engineering department.

LIFE TEST

Tubes for life test are selected daily by the traveling inspectors from the current factory production, the number selected depending on the

production of the type in question. This varies from five to twenty-five tubes per week. These tubes are sent to the engineering department for life test and are given an initial electrical inspection, readings being recorded. Tubes are then placed on the life test rack at normal burning voltages. Readings are made periodically during the life of the tube for electrical characteristics. Life test results are also on a scoring basis.

The scores obtained on the various inspections and tests listed above determine the quality rating of each factory on a monthly basis. This rating materially affects a special compensation paid the factory supervisory staff and the Radio Engineering Department each month for maintaining a high quality product.

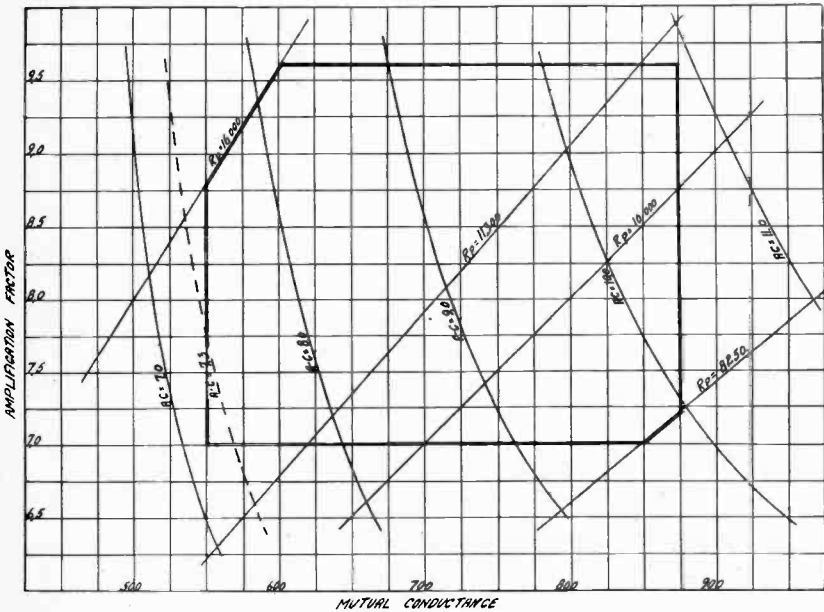

Fig. 1—Chart showing relation between various characteristics and the limits used.

Test Engineering

It is of interest to consider briefly the most important tube characteristics involved in production testing.

EMISSION

This test is a measure of the quality of the cathode as a source of electrons. It is generally made with a moderate value of voltage applied to the grid and plate tied together. It is in a sense a plate cur-

rent reading made under conditions very different from the ones under which the tube is used and such that the current read depends more on the actual emission from the cathode than on the geometrical construction of the tube. The limit is always given as a minimum without a maximum value.

The "emission" test is not designed to give a reading equal to the total emission from the cathode. This is unnecessary and in the case of coated filament tubes is impractical due to the absence of any well defined saturation current.

PLATE CURRENT

The plate current reading is the most representative and convenient single test for factory purposes. It is generally made at values of filament, plate and grid voltage recommended for actual service.

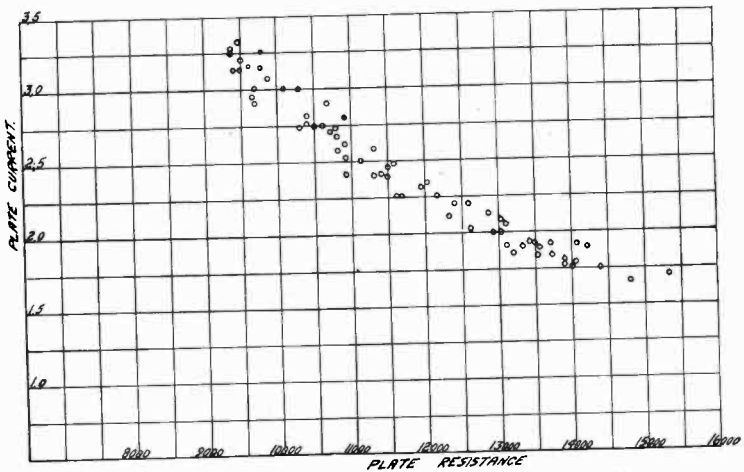

Fig. 2—Relation between plate current and plate resistance.

This value is always required to fall between a higher and lower limit. The plate current test, assuming that the limits have been properly set, takes care of variation in *plate resistance*, *mutual conductance*, and *amplification constant*. These are the factors which bear most directly on set operation, mutual conductance being the most important single characteristic in its effect on voltage or power amplification in a receiver. Plate resistance which is related to mutual conductance and amplification constant by the expression:

$$G_m = \mu u / R_p$$

is also of importance in its effect upon the voltage developed in the external plate circuit either in the case of a voltage or power amplifier.

ment inspection organization which makes a complete check on all characteristics, including capacities, on samples selected at random several times each day from the factory floor.

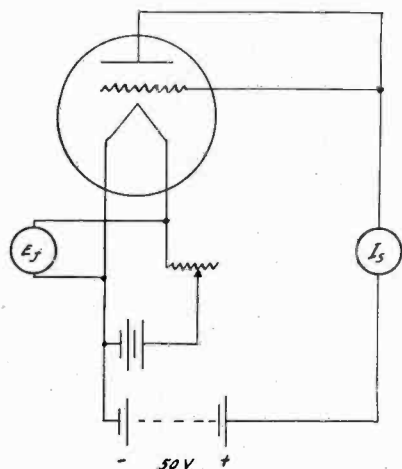

Fig. 5—Elementary circuit used for emission reading.

The relation between the most important characteristics covered by the factory and engineering department tests is shown in the following graphs.

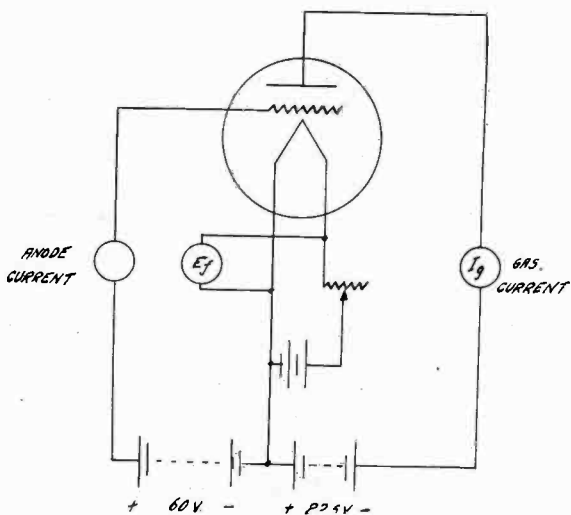

Fig. 6—Circuit used for emission check and gas.

Fig. 1 is a diagram showing the limit chart for a certain tube, the mutual conductance, amplification factor, and plate resistance at the

upper and lower limits forming the boundary of the area of approximately rectangular shape within which it is desired that all tubes will fall.

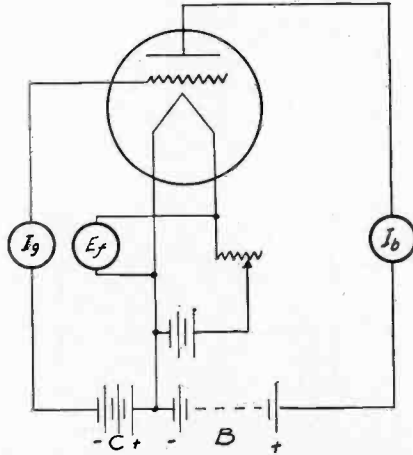

Fig. 7—Circuit used for plate current reading, gas, and leakage.

The plate current of the tube is more closely related to the plate resistance than to any other one characteristic, as shown by the curves Fig. 2, Fig. 3, and Fig. 4, in which plate current is plotted against plate

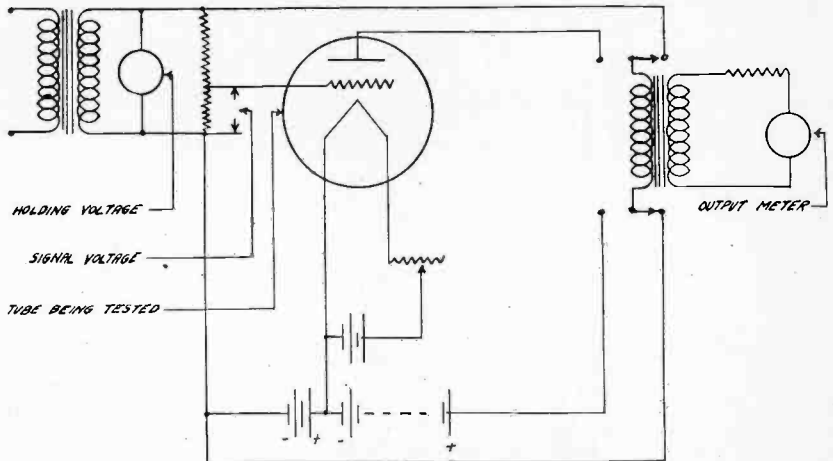

Fig. 8—Circuit arrangement for the a-c test.

resistance, amplification factor, and mutual conductance. There is as well a fair correlation between plate current and the other characteristics, so that the rejection of all tubes outside certain plate current

limits will automatically eliminate tubes with excessively high or low values of G_m and R_p , and amplification constant.

The points represented on these curves do not represent the usual distribution of tube characteristics as manufactured, but rather tubes selected to cover a wide enough range to fix the curves. A curve including all the tubes of a given lot would show points grouped so closely around the center as to give a very poorly defined curve. Of course, this is a desirable feature and every effort is made to keep the actual spread in production within as narrow limits as possible.

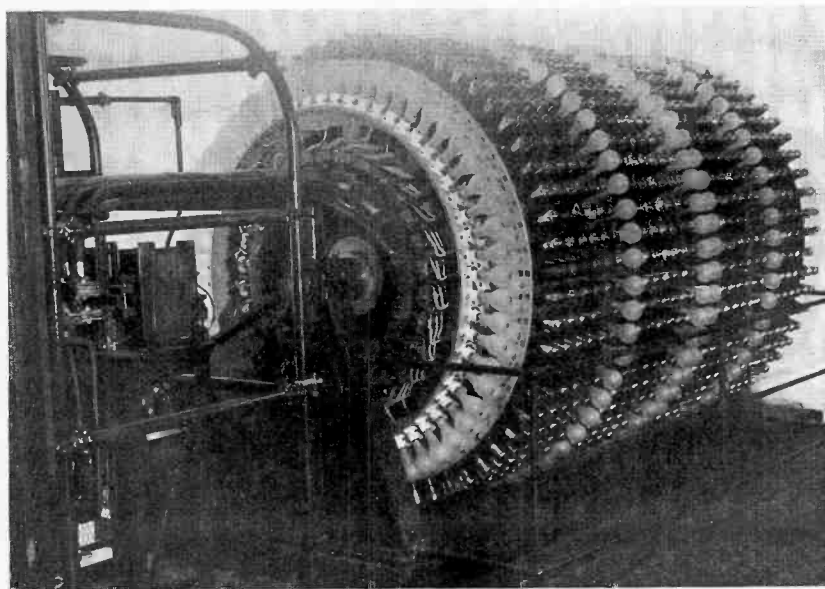

Fig. 9—Seasoning drum used in connection with the high-speed automatic test machine.

In Fig. 1 are also shown curved lines corresponding to tubes of equal a-c output as calculated by the expression:

$$a-c = MuE_g Z / \sqrt{(R_p + R)^2 + X^2}$$

E_g is the standard signal voltage applied to the grid, R_p is the plate resistance and R and X are the resistive and reactive components of the external impedance Z , the phase angle of which is generally about 0.5.

The lines of constant a-c output are generally approximately parallel to the lines of mutual conductance. However, by the proper

choice of the value of the external impedance they may be made to fall almost exactly parallel with either the mutual conductance or amplification factor lines.

CIRCUITS AND EQUIPMENT USED IN TESTING

The test tables used for factory testing are arranged with the tube socket and control switches mounted on the horizontal portion directly in front of the operator, and the meters are mounted on the vertical back panel.

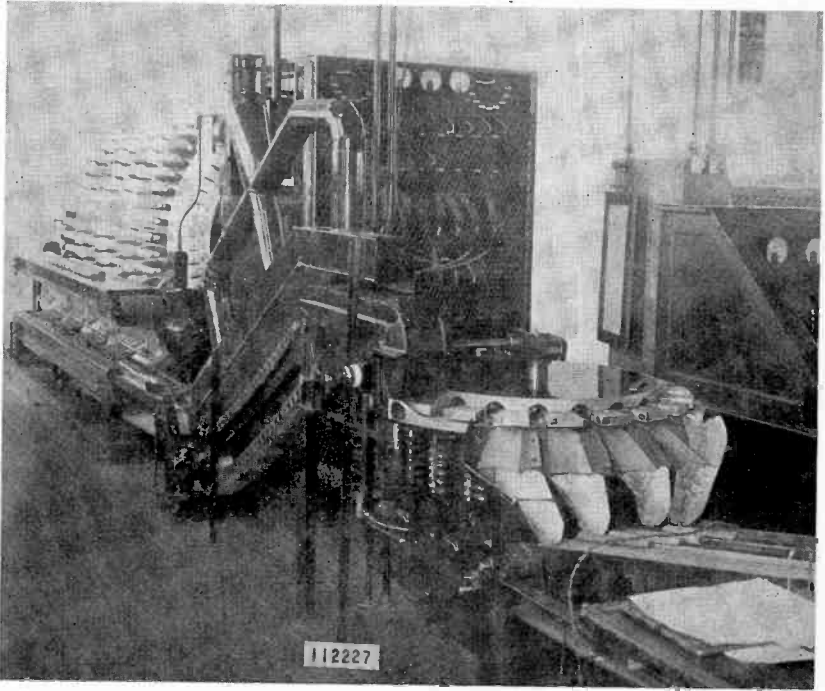

Fig. 10—General view of automatic test machine and drum seasoner.

For tubes having small plate currents and voltages standard telephone switches have been found very convenient for changing from one circuit arrangement to another. For output tubes, where high voltages and currents are involved, switching is done through relays or by a power controller built with heavy contacts.

Meter protection, in case of short circuits, is obtained in various ways depending on the circuit arrangement. A protective current limiting resistance is convenient wherever practicable. However, in many cases the introduction of a high resistance into the circuit can-

not be permitted, and in such cases light relays operating at currents of a few milliamperes are used.

For heavy currents, that is, for example, the plate current of output tubes, light circuit breakers are used for meter protection.

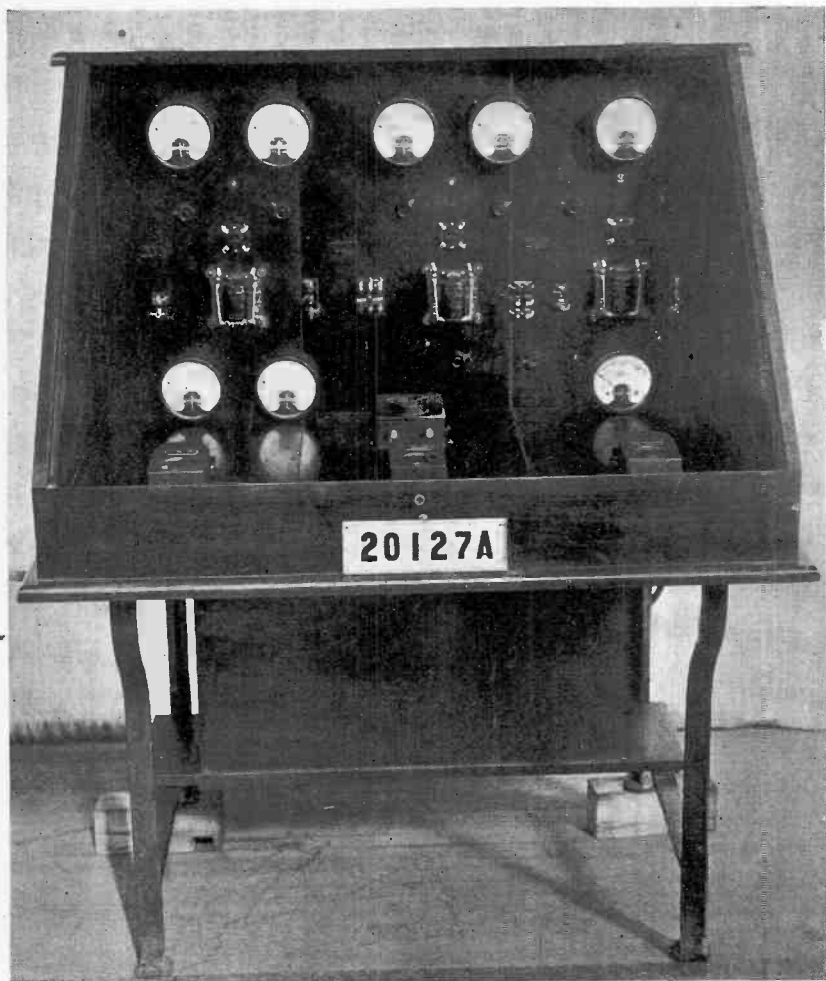

Fig. 11—Meter cabinet used with automatic test machine.

No perfectly satisfactory method has been found for protecting microammeters used for gas readings from a careless operator. Meter protection by a short circuiting button which opens when pressed is about as satisfactory as anything.

The wiring of a complete test position arranged with switches for changing circuits for several tests is rather complicated and difficult to follow; therefore, the basic circuits for the several tests will be used here.

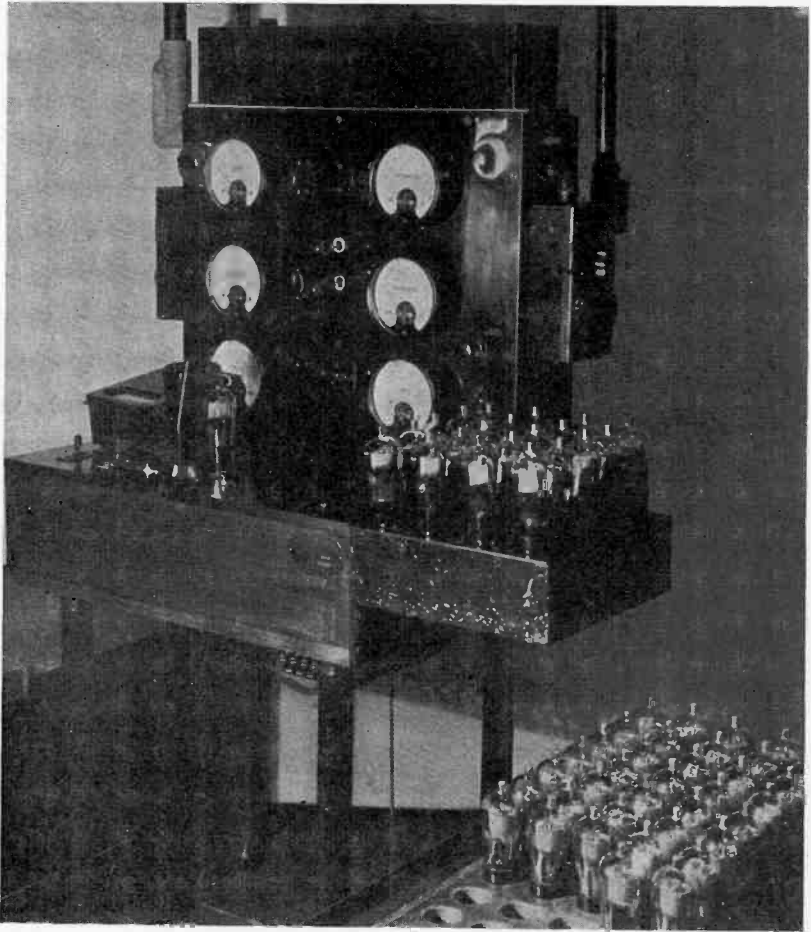

Fig. 12—Front view of hand-operated UY-224 test table.

EMISSION

The emission test is made with the circuit arrangement shown in Fig. 5 which is self-explanatory.

EMISSION CHECK

In this form of emission test, the filament voltage required to give

a certain anode current using a circuit such as shown in Fig. 6 is measured and must not be greater than the limit set. A moderate value of current is generally used in this test, the limiting filament voltage being below the normal operating voltage of the tube. It will be noted that the grid here is used as the anode.

GAS AND LEAKAGE

Gas is often read at the same time the emission is checked using the circuit shown in Fig. 6. Gas is read in the plate circuit; and with the filament voltage off, leakage is read in the grid circuit.

PLATE CURRENT

Plate current is read using a circuit similar to Fig. 7 with appropriate grid plate and filament voltage applied to the tube. Gas may be read as the reversed current in the grid circuit using this connection.

This use of the circuit Fig. 6 for reading of both gas and emission is convenient when practicable. However, it is obviously practicable only for tubes which come to temperature equilibrium very quickly since it involves setting the filament voltage at two different points during test.

The basic circuit for the a-c test is shown in Fig. 8.

In this test a certain voltage is held across R and in the "standby" position of the plate circuit switches this voltage is applied directly to the primary of the output transformer, holding the meter at the rejection point. When the switches are operated, the transformer is connected into the plate circuit of the tube under test. The meter needle should rise when this is done, otherwise the tube is rejected.

AMPLIFICATION CONSTANT, PLATE RESISTANCE, AND MUTUAL CONDUCTANCE

These are measured with various modifications of the Miller bridge. These and similar circuits have been described in detail in the standard textbooks and need not be considered further.

Capacity measurements are made at radio frequency using a substitution method, similar to that outlined in the NEMA handbook.

The above brief outline may be considered to cover the most important production tests. Others of a special nature are made on a laboratory scale in order to obtain information on the many factors which relate set and tube performance.

CROSS MODULATION IN R-F AMPLIFIERS*

BY

SYLVAN HARRIS

(Engineering Dept., F.A.D. Andrea, Inc., Long Island City, N. Y.)

Summary—The causes of cross modulation in radio-frequency amplifiers are described, particularly in connection with the use of a non-selective input circuit, and in connection with the static characteristics of the screen-grid tube. Remedies for the difficulties are suggested.

THE fact that screen-grid tubes may act as modulators, due to the non-linear properties of the mutual characteristics of amplifiers, is well-known. Little has been published on this matter, however, in spite of the fact that under certain conditions these effects may become quite marked, and may seriously affect the design of radio-frequency amplifiers for broadcast reception.

The first type of cross modulation to be discussed is that which occurs when the amplifier is coupled to the antenna by means of a resistance or closely coupled transformer, as an auto transformer. Since this stage is non-selective, all signals in the neighborhood of the antenna will be impressed upon the input of the tube in a degree depending upon the frequency characteristic of the coupling device.

The first tube then acts as a modulator, and the selective system following it may be tuned to the beat frequency produced between any two signals, provided this beat frequency lies within the tuning range of the system.

Fig. 1 is a chart which shows the various combinations of broadcasters in the New York district which will produce beat frequencies in the tuning range of the amplifier. The various stations have been located on this chart according to their frequencies, both vertically and horizontally. The intersection of an abscissa and an ordinate within the two triangles indicates the beat frequency produced, according to the diagonal scales of wavelength. As an example, WGCP and WEAJ produce a beat frequency of 590 kc, or slightly over 500 meters, as indicated in the "difference" triangle. Similarly, WOR and WJZ produce a beat frequency slightly above 200 meters, as indicated in the "summation" triangle. There is only a small portion of the broadcast range near its middle where no such beat frequencies may occur. On tuning the selective system of the amplifier to any of these beat frequencies the intermingled programs of the two stations are heard.

* Dewey decimal classification: R343.

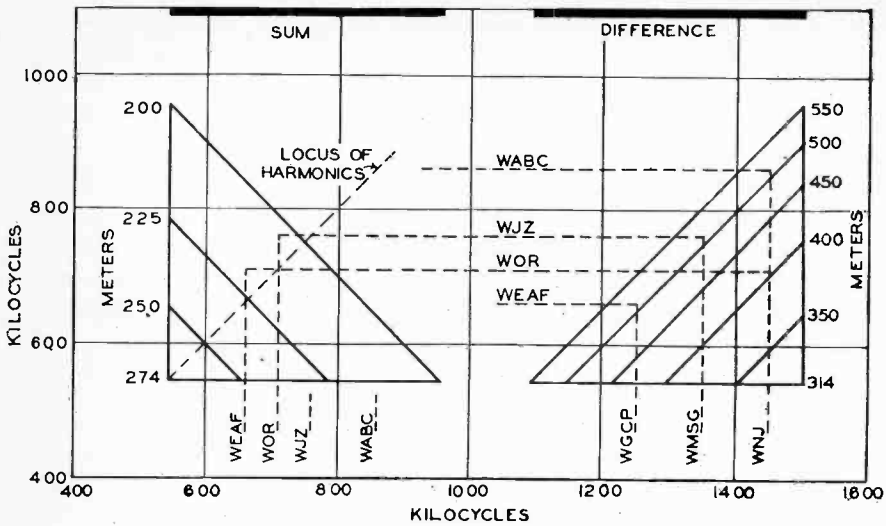

Fig. 1

The greater the amplification the more serious does this effect become, even when using voltages which place the operating point well up on the characteristic curve of UY-227 tubes. The obvious means of avoiding it is to make the antenna stage selective, as will be discussed later. Also, since this type of modulation is a function of even-order derivatives of the tube characteristic, it is possible to cancel it out in

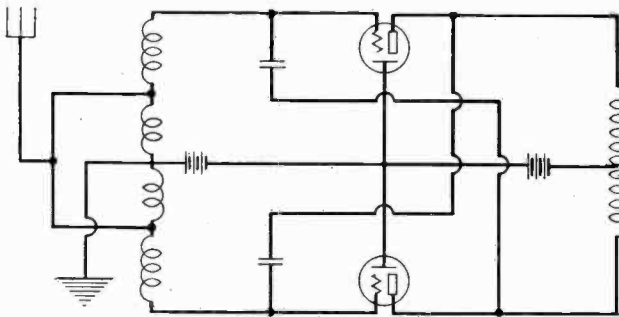

Fig. 2

the push-pull amplifier illustrated in Fig. 2. It is to be noted that the two antenna coils are wound in the opposite direction, in order that the two grids may have opposite polarities. It is necessary to neutralize the amplifier by means of the cross condensers shown. This system has been found to be quite effective for eliminating this type of modulation.

The form of modulation just described is entirely a matter of plate-circuit rectification since the grid is always sufficiently negative to prevent the flow of electrons to the grid. If the grid bias is made sufficiently low, however, a further complication, in the form of grid-circuit rectification, will be added to the problem.

This form of cross modulation is especially striking in amplifiers using UY-224 tubes, and in which "volume" is controlled by varying the screen- or control-grid voltages, or both. A common method of controlling volume is indicated in Fig. 3, in which the control grid is "self-biased," i.e., the bias is obtained in the form of a voltage-drop in a resistor placed in the circuit of the plate current. The corresponding

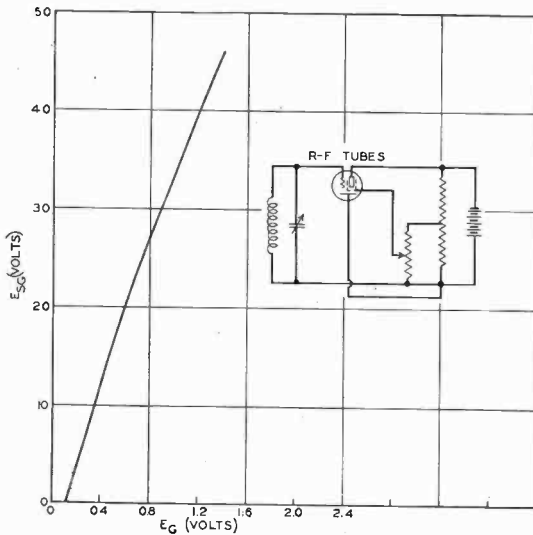

Fig. 3

values of screen- and control-grid voltages are indicated in the curve of Fig. 3.

Fig. 4 shows the plate and grid characteristics of a good 224 tube for four values of screen-grid voltage. The broken lines are the loci of the operating points taken from the curve of Fig. 3. It will be seen that the operating points on the curves of plate current are well above the knees of the curves. On the other hand it is also seen that the locus of operating points on the grid characteristics will pass through curves of grid current where the curvature is quite abrupt.

This form of modulation differs from the form previously described in that the selective system of the amplifier is not tuned to a beat frequency, but to one or the other of the interfering signals. It occurs only

at reduced voltages and at correspondingly low volumes, and is due primarily to grid rectification. Furthermore, it occurs even when the amplifier is selectively coupled to the antenna, requiring only the presence of two strong carriers not too widely differing in frequency, as for example, WOR and WJZ. On tuning to WJZ and reducing volume, WOR is heard in the background.

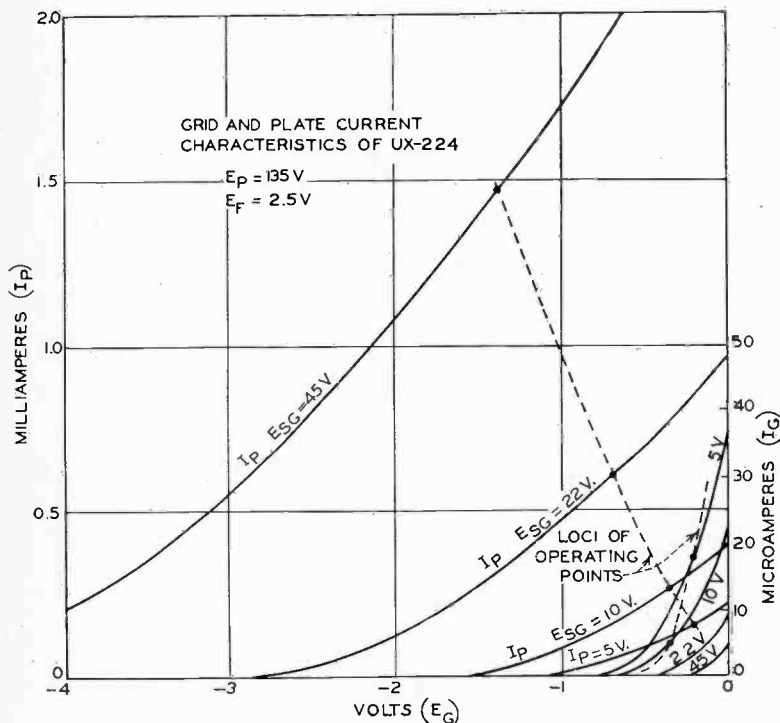

Fig. 4

The first remedy that suggests itself is that of keeping the control-grid voltage sufficiently high that no grid current can flow. With reference to Fig. 5, which shows characteristics of a "good" and a "poor" tube, it is seen that the required voltage is about 1.5 volts. In the controlling volume, therefore, the minimum control-grid voltage can be fixed at this value and no modulation will be encountered when the screen-grid voltage is reduced.

Another difficulty is found, however, in the form of poor quality of reproduction, which is due to operating the radio-frequency amplifier tubes near or at the cut-off of plate current. In order to obtain sufficiently low volumes, keeping the grid above 1.5 volts, it is found

necessary to reduce the screen voltage until the plate current per tube is as small as perhaps $30 \mu\text{a}$. Under this condition only the greater carrier voltages are amplified and the resulting quality of reproduction is quite unsatisfactory.

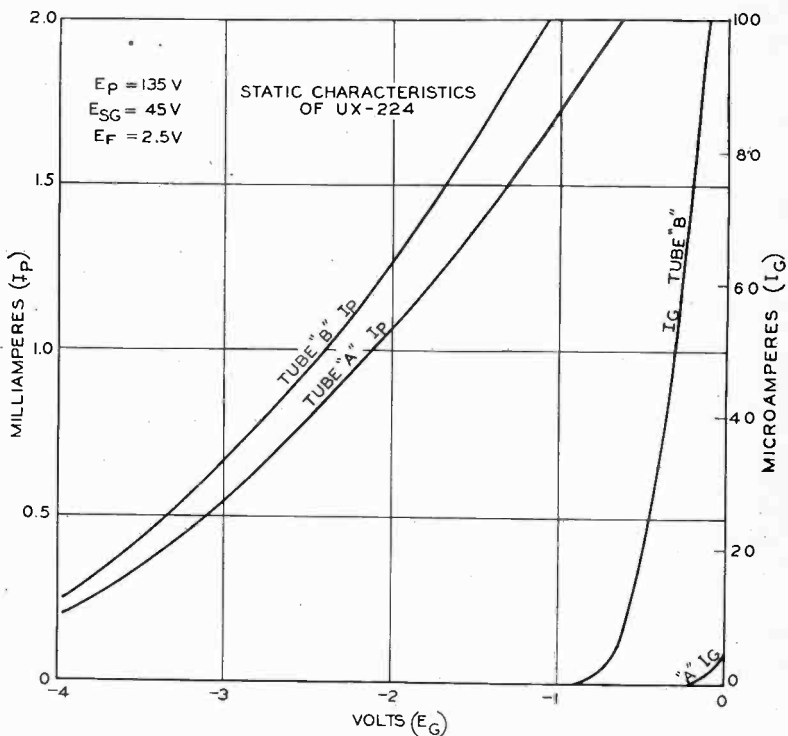

Fig. 5

The designer therefore has practically had to resort to the expedient of controlling the input to the amplifier (as across antenna and ground) and the tube voltages simultaneously, by means of two volume controls operated on a single shaft. This permits zero volume to be obtained before the tube voltages have been reduced to the values at which cross modulation or plate current cut-off occur.



BOOK REVIEW

Report of the Royal Commission on Radio Broadcasting. Obtainable from the King's Printer, Department of Public Printing and Stationery, Ottawa, Ontario, Canada. Paper bound, 59 pages, French and English in the same edition. Price, \$0.25.

The opening paragraph of the report, under the heading "Object of the Commission" states that:

"The Royal Commission on Radio Broadcasting was appointed by the Government to inquire into the existing situation in Canada and to examine the different methods adopted in other countries.

"The purpose of the inquiry was to determine how radio broadcasting in Canada could be most effectively carried on in the interests of Canadian listeners and in the national interests of Canada.

"According to the terms of reference of the Order in Council appointing the Commission, it was required: 'to examine into the broadcasting situation in the Dominion of Canada and to make recommendations to the Government as to the future administration, management, control and financing thereof.' "

The report goes on to tell of the visits of the commissioners to various European countries and the United States, of public sessions held in twenty-five Canadian cities, of conferences held with the authorities of the nine provinces of the Dominion, and of resolutions and written statements received from various individuals and representative public bodies.

Three schemes for putting broadcasting under Government ownership or subsidy are mentioned, and then the Commission's recommendation of a national company to own and operate all broadcasting stations located in the Dominion of Canada is presented. This company would be vested with the full powers and authority of any private enterprise, its status, and duties corresponding to those of a public utility.

The proposed organization is discussed in detail under the headings of personnel, broadcasting stations, finance, programs, interference, and control. Perhaps the most interesting of the detailed recommendations are those calling for the establishment of seven 50,000-watt stations, with provision for increasing both the number and power of these; and the system of financing whereby the cost of the broadcasting system would be met by license fees, Government subsidy, and rental of time on broadcasting stations for programs employing indirect advertising.

The report concludes with a "Summary of Recommendations."

There are four appendices as follows:

- I. Broadcasting in Other Countries.
- II. List of Persons Making Statements at Public Hearings.
- III. Statements Received from Provincial Governments.
- IV. Broadcasting in Canada.

The report is of interest to the people of Canada, to the engineer, and to the economist.

C. H. STARR

BOOKLETS, CATALOGS, AND PAMPHLETS RECEIVED

Booklets describing the following receivers may be obtained from the Radiomarine Corporation of America, 66 Broad Street, New York City.

Aircraft Beacon Receiver, Model AR-1286. Range-270 to 500 kc.

Airport Weather Receiver, Model AR-594-C. Range 255 to 520 kc.

Communication Receiver, Model AR-1308. Range-3,300 to 6,700 kc.

(Other ranges are obtainable if desired.)

"Development of Aircraft Radio Receivers" is the name of an interesting booklet issued by the Aircraft Radio Corporation of Boonton, N. J. It describes their Model B aircraft radio receiver having a range of from 280 to 360 kc. These receivers may also be obtained in other ranges between 280 and 6,000 kc.

The Western Electric 9-A aircraft radio receiver having a frequency range from 250 to 500 kc is described in a booklet "Long Wave Radio Receiver For Airplanes." Another brochure, "Aviation Communication Equipment," concerns the 9-B receiver and 8-A transmitter designed for aircraft operation on frequencies between 1,500 and 6,000 kc. These booklets may be obtained from the Western Electric Company, Aviation Communication, General Commercial Department, 195 Broadway, New York City.

Several booklets giving technical data on the characteristics of various receiving and transmitting tubes have become available subsequent to the notice which was published a short time ago. They cover the following tubes and may be obtained from the Radiotron Division, Radio-Victor Corporation of America, 233 Broadway, New York City.

UV-204A Triode. Oscillator and R-F Power Amplifier. Output-250 watts.

UV-211 Triode. Oscillator, Power Amplifier, Modulator. Output-75 watts.

UV-219 Diode. Maximum Peak Inverse Voltage-50,000 volts. Maximum Peak Plate Current-2.5 amperes.

UX-226 Triode. Directly-heated Amplifier For A-C Operation in Receivers.

UV-848 Triode. (Water Cooled) Modulator. Oscillator Input per Tube-8,600 watts.

UV-849 Triode. Oscillator, Power Amplifier, Modulator. Output-350 watts.

UV-851 Triode. Oscillator, Power Amplifier, Modulator. Output-1,000 watts.

UV-854 Triode. (Water Cooled) Oscillator, R-F Power Amplifier, Modulator. Output-10,000 watts.

UV-855 Diode. (Water Cooled) Maximum Peak Inverse Voltage-50,000 volts. Maximum Peak Plate Current-5. amperes.

UV-861 Tetrode. R-F Power Amplifier for High-Frequency Transmission. Output-500 watts.

Booklets describing the Western Electric 106-B, 1-kw; the 105-C, 5-kw; and the 107-A, 50-kw radio telephone broadcasting equipment may be obtained from the Graybar Electric Company, Graybar Building, New York City. Descriptive literature covering speech input equipment, for both station and portable use is available from the same source as are booklets describing the public-address and music-reproducer systems of the Western Electric Company.

MONTHLY LIST OF REFERENCES TO CURRENT RADIO LITERATURE

THIS is a monthly list of references prepared by the Bureau of Standards and is intended to cover the more important papers of interest to professional radio engineers which have recently appeared in periodicals, books, etc. The number at the left of each reference classifies the reference by subject, in accordance with the scheme presented in "A Decimal Classification of Radio Subjects—An Extension of the Dewey System," Bureau of Standards Circular No. 138, a copy of which may be obtained for 10 cents from the Superintendent of Documents, Government Printing Office, Washington, D. C. The various articles listed below are not obtainable from the Government. The various periodicals can be secured from their publishers and can be consulted at large public libraries.

R100. RADIO PRINCIPLES

- R113.8 Stchoukin, M.A. Observations sur la propagation des ondes electriques courts pendant l'eclipse solaire du 12 Nov. 1928. (Observations on the propagation of short electric waves during the solar eclipse of Nov. 12, 1928). *L'Onde Electrique*, 8, pp. 411-419; Sept., 1929.
(Records obtained at Leningrad of the transmission of RRP (Niini-Novgorod, wavelength = 15 meters) before, during and after the solar eclipse of Nov. 12, 1928 are reproduced and explained.)
- R115 Drake, F.H. and Wilmotte, R.M. On the daylight transmission characteristics of horizontally and vertically polarized waves from airplanes. *Proc. I. R. E.*, 17, pp. 2242-58; December, 1929.
(Transmission characteristics of horizontally and vertically polarized waves as transmitted from an airplane are compared. The experiments were carried on at distances up to 600 miles and a frequency of about 6000 kc was used. A method is described by which it is possible to deduce the transmission characteristics for flight at any altitude when those at a given altitude are known. Experiments with a very low ground antenna are described.)
- R115 Glas, E.T. On the effect of the ground on downcoming plane space waves. *Experimental Wireless & W. Engr.* London; 6, pp. 663-668; Dec., 1929.
(A discussion on the deforming action of the ground on downcoming space radiation is presented. Mathematical analysis shows that the ground itself may be responsible for certain peculiar polarization phenomena observed in short-wave work.)
- R131 Becker, J. A. Phenomena in oxide coated filaments. *Physical Review*, 34, pp. 1323-51; Nov. 15, 1929.
(A theory of the changes in activity in oxide coated filaments is proposed. It is shown to be probable that the high activity is due to absorbed metallic barium. Changes in emission produced by changes in plate potential and by currents sent into or drawn from the filament are ascribed to electrolysis of the oxide. The theory is tested by numerous experiments. An experimental technique is employed by which relative rates of evaporation of small amounts of positively and negatively charged materials can be determined with considerable precision.)
- R133 Pierret, E. Les ondes electriques ultra courtes. (Applications, production. Ultra short waves). *L'Onde Electrique*, 8, pp. 373-410; Sept., 1929.
(Numerous researches made recently into the production of short electromagnetic waves are briefly reviewed. Generator circuits using one or two triodes with positively charged plates are explained. Others, also employing one or two triodes but with negatively charged plates for producing electric oscillations of the Barkhausen type are described. Theories proposed to explain the Barkhausen oscillations are discussed (to be concluded).)

- R133 Kohl, K. Ungedampfte elektrische Ultrakurzwellen (Undamped ultra short electric waves). *Elektrische Nachrichten Technik*, 6, pp. 354-58; Sept., 1929.

(Part 1.—Results are given of a study of methods of production and causes of ultra-high frequency oscillations of the Barkhausen-Kurz type. By suitable grid and plate voltages oscillations down to 30-cm wavelengths are produced. The wavelength corresponds to the natural period of the oscillatory circuit in which grid-plate capacity varies with voltages employed, the dielectric constant varying with electron density. Part 2.—Using the spiral grid of a small vacuum tube for the oscillatory circuit 14-cm wavelengths are produced. With this source of radiation and a linear resonator for reception the reflection, refraction and permeability effects of lenses and disks of different materials are found analogous to optical effects.)

R200. RADIO MEASUREMENTS AND STANDARDIZATION

- R223 Johnstone, J.H.L. and Williams, J.W. The variation of dielectric constant with frequency. *Phys. Rev.*, 34, pp. 1483-90; Dec. 1, 1929.

(Measurements of dielectric constants were made of solutions of nitrobenzene and para-dichlorobenzene in mineral oil of high viscosity at three concentrations. A simple resonance circuit was used to measure the dielectric constants of the solutions. The high-frequency current was supplied by a piezo oscillator in each case. Three different piezo oscillators were used in the oscillating circuit so that by the use of the fundamentals and second harmonics, six frequencies were made suitable for measuring dielectric constants; viz; 1948, 3060, 3900, 4410, 6120, 8830 kc.)

- R240 Wilmotte, R.M. The comparison of the power factors of condensers. *Experimental Wireless & W. Engr.*, (London), 6, pp. 656-662; Dec., 1929.

(An experimental method for comparing at radio frequencies the power factor of a condenser with that of a standard condenser is described. Results obtained by the method in tests on two variable air condensers are given.)

- R261 von Ardenne, M. A sensitive valve voltmeter without "backing off." *Experimental Wireless & W. Engr.* (London), 6, pp. 669-75; Dec., 1929.

(A vacuum-tube voltmeter designed to give high sensitivity without any compensation of the steady plate current of the tube is described. The calibration curve of the meter is independent of frequency for frequencies above 50 cycles and the variation with battery voltage is small. The suitability of the instrument for measurements on high-frequency amplifiers is pointed out.

R300. RADIO APPARATUS AND EQUIPMENT

- R342.15Klev, P. and Shirling, D.W. Audio-frequency transformers. *Jour. A.I.E.E.* 48, pp. 907-911; Dec., 1929.

(A low-voltage cathode-ray oscillograph is used to determine the voltage ratio of audio transformers independent of other apparatus. Curves are given for several makes of transformers for a frequency range from 20 to 10,000-kc cycles and for different degrees of magnetic saturation.)

R500. APPLICATIONS OF RADIO

- R520 Furnival, E.H. Typical wireless apparatus used on British and European airways. *Proc. I. R. E.*, 17, pp. 2123-36; Dec., 1929.

(A description of the system in operation on the British airways.)

- R520 Walls, H. J. The civil airways and their radio facilities. *Proc. I. R. E.*, 17, pp. 2141-57; Dec., 1929.

(Description of radiotelephone and radiotelegraph equipment used in collection and broadcasting of weather information to aircraft is given. A directive radio transmitting system using crossed-coil antennas is employed to guide aircraft over established airways. Regulations that have been proposed for installation of radio equipment on aircraft are briefly given together with the more important frequencies allocated for aircraft work.)

- R520 Seymour, L.D. Radio for the air transport operator. *Proc. I. R. E.*, 17, pp. 2137-40; Dec., 1929.

(The aids of radio to air transport operators is discussed, with regard to low-frequency receiving equipment on the plane and with additional high-frequency transmitting equipment.)

- R520 Eisner, F. and Fassbender, H. Radio in aeronautics—its technical status and the organization for its application in Germany. *Proc. I. R. E.*, 17, pp. 2185-2229; Dec., 1929.

(A review of the present status of radio on aircraft in Germany. Apparatus used at present time is described and results of measurements on the fundamentals of radio in aeronautics. The subjects of low-frequency sets, sets for high and very high frequency navigation apparatus for aircraft using radio waves, and airship radio sets are discussed.)

- R525 Hyland, H.A. The constants of aircraft trailing antennas. *Proc. I. R. E.*, 17, pp. 2230-2241; Dec., 1929.

(Results of measurements of trailing wire antennas constants on several types of aircraft including the dirigible *Los Angeles* are given with a brief description of the method and apparatus used.)

- R526.1 Kear, F.G. and Jackson, W.E. Applying the radio range to the airways. *Proc. I. R. E.*, 17, pp. 2268-82; Dec., 1929.

(Methods of adjusting the space pattern of the aural type directive radio beacon system in order that the courses may align with the fixed airways. Interference was minimized by careful spacing of the radio range within the frequency band and by distinctive coding of each beacon. In selecting the proper coding for the beacons the physiological effects of various sound groups were made.)

- R526.1 Diamond, H. Applying the visual double-modulation type radio range to the airways. *Proc. I. R. E.*, 17, pp. 2158-84; Dec., 1929.

(This paper describes a number of circuit arrangements, the application of which makes possible the use of a single visual type radio range for serving two, three, or four courses radiating from a given airport at arbitrary angles with each other.)

- R529 Mirick, C.B. Effect of flight on hearing. *Proc. I. R. E.*, 17, pp. 2283-96; Dec., 1929.

(The unusual conditions imposed by flight on the sense of hearing are stated showing the need of audiometric study. After brief review of the theory of the audiometer, data are submitted on: (a) fatigue as indicated by measurements before and after flight; (b) fatigue as indicated by measurements taken during flight; (c) initial impairment coincident with flight; (d) group measurements of fliers and non-fliers as a test for permanent impairment. Results are discussed with particular view to their bearing on aircraft radio operation.)

R800. NON-RADIO SUBJECTS

- 621.313.23 Mirick, C.B. Temperature rating of wind-driven aircraft radio generators. *Proc. I. R. E.*, 17, pp. 2259-67; Dec., 1929.

(Measurements of temperature rise of generator under load are given for still air and in flight. Theory of heat emission is briefly reviewed, constants of emissivity are given from which rising and final temperatures of generators can be approximated. Conditions governing the rating of wind-driven aircraft radio generators are discussed.)

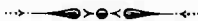

CONTRIBUTORS TO THIS ISSUE

Brown, Hugh Alexander: Received B. S. degree, University of Illinois, 1911; M. S. degree, University of Illinois, 1913; E. E., University of Illinois. General Electric Co. Test, 1912; operating engineering department, Illinois Traction System, 1913-1914; instructor in electrical engineering, University of Arkansas and Pennsylvania State College. At present assistant professor, electrical engineering, University of Illinois. Author of numerous technical papers. Associate member, Institute of Radio Engineers, 1916; Member, 1929.

Farnham, Paul O.: Born November 2, 1903 at Waterbury, Conn. Received B. S. degree, Lafayette College, 1926; M. S. degree, Harvard University, 1927. Inductive interference work, American Telephone and Telegraph Co., 1927-1928; development work on radio broadcast receivers, Radio Frequency Laboratories, Inc., 1928 to date. Non-member, Institute of Radio Engineers.

Harris, Sylvan: Born May 5, 1898 at Philadelphia, Penna. Received E. E. degree, University of Pennsylvania, 1922; engaged in power maintenance work, Midvale Steel Ordnance Co., Philadelphia, 1917-1918; Leeds and Northrup, 1918; technical editor, Lefax, 1922-1923; managing editor, *Radio News*, 1923-1925; director of research and design, Stewart-Warner Speedometer Corp.; Chicago, 1926-1927; laboratories of Brandes Products Corp., Newark, N. J., 1927 to date. Associate member, Institute of Radio Engineers, 1920; Member, 1926.

Jones, William J.: Born October 8, 1891 at Staten Island, N. Y. Graduated in chemistry, Pratt Institute, 1910. Assistant chemist, Bergenport Chemical Works of Standard Oil Company of New Jersey, 1910-1917; engineering department, Edison Lamp Works, General Electric Co. (quality control and factory inspections), 1917-1926; radio engineering department, Westinghouse Lamp Co. (quality control), 1926 to date. Non-member, Institute of Radio Engineers.

Krueger, Kurt: Born October 14, 1898 at Mallnitz, Germany. Studied at Technical High School of Berlin and at the University of Berlin and Wuerzburg; graduated Dr. Phil., Wuerzburg, 1922; assistant to Professor Zenneck, Technical High School of Munich, 1922-1926; since 1926 employed by German Experimental Institution for Air Traffic, department for radio and electrotechnics, Berlin-Adlershof. Non-member, Institute of Radio Engineers.

Landon, V. D.: Born May 2, 1901. Educated Detroit Central College. Employed in radio engineering department, Westinghouse Elec. and Mfg. Co., 1922-1929; in charge of radio-frequency development laboratory for several years; assistant chief engineer, Radio Frequency Laboratories, Inc., December, 1929 to date. Associate member, Institute of Radio Engineers, 1927; Member, 1929.

Llewellyn, F. B.: See PROCEEDINGS for January, 1930.

McNally, J. O.: Received B. S. degree, University of New Brunswick, 1924. Since 1924 with Western Electric Co. and Bell Telephone Laboratories, engaged in vacuum-tube development and in the study of distortion in vacuum-tube output. Associate member, Institute of Radio Engineers, 1926.

Morris, Lloyd P.: Received B. S. degree, University of Illinois, 1928. At present doing graduate work in electrical engineering at University of Illinois. Associate member, Institute of Radio Engineers, 1927.

Pidgeon, H. A.: Received B. S. degree, Ohio University, 1911; M. S. degree, 1912; Ph. D. degree, Cornell University, 1918. Instructor in physics, Ohio University, 1910-1912; instructor in physics, Cornell University, 1913-1918. Since 1918 with Western Electric Co. and Bell Telephone Laboratories. Engaged in thermionic studies and in the study of various problems connected with vacuum-tube development work. Member, American Physical Society; Member, Institute of Radio Engineers, 1929.

Plendl, Hans: Born December 6, 1900 at Munich, Germany. Studied at Technical High School of Munich, 1919-1923, becoming graduate engineer in 1923. Scientific work for Professor Zenneck at Physical Institute, Technical High School of Munich, 1923-1925, becoming graduate doctor-engineer in 1925. With Professor Meissner in research laboratory, Telefunken Company, Berlin, 1925-1927; at present with Professor Fassbender, department for radio and electrotechnics, German Experimental Institution for Air Traffic, Berlin-Adlershof. Non-member, Institute of Radio Engineers.

Thiessen, Arthur E.: Received B. S. degree in E. E., Johns Hopkins University, 1926. With Bell Telephone Laboratories working on investigation of magnetic alloys of iron and on development of amplifiers and other terminal equipment for high-speed submarine cables, 1926-1928; with engineering department, General Radio Co., December, 1928, to date. Associate member, Institute of Radio Engineers, 1929.

van der Pol, Balth.: Born January 27, 1889 at Utrecht, Holland. Received Doctor's degree, University of Utrecht, 1916. Research in radiotelegraphy and allied subjects, Cambridge, England, 1917. Conservator of Physical Research Laboratory, Teyler's Institute, Holland, 1919. Research Laboratory, Philip's Glowlamp Works, Ltd., Eindhoven, Holland, 1928. Member, Institute of Radio Engineers, 1920.

von Handel, Paul F.: Born January 30, 1901 at Bisenz, Austria. Studied at Technical High School, Munich, 1919-1923; became graduate engineer, 1923. Worked as leader of the Siemens Elektrowaerme G. m. b. H., Sornewitz, near Dresden, 1925-1926; experimental laboratory for development of sending apparatus of the Telefunkengesellschaft für drahtlose Telegraphie, Berlin. Since 1928 with the division for radiotelegraphy and electrotechnics under the direction of Prof. H. Fassbender, Deutsche Versuchsanstalt für Luftfahrt E. V., Berlin-Adlershof, Germany. Non-member, Institute of Radio Engineers.

Watanabe, Yasusi: Born 1897 at Kuji-machi, Ibarakiken, Japan. Graduated, department of electrical engineering of the Tokyo Imperial University, 1921; instructor, 1921-1922; assistant professor of electrical engineering, Tohoku Imperial University, Sendai, Japan, 1922-1929; received Doctor's degree, Tohoku Imperial University, 1926. Sent to Germany by the Ministry of Education for further study, 1927-1928; professor of electrical engineering, Tohoku Imperial University, 1929. Member, Institute of Radio Engineers, 1929.

***Furnival, J. M.:** Born at 1892 at Stoke-on-Trent, England. Educated Sutherland Institution; apprenticeship at Hantley, Causton, & Richmond, Ltd., and National Telephone Co. Posted as wireless officer to Royal Flying Corps; appointed to G. H. Q., R. A. F., in France, to take charge of the operation of radiotelephony in the British squadrons on the Western Front during the World War; joined staff of Marconi's Wireless Telegraph Co., Ltd., in 1919, and was promoted Chief of the Field and Aircraft Division in 1924, which position he still holds.

*Paper published in December, 1929, PROCEEDINGS.



SOUND REPRODUCTION

SINCE the inception of modern radio amplification the engineering laboratories of Thordarson have developed hundreds of transformers used in solving the problems of sound reproduction.

Standard units include those for coupling a microphone, a phonograph pickup or a radio tuner into any type of audio frequency amplifier.

Other units are available for coupling the output of an amplifier into transmission lines or directly into loud speakers.

Still other units allow coupling from any line into loud speakers or into additional amplifiers.

Your own work may be made easier and more profitable if you make use of Thordarson engineering service as applied to Thordarson transformers, chokes and amplifiers.

Tell us of your requirements and let us submit suggestions for an installation which will add to your good reputation.

THORDARSON

Transformer Specialists Since 1895

Microphone Transformers
Line to Tube, Tube to Line, Line to Line
Mixing Transformers Coupling Reactors Filter Chokes
Impedance Matching Transformers
Speaker Coupling Transformers
Complete Amplifiers

Thordarson Electric Manufacturing Company
Huron, Kingsbury and Larrabee Streets, Chicago, Ill., U. S. A.

When writing to advertisers mention of the PROCEEDINGS will be mutually helpful.

Volume Control INSURANCE!

Sorry to bother you! An insurance man is hardly popular these days. Of course you are fed up on insurance.

But our *Volume Control Insurance* is something entirely new in insurance. It gives you maximum protection, yet it doesn't cost you a cent! How?

Here's our story: If you check up with jobbers and dealers, and service men, you will find that the greatest source of service troubles, aside from the use and misuse of tubes, is faulty volume controls. Our *Volume Control Insurance* covers you on tone distortion, unsatisfactory volume control, and volume control replacements. And a *Volume Control Insurance* is virtually issued to you when you include in your radio assembly the

WIRE-WOUND VOLUME CONTROL CLAROSTAT



SWITCH TYPE

Yes, here it is in perfected form—the ideal volume control—a real *Volume Control Insurance*. We have specialized in variable resistors for years past. We developed the best compression type variable resistor and specialized in that type for several years. Then we developed a line of fixed resistors. For two years we have worked on a satisfactory wire-wound volume control, with one design after the other subjected to gruelling tests, and with no end of special winding equipment. And at last we have the answer.

The new WIRE-WOUND VOLUME CONTROL CLAROSTAT is compact, simple, silent, smooth, foolproof and long-lived. It is matched to your exact resistance requirements. The bakelite casing, with metal end plate, protects winding and contact member from dirt

and dust and tampering. The turns cannot slip or short circuit.

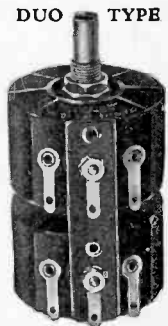

But best of all, it is matched to your needs. We have developed special winding equipment for variable spacing of turns, as well as tapered support strips. We can provide volume controls, rheostats or potentiometers which positively match any resistance curve you may desire, thereby providing true control of any circuit. Our machines permit of handling the finest resistance wire, so that our units can be made in resistance values up to 50,000 ohms. Here is a laboratory product, a precision instrument, an ideal device. But the installation of a battery of special and costly winding machines enables us to produce these devices in any quantity to meet your demands. And the price is right—for quality merchandise—with *Volume Control Insurance*.

AND DON'T OVERLOOK LINE VOLTAGE INSURANCE

in the form of the CLAROSTAT LINE BALLAST, the perfected and inexpensive method of regulating line voltage automatically, now employed in the better type socket-power radio sets. It costs little, but saves much. Your assembly is not complete without this 1930 feature.

Write for technical data regarding the wire-wound CLAROSTAT and the Line Ballast CLAROSTAT. If you are a radio manufacturer or designing engineer, send us your specifications and we shall gladly supply the necessary samples for examination and tests.

Clarostat Manufacturing Company, Inc.



289 North Sixth Street

::

Brooklyn, N.Y.

Specialists in Radio Aids

When writing to advertisers mention of the PROCEEDINGS will be mutually helpful.

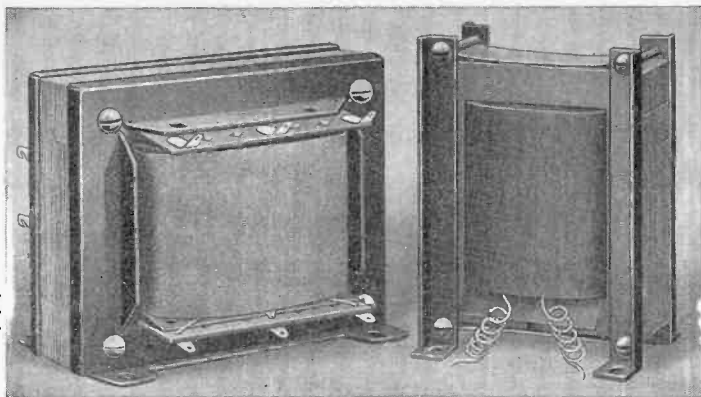

Jefferson Power Transformer and Choke for use with 245 power and 224 or 227 amplifier tubes.

Jefferson Standardization Solves Transformer Problems for ALL Set Manufacturers . . .

A Reliable Source of Supply

The Jefferson policy assures dependable delivery . . . even in peak periods. Besides this important and often vital matter of sure delivery, Jefferson service includes the assistance of a corps of trained electrical engineers who are ready, if need be, to go right into your own plant and assist your own engineers in the solution of your power and amplification problems.



NOW any receiving set manufacturer, no matter how small, may obtain Jefferson quality audio and power transformers and chokes. Through standardization, Jefferson can give all manufacturers the same high quality which was restricted heretofore to large producers of receiving sets.

Jefferson electrical units have proved their superior quality by many years' use in the sets of the largest and representative manufacturers. Jefferson engineers have cooperated with receiver manufacturers and aided them in the solution of their audio and power problems.

Jefferson progressiveness in the field of radio transformer development was demonstrated when the 245 power and 224 amplifier tubes were still in the experimental stage. Jefferson engineers anticipated the new electrical problems to be met and developed transformers, chokes and audios to work with these new tubes. And like all other Jefferson transformer developments, they won the endorsement of quality set manufacturers.

Whether you are a large or small producer, insure the success of your set, from an electrical standpoint, by using Jefferson quality standardized units. Complete information and prices on request.

Jefferson Electric Company
1591 S. Laffin St., Chicago, Ill.

JEFFERSON

AUDIO and POWER TRANSFORMERS and CHOKES

When writing to advertisers mention of the PROCEEDINGS will be mutually helpful.

OUR OIL PROCESS CONDENSERS ARE EQUALLY SUITABLE FOR POWER OR RADIO APPLICATION. LET US AID YOU WITH YOUR SPECIFICATIONS.



CONDENSER CORPORATION OF AMERICA
259-271 CORNELISON AVE. JERSEY CITY, N. J.

The Ekko Co.
Daily News Bldg.
Chicago, Ill.

W. C. Laing
Southern Ohio Bank Bldg.
Cincinnati, Ohio

When writing to advertisers mention of the PROCEEDINGS will be mutually helpful.

MILLIONS of Bradleyunits

In Radio Sets TODAY

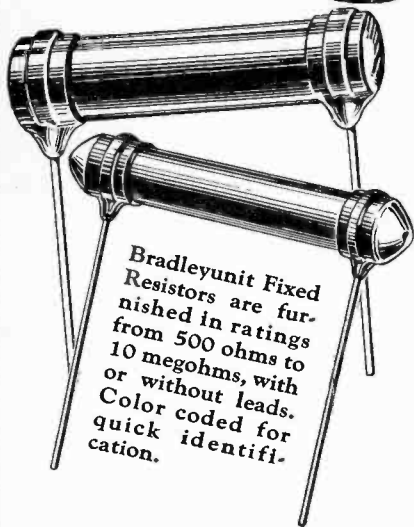

Bradleyunit Fixed Resistors are furnished in ratings from 500 ohms to 10 megohms, with or without leads. Color coded for quick identification.

MANUFACTURERS of leading radio receivers are using millions of Bradleyunits for grid leaks and plate coupling resistors, because Bradleyunits are absolutely noiseless in performance. In radio sets, Bradleyunits are specified because their accurate rating is unaffected by temperature, moisture and age. In production, Bradleyunits are preferred because they are not fragile. There are no breakage losses. You too can benefit by standardizing on Bradleyunit Solid Molded Resistors.

Write for complete information and prices, today!

The huge Allen-Bradley plant at Milwaukee provides unlimited research and production facilities.



ALLEN-BRADLEY CO., 282 Greenfield Ave., Milwaukee, Wis.

Allen-Bradley

PERFECT RADIO  RESISTORS.

When writing to advertisers mention of the PROCEEDINGS will be mutually helpful.



**Nearly
a hundred miles
of DURHAM
METALLIZED FILAMENT**

used during peak months in 1929 in American Radio. The monthly volume of these units now employed by America's most important manufacturers of radio receivers, power amplifiers and allied products if laid end to end would nearly stretch from New York to Philadelphia. This tremendous volume and this widespread preference by competent radio engineers is conclusive proof that *the Durham metallized principle MUST be right!*

Engineering data and samples for testing gladly sent upon request. Please state rating in which you are interested.

DURHAM
METALLIZED
RESISTORS & POWEROHMS

International Resistance Co., 2006 Chestnut St., Philadelphia

When writing to advertisers mention of the PROCEEDINGS will be mutually helpful.

Continental Resistors

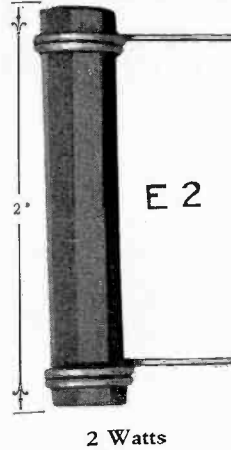
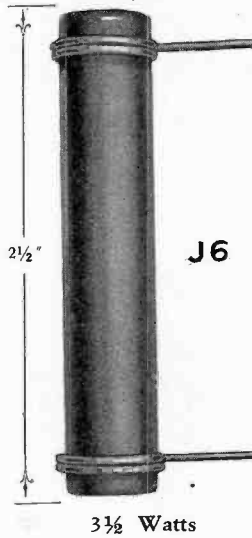
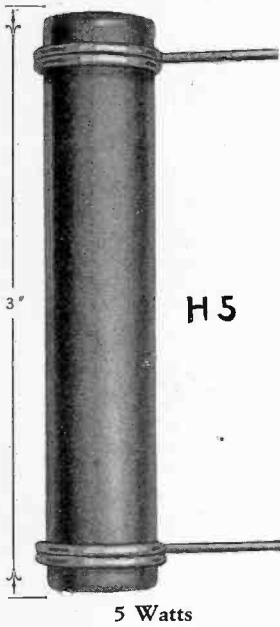

CHARACTERISTICS:

NOISELESS
RESISTANCE CONSTANT
SMALL TEMPERATURE COEFFICIENT
RUGGED
FIRMLY SOLDERED TERMINALS
DEPENDABLE
COLOR CODED

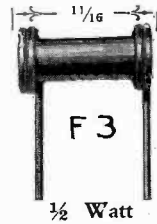
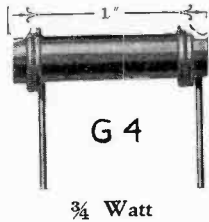
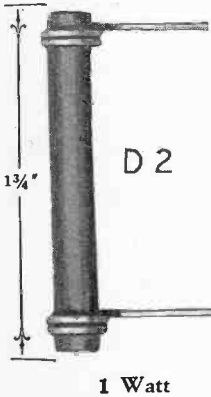

Write for Information and Prices

CONTINENTAL CARBON INC.
WEST PARK, CLEVELAND, OHIO

When writing to advertisers mention of the PROCEEDINGS will be mutually helpful.

Flawless TONE

results from these technical features



PACENT Super Phonovox

List Price \$15.00

Slightly higher west of the Rockies

THE Super Phonovox has extreme sensitivity thru the use of *English 36 per cent Cobalt Magnets*. It is free from troublesome rubber bearings and the balanced tone arm insures correct needle pressure. Now equipped with new combination switch and volume control and adapter for screen grid tubes at no extra cost. Two new low impedance models available.

PACENT ELECTRIC CO., INC., 91 Seventh Ave., N. Y.

Pioneers in Radio and Electric Reproduction for over 20 years

*Manufacturing Licensee for Great Britain and Ireland: Igranic Electric Co., Ltd., Bedford, Eng.
Licensee for Canada: White Radio Limited, Hamilton, Ont.*

When writing to advertisers mention of the PROCEEDINGS will be mutually helpful.

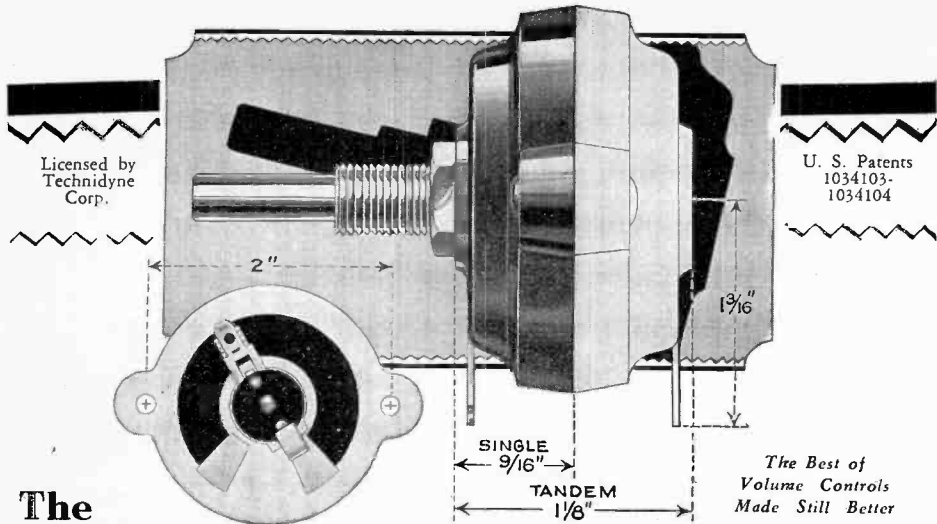

The New ELECTRAD Model "B" Super-TONATROL Superior DUAL-UNIT Volume Control

THE New ELECTRAD Model "B" Super-TONATROL solves volume control problems for manufacturers. It has all of the features of the original Super-TONATROL in more compact form and is obtainable in single or double units, operating on one shaft.

The unique method of insulating the shaft from the contact arm (*shown above*) provides complete circuit isolation between units.

The resistance element is *permanently* fused to the surface of a vitreous enameled steel plate and dissipates a full 3-watts. A pure silver floating contact provides amazingly smooth stepless variation, with absolute freedom from noise.

Completely enclosed Bakelite case for either panel or baseboard mounting. Practically immune to changes of temperature and humidity.

Single or tandem units can be made with all usual resistance ratings with uniform or tapered curve.

*A Prominent
Radio Engineer's*
Endorsement
of the
Super-
TONATROL*

"—it gives me great pleasure to write you this unsolicited testimonial, and to congratulate you upon the production of the Super-TONATROL, by far the smoothest, longest lived and otherwise most perfect commercial volume control it has been my pleasure to encounter.

* Name on request.

Write Dept. PE2 for Data and Blueprint

175 Varick St., New York, N.Y.
ELECTRAD
INC.

ELECTRAD manufactures a complete line of resistances and voltage controls for all radio and power supply requirements, including Television.

When writing to advertisers mention of the PROCEEDINGS will be mutually helpful.



THE TELEPHONE BRINGS THE ADVANTAGES THAT COMFORT AND CONVENIENCE GIVE TO LIVING

This is the telephone's mission

An Advertisement of the American Telephone and Telegraph Company

IN THIS COUNTRY, a new type of civilization is being reared—a civilization of better opportunity for the average man, comfort and convenience, business enterprise and higher standards that enrich the daily life of all the people.

To build for this new age, the Bell System in 1929 expended more than 550 million dollars. These millions were used to add new plant and further improve service. Hundreds of new buildings, millions of miles of wire, chiefly in cable, eight hundred thousand new telephones—these were some of the items in the year's

program of construction. At the same time, better records were made for speed and accuracy in service. This American development of instantaneous communication, of fast, far-reaching speech, belongs not to the few, but to the many.

It is the aim of the Bell System to permit each personality to express itself without regard to distance.

This is part of the telephone ideal that anyone, anywhere, shall be able to talk quickly and at reasonable cost with anyone, anywhere else. There is no standing still in the Bell System.



When writing to advertisers mention of the PROCEEDINGS will be mutually helpful.

From now on —



THE set manufacturer to stay in business will be the one who plays safe by refusing to take the risk of using parts of uncertain performance or dependability. When competition whets its blade and selling costs go up, it becomes increasingly important to hold assembly costs as low as possible.

Take mica condensers for example. Unless capacity ratings are accurate, a terrible burden is thrown on the inspection department and "rejects" pile up until

they exceed the stock of usable condensers on hand. It doesn't require much imagination to picture what happens to production costs under such circumstances.

When you order Sangamo Condensers you need not make over-allowances for "rejects." The reliability of Sangamo ratings is attested to by a number of nationally known radio manufacturers.

And Sangamo is equally reliable as a source of supply.

SANGAMO High Voltage Condensers

Tested at 5000 volts d. c. and 3500 a. c. and built to Sangamo standards, known throughout the radio world, amateurs, commercial men and manufacturers have learned to depend on Sangamo High Voltage Condensers. Accurately rated and adequately tested—these condensers offer the maximum protection in high voltage, high frequency circuits.

SANGAMO ELECTRIC CO.

SPRINGFIELD, ILLINOIS, U. S. A.

Manufacturers of Precision Electrical Apparatus for 30 Years





TONE!

Curve of Type "A" Sangamo Straight Audio Transformer showing uniformity of amplification at all audible frequencies.

What happens out on the "skirmish line"?

When your set goes up to the front line to meet prospective buyers—does it have an outstanding strategic advantage over competition or is it just a "long, hard pull" for your dealers?

Radio receivers must satisfy two different types of buyers. One is the amateurs who not only know the difference between good and indifferent performance but who understand what causes the difference. They are also an important recommending factor in the final purchase of all receivers.

The other type is not technical-minded but regards a radio receiver simply as a musical instrument.

To both classes *tone quality* is all-important. When a dealer tells an amateur that your set has Sangamo Transformers in the "audio end" he *knows* that the tone will be right. He also has more confidence in your set all the way through because he knows that no manufacturer who uses Sangamo Transformers will jeopardize their performance by using inferior parts elsewhere in the set. When equipped with Sangamo Transformers, your set need only be demonstrated to sell those who judge by ear alone.

Sangamo "A" Line Transformers are built for the custom set maker or manufacturer who wants a "tone" advantage over competition. The cost is slightly higher but is more than offset by the increased salability of the receiver.

"A" Line Transformers

- Type A straight audio amplification, list price, \$10.00
- Type B Push-pull Input Transformer for all tubes, list price, 12.00
- Type C-171 Push-pull Output, for 171 or 250 type power tubes with cone speaker list price, 12.00
- Type D-210, same as C except for 210 and 112 power tubes list price, 12.00
- Type H-171, Push-pull Output for 171 or 250 power tubes for Dynamic Speaker list price, 12.00
- Type G-210, same as type H except for 210 and 112 tubes, list price, 12.00
- Type F Plate Impedance for use as a choke to prevent oscillation and for impedance coupled amplifiers, list price, 5.00

Unusual facilities for furnishing transformers with or without cases ready for mounting and quick assembly with the receiver. Prices on application.



SEND THIS TO YOUR LETTERHEAD AND MAIL
 SANGAMO ELECTRIC CO.
 Springfield, Illinois, U. S. A., Dept. R9

(For manufacturers) I am interested in engineering data regarding your transformers and condensers.

(For set builders) Please send circulars describing your apparatus and latest audio hook-ups. I enclose 10c to cover cost of mailing.

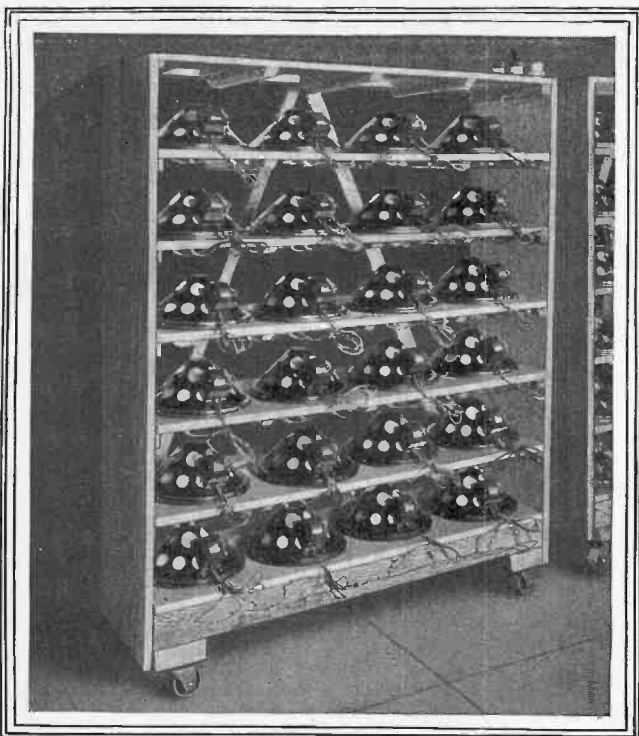

OPERADIO

A REAL SHAKE-DOWN!

AFTER the Operadio electrodynamic is assembled, it goes through all the stereotyped tests: visual inspection, oscillator, and comparator, *but it also goes through one test which we believe is unique in speaker manufacturing, and a test which perhaps more than any single factor has been responsible for the extremely low returns on our speakers. This test is really a "shake down" which almost invariably will show up any mechanical defects in the manufacture.*

The fields are energized under a 50% overload, and 60 cycle A. C. from the power service is supplied to one-half of the input transformer. Every speaker is left on this test for 15 minutes prior to the final oscillator and tone test.

Another evidence of Operadio's effort to do the job right!

OPERADIO MFG. CO.
ST. CHARLES, ILLINOIS

When writing to advertisers mention of the PROCEEDINGS will be mutually helpful.



A FAMILY OF HEAVY DUTY

ISOLANTITE now offers a new series of antenna insulators for the suspension of structures of the heavier types. These insulators are designed not only to support greater loads but provide a longer insulating path between fittings to give greater protection against electrical leakage and flash-over in the high voltage network. The insulators listed here-with are given individual load tests before shipment, a feature of added interest to those demanding the utmost in mechanical reliability.

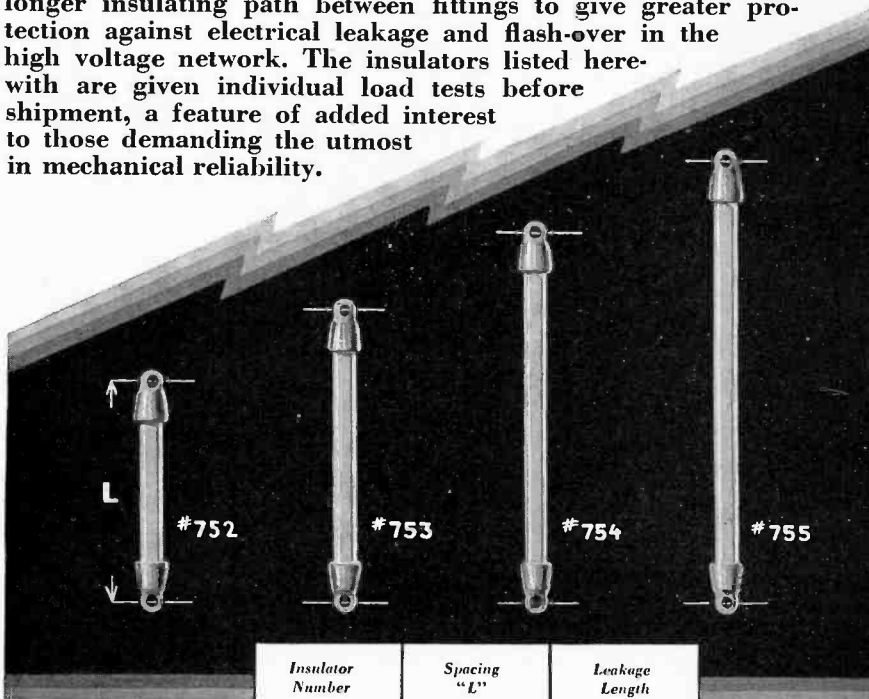

Insulator Number	Spacing "L"	Leakage Length
No. 752	12 inches	8 inches
No. 753	16 inches	12 inches
No. 754	20 inches	16 inches
No. 755	24 inches	20 inches

Ultimate Strength 2,000 Pounds

Isolantite Company

SALES OFFICES -----
 551 FIFTH AVE., NEW YORK CITY

When writing to advertisers mention of the PROCEEDINGS will be mutually helpful.

ANTENNA INSULATORS --

by Isolantite

Full technical details and quotations will be made available to all radio engineers, upon request

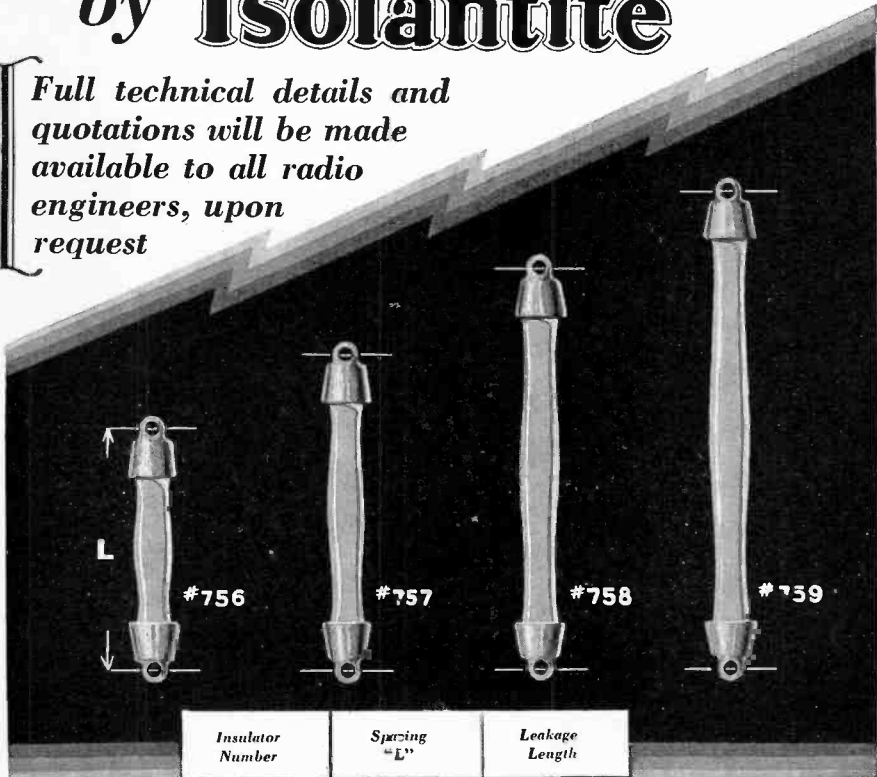

Insulator Number	Spacing "L"	Leakage Length
No. 756	13 inches	8 inches
No. 757	17 inches	12 inches
No. 758	21 inches	16 inches
No. 759	25 inches	20 inches

Ultimate Strength 4,000 Pounds

of America, Inc.

-----FACTORY
BELLEVILLE, N. J.

When writing to advertisers mention of the PROCEEDINGS will be mutually helpful.

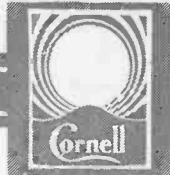
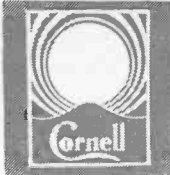

RADIO FREQUENCY Multiple By-Pass Assembly

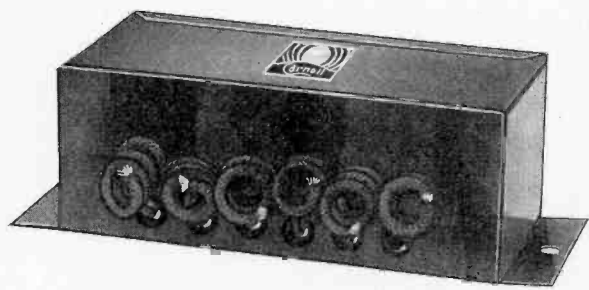

We show here a Cornell Assembly that has been designed particularly for radio frequency circuits where each stage of radio frequency is to be independently isolated. It has been designed with the idea of economy, using one housing for the entire block of by-pass condensers, and also so that the larger and more economical condenser can be used.

Send us your specifications or blueprints. We shall be glad to quote on any size can or by-pass combination you desire.

Cornell

UNIFORMLY HIGH INSULATION RESISTANCE
PAPER DIELECTRIC CONDENSERS
(ALL TYPES)

Cornell is equipped to give you what you want when you want it at prices within the range of commercial set manufacturing. Cornell quality and service will meet your most exacting requirements.

Write for a Sample "Cub" Condenser and Catalog of Complete Line of Cornell Products.

Cornell Electric Mfg. Co., Inc.
LONG ISLAND CITY, NEW YORK



When writing to advertisers mention of the PROCEEDINGS will be mutually helpful.



HIGH-QUALITY, DEPENDABLE TUBES FOR TALKING PICTURES AND TELEVISION

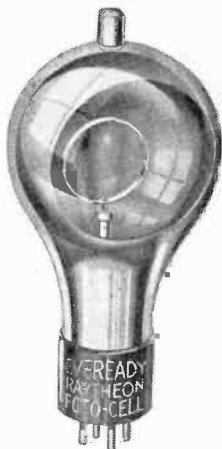

EVEREADY Raytheon Television Tubes are the result of our extensive research and experience in this new science. Their construction is along the same advanced lines which give all Eveready Raytheon Tubes their well-known superior performance.

The Eveready Raytheon Foto-Cell is a long-life, sensitive, quick-response transmitting tube for talking pictures. Used also in television. It is made in several types. Foto-Cells to special specifications will be made at reasonable prices.

The Eveready Raytheon Kino-Lamp for television reception is the first tube developed commercially which will work with all systems. Uniform glow over the entire plate, perfect reproductive qualities without the need of mirrors or ground glass, tested performance . . . are features which make this tube outstanding.

Correspondence is invited from every one interested in television.

NATIONAL CARBON COMPANY, INC.

General Offices: New York, N. Y.

Branches: Chicago Kansas City New York San Francisco

Unit of Union Carbide  and Carbon Corporation



When writing to advertisers mention of the PROCEEDINGS will be mutually helpful.



GILBY FILAMENT WIRE AND SELVAGE MESH *for BETTER TUBES!*

SELVAGE MESH a comparatively late development has taken the field by storm. The solid even edges simplify welding and this screen material in which the mesh is interlocked is rigid and rugged beyond belief. It may be supplied accurately within .005 plus or minus as specified. Its use will cut production shrinkage and lend a more finished appearance to your product. One customer says "So far as we are concerned this Gilby Selvage Mesh represents the difference between producing 224's and not producing them." This Selvage Mesh has proven itself so valuable that it is being widely imitated. In fairness to all concerned we give notice that our rights will be vigorously defended. Patent applications fully cover both the material itself and the tube of which it is a part.

FILAMENT WIRE—A tube is no better than its filament. There is no filament better than Gilby. Gilby Filament Wire has long been recognized as the Superior Product. Its uniformity, accuracy and long life is readily testified to by tube manufacturers.

We would appreciate inquiries and an opportunity to co-operate with your staff. Samples of Filament Wire and Selvage Mesh on request. Resistance and Ballast Wires too!

GILBY WIRE COMPANY
Wilbur B. Driver, President
NEWARK, NEW JERSEY



When writing to advertisers mention of the PROCEEDINGS will be mutually helpful.

The Institute of Radio Engineers Incorporated

33 West 39th Street, New York, N. Y.

APPLICATION FOR ASSOCIATE MEMBERSHIP

(Application forms for other grades of membership are obtainable from the Institute)

To the Board of Direction
Gentlemen:

I hereby make application for Associate membership in the Institute.

I certify that the statements made in the record of my training and professional experience are correct, and agree if elected, that I will be governed by the constitution of the Institute as long as I continue a member. I furthermore agree to promote the objects of the Institute so far as shall be in my power, and if my membership shall be discontinued will return my membership badge.

Yours respectfully,

.....
(Sign with pen)

.....
(Address for mail)

.....
(Date)

.....
(City and State)

References:

(Signature of references not required here)

Mr. Mr.

Address Address

Mr. Mr.

Address Address

Mr.

Address

The following extracts from the Constitution govern applications for admission to the Institute in the Associate grade:

ARTICLE II—MEMBERSHIP

Sec. 1: The membership of the Institute shall consist of: * * * (d) Associates, who shall be entitled to all the rights and privileges of the Institute except the right to hold the office of President, Vice-president and Editor. * * *

Sec. 5: An Associate shall be not less than twenty-one years of age and shall be: (a) A radio engineer by profession; (b) A teacher of radio subjects; (c) A person who is interested in and connected with the study or application of radio science or the radio arts.

ARTICLE III—ADMISSION

Sec. 2: * * * Applicants shall give references to members of the Institute as follows: * * * for the grade of Associate, to five Fellows, Members, or Associates; * * * Each application for admission * * * shall embody a concise statement, with dates, of the candidate's training and experience.

The requirements of the foregoing paragraph may be waived in whole or in part where the application is for Associate grade. An applicant who is so situated as not to be personally known to the required number of members may supply the names of non-members who are personally familiar with his radio interest.

CORWICO

NEW

SUPER
Braidite
HOOK-UP
WIRE

THEY ALL LIKE IT!

The advantages of Corwico Super-Braidite are so outstanding as to make an instant appeal to everyone interested in the manufacture of radio sets.

The Engineer Likes Super-Braidite

Because of the increased voltage breakdown and the possibility of controlling this voltage breakdown between practical limits.

The Production Manager Likes Super-Braidite

Because of its ease in handling. Super-Braidite is readily stripped back by our model "A" Stripper or with any automatic Stripper, thus speeding up production and cutting costs.

The Sales Manager Likes Super-Braidite

Because Super-Braidite adds to the mechanical appearance of the set. The neat appearing, glossy insulation is flameproof and does not bunch up nor fray when pushed back. Soldered joints are neat and clean.

The Purchasing Agent Likes Super-Braidite

Because he can pass on to the production department a superior product without increased cost.

Corwico Super-Braidite is made with both solid and stranded core in 15 different color combinations.

With Corwico Super-Braidite we furnish our Model "A" Stripping Machines for use in your plant. Write for a sample of Super-Braidite and full particulars.

More Than a Wire—A Hook-Up Service.

CORNISH WIRE COMPANY Inc.

30 CHURCH ST., NEW YORK CITY

When writing to advertisers mention of the PROCEEDINGS will be mutually helpful.

BACK OF PROGRESS



RADIO has made phenomenal progress. But its progress would not have been so rapid or so great were it not for the radio engineer—and the manufacturers who have been able to keep abreast of his inventive genius.

SCOVILL was pioneer in the making of radio condensers and SCOVILL is proud that it is one of those manufacturers who have kept step with progress.

Back of the radio engineer and back of every radio set is the SCOVILL emblem of quality and service as exemplified in SCOVILL radio condensers. SCOVILL has served, serves and will continue to serve those leaders in the field who insist on the best.

SCOVILL

Established 1802

MANUFACTURING COMPANY

· WATERBURY · CONNECTICUT ·

NEW YORK
LOS ANGELES
PROVIDENCE
ATLANTA
CLEVELAND
SAN FRANCISCO



PHILADELPHIA
CINCINNATI
BOSTON
DETROIT
CHICAGO

In Europe—THE HAGUE, HOLLAND

When writing to advertisers mention of the PROCEEDINGS will be mutually helpful.

All Worthy of The Name

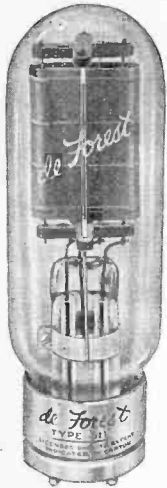

Audion 511

DeForest

REG. U. S. PAT. OFF.

The De Forest reputation for engineering skill and painstaking precision has been zealously guarded in the production of all De Forest receiving and transmitting Audions. The De Forest Engineering staff is continually bringing out new developments which will be announced from time to time in this publication.

The new D. C. Screen Grid Audion for Portable Sets



Audion 422A

Transmitting Audions

- 510**—15 Watt Oscillator
- *503A**—50 Watt Oscillator and R. F. Power Amplifier
- *511**—50 Watt Oscillator, R. F. Amplifier, Modulator or R. F. Power Amplifier
- *545**—50 Watt A. F. Amplifier and Modulator
- 552**—75 watt Oscillator and R. F. Amplifier
- 501A**—250 watt Oscillator, Modulator or R. F. Power Amplifier
- 500**—500 watt Special Oscillator
- 520B**—5000 watt Oscillator and R. F. Power Amplifier—water cooled
- 565**—7½ watt Screen Grid R. F. Amplifier
- 560**—75 watt Screen Grid R. F. Amplifier
- 561**—500 watt Screen Grid R. F. Amplifier
- *566**—A half-wave hot cathode, mercury vapor rectifier. Medium Current.
- 572**—A half-wave hot cathode, mercury vapor rectifier. Heavy Current.
- 601**—Vis-ion Neon Lamp.
- 602**—Photo Electric Cell.

422—Long life, oxide-coated filament which insures ample emission. Interchangeable with standard—22 type tubes but with a higher actual gain per stage because of lower plate resistance and high mutual conductance. Non-microphonic because of special design of filament and rigidly supported elements.

***422A**—Valuable for portable installations. Filament rating .06 amp. at 3.3 volts. Operating characteristics and life same as 422.

***499**—Non-microphonic long-life—99 type tube. Valuable for portable work. Sturdy and uniform. Containing the special oxide-coated filament standard with all De Forest receiving Audions.

***503A**—An improved "50 watter" interchangeable with standard—03A types. Especially valuable as a medium power, self-excited oscillator or radio frequency power amplifier.

***511**—Audion 511 is similar in construction to 503-A but also suitable as an audio-frequency amplifier as well as an oscillator and radio frequency power amplifier. Interchangeable with standard—11 types.

***545**—Designed especially as a modulator or audio-frequency power amplifier. Interchangeable with standard—45 type Transmitting tubes.

***566**—A high grade hot-cathode mercury vapor rectifier. Especially designed to prevent breakdown between anode and filament. Filament rating 2.50 volts at 5 amps. Max. inverse peak, 7500 volts.

For further information consult your local dealer or address—

De Forest Radio Co.
Passaic New Jersey

Receiving Audions

- 401A**—Detector-Amplifier
- 410**—Power Amplifier
- 412A**—Detector-Amplifier, Power Amplifier.
- *422**—Standard D. C. Screen Grid Amplifier.
- *422A**—A 60 m. a. D. C. Screen Grid Det.-Amp.
- 424**—A. C. Screen Grid Amplifier.
- 426**—Amplifier (A. C. Fil)
- 427**—Detector-Amplifier (A. C. Heater Type)
- 440**—High Mu Audion
- 445**—A. C. Power Amplifier
- 471A**—Power Amplifier, Last Audio Stage
- 471B**—Power Amplifier, Last Audio Stage
- 480**—Full-Wave Rectifier (125 M. A.)
- 481**—Half-Wave Rectifier (110 M. A.)
- 450**—Power Amplifier
- *499**—60 m. a. General Purpose

When writing to advertisers mention of the PROCEEDINGS will be mutually helpful.



Faradon

ELECTROSTATIC
CONDENSERS

for All Purposes



*The Accepted Standard
for Exacting Service as well as
General Application on
Land and Sea and
in the Air*

WIRELESS SPECIALTY
APPARATUS COMPANY

Est. 1907

Jamaica Plain

Boston

When writing to advertisers mention of the PROCEEDINGS will be mutually helpful.

SM

S-M Transformers Still the Peers of Them All

S-M's audio transformers—models announced nearly two years ago—still lead the field! Nothing has been developed since to equal the unique Clough system: a design providing a better low-frequency characteristic with higher amplification than any other transformer on the market regardless of price.

The S-M 255, first stage audio transformer, is designed for use between any standard detector (or magnetic record pickup) and first-stage amplifier tube, to provide a rising curve between 65 and 300 cycles, the same amplification at 65 as at 1,000 cycles, and a flat curve up to 5,000. Effective transformation ratio 4.2 to 1. Price \$3.60. (All prices net.)

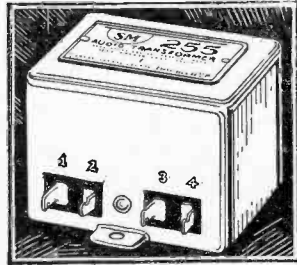

The S-M 256, second stage audio transformer, is intended for use between a standard first and second-stage amplifier. Effective transformation ratio 3.5 to 1. An audio amplifier using one 255 and one 256 transformer will give the same amplification at 65 as at 1,000 cycles, and a flat curve on up to 5,000 cycles or more. Price \$3.60.

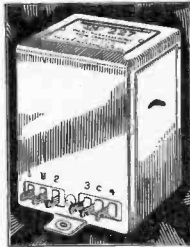

S-M 227

The S-M 257 is the ideal push-pull input transformer, designed to operate between one standard amplifier tube and two power amplifier tubes. It is especially recommended for use in a second audio stage. Its effective transformation ratio is 1.8 to 1, and its frequency characteristic is flat from 45 to 5,000 cycles. Price \$4.20.

Two Transformers for Dual-push-pull

The S.M. 227 push-pull interstage transformer (built on the Clough principle) is admirably designed to couple two standard voltage amplifier tubes to two or more voltage amplifier or output tubes. Its effective transformation ratio is 1.8 to 1. Its frequency characteristic—flat from 40 to 8,000 cycles. This transformer (illustrated above) is recommended for use with the 257 push-pull input transformer. Housed in the same type mounting case as the 255, 256, etc., but 3½ inches high. Price \$4.80.

The 233U output transformer, while extremely flexible, has a flat curve (to within 1.7 DB) from 30 to 10,000 cycles. Three windings, with twelve lugs, enable it to match almost any impedances. As an output transformer it will work out of '71, '45 or '50 tubes, singly or in push-pull. It is suitable for use with twenty-two different impedances of from 9 to 200 ohms, to feed directly into the voice coils of 1, 2, 3, 4, or more dynamic speakers. Price \$9.00.

By reading the **RADIOBUILDER** you can keep yourself informed in advance of what's going on in the S-M laboratories. Detailed descriptions of receivers, parts, and other developments are published there **FIRST**. Write at once for a sample copy.

If you build professionally, you should enquire about the Authorized S-M Service Station franchise. Three thousand custom builders have profited immensely through its benefits.

SILVER-MARSHALL, Inc. 6411 WEST 65TH STREET
CHICAGO, U. S. A.

When writing to advertisers mention of the **PROCEEDINGS** will be mutually helpful.



PREPAREDNESS PAYS

IT is safe to say that during the past year, more tempers were ruined, more headaches were caused and more money was lost because of delayed deliveries than from any other one factor which causes the hair of purchasing executives and production managers to grow thin and gray prematurely.

To meet the peak requirements of radio receiver manufacturers for quality condensers and resistors, the Aerovox plant has been increased to a total of 62,000 square feet, with every facility to produce, at short notice, any reasonable quantity

of condensers and resistors. To be assured of an unfailing supply of these units during the peak of the manufacturing season, it is important that tentative production schedules be arranged for, well in advance of actual requirements.

Quality Condensers and Resistors

IN the Aerovox Wireless Corporation, radio manufacturers will find a dependable source for quality condensers and resistors. Aerovox paper condensers are accurate, ruggedly made, have a high safety factor and are non-inductively wound, using 100% pure linen paper as dielectric material. They are thoroughly impregnated and protected against moisture.

Aerovox mica condensers are the acknowledged standard mica condensers in the industry.

A complete line of resistors for every requirement includes Pyrohm vitreous enamelled resistors in fixed and tapped combinations, Lavite non-inductive resistors, Metalohm grid leaks, wire-wound grid suppressors and center-tapped resistors in all standard and special values.

A COMPLETE CATALOG containing detailed specifications of all Aerovox units, including insulating specifications of condensers, current-carrying capacities of resistors and all physical dimensions, electrical characteristics and list prices of condensers and resistors will be sent gladly on request.

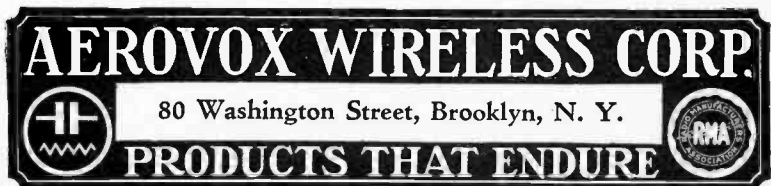

When writing to advertisers mention of the PROCEEDINGS will be mutually helpful.



*Programs in
7 seconds by
your watch.*

BUYERS WANT THIS KIND OF ACTION

by GEORGE LEWIS

Vice-President, Arcturus Radio Tube Company

Good performance is required to sell radio sets these days. Buyers are critical. They do more "shopping." The efficient set is the set that makes a lasting "first impression."

That's where Arcturus Radio Tubes can be a big help. They act quick — bringing in programs in 7 seconds *by the watch*. The demonstration gets away to a good start. Another important point about Arcturus Tubes is their exclusive construction which minimizes hum and inherent tube noises. And they hold the world's record for long life.

These are three good reasons why Arcturus Tubes are demanded by prominent set engineers and are standard equipment in many leading sets. It's a fact that the unique design and construction of Arcturus Tubes insure the best possible set performance under all conditions.

ARCTURUS RADIO TUBE COMPANY, NEWARK, N. J.

ARCTURUS

LONG LIFE

RADIO TUBES

When writing to advertisers mention of the PROCEEDINGS will be mutually helpful.

ROLLER-SMITH

Announces A New Issue of
BULLETIN NO. K-210

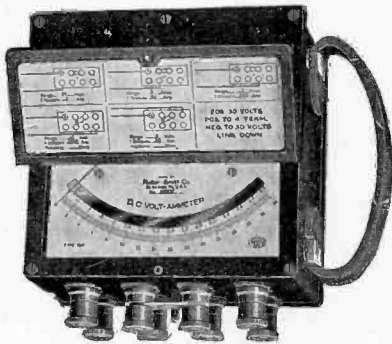

Type ISD
VOLT-AMMETER

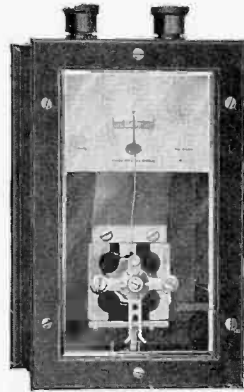

Type LGD
GALVANOMETER

This new Bulletin covers the entire line of Roller-Smith portable, direct current ammeters, milliammeters, voltmeters, millivoltmeters, galvanometers, circuit testers, shunts, multipliers, etc. Send for your copy of new Bulletin No. K-210.

*"Over thirty-five years' instrument experience is back of
Roller-Smith."*

ROLLER-SMITH COMPANY

Electrical Measuring and Protective Apparatus

Main Office:
2134 Woolworth Bldg.
NEW YORK



Works:
Bethlehem,
Pennsylvania

Offices in principal cities in U. S. A. and Canada
Representatives in Australia, Cuba, Japan and Philippine Islands

When writing to advertisers mention of the PROCEEDINGS will be mutually helpful.

U. S. ARMY and NAVY RADIO SURPLUS

Ammeter, Westinghouse, type C.A., either 0-1, 2 or 3 amps., zero adjustment, flush mounting..... 5.00
 Ampere hour meter, Sangamo, battery charge and discharge, type MS, 0-500. 10.00
 Milliammeter, Westinghouse, type C.A. 0-500, zero adjustment, flush mounting 5.00
 Voltmeter, Westinghouse, type C.A. 0-25, zero adjustment, flush mounting..... 5.00

Voltmeter, Westinghouse, A.C. 8" diameter with external resistance 0-175 volts, 60 cycle power house type..... 12.50
 Motor generator, Crocker Wheeler, 11W D.C. 220 A.C., 500 watt, 500 cycle. Ball bearing..... 50.00
 Complete line 500 cycle motor generators 1/4 to 5 K.W..... Prices on request.
 Transformers, Simon, 220 to 11500 closed core, 1/2 K.W., 500 cycle, "parake" secondary..... 5.00
 Condensers, Dubilier, mica, working volts 12,000, capacity .0004..... 10.00
 Condensers, Dubilier, mica, 40,000 volt, .0012-.001-.0008 or .003 mfd..... 30.00
 Condensers, Dubilier, mica, working volts 3,600, capacity .32..... 10.00
 Condensers, Wireless Specialty, copper glass leyden jar, 10,000 working voltage .002 mfd..... 2.00
 Condensers, Dubilier, mica, transmitting, 8500 working voltage .004 mfd..... 10.00
 Condensers, Dubilier, mica, transmitting, 12,500 working voltage .004 mfd. 15 & Western Electric Radiophone transmitter unit 326 W..... 20.00
 Headphone, Radio School, leather headband, 75 ohm..... 1.50
 Receivers, Navy, C.N. 24, 1000-10,000 meters..... 1.50
 Heterodyne, Signal Corps, type B.C. 104, 1000 to 3000 meters, with detector..... 50.00
 Battery, U. S. Army, lead-acid type, 10 volt, 20 ampere hour. Consisting of 5 individual 2 volt cells in carrying case, minus electrolyte..... 15.00
 Generators, 110 volt, A.C. 900 cycles, 200 watts, self excited..... 5.00
 Storage batteries, Edison Nickel Alkali 225 amp. hr. type AG, 1.2 volts per cell, weight each 20 lbs..... 15.00
 Generators, 12 volt, 60 amp. has automatic controls, 5,000 R.P.M..... 4.00
 Motor generator, R & M, 110 D.C. 3 1/4 h.p., 2 kw. 20 volt, 80 amp..... 20.00
 125.00

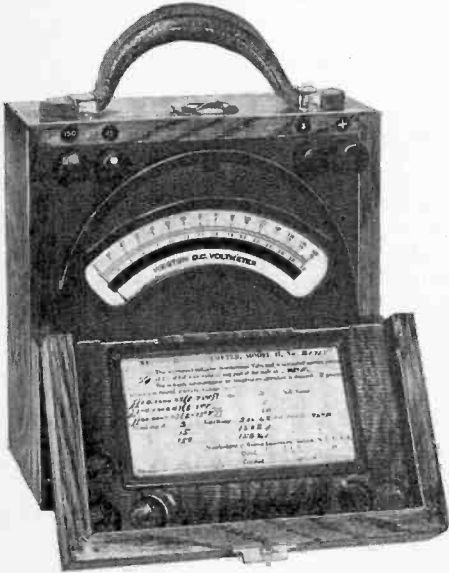

Voltmeters, D.C. portable new, Weston model 45, 3 scale 0-3-15-150 guaranteed 1/4 of 1% accurate.. 40.00
 Ammeters, D.C. portable, new Weston model 45, 3 scale 0-1.5-15-150 with 3 scale external shunt and leads 1/4 of 1% accurate..... 40.00

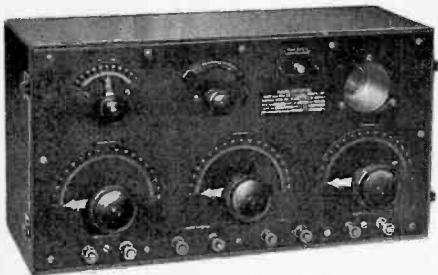

Receiver, Signal Corps, type 122 with detector; range 175-775 meters. Excellent for "stand-by" in coastal broadcast stations as required by Dept. Commerce..... 50.00

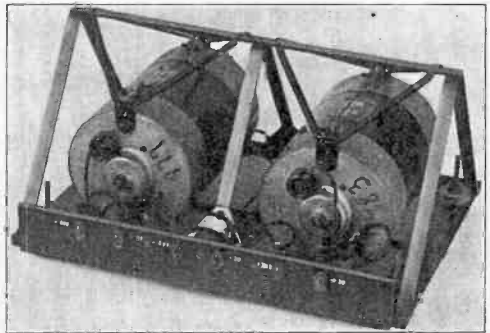

Western Electric Dynamotor C.W. 927. Two 32/350 volt dynamotors in shock-proof hanger. Used in parallel give 160 mills at 350 volts. In series give 80 mills at 700 volts. Can be used to operate transmitters to 50 watts from 32 volt D.C. Two dynamotors in hanger..... 25.00
 Single dynamotor without hanger..... 15.00
 West. Elec. Switchhd. C.W. 928. Control for Dynamotor C.W. 927. Has starting switches, fuses, 0-50-500 voltmeter, switches for testing main lines and output. Also complete filter system. Special..... 8.00

Largest Radio and Electric Supply House in U. S. specializing on Army and Navy Surplus. Deposit of 20% required on C.O.D. orders. NO C.O.D. ON CANADIAN ORDERS.

MANHATTAN ELECTRIC BARGAIN HOUSE
 Dept. R. 105-7 Fulton St., New York City

When writing to advertisers mention of the PROCEEDINGS will be mutually helpful.

Packed like **EGGS**

THE Dudlo policy of care and precision follows through to final destination. Not only are Dudlo coils designed, manufactured and inspected with the utmost care, but even the packing and shipping is such as to insure their arrival in perfect condition, irrespective of distance or mode of transportation.

Like so many eggs, every coil has its individual compartment separated by corrugated board. The completed case is then telescoped into an outer shipping container of heavy corrugated construction, giving double protection against damage in handling while in transit.

Dudlo was the first to adopt this method of packing which has saved thousands of dollars and an untold amount of trouble and inconvenience for coil users the world over.

DUDLO MANUFACTURING CO., FT. WAYNE, IND.
Division of General Cable Corporation

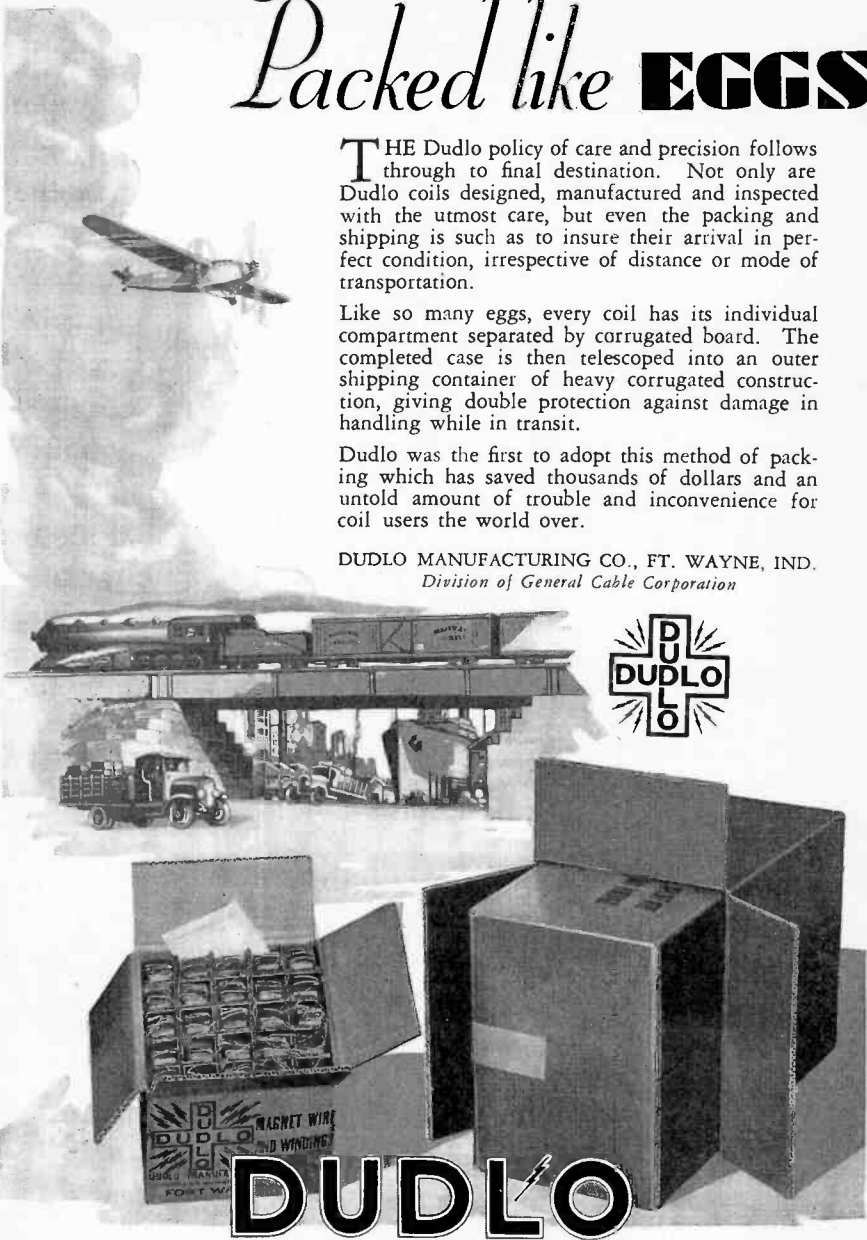

DUDLO

When writing to advertisers mention of the PROCEEDINGS will be mutually helpful.

ENGINEERS AVAILABLE

Advertisements on this page are available only to members of the Institute of Radio Engineers. For rates and further information address the Secretary, The Institute of Radio Engineers, 33 West 39th Street, New York, N.Y.

MANUFACTURERS and others seeking radio engineers are invited to address replies to these advertisements at the Box number indicated, care the Institute of Radio Engineers. All replies will be forwarded direct to the advertiser.

GRADUATE of Technical University of Munich, Germany, 30 years of age, 1923-29 radio engineer with Telefunken company of Berlin, now in United States, desires connection with concern engaged in transmitter or tube development and design work. Has had extensive experience in the design of high power tube transmitters for broadcasting, marine and point to point work. Box 5.

COLLEGE GRADUATE, E.E., '29, since April 1929 associated with large receiving set manufacturer as radio engineer on overall performance measurements on broadcast receivers, development, design and installation of precision receiver measuring apparatus, general development work on broadcast receivers. Desires become associated with firm of radio consulting engineers or licensing group in design-development of measuring equipment, general and aircraft communication engineering. Box 2.

COLLEGE GRADUATE, Columbia University, B.S. 1925, M.A. 1929; 1924-27, installing and testing power station equipment, including telephone and radio; 1927 to date Instructor in Electrical Engineering teaching electrical measurements, D.C. and A.C. theory and machines, elementary high frequency circuits; desires position giving employment in talking moving picture or radio work for two or three days a week during the academic year and at full time for three months during summer vacation. Box 7.

COLLEGE GRADUATE, 27 years of age, three years research in Dutch tube laboratory, two years with large U.S. set manufacturer on inspection and maintenance work, one year with talking moving picture firm as service engineer, desires position with receiver or tube manufacturing organization. Address Box 1.

FORMER student of School of Technology, Budapest, Hungary, 41 years of age, age, in U.S. since 1921 engaged by six manufacturers to date as model maker, in charge of condenser manufacture, experimental design work. Seeks position in experimental, model-making, design or manufacture. Box 6.

MAN with four years technical training, 1927-29 with radio manufacturer in service engineering, test foreman, sub-foreman test equipment laboratory; May 1929-December 1929, in charge of design and construction of all test equipment for large receiving set manufacturer; desires position in research, laboratory or test equipment work. Box 4.

GRADUATE University of Pennsylvania, '22, radio editor of technical magazine 1925-26; 1926 to date associated with several large manufacturers in receiver design and research. Desires responsible position with reputable receiver manufacturing concern. Box 3.

When writing to advertisers mention of the PROCEEDINGS will be mutually helpful.

You Can forget the Condensors if they are DUBILIERS



PL-1927

Capacity004 Mfd. Current 150 Amps.
Volts Effective25,000 Frequency400 K-C

Another example of Dubilier advances in mica dielectric power-type condenser units. A condenser measuring 16 inches by 12½ inches x 12½ inches height.

THE RICHEST

experience in condenser-work possible to any organization in the industry. This is the thing beyond—the added element of value—that goes with each Dubilier job.

Manufacturers profit by including Dublier condensers in their designs. Good condensers are a big factor in the success of new sets.

A n n o u n c i n g !

*A new
untuned radio frequency transformer*

One for use with the screen-grid tube which is extraordinarily effective over the entire wave-band.

Inquiries from interested manufacturers are invited.

Dubilier
C O N D E N S E R
C O R P O R A T I O N

342 Madison Avenue
New York, N. Y.

When writing to advertisers mention of the PROCEEDINGS will be mutually helpful.



What do you
put

INSIDE

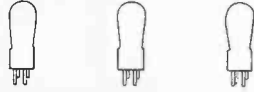

Your
Vacuum Tubes?

Are the arteries of your tubes
healthy or not?

? ? ?

Have you used good filament or
material that is just so-so?

? ? ?

In the final analysis only tubes
with dependable filament will
survive the test of wear.

! ! !

PRECISION FILAMENT

(Uncoated)

for VACUUM TUBES

has been used by leading tube
makers and they say

IT IS GOOD FILAMENT

• • •

A product of

SIGMUND COHN

44 Gold Street

New York



When writing to advertisers mention of the PROCEEDINGS will be mutually helpful.

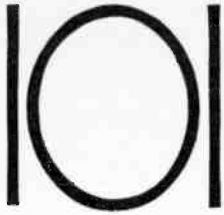

PRODUCTS USE

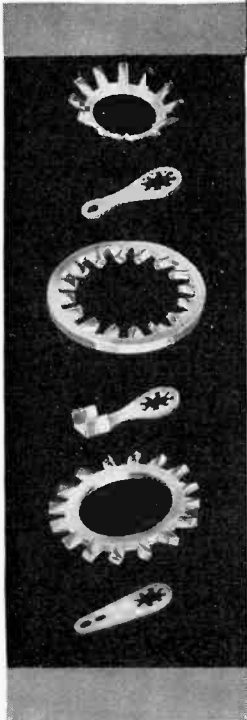
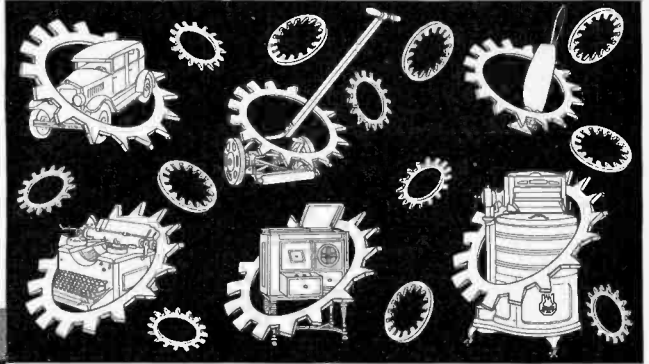

SHAKEPROOF

ALL over the town—all over the country—
—on automobiles and electric refrigerators
—on radio sets and vacuum cleaners—
—on machine tools and kitchen stoves—wherever
there is a bolt to come loose—wherever there
is a nut to lock—you will find SHAKEPROOF.
Big manufacturers—medium sized manu-
facturers—small manufacturers alike are
unanimous in their adoption of SHAKEPROOF,
not only because they hold and won't let go,
but because they speed up production, save
on bolt lengths and cut costs as well. There
is a place on your product for SHAKEPROOF.
You are paying for SHAKEPROOF whether you
are using them or not. Write for samples
and prove this to your entire satisfaction.

SHAKEPROOF
Lock Washer Company

[Division of Illinois Tool Works]

2501 North Keeler Avenue

Chicago, Illinois

**WRITE
FOR SAMPLES**

When writing to advertisers mention of the PROCEEDINGS will be mutually helpful.

CHANGE IN MAILING ADDRESS OR BUSINESS TITLE

Members of the Institute are asked to use this form for notifying the Institute office of a change in their mailing address or any change in the listing of their company affiliation or title for the Year Book membership list.

The Secretary,
THE INSTITUTE OF RADIO ENGINEERS,
33 West 39th Street,
New York, N.Y.

Dear Sir:

Effective please note change in my address
(date)
for mail as follows:

FROM

.....
(Name)

.....
(Street Address)

.....
(City and State)

TO NEW ADDRESS

.....
(Street Address)

.....
(City and State)

Also for the membership list for next year's Year Book note change in my business address (or title) as follows, this ^{is} my mailing address: _{is not}

.....
(Title)

.....
(Company Name)

.....
(Address: Street, City and State)

**PLEASE FILL IN, DETACH, AND POST TO THE
INSTITUTE PROMPTLY**

Back Numbers of the Proceedings Available

MEMBERS of the Institute will find that back issues of the Proceedings are becoming increasingly valuable, and scarce. For the benefit of those desiring to complete their file of back numbers there is printed below a list of all complete volumes (bound and unbound) and miscellaneous copies on hand for sale by the Institute.

The contents of each issue can be found in the 1914-1926 Index and in the 1929 Year Book (for the years 1927-28).

BOUND VOLUMES:

Vols. 8, 9, 10, 11 and 14 (1920-1921-1922-1926), \$8.75 per volume to members.

Vols. 16 and 17 (1928-1929), \$9.50 to members.

UNBOUND VOLUMES:

Vols. 6, 8, 9, 10, 11 and 14 (1918-1920-1921-1922-1923-1926), \$6.75 per volume (year) to members.

Vol. 17 (1929), \$7.50 to members.

MISCELLANEOUS COPIES:

Vol. 1 (1913) July and December

Vol. 2 (1914) June

Vol. 3 (1915) December

Vol. 4 (1916) June and August

Vol. 5 (1917) April, June, August, October and December

Vol. 7 (1919) February, April and December

Vol. 12 (1924) August, October and December

Vol. 13 (1925) April, June, August, October and December

Vol. 15 (1927) April, May, June, July, October, November and December

These single copies are priced at \$1.13 each to members to the January 1927 issue. Subsequent to that number the price is \$0.75 each. Prior to January 1927 the Proceedings was published bi-monthly, beginning with the February issue and ending with December. Since January 1927 it has been published monthly.

Make remittances payable to the Institute of Radio Engineers and send orders to:

THE INSTITUTE OF RADIO ENGINEERS

33 West 39th Street

NEW YORK, N. Y.

RADIO ENGINEERS
specify
VITREOSIL

(Fused Pure Silica and Quartz)

Insulation for Heater Type AC Tubes
Heat Treating Tubes for Metal Parts
Optical Details for Television

OBTAINING: Homogeneity; Impermeability; Freedom from Gas; Lowest Expansion; High Electrical Resistance; Freedom from Impurities.

And in TRANSPARENT VITREOSIL Best Transmission of Visible, Ultra-Violet and Infra-Red Rays

AVAILABLE SHAPES: Transparent Lenses, Prisms, Bulbs, etc.; Rods, Plates and Special Cross Section Strips; Single and Multiple Bore Tubing in All Diameters.

WRITE STATING PROBLEM

THE THERMAL SYNDICATE, LTD.
1716 Atlantic Avenue
Brooklyn, New York

When writing to advertisers mention of the PROCEEDINGS will be mutually helpful.

SERVICING

—*is it an asset or a liability to you?*

IT HAS been demonstrated time and again since the Weston Model 547 Radio Set Tester was brought to perfection and put on the market that radio servicing can easily be made one of the most profitable departments of radio retailing. With this set tester the service man's work is reduced to a certainty. No more is it necessary for the service man to waste time hunting for trouble. Model 547 gives him the answer instantly.

Tests—On A.C. sets the heater voltage and plate current can be read throughout the test while the D.C. voltmeter may be indicating plate bias or cathode voltage.

Self-contained, double-sensitivity continuity test provided. This can also be used for measuring resistance as well as testing for open circuits. Grid test can be made on A.C. or D.C. screen grid tubes—also the '27 tubes when used as a detector—without the use of adapters. Two sockets on the panel—UY tube adapters eliminated.

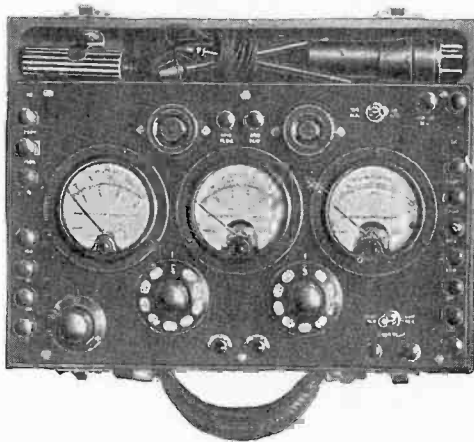

Weston
PIONEERS
SINCE 1888
INSTRUMENTS

WESTON ELECTRICAL INSTRUMENT CORPORATION
589 Frelinghuysen Avenue
Newark, N. J.

When writing to advertisers mention of the PROCEEDINGS will be mutually helpful.

FROST-RADIO

offers manufacturers Volume Control Units of precision and utmost dependability

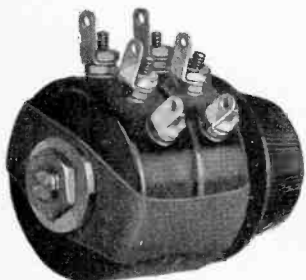

No. 2880-2880. Bakelite shell composition element only. Resistance range from 5,000 ohms to 1 megohm. All curves. Potentiometer or rheostat types. Units insulated from each other. Diameter, 1 1/2 in. Depth of shell, 1 1/8 in.

Controls have both these requirements. In addition, they are non-inductive, unaffected by temperature changes, noiseless, wear-proof, smooth in operation, and made to fit any desired curve.

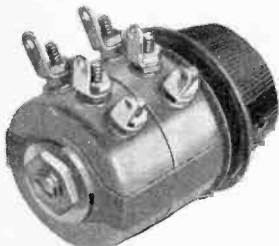

No. 590-590. Metal shell, composition element only. Resistances from 5,000 ohms to 1 megohm. All curves. Potentiometer or rheostat types. Units insulated from each other. Diameter, 1 5/16 in. Depth of shell, 1 1/8 in.

WHAT is it that every manufacturer seeks in a volume control? Isn't it first of all *precision workmanship* that insures absolute accuracy so that the unit will perform the duty assigned to it with certainty? And then isn't *dependability* next in importance? Summed up, these two essentials of a volume control are: To work perfectly, and to stand up.

Frost
Radio
Volume

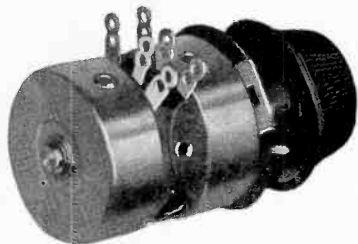

No. 200-200. Metal shell type wire wound resistors with resistances from 5 ohms to 10,000 ohms. Split windings. Rheostat or potentiometer types. Units insulated. Diameter, 1 7/16 in. Depth of shell, 1 1/2 in.

We are equipped to produce

Frost Radio Volume Controls in either wire wound or carbon element type, clockwise or counter-clockwise knob rotation, and with absolute accuracy in all resistance gradations from 5 ohms to 1 megohm. Our service is unique, speedy and satisfying. Ask us to submit samples based on your particular specifications.

HERBERT H. FROST, Inc.
Main Offices and Factory: Elkhart, Ind.
160 North La Salle Street, CHICAGO

The World's Largest Manufacturer of High Grade Variable Resistors

When writing to advertisers mention of the PROCEEDINGS will be mutually helpful.

VARIABLE CONDENSERS for TRANSMISSION

CAT. No. 149

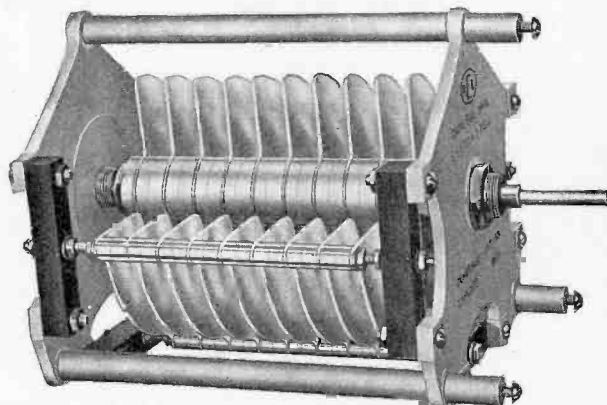

Super-Construction

Heavy Brass Plates . . . Substantial Cast Aluminum End Plates . . . Steel Shaft Projecting Through Both Ends . . . Cone Bearings with Locking Device . . . Heavy Isolantite Insulating Blocks.

The following table gives data on stock condensers:

Type No.	Breakdown Voltage	Number of Plates	Max. Cap. Mmfd.	Plate Spacing Inches	Overall Depth Inches	Wt. Lbs.	Price
K	3,000	19	200	.250	6.750	4.0	\$17.50
L	3,000	33	350	.250	9.100	8.0	21.00
M	3,000	59	650	.250	13.620	12.5	29.00
N	5,000	11	60	.500	6.750	3.5	17.25
O	5,000	19	100	.500	9.100	7.0	20.00
P	5,000	33	180	.500	13.620	10.5	28.00
R	10,000	7	25	1.000	6.750	3.0	17.00
S	10,000	11	45	1.000	9.100	6.0	19.00
T	10,000	19	80	1.000	13.620	9.5	27.00

Write for Bulletin 39



MANUFACTURES A COMPLETE LINE OF
APPARATUS FOR SHORT WAVE TRANSMISSION AND RECEPTION

Radio Engineering Laboratories, Inc.
100 Wilbur Ave. Long Island City, N.Y., U.S.A.

When writing to advertisers mention of the PROCEEDINGS will be mutually helpful.



Here is our new type S. G. SHIELDED CONDENSER

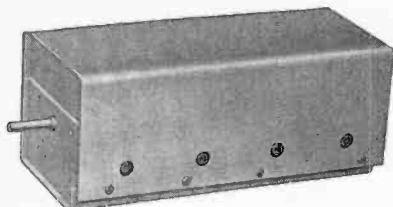
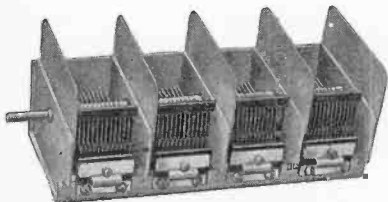

The completely shielded stators with section shields protruding beyond the grid ends of the stators eliminate every possibility of coupling—a much desired feature for 1930 set construction.

Minimum compensators of novel construction have a ground potential on the adjusting screw. This greatly facilitates balancing because the process of balancing is not affected by screw driver or hand capacity.

Bosses are arranged so that the condenser can be mounted either on bottom or side.

additional rigidity to the entire assembly and makes a neat and compact job that improves the mechanical appearance of any set in which this new condenser is incorporated.

The heavy drawn dust proof cover completely encloses the unit. This gives

Write for a sample, prices and complete information.

UNITED SCIENTIFIC LABORATORIES, Inc.
115-C Fourth Avenue, New York City

Branch Offices for Your Convenience in

St. Louis
Chicago
Boston
Minneapolis
Cincinnati

Los Angeles
Philadelphia
San Francisco
London, Ontario



When writing to advertisers mention of the PROCEEDINGS will be mutually helpful.

This New Clear Thinking -- Hard -- Fast -- In New Directions

It's Here -- Right Now -- Everywhere -- Sweeping
Into Every Industry

Something is happening —
Headed "Upward."

Moving Faster — Spreading Deeper.

Permanent —
Nothing can stop it now.

**Industry's Next Great Stage is
Starting**

THE new prosperity, now preparing, will be based on new thinking, new ways, new thoroughness. New conditions are ahead of us. Some are here now. Production-thinking and equipment-thinking are sharper, faster, more complete. And with a stronger will to mesh perfectly with every aim and problem of business.

Just the hint of a business dip was enough. Even if it is over by the time you read this, the fast, keen, fresh thinking that it started is going on. It is getting more momentum. Its results in business and industry will be permanent. The new direction of industry's advance is being determined right now.

Already you feel it everywhere. Nothing escapes the sharp scrutiny of this new thinking. Methods, materials, equipment, designs, models, old ways, old slots, old neglects of opportunities, old "leech wastes"; all are in the crucible now.

From top to bottom in industry the best thought of all workers is being enlisted by executives.

The Fact-Sheets of Industry aim to help the scope and thoroughness of the new thinking, by supplying it with practical material; facts that

Write NOW. There is no charge. First of FACT-SHEETS of INDUSTRY, now in preparation, will be mailed free to ANY Worker, any Executive, if quick. . . .

State work you do, your company's product or business; and whether request is for self. Address; Librarian (B-3), National Vulcanized Fibre Company, Wilmington, Del. (Card will do.)

every executive and every worker may find useful now. Facts no worker can do without, if he looks ahead and wants to be in step with his company's new aims and efforts.

The publication of this, the first of the Fact-Sheets of Industry, is the start of a plan which, when at its full growth, will supply freely to thinking workers in ALL levels of industry, practical knowledge which hitherto has not been readily accessible; facts from many other industries which may stimulate their own productive thinking; and which, (though they affect practically every business, every department and every worker), are usually known only in part and only by a limited group of specialists in each industry.

NVF

As a movement in line with national measures for further improvement of business conditions and of the circuit of producing, earning, consuming, equipping, etc.;—and as the initial step in this democratizing of inter-industry knowledge (which, under present conditions, is more needed by thinking workers, and can yield more important results than ever before);—all expenses of issuing the first of the Fact-Sheets of Industry are being borne by The National Vulcanized Fibre Company and its various divisions and associated industries.

When writing to advertisers mention of the PROCEEDINGS will be mutually helpful.

FOR
16
A LEADING SOURCE OF LAMINATED INSULATION
YEARS

FOR 16 years . . . practically since the industry began . . . Formica has been a source of supply for laminated insulation for many of the leading technical organizations in the United States.

During all of that time the Formica organization has been concentrated on just one product and the Formica laboratory has been working steadily to improve that product.

This exceptional concentration has resulted in a product and a service that is unusually satisfactory . . . and that has continued so for many years.

*Send your blue prints for quotations
on punched parts*

THE FORMICA INSULATION COMPANY
4646 Spring Grove Avenue
CINCINNATI, OHIO

FORMICA
Made from Anhydrous Bakelite Resins
SHEETS TUBES RODS

When writing to advertisers mention of the PROCEEDINGS will be mutually helpful.

A SAFE GUIDE

in the selection
of insulation for
Radio Transmitting
and Receiving Sets

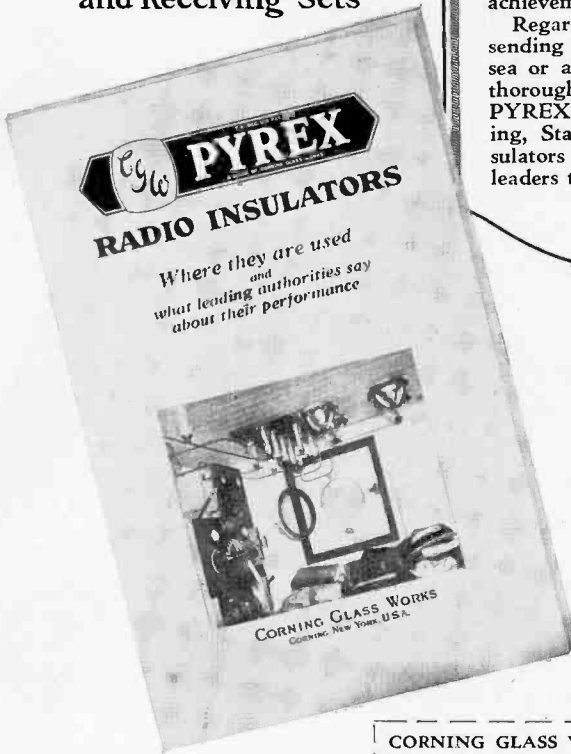

OVER 300 broadcasting stations, leading radio telegraph systems, the United States Army, Navy, Air Mail, Coast Guard and Ice Patrol Services, explorers like Commander Byrd, and exacting amateurs everywhere have utilized PYREX Insulators in many spectacular achievements.

Regardless of whether you are sending or receiving—on land, sea or airplane—you should be thoroughly familiar with the PYREX Antenna, Strain, Entering, Stand-off and Bus-bar Insulators that are helping these leaders to make radio history.

The new PYREX Radio Insulator booklet lists all types and sizes with data that you will want for ready reference.

Return the coupon for your copy, and if you want further advice on any insulation problem, our Technical Staff will answer your questions promptly.

CORNING GLASS WORKS, Corning, N. Y.
Send copy of your new bulletin on Radio Insulators

Name

Address

I. R. E.-2-30

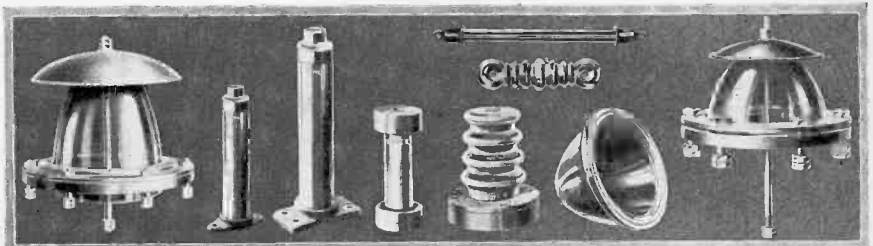

When writing to advertisers mention of the PROCEEDINGS will be mutually helpful.

"ESCO" Airplane Generators Provided the Power For This Remarkable Achievement.

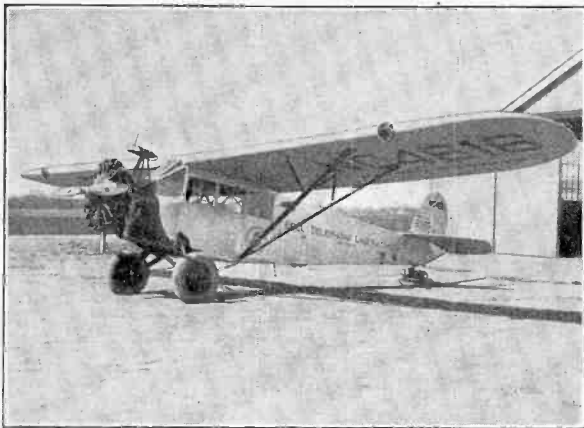

TALKS TO LONDON FROM PLANE IN AIR

Reporter in Craft Speeding Over City Has Conversation Across the Ocean.

THREE CALLS ARE MADE

Words Understood Clearly in Spite of Static—Electric Experts Pleased With Results.

Special to The New York Times.
HADLEY FIELD, N. J., June 25.—Flying at ninety miles an hour today with a thick fog blanket blotting out the earth below him, W. W. Chaplin, Associated Press reporter, casually turned a microphone and asked for the London office of the news association. The request, relayed through the laboratories of the Bell Telephone Company, passed on to the radio ocean radio telephonic station at Belfast, Me., and then carried again on the air across 3,000 miles of ocean to London.
 The connection was made quickly and Chaplin asked that Miss Martha Dalrymple of the London office be called to the phone. The conversation, once greetings were over, Chaplin said later, had to do mostly with the weather. It was broken somewhat by static, but the two persons talking, one in a fog-bound plane a half-mile in the air and the other in a fog-bound London office, understood each other and exchanged greetings.

Two "ESCO" Airplane Generators (wind driven) were mounted on the Bell Telephone Airplane. One supplied



power to the transmitter and the other to the receiver. Both were of standard "ESCO" design which insures reliable service under the severe operating conditions common to aviation.

Low wind resistance, light weight, non-corroding parts, ball bearings, tool steel shafts, steel shells, cast steel pole pieces, weather proof construction, many sizes to choose from, high voltage and low voltage windings to suit individual requirements, are a few of the many reasons for "ESCO" generators being the first choice.

ELECTRIC  **SPECIALTY**
COMPANY

300 SOUTH ST., STAMFORD, CONN.

Manufacturers of motors, generators, dynamotors and rotary converters.

When writing to advertisers mention of the PROCEEDINGS will be mutually helpful.

Volume Controls

TO vary the intensity of the faithful reproduction built into radio receivers without introducing noise or distortion, can only be accomplished by a careful and complete consideration of both mechanical and electrical features of the volume control.

Mechanically—The Centralab exclusive and patented rocking disc contact precludes any possibility of wear on the resistance material. This feature adds to the smoothness of operation since the contact shoe rides only on the disc. The shaft and bushing are completely insulated from the current carrying parts—eliminating any hand capacity when volume control is placed in a critical circuit.

Electrically — Centralab engineers have evolved tapers of resistance that produce a smooth and gradual variation of volume. These tapers have been thoroughly tried and tested for each specific application for current carrying capacity and power dissipation.

Centralab volume controls have been specified by leading manufacturers because of their quality and ability to perform a specific duty—Vary the intensity of faithful reproduction—faithfully.

Manufactured in three sizes

*Standard
Junior
Midget*

*Also Double Standard
and Double Junior*

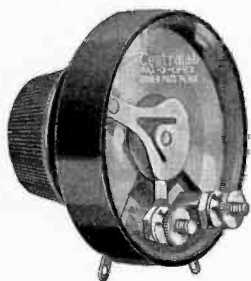

*Write for full particulars of
specific application.*

Centralab
CENTRAL RADIO LABORATORIES

36 Keefe Ave.

Milwaukee, Wis.

A CENTRALAB VOLUME CONTROL IMPROVES THE RADIO SET

When writing to advertisers mention of the PROCEEDINGS will be mutually helpful.

AMERTRAN

TRADE MARK REG. U.S. PAT. OFF.



*AmerTran ABC Hi-Power Box—500 volts DC plate voltage, current up to 110 ma; AC filament current for all tubes for any set. Adjustable bias voltages for all tubes. Price, east of Rockies—less tubes—\$130.00.



*Complete 2 stage audio amplifier with first stage AmerTran De Luxe for UX 227 AC and second stage AmerTran Push-Pull for two 171 or 210 power tubes. Operates with 450 volt AmerTran Hi-Power Box. Price east of Rockies—less tubes—\$80.00.



AmerTran De Luxe Audio Transformer—List Price \$10.00. Type 151—Between one input and two output tubes—List Price \$15.00

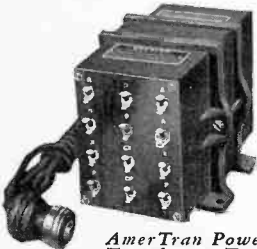

AmerTran Power Transformer Type PF-245A—List Price \$22.00

*Licensed under patents of the Radio Corporation of America and associated companies for radio, amateur, experimental and broadcast reception.

Quality RADIO PRODUCTS

AmerTran Audio and Power Transformers and Amplifiers are designed for those who truly appreciate fine quality in radio reception.

Weakness in the audio system in many receiving sets results in failure to deliver full richness of tone along the entire scale. AmerTran Radio Products perfect the audio system and reproduce music and the speaking voice in true tone (without distortion at any volume) just as broadcast in the studio.

FOR DETAILED INFORMATION WRITE FOR THE FOLLOWING BULLETINS:

- BULLETIN 1084
AmerTran DeLuxe Audio Transformer
- BULLETIN 1087
AmerTran Audio Transformer Type AF-8
- BULLETIN 1088
AmerTran Power Transformer Type PF 245A
- BULLETIN 1076-A
AmerTran Hi-Power Box Type 21-D
- BULLETIN 1075-A
AmerTran Push-Pull Amplifier Type 2-AP
- BULLETIN 1065
The Complete AmerTran Line.

AmerTran Quality Radio Products are sold by all good dealers, or direct if they cannot supply you.

AMERICAN TRANSFORMER COMPANY

Transformer builders for over 29 years

172 Emmet Street, Newark, N. J.

AMERICAN TRANSFORMER COMPANY, I.R.E.-2-30
172 Emmet Street, Newark, N. J.

Please send me the following Bulletins (Check (✓) those you want). Bulletin 1084 () ; 1087 () ; 1088 () ; 1076-A () ; 1075-A () ; 1065 () .

Name.....

Street and No.....

Town..... State.....

When writing to advertisers mention of the PROCEEDINGS will be mutually helpful.

CARDWELL CONDENSERS

*Condensers
Standard and
Built to Order
For
Broadcast and
Commercial
Transmitters*

Receivers

*Fixed (Oil Dielectric)
Condensers
For Induction
Furnaces*



Inductances

Transformers

*Radio Receivers
and Transmitters*

Relays

*Automatic
Telegraph Apparatus*

*Electro-Mechanical
Devices
Manufactured
To
Specifications*

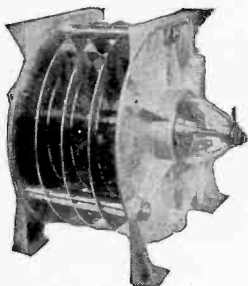

VERSATILITY

ALTHOUGH for some years past the name CARDWELL has been associated in the Public mind with condensers almost exclusively, this Corporation has successfully handled other engineering and manufacturing problems receiving little or no public attention.

A well equipped laboratory and a modern plant have made possible the direction of the activities of this organization into several channels, more or less allied, keeping faith with our many friends, making new ones and insuring that the products of CARDWELL shall continue to be "The Standard of Comparison."

Your proposals are solicited. CARDWELL condensers are made for transmitting and receiving circuits. Send for literature.



THE ALLEN D. CARDWELL
Manufacturing Corporation
81 PROSPECT ST., BROOKLYN, N.Y.

Since Broadcasting Began

«THE STANDARD OF COMPARISON»

When writing to advertisers mention of the PROCEEDINGS will be mutually helpful.

PROFESSIONAL ENGINEERING DIRECTORY

For Consultants in Radio and Allied Engineering Fields

THE MAGNAVOX COMPANY

Oakland, Calif. & Chicago, Ill.

*PIONEERS AND SPECIALISTS
IN THE ART OF
SOUND PRODUCTION.*

*DYNAMIC SPEAKERS SINCE
1911.*

FERRANTI, Inc.

★

*Consulting Engineers
Audio Amplification
Design-Construction-Advice*

★

130 West 42nd St., New York

RADIO ENGINEERS

Ten dollars will introduce you directly to over 7,000 technical men, executives, and others with important radio interests. For details write to

Advertising Dept., I.R.E.

The J. G. White
Engineering Corporation

Engineers—Constructors

*Builders of New York Radio
Central*

43 Exchange Place New York

Radio



Engineers

Your card on this professional card page will give you a direct introduction to over 7,000 technical men, executives, and others with important radio interests.



Per Issue—\$10.00

When writing to advertisers mention of the PROCEEDINGS will be mutually helpful.

Alphabetical Index to Advertisements

- A**
Aerovox Wireless Corp.....XL
Allen-Bradley Co.....XIX
American Transformer Co.....LXI
American Tel. & Tel. Co.....XXIV
Arcturus Radio Tube Co.....XLI
- C**
Cardwell, Allen D., Mfg. Corp....LXII
Central Radio Laboratories.....LX
Clarostat Mfg. Co., Inc.....XVI
Cohn, Sigmund.....XLVII
Condenser Corp. of America...XVIII
Continental Carbon Inc.....XXI
Cornell Electric Co.....XXX
Corning Glass Works.....LVIII
Cornish Wire Co.....XXXV
- D**
De Forest Radio Co.....XXXVII
Dubilier Condenser Corp.....XLVI
Dudlo Manufacturing Co.....XLIV
- E**
Electrad, Inc.....XXIII
Electric Specialty Co.....LIX
- F**
Formica Insulation Co.....LVII
Frost, H. H.....LIII
- G**
General Radio Co., Outside Back Cover
Grebe, A. H., and Co., Inc.....
.....Inside Back Cover
Gilby Wire Co.....XXXII
- I**
International Resistance Co.....XX
Isolantite Co. of Am...XXVIII, XXIX
- J**
Jefferson Electric Co.....XVII
Jewell Electrical Instrument Co..LXVI
- M**
Manhattan Electric Co.....XLIII
- N**
National Vulcanized Fibre Co....LVI
National Carbon Co.....XXXI
- O**
Operadio Mfg. Co.....XXVII
- P**
Pacent Electric Co., Inc.....XXII
Polymet Manufacturing Corp....LXV
Professional Engineering Directory
.....LXIII
- R**
Radio Engineering Laboratories...LIV
Roller-Smith Co.....XLII
- S**
Sangamo Elec. Co.....XXV, XXVI
Scientific Radio Service.....LXVII
Scovill Manufacturing Co....XXXVI
Shakeproof Lock Washer Co..XLVIII
Silver-Marshall Co.....XXXIX
- T**
Thermal Syndicate, Ltd.....LI
Thordarson Electric Co.....XV
Transformer Corp. of America LXVIII
- U**
United Scientific Labs.....LV
- W**
Wireless Specialty Apparatus Co....
.....XXXVIII
Weston Electric Inst.....LII
-

When writing to advertisers mention of the PROCEEDINGS will be mutually helpful.



COILS

OF POLYMET QUALITY

That three-fold Polymet Policy—Quality, Service, and Dependability — which appeals to 80% of the RCA licensees, will prove equally advantageous to you.

The Coilton Division of Polymet is a modern expansion of the oldest exclusive coil-winding plant in the electrical industry. New buildings, machinery, and equipment, with close engineering supervision of production, insure an exactness of coil performance justifying the designs of engineers and the judgment of purchasing agents.

Coil specifications, submitted to Polymet, have prompt attention, careful fabrication, dependable delivery.

Coilton Division (*Coil Windings exclusively*)
Easton, Pa.

Strand & Sweet Division (*Magnet Wire exclusively*)
Winsted, Conn.

Address all communications to

Polymet Manufacturing Corporation

829 E. 134th St., New York City

World's Largest Manufacturers of Radio Essentials:

Condensers Resistors Volume Controls
Coils Transformers Magnet Wire

COILS FOR

Power Transformers
Audio Transformers
Magnetic Speakers
Dynamic Speakers
Speaker Filters
Magnetic Actions
Ignition Devices
X-ray Apparatus
Small Armatures
Chokes, Horns, etc.

When writing to advertisers mention of the PROCEEDINGS will be mutually helpful.



Features of the Jewell 199

- 1 Makes every essential field test.
- 2 Endorsed by manufacturers and engineers.
- 3 Used by largest radio service organizations.
- 4 Simple to operate.
- 5 Backed by the most complete data service.
- 6 The most popular radio set analyzer.

Good Service Equipment Pays

It is the Correct Foundation for Good Service

THE Jewell Pattern 199 Set Analyzer is built to the specifications of service men. It is a marvel of simplicity—easy to operate—yet it provides every essential test for checking receivers in service.

Instruments, switches, binding posts, panel, case, and plugs are of the best. The Jewell 199 is built to the highest standards throughout, yet it is the lowest priced complete radio service kit on the market.

The price of the Jewell Pattern 199 is so reasonable that no good service man can afford to be without it. In the hands of a good service man it quickly pays for itself many times over.

But the service man who does not have a 199 pays for it over and over again in wasted time, costly service, troublesome complaints, and loss of business due to dissatisfied customers.

Order a Jewell Pattern 199 from your jobber and pave the way to increased sales as well as service profits through the superior performance it provides.

Jewell Electrical Instrument Co.
1642-D Walnut St., Chicago, Illinois

Jewell Set Analyzers are backed by the most thorough data service. This data, plus the Jewell Chart Method of Set Analyzing, takes the guesswork out of set servicing.

Free to Service Men

The latest edition of the Jewell booklet, "Instructions for Servicing Radio Receivers" contains data on 139 of the most popular sets. Write for your copy today.



30 YEARS MAKING GOOD INSTRUMENTS

JEWELL

When writing to advertisers mention of the PROCEEDINGS will be mutually helpful.

Piezo Electric Crystals and Constant Temperature Equipment

Piezo Electric Crystals:

We are prepared to grind Piezo Electric Crystals for POWER use to your assigned frequency in the 550 to 1500 KC band, *accurate to plus or minus 500 cycles* for \$55.00 fully mounted. Crystals for use in the HIGH FREQUENCY BROADCAST BAND (4000 to 6000 KC) for POWER use, accurate to plus or minus .03% of your assigned frequency, fully mounted, \$85.00. In ordering please specify type of tube used, plate voltage and operating temperature. All crystals guaranteed with respect to output and accuracy of frequency. Deliveries can be made within three days after receipt of order.

Constant Temperature Equipment

In order to maintain the frequency of your crystal controlled transmitter to a high degree of constancy, a high grade temperature control unit is required to keep the temperature of the crystal constant. Our unit is solving the problem of keeping the frequency within the 50 cycle variation limits. Our heater unit maintains the temperature of the crystals constant to **BETTER THAN A TENTH OF ONE DEGREE CENTIGRADE**; is made of the finest materials known for each specific purpose and is absolutely guaranteed. Price \$300.00. Further details sent upon request.

Low Frequency Standards:

We have a limited quantity of material for grinding low frequency standard crystals. We can grind them as low as *15,000 cycles*. These crystals will be ground to your specified frequency accurate to **ONE HUNDREDTH OF ONE PER CENT**. Prices quoted upon receipt of your specifications.

Scientific Radio Service

"The crystal specialists"

P. O. Box 86

Dept. R6

Mount Rainier, Md.

When writing to advertisers mention of the PROCEEDINGS will be mutually helpful.

Smooth... silent... **POWER**



A STEADY, unwavering flow of energy, smooth and silent, has been the dream and the despair of radio engineers throughout the history of the A.C. Set. In these power-supply transformers, developed by T.C.A., the dream has become a reality.

Any power-pack must of necessity have adequate capacity to handle the set . . . but the quality of the output of the transformer and filter circuit is a hidden "fourth dimension" that puts real value into a radio receiver. This smooth quiet power is a composite result of scientific design, fine materials and skilled workmanship.

Only scrupulous control of every manufacturing process and minute oversight of every operation makes possible such a result on a volume production basis.

**Power Transformers
Power Packs
Audio Transformers
Chokes
Dynamic Speakers**

*Engineering co-operation
gladly furnished to meet
your special requirements.*

**TRANSFORMER CORP.
OF AMERICA
2301-2319 S. Keeler Ave.
CHICAGO, ILL.**



When writing to advertisers mention of the PROCEEDINGS will be mutually helpful.

INSTITUTE SUPPLIES

EMBLEMS



Three styles of Institute emblems, appropriately colored to indicate the various grades of membership in the Institute, are available. The approximate size of each emblem is that of the illustrations.

The lapel button is of 14k gold, the background being enamelled in the membership color, the lettering being gold. The button is supplied with a screw back with jaws which fasten it securely to the coat. This style emblem can be obtained for \$2.75, postpaid, for any grade.



The pin is also of 14k gold. It is provided with a safety catch and is appropriately colored for the various grades of membership. Price, for any grade, \$3.00 postpaid.



The watch charm is handsomely finished on both sides and is of 14k gold. The charm is equipped with a suspension ring for attaching to a watch fob or chain. Price for any grade \$5.00 postpaid.

BINDERS

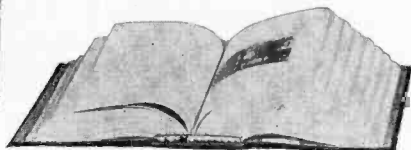

The binder pictured here contains over three inches of filing space. It serves either as a temporary transfer binder or as a permanent cover. It is made of handsome Spanish Grain Fabrikoid in blue and gold. The binder is so constructed that each individual copy

of the PROCEEDINGS will lie flat when the pages are turned. Copies can be removed from the binder in a few seconds and can be permanently preserved in undamaged condition. Hundreds of these binders are sold each year. Price, \$1.50 each, or \$2.00 with the member's name or the PROCEEDINGS Volume Number stamped in gold.

BACK ISSUES OF THE PROCEEDINGS

Back issues of the PROCEEDINGS are available in unbound form for the years 1918, 1920, 1921, 1922, 1923, and 1926 at \$6.75 per year (six issues). Single copies for any of the years listed to 1927 are \$1.13 each. From 1927 on (where available) the single copy price is \$0.75. Foreign postage on the volume is \$0.60 additional. On single copies \$0.10.

A number of individual copies for years other than those listed above are available. For a list of these, members should apply to the Secretary.

Bound volumes in Blue Buckram binding are available for the years 1920, 1921, 1922, 1923, and 1926 at \$8.75 per year. The bound volume for 1928 is priced at \$9.50. Foreign postage is \$1.00 per volume.

Bound volumes, for the above years, in Morocco Leather binding are available at \$11.00 each.

These prices are to members of the Institute.

FOURTEEN YEAR INDEX

The PROCEEDINGS Index for the years 1909-1926, inclusive, is available to members at \$1.00 per copy. This index is extensively cross indexed.

YEAR BOOK

The 1927 and 1928 year books are available to members at \$0.75 per copy, per year. The 1929 year book, including the report of the 1928 Committee on Standardization, is available to members at \$1.00 per copy.

When ordering any of the above, send remittance, with order to the Secretary, The Institute of Radio Engineers, 33 West 39th Street, New York, N.Y.

When writing to advertisers mention of the PROCEEDINGS will be mutually helpful.

We are in need of a man to work on the application of the vacuum tube to electrical measurements.

A man with two or three years graduate study, or the equivalent, and with some experience in the use of vacuum tubes, should be able to undertake our problem. Further experience will of course be highly acceptable and the starting salary will be commensurate with the individual's professional training.

We are a stable and growing organization offering an unusually excellent opportunity.

Address replies to
Box 834 I. R. E.

Temperature-Control Boxes

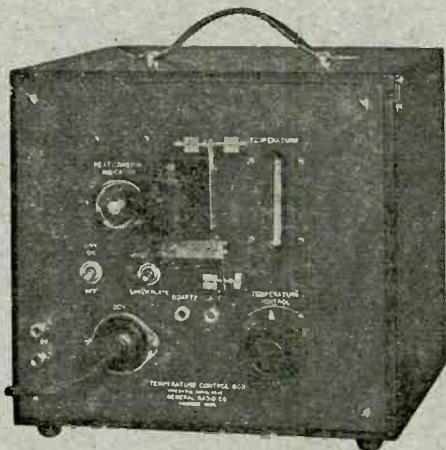

Type 547-A Temperature-Control Box

A TEMPERATURE-CONTROL box worthy of the name must maintain its temperature within specified limits over a wide variation in the temperature of the room in which it operates. General Radio temperature-control devices will remain within their specified limits for room temperature variations of ± 20 degrees F., a range of 40 degrees. They are practically independent of the weather and the janitor's ability to keep constant the temperature of the operating room.

The Type 547 Temperature-Control Boxes are made in the two types listed above but the second one is

recommended only for use where it is necessary to adjust the operating temperature while the unit is in operation.

Both are encased in walnut cabinets within which are arranged (in order) a balsa-wood insulating layer, the heaters (on all six faces), an aluminum distributing layer, an asbestos pressboard attenuation layer, and a second casing of aluminum which forms the temperature-controlled chamber.

GENERAL RADIO COMPANY
CAMBRIDGE A, MASSACHUSETTS

British Branch: 76 Old Hall Street, Liverpool

GENERAL RADIO INSTRUMENTS

FOR MEASURING ELECTRICAL QUANTITIES AT ALL FREQUENCIES



STANDARD AND SPECIAL ITEMS FOR LABORATORY AND INDUSTRIAL USE

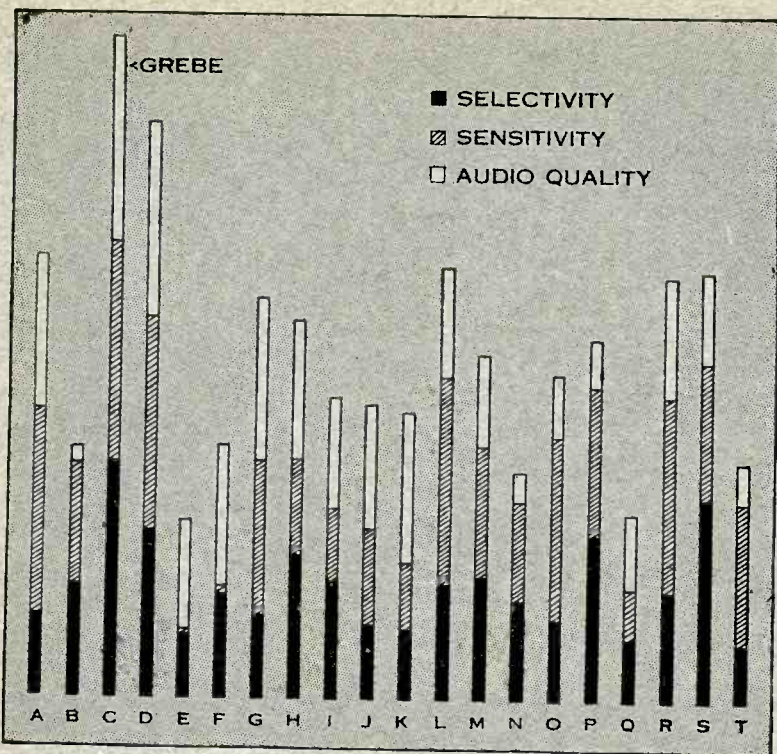

Measurements of band width at 1400 K.C.—average microvolt per meter input at 1400—1000—600 K.C. and total decibels audio amplifier loss relative to 500 cycles (at 60 and 5000 cycles) form the basis for a comparison with 20 sets measured for the same qualities. The Grebe measured 43 K.C. width at 1400 K.C. with 100 times input. It measures an average of 1.75 microvolts per meter input for standard output and it shows a total loss of 5.5 D. B. (4.5 D. B. at 60 cycles and 1 D. B. at 5000 cycles) from detector to voice coil. Translated in the new Grebe rating in % this respectively gives 93, 88 and 82%. The equation for selectivity rating is $\frac{40}{\text{band width}}$. Sensitivity $1 - \frac{1}{2} \log (S)$. Audio $\frac{30 - \text{sum D. B.}}{30}$

Grebe radio

SUPER-SYNCHROPHASE 

A. H. GREBE & CO., INC., Richmond Hill, N. Y.
 Western Branch: 443 So. San Pedro Street, Los Angeles, California