

VOLUME 16

JANUARY, 1928

NUMBER 1

PROCEEDINGS
of
The Institute of Radio
Engineers



Published Monthly By
THE INSTITUTE OF RADIO ENGINEERS
Publication Office: 450-454 Ahnaip St., Menasha, Wis.

Editorial and Advertising Departments
37 West 39th Street, New York, N.Y.

Subscription \$10.00 per Annum in the United States
\$11.00 in all other Countries
General Information and Subscription Rates on Page 1.



AS
you want them
WHEN
you want them

That's the kind of service
you will always get on

Radio Transformers

when you place your trust
in *Thordarson*. There are no
better custom made radio
transformers for all uses
than those made by Thor-
darson—with ample manu-
facturing facilities and well
known engineering skill be-
hind them, plus

PROMPT DELIVERY
and
RIGHT PRICES

THORDARSON RADIO

Supreme in Musical Performance
TRANSFORMERS

THORDARSON ELECTRIC MANUFACTURING CO.
Transformer specialists since 1895
WORLD'S OLDEST AND LARGEST EXCLUSIVE TRANSFORMER MAKERS
Chicago, U.S.A. (5370)

When writing to advertisers mention of the Proceedings will be mutually helpful.

Most of the better sets
are **FARADON** equipped

Radio manufacturers specify Faradon Capacitors to assure themselves of dependable condenser operation. They add to the confidence and sales arguments of their dealers by including the unit of known reliability and accepted prestige throughout the trade.

There are several hundred distinct Faradon units in regular production on which data is available upon mention of the required application. Write our Engineering Department for data concerning any unusual condenser problem.



WIRELESS
SPECIALTY
APPARATUS
COMPANY

Jamaica Plain,
Boston, Mass.,
U. S. A.

Established 1907



Faradon

ELECTROSTATIC CONDENSERS
FOR ALL PURPOSES

1456

When writing to advertisers mention of the Proceedings will be mutually helpful.

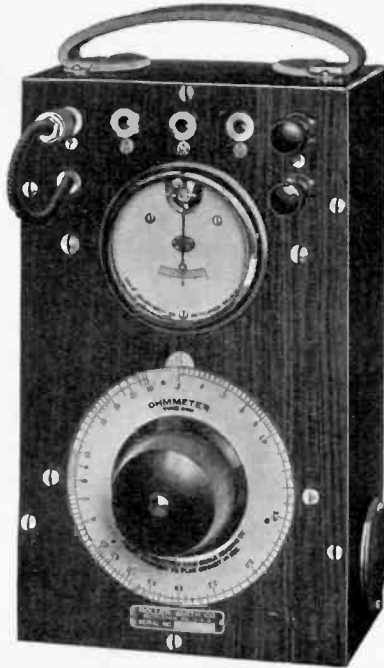

New Roller-Smith COM Ohmmeter

Portable direct reading, small, compact, light, rugged, accurate, entirely self-contained. Measures resistance values from .5 ohm to 50,000 ohms. List price \$70.00, subject to discount. Send for new Supplement No. 1 to Bulletin No. K-300.



New

Roller-Smith HTD Circuit Tester

Instantly locates open circuits in coils and circuits. Shows approximate resistance up to 10,000 ohms. Small, compact, rugged and dependable. List price \$21.00, subject to discount. Send for new Supplement No. 1 to Bulletin No. K-300.

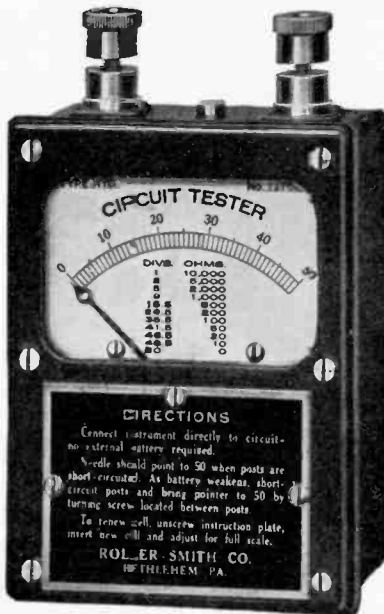

ROLLER-SMITH COMPANY
2134 Woolworth Bldg.
NEW YORK CITY

When writing to advertisers mention of the Proceedings will be mutually helpful.

AMER TRAN NOW OFFERS

Complete Light-Socket Power with Fidelity of Reproduction

The AmerTran ABC Hi-Power Box, \$95. Rectifying tubes extra, east of the Rockies.

No batteries, liquids, or chargers. No attention or adjustment necessary. Uniform, dependable power from the house current.

The AmerTran Push-Pull Power Amplifier, \$60. Tubes extra, east of the Rockies.

A new standard of quality in Audio Amplification. The tone you have always wanted. Connects to the detector of any good receiver.

BEFORE you think of another set, think what these new AmerTran products will do for the one you have. The ABC Hi-Power Box will deliver smooth power to plate and filament from the light socket, supplying sufficient voltage and current to push-pull 210 tubes and all other A C tubes required in a modern receiver. There is no fussing, no batteries, no weak reception. This complete unit contains AmerTran-designed equipment, with a power transformer having separate windings to provide A C filament current at $7\frac{1}{2}$ volts for two 210 power tubes, a similar winding for the 281 rectifying tube, a third winding at $2\frac{1}{2}$ volts—providing heater current for three or four UY-227 A C tubes, and a fourth winding providing current at $1\frac{1}{2}$ volts for four or five UX-226 raw A C tubes. These capacities are ample for practically every set, with a generous margin of safety.

With either an A C power supply system or batteries, you'll find the fidelity of reproduction brought by the AmerTran Push-Pull Power Amplifier actually limited *only* by the perfection of the speaker. Operated from the Amer-Tran ABC Hi-Power Box, the input to the speaker is free from distortion and objectionable A C hum. The energy output is increased especially at the lower musical frequencies, bringing greater clarity at high or low volume. The amplifier connects to the detector of the receiver and may be entirely A C operated. It is furnished with cable and plug to connect directly with the Hi-Power Box. Here is a combination that not only gives light-socket power with good reception, but with *finer* reception than you have ever heard.

Both units are licensed under patents owned or controlled by R C A and must be sold complete with tubes. Write for literature direct.

AMERICAN TRANSFORMER COMPANY
180 Emmet St. Newark, N. J.
"Transformer Builders for Over 27 Years"

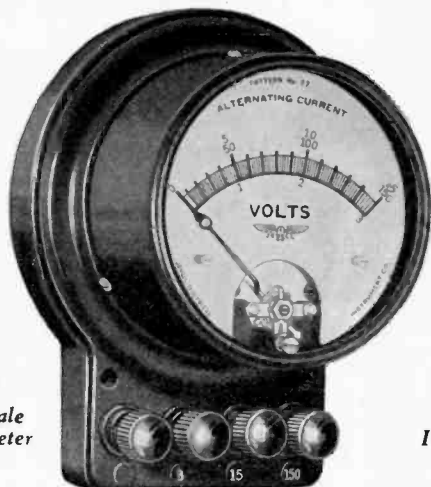

*Pattern
No. 77
Triple Scale
A.C. Voltmeter*

*A
Quality
Instrument*

Find A. C. Trouble Quickly

For locating trouble in the new A.C. operated radio sets, the Jewell Pattern No. 77 triple range voltmeter is the best addition that can be made to any service man's kit of service equipment.

One of the chief troubles in the new A.C. sets, using D.C. tubes in series, is paralysis of the tubes due to improper filament voltage. Another source of trouble is traced to line voltage which varies considerably in some localities. Most sets have some means of compensating for variations in line voltage, but some method of knowing definitely what values are being obtained is quite essential. In sets using the new A.C. four and five prong tubes it is often more important that the filament is right than in sets employing D.C. tubes, as it is found that a particular setting of the filament is sometimes necessary to eliminate hum.

Primary and secondaries in charging transformers also need occasional checking to determine cause of trouble.

Any of the above conditions may be quickly located with the Jewell Pattern No. 77 A.C. voltmeter. The 0-3, 0-15 and 0-150 volt ranges are ample for all ordinary A.C. testing. The Pattern 77 is a quality instrument throughout and holds forth the usual Jewell assurance of years of satisfactory use. The size is such that it can be easily handled and arrangement is made for either bench or wall mounting.

Write for descriptive circular No. 1145.

Jewell Electrical Instrument Co.

1650 Walnut St. - Chicago

"28 Years Making Good Instruments"

When writing to advertisers mention of the Proceedings will be mutually helpful.

17 in.
Diameter



Pacent Balanced Cone \$22.50

\$12.50
complete



Pacent Phonovox
The Electric Bak-Up

PACENT Parts and Accessories Meet Every Radio Requirement

IN SPECIFYING or using radio parts and accessories made by Pacent, you have the satisfaction and confidence in knowing that they represent the most advanced engineering design and are of unquestioned quality.

Among the leading Pacent products that are the outstanding popular choice of engineers, experimenters or radio listeners are the Pacent Transformers, a full and complete line including push and pull filament and power, and the famous audio transformers used by several of the leading set manufacturers and designed for present day amplifying requirements; the Pacent *Balanced Cone* which has established new standards in radio reproduction and the Pacent Phonovox which utilizes the radio set to electrify a phonograph—the biggest sensation of the year.

Pacent products may be obtained at all good dealers. Write for descriptive literature on the items interested in.

PACENT ELECTRIC CO.

91 Seventh Avenue, New York
Manufacturing Licensee for Great Britain
and Ireland

Igranic Electric Co., Ltd., Bedford, England

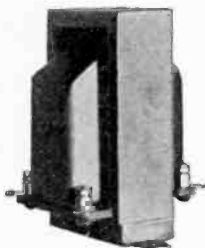

Pacent Transformers
Shielded \$7.50

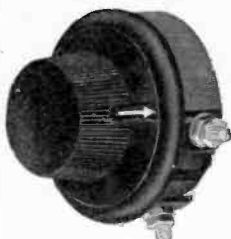

Pacent Rheostats
65c in all capacitors



Pacent Push-Pull
Transformers
\$16.00 per pair



Pacent Auto Plug
60c

When writing to advertisers mention of the Proceedings will be mutually helpful.

Radio - Is - BETTER - With - Dry - Battery - Power



Y
ou can candle
an egg—but not a *battery*

THERE isn't much difference in the size or shape of batteries. And you can't tell how good they are before you use them. ¶ If you could, one element alone would win your preference for Burgess. That element is *Chrome*. ¶ *Chrome* is the *preservative* that maintains an abundance of unfailing energy in Burgess Batteries—long after most dry cells cease to function. The black and white stripes are individual marks for identifying Burgess *Chrome* Batteries. Buy them for long lasting, dependable performance!

Chrome—the preserving element in leather, metals, paints and other materials subject to wear, is also used in Burgess Batteries. It gives them unusual *staying* power. Burgess *Chrome* Batteries are patented.

Ask Any Radio Engineer

BURGESS BATTERY COMPANY

General Sales Office: CHICAGO

Canadian Factories and Offices: Niagara Falls and Winnipeg



BURGESS BATTERIES

When writing to advertisers mention of the Proceedings will be mutually helpful.



ISOLANTITE

*A Tried, Tested and Approved
Insulator for Greater
R. F. Efficiency*



 SOLANTITE is a highly refined, scientifically processed ceramic of exceptional merit for high frequency insulation applications. It is non-porous, low in electrical losses even at extreme frequencies, strong mechanically and produced in a wide range of sizes and designs to your specification.

{ Let us quote on your Insulating Parts }

ISOLANTITE COMPANY *of* AMERICA

New York Sales Offices

551 FIFTH AVENUE, NEW YORK, N. Y.



When writing to advertisers mention of the Proceedings will be mutually helpful.

Nine Reasons Why Radiotrons UX-280 and UX-281 Are Most Economical Rectifiers

- 1 Fewer Condensers required in rectifying and filtering circuits (Buffer Condensers across transformer secondary not required).
- 2 Lower Capacity Condensers can be used (Wave form of UX-280 and UX-281 does not have jagged peaks, thus simplifying filter requirements).
- 3 Lower Voltage Condensers can be employed effecting further manufacturing economy.
- 4 High initial surge voltage from transformer not required as UX-280 and UX-281 start at any voltage. Thus design is simplified and possible failure of condensers due to erratic surge peak is eliminated.
- 5 Possibility of failure to operate due to insufficient breakdown voltage is eliminated.
- 6 Erratic and noisy operation is not experienced with highly evacuated tubes such as Radiotrons UX-280 and UX-281.
- 7 New Ribbon Filament makes tubes unusually rugged.
- 8 Long life.
- 9 The UX-280 will furnish adequate B and C voltage for a receiver using Radiotron UX-171A at maximum plate voltage.

RADIO CORPORATION OF AMERICA
New York Chicago San Francisco

RCA Radiotron

MADE BY THE MAKERS OF THE RADIOLA

When writing to advertisers mention of the Proceedings will be mutually helpful.

PROCEEDINGS OF
The Institute of Radio Engineers

Volume 16

January, 1928

Number 1

CONTENTS

| | Page |
|-----------------------------------------------------------------------------------------------------|------|
| Officers and Board of Direction | 2 |
| Committees | 2 |
| Institute Sections | 4 |
| Institute Activities | 9 |
| News of the Sections | 10 |
| Committee Work | 13 |
| Edwin H. Armstrong, "Method of Reducing the Effect of Atmospheric Disturbances" | 15 |
| Discussion on E. H. Armstrong Paper by C. R. Englund | 27 |
| Harold A. Wheeler, "Automatic Volume Control for Radio Receiving Sets" | 30 |
| Discussions on H. A. Wheeler Paper by G. W. Pickard and E. Bruce | 35 |
| Senatore Guglielmo Marconi, "Radio Communication" | 40 |
| Herbert C. Hazel, "The Calibration of Ammeters at Radio Frequencies" | 70 |
| Raymond A. Heising, "Experiments and Observations Concerning the Ionized Regions of the Atmosphere" | 75 |
| Book Review | 100 |
| J. B. Brady, Digests of U. S. Radio Patents | 102 |
| Geographical List of Members Elected December 7, 1927 | 104 |

GENERAL INFORMATION

The PROCEEDINGS of the Institute are published monthly and contain the papers and the discussions thereon as presented at meetings.

Payment of the annual dues by a member entitles him to one copy of each number of the PROCEEDINGS issued during the period of his membership.

Subscriptions to the PROCEEDINGS are received from non-members at the rate of \$1.00 per copy or \$10.00 per year. To foreign countries the rates are \$1.60 per copy or \$11.00 per year. A discount of 25 per cent is allowed to libraries and booksellers.

The right to reprint limited portions or abstracts of the articles, discussions, or editorial notes in the PROCEEDINGS is granted on the express conditions that specific reference shall be made to the source of such material. Diagrams and photographs in the PROCEEDINGS may not be reproduced without securing permission to do so from the Institute through the Secretary.

It is understood that the statements and opinions given in the PROCEEDINGS are the views of the individual members to whom they are credited, and are not binding on the membership of the Institute as a whole.

Entered as second class matter at the Post Office at Menasha, Wisconsin.

Acceptance for mailing at special rate of postage provided for in the Act of February 28, 1925, embodied in paragraph 4, Section 412, P. L. and R. Authorized October 26, 1927.

Copyright, 1928, by

THE INSTITUTE OF RADIO ENGINEERS, Inc.

Publication Office 450-454 Ahnaip Street, Menasha, Wis.

Editorial and Advertising Departments, 37 West 39th St., New York, N.Y.

OFFICERS AND BOARD OF DIRECTION, 1927

(Terms expire January 1, 1928, except as otherwise noted)

President

RALPH BOWN

Vice-President

FRANK CONRAD

Treasurer

MELVILLE EASTHAM

Secretary and Editor

ALFRED N. GOLDSMITH

Managers

L. A. HAZELTINE

R. H. MANSON

L. E. WHITEMORE
(Serving until Jan. 1, 1929)

J. V. L. HOGAN

A. E. REOCH

R. H. MARRIOTT
(Serving until Jan. 1, 1929)

R. A. HEISING
(Serving until Jan. 1, 1930)

Junior Past Presidents

J. H. DELLINGER

DONALD McNICOL

Assistant Secretary

JOHN M. CLAYTON

Associate Editor

GEORGE R. METCALFE

Committees of the Institute of Radio Engineers, 1927

Committee on Meetings and Papers

R. H. MARRIOTT, *Chairman*

STUART BALLANTINE

R. R. BATCHER

CARL DREHER

W. G. H. FINCH

ERICH HAUSMANN

S. S. KIRBY

G. W. PICKARD

PAUL WEEKS

W. WILSON

Committee on Admissions

F. CONRAD, *Chairman*

ARTHUR BATCHELER

HARRY F. DART

C. P. EDWARDS

A. H. GREBE

L. A. HAZELTINE

R. A. HEISING

L. M. HULL

F. H. KROGER

A. G. LEE

F. K. VREELAND

Committee on Revision of the Constitution

J. H. DELLINGER, *Chairman*

J. V. L. HOGAN

DONALD McNICOL

Committee on Publicity

W. G. H. FINCH, *Chairman*

C. E. BUTTERFIELD

DAVID CASEM

ORRIN E. DUNLAP

E. EHLERT

L. W. HATRY

E. H. HANSEN

LLOYD JACQUET

J. F. J. MAHER

Committees of the Institute—(Continued)

J. G. UZMANN
WILLIS K. WING
R. F. YATES

Committee on Membership

HARRY F. DART, *Chairman*
M. C. BATSEL
M. BERGER
F. R. BRICK
GEORGE BURGHARD
E. M. DELORAINE
DR. L. J. DUNN
C. P. EDWARDS
W. G. H. FINCH
C. M. JANSKY, JR.
ROBERT S. KRUSE
WILLIAM J. LEE
PENDLETON E. LEHDE
C. L. RICHARDSON
F. H. SCHNELL
E. R. SHUTE
G. S. TURNER
E. H. ULRICH

Committee on Institute Sections

DAVID H. GAGE, *Chairman*
M. BERGER
L. F. FULLER
D. HEPBURN
L. G. PACENT
M. C. RYPINSKI
E. R. SHUTE

All Section Secretaries ex-officio

Committee on Standardization

L. E. WHITEMORE, *Chairman*
M. C. BATSEL
EDWARD BENNETT
E. L. CHAFFEE
J. H. DELLINGER
MELVILLE EASTHAM
C. P. EDWARDS
GENERAL FERRIE
A. N. GOLDSMITH
L. A. HAZELTINE
J. V. L. HOGAN
W. E. HOLLAND
L. M. HULL
F. A. KOLSTER
MAJOR J. O. MAUBORGNE
R. H. MANSON
DONALD MCNICOL
E. L. NELSON
H. S. OSBORNE
H. B. RICHMOND
LT. COMDR. W. J. RUBLF
E. H. SHAUGHNESSY
H. M. TURNER
C. A. WRIGHT
HIDETSUGU YAGI
J. ZENNECK

INSTITUTE SECTIONS

ATLANTA SECTION

Chairman
Walter Van Nostrand

Secretary-Treasurer
George Llewellyn, Room 524, Post Office
Bldg., Atlanta, Ga.

BOSTON SECTION

Chairman
George W. Pierce

Secretary-Treasurer
Melville Eastham, 30 State St.,
Cambridge, Mass.

BUFFALO—NIAGARA SECTION

Chairman
L. C. F. Horle

Secretary
C. J. Porter, 141 Milton Street,
Buffalo, New York

CANADIAN SECTION

Chairman
A. M. Patience

Secretary
C. C. Meredith, 110 Church St., Toronto, Ontario

CHICAGO SECTION

Chairman
John H. Miller

Secretary
H. E. Kranz, 4540 Armitage Ave., Chicago, Ill.

CLEVELAND SECTION

Chairman
John R. Martin

Secretary-Treasurer
B. W. David, 3223 Ormond Road,
Cleveland Heights, Ohio

CONNECTICUT VALLEY SECTION

Chairman
W. G. Cady

Secretary-Treasurer
George W. Pettengill Jr., P.O. Box 551
Ludlow, Mass.

DETROIT SECTION

Chairman
Thomas E. Clark

Secretary-Treasurer
W. R. Hoffman, 615 West Lafayette Blvd.,
Detroit, Mich.

LOS ANGELES SECTION

Chairman
L. Taufenbach

Secretary
L. Elden Smith, 340 N. Painter Ave.,
Whittier, Cal.

PHILADELPHIA SECTION

Chairman
J. C. Van Horn

Secretary
John C. Mevius, 1533 Pine St.,
Philadelphia, Pa.

ROCHESTER, N.Y. SECTION

Chairman
Harvey Klumb

Secretary
F. W. Reynolds, 1060 University Ave.,
Rochester, N. Y.

SAN FRANCISCO SECTION

Secretary-Treasurer
D. B. McGown, Custom House,
San Francisco, Cal.

SEATTLE SECTION

Chairman
Tyng Libby

Secretary-Treasurer
W. A. Kleist, 820 Dexter Horton Bldg.
Seattle, Wash.

WASHINGTON SECTION

Chairman
A. Hoyt Taylor

Secretary-Treasurer
F. P. Guthrie, 122 Conn. Ave., Washington, D.C.



FRANK CONRAD
Vice-President, Institute of Radio Engineers—1927

Frank Conrad

VICE-PRESIDENT OF THE INSTITUTE, 1927

Frank Conrad was born in 1874 in Pittsburgh, Pennsylvania. In 1890 he entered the employ of the Westinghouse Electric and Manufacturing Company in Pittsburgh as an assistant in the shops making registering trains for the Shallenberger ampere-hour meters. Mr. Conrad's rise in the Westinghouse organization was rapid. He entered the laboratory after several years as an assistant in the shops. During this stage of his work he invented a number of forms of switches, lightning arresters, and breakers for use in alternating current work. He was closely associated with, and later in entire charge of the Arc Lamp Design Department. This was his first engineering work. Mr. Conrad's connection with radio dates back before the days of any broadcasting. He became interested as an amateur in radio reception of time signals and later in radio-telephone transmission by means of vacuum tubes. He established an amateur radio telephone station which later resulted in the development of the Westinghouse Station, KDKA.

Mr. Conrad was appointed a General Engineer of the Westinghouse organization in 1904 and was promoted to the position of Assistant Chief Engineer in 1921.

In 1925, he was awarded the Morris Liebmann Memorial Prize of the Institute for his early work in connection with high-frequency transmission. He is a Fellow of the Institute of Radio Engineers, a Member of the American Institute of Electrical Engineers, a member of the Society of Automotive Engineers, and a member of the American Association for the Advancement of Science. Mr. Conrad was elected Vice-President of the Institute in 1927 and was the Chairman of the Committee on Admissions during 1927.

CONTRIBUTORS TO THIS ISSUE

Armstrong, Edwin H., Born December 18th, 1890. Was educated at Columbia University, E. E. degree. Research graduate under Professor M. I. Pupin in the Hartley Research Laboratory at Columbia University for a number of years. During the war a captain and later major in the Signal Corps of the United States Army in the Army Research Laboratories in Paris, France. Mr. Armstrong is universally known for his work in connection with the regenerative circuit, the superheterodyne circuits and the superregenerative circuit. At present he is doing research work in the Hartley Research Laboratory of Columbia University. In 1918 Mr. Armstrong was awarded the Institute Medal of Honor. He has been a frequent contributor to the PROCEEDINGS of the Institute, and is a Fellow of the Institute.

Hazel, Herbert C.: Born at Harrodsburg, Indiana, September 26th, 1899. Received A.B. degree Indiana University 1922; received M.A. degree, 1926. During research connected with this work on problems of measuring current and resistance at radio frequencies, the thermionic vacuum tube method of calibrating ammeters was devised. At present, critic teacher in physics in Bloomington (Indiana) High School. Member of Phi Beta Kappa and of Indiana Academy of Science.

Heising, Raymond A.: Born at Albert Lea, Minnesota, August 10th, 1888. Received the E. E. degree, University of North Dakota, 1912; M.S. degree, University of Wisconsin, 1914. With the Research Department, Radio Section, Western Electric Company since 1914 until the Bell Telephone Laboratories were organized. At present with the latter concern. Connected with the development of transmitting apparatus, designed and operated the Arlington Trans-Atlantic Telephone Transmitter, 1915; invented constant current modulation system used extensively in commercial broadcast work and by the United States Army and Navy. Since the war continued research and development work in connection with ship to shore operation, transatlantic tests, etc. Mr. Heising is a Fellow of the Institute. He has contributed numerous papers to the PROCEEDINGS of the Institute and is a member of its Board of Direction. In 1921, he was the recipient of the Institute's Morris Liebmann Memorial Prize.

Marconi, Guglielmo.: Born at Bologna, Italy, April 25th, 1874. Educated at Leghorn Technical School. In 1895 began series of experiments on communication by means of Hertzian waves at which time he was able to transmit intelligible signals to a distance of $1\frac{1}{2}$ miles. In 1896 he took out the first patent granted for a practical system of wireless telegraphy. He transmitted the first signals across the Atlantic in 1901. Senatore Marconi has been associated constantly with the development of radio telegraphy and telephony through his connection with the British Marconi Company and its associated companies. In 1920 Senatore Marconi was awarded the Institute Medal of Honor. He has been a frequent contributor to the PROCEEDINGS of The Institute of Radio Engineers and is a Fellow of the Institute.

Wheeler, Harold A.: Born May 10th, 1903. Assistant in tests of radio receiving equipment, Bureau of Standards, 1921-1922. Associated with Professor Hazeltine in the study of neutralization of capacity coupling in vacuum tubes, 1922-1923. Engineering, Hazeltine Corporation in development of Neutrodyne receivers, including automatic volume control, 1924 to present. Received the B.S. degree in physics, George Washington University, 1925. Assistant in Physics Department, Johns Hopkins University, 1925 to date. Associate member of the Institute.

INSTITUTE ACTIVITIES

1928 CONVENTION PLANS

PLANS for the 1928 Convention have been completed. The Convention will be held on January 9th, 10th, and 11th, the Convention Headquarters being in the lobby of the Engineering Societies Building, 33 West 39th Street, New York City.

Papers on the following subjects will be presented: "A Digest of The International Radiotelegraph Conference;" several papers on "Audio Frequency Amplifiers"; "The Making of Talking Moving Pictures" (with demonstration); "Radio Picture Transmission Symposium on Inter-Electrode Tube Capacities," and several others.

The inspection trips will include a bus ride through the new Holland Tunnel, through the Experimental High Power Station group at Whippany, New Jersey, and the National Broadcasting Company's Station, WJZ; an inspection of the technical equipment of Roxy's Theater; inspection of the studios of the National Broadcasting Company; inspection of the F. A. D. Andrea plant; inspection of Aerovox plant. The plans call for a dinner with entertainment on the evening of January 11th.

DECEMBER MEETING OF THE BOARD OF DIRECTION

At the meeting of the Board of Direction held on December 7th in the offices of the Institute the following were present:

Ralph Bown, President; A. N. Goldsmith, Secretary; Melville Eastham, Treasurer; L. A. Hazeltine, R. A. Heising, R. H. Marriott, R. H. Manson, Donald McNicol, and J. M. Clayton, Assistant Secretary.

The following were transferred or elected to higher grades in the Institute:

Transferred to the grade of Member; T. G. Deiler, B. A. Engholm, W. H. Fortington, L. J. Gallo, J. J. Stanley and John A. Victoreen.

Elected to the grade of Member; E. A. Beane, L. B. Root, and J. K. Skirrow.

One hundred and thirty eight Associate and eight Junior members were elected.

BOUND VOLUMES

Due to the increase in the number of pages in the PROCEEDINGS throughout the year it has been necessary to increase the price of the 1927 *Bound Volumes*. These volumes in blue buckram can

be purchased for \$12.00 in the United States and Canada and \$13.00 in other countries. Members of the Institute, libraries, and book sellers are entitled to a 25 percent discount from these prices.

Bound volumes are available from 1917 to 1927 inclusive. The cost of those prior to 1927 is \$8.75 to members of the Institute, book dealers, and libraries, and \$11.00 to non-members.

Institute Meetings

NEW YORK MEETING

At the New York Meeting of the Institute held on December 7th in the Assembly Room of the Engineering Societies Building, 33 West 39th Street, R. A. Heising of the Bell Telephone Laboratories presented a paper, "Experiments and Observations Concerning the Ionized Regions of the Atmosphere."

Following the presentation of the paper the following participated in its discussion: Messrs. Ballantine, Hallborg, Ohl, Rybner, Shaughnessy, and Brandt.

Over three hundred members attended the meeting.

A limited number of preprint copies of the paper in pamphlet form are available free of charge to members of the Institute upon application to the Institute office.

ATLANTA SECTION

A meeting of the Atlanta Section was held on December 7th in Room 207 of the Chamber of Commerce Building, Atlanta, Georgia. Major Walter Van Nostrand was the presiding officer. C. F. Daugherty read Major Armstrong's paper on "Method of Reducing the Effect of Atmospheric Disturbances." An informal discussion followed the reading of the paper.

The next meeting of the Atlanta Section will be held on January 4, 1928.

BUFFALO-NIAGARA SECTION

At the meeting of the Buffalo-Niagara Section held on November 17th in Foster Hall of the University of Buffalo Dr. Ralph Bown, President of the Institute, presented a paper on "Trans-Atlantic Telephone." L. C. F. Horle was the presiding officer.

A general discussion followed the presentation of this paper.

The attendance at this meeting was over 130.

On December 2d the Buffalo-Niagara members attended a meeting of the American Institute of Electrical Engineers to hear two papers, one by C. H. Bell of the Gould Storage Battery

Company on "Storage Battery Engineering and Development," and the other by A. T. Hinckly of the U. S. Light and Heat Corporation entitled "Dry Battery Developments."

CHICAGO SECTION

There will be a meeting of the Chicago Section on December 16th. Dr. Fred W. Kranz of Riverbank Laboratories will read a paper on "Some Characteristics of Speech and Hearing."

CONNECTICUT VALLEY SECTION

The Connecticut Valley Section held a meeting on December 2d in the club rooms of the United Electric Light Company of Springfield, Massachusetts. Dr. W. G. Cady was the presiding officer.

Carl J. Madsen delivered a paper on "Recent Experience in Installing a 20 Kilowatt Radio Transmitter in Siberia." A general discussion followed the presentation of this paper.

For 1928 the following officers of the Section were elected: Chairman, Dr. W. G. Cady; Vice-Chairman, Dr. K. S. Van Dyke; Secretary-Treasurer, George W. Pettingill.

CLEVELAND SECTION

On December 2d a meeting of the Cleveland Section was held in the Case School of Applied Science. John R. Martin presided.

C. A. Wright presented a paper entitled "Measurement of Inductance." F. T. Bowditch read a paper on "The Measurement of Choke Coil Inductance." Messrs. Victoreen, David, Martin and others discussed these papers.

The new officers of the Cleveland Section were elected as follows: Chairman, J. R. Martin; Vice-Chairman, D. Schregardus; Secretary-Treasurer, B. W. David.

Ralph Farnham was appointed Chairman of the Meetings and Papers Committee and John A. Victoreen was appointed Chairman of the Publicity Committee.

Forty-four members attended this meeting.

DETROIT SECTION

A meeting of the Detroit Section was held on November 18th in the Conference Room of the Detroit News Building, Detroit, Michigan. Thomas E. Clark was the presiding officer.

Stanley R. Manning of the Engineering Department of the Michigan Bell Telephone Company read a paper on "The Effect of Filter Circuits Upon Audio Frequencies." There was included

a demonstration of the elimination of frequencies through filters, specially prepared phonograph records being used.

Thirty-two members of the Section were present at this meeting.

On December 16th there will be a meeting of the Section in the Michigan Bell Telephone Building at which time Dr. N. H. Williams will deliver a paper on "Some Operating Characteristics of The Screen Grid Vacuum Tube." It is planned that a banquet will be held before the next meeting.

PHILADELPHIA SECTION

A meeting of the Philadelphia Section was held in the Franklin Institute on November 25th. J. C. Van Horn presided.

Dr. J. P. Maxfield delivered a paper on "Electrical Recording and Reproducing."

Two hundred and seventy five members of the Section and their guests attended this meeting.

The next meeting of the Section will be in the Bartol Laboratories on January 27th.

SAN FRANCISCO SECTION

Plans for the reorganization of the San Francisco Section are actively under way. A meeting of a committee of the Section membership was held in November. A general meeting, for the purpose of electing officers and making business arrangements for the resumption of the Section's activities, will be held on December 29th. It is expected that regular meetings of the San Francisco Section will be resumed during January of 1928.

Prominent in the reorganization work are: Dr. Leonard F. Fuller (Member Committee on Sections), D. B. McGown, B. H. Linden, A. Y. Tuel and others.

SEATTLE SECTION

The October meeting of the Seattle Section was held on the 15th of the month in the Club Rooms of the Telephone Building, Third and Seneca Streets, Seattle, Washington, T. M. Libby presided.

Two papers were presented, the first by F. A. Brown was entitled, "Inspection of Fishers Blend Station KOMO." The second paper was presented by W. A. Kleist and was entitled, "Trans-Atlantic Telephone Circuit."

Messrs. Libby, Rowe, Renfro, Deardorff, Sylvester, and others discussed these papers.

PROPOSED PITTSBURGH SECTION

There has been received at headquarters of the Institute a petition from members residing within the vicinity of the Pittsburgh territory asking for approval of the formation of a Pittsburgh Section of the Institute. W. K. Thomas, of Ludwig Hommel, has been the leader in the organization of this territory. This petition will be presented to the Board of Direction at the January meeting thereof.

Committee Work

COMMITTEE ON ADMISSIONS

At the meeting of the Committee on Admissions held in the offices of the Institute on December 7th were the following members:

L. A. Hazeltine, F. K. Vreeland, and H. F. Dart.

Eighteen applications for transfer or admission to the higher grades of membership in the Institute were considered. The committee approved the applications for transfer to the grade of Member from six associates. The committee also recommended that three applicants be directly elected to the Member grade.

COMMITTEE ON SECTIONS

At a meeting of the Committee on Sections, October 26th, Messrs. Gage (Chairman), Berger, Shute, and Clayton were present.

The Committee reviewed correspondence with members in the San Francisco territory regarding the reorganization of the San Francisco Section.

Plans for a Section representatives' meeting at the 1928 Convention were formulated.

COMMITTEE ON MEMBERSHIP

On October 31st a meeting of the Committee on Membership was held in the offices of the Institute. Messrs. Dart (Chairman), Finch, Shute, Brick, and Clayton were present.

The committee has been working for some time on a list of persons who are probably qualified for transfer to the higher grades of membership in the Institute.

The committee is considering comments whereby the Institute can be brought more closely in contact with students in engineering courses in technical schools throughout the country.

It was reported that the membership in the Institute during 1927 has undergone a *paid* increase of over forty-four per cent.

Patent Digests

Officers of the Institute have felt for some time that the Patent Digest Section of the PROCEEDINGS may not be serving the majority of the Members of the Institute to any great advantage. It is thought that these additional pages could be devoted to other matters with better advantage to the membership. Unless definite and concrete suggestions to the contrary are received in any quantity, the Patent Digest portion of the PROCEEDINGS will be eliminated immediately.

Personal Mention

W. C. Fogg has joined the Meter Testing Department of the Union Gas and Electric Company of Cincinnati, Ohio.

J. Kelly Johnson is now an instructor in electrical engineering, Columbia University, New York City.

C. B. Joliffee, formerly with the Buckeye Incubator Company of Springfield, Ohio, has rejoined the radio staff of the Bureau of Standards at Washington, D.C.

William F. Devine has become associated, as operating engineer, with Station WREN of Lawrence, Kansas. He was formerly in the Sales Department with the Broadway Radio Company of Kansas City.

Harry Diamond, formerly instructor in electrical engineering, Lehigh University, Bethlehem, Pennsylvania, is now an associate radio engineer at the Bureau of Standards, Washington, D.C. in the Radio Aeronautic Section in the Development of Radio Aids to Aviation.

Lewis M. Hull has recently become director of research of the General Radio Company of Cambridge, Massachusetts with headquarters at Cambridge. He continues to be the director of research of the Radio Frequency Laboratories of Boonton, New Jersey with which he has been associated for nearly six years. Through this new arrangement the facilities of the laboratories of both the General Radio Company and the Radio Frequency Laboratories will be available on problems of the other.

Errata

In the paper by Mr. Greenleaf W. Pickard on "The Relation of Radio Reception to Sunspot Position and Area," published in the PROCEEDINGS for December, 1927, the ordinates of Figs. 1 to 9, inclusive, have been erroneously designated as "Microvolts Per Meter." These ordinates represent percentage variation of the elements.

METHODS OF REDUCING THE EFFECT OF ATMOSPHERIC DISTURBANCES*

BY
EDWIN H. ARMSTRONG

(Marcellus Hartley Research Laboratory, Columbia University)

Summary—The transmitter sends the dots and dashes on one frequency and the spaces on a slightly different frequency. At the receiver a local frequency is superimposed producing two audio frequencies. The paths of the two audio frequencies are combined differentially so they would oppose if they occurred at the same time; also, they would pull the marking pen in the opposite direction if they occurred at the same time. Since one audio frequency is due to the dots and dashes while the other is due to the spaces, they do not occur at the same time. Since static hasn't a definite frequency it may produce about the same amount of audio-frequency current in each path, thereby more or less neutralizing its own effects. The tape records made with this system and an ordinary system show marked advantage in this system for reducing the effects of static and for increasing speed of recording.

IT is the purpose of this paper to describe a method of reducing the effects of atmospheric disturbances by selective means as distinguished from that means which depends on the geography of the situation: directional reception.

The method is based on the fact that the distribution of energy with respect to frequency of the waves of natural origin is such that over short periods of time the energy in the component at a given frequency is substantially equal to the energy at a closely adjacent frequency, and that in a "crash" or burst of static both these frequencies will be present simultaneously.

In the respect that the energy of the disturbances is distributed through a band and the energy of the signal concentrated in substantially one frequency there lies a fundamental difference which has been utilized to the utmost to effect the separation of the two by means of electrical tuning.

In the respect that the energy of the disturbances and the energy of the signal is alternately present or absent, the first by reason of the irregularities of nature, the second by reason (in telegraphy) of the Morse code or equivalent, there is no fundamental difference. In this respect the two are the same, the difference being one of degree only.

The method which is here described is based on the establishment of a difference between the natural waves and the signaling waves which lies in imparting to the signaling waves a charac-

* Received by the Institute, August 25, 1927.

* Presented before the Institute of Radio Engineers, New York City, October 5, 1927.

teristic not found in the waves of natural origin. This difference is established by producing at the transmitter two waves of closely adjacent frequency and radiating them alternately. Now consider that band of frequencies which just includes the two frequencies selected for signaling. Energy from the waves of natural origin will be received simultaneously in substantially equal amounts throughout the band. Energy from the signaling waves will be received alternately at the upper and lower ends of the band. With this fundamental difference it becomes possible

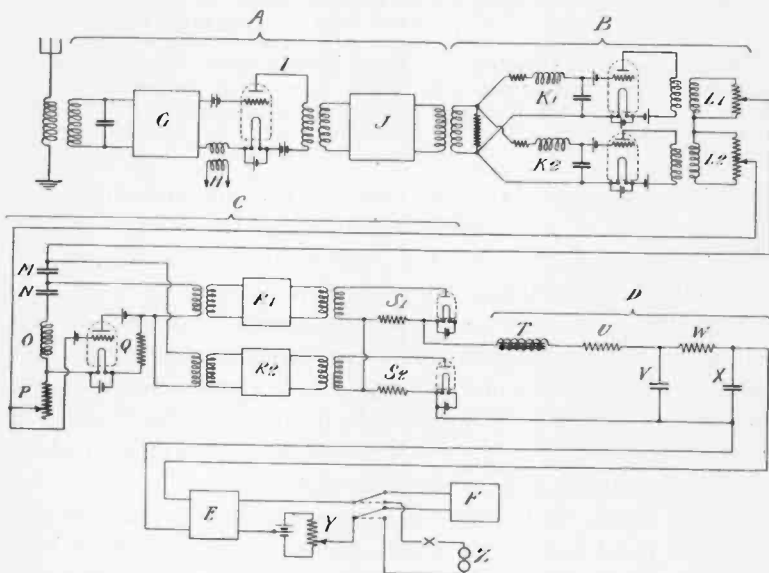

Fig. 1

to provide that long looked for device, the receiver which acts cumulatively with respect to the signal but differentially with respect to the "static." This receiver is one which produces a certain effect on the indicator when one of the two frequencies in question is present alone; an opposite effect on the indicator when the other frequency is present alone; but a neutralized or zero effect when both frequencies are present simultaneously.

Both the nature of the problem and the conditions of practical working require that the two signaling frequencies shall be very close to each other. Hence the method of selection must be capable of effectively separating the two frequencies in a minimum of time to meet the requirements of rapid signaling. In general,

on the long waves used in trans-oceanic signaling, a frequency variation of from 25 to 100 cycles is sufficient; on the shorter waves a greater variation (where the variation lies in the fundamental and not in a modulated or superimposed frequency) is necessary although the increase is not in any sense a proportional one.

The method of transmitting the two signaling frequencies requires no further comment than to say that the key is arranged to change the frequency transmitted when the key is down from, say 20,000 cycles, to 20,050 when the key is up.

The method of reception is illustrated by the arrangement of Fig. 1. In this figure *A* represents the usual form of receiver comprising a tuned amplifier *G*, a detector *I*, heterodyne *H*, and

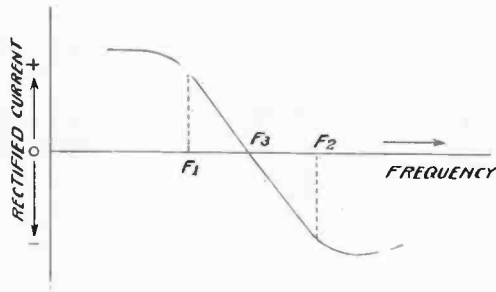

Fig. 2

low frequency amplifier *J*. Connected to the output of this low frequency amplifier are two tuned circuits K_1 and K_2 resonant respectively to the two beat frequencies composing the signal. In the case to which the curves hereinafter shown refer, these two frequencies were 1200 and 1280 cycles. Each circuit controls an amplifier and the outputs of the amplifiers are differentially connected through transformers and potentiometers L_1 and L_2 . The organization just described has the double function of selectively responding to the two signaling frequencies with equal facility and of equalizing the energy of the natural waves between these two frequencies so that such irregularities as do occur are minimized.

The organization connected to the output of the equalizer and shown under the heading *C* represents the selective system for separating the two signaling frequencies, converting them to continuous currents and combining the resulting effects cumulatively. *M*, *N*, and *O* are condensers and an inductance whose values are so chosen that the combination of *N* and *O* is non-

reactive for 1220 cycles and the combination M , N , and O is non-reactive for 1280 cycles. The two combinations form the basis for the rapid separation of the two signaling frequencies. P , Q , and the associated vacuum tube amplifier is a resistance compensator for neutralizing the effect of the resistance in the condensers M and N , and of the inductance O . Q is a large resistance, normally four to five thousand ohms, and P is a resistance commensurate with the resistance of the combination M , N , O . Connected across the combinations N , O and the compensator and M N O and the compensator are two transformer primaries of

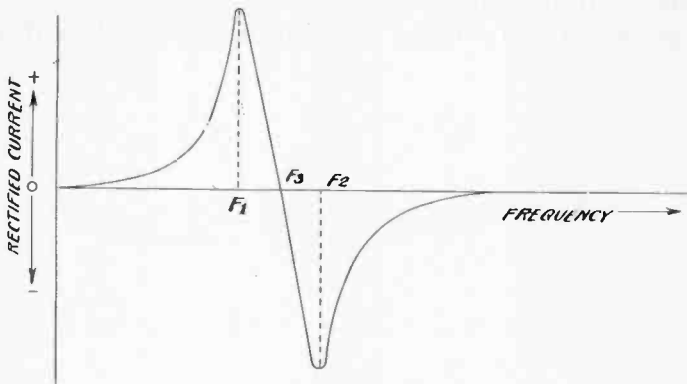

Fig. 3

sufficiently high impedance so that the characteristics of the system M N O are not affected. The secondaries of these transformers control two equal amplifiers R_1 and R_2 whose outputs are connected respectively to two valve rectifiers which are furnished with series resistances S_1 and S_2 of such value, that for the strength of signal used, substantially straight line rectification is effected. The outputs of these rectifiers is then differentially combined.

The relation between the combined continuous current output of the rectifiers and the alternating current input to the combination M N O with respect to frequency is shown in Fig. 2. As the frequency of the input current is increased the rectified current does not vary materially until a certain frequency F_1 is reached (1220 cycles). Further increase in frequency causes a decrease in the rectified current until it reaches zero at a certain frequency F_3 . Still further increase of input frequency causes the output current to flow in the opposite direction and to increase until a certain frequency F_2 is reached beyond which the current again does not vary materially. The combined characteristic of the

equalizer *B* and selector *C* is illustrated in Fig. 3. Here the frequencies above F_2 and below F_1 are substantially cut off and a maximum and opposite response is obtained at each of these frequencies respectively.

Referring again to Fig. 1 the combined outputs of the rectifiers are fed into a low pass filter *D* as shown. The output of this filter is connected to a d-c. amplifier *E* whose output controls a siphon recorder *F*.

With this description of the system of Fig. 1 in mind examine the action of the arrangement for incoming signals (in the absence

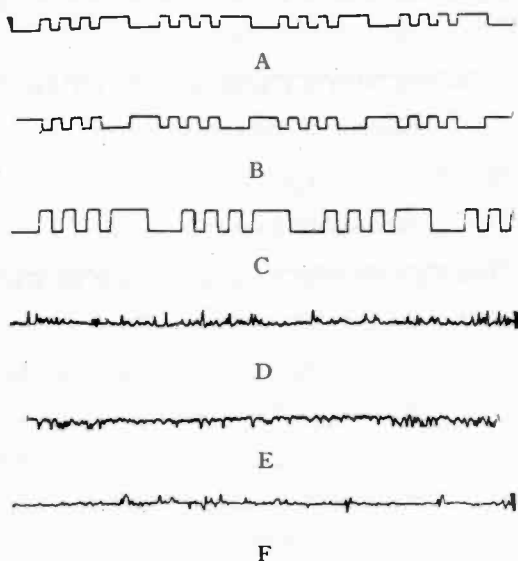

Fig. 4

of static): Suppose that the transmitted signal, with the key down, is 20,000 cycles and with the key up 20,060 cycles. Suppose the heterodyne to be adjusted to 18,780 cycles. Then when the key is up a beat frequency of 1280 cycles is produced and in accordance with the curve of Fig. 3 a rectified current having the polarity and magnitude corresponding to F_2 results. This passes through the filter *D*, is amplified by the d-c. amplifier *E*, and produces a deflection of the marker of the siphon recorder from the neutral position in a direction which depends on the polarity of the rectified current.

When the position of the transmitter key is reversed (i.e., down, 20,000 cycles transmitted) a beat frequency of 1220 cycles

is produced and this produces a rectified current corresponding in magnitude and direction to F_1 in Fig. 3. This rectified current is of substantially the same amplitude as that produced by the 20,060 cycles when the key was up, but it is of opposite polarity. This rectified current causes the marker of the siphon recorder to return to and pass through its neutral position and to be deflected in the direction opposite to that in which it was deflected when the transmitter key was up. Hence the total deflection of the siphon recorder is double that which would be obtained with the standard

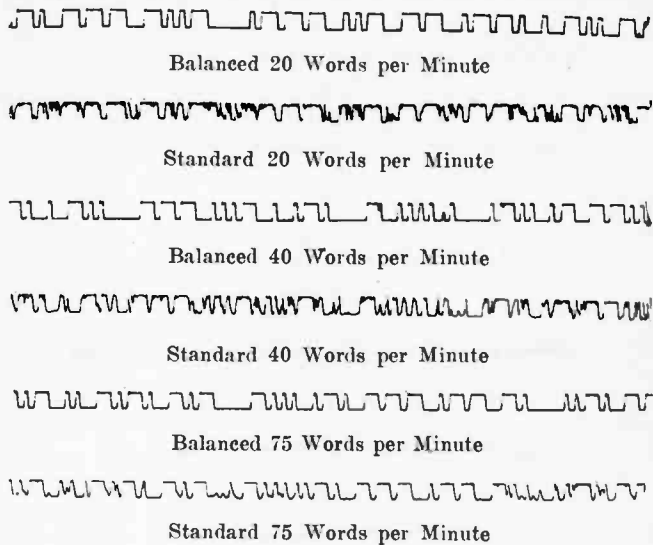

Fig. 5

method of signaling. The three tapes shown in Fig. 4 illustrate this action. Tape *A* is a record in which only the 20,000 cycle current was transmitted, the letter *V* being sent by ordinary keying, (i.e., interruption). Tape *B* is the record produced when the same letter *V* is transmitted on 20,060 cycles, keying in the same way. In this case the response is inverted. Tape *C* is the record produced when keying is accomplished by alternately radiating both frequencies. In this case the response is substantially the cumulative combination of *A* and *B*.

Now consider the action of the system for the waves of natural origin (in the absence of signals). Over a period of time there will be substantially the same amounts of energy received from these waves between the frequencies F_1 and F_2 as between the fre-

quencies F_3 and F_2 . Over short intervals of time due in part to the inequalities of heterodyning,* as well as to the irregularities of nature, more energy may be in the lower or higher of the two frequency bands. The equalizer B reduces this inequality so that there are delivered to the selector system C two bands of frequencies of about the same energy. These two bands are separated by the selector C into high and low frequency groups which are supplied respectively to the rectifiers. The character of the currents produced in the output of each of these rectifiers is illustrated in Fig. 4 by tapes D and E . Each current is a pulsating unidirectional one. When the two are combined differentially the resultant current shown in tape F is produced. It will be observed that this resultant current is irregularly alternating and that the

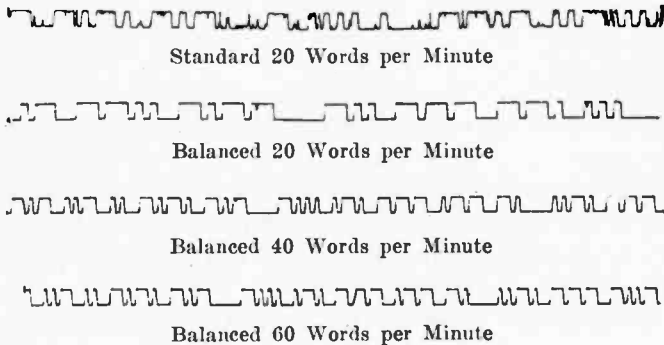

Fig. 6

average values above and below the zero line are equal. It will also be observed that during the interval of a dot or dash that the signaling current is unidirectional over a longer period than is required for the residual currents produced by the atmospherics to reverse themselves. Hence the two currents are capable of further separation by means of the low pass filter D interposed between rectifiers and recorder.

The foregoing analysis describes in a general way what happens in this system when signals are being received alone and when static is being received alone. While a great deal more might be written about the action when both are received in combination since the particular phase relation between the signaling currents and the disturbing currents modifies the behavior of the system somewhat, yet it will be along the lines laid down and this part of

(* The particular initial phase relation between the heterodyne current and the individual natural waves.)

the operation can best be followed by an analysis of the tapes taken under conditions of practical working.

There are two bases upon which comparisons may be made between the standard method of signaling and the method herein described. One is to make a record of the balanced method at a speed at which the tape is just readable without error and to compare it with a record taken at the same speed with the standard method, estimating the extent to which the signal has been buried

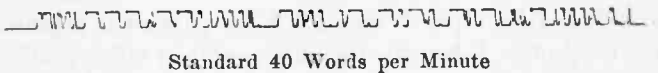

Standard 40 Words per Minute

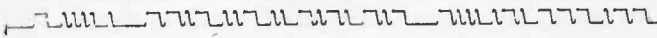

Balanced 100 Words per Minute

Fig. 7

in the second case. The other is to make a comparison of the relative speeds of the two methods at which it is possible to work without error.

The first method of comparison is perhaps the most spectacular and interesting to the engineer, particularly those who have spent much time on the problem. The second method is the one which

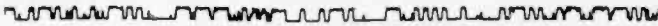

Standard 30 Words per Minute

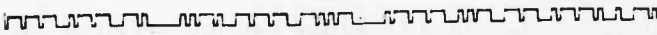

Balanced 30 Words per Minute

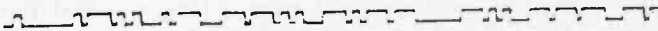

Balanced 60 Words per Minute

Fig. 8

will appeal to the traffic manager and to all those who deal with the delicate balance between paid words handled, and overhead operating expense and cable competition.

The results obtained with either of these methods will vary depending on the type of atmospheric disturbances encountered. For example, assuming extremes, we might have a condition where the disturbances were due entirely to lightning strokes occurring in the immediate neighborhood of the station. Even though the balanced method were capable of reducing the effect

of these disturbances to a few per cent of their original value the overpowering effect of the residual would make its mark upon the tape and destroy the signal to the same extent as in the standard method, and no advantage would be gained. On the other hand the disturbances might consist wholly of grinders of about the same amplitude as the signal but present in such quantities as to bury it completely when using the standard method. These grinders, if reduced to a few per cent of their value, would disappear as a factor and a signal readable at any speed within the capabilities of the recorder would result. Between these two theoretical limits there lie the conditions of practical working, although both extremes are sometimes approached.

There are illustrated in Figs. 5, 6, 7, and 8, photographic reproductions of representative sections of records which have been taken over a long period of time under the varying conditions referred to and with both methods of comparison. The comparisons were made between the arrangement shown in Fig. 1 and the standard form of receiver now widely used in trans-oceanic work. This latter consisted of a tuned amplifier system for the 20,000-cycle current, comprising four tuned circuits arranged for a maximum of selectivity, a push pull detector system with separate heterodyne, and a low frequency amplifier whose output, when rectified by a simple valve, produced a current of 6-8 mil amperes in the coil of an R.C.A. standard siphon recorder. The comparisons were made on the non-directional antenna at Columbia University of a single wire about 100 feet high and 500 feet long. Signals were transmitted from a local oscillator feeding into the antenna and arranged to transmit either the normal type or the double frequency type of signal. The frequency used was about 20,000 cycles with a variation of 40 cycles. The ordinary Wheatstone automatic was used throughout. On account of the difficulty of operating two systems with two separate recorders simultaneously the records for comparison were made consecutively, usually within a few seconds of each other. In all practical cases this gives a sufficiently accurate comparison.

Fig. 5 shows some tapes taken according to the first method of comparison at three different speeds—20, 40, and 75 words per minute. In each case the record for the balanced method was taken first, the strength of the transmitted signal being adjusted to give just readable tape. As soon as this record was completed the record for the standard method was taken, both speed and signal strength remaining constant. These records were taken

under conditions encountered on the ordinary summer evening and speak for themselves.

Fig. 6 shows some records taken according to the second method of comparison. In each case the tape for the standard was taken first, the signal strength being adjusted to give a readable signal. The recorder was then connected to the balanced system, and, with the same signal strength, the speed of the

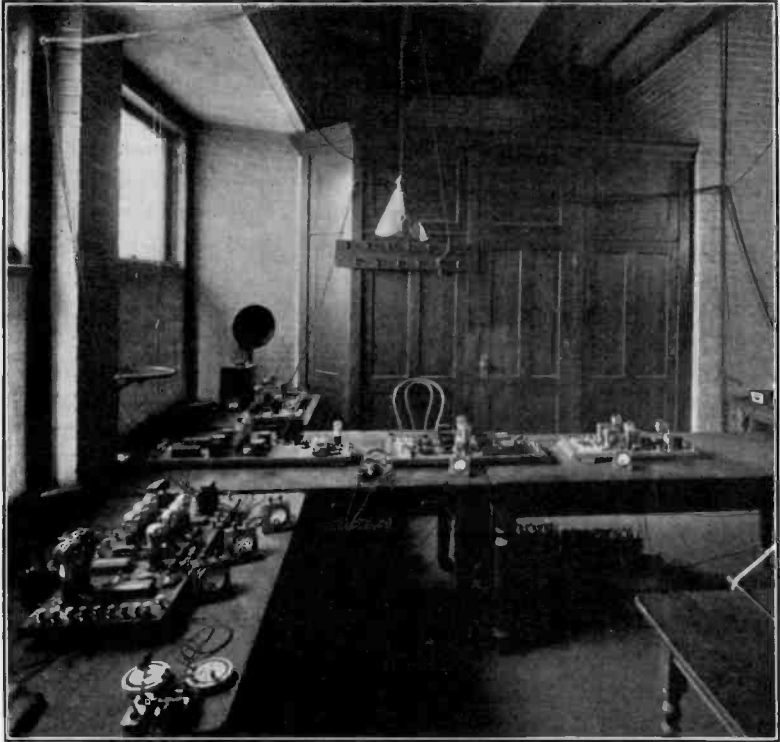

Fig. 9—Balanced Receiver Set-up in Hartley Research Laboratory.

Wheatstone increased until the limit of readability was reached. This set of tapes shows that a signal on the standard which is just readable at 20 words per minute is easily readable with the balanced method at 60 words per minute. Another set of tapes illustrated in Fig. 7 shows a signal readable at a speed of 40 words per minute on the standard reaching easily 100 words per minute with the balanced method. In this particular case the limit was not the atmospheric disturbances but the inability of the transmitter relays available to behave properly above this speed. The

records of Figs. 6 and 7 were both made on a normal summer evening. Fig. 8 illustrates a comparison made according to the second method during a heavy thunder storm. An improvement of double the speed was obtained.

Figs. 9 and 10 show the principal parts of the balanced receiver set-up in the Hartley Research Laboratory at Columbia University and give a general idea of the amount of apparatus involved.



Fig. 10—Balanced Receiver Set-up in Hartley Research Laboratory.

Referring to Fig. 9 the apparatus mounted on the two center tables and the table in the lower left of the photograph corresponds to the apparatus designated, in Fig. 1, by *J*, *B*, *C*, *D*, and *E*.

Summing up the results of a long series of tests it appears that, in Morse signaling, the speed obtained with the standard method can at all times be doubled and, under certain conditions, improved from three to five times. In facsimile transmission it is probable that the improvement will be even greater, for the criterion to be applied there is not one of intelligibility to a skilled

operator who is the medium between a ragged tape and a type-written copy. The criterion in facsimile transmission is one of intelligibility plus the question of how much permissible smudge may be forwarded to the customer on his message. In this last respect the difference between the two methods is even more pronounced than in the matter of speed.

In closing this paper I want to make an acknowledgment of the debt I owe to my old professor, Michael Idvorsky Pupin. Over thirteen years ago we began an investigation of the problem of atmospheric disturbances. For three years we continued it to the exclusion of all other work. The result was barren in the sense of arriving at a solution, yet the instruction that I received in electrical transients and the knowledge that I gained of that particular kind of transient which we designate as static, lies at the base of the present development. I want also to express my appreciation to Mr. Thomas J. Styles, whose assistance throughout the course of this work has been invaluable.

Discussion

Carl R. Englund: Some dozen years ago the subject of static was a very live and at the same time a rather mysterious subject. The mystery is in great measure gone now, and a realization of what can actually be done to mitigate static has tempered the interest which most of us feel in the subject while the fact that we still know little of the origin of static is of more theoretical than practical importance. Now, in the paper before us, we have a former line of static argument reopened and I am sure I am not alone in the feeling that this paper should be carefully scrutinized.

The earlier schemes for balancing static out while leaving the signal in, may perhaps be grouped in three classifications. Thus:

(a) Schemes where receptions from several antennas with unlike constants are directly combined to balance out the static.

(b) Schemes as above but combined for balancing after detection or rectification.

(c) Schemes combining the outputs of antennas either having different polar characteristics or spaced widely apart so as to obtain directive characteristics and balances.

We now know that schemes (a) do not work satisfactorily and that schemes (c) may be made to work satisfactorily. Schemes (b), however, in which category the Armstrong apparatus appears to be included, are more difficult to prove or disprove. For schemes (a) a balance is obtained only when both amplitudes and phases are correctly adjusted for all frequencies and one of the ideas justifying a study of schemes (b) has been that by rectification we in some measure remove the phase balance condition from the requirements for a static balance. As far as I know this scheme was first discussed by John Mills some eleven years ago and first tested by H. T. Friis about six years ago. Experiment showed that single impulses could be balanced out but overlapping impulses could not be balanced. Now for a pure impulse and two antenna systems, say, the transient currents flowing will be

$$\left. \begin{aligned} I_1 &= I_a t^{-\alpha_1} \sin \omega_1 t \\ I_2 &= I_b t^{-\alpha_2} \sin \omega_2 t \end{aligned} \right\}$$

and if by adjustment of the circuit constants we make $\alpha_1 = \alpha_2$ and rectify, we shall have two rectified pulses having about the same shape or envelope and a balance adjustment can be made. But

Received by the Institute, November 2, 1927.

a second impulse occurring before the currents from the first impulse have subsided finds itself occurring in the two systems at a different phase with respect to the existing current, which adds in on the new transient, and the rectified pulses will no longer have a common shape. This simple line of argument is not rigorous when applied to static but gives a picture which can be used with discretion. Certainly the larger part of static fits more nearly the overlapping rather than the isolated impulse case.

Another method of attack on the static reduction problem is by the use of selective circuits. Here the mathematician can be of assistance and has already rendered aid. Koert's "Atmosphärische Störungen in der drahtlosen Nachrichtenübermittlung," 1924, Burch and Bloemsma *Phil. Mag.* 49, 480, 1925 and Carson, *Bell Tech. Jl.* 4, 265, 1925 all arrive at substantially the same result, by an application of the Fourier analysis with certain plausible assumptions. This result may be roughly stated as follows. The figure of merit of a selective system for a signal frequency band versus an arbitrary interference, is the ratio of the area under the resonance curve of the system occupied by the band to the total area under the resonance curve. The chief assumption required is that the frequency spectrum of the interference have no pronounced oscillations through the width of the resonance band, an assumption which is defensible.

The application of the foregoing to Armstrong's paper is evident. The fact that he uses a common antenna for two receptions does not seem to be vital, especially when used in connection with the balanced amplifier B and the circuit M, N, O, P, Q . Both of these latter are conjugate devices to split his double-frequency transmission into two quite separate channels so that the balancing after detection comes under schemes (b). At the same time that he utilizes this balancing scheme he has both ordinary resonant circuits and a low pass filter operating on the signals and the resulting selectivity should be marked and possibly nearly equal to the maximum useful selectivity his relatively low-frequency signal can use. Since schemes (b) have been found inoperative on practically all static in earlier work, and as both theory and practice demonstrate the pronounced reduction of interference possible by high selectivity on narrow band transmission of the type he used, it is fair to ask if his results are not in great measure due to selectivity alone. None of his signals occupied a frequency band much exceeding 100 cycles in width, and if I understand his paper correctly he has *not* compared balance and non-balance

conditions on signal transmission using the same total selectivity for both. I refer particularly to the low pass filter in his own apparatus. A mere comparison of the performance of a separate standard set with his apparatus is not a valid procedure for proving the operation of a static balancing apparatus.

Considering the importance of Mr. Armstrong's conclusions, the data given by him are rather too brief to be satisfactory. Record *F* does show a marked balance over records *D* and *E*, but if these are all to the same time scale as records *A*, *B*, and *C*, a low pass filter would remove practically all the static unaided in my opinion. Records *D*, *E*, and *F* are the only static-bearing records depending solely on a balance which he gives, and are not sufficient to permit an estimation of the part played by the "balance" factor in the improvement of the signal reception records 5, 6, 7, and 8. It is of course this "balance" in which we are above all things interested.

Mr. Armstrong in his second paragraph assigns the operation of the system to an energy balance valid for signals as against static. This can ordinarily be defended if qualified by the proviso that the energy is averaged over a sufficient interval, but experience shows that such intervals do not exist. Mr. Armstrong, however, rallies to his aid the idea that the static energies in two receivers operating at only slightly different frequencies will be so nearly identical in electrical form that a balance can be gotten. But the sharper the bridge balance necessary to resolve two adjacent frequencies becomes, the greater the ability of the system to pick out unbalance also becomes, and a net gain seems doubtful. It is surely to be hoped that Mr. Armstrong will give us further data where the separate roles of balance and selectivity are more clearly brought out. Especially to be desired are over all, or ether-to-siphon-recorder, selectivity curves for both sets.

AUTOMATIC VOLUME CONTROL FOR RADIO RECEIVING SETS*

By

HAROLD A. WHEELER

(Hazelbline Corporation)

Summary—A receiving set is described in which the radio-frequency amplification is automatically controlled to give a nearly constant radio-frequency voltage at the detector, independent of differences in antenna signal voltage. This results in nearly uniform response at the loud-speaker from nearby and distant broadcasting stations and also reduces the effect of fading. The method employed consists in using the rectified carrier voltage to adjust the grid bias of the radio-frequency amplifier tubes. There are indicated the solutions of special problems that arise in carrying out this method.

IN the present radio receiving sets employing high amplification, it is necessary to adjust carefully a "volume control" in order to reproduce signals of different intensities with the same audible intensity from the loud speaker. There are various devices which could be employed to regulate automatically the

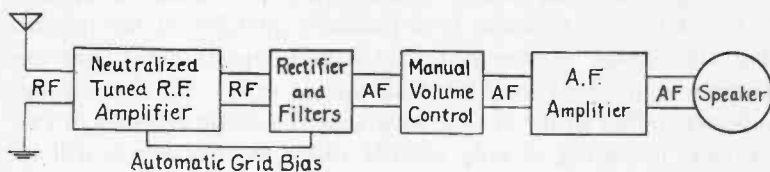

Fig. 1

amplification of the signal, some of which employ moving mechanical parts. It is the purpose of this paper to describe a simple electric circuit, without moving parts, in which the amplification is regulated automatically by the signal, and the loud speaker intensity reaches approximately the desired level for each signal, independent of the signal intensity and therefore irrespective of a reasonable amount of fading.

Any device to accomplish this object without introducing distortion of music or speech must operate by the signal carrier wave. Any variations in its intensity must be compensated by reciprocal variations in its amplification. The method to be described provides for controlling the radio-frequency amplifier, thereby maintaining the desired signal level in the detector or rectifier, audio-frequency amplifier and loud-speaker.

* Received by the Institute, October 6, 1927.

* Presented before the Institute of Radio Engineers, New York City, November 2, 1927.

Fig. 1 shows the outline of a set which has been constructed for broadcast reception, embodying this automatic volume control, comprising the following component sections. (1) A four-stage radio-frequency amplifier of the well-known Neutrodyne type, with UX 201-A tubes, the antenna circuit tuned by one dial and

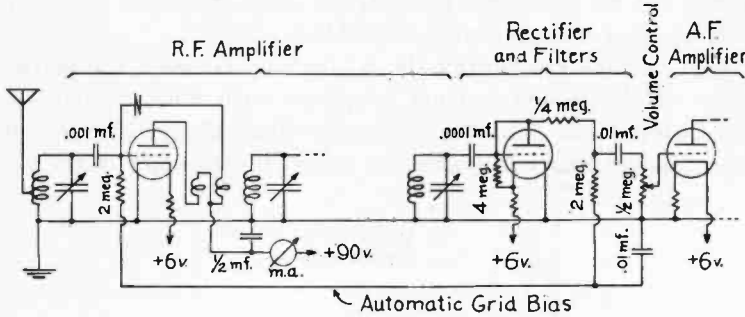

Fig. 2

the four coupling transformers tuned simultaneously by a second dial. The total amplification is controlled by varying the negative grid potential of the first three tubes. (2) A two-element rectifier with simple filter circuits to reject the radio-frequency currents

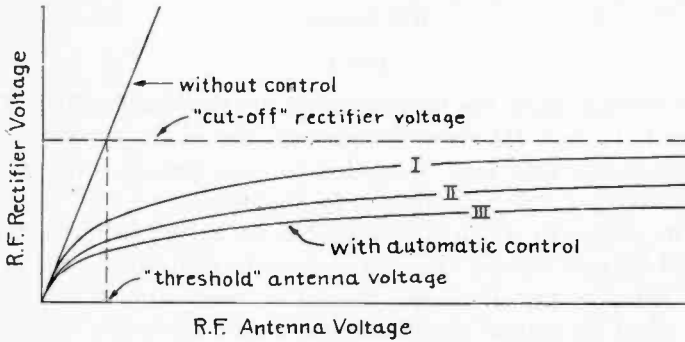

Fig. 3

and to segregate the direct and audio-frequency components of the pulsating rectified voltage. (3) A manual volume control in the form of a voltage attenuator connected to the grid of the first audio-frequency amplifier tube. (4) A four-stage audio-frequency amplifier and loud speaker. The entire set, excepting the last two audio-frequency stages, was enclosed in a grounded metal box divided into compartments, one for each tube with its preceding coupling circuit.

Fig. 2 shows the essential circuit details pertaining to the control system. The direct component of the rectified voltage, free of audio-frequency variations, is applied to the grids of the first three tubes. If the radio-frequency rectifier voltage could exceed a value of about ten volts, this automatic grid bias would thereby cut off the signal through the radio-frequency amplifier, so the rectifier voltage cannot exceed this value.

Fig. 3 shows graphically the comparison between the performance of the radio-frequency amplifier with and without the automatic control. With the system described, the rectifier voltage and audio-frequency voltages are nearly independent of the an-

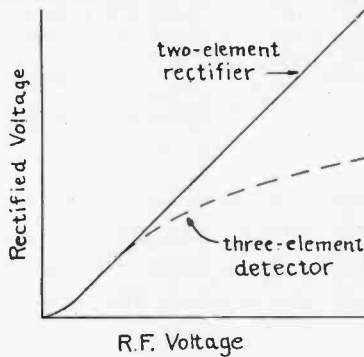

Fig. 4

tenna voltage, when the latter exceeds the threshold value. The curves I, II, and III show the performance of the system when the automatic grid bias is applied to one, two, or three tubes, respectively, of the radio-frequency amplifier.

The degree to which the signal can be cut off in one tube is limited by two factors. First, any error in neutralizing the grid-plate capacity permits signal current to pass through the tube, even when its mutual conductance is zero. Secondly, the sharp bend in the plate-current grid-voltage curve causes distortion of a strong signal on the grid, when the mutual conductance is reduced too far by the grid bias. In view of such limitations, it is undesirable to reduce the amplification ratio per stage below about 1/10 of its normal value. When controlling several tubes, these limitations become unimportant. The last radio-frequency stage is not controlled because it must supply as high as ten volts to the rectifier.

The properties of the two-element rectifier contribute largely to the simplicity of the control system. Fig. 4 shows the nearly

linear proportionality between alternating and rectified voltages in this form of rectifier, as contrasted with the irregular performance of the three-element detector. The signal modulation is rectified without distortion. Also the average rectified voltage is equal to the rectified carrier voltage, while with a "voltage-squared" detector the average rectified voltage is proportional to the average total power of carrier and sidebands. This last feature is worthy of mention in connection with the control system, since the automatic grid bias should depend only on the carrier amplitude, independent of the modulation.

With the circuit constants shown in Fig. 2, the time constant of the circuit which connects the rectifier to the grids of the control tubes is $1/40$ second, so that the control system comes nearly to equilibrium in $1/20$ second. This time can be reduced further if necessary, but is ultimately limited by the allowable reduction of the signal modulation at the lowest audio frequencies.

In consequence of the automatic control action, it becomes difficult to tune the receiving set accurately by ear to a desired signal. The amplification of the controlled tubes is decreased as the response to the signal is increased by tuning, and vice versa, so that the point of resonance is indicated by minimum plate current in the radio-frequency amplifier. Taking advantage of this fact, a milliammeter (*m.a.*, Fig. 2) is connected in the plate circuit of the first tube, to be used as a resonance indicator, and also to give an indication of relative signal intensities.

There is an incidental problem in supplying the plate current to all tubes of the set described from a common rectifier and filter system. In the controlled radio-frequency amplifier tubes, when operating at low plate current, the signal carrier is modulated appreciably by small fluctuations in the plate voltage. Such fluctuations are caused by the plate current pulsations in the audio-frequency amplifier. In the presence of a strong carrier wave, these two effects may cooperate to generate a low frequency oscillation. This disturbance may be avoided by reducing the internal output impedance of the rectifier-filter, by decreasing the amplification at low frequencies in the audio-frequency amplifier, or by using separate rectifier-filter systems to supply the plate currents of the radio- and audio-frequency amplifiers, respectively.

The performance of the automatic volume control as described can be summarized briefly as follows. A maximum variation of signal voltage in the ratio of 1:1000, corresponding to differences in distance, fading, or tuning, results in a maximum variation of

the rectified carrier voltage in the ratio of only about 1:3. This small variation, together with possible differences in the degree of modulation of different stations, can readily be compensated if necessary by adjusting the manual volume control for the audio-frequency amplifier, which also determines the "volume level" for the automatic volume control.

The name "Audiostat" has been selected for this device, by reason of its tendency to maintain the audible intensity at a constant value.

Attention might be called to British Patent 259,664 (Western Electric Co., July 14, 1925), in which a somewhat similar system is presented. This latter system is applied to a super-heterodyne receiving set, and is more involved in several respects than the system described in this paper.

It is desired to acknowledge the cooperation of the Howard Radio Company of Chicago, in whose laboratory the set described was assembled.

Discussion*

G. W. Pickard: Mr. Wheeler has confined his bibliography to a single reference, British Patent 259,664 of July 14, 1925. May I suggest that the PROCEEDINGS of the Institute of Radio Engineers is in this case a more fertile field than patent files, for in a paper entitled "Short Period Variations in Radio Reception," presented before this Institute on December 12, 1923, and published in the PROCEEDINGS of April, 1924, will be found a description of the exact system of Mr. Wheeler's paper.

For convenience, I will give the quotation from my 1923 paper:

So far as the varying intensity of the sound in the telephone receiver is concerned, there are several simple expedients which will markedly smooth out reception from a distant station. Thus, the grids in a radio-frequency amplifier train may be floated on a fairly large condenser, shunted by a high resistance. When reception is weak, the grids assume a small negative potential, and amplification is at a maximum. When the input rises, a large negative charge is built up on the grids, and amplification is reduced. *Similarly, a separate rectifier connected to the output end of the radio-frequency amplifier and to the grids will have the same effect.* (Italics mine. G. W. P.)

By accident rather than by design, some of the resistance-coupled radio-frequency amplifiers of 1917-1918 achieved a certain degree of automatic volume control. In these amplifiers rectification went hand-in-hand with amplification, with the result that a strong signal would build up so large a charge on the grids that amplification was greatly reduced.

Mr. Wheeler mentions the difficulty in tuning such a receiver by ear. This difficulty is due to his choice of a too-small time-constant for the rectifier-grid circuit. Inasmuch as the more important fading periods of broadcast reception are of the order of a minute or more rather than seconds or fractions of a second, it is not necessary or even advisable that the control should operate within a small fraction of a second. In my work with this form of receiver, I made the time-constant of the control about ten seconds, which gave ample time for tuning.

It is not likely that any system of automatic volume control will make a distant station behave just like a local. When one is located in the zone of most violent fading, that is, at such a distance from the transmitter that the direct and refracted waves are of the same amplitude, the field intensity at the bottom of a deep fade is usually below the disturbance level. Under these conditions, I have found that a receiver with automatic volume

* Received by the Institute, November 2, 1927.

control may maintain an approximately constant signal output from the loud speaker, but this will be periodically obliterated by the rising and falling noise level.

E. Bruce †: Several years ago during the ship-to-shore experiments conducted by the Western Electric Company, Mr. H. T. Friis, now of the Bell Telephone Laboratories, employed the automatic electrical gain control disclosed in British patent No. 259,664 to which Mr. Wheeler's paper refers. In this connection, a circuit suggested by Mr. Affel of the American Telephone and Telegraph Company disclosed in U. S. patent No. 1,511,015, October 7, 1924 is of interest.

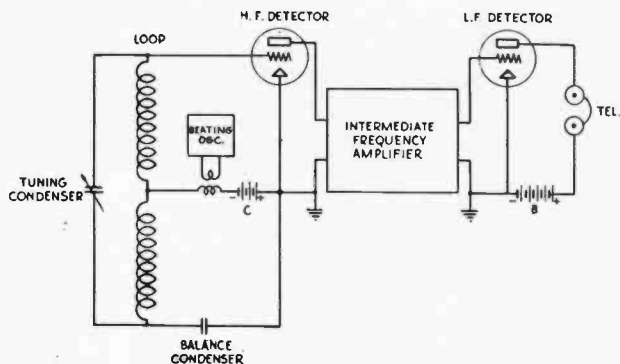

Fig. 1

The writer has devised a method of automatic gain control which is extreme in its constructional simplicity and at the same time avoids the range limitations experienced by Mr. Wheeler and also mentioned by Mr. Friis. Since this material has never been published, it seems appropriate, at this time, to present it to the Institute for consideration along with the method described by Mr. Wheeler.

The basic idea involved is to cause the rectified output to operate on the frequency changing device of a double detector or "superheterodyne" system. Since the output of this device occurs at the intermediate-frequency, no signal output is possible when this device is made to be inoperative. In other words, we obtain a practically infinite operating range. This is in marked contrast to operating on amplifier tubes which require elaborate and accurate balancing schemes to prevent the signal from passing

Received by the Institute, November 10, 1927.

† Bell Telephone Laboratories, New York City.

via the inter-electrode capacities of the tube. Mr. Wheeler has pointed out that the range of such signal reduction is limited to the practical accuracies to which these balances may be adjusted.

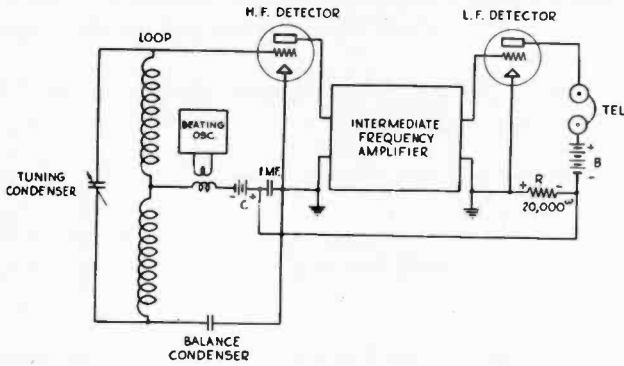

Fig. 2

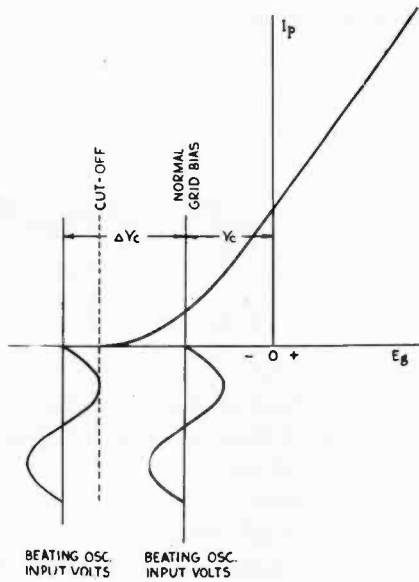

Fig. 3. Characteristic of High-Frequency Detector.

Fig. 1 shows an approved form of double-detection receiver. Fig. 2 indicates how it may be provided with an automatic control by simply adding a one micro-farad capacity and a 20,000-ohm resistance.

Fig. 2 shows that the rectified output of the low-frequency detector causes an increase in the IR drop across the 20,000-ohm resistance. This IR drop furnishes an additional negative bias to the high-frequency detector, driving that tube toward plate current cut-off. At cut-off the amplification of the receiver is totally destroyed.

Fig. 3 shows the change in negative bias necessary to reach cut-off. Referring to the figure,

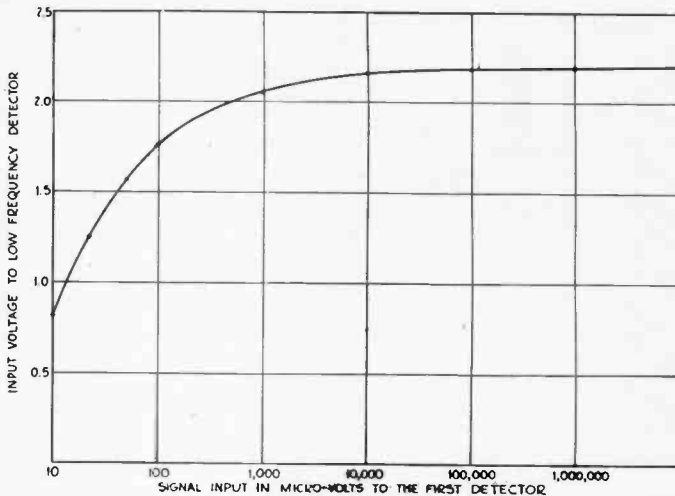

Fig. 4

$$\text{lim. } \Delta V_c = V_s + V_{bo} + \frac{V_b}{\mu} - V_c$$

where ΔV_c = change in grid bias.

V_s = peak signal voltage at detector input.

V_{bo} = peak voltage of beating oscillator input.

V_b = plate battery voltage.

μ = voltage amplification of tube.

V_c = normal negative grid bias.

Let us assign practical values to these terms respectively in the above order, then

$$\text{lim. } \Delta V_c = \text{negligible} + 1 + \frac{45}{6} - 6 = 2.5 \text{ volts.}$$

ΔV_c is the ultimate limit (signal voltage small compared with beating oscillator) of the biasing voltage that need be provided by the drop across the resistance R .

$$\lim. \Delta V_c = I_r R.$$

$$I_r = \frac{\lim. \Delta V_c}{R} \times 10^6 \text{ microamperes} = \frac{2.5 \times 10^6}{2 \times 10^4} = 125 \text{ microamperes.}$$

An average *N* tube voltmeter characteristic shows that a change in plate current of 125 microamperes represents an input of 2.5 volts for a plate circuit load of 20,000 ohms. It is therefore concluded that the input to the low-frequency detector can never exceed 2.5 volts for any practical signal.

Fig. 4 is a measured characteristic of the signal input in microvolts to the first detector vs. input voltage to the low-frequency detector. The intermediate frequency amplifier possessed a voltage gain of 120,000. If we start at a level of 1000 microvolts and increase this signal 1000 times, the output will only increase by about 6 percent.

With the arrangement as described, the desired output may be manually adjusted by altering the value of the negative biasing battery marked *C* in Fig. 2.

An automatic gain control of the kind described has been found to operate very satisfactorily. In the circuit used, the flat characteristic has been improved through the use of detector tubes having a voltage amplification constant of 30 instead of 6.

In the present state of development of the automatic gain control, there are two serious limitations: First—As the gain of the set rises and falls, in order to compensate for a fading signal, it is accompanied with a corresponding rise and fall of static and inherent set noise. This is quite disturbing to intelligibility. Second—It is common experience that speech quality is poor during the minimum of a fading period. An automatic gain control is incapable of remedying this situation.

RADIO COMMUNICATION*

By

SENATORE GUGLIELMO MARCONI, G.C.V.O., D.Sc., LL.D.

I very much appreciate the honour of being able to read this address before members of the American Institute of Electrical Engineers and of The Institute of Radio Engineers, especially as I know that in America radio science is more deeply investigated, more universally understood, and more generally utilised than in any other country on earth.

I also cannot but cherish always the recollection that the American Institute of Electrical Engineers was the only technical and scientific body which more than twenty-five years ago first believed in me and endorsed my statement that in December, 1901, I had succeeded in getting the first radio signals across the Atlantic Ocean, the first distinguished and authoritative Society enthusiastically to celebrate the event and to extend to me their generous support and valuable encouragement.

It is a further satisfaction to me to realise that as a result of recent discoveries and inventions the subject of radio communication is today attracting more world-wide interest and attention than any other advance of physical science and of electrical engineering.

In the early days of "Wireless," when electromagnetic waves were first beginning to be employed for practical purposes, we spoke only of "wireless telegraphy," or "radio telegraphy," but with the advance of the art these waves have been more and more widely utilised not only for telegraphy but also for telephony and broadcasting, direction-finding at sea and in the air, for the control of mechanisms and the ignition of explosives at a distance, principally for war purposes and, more recently, also for the transmission of line drawings, photographs and facsimiles, and finally, for television, which is now, I believe, finally emerging from the laboratory stage.

I hope I shall not be thought too visionary if I say that it may perhaps be possible that some day electromagnetic waves may

* Delivered before the American Institute of Electrical Engineers and The Institute of Radio Engineers, New York City, October 17, 1927.

also be used for the transmission of power, should we succeed in perfecting devices for projecting the radiation in parallel beams in such a manner as to minimize their dispersion and diffusion into space.

The achievements and possibilities of radio have already become so vast, so far-reaching, and their theory so complex and undergoing at the present time such a bewildering process of evolution that you will easily understand that, did I not confine myself to the generalities of even a small part of my subject, I would find it quite impossible to keep the length of my address within practical limits.

It would also be quite useless for me to endeavour to describe at any length the general achievements and utility of radio in a country where so very much is already known of this art and science and where such gigantic strides are being made in its practical application and scientific development.

I shall, therefore, necessarily be unable to dwell upon the valuable research work on the now all-important subject of short waves which has been carried out here, particularly by the engineers of the Radio Corporation of America, but this has already, in part, been described in an admirable paper by Messrs. H. E. Hallborg, L. A. Briggs, and C. W. Hansell, which was published in the June number of the *PROCEEDINGS* of The Institute of Radio Engineers.

I, therefore, propose to limit myself to referring briefly to the development and utilisation of this latest and most important evolution of radio science, which has already had the effect of compelling us to modify radically our views in regard to the practice and theory of long-distance transmission.

For this purpose I shall confine myself principally to a brief historical sketch of the investigations carried out by myself and my assistants on the subject of short waves and to describing some of the strides that have already been made in their application to radio communications over long distances.

I feel that I must here repeat my belief that we are as yet far from being able to assert that radio is based on well-understood foundations, unless, of course, we should go back to the long-distance technology of the past which, to my mind, has become more or less obsolete when applied to present-day long-distance practice.

Whatever degree of perfection may have already been achieved

in the design and construction of "wireless" stations and radio apparatus, we must realise that we still know too little of the true mechanism governing the propagation of the waves, and of the properties and behavior of the space which they traverse.

Speaking generally, it seems to me that latest developments tend to show us that four or five years ago radio engineers thought they knew much more about the subject than, perhaps, we think we know today. Laws and formulas were announced and accepted showing which wavelengths were best adapted for various distances for both day and night transmission and indicating what amounts of power would be necessary in order to enable us to communicate with a fair degree of regularity over any given distance. But, unfortunately, the logical application of these laws and formulas brought us to the necessity of employing for long-distance work such enormous and expensive antenna-systems and such large amounts of power as to make radio transmission so costly in capital expenditure and operation that it would hardly compete economically with modern cable and land lines.

The study of what are now termed short electrical waves can be said to date from the time of the discovery of electromagnetic waves themselves, that is, from the time of the classical experiments of Hertz and his contemporaries nearly forty years ago: for Hertz used short waves in his laboratory when he first conclusively proved that electrical waves existed, and that they were subject to the same laws as the waves of light in regard to reflection, refraction, diffraction, interference, and speed of propagation.

I might also, perhaps, recall the fact that in my own earliest experiments thirty-one years ago I was able to demonstrate the transmission and reception of intelligible signals through space over a distance of $1\frac{3}{4}$ miles by means of a directive system employing waves of only about 1 meter in length, whereas at that time, by means of the antenna or elevated wire system employing much longer waves, I could only, curiously enough, get signals over a distance of about one mile and a half.¹

The progress which has, however, been made subsequently with the long-wave system was so rapid and so spectacular in regard to distance, and the results available so easily applicable to the urgent needs of shipping, that it diverted all research from short waves, especially as it appeared, as indeed was proved,

¹ See paper read before the Institute of Electrical Engineers in London, March, 2, 1899.

that by efficiently utilising waves longer, and longer than those of about 150 meters—which were the first to be employed for any considerable distance—the ranges over which it was possible to communicate were steadily increased and the absorption caused by the effect of sunlight decreased and later, by the use of the longest waves, finally overcome.

This neglect of short waves was, I think, regrettable, for, notwithstanding the intense radio research that has been carried out in most countries for the last twenty-five years at least, it has been left to us only recently to discover that these waves possess most valuable and unsuspected qualities in regard to world-wide transmission and that they are capable of results unobtainable by the lower frequency system which, up to almost the present day, has held the field for all long-distance radio communication.

Since my early experiments carried out in 1896–97 and for a very long period of years afterward, no serious research work was carried out, or at least published, so far as I can ascertain, in regard to the application of very short waves to radio purposes.

Research along such lines did not appear promising: short waves were not easy to produce or to detect with the means then at our disposal, and up to recent times the power that could be put into them was small. This, together with the erroneous but general belief of the high attenuation of the waves over even short distances, deterred experimenters from entering this new field of research.

Some years ago, during the World War, I could not help feeling that we had perhaps gotten into a rut by confining all our researches and all our tests to long waves; that is, to waves of hundreds of thousands of meters in length; especially as I realised that, in accordance with theory, it would be practically possible only by the use of short waves to project the radiation in narrow beams in any desired direction instead of allowing it, as had always been done, to spread and dissipate in every direction.

I was greatly impressed by the advantages that such a system might possess for point-to-point communication, by the possibility which it would afford of reducing tapping and interference even if several stations were worked in the same area, and also by the possibility of a better and more logical utilization of the energy radiated from the transmitter.

My doubts were as to whether atmospheric absorption, the interposition of obstacles, and the curvatures of the earth would

not result in always limiting the distance of useful operation to a few score of miles, but I hoped that through the concentration of energy brought about by the utilization of efficient reflectors and, perhaps, by some unknown yet beneficent effect of the upper conducting layer, it might, nevertheless, be possible to effect communication across not inconsiderable distances.

This line of research was taken up by me in Italy early in 1916, and in subsequent development work during that year and afterwards I was most valuably assisted by Mr. C. S. Franklin, of the Marconi Company.

Mr. Franklin, under my direction, followed up the subject with great thoroughness, and the results of several years of our investigations were described by him in a paper read before The Institution of Electrical Engineers in London on the 3rd of May,

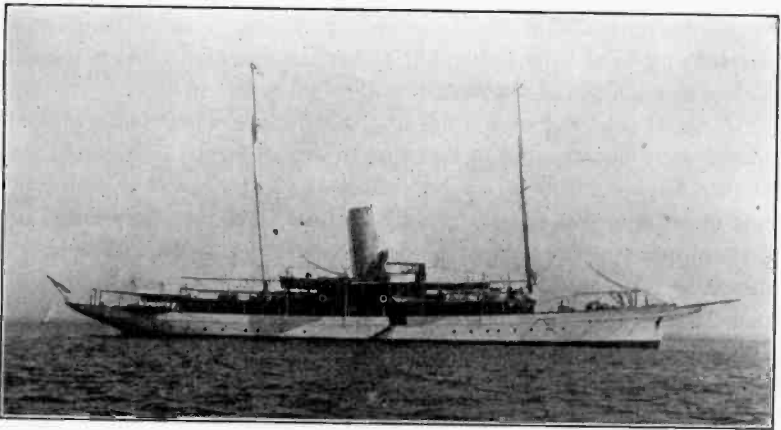

Fig. 1—Senatore Marconi's Yacht *Elettra*

1922, and also by me in an address delivered before a joint meeting of the American Institute of Electrical Engineers and The Institute of Radio Engineers in New York on the 20th of June of that same year.

The results obtained up to that time definitely convinced us of the enormous advantage to be gained by the use of suitable reflectors at both the transmitting and receiving stations. The tests were carried out with very small power and with waves from between 2 and 15 meters in length, up to distances of about 100 miles; but I should point out that at that time there was nothing to indicate to us that these distances constituted the limit range of

the waves thus employed. We did, however, ascertain by a number of careful measurements that the energy received when suitable reflectors were used at both the transmitting and receiving ends could be 200 times that of the energy received when no reflectors were employed.

Systematic tests, the object of which was to ascertain the range and capabilities of short waves over varying distances, were commenced by myself and Mr. C. S. Franklin in the spring of 1923 between a small experimental transmitting station situated at Poldhu in Cornwall and a special receiving station installed on the Steam Yacht *Eletra*.

The results obtained from these tests went far to convince me that short electric waves possessed qualities which, up to that time, had remained unknown and that this new line of investigation was opening up a vast field of profitable research full of undreamed-of possibilities.

The principal objectives aimed at in the experiments carried out between Poldhu and the S. Y. *Eletra* were:

(1) To ascertain the day and night ranges and reliability of signals transmitted on wavelengths of less than 100 meters, possibly over considerable distances, with or without the use of reflectors or directional devices.

(2) To investigate the conditions which might adversely affect the propagation of short waves, such as the interposition of land or mountains between the two stations, and also how the night or day ranges varied with the wavelength employed and the power utilized.

(3) To investigate and determine, if possible, the angle and spread of the beam of radiation emitted when employing a transmitting reflector, especially with a view to the possibility of establishing long-distance directional services.

A wavelength of approximately 97 meters was first employed, with a power of 12 kilowatts in the aerial, and during our journey, in the course of which ports and places in Spain, Morocco, Madeira, and Cape Verde were touched, it was ascertained that, with the power and wavelength employed, signals could be reliably received during daylight up to distances of 1,250 nautical miles.

In carrying out these tests I first noticed that it is by no means correct, in dealing with waves of approximately 100 meters, to refer to distances covered during daylight as "day ranges," because the strength of the signals which could be received varied definitely

and regularly in accordance with the mean altitude of the sun over the space or region intervening between the two stations.

The night signals came in always with great strength and remarkable regularity up to the maximum distance to which the yacht was able to proceed on that occasion, which was as far as the Cape Verde Islands, situated at 2,320 nautical miles from Poldhu. The strength of the signals received here at night left no doubt in my mind that their practical range was very greatly in excess of that distance.

I believe that I am right in saying that up to that time the general impression prevailing among most technical experts in regard to the behavior of very short waves was:

- (1) That their range during day-time would be very short.
- (2) That their night ranges, although occasionally considerable, would be exceedingly variable and freaky and subject to long periods of "fading," rendering their use altogether too unreliable for practical purposes in long-distance commercial working.
- (3) That any considerable stretches of intervening land, especially if mountainous, would greatly reduce the distance over which it might be possible to communicate.

Our 1923 tests brought me absolutely and definitely to the conclusion that such opinions and beliefs were wrong in so far as they might concern the behavior of waves of about 100 meters in length, for we discovered:

- (1) That the daylight ranges were not by any means inconsiderable and, in fact, proved to be much greater than had been anticipated.
- (2) That the night working was very much more reliable than had been believed possible; that "fading" was not at all so serious as had been anticipated and that the great strength of signals received indicated that the night range would probably be much greater than anyone, myself included, had ever before expected or anticipated.

Moreover, a fact of great practical value was also observed, and this was that even in the tropical countries the atmospheric electrical disturbances, termed "static" or "X's," were invariably much less troublesome and severe when receiving on short waves than those experienced with the much longer waves which, up to that time, were being exclusively used for all long-distance work.

The results of these tests were set forth in a technical report drawn up at the time, and were also described in detail and pub-

lished in a paper which I read before the Royal Society of Arts in London on the 2nd of July, 1924. In that paper I ventured to predict that it would be possible by means of short wave directive stations of small power to send and receive a far greater number of words per 24 hours over world-wide distances than would be practicable by means of the existing or the then proposed powerful and expensive long-wave stations. This, at the time, may have seemed a bold statement, but I felt sure it was going to be justified by results.

Further tests and experiments were carried out in February and March, 1924, with the object of determining the maximum practical ranges of these waves, and we found that, while the day range of a 92-meter wave was about 1,400 miles, *i. e.*, greater than the day range of a 97-meter wave, strong and fairly reliable signals could be received during the dark or semidark hours not only in the United States but also in Australia; that is, over world-wide distances.

The results were so encouraging that I was tempted shortly afterwards to try a telephony test to Australia, which was quite successful (30th of May, 1924).

In August and September of the same year another series of tests was carried out between the Poldhu station and the S. Y. *Elettra*, with the object of studying the behavior of still shorter waves over long distances, in order to ascertain whether it might not be possible to overcome in some measure at least the curtailment of the hours of working brought about by the effects of daylight, for, of course, we realised that this limitation of the period of operation to practically only the hours of darkness constituted the principal drawback to the possible general adoption of these waves for commercial and practical purposes.

Experiments were, therefore, conducted over varying distances with four wavelengths of 92, 60, 47, and 32 meters respectively.

These tests enabled us to discover the important fact that for long distances the daylight range steadily increased as the wavelength was reduced below 92 meters, the 32-meter wave being received with ease all day at Beyruth, Syria, over a distance of 2,100 miles, while the 92-meter wave began to fail over this track during daylight at a distance not much in excess of 1,000 miles.

During these tests the 60-meter wave appeared to be slightly better than the 92-meter wave during daylight, the 47-meter wave still better, and the 32-meter wave very much better.

From the result of these experiments we naturally presumed, and later experience confirmed our anticipation, that still shorter wavelengths would show still greater daylight range and further tests carried out by ourselves and other workers not only proved this to be a fact but also showed that very short waves, while being capable of working over the greatest distances during daylight, had but a comparatively short and unreliable range of action during darkness.

This discovery, which has brought about a reversal of what was noticed in regard to wavelengths longer than 200 meters, apart altogether from its enormous practical importance, gives rise to scientific questions of the highest interest and importance and requiring theoretical explanation as to how these waves can travel, even right around the world.

I do not intend, on this occasion at least, to indulge in any theoretical hypothesis or theory, as I much prefer to confine myself to the description of observations and of what I believe to be facts, leaving to others to arrive at the most valuable theoretical inferences which may be deduced from them.

In October, 1924, transmission tests were carried out on a wavelength of 32 meters from England to specially installed receivers at Montreal, Long Island (New York), Buenos Aires, and Sydney (Australia), and it was at once found possible to transmit messages when utilising only 12 kilowatts or less at the transmitter to all these distant places even when the whole of the great circle track between them and England was exposed to daylight.

With Australia, however, it is only possible to have a track from England completely exposed to daylight for 2 or 3 hours at a time, and, furthermore, the scientific aspect of the test is complicated by the fact that the waves may have several ways of getting round the earth with comparative ease, as a large part of Australia is not very far from the antipodes of England.

The Australian tests showed, however, that it was possible to get through for about $23\frac{1}{2}$ hours out of the 24.

Numerous other tests were carried out with various far-distant countries, including Japan, from a small power station at Chelmsford, England, which utilised only about *one-fifth of a kilowatt* of antenna energy, the object being to test still shorter waves. It was thus noticed that a wavelength of 10 meters was about the shortest which enabled signals to be detected at Sydney in Australia, and then only during the time when practically the whole of

the great circle track between England and Australia was exposed to daylight.

I should point out that these particular tests were carried out without reflectors at either end, the sole object being to ascertain the range and general behaviour of these waves over long distances.

In the directive experiments I carried out in Italy and in England, in 1916 and subsequent years, the reflectors consisted of a number of vertical wires of suitable length parallel to the antenna and spaced around it on a parabolic curve, of which the transmitting or receiving antenna constituted the focal line. The aperture

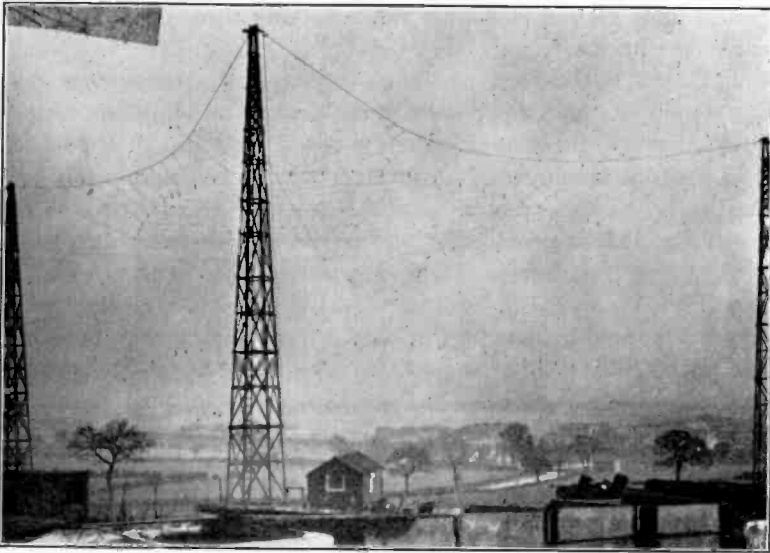

Fig. 2—Parabolic Reflector: Hendon

of the reflector was always made to be not less in width than 2 or 3 wavelengths.

Suggestions for utilising reflectors of this kind were made by Brown in 1901 and by DeForest in 1902, but many essential conditions necessary for efficiency were apparently not realised at that time, which fact may explain why no practical application of their arrangements was made.

Since 1916 various patents have been taken out by myself, Mr. C. S. Franklin, and other workers for reflectors and directive antennas, but in the commercial shortwave stations which have been constructed by the Marconi Company for the British and

other governments, and which are now in operation, an arrangement patented by Mr. C. S. Franklin is employed.

In this arrangement the antennas and the reflector wires are disposed so as to constitute grids parallel to each other, the aerials being energised simultaneously from the transmitter at a number of feeding points through a so-called "feeder system," and in such a manner as to meet the condition that the phase of the oscillations in all the wires is exactly the same.

It has been proved by calculations confirmed by experiments that the directional effect of such an arrangement is a function of its dimensions relative to the wavelength employed.

A similar system of aerials and reflecting wires is used at the receiving stations.

For a more complete account of our investigations, together with a more detailed description of the general principles on which my short-wave directional system is based, and also in regard to the apparatus employed, I would refer you to my papers read before the Royal Society of Arts on the 2nd of July and the 11th of December, 1924, to the paper read before the American Institute of Electrical Engineers and The Institute of Radio Engineers in New York on the 20th of June, 1922, to my "James Forrest" lecture delivered before the Institution of Civil Engineers in London on the 20th of October, 1926, to my paper "Le Radiocomunicazioni a Fascio" published in the Nuova Antologia of Rome in its issue of the 16th of November, 1926, to Mr. C. S. Franklin's paper read before the Institution of Electrical Engineers in London on the 3rd of May, 1922, and also to an article by Dr. J. A. Fleming which appeared in the *Wireless Engineer* of London in July of this year.

As I have already said, it has been proved long ago by calculations confirmed by observations that the directional effect of a radio reflector is a function of its dimensions in relation to the wavelength employed. Hence it follows that the dimensions of the reflector can be reduced proportionately to that of the wavelength and, therefore, that the cost is much lower and the space occupied much smaller for wavelengths of, say, 20 meters than for wavelengths of 90 or more meters.

The same calculations show us that the dimensions of a reflector for really long waves would be so enormous as to render its construction impracticable and impossible both for economic and engineering considerations.

Early in 1924 the British Government began to consider seriously proposals made by the English Marconi Company for the employment of the short wave directive system, now generally known as the "beam system," in order to satisfy the long-expressed desire of the dominions for a rapid and efficient means of radio communication with the mother country, and in July of that year a comprehensive agreement was entered into between the British Post Office and the Company for the construction of radio stations on the beam system in England and in the British Dominions, to

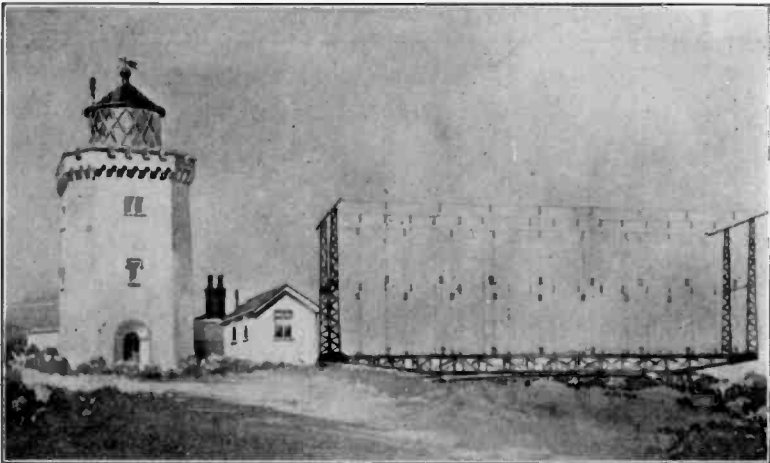

Fig. 3—South Foreland Revolving Beam

be operated in England by the Government, which would be capable of ensuring a high-speed commercial service from and between England and Canada, South Africa, India, and Australia.

This contract stipulated that the transmitting stations should dispose of a power of 20 kilowatts to be delivered to the anodes of the tubes used for generating the oscillations, that the aerial and reflector system was to be designed so as to concentrate the emitted waves within an angle of 15 degrees on either side of the axis of transmission, the energy emitted beyond this angle not to exceed 5 per cent of that on the axis, the receiving stations to have a similar aerial and reflector system designed to have its maximum receptivity in the direction of the corresponding station.

The conditions in regard to the speed of working were exceptionally stringent and severe.

The stations for corresponding with Canada were to be capable

of accurately sending and receiving at the same time to and from Canada at the rate of one hundred five-letter words per minute (exclusive of any repetitions necessary to secure accuracy), during a daily average of eighteen hours.

The stations for communicating with South Africa were to be capable of maintaining the same daily rate of speed and accuracy for eleven hours.

The stations working with India had to meet the same requirement for twelve hours and those working to and from Australia for seven hours daily.

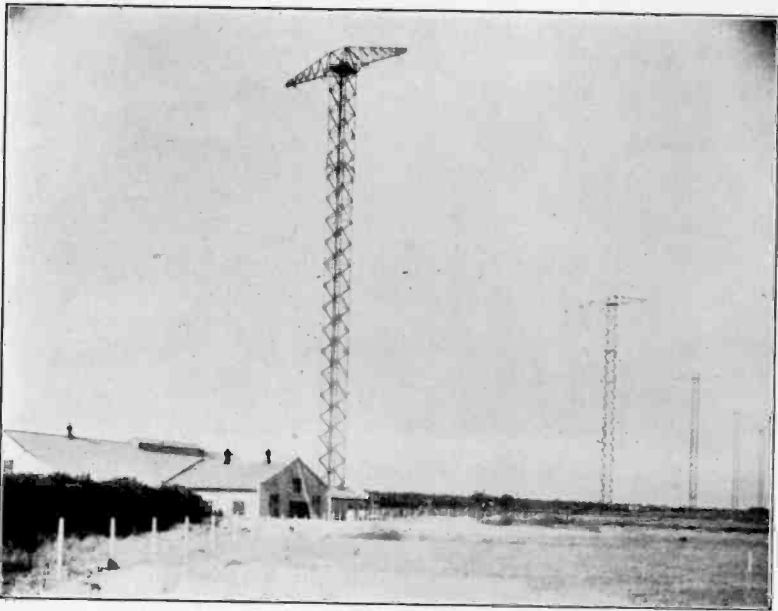

Fig. 4—Bodmin Beam Station. South African Masts

The Company was to give the Post Office a practical demonstration of actual working for seven consecutive days, which would prove to the satisfaction of the Government engineers that these severe conditions could be fulfilled.

In November of last year the Canadian circuit passed its official test, and in March, May, and August of this year the Australian, the South African, and the Indian Stations also completed their official communication tests and are now carrying on an important commercial public service which has already had the beneficial

effect of bringing about a reduction of the telegraphic rates between England and her most important dominions.

It has been found that, in regard to the stations communicating with Australia, South Africa, and India, a daily average of over twenty hours of high-speed communication is attainable, and that the spread of the beam is much narrower than had been specified in the Government requirements.

These results, which are truly unprecedented in the history of

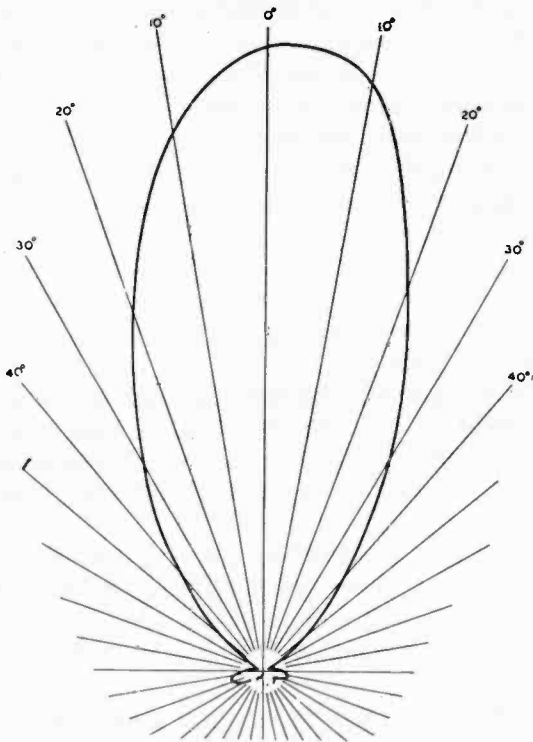

Fig. 5—Polar Curve, Hendon. Reflector, 28 Meter Aperture, 14.8 meter wave. Measured on circle of 31 meter radius.

radio communication, have been of the greatest possible satisfaction to myself and my co-workers, because they go to prove that our faith in the new system, which for years we upheld in the face of much scepticism and criticism, was not altogether misplaced.

The British Government has already expressed through its executive officials its high appreciation of the success of the new radio system.

Colonel T. F. Purves, Engineer-Chief of the British Post Office, in a letter of the 26th of August last addressed to the Marconi Company stated:

"All four stations erected by your Company providing direct telegraph communication with Canada, South Africa, India, and Australia have now been completed. It is with pleasure that I take this opportunity of offering my congratulations on the high degree of technical skill and resource displayed in successfully surmounting the many novel difficulties encountered in the work of carrying to fruition this great new development of the radio art."

The Rt. Hon. W. Mitchell-Thomson, British Post-Master General, also wrote on the 5th of October as follows:

"The introduction of the beam system will have far reaching effects in reducing the cost of long-distance communications by wireless telegraphy and I cordially congratulate your Company on a notable achievement."

The English stations for working with Canada and South Africa are situated at Bodmin, and at Grimsby for working with Australia and India; the receiving stations being respectively at Bridgewater and Skegness.

The corresponding stations in Canada are at Drummondville and Yamachiche not far from Montreal; in Australia at Bellan and Rockgank, near Melbourne; in South Africa at Klikheuvell and Milnerton, near Cape Town, and in India at Kirkee and Dhond, near Poona.

The stations are all worked by what is termed "remote control" through land lines from the Central Telegraph Office in London, and the received signals are strong enough to work high-speed recording and even printing instruments also in the same office in London.

In India and in the other dominions the same system of direct control is in operation between the Telegraph Offices in Montreal, Melbourne, Cape Town, and Bombay with the corresponding radio sending and receiving stations.

The aerial and reflector system at each station is supported by a row of masts so arranged that the great circle bearing to the distant station with which each particular aerial system is intended to communicate is at right angles to the line of masts. The design of the aerial and reflector system is substantially the same at each station. The masts are spread at a distance of 650 feet from each other.

In the case of the Canadian, South-African, and Indian services, each reflector and aerial system is suspended on a line of five lattice steel masts, each 287 feet high, but in the case of the Australian stations where a single wave is being used there are only three masts and their height is 260 feet.

The Australian system has the further difference that it is constructed with an aerial system on either side of a central reflector so that it is capable of transmitting to Australia in the direc-

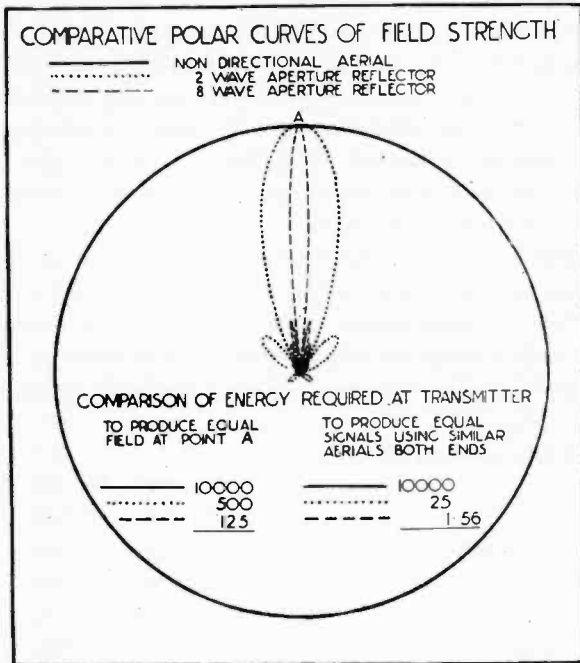

Fig. 6—Comparative Polar Curves on Beam and Round Transmitter

tion of either the easterly or westerly great circle. This arrangement has been made as a result of the experience which we gained when carrying out our preliminary short-wave tests with Australia at the beginning of 1924.

It was then found that the position and altitude of the sun had an effect as to which route the waves preferred to follow, and that during the morning period in England the waves preferred to travel from England to Australia in a westerly direction across the Atlantic Ocean following the great circle along the longest route which is approximately 14,000 miles; whereas, during the

afternoon and part of the night period the waves travel best in an easterly direction over Europe and Asia following the shortest great circle route which is about 10,000 miles. It is the practical application of this discovery which has resulted in the construction of the Australian transmitters and receivers so that transmission or reception can take place in either direction as required.

In all the sending stations the radio-frequency current is conveyed to and from the aerials through what I have already referred to as a "feeder system" consisting of concentric copper tubes air-insulated from each other to reduce loss. The outer tubes are earthed and carried on iron standards driven into the ground. The inner tubes, which constitute the conductors, are kept in position and insulated from the outer tubes by means of porcelain spacing insulators. The length of feeder tube from the transmitter to each individual aerial wire in each aerial system is made to be exactly the same.

Thermionic tubes are used to generate the extra high-frequency oscillations and oil-cooled valves or tubes are employed on the main circuits in preference to water-cooled tubes because in short-wave work oil is easier to handle besides being itself an insulator.

The wavelengths in meters and frequencies in kilocycles used are:

For communicating with:

| | | | |
|------------------------|---|--------|--------|
| Canada | } | 16.574 | 18,100 |
| | | 32.397 | 9,260 |
| Australia | } | 25.906 | 11,580 |
| | | 16.146 | 18,580 |
| South Africa | } | 34.013 | 8,820 |
| | | 16.216 | 18,500 |
| India | } | 34.168 | 8,780 |
| | | | |

It is obvious that I am not even attempting to give anything like a complete description of these stations, nor have I said anything in regard to the buildings, power-plant, switchboards, rectifiers, controls, keying-systems, etc. To describe these important items and the receiving apparatus and stations together with an even brief account of the engineering and other difficulties encountered would require much more than one lengthy paper.

Other beam stations in England are nearing completion for the purpose of working high-speed services to corresponding stations erected by or in cooperation with the Radio Corporation of America in the United States and also with South America; and

similar stations have already been erected and are now carrying on a public service between Portugal and many of her distant colonies.

Mr. C. S. Franklin has to his credit the successful design and testing of most of the arrangements and devices employed, especially on the technical and scientific side; and Mr. R. N. Vyvyan for those on the engineering side. I hope they may soon be able

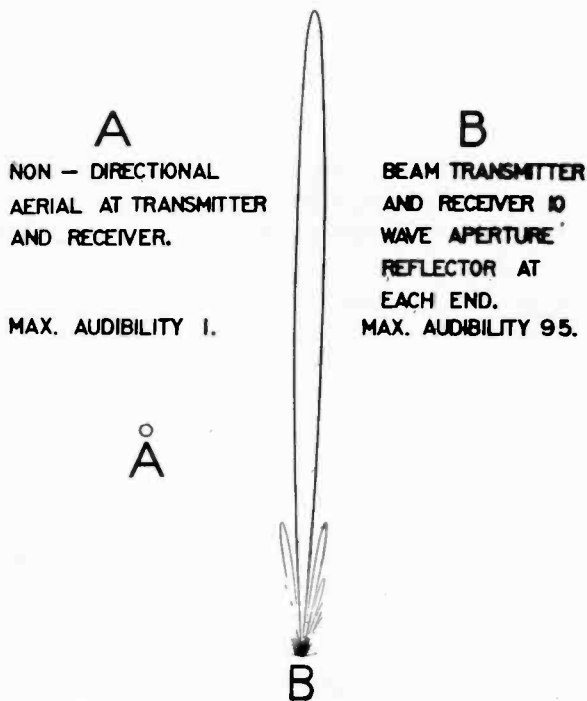

Fig. 7—Polar diagrams illustrating relative audibility at equal range and with equal transmitting power, assuming the wavelength and other conditions are the same.

to find time to prepare and publish a more complete description of these stations.

The commercial continuous working of these long-distance services over a period of many months has made possible the collection of observations of great scientific interest, and the carrying-out of further tests the results of which are, perhaps, quite novel in the history of long-distance radio.

One of them is in regard to electrical atmospheric disturbances generally termed static or "X's."

I think we all know that static has all along been the bugbear of radio, but one of the most salient facts that we have noticed in working long-distance services by means of short waves is that, particularly when receiving reflectors are employed, static has been generally conspicuous by its absence, and, when noticeable, the signal strength has mostly been well above the disturbance strength-level of static. Thunderstorms in the vicinity of the receiving stations occasionally interfere with working when they happen to be inside the angle of receptivity of the receiving reflectors, but not even then when they are at some considerable distance.

In working the high-speed receiving stations situated near Bombay throughout the whole of the East-Indian summer and during the monsoon period, interruption or interference with the signals received from England due to static has been of very rare occurrence.

I feel quite confident that our old enemy of static interference no longer exists as a serious hindrance to the working of high-speed radio as carried out by the beam system.

I fully realize that this is a bold statement to make, but I feel quite confident that I am right in making it.

The variations, or rather, the attenuation of signal intensity, now termed "fading" is the one, and I believe the only really serious difficulty with which we still have to contend.

Fading has been a marked feature of long-distance radio, especially when short waves are employed, and although in my experience fading appears to be worse on wavelengths between 200 and 1000 meters it has often proved to be serious on the very short waves now utilized by the beam system.

According to my experience, the use of reflectors has the advantage of diminishing the bad effects of fading. This is due, no doubt, to the very considerable increase of the average strength of signals obtained by the utilisation of the directional system which, thereby, increases the margin of readability of received signals enabling them to be still recorded or read through most of the fading periods.

I have been able to make some very interesting observations in regard to the phenomena of fading from the working of the short-wave beam system for world-wide communication of which England is now the center.

Fading has always been more frequent and more severe on

the England-Canada circuit than on any of the others. It may be noticed that our Canadian service is also our shortest distance service, that it is mostly across the sea and that the Canadian station is the one which happens to be nearest to the north magnetic pole.

Some interesting suggestions on the "Correlation of Radio Reception with Solar Activity and Terrestrial Magnetism" have been set out in a paper by Mr. Greenleaf W. Pickard, published in the PROCEEDINGS of The Institute of Radio Engineers, Vol. 15, No. 2, of February of this year.

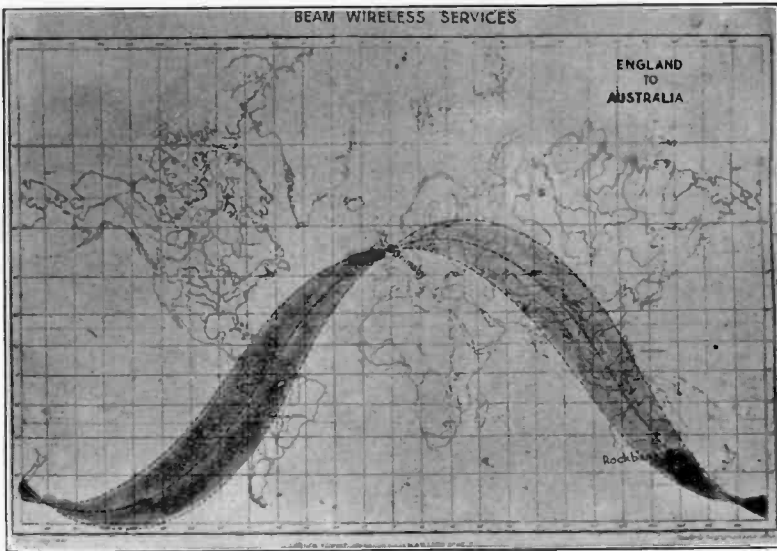

Fig. 8—Beam Services

It frequently occurs that when the Canadian communication fades out for some hours on end, the other services to Australia, India, and South Africa, which use similar wavelengths, continue working with undiminished efficiency. It has also been noticed that the times of bad fading practically always coincide with the appearance of large sun-spots and intense aurora-boreali usually accompanied by magnetic storms and at the same periods when cables and land lines experience difficulties or are thrown out of action.

We have also frequently noticed that during these periods signals could be received on a shorter wavelength than the one

usually employed, often on a 16-meter wave when a 26-meter wave would not come through.

As is now generally known, very short waves, of 16 meters and under, can be better received at long distances by daylight and in summer time than during winter or at night, and we also know that very long waves are not affected by daylight.

It may be that, on certain occasions during periods when sun-spots and auroras are prevalent, conditions due to the increased ionisation of the atmosphere at a certain height are prevalent,

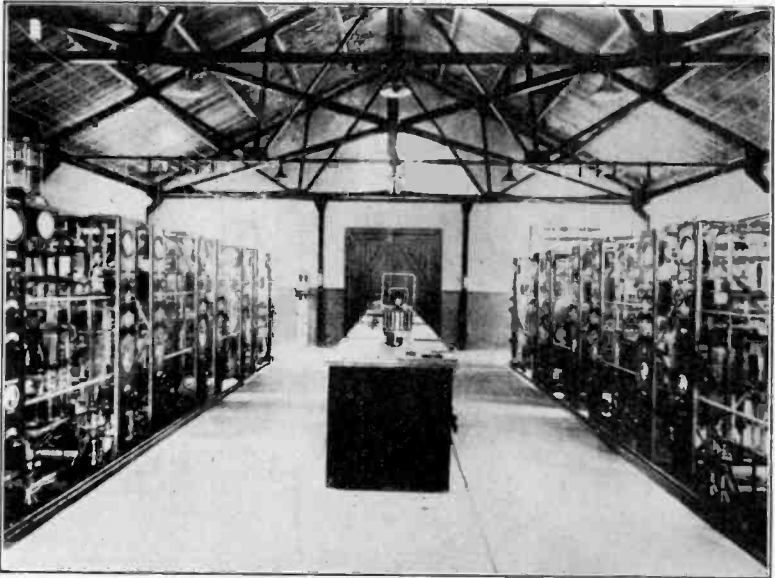

Fig. 9—Bodmin Transmitters. Left, Africa; right, Canada

resulting in the lowering of the ionised stratum which would produce an effect equivalent to what we might term "intensified daylight."

Professor Elihu Thomson in a lecture delivered in London during 1924² stated that it was his opinion that extensive auroral display was coincident with the existence of exceptional areas of disturbance in the sun, and he also referred to the probability under such circumstances of a decided elevation of charge, or potential, of the outer conducting layer 50 or 60 miles above the earth's surface.

² "James Forrest". Lecture delivered before The Institution of Civil Engineers in London on the 8th of July, 1924.

The phenomenon of fading is now being investigated by many workers, and progress is already being made in overcoming the difficulties which have been experienced in maintaining an absolutely continuous service between distant stations.

Time will not allow me to deal with this all-important subject which would necessarily require my referring to lengthy papers and reports and the publication of data which may still need experimental confirmation over protracted periods.

I shall, however, make a very brief reference to the subject of "skip distances."

This phenomenon, the study of which has been taken up since the advent of short waves, has been very carefully investigated

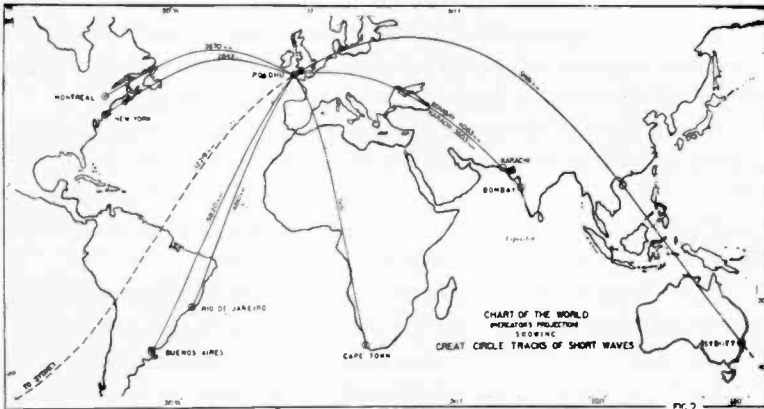

Fig. 10—Map of the World. Great Circle Tracks

by Mr. A. Hoyt Taylor and set forth and discussed by him in several admirable papers.

It is now, of course, well known that a wave of about 15 meters can be received with much greater strength and regularity during day time at distances about or over 5,000 miles than at distances of the order of a few hundred miles.

My experience, which I wish to record because it differs somewhat from the conclusions arrived at by Mr. Hoyt Taylor, is that when receiving on my yacht, even with land intervening between the two stations, there are no distances at which I have ever found zones of absolute non-reception, but that I have noticed zones where signals were weak and variable and where reception conditions closely resembled those prevalent at the normal ranges of the stations when fading conditions existed. In

these zones of weak reception, which more or less coincide with the so-called skip-distances, the received waves appear to be scattered in such a manner that direction finders fail to indicate any definite direction of origin or of propagation.

My observations were made on the S. Y. *Eletra* during a cruise which took place last August and September, when almost continuous observation was kept on the signals of eight beam stations situated at varying distances, both great and small, and working on wavelengths of approximately 16, 26, and 32 meters.

It may well be that the amount of energy radiated by these stations along the path of the beams was sufficient to give signals on our receivers even at distances over which reception could not otherwise have been detected.

Before concluding this address I would like to put before you a few considerations in regard to what I believe is the relative value of short waves versus long waves for long-distance radio.

We all know that space is becoming seriously congested over a very considerable range of wavelengths, and as we have only one medium of transmission for us all, it may be well to figure out roughly the probable number of possible wavelengths or channels which can be used without mutual interference.

If we assume that long waves may be classed between 5,000 and 30,000 meters, and short waves between 5 and 100 meters, then, by applying the basis of a rule proposed for the consideration of the International Radiotelegraph Conference at Washington, we find that 3,700 wave-bands or channels will be practicable and permissible for the short waves, but only 90 for the long waves.

This, of course, is rather a conservative estimate of the number of channels, but should narrower wave bands be adopted the proportionate permissible number of short wave-bands would bear the same proportion to the possible number of long waves.

But, in addition to this very great advantage for the short waves, they have a further one due to the possibility of restricting a large proportion of their power to within a narrow angle and also to the screening effect of the receiving reflectors which, by very greatly reducing the angle of receptivity and, thereby, minimizing interference, tends still further to increase the number of separate services which can be worked by means of these waves.

We should also not lose sight of the fact that very high speeds of working appear to be possible only if short waves are employed,

while, with the lower frequency of the long waves, speeds of the same order are quite unattainable.

I might, in other words, state that in regard to short waves there exists no theoretical reason why, with a frequency of 3,000,000, such as is the frequency of a 100-meter wave, the possible speed of working should not be 200 times greater than that attainable with a frequency of 15,000, which is that of the main transmitter of the high-power long-wave station at Rugby in England.

But long-wave stations, such as the one at Rugby, although

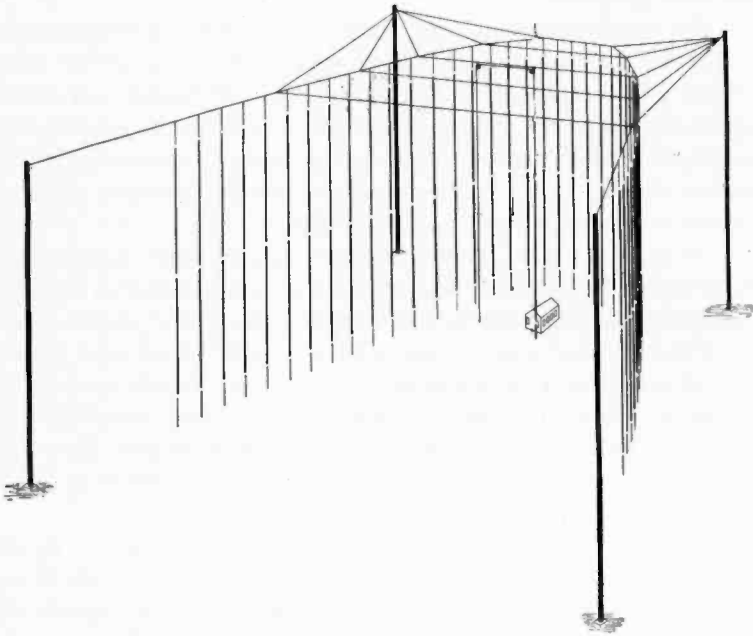

Fig. 11—Parabolic Reflector with Aerial at Focus

utilizing a power of over 500 kilowatts cannot even communicate at low speed with Australia for the same daily average number of hours as is possible by means of an efficient beam station, although the latter be using only 20 kilowatts of electrical energy.

There is also an interesting and economic feature in regard to long-distance services by means of short waves compared with cables which should not be overlooked.

With cables, the capital and maintenance costs of the cable itself increase in simple and direct proportion with its length,

but with short-wave radio it has been found that the capital cost of stations for communicating between England and Australia, over a distance of 10,000 miles, is materially less than the cost of stations for communicating with Canada over 2,500 miles: *i.e.*: over only a quarter of the distance, while, if anything, the service is better over the longer distance.

I have often been asked why it is that if these short waves are capable of covering the greatest distances without employing the beam system, I have always insisted on using it in all the stations my Company has established or is erecting for important long-distance services.

My reasons are that, as I have perhaps learned something in regard to the severe exigencies of present-day commercial telegraphy, I have realised that in consequence of fading and atmospheric interferences the signals obtained from such non-directive stations are rarely strong enough for operating the recording instruments necessary for high speed commercial services required between important far-distant countries.

Doubts have also often been expressed by some experts as to whether or not the reflectors and directive aerials used at the various beam stations were in fact fulfilling any useful object at all.

The tests over long distances have already shown that the use of beam aerials and reflectors at both ends results in a signal strength which, from careful measurements, Mr. Franklin estimates to be on the average about 100 times greater than that obtainable with non-directional transmitting and receiving aerials utilising the same power.

Now, since the increase of strength of the received signals rises in proportion with the square foot of the power of the transmitter, it is easy to estimate that in order to obtain signals 100 times the strength it would be necessary to use 10,000 times the energy and, hence, as the power supplied to the anodes of the tubes is 20 kilowatts it would be necessary to use the impossible and absurd power of 200,000 kilowatts with the ordinary all-round radiating and receiving stations to give the same average strength of signals at the receiving end, if suitable reflectors were not employed.

During my recent cruise on the S. Y. *Elettra* I had numerous opportunities of testing the strength of many of the beam stations over both short and long distances, and although on this occasion I did not carry suitable measuring instruments, I am quite sure

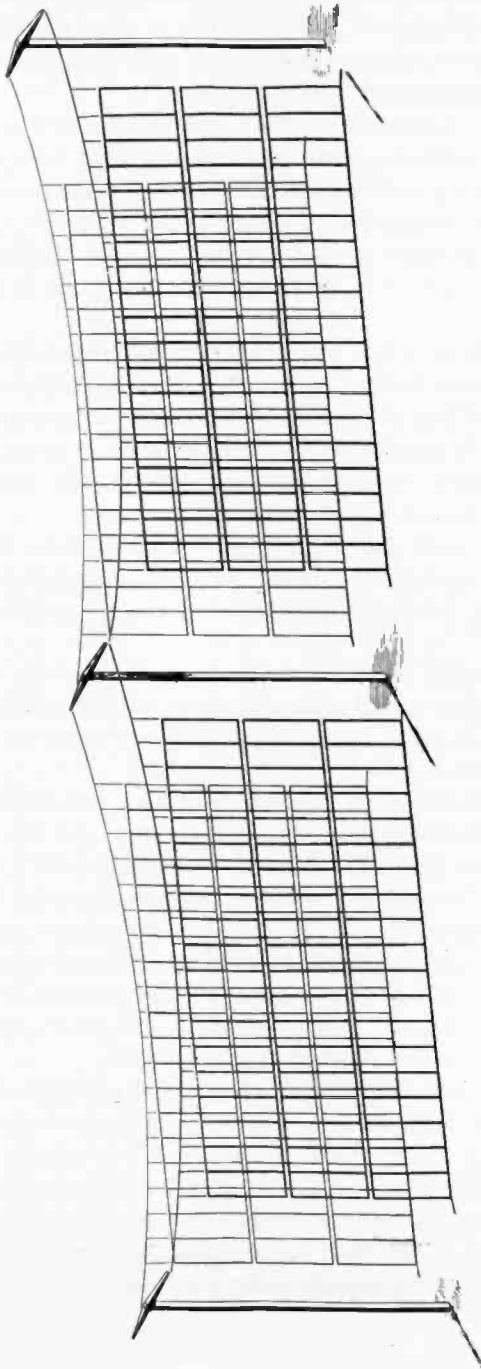

Fig. 12—Parallel Flat Aerial and Reflector

and satisfied that there is no possible doubt in regard to the very great increase in strength and reliability of the signals when these are received in the center or in the path of the beams as compared with those which can be received outside.

There exist, however, occasional periods, frequently coincident with fading conditions, when reflectors appear to be of no marked advantage. When such conditions prevail signals are seen not to arrive from any defined direction or angle but to be scattered to and from all directions, probably by the Kennelly-Heaviside layer, just as might occur from multiple reflection, or as in the case of diffused light.

This condition of scattering appears to prevail constantly at the so-called zones of skip-distances of each particular wavelength employed, and this fact may explain why certain observers in Germany and in America have found no trace of beam effect. If, as seems possible, their tests were made in the zone of skip-distances, the explanation appears clear.

These effects of the scattering of short electric waves have been carefully investigated by Mr. T. L. Eckersley of the Marconi Company who, I hope, will soon be able to publish a paper on the subject.

It is known that signals from the beam stations can be received at distant places far and wide and quite outside the angle of the beams, and it has also been suggested that this proves the inefficiency of the beam system.

It should, however, be remembered that a comparatively small amount of radiation escapes in all directions from the aerial and reflector system, and although this represents only a very small proportion or fraction of the energy contained in the beam, it is nevertheless capable of being detected, sometimes strongly, on sensitive receivers at very great distances in the same way as amateurs have shown us that the energy of a short-wave broadcasting transmitter, even when radiating only a few watts, can often be received and detected as far as the antipodes.

The same sort of effect occurs perhaps to a lesser degree even in the case of light when projected in a beam from a searchlight. Many of us may have noticed that it is usually quite easy to see plainly the beam of light projected by a searchlight and its glare even when the beam is not directed towards the observer.

The signals which can be received outside the beams are, however, rarely strong enough to work high-speed recording instru-

ments reliably, and as the messages which are sent in Morse code by the principal beam stations are normally transmitted at speeds approaching or exceeding one hundred words per minute, it is quite impossible to read them by ordinary aural or telephonic reception.

This affords a certain degree of secrecy not realisable by the older long-wave system.

Restriction of the angle of the beam and decrease of stray radiation outside of it appears, however, to be possible by increasing the dimensions of the reflectors in respect of the wavelength employed, and also by augmenting the number of wires in each grid. Further discoveries and the perfecting of design may also bring about this much-desired improvement.

Although the beam system is, in my opinion, still far from perfect, progress and improvement are continuous and the results already secured during many months of continuous working on a



Fig. 13—The Beam

commercial basis across a variety of distances between so many different parts of the earth's surface have firmly convinced me that a good directional system is the system of the future for point-to-point radio communication over long distances throughout the world.

I have always felt that radio waves are far too valuable to be scattered and broadcast equally in all directions in a point-to-point service instead of being concentrated as much as possible on the station or group of stations with which it is desired to communicate.

The enormous increase in telegraphic speed is not the only advantage attached to the short wave-beam system: recent tests having fully demonstrated the adaptability of this system to radio telephony and also the ease with which it is possible to superimpose a commercial telephone channel upon high-speed telegraph services using the same system, as is now being done experimentally between Canada and England, thus obviating the cost of erecting separate stations for carrying on telephonic communications.

The commercial advantages of such an important development of the application of short waves are very great and the opening of the first multiplex telephone and telegraph service will certainly constitute an important new departure in the history of long-distance radio communication.

Much research work and the task of devising, designing, and testing the special arrangements and instruments used at the short-wave receiving stations have been successfully carried out by Mr. G. A. Mathieu of the Marconi Company.

Short waves are also beginning to show un hoped-for results in improving broadcasting and making it workable over great distances even during the hours of daylight. And directive methods, I feel confident, will soon be utilized for broadcasting by enabling programmes and speeches to be transmitted over large portions or sectors of America and to distant countries with much greater strength and freedom from interference than is possible with existing methods.

And, lastly, short waves cannot but enormously assist in rendering more practical the systems of picture and facsimile transmission including television, which are most likely to bring to an end the necessity for Morse code signal transmission on which is based telegraphy as we know it today.

In reviewing the progress recently made in the applications of short waves I may, perhaps, be forgiven if I say that it is with some considerable satisfaction and even pride that I am able to recall the fact, that when five years ago I last had the honor and pleasure of addressing you here, no practical use of short waves had yet been made and it was probably the first occasion on which the question of the urgent desirability of the study of short waves for practical radio purposes was publicly proposed and strongly recommended to the attention of experts.

I then stated that I considered we had perhaps got rather into a rut by confining all our researches and tests to long waves, because I felt that the study of short waves, although sadly neglected all through the history of radio, was still likely to develop in many unexpected directions and to open up new fields of profitable research.

The results obtained by amateurs by means of short waves do great credit to them, especially if we consider that most amateurs possess only limited facilities for experimental work. Their observations have frequently been of value in helping us to arrive at

a better understanding of the very complex phenomena involved, but care should be exercised in accepting their observations, especially when they concern what I might term negative results.

Some short time ago I read a statement by an eminent English authority that, according to amateur observations, the daylight range of a 100-meter wave did not exceed 200 miles, and for a wave of 50 meters, 100 miles.

These distances were very far short of those ascertained by myself and my assistants, but it may very well be that some of the observers did not possess efficient receivers or that the location of their stations was not favorable to reception, or that they lacked operating experience.

I have always found that for reliable comparative observations and deductions in regard to transmission over different and varying distances there is nothing so good as a receiving station installed on a suitable steamship.

On a ship or yacht, one has the advantage of using the identical aerial system, the same receiving apparatus, and the same observers throughout, and at all distances, and this is, I believe, a most reliable way of testing the behavior of these waves, especially at what I might call intermediate distances.

Looking back at our old difficulties, of only a few years ago, the ease and perfection recently achieved by radio, especially in regard to broadcasting, appears little short of miraculous. It shows us what can be done by the combination of a great number of workers all intent on securing improved results. And how many, who began as amateurs, have contributed in one form or another to this progress and to this success?

We are yet, however, in my opinion a very long way from being able to utilise electric waves to anything like their full extent, but we are learning gradually how to use electric waves and how to utilise space, and thereby humanity has attained a new force, a new weapon which knows no frontiers, a new method for which space is no obstacle, a force destined to promote peace by enabling us to better fulfil what has always been essentially a human need: that of communicating with one another.

A NEW METHOD FOR THE CALIBRATION OF AMMETERS AT RADIO FREQUENCIES

BY
HERBERT C. HAZEL

(Radio Frequency Laboratory, Department of Physics, Indiana University)

Summary—This paper describes the construction and operation of a thermionic vacuum tube which is designed for the measurement of radio-frequency currents. The input circuit consists of a filament whose cross section is small enough that the "skin effect" is negligible at the frequencies used. The filament is heated first by currents of known magnitude (at a low frequency) and again by radio-frequency currents to be measured. Electrons emitted by the heated filament are drawn to an anode sealed into the tube and a comparison of the resulting space currents indicates, if the necessary precautions are taken, the amount of current in the input circuit.

DURING the last few years progress in methods of radio communication has given impetus to a study of the problems involved in the measurement of current and resistance at radio frequencies. While marked achievement has characterized the field of radio investigation in general, the method of calibrating ammeters for radio work has remained rather crude and inaccurate. Many problems arise in the design and construction of radio-frequency instruments due mainly to the fact that changes of current distribution with frequency may entirely change the effective resistance of a circuit. For measurements of extreme precision at very high frequencies a substitute type of measuring device, a thermionic ammeter, has been developed. This paper describes the new instrument with its auxiliary apparatus and associated circuits.

CONSTRUCTION AND OPERATION OF THE THERMIONIC AMMETER

If a radio-frequency current is sent through the filament of a vacuum tube, the temperature of the filament will be the same as that caused by an equivalent low-frequency or direct current, providing the filament is made of such small diameter that the "skin effect" is negligible. Now the rate of electron emission of a hot filament is a function of the temperature.¹ Consequently, if the potential gradient from the filament of the tube to a plate sealed into the tube is the same in the two cases, a radio-frequency current sent through the filament will produce the same space current in the plate circuit as would be produced by an equivalent low-frequency current through the filament. Obviously the

¹ Van der Bijl: "Thermionic Vacuum Tube."

filament-plate capacity should be small enough that no appreciable displacement current may result at any frequency used. Since it is only necessary to get a measurable plate current, the plate may be made very small, thereby reducing the filament-plate capacity to practically zero.

An ordinary commercial amplifying tube for radio receiving apparatus does not, of course, quite meet the tube requirements in that the plate is large, the filament is slightly inductive, and the presence of the grid offers possibilities for such undesirable occurrences as eddy currents and irregular modification of the potential gradient between the filament and plate. Fig. 1 below

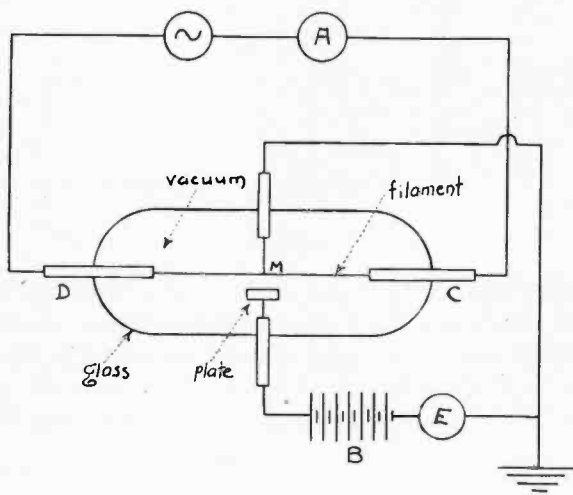

Fig. 1

shows the construction of a tube and the associated circuit designed especially for the calibration of ammeters at radio frequencies.² The radio-frequency input terminals are *D* and *C*. The mid-point of the filament *M* is grounded and electrons emitted by the hot filament are drawn to the plate by the electric field set up between the filament and plate by the battery *B*. The movement of electrons constitutes a current which is measured by the milliammeter or microammeter *E* (depending on the size of the plate, its distance from the filament and the magnitude of difference of potential between plate and filament as controlled by *B*).

In order to calibrate an ammeter with this specially constructed vacuum tube it is necessary to obtain the filament current-plate

² Patent application serial number 115,361.

current characteristic of the vacuum tube for low-frequency (say 60 cycle) filament current. This current may be easily measured very accurately by an instrument calibrated for use at the low frequency. By comparison of the resultant space currents as indicated by the meter E , in the plate circuit, the corresponding values of current in the input circuit can readily be determined.

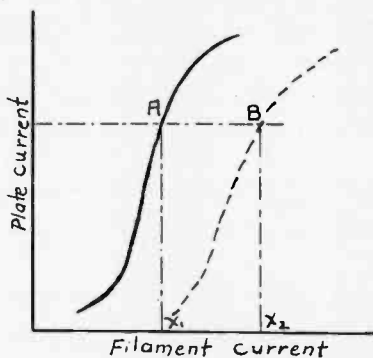

Fig. 2

If the radio-frequency ammeter used at A is in error, the characteristic curve resulting will not coincide with the curve obtained when accurately measured low-frequency current is used in the filament. For example, if the solid line of Fig. 2 be the curve for accurately measured 60-cycle current through the filament, and the dotted

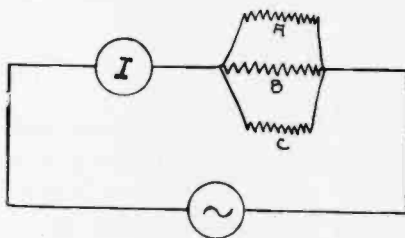

Fig. 3

line be the curve obtained with the radio-frequency current through the filament, then x_1 is the true value of the filament current which produced the plate current A . Then tracing across horizontally to the point B on the curve obtained with radio-frequency current at which the same plate deflection occurred, one sees that x_2 was the reading of the ammeter for the filament current which produced the plate current B . That is, x_2 is the

reading of the ammeter which corresponds to the true value of current x_1 . The complete calibration curve may be easily obtained in this way. Of course one need not use any radio-frequency ammeter at all, but use the instrument just described to measure radio-frequency current directly.

The thermionic ammeter described above has several outstanding advantages. At extremely high frequencies the insertion

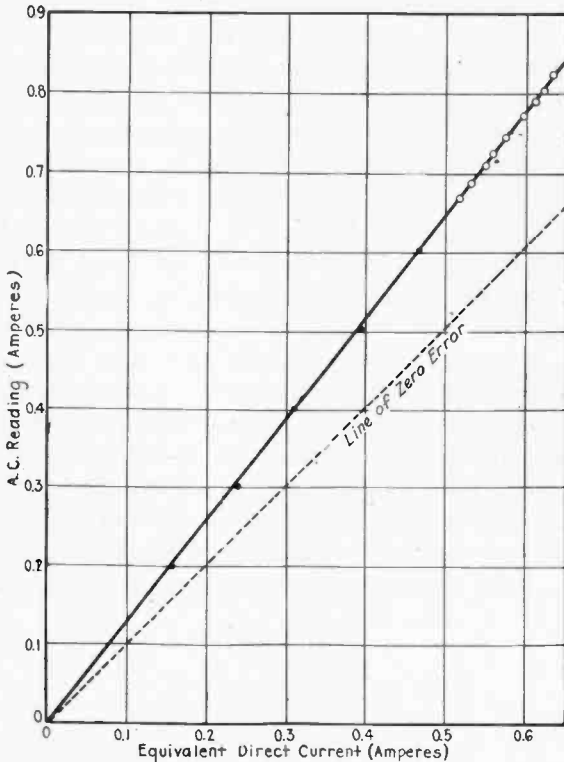

Fig. 4—Calibration Curve for a Commercial Ammeter (10,000,000 cycles).

of an ordinary ammeter in the circuit so profoundly changes the constants of the circuit that its use would be worthless. The specially constructed vacuum tube of the thermionic ammeter may be made of tiny dimensions with negligible inductance and capacity so that it may be used in circuits of extremely high frequency without appreciable error. The indications of the device, depending as they do on the fundamental property of electron emission of hot bodies, are practically instantaneous in action and are free from zero shifting. Since a given tube can, from the

nature of its functions, cover only an extremely limited range of current, and since the change of plate current with a very small increment of filament current can be made enormously large, the instrument is "microscopic" in its accuracy. Several tubes may be mounted on one base with a single milliammeter in a completely constructed ammeter offering opportunity for use over the desired range of magnitude, and yet retaining the extreme accuracy due to the fact that as incandescence approaches, the electron emission increases enormously. Several tubes may be used in parallel, the single milliammeter recording the sum of the plate currents of all the tubes. This would not be subject to the errors involved in putting a thermo-junction in contact with only one of a group of parallel wires neglecting the change in current distribution. That is, with reference to Fig. 3, I is not necessarily equal to three times the current through A (where A , B , and C are exactly alike) but is equal to the sum of currents through A , B , and C .

Calibration curves have been worked out by the new method for several Jewell, Weston, and Westinghouse radio-frequency ammeters at various frequencies, and have been checked by the calorimeter method. Fig. 4 shows one of these curves for a commercial instrument calibrated at a frequency of 10,000,000 cycles. The circles represent points on the curve obtained by the thermionic vacuum tube, and the solid line is the curve obtained by the calorimeter method. In this particular instrument the skin effect clearly predominates. As will be seen in the graph, the calibration curve has a greater slope than the line of zero error, and lies entirely above this line.

EXPERIMENTS AND OBSERVATIONS CONCERNING THE IONIZED REGIONS OF THE ATMOSPHERE*

BY

R. A. HEISING

(Bell Telephone Laboratories, Inc., New York City)

Summary—Experiments are described in which a virtual height of the reflecting ionized region was measured using time lag between impulses arriving over a direct, and the reflected path. The measurements were made on 57 and 111 meters. The height was ascertained only at night and the daylight hour before sunset. Movements of the reflecting region are plotted showing slow rises and rapid drops. The rising rate approximates 6 miles a minute, and the falling rate about 20 miles a minute. Multiple reflections were observed. Transmission measurement curves are given showing dependence of 16-7/8 meter signals on the night ionization, and the assistance that sunlight ionization can give. Experiments and curves are mentioned that show absorption to be one of the important factors causing poor daylight transmission in the wavelength region contiguous to 214 meters. It is pointed out that the absorbing region is below the refracting region and that the sky wave must make two passages through the absorbing region. A discussion is given to show that both electromagnetic waves from the sun, and β particles, must be assumed as producers of ionization to explain phenomena observed. By this theory the electromagnetic waves from the sun produce the ionization in the absorbing region, and part of the day ionization in the refracting region. This ionization is pictured as beginning at an altitude of about 16 miles and extending upward, and as experiencing diurnal and seasonal variations. The β particles produce, at an altitude higher than the absorbing region, further ionization which is the principal ionization at night due to the absence of the electromagnetic ionization. This ionization is pictured as occupying part of the same region as the electromagnetic ionization and being very irregular in intensity and position.

THE great extent to which radio wave propagation is dependent upon atmospheric phenomena has been appreciated only during the last few years. That there was some relation has long been suspected. The first definite connection noticed was absorption, and it led engineers to look upon the atmosphere as a necessary evil. The phenomenon of transmission around the globe which could not be explained by any pure diffraction theory led to the first suggestions that the atmosphere might have something to do with the transmission as well as the absorption of waves. As investigations have progressed, it has become more and more evident

Presented before the Institute of Radio Engineers, December 7, 1927.

Original manuscript received by the Institute, November 2, 1927.

* Presented at the meeting of the American Section of International Union of Scientific Radio Telegraphy, April 21, 1927.

that all radio transmission to appreciable distances is dependent upon atmospheric phenomena to a hitherto unsuspected degree.

With the knowledge that the atmosphere was of importance in the transmission of radio waves, the radio engineer naturally looked to the meteorologist for information in studying the subject. The time is rapidly approaching, however, when the reverse may be true—the meteorologist may be looking to the radio engineer for information in his studies. The additional tools and methods that the radio engineer provides may enable the meteorologist to obtain data concerning those parts of the atmosphere about which he has very little information at the present time.

In our short-wave experiments of the last few years several phenomena have been observed which it is felt have a direct bearing upon the subject of ionization in the upper atmosphere. Some of these things were observed in our transmission measurement work, a partial report of which has been published,¹ while others were observed in experiments interspersed with the transmission measurement work. Much of our work corroborates the experimental results of others and supports some of the hypotheses which have been advanced in explanation.

REFLECTED WAVES

Among our special tests was the measurement by reflection of radio waves of the height of the reflecting ionized region. The work did not start with this object in view, but began as a study of quality distortion. That reduction of quality was caused by the variation of the carrier frequency had been shown by Bown, Martin, and Potter,² and it was desired to get some quantitative observations on the disturbing phenomena in the short-wave region.

The idea was conceived of deliberately wobbling a steady carrier and making an oscillographic record at a receiving station. The idea had scarcely taken form when it was realized that if the variation in received carrier amplitude is caused by interference between two beams that arrive over different paths a beat note would result whose pitch would depend upon the rate of frequency variation and the difference in path lengths. Our first tests were made in the summer of 1925. The results were sufficiently promising that it was decided to continue the tests with improved apparatus.

¹ Heising, Schelleng, & Southworth, *I. R. E. Proc.*, Oct. 1926.

² Bown, Martin, & Potter, *I. R. E. Proc.*, Feb. 1926.

The method used was as follows. Signals of the form of curve *a* in Fig. 1 were transmitted from our laboratory at Deal, New Jersey. The signals consisted of dashes of steady high-frequency power approximately $1/16$ of a second duration with spaces of equal length between. The frequency of the antenna current was varied uniformly during the period that the current flowed as represented in curve *b* of Fig. 1. The frequency used was usually 2700 or 5260 (111 or 57 meters) kilocycles. The amount of variation Δf , during the period of a dash was between 800 and 4000 cycles. The signals were received at a field laboratory at Albertson

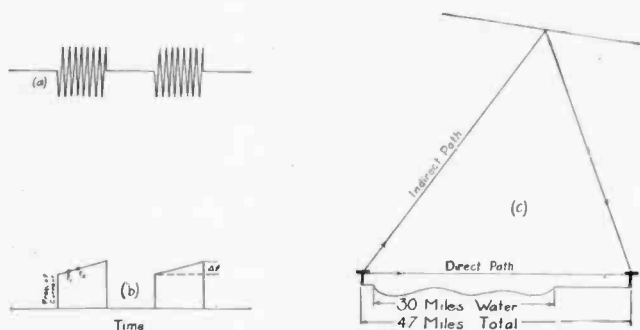

Fig. 1.—(a) Diagram showing type of antenna current pulses approximately $1/16$ second long, and of varying frequency transmitted during “wobler” tests. (b) Diagram showing how the frequency was varied at a uniform rate during the periods of transmission. Δf represents the frequency variation during a period. (c) Diagram showing probable paths with point reflection assumed for the indirect path.

near Mineola, L. I., a distance of 47 miles in a straight line as shown in Fig. 1, diagram *C*. The two paths expected for the two beams were the direct path, 47 miles, and the indirect path in which reflection or refraction occurred from the ionized region at some altitude. The wave radiated at time t_1 of curve *b* and traveling over an indirect path arrived at the receiving station at the same time that the wave radiated at time t_2 from the transmitting station arrived by the direct path. The two waves being different in frequency on account of their having left the transmitting antenna at different times produced a beat note. The frequency of the beat note was the difference of the frequency of the two waves, while timing, and measurements at the transmitter showed at what rate the frequency was varying during the period that the power was on. From these observations the difference between times t_1 and t_2 was ascertained, and this was the difference in the

times required for the waves to travel over the two respective paths. From this difference in time and the velocity of light, the apparent difference in path length and approximate distance of the reflecting layer was computed.

In Fig. 2, oscillograms VII, VIII, and IX show the transmitting antenna current. Except for a slight transient at the beginning of each dash the current was constant. To be sure that variations in current at the receiving station were not caused in the receiving equipment, oscillograms were taken at the receiving

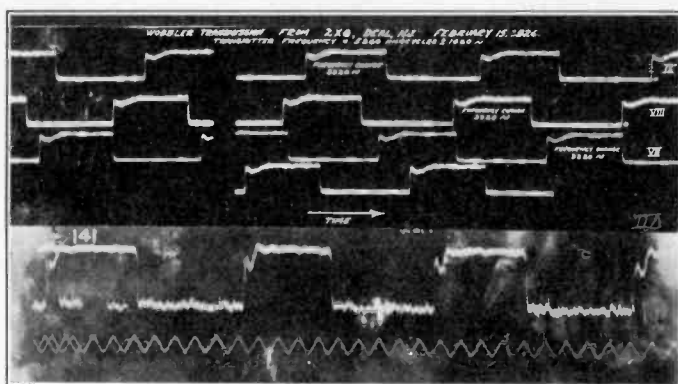

Fig. 2.—Oscillograms VII, VIII, and IX, showing variation in transmitting antenna current during “wobbler” experiments. Oscillogram 141, showing the received current at a time when no fading was occurring, Feb. 10, 1926, 3:10 P.M. The frequency was being varied over a 4000-cycle range during each period of this transmission. The rates of movement of the two films are not the same. The dip occurring at the start of each pulse was a transient in the transmitter (audio filter) and it is somewhat accentuated by the receiver square law detector.

station with no variation in frequency of the transmitting current. Oscillograms such as No. 141 of Fig. 2 were also taken at a time when fading was not present. This oscillogram shows no variation in amplitude beyond that produced in the transmitter, and by noise, even though the carrier frequency was varied over a 4000 cycle range during each dash.

The types of signals received at times when fading was present are shown in Figs. 3 and 4. The information concerning these figures is given in the captions and will not be repeated here. It may be remarked here that the heights given are virtual heights. The actual height is a matter of definition, since the waves penetrate a certain distance into the medium, and the actual velocity is not that of light while they traverse an ionized region.

The more carefully made records checked our earlier rougher records very well. We were not, however, entirely satisfied with the results because it was only occasionally that the beat frequency could be ascertained very accurately. Many oscillograms were secured showing beats too complex to allow of satisfactory analysis and it was thought some of them might have been caused by multiple reflections. It was therefore decided to adopt a different scheme so as to be able to measure not only the path difference but to ascertain how many paths there were.

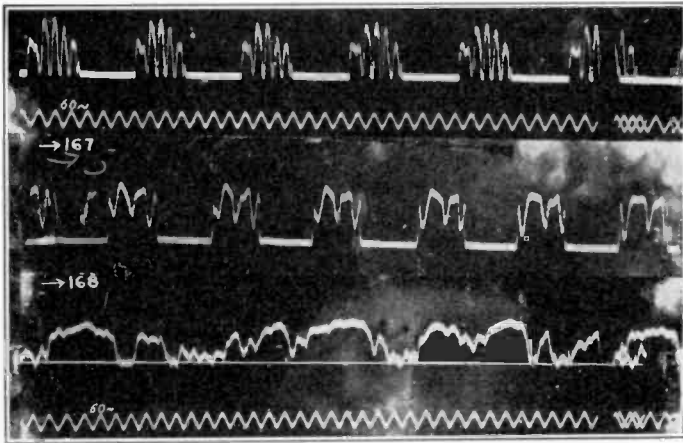

Fig. 3.—Wobbler signals received at Alberton, L.I., February 17, 1926. Average carrier frequency 5260 K.C. (57 meters).
 No. 164 $\Delta f=3320$ cycles. Height of layer about 160 miles 4:08 P.M.
 No. 167 $\Delta f=1660$ cycles. Height practically the same, 5:00 P.M.
 No. 168 Rapid fading observed 5:30 P.M. while a constant carrier was being transmitted.

The scheme adopted was somewhat similar to that used by Breit and Tuve.³ Steady power of constant frequency was radiated in "jabs." These "jabs" of power were between 0.001 and 0.0016 second in duration, practically always the former. They were transmitted at the rate of about 60 jabs per second so as to provide between jabs a time interval that was long compared to the duration of the jab itself. When more than one path for the wave existed between the transmitter and the receiver, and the paths were different in length, a greater time was required for the wave to traverse the longer path than the shorter path. Under these conditions, for each jab transmitted, two or more jabs arrived at the receiving station at slightly different times. By measuring

³ *Phys. Rev.*, Sept. 1926.

the difference between times of arrival of the jabs the difference in lengths of the paths was computed, and knowing the shortest path, or straight line distance, the apparent distance to the reflecting region was found.

Fig. 5 gives two oscillograms of actual transmitted jabs. Numerous oscillograms taken at the receiving station are given in Figs. 6, 7, 8, and 9. These are a representative lot among a large number that were taken. Fig. 6 is a group showing two paths quite clearly with the height of the layer of 221, 233, and 155 miles respectively, assuming the layer is nearly parallel with the earth's surface. The jabs arriving over the direct and indirect paths are

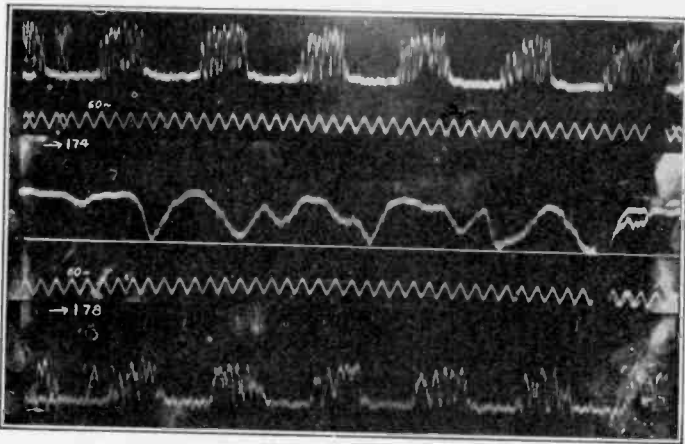

Fig. 4.—Wobbler signals received later the same day, February 17, 1926.
 No. 171 $\Delta f=3320$ cycles. Height, 250 to 300 miles; 7:48 P.M.
 No. 174 Steady carrier alone, 8:06 P.M.
 No. 178 $\Delta f=1660$ cycles. Height, about 250 miles; 8:45 P.M.

quite distinct. They are distinct enough to be measured with considerable accuracy. The first film shows the signal arriving over the indirect path to be stronger than that coming over the direct path. The second oscillogram shows that conditions are reversed. The third one has the same characteristics as the second. It was taken with smaller amplification, and extraneous noises were much less. In some cases the oscillograms showed presence of noise about as great in magnitude as the received jabs but the regular re-occurrence of the received signals still enabled them to be picked out. In Fig. 7 is given a set of oscillograms showing more than one reflection from the ionized layer. One of them shows

three reflections while the others show two. The extra reflections show decreasing amplitude as would be expected.

Oscillograms were taken at times as shown in Fig. 8 to ascertain if there was a connection between fading and multiplicity of paths. All our records indicate that whenever fading occurred there was a multiplicity of paths. It was not, however, always possible to ascertain the number of paths or their difference in lengths because there were occasions when we did not get two or more distinct jabs but got a very broad one, as broad in time as two or three jabs following each other would be. This type of a received

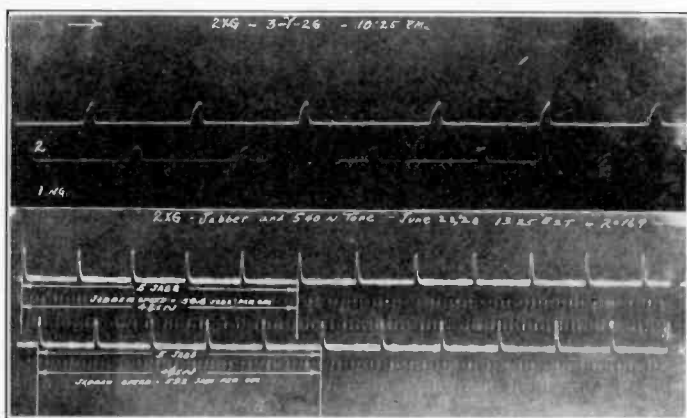

Fig. 5.—Oscillograms showing “jabs” of high frequency current in the antenna at the transmitting station.

March 1, 1926, 10:25 P.M., on 5260 kc. (57 meters).

June 23, 1926, 1:25 P.M., on 17800 kc. (16 $\frac{2}{3}$ meters).

signal appears to be closely connected with the downward movement of the ionized region.

In the experiments reported by Breit he gives a probable height of the reflecting layer as under 141 miles for all observations. On only one occasion did our observations show as low a level as this. The heights which we found correspond to most of those secured by Taylor and Hulburt⁴ by a totally different method. Most of our heights occur between 150 and 250 miles. We did find occasions when it was very much greater as indicated by oscillogram 267 in Fig. 9. In this case the height was of the order of 400 miles. The oscillogram given here happens to have been made on a different wavelength than the preceding ones, but that this was not the cause of the great difference in heights has been determined by other observations.

⁴ *Phys. Rev.*, Feb. 1926.

Fig. 9, oscillogram 30 was taken at Dickinson, North Dakota at a still shorter wavelength than previous oscillograms, namely 16-7/8 meters, (17800 kc.) There are five paths apparent in this oscillogram with a sixth one developing. The straight line distance from Deal to Dickinson is 1510 miles. The signal represented by the fifth jab traveled a distance of 2000 miles greater than that traveled by the first jab, indicating that at the time of these experiments some of the energy traversed a path of at least 3500 miles.

As a rule reflection was observed during daylight only toward the end of the day. It is significant that that was also true of fading

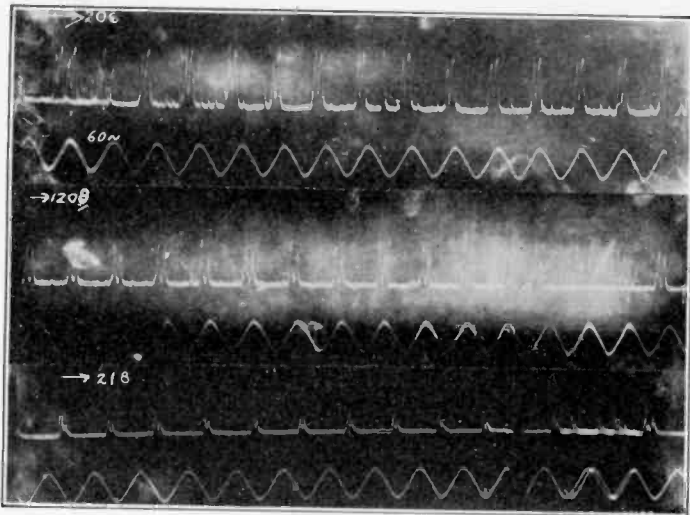

Fig. 6.—Oscillogram showing more than one path, taken at Albertson, L.I.
 No. 206 Feb. 26, 1926, 9:19 P.M., 57 meters; height 221 miles.
 No. 208 Feb. 26, 1926, 9:23 P.M., 57 meters; height, 232 miles.
 No. 218 March 1, 1926, 4:41 P.M., 57 meters; height, 155 miles.

on wavelengths longer than 50 meters. On 67 meters fading would be first observed about an hour before sunset, and cease an hour after sunrise. For 111 meters the fading began very nearly at sunset and ceased as nearly after sunrise. If fading occurred during earlier afternoon hours during which observations were made it was too small to observe, and the same was true of reflections. This would be expected from our absorption observations and from signal strength measurements that are referred to later. It is estimated that in the middle of the day the reflected jab would be only a few percent of the magnitude of the direct jab, on 111 meters, and such a small signal would not show on the oscillograms.

MOVEMENTS OF THE REFLECTING OR REFRACTING IONIZED REGION

In Fig. 10 are plotted curves from several series of observations showing the movement of the ionized layer. These observations were made at intervals of one or more minutes, usually depending upon the time required to change film holders and check up on oscillator adjustment.

The daylight or late afternoon observations secured indicate a level around 160 miles high. As evening passes, the general level rises. On March 1, 1926 the level rose from 160 miles about 4:41 P. M. to 200 miles about 8:00 P. M. and 220 miles about 10:15 P. M. On other occasions as may be observed from Fig. 10, it was higher. The highest level found was almost 400 miles at 8:34 P. M. March 5.

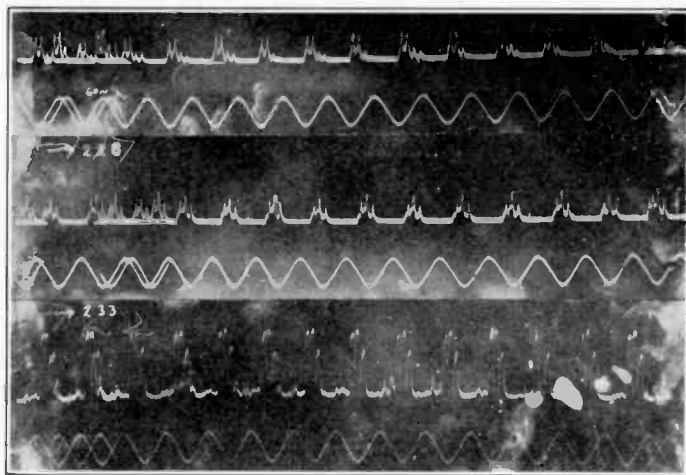

Fig. 7.—Oscillograms showing more than one reflection.

No. 226 March 1, 1926, 8:07 P. M., 57 meters; height, 200 miles. Path differences from direct path computed as 361, 762, and 1210 miles.

No. 228 March 1, 1926, 8:12 P. M., 57 meters; height, 200 miles. Path differences from direct path of 361 and 745 miles.

No. 233 March 1, 1926, 10:16 P. M., 57 meters, height 220 miles. Path differences from direct path of 394 and 835 miles.

The curves show an almost universal tendency to rise. The only exception is the one drawn between two readings taken at 10:58 and 11:00 P. M. March 3, where a drop is indicated of 45 miles in less than two minutes. Because the major part of the readings indicates a slow rise, and a few indicate a faster drop, it is thought that the level rises slowly and drops very rapidly, intermittently, with an average periodicity approximating once in about fifteen minutes for the occasions on which these observations were made.

The times at which multiple reflections occurred, indicating the layer was parallel with the earth's surface, were always times during which the level was rising and had been rising for some time. The multiple reflections were never observed just after a drop. This suggests a possible explanation. It would appear as though great masses of electrons are tossed into the atmosphere rather quickly and that as a result the level drops with accompanying turbulence and variation in density near the lower edge. Immediately thereafter, repulsion by the negative charge on the earth causes the entire mass to rise and the unevenness to disap-

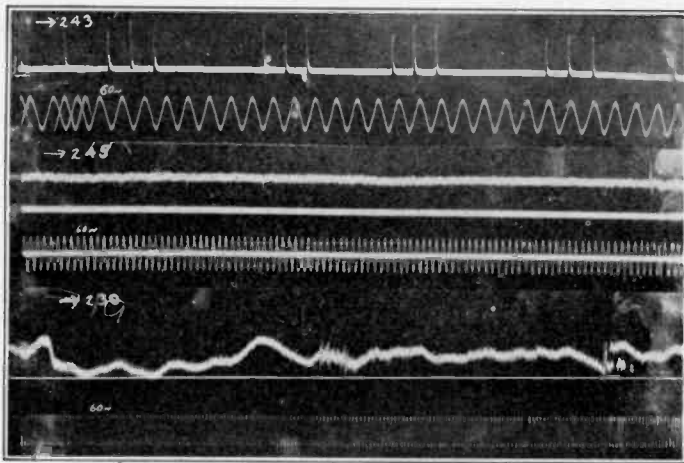

Fig. 8

- No. 243 Type of signal received when no reflection occurred. The jabs were sent in groups on this occasion. March 3, 1926, 3:42 P.M., 57 meters.
- No. 245 Showing absence of fading on the same afternoon as No. 243; 3:49 P.M. when a steady carrier was transmitted.
- No. 230 Fading occurring when steady carrier was sent on the occasion of oscillograms of Fig. 7. March 1, 1926, 10:09 P.M., 57 meters. The 60-cycle hum in the current should not be confused with the fading.

pear. After the mass of electrons has moved upward for a few minutes, the disposition approaches uniformity in a horizontal direction and we get the phenomenon of multiple reflection. Immediately after the arrival of another mass of electrons, the layer drops with a turbulent movement again and the multiple reflection disappears. There are times as stated previously when no height can be computed due to the absence of two distinct jabs on the oscillogram, but where a broadening of the single jab occurs to such an extent that there is clearly a time lag involved. It is

thought that these observations occurred while the layer was descending. At 8:11 p. m. March 1 between two multiple path observations a two-path observation was secured in which the second path jab was a broad large jab indicating a turbulent condition and leading us to believe that a mass of electrons had arrived in the few minutes previous and lowered the layer level. The lower level measured at this time as compared to the previous and subsequent times strengthens this belief.

The heights as given in this paper are virtual heights. They are calculated on the assumption that ordinary reflection takes place and that the layer is parallel to the earth's surface. This latter is not necessarily true as the layer may be at some angle as represented in Fig. 1 in which case "distance to the layer" would be the more proper phrase. The distance between the transmitter and receiver was small in comparison to the distance to the layer, so that any error that would occur in computation due to varying direction is very small. As regards the questions involved in assuming regular reflection at the ionized layer, reference is made to the paper by Breit and Tuve where the matter is discussed in some detail.

LONG DISTANCE TRANSMISSION OBSERVATIONS

The experiments just described were all made with wavelengths of 57 or 111 meters. Further light on the phenomena connected with the ionized regions is obtained from field strength measurements on long distance transmission.

In Fig. 11 are given diurnal curves of average field strength on 16-7/8 meters as measured simultaneously at three points during the first two weeks of June 1926. The measurements were made at Dickinson, N. D. (1510 miles), Seattle, Wash. (2420 miles), and New Southgate, Eng. (3560 miles). The transmissions were made from Deal, N. J. It is a significant fact that though the two most widely separated stations are over 122 degrees different in longitude and on opposite sides of the transmitting station, the diurnal curves are very similar. In the paper previously referred to¹ there was mentioned a depression in the transmission curves and surfaces which appeared around midnight on wavelengths of 45 meters and under (page 627). This depression also appears in data of other observers. It is very pronounced in these three diurnal curves. Since the time to which the curves are plotted is Deal time, it is apparent that the night time conditions near the transmitting station predominate in producing this pronounced dip in the

curves. Mr. Schelleng has suggested a possible cause for this phenomenon which will be more easily understood by reference to the following table:

Table showing the distances from various places to that region in the sky to the north at midnight (at each place, June 21) where sunlight may be found, assuming no refraction by the atmosphere. Also height of that region above the earth.

| | Distance | Vert. Height |
|--------------------------------------------------------------------------|-----------|--------------|
| Deal | 403 miles | 363 miles |
| Dickinson | 232 " | 218 " |
| Seattle | 214 " | 202 " |
| New Southgate | 137 " | 132 " |
| Most northerly point on great circle path between Deal and New Southgate | 105 " | 102 " |

The table shows that at midnight in June at New Southgate, Dickinson, and Seattle, the distances to the region of perpetual sunlight are not very great. They are of the order of magnitude or less than most of the heights shown in Fig. 10. Since a short wave such as was used in these tests penetrates further into the ionized region than the waves used in the tests of Fig. 10, it is reasonable to say that the distances to the region of perpetual sunlight at these locations is less than one would expect to find for the effective height of the ionized region at night on this wavelength.

At Deal the distance to the region of perpetual sunlight at midnight in June is much greater than the distances at the receiving stations and greater than the heights shown in Fig. 10. The night at Deal produces a pronounced effect on the transmission in both directions. It is therefore apparent that *sunlight produces some of the ionization in the refracting region.*

As corroborative evidence of the above, it may be stated that similar curves taken at New Southgate, England, at other times of the year when the distance to the region of perpetual sunlight is large, show as pronounced an effect of the night at the receiving station as is produced by the night at the transmitting station. Signals are received practically only during mutual daylight hours. It appears as though *sufficient ionization for satisfactorily refracting 16-7/8 meters is produced only by sunlight.*

Another conclusion to be drawn from these curves and data is that a wave such as 16-7/8 meters travels to an altitude of between 200 and 400 miles on its passage from Deal to the receiving locations mentioned. Curves for 22 1/2 and 33 3/4 meters corresponding to those of Fig. 11 show that the longer waves travel at progressively lower altitudes since night effects of the receiving locations become progressively more noticeable. This agrees with the refraction theory as well as with the observations of Taylor.

The significant deductions from these experiments can also be

stated as follows: (1) Sunlight, probably the ultra-violet and gamma rays, produce ionization in the atmosphere which assists in the refraction of radio waves. (2) The refraction at night on 16 to 25 meters occurs well over 100 miles up, probably over 200 miles up, but probably not over 400 miles up. (3) After midnight in the absence of sunlight there may be insufficient ions to refract satisfactorily the shorter waves though other data show that there are plenty to refract longer waves (67 or 111 meters.)

ABSORPTION OBSERVATIONS

Some further observations that may throw light on the factors affecting transmission are contained in the I. R. E. paper previously referred to.¹ Fig. 12, which is taken from that paper, shows ratios between average night and average day signals as a function of frequency. It is to be observed that the ratio of night to day signal strengths decreases as the frequency is increased, and that finally the day signal will be the stronger, depending upon the distance and frequency. On account of the shape and positions of the curves, it appears necessary to assume that absorption plays a large part in the phenomenon, and the observations admit of a simple explanation on this basis.

We may take, for instance, the case of transmission from Deal to Fairfax, Va. or Emporium, Pa. The distances are 215 and 243 miles, respectively. The location of either of these stations is such that the ground wave reaching it was reduced to much less than five per cent of the night signal strength no any wavelength measured. The received wave was therefore practically entirely an overhead wave. During the day the strength of signal received on such a wave as 67 meters will depend, among other things, upon the height of the reflecting region, as it affects both the angle at which the radiation must leave the vertical transmitting antenna, and the actual length of path traversed. At night the reflecting region is higher. The increased height will lengthen the path and increase the angle at which the signal leaves the antenna. Both effects tend to reduce the strength of the received signal. However the signal actually received on 67 meters at night is the stronger. This discrepancy is accounted for by absorption. However, there are wavelengths, such as 45 meters, for which the day signal is actually stronger. Hence forty-five meters is a wavelength for which at these distances the absorption by day is less than the reduction by night due to increased distance and greater angle of the wave leaving the antenna. For greater distances than these

two places mentioned, the same rise in height of the refracting region would produce a smaller change in path length and a smaller change in angle of leaving the transmitter so that a smaller reduction in night over day signal would tend to occur and less absorption would be sufficient to neutralize it. The absorption decreases with wavelength in the region under consideration and hence it would be expected, as is found, that for greater and greater distances, the frequency must be increased more and more to secure better day than night transmission. There is, of course, a limit in this direction due to variation in refraction with frequency, to

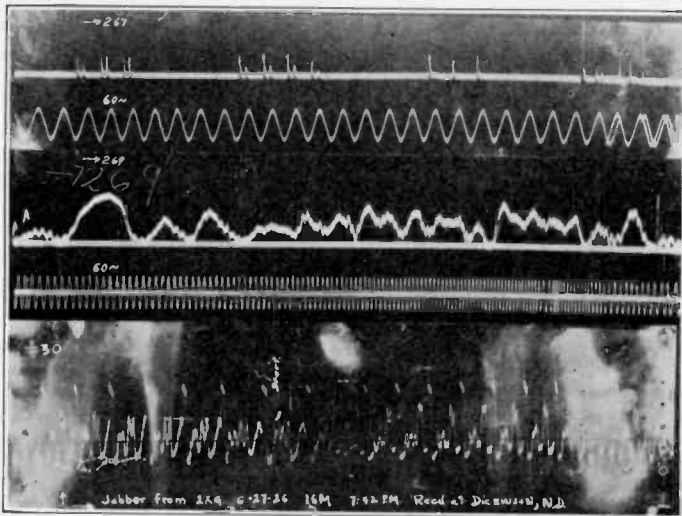

Fig. 9

- No. 267 Two paths with the ionized layer very high. March 5, 1926, 8:39:30 P.M. 111 meters; height, 397 miles.
- No. 269 Fading on the same evening, steady carrier radiated. March 5, 1926, 8:42:30 P.M. 111 meters.
- No. 30 Multiplicity of paths observed at Dickinson, North Dakota, on June 27, 1926, 7:42 P.M. E.S.T. on 167½ meters. Paths are about 800, 1300, 1600, and 2000 miles longer than the most direct path, with a path 3000 miles longer developing, if jabs between the large jabs are delayed from the large jab just preceding. In this oscillogram the "zero line" is variable as a transformer was used.

the height of the refracting region, and to the curvature of the earth.

DISCUSSION

That sunlight affects the transmission of radio waves has long been known. For the longer of what are called short waves, such as 67 meters and over, the signals are strong during the night

hours, the signals disappear very quickly when sunrise occurs at either end of the path and they appear just as quickly after sunset has passed the last of the communicating stations. The sunlight appears to hinder their travel, though it aids the shorter waves.

The short wavelengths longer than 50 meters usually have fairly uniform transmission during dark hours. They do not experience the falling off after midnight that is found in the case of the still shorter waves. The 16- to 50-meter waves require a greater

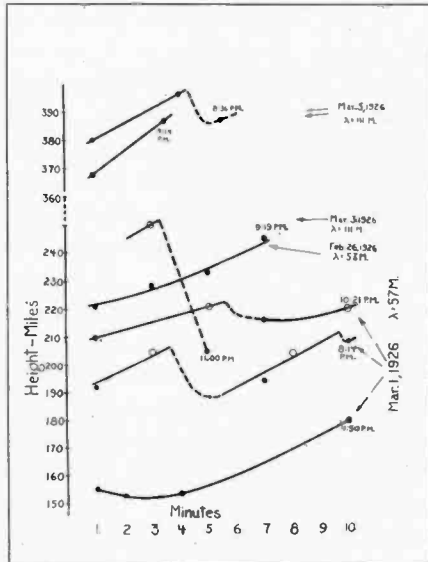

Fig. 10.—Variation of Height of the Region with Time. Circles and dots are observations. Circles are observations in which multiple reflection occurred.

electron density or density gradient for refraction than the 50–150-meter waves and the falling off in signal strength after midnight is probably due to a reduction in the number of electrons to the point where the shorter waves only are seriously affected.

Fading and reflection, which have been shown to be coexistent, were not observed at Albertson on 57, 67, and 111 during most of the day. Fading appeared on 57 or 67 meters before sunset, often as much as an hour and a half, but would not appear on 111 meters until practically sunset. Reflection was observed before sunset on 57 meters on several occasions, while on 111 meters it could not be found. Since a smaller electron density or density gradient is needed to refract 111 meters than 57 meters, the failure to get the

reflection on 111 meters when it was found for 57 meters could not be ascribed to failure in reflection, but to absorption which is closely connected with sunlight. It is known from other experiments that both fading and reflection would be observed in these experiments if the receiving station were at such a distance that more amplification was necessary for the ground wave, or if amplification had been "cut in" at the instant the reflected jab was expected.

Diurnal transmission curves of field strength indicate a daylight influence. On the longer of short waves where one can be sure the electron density or density gradient seldom falls to too low a value to refract sufficiently, the night average intensity of signals is surprisingly constant while the day intensity has a minimum around noon. The 111 meters suffers more attenuation than 67, and 67 more than 45 meters. At night the signal strengths on the three may be closely the same, while during the day they are widely different. Some of these characteristics appear in the curves given in the paper previously referred to by Schelleng, Southworth, and the writer. The shapes of the curves strongly suggest that these phenomena are due to absorption.

Since the reflection of 57 meters before sunset indicated the height of the layer was 150 miles or more at times when no reflection on 111 could be observed, the question arises as to whether the absorbing of 111 and refracting of 57 meters are accomplished by the same ionized region.

The effect of free electrons in the atmosphere upon radio waves has been discussed by Eccles,⁵ Larmor,⁶ and Nichols and Schelleng.⁷ The correlation of this type of phenomenon with other radio transmission and cosmic data would appear to require the postulation of two distinct regions in which refraction and absorption occur. The free electrons may be produced by an ionizing agent operating on the gases of the atmosphere liberating free electrons, or they may come from an outside source thereby producing an excess of electrons over what are needed to render the gases neutral. It is desirable at this time to emphasize a point not discussed in these papers, but yet obviously present and underlying the discussions, which is of fundamental importance in interpreting these experiments if we hold to the idea that free electrons are responsible for the phenomena. The point concerns the possible locations of the regions in which absorption or refraction

⁵ *Proc. Roy. Soc.*, June 1912.

⁶ *Phil. Mag.*, Dec. 1924.

⁷ *Bell Tech. Journal*, April 1925.

can occur. The assumption necessary to any theory of refraction by free electrons is that the mean free path be so long that the electrons can absorb energy from the passing wave and then re-radiate it all in a slightly different phase. If the mean free path is small, the electron may strike a gas molecule or ion before it has reradiated all the energy absorbed, and the remaining energy will be lost to the advancing wave. There will be a much greater chance of this loss in energy where there are greater numbers of gas molecules present. As pointed out by Nichols and Schelleng, the greatest loss of energy per electron will occur at some certain

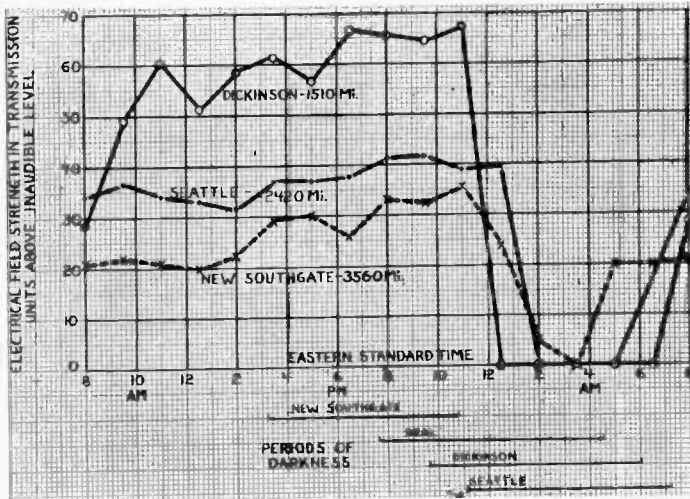

Fig. 11.—Diurnal Curves Showing the Average Field Strength of Signals on 16 2/3 meters as Measured Simultaneously at London, Seattle, and Dickinson—June, 1926.

density of the atmosphere, it being expressed as the place where, (for no magnetic field, or for the electric vector parallel to the magnetic field) the electron collision frequency equals 2π times the radio frequency. For other wave components in a magnetic field it is slightly different from this. For altitudes below that at which this required condition obtains, the absorption quickly becomes small or negligible and the same occurs above this altitude for most components. Below this maximum absorption altitude which in this paper is termed the "absorption region," the electrons do not have a chance to move under the influence of a wave long enough to absorb and reradiate much energy before they strike gas molecules, and therefore there can be no refraction, while sufficiently above this region they may seldom strike molecules

and there will be little absorption. In the desirable refracting region the collisions will be so small in number as to entail little or no absorption. From these considerations it may be deduced, therefore, that *the refracting region is always above the absorbing region and the "overhead" or "sky" wave will always pass through the absorbing region twice in its path from one point on the earth's surface to another.*

With this picture of the absorbing and refracting regions, it becomes increasingly clear why the very long and very short waves can be used for long distance communication while the region in between is useless during daylight hours. The unsatisfactory results attending efforts to ascribe transmission around the curved surface of the earth to diffraction, and the effect of a conducting earth, have left the alternative of ascribing such transmission to refraction above the earth's surface. All long distance communication must therefore be dependent upon refraction, and although all waves from 15 to 10,000 meters are satisfactorily refracted, only those waves within this region are satisfactory for long distance communication if they can make their two or more passages through the absorption region without undue attenuation. Nichols and Schelleng show definitely in their paper that one effect of the earth's magnetic field is to reduce enormously the absorption that occurs on the longer waves—such as 2000 to 10,000 meters. The effect of the magnetic field on the absorption of waves under 100 meters is small, but the mass of the electron begins to play the same part here as does the magnetic field for long waves. As a result, it will be found that the absorption constant is small for the shortest usable waves, that it is increasing rapidly as the wavelength is increased, and that it passes a maximum slightly above 214 meters and decreases again in the longer wave region for some components of the wave. The failure of the middle region to be of any use in long distance communication during daylight hours is thus easily explained purely upon the basis of electronic absorption.

With this picture as a basis, it also becomes possible to explain many phenomena including those described in this paper, and to show that they point to the existence of two ionizing agencies instead of one, both agencies having been suggested many times but not indicated previously as being equally necessary.

The locations of the regions of the atmosphere where absorption and refraction occur can be deduced reasonably well from our knowledge of the structure of the atmosphere. Using the table

given by Chapman and Milne⁸ for the pressures and mean free paths of gases in the atmosphere, the altitude at which maximum absorption occurs for 50 meters is computed as about 40 miles. For longer waves it is higher, being around 15 or 20 miles higher for 3000 to 10,000 meters. At 50 meters the depth of the absorbing region is fairly narrow, being about 15 miles deep so that the refracting regions for 50 meters could be considered as beginning

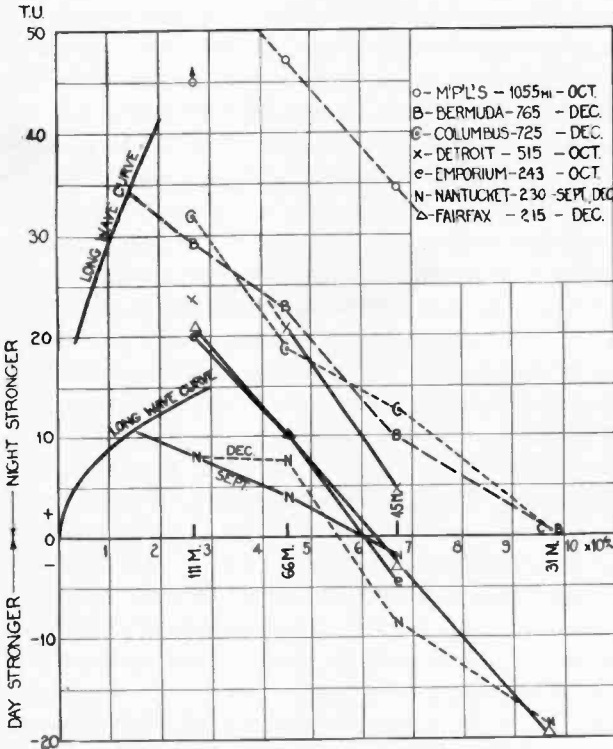

Fig. 12.—Ratio of Average Night to Average Day Signals as a Function of Frequency. (Tests made in 1925).

around 50 miles up and continuing on up indefinitely. For shorter waves than 50 meters, the absorbing and refracting regions are lowered a few miles while for longer waves they are slightly higher.

An item of importance is the electron distribution and its cause. The close connection between poor long distance transmission on the wavelengths contiguous to 214 meters and daylight indicates that electro-magnetic rays from the sun cause the ionization in this region. It appears very improbable that the β particles from the sun cause the ionization. Chapman and Milne have estimated

⁸ Quarterly Journal of the Royal Meteorological Soc. V. 46, 1920.

that the height of the region of maximum ionization by high velocity electrons from the sun is about 35 miles. While this is below the computed altitude of the absorbing region, it would not appear to be the cause of poor daylight transmission since the electrons cannot approach the earth in straight lines and produce ionization uniformly over the sunlit side, but must come along magnetic lines of force. They can arrive only near the polar regions except under most unusual conditions. The phenomenon of absorption should be confined to that part of the earth's surface at which the gaseous ionization occurs unless forces are present which cause the free electrons to migrate to all latitudes *before* rising under the influence of the negative charge on the earth, to an altitude above the absorbing region. Such migration from the polar regions would be expected on the dark side of the earth as well as on the sunlit side and produce absorption at night. The number of electrons reaching the tropics would be less than the number reaching the temperate zone thereby producing a variation in absorption with latitude. The absorption would be expected to vary widely with variation in the number of β particles arriving. Such expected phenomena have not been observed. Besides, it is not evident how such a hypothesis can be made to fit the following facts. The absorption on 67 meters or 111 meters is maximum about the middle of the day. It falls off toward sunset. It is small enough an hour before sunset due to obliquity of the sun's rays so that fading is observed on 67 meters and on 57 meters, and the existence of multiple paths can be determined for 57 meters. After sunset the absorption on 111 meters disappears so quickly and completely that this wave may be used for transmission up to several thousand miles. Long distance signals on 111 meters disappear quickly at sunrise, and on 67 a short time afterward. Only a cause which disappears at sunset and reappears at sunrise, without a hold-over effect or time lag period of any magnitude can be satisfactorily assumed. The ionization of the atmosphere by ultra-violet or gamma rays appears at present to be the most probable cause of free electrons in the absorbing region.

Computations made to determine the probable ionization by waves from the sun and based upon known penetration constants for gamma rays in various substances, and upon Chapman and Milne's structure of the atmosphere, indicate that the maximum number of electrons would be liberated in a given time at an altitude of 16 miles. The number produced would decrease very rapidly below that point, and decrease much more slowly above it.

The ionization produced by this means thus extends to a sufficiently low altitude to include the absorbing region.

In the refracting region conditions are more complex than in the absorbing region. It is more difficult to fit all experimental facts to a given hypothesis. In general, it has been assumed that the refracting region was "the ionized layer" where the free electrons were produced either by electromagnetic radiation or β ray impact, or by the β ray electrons themselves. The experiments described in this paper appear to support the hypotheses that refraction is assisted by, and at times is entirely due, to electrons entering the atmosphere.

A few of the points to be kept in mind may be listed as follows:

1. In the refracting region the electron collision frequency must be small, that is, the atmosphere must be very rarefied.

2. The amount and direction of refraction depends upon the electron density, the electron density gradient with height, and the magnetic field gradient with height. An electron density gradient appears to be the most necessary condition though an enormous change in refraction may occur in certain wave components by a change in electron density only.

3. The ionized condition lasts throughout the night sufficiently well to refract downward wavelengths of 67 meters and longer.

4. The conditions of ionization may change sufficiently during the night to affect seriously the refraction on wavelengths shorter than about 50 meters.

5. The refraction is noticeably increased on the shortest waves by sunlight. If the sunlight can operate on the refracting region at a time when refraction is not good, the refraction may be changed from an unusable to a usable value.

6. An electron density of 10^5 appears necessary for refraction back to earth of 50 meters and $10^{5.5}$ for 16 meters (From Nichols and Schelleng's approximate formula).

7. The ionizing conditions after sunset are not constant nor do they change at a uniform rate, but actually vary enormously. This is very noticeable as regards the height of the region.

8. A wide variation in the apparent height is observed from night to night, the values obtained being anywhere from 100 to 400 miles.

If it is attempted to explain the above phenomena on a hypothesis involving electromagnetic radiation only, two physical facts stand out as difficult to explain. The first is the persistence of the ionization after sunset. The second is the variation in height which

occurs after sunset, both from minute to minute and from day to day. Take first the matter of the persistence of ionization after sunset. It is usually suggested that the time of recombination would be so long that the ionization, though decreasing, could last throughout the night. Computation of the falling off of electron density after sunset on the basis of recombination is very difficult on account of the lack of sufficient information. However, an approximate computation can be made. Since the reflection of waves of 60 meters and longer is always observed hours after sunset, the electrons must still be present in the refracting region at this time to the amount of 10^6 per cc. The electron collision frequency and number of gas molecules per cc. are respectively 2500 per second, and 5×10^{11} (100 miles high) and 100 per second and 2×10^{10} (200 miles high). A calculation based on the assumptions that all collisions of electrons with ionized gas molecules result in combination, that the attraction of the positive ions and electrons and the effect of neutral molecules is ignored indicates that a period of less than 30 minutes will suffice for a reduction of electrons from 10^7 to 10^5 per cc. at these altitudes. The time would be longer if the temperature is lower than that assumed by Chapman and Milne, -54 deg. centigrade, and shorter if the temperature is higher.

The other phenomenon which it is difficult to account for is the rapid variation in height of the region from minute to minute, and to a lesser extent from night to night. The layer was observed to rise at a rate of about 6 miles per minute, and fall at a rate of about 20 miles per minute with a period approximating fifteen minutes. Such movements in the ionized region after sunset if the electrons are produced by electromagnetic radiation would require that rays of varying strength approach the earth on the dark side, or that great electric fields cause the uncombined electrons to migrate up and down in the air.

The difficulties attending the fitting of facts to the ultra-violet light hypothesis make it desirable to give some attention to a possible explanation by the β particle hypothesis. Many of the experimental facts are easier to explain on this basis. To begin with, one must differentiate between the ionization caused by collision as the arriving β particles are brought to rest, and the effective ionization caused by the presence of the arrived electrons alone after the original gaseous ionization has recombined. The β particles cannot approach the earth in straight lines over the sunlit side, but are constrained to follow down along the magnetic field into the polar regions. It has been computed that they produce the

greatest ionization at around a 35-mile altitude. The ionization by collision therefore can occur only in the polar regions and not uniformly over the projected surface of the globe, so that the presence of free electrons in the refracting region over other than the polar regions must be accounted for by movement from these latter regions. The gaseous ionization at the ionizing level will quickly disappear, but the excess of electrons occurring due to the arriving β particles will cause a space charge to occur which can cause a migration of electrons in all directions. The effect of the atmosphere, the earth's magnetic field, the negative charge on the earth, and the rotation of the atmosphere with the earth, upon the movement of the superfluous electrons is rather complicated and the exact movements cannot be easily ascertained. The migration of the extra electrons to lower latitudes in variable amounts depending upon variable rates of arrival would account for the movements of the region that have been observed. The principal ionization in the refracting region would be that due to the extra electrons as they moved away from the polar region and while on their journey away from the earth.

When electrons arrive from the sun and strike the earth's magnetic field, they are either deflected away or are captured. The earth's field is in such a direction that an electron striking it over the advancing side of the earth is likely to be deflected away and expelled while if it strikes that part over the following side, it will be deflected in toward the earth and into a denser field and its probability of capture is greater. The greatest number will arrive on the earth not at a point between the magnetic pole and the sun but at a point toward the sunset side. This is substantiated by visual observations on aurora which show definitely a greater number of aurora occurring before midnight than after. The numbers of electrons present in our latitude after sunset would be large because of proximity to the "pole of arrival." The post-midnight depressions in the transmission curves and surfaces on received field strength of the shorter waves would be accounted for by the reduced electron arrival on that side (the early morning side) of the magnetic pole as well as to the greater distance to the "pole of arrival." The number of free electrons reaching the locality of Deal, for instance at this time, the early morning, is not sufficient under average conditions to refract the 16-7/8 meter waves, but at London, Seattle, and Dickinson with the added ionization produced by sunlight, enough are present in June to refract the waves properly during this part of the night.

It is not supposed that all refraction is due to β ray electrons alone. During the day, sunlight will produce large numbers at all altitudes above 16 or 20 miles. The numbers produced will depend upon the strength of the ionizing electromagnetic waves, while their distribution with altitude will be independent of the strength. The variation from minute to minute or day to day will depend upon the variation in strength of the sun's radiation, and so far as is known, that variation is relatively small. The number of electrons produced in the refracting region during the day by the radiation from the sun is likely to be greater than the number usually present from the β ray source, thereby determining to a large extent the refracting region conditions during the day. Under such conditions the height would be decidedly lower during the day than at night. The variations would be less and therefore more uniform refraction would occur. At night, however, the absence of the steady ionization due to sunlight would leave all refraction to the β ray electrons, and the relative variation in ionization from minute to minute becomes more pronounced. The more rapid fading found on those wavelengths that travel well at night than occurs on the shorter waves that travel well in the daytime appears to support this idea.

There are other physical phenomena which fit in well with this hypothesis. β particles from the sun are probably arriving all the time. The occasions when they are brought to our attention are those occasions when extra large numbers arrive, such as during a display of the aurora borealis. They are probably arriving even when the aurora is not seen as Lord Rayleigh⁹ reported the existence of the green auroral line in the night sky at all times. The refraction region at night is at the height or some distance above the observed level of the aurora. The aurora is closely associated with earth currents and currents in cables and telegraph lines, while the period of movements observed in this layer correspond closely with the periods of the principal disturbing currents measured in cables. Radio transmission has been observed to be seriously affected at the time of aurora displays. It has also been observed to have a connection with sunspots.

If the views put forward in this paper are correct the refracting region at night should be much lower in the arctic and higher in the tropics than at this latitude (41 deg.). The space charge occurring over the polar region might be forced to an altitude low enough to embrace the absorbing region and produce absorption day and

⁹ *Proc.*, Royal Soc. London, Vol. 109, 1925.

night a large part of the time. On occasions of aurora displays of exceptional magnitude, the ionization might be lowered at our latitude as far as the absorbing region and might produce the equivalent of daylight transmitting conditions at night for those waves susceptible to absorption.¹⁰ The height of the refracting or reflecting region should show a connection with sunspot activity. While no direct measurements bearing on this relation are available, it may be significant that Pickard¹¹ has found a connection between the occurrence of sunspots and long-distance transmission at broadcasting frequencies.

A natural result of our work has been the formation in the mind of a picture of the ionization as it is thought to occur. In one of the earlier efforts two separate and distinct ionized layers were postulated. It was thought they were produced by the two separate ionizing agencies mentioned. An attempt was made to fit this picture to the facts available. It was thought that the difference in absorption noticeable among the short waves could be attributed to the position of the absorbing ionized layer with respect to the absorbing regions for the various short waves. This picture has, however, been discarded in favor of the following.

The greatest number of electrons are pictured as being produced by sunlight, and extending from an altitude of about 16 miles to the limit of the atmosphere. This ionization experiences a diurnal variation due to the rotation of the earth, and a seasonal variation due to the inclination of the earth's axis to the orbit. The intensity at a given height depends largely upon the obliquity of the sun's rays and upon the rate of recombination. The relative intensity of distribution with height is independent of the intensity of sunlight, except as affected in the rarer regions by the rate of recombination. This ionization extends clear across both refracting and absorbing regions. Absorption is produced by this ionization occupying the absorbing region. Within the space occupied by this ionization, a second ionization occurs, irregular in its variation, produced by β particles from the sun. The altitude at which this second ionization occurs is generally considerably above the absorbing region, and only under unusual conditions does it extend down to it. At night the diurnal sunlight ionization disappears and the irregular β ionization remaining is sufficient to refract all but the shortest of usable waves. Rapid fading is the result of rapid variations of intensity in, or position of, this ionization. This ionization is the principal ionization on the dark side of the earth.

¹⁰ Southworth reports observing this phenomenon in April 1926.

¹¹ I. R. E. Proc., Feb. 1927.

BOOK REVIEW

Radio Manual (U. S. Naval Institute, Annapolis, Md.). 1927 Edition, 141 pages. Price, \$5.50.

This Manual is a text book on radio communication first prepared in 1925 by a group of officers in the Department of Electrical Engineering and Physics at the Naval Academy. It is stated in the preface that other texts available were found either too comprehensive or not comprehensive enough for the thirty lessons devoted to the subject at the Academy. Another reason for the writing of this book was the need for an up-to-date work; this requirement has been met by yearly revisions, the 1927 edition being the third.

Of the eighteen chapters, the first three are on wave motion and the characteristics of simple oscillating circuits. In this section, as throughout the Manual, the calculus is used, but merely for purposes of definition. Vector analysis and graphical methods are introduced as required, but the mathematical treatment is very restricted in all the chapters. This is, no doubt, a necessity in such a condensed text. Following chapters on the use of the frequency meter, and apparatus for damped and continuous wave transmission and reception, five chapters are devoted to a discussion of vacuum-tube theory and practice in receivers and transmitters. The remaining chapters are on such subjects as "Radio Telephone Transmitter," "Coil Antennas," etc. The 1926 Report of the Committee on Standardization of the Institute of Radio Engineers is printed as a 21-page supplement, together with membership lists of this Committee for 1923-1925. The book itself has a comprehensive index.

The work is somewhat longer than the number of pages (141) would seem to indicate, the pages being of 8 by 10½ inch size. Even so, a comprehensive treatment of the modern subject of radio communication is impossible in such a space. Morecroft's recently revised text, for example, while not extended deeply into the various specialties, runs to over 1,000 pages. The Manual must accordingly be judged in the light of its purpose: to provide an elementary course in radio theory for student officers, with sufficient practical material to give the men so trained the initial preparation for handling Naval radio equipment later, with the aid of special instruction books and other directions. This object is admirably fulfilled. The treatment is clear throughout, and

the material, carefully arranged, is rendered accessible through numerous and well-worded captions. Each chapter is written and page-numbered as a separate unit, to facilitate frequent revision. If, as a result of the extreme epitomization, statements are occasionally made, as ". . . it cannot be said that there has been any considerable degree of success attained in the elimination of these effects (atmospheric interference)," which the experienced radio specialist might wish to qualify, this cannot be taken as detracting from the value of such a work in the field of its usefulness. This Manual might, in fact, prove valuable in other elementary radio engineering courses where the allowable time is as limited as at the Naval Academy.

CARL DREHER

Please Refer to Page 14 regarding the discontinuance of publication of these Patent Digests. It is thought that they are not of sufficient general interest to warrant further publication.

DIGEST OF UNITED STATES PATENTS RELATING TO RADIO TELEGRAPHY AND TELEPHONY

Issued November 22, 1927 to December 13, 1927

By
JOHN B. BRADY

(Patent Lawyer, Ouray Building, Washington, D. C.)

- 1,648,808—WAVE SIGNALING SYSTEM—Louis A. Hazeltine, Hoboken, N. J. Filed Feb. 27, 1925, issued Nov. 8, 1927. Assigned to Hazeltine Corp.
- 1,649,589—WAVE SIGNALING SYSTEM—Louis A. Hazeltine, Hoboken, N. J. Filed Feb. 27, 1925, issued Nov. 15, 1927. Assigned to Hazeltine Corp.
- 1,649,810—VACUUM TUBE—E. L. Chaffee, Belmont, Mass. Filed (original) Oct. 14, 1918, renewed Feb. 27, 1925, issued Nov. 22, 1927. Assigned to John Hays Hammond.
- 1,650,032—RADIO APPARATUS—T. W. New, Cincinnati, Ohio. Filed May 27, 1925, issued Nov. 22, 1927. Assigned to The Teleforce Radio Laboratories Co.
- 1,650,232—THERMIONIC TUBE—G. W. Pickard, Newton Center, Mass. Filed March 7, 1922, issued Nov. 22, 1927. Assigned to Wireless Specialty Apparatus Co.
- 1,650,353—WAVE SIGNALING SYSTEM—L. A. Hazeltine, Hoboken, N. J. Filed Feb. 27, 1925, issued Nov. 22, 1927. Assigned to Hazeltine Corp.
- 1,650,250—TWO WAY CIRCUIT ARRANGEMENT FOR WIRELESS TELEPHONY—O. Von Bronk, Berlin, Germany. Filed Feb. 20, 1923, issued Nov. 22, 1927. Assigned to Gesellschaft fur Drahtlose Telegraphie.
- 1,650,395—FIXED CAPACITY CONDENSER AND METHOD OF MAKING THE SAME—S. Siegel, New York, N. Y. Filed April 14, 1925, issued Nov. 22, 1927. Assigned to Aerovox Wireless Corp.
- 1,650,461—ANTENNA DEVICE—A. R. Nilson, Brooklyn, N. Y. Filed Oct. 10, 1925, issued Nov. 2, 1927.
- 1,650,465—VARIABLE CONDENSER—W. Reese, Brackenridge, Pa. Filed Dec. 27, 1926, issued Nov. 22, 1927.
- 1,650,701—RADIO SIGNALING SYSTEM—J. F. Farrington, Flushing, N. Y. Filed April 22, 1925, issued Nov. 29, 1927. Assigned to Western Electric Co., Inc.
- 1,650,754—VACUUM TUBE UNIT—A. A. Kent, Ardmore, Pa. Filed Apr. 20, 1923, issued Nov. 29, 1927.
- 1,650,898—TUNED RADIO FREQUENCY CIRCUITS—D. R. Lovejoy, New York, N. Y. Filed June 4, 1925, issued Nov. 29, 1927. Assigned to Lovejoy Development Corp.
- 1,650,921—VACUUM TUBE—A. Winkelmann, Hoboken, N. J. Filed May 9, 1923, issued Nov. 29, 1927.
- 1,650,862—SPIRAL PLATE CONDENSER—F. A. Borzych, Minatare, Neb. Filed Feb. 15, 1926, issued Nov. 29, 1927.
- 1,650,925—COMBINED TELEPHONE AND WIRELESS RECEIVER—C. H. Allen, Pittsburgh, Pa. Filed Mar. 10, 1923, issued Nov. 29, 1927.
- 1,650,934—SYSTEM OF MODULATION—L. W. Chubb, Swissvale, Pa. Filed Aug. 30, 1923, issued Nov. 29, 1927. Assigned to Westinghouse Electric & Mfg. Co.
- 1,650,944—APPARATUS FOR RADIO TRANSMISSION—Abd-El-Rahman Z. A. Khalifah, Philadelphia, Pa. Filed Nov. 29, 1922, issued Nov. 29, 1927.
- 1,650,983—INSULATING STRUCTURE FOR HIGH POTENTIAL CONDENSER TERMINALS AND THE LIKE—W. Dubilier, New York, N. Y. Filed Nov. 13, 1921, issued Nov. 29, 1927. Assigned to Dubilier Condenser Corp.
- 1,651,065—METHOD OF EXHAUSTING THERMIONIC TUBES AND LIKE DEVICES—H. E. Metcalf, Oakland, Calif. Filed Jan. 21, 1927, issued Nov. 29, 1927. Assigned to Magnavox Co.
- 1,651,308—AUDIO AMPLIFIER—L. Winkelmann, Hoboken, N. J. Filed Apr. 10, 1922, issued Nov. 29, 1927.
- Re-16,805—RADIO TELEGRAPH AND TELEPHONE RECEIVING SYSTEM—F. G. Simpson, Seattle, Wash. Filed Nov. 4, 1922, issued Nov. 29, 1927. Assigned to Simpson Radio Corp.
- 1,651,810—AMPLIFYING SYSTEM—Alfred Crossley, of Washington, D. C. Filed Nov. 10, 1925, issued Dec. 6, 1927. Assigned to Wired Radio, Inc.
- 1,651,953—SUPPORT FOR RADIO APPARATUS—A. C. Hayden, of Brockton, Mass. Filed Dec. 13, 1926, issued Dec. 6, 1927.

- 1,651,975—VARIABLE CONDENSER—H. M. Specht, of Pelham, N. Y. Filed Dec. 19, 1923, issued Dec. 6, 1927.
- 1,652,118—RADIO CONDENSER—M. Guett, of Hartford, Connecticut. Filed July 1, 1925, issued Dec. 6, 1927. Assigned to Hart & Hegeman Manufacturing Co.
- 1,652,155—ELECTRICAL SYSTEM AND SIGNALING METHOD—A. F. Van Dyck, of Rye, New York, Filed May 27, 1924, issued Dec. 6, 1927. Assigned to Radio Corporation of America.
- 1,652,158—VARIABLE ELECTROSTATIC CONDENSER—W. Aull, Jr., New York, N. Y. Filed Nov. 29, 1922, issued Dec. 13, 1927. Assigned to Dubilier Condenser Corp.
- 1,652,164—METALLIC OSCILLION AND METHOD OF CONSTRUCTING SAME.—H. S. Coyer, New York. Filed Dec. 18, 1920, issued Dec. 13, 1927.
- 1,652,212—ELECTRICAL CONDENSER AND METHOD OF MAKING IT—W. H. Priess, Belmont, Mass. Filed Mar. 30, 1921, issued Dec. 13, 1927. Assigned to Wireless Specialty Apparatus Co.
- 1,652,219—RADIO RECEIVING APPARATUS—A. A. Thomas, New York, N. Y. Filed May 20, 1922, issued Dec. 13, 1927.
- 1,652,257—COMPOSITE RADIO PANEL AND SOUND MODIFIER—W. B. Stevenson, Philadelphia, Pa. Filed Aug. 20, 1925, issued Dec. 13, 1927. Assigned to Victor Talking Machine Co.
- 1,652,376—VARIABLE CONDENSER—J. D. Sartanoff, New York, N. Y. Filed Sept. 29, 1925, issued Dec. 13, 1927. Assigned one-half to Khetah Corp.
- 1,652,388—METHOD AND ARRANGEMENT FOR THE MULTIPLE AND DIRECTED RECEIVING OF RADIO SIGNALS—V. I. Bashenoff, Moscow, Russia. Filed June 18, 1923, issued Dec. 13, 1927.
- 1,652,497—THERMIONIC DEVICE—H. M. Ryder, Wilkinsburg, Pa. Filed June 25, 1921, issued Dec. 13, 1927. Assigned to Westinghouse Electric & Mfg. Co.
- 1,652,516—RADIO TRANSMITTING SYSTEM—F. Conrad, Pittsburgh, Pa. Filed Dec. 23, 1923, issued Dec. 13, 1927. Assigned to Westinghouse Electric & Mfg. Co.
- 1,652,863—ELECTRIC CONDENSER—F. J. Kent, Verona, N. J. Filed Mar. 31, 1923, issued Dec. 13, 1927. Assigned to Unitrol Condenser Corp.
- 1,652,880—VACUUM TUBE AND TUBE CIRCUITS—A. G. Thomas, Lynchburg, Va. Filed July 25, 1923, issued Dec. 13, 1927.
- 1,652,901—VARIABLE CONDENSER—R. H. Langley, Schenectady, N. Y. Filed Sept. 26, 1923, issued Dec. 13, 1927. Assigned to General Electric Co.
- 1,652,927—CRYSTAL DETECTOR AND CLIP—J. Buchanan, North Braddock, Pa. Filed June 2, 1924, issued Dec. 13, 1927.

GEOGRAPHICAL LOCATION OF MEMBERS ELECTED

December 7, 1927

Transferred to the Member grade

| | | |
|------------|------------------------------------------------|---------------------|
| California | Oakland, Rola Co., 4250 Hollis Street | Engholm, Bernard A. |
| Illinois | Chicago, Rowan Trees Hotel, 500 Englewood Ave. | Fortington, W. H. |
| Louisiana | New Orleans, U. S. Customhouse, Room 217 | Deiler, Theodore G. |
| | New Orleans, 2222 Sapeyrouse Street | Gallo, Louis J. |
| New Jersey | Maywood, 96 Maywood Avenue | Stantley, Joseph J. |
| Ohio | Cleveland, 3041 Fairfax Road | Vioreen, John A. |

Elected to the Member grade

| | | |
|---------------|-----------------------------------|------------------|
| Illinois | Chicago, 549 W. Washington Street | Beane, E. A. |
| Massachusetts | Cambridge, 38 Woods Avenue | Root, Leland B. |
| New York | New York City, 253 Broadway | Skirrow, John F. |

Elected to the Associate grade

| | | |
|-------------------|------------------------------------------------|------------------------|
| California | Alhambra, 2600 La Crescenta | Harper, Harold R. |
| | Bolinas, c/o Radio Corporation of America | Park, Charles W. |
| | Grass Valley, 209 Marshall Street | Cordell, Harry S. |
| | Los Angeles, 2408 W. Vernon | Hayes, E. K. |
| | Mayfield, 285 College Avenue | Paul, Ernest Edward |
| | Oakland, 2552 Foothill Boulevard | Soleberg, Arnold J. |
| | San Diego, 4814 Idaho Street | Burnett, William W. L. |
| | San Francisco, 480 Second Street | MacGregor, Robert |
| | Santa Barbara, 1010 Bath Street | Kempton, Walter D. |
| Colorado | Denver, 1337 So. University Street | Grove, William C. |
| | Denver, c/o Denver Tramway Corp. | Love, Nelson R. |
| Connecticut | New Haven, 1 Beacon Avenue | Tucker, George B. |
| | New London, U. S. S. Downes | Dilow, Arthur P. |
| | Stamford, 20 Worth Street | Stephenson, Martin L. |
| Dist. of Columbia | Washington, Radio Section, Bureau of Standards | Heaton, Vincent |
| Florida | Orlando, Box 1464 | Danforth, Harvey P. |
| Georgia | Royston | Berryman, Forrest G. |
| Illinois | Chicago, A. T. & T. Co., 208 W. Washington St. | Dutton, Charles E. |
| | Chicago, 140 S. Kilbourn Avenue | Herrick, R. H. |
| | Chicago, 3829 Fulton Street | Keogh, Raymond J. |
| | Chicago, 1942 N. Lowell Avenue | Porter, G. O. |
| | Chicago, 5531 Washington Boulevard | Stevens, Fred B. |
| | Zion, 3010 Emmaus Avenue | Mason, C. T. |
| Kansas | Ellis, 503 West Adams Street | Harrison, Louis A. |
| Louisiana | New Orleans, 119 So. St. Patrick Street | Jensen, Valdemar |
| Maryland | Baltimore, 2502 Dulaney Street | Seitz, J. Fred |
| | Cumberland, Box 345 | Craig, Joseph B. |
| | Westminster, 93 Liberty Street | Utz, William C. |
| Massachusetts | Atlantic, 49 Hovey Street | Heap, Shelson S. |
| | Boston, 8 Commonwealth Avenue | Currier, Guy, Jr. |
| | Winchester, 407 Main Street | Burgoyne, Roger M. |
| Michigan | Ann Arbor, Elec. Eng. Dept., Univ. of Michigan | Worel, Frank |
| | Detroit, 5716 Crane Avenue | Malo, Charles D. |
| | Detroit, 5316 Seebaldt Avenue | Puddiford, Stanley W. |
| | Grand Rapids, 38 West Hall Street | King, Glenn C. |
| Minnesota | Edgerton | Rust, Leslie W. |
| | Kent | Olson, Martin N. |
| | Lakefield | Tkach, George |
| | St. Paul, 469 Michigan Avenue | Brantzen, Arthur M. |
| Missouri | Kansas City, 2015 Grand Avenue | Bielenberg, John T. G. |
| | St. Louis, 5201 Cabanne Avenue | Corwin, Willis P. |
| | St. Louis, 3827 Vest Avenue | Henrie, Edward F. |
| | St. Louis, 5950 Kingsbury Avenue | Whitlock, Fred |
| Montana | Anaconda, 619 East Third Street | Horsfall, James R. |
| New Hampshire | Tilton, 23 Summer Street | Booth, Howard M. |
| New Jersey | Jersey City, 654 Bergen Avenue | Schormann, Walter W. |
| | Kearny, c/o Western Electric Co. | McCrea, M. U. |
| | Summit, 901 Springfield Avenue | Biele, Charles E. |
| | Union City, 311 28th Street | Erkard, John Allen |
| New York | Albany, 78 Oxford Road | Covey, James H. |
| | Astoria, 319 16th Avenue | Schram, William |
| | Bronx, 740 Prospect Avenue | Frimmerman, Frank |
| | Bronx, 1721 Bathgate Avenue | Solv, Abraham |
| | Brooklyn, 678 Pennsylvania Avenue | Belock, Harry D. |
| | Brooklyn, 5818 13th Avenue | De Martino, Michael W. |
| | Brooklyn, 243 Sumner Avenue | Dobler, William |

| | | |
|-------------------------------------------|------------------------------------------------------------|----------------------------------|
| New York | Brooklyn, 130 Glen Street, Cypress Hills | Kieran, P. J. |
| | Brooklyn, 359 Ovington Avenue | Lussier, Elphege A. |
| | Brooklyn, 287 East 18th Street | Mac Dougall, Arthur |
| | Brooklyn, 172 Garfield Place | Martin, Rosaire J. |
| | Brooklyn, 846 Quincy Street | O'Connor, Mort F. |
| | Buffalo, 75 Chatham Drive | Dickinson, Alfred H. |
| | Buffalo, 506 Wilson Street | Kisker, Lawrence J. |
| | Buffalo, 723 Parkside Avenue | Mengle, Harold B. |
| | Buffalo, 522 Northampton Street | Peters, Albert H. |
| | Buffalo, 48 Grove Street | Schricber, A. J. |
| | Buffalo, 167 Taunton Place | Wagener, W. Hall |
| | Buffalo, 94 Southampton Street | Woodlin, Merrill Lloyd |
| | Central Valley | Raynolds, Edward F. |
| | East Rochester, 109 W. Chestnut Street | Lucia, Raymond H. |
| | Forest Hills, L. I., 71 Colonial Avenue | Bonanno, Joseph T. |
| | Kenmore, 149 Palmer Avenue | Miers, Floyd |
| | Mamaroneck, 124 Barry Avenue | Annucci, Louis M. |
| | Middletown, 254 Wisner Avenue | Clark, Ogden V. |
| | New York City, Radio Institute of America, 326 Broadway | Black, O. M. |
| | New York City, 3852 Tenth Avenue | Di Giacomo, Aniello |
| | New York City, Room 4107, Grand Central Term. Bldg. | Fernando, K. A. |
| | New York City, North Brother Island | Halpin, William A. |
| | New York City, A. T. & T. Co., 195 Broad- way | Kelley, Leo A. |
| | New York City, 11 E. 199th Street | Potts, John H. |
| | New York City, 290 East 2nd Street | Robins, J. Francis |
| | New York City, 2671 Broadway | Spiegelthal, Edwin |
| | New York City, 23 West 49th Street | Volney, S. C. |
| | New York City, R.C.A., 70 Van Cortlandt Park South | Wolff, Irving |
| | Rochester, 133 Wilder Terrace | Cass, Lewis S. |
| | Schenectady, 1011 Union Street | Gunther, Clarence A. |
| | Schenectady, Box 150, R. D. No. 8 | Patterson, Franklin G. |
| | Williamsville, 5565 Main Street | Hopkins, Nelson S. |
| | North Carolina | Greensboro, 404 Blandwood Avenue |
| Ohio | | Davis, Kenneth |
| Akron, 20 N. Balch Street | | Schoenduve, George C. |
| Akron, 145 Center Street | | Schoenduve, H. W. |
| Akron, Lake States Gen. Electric Sup. Co. | | Wanstrath, Wm. T. |
| Cinti, 2175 Central Avenue | | Domizi, Dante |
| Cleveland, 3097 West Boulevard | | Gibson, E. Lyle |
| Cleveland, 992 Eddy Road | | Leeka, Warren C. |
| Columbus, 79 18th Avenue | | Gross, Benjamin F. |
| Pennsylvania | | Ehle, Francis R. |
| Mt. Carmel, 451 W. Avenue | Fisher, Roy S. | |
| Philadelphia, 1936 Market Street | Stover, Wilmer A. | |
| Philadelphia, 1123 E. Rittenhouse Street | Kotch, Elmer G. | |
| West Philadelphia, 6435 Woodcrest Avenue | Gottlieb, Morris | |
| Wilksburg, 515 North Avenue | Shaw, Frederick L. | |
| York, 1499 Monroe Street | Pautz, Walter O. | |
| Rhode Island | Sims, James W. | |
| South Dakota | Barrow, Lemuel T. | |
| Tennessee | Johnson, Charles S. | |
| Texas | Flynn, Roy M. | |
| La Grange | Hopf, Max H. | |
| Bastrop, Box 35 | Shaw, Paul | |
| Beaumont, 670 Sabine Pass Avenue | Cathey, Roby Lee | |
| Dallas, 2510 Grand Avenue | Wilson, S. Earle | |
| Harper | Lacourse, Thaddeus W | |
| Lockhart | Taylor, Floyd F. | |
| Lubbock, Box 152 | Meland, Bjorn L. | |
| Rockland, P. O. Box 40 | Mason, Howard F. | |
| Vermont | St. Johnsbury, 29 Mount Vernon Street | McLean, T. Wendell |
| | Pasco, 518 Bonneville Street | Evert, W. E. |
| Washington | Richmond Highlands | Wetzel, Joseph A. |
| | Seattle, 3335 33rd Avenue, South | Braeking, Alvin F. |
| Wisconsin | Spokane, 214 W. 19th Avenue | Yonemoto, Masate |
| | Lodi, 221 Parr Street | Hooper, Edgar M. |
| Hawaii | Madison, Room 26, Federal Bldg. | Brooker, Vivian M. |
| | Milwaukee, 550 36th Street | Endean, Douglas A. |
| Australia | Maui, Kahului | |
| | Hobart Tasmania, Box 401 | |
| | Victoria, Braybrook, Braybrook Radio Station | |
| Canada | Victoria, East Malvern, 8 Viva Street | Claringbull, D. |
| | British Columbia, Vancouver, Canadian Natl. Ry. | Kynnersley, Charles |
| Colombia | Ontario, Toronto, 727 Indian Road | Marrriott, John S. |
| | British Columbia, Ocean Falls, Box 171 | Hiel, H. F. |
| Czechoslovakia | Santa Marta, United Fruit Company | Strnad, Joseph |
| | Prague, Ministry of Posts and Telegraphs | |
| England | Bucks, Wolverton, New Bradwell, 30 King Edward St. | Clarke, D. O. |
| | London S. W. 7, 49 Queen's Gate Gardens | Hirshman, C. L. |
| | London N. 19, 8 Fulford Mansions | Mason, Godfrey |
| | London W. 4, Cheswick, 59 Duke Road | Peters, Samuel J., Jr. |
| | Weybridge, Outlands Park, Lynwood | Dorts, Philip H. |

Geographical Location of Members Elected December 7, 1927

| | | |
|-------------|-----------------------------------------------------|-------------------|
| Ireland | Co. Tipperary, Main Street, Emly..... | Gargan, Edward F. |
| Japan | Tokyo, 500 Oimachi..... | Yoshio, Imaoka |
| Mexico | Mexico D. F., Calle del Buen Tono No. 12. | Buchanan, J. C. |
| New Zealand | Wellington, Radio Dept., Union Steamship Co..... | Matthews, P. H. |

Elected to the Junior grade

| | | |
|---------------|-------------------------------------------|-------------------------|
| Georgia | Atlanta, 1593 Rodger Avenue, S. W..... | Matthews, Allen A., Jr. |
| Illinois | Chicago, 5783 Ridge Avenue..... | Riddel, O. A. |
| Kansas | Lawrence, 1622 New Hampshire Street..... | Douglas, Nowel |
| Massachusetts | Cambridge, 61 Randolph Hall..... | Baldwin, Preston |
| Michigan | Ann Arbor, 1221 S. University Avenue..... | Katzin, Martin |
| Missouri | St. Louis, 6014 Cabanne Place..... | Fill, John V. |
| New York | Canandaigua, Canandaigua Radio Service.. | Thompson, John M. |
| Ohio | Fort Clinton, 120 Maple Street..... | Anderson, G. J. C. |



*Every Radio Engineer Will Want
the NEW
Second Revised Edition*

PRINCIPLES of RADIO COMMUNICATION

By J. H. MORECROFT

*Past President, Institute of Radio Engineers.
Assisted by A. PINTO and W. A. CURRY*

Morecroft's famous book has been completely revised. The second edition is practically a new book. Notable additions occur in Chapter I, where new data on coils and condensers at radio frequencies are given. Chapter IV deals with the general features of radio transmission; and new material on field strength measurements, reflection and absorption, fading, short-wave propagation, etc., has been introduced. In Chapter VIII much has been added on voice analysis, the performance of loud-speaking telephones, frequency control by crystals, etc. In Chapter X the question of distortionless amplification has been thoroughly dealt with, some of the information being published for the first time. Radio frequency amplification, balanced circuits, push-pull arrangements, have also been explained.



J. H. Morecroft

This book is thorough and up to date in every detail. Every radio engineer, who wants to keep up with the rapid progress made in the radio art, will want a copy of the New edition.

(1001 pages
6 by 9
831 figures
Cloth, \$7.50)

- A WILEY BOOK -

FREE EXAMINATION COUPON

JOHN WILEY & SONS, INC., 440 Fourth Avenue, NEW YORK CITY

Gentlemen: Kindly send me on 10 days' free examination, Morecroft's "Principles of Radio Communication."

I agree to remit the price (\$7.50) of the book within ten days after its receipt or return it postpaid.

Name

Address

Position or Reference

Subscriber

Proceedings of I. of R. E. } Yes
No

(To Residents of U. S. Proper, and Canada only.)

PIRE-1-28

When writing to advertisers mention of the Proceedings will be mutually helpful.

Specialists *in* Radio Insulation

The largest organization and most varied and modern equipment for Laminated Phenolic Insulation is at your service at The Formica Plant.

For 15 years only one product has been made here. The organization is competent and is made up of specialists.

They produce good, uniform material and fabricate it rapidly and accurately.

The Formica Insulation Company
4646 Spring Grove Avenue, Cincinnati, Ohio

FORMICA
Made from Anhydrous Bakelite Resins
SHEETS TUBES RODS



Scientific measurement of inductance has made Hammarlund Space-wound Coils the most efficient and dependable ever devised.

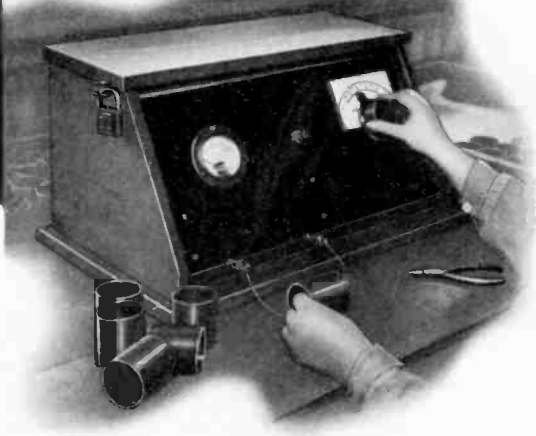

Hammarlund Coil Inductance *Scientifically Measured*

NOT very long ago so many turns of wire on such and such size core were considered accurate enough for inductance measurement.

But in this age of multi-tuned, single-control circuits, guesswork is out of the question. Coils must be matched to the finest degree.

Not satisfied merely with producing the most efficient type of coil, Hammarlund devised the instrument, pictured above, to insure accurate measurement of inductance values.

You can depend on Hammarlund precision. It means standardized quality and assurance that you get what you pay for.

Hammarlund Matched Coils are available for the latest popular circuits. We shall gladly quote on special requirements.

HAMMARLUND MANUFACTURING COMPANY
424-438 West 33rd Street, New York

More than a score of radio designers officially specify Hammarlund Precision Products for their newest circuits.

For Better Radio
Hammarlund
PRECISION
PRODUCTS

Inquiries invited concerning several new and appealing Hammarlund developments, having a wide sales demand.

When writing to advertisers mention of the Proceedings will be mutually helpful.

**A.C. radio receivers in the D.C. Districts?
Certainly! with an "ESCO" dynamotor
 or motor-generator —**

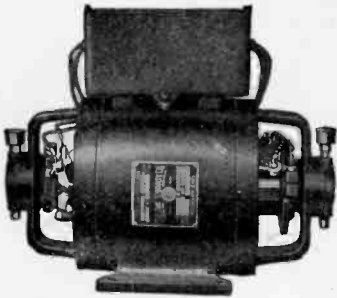

**Dynamotor with Filter for
 Radio Receivers**

The type R143 rotary converters are suitable for phonographs with vacuum tube amplifiers such as the Orthophonic Victrolas and Brunswick Panatropes without radio receivers. No filters are required.

The dynamotors and motor generators are suitable for radio receivers and for combination instruments containing phonographs and receivers. Filters are usually required. The dynamotors and motor-generators with filters give as good or better results than are obtained from ordinary 60-cycle lighting sockets. They are furnished completely assembled and connected and are very easily installed.

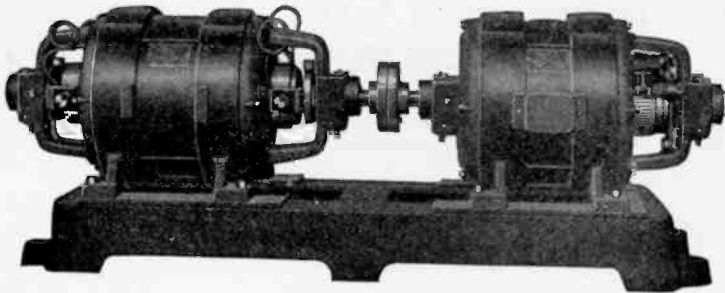

"ESCO" two and three unit sets have become the accepted standards for transmission. The "ESCO" line consists of over 700 combinations. These are covered by Bulletin 237D.

Our engineers are always willing to cooperate in the development of special sets.

"ESCO" is the pioneer in designing, developing and producing Generators, Motor-Generators, Dynamotors and Rotary Converters for all Radio purposes.

How can "ESCO" Serve You?



ELECTRIC SPECIALTY COMPANY

TRADE "ESCO" MARK



300 South Street

Stamford, Conn.

When writing to advertisers mention of the Proceedings will be mutually helpful.

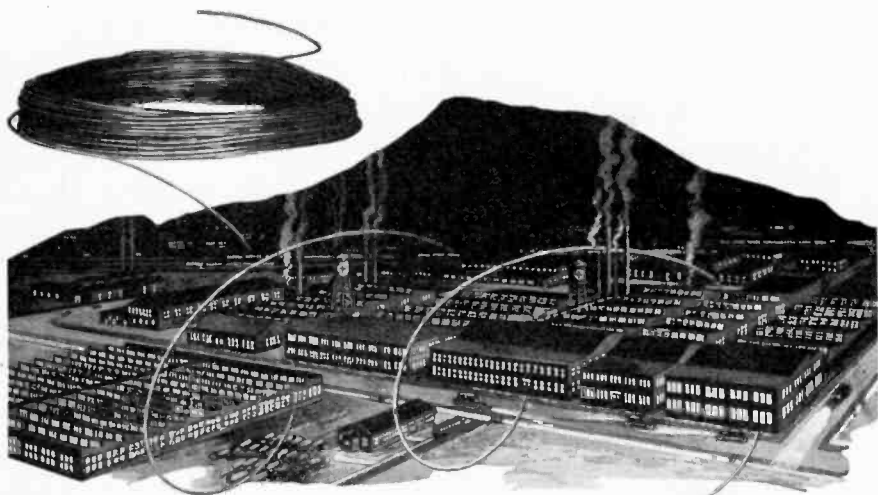

From Copper Rod to Magnet Wire *and* Coils!

The Dudlo production cycle is complete, controlling all materials and processes from rod to coil. Beginning with the bare copper rod, the drawing, annealing, insulating and winding is completed in the Dudlo factories under scientific, progressive inspection. This system of inspection prevents hidden flaws and insures uniform high quality.

The bare wire is drawn and then insulated with enamel, cotton, silk, or any combination of the three, to standard specifications or to meet special requirements for the Coil Winding Department.

Specializing solely in the production of Magnet Wire and Coils—with a wide variety of experience with wire and coil problems—with every resource of specially designed machinery and skilled engineers, Dudlo gains greater efficiency, greater flexibility and thus renders greater service to the electrical trade.

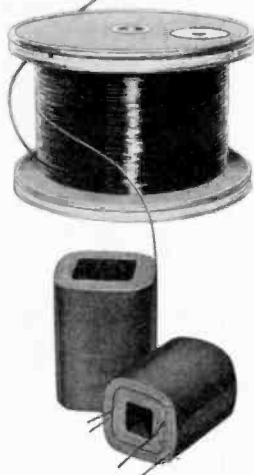

DUDLO

DUDLO MANUFACTURING CORPORATION, FORT WAYNE, INDIANA

Division of the General Cable Corporation

56 Earl Street
NEWARK, N. J.

160 North La Salle St.
CHICAGO, ILL.

4153 Bingham Ave.
ST. LOUIS, MO.

274 Brannan St.
SAN FRANCISCO, CALIF.

When writing to advertisers mention of the Proceedings will be mutually helpful.

XIII

PROFESSIONAL ENGINEERING DIRECTORY

For Consultants in Radio and Allied Engineering Fields

The J. G. White Engineering Corporation Engineers—Constructors

*Builders of New York Radio
Central*

Industrial, Steam Power, and Gas
Plants, Steam and Electric Rail-
roads, Transmission Systems.

43 Exchange Place New York

Q R V RADIO SERVICE, Inc.

JOHN S. DUNHAM
J. F. B. MEACHAM

*Devoted to Servicing Broadcast
Receivers Exclusively*

1400 BROADWAY, NEW YORK
WISCONSIN 9780

Electrical Testing Laboratories RADIO DEPARTMENT

also

**Electrical, Photometric,
Chemical and Mechanical
Laboratories**

80th Street and East End Ave.
NEW YORK, N. Y.

J. E. JENKINS, and S. E. ADAIR *Engineers*

Broadcasting Equipment
General Radio Telephone
Engineering

1500 N. DEARBORN PARKWAY
CHICAGO, ILLINOIS

Need Trained Radio Men?

Our Employment Department can supply thoroughly trained, experienced Radio Mechanics, Salesmen, Assemblers, Repairmen, Operators, etc.

No charge to employer or employee. If you need expert Radio help, let us recommend some one from our list. Bulletin of available men sent upon request.

National Radio Institute
Dept. I.R.E., Washington, D. C.

BRUNSON S. McCUTCHEN

Consulting Radio Engineer

17 State Street
NEW YORK

Experimental Radio

Third Edition. (1928)

By R. R. RAMSEY, Ph.D., *Professor of
Physics, Indiana University.*

117 experiments covering fundamental theory, calibration of radio apparatus, radio frequency measurements, and standard tests. Price \$2.75 post paid.

RAMSEY PUBLISHING CO.
615 E. 3rd St.
Bloomington, Ind.

John Minton I. G. Maloff

JOHN MINTON, Ph.D.

Consulting Engineer
for

Developing — Designing —
Manufacturing
of

Radio Receivers, Amplifiers, Transform-
ers, Rectifiers, Sound Recording and
Reproducing Apparatus.

Radio and Electro-Acoustical
Laboratory

8 Church St. White Plains, N. Y.

When writing to advertisers mention of the Proceedings will be mutually helpful.

Condensers for Built-in "B" Eliminator Units *for AC and All-Electric Sets*

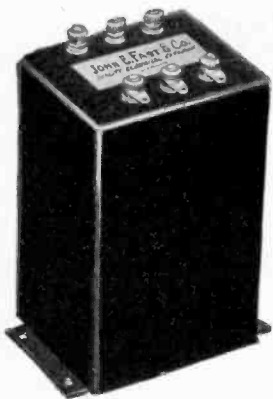

Specialists

We make one thing and one thing only—wax impregnated paper condensers in medium and large capacities. We make no set hardware, no eliminators, no transformers, no parts, no sets. Our entire concentrated effort is on one product alone. Such specialization assures highest quality, economical production and real service.

SUPPLYING the needs of set manufacturers is our specialty. Right now the trend is toward complete built-in power units in A-C operated sets. Let us show you how happily we can solve the condenser problem for your eliminator units as well as your other condenser needs.

Millions of Fast Condensers are in daily use in radio sets made by the leading set manufacturers. Fast condensers are a high-quality product, renowned for their high insulation resistance and excellent and dependable electrical characteristics.

Manufacturers looking for a dependable source of supply will find here one of the largest organizations of its kind in the world. Specialization keeps our costs low and quality high.

Send us your specifications. We make everything in the condenser line.

JOHN E. FAST & CO.

Established 1919

3982 Barry Avenue
Dept. I.R.E.
Chicago, U. S. A.



RADIO INTERFERENCE FILTERS

For Reduction of Radio Interference caused by Household Motors and Similar Appliances—

In its Radio Interference Filter # 1 Tobe Deutschmann Company presents a small and compact piece of equipment for use with interfering household appliances up to and including 1-4 h.p. This covers the usual range.

Five leads are employed, so that no additional wire is required.

A wiring diagram is printed directly on the label. List price, each . . . \$10.00

The Tobe Radio Interference Filter # 2 for interfering electrical apparatus too large to be handled by the # 1 Filter. It will handle motors and other appliances up to 5 h. p. at 220 volts.

It is built in accordance with code requirements, in a ventilated metal box, for attachment to wall or machinery.

Terminals are brought out to a Bakelite strip with heavy screw posts, and openings provided in the bottom of the box, of proper size for attachment to standard Bx or conduit.

Complete wiring diagram is supplied inside the cover. List price, each . . . \$15.00



Interference Filter No. 2

Send for Pamphlet O-1

TOBE DEUTSCHMANN COMPANY
Cambridge, Massachusetts



A Smooth, Positive Volume Control For Circuits Using "AC" Tubes

THE delicate balance of "AC" circuits requires a different method of volume control than that commonly used with battery sets.

Centralab Radiohms RX-100 or RX-025 have been developed especially for smooth volume control with "AC" tubes. They have the same appearance as standard Radiohms, but the taper of resistance is entirely special.

The RX-100 Radiohm in the secondary of an R. F. stage will control oscillation as well as volume. The RX-025 across an R. F. primary provides volume control and does not detune. The same unit has the proper resistance for antenna circuit control, but no antenna circuit resistance will prove as uniformly satisfactory as when used across one of the R. F. stages.

A Centralab PR-050 Power Rheostat in series with the "AC" transformer will provide accurate voltage control and lengthen the life of the tubes. Centralab wire wound Potentiometers and Fixed Resistors will prove trouble free in the power circuits.

Write for full information about these high quality controls. The new "AC" information sheet is now ready for you.

CENTRAL RADIO LABORATORIES

Keefe Avenue, Milwaukee, Wisconsin

Centralab

When writing to advertisers mention of the Proceedings will be mutually helpful.

XVII

Farrand **CONCERT** S P E A K E R

An entirely NEW

type of

FARRAND SPEAKER



FARRAND
MFG. CO., Inc.
Long Island City,
New York

When writing to advertisers mention of the Proceedings will be mutually helpful.

XVIII

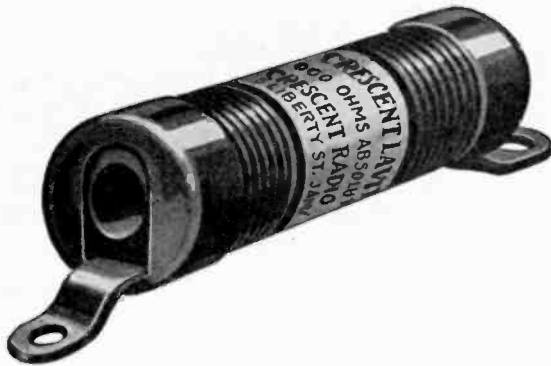

Crescent Lavite

is the pioneer resistance and still in the van. Economical in size but gluttons for punishment

Used by U. S. Government, General Electric Co., Bell Telephone Laboratories, Westinghouse Electric and Manufacturing Co., and ninety broadcast stations.

Write for data which will be supplied on request.

Cresradio Corporation

166-32 Jamaica Ave., Jamaica, N. Y.

**CRESCENT
LAVITE
RESISTANCES**

When writing to advertisers mention of the Proceedings will be mutually helpful.

And now the **VOLUME CONTROL CLAROSTAT**

A BIG RESISTANCE in a small package—and at low cost! Especially designed for light-duty applications which do not justify the capacity and cost of the larger Clarostats.

Resistance range of 0-500,000 ohms in several turns of knob for micrometric adjustment. Handsomely nickel-plated, with new style bakelite knob if desired. One-hole mounting. Screw binding posts. Requires minimum of space in radio assembly. A genuine Clarostat through and through, which means that it is noiseless, holds its adjustment, is trouble-proof, and wears well.

It seems hardly necessary to tell a radio engineer how to employ such a desirable resistance. However, just by way of suggestion, the Volume Control Clarostat may be applied to the control of plate voltage, volume, tone, regeneration, stabilization, balancing, and many other purposes served by light-duty resistance.



Meanwhile, the Standard (20-watt) and the Power (40-watt) Clarostats continue to serve for the heavy-duty applications in radio power units, electrified receivers, line-voltage controls, gain controls, transmitters and other purposes.

As with all standards, the Clarostat is widely copied. The similarity, however, is only skin deep. Therefore, look for the name CLAROSTAT stamped on the metal shell. Don't jeopardize your engineering efforts because of inferior variable resistances!

We are always glad to co-operate with radio engineers on resistance problems. Write us for general data and for specific information on your own requirements.

American Mechanical Laboratories, Inc.



Specialists in Variable Resistors

285-87 N. Sixth St. :: Brooklyn, N. Y.

—CLAROSTAT—

When writing to advertisers mention of the Proceedings will be mutually helpful.

XX

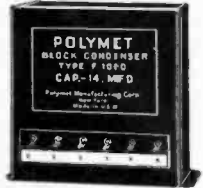

POWER

To meet the power requirements of Radio, Polymet Power is the first choice of leading engineers. Rigid, comparative tests prove Polymet's superiority in efficiency and value.

Polymet Condensers are rugged and strong. They are made under the most modern and scientific conditions.

Polymet Condensers are dependable. They stand up and deliver their full rated capacities throughout their long life.

Because they are so widely and favorably known, it is easier to sell any electric receiver or power unit in which **Polymet Condensers** are incorporated.

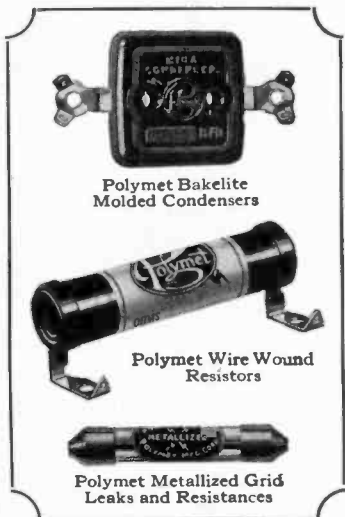

Polymet Bakelite Molded Condensers

Polymet Wire Wound Resistors

Polymet Metallized Grid Leaks and Resistances

Write for complete information regarding Polymet parts and catalog of all Polymet Radio Essentials.

POLYMET MANUFACTURING CORPORATION
599 A Broadway, New York City

POLYMET CONDENSERS

When writing to advertisers mention of the Proceedings will be mutually helpful.

KOLSTER ELECTRIC



At the left is Model 6K. This is the six-tube full console electric (battery-less) Kolster Radio. Cabinet of walnut with special built-in cone speaker. Price (less tubes) \$250.

Below, Model 6F, the six-tube table model electric (battery less) Kolster Radio, enclosed in attractive mahogany cabinet. Price (less tubes) \$160.



Kolster Electric Sets use the new A.C. tubes. No batteries of any kind required. Operated solely on A.C. house current (100-120 volts; 60 cycles). Indoor or outdoor antenna.

The Kolster Radio Compass, the use of which permits the safe navigation of vessels during thick or foggy weather, is also manufactured by this company.

FEDERAL-BRANDES, INC.

200 Mt. Pleasant Avenue

Newark, N. J.

© 1928, Federal Brandes, Inc.

When writing to advertisers mention of the Proceedings will be mutually helpful.

VARIABLE CONDENSERS for TRANSMISSION

CAT. NO. 149

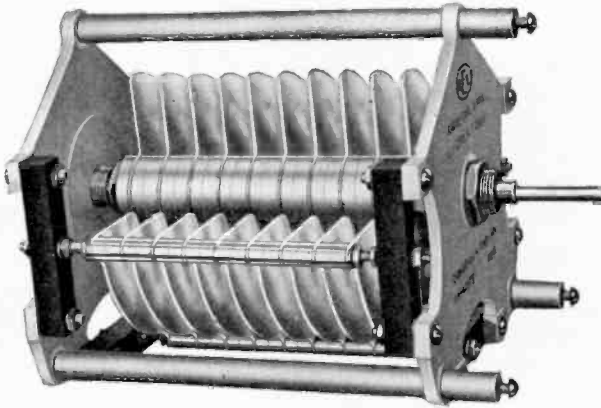

Super-Construction

Heavy Brass Plates . . . Substantial Cast Aluminum
End Plates . . . Steel Shaft Projecting Through Both
Ends . . . Cone Bearings with Locking Device . . .
Highly Polished Rubber Insulating Blocks.

The following table gives data on stock condensers:

| Type No. | Breakdown Voltage | Number of Plates | Max. Cap. Mmfd. | Plate Spacing Inches | Overall Depth Inches | Wt. Lbs. | Price |
|----------|-------------------|------------------|-----------------|----------------------|----------------------|----------|---------|
| K | 3,000 | 19 | 200 | .250 | 6.750 | 4.0 | \$17.50 |
| L | 3,000 | 33 | 350 | .250 | 9.100 | 8.0 | 21.00 |
| M | 3,000 | 59 | 650 | .250 | 13.620 | 12.5 | 29.00 |
| N | 5,000 | 11 | 60 | .500 | 6.750 | 3.5 | 17.25 |
| O | 5,000 | 19 | 100 | .500 | 9.100 | 7.0 | 20.00 |
| P | 5,000 | 33 | 180 | .500 | 13.620 | 10.5 | 28.00 |
| R | 10,000 | 7 | 25 | 1.000 | 6.750 | 3.0 | 17.00 |
| S | 10,000 | 11 | 45 | 1.000 | 9.100 | 6.0 | 19.00 |
| T | 10,000 | 19 | 80 | 1.000 | 13.620 | 9.5 | 27.00 |

Write for Bulletin 39



MANUFACTURES A COMPLETE LINE OF
APPARATUS FOR SHORT WAVE TRANS-
MISSION AND RECEPTION.

RADIO ENGINEERING LABORATORIES

100 Wilbur Ave. :: Long Island City, N. Y., U.S.A.

When writing to advertisers mention of the Proceedings will be mutually helpful.



This Book Contains Valuable Information For You

WE believe that every designer of radio equipment will want a copy of "Aluminum for Radio" just issued, which describes and illustrates many of the latest applications of aluminum in radio apparatus. Between the covers of this little book is information which cannot fail to interest you and which may prove of inestimable value to you.

Manufacturers today are using more and more Alcoa Aluminum because of the efficiency with which this *one* metal meets the widely differing conditions encountered in radio design.

Aluminum is widely used for shielding, condenser blades, chasses, sub-panels, loud speaker frames and for front panels (decorated in a variety of rare wood grain effects). Countless screw machine radio parts of Alcoa Aluminum are being used. Aluminum foil is preferred for fixed condensers.

We will be glad to have you consult us on problems involving the use of Aluminum in Radio. Call upon us freely for access to the fund of technical information that has been accumulated by our laboratories.

Write us today for your copy of "Aluminum for Radio."

ALUMINUM COMPANY OF AMERICA
2469 Oliver Building Pittsburgh, Pa.

ALUMINUM

The mark of Quality in Radio

When writing to advertisers mention of the Proceedings will be mutually helpful.

XXIV



DURHAM LEADERSHIP

*The Original Metallized Resistor—Adapted by
Finest Set Manufacturers—Endorsed by Leading
Radio Engineers—Sold by Good Dealers.*

DURHAM Resistors and Powerohms have won their position of leadership because they have never failed to deserve the recognition of radio leaders who appreciate flawless accuracy and utmost dependability.

Ever since their first appearance, years ago, manufacturers, engineers, professional builders and radio fans have adopted Durhams in steady progression. Today Durhams are in use wherever fine results are a foremost consideration.

If you are not using Durhams now, an experiment with replacements may prove why they are the accepted leaders in their field.

*Adopted and Used by Leading Radio
Manufacturers*

| | | |
|-----------------|------------------------|-------------------------|
| <i>Philco</i> | <i>Browning-Drake</i> | <i>Fansteel-Balkite</i> |
| <i>Garod</i> | <i>Kokomo Electric</i> | <i>A-C Dayton</i> |
| <i>Kellogg</i> | <i>Howard Radio</i> | <i>F.A.D. Andrea</i> |
| <i>Sterling</i> | | <i>Western Electric</i> |



DURHAM POWEROHMS

For "B" Eliminators and Amplifier Circuits. Made in 2.5 and 5 watt sizes in ranges from 500 to 100,000 ohms.



DURHAM RESISTORS

Made in ranges from 500 ohms to 10 megohms. Standard or Special tips.

DURHAM
METALLIZED
**RESISTORS
& POWEROHMS**

INTERNATIONAL RESISTANCE CO., Dept. W, 2½ So. 20th St., Philadelphia

When writing to advertisers mention of the Proceedings will be mutually helpful
XXV

Alphabetical Index to Advertisements

| | |
|---------------------------------------------|--------------------|
| A | |
| Allen-Bradley Co. | XXVIII |
| Aluminum Company of America | XXIV |
| American Mechanical Laboratories, Inc. | XX |
| American Transformer Co. | III |
| B | |
| Burgess Battery Co. | VI |
| C | |
| Cambridge Instrument Co. | XXVII |
| Central Radio Laboratories | XVII |
| Cresradio Corporation | XIX |
| D | |
| Deutschmann, Tobe Co. | XVI |
| Dudlo Manufacturing Corporation | XIII |
| E | |
| Electric Specialty Co. | XII |
| F | |
| Farrand Mfg. Co., Inc. | XVIII |
| Fast, John E. & Co. | XV |
| Federal-Brandes, Inc. | XXII |
| Formica Insulation Co. | X |
| G | |
| General Radio Co. | Back Cover |
| Grebe, A. H. and Co., Inc. | Inside Back Cover |
| H | |
| Hammarlund Manufacturing Company | XI |
| I | |
| International Resistance Co. | XXV |
| Isolantite Company of America | VII |
| J | |
| Jewell Electric Instrument Co. | IV |
| P | |
| Pacent Electric Co. | V |
| Polymet Manufacturing Corporation | XXI |
| Professional Engineering Directory | XIV |
| R | |
| Radio Corporation of America | VIII |
| Radio Engineering Laboratories | XXIII |
| Roller-Smith Co. | II |
| T | |
| Thordarson | Inside Front Cover |
| W | |
| Wiley, John A. | IX |
| Wireless Specialty Apparatus Co. | I |

*When writing the advertisers please mention The Proceedings of
The Institute of Radio Engineers.*

CAMBRIDGE INSTRUMENTS



Type A

Range 0—1.5 volts
Weight 4 lbs.

Type B

Range 0—5 volts
6x8x4 inches

THERMIONIC VOLTMETER

For the measurement of small Voltages
at high or low frequencies.

This instrument measures high frequency voltages as low as $\frac{1}{4}$ v. with a power loss of less than 1 micro-watt. It gives true readings independent of frequency, up to at least one million cycles.

It is thirty times as sensitive as a thermo-junction set and cannot be damaged by overloading.

APPLICATIONS

- (1) Radio Telephony — measurement of signal strength and inter-stage amplification.
- (2) Determination of losses in insulators.
- (3) Measurement of small leakage fields in dynamos and transformers.
- (4) Harmonic analysis of alternating wave forms.
- (5) Measurement of stray magnetic fluxes.
- (6) Direct measurement of very small self and mutual inductances.
- (7) Determination of power factor of condensers.

Send for list R 162

This instrument is only one of many Cambridge Precision Electrical Instruments for use in the field of Radio research.

We invite your enquiries.

CAMBRIDGE
INSTRUMENT CO. INC.

3512 Grand Central Terminal, NEW YORK

Resistors for B-Eliminators That Do Not Deteriorate

BRADLEYOHM - E

This variable resistor provides unusually wide range and accuracy of control. These two features have caused it to be extensively used by B-Eliminator manufacturers. The scientifically treated discs comprising the resistance, are not affected by use or atmospheric conditions. The resistance does not vary in service.

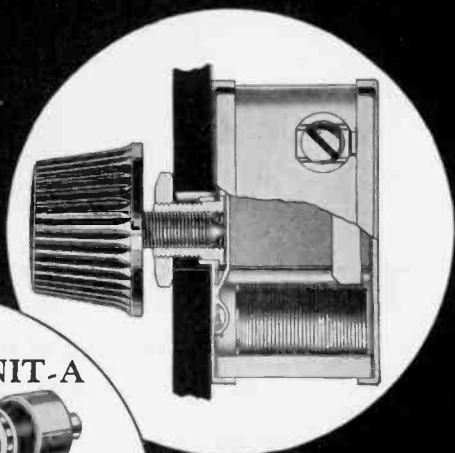

BRADLEYUNIT-A



A molded fixed resistor baked under high pressure, and accurately calibrated. Unaffected by temperature, moisture, or age.

BRADLEYUNIT-B



Has characteristics of Bradleyunit-A, but made especially for manufacturers in an extremely wide range of accurately calibrated resistance values.

Write for data and prices

Allen-Bradley Co.
282 Greenfield Avenue
Milwaukee, Wis.

Allen-Bradley

PERFECT RADIO RESISTORS

When writing to advertisers mention of the Proceedings will be mutually helpful.

XXVIII

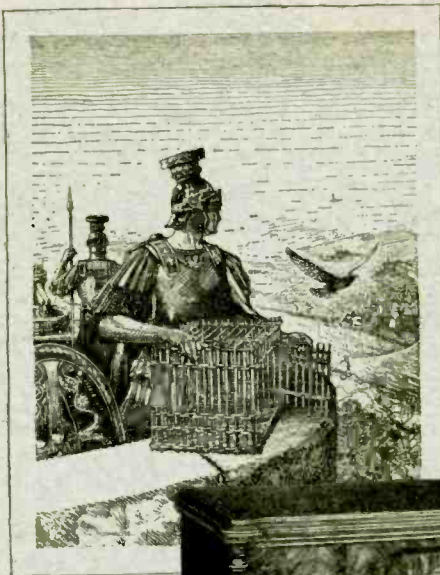

To prevent communication with the outside world, Antony closely surrounded the city of Modena with his army and stretched nets across the river. Brutus, in charge of the defense, easily thwarted these measures by the simple expedient of fastening letters to the feet of carrier pigeons.



Doctor Wily



Surmounting Barriers—Neither winter snows, nor impassable roads, nor sickness itself can bar you from contact with world events. Whatever the reason for your isolation, a Grebe Synchronphase Seven bridges the gap, bringing you concerts, sermons, lectures, music, sporting events in such clear, full, life-like fashion that you are one of the audience. You forget it's radio.

The Synchronphase Seven, especially when combined

with the Grebe Natural Speaker, is unrivaled in naturalness of tone. It is easy to operate, exceptionally pleasing to look at. The durability of its many superior qualities is assured by that sound construction which, for eighteen years, has been a synonym for the name, "Grebe."



Grebe Synchronphase Seven \$135;
Grebe Natural Speaker \$35. Send for Booklet I; then ask your dealer to demonstrate, in your home, that you can "set it better with a Grebe."

GREBE

SYNCHROPHASE

RADIO

A. H. Grebe & Co., Inc., 109 W. 57th St., New York City
 Factory: Richmond Hill, N. Y. Western Branch: 443 S. San Pedro St., Los Angeles, Ca.
 Makers of quality radio since 1909

When writing to advertisers mention of the Proceedings will be mutually helpful.



Type 377

OSCILLATOR

Most communication laboratories require a variable frequency source of good wave form.

The frequency of the type 377 vacuum tube oscillator is continuously variable over a range of from 50 to 60,000 cycles.

The vacuum tube oscillator is an essential accessory to the study of transformer and filter characteristics.

Licensed under Pat. No. 1113149 for radio laboratory experimental use only where no business features are involved.

Bulletin 6100-I on request.

Price \$350.00

General Radio Company, *Thirty State St.*, Cambridge, Mass.

GENERAL RADIO

LABORATORY EQUIPMENT