

VOLUME 15

DECEMBER, 1927

NUMBER 12

PROCEEDINGS
of
The Institute of Radio
Engineers



Published Monthly By
THE INSTITUTE OF RADIO ENGINEERS

Publication Office: 450-454 Ahnaip St., Menasha, Wis.

Editorial and Advertising Departments
37 West 39th Street, New York, N.Y.

Subscription \$10.00 per Annum in the United States
\$11.00 in all other Countries

General Information and Subscription Rates on Page 971.

Cunningham RADIO TUBES

SINCE 1915

STANDARD FOR ALL SETS



GIFTS

that bring happiness
at Christmas time and
throughout the year

Radio sets and radio
equipment make im-
mensely popular
Christmas gifts.

To assure the utmost in
Yule-tide Radio enchant-
ment, see that Cunning-
ham Radio Tubes are on
duty in every socket.
Every owner of a radio
will be delighted to re-
ceive a set of new tubes.

Buy them in combination
of five or more. Your
dealer will tell you the
correct types of Cunning-
ham Radio Tubes for
which any radio set is
designed.

*Don't use old tubes with
new ones. Use new
tubes throughout.*

E. T. CUNNINGHAM, INC.
New York Chicago
San Francisco

When writing to advertisers mention of the Proceedings will be mutually helpful.



Dependability, convenience and long life are three of the outstanding advantages of Faradon products.

Experts make sure they get Faradon.

For any data desired, communicate directly with the Company, attention of the Engineering Department.

**WIRELESS SPECIALTY
APPARATUS COMPANY**

Jamaica Plain Boston, Mass. U.S.A.

Est. 1907

Faradon

*The
choice of
men who
know*

**ELECTROSTATIC CONDENSERS
FOR ALL PURPOSES**

1436

When writing to advertisers mention of the Proceedings will be mutually helpful.

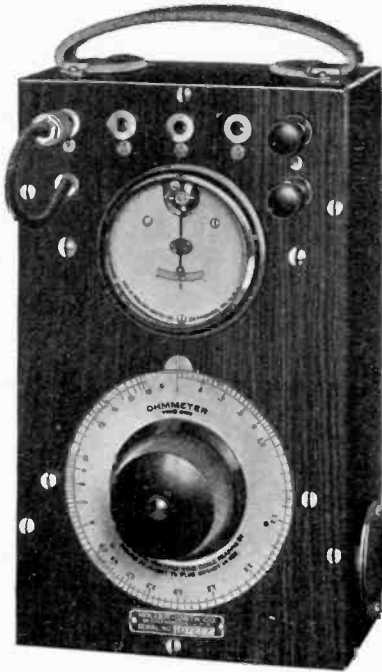

New Roller-Smith COM Ohmmeter

Portable direct reading, small, compact, light, rugged, accurate, entirely self-contained. Measures resistance values from .5 ohm to 50,000 ohms. List price \$70.00, subject to discount. Send for new Supplement No. 1 to Bulletin No. K-300.



New Roller-Smith HTD Circuit Tester

Instantly locates open circuits in coils and circuits. Shows approximate resistance up to 10,000 ohms. Small, compact, rugged and dependable. List price \$21.00, subject to discount. Send for new Supplement No. 1 to Bulletin No. K-300.

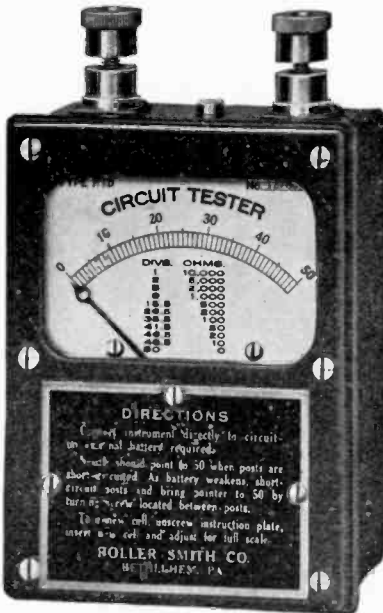

ROLLER-SMITH COMPANY

2134 Woolworth Bldg.
NEW YORK CITY

When writing to advertisers mention of the Proceedings will be mutually helpful.

A Complete **AMERTRAN PUSH-PULL Power Amplifier**



THE *new* AMERTRAN PUSH-PULL Power Amplifier is a completely assembled two-stage unit embodying a first stage AMERTRAN DeLuxe followed by AMERTRAN Input and Output Transformers for Power Tubes. The metal box has four sockets, two for power tubes, and a four prong and a five prong socket in the first stage for either a standard amplifying tube or the UX-201 A type, or a UY-227 (C-327) A.C. tube. Using the latter tube, the amplifier can be entirely A.C. operated.

This amplifier can be connected to the detector of any good receiver, replacing the audio amplifier. When operated from a power source supplying sufficient voltage, the reproduction will be as perfect as the speaker is capable of making it. In addition, distortion and the hum from raw A.C. on the power tubes, are eliminated. The energy output to the speaker, especially at the lower musical frequencies, also is increased.

It is recommended that this amplifier be operated from the Amer-Tran A.B.C. Hi-Power Box, but it can be used with any good power supply system or batteries. Tone realism and volume will be finest, with the largest available power tubes in the power stage. Therefore, UX-210 or CX-310 tubes will normally be supplied. If the 171 type of tube is preferred, the amplifier will be equipped with the Amer-Tran Type 271 Output Transformer.

AmerTran Push-Pull Amplifier has a complete unit, is licensed under patents owned or controlled by the Radio Corporation of America and must be sold complete with tubes. When ordering, please state choice of tube for the first stage (either UX-201A or UY-227, or Cunningham equivalent) and either two (UX-210, CX-310) or two (UX-171, CX-371) power tubes for the power stage. Price on application.

*Send for further information. Inquiries on
 this new unit will be handled promptly.*

AMERICAN TRANSFORMER COMPANY
 178 Emmet St. Newark, N. J.
"Transformer Builders for Over 26 Years"



A Jewell A. C. Meter for Filament Control

*Diameter
2 inches*

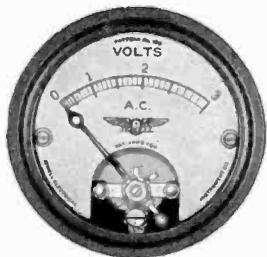

*Pattern No. 190
A.C. Voltmeter*

The advent of vacuum tubes having filaments adaptable for excitation from alternating current creates the necessity for an absolute means of control other than the filament rheostat, for it is frequently found that a particular setting of the filament voltage is necessary to eliminate objectional hum.

For A.C. filament control the new Jewell A.C. voltmeter, Pattern No. 190 is very desirable. Jewell Pattern No. 190 instruments have a body diameter of 2 inches and in general appearance are similar to the Jewell Pattern No. 135 direct current style. The movement is of the moving vane type with special modifications for the small size case. The instruments are accurate and neat in appearance and are designed for continuous service. Energy consumption is very small.

Pattern No. 190 instruments are available in many ranges, of which the 0-1.5, 0-3, 0-15 and 0-150 volt ranges are most in demand. The 0-1.5 volt range is suitable for tubes having a direct heated Cathode, the 0-3 volt range for tubes having an indirectly heated Cathode, and the 0-150 volt range where primary control is used.

Write for a copy of our 15-C catalog supplement which describes this instrument in detail.

Jewell Electrical Instrument Co.

1650 Walnut St. - Chicago

"27 Years Making Good Instruments"

When writing to advertisers mention of the Proceedings will be mutually helpful.



About 800 B. C. the Greeks sent messages by means of the Clevevdras. In two stations were water jars of equal size in which floated marked rods. On signal by torch or flag, plugs were pulled. When the rods lowered to a certain mark, at another signal both plugs were reinserted. The rods in both towers dropping to the same mark, the message was known.



Selectivity—Turn the dial of a Grebe Synchronphase Seven. Stations come in—clean, full-toned. No overlapping of programs—station separation is sharply defined.

The tone of the Synchronphase Seven, especially when combined with the Grebe Natural Speaker, is unrivaled in naturalness. Its one-dial control assures simplicity of tuning that is remarkable.



Grebe construction, backed by eighteen years of making nothing but the highest grade radio apparatus, guarantees the durability of these superior qualities.

Grebe Synchronphase Seven, \$135; Grebe Natural Speaker, \$35. Send for Booklet I; then ask your dealer to demonstrate, in your home, that you can "get it better with a Grebe."

GREBE

SYNCHROPHASE

RADIO

A. H. Grebe & Co., Inc., 109 W. 57th St., New York City
 Factory: Richmond Hill, N.Y. Western Branch: 443 So. San Pedro St., Los Angeles, Cal
 Makers of quality radio since 1909

When writing to advertisers mention of the Proceedings will be mutually helpful.

Radio - Is - **BETTER** - With - Dry - Battery - Power



You can candle
an egg—but not a *battery*

THERE isn't much difference in the size or shape of batteries. And you can't tell how good they are before you use them. ¶ If you could, one element alone would win your preference for Burgess. That element is *Chrome*. ¶ *Chrome* is the *preservative* that maintains an abundance of unfailing energy in Burgess Batteries—long after most dry cells cease to function. The black and white stripes are individual marks for identifying Burgess *Chrome* Batteries. Buy them for long lasting, dependable performance!

Chrome—the preserving element used in leather, metals, paints and other materials subject to wear, is also used in Burgess Batteries. It gives them unusual *staying* power. Burgess *Chrome* Batteries are patented.

Ask Any Radio Engineer

BURGESS BATTERY COMPANY

General Sales Office: CHICAGO

Canadian Factories and Offices: Niagara Falls and Winnipeg

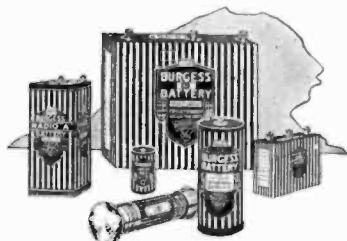

BURGESS BATTERIES

When writing to advertisers mention of the Proceedings will be mutually helpful.

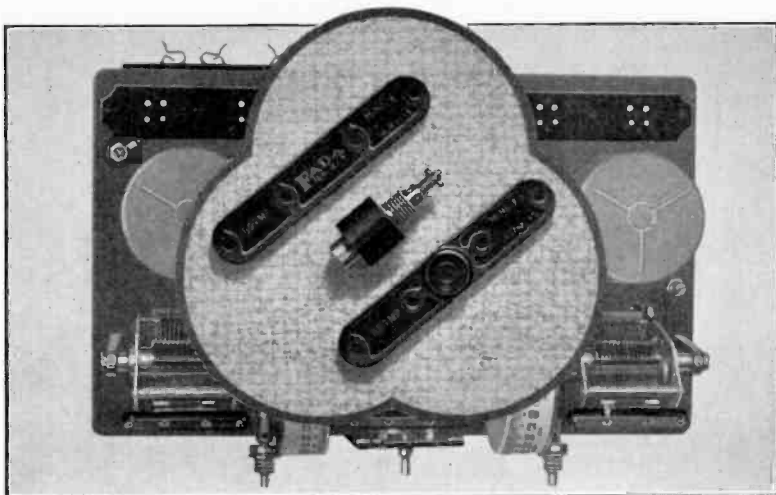

Chassis of Fada Special Receiver, Bakelite Insulated. In addition to the parts illustrated, Bakelite Materials are also used for socket lower plate R.F. transformer, condenser and leak mounting strips and minimum adjustor base. This Receiver is made by F. A. D. Andrea, Inc., Long Island, N.Y.

In the Fada Special ~ ~ vital parts are insulated with Bakelite Materials!

RECOGNIZING that sustained excellence of performance may only be assured through the use of an insulation whose properties are unimpaired by time, exposure or use, F. A. D. Andrea, Inc., have adopted Bakelite Materials for many parts of the Fada Special Receiver.

The use of Bakelite Materials not only provides excellent insulation, but economical production as well. For example, twenty of the upper and lower condenser strips are molded at one time with holes, recesses, and relief lettering accurately formed. In the case of the neutrodon cylinder part a nine

cavity mold is used, the Bakelite Molded cylinders being formed around the terminal posts.

Since the earliest days of Radio, the Bakelite Corporation has kept pace with the development of Broadcast Receivers, and its engineers and research laboratories have co-operated with manufacturers in adapting Bakelite Materials to each exacting need. The wealth of knowledge acquired during these years of experience is offered to the radio industry through our Service Engineers located in important industrial centers.

Write for Booklet 33

BAKELITE CORPORATION

247 Park Avenue, New York, N.Y.
BAKELITE CORP. OF CANADA, LTD.

Chicago Office, 635 W. 22nd Street
163 Dufferin Street, Toronto, Ont.

BAKELITE

REGISTERED



U. S. PAT. OFF.

THE MATERIAL OF A THOUSAND USES

"The registered Trade Mark and Symbol shown above may be used only on products made from materials manufactured by Bakelite Corporation. Under the symbol 'B' is the material sign for Bakelite, in substance identical to the trademark character number of register and Service mark of Bakelite Corporation's product."

When writing to advertisers mention of the Proceedings will be mutually helpful.

RADIOTRONS

for modern

A. C. OPERATION

POWER AMPLIFIER RADIOTRON UX-171

Filament—5 Volts—5 Amperes

Plate Voltage	90	135	180	Volts
Negative Grid Bias	16½	27	40½	Volts
Plate Current	10	16	20	Milliamperes
Plate Resistance (A.C.)	2500	2200	2000	Ohms
Mutual Conductance	1200	1360	1500	Micromhos
Voltage Amplification Factor	3.0	3.0	3.0	
Max. Undistorted Output	130	330	700	Milliwatts

R. F. & A. F. AMPLIFIER RADIOTRON UX-226

Filament (A. C.) 1.5 Volts—1.05 Amperes

Plate Voltage	90	135	180	Volts	
Negative Grid Bias	6	12	9	13½	Volts
Plate Current	3.7	3	6	7.5	Milliamperes
Plate Resistance (A.C.)	9400	10,000	7400	7000	Ohms
Mutual Conductance	875	820	1100	1170	Micromhos
Voltage Amplification Factor	8.2	8.2	8.2	8.2	
Max. Undistorted Output	20	60	70	120	Milliwatts

DETECTOR RADIOTRON UY-227

Heater (A. C.) 2.5 Volts—1.75 Amperes

Plate Voltage		45	90	Volts	
Grid Leak			2-9	¼-1	Megohms
Plate Current			2	7	Milliamperes
Plate Resistance (A.C.)		10,000	8000	8000	Ohms
Mutual Conductance		800	1000	1000	Micromhos
Voltage Amplification Factor			8	8	

FULL WAVE RECTIFIER RADIOTRON UX-280

A.C. Filament Voltage		5.0	Volts
A.C. Filament Current		2.0	Amperes
A.C. Plate Voltage (Max. per plate)		300	Volts
D.C. Output Current (Maximum)		125	Milliamperes
Effective D.C. Output Voltage of typical Rectifier Circuit at full output current as applied to Filter		260	Volts

HALF WAVE RECTIFIER RADIOTRON UX-281

A.C. Filament Voltage		7.5	Volts
A.C. Filament Current		1.25	Amperes
A.C. Plate Voltage (Max. per plate)		750	Volts
D.C. Output Current (Maximum)		110	Milliamperes
Effective D.C. Output Voltage of typical Rectifier Circuit at full output current as applied to Filter		620	Volts

RADIO CORPORATION OF AMERICA

New York

Chicago

San Francisco

RCA Radiotron

MADE BY THE MAKERS OF THE RADIOLA

When writing to advertisers mention of the Proceedings will be mutually helpful.

PROCEEDINGS
OF
THE INSTITUTE OF RADIO
ENGINEERS
(INCORPORATED)

VOLUME 15
1927



PUBLISHED MONTHLY BY
THE INSTITUTE OF RADIO ENGINEERS
(INC.)
37 WEST 39TH STREET, NEW YORK, N. Y.

GENERAL INFORMATION

The PROCEEDINGS of the Institute are published every month and contain the papers and the discussions thereon as presented at the meetings and at the various Sections of the Institute.

Payment of the annual dues by a member entitles him to one copy of each number of the PROCEEDINGS issued during the period of his membership.

Subscriptions to the PROCEEDINGS are received from non-members at the rate of \$1.00 per copy or \$10.00 per year. To foreign countries the rates are \$1.10 per copy or \$11.00 per year. A discount of 25 per cent is allowed to libraries and booksellers.

The right to reprint limited portions or abstracts of the articles, discussions, or editorial notes in the PROCEEDINGS is granted on the express conditions that specific reference shall be made to the source of such material. Diagrams and photographs in the PROCEEDINGS may not be reproduced without securing permission to do so from the Institute through the Editor.

It is understood that the statements and opinions given in the PROCEEDINGS are the views of the individual members to whom they are credited, and are not binding on the membership of the Institute as a whole.

COPYRIGHT, 1927, BY
THE INSTITUTE OF RADIO ENGINEERS, INC.
37 W. 39TH STREET, NEW YORK, N. Y.

CONTENTS OF VOLUME 15

1927

NUMBER I; January, 1927

	PAGE
OFFICERS AND BOARD OF DIRECTION, 1926	2
I. R. E. SECTIONS	3
COMMITTEES, 1926	4
INSTITUTE ACTIVITIES	5
NEWS OF THE SECTIONS	6
H. CROSSLEY, "PIEZO-ELECTRIC CRYSTAL-CONTROLLED TRANSMITTERS"	9
HOY J. WALLS, "SIMULTANEOUS PRODUCTION OF A FUNDAMENTAL AND A HARMONIC IN A TUBE GENERATOR"	37
DISCUSSION ON GOLDSMITH PAPER	40
T. A. SMITH AND G. RODWIN, "AN AUTOMATIC FADING RECORDER"	41
H. A. BROWN AND C. T. KNIPP, "BEHAVIOR OF ALKALI VAPOR DETECTOR TUBES"	49
DISCUSSION OF ROBERTS PAPER	57
E. C. HOLTZAPPEL, "INFLUENCE OF THE SOLAR ECLIPSE"	61

NUMBER II; February, 1927

OFFICERS AND BOARD OF DIRECTION	64
I. R. E. SECTIONS	65
COMMITTEES, 1926	66
INSTITUTE ACTIVITIES	67
ANNUAL CONVENTION	67
NEWS OF THE SECTIONS	69
APPOINTMENT OF ASSISTANT SECRETARY	69
DONALD MCNICOL, "OPENING ADDRESS AT ANNUAL CONVENTION"	71
RALPH BOWN, "RESPONSE OF INCOMING PRESIDENT"	79
G. W. PICKARD, "CORRELATION OF RADIO RECEPTION WITH SOLAR ACTIVITY AND TERRESTRIAL MAGNETISM"	83
W. A. MACDONALD, "IMPORTANCE OF LABORATORY MEASUREMENTS IN THE DESIGN OF RADIO RECEIVERS"	99
E. L. CHANNING AND G. H. BROWNING, "A THEORETICAL AND EXPERI- MENTAL INVESTIGATION OF DETECTION FOR SMALL SIGNALS"	113
DISCUSSION ON AUSTIN PAPER	155
JOHN B. BRADY, DIGEST OF U. S. RADIO PATENTS	159
GEOGRAPHICAL LIST OF NEW MEMBERS	163

NUMBER III; March, 1927

OFFICERS AND BOARD OF DIRECTION	166
I. R. E. SECTIONS	167
COMMITTEES, 1927	168

	PAGE
INSTITUTE ACTIVITIES	171
COMMITTEE ACTIVITIES	172
NEWS OF THE SECTIONS	177
ADVERTISING	179
E. L. CHAFFEE, "VACUUM TUBE NOMENCLATURE"	182
J. E. ANDERSON, "INFLUENCE ON THE AMPLIFICATION OF A COMMON IMPEDANCE IN THE PLATE CIRCUIT OF AMPLIFIERS"	195
DE L. K. MARTIN, G. D. GILLETT, I. S. BEMIS, "SOME POSSIBILITIES AND LIMITATIONS IN COMMON FREQUENCY BROADCASTING"	213
H. P. MILLER, JR., "THE INSULATION OF A GUYED MAST"	225
DISCUSSION ON LEVIN AND YOUNG PAPER	245
DISCUSSION ON WARNER AND LOUGHREN PAPER	249
DISCUSSION ON CHAFFEE PAPER	253
JOHN B. BRADY, DIGEST OF U. S. RADIO PATENTS	255
GEOGRAPHICAL LIST OF NEW MEMBERS	263

NUMBER IV; April, 1927

OFFICERS AND BOARD OF DIRECTION	268
INSTITUTE SECTIONS	269
COMMITTEES, 1927	270
INSTITUTE ACTIVITIES	273
NEWS OF THE SECTIONS	275
COMMITTEE WORK	277
A. MEISSNER, "PIEZO-ELECTRIC CRYSTALS AT RADIO FREQUENCIES"	281
G. ANDERS, "QUANTITATIVE MEASUREMENTS ON RECEPTION IN RADIO"	297
G. T. ROYDEN, "THE FREQUENCY CHECKING STATION AT MARE ISLAND"	313
DISCUSSION ON WARNER AND LOUGHREN PAPER	319
DISCUSSION ON O. C. ROOS PAPER	319
DISCUSSION ON G. W. PICKARD PAPER	326
DISCUSSION ON W. A. MACDONALD PAPER	329
REVIEW OF CURRENT LITERATURE BY STUART BALLANTINE— "PROPAGATION OF SHORT WAVES AROUND THE EARTH"—E. QUACK	341
GEOGRAPHICAL LOCATION OF MEMBERS ELECTED MARCH 2, 1927	347

NUMBER V; May, 1927

OFFICERS AND BOARD OF DIRECTION	350
COMMITTEES, 1927	350
INSTITUTE SECTIONS	352
INSTITUTE ACTIVITIES	353
NEWS OF THE SECTIONS	354
COMMITTEE WORK	356
MEASUREMENTS AT RADIO FREQUENCIES AT A. I. E. E. MEETING	361
I. WOLFF AND A. RINGEL, "LOUD SPEAKER TESTING METHODS"	363
S. UDA, "HIGH ANGLE RADIATION OF SHORT ELECTRIC WAVES"	377
T. A. SMITH AND G. RODWIN, "NOTES ON RADIO RECEIVER MEASUREMENTS"	387
J. B. DOW, "THE TUNED-GRID TUNED-PLATE CIRCUIT USING PLATE-GRID CAPACITY FOR FEED-BACK"	397
K. W. JARVIS, "SELECTIVITY OF TUNED RADIO RECEIVING SETS"	401

	PAGE
P. C. OSCANYAN, JR., "RADIO PHENOMENA RECORDED BY THE UNIVERSITY OF MICHIGAN GREENLAND EXPEDITION, 1926"	425
V. KUSUNOSE, "PUNCTURE DAMAGE THROUGH THE GLASS WALLS OF A TRANSMITTING VACUUM TUBE"	431
DISCUSSION ON S. A. LEVIN AND C. J. YOUNG PAPER	439
J. B. BRADY, DIGEST OF U. S. RADIO PATENTS	445
GEOGRAPHICAL LOCATION OF MEMBERS ELECTED APRIL 6, 1927	449

NUMBER VI; June, 1927

OFFICERS AND BOARD OF DIRECTION	454
COMMITTEES, 1927	454
INSTITUTE SECTIONS	456
INSTITUTE ACTIVITIES	457
NEWS OF THE SECTIONS	458
PAST NUMBERS OF THE PROCEEDINGS	462
FOURTEEN-YEAR PROCEEDINGS INDEX	463
COMMITTEE WORK	463
H. E. HALLBORG, L. A. BRIGGS, AND C. W. HANSELL, "SHORT-WAVE COMMERCIAL LONG DISTANCE COMMUNICATION"	467
H. E. HALLBORG, "SOME PRACTICAL ASPECTS OF SHORT-WAVE OPERATION AT HIGH POWER"	501
W. VAN B. ROBERTS, "MAXIMIZATION METHODS FOR FUNCTIONS OF A COMPLEX VARIABLE"	519
VICTOR G. SMITH, "A MATHEMATICAL STUDY OF RADIO-FREQUENCY AMPLIFICATION"	525
DISCUSSION ON E. L. CHAFFEE PAPER	537
DISCUSSION ON L. W. AUSTIN PAPER	539
JOHN B. BRADY, DIGEST OF U. S. RADIO PATENTS	541
GEOGRAPHICAL LOCATION OF MEMBERS ELECTED MAY 4, 1927	545

NUMBER VII; July, 1927

OFFICERS AND BOARD OF DIRECTION	550
COMMITTEES, 1927	550
INSTITUTE SECTIONS	552
INSTITUTE ACTIVITIES	553
NEWS OF THE SECTIONS	554
COMMITTEE WORK	557
C. A. BODDIE, "TELEPHONE COMMUNICATION OVER POWER LINES BY HIGH FREQUENCY CURRENTS"	559
SYLVAN HARRIS, "MEASUREMENTS OF RADIO FREQUENCY AMPLIFICATION"	641
BOOK REVIEW	649
J. B. BRADY, DIGEST OF U. S. RADIO PATENTS	651
GEOGRAPHICAL LOCATION OF MEMBERS ELECTED JUNE 1, 1927	655

NUMBER VIII; August, 1927

OFFICERS AND BOARD OF DIRECTION	660
COMMITTEES	660
INSTITUTE SECTIONS	662

	PAGE
INSTITUTE ACTIVITIES	663
PERSONAL MENTION	663
NEWS OF THE SECTIONS	663
COMMITTEE WORK	666
ISAAC KOGA, "A NEW FREQUENCY TRANSFORMER OR FREQUENCY CHANGER"	669
JOHN M. THOMSON, "AUDIO FREQUENCY TRANSFORMERS"	679
EDWARD T. DICKEY, "NOTES ON THE TESTING OF AUDIO FREQUENCY AMPLIFIERS"	687
A. H. TAYLOR, "VARIATIONS IN HIGH-FREQUENCY GROUND WAVE RANGES"	707
G. BREIT, "A SUGGESTION OF A CONNECTION BETWEEN RADIO FADING AND SMALL FLUCTUATIONS IN THE EARTH'S MAGNETIC FIELD"	709
A. HUND, "NOTE ON PIEZO-ELECTRIC GENERATORS WITH SMALL BACK ACTION"	725
M. S. STROCK, "STANDARD FREQUENCY DISSEMINATION"	727
FREDERICK W. GROVER, "FORMULAS FOR THE CALCULATION OF THE CAPACITY OF ANTENNAS"	733
J. B. BRADY, DIGEST OF U. S. RADIO PATENTS	737
GEOGRAPHICAL LOCATION OF MEMBERS ELECTED JULY 6, 1927	741

NUMBER IX; September, 1927

OFFICERS AND BOARD OF DIRECTION	744
COMMITTEES.	744
INSTITUTE SECTIONS.	746
GREANLEAF W. PICKARD, "THE CORRELATION OF RADIO RECEPTION WITH SOLAR ACTIVITY AND TERRESTRIAL MAGNETISM. II"	749
H. DIAMOND AND J. S. WEBB, "THE TESTING OF AUDIO-FREQUENCY TRANSFORMER-COUPLED AMPLIFIERS"	769
W. VAN B. ROBERTS, "NOTE ON DETECTION BY GRID CONDENSER AND LEAK"	795
ROSS GUNN, "THE TORUSOLENOID"	799
S. S. KIRBY, BOOK REVIEW, "ROBISON'S MANUAL OF RADIO TELEGRAPHY AND TELEPHONY," BY COMMANDER S. S. ROBISON	811
J. B. BRADY, DIGEST OF U. S. RADIO PATENTS	813
GEOGRAPHICAL LOCATION OF MEMBERS ELECTED AUGUST 4, 1927	815

NUMBER X; October, 1927

OFFICERS AND BOARD OF DIRECTION	820
COMMITTEES.	820
INSTITUTE SECTIONS.	822
INSTITUTE ACTIVITIES	823
NEWS OF THE SECTIONS	823
COMMITTEE WORK	824
L. W. AUSTIN, "LONG WAVE RADIO MEASUREMENTS AT THE BUREAU OF STANDARDS IN 1926 WITH SOME COMPARISONS OF SOLAR ACTIVITY AND RADIO PHENOMENA"	825
L. W. AUSTIN, "RADIO ATMOSPHERIC DISTURBANCES AND SOLAR ACTIVITY"	837
E. H. KINCAID, "TWO CONTRASTING EXAMPLES WHEREIN RADIO RECEPTION WAS AFFECTED BY A METEOROLOGICAL CONDITION"	843

PROCEEDINGS OF
The Institute of Radio Engineers

Volume 15

December, 1927

Number 12

CONTENTS

	Page
Officers and Board of Direction	972
Committees	972
Institute Sections	974
Institute Activities	975
News of the Sections	978
Committee Work	979
A. E. S. C. Sectional Committee on Radio	980
J. E. I. Cairns, "Atmospherics at Watheroo, Western Australia"	985
Edwin J. Alway, "Propagation of Short Waves during a Solar Eclipse"	998
Discussion on L. W. Austin Paper by K. Sreenivasan	1002
Greenleaf W. Pickard, "The Relation of Radio Reception to Sunspot Position and Area"	1004
V. J. Bashenoff, "Abbreviated Method for Calculating the Inductance of Irregular Plane Polygons of Round Wire"	1013
J. R. Harrison, "Piezo-Electric Resonance and Oscillatory Phenomena with Flexural Vibrations in Quartz Plates"	1040
Discussions on C. A. Boddie Paper by R. D. Duncan, Jr. and Alexander Nyman	1055
Review of Current Literature by Stuart Ballantine	1065
Book Review	1071
J. B. Brady, Digests of U. S. Radio Patents	1073
Geographical Location of Members Elected November 2, 1927	1075

At the end of this number are the title page, page of general information and Table of Contents pages for the entire Volume 15 (1927) of the PROCEEDINGS. These last may be suitably placed at the beginning of the volume for binding.

GENERAL INFORMATION

The PROCEEDINGS of the Institute are published monthly and contain the papers and the discussions thereon as presented at meetings.

Payment of the annual dues by a member entitles him to one copy of each number of the PROCEEDINGS issued during the period of his membership.

Subscriptions to the PROCEEDINGS are received from non-members at the rate of \$1.00 per copy or \$10.00 per year. To foreign countries the rates are \$1.60 per copy or \$11.00 per year. A discount of 25 per cent is allowed to libraries and booksellers.

The right to reprint limited portions or abstracts of the articles, discussions, or editorial notes in the PROCEEDINGS is granted on the express conditions that specific reference shall be made to the source of such material. Diagrams and photographs in the PROCEEDINGS may not be reproduced without securing permission to do so from the Institute through the Secretary.

It is understood that the statements and opinions given in the PROCEEDINGS are the views of the individual members to whom they are credited, and are not binding on the membership of the Institute as a whole.

Entered as second class matter at the Post Office at Menasha, Wisconsin.

Acceptance for mailing at special rate of postage provided for in the Act of February 28, 1925, embodied in paragraph 4, Section 412, P. L. and R. Authorized October 26, 1927.

Copyright, 1927, by

THE INSTITUTE OF RADIO ENGINEERS, Inc.

Publication Office 450-454 Ahnaip Street, Menasha, Wis.

Editorial and Advertising Departments, 37 West 39th St., New York, N. Y.

OFFICERS AND BOARD OF DIRECTION, 1927

(Terms expire January 1, 1928, except as otherwise noted)

President

RALPH BOWN

Vice-President

FRANK CONRAD

Treasurer

MELVILLE EASTHAM

Secretary and Editor

ALFRED N. GOLDSMITH

Managers

L. A. HAZELTINE

R. H. MANSON

L. E. WHITEMORE
(Serving until Jan. 1, 1929)

J. V. L. HOGAN

A. E. REOCH

R. H. MARRIOTT
(Serving until Jan. 1, 1929)

R. A. HEISING
(Serving until Jan. 1, 1930)

Junior Past Presidents

J. H. DELLINGER

DONALD McNICOL

Assistant Secretary

JOHN M. CLAYTON

Associate Editor

GEORGE R. METCALFE

Committees of the Institute of Radio Engineers, 1927

Committee on Meetings and Papers

R. H. MARRIOTT, *Chairman*

STUART BALLANTINE

R. R. BATCHER

CARL DREHER

W. G. H. FINCH

ERICH HAUSMANN

S. S. KIRBY

G. W. PICKARD

PAUL WEEKS

W. WILSON

L. M. HULL

F. H. KROGER

A. G. LEE

F. K. VREELAND

Committee on Revision of the Constitution

J. H. DELLINGER, *Chairman*

J. V. L. HOGAN

DONALD McNICOL

Committee on Publicity

W. G. H. FINCH, *Chairman*

DAVID CASEM

ORRIN E. DUNLAP

E. EHLERT

L. W. HATRY

E. H. HANSEN

LLOYD JACQUET

J. F. J. MAHER

Committee on Admissions

F. CONRAD, *Chairman*

ARTHUR BATCHELER

HARRY F. DART

C. P. EDWARDS

A. H. GREBE

L. A. HAZELTINE

R. A. HEISING

Committees of the Institute—(Continued)

J. G. UZMANN
WILLIS K. WING
R. F. YATES

Committee on Membership

HARRY F. DART, *Chairman*
M. C. BATSEL
M. BERGER
F. R. BRICK
GEORGE BURGHARD
E. M. DELORAINE
DR. L. J. DUNN
C. P. EDWARDS
W. G. H. FINCH
C. M. JANSKY, JR.
ROBERT S. KRUSE
WILLIAM J. LEE
PENDLETON E. LEHDE
C. L. RICHARDSON
F. H. SCHNELL
E. R. SHUTE
G. S. TURNER
E. H. ULRICH

Committee on Institute Sections

DAVID H. GAGE, *Chairman*
M. BERGER
L. F. FULLER
D. HEPBURN
L. G. PACENT
M. C. RYPINSKI
E. R. SHUTE

All Section Secretaries ex-officio

Committee on Standardization

L. E. WHITTEMORE, *Chairman*
M. C. BATSEL
EDWARD BENNETT
E. L. CHAFFEE
J. H. DELLINGER
MELVILLE EASTHAM
C. P. EDWARDS
GENERAL FERRIE
A. N. GOLDSMITH
L. A. HAZELTINE
J. V. L. HOGAN
W. E. HOLLAND
L. M. HULL
F. A. KOLSTER
MAJOR J. O. MAUBORGNE
R. H. MANSON
DONALD MCNICOL
E. L. NELSON
H. S. OSBORNE
H. B. RICHMOND
LT. COMDR. W. J. RUBLE
E. H. SHAUGHNESSY
H. M. TURNER
C. A. WRIGHT
HIDEITSUGU YAGI
J. ZENNECK

INSTITUTE SECTIONS

ATLANTA SECTION

Chairman
Walter Van Nostrand

Secretary-Treasurer
George Llewellyn, Room 524, Post Office
Bldg., Atlanta, Ga.

BOSTON SECTION

Chairman
George W. Pierce

Secretary-Treasurer
Melville Eastham, 30 State St.,
Cambridge, Mass.

BUFFALO—NIAGARA SECTION

Chairman
L. C. F. Horle

Secretary
C. J. Porter, 141 Milton Street,
Buffalo, New York

CANADIAN SECTION

Chairman
A. M. Patience

Secretary
C. C. Meredith, 110 Church St., Toronto, Ontario

CHICAGO SECTION

Chairman
G. M. Wilcox

Secretary
H. E. Kranz, 4540 Armitage Ave., Chicago, Ill.

CLEVELAND SECTION

Chairman
John R. Martin

Secretary-Treasurer
L. L. Dodds, 6528 Carnegie Ave.,
Cleveland, Ohio

CONNECTICUT VALLEY SECTION

Chairman
W. G. Cady

Secretary-Treasurer
K. S. Van Dyke, Scott Laboratory,
Middletown, Conn.

DETROIT SECTION

Chairman
Thomas E. Clark

Secretary-Treasurer
W. R. Hoffman, 615 West Lafayette Blvd.,
Detroit, Mich.

LOS ANGELES SECTION

Chairman
L. Taufenbach

Secretary
L. Elden Smith, 340 N. Painter Ave.,
Whittier, Cal.

PHILADELPHIA SECTION

Chairman
J. C. Van Horn

Secretary
John C. Mevius, 1533 Pine St.,
Philadelphia, Pa.

ROCHESTER, N.Y. SECTION

Chairman
Harvey Klumb

Secretary
F. W. Reynolds, 1060 University Ave.,
Rochester, N. Y.

SAN FRANCISCO SECTION

Secretary-Treasurer
D. B. McGown, Custom House,
San Francisco, Cal.

SEATTLE SECTION

Chairman
Tyng Libby

Secretary-Treasurer
W. A. Kleist, 820 Dexter Horton Bldg.
Seattle, Wash.

WASHINGTON SECTION

Chairman
A. Hoyt Taylor

Secretary-Treasurer
F. P. Guthrie, 122 Conn. Ave., Washington, D.C.

INSTITUTE ACTIVITIES

NOVEMBER MEETING OF THE BOARD OF DIRECTION

On November 2nd the regular monthly meeting of the Board of Direction was held in the Offices of the Institute. The following were present: Ralph Bown, President; A. N. Goldsmith, Secretary; Melville Eastham, Treasurer; J. H. Dellinger, L. A. Hazeltine, R. A. Heising, J. V. L. Hogan, R. H. Manson, R. H. Marriott and J. M. Clayton, Assistant Secretary.

E. H. Armstrong was transferred to the grade of Fellow in the Institute. The following were transferred to the grade of Member: Wm. C. Ballard, Charles T. Burke, K. W. Jarvis, Charles E. Strong, W. G. Lush, and George T. Royden. The following were elected to the grade of Member: R. F. Durrant, Philip E. Glover and H. L. Roosevelt.

One hundred and twenty-seven Associate and eleven Junior members were elected.

1928 CONVENTION PLANS

The 1928 Convention of the Institute is to be held on January 9, 10, and 11. The program is to include the annual meeting of the Institute, reports of officers, installation of new officers, presentation of the Liebmann Memorial Prize, a series of technical sessions, inspection trips to a number of interesting places around New York and a dinner-dance on the last evening.

The Committees are actively at work on plans for the Convention. The membership of the Committee is as follows:

Convention Committee, Douglas Rigney, Chairman; J. V. L. Hogan, R. H. Marriott, G. C. Furness, R. H. Ranger, and W. G. H. Finch. Technical Sessions Committee: R. H. Marriott, Chairman; L. A. Hazeltine, A. A. Oswald, Paul Weeks, F. H. Kroger, Carl Dreher, Willis K. Wing, and A. Bailey. Trips Committee: R. H. Ranger, Chairman; O. B. Hanson, H. F. Dart, L. M. Clement, J. L. Reynolds, and N. Levinson. Dinner and Entertainment Committee: G. C. Furness, Chairman; G. W. Johnstone, Fulton Cutting, W. G. H. Finch, W. Wilson, H. T. Melhuish, and H. B. Coxhead. Publicity Committee: W. G. H. Finch, Chairman; D. G. Casem, O. E. Dunlap, F. J. F. Maher, Lloyd Jacquet, L. M. Cockaday, W. K. Wing, H. Gernsbach, L. W. Hatry, R. F. Yates, U. B. Ross, F. Ehlert, Austin Lescarboursa, E. H. Hansen, J. G. Uzmann.

A WAR MEMORIAL TO ENGINEERS

No memorial has been created for American engineers who gave their lives in service outside this country during the world war, although nine years have passed since the Armistice. A unique opportunity for establishing a beautiful and acceptable memorial was found last June by the delegate sent to the five hundredth anniversary of the University of Louvain by the American Societies of Mechanical, Civil, Mining and Metallurgical, and Electrical Engineers. These Societies have accepted the opportunity and are initiating the plan of action. The Institute of Radio Engineers has been invited to participate.

The ancient library of Louvain was destroyed at the outbreak of the war. A beautiful new building is being erected with funds given wholly by Americans—almost a million of them—school children and teachers, college students and professors, policemen and firemen, and persons from all walks of life.

The new library has a fine tower in which space has been allotted for a clock and a carillon, but the clock and the carillon are the only items for which funds have not been provided. The privilege of giving them as a war memorial was secured for engineers in the United States. It is planned to have them ready for operation at the dedication of the building next May or June. Names of the engineers to be memorialized will be inscribed on tablets to be placed in the tower.

The Societies which have undertaken the project desire that the memorial shall embrace all American engineers who made the supreme sacrifice overseas, without limit to society membership, and that all American Engineers who can be reached may have the privilege of participating in this memorial. Contributions of five dollars or more are being requested, but any amounts which donors feel able to contribute will be quite acceptable. The names of all contributors, without mention of amounts, will be recorded in a handsome memorial volume to be deposited in the new Library.

Every dollar given will go into the memorial. Expenses are being provided for separately. A fund of \$80,000 is needed to pay for the clock with four dials, the three-octave carillon with thirty-six bells, and to provide a sufficient fund for perpetual operation and maintenance. Contributions will be treated as a joint fund for all societies. The memorial will be given to the University of Louvain in the names of the participating societies.

The Institute of Radio Engineers thinks that this is a very worthy project and feels that each member of the Institute will desire to contribute to the fund.

Contributions should be made payable to the *Committee on War Memorial to American Engineers*, and should be sent to the Institute's office with the form found on page xxiii of this issue of the PROCEEDINGS.

In order to complete the records of the Institute, it will be appreciated if each member will advise the Institute of the names of any members who died "over there" during the war. Space is provided on the form on page xxiii for inclusion of these names.

All contributions must reach the Institute before February 1, 1928.

RALPH BOWN, FIFTEENTH PRESIDENT OF THE INSTITUTE

Dr. Bown was born February 22, 1891 at Fairport, N. Y. After graduating from Fairport High School he went to Cornell University, where he obtained the M.E. degree in 1913. Following this he spent four years in the Department of Physics at Cornell as an instructor and graduate student, receiving the M.M.E. in 1915 and Ph. D. in 1917. During this period he became interested in radio and carried out some investigations on vacuum tube detectors. Going into the Army Signal Corps, Radio Division, first as a Lieutenant, he was in a few months promoted to Captain and became officer in charge of the radio development work at the Signal Corps Radio Laboratories at Camp Alfred Vail, N. J.

Upon discharge from the Army he became a member of the Department of Development and Research of the American Telephone and Telegraph Company and has been engaged in the various radio development activities of that company. One of his main interests has been endeavoring to develop the transmission side of radio engineering in a quantitative way. Together with his associates he has published a number of papers on various aspects of this work in connection with broadcasting and trans-Atlantic telephony.

Dr. Bown is a member of various scientific societies. He is a Fellow of the Institute of Radio Engineers and in 1925 was the chairman of its Committee on Standardization, in 1926 becoming vice-president of the Institute.

In 1919 he was married to Alma Crawford of Freehold, New Jersey. They have two sons. Dr. Bown's residence is at 85 Pine Street, Maplewood, N. J.

Institute Meetings

NEW YORK MEETING

On the evening of November 2nd a paper by H. A. Wheeler on "Automatic Volume Control for Radio Receiving Sets" was presented to the New York meeting of the Institute by Mr. Wheeler. The meeting was held in the Engineering Societies Building.

In the discussion which followed the paper the following took part: G. W. Pickard, Lewis M. Hull, Edmund Bruce, H. A. Wheeler, L. A. Hazeltine, R. H. Marriott, A. N. Goldsmith, Ralph Batcher, Ralph Bown, and L. W. Hatry.

CANADIAN SECTION

At a meeting of the Canadian Section, held on October 5th in Room 23, Electrical Building, University of Toronto, W. R. McLachlan delivered a paper on "Broadcasting the Second Wrigley Marathon."

C. I. Soucy delivered the second of the series of Junior Lectures, the subject being "Condensers."

The attendance at this meeting was sixty.

On November 2nd a meeting of the Canadian Section was held in the Electrical Building, University of Toronto. C. T. Burke of the General Radio Company delivered a paper on "Radio Frequency Measurements."

Messrs. Price, Soucy, Smith, Hepburn and others took part in the discussion.

A. M. Patience delivered the third of the series of Junior Lectures entitled "The Oscillatory Circuit."

There were eighty-four persons in attendance.

The next meeting of the Section will be held on December 7th in the Electrical Building of the University of Toronto.

CHICAGO SECTION

A meeting of the Chicago Section was held on October 28th in the Monadnock Building. Montford Morrison presented a paper on "Methods of Reducing the Effects of Atmospheric Disturbances." Messrs. Minium, Harper, Wilcox and Henry discussed the paper.

CLEVELAND SECTION

At a meeting of the Cleveland Section held on November 4, 1927 in the Case School of Applied Science, Cleveland, Dr. Ralph Bown delivered a paper entitled "Trans-Atlantic Telephony."

A general discussion followed the presentation of the paper.

The attendance at this meeting was sixty-four.

There will be another meeting of the Cleveland Section on December 2nd.

CONNECTICUT VALLEY SECTION

On October 28th Dr. Ralph Bown delivered a talk on "Trans-Atlantic Telephony" before the Connecticut Valley Section of the Institute. The meeting was held in the assembly hall of the Traveler's Insurance Company, Hartford, Connecticut.

A general discussion followed the presentation of the talk.

Following the meeting, the members of the Institute in attendance (one hundred) visited the Travelers' Broadcasting Station WTIC.

DETROIT SECTION

A meeting of the Detroit Section was held in the Conference Room, Detroit News Building, on October 21st. Professor Joseph Cannon of the University of Michigan delivered a paper on "Electric Filters."

There were forty-four members of the Section present.

PHILADELPHIA SECTION

On October 28th a meeting of the Philadelphia Section was held in the Bartol Laboratories. C. Brown Hyatt delivered a paper entitled "Development and Application of Socket Power." Messrs. Nadick, Snyder, Tindell, Eaton, and Darlington discussed the paper.

There were fifty members of the Section present.

Committee Work

SUB-COMMITTEE ON POWER SUPPLY

The Sub-Committee on Power Supply, of the Institute's Committee on Standardization, held a meeting at Institute Headquarters on November 3rd. Further progress was made on the proposed standard methods of ripple measurement and of measuring inductance of iron core inductors. Methods which have been developed and tried in some of the largest radio laboratories are be-

ing scrutinized and tested by the committee members in an effort to reduce them to the simplest and most practical terms.

A list of terms and definitions applying to socket power units, rectifiers and filter systems was approved by unanimous vote of the committee for recommendation as new Institute standards.

SUB-COMMITTEE ON RECEIVING SETS

A meeting of the Institute's Sub-Committee on Receiving Sets was held in New York on November 1st. Those present were: Dr. J. H. Dellinger, Chairman; E. E. Hiler, Professor L. A. Hazeltine, Professor C. A. Wright, W. A. Diehl, I. G. Maloff, L. C. F. Horle, Mr. Moore (representing V. M. Graham), E. T. Dickey (representing A. F. Van Dyck), W. M. Kirshbaum (representing M. C. Batsel) and M. Ferris (representing L. M. Hull).

The subcommittee considered the preliminary draft of its report as given in the printed pamphlet of May 20. Sections A, B, and C were approved with minor modifications. It was determined to add to Section D3 an alternative means of measuring field intensity by introducing voltage in a resistance in series with the antenna. It was also agreed to add a Section E, "Test Procedures." This Section is to give the details of procedure in carrying out the tests of sensitivity, selectivity, and fidelity. A Section F, to contain an improved bibliography, is also to be added. Subcommittees were appointed to prepare the additional material mentioned, and also to begin the drafting of test outlines of such additional set characteristics as distortion, radiation, and noise level.

A. E. S. C. Sectional Committee on Radio

TECHNICAL COMMITTEE ON VACUUM TUBES

A meeting of this technical committee was held on November 2nd. Those present were: Dr. J. H. Dellinger, Chairman; Mr. W. C. White, Dr. M. J. Kelly, Dr. C. H. Sharp, Lieut. Comdr. W. J. Ruble and Mr. Stinchfield (representing R. M. Wise).

The Committee considered the standards previously recommended to the Sectional Committee on Radio. These standards included tube terminology and the UX base. After circulation by the Sectional Committee a number of comments of value had been received, and these received action by the technical committee.

Dr. Dellinger reported that the International Electro-technical Commission, at its meeting in Italy in September, had recommended for adoption two world standards for tube bases, a

modified European base and the UX base. This action covered only the pin dimensions and spacing. The committee voted approval of the I. E. C. action, with an expression of opinion that international action may also be necessary on shell and bayonet pin dimensions.

The committee voted to adopt as the specific representation of the tube base standard the diagrams given on pages 55 and 56 of the September 1927 edition of the National Manufacturers Association "Handbook of Radio Standards." It was also decided to replace the designation UX by "American standard 4-pin vacuum tube base."

The Committee voted to submit to the consideration of the Institute of Radio Engineers Standardization Committee, the possible standardization of the measurement of tube capacities, the adoption of the term "tetrode" for 4-element vacuum tubes, and the possible standardization of terminology and other features of a.c. vacuum tubes.

The Committee determined not to undertake standardization at this time of filament voltage or current tolerances, or of internal capacity tolerances.

The Committee decided to undertake the assembly of data on the 5-pin base and on rectifier tube bases, with a view to possible future standardization.

1928 MEMBER DUES

It is desirable that the attention of the membership be called to the bills for the 1928 dues which will be mailed during the latter part of December. Prompt payment of these bills will materially decrease the burden on the Institute office, and in addition will insure prompt receipt of all Institute publications by the membership.

PUBLICATION SCHEDULE

Due to the publication of the PROCEEDINGS monthly since the first of the year and to a change in the printing establishment with the October number of the PROCEEDINGS, papers can be published in general in approximately one third the time formerly required.

The Institute will always appreciate constructive criticism on the PROCEEDINGS both as to the type of papers published and the mechanical make-up of the journal.

1928 YEAR BOOK

Members are cautioned that changes in address (both residential and business) cannot be included in the 1928 Year Book unless the Institute is notified thereof by not later than December 15, 1927.

Unpaid members desiring to appear in the Year Book must settle their accounts on or before December 15th.

MEMBERSHIP CARDS

As announced last month, membership cards for 1928 will be available to *all* members of the Institute when the Institute's office is requested to issue such cards.

INCREASE IN OFFICE FORCE

During the current year four additions have been made to the office staff of the Institute in an effort to keep up with the ever-increasing amount of work involved in the operation of the Institute and the publication of the PROCEEDINGS.

OBITUARY

The Board of Direction of the Institute of Radio Engineers announces with deep sorrow the death of its member:

John F. Dillon

His career has been a notable one from the viewpoint of service to the public. For nearly thirty years he served in the Army of the United States, rising to the grade of Lieutenant-Colonel. For fifteen years he was a member of the Federal Radio Inspection Service of the United States Government, having been one of the first radio inspectors appointed in the United States.

At the height of his career he was appointed a member of the Federal Radio Commission in 1927. He served with the Commission in Washington in framing the preliminary policies and tentative regulations of that body until severe illness in June, 1927 prevented the continuance of his activities.

Colonel Dillon was an active worker in the radio field from its earliest days and was responsible for much of the development and coordination of radio communication on the Pacific Coast. He was a Fellow of the Institute of Radio Engineers, Chairman of the San Francisco Section of the Institute, and an active participant in Institute activities.

His loss is a real one to his country, the radio field, and the Institute, of which he was an officer.

ATMOSPHERICS AT WATHEROO, WESTERN AUSTRALIA

BY

J. E. I. CAIRNS

(Watheroo Magnetic Observatory, Western Australia. Carnegie Institution of Washington.)

Early in the year 1927 observations on the wave-form, field-strength, and duration of atmospherics were begun at the Watheroo Magnetic Observatory employing an apparatus essentially the same as that described by Appleton, Watson Watt, and Herd in the Proceedings of the Royal Society (*A*, Vol. 111, 1926), local conditions causing the introduction of only a few minor changes. For a month after the apparatus was set in proper working order, observations were made almost nightly, though no drawings were made, since at that time the calibrating oscillator for the time-base was in course of construction and rough calibrations only could be made by comparison of the sound produced in a pair of headphones with the note of a violin. The month was employed profitably by the observer's gaining experience in the delineation of the atmospheric wave-forms, and in increasing the speed with which the observations could be made. On March 18, 1927, the calibrating oscillator was delivered, and observations were begun on March 20.

It was first desired to measure 5,000 late summer atmospherics, but shortly after the first thousand had been drawn the oscillograph-tube became inoperative, owing either to a gas leak or to inactivation of the filament, and the observations had to be suspended. Summer atmospherics, especially late summer, are distinctly the worse experienced at this station, as elsewhere, and it was to measure these that the work was planned. Before the defective tube could be replaced the summer had broken, and consequently the statistical analysis has had to be made on 1000 wave-forms and not on 5000 as originally intended. However, it is believed that the result of this analysis is fairly typical. Several thousand atmospherics were examined during the month prior to March 20, 1927, and though some uncertainty attached to the values of the time-bases used, yet it may be stated that in both magnitude and duration, and in distribution as regards duration,

Original Manuscript received by the Institute, September 20, 1927.

these atmospherics were similar in every respect to those subjected to analysis.

FORMULAS

It is shown in the paper "On the Nature of Atmospherics," Parts II and III by Appleton, Watson Watt, and Herd,¹ that the effect of the rapid variation of the Earth's electric field which constitutes an atmospheric upon the system shown in Fig. 1 is given by

$$f(t) = \frac{v}{h} \cdot \frac{C_0 + C_1}{C_0} \quad (1)$$

where $f(t)$ is the change which the vertical electric field undergoes, h is the height of the exposed conductor, v is the potential developed

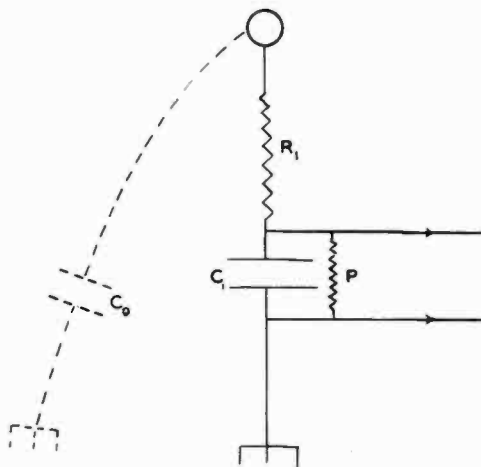

Figure 1

across the plates of the condenser C , and C_0 is the capacity of the exposed conductor, so that if the potential v be examined oscillographically it is possible, by means of the condenser potentiometer, to ascertain the changes in the Earth's field caused by an atmospheric for those cases where the initial and final values of the field are the same. For this to hold, the system comprised of C_0 and R_1 must be non-oscillatory and the time constant of the entire system must be small compared with the duration of the field change. Also, the time constant $C_1\rho$ must be large compared with the field change.

For a change involving a net change in the vertical field, a redistribution of charge on the exposed conductor takes place;

at the end of the disturbance the charge induced on the conductor disappears by leakage through the resistance ρ in time $(C_0 + C_1)\rho$. This exponential discharge produces a series of sloping lines on the oscillograph screen due to several transverse of the indicating spot. The expression giving the maximum potential attained by the field change during a semi-permanent change is

$$[E] = \frac{v}{h} \cdot \frac{C_0 + C_1}{C_0} \quad (2)$$

where the symbols have the same significance as in (1).

APPARATUS

The exposed conductor was an ordinary L receiving antenna of rather small dimensions; 91 meters long, 4.95 meters high at the center of capacity, and having a capacity of 0.00059 μf . With an inserted capacity C_1 of 0.002 μf . and an oscillograph sensitivity of 0.86 volts per mm., one mm. deflection on the oscillograph screen corresponded to a field-change of 0.00811 volts per meter, the amplification of the amplifier being 94. The resistance ρ was 12 megohms, and the lowest aerial resistance measured was 224 megohms, the insulation being maintained by means of sulphur strain insulators and a sulphur insulated lead-in tube. No measurements were made during wet weather, and when rain occurred, the insulators were scraped before the system was again used. Ground resistance was approximately 12 ohms.

The measuring apparatus is shown diagrammatically in Fig. 2, leads for the calibrating oscillator for the time-base and the time-base voltage generator itself being also shown. R_1 , wound anti-inductively and anti-capacitatively, was just large enough so as to be greater than that required for critical damping, so as to give rapid response to field changes; ρ was a metallised non-inductive resistor. Switch S permitted the application of aerial voltage, amplified aerial voltage, or time-base calibrating oscillations as desired to the oscillograph plates. Otherwise the diagram is self-explanatory. The amplifier consisted of two stages of resistance capacity coupling, this form of amplifier being employed for reasons of economy, and also because the work was not of fundamental character. No change of amplification with frequency was observed for the range 256 to 1024 cycles, and the value of the

¹ E. V. Appleton, R. A. Watson Watt, and J. F. Herd, *Proc. Roy. Soc. A*, 3, 1926.

amplification was extrapolated backward to include the lower frequencies. The anode resistances, metallised, were continuously variable up to 80,000 ohms each, but none other than the maximum amplification was ever employed, the oscillograph deflections then being of convenient magnitude. The valves were Marconi Osram D. E. 5b, "high mu" valves, impedance 30,000 ohms. Rectification occurred in the valves when the grid potential exceeded 4 volts; when this value was attained at the grid of the second valve, the oscillograph spot was high on the

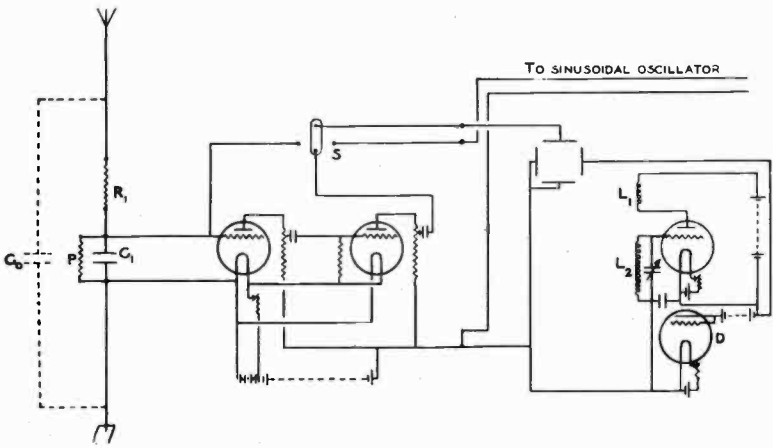

Figure 2—General Wiring Diagram.

screen, and on the portion not covered by the oscillograph calibration. Moreover, the image was confused, similar to a semi-permanent field-change with a radiation field superimposed. Such fields were readily recognised and omitted; no serious weighting of the results occurs as a result of neglecting these off-scale deflections, because of those deflections below 0.5 mm. which were also neglected. The omission at either end of the oscillograph range tends to preserve a correct mean.

The oscillograph was a standard Western Electric cathode-ray oscillograph, Vacuum Tube 224A. Anode potential used was 270, derived from radio plate-batteries, and filament current 1.4 amperes, the indicating spot being very brilliant at these values. All other vacuum tubes used in the apparatus were covered with light-proof sheaths to prevent excess stray illumination.

The audio-frequency oscillator employed to develop the sinusoidal oscillations for calibrating the time-bases was an

ordinary valve generator, a Marconi Osram *R* valve being used for the purpose. The output voltage was only two volts and was therefore stepped up with a 5-to-1 a.f. transformer to give a larger oscillograph deflection.

A linear, uni-directional time-base was secured by the use of the non-linear oscillator described in the paper¹ previously mentioned. A short train of oscillations charges up the grid condenser until the oscillations cease; this charge then leaks off through the saturated diode *D* of Fig. 2 in a linear fashion until the voltage reaches the value where oscillations begin again. The application of the potential of the grid condenser plates during this process to the oscillograph plates produces a to-and-fro motion of the spot, the movement in one direction being far more rapid than in the other. The charging up of the grid condenser is practically instantaneous, so that the motion of the oscillograph spot is unobserved during this process. The coils L_1 and L_2 were ordinary tuning coils, suitably mounted, and it was found that the system oscillated better when the grid coil was tuned by a 0.0005- μ .f. variable condenser. It was also found necessary to screen this oscillator with an earthed metal screen; owing to the proximity of the time-base oscillator and the amplifier in the arrangement of the apparatus, there was considerable stray pick-up. When the earthed screen was introduced, the trace on the oscillograph screen with the aerial disconnected from the amplifier, was perfectly straight, whereas before it had shown a Lissajous figure. No trace of backstroke could be detected except at a frequency of 1024 p.p.s., when one wave of 512-cycle voltage was held on two strokes of the time-base; the return of the spot was just barely distinguishable, and as far as could be ascertained, parallel to the time-base.

OBSERVATIONS

The observations were made at night when weather conditions permitted. Usually at this time of the year at Watheroo the only rains are those due to thunderstorms, but unfortunately, heavy unseasonal rains from the northeast commenced almost simultaneously with the beginning of the observations and thus forced the observer to extend them over a longer period of time than would otherwise have been the case. Owing to the necessity of performing the ordinary observatory routine work, it was impossible to begin the observations until after 21^h; as these extended over three hours for the number of time-bases used and the period on each, there was danger of a diurnal variation creeping in and

affecting the numerical distribution of the atmospherics with respect to their duration. To correct this effect, in the latter half of the series, the time-bases were used in the reverse order to the former: i.e. in the first half, time-bases of long duration were observed first, the duration being decreased as each time-base was examined, while in the second half, short-duration bases were

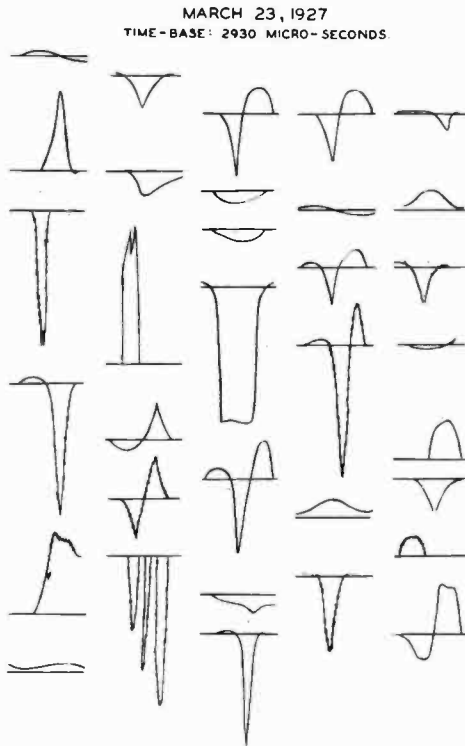

Figure 3—Observed Atmospherics.

observed first. This was the most satisfactory procedure, especially under humid conditions, for it was noticed that after rain had fallen, a slight leak across the grid condenser of the linear oscillator prevented the use of very low frequencies; when the short-duration bases were examined first, the apparatus became warmed up before these very long bases were examined, and no leak occurred. The ionisation in the oscillograph tube also provided a leakage path, but even at the lowest frequencies it did not appear to affect the linearity of the time-base. To offset the effect of this leak, (which is practically constant and linear), the largest grid condenser

permissible was used in the time-base oscillator; in the actual apparatus it was 0.005 $\mu.f.$

Time-bases of 20-mm. length were used almost exclusively; on a few occasions 15-mm. bases were employed, but the thickening of the base-line caused their abandonment. Adjustment to length was effected by varying the coupling of the coils L_1 and L_2 of Fig. 2 of the time-base oscillator. The bases were calibrated against the sinusoidal oscillator which was itself standardised against a 512-cycle tuning fork by reducing the beat-note between the fork and the note produced in a loudspeaker connected to the sinusoidal

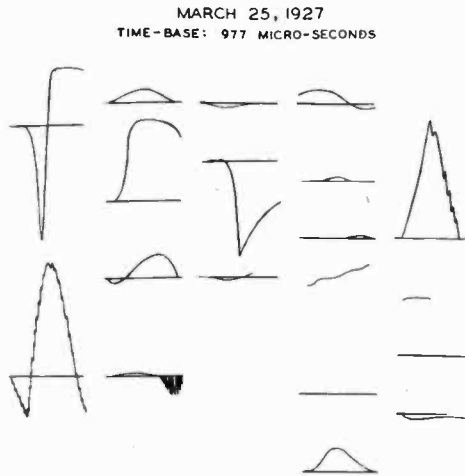
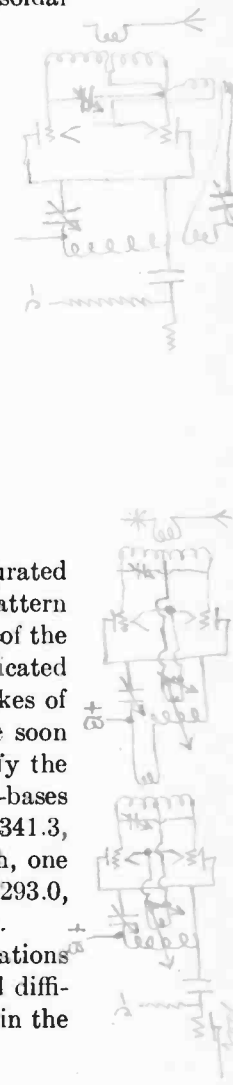

Figure 3a—Observed Atmospherics.

oscillator to zero. The time-base grid-condenser leak, the saturated diode D of Fig. 2, was then adjusted until the required pattern was held on the screen. Patterns containing up to six waves of the sinusoidal voltage could be held easily, and the more complicated patterns, such as where three waves were held on two strokes of the base, though a little difficult to interpret at first, were soon recognized with ease after a violin had been used to identify the audible note emitted. The strokes per second of the time-bases employed were as follows: 85.3, 102.4, 128.0, 170.7, 256.0, 341.3, 512.0, 768.0, and 1024 so that with bases of 20-mm. length, one mm. on these bases corresponded to 585.9, 488.3, 390.6, 293.0, 195.3, 146.5, 97.7, 65.1, and 48.8 micro-seconds respectively.

Originally it was intended to allot 15 minutes to observations on each base; one observer only made the observations and difficulty was experienced in keeping the observation time within the



prescribed limits. In an attempt to correct for the differing durations of observation (amounting to ± 3 minutes), the results have been weighted, though very little change in the unweighted figures is produced thereby.

Upon the end of the oscillograph tube, lines were marked parallel to the time-base and 5 mm. apart. Readings to 0.5 mm. could

TABLE I
SUMMARY OF ATMOSPHERICS AT WATHEROO MAGNETIC OBSERVATORY, WESTERN AUSTRALIA,
MARCH 20 TO 28, 1927

Type ¹	No.	Duration in μs	Field strength in v/m	Type ¹	No.	Duration in μs	Field strength in v/m
Aperiodic Types, P							
A+	12	1793	0.153	A-	45	786	0.162
B+	36	1798	0.032	B-	54	1137	0.039
C+	56	3198	0.167	C-	71	2348	0.074
D+	9	2783	0.179	D-	21	1910	0.121
E+	21	1892	0.030	E-	44	1634	0.026
F+	21	1870	0.039	F-	16	1915	0.037
Indeterminate+	32	1553	0.095	Indeterminate-	33	2278	0.065
Total P+	187	2172	0.095	Total P-	284	1680	0.074
Quasi-periodic Types, Q							
Greater voltage first				Greater voltage first			
A+	21	3316	0.128	A-	29	3288	0.081
B+	10	3592	0.176	B-	1	4965	0.137
C+	15	2473	0.026	C-	15	2826	0.028
D+	0	D-	0
E+	3	4148	0.058	E-	0
F+	0	F-	0
Indeterminate+	7	2415	0.035	Indeterminate-	0
Greater voltage later				Greater voltage later			
G+	20	3227	0.186	G-	50	2410	0.144
H+	4	2478	0.148	H-	10	2576	0.190
I+	19	2448	0.051	I-	30	2722	0.058
J+	7	3014	0.123	J-	92	3458	0.132
K+	5	2538	0.081	K-	20	2788	0.065
L+	6	2749	0.199	L-	2	3738	0.234
M+	3	2606	0.220	M-	14	3176	0.232
N+	3	1531	0.269	N-	1	6095	0.202
O+	4	4320	0.227	O-	1	977	0.186
Indeterminate+	8	2076	0.107	Indeterminate-	31	2394	0.102
Total Q+	135	2876	0.118	Total Q-	296	2960	0.116
A \pm	1	9020	0.026	F \pm	0
B \pm	0	G \pm	6	4410	0.019
C \pm	0	H \pm	1	6975	0.021
D \pm	0	Indeterminate \pm	16	1998	0.081
E \pm	0	Total Q \pm	23	3126	0.060

¹ Type as defined in sketches of Fig. 5 either positive or negative.

be made without difficulty, so that the lowest value discernible corresponded to a field change of 0.004 volts per m. The time-base was adjusted to coincide with one of these parallel lines by means of the tuning condenser across L_2 ; change in the frequency of the oscillations constituting the short train which charged up the grid condenser appeared to affect the terminal voltages of the train

and thus move the base as a whole parallel to itself. The adjustment was not very critical, but sufficient to correct any drift which occurred.

Owing to the necessity for the maintenance of high aerial insulation, special attention was given to this and the insulation tested twice nightly, before and after the observations, by means of a microammeter and a 200-volt battery. In no instance was the insulation resistance below 224 megohms, giving a minimum value of 11.4 megohms for the resistance ρ and therefore a value for the time constant $C_1\rho$ of 22,800 micro-seconds. In addition, a voltmeter could be inserted at various points to ensure the main-

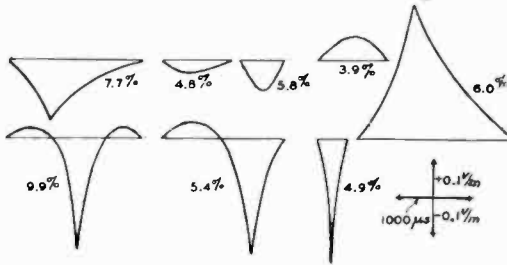

Figure 4—Reconstructed Typical Atmospherics.

tenance of the conditions necessary for the correct functioning of the amplifier and time-base oscillator.

RESULTS

The wave-forms were drawn by hand; typical forms observed are shown in Fig. 3. In nearly all the atmospherics observed the structure was rippled; so much so that it was impossible to draw all the ripples, but merely to indicate on the drawing that ripple was present. When the time-base was opened out to 1000 μ s these ripples were seen to be approximately 1 to 2 mm. in length corresponding in time to 50 to 100 μ s. The results obtained are expressed concisely in Table 1, following the method of Appleton, Watson Watt, and Herd, and it will be noted that the wave-forms are identical with those obtained by these investigators. The curves in Fig. 4 are reconstructed from the mean values obtained for the most frequently occurring form in each class, and the individual curves may be taken as the typical atmospheric in that particular class. The percentages alongside each curve give the percentage with which the particular form occurred in the total number of radiation-fields examined (this excludes semi-

permanent field-changes). The curves are not idealised to any great extent.

Negative atmospherics (the convention as to sign is that the atmospheric is given the sign of the greatest peak, regardless of the order of incidence of the peaks, and the positive sign is given to that atmospheric which tends to make the aerial terminal of the coupling condenser C_1 positive) predominate, though the peaked aperiodic positive forms an important class, comprising 6 per cent of the total number. These peaked positive aperiodics were almost invariably associated with visible lightning, and their magnitude is evidently due to the proximity of the source. The flashes were, in general, diffuse glows, but the district is so sparsely settled that no data as to distance could be obtained. Cloud-to-earth flashes are comparatively rare in the locality but "summer lightning" is frequently visible at night at the season of the observations. The symmetrical peaked negative is worthy of notice on account of the shortness of its duration, 786 μ s. The peaked forms were far more numerous and of greater amplitude than the rounded, and the peaked quasi-periodics occurred more frequently, though attaining slightly smaller amplitudes on the whole, than the peaked aperiodics.

RIPPLED STRUCTURE

It was mentioned previously that ripple was present in nearly all the atmospherics examined; on nearly every occasion that observations were made the familiar summer "static roar" was present when a radio receiver was tuned to any station. It is believed that the cause of this "roar" is to be found in the small ripples of durations 50–100 μ s. and of amplitude 0.008 volts per m. approximately from consideration of the following: Every night before commencing the observations, the apparatus was tested before darkness set in, and one or two stations were tuned in on the receiver. The static roar was always accompanied by ripples on the oscillograph screen when the time-base was opened out to 1000 μ s., and on those occasions when the roar was absent (its absence was always marked) ripples were also absent. This coincidence occurred on several occasions in the 5 weeks during which observations were made, though only on one or two during the 9 days on which the most precise measurements were carried out. When the roar was very bad, these ripples were practically continuous; in fact, by varying the time-length of the base-line, it was possible on occasions to hold the pattern or to watch it

progressing or retrogressing for a short period, a fact that led to the suspicion that local interference might be the cause. The electric motors driving other observatory apparatus were suspected, but shutting these off produced no change in the appearance on the oscillograph screen; in fact, all possible sources of stray pick-up were investigated but no evidence was found that there was any local interference. The only conclusion that can be reached is that the continuous summer roar is caused by continuous or almost continuous atmospheric ripples of from 50–100 μ s. duration and about 0.008 volts per m. amplitude. No long-wave station employing a wavelength anywhere near the vicinity of

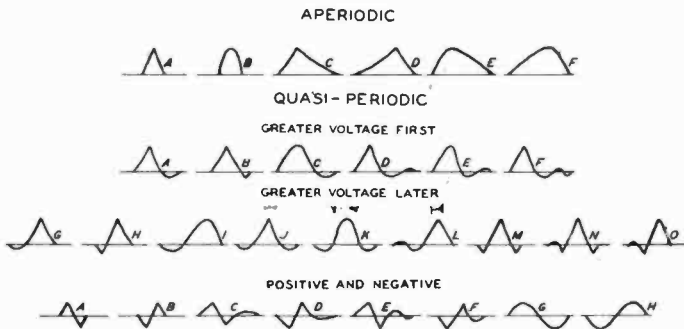

Figure 5—Types of Atmospherics.

13,330 metres (22.5 kc.) is situated in or near Australia, nor could such a station be tuned in on a receiver. Such interference is possible, because of the aperiodic aerial employed. This "roar" is most probably identical with the "rattle" which De Groot² observed in the Dutch East Indies, and which he ascribed to extra-terrestrial influence.

SEMI-PERMANENT FIELDS

Semi-permanent field-changes were fairly numerous, their incidence amounting to 17.6 per cent of the total number of 1124 atmospherics examined. The sign of a number of these was not noted on occasions, but of those which were measured the negative had a large predominance; positives were very few. One class, giving a complex screen pattern, was termed " \pm ," for it appeared to occur on both sides of the base-line; however, it is thought that these were semi-permanent field-changes accompanied by radia-

² De Groot, Proc. Inst. Radio Eng., New York, 5, 1917, p. 75.

tion-field. That they were not caused by rectification in the amplifier is shown by the fact that the deflections of this type were frequently small, and well within the linear amplification range. Further investigation of the semi-permanent field-changes was postponed until after the required number of radiation-fields had been examined; unfortunately, however, work in this direction was prohibited by the failure of the oscillograph tube. Regardless of sign, the mean semi-permanent field-change was 0.1372 volts per m. but this value is probably low, since off-scale deflections were common.

Though none of the semi-permanent field-changes measured were observed simultaneously with lightning flashes, owing to the impossibility of one observer's making both observations, yet it is known that the storms were in all cases over 50 km. distant. No thunder was heard, and the storms seemed to cling to the horizons, north, northwest, west, and southwest. Mostly they were just visible over the horizon, the lightning playing in the clouds. During the preliminary period, February to March 20, on one or two occasions two observers made observations; on these occasions it was found that every lightning flash did not produce a measurable field-change at the aerial, and conversely, every semi-permanent field-change was not invariably associated with visible lightning. Local storms are fairly high; one on December 31, 1926, at about 22^h was approximately 7 km. high as judged by the difference in time between the flash and the thunderclap.

SUMMARY

Of nearly 1000 atmospheric radiation wave-forms observed over a period of 9 days at the Watheroo Magnetic Observatory from March 20 to March 28, 1927, the most frequently occurring form was found to be a negative peaked quasi-periodic consisting of 3 "half cycles," the maximum field change being associated with the second "half cycle." The mean duration and field-strength of this type, which occurred in 10 per cent of all cases examined, were 3458 μ s. and 0.139 volts per m., respectively. Reconstructed drawings of the most frequently-occurring forms are given, as well as reproductions of actual sheets of observations.

The summer "roar" is shown to be most probably due to short-period, small-amplitude, almost continuous ripples, the period lying between 50 and 100 μ s. and the amplitude being approximately 0.008 volts per m. The static "rattle" noted by

De Groot in the Dutch East Indies is probably due to ripples similar to these.

Negative atmospherics predominated, the only notable positive being an aperiodic of relatively long duration, this form being almost invariably associated with lightning. Quasi-periodics were more numerous than aperiodics, and the peaked form occurred in greater numbers than the rounded. The symmetrical negative peaked aperiodic was noteworthy, because of the shortness of its duration, 786 μ sec. All atmospherics seen on the oscillograph screen were accompanied by a noise in a radio receiver.

Semi-permanent field-changes were fairly numerous, the negative change occurring far more frequently than the positive, the thunderstorms producing these changes being usually over 50 km. distant.

ACKNOWLEDGMENTS

Thanks are due to Mr. H. F. Johnston, Observer-in-Charge at Watheroo for material assistance in the provision of batteries, of which there are many in the apparatus, and for continued interest in the work; to Mr. F. W. Wood who helped to identify the various time-base screen patterns with the aid of a violin; to the Department of Physics of the University of Western Australia for the loan of a tuning fork, and to Mr. D. W. Everson of that Department, for the manufacture of the sinusoidal oscillator.

PROPAGATION OF SHORT WAVES DURING A SOLAR ECLIPSE

By

EDWIN J. ALWAY

Special watch was kept on 30 to 45 meters from 0400 to 0530 hours G.M.T. on the morning of June 29, 1927, for the purpose of observing effect of solar eclipse on transmission of 40-45 meter waveband.

The receiving station was situated at Heliopolis near Cairo, Egypt. Dawn occurred at 0200 hours G.M.T. Progress of eclipse could be observed through window; eclipse was only partial in Egypt, though total in England at 0524 G.M.T. First indication of effect on short-wave transmissions was observed on signals from WIZ, 42 meters, which generally persists with gradually weakening strength until some hours after dawn. On this occasion, WIZ began to rise slightly in strength at 0420 hours, which was time of first contact on line of totality. At 0423 station ER5AA was heard calling, quite loudly, CQdeER5AA on 32 meters.

This station has never before been heard here as late as 0423. The wave in question, however, 32 meters, was not considered long enough to show any marked night-contra-daylight properties. Listening out was now confined to 40-45 meter band; signals from Europe on these waves always fade to zero when daylight covers whole path, daylight being 2 hours later in Europe.

At 0430, 10 minutes after first contact, a Vickers Vanguard aircraft GEBCP, was heard calling, "CQ de GEBCP—Time now 0530 B.S.T.—over Mersey—no bumps—over Mersey—" and later "—now over Liverpool—speech—std bi fone—"

This machine was transmitting on a wave of 42.5 meters, and was received R7; machine was then only a few miles from line of totality.

At 0450 the following was heard, "CQ de LCHO—test transmission from Oslo (Norway), radio on 45 meters," (R7).

At 0500 the British amateur G2WJ was heard on 45 meters sending code words. These code words have not yet been checked, but reception of them was not at all doubtful; here are two:

Original Manuscript received by the Institute, July 19, 1927.

“UFE0FROGEYIMEOMAESYIZY0FAAROICU de G2WJ,”
 and “YNI0CAIREUHA0ZUYS0AUMENAJAAGIUFY de
 G2WJ.”

At 0500, WIZ was still heard quite loudly and persisted till
 after 0530 G.M.T.

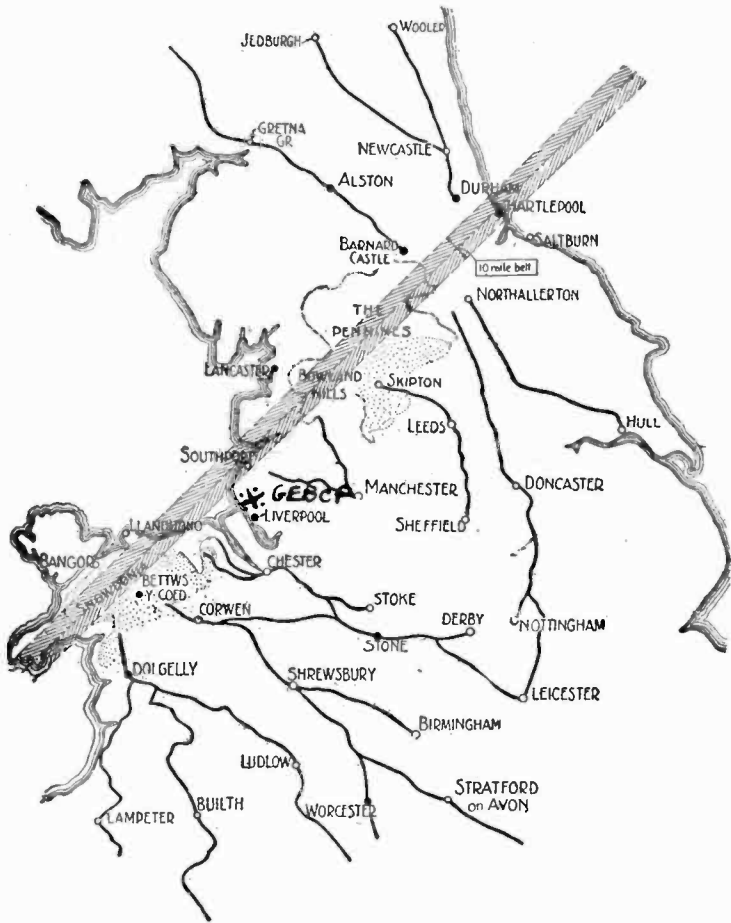

Figure 1—G2WJ is situated in the right-hand lower corner. First ct., 0420;
 total ct., 0524; last ct., 0614.

At 0516 G.M.T. the following call was heard on about 40
 meters, “8 CER NU 3ASL—R ck—ur tone gud AC cut a little—
 gru hr—vy gld ti QSO ob, bi uw om so wl QRT nw vy best 73’s eu
 agn—A 8 C.E.R. nu 3 AHL (?).” This transmission, apparently
 from an amateur station in the third zone in the United States,

could scarcely have been heard at Heliopolis, Egypt, after three and one-quarter hours of daylight under normal circumstances. It is worthy of note that this particular station was heard just previous to the time of totality in England.

At 0520, G2WJ could still be heard sending test code words, but was not so easily receivable, more errors being made; the following incomplete code word was received: "TOALOORY-UZOAUUASMXA—de G2WJ."

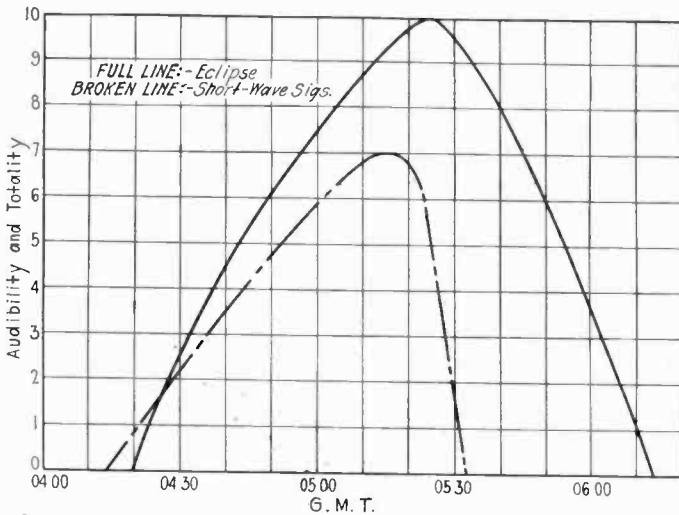

Figure 2

At 0530, Oslo LCHO, had also fallen in strength, though still readable.

A station on 39 meters was also heard at 0530 calling "18GR de OC1," but I have been unable to identify the calls signs. After 0530 G.M.T., all signals ceased on 40-45 meters, and atmospherics, which had been present from 0400-0530 also ceased, and the watch was discontinued.

One concludes by assuming that, at least locally, a solar eclipse produces a pseudo-night-effect, this effect beginning with the eclipse but finishing before it; that is, when the eclipse occurs in the morning.

N.B. G2WJ is situated in London N 12.

GEBCP and G2WJ were approximately 2500 miles from Cairo.

LCHO was approximately 3000 miles from Cairo.

ER5AA has not been identified, but is probably of Russian origin; if so, it is more than 500 miles distant.

8CER and 3AHL (or 3 ASL) were prefixed by the Amateur International Signs NU and are of American origin.

3 valve receiver used 1 detector, 2 audio-frequency amplifiers.

Discussion on
LONG DISTANCE RECEIVING MEASUREMENTS AT
THE BUREAU OF STANDARDS IN 1925* (L. W. AUSTIN)

K. Sreenivasan †: It was hoped at one time that the observations on Madras radio should be examined with respect to magnetic disturbances; but the difficulty in getting magnetic data together with the assumption that at short distances like 300 Km, such disturbances will not have noticeable effect on reception prevented any further work.

The important paper by Mr. G. W. Pickard¹ on the correlation of radio reception with solar activity showed that the assumption was not justifiable. An examination of the intensity variations in relation to solar activity and terrestrial magnetism is now undertaken on the lines suggested by Mr. Pickard² in his comments on my discussion of Dr. Austin's paper.

The curve obtained from the Madras observations of October and November, 1926 show the marked influence of sunspot activity with reception. Considering that both these months were of comparatively violent changes in intensity from day to day and week to week, the inverse relationship as shown by the curve is of considerable interest. That the day observations of Bangalore are not an exception seems to be borne out by similar relationship that Mr. Pickard has found with Dr. Austin's observations on European stations at Washington.

Of peculiar interest is Mr. Pickard's remark that 1926 is an exception to the general rule of direct relationship between sunspots and day reception. Why this should be so, it is very difficult for me to understand. But 1926 was characterised by a violent magnetic storm during the latter part of October which completely blocked the beam system of transmission between England and Canada. According to published information available, there has been practically no abnormality during the severest part of the storm in the reception of long-wave signals. This indicates some kind of selective action. Without laying too much stress on the

Original Manuscript received by the Institute, October 5, 1927.

* PROCEEDINGS, Institute of Radio Engineers, 14, 663, 1926.

¹ PROCEEDINGS, Institute of Radio Engineers, 15, 83, 1927.

² PROCEEDINGS, Institute of Radio Engineers, 15, 539, 1927.

† Radio Laboratory, Dept. of Electrical Technology, Indian Institute of Science, Bangalore, India.

Madras observations, the weekly averages seem to suggest an explanation which may be worth some attention, although at present it can only be in the nature of a conjecture. Is it possible that short waves on account of their penetration to a greater height into the ionised atmosphere up above respond more readily than lower frequency waves to such phenomena as magnetic storms? Is it not likely that any violent disturbances above will reach the lower "turbid" layers rather slowly and as a consequence that long-wave reception will show less immediate and violent changes, beginning some time after the storm has started and assuming normal values comparatively long after it has ceased?

If there were sufficient data on reception over a number of years throughout the radio spectrum from short waves through the broadcast band to long waves, the above suggestion might have been examined for what it is worth.

Besides the Madras observations, the intensity of the British Post Office Station at Rugby (G B R, 16 Kc. per sec.) has been measured daily due to the kindness of Mr. E. H. Shaughnessy, who readily agreed to the transmission of special test signals twice daily for two months from July 10th, 1927. Each of them consists of a three-minute dash, the morning signal lasting from 0115 to 0118 G.M.T. and the afternoon signal from 1115 to 1115 G.M.T. With a time difference of about $5\frac{1}{2}$ hours between Rugby and Bangalore, the path of the morning signal lies mostly in darkness. During the evening signal, the path is lighted through-out.

Report on these measurements will be made soon after the transmission stops after September 10th. Unfortunately, the measurements on the test signals from Malabar (P K X, 15.6 Km) at 2340 G.M.T. were discontinued from July 10th, 1927. Even as long as it lasted, there were so many breaks due to one reason or another, that the number of readings is far too small to be useful.

THE RELATION OF RADIO RECEPTION TO SUNSPOT POSITION AND AREA*

By

GREENLEAF W. PICKARD

(Consulting Engineer, the Wireless Specialty Apparatus Company, Boston, Massachusetts.)

(Communication from the International Union of Scientific Radio Telegraphy.)

As a matter of years or even months, the relation between radio reception and solar activity is now quite definitely known.¹ An increase of solar disturbance, as indicated by an increase in the number of sunspots, solar constant or ultraviolet radiation, is accompanied by an improvement in day reception and a lowering of night reception. By taking periodic daily averages for a number of solar rotations certain general day-to-day relations can be found; for example, the meridian transit of a sunspot group is usually accompanied by a depression of night reception and (with the exception of 1926 and the early part of 1927) a slight increase of day field.²

Night reception in that portion of the broadcast band between 750 and 1500 kilocycles and over east-west transmission paths shows the highest relation to measures of solar activity. But even with this most sensitive type of radio transmission, if intervals of less than a month are taken the degree of correlation rapidly decreases. Comparing night reception at Newton Centre, Massachusetts, from stations WBBM and WGN at Chicago, with Wolfer Provisional Sunspot Numbers over the interval January, 1926 to September, 1927, the following correlations are found:

Interval	Correlation	r/e
Three months,	-0.92 ± 0.038	24.0
Two months,	-0.75 ± 0.003	8.1
One month,	-0.54 ± 0.10	5.4
Fifteen days,	-0.45 ± 0.084	5.4
Seven days,	-0.30 ± 0.06	5.0

Original Manuscript received by the Institute, October 19, 1927.

* Presented before the International Union of Scientific Radio Telegraphy, Washington, D. C., October 14, 1927.

¹ "The Correlation of Radio Reception with Solar Activity and Terrestrial Magnetism," PROCEEDINGS of the Institute of Radio Engineers, Vol. 15, No. 2, February, 1927.

² "The Correlation of Radio Reception with Solar Activity and Terrestrial Magnetism. II." *Bull. National Research Council*, No. 61, July, 1927. PROCEEDINGS of the Institute of Radio Engineers, Vol. 15, No. 9, September, 1927.

When a day-to-day comparison of reception and Wolfer sunspot numbers is attempted, a very low correlation is found. If recognition is taken of the distance of the sunspots from the sun's center, by multiplying their area by $(1-\rho)$, where ρ is the distance from the center of the solar disk, a somewhat larger correlation coefficient results. A further improvement results when only spots within a few degrees of the central meridian are taken. But even when position as well as area is considered, the

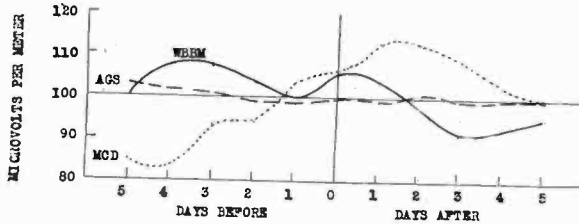

Figure 1—Reception and magnetism with maxima of 4 or more spots in central 13.3 deg. band. 88 cases, February 17, 1926 to May 21, 1927.

connection between individual sunspot groups and reception is not sufficient to show that we are dealing with cause and effect.

As a working hypothesis, I have assumed that there are definite solar areas which are responsible for reception disturbances, and which usually persist for a number of solar rotations. In general these active areas are also areas of sunspot formation, but they are effective in producing reception disturbances even when

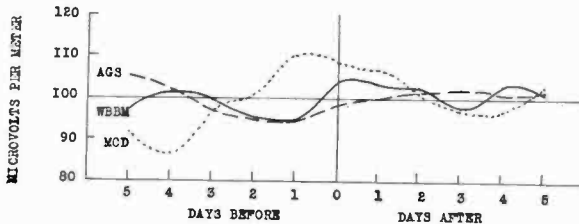

Figure 2—Reception and magnetism with maxima of 4 to 10 spots in central 13.3 deg. band. 62 cases, February 17, 1926 to May 21, 1927.

they contain no spots. Large sunspot groups may also occur entirely outside these active areas, in which event the earthward presentation of such spots is less likely to be accompanied by changes in reception.

But as the active areas persist for a number of solar rotations (sometimes over a year) and are the most likely places for sunspot formations, we may still use sunspot area and position to derive

general relations despite their inadequacy in the individual case. It is the object of this paper to show that the central passage of sunspots does not exactly coincide with the associated reception disturbances, and that the interval between the transit of the sunspots and the reception change varies both with the area of the sunspot group and with the particular period taken for investigation.

In the first seven figures night reception, day reception, and terrestrial magnetism are compared with the central passage of sunspot maxima. The night reception is taken from my measurements at Newton Centre, Massachusetts, and Seabrook Beach, New Hampshire, of station WBBM at Chicago, the day reception

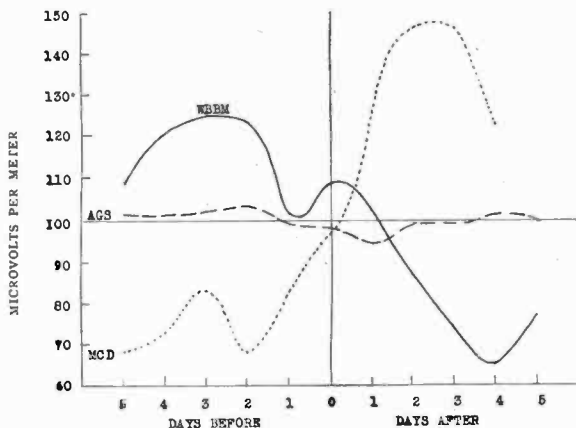

Figure 3—Reception and magnetism with maxima of 12 or more spots in central 13.3 deg. band. 26 cases May 13, 1926 to May 12, 1927.

is at Washington from AGS to Nauen, Germany, while the magnetic measure used is the Magnetic Character of Day Number given by the Observatory at Cheltenham, Maryland. The sunspots were counted in a central band 13.3 deg. wide, which is one day's travel in solar rotation.

In Fig. 1 is shown the relation between day and night reception, terrestrial magnetism and sunspot maxima of four or more spots, over the period February 17, 1927, to May 21, 1927. The ordinates represent percentage variation of the elements, and the graph covers an interval of eleven days. Night reception, shown in full-line, reaches a minimum about three days after the central passage of the spots, day reception an ill-defined minimum one day before, while magnetism, shown in dotted line, shows a maximum of disturbance between two and three days after.

A comparison of reception and magnetism over the same period, but with sunspot maxima limited to four to ten spots is shown in Fig. 2. Now both night and day reception show minima one or two days before, with a maximum of magnetic disturbance one day before.

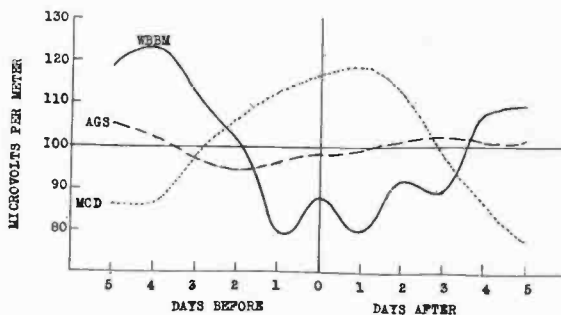

Figure 4—Reception and magnetism with maxima of 4 to 10 spots in central 13.3 deg. band. 26 cases, February 17, 1926 to October 4, 1926.

In Fig. 3 only the larger sunspot groups are taken, with spot numbers of twelve or more in the central band. The amplitude of the night reception and magnetic disturbance has now increased, with minimum and maximum values, respectively, four and three days after the passage of the spots, while day reception shows a slight depression one day after.

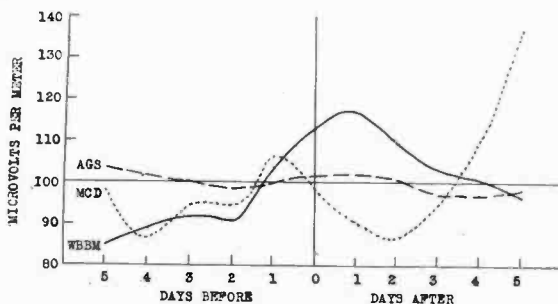

Figure 5—Reception and magnetism of 4 to 10 spots in central 13.3 deg. band. 36 cases, October 8, 1926 to May 21, 1927.

It would seem from these figures that the interval between sunspot transit and reception depression is related to sunspot area, much as if the smaller spot groups were on the western, and the larger spots on the eastern boundary of the active areas. But there is another factor to be considered, namely the period covered by the observations. In the preceding figures this has been approxi-

mately fifteen months; now this interval will be broken into two nearly equal parts. In Fig. 4 the interval is from February 17, 1926 to October 4, 1926, with sunspot maxima of four to ten. Night reception shows a depression centering one day after, magnetism a maximum one day after, and day reception a minimum two days before.

In Fig. 5 the period is October 8, 1926 to May 21, 1927, with sunspot maxima of four to ten. Although at first sight this figure is the inverse of the preceding one, the night reception maximum one day after the passage of the spots is not related to this particu-

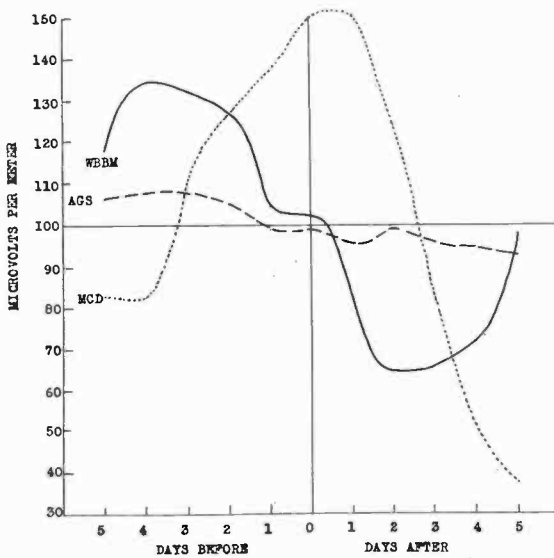

Figure 6—Reception and magnetism with maxima of 12 or more spots in central 13.3 deg. band. 8 cases, May 13, 1926 to September 19, 1926.

lar transit, but merely represents reception recovery from some preceding disturbance; actually what has happened is merely a considerable displacement in time. The inverse relation of magnetism and night reception is here the best guide to the true position of the reception minimum, which is more than five days after the spot transit. Apparently the smaller sunspot groups were quite near the center of the active areas during the first seven months, but in the second period they moved east by at least 65 deg.

The larger sunspot groups show a similar displacement, although to a lesser degree. In Fig. 6 reception and magnetism from May 13, 1926 to September 19, 1926, are compared with sunspot

maxima of twelve or more. Night reception shows a minimum two days after, and magnetism a maximum one day after. Fig. 7 is also for sunspot maxima of twelve or more, for the period of October 11, 1926 to May 12, 1927, and here the reception and magnetic elements show minimum and maximum values three and four days, respectively, after the transit of the spots; a displacement of about two days or 27 deg. to the east.

It is evident from the preceding figures that the relation of reception to magnetism is much more intimate than its connection

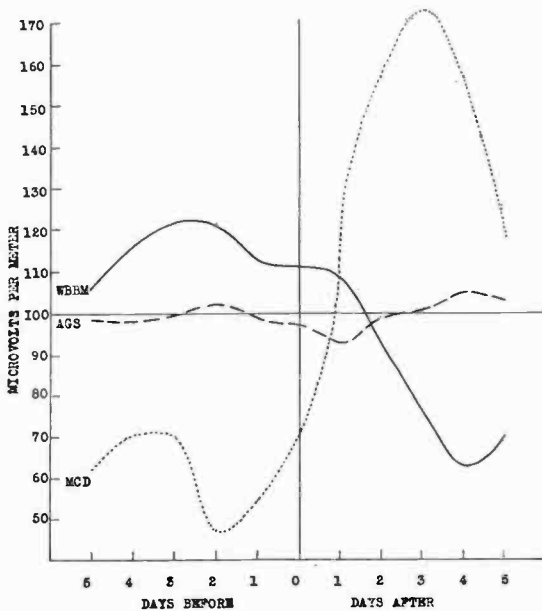

Figure 7—Reception and magnetism with maxima of 12 or more spots in central 13.3 deg. band. 18 cases, October 11, 1926 to May 12, 1927.

with sunspots. In Fig. 8 the magnetic storm is taken as the event, instead of sunspot transit. Within the nineteen months from January, 1926 to August, 1927, there were fourteen magnetic storms recorded by Cheltenham, and the depression of night reception accompanying these storms is very striking. Day reception shows an inverse effect, an increase of field accompanying and following the storm. The night reception maximum three days before is not in anticipation of the coming storm; it merely represents the recovery of reception from the depression associated with a preceding magnetic disturbance.

Although the most marked reception disturbances accompany magnetic storms, even a moderately disturbed day has its associated reception depression. In Fig. 9, which covers the period January 24 to June 12, 1927, all magnetically-disturbed days are taken, that is, all days with character number of 1 or 2. The night reception data are here an average of three transmission paths; WBBM at Washington and Newton Centre, and WJAX of Jack-

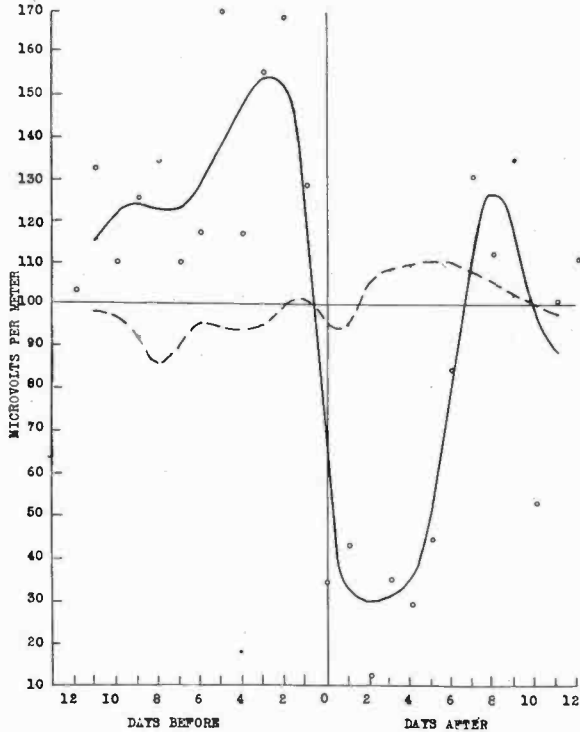

Figure 8—Reception from WBBM and WGN with magnetic storms observed at Cheltenham. 14 cases, January 26, 1926 to August 19, 1927. AGS day-reception in broken line.

sonville, Florida, at Washington. Over the first half of 1927 magnetic disturbances came at intervals of approximately fifteen days, so the reception maximum three days before represents the recovery of reception from the depression associated with a preceding magnetic disturbance, and the curve has a period of fifteen days.

On the 19th and 20th of August, 1927, there was a magnetic storm of considerable intensity, with displays of Northern Lights on both evenings visible throughout New England. In Fig. 10 I

have shown the reception depression associated with this storm, in which the field from WGN remained at a low value for a week.

Night reception over any extended period is largely a series of abrupt depressions followed by relatively slow recoveries. The recovery, at least during a sunspot maximum, is rarely completed before the next depression occurs, so that the mean field for, say,

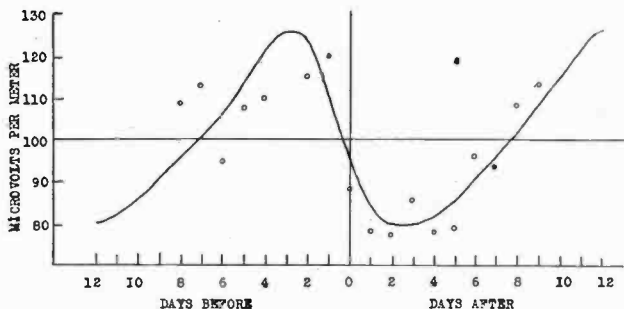

Figure 9—Mean reception from WBBM and WJAX at Washington and Newton Centre with maxima of magnetic disturbance at Cheltenham. 36 cases, January 24 to June 12, 1927.

a month, is largely determined by the interval between these abrupt depressions. If this interval is short, for example a week, the mean field will be low; if two or three quiescent weeks intervene the mean field will be high.

These depressions quite definitely accompany disturbances of terrestrial magnetism, and less definitely the central passage of

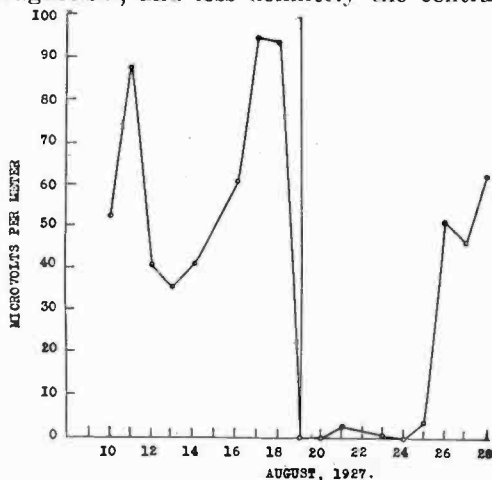

Figure 10—Night reception from WGN, Chicago, at Seabrook Beach, N. H., and the magnetic storm of August 19 and 20, 1927.

sunspot groups, but in neither case are we warranted in assuming that the connection is one of cause and effect. However, the relation of reception to terrestrial magnetism is so definite it is difficult to escape the conclusion that disturbances of these two elements arise from a common and nearby cause; an electrical change in our atmosphere. Any inexactness in this relation might be explained on the assumption that magnetic disturbances require an electrical movement, whereas reception is dependent upon the degree and disposition of ionisation.

I wish to acknowledge the cooperation of Mr. H. H. Clayton, who not only made a preliminary analysis of my reception data by the method which I have used herein, but also supplied from his own solar observations the central band sunspot numbers. I am also indebted to the U. S. Coast and Geodetic Survey for the Magnetic Character of Day Numbers from the Cheltenham Observatory.

ABBREVIATED METHOD FOR CALCULATING THE INDUCTANCE OF IRREGULAR PLANE POLYGONS OF ROUND WIRE

(Part I of paper, "On the Calculation of Closed Aerials")

By

V. J. BASHENOFF

(Chief of the Wireless Section of the State Electrical Research Institute, Moscow, Union
of Socialist Soviet Republics)

INTRODUCTION

There are many well-known theoretical and experimental papers dealing with the calculation of the inductance of coils and loops of small area and large number of turns. Such coils, arranged so as to allow for their rotation about a vertical axis, have been used for portable antennas and are suitable for installation in the interior of a building. The problem of the calculation of the constants of closed loops having a large area and a very small number of turns has, on the contrary, received until the present very little attention in radio journals or radio handbooks.

Such antennas, which often consist of a single turn of wire supported by a single mast, are of especial importance at present on account of the definite tendency, very evident in western Europe, at least, to adopt this type of antenna in preference to the smaller loops which have earlier been almost exclusively used. For example, there may be cited changes made in 1924 in the radio centrals of Paris and Berlin (Creisne and Geltow). These stations, which in the period 1920-23 employed small loops with an area of a turn of from 4 to 16 square meters, now make use of closed aerials with an area of several thousand square meters, hung from masts as high as 75 meters. The Marconi Wireless Telegraph and Telephone Company employs in all its radio receiving sets a radiogoniometer system consisting of two mutually-perpendicular triangular closed aerials of one or two turns, hung from masts which, in different cases, range from 12 to 75 meters in height.

Finally, the French Society, "S.F.R." in its 1926 model of universal direction-finder for wavelengths of from 100 to 3000 meters has come over to the use of a large loop of only four turns,

Original Manuscript received by the Institute, May 17, 1927.

Revised Manuscript received by the Institute, July 21, 1927.

in place of the small loops of a large number of turns which it used formerly.¹

The superiority, both from practical and scientific stand-points, of closed aerials of a few turns of great area, over loops of many turns of small area was established, as far back as 1915, by the author of the present paper, as a result of an experimental and theoretical study of radio reception with (a) coils with areas of a single turn up to 20 square meters, and (b) closed aerials with areas of some thousands of square meters, supported by a single mast.

This principle² has been embodied in the design of some dozens of radio stations installed since that time under the direction of the author. As an example may be mentioned the construction in 1920-4 of the radio station of Lubertzy³ which was the main receiving station of the Radio Central of Moscow.

In all the radio stations built by the author the closed aerial is hung from a single mast, a construction dictated by economical and practical considerations. As to the shape of such aerials a triangular form would give the greatest area, but in practice to reduce the effective resistance and capacity it is necessary to cut off the lower corners of the triangle.⁴

For purposes of approximate calculation we may seek to replace the irregular polygons, formed by such closed aerials, by a simpler equivalent plane figure of either equal area or equal perimeter. Of such figures it is obvious that a triangle most closely approximates the given contour. Exceptions would be offered by closed

¹ This coincides with the conclusion expressed by the Radio Research Board, Department of Scientific and Industrial Research, U. K., Special Report, No. 1, 1923, that a single-turn loop is the theoretical ideal for a direction finder.

² The comparison of the reception on closed and frame aerials will be treated in a later paper. On this account a simple note will suffice for the present to show the theoretical advantage of the closed aerial of large area and few turns over the coil of small area and many turns. The product S_n which occurs in the expression for the effective height of a frame aerial may be obtained for a given length l of wire, either with a single turn aerial or by using a frame of n turns. Let us suppose, for simplicity, that in both cases enclose a square area. Then for a closed aerial of a single turn the length of a turn is $\frac{l}{4}$ and the area $s = \frac{l^2}{16}$. For the frame antenna of n turns the length of a side is $\frac{l}{4n}$ and the area $s_n = n$ times the area of a single turn, or $\frac{l^2}{16n}$. Thus the effective height is diminished in proportion as the number of turns is increased.

³ German Patents, No. 420450, Oct. 26, 1925 and No. 430695, June 18, 1926.

⁴ Telefunken Patent D. R. P. No. 317880, and the author's patent D. R. P. No. 420450.

aerials suspended from a single point and having circular, rectangular or square shapes. The first two cases are not met in practice, and the last, patented by the Telefunken Co. in a small frame aerial, offers no advantages over the truncated triangular shape.

Because, then, of the predominant importance of the triangular shape, the author and his collaborators have, as will be seen later, investigated especially the problem of the calculation of the constants of triangular antennas. The following is an attempt to indicate methods for the calculation of the inductance of closed aerials. The accuracy of the theoretical analysis is confirmed by experimental data obtained by the author over a period of ten years.

Calculation of the Inductance—Single Turn Closed Aerial

A. SPECIAL FORMULAS FOR VARIOUS FIGURES

The following formulas for several of the geometrical figures are well-known. All the formulas are based on: (1) Circular section of wire with radius r . (2) Wire-material having $\mu = 1$ —unless some other value is specified. (3) Napierian logarithms.

1. Circle

The formula giving the greatest accuracy (for direct and low-frequency currents) is, with a —radius of the circle,

$$L = 4\pi a \left[\left(I + \frac{r^2}{8a^2} \right) \log \frac{8a}{r} + \frac{r^2}{24a^2} - 1.75 \right] \quad (1)$$

(Rayleigh and Niven)

Approximate formulas, generally used in practice: (a) for low frequencies

$$L = 4\pi a \left(\log \frac{8a}{r} - 1.75 \right) \quad (2)$$

(Kirchoff)

(b) for high frequencies

$$L = 4\pi a \left(\log \frac{8a}{r} - 2 \right) \quad (3)$$

(c) general formula—for any frequency

$$L = 4\pi a \left(\log \frac{8a}{r} - 2 + \mu \delta \right) \quad (4)$$

(Bureau of Standards)

in which δ —one of the correction factors for frequency is determined as a function of x (see Fig. 1)—which in turn is expressed by

$$x = 0.281 \cdot r \sqrt{\frac{\mu \cdot f}{\rho}} \tag{5}$$

In this formula: a —radius of circle; f —frequency; r —radius of wire in centimeters; μ —magnetic permeability ($\mu=1$ for all

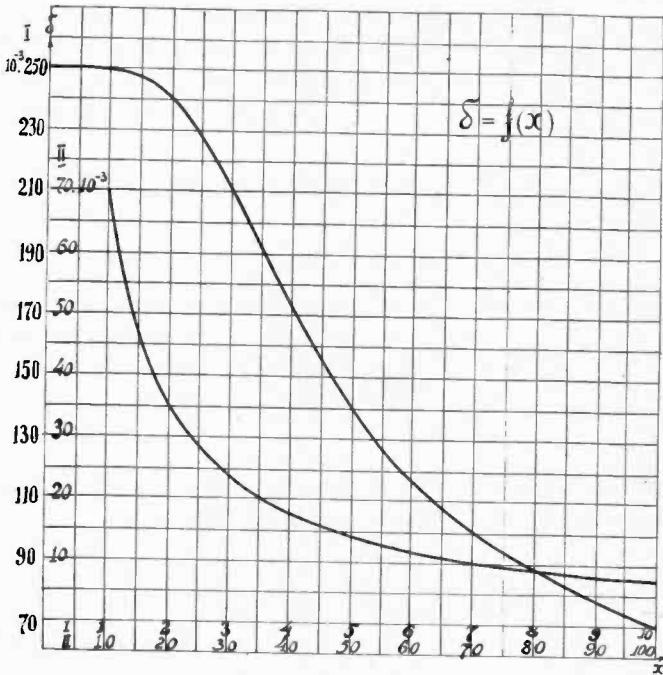

Figure 1

wires except ferromagnetics); ρ —specific resistance of wire in microhms/cm³.

2. Square

$$L = 8a \left(\log \frac{a}{r} + \frac{r}{a} - 0.774 + \mu \delta \right) \tag{6}$$

(Kirchoff)

in which a is the side of the square.

Another approximate formula is

$$L = a \cdot \gamma \tag{7}$$

(Esau)

in which γ is a function of $\frac{a}{r}$ and is obtained from Fig. 2.

3. Equilateral Triangle

The formula is:

$$L = 6a \left(\log \frac{a}{r} - 1.55465 + \frac{r}{a} 1/4 \frac{r^2}{a^2} + \dots \right) \quad (8)$$

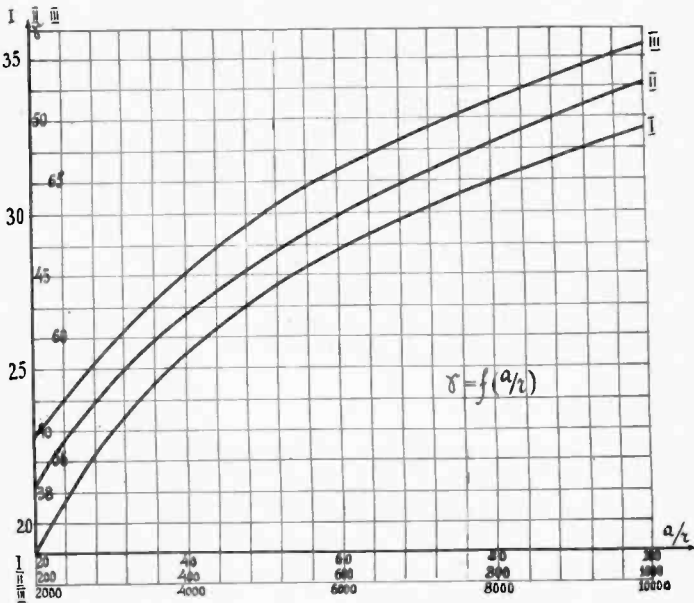

Figure 2

for direct current (low frequencies) (Grover).⁵

$$L = 6a \left(\log \frac{a}{r} - 1.405465 + \mu \delta \right) \dots \quad (8a)$$

for radio frequencies.

4. Regular Hexagon

The formula is

$$L = 12a \left(\log \frac{a}{r} + 0.098476 + \frac{r}{a} - 1/4 \frac{r^2}{a^2} + \dots \right) \quad (9)$$

⁵ The formulas (8), (9), and (10) were found by Grover in deriving a formula for calculating the inductance of polygonal coils, *Sci. Paper 463*, Bureau of Standards.

for direct current (low frequencies) (Grover)⁵

$$L = 12a \left(\log \frac{a}{r} - 0.151524 + \mu\delta \right) \dots \quad (9a)$$

for radio frequencies.

5. Regular Octagon

The formula is

$$L = 16a \left(\log \frac{a}{r} + 0.461976 + \frac{r}{a} - 1/4 \frac{r^2}{a^2} + \dots \right) \quad (10)$$

for direct current (low frequencies) (Grover)⁵

$$L = 16a \left(\log \frac{a}{r} + 0.211976 + \mu\delta \right) \quad (10a)$$

for radio frequencies.

6. Rectangle

$$L = 4 \left[(a+b) \log \frac{2ab}{r} - a \log (a+d) - b \log (b+d) \right] + 4 [\mu\delta(a+b) + 2(d+r) - 2(a+b)] \quad (11)$$

in which a and b are the sides of the rectangle and d its diagonal.

7. Triangle

(a) *Right triangle.*

The following formula gives a degree of accuracy amply sufficient for all practical purposes.

$$L = a \left[\frac{a}{c} \log \frac{a(c-a)}{b(c+b)} + \log \frac{4a^2b^2}{r^2(c+a)^2} \right] + b \left[\frac{b}{c} \log \frac{b(c-b)}{a(c+a)} + \log \frac{4a^2b^2}{r^2(c+b)^2} \right] + c \left[\log \frac{a^2b^2c^2}{r^2(a^2+c^2)(b^2+c^2)} - 2 \right] \quad (12)$$

(Bashenoff)⁶

(b) *Equal-leg right triangle.*

This formula is easily derived (see below)

$$L = 2l \left[\log \frac{2l}{r} - 3.331 \right] \quad (13)$$

in which l is the perimeter of the triangle.

⁶ For the derivation of formula (12) see *Jahrb. draht. Tel.* 1926, vol. 27, no. 4 and "Transactions of the State Electrical Research Institute" (Moscow) publ. 14.

8. *Quadrilateral (trapezium)*

Of definite shape (Fig. 3).

$$L = 2l \left[\log \frac{2l}{r} - 3.227 + \mu\delta \right] \tag{14}$$

(Starik).⁷

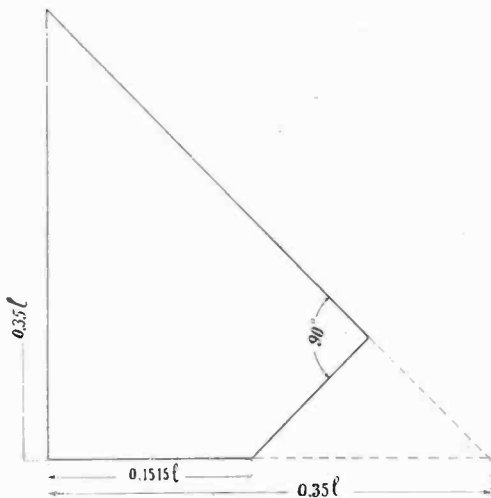

Figure 3

**B. GENERAL FORMULA FOR A PLANE POLYGONAL FIGURE
HAVING NO REENTRANT ANGLES, INCLUDING
OBLIQUE-ANGLED TRIANGLES**

1st Method

The approximate method of computing the inductance of such polygonal figures is based on the author's assumption,⁶ that the inductance of an oblique-angled triangle or another plane figure must, practically, be very nearly equal to the inductance of a right triangle, having perimeter and area equal to those of the given plane figure.

Indeed, in selecting an equivalent simple figure whose inductance shall approximate that of the actual (more complicated) figure, the most important condition to be satisfied is that of *equal perimeter*. This insures that the sum of the *self* inductances of the various wires of which the figure is composed shall be nearly the same both in the actual and the equivalent figures.

⁷ Formula (14) was derived by Mr. Starik, by summation of the self and mutual inductances of all the elements, using the well-known formula given below.

The total inductance of the figure is *less* than the sum of the self inductances of the separate elements, being reduced by the mutual inductances between certain of the different sides of the figure. The mutual inductance of any pair of filaments is greater, the nearer the wires are together, and the more closely parallel they are. Thus, the mutual effects will be approximately taken into account by imposing the further condition that the areas of the actual and the equivalent figures shall be the same. Since, however, in most practical cases the sum of the mutual inductances amount to considerably less than half the value of the sum of the self inductances of the wires, this second condition is not so

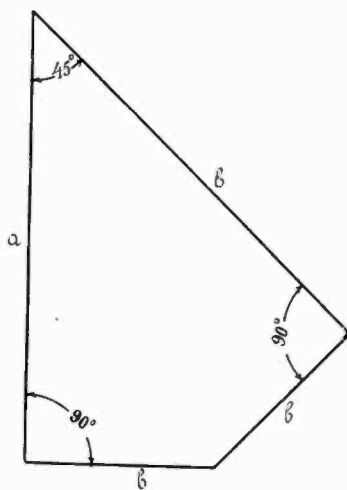

Figure 3a

important as that of equal perimeter. In those cases where both conditions cannot be simultaneously satisfied, that of equal perimeter should be chosen, and the area of the equivalent figure should be taken as nearly equal to that of the actual figure as possible. This amounts to imposing the condition that the right triangle of equal *perimeter* shall have equal legs.

With this assumption formula (12) may be used, substituting for a , b , and c the values found in replacing the given figure by a right triangle of equal perimeter and area; the sides a and b of the right angle of this equivalent right triangle are expressed by

$$a = \frac{8S}{\left(l + \frac{4S}{l}\right) \pm \sqrt{\left(l + \frac{4S}{l}\right)^2 - 32S}} \quad (15)$$

and

$$b = \frac{1}{4} \left[\left(l + \frac{4S}{l} \right) \pm \sqrt{\left(l + \frac{4S}{l} \right)^2 - 32S} \right] \quad (16)$$

in which S is the area and l the perimeter of the figure.

This replacement is possible only for figures for which there exists between l and S the following relation

$$\frac{l}{\sqrt{S}} \geq 4.8284 \quad (17)$$

If the perimeter l and the area S of the figure satisfy the expression

$$\frac{l}{\sqrt{S}} < 4.8284 \quad (18)$$

it is necessary to resort to a roughly approximate method of calculation, using formula (14), in which a is one of the legs of the equal-leg right triangle which has a perimeter equal to that of the given plane figure.

Such a triangle always exists and its sides are determined by the following formulas:

$$a = b = \frac{l}{2 + \sqrt{2}}; \quad c = \frac{l}{1 + \sqrt{2}} \quad (19)$$

This approximation method (formulas (18) and (19)) gives generally a lower value than the measured value by 5 to 20 per cent. In general, the more the ratio l/\sqrt{s} for a given figure falls short of 4.8284 the more the calculated value of l exceeds its true value.

Dr. Grover has suggested to me the possibility of extending the range of values of the ratio l/\sqrt{s} for which an equivalent figure may be found. If, instead of a triangle, a rectangle be sought which shall be equivalent to the given figure, it is found that the conditions of equal area and perimeter may be satisfied, provided that the ratio l/\sqrt{s} is not less than 4. Thus for values of l/\sqrt{s} between 4 and 4.8284 more accurate values of the inductance are obtained if a rectangle of equal perimeter and equal area be used as the equivalent figure, than when an equal-leg right-angled triangle of equal perimeter is employed. For values of $l/\sqrt{s} \geq 4.8284$ the use of the equivalent right triangle is to be recommended.

As an illustration of these points Dr. Grover has communicated to me a calculation of the inductance of one of the antenna forms described in one of my former papers,⁷ viz., one of the Lübertzy

closed aerials, shown in Fig. 4, for which the perimeter is 370.9 meters and the area is 6658.5 square meters.

The accurate value of the inductance was obtained by summation of the self inductances of the different elements (using the well-known formula for the self inductance of a straight wire) and the mutual inductances of the various pairs of filaments. These mutual inductances can be calculated by the general formulas of Martens⁸ or Campbell.⁹ The calculations were not difficult but rather long and tedious on account of the number of mutual inductances to be calculated. The value found (not including internal linkages) is 720140.

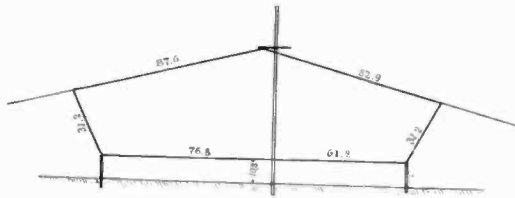

Figure 4

The following table shows the values obtained from the different approximations.

TABLE I

	l	$\frac{l}{\sqrt{s}}$	a	b	c
True Value	720140	4.546			
Equivalent Rectangle	722040	4.546	136.76	48.68	
Equilateral Triangle	714050	4.559	123.63		
Equal-Leg Right Triangle	704200	4.828	108.64	108.64	153.6
Regular Hexagon	755455	3.722	61.83		

The rectangle is the only figure for which both the perimeter and the area can be made equal to those of the given figure, although the equilateral triangle of the same perimeter has nearly the correct area in this case. The area of the equal-leg right triangle of the given perimeter is considerably smaller than that of the given figure, and a too small inductance is to be expected. The regular hexagon of equal perimeter has an area considerably too large, and thus an inductance too large is to be expected. We see that these differences are in the opposite direction to the values of the ratio l/\sqrt{s} . For this example the equivalent rectangle gives an approximation which is amply sufficient.

⁸ Martens *Ann. der Phys.*, 29, 963; 1909.

⁹ Campbell, *Phys. Rev.*, June 1915.

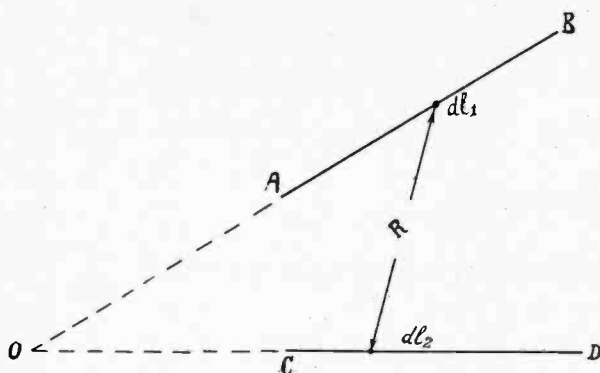

Figure 5

2nd Method

The following formula is taken as a basis for solving the problem

$$L = \sum_{i=1}^{i=n} L_i + \sum_{i=1}^{k=n} \sum_{k=1}^{k=n} M_{ik} \quad (20)$$

in which L_i is the coefficient of self-induction for one of the sides of the polygon; M_{ik} —coefficient of mutual induction between sides (i, k) of the same polygon.

As is well known, for a straight wire (using the same symbols)

$$L = 2l \left[\log \frac{2l}{r} - 1 + \mu \delta \right] \quad (\text{Neumann})$$

As to M_{ik} for parallel wires, the distance between which is d

$$M = 2 \left[l \cdot \log \frac{l + \sqrt{l^2 + d^2}}{d} - \sqrt{l^2 + d^2} + d \right] \quad (22)$$

If l is large as compared with d

$$M = 2l \left[\log \frac{2l}{d} + \frac{d}{l} - 1 \right] \quad (23)$$

For wires l_1 and l_2 , intersecting at an angle e

$$M = \int_{l_1} \int_{l_2} \frac{dl_1 dl_2}{R} \cos e \quad (24)$$

in which formula dl_1 and dl_2 are elements of the wires l_1 and l_2 , and R —the distance between dl_1 and dl_2 .

Lastly, if the wires do not intersect (see Fig. 5)

$$M_{AB} = M_{OB} - M_{OD} + M_{OC} - M_{OC} \quad (25)$$

Integrating (24),

$$M = -\cos e \left\{ (a+b) \operatorname{arc} \sin h\beta + a \cdot \operatorname{arc} \sin h \frac{C - a \cos e}{a \sin e} \right. \\ \left. + b \operatorname{arc} \sin h \frac{a - b \cos e}{b \sin e} \right\} \quad (26)$$

(Starik)

or, substituting $m = \frac{b}{a}$; $\beta = \cotan e$.

$$M = -a \cos e \left\{ (1+m) \operatorname{arc} \sin R\beta + \operatorname{arc} \sin h \frac{m - \cos e}{\sin e} \right. \\ \left. + m \operatorname{arc} \sin h \frac{1 - m \cos e}{m \sin e} \right\} = -a \cdot \cos e \cdot f(m, e) \quad (27)$$

(Starik).¹⁰

It follows that M is equal to the length of one of the sides multiplied by a certain function of the ratio of the sides and the angle between them. By plotting this function the computation of the coefficient of mutual induction of each pair of intersecting wires is greatly simplified.

The calculation of the inductance of a plane polygonal figure may thus be made by formula (20) by calculating the self-inductance of the straight wires by (21) and the mutual inductances between them by formulas (22–27).

The calculation of L for a polygonal figure by the above method is rather long, as it requires a number of preliminary calculations. The author and one of his pupils, Mr. Starik, propose the following practical approximate method of computing the inductance.

The first term in the right side of the expression (20) takes into account the self-inductances of the sides of the polygon. We suppose the sum of these terms to be a function of l and l/r only and that they can be expressed as the self-inductance of a straight wire having the same radius of section and a length equal to the

¹⁰ For the same solution, but in another form, see Mesny: "L'Usage des Cadres et la Radiogoniometrie."

perimeter of the figure. Then, the first term in the right side of the expression (20) can be written¹¹ as:

$$\Sigma L_i = 2l \left(\log \frac{2l}{r} - 1 + \mu\delta \right) \tag{28}$$

in which, as before, $\mu\delta$ is a correction for frequency. It follows that for a given frequency and wire material

$$\Sigma L_i = f \left(\frac{l}{r} \right) \tag{29}$$

The second term in (20), expressed in its most general form (27) is

$$\Sigma M_{ik} = \Sigma a_{ik} f(\epsilon_{ik}, m_{ik}) = 2ly \tag{30}$$

in which y for a given shape (i.e., for all similar figures having the same ϵ_{ik} and $M_{ik} = ai/ak$) is a constant.

For any plane polygonal figure in general we have, accordingly,

$$L = 2l \left(\log \frac{2l}{r} - 1 + \mu\delta + y \right) = 2l \left(\log \frac{2l}{r} - a_k + \mu\delta \right) \tag{31}$$

in which a_k for a figure of given shape (definite ϵ_k and $m_{ik} = ai/ak$) is a constant.

Between two figures of equal perimeter and equal radius of wire according to (31) there can exist, at the same frequency f , only a difference in the parameter a_k . The value of the parameter a_k in its turn, as follows from the proposition set down above, must be the same for all figures with equal l/\sqrt{s} when their

¹¹ The formula (28) is, of course, approximate, since it does not represent accurately the sum of the inductances of the sides. For example, for a triangle of sides a, b, c , the expression for the sum of the self inductances of the sides:

$$L_a + L_b + L_c = 2a \left(\log \frac{2a}{r} - 1 + \mu\delta \right) + 2b \left(\log \frac{2b}{r} - 1 + \mu\delta \right) + 2c \left(\log \frac{2c}{r} - 1 + \mu\delta \right) \tag{28a}$$

is not the same as $2l \left(\log \frac{2l}{r} - 1 + \mu\delta \right)$, where $l = a + b + c$. The quantity

$2l \left(\log \frac{2l}{r} - 1 + \mu\delta \right)$ is the self inductance of a straight round wire of length l and this is accurately equal to

$$L_a + L_b + L_c + 2M_{a,b} + 2M_{a,c} + 2M_{b,c} \tag{28b}$$

in which the elements a, b, c all lie in the same straight line.

However, the equation (31) below is of the correct form to represent the inductance of any plane polygonal figure, if only the value of a_k can be properly (experimentally) determined.

perimeters are equal, i.e., the parameter a_k is a function of this ratio only.

C. VERIFICATION OF THE PRINCIPLES OF SECTION B

Let us verify the validity of the principles stated in Section B by applying them to the special formulas given in section A. It must be noted to begin with that the assumptions made above limit the accuracy obtainable in applying the general formula (31); the aim of the latter is, however, to obtain approximate values having a sufficient degree of accuracy in practice for calculating closed aerials.

In closed aerials r/a is always small as compared to $\log a/r$; r (radius of the wire) very rarely exceeds 0.25 cm.; a (radius of the circle, side of the regular polygon, leg of equal-leg right triangle etc.) is, on the contrary, never less than 100 cm. The value of r/a is consequently always less than 0.0025, and may be certainly regarded as negligible in comparison with $\log a/r$ (which, under limitations just specified, is always >5.99). The corresponding difference of value does not exceed 0.4 per cent. We may certainly with still more right neglect the second and higher powers of the ratio r/a .

The special formulas of Section A, omitting the terms of the order of r/a , can be written as follows:

1. Circle

$$L = 2l \left\{ \log \frac{2l}{r} - 2.451 + \mu\delta \right\} \quad (32)$$

2. Square

$$L = 2l \left\{ \log \frac{2l}{r} - 2.853 + \mu\delta \right\} \quad (33)$$

3. Equilateral triangle

$$L = 2l \left\{ \log \frac{2l}{r} - 3.197 + \mu\delta \right\} \quad (34)$$

4. Regular hexagon

$$L = 2l \left\{ \log \frac{2l}{r} - 2.636 + \mu\delta \right\} \quad (35)$$

5. Regular octagon

$$L = 2l \left\{ \log \frac{2l}{r} - 2.5610 + \mu\delta \right\} \quad (36)$$

6. Polygon of the type shown in Fig. 3

$$L = 2l \left\{ \log \frac{2l}{r} - 3.227 + \mu\delta \right\} \tag{14}$$

7. Equal-leg right triangle

$$L = 2l \left\{ \log \frac{2l}{r} - 3.332 + \mu\delta \right\} \tag{37}$$

8. Regular pentagon (a new formula derived by Dr. Grover) with $l/\sqrt{s} = 3.812$

$$L = 2l \left(\log \frac{2l}{Z} - 2.712 + \mu\delta \right) \tag{37a}$$

9. Quadrilateral of the type shown in Fig. 3a ($a = (\sqrt{2}/4)$, $l = 0.35355l$; $b = (2 - \sqrt{2})/4$, $l = 0.14645l$) (derived by Dr. Grover)

$$L = 2l \left(\log \frac{2l}{r} - 3.091 + \mu\delta \right) \tag{37b}$$

Using formulas (32-37), we can draw the curve $a_k = f\left(\frac{l}{\sqrt{s}}\right)$ in which $a_k = 1 - y$, by plotting the points for the above nine figures, for which the value of the ratio $\frac{l}{\sqrt{s}}$ is well-known.

The curve Fig. 6 was obtained in this manner. Further details of its construction are given below in Section D. From the curve, a_k can be read with sufficient approximation for a given ratio l/\sqrt{s} and by using the value thus found in formula (31) the inductance can be calculated.

As to the quantity $\mu\delta$ found by means of a curve (Fig. 1) in which it is given as a function of x , the expression (5) in the case, most often met with, of a copper wire at 20 deg. C, goes over into

$$x = 0.2142r\sqrt{f} \tag{38}$$

This expression can be plotted in a nomogram (an abac) which makes practical calculations easier.

In practical calculations of closed aerials, constructed nearly always of non-magnetic metals $\mu = 1$. The wire being of comparatively large section ($d \geq 0.2$ cm.), $x = 0.2142r\sqrt{f}$ (for copper at 20 deg. C) gives numerical values of 23 and more, even when $\lambda = 25000$ m ($f = 12000$). Consequently δ and $\mu\delta$ (at $\mu = 1$) in Fig. 1 have values of about 0.03 or less. In closed aerials $\log 2l/r$

has nearly always a larger value than 6 so that it follows that we can neglect $\mu\delta$ in wireless practice with a degree of accuracy never below a fraction of one per cent, provided we are interested in knowing the inductance for radio frequencies only. Thus the formula for the inductance of any plane figure at radio-frequencies is finally expressed by

$$L \cong 2l \left(\log \frac{2l}{r} - a_k \right) \quad (39)$$

in which l is the perimeter and a_k is a function of only l/\sqrt{s} and is taken from the curve in Fig. 6.

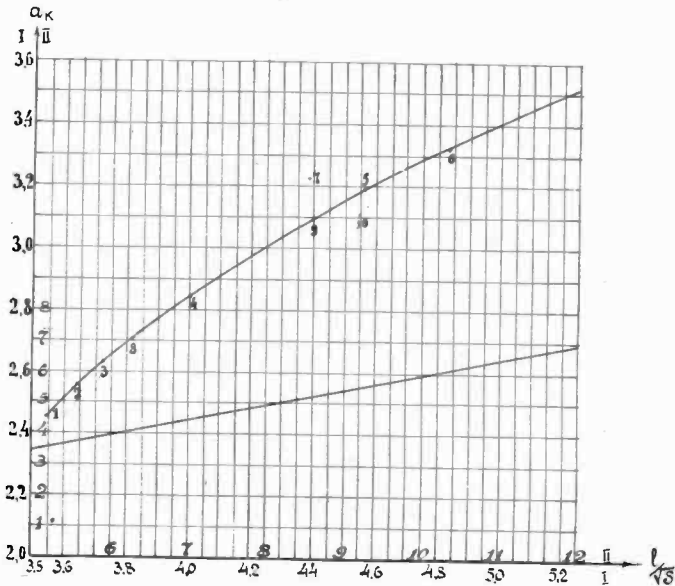

Figure 6

It is clear from formula (31), that the total change in the value of the inductance of a figure depends upon the value of ratio-perimeter to radius of cross section and value of $\mu\delta$; e.g., for a wire of a length 50 times that of its radius, the inductance is diminished only 6 per cent when the frequency changes from zero to infinity; for a wire with the ratio $l/r = 200000$ when the frequency change in the same limits, ΔL , is only 2 per cent.

The above formulas cover the calculation of all practical types of single-turn closed aeriels. It should be noted, however, that figures having sharply reëntrant angles cannot be so calculated. This can be seen from Table II, which gives the measured values

of the inductance found for certain irregular figures having reentrant angles, together with values of the inductance calculated by formula (35) and curve 6.

TABLE II

Figure (see Fig. 7)	Perimeter		$\frac{l}{\sqrt{s}}$	L measured	L calc. from (35) and curve (6)	ΔL in per cent
	of figure cm	Area cm ²				
1	2314	186000	5.43	43000	35090	-18.04
2	4000	454500	5.93	62500	60975	-2.44
3	4106	304500	7.54	59000	56925	-3.52
4	4332	154500	11.03	37500	43945	+23.6
5	4332	454500	6.42	64500	64650	+0.23

NOTE: For all figures $r=0.1$ cm, $\mu=1$.

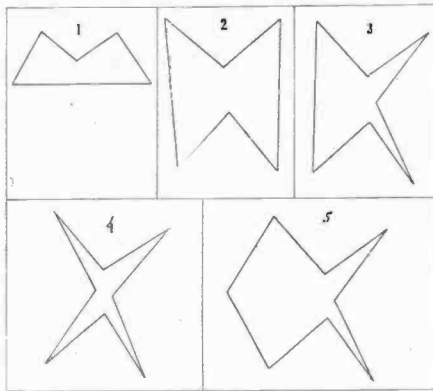

Figure 7

D. FINAL CONCLUSIONS ON THE CALCULATION OF THE INDUCTANCE OF SINGLE-TURN CLOSED AERIALS

Of the two methods of calculation proposed in Section B, the second is, naturally, to be preferred as the more simple. It gives in general the same degree of accuracy as the first. Thus, the general formula for the calculation of the inductance of single-turn closed aerials and, in general, plane figures having no reentrant angles, the value of r/l being small, will be taken as

$$L = 2l \left(\log \frac{2l}{r} - a_k + \mu\delta \right) \tag{31}$$

in which l is the perimeter of the figure r , radius of the wire; μ , magnetic permeability of the wire material; δ , a correction factor for frequency, determined in turn by formula (5) and the curve in Fig. 1; a_k , a constant, being a function of l/\sqrt{s} and taken

TABLE III

Point number	Type of figure	$\frac{l}{\sqrt{s}}$	a_k	Source
1	Circle	3.545	2.451	Formulas (4) and (32)
2	Regular octagon	3.641	2.561	Formulas (10a) and (36)
3	Regular hexagon	3.722	2.636	Formulas (9a) and (35)
4	Square	4.000	2.853	Formulas (6) and (33)
5	Equilateral triangle	4.559	3.197	Formulas (8a) and (34)
6	Equal-leg right triangle	4.828	3.331	Formulas (13) and (37)
7	Quadrilateral Fig. 3.	4.38	3.227	Formula (14)
8	Regular pentagon	3.812	2.712	Formula (37a)
9	Quadrilateral of Fig. 3a	4.395	3.091	Formula (37b)
10	Irregular pentagon Fig. 4	4.546	3.116	Exact solution for L taken with (31) to solve for a_k

from the curve in Fig. 6. The plotting of this curve becomes accordingly a matter of special interest.

The above pairs of values of a_k and l/\sqrt{s} were used. The points are indicated in Fig. 6 by the same numbers as those here given.

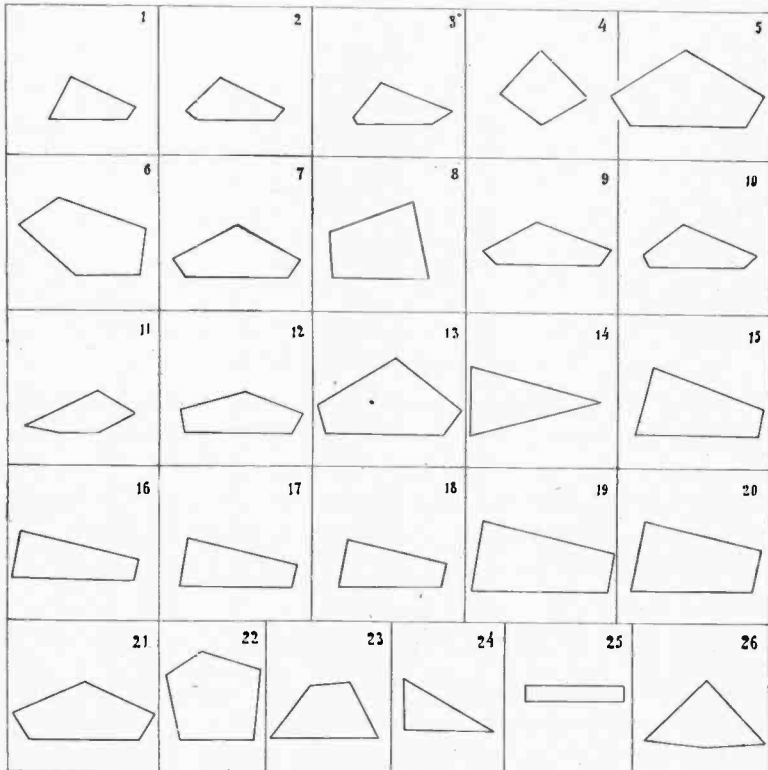

Figure 8

Fig. 6 shows the curve plotted by the above method. The values of a_k for this curve up to $\frac{l}{\sqrt{s}}=4$ coincide completely with the theoretical values; further, up to $\frac{l}{\sqrt{s}}=4.828$ the curve is drawn through points giving sufficiently accurate values (better than 1 per cent). The part of this curve beyond the abscissa value $\frac{l}{\sqrt{s}}=4.8284$ is plotted by extrapolation, and is, of course, only a rough approximation. Table IV shows the results of a comparison and measured values¹² of the inductance for many antennas, the sizes and shapes of which are shown in Fig. 8.

TABLE IV

Closed aeri-als	Per-imeter	Area	$\frac{l}{\sqrt{s}}$	Radius of Wire	L		ΔL per cent	
					measur.	calcul.		
1								
2	Warsaw	285	3705	4.68	0.2	552000	546950	-0.92
3	Nauen	310	4373	4.68	0.2	606000	605800	-0.03
4	San-Paolo	315	4315	4.794	0.2	609000	604610	-0.72
5	Paris I	160	1593	1.00	0.2	307700	300160	-2.45
6	The closed aeri-als of Lübertz's radio receiving station near Moscow (Types 1920-1924)	275	4525	4.03	0.2	565000	542620	-3.96
7	Tashkend I	304	4816	4.38	0.2	598000	594440	-0.6
8	S. E.	335	5736	4.42	0.2	685000	670430	-1.56
9	Carnarvon I	220	2794	4.17	0.2	445000	421650	-5.25
10	Carnarvon II	375	5868	4.89	0.2	753000	729525	-3.12
11	Paris II	370	5038	5.2	0.2	740000	703300	-4.32
12	Tashkend II	350	5005	4.95	0.2	695000	673960	-3.02
13	America West	385	6234	4.87	0.2	785000	751675	-4.24
14	The isosceles triangle	330	4352	5.00	0.2	666000	630300	-5.35
15	The irregular quadrilateral	45.2	85	4.9	0.2	81000	75025	-7.37
16	The irregular quadrilateral	44.9	101	4.46	0.2	76500	76435	-0.085
17	The irregular quadrilateral	61.4	158	4.88	0.2	104000	105790	+1.72
18	The irregular quadrilateral	57.85	152	4.69	0.2	100000	106025	+0.02
19	The irregular quadrilateral	54.3	141	4.57	0.2	95000	93865	-1.19
20	The irregular quadrilateral	50.7	135	4.365	0.2	89000	88105	-1.00
21	The irregular quadrilateral	47.2	122	4.275	0.2	83000	81815	-1.43
22	The irregular pentagon	145	1175	4.23	0.2	275000	284750	-3.51
23	The irregular pentagon	52.12	187	3.81	0.2	98000	94775	-3.29
24	The irregular quadrilateral	45.94	115	4.28	0.2	75100	79385	+5.7
25	The right triangle	15.92	9.86	5.07	0.04	25500	25820	+1.25
26	The rectangle	70	150	5.71	0.1	121500	116970	-3.73
27	The Marconi d. f. aerial	97.5	330	5.37	0.1	164000	172535	+5.2

ΔL_m per cent = mean value for 26 examples = -1.39 per cent

The fact that on the average the calculated value of the inductance is smaller than the measured value in the above instances is probably to be attributed to the fact that the measured values include the inductance of the lead wires from the measuring apparatus to the aerial. This could readily account for the difference above.

¹² All measurements of inductance were made with a Siemens and Halske low-frequency bridge using standard coils of 10^5 , 10^6 , and 10^7 cm. by the same firm. The mean accuracy of the measurements was about 0.5 per cent for inside work and about one percent for outside work. Calculations were generally made with a 25 cm. slide-rule.

LIMITS OF APPLICABILITY OF FORMULA (31)

The one approximation¹³ used in deriving the expression (31) was the neglecting of terms of the order of r/l (first and higher powers), which are small in comparison with the main terms. It is just these quantities by which the formulas (1, 6, 8, 9, 10) and those forming a basis for deriving formula (31), i.e., formulas (32, 33, 34, 35, 36) differ. It follows that the limits of applicability of formula (31) are determined by the relative importance of values of the order of r/l and the remaining terms in the parenthesis of formula (31). Formulas (6, 8, 9, 10) for regular polygons differ from the approximate formulas (33, 34, 35, 36) in that to the expression for the inductance deduced from the fundamental formulas on which is based our curve (6), the quantity $2nr$ is to be added (in this, n is the number of sides of the polygon). In analogy to the square, formulas (6) and (33), it may be supposed that the accurate formulas should contain, in the factor in brackets, a term of the order of r/l , if we did not neglect quantities of the order of r/l to simplify the integration. This quantity must, similarly, figure in formula (31). The value of this correction for a figure of any shape remains as yet undetermined. For *regular figures* formula (31) may be probably made a closer approximation

by introducing into the brackets the term $r \cdot \frac{n}{l}$. Then the

¹³ Dr. Grover has been so kind as to check more in detail the assumption on which the derivation of formula (31) has been based, that the value of a_k is a function of $\frac{l}{\sqrt{s}}$ only. As a result of his analysis he has pointed out that in general the values of a_k given by the curve of Fig. 6 are only approximations and that the constant a_k although a function of $\frac{l}{\sqrt{s}}$ in every case is also dependent upon the type of polygon in question; that is, a_k is not the same for different types of figure, even though they have the same value of $\frac{l}{\sqrt{s}}$. Dr. Grover has plotted a_k as a function of $\frac{l}{\sqrt{s}}$ for triangles different types. The points all lie on the same curve, which is the same as that determined by points 5 and 6 in Figure 6. The curve calculated for rectangles, on the contrary, leaves this curve at the point 4, and runs below it, diverging gradually for greater values of $\frac{l}{\sqrt{s}}$.

In conclusion, however, Dr. Grover believes that the second method of calculating the inductance (formula 31) is capable of giving numerical values with an error not greater than a few per cent and because of its convenience is to be recommended as a valuable simplification for routine calculations of the inductance of irregular plane polygons of round wire.

formula for all regular figures will read:

$$L = 2l \left(\log \frac{2l}{r} - a_k + \mu\delta + r \frac{n}{l} \right) \tag{31a}$$

Taking the square as an example, the limits of applicability of formula (31) have been found, as well as the error resulting in using formula (31) instead of the exact formula (16) for the square. For various l/r ratios a correction in per cent is obtained (see

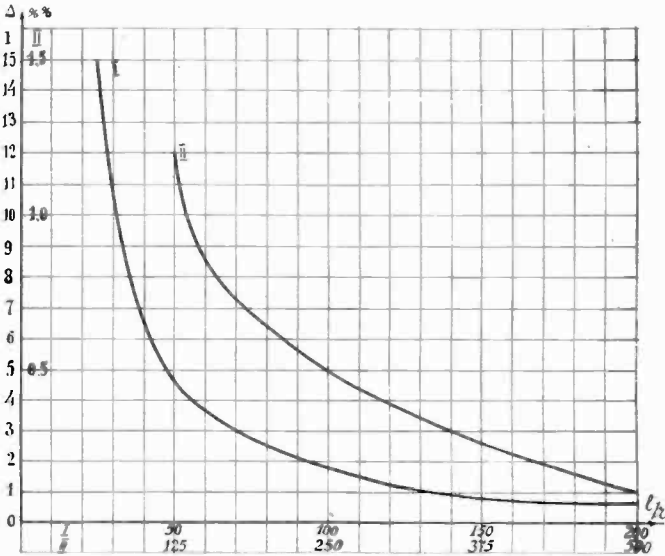

Figure 9

curves in Fig. 9). (The calculations have been made for the most disadvantageous case (radio frequency) when $\mu\delta = 0$.) The value found from (31) must be augmented by just this quantity to obtain a more accurate expression for the inductance of a square of given dimensions. There is good reason to suppose that the value of this correction in per cent remains constant for all other figures. If so, our formula (31) with the addition of the correction Δ in per cent (from Fig. 9) will be true for all figures, all frequencies, and all values of l/r :

$$L = 2l \left(\log \frac{2l}{r} - a_k + \mu\delta \right) (1 + \Delta) \tag{31b}$$

This correction curve confirms the opinion we have expressed (Section B) that in all calculations of closed aerials ($l/r > 500$)

the correction in per cent may be neglected, the error not exceeding in the most disadvantageous conditions 0.1 per cent.

The advantage in using in calculations the simple formula (31) can be increased still more if we construct abacs for every term contained in the brackets of the expressions (31) or (31b).

(1) If the value of L is to be determined for high-frequencies only, the formula may be transformed into

$$L = 2l \left(\log \frac{2l}{r} - a_k \right) \quad (39)$$

By means of the abac (see Fig. 10) we find the value of $\log \frac{2l}{r} = f\left(\frac{l}{r}\right)$ and by means of curve (6) we determine $a_k = f\left(\frac{l}{\sqrt{s}}\right)$. Subtracting the second value from the first and multiplying the difference D by the quantity $2l$ (all in cm.) we obtain (also in cm.) the required value of the inductance.

(2) To find the inductance for low frequency ($\mu\delta$) we read in the nomogram (Fig. 11) the perimeter x , for given f (or λ) and r and obtain from the curve in Fig. 1 the corresponding value for $\delta = f(x)$. Multiplying the last by μ we add the product to the difference D found above. Multiplying the resulting sum by $2l$ we obtain the required value of the inductance at the given frequency.

(3) Lastly, when formula (31b) is applied to general calculations in electrical engineering or physics, for any possible value of the ratio l/r , a correction must be made; this is obtained from the curve in Fig. 9: $\Delta = f\left(\frac{l}{r}\right)$. The value of Δ (divided by 100)

corresponding to the given l/r is to be added to 1 and the result found above in (1) or in (2) is to be multiplied by this sum.

(4) This formula is completely applicable to curvilinear figures (ellipse etc.); until now there have been no methods and formulas for these cases (excepting, of course, for the circle). It is likely that these formulas are applicable to the calculation of the inductance of power lines, etc., at least for one phase. The author is continuing work in this direction.

(5) As to the application of these formulas in the deduction of which the quasi-stationary condition is assumed to the case of high frequency currents in long wires (aerials) they are valuable to the cases of a normal working (sending or receiving) when the natural wavelength of the antenna has been increased to a length

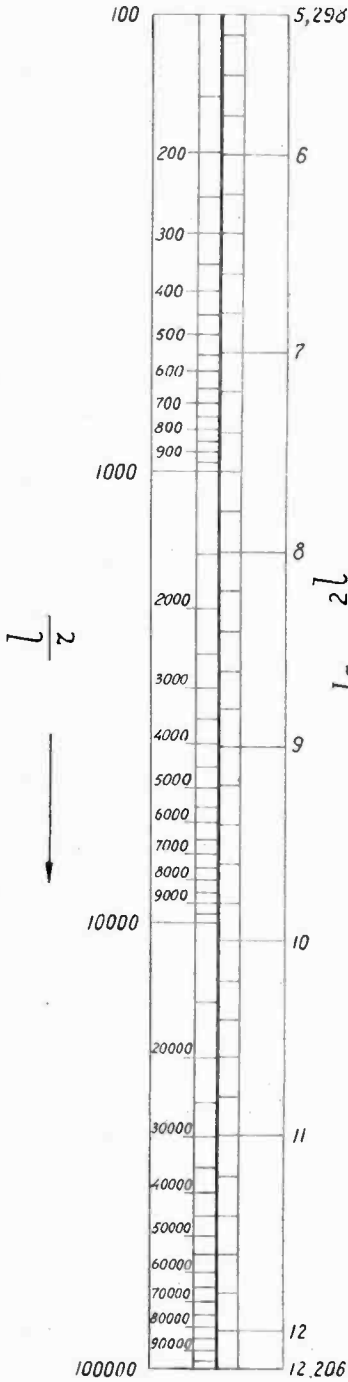

$$x = 0,2142 \cdot \tau \cdot \sqrt{f}$$

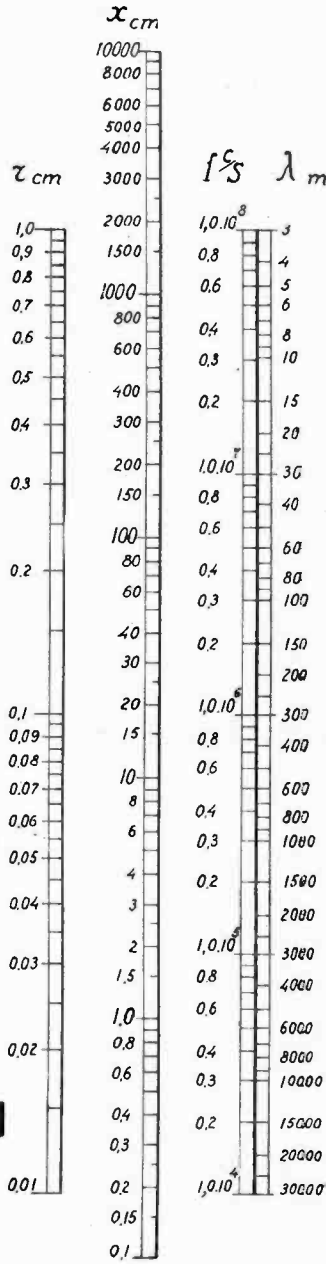

more than twice as great by the insertion of coils or condensers. Otherwise our formulas give only the static inductance, from which one must find the effective (dynamic) inductance.

There was made one comparison between the effective (dynamic) value of L (measured with Behnken's method) and L calculated with the above formula (31). The isosceles triangle had the dimensions: $a=b=7.12$ m.; $c=9.88$ m.; the leads' length was 6 m. For wavelengths $\lambda=250$ m. and $\lambda=600$ m., the differences between L measur. and L calcul. were 2.82 per cent and 2.61 per cent respectively.

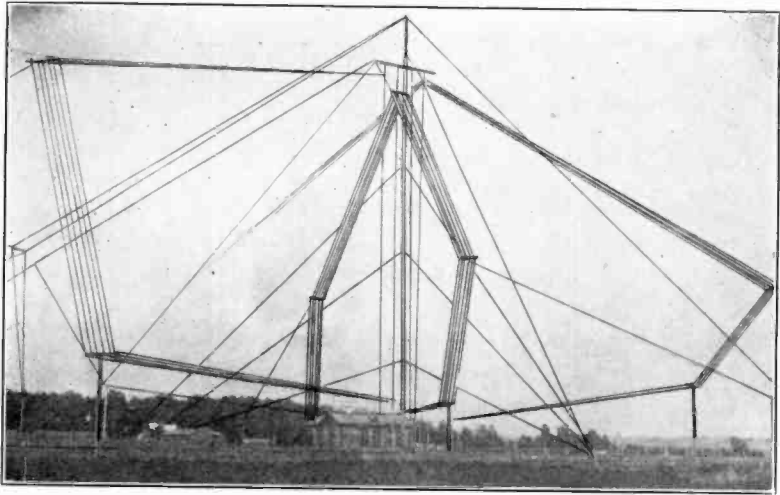

Figure 12—General View of Lubertzy's Mean Receiving Station (Construction of 1924)

In conclusion I wish to express my heartiest thanks to Professor M. V. Schuleikin, of Moscow, and to Professor F. W. Grover, of Washington, for helpful suggestions during this work. The latter has given assistance in the revision of the English copy of the manuscript.

The measurements were made in the Radio Department of the State Electrical Research Institute with the help of the Department's staff. To those who took part I offer my warmest thanks; especially I am obliged to M. E. Starik, electrical engineer, and N. K. Swistoff, student, who besides their work in the measurements afforded me very real help by making some of the calculations.

SUMMARY

The article contains the first part of an investigation on the design and use of closed aerials (calculation of the inductance for single-turn aerials). Two methods are given for determining the inductance for closed aerials and, in general, plane figures of any shape, having no reëntrant angles. The first method is based on the author's supposition of the practical equivalence of the inductance of any figure and the inductance of a right triangle or rectangle, having area and perimeter equal to those of the given figure. The second method is a development of the basic assumption of the first, and results in the derivation of a simple formula for all possible figures, including curved ones.

Numerous tests of the correctness of both methods by practical measurements on closed aerials with a height of the point of support from 65 down to 2 meters have fully confirmed the author's conclusions.

Appendix

Dr. Grover has communicated the following formula for the inductance of any type of triangle, which we publish with his permission. The lengths of the sides of the triangle are taken to be a , b , and c .

$$L = 2 \left[a \log \frac{2a}{r} + b \log \frac{2b}{r} + c \log \frac{2c}{r} - (a+b+c) \right. \\ \left. - (b+c) \operatorname{arc} \sin h \frac{c^2 + b^2 - a^2}{v} - (a+b) \operatorname{arc} \sin h \frac{a^2 + b^2 - c^2}{v} \right. \\ \left. - (a+c) \operatorname{arc} \sin h \frac{a^2 + c^2 - b^2}{v} \right] \quad (40)$$

where $v^2 = 2(a^2c^2 + a^2b^2 + b^2c^2) - a^4 - b^4 - c^4$.

The same formula for the case of an isosceles triangle (the sides: a , a , and c) takes the form:

$$L = 2 \left[2a \log \frac{2a}{r} + c \log \frac{2c}{r} - (2a+c) - 2a \operatorname{arc} \sin h \frac{2a^2 - c^2}{c\sqrt{4a^2 - c^2}} \right. \\ \left. - 2(a+c) \operatorname{arc} \sin h \frac{c}{\sqrt{4a^2 - c^2}} \right] \quad (41)$$

Finally for a right triangle this general formula (40) transforms itself in the following one:

TABLE V

NN	Type of figure	Perimeter Area of figure • meters square meters	Radius of wire cm.	$\frac{l}{\sqrt{s}}$	L Measured	L calculated		$\Delta L_{11}\%$	$\Delta L_{21}\%$
						from for- mula (12)	from for- mula (43)		
1	The right triangle { a=3.9 m. b=17.7 m. c=18.1 m.	39.7	0.15	6.75	59100	52530	53195	-11.12	-10
2	The right triangle { a=3.4 m. b=5.8 m.	15.92	0.04	5.07	25500	25970	25460	+ 1.84	- 0.157
3	The rectangle { a=1 m. b=8 m.	18	0.1	6.36	25700	23365	23540	- 9.08	- 8.4
4	The rectangle { a=5 m. b=30 m.	70	0.1	5.715	121500	115355	114850	- 5.05	- 5.4
5	The closed aeri-als of Karnarvon	375	0.2	4.89	733000	730055	724650	- 1.86	- 3.75
6	Paris	370	0.2	5.2	740000	709165	700200	- 4.17	- 5.4
7	Lübertz's radio-receiving station near Moscow	350	0.2	4.95	695000	681515	685000	- 1.94	- 3.8
8	America	385	0.2	4.87	785000	762695	747750	- 2.84	- 4.75
9	West	330	0.2	5.00	666000	635910	624200	- 4.52	- 6.25

$$L = 2 \left[a \log \frac{2a}{r} + b \log \frac{2b}{r} + c \log \frac{2c}{r} - (a+b+c) \right. \\ \left. - (a+c) \operatorname{arc} \sin h \frac{a}{b} - (b+c) \operatorname{arc} \sin h \frac{b}{a} \right] \quad (42)$$

Passing from hyperbolic functions to usual geometrical, the last formula can be written in the form

$$L = a \left[\frac{a}{c} \log \frac{a(c-a)}{b(b+c)} + \log \frac{4a^2b^2}{r^2(c+a)^2} - 2 \right] \\ + b \left[\frac{b}{c} \log \frac{b(c-b)}{a(c+a)} + \log \frac{4a^2b^2}{r^2(c+b)^2} - 2 \right] \quad (43) \\ + c \left[\log \frac{4a^2b^2c^2}{r^2(a^2+ac)(b^2+bc)} - 2 \right]$$

In these formulas terms in $\frac{r}{a}$, $\frac{r}{b}$, and $\frac{r}{c}$ have been neglected.

They do not include the internal linkages $\mu\delta$. Our earlier formula (12) gives values a little different from (43), the values being in general a little larger. Although a comparison of the inductances of the aerials shown in Table V makes clear that the inductances calculated by (12) are in good agreement with the measured values (at least for the larger aerials), the author believes that Dr. Grover's formulas (40) to (43) are a little more accurate, since the neglected quantities are smaller than those neglected in (12).

PIEZO-ELECTRIC RESONANCE AND OSCILLATORY PHENOMENA WITH FLEXURAL VIBRATIONS IN QUARTZ PLATES

By

J. R. HARRISON

(Wesleyan University, Middletown, Connecticut.)

The resonating and oscillatory effects of piezo-electric crystals were first described by Cady.¹ It is well-known that a rectangular plate cut from a quartz crystal having length l , breadth b , and thickness e , parallel respectively to the Y axis, Z (optic) axis and X (electric) axis has three fundamental natural frequencies as determined by these dimensions with a series of overtones for each. The length l of the crystal determines the frequency for the "transverse effect," the thickness e , that for the "longitudinal effect" and the breadth b , a third vibration frequency.² Each effect is due to a compressional wave traveling in one of the three respective dimensions of the crystal. In each case the electromagnetic wavelength corresponding to the frequency of the vibration is of the order of 110 meters per millimeter of crystal in the direction concerned.

In the course of some recent investigations with quartz plates it was found possible to excite plates into resonance at a frequency considerably lower than that of the transverse fundamental.³ The transverse fundamental was the lowest frequency hitherto obtained in any quartz resonator as will be seen. This new piezo-electric resonance reaction has been found to be due to a flexural vibration in the length-breadth plane of the crystal, which is illustrated in Fig. 1, in which n, n represent the nodes which are $0.22 l$ from the ends of the bar. When the electric field is applied in a manner herein explained, the stresses are such as to tend to make the crystal assume a shape as shown by the dotted lines. A reversal of the polarity of the applied field reverses the mechanical stresses so that the crystal edges will now be concave upward. An alternating electric field causes a rapid series of these concave upward and downward positions, the period of which is determined

¹ W. G. Cady, Proc. I. R. E., 10, pp. 83-114, 1922. J.O.S. and R.S.I., pp. 475-489, 1925.

² A. Hund, Proc. I. R. E., 14, pp. 455-456, 1926.

³ Preliminary reports of this work have appeared in *The Physical Review*, 29, p. 366, 1927, and 29, p. 617, 1927.

by the frequency of the applied electromotive-force. Resonance effects are obtained with this flexural mode of vibration exactly analogous to those obtained for the three simple modes due to compressional waves in the quartz. The response frequencies that have been obtained for several crystals are shown in Table I.

TABLE I

Crystal	Length mm.	Breadth mm.	Thickness mm.	Flexure	Transverse	Flexure	Transverse
				kes.	Fundamental kes.	meters	Fundamental meters
E1	40.03	10.04	0.603	29.70	64.5	10100	4650
E2	40.03	10.05	0.617	30.0	67.8	10000	4430
E5	30.06	10.10	1.11	51.4	93.0	5850	3220
E6	30.06	10.10	1.12	50.9	92.2	5900	3250
W2	3.90	2.00	1.10	4,920.	6,990.	610	430
HA15	21.72	2.90	1.32	33.6	128.	8920	2350

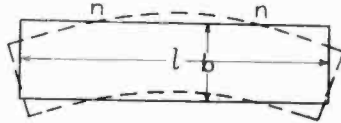
Figure 1—Flexural vibrations in the length-breadth plane showing nodes n, n

The frequency of a *thin* bar vibrating with any mode of flexural vibration is determined by the equation:⁴

$$N = \frac{m^2 k}{2\pi l^2} \sqrt{\frac{q}{d}} \quad (1)$$

where N is the frequency, k the radius of gyration, l the length, q Young's modulus, d density, and m a constant depending upon the mode of flexural vibration.

$$k = \sqrt{\frac{I}{M}} \quad (2)$$

where I is the moment of inertia of a cross section about a transverse axis through its center and M is the mass of the bar. Equation (1) holds accurately for flexural vibrations in the length-thickness plane so long as the thickness is small, but is equally applicable to flexural vibrations in the length-breadth plane for a bar whose breadth is small in comparison to its length. In this latter case the moment of inertia is taken about a transverse axis through its center:

$$I = \frac{1}{12} M b^2 \quad (3)$$

⁴ Barton, "Text-Book on Sound," p. 281 et. seq. or Horace Lamb, "Dynamical Theory of Sound," p. 122 et. seq.

where b is the breadth of the bar. Substituting the values in (1) determined by equations (2) and (3), $m=4.73$ for the first mode of flexural vibration and the constants for quartz $d=2.654$ grams per cubic centimeter, $q=7.85 \times 10^{11}$,⁵ the frequency for flexural vibrations in the length-breadth plane of a quartz bar is:

$$N = 5.79 \frac{b}{l^2} \times 10^5 \text{ or} \quad (4)$$

$$\lambda = 518 \frac{l^2}{b} \quad (5)$$

where λ is the electromagnetic wavelength in meters corresponding to the frequency N , l and b are the length and breadth of the bar in centimeters, respectively.

Comparison of the observed frequency of flexural vibration with that computed from equation (4) shows a large discrepancy with bars in which the ratio of length to breadth is not large, just as would be expected. A series of tests were accordingly made to find the relation between the response frequency on the first flexural mode and the physical dimensions of the bar. Table II shows the results of a series of measurements taken on several plates of practically the same length and breadth but of different thicknesses. This conclusively shows that the response frequency of the crystal is independent of the thickness as it should be according to the theory.

In this Table II the transverse fundamental frequencies (longitudinal vibration) and the corresponding wavelengths have also been recorded for the eight plates. As would be expected from theory the thickness has not an appreciable effect.

TABLE II

Crystal	Length	Breadth	Thickness	Frequency		Wavelength	
				Flexural Fundamental	Transverse Fundamental	Flexural	Transverse Fundamental
	mm.	mm.	mm.	kes.	kes.	meters	meters
A1	28.62	9.65	1.044	53.8	96.8	5580	3100
A2	28.68	9.65	1.058	53.3	96.5	5640	3120
A3	28.62	9.65	1.999	53.3	96.5	5630	3120
A4	28.62	9.66	2.015	52.6	95.6	5700	3140
A5	28.60	9.65	4.257	53.5	95.3	5620	3150
A6	28.64	9.66	4.256	52.6	95.0	5700	3160
A7	28.56	9.63	2.907	53.3	95.8	5640	3130
A8	28.64	9.63	3.557	52.6	96.8	5700	3100

⁵ This value of Young's modulus was computed from the mean value of the number of meters per millimeter for the transverse fundamental of quartz taken from the results of the following observers: Mallet and Terry, *Wireless World*, 16, pp. 631-636, 1925. Giebe and Scheibe, *Zeit. f. Physik*, 33, pp. 335-344, 1925. Cady, *Proc. I. R. E.*, 12, pp. 805-816, 1924. Bureau of Standards, Letter Circular, No. 186.

Measurements were made of the response frequency for the flexural vibration and the transverse fundamental as the length l of the crystal was diminished by grinding. Table III gives a typical set of tabulated results such as were obtained in this manner for several crystals. The observed results agree with those computed from equation (4) or (5) only when the ratio of length to breadth is large. The logarithmic plot of the length l of the crystal against the electromagnetic wavelength corresponding to the observed flexural response frequency of the crystal is shown in Fig. 2 by curve 1 for the results given in Table III. The slope of this curve 1 is less than would be expected from the theoretical

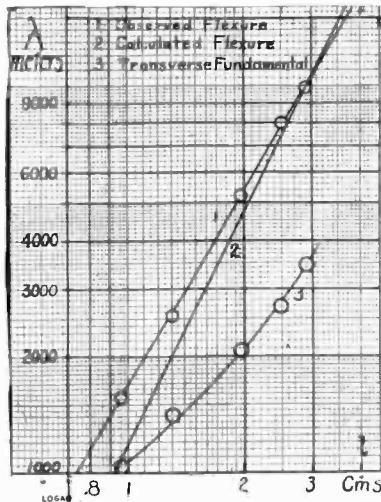

Figure 2—Logarithmic plot of length of crystal plate against the electromagnetic wavelength corresponding to the response frequency for the first mode of flexure and the transverse fundamental, the breadth remaining constant.

formula for flexural vibrations (5) the values computed from which are shown by curve No. 2 on the same graph. The slope of the curve 2 is 2 but curve No. 1 has a slope of only 1.7. This indicates that the exponent of the length l for these bars should be 1.7 instead of 2 as the theory indicates. Similar measurements were made on the variation of the flexural response frequency of a short bar or plate as the breadth b was diminished by grinding. Here again the numerical value of the exponent is less than that given by the flexural theory. From these results an approximate empirical formula has been developed which gives much better agreement with the observed flexural response frequencies of short bars than

the theoretical formula (4). This formula for the electromagnetic wavelength corresponding to the response frequency for flexural vibrations in short bars is:

$$\lambda = k \frac{l^{1.7}}{b^{0.75}} \quad (6)$$

The value of k is nearly a constant for a series of measurements such as those given in Table 3 and is approximately equal to the constant in equation (5) for all but very short bars.

TABLE III

	Length l in cms.	Observed Flexure in meters	Calculated Flexure in meters	Observed Flexure in kilocycles	Calculated Flexure in kilocycles	Transverse Fundamental	
						meters	kcs.
1	2.89	9900	9850	30.4	30.4	3460	86.7
2	2.82	9540	9350	31.5	32.1	3200	93.7
3	2.67	8750	8390	34.3	35.8	2880	104.2
4	2.50	8000	7350	37.6	40.8	2680	112.0
5	2.37	7240	6610	41.5	45.5	2530	119
6	2.25	6630	5960	45.3	50.4	2400	125
7	1.97	5200	4560	57.7	65.8	2070	145
8	1.31	2535	2020	118.3	148.5	1410	213
9	0.96	1570	1080	191.0	278.0	1040	288

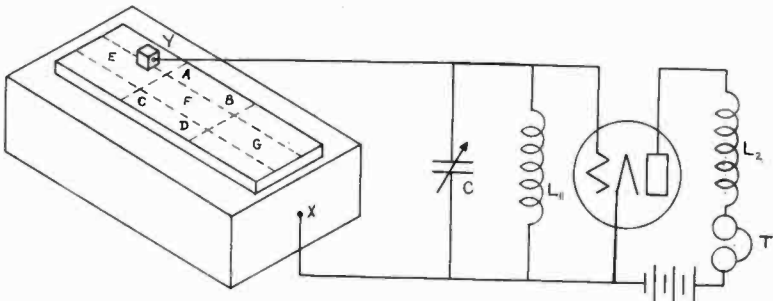

Figure 3—Simple oscillator circuit with large electrode X and small exploring electrode Y for locating regions of maximum resonance response in the piezo-electric crystal EG .

Resonance effects with the new low-frequency vibration were strongest when only half of the breadth of the quartz plate was enclosed by the metallic electrodes of the crystal mounting. When the whole crystal was enclosed by the mounting so that the applied electric field was practically uniform over the entire side of the plate the response at this frequency was found to be extremely faint and in many cases not audible in the phones. A simple vacuum-tube oscillator was used in these tests as shown in Fig. 3; the coils L_1 and L_2 were loosely coupled. Resonance conditions were found by noting the ringing sound or click of the crystal as the capacity C_1 was tuned through the critical frequency. In the following work a two-stage audio-frequency amplifier was

used in connection with this oscillator circuit to make the method sensitive enough for the tests.

A study was made of the crystal response when very small exploring electrodes were placed at different points on the crystal. The crystal was placed on a metallic plate the dimensions of which were somewhat greater than those of the crystal. The exploring electrode *Y* (Fig. 3) was only $2 \times 2 \times 2$ millimeters square and was connected by a very fine wire to the oscillator circuit. The electrodes were connected to the filament and grid of the vacuum tube in the oscillator circuit as shown in Fig. 3. With this exploring

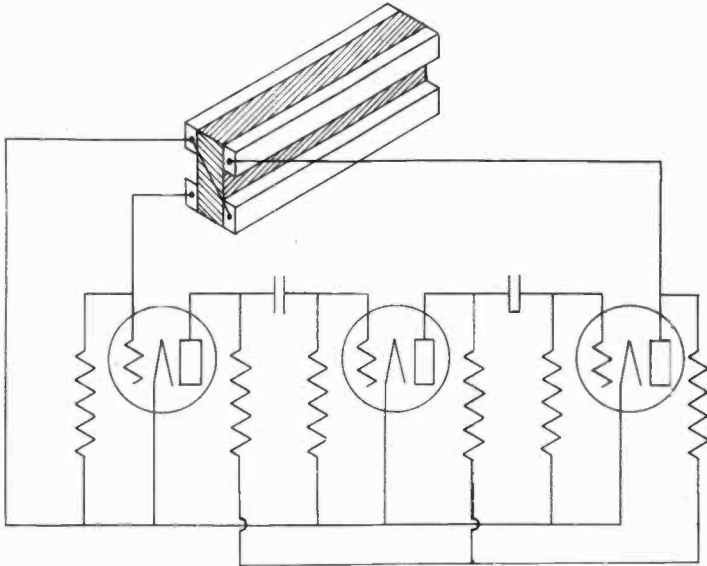

Figure 4—A Cady type of piezo-electric flexural oscillator involving no tuned electrical circuit.

electrode it was possible to explore the surface of the crystal and locate areas of maximum resonance response. These areas were indicated by the loudness of the click in the phones as the condenser in the vacuum-tube oscillator circuit was tuned through the flexural resonance frequency of the crystal. Maximum response regions were found near the upper and lower edges of the crystal, especially the central regions *AB* and *CD* as indicated in Fig. 3. When the exploring electrode was placed in the central part of the crystal at such points as *E*, *F*, or *G* the response was found to be very weak and in most cases inaudible. Two exploring electrodes were then connected in parallel and used on the upper side

of the crystal, the lower electrode remained as in the previous test, with one exploring electrode placed in the region AB and the other at CD ; no response was heard on tuning through the flexural resonance frequency. If both electrodes were placed together in either the region AB or CD the response was found just as would be expected.

A crystal mounting was then so designed that the electric field was applied to the two areas which were symmetrically disposed with respect to the longitudinal axis of the quartz plate and the polarities in the quartz were in opposite directions. Such a crystal mounting is shown in Figs. 4, 5, and 7. The four metallic electrodes A , B , C , and D shown in Fig. 7 are equal to the crystal in length and about one-third as wide. The upper and lower electrodes are separated by strips of insulating material. Electrode A is con-

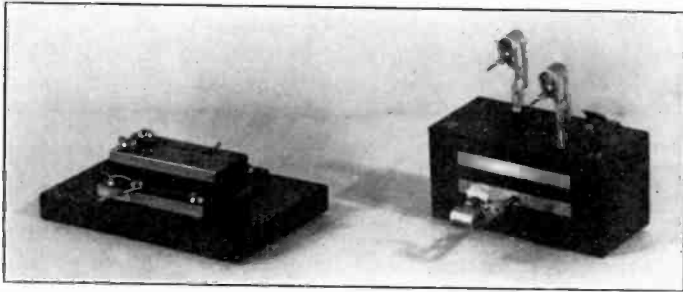

Figure 5—Two examples of the new type of crystal mounting with four electrodes for the first mode of flexural vibration.

nected to D , and B to C , and a binding post provided for each pair of electrodes. This same crystal mounting may be used to obtain the transverse fundamental and the longitudinal fundamental by connecting electrode A to B and C to D , so that they are effectively a single pair of plates. Fig. 5 shows crystal mountings such as were used in these tests. These were designed for plates of the same size and are identical except that one is completely enclosed to protect the crystal plate from dust and moisture.

THE PIEZO-ELECTRIC OSCILLATOR

The crystal will also function as a piezo-electric oscillator on this flexural mode of vibration. Since the crystal mounting consists of four metallic plates, either a Cady or Pierce type of circuit may be used. One of the types of crystal oscillator circuit described

by Cady⁶ furnishes the necessary feedback of energy from output to input, to maintain sustained oscillations, through the vibrating piezo-electric crystal. To accomplish this the crystal mounting contains four electrodes or the equivalent, one pair of electrodes being connected to the input and the other pair to the output of a thermionic vacuum tube. The crystal mounting for the Pierce⁷ type of oscillator requires but two electrodes or the equivalent connected to either grid and filament or grid and plate of the tube. The feedback in this case is produced entirely through the inter-electrode capacity of the thermionic tube unless a pickup or sensitizing coil is connected in series with the crystal. In this article crystal mountings are described having as many as twelve or more electrodes, but these are so interconnected that they act effectively as a mounting of two or four electrodes depending upon the type of circuit used. Fig. 4 illustrates this Cady type of circuit, as originally used, and involves neither inductance nor capacity, since the resistance-coupled amplifier insures sufficient energy to maintain the crystal oscillations. Two diagonally opposite electrodes *A* and *D* of the crystal mounting are connected to the filaments; the other electrodes *B* and *C* are connected to the output and input respectively.

With both Cady and Pierce type of circuit some difficulty is usually experienced in obtaining crystal oscillations if but a single vacuum tube is used. This trouble may be entirely overcome by introducing a pickup⁸ or sensitizing coil in series with the crystal in the grid circuit. This method is illustrated in the Cady type of circuit by Fig. 6. The pickup coil L_1 should be loosely coupled to the inductance L_2 of the tuned plate circuit. The coupling between L_1 and L_2 is made as loose as possible to avoid cracking the crystal with excessive power, and also to avoid setting up oscillations not of crystal frequency, but due to the electrical constants of the circuit alone. Experiments indicate that under these conditions the frequency of the oscillator seems to be as constant as for the other modes of vibration. With the Pierce type of circuit, Fig. 7, one pair of diagonally opposite electrodes of the crystal mounting are connected to the grid of the vacuum tube and the other pair to the filament. As before in the Cady type of oscillator circuit a pickup coil L_1 is used in series with the crystal in the grid circuit. This type of circuit seems to be most promising for future develop-

⁶ W. G. Cady, Proc. I. R. E., 10, p. 112 et seq. 1922.

⁷ G. W. Pierce, Proc., Amer. Acad. of Arts & Sci., 59, pp. 79-106, 1923.

⁸ A. Hinderlich, *Experimental Wireless*, 4, pp. 29-41, 1927.

ment since the output power developed is considerably greater than that obtainable from the Cady type of circuit and arcing between the plates of the crystal mounting is not experienced at normal plate voltages as is found to be the case with the former circuit. A plate of quartz $30 \times 10 \times 1$ mm. vibrating flexurally at 60 kilocycles was used in the Pierce circuit as a power oscillator. A type UX-210 tube was used with 400 volts on the plate. The observed output power was about 0.5 watts, which considering the low fre-

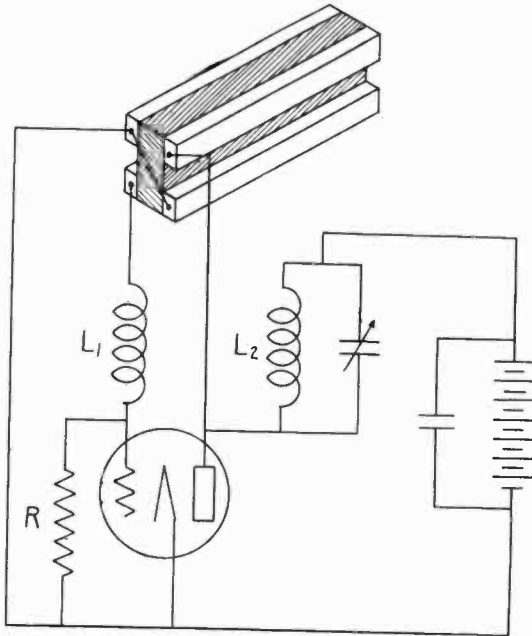

Figure 6—Piezo-electric flexural oscillator with sensitizing coil L_1 in the grid circuit.

quency compares favorably with the output from crystals vibrating at high frequencies.⁹

HIGHER MODES OF FLEXURE

Other modes of flexural vibration of higher frequency and in the length-breadth plane of the crystal have also been obtained. Resonance effects have been found and regions of maximum resonance response determined just as described above with small exploring electrodes. To obtain oscillations on these higher modes of flexural vibration, it is desirable to use a crystal mounting that

⁹ A. Crossley, Proc. I. R. E., 15, pp. 9-36, 1927.

applies the electric fields in such directions that the resultant stresses in the crystal are a maximum. For the second mode of flexural vibration the mechanical stresses are such as to make the crystal assume the shape shown in Fig. 8. The regions n are nodes.

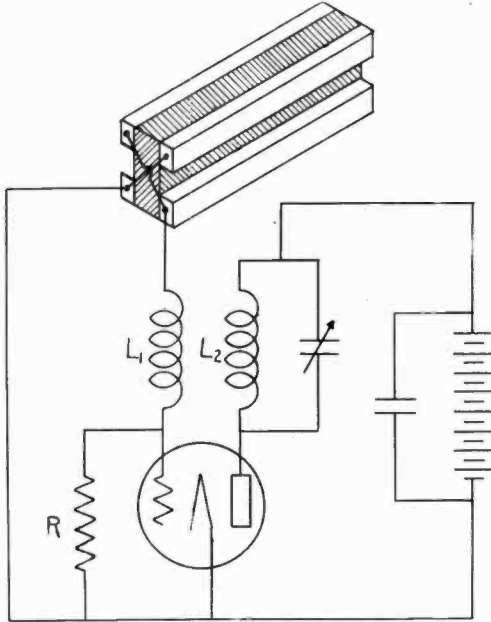

Figure 7—Piezo-electric flexural oscillator of Pierce type with sensitizing coil L_1 in grid circuit.

two of which are 0.12 of the length l from the ends and the third is centrally located along l according to theory and roughly confirmed by actual observation. The existence of these nodes is quite strikingly illustrated by sprinkling a little lycopodium powder on the long edge of the vibrating crystal. The lycopodium

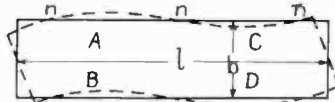

Figure 8

will pile up in the nodal regions n showing them to be regions of minimum motion. When the regions A and D in the crystal are in a state of tension regions B and C will be in compression and vice versa. Accordingly the electric field applied to the regions A and D should be opposite in direction to that applied at B and C .

Crystal mountings which apply the electric fields in this manner are illustrated in Figs. 9 and 10. The crystal mounting (Fig. 9) consists of eight metallic electrodes *S*, *T*, *U*, *V*, *W*, *X*, *Y*, and *Z*

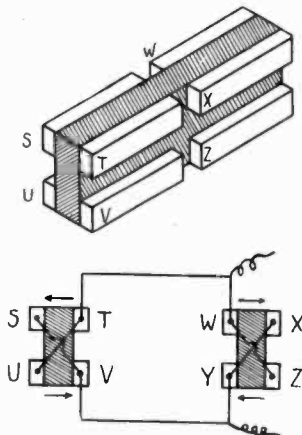

Figure 9—The upper diagram shows the new crystal mounting of eight electrodes for the second mode of flexural vibration. The lower diagram indicates the method of connecting electrodes. The arrows indicate the relative direction of the electric field in various portions of the crystal.

which are slightly less than one-half the crystal in length and about one-third as wide. These electrodes are arranged along and flush with each long edge of the crystal as shown. The electrodes *S* and *V* are connected together by a wire as are likewise the follow-

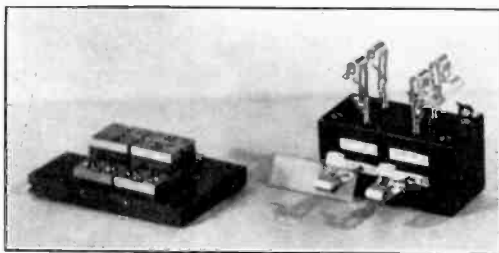

Figure 10—Two examples of crystal mountings with eight electrodes for the second mode of flexural vibration. By properly interconnecting the electrodes this may also be used to excite the first mode of flexural vibration and various other frequencies by means of the transverse and longitudinal effects.

ing electrodes: *T* and *U*, *X* and *Y*, and *W* and *Z*. The pair *S* and *V* are now connected to the pair *X* and *Y* and likewise the pair *T* and *U* are connected to the pair *W* and *Z*. These connections are illustrated in the lower part of Fig. 9 where *both* ends of the crystal and

the mounting are shown. The direction of the electric field for each pair of electrodes is indicated by arrows. In like manner a crystal mounting may be designed for the third mode of flexural vibration, but four additional electrodes will be required, making twelve in all. This type of crystal mounting is indispensable for crystal oscillators, but is not necessary for simple resonance effects as has been pointed out before. Table 4 gives a typical set of data for the frequencies of the first and second modes of flexure and of the transverse fundamental as the length is diminished by grinding. The equation for the second mode of flexure is identical with that for the first mode (equations (5) and (6)) except that a new constant m must be introduced (see equation (1)). These observations, Table 4, indicate that the frequency increases for all modes as the length is diminished. The frequency for the transverse fundamental increases linearly with diminishing breadth. The frequency for the flexural modes increases at a much greater rate. The second mode of flexure becomes of higher frequency than the transverse fundamental in short bars.

The only reason for using these flexural vibrations is to extend the range of response frequencies obtainable from a crystal plate on the low frequency side. The limit of utility is then reached when a given mode of flexural vibration is of higher frequency than the transverse fundamental. The transverse fundamental was the lowest frequency hitherto obtained from a crystal. The response frequency for the third mode of flexural vibration is usually higher than that of the transverse fundamental except in the case of long narrow bars, since then all the flexural response frequencies are correspondingly lower.

TABLE IV

Length	First Mode of Flexure	Frequency Second Mode of Flexure	Transverse Fundamental	First Mode of Flexure	Wavelength Second Mode of Flexure	Transverse Fundamental
mm.	kcs.	kcs.	kcs.	meters	meters	meters
28.9	30.4	72.0	86.7	9900	4160	3460
28.2	31.5	75.0	93.7	9540	4000	3200
26.7	34.3	81.1	104.	8750	3700	2880
25.0	37.6	92.0	112.	8000	3260	2675
22.5	45.3	109.	125.	6630	2750	2400
19.7	57.7	135.	145.	5200	2220	2070

LUMINOUS PHENOMENA

Giebe and Scheibe¹⁰ have recently shown that the resonance state of a piezo-electric crystal may be made directly visible under

¹⁰ Giebe and Scheibe, *Zeit. f. Physik*, **33**, pp. 335-344, 1925. *Elektrotech. Zeit.*, **47**, pp. 380-85, 1926. H. Kroncke, *Wireless World*, **17**, p. 896, 1925.

certain conditions by the luminous glow emitted. With electrodes that cover the full length and breadth of the plate, this luminous glow is observed in the air gap between the crystal and mounting, when resonance conditions are reached in a partially evacuated chamber. Dye¹¹ has more recently pointed out that the voltage gradient in the quartz is enormously increased when an air gap exists between the crystals and the electrodes. The voltage across the air gap may be 30 times the voltage applied to the electrodes. Under these conditions and with the crystal placed in a suitable vacuum a glow discharge may be expected.

Before making tests for luminous effects with flexural vibrations, observations were made according to Giebe and Scheibe of the crystal glow for the transverse fundamental and its overtones. In all these tests the plate was placed flush with one side of the crystal mounting, so that but one air gap existed between the two. The luminous glow for the transverse fundamental effect is of maximum intensity at the center of the plate along the length l ; the intensity diminishes somewhat on both sides of this region. The total region of luminosity extends over about one-third the length l of the crystal, varying somewhat with air gap, applied electromotive-force and probably other conditions. With a suitable crystal mounting consisting of four electrodes (the Cady type) as described by Giebe and Scheibe two regions of maximum luminous intensity were found for the first overtone of the transverse fundamental. The other overtones may also be indicated in a similar manner.

The luminous glow emitted by crystals can also be observed at the flexural vibration frequency and under certain conditions presents striking peculiarities which still await explanation. With a single pair of electrodes covering the whole of both sides of the crystal no luminous glow appears at the flexural vibration frequency as would be expected, for the crystal does not vibrate flexurally under these conditions. Using the new crystal mounting for flexural vibrations as described in this paper, Fig. 5, a luminous glow was observed in the air gap between the crystal and electrodes which very much resembled that found for the transverse fundamental. With a simple crystal mounting of two electrodes which cover only one-third of the breadth and approximately the full length (see Fig. 11), a peculiar striated luminous glow appears on the upper edge XY of the crystal and not, as might be expected, in the air gap. At higher pressures when the glow first appears,

¹¹ D. W. Dye, *Proc., Phys. Soc. of London*, 38, p. 453, 1926.

it is always as described above in the form of beads or striations running perpendicular to the length l , that is, parallel to the direction of the applied electric field. As many as seven beads have been observed with some crystals, the form of which is approximately represented on the upper edge of the crystal in Fig. 11. Many photographs of this effect have been made, but the results are not sufficiently good to warrant direct reproduction.

To make the beads visible, the frequency of the applied electromotive force must be carefully tuned to crystal resonance. When the applied frequency is slightly detuned from crystal resonance the glow diminishes in intensity and the beads are

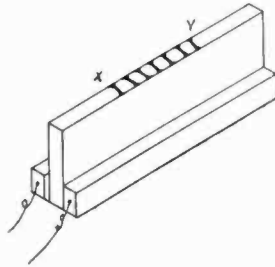

Figure 11—Piezo-electric crystal with simple electrodes covering only one-third of the breadth. The appearance of the beads or striated luminous glow is indicated on the upper edge XY of the crystal.

replaced by a faint but uniform luminosity. The beads will only be visible for a short period of time unless the oscillator is free from small transient shifts in frequency. As the vacuum is raised in the crystal chamber the beads diminish in number and become more diffuse and indistinct.

The striated appearance of the glow discharge may be due to some peculiar and as yet unexplained effects in the mechanical vibration at the center of the plate. It is to be noted that the amplitude of vibration of the crystal is considerably less with the mounting (Fig. 11) than would be the case with the special mounting for flexural vibrations. The striated glow is only present when a single pair of electrodes is used and appears on the edge most remote from the electrodes. With the four electrode mounting the peculiar mechanical effect may still be present, but only the usual type of discharge between electrodes and crystal is then observed as previously described.

When the luminous effect is to be used as a visual indicator of frequency, best results will be obtained with a residual gas of

helium or neon in the crystal chamber. Similar results are obtained with air, but the luminous glow is not so intense.

The luminous effect is sometimes obtained even at atmospheric pressure when the applied voltage is sufficiently great. There is considerable danger of damaging the crystal under these conditions because of excessive mechanical strain.

Finally, the author wishes to thank Professor W. G. Cady, under whose direction the problem was undertaken, for his kind advice and constant cooperation.

SUMMARY

A method of obtaining flexural vibrations from piezo-electric quartz plates together with the equations for flexural vibrations in quartz is given. Crystal mountings for obtaining best results with the first, second, and higher modes of flexural vibration are developed. The use of the crystal at flexural frequencies in the oscillator circuits of Cady and Pierce, and the luminous phenomena obtained when resonating in a partially evacuated chamber with different types of mountings, are also described. Without using unusually long plates the range of frequencies obtainable is extended into the audible range.

Among the problems still to be solved are the temperature coefficient of frequency and logarithmic decrement for the various modes of flexural vibration as well as constancy of frequency under variations of load and constants of the electric circuit. Investigations are still in progress, of which a report will be communicated later.

Discussions on

TELEPHONE COMMUNICATION OVER HIGH POWER LINES BY HIGH FREQUENCY CURRENTS* (BODDIE)

R. D. Duncan, Jr.:† This paper is one of the very few concerning high-frequency communication over power lines which have been published in this country. Mr. Boddie's statement and analysis of the fundamental problems involved and of the requirements of equipment for this service are clear and comprehensive. It is with the section of the paper on "Attenuation Constant at High Frequencies" and those following that this discussion is concerned.

In the sections referred to comparison is made between measured and computed values of the inductance, capacity, and resistance per unit length of overhead high voltage power lines, for different physical arrangement of conductors and for frequencies in the neighborhood of 60 kilocycles. A good agreement between measured and computed values of the linear inductance and capacity for full-metallic systems was obtained; there was considerable difference, however, between similar values of the high-frequency resistance of the lines, the measured values in every case being much greater than those computed from well-known skin effect formulas. For full metallic circuits the differences were within the limits 181 to 294 per cent; for circuits with ground return much greater differences were obtained.

It is suggested in the paper that for the full metallic circuits, these differences were due in part to the presence of nearby parallel conductors in which currents were induced. In the line-ground system they were attributed to ground-return resistance. Neither of these effects is taken into account by the theory upon which the computed values of resistance were based.

The manner of behavior of overhead lines at high frequencies, when free in space or when surrounded by other lines, and the advantages or disadvantages of full metallic versus line-ground return carrier circuits, have undoubtedly received the consideration at one time or other of every engineer engaged in this particular branch of radio. In the field of wired radio broadcasting

Received by the Institute, August 8, 1927.

* Proc., Vol. 15, 7, Page 559, July 1927.

† Wired Radio, Inc., New York City.

wherein high-frequency currents are superimposed upon the electric light and power lines of a community, every advantage has been with full-metallic operation. It requires less transmitting power than the line-ground system and is not subject to fading of signals, line noises and interference from high-power space radio as is the latter system. Full-metallic carrier operation produces the minimum inductive interference in nearby overhead lines (for example, telephone lines) and space radio receivers, antenna or loop types which may be in operation near the lines. A great advantage of full-metallic operation is that it lends itself readily to the use of polyphase carrier which is referred to later in this discussion. To investigate the carrier properties of overhead lines the necessary measurements were carried through for both full-metallic and line-ground systems to enable the derivation of the unit resistance, inductance, capacity, and leakage conductance, over the range of frequencies normally employed in carrier operation. It is believed that a statement of these results and a comparison thereof with those obtained by Mr. Boddie will not be without interest and will assist in explaining some of the differences between theory and experiment noted in the paper under discussion.

Mr. Boddie derived values of linear resistance by measuring the characteristic impedance Z_0 of the lines, and the transmitted and received currents with the lines terminated in an impedance, Z_0 . The resistance R is computed from the approximate expression

$$R = 2 \cdot \alpha \cdot Z_0 \quad (1)$$

which is the first term of the more general expression

$$\alpha = \frac{R}{2} \sqrt{\frac{C}{L}} + \frac{G}{2} \sqrt{\frac{L}{C}} \quad (2)$$

under the assumption

$$Z_0 = \sqrt{\frac{L}{C}} \quad (3)$$

In the expressions α , L , C , and G are respectively the attenuation constant, inductance, capacity, and leakage conductance.¹ The attenuation constant α is related to the ratio of transmitted to

¹ Here taken as per loop mile for full-metallic and per wire mile for ground-return circuits.

received current of the lines of length l , when terminated in Z_0 through the usual expression

$$\frac{I_T}{I_R} = e^{\alpha l} \quad (4)$$

In utilizing relations (1), (3), and (4) for deriving the resistance, the leakage conductance is implicitly assumed to be zero. This assumption may or may not be valid for highly insulated high-voltage lines. It was not found to be true for low voltage power lines. Certain types of insulators while entirely satisfactory at commercial power frequencies, exhibit losses at carrier frequencies and are unsatisfactory. The possibility of such losses occurring even with high voltage insulators, thereby requiring the consideration of the second member of expression (2) was suggested by one of the members during the discussion of Mr. Boddie's paper. The results of measurements quoted herewith show that at least for some types of power lines the leakage conductance is appreciable and cannot be neglected. They also show, however, that including the second term in expression (2) does not account for all of the difference between the measured and computed values of line resistance, and that factors other than ground resistance cause a large portion of the line losses in a line-ground system.

In explanation of these statements the following experimental data² is submitted which gives the characteristic impedance, and the inductance, capacity, resistance, leakage conductance, attenuation, and wavelength constants, per loop mile for full-metallic circuits and per wire mile for line-ground circuits, for aerial conductors of average height above ground of 30 feet and spacing (horizontal) between conductors of 42 inches. The lines are No. 6 copper, diameter 0.162 inch, approximately one-half mile in length. Each conductor has standard weather-proof insulation and was supported by porcelain pin insulators such as are normally employed in 2300 volt construction. The lines were strung on the same pole with other lines and for a portion of their length jointly occupied the same cross arm with other power lines. In general their construction was typical and the reaction due to the proximity of adjacent lines may be considered typical of what is encountered in overhead city construction.

² The line measurements and computations were made by Messrs. S. Isler, S. A. Barone, G. C. Salmons, and C. E. Bohner, of the engineering staff of Wired Radio, Inc.

TABLE I
FULL-METALLIC SYSTEM

1 Frequency K. c. per sec.	2 Char. Impedance Z_0	3 Inductance L	4 Capacity C	5 Leakage Conductance g	6 Resistance R	7 Attenuation Constant α	8 Wavelength Constant β	9 Resistance (Computed)	10 Inductance (Computed)	11 Capacity (Computed)
	Ohms (1)	Henrys (2)	μf (2)	$\mu mhos$ (2)	Ohms (2)	Hyp. Radians (2)	Cir. Radians (2)	Ohms (2)	Henrys (2)	μf (2)
30	698	0.00423	0.00867	14.28	13.1	0.0143	1.133	11.4	0.00413	
40	703	0.00422	0.00853	15.77	19.1	0.0189	1.506	13.2	0.00412	
50	706	0.00426	0.00853	12.29	24.0	0.0214	1.895	14.7	0.00411	0.00715
60	706	0.00424	0.00849	10.00	30.0	0.0259	2.260	16.1	0.00410	
70	697	0.00420	0.00863	7.74	36.7	0.0290	2.647	17.4	0.00410	

(1) Phase angle of the order of 20 minutes negative.

(2) Per loop mile.

The experimental procedure followed, consisted in measuring the input resistance and reactance³ for the two conditions of the far ends of the lines, open-circuited and short-circuited upon themselves. Thence by well established methods⁴ the unit constants were derived. No special difficulty has been encountered in applying this method at carrier frequencies.

The data in Table I is for the full-metallic system, and in Table II, for a line-ground system. Columns 1 to 8 inclusive in both tables give measured values, and columns 9, 10, and 11 give values computed from the dimensions of the system.

In Table I for the full-metallic system the characteristic impedance Z_0 is seen to be practically independent of the frequency with an average value of 700 ohms, and virtually non-reactive. The measured and computed values of inductance L differed by 3 per cent, and of capacity C by approximately 16 per cent. The ratio of measured to computed resistance varied from 1.15 at 30 kc. to 2.11 at 70 kc. The difference in inductance values is too small to have any significance. The differences in the capacity and resistance values, however, are large and in the case of the latter are of the order of those observed by Mr. Boddie.

For the line-ground system of Table II the characteristic impedance decreased with increasing frequency and, as compared with the full metallic system, was smaller and showed a higher negative phase angle. The inductance and capacity per wire mile on the average showed an increase of 24 per cent and 11 per cent respectively over the computed values. The computed skin effect resistance may be taken as one-half of that of the full metallic system, given in column 9, Table I; the ratios of measured to computed resistance for 30 and 60 kilocycles are respectively 10.17 and 13.25 or much higher than with the full-metallic system. It is noted that the leakage conductance of the full metallic system is less, that is, the effective leakage resistance is higher, than with the line-ground system.

The increase in unit resistance and capacity of the lines in full-metallic operation is undoubtedly due to the proximity of lines running parallel and close to those measured. By virtue of their coupling with the lines in question an added resistance is introduced and the total interwire capacity increased. In the line-ground system because of the more widely distributed char-

³ By a method similar to that outlined by Mr. Boddie. See also "Recent Attainments in Wired Radio," *Journal of Franklin Institute*, Jan. 1921.

⁴ Pernot, "Electrical Phenomena in Parallel Conductors," Vol. 1, Chapt. VIII.

TABLE II
LINE-GROUND SYSTEM

1 Frequency K.c. per sec.	2 Char. Impedance Z_0 Ohms (1)	3 Inductance L Henrys (2)	4 Capacity C μf (2)	5 Leakage Conductance G $\mu mhos$. (2)	6 Resistance R Ohms (2)	7 Attenuation Constant α Hyp. Radians (2)	8 Wavelength Constant β Cir. Radians (2)	9 Resistance (Computed) Ohms (2)	10 Inductance (Computed) Henrys (2) (3)	11 Capacity (Computed) μf (2)
30	608	0.00387	0.0105	32.5	58.0	0.0576	1.203	5.7		
40	566	0.00359	0.0112	35.0	67.0	0.0692	1.594	6.6	0.002606	0.00983
50	529	0.00303	0.0108	54.0	86.0	0.0956	1.801	7.3		
60	523	0.00326	0.0119	18.8	106.0	0.1064	2.354	8.0		

(1) Phase angle of the order of 3 deg. negative.

(2) Per wire mile.

(3) Neglecting skin effect.

acter of the electric field surrounding the conductor it is to be expected that the proximity effect of adjacent conductors would be very pronounced, and hence would contribute largely to the change in the line constants observed. Mr. Boddie has ascribed the entire change to ground-return resistance, and in accordance with the theory developed by Carson⁵ the resistive component of the ground-return impedance of an overhead line is by no means negligible. Considerable experimental work at high frequencies with overhead lines under congested pole line conditions, however, has indicated that nearby lines may greatly increase the effective attenuation of a distributed circuit, and it is believed that in line-ground systems the change in line constants due to the proximity of other conductors is of equal importance to the ground-return effect.

Two other sources of loss which should be mentioned are those due to electromagnetic radiation and, in the case of the paper under discussion, the steel core of the stranded conductor. In accordance with what little is known concerning radiation from long distributed systems the resistance so introduced at these carrier frequencies appears to be negligible. The close agreement between the measured and computed values of inductance quoted by Mr. Boddie would indicate that at carrier frequencies the current penetration into the conductor does not reach the steel core.

Another point of interest in comparing Tables I and II is the lower characteristic impedance of the line-ground system which, however, has the much higher attenuation. That is, for the same applied voltage a higher input current is obtained, but less of it is effective in reaching the receiving end of the lines. Both of these features have been observed experimentally.

Because of the growing importance of wired radio on all types of line wire systems it is suggested that an experimental research into the high-frequency transmission characteristics of aerial conductors, both free in space and in the presence of other conductors in specified arrangements, is a problem well worth consideration. An experimental check upon existing theory would be provided and information of great value made available.

In concluding this discussion it is desired to direct attention to the advantages of employing polyphase carrier on polyphase power systems. In particular when communicating over a three-

⁵ Carson, *B. S. T. J.* Vol. V, No. 4, page 539, 1926.

phase power line, three-phase high-frequency energy, properly modulated would be impressed on the lines and all phases thereof utilized at both the transmitting and receiving terminals. A power transmission system is thus established similar in every respect to the normal power system and obeying the same laws but operating at a much higher order frequency. In wired radio broadcasting on polyphase systems where power for lighting is supplied from all phases extending from a substation, it is necessary to distribute high frequency current *uniformly* over all phases in order to obtain a uniform signal level. Single phase carrier has not provided this uniformity whereas polyphase carrier has successfully met all requirements.⁶ In the general field of radio it is interesting to note that three-phase high frequency provides a means for effecting carrier-frequency suppression⁷ and duplex radio telephone operation.⁸ It is believed that polyphase carrier will play an important part in future methods of high-frequency communication.

Alexander Nyman:† *A considerable portion of the above paper is devoted to the calculation of antenna efficiency for transmission of signals to power lines. As a result of these calculations the author comes to the conclusion that the advantage of condenser coupling as compared with antenna coupling is negligible since the antenna efficiency from $97\frac{1}{2}$ per cent to 94 per cent can always be secured.

On further investigation of this conclusion it appears that the transmitting set to which this antenna or condenser is connected was not taken into consideration in determining the efficiency, and yet it is this transmitting set in connection with the coupling system which really determines the efficiency of the whole operating scheme.

To illustrate it more clearly, consider the following:

The paper shows that the current through the power line is about one-quarter of the current through the antenna. As the antenna current must be supplied by the transmitting set, probably by some tuned means such as an inductance, it is quite evident that the losses in that inductance as well as in the antenna must be taken into account. Assuming the values of capacity of the antenna, which are given by the author as $0.003 \mu\text{f.}$, and an operat-

⁶ U. S. Patent No. 1578881.

⁷ U. S. Patent No. 1560505.

⁸ U. S. Patent No. 1591025.

*Original Manuscript received by the Institute, September 21, 1927.

† Consulting Engineer, Dubilier Condenser Corporation.

ing frequency of 50,000 cycles, an inductance of about 9.4 millihenrys will be necessary, with a reactance of 1060 ohms at that frequency. Since with the best possible design it is difficult to get a power factor less than 1 per cent on an inductance coil of this magnitude and this frequency, the resistance value would be about 10 ohms and with 1 ampere current the additional losses would be about 10 watts, which must be added to the transmitter power of 27 watts.

Thus the efficiency of the whole system would be now

$$\frac{27}{27+10} = 73 \text{ per cent}$$

If on the other hand instead of antenna a condenser of the same capacity (0.003 μ fds) were used, the current supplied by the inductance coil would be exactly equal to the current put into the line, that is, 0.26 amperes, and the losses in that inductance coil instead of 10 watts, would be only 0.68 watts, giving a total efficiency of

$$\frac{27}{27+0.68} = 97.5 \text{ per cent}$$

These values of efficiency, of course, do not take into account the actual antenna or condenser efficiency; they are simply the values of efficiency as determined by the inductance coil. If as the author claims he can secure an efficiency of 94 per cent to 97½ per cent of the antenna, the above figure of 73 per cent should be multiplied by this antenna efficiency. On the other hand, with condenser coupling the power factor of the condenser is a fraction of 1 per cent and hence the efficiency of the condenser coupling device is more than 99 per cent.

In determining the effective resistance of the antenna in order to establish its efficiency, I further note that the author has apparently disregarded entirely the ground resistance, stating however that these ground losses are likely to be quite appreciable. It is incorrect to state that these "ground losses are not chargeable directly to the mechanism of coupling, but to the existing conditions" since under other conditions such as condenser coupling these ground losses disappear, or under the worst circumstances are reduced 16 times on account of practically 4 times smaller current. To make this clear, assume a resistance in the ground of 5 ohms. In case of antenna coupling, this would produce a loss

of 5 watts and a reduction of efficiency as claimed by the writer from $97\frac{1}{2}$ per cent to

$$\frac{27}{27.76+5} = 82.5 \text{ per cent}$$

giving a total efficiency of

$$82.5 \text{ per cent} \times 73 \text{ per cent} = 60 \text{ per cent}$$

On the other hand with a condenser coupling and assuming as the worst case a ground return with the same resistance of 5 ohms, the current is only 0.26 amperes and the corresponding loss 0.34 watts. Thus, the efficiency instead of 97.5 per cent will be changed to

$$\frac{27}{27+0.68+0.34} = 96.5 \text{ per cent}$$

These figures would give quite a different conclusion from that of the author, showing that the condenser coupling apart from the considerable simplification, in connection, and the improvement on the receiving circuit, would also give an efficiency of 96.5 per cent under worse circumstances, as against 60 per cent on the antenna coupling, or, in other words, the loss with condenser coupling is about 10 times smaller than in antenna coupling.

Review of Current Literature

Prepared by

STUART BALLANTINE

Boonton

New Jersey

FURTHER COMMUNICATION ON THE PROPAGATION OF SHORT-WAVES.*

By

E. QUÄCK

(Berlin)

(*Zeitschrift für Hochfrequenztechnik*, 30, 41, Aug. 1927)

In an earlier communication the occurrence of doubled-signals in the propagation of short waves was reported.¹ For the purpose of calculating the height of the Heaviside layer it was assumed in that paper that the waves were propagated with the velocity of light. According to more recent work,² however, it appears that

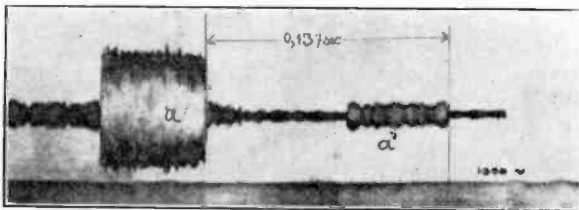

Figure 1—Doubled signals from transmitter SPU, Rio (15.5 m.) a direct signal; a' same signal which has made an additional circuit of the earth. Photographed May 31, 1927; 2135 E. M. T.

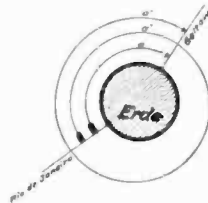

Figure 2—Schematic diagram of the paths taken by the signals shown in Fig. 1.

the velocity of propagation is smaller than the light-velocity; therefore the computed height of the Heaviside-layer will be correspondingly diminished. Consequently, a new determination of the height of the layer should be attempted on the supposition that the wave velocity is dependent upon the index of refraction and the frequency. Repeated observations at Geltow of the signals

* Original Manuscript received by the Institute, October 3, 1927.

¹ E. Quäck, *Zeit. für Hochfrequenztechnik*, 28, 177, 1926: *Proc. Inst. Radio Eng.* 15, 341; 1927.

² A. H. Taylor and E. O. Hulburt, *Phys. Rev.*, 27, 198, 1926. H. Lassen, *Zeit. für Hochfrequenztechnik*, 28, 109, 139, 1926.

radiated at Nauen have yielded values between 0.137 and 0.139 sec. for the time difference between the direct signal and the signal which encircles the earth.

It has been impossible to discover any difference between the transmitters *AGC* ($\lambda = 18.22$ m.) and *AGA* ($\lambda = 14.9$ m.) at Nauen with respect to the time-lag of their direct and doubled signals. It is also remarkable that the doubling in the case of the Nauen transmitter *AGC* could be observed at night (22:00 European Mean Time.) These observations have been supplemented by those of several other observers, notably Dr. Moegel and Mr. Wiesner.

In May the Brazilian Radiotelegraph Company, Rio de Janiero, placed in operation the short-wave beam transmitter

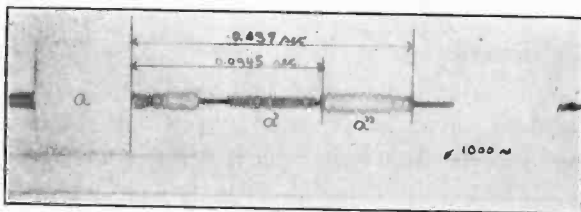

Figure 3—Tripled signal from WIK, Rocky Point (21.45 m.) *a* direct signal; *a'* secondary signal which has gone the other way around the earth; *a''* tertiary signal taking direction of direct signal but making an additional circuit of the earth. Photographed April 10, 1927; 0220 E. M. T.

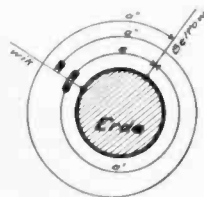

Figure 4—Schematic diagram of paths of signals *a*, *a'*, *a''* shown in Figure 3.

SPU, wavelength 15.66 m., and antenna power of 10 k. w. Strong doubled-signals from this transmitter have been observed from 1300 to 1800 G.M.T. and also from 2045 and 2330 G.M.T. During the latter period time differences between direct and doubled-signals were observed which correspond to a path of the secondary signal around the earth in the same direction as the direct signal, but making a complete additional circulation. The time-difference of this complete circuit amounts to about 0.1365 to 0.140 second. An oscillographically-recorded doubled-signal of this type is shown in Fig. 1; in Fig. 2 are shown the different paths taken by the signals. The direct signal *a* has the path *a* from Rio to Geltow; the doubled-signal *a'* takes the path *a'* from Rio over Geltow finally arriving at Geltow after completing the circuit of the earth. The doubled-signal thus traverses a path compared with that of the direct signal which corresponds to the observed time-difference of 0.137 second.

Fig. 3 illustrates a tripled signal, the possibility of which is brought about by the wave taking a direct path, a path the other way around the earth, and a path of the type just described.

Observations were made on June 10th of this year at about 02:20 E.M.T. on the non-directional transmission of the North American short-wave transmitter *WIK* ($\lambda = 21.45$ m.). From many oscillographic records, of which Fig. 3 is a specimen, the following observations have been made: The direct signal *a* is followed after 0.0945 sec. by the secondary signal *a'* which has taken the other path around the earth to Geltow. After this appears the tertiary signal *a''* which starts out with the direct signal, passes over Geltow, and makes a complete circuit of the earth in this

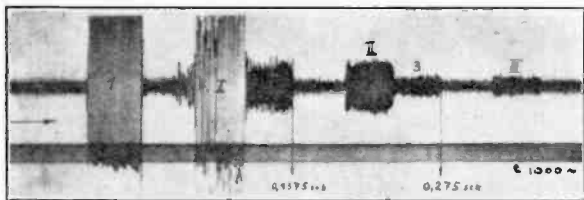

Figure 5—Double circulation around the earth. Tripled signal from *SPU* (15.5 m.), Rio. *I* and *I* direct signals, *2* and *II* signals in direction of direct signal but with additional circuit about earth, *3* and *III* in direction of direct signal but with two additional circulations. Photographed June 27, 1927, E. M. T.

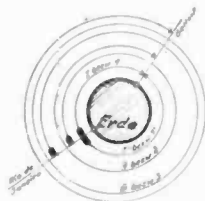

Figure 6—Schematic diagram of paths taken by signals shown in Figure 5.

direction previous to its arrival at Geltow after a time interval of 0.137 to 0.138 second. The amplitude of *a''* is greater than that of *a'* in spite of the longer path. These paths are represented schematically in Fig. 4.

Evidence that the wave may encircle the earth several times is furnished by Fig. 5. This record was obtained with the signals from the Brazilian station *SPU* previously mentioned. This station emits every second two dots spaced about $1/20$ second apart which are photographed as the direct signals *I* and *I*. After 0.1375 sec. the secondary signals *2* and *II* are recorded after their complete circuit around the earth in the direction of the direct signals; after another 0.1375 sec. (or total of 0.275 sec.) the tertiary signals *3* and *III* are registered; these signals have thus twice encircled the earth. The paths are again schematically shown in Fig. 6.

Fig. 7 contains evidence of further signal multiplication, although perhaps not quite so clear and certain. In addition to the

previously described doubled-signals the signals marked I' and I'' are discernible corresponding to waves which have taken the reverse path around the earth as shown in Fig. 6. The remarkable thing about this is that inasmuch as Rio is equipped with directional (beam) antenna system one would not expect to find recordable signals radiated in this direction.³

It appears as if this multiple circulation about the earth occurs with especial facility when the great circle containing the sending and receiving points lies essentially in the zone of twilight. This is especially the case in the Rio observations where this type of signal was nightly encountered from 21:00 to 22:00 E.M.T., at which time the great circle lay directly in the twilight. In daytime

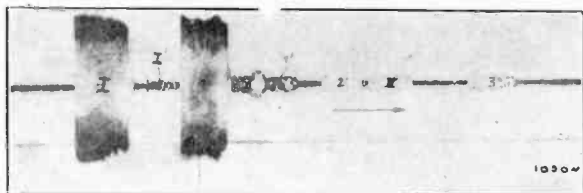

Figure 7—Quadrupled-signal from SPU, Rio (15.5 m.)

there occurred only the ordinary doubled-signals, corresponding to the reverse path around the earth. Up to the present time doubled-signals have been observed in the region of wavelengths extending from 14 to 34 meters. It is astonishing how much energy is still retained by the waves after several circulations around the earth, and it is certainly to be expected that further circulations occur in addition to those here recorded. For the practical use of short-waves, however, there must be found ways and means for avoiding the disturbances of operation occasioned by these "ghost" signals. Their systematic observation will aid in this, as well as contribute to the explanation of the propagation of waves of this type.

S. B.

³[This observation seems to be in agreement with the ideas of L. Bouthillon (*Comptes Rendus*, 184, 190, 1924), who contends that inasmuch as the rays most effective in establishing long range communication are those making a small angle with the zenith and that beam projectors of the type of the Marconi Company at Bodmin radiate less directionally at such angles, the efficacy of such systems becomes less and less from the viewpoint of wave concentration as the distance increases. On the other hand, according to Hulbert's theory waves of this length are totally reflected only if their zenith angles are greater than 60-70 degrees, which would appear to conflict with Bouthillon's small zenith angles. Inasmuch as the precise mode of propagation of Quäck's ghost waves is still very much in doubt it does not yet seem possible to decide between these rival views.—S. B.]

RÉSUMÉ OF PROF. G. W. O. HOWE'S CRITIQUE OF HERR QUÄCK'S COMPUTATIONS

In connection with the extraordinarily interesting and important observations of Herr Quäck on the propagation of short waves the comments of our English contemporary Prof. G. W. O. Howe, contained in an article entitled "Phase and Group-Velocities in an Ionized Medium,"¹ are of interest. A brief résumé of Howe's criticism follows:

Herr Quäck computed the apparent height of the great circle path of the ray corresponding to the oscillographically recorded "double-signal" by multiplying the time difference, as measured upon the oscillogram, by the velocity of light. This turned out to be 182 kms., although with the most recent value of the time interval given by Quäck (0.138 sec., *vide* the above article) the value of 205 kms. appears more accurate. In any event this is considerably greater than the ionic refraction theory and other experimental evidence as to the ionization at various heights would seem to indicate. Prof. Howe suggests that the divergence may be explained by the difference between the group and phase-velocities.

In works on optical theory it is shown that in the case of propagation in a dispersive medium, i.e., one in which the wave (phase) velocity is a function of the frequency, the velocity of a homogeneous group of such waves, measured let us suppose from the head of the group, will be given by:²

$$v_g = \frac{v}{1 - \frac{n}{v} \frac{dv}{dn}} \quad (1)$$

Now in the case of an ionized medium in which dispersion is caused by motion of the electrons, the wave-velocity is given by:

$$v = \frac{c}{\sqrt{1 - \frac{Ne^2c^2}{\pi m n^2}}} \quad (2)$$

the influence of collisions and of the earth's magnetic field not being considered. Hence the group-velocity is:

$$v_g = c\sqrt{1 - (Ne^2c^2)/(\pi mn^2)} \quad (3)$$

¹ *Exp. Wireless*, 4, 259, May 1927.

² See T. H. Havelock; "Propagation of Disturbances in Dispersive Media," *Cambridge Tract*, No. 17, p. 3.

For the group-velocity to differ by 1 per cent from the velocity of light, N , the number of electrons per cc, would have to be 5.6×10^4 ; for a difference of 5 per cent $N = 28 \times 10^4$. These are quite reasonable values for N . Appleton and Barnett deduced for certain conditions a minimum value of N of 100,000 and Appleton has recently deduced a minimum value of 2.5×10^6 . (More recent computations based upon radio transmission measurements yield values of N ranging from $3-6 \times 10^5$).

In view of this, Quäck's value of 182 km. for the height of the Heaviside layer would be reduced to 116.5 kms., for a velocity 1 per cent less than that of light, and to 51 kms. for a velocity 2 per cent less.

Prof. Howe suggests that the result of the experiment is therefore not to determine the height at which the ray travels, but rather to determine from the assumed height the value of electron density in the medium through which the ray travels. N varies but little for widely different assumptions as to the height; an accurate determination of the time taken to encircle the globe would therefore decide within narrow limits the electron density of the medium. Since there are no insuperable difficulties connected with the accurate measurement of the time-differences the method would appear to be a most sensitive and important one for the investigation of this fundamental quantity.

BOOK REVIEW

Principles of Radio Communication by JOHN H. MORECROFT,¹ assisted by A. PINTO² and W. A. CURRY.³ SECOND EDITION, 1001 Pages, Published by JOHN WILEY & SONS, New York. Price \$7.50.

Morecroft's first edition came out just before the broadcasting cyclone struck. For a time many radio men referred to that first edition as their radio bible. But the broadcasting cyclone changed the relative importance of radio matters and sped up radio to such an extent that radio men have been asking why Morecroft did not get out an up-to-date edition. They have been asking that for the past three or four years.

The second edition is out now. The advertising sheets announcing that edition have been sent out, presumably to all members of the Institute; at least, one has been sent to me. A glance at this advertising might give one the impression that the book is chiefly about the old spark type of radio, because about the most conspicuous thing in that advertising is two cuts of one of the neat little spark transmitters which, according to my recollection, Emil J. Simon designed nearly fifteen years ago. They were good spark sets, but they are apt to give that advertising a through ticket to the waste basket, for who wants to buy a book about spark sets now. That is unfortunate because the book is very much more up-to-date than those conspicuous cuts imply.

Chapter V is headed "Spark Telegraphy." That chapter includes 77 of the 1001 pages in the book, and 27 of those 77 pages are about receiving circuits, detectors, head phones, amount of power in sound waves, audibility, and the characteristics of crystal rectifiers. Therefore it will be seen that spark telegraphy is only a minor part of this second edition. The first edition contained twelve more pages on that subject, although the total number of pages in the first edition was less than the total number in this second edition.

Chapter VI is the largest chapter in the book. That chapter takes up 240 pages or nearly one-fourth of the book, and its title

Original Manuscript received by the Institute, October 24, 1927.

¹ Professor of Electrical Engineering, Columbia University; past president of the Institute of Radio Engineers.

² Electrical Engineer, Otis Elevator Co.

³ Assistant Professor of Electrical Engineering, Columbia University.

is "Vacuum Tubes and their Operation." Sparks characterized the past and vacuum tubes characterize the present in radio. From those chapters it will be seen that the authors have tried to make this book as comprehensive and modern as a book can be made.

Presumably to give more room for recent developments, the authors have not only eliminated part of the chapter on spark telegraphy and put more pages in this edition than in the first edition, but they have eliminated chapters X and XII on "Wave-meters and their Use" and "Radio Experiments," which were in the first edition. I believe they should have put in and improved the chapter on "Radio Experiments," because it not only showed how experiments are carried on but included problems to be solved. Such a chapter is valuable to people who are learning about radio and a new group comes along every year to learn about radio.

This edition is divided into ten chapters. Each chapter has a title and is further divided by sub-titles. The titles and sub-titles appear in the table of contents and at the tops of the pages. Also, the sub-titles are included in the index at the back which occupies over twelve pages. This arrangement helps the user to find what he wants. The titles of the chapters are: Fundamentals, Ideas and Laws; Resistance—Inductance—Capacity—Shielding; Laws of Oscillating Circuits; General View of Radio Communication; Spark Telegraphy: Vacuum Tubes and Their Operation in Typical Circuits; Continuous-wave Telegraphy; Radio Telephony; Antennae and Radiation; and Amplifiers.

Broadcast transmitters, receivers and loud speakers are uppermost in many minds at present. These subjects are treated in the chapter on Radio Telephony. Receivers are also treated, for example, in the chapters on Spark Telegraphy and Amplifiers.

The volume is well illustrated on almost every page, some pages carrying several illustrations. Sketches, photographs, circuit diagrams, curves and, best of all, numerous oscillograms are used to show what happens in one, two, or three circuits at one time.

Not only do the authors consider many phases of radio subjects, but they have included numerous references at the bottom of pages, to special papers on those subjects.

The text begins with a discussion of the "Nature of Electricity" taking up "Electrons" as the next subject. The text ends with the diagram and description of an amplifier equipped with transformer, rectifier and filters to take the filament and 350-volt plate power from a 60-cycle line. That is an indication of how modern and comprehensive this book is. It is a big book, too big to describe well enough in this review.

R. H. Marriott

DIGESTS OF UNITED STATES PATENTS RELATING TO RADIO TELEGRAPHY AND TELEPHONY

Issued October 18, to November 15, 1927

By

JOHN B. BRADY

(Patent Lawyer, Ouray Building, Washington, D. C.)

- 1,645,231—ELECTROMAGNETIC SOUND REPRODUCER—FREDERICK DIE-
TRICH, of New York, N. Y., and WILLIAM H. GERNS, East Orange, N. J. Filed
March 5, 1926, issued October 11, 1927. Assigned to Brandes Laboratories, Inc.
- 1,645,483—ELECTROMAGNETIC DRIVER—C. A. BRIGHAM and W. H. GERNS
of East Orange, N. J. Filed August 22, 1925, issued October 18, 1927. Assigned to Brandes
Laboratories, Inc.
- 1,646,292—METHOD OF DIRECTING LIGHT RAYS UPON LIGHT SENSITIVE
ELEMENTS—CLINTON W. HOUGH, Boonville, N. Y. Filed Oct. 22, 1925, issued
Oct. 18, 1927. Assigned to Wired Radio, Inc.
- 1,645,523—CRYSTAL DETECTOR OF ELECTRIC CURRENTS—H. M. DOWSETT,
Colchester, England. Filed Dec. 18, 1920 issued Oct. 18, 1927. Assigned to Radio Corp.
of America.
- 1,645,542—CIRCUIT ARRANGEMENT FOR HIGH FREQUENCY SENDING STA-
TIONS—M. OSNOS, Berlin, Germany. Filed Dec. 27, 1922, issued Oct. 18, 1927. Assigned
to Gesellschaft für Drahtlose Telegraphie.
- 1,645,560—WIRELESS TELEGRAPH RECEIVING APPARATUS—R. A. WEAGANT,
New York, N. Y. Filed April 14, 1920, issued Oct. 18, 1927. Assigned to Radio Corp. of
America.
- 1,645,850—REGULATOR—F. S. BERNHARD, Brooklyn, N. Y. Filed Nov. 22, 1923,
issued Oct. 18, 1927. Assigned to Western Electric Co.
- 1,645,904—ELECTRON DISCHARGE DEVICE—P. GAVIN, National Sanatorium, Tenn.
Filed Aug. 5, 1925, issued Oct. 18, 1927.
- 1,646,152—RADIO CIRCUIT TESTING INSTRUMENT—J. O. KLEBER, Pittsburgh,
Pa. Filed May 20, 1926, issued Oct. 18, 1927.
- 1,646,236—VARIABLE CONDENSER—W. DUBILIER, New York, N. Y. Filed Feb. 14,
1924, issued Oct. 18, 1927. Assigned to Dubilier Condenser Corp.
- 1,646,443—COMPENSATOR FOR RADIO COMPASSES—W. B. BURGESS, Boston,
Mass. Filed Mar. 11, 1921, issued Oct. 25, 1927.
- 1,646,471—STATION RECORDING MEANS FOR RADIO RECEIVING DEVICES
—A. ZILLGER, Narberth, Pa. Filed Dec. 9, 1924, issued Oct. 25, 1927. Assigned to Music
Master Corp.
- 1,646,517—KEY CIRCUIT FOR TUBE SENDERS—W. ZELETSKI, Berlin, Germany.
Filed Mar. 26, 1923, issued Oct. 25, 1927. Assigned to Gesellschaft für Drahtlose Tele-
graphie M. B. S.
- 1,646,626—VACUUM TUBE—H. E. METCALF, San Leandro, Calif. Filed July 23, 1924,
issued Oct. 25, 1927. Assigned to The Magnavox Company, of Oakland, Calif.
- 1,646,633—PROCESS FOR EXHAUSTING DETECTOR TUBES—R. T. ST. JAMES
Chicago, Ill. Filed April 10, 1922, issued Oct. 25, 1927. Assigned to Chicago Miniature,
Lamp Works.
- 1,646,663—CONDENSER—R. C. ROSE, Osceola, Arkansas. Filed Oct. 27, 1926, issued Oct.
25, 1927.
- 1,646,707—ACOUSTIC HORNS—W. R. RESPESS, St. George, N. Y. Filed (original) Dec.
8, 1923; divisional filed Sept. 30, 1924, issued Oct. 25, 1927. Assigned to Brandes Labora-
tories, Inc.
- 1,647,238—ELECTRON DISCHARGE DEVICE—E. H. MANTHORNE, Bayside, N. Y.
Filed June 18, 1925, issued Nov. 1, 1927. Assigned to Bell Telephone Laboratories, Inc.
- 1,647,283—ARRANGEMENT FOR IMPROVING SHORT WAVE RADIATION INTO
SPACE—A. ESAU, Jena, Germany. Filed Oct. 8, 1926, issued Nov. 1, 1927.
- 1,647,290—ANTENNA SWITCHING RELAY—A. HADDOCK, East Orange, N. J. Filed
June 22, 1922, issued Nov. 1, 1927. Assigned to Western Electric Co., Inc.
- 1,647,349—RADIO SIGNALING APPARATUS—H. T. FRIIS, Red Bank, N. J. Filed,
June 9, 1925, issued Nov. 1, 1927. Assigned to Western Electric Co. Inc.
- 1,646,292—MOUNTING FOR ACOUSTIC HORNS—DAVID H. MOSS, Brooklyn, N. Y.
Filed Feb. 13, 1924, issued Nov. 1, 1927. Assigned to Brandes Laboratories, Inc.
- 1,647,364—ELECTRONIC DEVICE—B. F. JANCKE, Brooklyn, N. Y. Filed Oct. 8, 1925,
issued Nov. 1, 1927. Assigned to Manhattan Electrical Supply Co.
- 1,647,474—VARIABLE PATHWAY—F. W. SEYNOUR, Flushing, N. Y. Filed Oct. 25,
1925, issued Nov. 1, 1927.

- 1,647,609—HETERODYNE RECEIVING SYSTEM—W. F. COTTER, Buffalo, N. Y. Filed Feb. 16, 1925, issued Nov. 1, 1927. Assigned to Federal Telephone Mfg. Corp.
- 1,647,617—ELECTRON DISCHARGE DEVICE—T. R. GRIFFITH, Dover, N. J. Filed July 7, 1926 issued Nov. 1, 1927. Assigned to Bell Telephone Laboratories, Inc.
- 1,647,994—ELECTRON DISCHARGE DEVICE—W. G. HOUSKEEPER, of New York, N. Y. Filed October 27, 1922, issued November 8, 1927. Assigned to Western Electric Co., Inc.
- 1,647,996—ELECTRON DISCHARGE DEVICE—F. L. HUNTER, Jr., of Towaco, and SYLVESTER W. CROWLEY, of Weehawken, N. J. Filed January 17, 1924, issued November 8, 1927. Assigned to DeDorest Radio Telephone & Telegraph Co.
- 1,648,183—METHOD AND APPARATUS FOR CONDUCTING CURRENT—K. H. KINGDON, and IRVING LANGMUIR, of Schenectady, New York. Filed December 21, 1922, issued November 8, 1927. Assigned to General Electric Co.
- 1,648,428—MACHINE FOR TESTING ELECTROMAGNETIC SOUND REPRODUCERS—RAY G. STACY, East Orange, N. J. Filed March 18, 1927, issued Nov. 8, 1927. Assigned to Brandes Laboratories, Inc.
- 1,648,293—ELECTRIC DISCHARGE DEVICE—ERNEST E. CHARLTON, of Schenectady, N. Y. Filed original Nov. 29, 1922. Renewed September 23, 1927, issued November 8, 1927. Assigned to General Electric Co.
- 1,648,312—ELECTRON DISCHARGE DEVICE—K. H. KINGDON and IRVING LANGMUIR, of Schenectady, N. Y. Filed November 6, 1923, issued November 8, 1927. Assigned to General Electric Co.
- 1,648,458—ELECTRON DISCHARGE DEVICE AND METHOD OF OPERATING THE SAME—G. M. J. MACKAY and ERNEST E. CHARLTON, of Schenectady, N. Y. Filed August 27, 1926, issued November 8, 1927. Assigned to General Electric Co.
- 1,648,521—RADIO RECEIVING SET—A. WIKSTROM, of Boston, Mass. Filed November 10, 1924, issued November 8, 1927. Assigned to Flash Radio Corp.
- 1,648,592—WIRELESS APPARATUS—L. R. RUOFF, of Syracuse, N. Y. Filed January 11, 1923, issued November 8, 1927. Assigned one-fourth to Howard P. Denison and one-fourth to Eugene A. Thompson, of Syracuse, N. Y.
- 1,648,682—VARYING FREQUENCY SYSTEM OF RADIOSIGNALING—J. H. HAMMOND, Jr., of Gloucester, Mass. Filed June 28, 1923, issued November 8, 1927.
- 1,648,835—TWO-WAY RADIO COMMUNICATION SYSTEM—P. WARE, of New York, N. Y. Filed September 4, 1920, issued November 8, 1927. Assigned to Ware Radio, Inc.
- 1,648,689—CONDENSER TRANSMITTER—AUGUST HUND, Bethesda, Maryland. Filed Apr. 10, 1926, issued Nov. 1, 1927. Assigned to Wired Radio, Inc.
- 1,648,941—MANUFACTURE OF OXIDE-COATED CATHODES—WILLIAM BENJAMIN GERO and GEORGE WILSON HALLOCK, Bloomfield, N. J. Filed July 16, 1926, issued Nov. 15, 1927. Assigned to Westinghouse Electric & Mfg. Co.
- 1,648,958—EVACUATED DEVICE AND METHOD OF EXHAUST—RALPH E. MYERS, East Orange, N. J. Filed May 5, 1923, issued Nov. 15, 1927. Assigned to Westinghouse Electric & Mfg. Co.
- 1,649,016—OLIVER E. BUCKLEY, Maplewood, N. J. Filed Dec. 13, 1917 (original) renewed Apr. 9, 1927, issued Nov. 15, 1927. Assigned to Westinghouse Electric & Mfg. Co.
- 1,649,122—OSCILLATION GENERATOR—SIEGMUND LOEWE, Berlin, Germany. Filed Sept. 2, 1921, issued Nov. 15, 1927. Assigned to Westinghouse Electric & Mfg. Co.
- 1,649,131—TUNING ARRANGEMENT FOR RADIO COMMUNICATION—C. SCHWARZ, Charlottenburg, near Berlin, Germany. Filed Oct. 31, 1921, issued Nov. 15, 1927. Assigned to Westinghouse Electric & Mfg. Co.
- 1,649,391—PROTECTIVE SYSTEM FOR HOT CATHODE DEVICES—R. L. DAVIS, Wilkensburg, Pa. Filed June 23, 1925, issued Nov. 15, 1927. Assigned to Westinghouse Electric & Mfg. Co.
- 1,649,489—VACUUM TUBE—H. J. ROUND, London, England. Filed July 9, 1921 issued Nov. 15, 1927. Assigned to Radio Corp. of America.
- 1,649,499—RECEIVING ARRANGEMENT FOR WIRELESS TELEGRAPHY—G. G. VON ARCO, Berlin, Germany. Filed April 30, 1923, issued Nov. 15, 1927. Assigned to Gesellschaft fur Drahtlose Telegraphie.
- 1,649,510—WIRELESS INSTALLATION ON VEHICLES SUCH AS AUTOMOBILES—N. H. CLOUGH, London, England. Filed Oct. 23, 1923, issued Nov. 15, 1927. Assigned to Radio Corp. of America.
- 1,649,727—AERIAL FOR RADIO RECEPTION—C. F. PEITZMAN, Grimes, Iowa. Filed May 5, 1926, issued Oct. 15, 1927.
- 1,649,778—MEANS FOR AND METHOD OF CHANGING THE INTENSITY OF SIGNALS IN RADIO DYNAMIC RECEIVING SYSTEMS—J. H. HAMMOND, Jr. and E. L. CHAFFEE, of Gloucester, Mass. and Belmont, Mass. respectively. Filed (original) June 27, 1917, renewed May 31, 1924, issued Nov. 15, 1927. Chaffee assigned to Hammond.
- 1,649,257—SUSPENSION FOR ARMATURES OF ELECTROMAGNETIC SOUND REPRODUCERS—C. R. ROWE and W. H. GERNS, of East Orange, N. J. Filed Aug. 7, 1925, issued Nov. 15, 1927. Assigned to Brandes Laboratories, Inc.
- Des. 73,878—RADIO CABINET—DAVID S. SPECTOR, New York, N. Y. Filed June 22, 1927, issued Nov. 15, 1927. Assigned to Federal Telegraph Co.
- Des. 73,879—RADIO CABINET—DAVID S. SPECTOR, New York, N. Y. Filed June 22, 1927, issued Nov. 15, 1927. Assigned to Federal Telegraph Co.

GEOGRAPHICAL LOCATION OF MEMBERS ELECTED November 2, 1927

	Transferred to the Fellow grade	
New York	New York City.....	Armstrong, E. H.
	Transferred to the Member grade	
Massachusetts	Cambridge.....	Burke, C. T.
New Jersey	Newark.....	Royden, George T.
New York	Ithaca.....	Bullard Wm. C.
	New York City.....	Lush, W. G.
Ohio	Cincinnati.....	Jarvis, K. W.
England	London.....	Strong, Chas. E.
	Elected to the Member grade	
England	London.....	Durrant, R. F.
	London.....	Glover, Philip F.
France	Paris.....	Roosevelt, H. L.
	Elected to the Associate grade	
California	Glendale, 1126 E. California Ave.....	Engen, R. E.
	Los Angeles, 1025 W. 78th Street.....	Appleton, H.
	San Diego, 1346-39th Street.....	Wisner, F. L.
	Stockton, Box 730.....	Harvey, V. L.
Colorado	Colorado Springs, P. O. Box 316.....	Bergman, L. J.
	Denver, 1538 Gilpin Street.....	Painter, Chas. E.
	Denver, Western Union Tel. Co.....	Rowe, F. S.
Connecticut	Hartford, 191 Lawrence Street.....	Angello, A. A.
	Storrs, Connecticut State College.....	Pownall, R. F.
Dist. Columbia	Washington, 4828 Sixteenth St. N. W.....	Bliss, A. O., Jr.
Georgia	Columbus, 161-13th Street.....	Ray, Fred
	Macon, City Hall.....	Rankin, G. P. Jr.
Illinois	Chicago, 5709 So. Spaulding Ave.....	Campbell, D. O.
	Chicago, 3982 Barry Avenue.....	East, John E.
	Chicago, Randolph & Canal Sts. e. o Butler.....	Kamin, Vernon
	Chicago, 9402 Ewing Ave., RCA Radio WGO.....	Newell, L. T.
	Galesbury, 1347 W. Main Street.....	Bellinger, C. E.
	Geneva, Riverbank Laboratories.....	Crozier, Wm. D.
	Streator, 115 S. Vermillion St.....	Williams, N. B.
Iowa	Marshalltown, 503 N. Second Ave.....	Pickett, E. L.
Kansas	Atchison, 324 Santa Fe.....	Moore, E. A.
	Wichita, 355 North Estelle.....	Lyons, S. J.
Kentucky	Weeksburg.....	Hines, O. T.
Louisiana	New Orleans, 321 St. Charles Street.....	Carrington, L. E.
	New Orleans, 1633 Bordeaux Street.....	Gidiere, Philip
	New Orleans, 3813 Cleveland Avenue.....	Sweetman, J. M.
Massachusetts	Dorchester, 37 Bailey Street.....	Gurney, Wm. S.
	Mattapan, 160 Brook Road.....	Weber, H. C.
	Newton, 13 Newtonville Avenue.....	Wilson, T. C.
	No. Attleboro, 9 Elm St.....	Langlais, G.
	Siasconset.....	Holden, H. H.
	Somerville, 22 Oxford St.....	Cook, W. H.
Michigan	Ann Arbor, 713 E. University Ave.....	Swain, Robt. R.
	Detroit, 5479 Stanton Avenue.....	Manning, S. R.
	Mt. Pleasant, 518 So. Kinney Ave.....	Wilbur, D. A.
Nebraska	Omaha, 417 South 13th Street.....	Crawford, J. B.
New Jersey	Cliffwood, Box 31.....	Mutch, W. W.
	Maplewood, 28 Cypress Street.....	Courter, G. H.
	Newark, 151 North 12th St.....	Glauber, J. J.
New York	Albany, 96 Ontario Street.....	Kaiser, F. J.
	Bronx, 140th St. & Rider Ave., N. Y. Edison.....	Smith, Henry
	Brooklyn, 623 45th St.....	Briggs, H. F.
	Brooklyn, 65 Pineapple St.....	Milania, Clarence
	Buffalo, 155 Dundee St.....	Barker, H. T.
	Buffalo, 56 Hedley Place.....	Butler, S. J.
	Buffalo, 158 Box Avenue.....	Fox, R. A.
	Buffalo, 24 Hoffman Place.....	Goss, Edward A.
	Buffalo, 77 Grey Street.....	Stevens, F. B.
	Buffalo, 331 Sherman Street.....	Tellak, T. J.

New York	Buffalo, 240 Rodney Avenue	Wemple, C. V.	
	Buffalo, 75 Putnam St.	Wingert, L. E.	
	Riverhead, L. I., c/o Radio Corp. of America	Colvin, R. S.	
	Rockville Centre, L. I., 19 Clinton Ave.	Costello, J. C.	
	Freeport, L. I., 209 N. Long Beach Ave.	O'Neill, John	
	New York City, 602 W. 139th St.	Glenn, P. R.	
	New York City, 1079 Washington Ave.	Hills, B. E.	
	New York City, 370 Seventh Ave.	Nelson, J. R.	
	New York City, 604 W. 112th St.	Seckel, Wm.	
	New York City, 66 Broad St.	Shore, Henry	
	New York City, 30 Broad Street	Truax, John	
	Peekskill, 1115 Cortland St.	Wombacher, J. A.	
	Scotia, R. F. D. No. 2	Baker, J. O.	
	Ohio	Akron, 1077 Sixth Avenue	Werhan, A. B.
Canton, 523 Case Place, N. W.		Catterhall, J. B.	
Cleveland, 392 East 147th St.		Butler, Roy	
Cleveland, 2419 East 79th St.		Jenkins, Myron	
Cleveland, 623 St. Clair Ave., N. W.		Mc Mullen, F. C.	
Cleveland, 1006 Rockefeller Bldg.		Wise, W. B.	
Lakewood, 14802 Clifton Blvd.		Satterthwaite, Wm.	
Lakewood, 1392 Webb Road, Apt. 11		Van Voorhis, M. G.	
Salem, 14 Penn Street		Strawn, J. D.	
Youngstown, 157 Rhoda Avenue		Remedio, Dominic	
Pennsylvania		Bradford, 65 State Street	Francis, T. C.
	Corry, 143 Maple Avenue	Caldwell, Dan	
	Drexel Hill, 712 Blythe Ave.	Willard, J. M.	
	Greenville, 299 Clinton Street	Bradshaw, G. R.	
	Harrisburg, 60 S. Cameron St.	Mc Cachren, W. S.	
	Harrisburg, 1328 Vernon Street	Roland, A. W.	
	Harrisburg, 1614 N. 6th Street	Shane, John	
	Harrisburg, 324 So. 16th Street	Sours, M. D.	
	Harrisburg, 1603 Derry Street	Stormfeltz, S. H.	
	Matamoras, P. O. Box 119	Willers, T. H., Sr.	
	Monessen, P. O. Box 1488	Chuberka, Chas.	
	Norristown, Clearfield Ave., R. D. No. 1	Rue, Wm. F.	
	North Braddock, 1426 Ridge Ave.	Barden, Wm. S.	
	Philadelphia, 4932 N. Fairhill St.	Cain, Robt. E.	
	Philadelphia, 807 Catharine St.	Murni, Joseph	
	Pittsburgh, P. O. Box 24, North Side P. O.	Molk, F. T.	
	Pittsburgh, 5510 Baum Blvd.	Phillips, J. H., Jr.	
Washington, George Washington Hotel	May, Samuel		
Yeadon, Del. Co., 414 Holly Road	Mae Nicholl, A. J.		
South Carolina	Charleston, 188 Tradd Blvd.	Zeigler, T. W.	
	Texas		
Texas	Childress, P. O. Box 92	Hughes, R. E.	
	Lufkin	Hackney, V. C.	
	Pampa, Box 698	Groves, W. M.	
Utah	Salt Lake City, Station KDYL	Albert, John	
Washington	Seattle, 8237 Stroud Avenue	Zaluskey, E. R.	
Wyoming	Casper, 232 East 2nd Street	Martin, Donald E.	
Alaska	Seward	Martin, John, P.	
Canada	Ont., Niagara Falls, 1171 McGlashan Cres.	Brunton, Albert	
	Ont., Windsor, 428 Oak Avenue	Dresser, Carl	
	Ont., Hamilton, 34 Kensington Ave. S.	Emery, Fred	
	Ont., Hamilton, 179 Ottawa St. S.	Shrive, Frank	
	Quebec, Montreal, 260 Prud'honue Ave.	Goldin, H. C.	
	Ont., Toronto, 1186 Ossington Ave.	Mc Hale, Thos.	
	Ont., Toronto, 55 Dagmar Ave.	Mock, E. E.	
	Ont., Toronto, 100 Harvie Avenue	Wilkinson, J.	
	England		
	England	Essex, Westeliff, 839 London Road	Eldred, E. M.
London, E. C. 3, Wireless Dept., T. Oakbank		Pilling, John	
London, W. 14, 47 West Kensington Mansions		Tiltman, R. F.	
Surrey, Thornton Heath, 52 Limpsfield Ave.		Hughes, D. D.	
Surrey, Wallington, 15 A Onslow Gardens		Snurthwaite, F.	
Wilt, Swindon, 82A Croft Road	Matthews, L. A.		
Isle of Wight	Ryde, Esplanade, Royal Eagle Hotel	Turtle, J. P.	
Japan	Fukushimaken, Haranomachi, Shutehojo	Kobayashi, Miehiji	
	Fukushimaken, Haranomachi, Nippon Musen	Ono, Shoji	
	Fukushimaken, Haranomachi, Nippon Musen	Sakai, Sadao	
	Tokyo, Kojimachi, 48 Shimorokubancho	Kato, Y.	
	Tokyo, Nippon Musen Denshin Kaisha	Kobayachi, Riuji	
	Tokyo, Nippon Musen Denshin Kaisha	Kusukari, T.	
Tokyo, Nihon Musen Denshin Kabushiki	Taguchi, Minoru		
New Zealand	Auckland, G. P. O. Box 532	Burrell, Robt.	
	Auckland, P. O. Box 779	Sangster, R. L.	
Russia	Nijni-Novgorod, % State Bank	Grzybowski, W.	

Scotland	Dundee, 9 Commercial Street	Brown, R. B.
	Dundee, Broughty Ferry, 6 Home Terrace	Jamieson, Wm. E.
South Africa	Johannesburg, Box 4576	Myers, H.
Wales	Montgomeryshire, Welshpool, Greespluan	Bond, A. E.

Elected to Junior grade

California	Los Angeles, 1259 S. Harcourt Ave.	Zweiger, Owen
Connecticut	Storrs, Conn. Agricultural College	Van Heiningen, W. A.
Louisiana	Lake Charles, 1020 Kirby Street	Lake, Thornton
Maine	Yarmouth, Gilman Street	Wright, Louis
Massachusetts	Somerville, 47 Hancock Street	Ekstrand, E. B.
New York	Jamaica, Locust Manor, 117-19 168th St.	Voigt, George
	Staten I., Pier 13, U. S. S. Bouwell, C. G.	Hagan, E. J.
Pennsylvania	Bellevue, 30 E. Orchard Ave.	O'Shea, J. G.
Texas	Dallas, 3100 Live Oak Street	Honnel, Pierre M.
Canada	Quebec, Magag, Stanstead Co., 20 Victoria St., Bergeron, J. C	
China	Shanghai, 21 Kiaochow Road	Sucz, Robert

AS
you want them
WHEN
you want them

That's the kind of service
you will always get on

**Radio
Transformers**

when you place your trust
in *Thordarson*. There are no
better custom made radio
transformers for all uses
than those made by Thor-
darson—with ample manu-
facturing facilities and well
known engineering skill be-
hind them, plus

PROMPT DELIVERY
and
RIGHT PRICES

THORDARSON
RADIO
Supreme in Musical Performance
TRANSFORMERS

THORDARSON ELECTRIC MANUFACTURING CO.
Transformer specialists since 1895
WORLD'S OLDEST AND LARGEST EXCLUSIVE TRANSFORMER MAKERS
Chicago, U.S.A. (3570)

When writing to advertisers mention of the Proceedings will be mutually helpful.

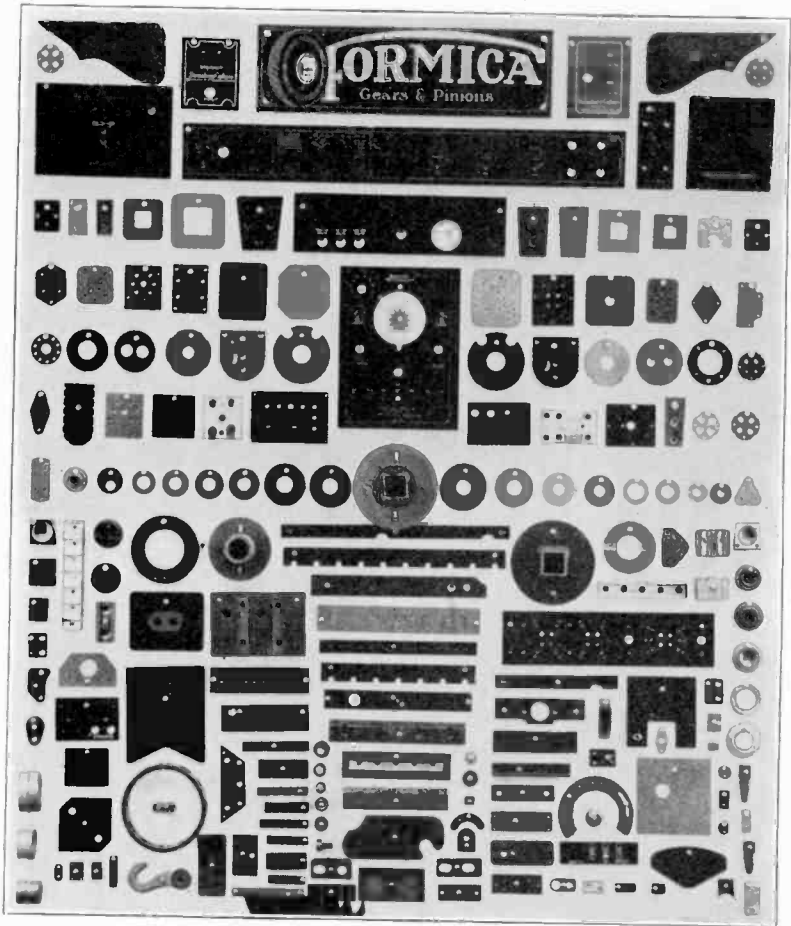

Formica Parts for Many Purposes

Formica is provided for all sorts of radio electrical and mechanical purposes in a great variety of shapes and sizes—punched, drilled and machined in a variety of ways. It combines excellent quality as an insulator for high or low frequency work, with mechanical strength, immunity to moisture, absorption and chemical inertness.

THE FORMICA INSULATION COMPANY

646 Spring Grove Avenue, Cincinnati, Ohio

Hear the
FORMICA
Orchestra Tuesday 9
to 10 over
WLW

FORMICA
Made from Anhydrous Bakelite Resins
SHEETS TUBES RODS

Formica has a
Complete Service
on Insulating Material for Radio
Manufacturers

When writing to advertisers mention of the Proceedings will be mutually helpful.

X

A New Standard of A-C Operation With Arcturus A-C Tubes

The unique advantages which we claim for Arcturus A-C Tubes are directly traceable to unique features of construction and exceptional operating characteristics.

The exceptionally long life of Arcturus Tubes is due to the enormous electron supply, resulting from the heater operating at a low temperature.

The highly efficient cathode is responsible for the unusual sensitivity of Arcturus A-C Tubes and for the exceptional volume and tone quality which their use insures. This cathode produces: 1. A high amplification factor (10.5). 2. A low plate impedance (9,000 ohms). 3. A high mutual conductance (1160 micromhos).

Since the base of the Arcturus A-C Tube is of the standard four-prong type, no additional terminals are required, making Arcturus Tubes adaptable to existing circuits with all the simplicity of D-C tubes. No center taps or balancing are required. A common toy transformer may be used. Filament voltage is the same (15 volts) for all types, detector, amplifier and power.



The freedom from hum which is one of the most important features of Arcturus A-C Tubes, is due to the use of low A-C current, only 0.35 ampere. Arcturus Tubes in all stages are four element tubes with indirectly heated cathodes.

Normal variations in line voltage do not affect the operation of Arcturus A-C Tubes. The amplification factor is practically constant over a wide range of filament voltages—13.0 to 18.0 volts.

ARCTURUS RADIO COMPANY, INC.
255 Sherman Avenue, Newark, N. J.

When writing to advertisers mention of the Proceedings will be mutually helpful.

A.C. radio receivers in the D.C. Districts? *Certainly!* with an "ESCO" dynamotor or motor-generator —

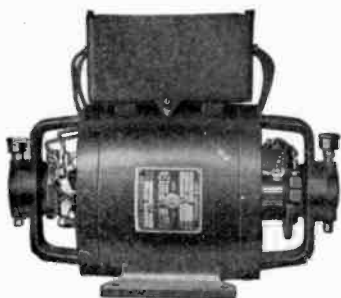

Dynamotor with Filter for
 Radio Receivers

The type R143 rotary converters are suitable for phonographs with vacuum tube amplifiers such as the Orthophonic Victrolas and Brunswick Panatropes without radio receivers. No filters are required.

The dynamotors and motor generators are suitable for radio receivers and for combination instruments containing phonographs and receivers. Filters are usually required. The dynamotors and motor-generators with filters give as good or better results than are obtained from ordinary 60-cycle lighting sockets. They are furnished completely assembled and connected and are very easily installed.

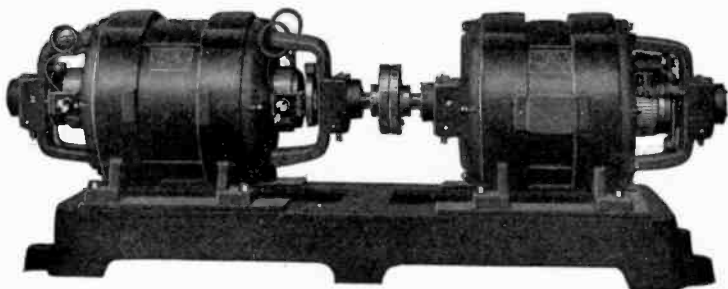

"ESCO" two and three unit sets have become the accepted standards for transmission. The "ESCO" line consists of over 700 combinations. These are covered by Bulletin 237D.

Our engineers are always willing to cooperate in the development of special sets.

"ESCO" is the pioneer in designing, developing and producing Generators, Motor-Generators, Dynamotors and Rotary Converters for all Radio purposes.

How can "ESCO" Serve You?



ELECTRIC SPECIALTY COMPANY

TRADE "ESCO" MARK



300 South Street

Stamford, Conn.

When writing to advertisers mention of the Proceedings will be mutually helpful.

Enameled Magnet Wire



Elongation Test

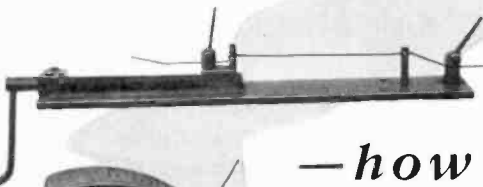

Mercury Bath Test

A positive method of detecting and guarding against imperfections in the enamel insulation.

—how would YOU test it?

Regardless of how varied or severe your tests might be, Dudlo enameled wire has already been subjected to a series of scientific tests at the factory, covering every physical or electrical characteristic required for any purpose.

Besides the four tests illustrated here, a number of others regularly employed including the "Ageing" test to determine the ability of the enamel to stand up under heat over continued use—also the "Insolubility" test proving the qualities of the insulation to resist the effects of oil, water, varnish, etc.

Thus Dudlo protects the quality of *your products* by constantly maintaining the highest possible standard of its own.

Reactance Test

Determines the softness of the wire. Checks the completeness and uniformity of the annealing.

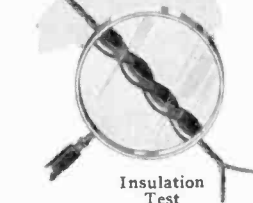
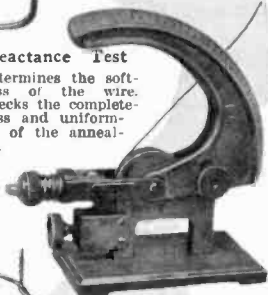

Insulation Test

Measures the dielectric strength of the enamel insulation by determining the voltage required to break it down.

DUDLO

DUDLO MANUFACTURING CORPORATION, FORT WAYNE, INDIANA

56 Earl Street Newark, N. J. 160 North La Salle Street Chicago, Ill. 4153 Bingham Ave. St. Louis, Mo. 274 Brannan St. San Francisco, California

When writing to advertisers mention of the Proceedings will be mutually helpful.

PROFESSIONAL ENGINEERING DIRECTORY

For Consultants in Radio and Allied Engineering Fields

The J. G. White Engineering Corporation

Engineers—Constructors

*Builders of New York Radio
Central*

Industrial, Steam Power, and Gas
Plants, Steam and Electric Rail-
roads, Transmission Systems.

43 Exchange Place New York

Q R V RADIO SERVICE, Inc.

JOHN S. DUNHAM
J. F. B. MEACHAM

*Devoted to Servicing Broadcast
Receivers Exclusively*

1400 BROADWAY, NEW YORK
WISCONSIN 9780

Need Trained Radio Men?

Our Employment Department can supply thoroughly trained, experienced Radio Mechanics, Salesmen, Assemblers, Repairmen, Operators, etc.

No charge to employer or employee. If you need expert Radio help, let us recommend some one from our list. Bulletin of available men sent upon request.

National Radio Institute
Dept. I.R.E., Washington, D. C.

BRUNSON S. McCUTCHEN

Consulting Radio Engineer

17 State Street
NEW YORK

Electrical Testing Laboratories

Electrical, Photometrical,
Chemical and Mechanical
Laboratories

RADIO DEPARTMENT
80th St., and East End Ave.
New York, N. Y.

J. E. JENKINS and S. E. ADAIR Engineers

Broadcasting Equipment
General Radio Telephone
Engineering

1500 N. DEARBORN PARKWAY
CHICAGO, ILLINOIS

Radio Fundamental Co. Hearst Square Chicago

Specializing in radio and allied problems—both mathematical and practical. Analysis. Criticisms. Economical production. Expert designing. Radio power supply. Small and large tube design. Also plant construction. Photo electric problems. Set design. Translations. Patent problems. Cost systems, etc. Write us in confidence.

John Minton I. G. Maloff

JOHN MINTON, Ph.D. Consulting Engineer

for
Developing — Designing —
Manufacturing
of

Radio Receivers, Amplifiers, Transform-
ers, Rectifiers, Sound Recording and
Reproducing Apparatus.

Radio and Electro-Acoustical
Laboratory

8 Church St. White Plains, N. Y.

When writing to advertisers mention of the Proceedings will be mutually helpful.

The new Kolster Radio Compass provides

Greater Safety—
Visual Bearings—
Simple, Positive Operation

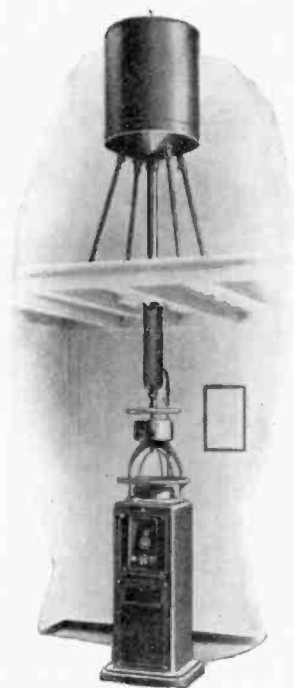

From its aluminum pedestal to the new enclosed loop, the new Kolster Radio Compass [Type AM 4490] embodies every improvement radio science has to offer. The insulated cylindrical housing of the loop affords complete protection against wind, ice, snow, and spray. A tiny lamp flashes the signals of nearby stations. While for long-distance bearings, a Kolster eight-tube receiver with a new circuit especially designed for radio compass work provides the maximum of selectivity and sensitiveness.

No knowledge of radio is necessary to operate the Kolster Radio Compass. It is built for the navigator. The positive unidirectional indicator gives instantaneous readings without guesswork or computation. A new and improved Kolster automatic compensator corrects all natural errors, and makes *direct* readings absolutely accurate.

Kolster Radio is also setting new standards of performance in brose

FEDERAL-BRANDES, INC.
200 Mt. Pleasant Avenue
Newark, N. J.



In the Still of the Arctic Night

IN THE STILL of the Arctic night, broken only by the occasional bark of a far-off walrus, the Radio Operator cannot leave his ship, frozen into the ice pack, and run around the corner to the Radio Shack for a new filter condenser to replace the one that just blew out.

He has got to be sure when he starts that his equipment is not going to give out.

That is why Cliff Himoe took TOBE Condensers with him on the *Bowdoin* for the MacMillan Arctic Expedition.

Here is a Radio message just received from the boat: The TOBES are up to the mark!

"YOUR FILTER CONDENSER STANDING UP WELL ON BOWDOIN'S TRANSMITTER, WITH NO SIGNS OF TROUBLE AT CONTINUOUS 2000 VOLTS D.C. REGARDS FROM THE ARCTIC."

HIMOE WNP

The University-of-Michigan-Greenland Expedition is also equipped with TOBE Condensers.

Make sure that your Radio Power Equipment includes TOBE Condensers. TOBE Condensers cure condenser worries permanently and painlessly.

Tobe Deutschmann Co.

Cambridge :: Mass.

When writing to advertisers mention of the Proceedings will be mutually helpful.

Farrand

B

ELIMINATOR

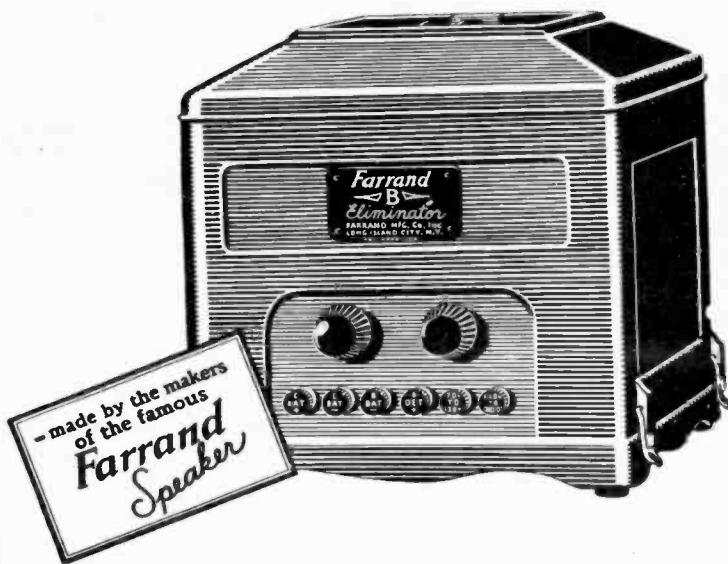

KNOWN QUALITY

When writing to advertisers mention of the Proceedings will be mutually helpful.

for better Radio Reception

Irrespective of the receiving circuit employed, it can be materially improved by micrometric resistance, or simply specifying

VOLUME CONTROL CLAROSTAT

This device is compact, good looking, inexpensive and handy. It is becoming most popular in manufactured, custom-built and home-made radio sets as a volume control and as a plate voltage control for r.f. and detector tubes. It may be applied as a loud-speaker control. It serves to match transformers for best tone quality. It can be used as a tone control in conjunction with a fixed condenser. It is an ideal micrometric control of regeneration particularly on short waves.

The Volume Control Clarostat has a resistance range of practically zero to 500,000 ohms in several turns of the knob. It has ample current-carrying capacity for receiver applications. It is silent in operation. One-hole mounting. Convenient terminals. Absolutely dependable. *And only \$1.50.*



Of course you must continue to specify the Standard Clarostat for B-eliminator applications, the Heavy-Duty Clarostat for line-voltage control, and the Power Clarostat for heavy-duty B-power units, A-B-C radio power units, electrified sets, and other applications.

There's a Clarostat for every purpose. Make sure, however, you specify and get genuine Clarostats, with the name CLAROSTAT stamped on the shell. Don't jeopardize your engineering and production by utilizing questionable resistors!

Write us for data on all types and ranges of Clarostats, and place your resistance problems up to us.

AMERICAN MECHANICAL LABORATORIES, INC.
MEMBER RMA Specialists in Variable Resistors
285 N. Sixth St., BROOKLYN, N. Y.

—CLAROSTAT—

When writing to advertisers mention of the Proceedings will be mutually helpful.

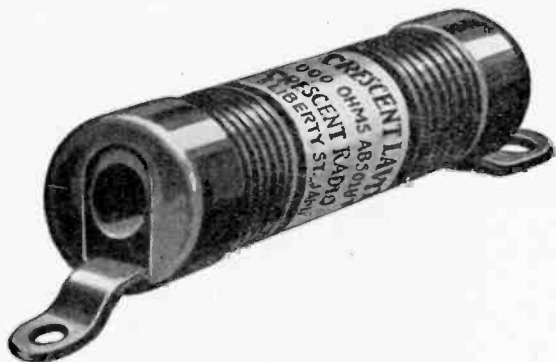

Crescent Lavite

is the pioneer resistance and still in the van. Economical in size but gluttons for punishment

Used by U. S. Government, General Electric Co., Bell Telephone Laboratories, Westinghouse Electric and Manufacturing Co., and ninety broadcast stations.

Write for data which will be supplied on request.

Cresradio Corporation

166-32 Jamaica Ave., Jamaica, N. Y.

**CRESCENT
LAVITE
RESISTANCES**

When writing to advertisers mention of the Proceedings will be mutually helpful.

◆ RADIO PARTS ◆

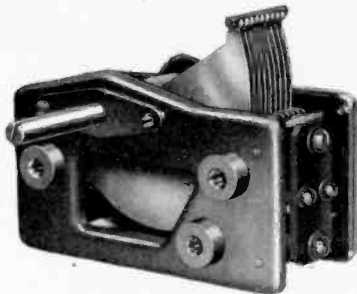

Hidden parts of delicate construction—heart of the radio. How truly present-day “music of the spheres” depends on mechanical exactness for proper reception! Scovill accuracy in fabrication and capacity for large-scale production bring radio manufacturers to us as a matter of course.

A SCOVILL PRODUCT

Scovill is the name of a broad service to industry. It places acres of factories, forests of machinery, hosts of skilled workmen, metallurgists, modern laboratories and trained representatives at the disposal of those who require parts or finished products of metal. Why not see how Scovill can serve you? Call our nearest office.

THESE ARE SCOVILL PRODUCTS

Made to Order: Condensers, Variable and Variable Vernier and parts for same, Metal Stampings, Screw Machine Products, Switches, Decorated Metal Radio Panels, Parts from Brass, Steel and Aluminum. *Carried in Stock:* Butts and Hinges, Continuous Hinges, Machine Screws. *Brass Mill Products:* Sheet, rod, wire, tubing.

SCOVILL MANUFACTURING COMPANY Waterbury Connecticut

New York, Boston, Chicago, Providence, Philadelphia, Cleveland,
San Francisco, Los Angeles, Atlanta, Cincinnati, Detroit

Member, Copper and Brass Research Association



When writing to advertisers mention of the Proceedings will be mutually helpful.

XX

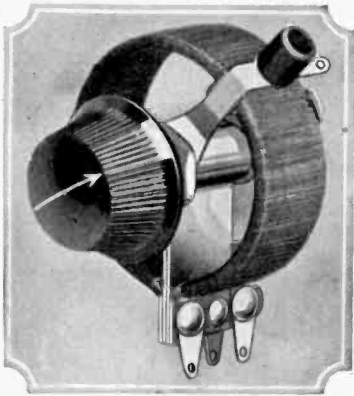

*Greater Efficiency
and Economy*

in

**“B” Eliminator
Resistances**

THE new Centralab 4th Terminal Potentiometers have two variable contact arms on each unit. Two of these units in series will provide complete voltage regulation for any “B” power supply without additional fixed resistors or variables. One additional unit will provide two “C” bias taps when desired. The economy is apparent in that there are fewer units to buy, and less assembly time to mount them on the panel.

Centralab 4th Terminal Potentiometers are wire wound on a frame of metal and asbestos. They will safely dissipate in excess of 30 watts without break down. This high current carrying capacity makes possible a low total resistance across the “B” supply, giving much better voltage regulation than the high resistances normally used, and sufficient current load on open circuit to substantially lessen the danger of condenser break down.

Fourth Terminal Potentiometers are wire wound in resistance values up to 6000 ohms. The diameter is 2", depth $\frac{3}{4}$ ". They are recommended as the best and most economical of available “B” power voltage controls.

Where smaller units must be used because of small panel space, there are other Centralab wire wound potentiometers with diameters of $1\frac{5}{8}$ " and $1\frac{3}{8}$ " respectively that can be furnished in resistances up to 20,000 ohms, and variable high resistances up to 500,000 ohms.

*Complete information and circuit data
will be gladly mailed to those interested.*

Central Radio Laboratories
16 Keefe Avenue, Milwaukee, Wisconsin

Centralab

When writing to advertisers mention of the Proceedings will be mutually helpful.



New Instruments for A. C. Operation

TO meet the new need, Weston has developed the Model 528 A.C. instruments—small, compact and portable—for testing A.C. operated radio sets.

These instruments represent a distinct achievement in high-grade, small A.C. meter design and construction. They are responsive and excellently damped, may be used continuously at full scale reading, have open scales and are accurate on any commercial frequency. They are made as Voltmeters and Ammeters, the former having an exceptionally high internal resistance, self-contained in double ranges up to 600 volts.

So that they may be readily distinguished from Model 489, their companion D.C. instruments, these new A.C. Portables have red and black mottled bakelite cases instead of the plain black.

Circular J, a very complete little catalogue covering the entire line of Weston Radio Instruments, will be mailed upon request. Everyone interested in radio will find it a valuable reference.

WESTON ELECTRICAL INSTRUMENT CORPORATION
73 Weston Ave. Newark, N. J.



When writing to advertisers mention of the Proceedings will be mutually helpful.
XXII

(Fill in and mail to the Institute of Radio Engineers,
37 West 39th Street, New York, N. Y.)

To the Committee on War Memorial for American Engineers:

The undersigned, a member of the Institute of Radio Engineers, encloses herewith a donation to the fund for the creation of a war memorial to American Engineers who gave their lives in service out of this country during the World War.

(Name)

(City)

(State)

The following members of the Institute of Radio Engineers are known to have given their lives in service outside this country during the war:

Name

Died at

_____	_____
_____	_____
_____	_____
_____	_____

When writing to advertisers mention of the Proceedings will be mutually helpful.

Service to Manufacturers



MILLIONS of Fast condensers are in daily use in radio sets made by leading set manufacturers. They offer conclusive proof as to their extraordinarily high insulation resistance and excellent electrical characteristics. Special one-piece die-press steel housing seals and protects them permanently from climatic conditions or abuse. Built for endurance, long life and reliability.

Manufacturers looking for a dependable source of supply will find here one of the largest organizations of its kind in the world. Specialization keeps our costs low and quality high.

Send us your specifications. We make everything in the condenser line.

JOHN E. FAST & CO.

Established 1919

3982 BARRY AVE., Dept. I.R.E., CHICAGO, ILL.

When writing to advertisers mention of the Proceedings will be mutually helpful.
XXIV

Alphabetical Index to Advertisements

A	
Allen-Bradley Co.	XXVI
American Mechanical Laboratories, Inc.	XVIII
American Transformer Co.	III
Arcturus Radio Company.	XI
B	
Bakelite Corporation	VII
Burgess Battery Co.	VI
C	
Central Radio Laboratories.	XXI
Cresradio Corporation	XIX
Cunningham, E. T., Inc.	Inside Front Cover
D	
Dudlo Manufacturing Corporation.	XIII
E	
Electric Specialty Co.	XII
F	
Farrand Mfg. Co., Inc.	XVII
Fast, John E. & Co.	XXIV
Federal-Brandes, Inc.	XV
Formica Insulation Co.	X
G	
General Radio Co.	Back Cover
Grebe, A. H. and Co., Inc.	V
I	
I. R. E.	XXIII
J	
Jewell Electrical Instrument Co.	IV
N	
National Carbon Co.	Inside Back Cover
P	
Professional Engineering Directory	XIV
R	
Radio Corporation of America.	VIII
Roller-Smith Co.	II
S	
Scovill Manufacturing Co.	XX
T	
Thordarson	IX
Tobe-Deutschmann Co.	XVI
W	
Ward-Leonard Electric Co.	XXII
Weston Electrical Instrument Corporation.	XXII
Wireless Specialty Apparatus Co.	I

*When writing the advertisers please mention The Proceedings of
The Institute of Radio Engineers.*

Perfect Resistors

for B-Eliminator Manufacturers

Bradleyohm-E

PERFECT VARIABLE RESISTOR

Because of its unusually wide range and accuracy of control, the Bradleyohm-E is extensively used by B-eliminator manufacturers. The resistance of the scientifically-treated discs is not affected by use or atmospheric conditions. It does not vary in service. When once the correct value is selected, it remains fixed.

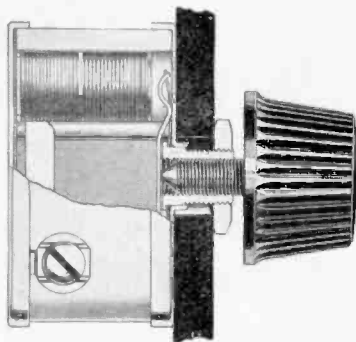

Bradleyunit-A

PERFECT FIXED RESISTOR



This molded resistor is baked under high pressure, and then accurately calibrated. Bradleyunits are guaranteed to be accurate within 5% of their ratings. Unaffected by temperature, moisture or age.

Bradleyunit-B

PERFECT FIXED RESISTOR



Has the characteristics of Bradleyunit-A, but is made especially for manufacturers. Made in an extremely wide range of accurately calibrated resistance values.

Write for data and prices

ALLEN-BRADLEY COMPANY
282 Greenfield Avenue, Milwaukee, Wisconsin

Allen-Bradley

PERFECT RADIO RESISTORS

When writing to advertisers mention of the Proceedings will be mutually helpful.

XXVI

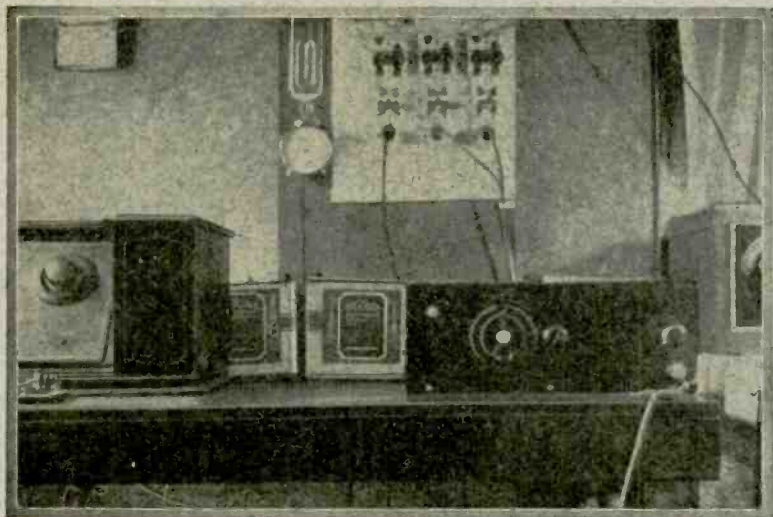

It's not the bottle but the *kind of juice* that counts

Using a UX-199 tube as an oscillator with Eveready No. 770 Heavy-Duty "B" Batteries for plate power, H. A. Mackley, 9 LF, Peoria, Ill., has done some remarkable work. "Daylight communication has been held with the 5th and 6th District, New Mexico and California, on the south and west," he says, "and with the 1st and 3rd on the east." In this and in more severe tests, the 770's "stood up exceptionally well and the curve was very flat the first 200 hours' use. I heartily recommend Eveready batteries, especially the 770 and the Layerbilt, for amateur use on up to 5-watt tubes. If

some of the amateurs would try to perfect their apparatus instead of crowding some of the 50-watt bottles to the limit, they would get remarkable distance with a 201-A or a 5-watter." Eveready "B" Batteries produce pure DC only, which is why they are the preferred source of plate power not only for short wave work, but also for BCL receivers.

NATIONAL CARBON CO., INC.
New York San Francisco

Unit of Union Carbide and Carbon Corporation

*Tuesday night is Eveready Hour Night—
9 P. M., Eastern Standard Time, through
the WEA network.*

EVEREADY

Radio Batteries

—they last longer

When writing to advertisers mention of the Proceedings will be mutually helpful.

IMPEDANCE BRIDGE

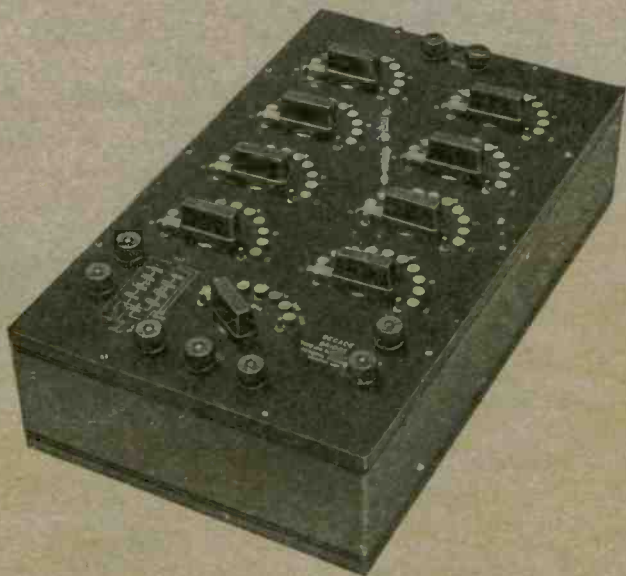

TYPE 193—DECADE BRIDGE

A Wheatstone Bridge using the dial-decade design.

For measurement of direct current resistance and alternating current resistance, inductance and capacitance at commercial and audio frequencies.

The third resistance can be switched into either the unknown or the standard arm for inductance and capacitance measurements.

Described in Bulletin 4050-I.

Price \$115.00

General Radio Company, *Thirty State St.*, Cambridge, Mass.

GENERAL RADIO

LABORATORY EQUIPMENT