

VOLUME 11

DECEMBER, 1923

NUMBER 6

PROCEEDINGS
of
The Institute of Radio
Engineers



EDITED BY

ALFRED N. GOLDSMITH, Ph.D.

PUBLISHED EVERY TWO MONTHS BY
THE INSTITUTE OF RADIO ENGINEERS

140th Street and Convent Avenue, New York, N. Y

Subscription \$9.00 per Annum in the United States
\$9.60 in all other Countries

GENERAL INFORMATION AND SUBSCRIPTION RATES ON PAGE 577

Entered as second-class matter, February 16, 1916, at the Post-Office, at New York, N. Y., under the Act of March 3, 1879.

Acceptance for mailing at special rate of postage provided for in Section 1103, Act of October 3, 1917, authorized October 7, 1918.

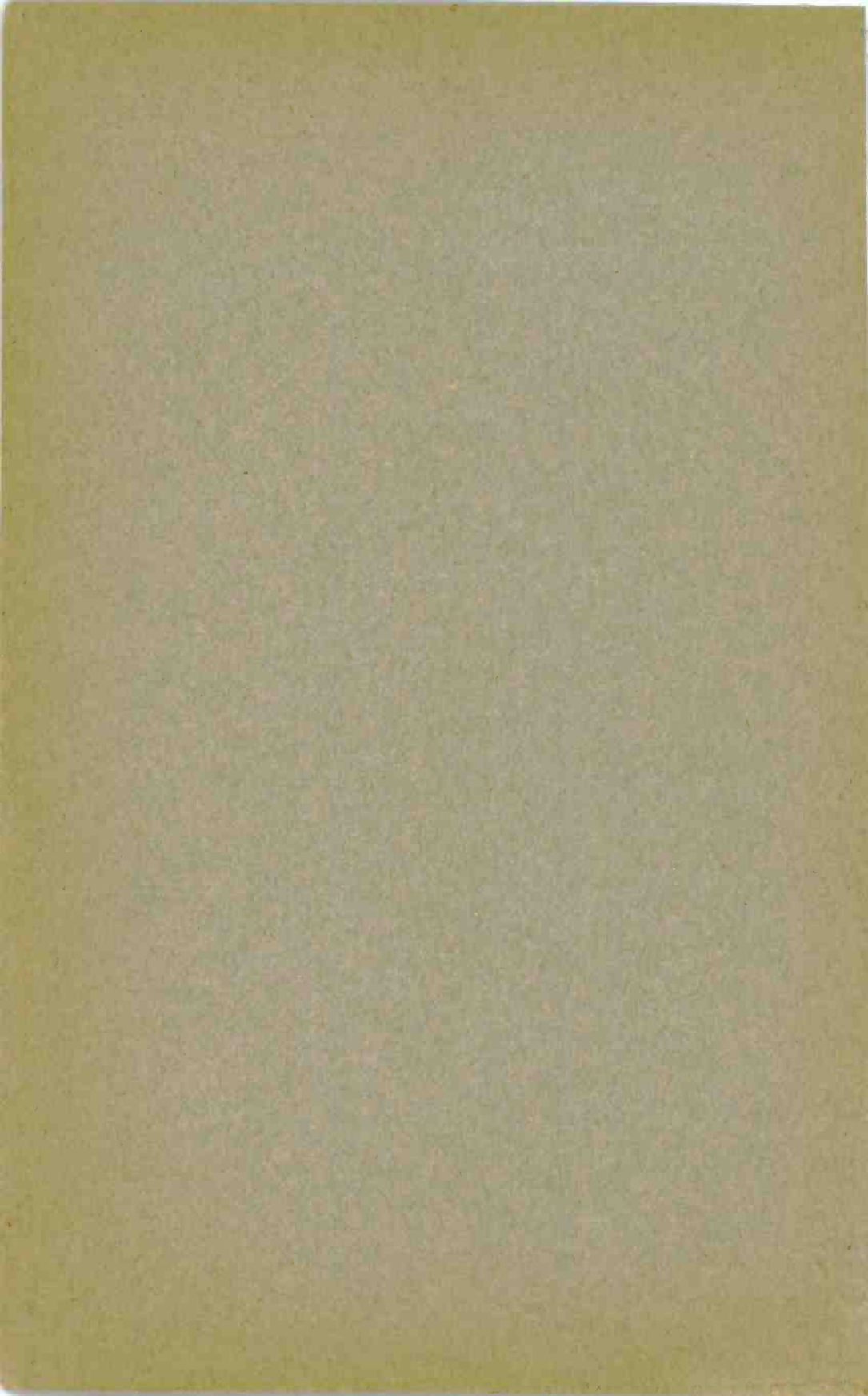

Faradon

FOR SERVICE

RADIO CONDENSERS

Constant Capacity
Extremely Low Losses
Safety Gap Protection
High Current Carrying Capacity
Minimum Volume
Moisture-Proof Construction
Long Life
Quick Deliveries

These are some of the reasons why radio engineers specify FARADONS.

There are over 200 standard FARADON condensers on which immediate deliveries can be made. Complete specification list and price list will be sent on request.

Wireless Specialty Apparatus Company
BOSTON, MASS.

Established 1907



No Matter What You Pay

You cannot get a Head-Set that will give you more satisfactory service than the

ROLLER-SMITH Universal Type A (3,000 ohms)

Our twenty years' experience in the making of precision instruments is built in to every one.

List price, \$6.00. Send for new Bulletin No. K-20

ROLLER-SMITH COMPANY

Electrical Instruments, Meters and Circuit Breakers

MAIN OFFICE:
2134 Woolworth Bldg., NEW YORK



WORKS:
Bethlehem, Pennsylvania

Offices in Principal Cities in U. S. and Canada

ACME TRANSFORMERS

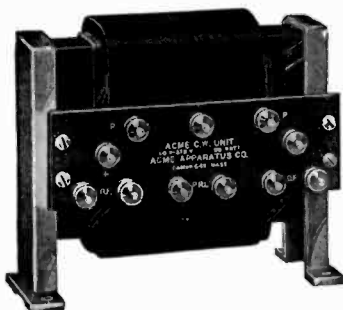

As specialists in the design and construction of Transformers we are prepared to quote prices and delivery on Transformers singly or in quantity.

Our Radio Transformers are well known for their high efficiency and ruggedness.

ACME APPARATUS COMPANY
200 MASSACHUSETTS AVENUE
CAMBRIDGE 39, MASS.

TRANSFORMER AND RADIO ENGINEERS AND MANUFACTURERS

Constant Impedance
AUDIBILITY METER

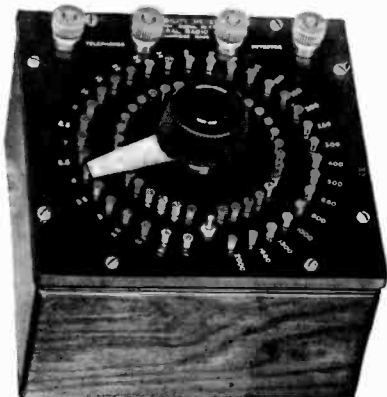

Type 164

**AUDIBILITY
METER**

Price, \$36

The ear alone cannot be depended upon to estimate the intensity of received signal strength. Some auxiliary standard of reference must be used.

One of the more common methods is to shunt the telephone receivers. As the receivers are shunted, however, a series resistance of such a value should be added to the circuit that the impedance will remain unchanged.

The Type 164 Audibility Meter is so designed that it is direct reading in audibilities, and keeps the total impedance of the circuit practically constant.

Do not guess at your receiving results. Know the real facts.

Send for Bulletin R

GENERAL RADIO CO.

Manufacturers of

*Radio and Electrical Laboratory
Apparatus*

Massachusetts Avenue and Windsor St.

CAMBRIDGE 39

MASSACHUSETTS



“EVERYTONE”

(GUARANTEED)

RADIO HEADSET

Meets the need for a dependable quality headset at a price that every one can afford. The Pacent “Everytone” is of superior light-weight construction and embodies improved features that insure clear reception and long, satisfactory service. Backed by a one-year guarantee and the Pacent Trade-mark—known for years as standing for the best in radio essentials.

\$3.50

2,200 OHMS

3,000 Ohms, \$3.75

Write for Catalog D-12

**PACENT ELECTRIC
CO., Inc.**

22 Park Place
New York, N. Y.

Pacent

RADIO ESSENTIALS



for use on a 110-volt D.C. line. Equipped with the famous Ward Leonard Vitrohm (Vitreous enamelled) Resistor Units. Literature on request.

RADIO BATTERY CHARGER

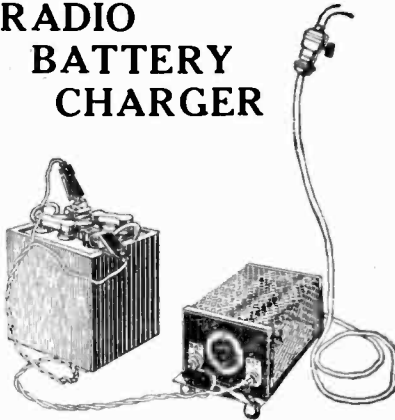

Ward Leonard Electric Company

Mount
Vernon,
New York

CLASS OF SERVICE	SYMBOL
Telegram	
Day Letter	DL
Night Message	NM
Night Letter	NL

If none of these three symbols appears after the check (number of words) this is a telegram. Otherwise the character is indicated by the symbol appearing after the check.

WESTERN UNION TELEGRAM

NEWCOMB CARLTON, PRESIDENT

GEORGE W. E. ATKINS, FIRST VICE-PRESIDENT

CLASS OF SERVICE	SYMBOL
Telegram	
Day Letter	DL
Night Message	NM
Night Letter	NL

If none of these three symbols appears after the check (number of words) this is a telegram. Otherwise the character is indicated by the symbol appearing after the check.

RECEIVED AT²¹ NORTH WASHINGTON ST.
JAMAICA, N. Y.
11 AM CBU 50 NL

AVALON CALIF OCT 25-26 1923

DOUGLAS RICNEY

A. H. GREBE & CO VANWYCK BLVD RICHMONDHILL LI. NY

COPIED MACMILLIAN SHIP TWO HOURS LAST NIGHT ON THIRTEEN TOOK
MANY MESSAGES AND PRESS REPORTS THEY ARE ELEVEN DEGREES FROM
POLE ALL WELL HEAVY SNOW TEMPERATURE BELOW ZERO SAW SUN
FOR LAST TIME YESTERDAY EASILY WORK HIM ON YOUR SPLENDID
RECEIVER ~~AM~~ FIRST AMERICAN PACIFIC COAST STATION TO HEAR HIM
MAJOR LAWRENCE MOTT

916A



Copying the "Bowdoin" With the Grebe "13"

Major Lawrence Mott, 6 NAD-6 ZW, Avalon, Cal., needs no introduction to the amateur fraternity.

We congratulate Major Mott upon his success in copying the "Bowdoin" for two hours. That his should be the first U. S. Pacific Coast Station to hear the MacMillan ship for so long a period is fitting testimony of the Major's ability as an operator and of the excellence of his equipment.

We are pleased to learn that the Grebe "13" was the Receiver used by Major Mott.

Write us

A. H. GREBE & CO., Inc.
72 Van Wyck Boulevard, Richmond Hill, N. Y.
Western Branch: 451 East 3rd Street, Los Angeles, Cal.

"The coming of a friend
from a far-off land—is
this not true joy?"
—Confucius.

Talking with a friend in
a far-off land is also true
delight when one uses a
Grebe "13."

Doctor H. H. H.



Licensed under
Armstrong U. S.
Pat. No. 1,113,149.

W

W

Double Range Portable Voltmeter

A new, high resistance instrument for accurately measuring filament, plate and grid voltages. Ranges 150 and 7½ volts. Mounts on panel if desired.

Other Weston instruments include plate and filament voltmeters, for panel, milliammeters, ammeters, thermo-ammeters, thermo-galvanometers, etc.

Full particulars in Booklet J.
Write for it.



Weston Electrical Instrument Co.
72 Weston Ave. Newark, N. J.

Branch Offices in all Principal Cities.

Electrical
Indicating
Instrument
Authorities
Since 1888

WESTON

STANDARD - The World Over

The AMERTRAN

- REG. U. S. PAT. OFF. -

Price \$7

A Super Audio Frequency Amplifying
Transformer Without Distortion

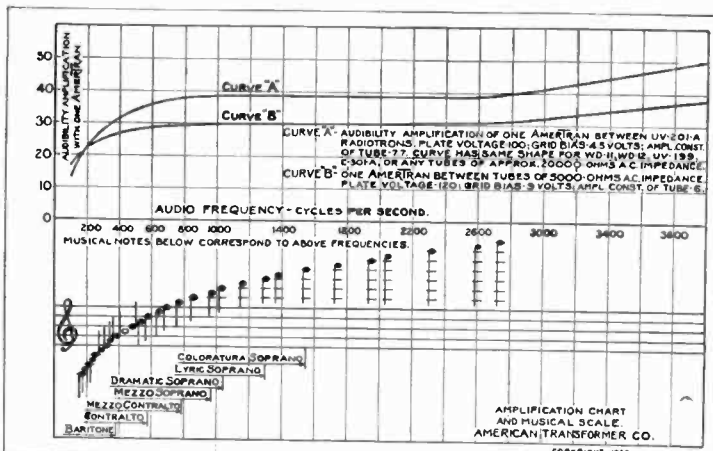

American Transformer Company

Newark, N. J.

AMRAD

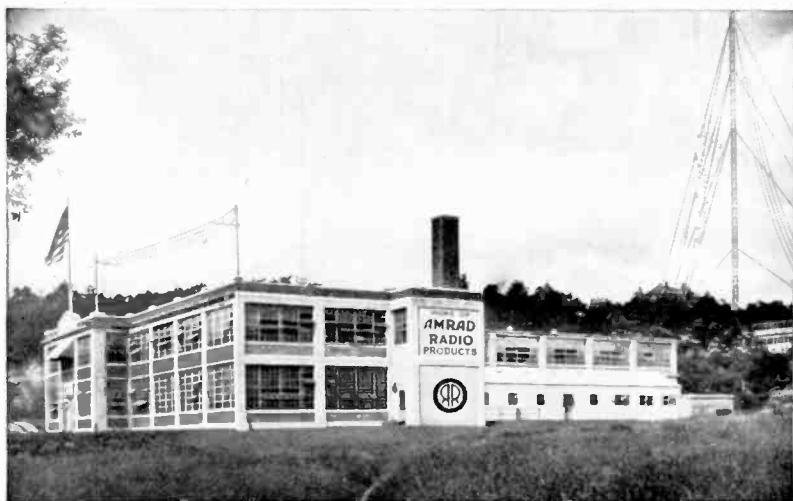

Main Factory of the American Radio and Research Corporation, Medford Hillside, Mass. Home of Amrad Radio. Showing at extreme right Research and Engineering Laboratories and Broadcasting Station WGI, erected June 1915, the World's Oldest Broadcasting Station operating to-day

Exclusive Developments

For eight years this Corporation has specialized in the development of Radio. Among results—

The AMRAD "S" Tube—a Rectifier with NO FILAMENT TO BURN OUT.

The AMRAD BASKETBALL Variometer—a radical improvement over the conventional moulded type.



BASKETBALL VARIOMETER
Remarkably low Dielectric losses and distributed capacity.



The S-TUBE
Rectifies up to 1000 volts A.C. Resulting D.C. has minimum wave ripple with ordinary filter.

AMERICAN RADIO AND RESEARCH CORPORATION

MEDFORD HILLSIDE, MASS.

(4 Miles North of Boston)

New York

Chicago

Radiotron



In high quality receiving sets the vacuum tubes — the heart of their fine performance—bear the name **Radiotron** and the **RCA** mark. Be sure to look for this identification when you replace your tubes.

Radiotron WD-11
Radiotron UV-199
Radiotron WD-12
Radiotron UV-200
Radiotron UV-201-A



This symbol of quality is your protection

Radio Corporation of America

Sales Offices: Dept. 2092

233 Broadway

New York

10 So. La Salle Street, Chicago, Ill.

433 California Street, San Francisco, Cal.

Radiola

REG. U.S. PAT. OFF.

PROCEEDINGS OF
The Institute of Radio Engineers

Volume 11

DECEMBER, 1923

Number 6

CONTENTS

	PAGE
OFFICERS OF THE INSTITUTE OF RADIO ENGINEERS	578
L. W. AUSTIN, "RECEIVING MEASUREMENTS AND ATMOSPHERIC DISTURBANCES AT THE BUREAU OF STANDARDS, WASHINGTON, D. C., MAY AND JUNE, 1923"	579
J. C. WARNER, "RECENT DEVELOPMENTS IN HIGH VACUUM RECEIVING TUBES—RADIOTRONS, MODEL UV-199 AND MODEL UV-201-A"	587
W. R. G. BAKER, "COMMERCIAL RADIO TUBE TRANSMITTERS"	601
H. H. BEVERAGE AND H. O. PETERSON, "RADIO TRANSMISSION MEASUREMENTS ON LONG WAVE LENGTHS"	661
A. PRESS, "STATIONARY WAVES ON FREE WIRES AND SOLENOIDS"	675
JOHN B. BRADY, "DIGESTS OF UNITED STATES PATENTS RELATING TO RADIO TELEGRAPHY AND TELEPHONY; Issued August 28, 1923 - October 23, 1923"	679

At the end of this number are the title page, page of general information and Table of Contents pages for the entire Volume 11 (1923) of the PROCEEDINGS. These last may be suitably placed at the beginning of the volume for binding.

GENERAL INFORMATION

The PROCEEDINGS of the Institute are published every two months and contain the papers and the discussions thereon as presented at the meetings in New York, Washington, Boston, Seattle, San Francisco, or Philadelphia.

Payment of the annual dues by a member entitles him to one copy of each number of the PROCEEDINGS issued during the period of his membership.

Subscriptions to the PROCEEDINGS are received from non-members at the rate of \$1.50 per copy or \$9.00 per year. To foreign countries the rates are \$1.60 per copy or \$9.60 per year. A discount of 25 per cent is allowed to libraries and booksellers.

The right to reprint limited portions or abstracts of the articles, discussions, or editorial notes in the PROCEEDINGS is granted on the express condition that specific reference shall be made to the source of such material. Diagrams and photographs in the PROCEEDINGS may not be reproduced without securing permission to do so from the Institute thru the Editor.

It is understood that the statements and opinions given in the PROCEEDINGS are the views of the individual members to whom they are credited, and are not binding on the membership of the Institute as a whole.

PUBLISHED BY

THE INSTITUTE OF RADIO ENGINEERS, INC.
140TH STREET AND CONVENT AVENUE, NEW YORK, N. Y.

EDITED BY

ALFRED N. GOLDSMITH, Ph.D.

OFFICERS AND BOARD OF DIRECTION, 1923

Terms expire January 1, 1924; except as otherwise noted.

PRESIDENT

IRVING LANGMUIR

VICE-PRESIDENT

JOHN H. MORECROFT

TREASURER

WARREN F. HUBLEY

SECRETARY

ALFRED N. GOLDSMITH

EDITOR OF PUBLICATIONS

ALFRED N. GOLDSMITH

MANAGERS

(Serving until January 2, 1924)

EDWIN H. COLPITTS

JOHN V. L. HOGAN

LOYD ESPENSCHIED

GEORGE H. LEWIS

DONALD McNICOL

(Serving until January 7, 1925)

MELVILLE EASTHAM

JOHN H. MORECROFT

(Serving until January 6, 1926)

EDWARD BENNETT

LOUIS A. HAZELTINE

ADVERTISING MANAGER

DE WITT V. WEED, JR.

WASHINGTON SECTION

ACTING EXECUTIVE COMMITTEE

ACTING CHAIRMAN

COMM. A. HOYT TAYLOR
Navy Department,
Washington, D. C.

LOUIS W. AUSTIN
Navy Department,
Washington, D. C.

CAPTAIN GUY HILL
War Department,
Washington, D. C.

BOSTON SECTION

CHAIRMAN

GEORGE W. PIERCE
Harvard University,
Cambridge, Mass.

SECRETARY-TREASURER

MELVILLE EASTHAM
11 Windsor St.,
Cambridge, Mass.

SEATTLE SECTION

CHAIRMAN

J. R. TOLMIE
University of Washington
Seattle, Washington

SECRETARY

ALBERT KALIN
University of Washington
Seattle, Washington

TREASURER

ARCHIE BOLSTAD
SEATTLE, WASHINGTON

SAN FRANCISCO SECTION

CHAIRMAN

MAJOR J. F. DILLON,
526 Custom House,
San Francisco, Cal.

SECRETARY-TREASURER

D. B. McGOWN,
Custom House,
San Francisco, Cal.

COPYRIGHT, 1923, BY

THE INSTITUTE OF RADIO ENGINEERS INC.

140TH STREET AND CONVENT AVENUE

NEW YORK, N. Y.

RECEIVING MEASUREMENTS AND ATMOSPHERIC
DISTURBANCES AT THE BUREAU OF STANDARDS,
WASHINGTON, D. C., MAY AND JUNE, 1923*

By

L. W. AUSTIN

(CHIEF, RADIO PHYSICAL LABORATORY, BUREAU OF STANDARDS)

*(Communication from the International Union for Scientific
Radio Telegraphy)*

At the end of April, Lafayette Station increased its frequency for the U. R. S. I. signals at 3 P. M., E. S. T.,¹ to 16.2 kilocycles (18,500 m.), tho continuing to send occasionally on 12.8 kilocycles (23,400 m) at other times. This change was not known here, however, until May 11, consequently no observations were obtained at 3 P. M. during the first part of that month.

It was also found that Lafayette, which had been heard very irregularly at 10 A. M. for several months past, could be depended upon with considerable certainty between 8 and 9 A. M. Accordingly, on June 1, the observation time was shifted to the earlier hour and measurements made both in the morning and afternoon on the 16.2 kilocycles (18,500 m.) wave.

The observations for May and June show a greater difference in strength between the two stations than was found in the corresponding months of last year, Lafayette being stronger during the morning (all daylight signal path) and showing much less afternoon fading than last year; while Nauen is weaker in the morning and fades badly in the afternoon, averaging about the same in intensity as in the corresponding period of 1922. This year's observations on Nauen's fading are much more reliable than those of a year ago, on account of more accurate information regarding the times of transmission on afternoons when the signals could not be heard.

The atmospheric disturbances at Nauen's wave length are approximately the same, while the disturbances corresponding to

* Published by permission of the Director of the Bureau of Standards of the United States Department of Commerce. Received by the Editor, August 15, 1923.

¹ Eastern Standard Time (Washington).

Lafayette's signals, partly at least due to the change in wave length, average about half the strength of last year.

As was pointed out in the resume of last year's results, the Hertzian term of the transmission formula, if the curvature of the earth be taken into account, should have the great circle distance between the sending and receiving points replaced by $r \sin \phi$, where r is the radius of the earth and ϕ the angle between the two stations as seen from the earth's center. This correction amounts to about 20 percent for the distance Washington to Berlin.

The calculated A. M. intensities (all daylight between stations), assuming 480 amperes for Lafayette at 16.2 kc. (18,500 m.) and 380 amperes for Nauen (24.0 kc. or 12,500 m.) are according to the formula:

$$E \text{ (Lafayette)} = 37.3 \cdot 10^{-6} \text{ volts/meter and}$$

$$E \text{ (Nauen)} = 18.5 \cdot 10^{-6} \text{ volts/meter}$$

FIELD INTENSITY OF NAUEN AND OF DISTURBANCES
 $f=24.0$ kc. ($\lambda=12,500$ m.) IN MAY, 1923, IN MICROVOLTS PER
METER

Date	10 A. .M.		3 P. M.	
	Signal	Dis- turbances	Signal	Dis- turbances
1	30.3	30	*	85
2	31.6	90	3.4	150
3	14.1	375	13.6	180
4	3.7	220	2	300
5	22.7	110	*	190
7	27.4	25	10.0	46
8	9.2	55	*	3000
9	29.5	26	10.6	130
10	24.0	22	5.4	55
11	51.5	50	15.9	95
12	51.5	65	2.0	260
14	10.6	220	*	340
15	12.9	70	*	350
16	25.0	180	*	250
17	47.0	20	10.0	200
18	27.8	160	12.8	100
19	47.0	45	5.0	290
21	**	60	**	160
22	**	35	*	130
23	**	120	*	290
24	**	95	*	300
25	**	50	*	150
26	**	60	**	100
28	**	25	*	180
29	37.6	20	*	300
31	18.0	290	**	350
Average	27.4	96.9	3.8	306.0

* Not heard.

** Not sending.

... Not taken.

FIELD INTENSITY OF LAFAYETTE AND OF DISTURBANCES
 $f=12.8$ kc. ($\lambda=23,400$ m.) A. M., $f=16.2$ kc. (18,500 m.) P. M.
 IN MAY, 1923, IN MICROVOLTS PER METER

Date	10 A. M.		3 P. M.	
	Signal	Dis- turbances	Signal	Dis- turbances
1	**	65	150
2	**	145	230
3	**	500	200
4	**	540	450
5	**	240	320
7	**	55	95
8	70.0	100	3000
9	85.0	50	220
10	**	45	100
11	**	85	200
12	**	65	7.5***	350
14	50.0	220	14.0	450
15	**	70	16.7	380
16	**	180	40.0	460
17	**	20	72.3	220
18	**	160	78.1	130
19	**	45	60.3	320
21	**	60	43.5	210
22	**	35	56.0	160
23	**	120	53.0	310
24	**	95	21.2	350
25	**	50	66.1	185
26	**	60	52.0	150
28	**	25	33.1	200
29	72.3	20	13.0	450
31	**	290	36.2	390
Average	69.3	128.5	41.4	370.0

* Not heard.
 ** Not sending.
 Not taken.
 *** Lafayette began sending U.R.S.I. signals on 16.2 kc.
 (18,500 m.) April 28.

FIELD INTENSITY OF NAUEN AND OF DISTURBANCES
 $f=24.0$ kc. ($\lambda=12,500$ m.) IN JUNE, 1923, IN MICROVOLTS PER
METER

Date	9 A. M.		3 P. M.	
	Signal	Dis- turbances	Signal	Dis- turbances
1	27.8	50	*	380
2	19.8	250	*	400
4	19.2	8.5	**	150
6	18.5	42.5	*	320
7	15.3	160	**	180
8	27.8	52	*	150
9	13.8	15	10.7	100
11	12.9	20	13.2	65
12	19.2	15	*	45
13	25.6	15	9.9	20
14	22.9	50	19.0	100
15	**	40	*	250
16	19.2	90
18	25.6	20	2.0	350
19	32.0	38	2.0	280
20	34.2	25	2.0	390
21	47.0	150	*	250
22	26.0	60	13.8	150
23	32.0	18
25	34.0	30	16.5	300
26	23.6	75	**	405
27	30.0	80	2.0	250
28	25.8	63	150
29	34.0	43	23.0	130
30	21.0	25
Average	25.3	57.4	6.3	219.0

* Not heard.

** Not sending.

.... Not taken.

FIELD INTENSITY OF LAFAYETTE AND OF DISTURBANCES
 $f=16.2$ kc. ($\lambda=18,500$ m.) IN JUNE, 1923, IN MICROVOLTS PER
METER

Date	9 A. M.		3 P. M.	
	Signal	Dis- turbances	Signal	Dis- turbances
1	**	60	42.3	430
2	114.0	300	*	460
4	**	125	34.0	230
6	108.0	80	2.0	330
7	126.0	150	49.8	3000
8	132.0	65	34.5	210
9	160.0	30	60.2	150
11	114.0	25	57.3	80
12	120.0	15	59.0	45
13	120.0	48	102.0	60
14	66.5	75	78.0	150
15	108.0	80	57.3	380
16	96.2	100
18	132.0	28	72.3	360
19	72.3	45	19.0	300
20	126.0	30	38.8	450
21	108.0	180	60.0	300
22	120.0	85	84.0	180
23	126.0	25
25	132.0	38	84.0	310
26	84.0	85	2.0	450
27	108.0	100	78.0	300
28	126.0	80	72.2	150
29	90.0	50	130
30	102.0	30
Average	112.5	77.2	56.5	383.0

* Not heard.

** Not sending.

.... Not taken.

RATIO OF AVERAGES

f kilo- cycles)	λ (meters)	Signal	Dis-	A.M.	P.M.
		P.M.	turbance	Signal	Signal
		A.M.	P.M.	Dis-	Dis-
		A.M.	A.M.	turbance	turbance
May					
12.8 A.M.	23,400 A.M.	} 0.60	2.90	0.54	0.11
16.2 P.M.	18,500 P.M.		0.14	3.14	0.28
24.0	12,500				
June					
16.2	18,500	0.50	5.0	1.46	0.15
24.0	12,500	0.25	3.8	0.44	0.029

SUMMARY: The signal strength of the Lafayette and Nauen stations and the strength of the corresponding atmospheric disturbances are given for May and June, 1923.

RECENT DEVELOPMENTS IN HIGH VACUUM RECEIVING TUBES—RADIOTRONS, MODEL UV-199 AND MODEL UV-201-A*

BY

J. C. WARNER

(RESEARCH LABORATORY, GENERAL ELECTRIC COMPANY, SCHENECTADY, NEW YORK)

The present trend in vacuum tube development is largely toward the reduction of power required for excitation of the filament and at the same time, when possible, an improvement in the operating characteristics of the tube. This development is taking place as a result of several factors, the principal of which are the discovery and application of new physical phenomena, more complete knowledge of the relation between the mechanical and electrical design of the tube, better processes for carrying out of the designs required, and a better understanding of the requirements of the circuits in which the tube is to be used.

The purpose of this paper is to illustrate these points by a brief description of two receiving tubes which recently appeared on the market—the UV-199 and UV-201-A Radiotrons.

The UV-199 is a tube intended for use as a detector or as an amplifier and is designed for dry cell operation. The UV-201-A also may be used as a detector or as an amplifier and is designed to be interchangeable with the older UV-201, but requires only one-fourth as great filament current and has noticeably better operating characteristics than the UV-201. Internal and external views of the UV-199 and UV-201-A are shown in Figures 1 and 2.

Both of these tubes contain a new type of filament known as the X-L tungsten filament. Compared with the older tungsten filaments, the X-L filament operates at a much lower temperature, has a higher electron emission efficiency and a longer life. Another important but less apparent advantage is that for a given voltage and current, and at the normal operating temperature, the X-L filament is longer than the old type tungsten fila-

*Received by the Editor, July 23, 1923. Presented before THE INSTITUTE OF RADIO ENGINEERS, New York, September 5, 1923.

ment. This has considerable influence on the design of the tube, as will be seen later.

Coincident with the introduction of the X-L filament, new exhaust processes have been developed which serve to assure

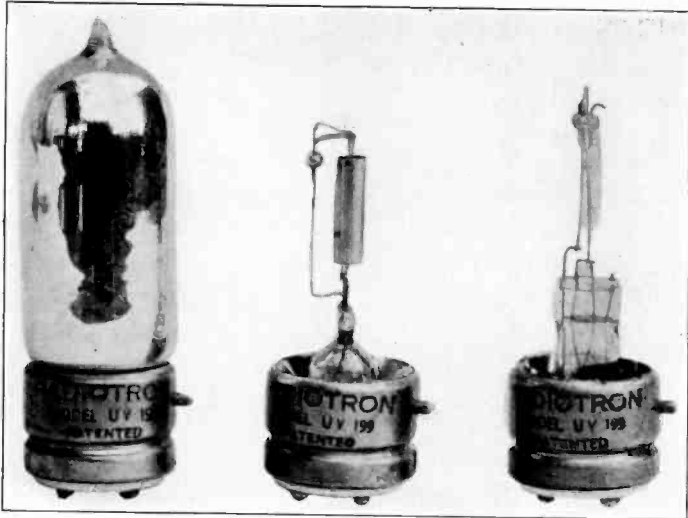

FIGURE 1—Radiotron Model UV-199

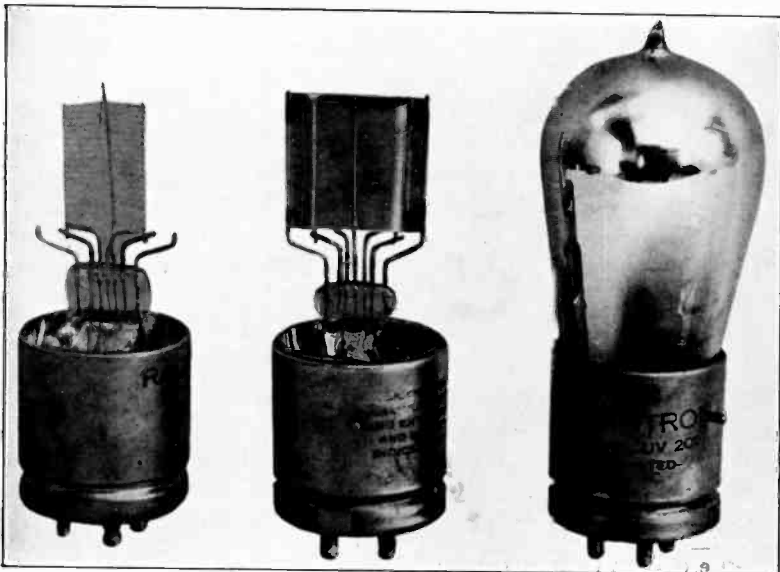

FIGURE 2—Radiotron Model UV-201-A

an extremely good vacuum in tubes containing the new filament. The typical silvered or colored appearance of the UV-199 and UV-201-A is incidental to these exhaust processes.

The filament of the UV-199 is conveniently operated from three dry cells in series as the filament rating is 3.0 volts and 60 milliamperes or 0.18 watt. The advantages of this rating are readily seen after a brief consideration of dry battery characteristics. Dry batteries are most efficient at small current loads; hence, for a given power it is most economical to draw this from the battery at a low current rate. Thus, the small current required by the UV-199 gives it an important advantage over other tubes in battery economy. The second requirement for best battery efficiency is that the battery be used until the closed-circuit voltage has fallen to one volt or less per cell, that is, the end-point of the cell should not be greater than one volt. The use of three cells in series on the UV-199 filament meets this requirement perfectly.

Figure 3 shows characteristics of an average "general purpose" dry cell which plainly indicate the advantage both of a low current rate and a low end-point.

Where it is desired to construct a receiving set of minimum size and weight, for instance for portable use, flashlight cells may be used for filament excitation. An ordinary three-cell

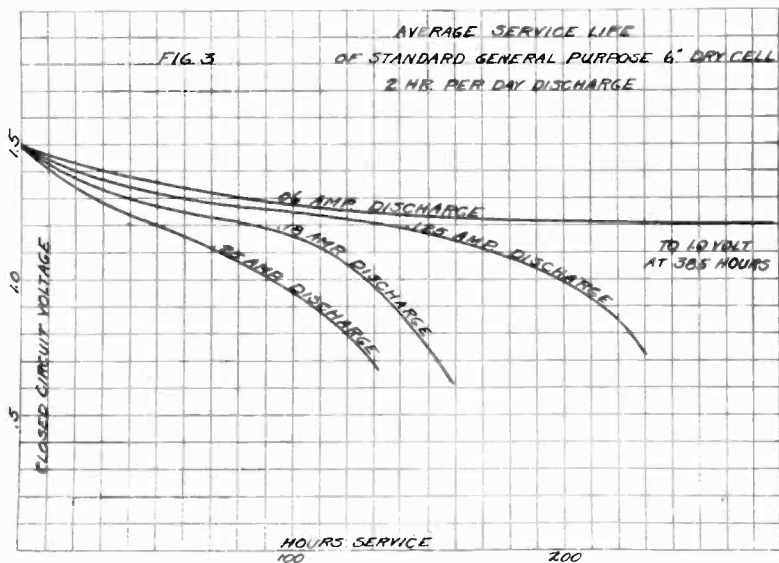

FIGURE 3

tubular battery will operate a one-tube set one hour per day for approximately one month. The economy of such operation is naturally less than when standard six-inch cells are used, but this is relatively unimportant in a portable equipment.

The small dimensions of the UV-199, 1 inch by $3\frac{1}{2}$ inch (2.54 by 8.9 cm.), are a considerable advantage in designing portable sets as well as in the six to eight-tube combinations which are coming more and more into use.

It is, of course, important that when a tube is designed for low filament power consumption, the operating characteristics should not be sacrificed; and the UV-199, in fact, shows a substantial improvement over the UV-201 altho consuming only one twenty-seventh the amount of power in the filament. This has been made possible by careful design of the electrodes, and by the perfection of factory processes for making and assembling the various component parts, so that in spite of a relatively short filament the space charge characteristics are better than in many larger tubes.

Figures 4 to 7 show some of the usual characteristics of the UV-199 and UV-201-A, and for comparison, the corresponding curves on the UV-201 are given.

In general, the UV-199 may be used in any of the usual receiving tube circuits, and requires no special adjustments other than suitable filament voltage control. On account of the low filament current, the rheostat resistance must be considerably higher than is required by the older one-ampere filaments. For example, a single tube operated from dry cells requires a thirty-ohm rheostat.

As a detector, the UV-199 operates most satisfactorily with approximately 40 volts on the plate altho critical adjustment of plate voltage is never required. Slightly better detector action may be obtained at 60 volts, but since the grid return is normally connected to the positive side of the filament, causing the mean grid potential to be slightly positive, the plate current becomes excessive at the higher plate voltage.

As an audio frequency amplifier, the tube may be used with plate voltages up to 100 if suitable negative grid bias is provided. This bias is approximately the same as is required by any amplifying tube which is expected to operate with comparatively high input voltages, and varies from 3.0 volts at 60 volts plate to 6.0 volts at 100 volts plate. The most common conditions for operation are 80 volts plate and 4.5 volts grid. This combination allows reasonably distortionless amplification up to the amount

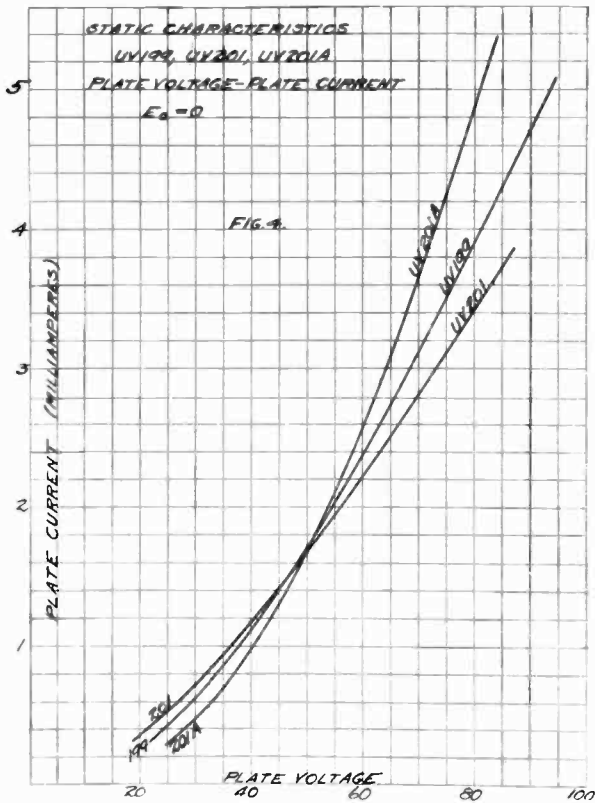

FIGURE 4

of power required to operate a loud speaker, and at the same time does not cause excessive drain from the plate battery. For head telephone reception, the higher plate voltages are unnecessary and very satisfactory results may be obtained at 40 volts. In this case a separate grid battery is unnecessary since the small bias obtained in the usual way by utilizing the voltage drop in the filament rheostat is sufficient. The purpose of this bias is to raise the input impedance of the tube to the point where it ceases to affect the terminal grid voltage, in other words to allow the total voltage induced in the secondary of the interstage transformer to be applied to the grid without loss in the windings of the transformer. A fraction of a volt is usually sufficient for this purpose.

The small elements and base of the UV-199 result in relatively low internal capacities, approximately 40 percent less than corresponding values for the UV-201. This feature is of particular

importance when the tube is used in certain radio frequency amplifying circuits, and the utilization of the advantage of the low tube capacity is aided by the location of the grid and plate pins diagonally opposite from each other instead of adjacent, as in previous tubes. This arrangement allows short and direct connections from the tube socket to the interstage transformers or reactors. Since a grid bias other than the rheostat drop is seldom used on radio frequency amplifier tubes, and since the input voltages on the tubes are small, the most satisfactory plate voltage is usually about 40 volts.

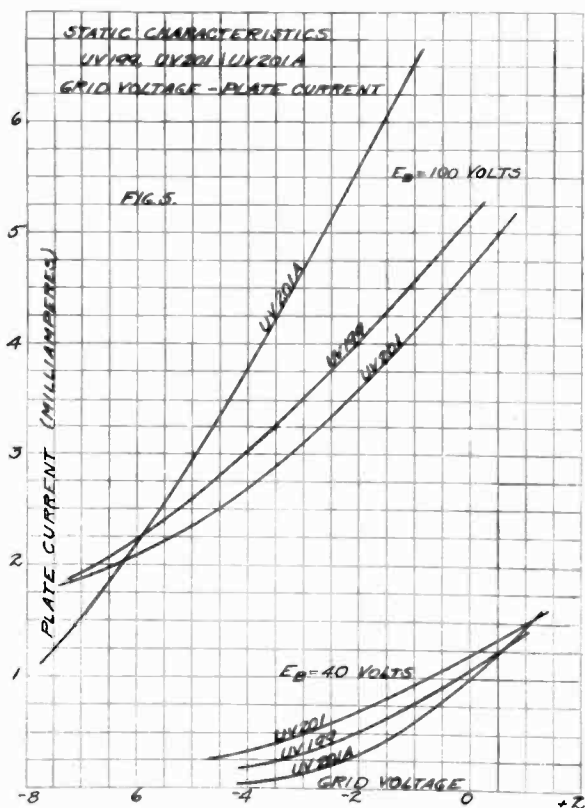

FIGURE 5

As has been mentioned before, the UV-199 is an example of a tube design in which the cathode is necessarily short, being about half the length of the UV-201 filament. In spite of this, excellent operating conditions have been obtained by careful arrangement of the other elements. In a tube of cylindrical construction, the

space charge relation is such that the plate current at a given plate voltage is directly proportional to the effective length of the electrode structure and is inversely proportional to a function of the grid and plate diameters. Therefore, the mutual conductance of the tube, which is perhaps the best single measure of the effectiveness of the tube as an amplifier, is proportional to these same functions.

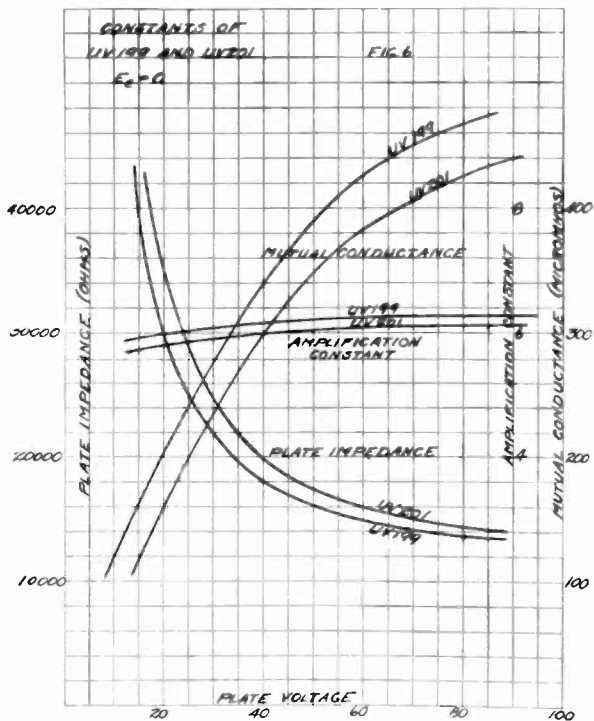

FIGURE 6

Similarly in a tube having planar structure, the mutual conductance is proportional to the effective area of the structure and inversely proportional to a function of the grid-filament and plate-filament distances.

The UV-201-A, while not having, strictly speaking, a planar structure, does owe its high mutual conductance to the large areas made effective by a long filament. The spacings, while comparatively small, are not as small as in the UV-199. This tube was designed to replace the UV-201 and besides requiring only 0.25 ampere as compared with 1 ampere for the UV-201, it

has other marked advantages which are principally due to the desirable characteristics of the X-L filament.

The rated filament voltage of the UV-201-A is 5.0 volts, so that the tube can be used in sets designed for the UV-201 and the filament can be operated in parallel with the UV-201 filament. However, the average electron emission at this voltage is about 45 milliamperes, which is in excess of what is ordinarily needed in a receiving tube, and for this reason, it is often possible to secure excellent results with 4.0 volts or even less on the filament, particularly when 40 volts or less are used on the plate.

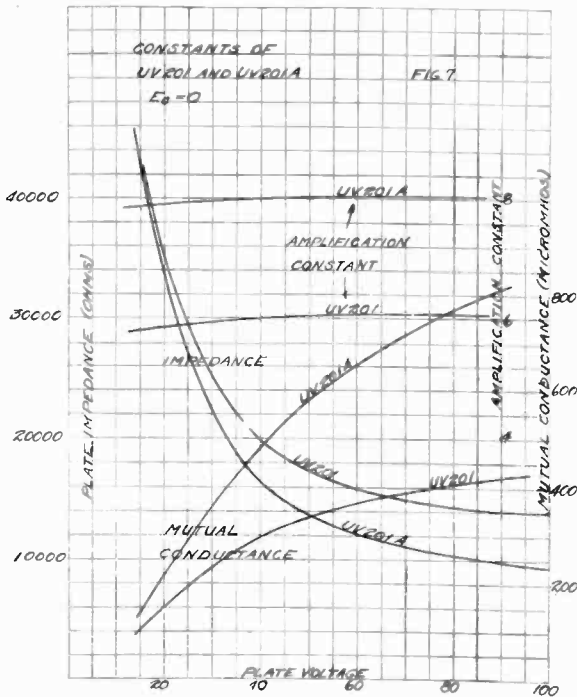

FIGURE 7

Figure 8 gives an interesting comparison of the total electron emission and the electron emission efficiency of the UV-201 and UV-201-A filaments. The great advantage of the X-L filament is shown by the fact that at normal voltage its efficiency is over twenty times as great as that of the older tungsten filament. Extensive life tests have shown that this high emission does not gradually decrease as the tube is run, but remains essentially constant until just before the end of life.

In determining the amplification constant and the plate impedance of the UV-201-A, there were evidently two ways of making use of the large electrode areas. First, the plate impedance could have been lowered, keeping the amplification constant the same as in the UV-201, or second, the amplification constant might have been raised, and the plate impedance left unchanged.

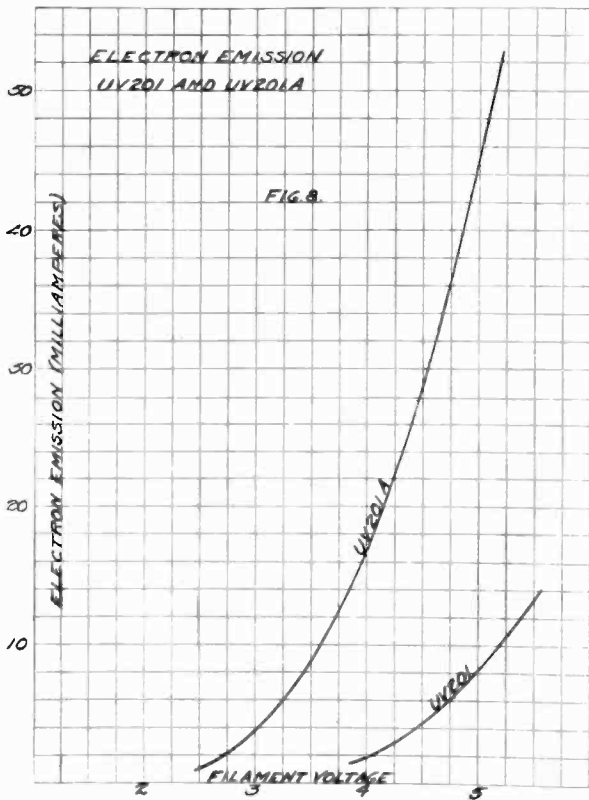

FIGURE 8

The design chosen represents a combination of these two possibilities as the amplification constant has been raised from 6 to approximately 8, and the plate impedance at 40 volts has been lowered from 20,000 ohms to approximately 16,500 ohms. The higher amplification constant serves to increase the ratio between output and input voltages, while the lower impedance aids in producing uniform amplification for all frequencies, and so reduces distortion.

The plate and grid voltages required by the UV-201-A are the same as for the UV-199 except that when the UV-201-A is used as an amplifier, the plate voltage may be increased to 120 volts without danger of overload. In this case a negative grid bias of 7.5 to 9.0 volts should be used.

On account of the high electron emission and high mutual conductance of the tube, it is especially suited to operation of loud speakers and the power output which may be obtained at a given input voltage is over twice as great as from the UV-201.

The detector action is noticeably good for a tube of the high vacuum type, due in part to the high mutual conductance. The usual conditions for detection are 40 volts on the plate, grid leak resistance of 2 to 10 megohms, and a grid condenser of 0.00025 microfarad capacity with the grid return connected to the positive side of the filament.

One other improvement which is due to the use of the X-L filament appears in both the UV-199 and UV-201-A tubes—the almost complete elimination of tube noises. These noises in tungsten filament tubes may ordinarily be divided into two classes, a crackling noise which is characteristic of high temperature filaments, and a hissing or frying noise which is due to small traces of gas in the tube. The low operating temperature of X-L filaments of course eliminates the first class entirely and the high vacuum renders the second class almost negligible.

While the various characteristics which have been illustrated are sufficient to enable prediction of the performance of these tubes in any amplifying circuit, it is of interest to compare some of the characteristics of the tubes under typical operating conditions. Figures 9 and 10 illustrate the alternating output current and output power of the UV-199 and UV-201-A with a 20,000 ohm resistance load in the plate circuit. These curves have been plotted from actual measurements, altho they check closely the curves calculated from the familiar amplification equation.

$$I_p = \frac{\mu E_g}{R_i + R_o}$$

where I_p = alternating plate current (root-mean-square)

μ = voltage amplification constant

E_g = voltage applied to grid (root-mean-square)

R_i = internal plate impedance of tube

R_o = load resistance.

No attempt is made here to determine the relation between

the amplitude of the fundamental component of the output current and the amplitude of any harmonics which may be present, but practice has shown that any distortion due to introduction of harmonics in the output is slight within the range of input voltages shown.

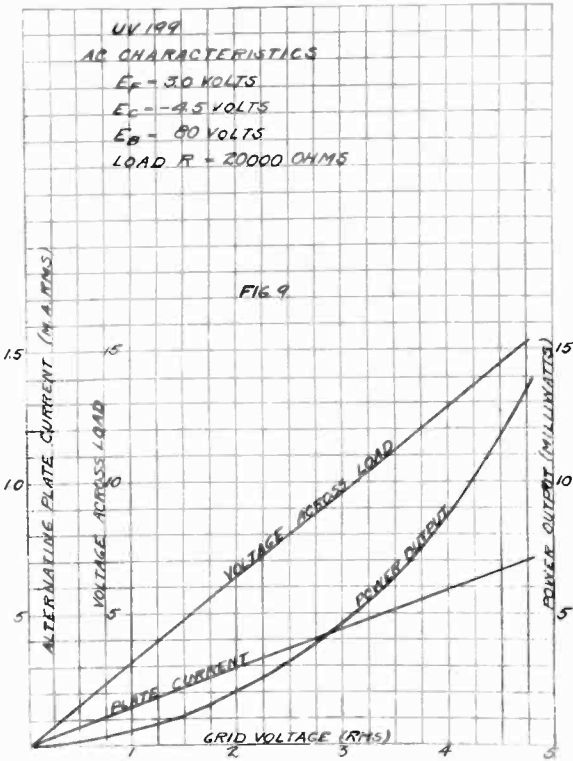

FIGURE 9

A brief consideration of the usual way of rating amplifier tubes calls attention to the need of a uniform method of rating, which will give the user of the tube or the designer of auxiliary apparatus a quantitative idea of the capabilities of the tube in the circuit for which the tube is best suited. The erroneous impression once existed, and still does to some extent, that the amplification constant of the tube was a measure of the actual amplification given by the tube in any circuit. The term itself is perhaps a misnomer, and the English term "voltage factor" would appear more suitable.

Recently the use of mutual conductance as a tube rating has

come into use. This, of course, gives a much better idea of the capabilities of a tube than does the amplification constant, but still does not furnish nearly all of the quantitative information which is desirable. For example, a loud speaker may have a certain impedance and require a certain amount of power to give satisfactory intensity. The mutual conductance alone does not show whether the tube in question can furnish this power, because it is defined on the basis of differential quantities, while under actual operating conditions, the current and voltage amplitudes may be considerable.

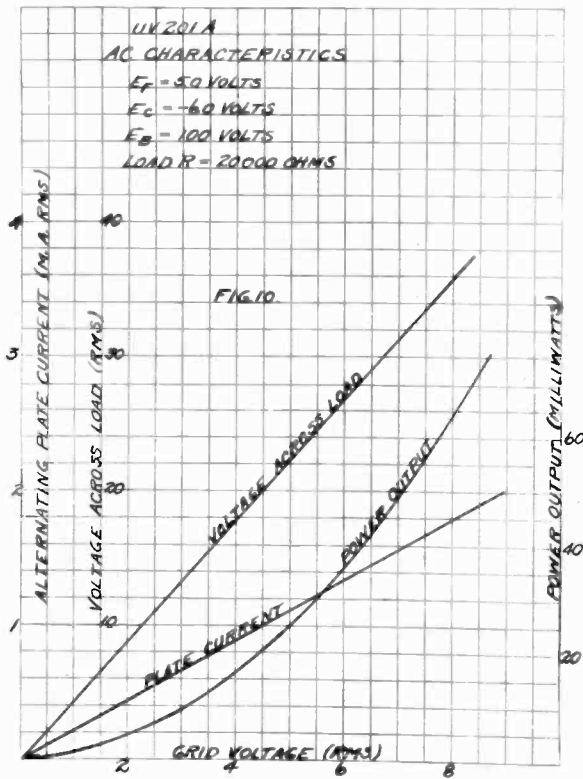

FIGURE 10

Hence, it would seem that the rating of the tube should include some such quantity as the power output in milliwatts or millivolt-amperes per volt squared input at rated plate and grid voltages, and also the maximum input voltage which can be handled without noticeable distortion, assuming the load conditions most

suitable for the tube. Then knowing the amount of power actually required, it would become a simple matter to predict the size of tubes and number of stages of amplification required.

Such a method of rating would go far in placing the receiving tube and its associated apparatus on the same substantial basis as other older and better standardized sorts of electrical equipment.

SUMMARY: The operating characteristics of radiotrons UV-199 and UV-201-A are given, together with the general considerations which determined the design of these tubes. A method of rating receiving tubes (in place of mutual conductance) when appreciable undistorted output is required, as for loud speaker operation, is discussed.

COMMERCIAL RADIO TUBE TRANSMITTERS*

By

W. R. G. BAKER

(RADIO ENGINEERING DEPARTMENT, GENERAL ELECTRIC COMPANY,
SCHENECTADY, N. Y.)

The development and design of commercial radio telephone and telegraph transmitters involves problems that cover a considerable portion of the field of radio engineering. Almost any one of the problems would make an interesting technical paper. In general, we shall consider in this paper various types of commercial transmitting equipments, the majority of which have been manufactured for the Radio Corporation of America by the General Electric Company.

Commercial transmitters may be classified according to power rating, service requirements, circuit design, and the like. For example, service classification might be as follows:

SERVICE CLASSIFICATION

1. Ship Stations.
2. Shore Stations (Fixed).
 - a. Ship to shore.
 - b. Trans-oceanic.
3. Aircraft.
4. Portable and Miscellaneous.

CIRCUIT CLASSIFICATION

1. Antenna Oscillator (Frequency determined by constants of antenna).
2. Tank Circuit.
3. Master Oscillator—Power Amplifier.
4. Miscellaneous Circuits comprising one of the preceding methods of setting the frequency combined with additional circuit features, such as side band or carrier elimination, and other more or less special arrangements.

*Received by the Editor, April 3, 1923. Presented before THE INSTITUTE OF RADIO ENGINEERS, New York, April 4, 1923.

Obviously telephone equipments might be classified according to the modulation system employed, such as absorption, modulating amplifier, plate modulation, or other forms. In this paper we shall consider classification according to service, in which case we are especially interested in classes 1 and 2-a.

ET-3602 AND ET-3608 TRANSMITTING EQUIPMENTS

These transmitters were designed particularly for ship service, but of course are adaptable for fixed station use when the range requirements are within the power ratings of the sets.

ET-3602 and ET-3608 transmitters are intended to provide communication by continuous wave telegraphy, interrupted continuous wave telegraphy, and telephony. The provision for transmitting interrupted continuous waves is made in order that communication may be carried on with stations not equipped for the reception of continuous wave signals. The wave form radiated on interrupted continuous wave transmission has characteristics sufficiently close to those of a spark transmitter that stations that can receive the latter can also receive the former. Transmission by continuous waves is so much more effective than that by interrupted continuous waves and by spark signals that it is only a matter of time before all receiving stations will be equipped to receive continuous waves. When that time comes, the provision in these tube transmitters for interrupted-continuous wave telegraphy may be omitted.

The 200-watt transmitter (Figure 1) utilizes four 50-watt radiotrons (UV-203) (Figure 2), as oscillators when transmitting continuous waves or interrupted continuous waves (hence the 200-watt rating) and five for telephony (two as oscillators, two as modulators, and one as a speech amplifier). The last radiotron amplifies the output of the microphone transformer before it is impressed on the grids of the modulating tubes, since the transformer alone has not sufficient capacity to permit modulation of the output of the oscillators efficiently.

The 1,000-watt transmitter in Figure 1 utilizes four 250-watt radiotrons (UV-204) (Figure 2) as oscillators when transmitting continuous waves or interrupted-continuous waves, and four for telephony (two as oscillators and two as modulators). In this set a UV-203 radiotron is also used as a speech amplifier for telephony.

The sets have a wave length range, on an average ship's antenna, of from 300 to 800 meters, and the three methods of communication are provided for thruout this range. The set

can also be supplied for a wave length range of 600 to 2,000 meters. Under these conditions, continuous wave and interrupted telegraphy are provided for thruout the entire range, but telephony is available only up to 1,000 meters.

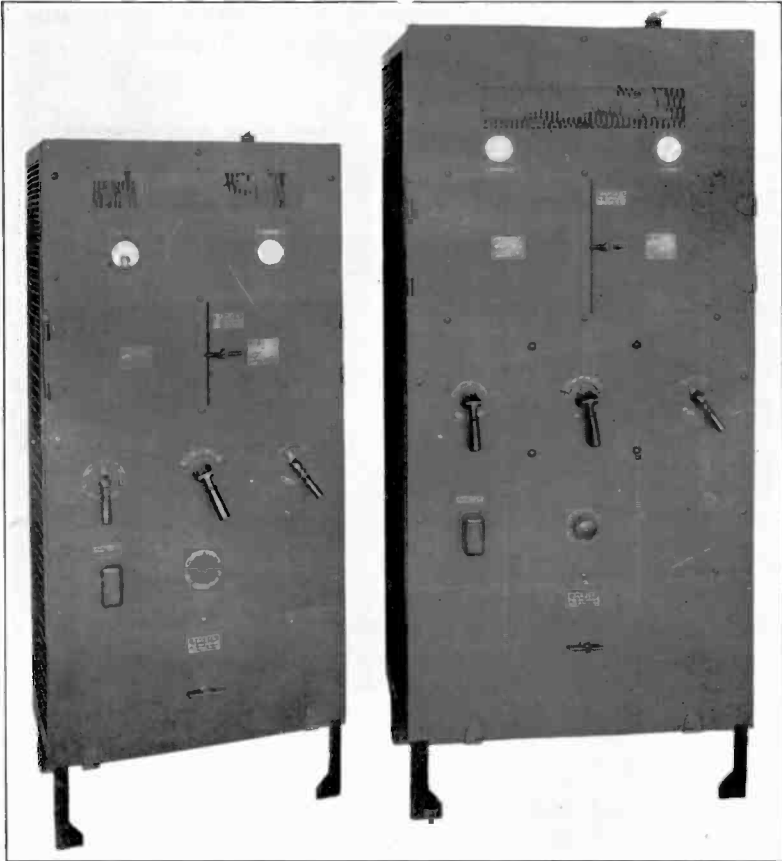

FIGURE 1—Left: Model AT-686, 200 Watt Radio Transmitter. Right: Model AT-702, 1 Kw. Radio Transmitter

For transmitting with interrupted continuous waves, use is made of a motor-driven interrupter mounted within the confines of the transmitter structure. This interrupter functions similarly to the transmitting key on the continuous wave position except that the oscillations are started and stopped at an audio frequency.

The filaments of all tubes are supplied with alternating current, which increases the filament life from 50 to 100 percent

over the life obtainable by direct current supply. This is because of the fact that when direct current is used, one side of the filament is at higher potential, with respect to the plate, than the other. This condition causes more rapid evaporation of one-half of the filament than the other. When alternating current is used, each half of the filament is alternately at higher and lower potentials with respect to the plates, thereby equalizing the evaporation of the halves of the filament.

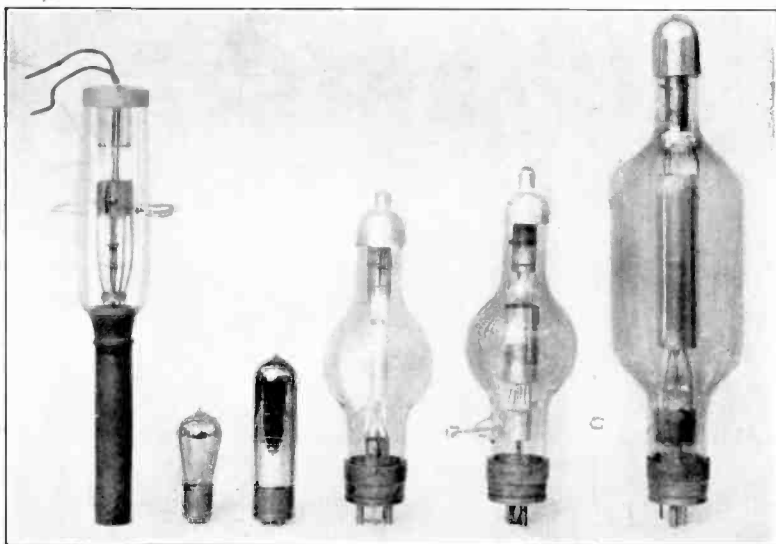

FIGURE 2—Radiotron Power Tubes. Models (Left to Right), UV-207, 202, 203, 204, 206, 208

Negative bias for the grids of the modulator and speech amplifier tubes is obtained by a potentiometer connected across the 125-volt direct current exciter forming one unit of the power equipment. The bias is increased with increase in power.

The wave length of the transmitters is established by the antenna circuit, including the loading inductance and "generating" coil in the transmitter. Series antenna condensers are used to obtain the lower wave lengths.

When the set is installed, adjustments of plate and grid coupling are made for each wave length which the set will utilize. These adjustments, once made, need not be changed thereafter. They cannot be made before installation, because they are dependent on the constants of the antenna on which the set operates.

All oscillator and all modulator tubes are connected in parallel. The same plate voltage supply is utilized for all tubes in each set, except the 50-watt speech amplifier in the 1,000-watt set. The plate voltage for this tube is 1,000 volts, while that for the remaining 250-watt tubes is 2,000 volts. The 1,000 volts is obtained from one of the 1,000-volt commutators of the power equipment, two of these commutators being connected in series to obtain 2,000 volts.

A small radio choke coil is included in the plate lead of both oscillator and modulator tubes to eliminate parasitic oscillations, which are otherwise likely to be generated when operating tubes in parallel.

The power equipment, illustrated in Figure 3, is a three-unit motor generator set, consisting of a motor, a double current self-excited generator, and a high voltage direct current generator.

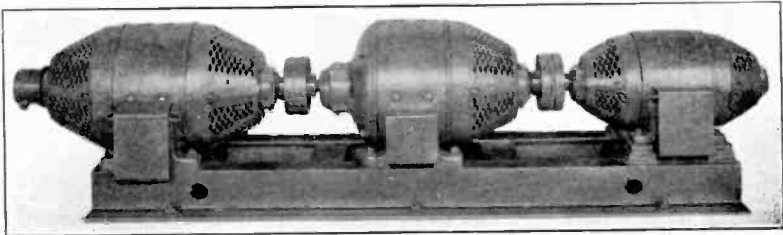

FIGURE 3—2,000-volt D. C. Motor Generator Model UP-703, for Radio Transmitting Equipment, Model ET-3608

The standard equipment consists of either a 115-volt direct current or a 110/220-volt, 50/60-cycle motor. The double current generator provides direct current at 125 volts for the excitation of the high voltage direct current generator, and for the operation of relays and auxiliaries. It also generates single phase alternating current which is stepped down thru suitable transformers for filament supply. The direct current equipments have a speed regulator. It will be noted that the combination of a speed regulator and a self-excited generator for the high voltage machine makes the filament and plate voltages practically independent of normal variations in supply voltage.

This combination of units in the power equipment also makes the power supply to the transmitter independent of the line supply, that is, the motor may operate from any supply without affecting the output to the transmitter, so long as the speed is maintained.

Suitable protective condensers are mounted on the power

equipment to absorb high potential surges which are sometimes incidental to the operation of the set.

The motor starter is mounted within the transmitter structure and is operated by means of momentary contact "start" and "stop" push buttons. Momentary contact control has been provided to insure under-voltage and no-voltage protection. In the case of voltage failure, the power equipment will stop and will not start again until the start button is depressed. The use of the momentary contact system also is utilized by the plate overload relay. This relay is made to break the circuit of the holding coil in the starter, shutting down the power equipment in the event of overload in the plate circuit.

The construction of the 1,000-watt transmitter is evident

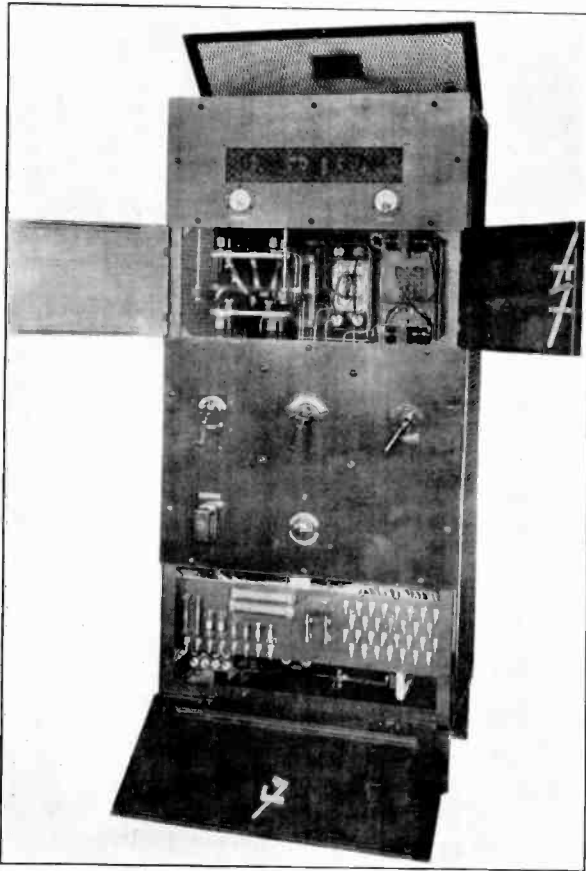

FIGURE 4—1 Kw. Radio Transmitter Model AT-702 for Radio Transmitting Equipment, Model ET-3608

from Figures 4, 5, and 6. It has been designed with ample consideration for high voltage clearances and creepage distances, ruggedness, and accessibility of component units. On the metal panel forming the front of the unit are mounted the following instruments and controls:

- (a) Wave-changing switch.
- (b) Signal-change switch.
- (c) Power-change switch.
- (d) Antenna ammeter.
- (e) Plate voltmeter.
- (f) Plate circuit relay.
- (g) Plate voltage rheostat.

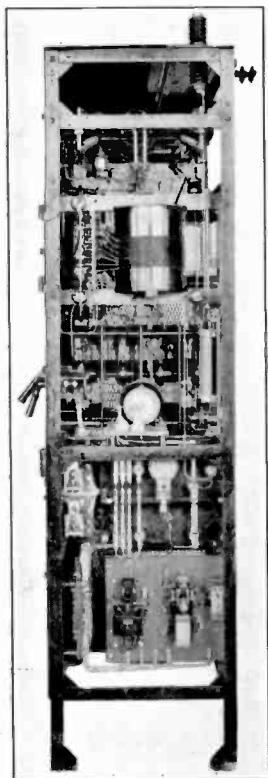

FIGURE 5—1 Kw. Radio Transmitter Model AT-702 for Radio Transmitting Equipment, Model ET-3608

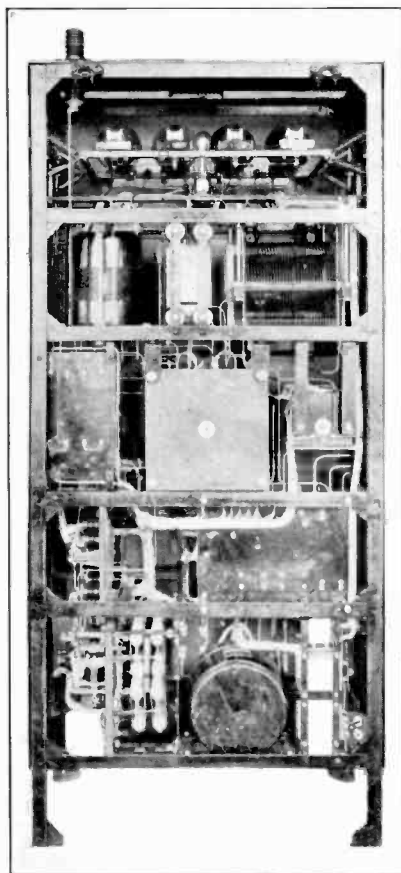

FIGURE 6—1 Kw. Radio Transmitter Model AT-702 for Radio Transmitting Equipment, Model ET-3608

The over-all dimensions of the transmitter proper are:

Width 29 inches (75.7 cm.).

Depth 23 inches (58.3 cm.), including projection of controls, and so on.

Height 69 inches (1.75 m.), including projection of antenna insulator.

Weight (boxed), approximate 225 lbs. (104 kg.).

The radiotrons are mounted on a spring-suspended rack at the top of the transmitter. They are visible to the operator at all times thru the perforated section of the panel.

The wave-changing switch is one of the most unique units making up the transmitter. It is designed for four positions, making it possible in one operation to shift to any one of the four wave lengths to which the transmitter is adjusted. It is a gang switch, including four banks which control taps on the following circuits and equipment:

- (a) Plate coil.
- (b) Grid coupling capacity.
- (c) Grid coupling connection to the antenna.
- (d) Loading inductance and series condensers.

The signal switch has for its function the changing of the connections necessary when transferring from one method of signaling to another. This is accomplished by one operation of the switch, inasmuch as the eight banks composing the switch transfer all circuits affected by the change in signaling.

The power change switch is a two-bank gang switch, simultaneously changing the plate voltage by variation of resistance in the high voltage generator field and changing the biasing voltage on the grids of the modulator tubes. The switch has two positions, for "high" and "low" (approximately one-third) power, respectively. Change in power requires no other adjustment than the operation of this switch.

The loading coil is made of copper strip, wound edgewise with rounded edges. The fact that this coil is wound of bare conductor makes it possible to connect to it at any point for exact tuning to required wave lengths. It is accessible thru a door in the upper part of the transmitter panel. Four bus bars are provided, one for each position of the wave change switch, running the length of the loading inductance. A flexible connector is attached to each bus, and may be shifted along the bus bar until opposite the point at which the other end of the connector will be attached to the loading inductance. This arrange-

ment eliminates complication in wiring, and insures positive clearance between the four flexible conductors.

Adjustments for plate and grid coupling are also made thru a door in the panel, located in the upper right hand side of the structure.

The three series antenna condensers have capacities of 0.00028, 0.00078, and 0.004 microfarad. These are mounted in the transmitter, and are provided with mica dielectric and aluminum cases.

Provision has been made for remotely operating the send-receive controls from a distant station by a so-called "subscriber." To accomplish this, it is necessary to place one unit at the operator's transmitting station and five units at the subscribers' station. The operator's control unit, shown in Figures 7 and 8

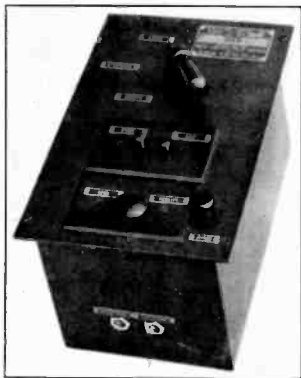

FIGURE 7—Model UT-697 Operator's Control Unit (Exterior View), for Models ET-3602 and ET-3608 Radio Telephone Transmitters

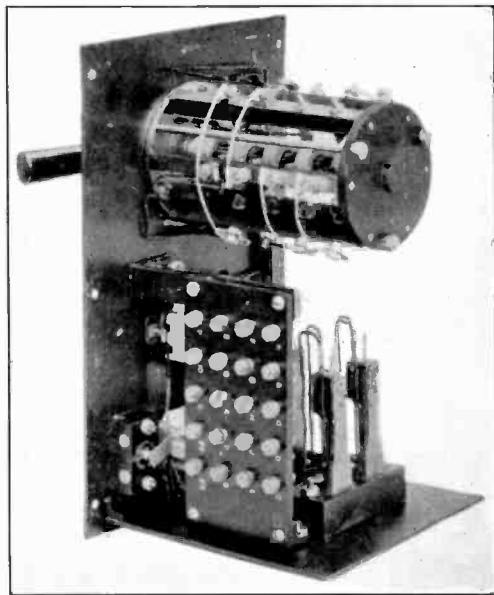

FIGURE 8—Model UT-697 Operator's Control Unit (Interior View) for Models ET-3602 and ET-3608 Radio Telephone Transmitters

is 12 inches (21.8 by 30.2 cm.) long, 8 inches (21.8 cm.) wide and 6 inches (15.1 cm.) deep and weighs approximately 20 lbs. (9.1 kg.). It is designed to be mounted with its top flush with the surface of the operator's table.

The unit contains the following equipment:

- (a) Three-position control switch. This switch has three positions: "Local," "Remote," and "Interphone." When in the "Local" position the operator has complete control of the transmitter. When in the "Remote" position, the send-receive control is transferred to the send-receive switch in the subscriber's control unit. When in the "Interphone" position, wire telephony is available between the operator and the extension station.
- (b) Momentary contact "start" and "stop" push buttons. These controls are in the operator's control unit only. It is not possible to start or stop the transmitter from the extension station.
- (c) Operator's Send-receive Control. This is a tumbler switch, with name plates to designate its respective positions. When the control is thrown to the "Remote" position, the operator has no control over the send-receive switch.
- (d) Ringing Push Button. This button is used to ring the bell at the extension station.
- (e) Jack for Breast Microphone.
- (f) Jack for Head Phones.

In addition to the control unit the filament voltmeter (Figure 9) is also located on the operator's desk, where it can be readily observed. This is essential in order to obtain the maximum filament life. The operator's accessory apparatus is shown in Figure 10 and the grounding switch in Figure 11.

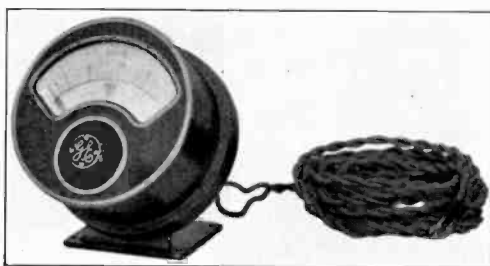

FIGURE 9—Filament Voltmeter with Support

C. The five additional units at the subscriber's station are shown in Figure 12. The subscriber's unit contains a tumbler send-receive switch which controls the send-receive relay in the transmitter when the operator has thrown the control to the

subscriber's station, and a "Ringing" push button to call the operator. The unit is approximately 6 inches (15.1 cm.) long and 3 inches (7.6 cm.) high, and 2 inches (5.1 cm.) deep, and is designed for mounting on the desk at the extension station in a convenient position to facilitate the manipulation of the send-receive control.



FIGURE 10—Operator's Equipment for Models ET-3602 and ET-3608 Radio Telephone Transmitter

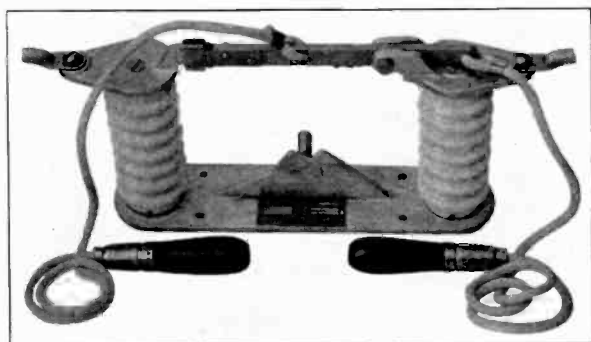

FIGURE 11—Lighting Switch Model UQ-695 used with Radio Transmitting Equipments, Model ET-3608 and ET-3602

In case it is desired to control the transmitter from more than one extension station, the control unit shown in Figure 13 is em-

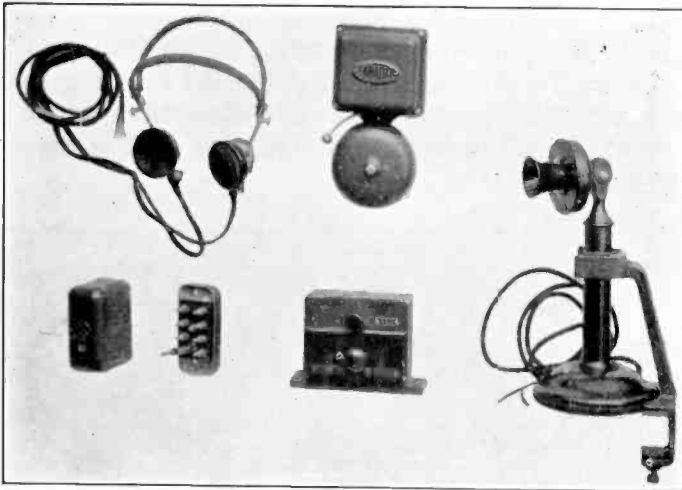

FIGURE 12—Extension Station Equipment for Models ET-3602 and ET-3607 Radio Telephone Transmitters

ployed. This equipment in addition provides communication between the operator and any one of five extension stations.

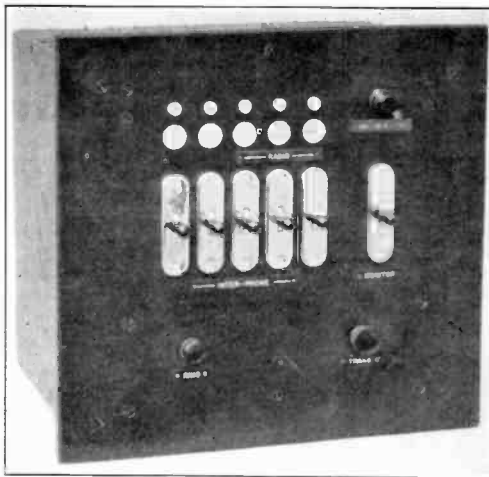

FIGURE 13—Control Unit for Multiple Extension System

Spare parts for either the ET-3602 or ET-3608 equipment are supplied in a suitable box illustrated in Figure 14.

Circuit diagrams for the ET-3608 transmitter are shown in Figures 15 and 16 and are self-explanatory. The circuits of the

ET-3602 equipment are essentially the same. Attention is called to the use of the exciter voltage for biasing the oscillator grids for keying purposes.

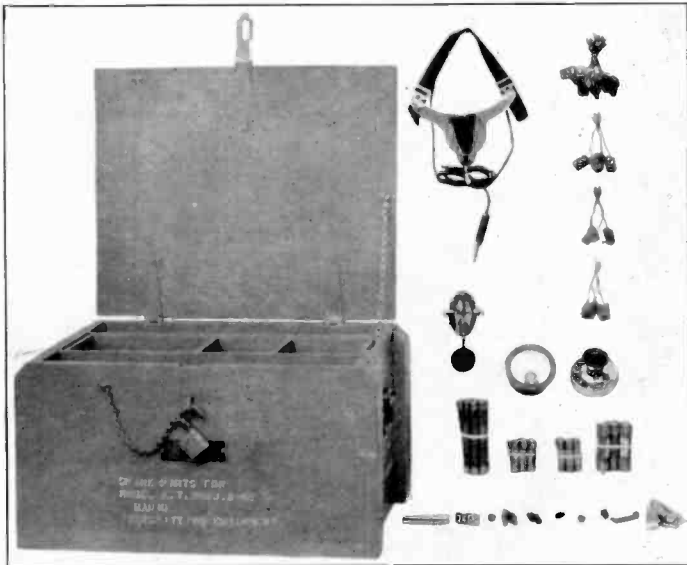

FIGURE 14—Spare Part Box Model for ET-3602, 200 Watt Radio Transmitting Equipment

The linear relation between the plate potential of the oscillators and the antenna current which is essential for telephony is illustrated in Figure 17. The variation of antenna current with filament volts is shown in Figure 18. Typical operating characteristics for the UV-203 and UV-204 radiotrons are shown in Figures 19 and 20.

Figure 19-B shows the plate and grid current voltage characteristics for a type UV-203 radiotron. These characteristics are of value in predicting the performance of the radiotron, as they cover the range of grid and plate voltages during which plate current flows when the associated circuit is adjusted for efficient operation. It will be seen that plate current flows only when the grid is positive, or only very slightly negative, so that the flow of plate current is necessarily limited to a fraction of a cycle, usually less than one-half.

By use of this characteristic, and assuming different angles during which plate current flows in the circuit, the performance of the tube under a number of conditions may be predicted and

the conditions for best performance for any given output may be determined. This has been done, and the results are shown in Figure 19-A. The use of a constant plate voltage of 1,000 volts is assumed here. It will be seen that for low outputs, the minimum instantaneous plate voltage is low, and the direct current grid voltage is high, the alternating current grid voltage being

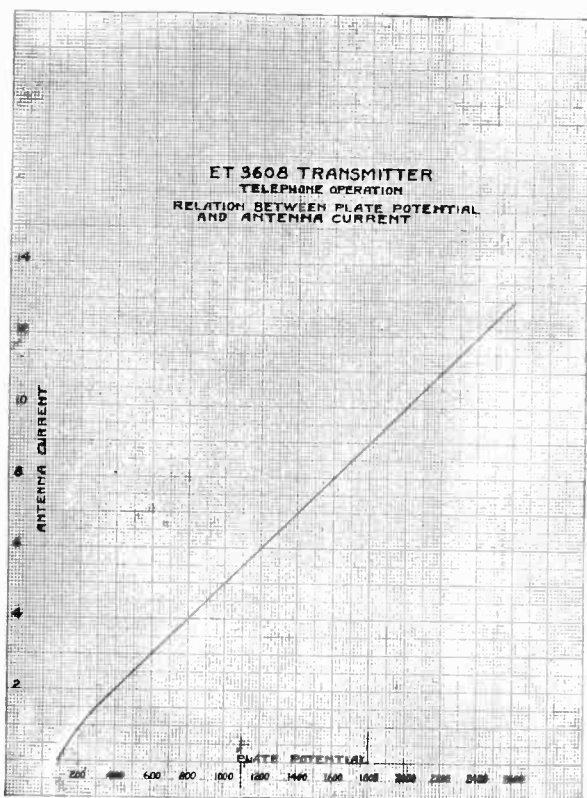

FIGURE 17—ET-3608 Transmitter Telephone Operation. Relation Between Plate Potential and Antenna Current

nearly constant over a considerable range of outputs. This means that the grid voltage does not reach a high positive value, and while it is positive, the plate voltage is low. Inspection of Figure 19-B shows that instantaneous values of plate current, and hence of tube input are low under these conditions, which would be expected for low output at high efficiency. As the output is increased, the grid becomes more positive and remains so for a longer portion of the cycle, hence the integrated grid current

becomes greater, and this, with the requirement of lower direct current grid volts, results in the use of a low grid leak resistance.

Figure 19-C shows the efficiency of the tube at different outputs when working with the best circuit adjustments. The electron loss is also shown, the loss in the grid leak being negligible.

It is interesting to note that while the tube is rated at 50 watts output with 100 watts electron loss, it is actually capable of delivering 124 watts to the circuit with an electron loss of 100 watts. To realize this output requires careful adjustment of the circuit and special care that the grid and plate voltages should be 180 degrees out of phase, as dephasing of the grid voltage increases the tube loss considerably. It should also be remembered that the output of the tube is the total power delivered to the circuit, and if the circuit has considerable loss, the power available may be much less than the output of the tube.

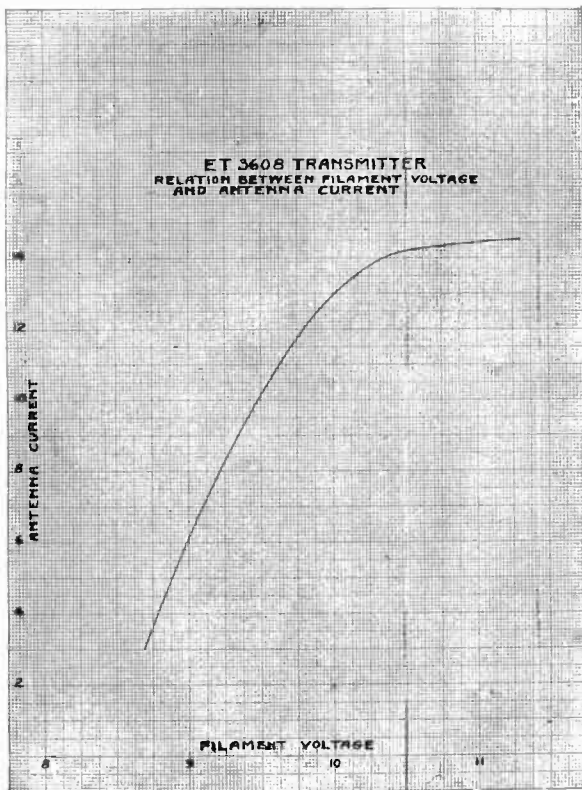

FIGURE 18—ET-3608 Transmitter. Relation Between Filament Voltage and Antenna Current

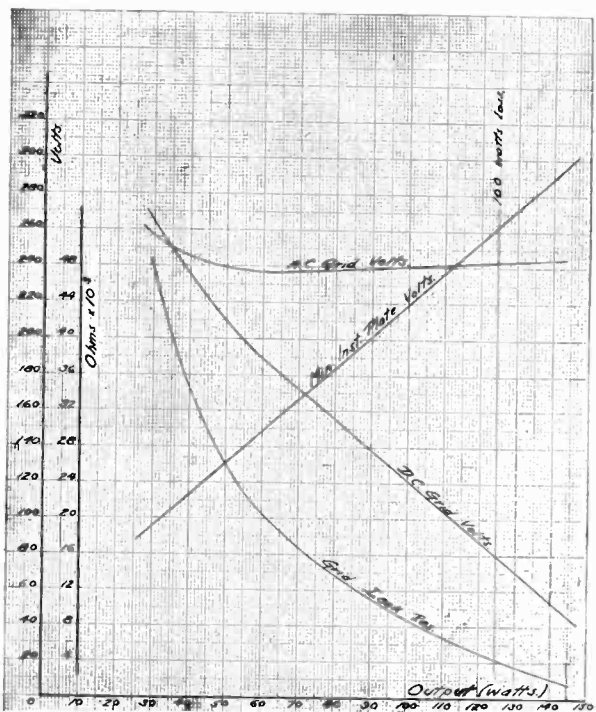

FIGURE 19A—Operating Characteristics of Typical UV-203 Radiotron

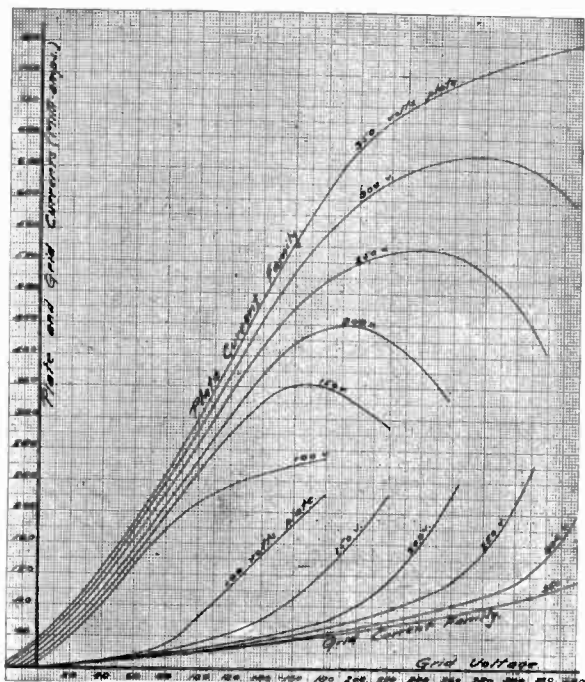

FIGURE 19B—Operating Characteristics of Typical UV-203 Radiotron

The receiving equipment used with the ET-3608 and ET-3602 transmitter is shown in Figure 21. The tuner consists of the usual two-circuit type utilizing regeneration. A wave length range of from 300 to 3,000 meters is provided. The amplifier system comprises standard detector and two-stage audio amplifier units. The UV-200 radiotron is used as a detector and the UV-201 (Figure 22) for the audio amplifier stages.

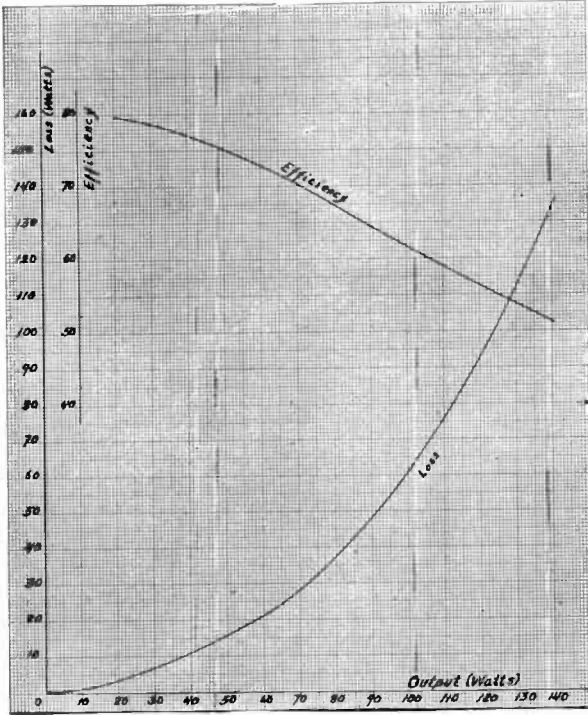

FIGURE 19C—Operating Characteristics of UV-203, Radiotron at 1,000 Volts D. C.

SPARK TUBE TRANSMITTER

The commercial tube transmitters just described were designed to replace completely the present spark equipment. In order to permit reception of these transmitters utilizing receivers designed only for spark transmitter work, means for interrupted continuous wave telegraphy were included in the tube sets. It is obvious that in some cases such an abrupt change in transmitting equipments could not be economically justified. The need for providing the advantages of continuous wave transmission

and yet retaining the spark equipment resulted in the design of an attachment which would permit either spark or continuous wave telegraphy.

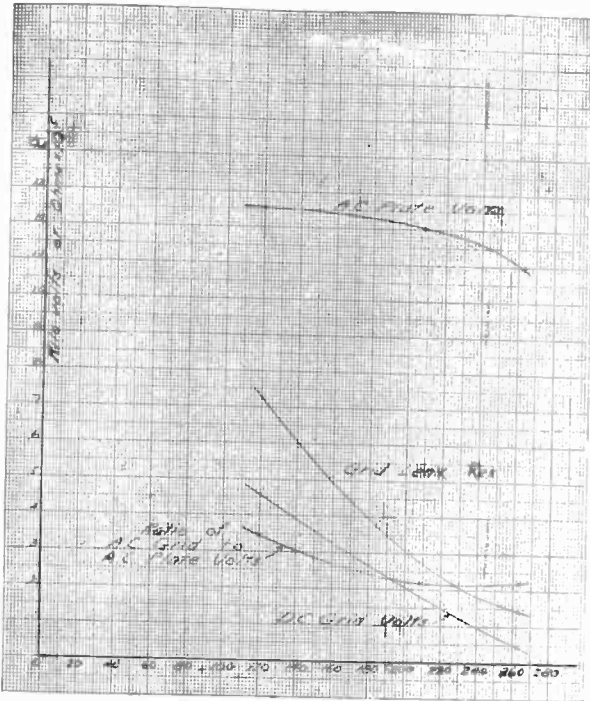

FIGURE 20A—Operating Characteristics of Typical UV-204 Radiotron

The tube attachment provides continuous wave telegraphy on any two wave lengths in the band of 1,800 to 2,600 meters. The output is approximately 750 watts. The tube equipment consists of one UV-218 kenotron operating as a half wave rectifier and a UV-206 radiotron as an oscillator. The entire power supply is furnished by the 500-cycle generator normally used with the spark transmitter. A filter is provided to reduce the ripple in the rectifier output to about 5 percent.

The general construction is shown in Figures 23 and 24. A double-throw switch not shown in these figures permits changing from spark to continuous wave transmission. The switch shown in Figure 24 provides selection of either of the wave lengths for which the equipment has been adjusted. As in the case of the ET-3608 transmitters, a filament voltmeter is located on the operator's table. The circuit for this unit is shown in Figure 25.

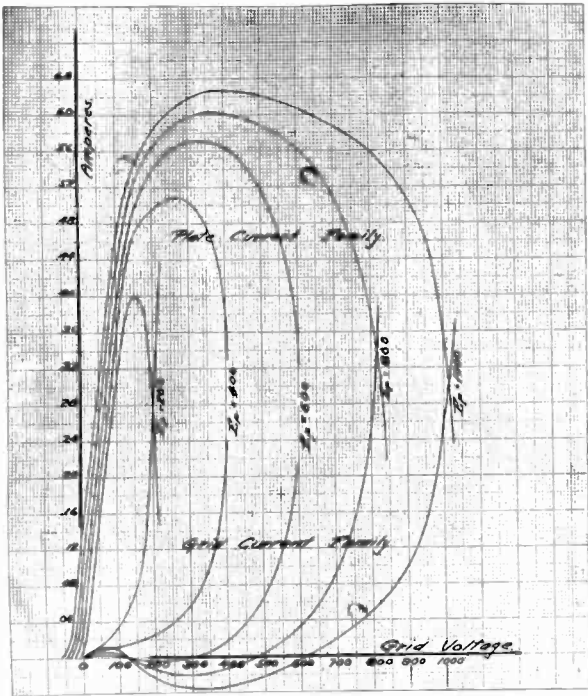

FIGURE 20B—Operating Characteristics of Typical UV-204 Radiotron

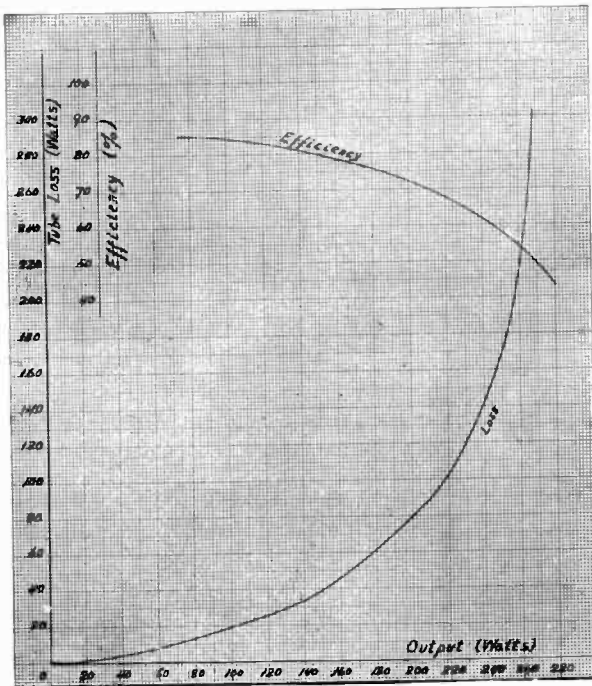

FIGURE 20C—Operating Characteristics of UV-204, Radiotron at 2,000 Volts D. C.

DUPLEX TRANSMITTING EQUIPMENT

The general operation of this type of equipment has been fully considered in a recent issue of the PROCEEDINGS. The particular set manufactured by the General Electric Company is shown in Figures 26 and 27. The rectifier utilizes two UV-218 kenotrons operating in a single phase, full wave circuit. All power is supplied by a 500-cycle generator quite similar to that ordinarily supplied for spark equipments.

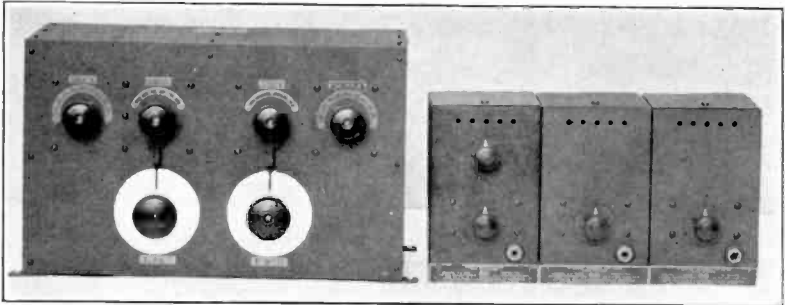

FIGURE 21—Radio Tuned Coupler Model AR-1529, Detector Model AD-1527, and 2 Tone Amplifiers Model AD-1528, Front View

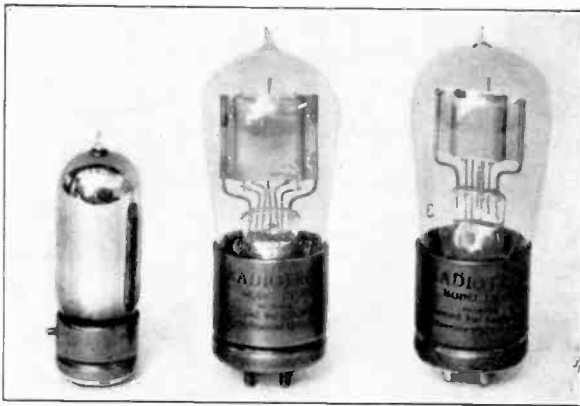

FIGURE 22—Radiotrons. Models UV-199, UV-200, UV-201

The transmitter unit covers a wave length range of 300 to 800 meters. Two UV-206 radiotrons are used, one as an oscillator, the other as a modulator. The speech amplifier consists of a UV-203 tube.

The receiver illustrated in Figure 28 provides reception over a range of wave lengths from 250 to 4,000 meters and uses 8

UV-201 radiotrons. Circuit diagrams are shown in Figures 29 and 30. This particular equipment was used on the S. S. America during the tests made in 1922.

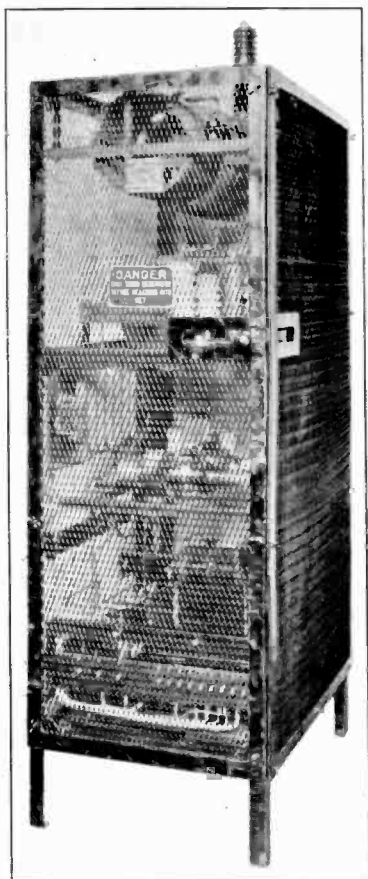

FIGURE 23—Vacuum Tube Radio Transmitting Equipment for use in Connection with Spark Sets

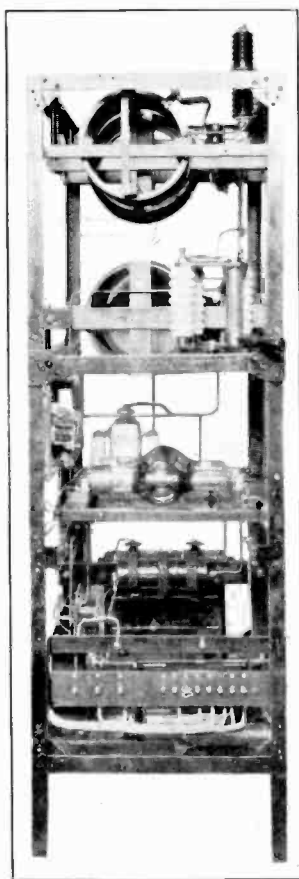

FIGURE 24—Vacuum Tube Radio Transmitting Equipment for Use in Connection with Spark Sets

MODEL ET-3619 TRANSMITTER

This equipment was designed for service on yachts or small vessels where only relatively short distance transmission is required. Ordinarily provision is made for only continuous wave telegraphy and telephony. Interrupted continuous wave telegraphy can, however, be obtained by the addition of a motor-driven interrupter. For telegraphy, four UV-202 radiotrons

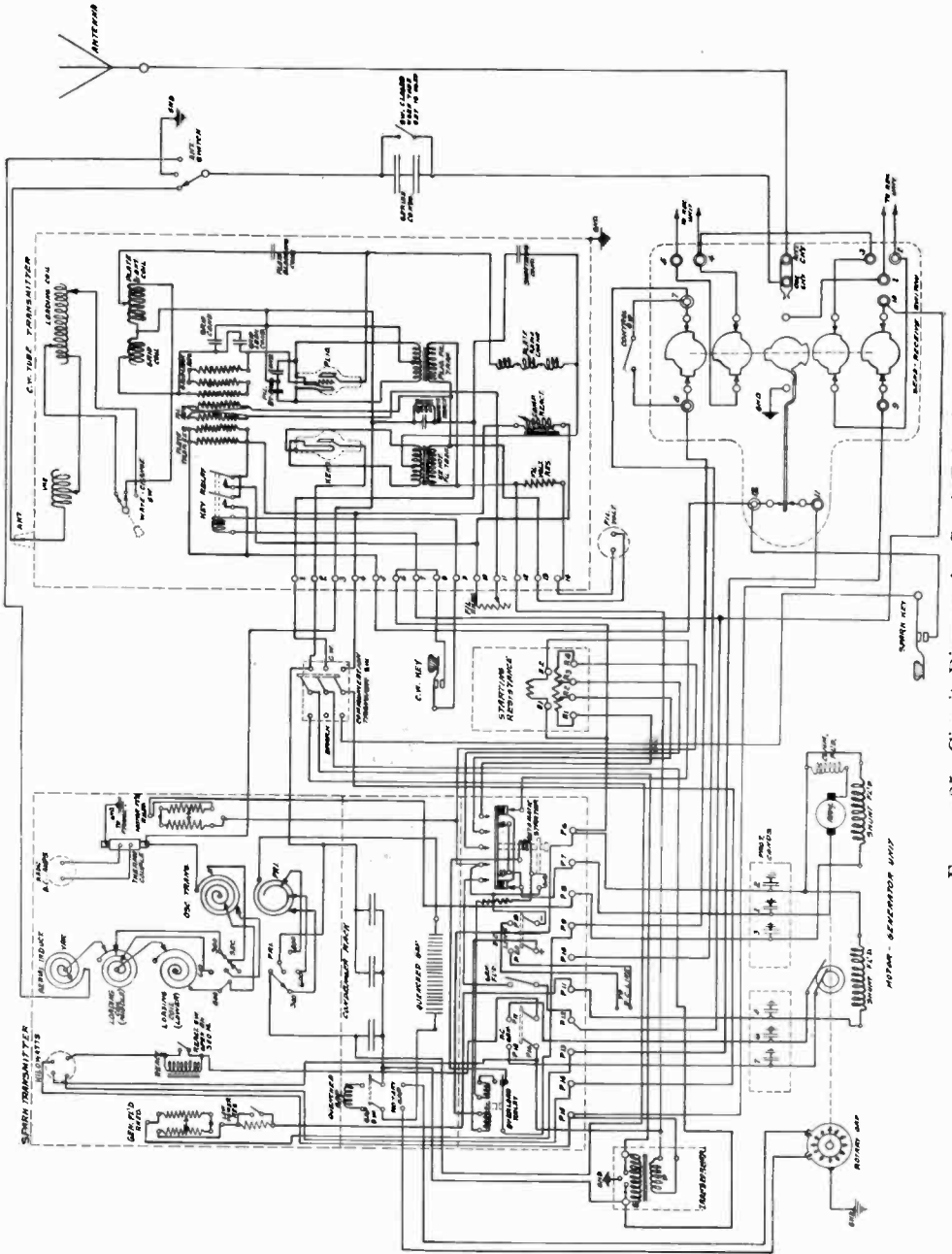

Figure 25—Circuit Diagram for Spark-Tube Set

(5 watts) are employed as oscillators. For telephony, two of these tubes are utilized as modulators.

A front view of the transmitter unit is shown in Figure 31. Two controls are supplied on the panel, one a signal switch which changes the connections from telephony to telegraphy, and the other an antenna condenser for wave length adjustment. Adjustment of the oscillating system is provided by connectors on the coil shown in the rear view of the transmitter unit (Figure 32). This view illustrates the method of mounting the various standardized units, the general plan of wiring, and the terminal board located at the base of the unit. The antenna insulator is shown at the lower left-hand side.

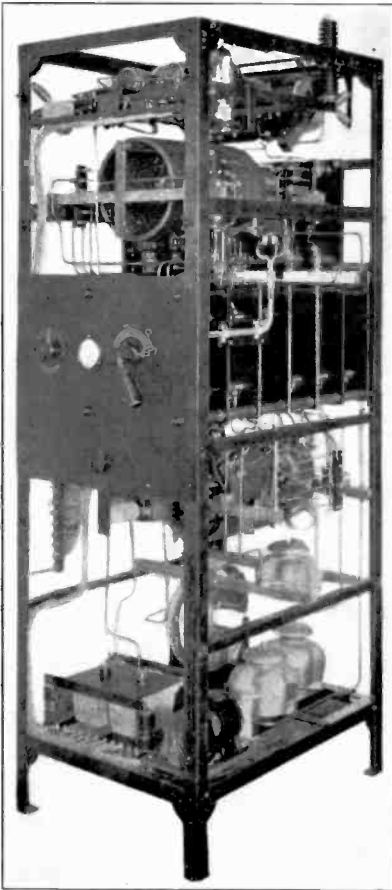

FIGURE 26—Duplex Radio Telephone Transmitter; Radio Unit

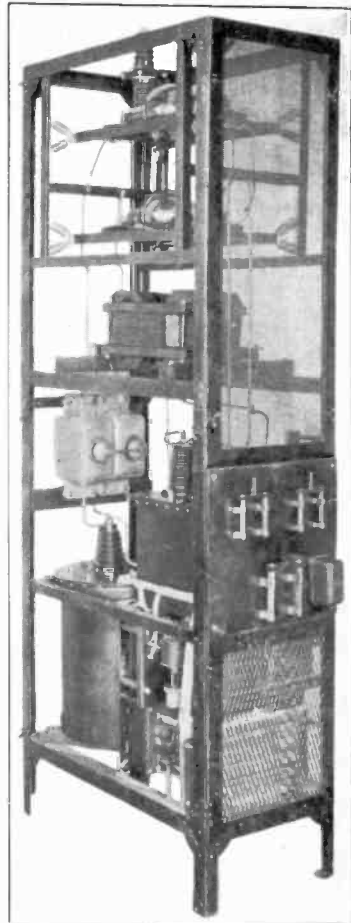

FIGURE 27—Duplex Radio Telephone Transmitter; Rectifier Unit

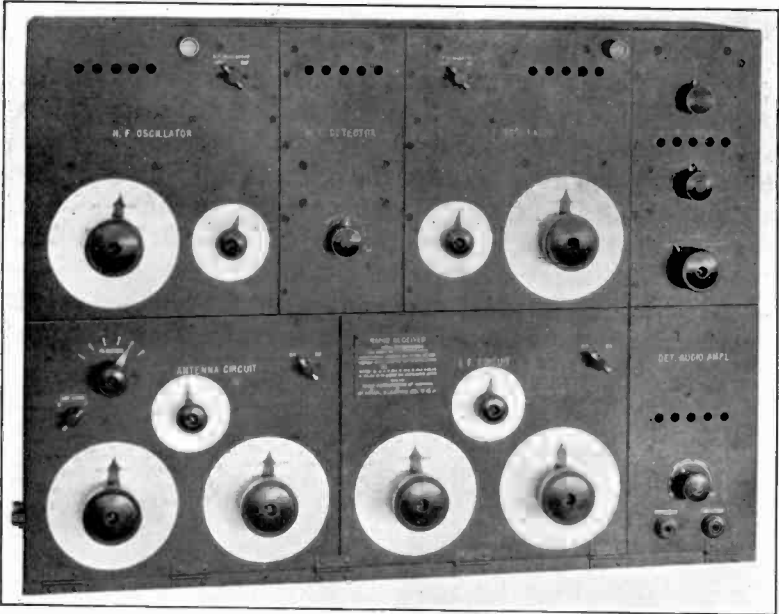

FIGURE 28—Model of Radio Receiver for Duplex Operation.

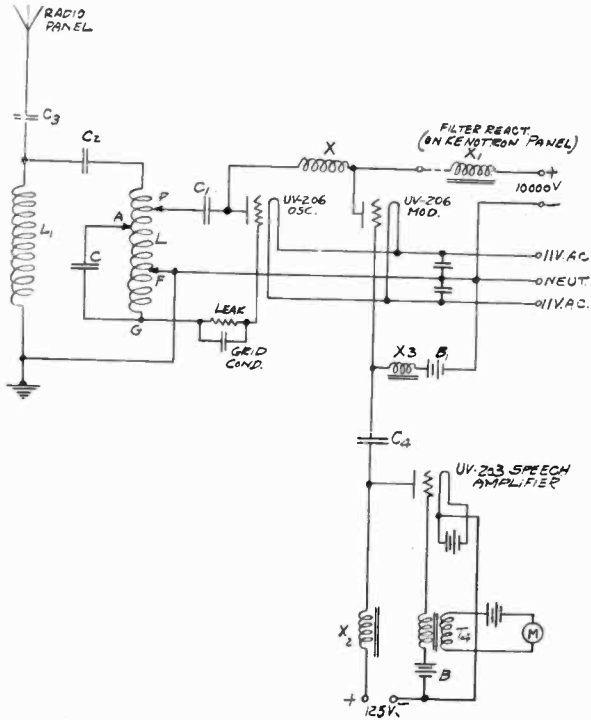

FIGURE 29—Circuit Diagram of Radio Panel

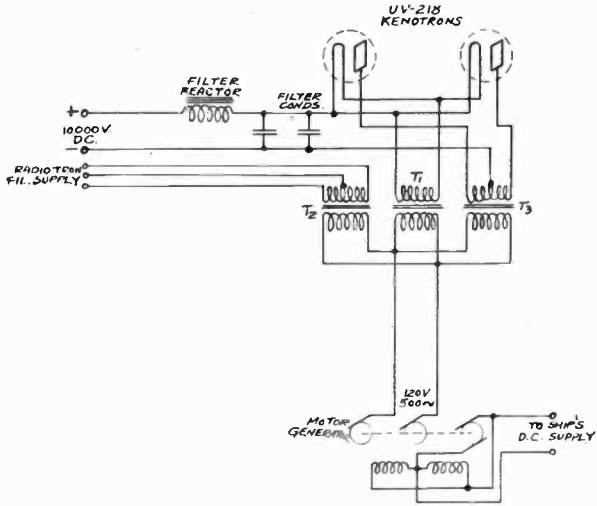

FIGURE 30—Circuit Diagram of Kenotron Panel

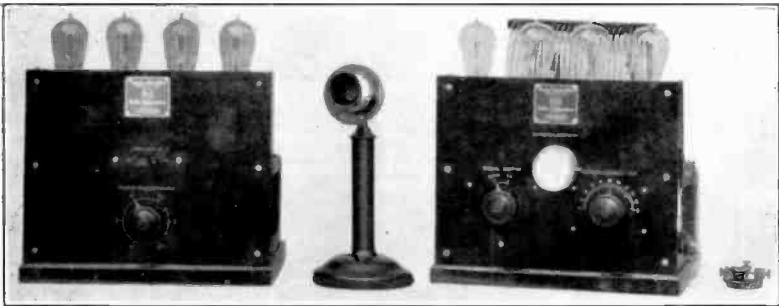

FIGURE 31—Model ET-3620, Kenotron Rectifier and Model ET-3619, Radio Transmitter (Front)

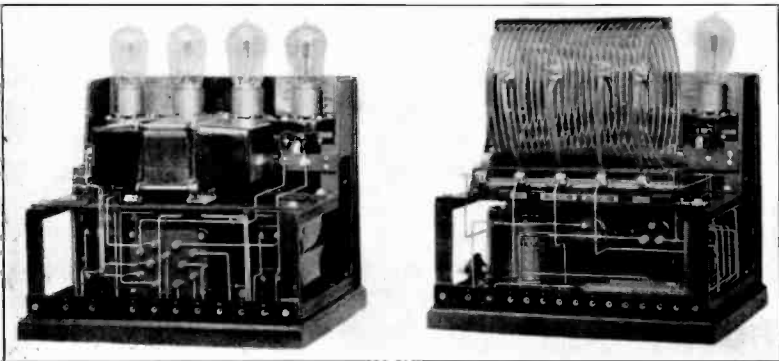

FIGURE 32—Model ET-3620, Kenotron Rectifier and Model ET-3619, Radio Transmitter (Back)

A schematic circuit diagram is shown in Figure 33. Operating characteristics of the UV-202 radiotron are indicated in Figure 34.

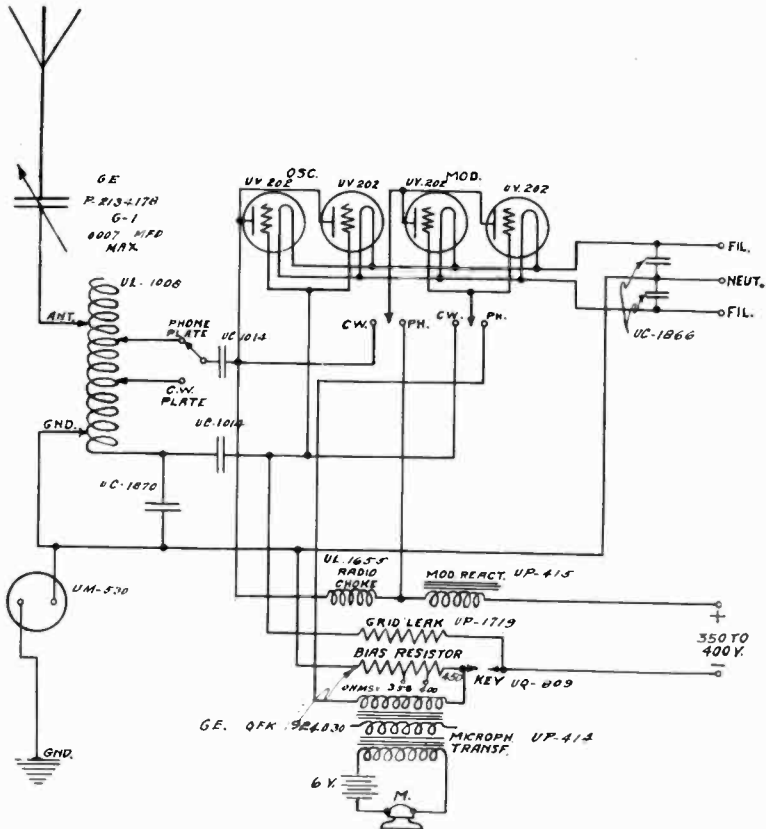

FIGURE 33—Circuit Diagram ET-3619, Transmitter

Power for the transmitter unit may be obtained from a motor generator or a kenotron rectifier. The motor generator is used principally where only direct current is available. In this case the high voltage direct current supply for the plate circuits is obtained from the generator. The filament energy is furnished by a transformer, the primary of which is supplied from slip rings on the motor.

The circuit arrangement shown in Figure 35 constitutes a single phase full wave rectifier. If no filter or smoothing network were used, the current supplied to the oscillator would have the form shown by the middle oscillogram in Figure 36. The use of the filter reduces the ripple so that the output of the rectifier

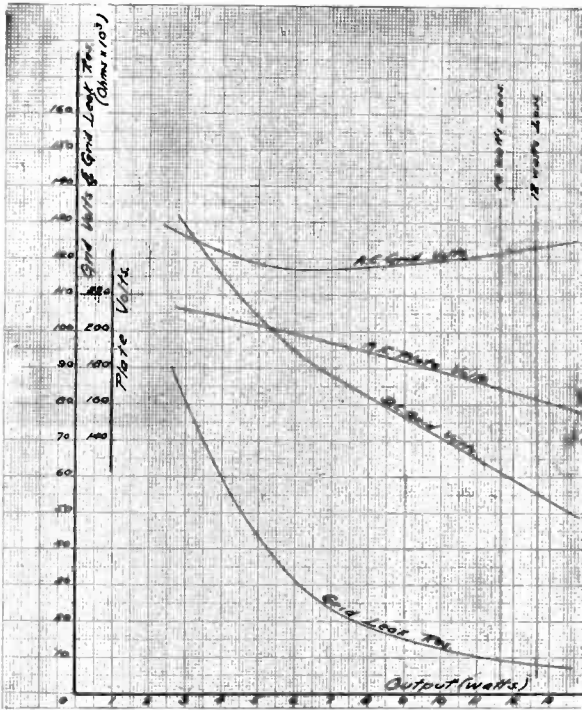

FIGURE 34A—Operating Characteristics of Typical UV-202

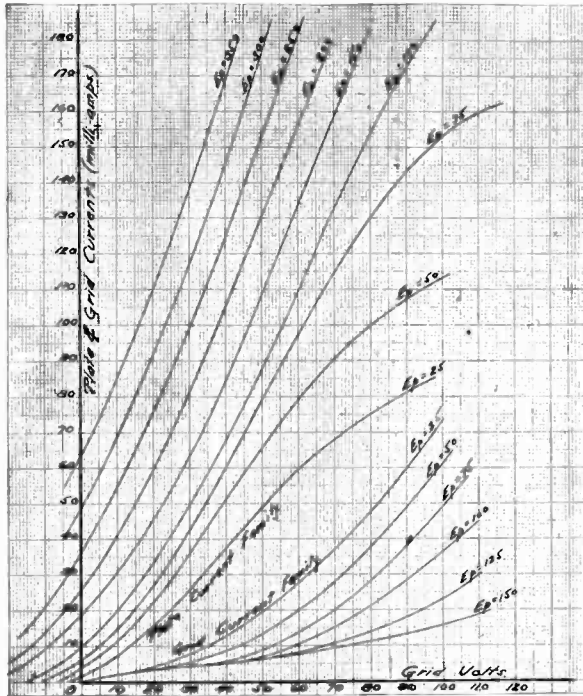

FIGURE 34B—Operating Characteristics of Typical UV-202

takes the form shown in Figure 37. The UP-1368 transformer has three secondary windings, two of which supply power to the filaments of the UV-216 kenotrons, and the UV-202 radiotrons (Figure 38). The third winding terminates on the plates of the kenotrons. The taps on primary of the transformer permit the

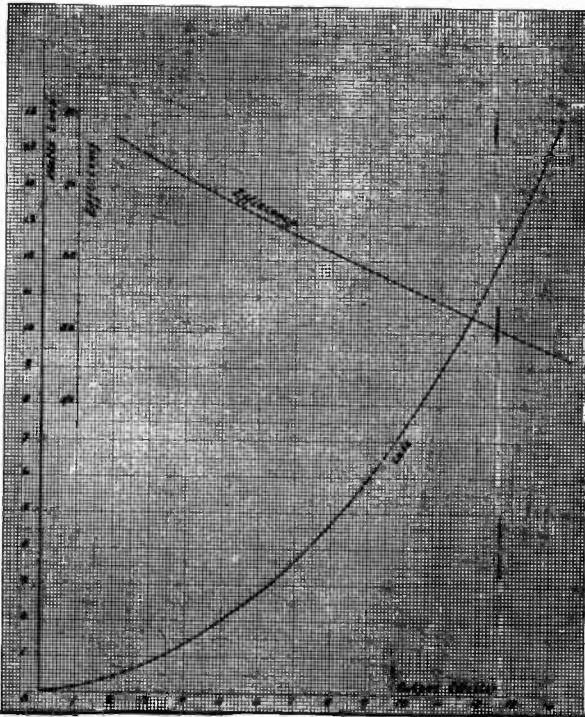

FIGURE 34C—Operating Characteristics of UV-202, Pliotron at 350 Volts D. C.

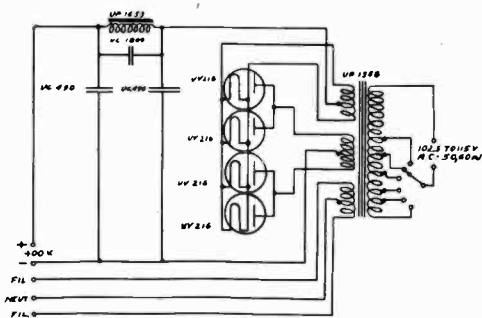

FIGURE 35—Circuit Diagram of Model ET-3620, Kenotron Rectifier

proper secondary voltages over a range of line voltages from 102.5 to 115.

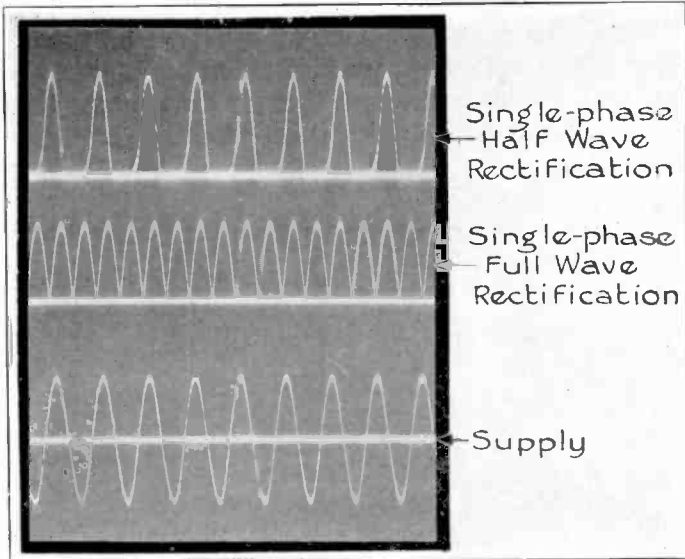

FIGURE 36

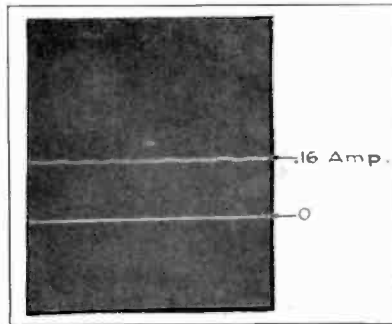

FIGURE 37—Current Wave ET-3620, Kenotron Rectifier

The load characteristics of the ET-3620 are shown in Figure 39. These characteristics were obtained by operating the rectifier under various load conditions, but holding the filament load constant. The over-all efficiency is based on the ratio of kenotron output plus filament losses to the total primary input. The actual over-all efficiency of low power rectifiers is not high, because of the filament energy. A characteristic curve of the UV-216 kenotron is shown in Figure 40.

RECTIFIERS

In view of the service requirements a fixed station is usually of considerably higher power than ship equipment. This ordinarily results in a relatively high voltage direct current supply (10,000 to 15,000 volts) for the oscillator plates. At present, when the power requirements are such that the direct current supply voltage must exceed 2,000 volts, it is desirable to employ kenotron rectifiers.

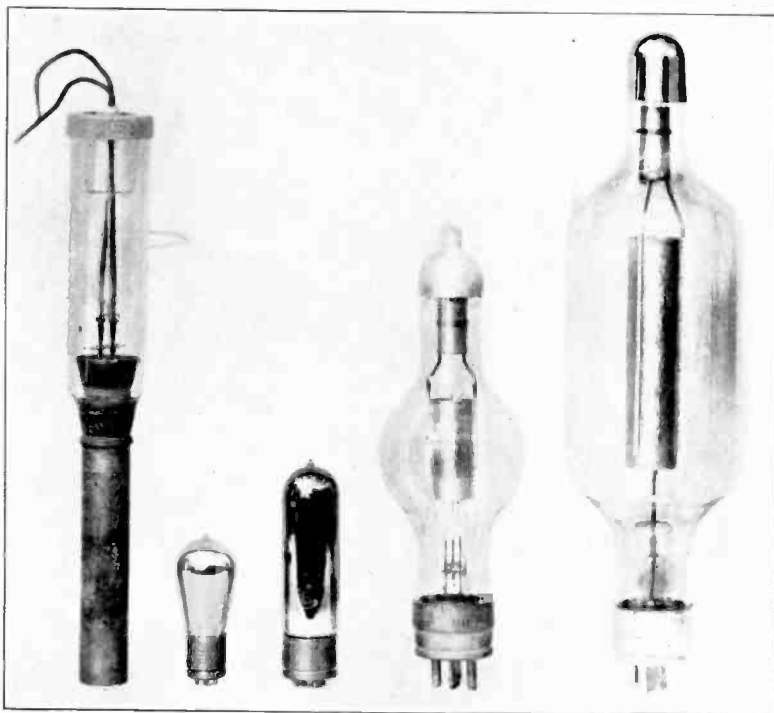

FIGURE 38—Kenotrons: Models (Left to Right), 214, 216, 217, 218, 219

Rectifiers may be single or polyphase, depending largely on the nature of the power supply and the value of rectified current required. The chief advantage of polyphase over single phase rectification lies in the lower value and higher frequency of the alternating current components in the rectified voltage wave, thereby making it easier to smooth. Single phase rectification is commonly employed where only a small value of rectified power is desired, such that the tube capacity required for polyphase rectification is in excess of the required output.

The simplest rectifier is one which utilizes only one-half of the alternating current voltage wave. The half wave rectifier has the advantage of employing fewer rectifier tubes, the minimum number being equal to the number of phases, but the full wave rectifier, rectifying both halves of the voltage wave, possesses such advantages over the half wave rectifier that the latter is little used, except in cases where the power demand is very small, or where extreme simplicity or low first cost of apparatus are desired.

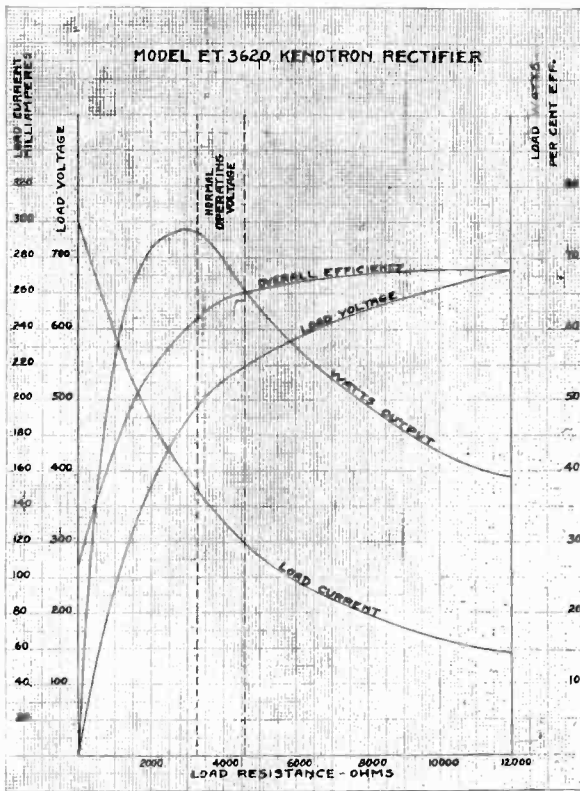

FIGURE 39

In general, full wave rectifiers are preferable to half-wave rectifiers for the following reasons:

- (1) The full wave rectifier delivers a smoother voltage wave.
- (2) The half wave rectifier operates the step-up transformer with a direct current component of flux in the core, with correspondingly high iron losses.

- (3) The step-up transformer in a half wave rectifier draws an unsymmetrical current from the line, with large, even-harmonic components. The accompanying poor regulation is usually objectionable.
- (4) In the case of a polyphase rectifier, the resultant even-harmonic voltages set up in the line have a phase rotation opposite to that of the fundamental. This is highly objectionable in the case of rotating machinery operating on the line.

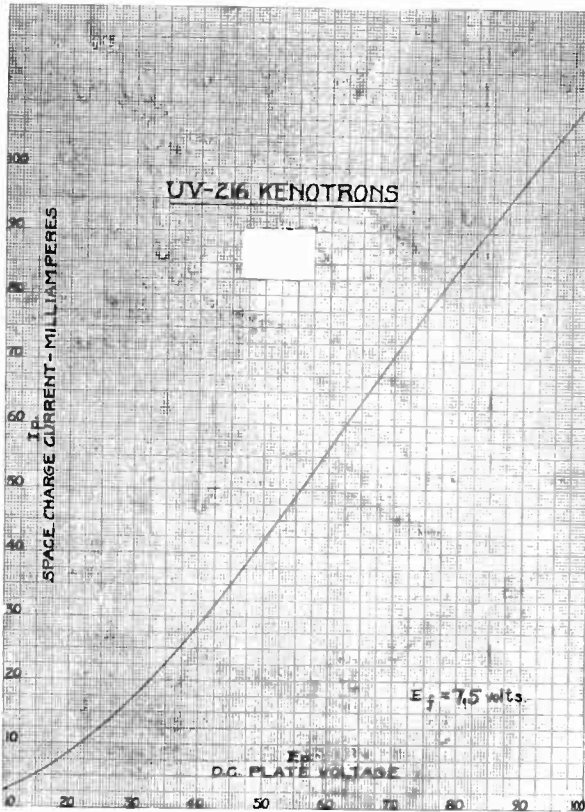

FIGURE 40

SINGLE PHASE HALF AND FULL WAVE RECTIFIERS

Figure 41 shows the circuit connections and resultant voltages for both half and full wave rectification on a single phase system.

THREE PHASE HALF WAVE RECTIFIER

Figure 42 shows a three phase half wave rectifier connection.

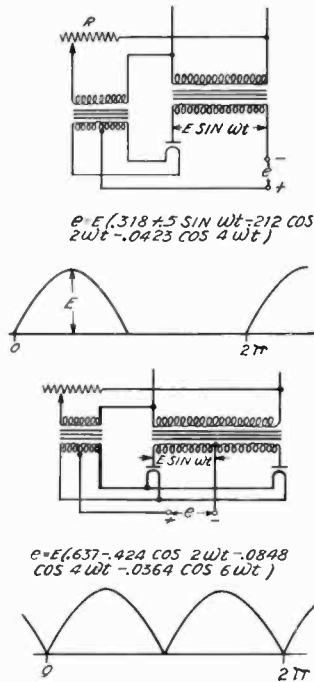

FIGURE 41

The dotted lines represent the transformer voltage waves. The current waves follow the rectifier voltage wave, assuming negligible resistance and reactance in the rectifier. The reason for this lies in the valve action of the kenotron, whereby, at any instant, only the kenotron with the highest positive potential on its plate will pass current. Thus each tube passes current for one-third of a cycle. The primary current in the transformer is unsymmetrical, and in the limiting case of high reactance in the load, assumes the square wave shape shown in the figure. This wave, if analyzed, is found to have a second harmonic component with a magnitude of 50 percent of the fundamental and a fourth harmonic with a magnitude of 25 percent of the fundamental, besides other higher even harmonics of lesser magnitude.

It will be noted that the filaments are heated from a three phase circuit. This is done so that the filament and space charge currents will add up equally in all kenotrons and produce equal filament temperatures. If all the filaments are lighted from one phase, the phase angle between filament and space charge current will differ from 120 degrees in successive tubes, and the sums will not be equal. The resultant unequal filament temperatures

shorten the mean filament life. Another method of securing equal filament temperatures is to heat the filaments from a single phase source, not synchronous with a three phase source.

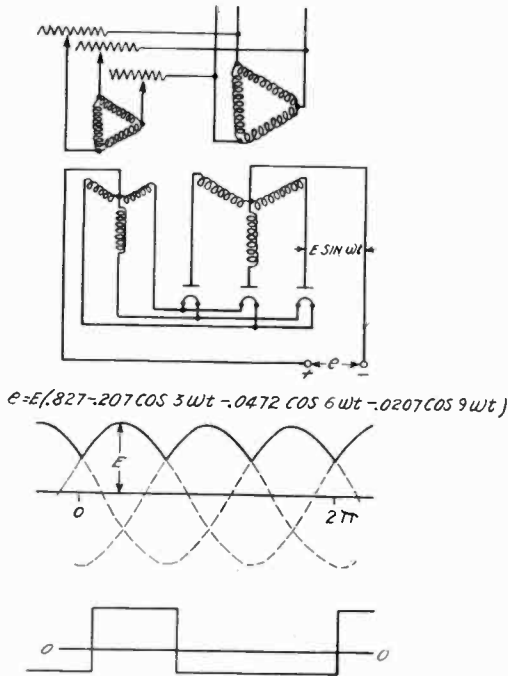

FIGURE 42

THREE PHASE FULL WAVE RECTIFIER

Figure 43 shows a three phase full wave rectifier. The step-up transformer for such a rectifier is wound with mid-taps on each of the three phases, and these are joined together to form the negative terminal of the rectifier. It will be noted that the currents drawn from the two sections of each secondary winding are equal and opposite in sign, hence the primary current is symmetrical and contains no even harmonics.

Since each tube passes current only when the voltage on its plate has a higher positive value than any other plate, it follows that in the three phase half wave rectifier, each tube passes current for one-third of the cycle, while in the three phase full wave rectifier, each tube passes current for only one-sixth of a cycle. Thus it follows that three phase half wave rectification is preferable to full wave rectification in that it utilizes the filament

emission to a much greater extent. On the other hand, full wave rectification is more desirable on account of its better regulation, absence of even harmonic in the line, and smaller harmonic components in the rectified voltage wave.

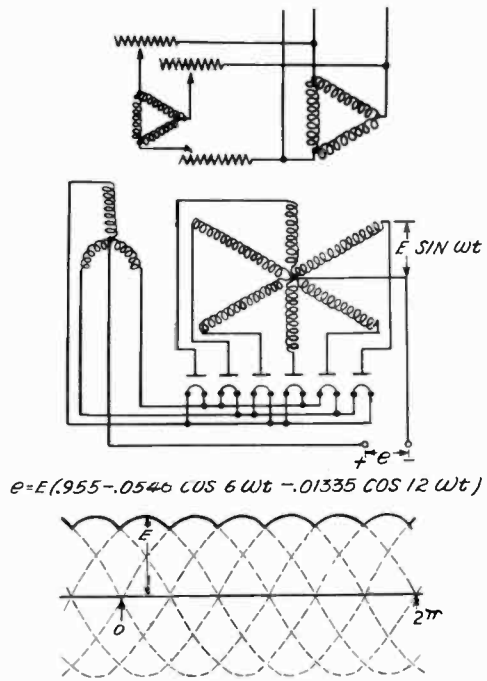

FIGURE 43

THREE PHASE DOUBLE Y RECTIFIER

The advantages of both full wave and half wave polyphase rectifiers may be realized by connecting the high tension windings of the transformer to form two Y's, 180 degrees out of phase, as shown in Figure 44; each Y, with its kenotrons, is a half wave rectifier delivering voltage waves, E_1 and E_2 , with the odd multiples of the triple harmonic components in the two Y's, 180 degrees out of phase and the even components in phase. If we connect the neutral points of the two Y's thru a large reactance, and draw current from the rectifier thru the mid-point of the reactance, the odd multiples of the triple harmonic component will not appear in the rectified voltage wave, since their value is zero at this point, but the even harmonic components will appear. The voltage across the reactor, or interphase transformer is the sum of the absolute values of the odd multiples of

the triple harmonic frequency voltage due to each Y. The current caused by this voltage is the interphase transformer magnetizing current, and circulates thru the kenotrons and transformer windings without appearing in the load.

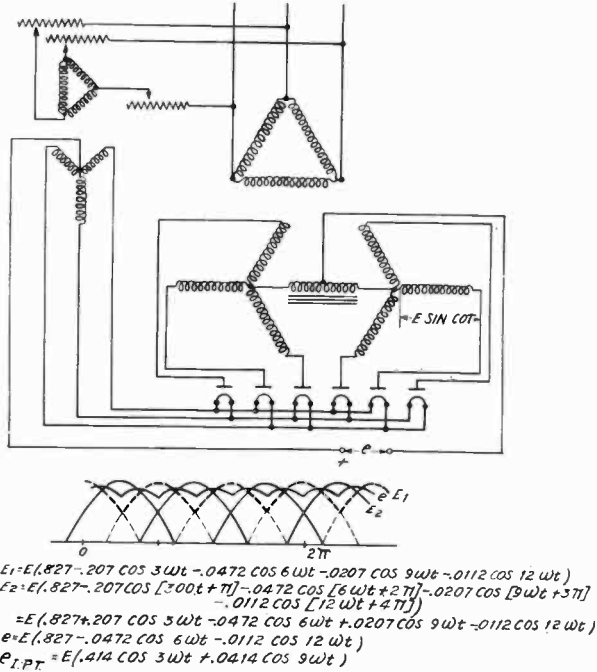

FIGURE 44

The current waves thru each kenotron are nearly square, lasting for one-third of the cycle. Since there are two high tension windings for each phase passing current in opposite directions, the primary current wave is symmetrical and contains no even harmonics. The direct current component delivered by each of the two Y's is one-half of the total direct current, so that each tube is required to pass only one-half the maximum value of current required per tube in an ordinary three phase full wave rectifier. This means that the filament temperature may be lower since less emission is required, and the filament life is accordingly prolonged.

Figures 45 and 46 show typical rectifier assemblies and Figure 38 illustrates the standardized kenotrons used in the various rectifiers. Characteristic curves of the UV-214, 218, and 219 are shown in Figures 47, 48, and 49.

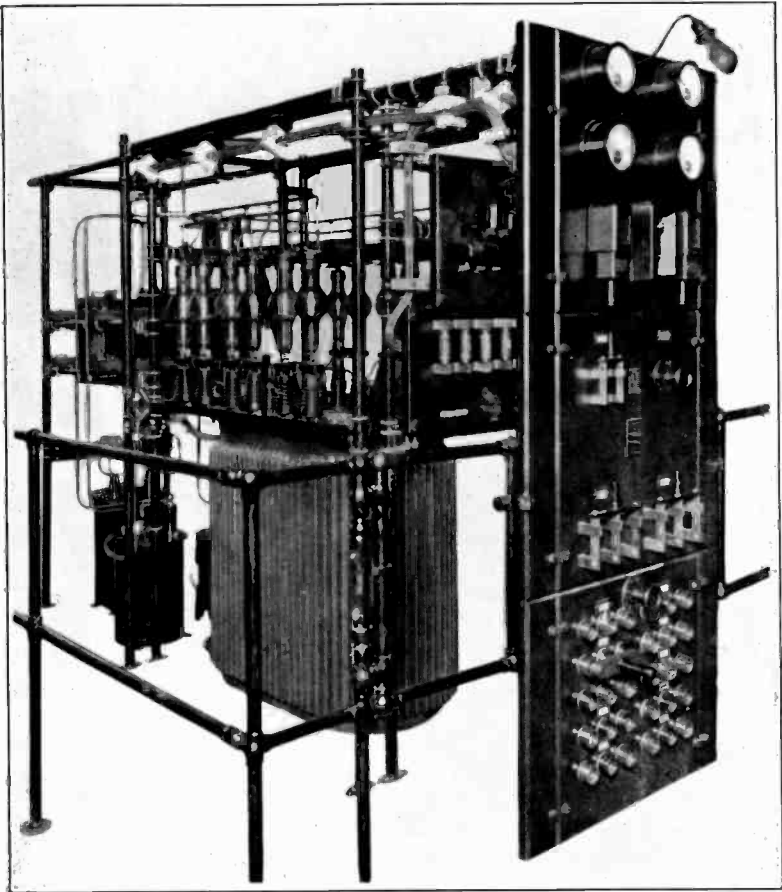

FIGURE 45—30 Kw. Rectifier Unit

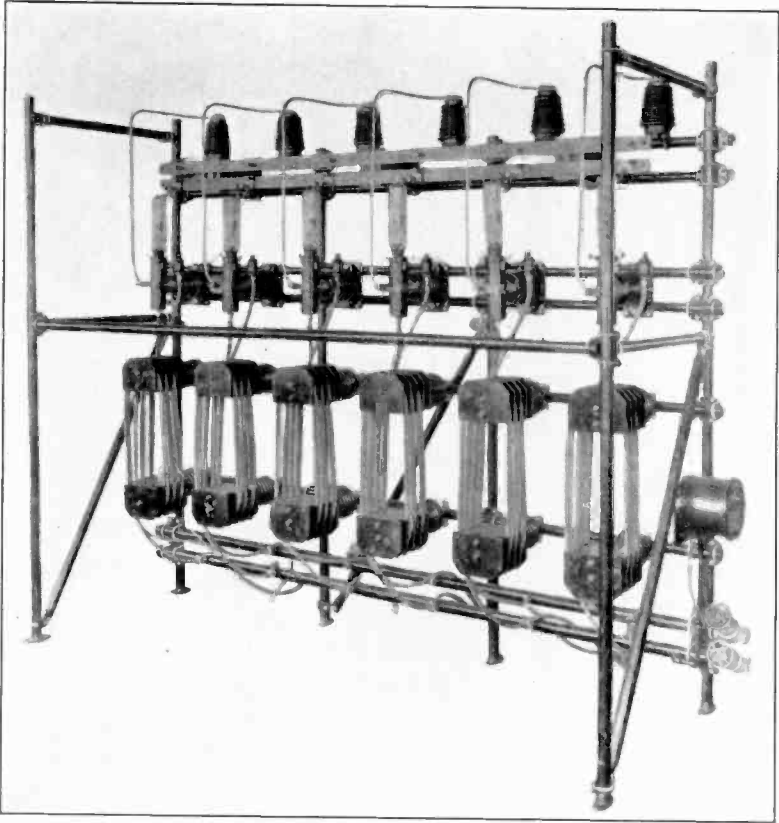

FIGURE 46—Assembly of UV-214, Kenotrons

TWO KILOWATT FIXED STATION EQUIPMENT

Figures 50 and 51 illustrate one type of fixed station equipment. The factors to be noted are the ruggedness, simplicity, and freedom from congestion of both the units and the wiring. The resemblance to a power switchboard is quite striking and results from the use of a great number of standard units normally utilized in power practice.

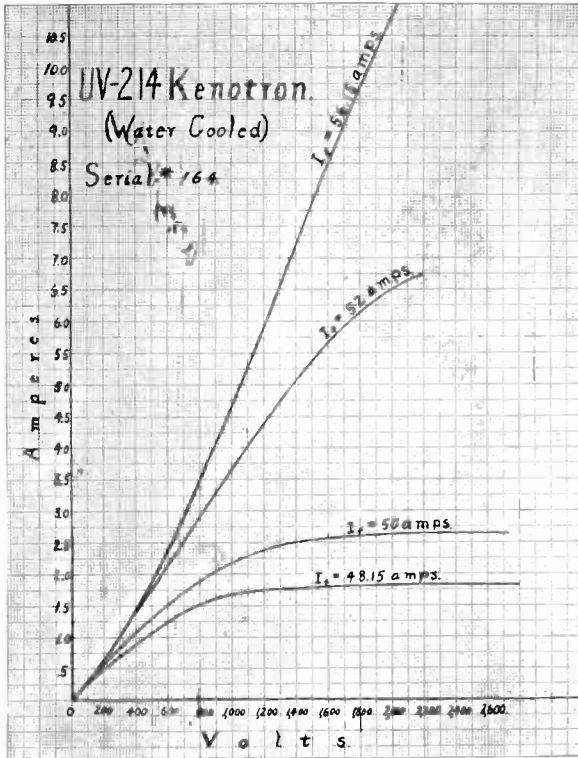

FIGURE 47

This equipment provides continuous wave and interrupted continuous wave telegraphy on wave lengths from 600 to 3,000 meters. The floor space required is ten square feet (1.08 sq. m.), and the over-all height is nine feet (2.74 m.). The equipment may be divided into two sections, the rectifier unit and the radio transmitter.

Referring to Figure 50 which shows the panel of the equipment, the left-hand section is the single phase, full wave kenotron rectifier, employing two UV-218 tubes.

The rectifier is designed to operate from a 220-volt 60-cycle power supply. When the required voltage is not available, an auto transformer may be used.

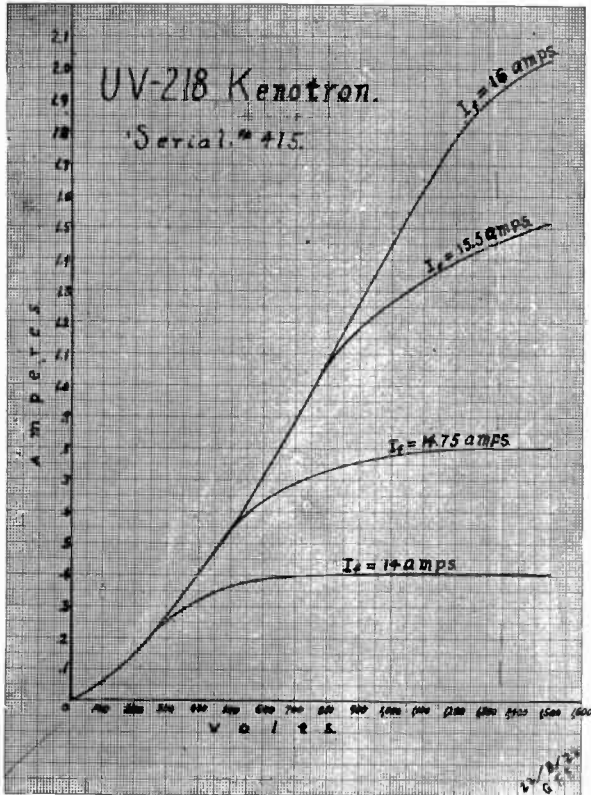

FIGURE 48

The upper portion of the panel contains the various meters required for control of the equipment. Directly below the meters are mounted three protective relays which prevent overloading the radiotrons sufficiently to destroy them. Below the protective relays is located the filament voltmeter transfer jack. The second section of the panel contains insulating switches for the filament and plate currents, as well as a line switch, rheostats for filament excitation control, and "stop" and "start" buttons. The lower section controls the power supplied, by means of taps on the auto transformer, thus providing a variation in the voltage impressed on the primary of the plate transformer, and permitting an adjustment of the output of the rectifier unit. The small

handle controls an induction regulator which enables compensation for small changes in line voltage.

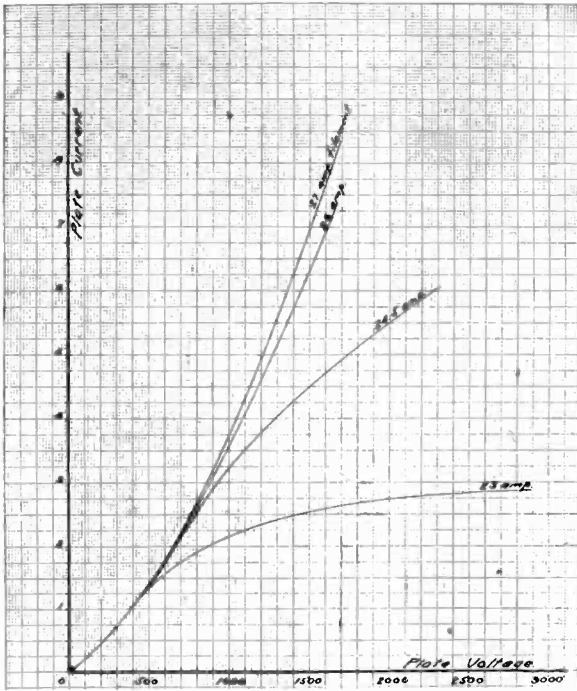

FIGURE 49—Characteristic Curves of UV-219 Kenotron

The lamps and buzzers mounted on the top of the panels are filament burn-out indicators. The left hand indicator is in the kenotron filament circuit, the other in the radiotron filament circuit. If a kenotron should burn out, the buzzer and lamp associated with this circuit would function. These units are designed to insert reactance in the filament circuit to prevent damaging the remaining tube in case of any increase in supply voltage, owing to the decreased load caused by the filament burning out.

The right-hand portion of the panel contains the control for the radio transmitter which employs two UV-206 radiotrons. The handle shown in the upper section provides means for selecting any one of three wave lengths between 600 and 3,000 meters. This wave change switch consists of a three position three bank switch so that, when changing wave lengths, it is only necessary to operate one switch which varies the constants

of the antenna and associated circuits. The center section of the panel contains the keying relay, which is remotely controlled by the operator's telegraph key. The two-position switch below the keying relay selects the type of telegraph communication, that is, continuous wave or interrupted continuous wave.

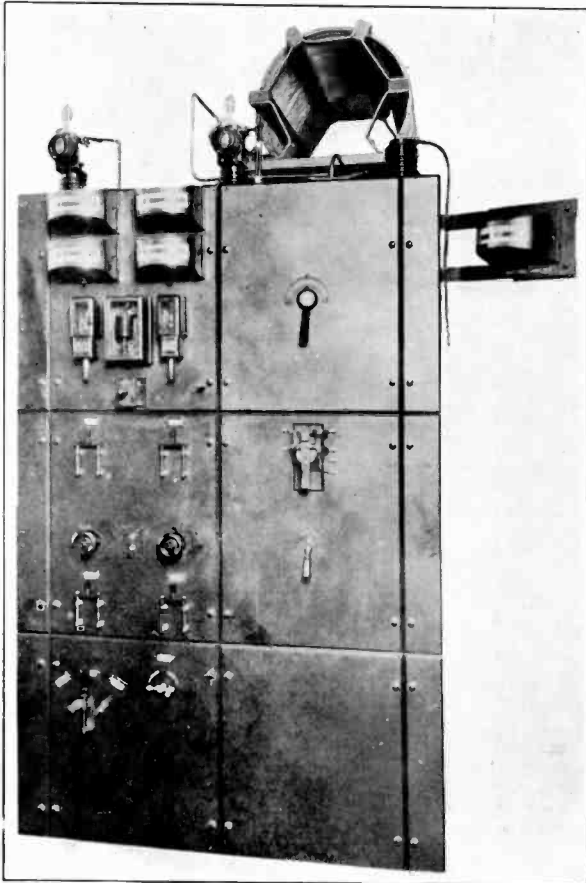

FIGURE 50—2 Kw. Radio Telegraph Transmitter, C. W. and I. C. W. Communication. Wave Length, 600 to 3,000 Meters

Complete control of the equipment is provided from the operator's desk. In addition to the telegraph key which controls the keying relay, two sets of push buttons are provided, "start" and "stop," "send" and "receive." The "start" and "stop" buttons control the main power contactor, which disconnects the power supply on the set side of the main line switch. The "send"

and "receive" buttons control the necessary contactors and interlocking circuits required to connect either the transmitter or the receiver to the antenna in such a way as to prevent accidental starting of the transmitter when the receive button is depressed.

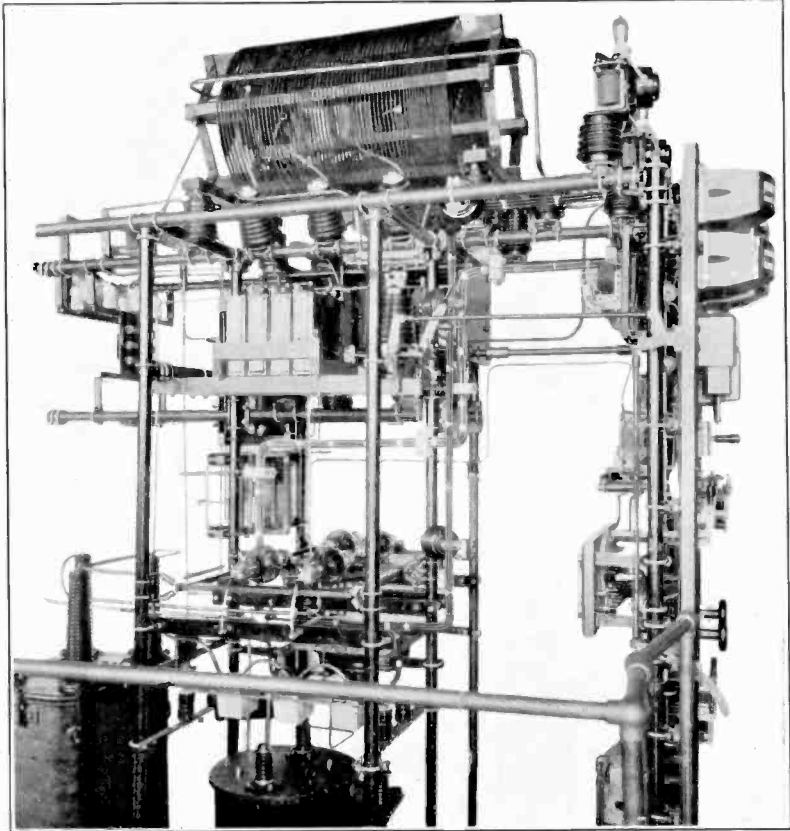

FIGURE 51—2 Kw. Radio Telegraph Transmitter, C. W. and I. C. W. Communication. Wave Length, 600 to 3,000 Meters

The circuit diagram of this equipment is shown in Figure 52.

A second type of two kilowatt fixed station and a 4 kilowatt equipment of the same general design is shown in Figure 53. These sets are designed to provide continuous wave telegraphy on any four wave lengths between 600 and 3,000 meters. The transmitter consists essentially of four component circuits. A rectifier circuit is used to obtain a source of high voltage direct current for the plate of the radiotron. The filter circuit is arranged to smooth out the ripple in the rectifier circuit current, an

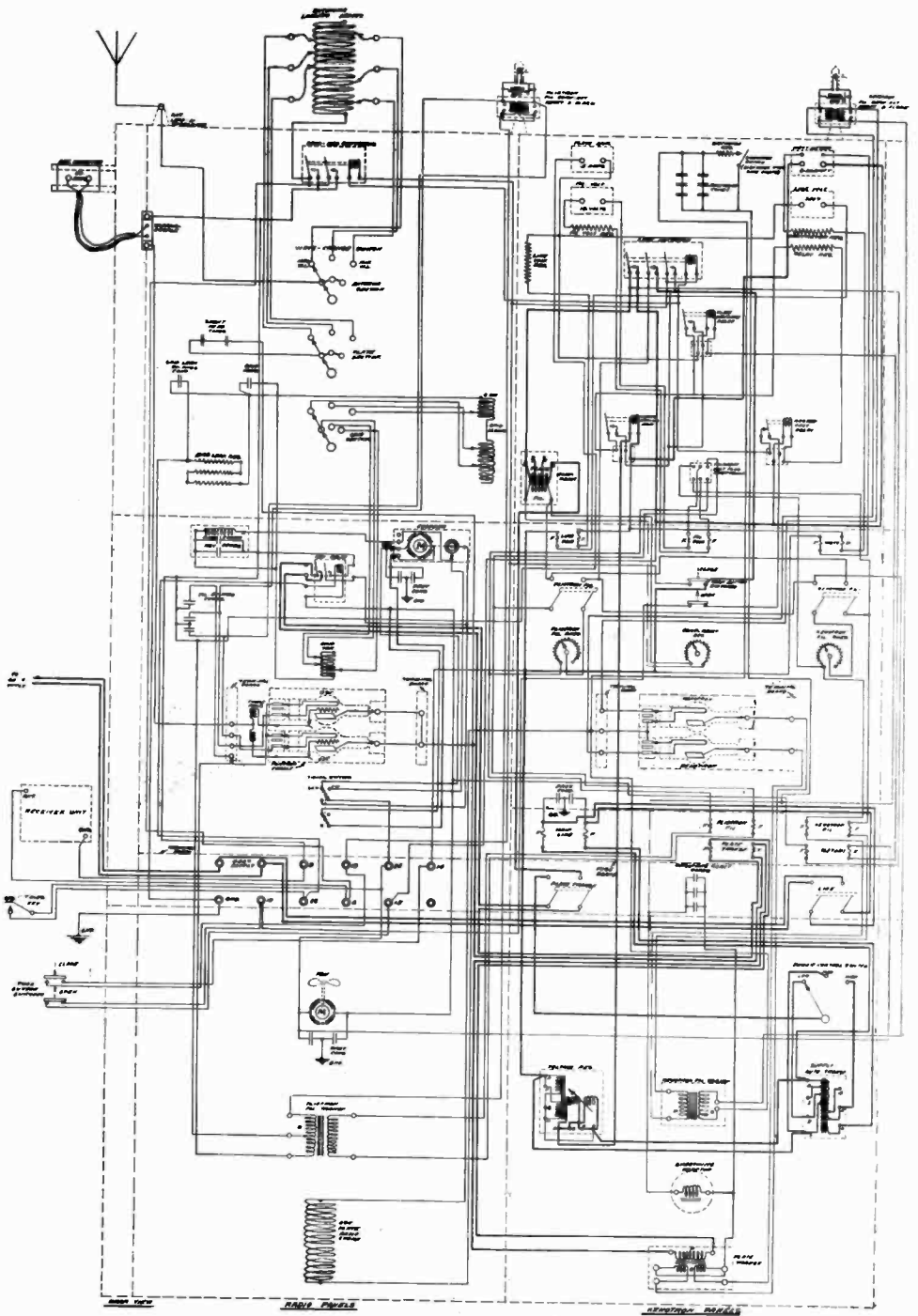

FIGURE 52—Circuit Diagram of 2 Kw. Transmitter

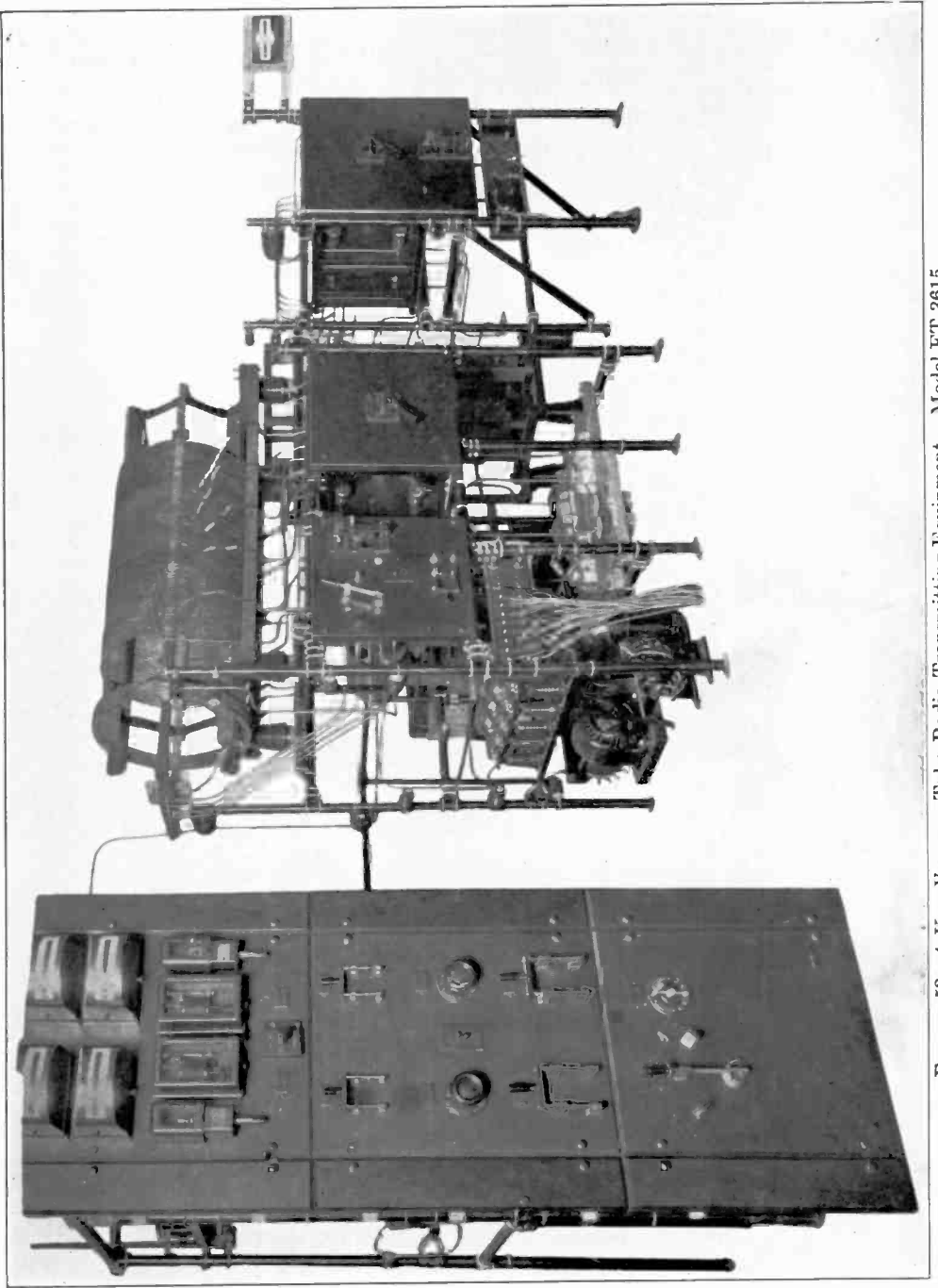

FIGURE 53—4 Kw. Vacuum Tube Radio Transmitting Equipment. Model E.T.-3615

oscillator circuit is provided which converts the high voltage direct current output of the rectifier and filter into radio frequency current, and a tuning system is included by means of which the wave length of the antenna circuit is adjusted to the wave length of the transmitter. The transmitted wave length is established primarily by the tank circuit in the transmitter which is loosely coupled to the antenna circuit.

The foregoing circuits are built in three independent units:— a vacuum tube rectifier panel which contains the rectifying and filter circuits, a vacuum tube oscillator panel which contains the oscillator and antenna circuits, and an antenna tuning unit which includes the equipment necessary for adjusting the wave length of the antenna.

The rectifier for the 4 kilowatt transmitter is shown in Figure 54. Rectifying equipment for the 2 kilowatt transmitter is quite similar in design, except that only two UV-218 kenotrons are used instead of four. Both rectifiers operate in a single phase, full wave circuit, with 110 or 220-volt, 60-cycle supply.

The radio frequency generating units shown in Figure 55 use three UV-206 tubes, for the 2 kilowatt outfit, and five UV-206 tubes for the 4-kilowatt equipment. A schematic circuit diagram is given in Figure 56. Any one of the four wave lengths may be selected by means of the four bank switch. The units mounted on the left-hand panel of the transmitter are a switch for controlling the coupling, the keying relay, communication switch, and start-stop push button.

The antenna loading coil with its wave-change switch is shown in Figure 57.

Control is normally obtained by means of auxiliary equipment constructed for mounting on the operator's table. This equipment consists of a telegraph key with a back contact for operating the break-in relay, and the operator's signal and control cabinet which includes the following:

1. Start and stop switch, which opens and closes the main line contactor on the rectifier panel.
2. Tumbler switch for controlling a stand-by send-receive switch mounted in the antenna unit structure.
3. Three indicating drops, which indicate plate overload and kenotron or radiotron filament over-voltage, respectively. Each of the three drops actuate a buzzer which indicates to the operator that the transmitter requires attention. This control unit is shown in Figure 58.

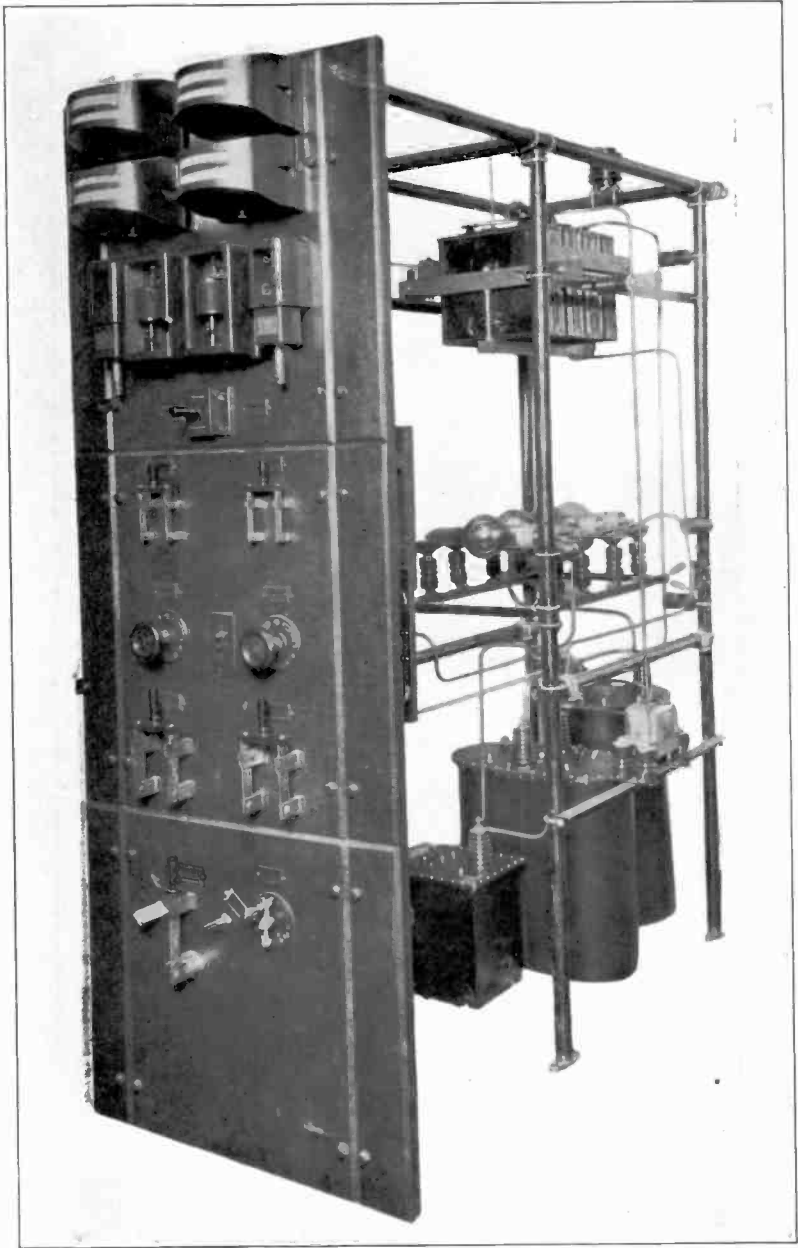

FIGURE 54—Vacuum Tube Rectifier, Model AP-1763, Radio Transmitting Equipment ET-3615

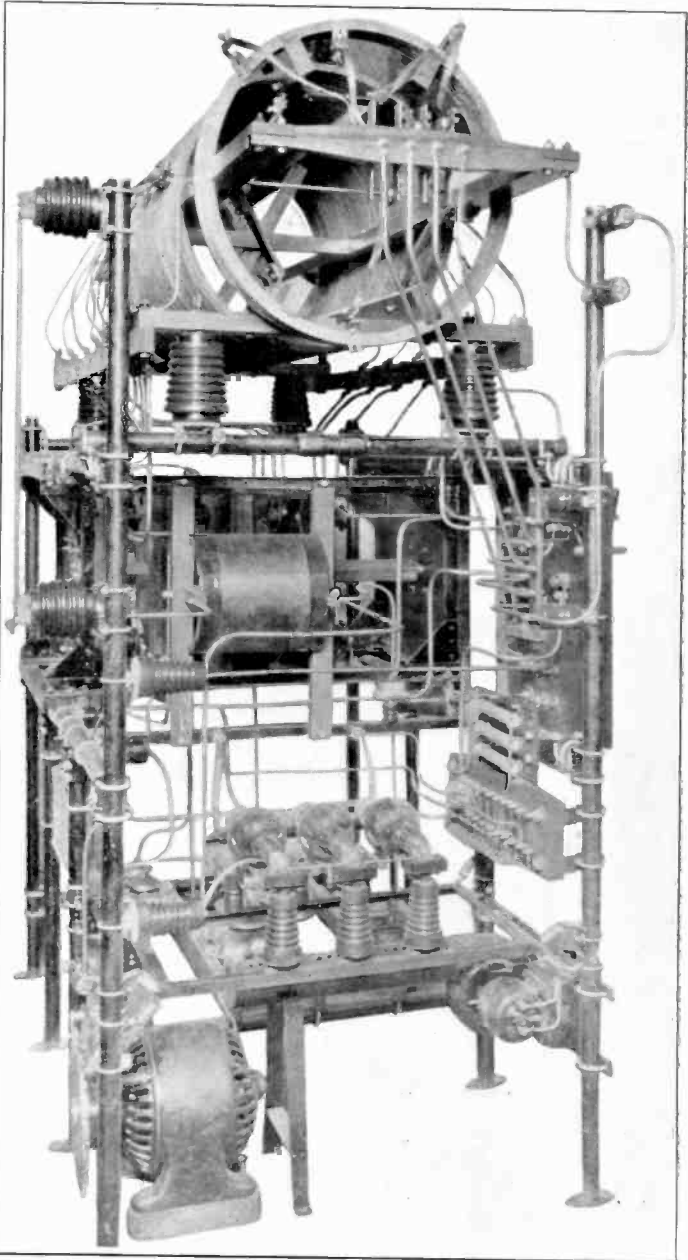

FIGURE 55—Vacuum Tube Oscillator, Model ST-1764, 2 Kw. Radio Transmitting Equipment, Model ET-3613

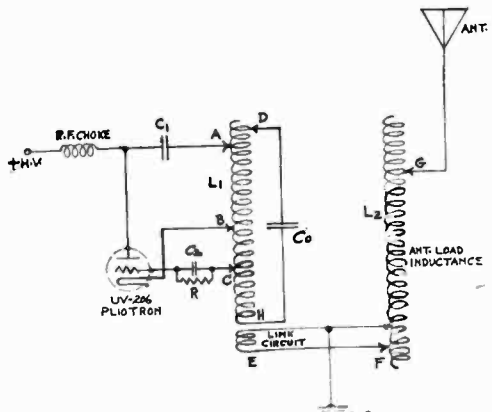

FIGURE 56—Schematic Diagram of Oscillating Circuits

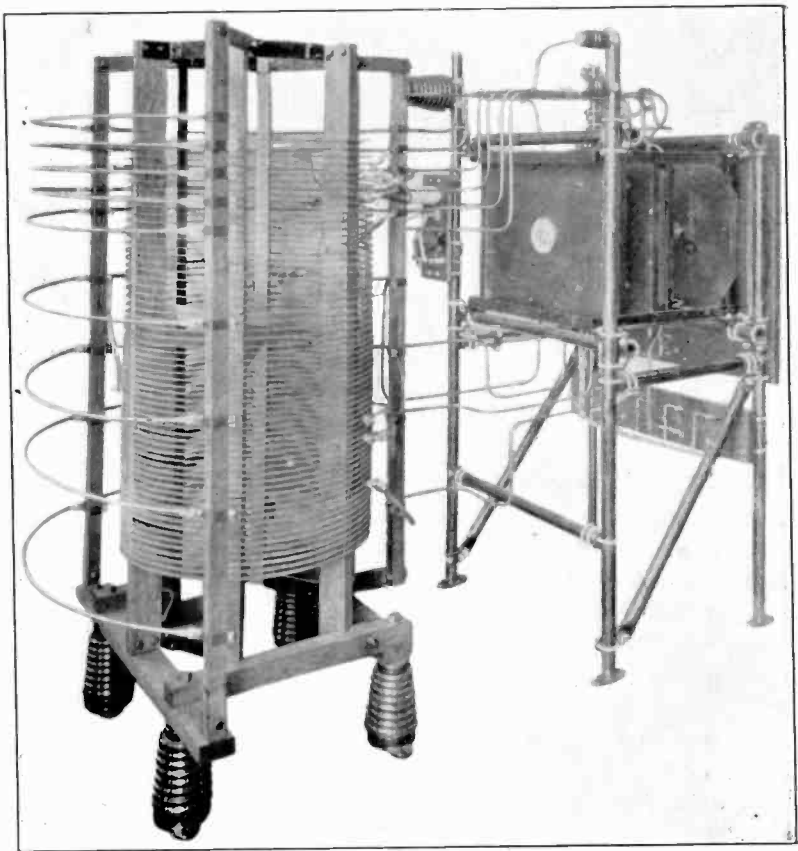

FIGURE 57—Antenna Tuning Unit, Model SL-1766, Vacuum Tube Radio Transmitting Equipment, Model ET-3615



FIGURE 58—Signal and Control Cabinet

The control supplied for the operator's cable, while sufficient for normal operation, does not take care of all adjustments for the set. Wave change, power change, signal change, filament voltage control, and line voltage compensation are controlled in the transmitter. Provision is also made for starting and stopping the set from push buttons located on the rectifier and oscillator panels. The equipments are provided with protective apparatus which will prevent any injury to the component parts in the event that the apparatus is improperly operated. Operating characteristics of the UV-206 radiotron are shown in Figure 59.

20 KILOWATT TRANSMITTING EQUIPMENT

An outline drawing of a 20-kilowatt equipment is shown in Figure 60. This transmitter consists of three main units:—rectifier, master oscillator, and radio frequency generator.

The three phase double Y rectifier utilizes six UV-219 kenotrons and is designed to operate on a three phase, 220 or 440-volt 60-cycle circuit.

The master oscillator includes one UV-206 radiotron with sufficient accessory apparatus to provide a band of wave lengths from 2,500 to 4,500 meters.

The power amplifier is divided into three units, UV-207 tube mounting with complete cooling system comprising a radiator pump and fan, tank circuit variometer and tank condensers. Characteristics of the UV-207 radiotron are shown in Figure 61.

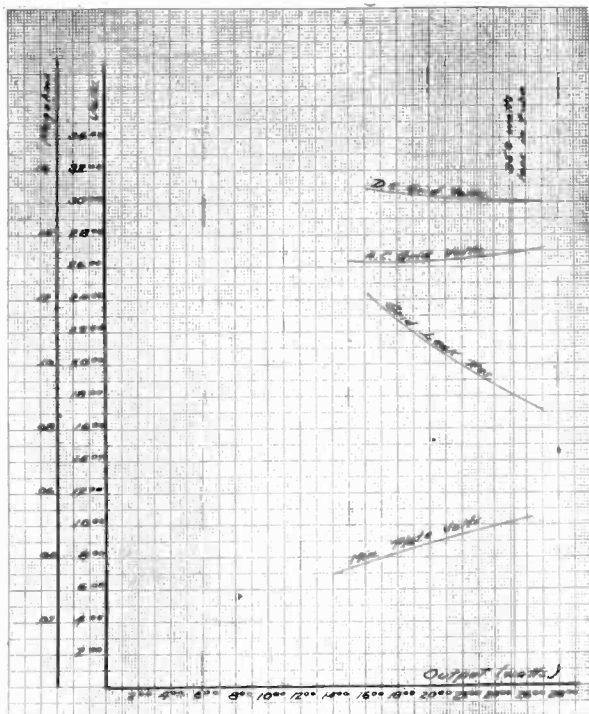

FIGURE 59A—Operating Characteristics of Typical UV-206 Radiotron

Some information on the radiotrons mentioned in this paper is given in the following table:

POWER TUBES

Model	Filament		Plate		μ	Output, Watts
	Volts	Amps.	Volts	Amps.		
UV-202	7.5	2.35	350	0.050	7.5	5
UV-203	10.0	6.50	1,000	0.150	15.0	50
UV-203A	10.0	3.25	1,000	0.125	25.0	50
UV-204	11.0	14.75	2,000	0.250	20.0	250
UV-204A	11.0	3.85	2,000	0.200	25.0	250
UV-206	11.0	14.75	10,000	0.125	250.0	1,000
UV-207	22.0	52.0	15,000	1.800	40.0	20,000
UV-208	22.0	24.5	15,000	0.450	300.0	5,000

KENOTRONS

Model	Filament		Watts
	Volts	Amps.	Outputs (d.c.)
UV-214	22.0	52.0	50,000
UV-216	7.5	2.35	20
UV-217	10.0	6.5	150
UV-218	11.0	14.75	2,500
UV-219	22.0	24.5	12,500

RECEIVING TUBES

Model	Filament		Plate		μ
	Volts	Amps.	Volts	Amps	
UV-199	3.0	0.06	40	0.001	6
UV-200	5.0	1.0	18 to 23	0.0005 to 0.002	
UV-201	5.0	1.0	40	0.001	6
UV-201A	5.0	0.25	40	0.0012	6.5

OPERATING LIFE OF TUBES

One of the most important features of a vacuum tube is its operating life. The length of this operating life shows a wide variation with respect to operating conditions, and to some extent with respect to individual tubes of the same type.

For any given type of tube, life test conditions are decided upon from the best approximation to average operating conditions, and a considerable number of tubes are thus tested and average and maximum values of length of life determined.

Such average figures, however, are obviously not representative of the operating conditions of every individual user. These conditions vary widely, and it is, therefore, impossible for the tube manufacturer to guarantee a certain operating life to each user.

In the case of large power tubes, for a considerable time after manufacture of the tube has been under way, life test data are not obtainable. Life data furnished the user in such cases are

then estimated and supplemented by data calculated from tubes having features most similar to the tube in question.

Tube failures fall into two general classes:

1. Normal or accelerated filament burn-outs.
2. Failures from causes other than filament burn-outs, which are traceable to incorrect use or defects in design or manufacture.

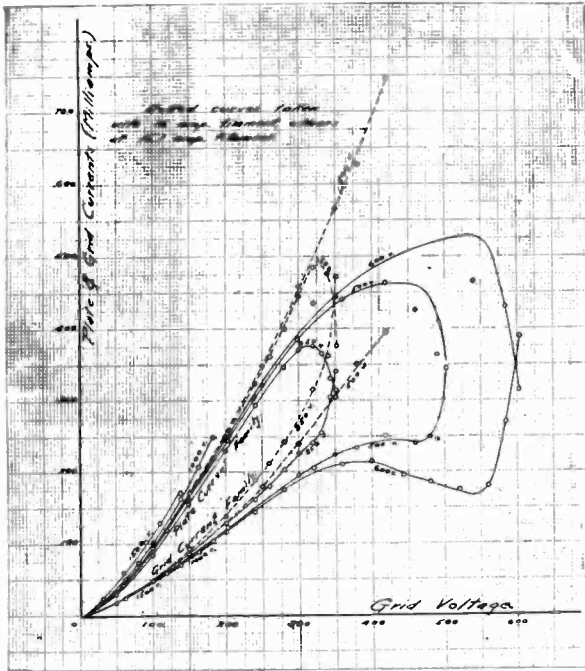

FIGURE 59B—Operating Characteristics of Typical UV-206 Radiotron

It would seem that the best policy in regard to life is to furnish for each type of tube what might be best termed a "life expectation" based on the average data obtainable. This figure, however, is in no sense a guarantee. If the user on actual records obtains a life so much shorter than the expected life that it cannot be reconciled with operating conditions, the tube should be inspected for the cause of the trouble. If this inspection shows a fault traceable to design or manufacture, this tube should be considered for adjustment or replacement.

This policy of tube life is only applicable to commercial installations where the operation is more or less routine and where

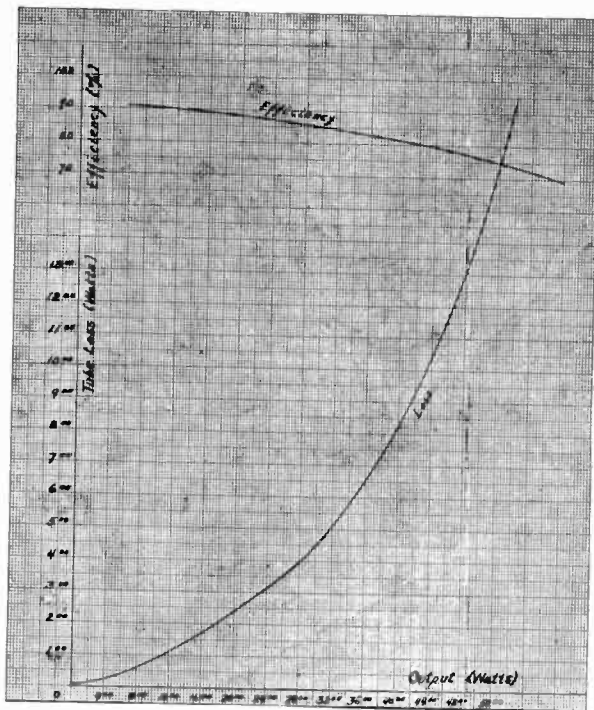

FIGURE 59C—Operating Characteristics of UV-206, Pliotron at 15,000 Volts D. C.

log sheets are maintained, so as to indicate with considerable accuracy not only the actual life obtained, but the conditions of operation. Tubes used for experimental purposes or where the conditions of operation are not controllable or made a matter of record, naturally cannot be considered in the way described.

SUMMARY: Tube transmitters for outputs from 500 watts to 20 kilowatts, and for continuous wave and interrupted continuous wave telegraphy and telephony are described in detail. The essential elements of such transmitters are discussed. Data are given on the characteristics of various power tubes and rectifiers, and a statement relative to the expectation of life of a tube.

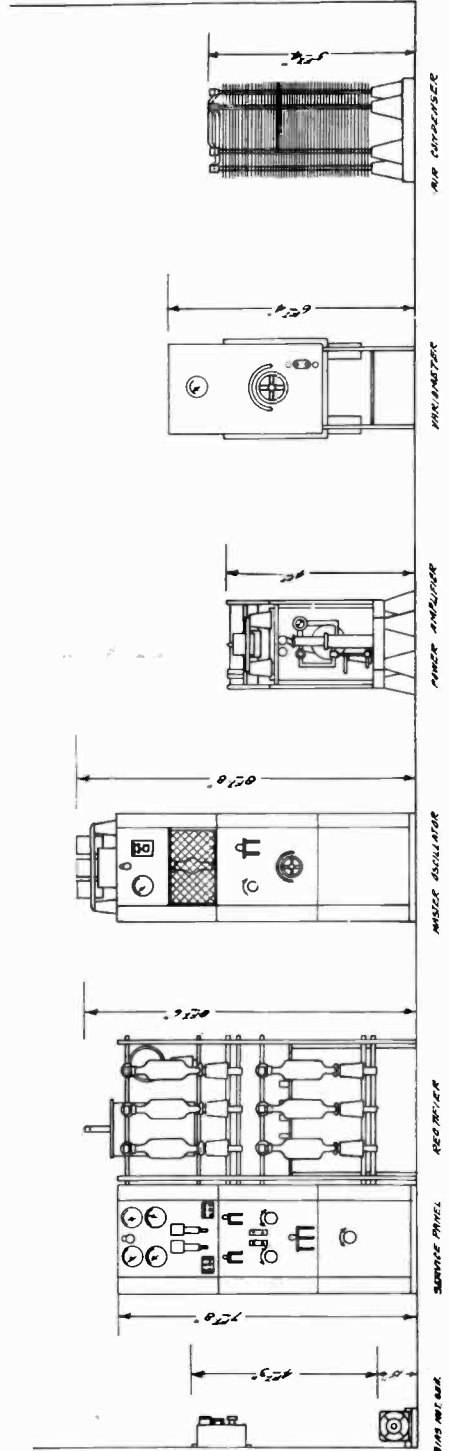
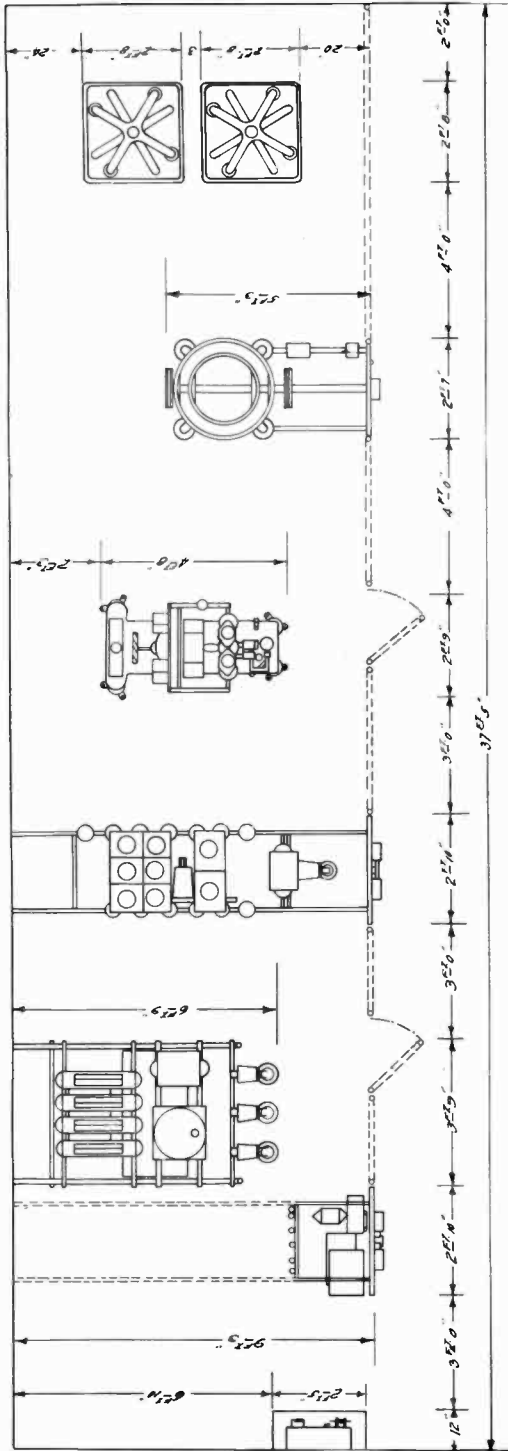

FIGURE 60—Outline of 20 Kw. Transmitter

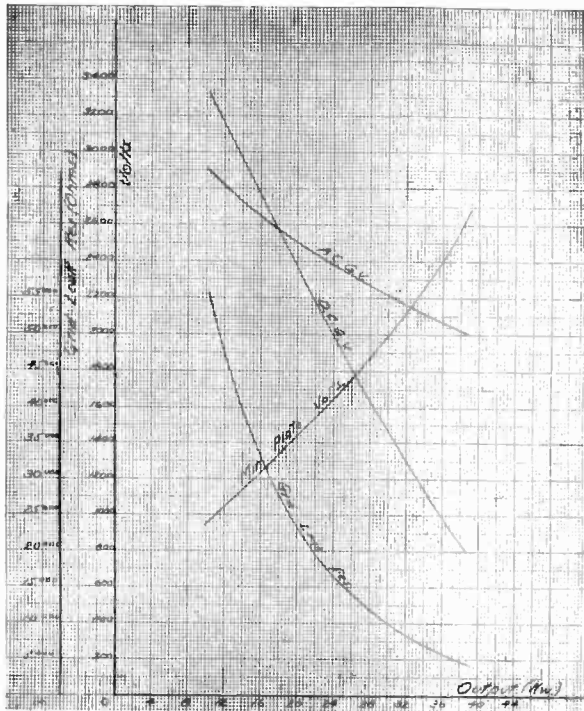

FIGURE 61A—Operating Characteristics of Typical UV-207, Radiotron

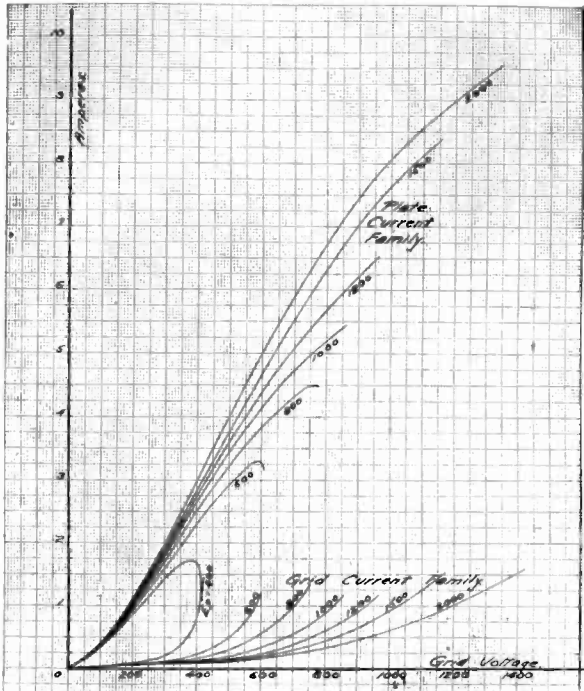

FIGURE 61B—Operating Characteristics of Typical UV-207, Radiotron

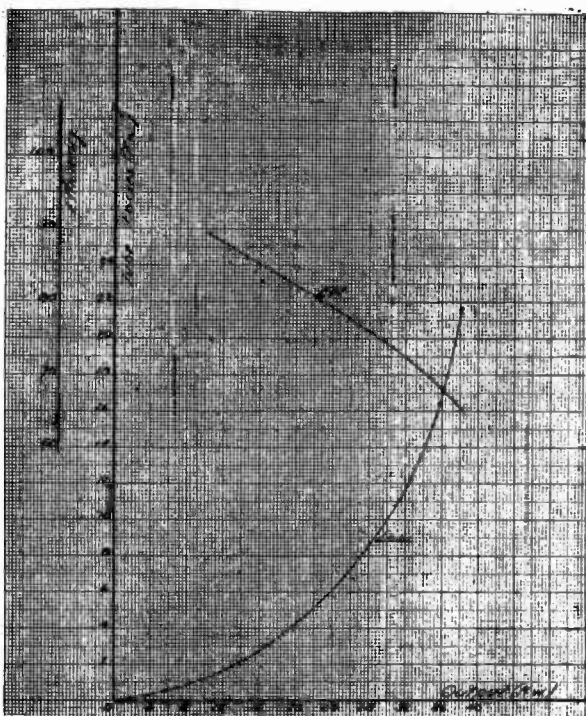

FIGURE 61C—Operating Characteristics of Typical UV-207, Radiotron

RADIO TRANSMISSION MEASUREMENTS ON LONG WAVE LENGTHS*

By

H. H. BEVERAGE

AND

H. O. PETERSON

(ENGINEERING DEPARTMENT, RADIO CORPORATION OF AMERICA, NEW YORK)

(*Communication from the International Union of Scientific Radio Telegraphy*)

INTRODUCTION

For some time, the authors have been working on methods for the quantitative measurement of field strength. The authors now have developed a satisfactory method, but have not yet obtained any great amount of data on transmission over great distances, as it takes months and even years of observation before drawing general conclusions, because of the great variability of signals over great distances. It is the purpose of this memorandum to describe the method used, and some of the results obtained during the development of this apparatus.

THEORY

The most reliable radio transmission formula known at present is the Austin-Cohen formula, which is as follows:

$$E = \frac{0.00126 H_R H_T f I}{D} \times \text{Absorption factor}$$

or

$$E = \frac{0.377 H_R H_T I}{\lambda D} \times \text{Absorption factor}$$

where E = volts induced in receiving antenna

f = frequency in kilocycles per second

λ = wave length in kilometers

I = transmitter antenna current, amperes

H_T = effective height of transmitting antenna in kilometers

H_R = effective height of receiving antenna in kilometers.

*Received by the Editor, July 24, 1923. Presented before THE INSTITUTE OF RADIO ENGINEERS, New York, September 5, 1923.

For daylight transmission over sea, Austin gives the absorption factor as:

$$\varepsilon^{-0.00087 D \sqrt{f}} \text{ OR } \varepsilon^{-\frac{0.0015 D}{\sqrt{\lambda}}}$$

where ε is the base of Napierian logarithms.

In the above formula, the factors which are directly measurable are antenna current I , frequency f or wave length λ , and distance D . The other three factors H_R , H_T , and absorption factor, can be calculated with some degree of accuracy, but it is very desirable to measure them by a precision method. It is fairly easy to measure any one of these three factors, if the other two are known.

The general method which the authors propose for separating these three factors, H_R , H_T , and absorption factor, is as follows:

First:—Calibrate the receiving antenna effective height, H_R . It is very difficult to calculate the effective height of a vertical receiving antenna accurately, as it depends upon the proximity of surrounding structures, ground conditions, and so on. However, the effective height of a loop may be calculated easily, and may be used to calibrate any desired antenna, provided the effective height of the loop actually agrees with its theoretical calculated value. The authors spent considerable time checking this point, as will be described later.

Second:—Using the calibrated receiving antenna, measure the field strength in microvolts per meter within a few wave lengths of the transmitting station, at which point the absorption is negligible, making the absorption factor unity. This measurement gives H_T , the effective height of the transmitting station.

Third:—Knowing the effective height of the receiving and transmitting antennas, measurements made at a great distance should give the absorption factor.

APPARATUS FOR MEASUREMENT OF FIELD STRENGTH

The received currents are very minute, so special methods are necessary to measure them. There are several methods, but the most direct method and the one preferred by the writers is the radio frequency comparison method. It consists in substituting an artificial signal voltage for the signal, and adjusting for equality between the artificial and actual signal. Then, by measuring the artificial signal voltage, the voltage due to the signal itself becomes known. If the artificial signal is intro-

duced into the antenna, the comparison should be independent of antenna resistance or receiver sensitivity.

Several investigators have developed apparatus for measuring signal intensity by the radio frequency method. The methods used consist simply of synchronizing a local oscillator with the incoming signal, measuring the current in the oscillating circuit or an associated circuit, and then introducing the voltage into the antenna thru a calibrated arrangement to control the intensity of the voltage introduced into the antenna.

Engineers of the Western Electric Company and the American Telephone and Telegraph Company have devised a method whereby the current in the oscillator is measured on a sensitive thermo-couple meter, and then introduced into the antenna thru a calibrated cable mile box. This method was recently described in a paper before THE INSTITUTE OF RADIO ENGINEERS by Messrs. Bown, Englund, and Friis.¹

In England, Mr. H. J. Round and his associates devised a measuring outfit in which the current in an intermediate circuit is determined by measuring the voltage across the intermediate circuit tuning condenser by the "slide back" method, and introducing the voltage into the antenna by means of a calibrated mutual inductance. Messrs. Weinberger and Dreher described a method using a calibrated mutual inductance for introducing the voltage into the antenna directly. (PROCEEDINGS OF THE INSTITUTE OF RADIO ENGINEERS, volume 7, number 6, page 584, December, 1919.)

The authors decided that the ideal measuring outfit should be similar to the Marconi outfit, but should have a direct reading meter for the oscillator current, rather than measuring the current by the more cumbersome "slide back" method. Accordingly, the authors developed the measuring outfit shown schematically in Figure 1.

This outfit requires little explanation. It consists essentially of an oscillator contained in a shielded compartment complete with filament and plate batteries. A UV-199 tube is used as the oscillator. The plate and grid coils are placed end to end in a honeycomb coil mounting, the windings progressing in such a manner as to form an astatic pair. The intermediate circuit inductance is coupled to the oscillator. In the intermediate circuit is a tuning condenser, a sensitive thermo-couple, and a relay for interrupting the circuit. Associated with the inter-

¹ See PROCEEDINGS OF THE INSTITUTE OF RADIO ENGINEERS, volume 11, number 2, page 115, April, 1923.

mediate circuit is the mutual inductance which introduces the artificial signal voltage into the antenna.

The voltage introduced into the antenna by this means is easily obtained from the relation:

$$E = I \omega M \text{ volts}$$

where I = current in the intermediate circuit as indicated by thermo-couple meter, amperes

$$\omega = 2\pi \times \text{frequency in cycles per second}$$

M = mutual inductance in henrys.

If the intermediate circuit is omitted, the error due to harmonics is about 2 percent or 3 percent, which may be neglected on measurements on distant signals, since the error of measurement is greater than 3 percent anyway.

METHOD FOR USING MEASURING OUTFIT

The mutual inductance may be connected into any form of antenna, either vertical antenna, loop antenna, wave antenna, or any circuit in which the induced voltage is to be measured. In case a loop antenna is used, it is usually necessary to place the mutual inductance in the center of the loop, grounding the mid-point of the secondary side of the mutual inductance. In the case of a vertical antenna, the mutual inductance may be placed at any point in series with the antenna lead-in; that is, it may be placed either on the antenna or the ground side of the receiver primary inductance, but it must not be shunted by a variable condenser. If a variable condenser is used in shunt to the primary inductance, it must not shunt the mutual inductance, as this would cause the mutual inductance voltage to be introduced into a circuit of different impedance than that offered to the real signal voltage. If this one precaution is observed, it will be found that the measurements are correct, practically independently of the antenna constants.

The greatest error in measurement of signals is in the equalizing of artificial and real signal voltages. If the signals are weak and are associated with considerable static, the usual method is to equalize by ear, by "chipping in;" that is, the local oscillator is keyed at intervals between the real signals, and the intensity of the artificial signal adjusted until it sounds exactly the same as the real signals. The ear cannot distinguish differences less than about 30 percent ordinarily, but after practice, it is usually possible to make the setting within 20 percent to 25 percent, or closer if static interference is not too heavy.

If the signal to be measured is considerably above the static,

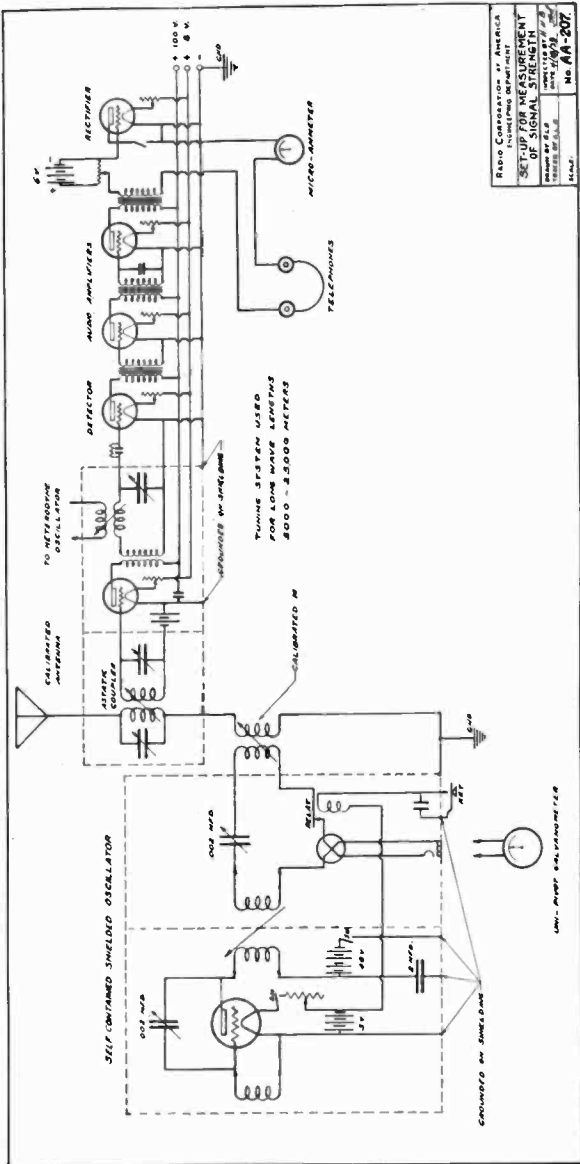

FIGURE 1

and the transmitting station is co-operating, measurements may be made within 2 percent or 3 percent. For this work, the signals are amplified and rectified, the rectified current being read on a direct current micro-ammeter. The transmitter makes a dash of several seconds' duration, and the direct current meter

deflection is noted. Then the transmitter is silent while a dash is made on the local oscillator and the mutual inductance adjusted to give the same deflection. This method is very accurate, since the deflection is proportional to the square of the antenna current, and a slight change in voltage makes a large change in deflection.

If the transmitter is not co-operating, it is still possible to get a fair accuracy with the direct current meter, as the meter will indicate just half maximum deflection when the transmitter sends a series of dots, which occurs whenever the tape on the automatic transmitter runs out. On high speed transmission, the deflection is also about half, but not so steady or precise as the dots, the latter being about as accurate as a dash.

All of the measurements on local transmitters were made with co-operative dashes in the manner described above.

CALIBRATION OF RECEIVING ANTENNA

For measuring distant signals, it is usually desirable to work with antennas of fairly high effective height, as this allows the use of larger mutual inductances, larger thermo-ammeters, less possible error from stray fields, and so on. However, it is necessary to calibrate the effective height of the vertical antenna. At Belmar an antenna about 30 meters (98 feet) high with a flat top 39 meters (98 feet) long was available. This antenna was compared with a large single turn loop, which gave an effective height of about 11.25 meters (37 feet) for the vertical antenna. As this seemed low, the authors built several other loops of various sizes, shapes, and number of turns. Hundreds of measurements were made comparing these loops with the vertical antenna, but the average result was 11.25 meters (37 feet) for the effective height of the vertical antenna. Correction formulas were also developed for loops of various shapes.

The simplest form of loop is a single turn rectangular loop. It may be considered as two opposed vertical antennas equal to the height of the rectangle, and having a phase difference equal to the length of the loop, thus:

$$H = 2h \sin \frac{\pi b}{\lambda}$$

or

$$H = 2h \sin \pi b \left(\frac{f}{300,000} \right)$$

where h = the height of the loop in meters

b = length of loop in meters

f = frequency in kilocycles per second

λ = wave length in meters.

If the length of the loop is not over one-sixth of a wave length, the angle is small, so the angle is equal to the sine of the angle, and we have

$$H = \frac{\pi h b f}{150,000} \quad \text{or} \quad H = \frac{2\pi h b}{\lambda}$$

Since $h \times b = \text{area of the loop}$, we can write

$$H = \frac{\pi N A f}{150,000} \quad \text{or} \quad H = \frac{2\pi N A}{\lambda}$$

where $N = \text{number of turns}$

$A = \text{area of loop.}$

For a triangle loop, there is a correction factor to correct for progressive phase differences of the increments of voltage along the sloping sides of the loop. This factor is given below.

For triangular loops

$$H = \frac{2\pi N A}{\lambda} \times \frac{b}{\lambda \sin^{-1}\left(\frac{b}{\lambda}\right)}$$

The correction factor

$$\left[\frac{b}{\lambda \sin^{-1}\left(\frac{b}{\lambda}\right)} \right]$$

may be neglected excepting for very large triangular loops.

There were some interesting points found in checking up the effective height of loops. One large rectangular loop came out about 20 percent low, apparently because of shielding from the steel supporting tower. Another interesting observation was made on a 20-turn loop 30 ft. (9.2 m.) high by 80 ft. (24.4 m.) long. It was found that the effective height decreased with decrease in wave length, whereas it should increase with decrease in wave length. The observed effective height of this loop is plotted as curve A, in Figure 3, while the calculated effective height is shown as curve B. The station wave antenna ran within 15 feet (4.6 m.) of this loop and was found to be responsible for these peculiar results. Upon opening the wave antenna at a distance of 200 meters (656 ft.) from the station, the measured values were found to be approximately the same as the calculated value, as shown by the points plotted on the curve B of Figure 3.

From our many observations on the various loops, it is apparent that the simple calculation of the effective height of loops is substantially correct, but that care must be taken to avoid shielding, or coupling to other wire systems.

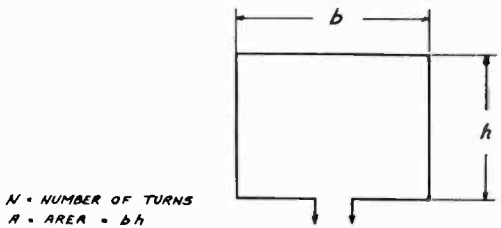

$$\text{EFFECTIVE HEIGHT } H = 2hN \sin\left(\frac{\pi b}{\lambda}\right)$$

$$= \frac{2\pi NA}{\lambda} \text{ APPROX.}$$

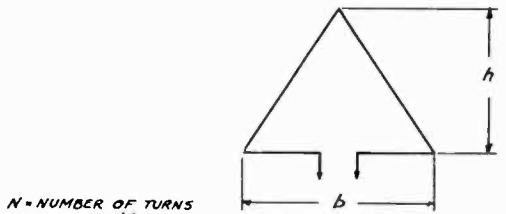

$$\text{EFFECTIVE HEIGHT } H = 2hN \sin\left(\frac{\pi b}{2\lambda}\right) \times \left[\frac{b}{\lambda \sin^{-1}\left(\frac{b}{\lambda}\right)}\right]$$

$$= \frac{2\pi NA}{\lambda} \times \left[\frac{b}{\lambda \sin^{-1}\left(\frac{b}{\lambda}\right)}\right] \text{ APPROX}$$

FIGURE 2

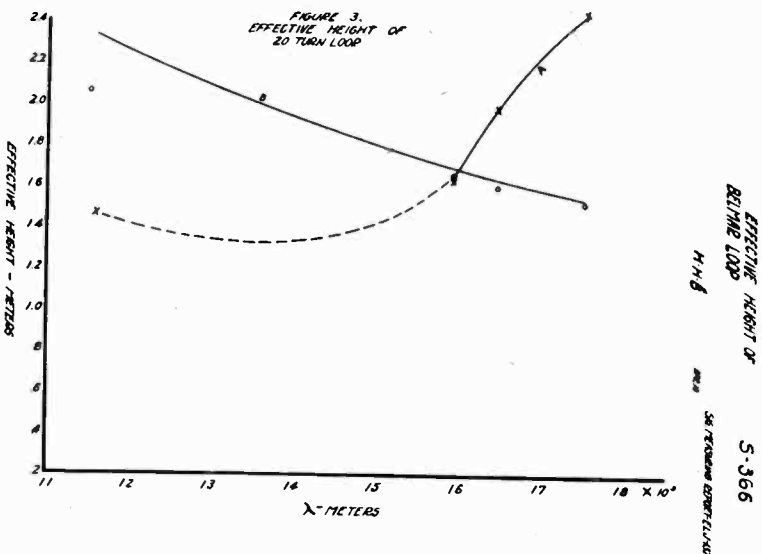

FIGURE 3

RESULTS OF MEASUREMENTS

The results of the average of all measurements made on the local transmitters of the Radio Corporation are given in Table 1. In order to eliminate all error due to absorption, measurements should have been made closer to the stations. As the authors were not prepared to do this, the absorption was calculated by the Austin-Cohen formula. From an inspection of the table, it is evident that the error would not exceed 5 percent if the absorption were neglected, with the exception of Marion, where the calculated absorption factor is 0.87. Marion is the only station which came much lower than the estimated effective height, and it is probable that, due to overland absorption, the received energy is less than the calculated energy for oversea absorption, and therefore the effective height of Marion is nearer the estimated value than the measured value. Both of the Tuckerton stations appear to be estimated too low, while the other stations are nearly correct.

TABLE 1

Location	Station Call	Frequency Kilo-cycles	Wave Length Meters	Radiation Am-peres	<i>d</i> Distance in Km.	Calculated Absorption Factor-Oversea
Radio Central..	WQL	17.13	17,500	603	125	0.952
Radio Central..	WQK	18.22	16,450	679	125	0.950
Tuckerton....	WGG	18.86	15,900	469	69.5	0.974
Tuckerton....	WCI	17.25	16,800	350	69.5	0.975
New Brunswick	WHI	22.06	13,600	576	50	0.980
Marion.....	WSO	25.96	11,550	530	322	0.870

	Calculated Microvolts per Meter, Belmar	Measured Microvolts per Meter, Belmar	Calculated Effective Height, Meters	Measured Effective Height, Meters
WQL.....	8,200	8,130	83	82.3
WQK.....	9,700	10,440	83	89
WGG.....	8,860	10,470	57	67
WCI.....	6,290	7,510	57	68
WHI.....	21,300	20,820	68	66.5
WSO.....	3,170	2,825	68	60.5*

* Doubtful because of overland attenuation.

During March, measurements were started on distant signals, using the vertical antenna of 11.25 meters (37 feet) effective height. In the morning when static was light, it was possible

to use the meter deflection method for equalizing the distant and artificial signals. In the afternoon, it was necessary to use the "chip in" aural method, as the static made the deflection method unworkable. The results of these measurements are shown in Table 2.

There are too few observations to draw any conclusions yet. The European signals seem abnormally high, but it is believed that the measurements are reasonably correct, since the same measuring outfit checks so closely on local signals.

No static intensity measurements are included with these long distance measurements, but work is proceeding in that direction. One method used with considerable success in Brazil consisted in estimating the readability of the measured signal. When the static was stronger than the signal, the local oscillator was keyed and its intensity increased until it could be read at a speed of 20 words per minute.

This measurement gave the microvolts per meter required to read 20 words per minute thru the noise due to the static, 20 words per minute being considered the working speed for code with a ratio of static noise to signal of unity. The curve shown in Figure 4 gives the working speed in five letter words for code, plotted against ratio of static to signal. A ratio of 2.5 gives a readability of 9 words per minute, and anything below that is considered unreadable commercially. Nine words per minute is usually taken as 18 words per minute double sending.

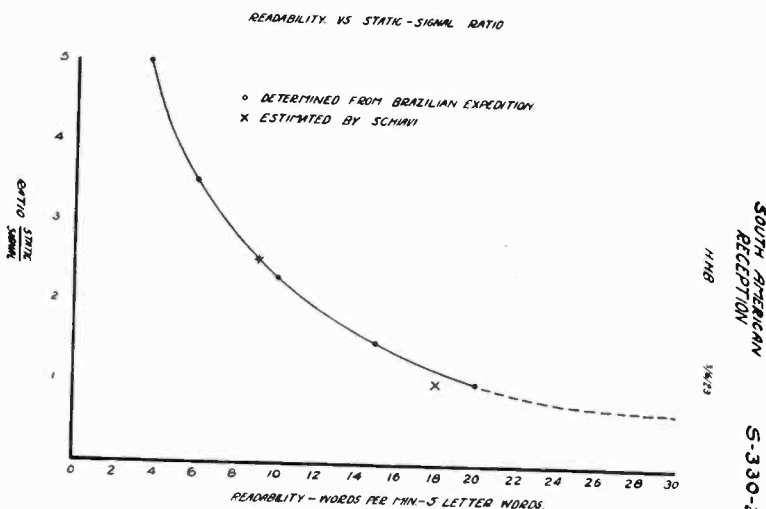

FIGURE 4

TABLE 2
 BELMAR, NEW JERSEY—SIGNAL STRENGTH—MICRO-VOLTS/MIETER

Date	POZ Nauen, Germany		KET Bolinas, California, U. S. A.		MUU Carnarvon, Wales		UFT St. Assise, France		LCM Stavanger, Norway	
	10 A. M.	3 P. M.	10 A. M.	3 P. M.	10 A. M.	3 P. M.	10 A. M.	3 P. M.	10 A. M.	3 P. M.
March	112	51	109		89	78	118	78	21	
	94	95	73	74	90	50	102	106		
	89	66	69	87	69	76	115	97	44	
28										
29	75	51	74	83	58	42	129	91		
30	80	76	74	68	61	35	120	112	27	
31	76	46	80	75	80	92	118	98		
April	49	66	57	93	57	44				
		42		53		31			80	
	74	54		46	72	18	132			
17	59	17	56	61	64			74		
18	49	20	56	56	69	47	101	47		
19	64	16		55	52	46	73	35		
20	60	23	51	57	52	71	81	43		
21	50		85		43		111			
22	49	30	49		43	51	82	70		
23					54	42	92	35		
25	37	11		69	53	58	92	35		
26	52	21	52	73	61		75	35		
27	60	29	59	62	57		68			
28	66		65		46		107			
30	59	38		55	58	53	89	63		
May	51	46								
	63	34	39	61	56	70	93	62		
	63		63	62	68	63	85	40		
Average	65	42.4	66.6	66.4	61.8	54.7	97.9	67.5	30.7	

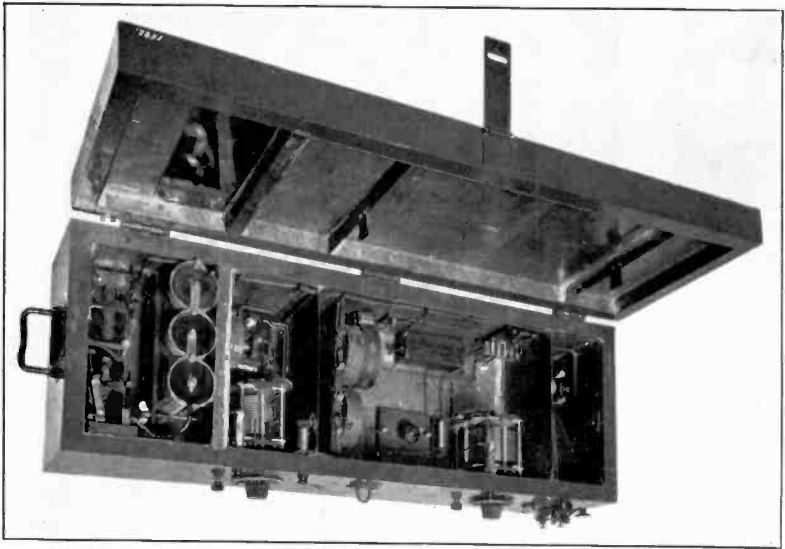

FIGURE 5—Shielded Oscillator for Measurement at Signal Intensity (Top View, Open)

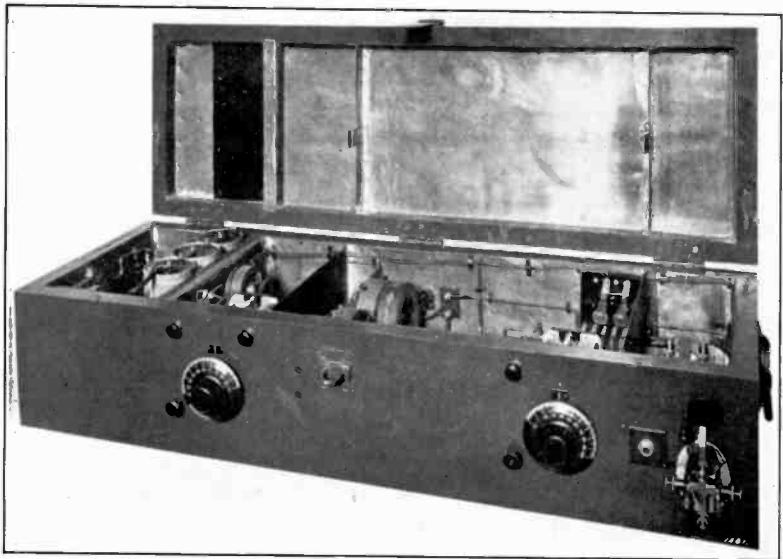

FIGURE 6—Shielded Oscillator for Measurement of Signal Intensity (Front View, Open)

CONCLUSION

By the methods described above it has been found possible to

- (1) Calibrate the effective height of a receiving antenna by comparison with loops.
- (2) Measure the effective height of local transmitting antennas with an accuracy of about 3 percent.
- (3) Measure distant signals to within 25 percent with bad conditions, and closer during good conditions. When sufficient data has been collected on distant signals, it should be possible to determine accurately the absorption term for long wave lengths over great distances.

May 22, 1923.

SUMMARY: A method of measuring the strength of received signals is described, both as to theory and apparatus employed

STATIONARY WAVES ON FREE WIRES AND SOLENOIDS*

BY

A. PRESS

(CHEVY CHASE, MARYLAND)

Disregarding radiation phenomena, which naturally affect our conceptions both of the capacity and inductivity coefficients, stationary wave phenomena require a solution of the equations:

$$L_x \cdot \frac{di}{dt} = -\frac{de}{dx}; \quad C_x \cdot \frac{de}{dt} = -\frac{di}{dx} \quad (1)$$

Taking the case of a free solenoid coupled to a driver circuit (see Figure 1), it follows that the self-induction coefficient (zero frequency) would be greatest per unit of length near the middle of the coil rather than toward the free ends. Similarly the electrostatic flux (zero frequency) should be greatest per volt near the coil center than with respect to the free ends of the coil.

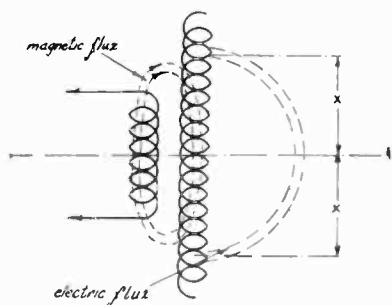

FIGURE 1

As a consequence of the above zero frequency conditions, the variable coefficients L_x , C_x give rise to nodal and antinodal current and voltage conditions similar to what takes place in a power circuit treated after the manner of a system of parallel wires, with the one wire acting as current return for the other. In the ordinary power circuit we have L_x and C_x constants.

* Received by the Editor, April 9, 1923.

However, for the coupling coil, or, free wire, with a nodal point of emf. always at the center, it is necessary to take L_x and C_x as functions of x , where the x is measured outwardly from the center.

It will be observed that in the ordinary parallel wire circuit we always have that

$$c^2 = \frac{1}{LC} \quad (2)$$

so that if L is calculated, the C follows immediately, by virtue of the above reciprocal theorem. In other words, the L and C vary inversely with respect to each other. Nevertheless, in the case of a free coil or wire, it is seen that L_x and C_x can vary proportionately to each other. This is an important distinction and gives rise to the result that the nodal distances fall off in value as the ends are approached. (See experiments of Professor Townsend.)

On separating out the voltage and current functions in (2) we have

$$\begin{aligned} \frac{d^2 e}{dx^2} + L_x \cdot \frac{d}{dx} \left(\frac{1}{L_x} \right) \cdot \frac{de}{dx} &= L_x C_x \cdot \frac{d^2 i}{dt^2} \\ \frac{d^2 i}{dx^2} + C_x \cdot \frac{d}{dx} \left(\frac{1}{C_x} \right) \cdot \frac{di}{dx} &= L_x C_x \cdot \frac{d^2 e}{dt^2} \end{aligned} \quad (3)$$

If then the forced frequency of the sinusoidally sustained oscillations corresponds to the formula

$$p = 2\pi f \quad (4)$$

equations (3) are of the form

$$\frac{d^2 e}{dx^2} + \frac{1}{\phi(x)} \cdot \frac{d}{dx} \phi(x) \cdot \frac{de}{dx} + \frac{LCp^2}{(\phi x)^2} = 0 \quad (5)$$

provided we set

$$\begin{aligned} L_x &= \frac{L}{\phi(x)} \\ C_x &= \frac{C}{\phi(x)} \end{aligned} \quad (6)$$

In equations (6), the quantities L and C are constants and $\phi(x)$ is any arbitrary function of x depending on physical conditions.

The general solution of the equation (5) is of the form

$$e = A \cdot \sin nf(x) + B \cdot \cos nf(x) \quad (7)$$

provided we satisfy the relations

$$\frac{d}{dx} f(x) = \frac{1}{\phi(x)} \quad (8)$$

$$LC p^2 = n^2 \quad (9)$$

The proof is as follows: With

$$e = A \cdot \sin nf(x) + B \cos nf(x)$$

we have

$$\frac{d e}{d x} = n \{ A \cdot \cos n f(x) \cdot f' x - B \cdot \sin n f(x) \cdot f' x \} \quad (10)$$

and therefore

$$\frac{1}{f' x} \cdot \frac{d e}{d x} = n \{ A \cdot \cos n f(x) - B \cdot \sin n f(x) \} \quad (11)$$

Operating once more with d/dx it follows

$$\begin{aligned} \frac{1}{f' x} \frac{d^2 e}{d x^2} + \frac{d}{d x} \frac{1}{f' x} \cdot \frac{d e}{d x} \\ = -n^2 \{ A \cdot \sin n f(x) + B \cdot \cos n f(x) \} \cdot f' x \\ = -n^2 \cdot f' x \cdot e \end{aligned} \quad (12)$$

Thus multiplying thru with $f' x$ the latter reduces to

$$\frac{d^2 e}{d x^2} + f' x \cdot \frac{d}{d x} \frac{1}{f' x} \cdot \frac{d e}{d x} + n^2 (f' x)^2 \cdot e = 0 \quad (13)$$

According to equation (5), therefore, it is necessary that the following relations be satisfied:

$$\begin{aligned} \frac{d}{d x} f(x) &= \frac{1}{\phi(x)} \\ n^2 (f' x)^2 &= \frac{LC p^2}{(\phi x)^2} \end{aligned} \quad (14)$$

The latter equations clearly indicate that we must have

$$LC p^2 = n^2 \quad (15)$$

April 6, 1923.

SUMMARY: The production of stationary waves on systems having distributed electrical constants is mathematically treated.

DIGESTS OF UNITED STATES PATENTS RELATING TO
RADIO TELEGRAPHY AND TELEPHONY*

ISSUED AUGUST 28, 1923—OCTOBER 23, 1923

BY

JOHN B. BRADY

(PATENT LAWYER, OURAY BUILDING, WASHINGTON, D. C.)

1,465,546—H. P. Donle, filed February 11, 1921, issued August 21, 1923. Assigned to Connecticut Telephone and Telegraph Company.

INDUCTANCE constructed upon a flap form having tapered arms between which the conductor is spirally wound. A zig-zag course is imparted to the conductor with sharp change in direction of the conductor as it bends over the edges of each arm adjacent the slots between the arms.

1,456,932—E. H. Colpitts, filed September 11, 1915, issued August 28, 1923. Assigned to Western Electric Company, Incorporated.

MULTIPLEX RADIO TELEGRAPH SYSTEM, in which a plurality of messages are transmitted simultaneously from one or several stations and may be received simultaneously on one antenna or on a plurality of antennas located at the same place or at various places. At the transmitting station a plurality of different frequencies are radiated. At the receiving station the distinct frequencies are received. A local source of oscillations is provided which reacts separately with each of the received frequencies producing differing beat frequencies, which are utilized in separate circuits for selectively receiving the several messages.

1,465,961—E. F. W. Alexanderson, filed April 19, 1916, issued August 28, 1923. Assigned to General Electric Company.

RADIO SIGNALING SYSTEM for overcoming the effect of static disturbances in radio reception. The transmitter is arranged

* Received by the Editor, November 10, 1923.

to radiate the radio frequency signals simultaneously on two different wave lengths. At the receiving station both of these waves are simultaneously received. The two sets of waves interact to produce a current having amplitude pulsations of a frequency equal to the difference between the two radio frequencies but above audibility. An oscillatory circuit is provided resonant to this last frequency in which the signal is detected and reproduced for translation.

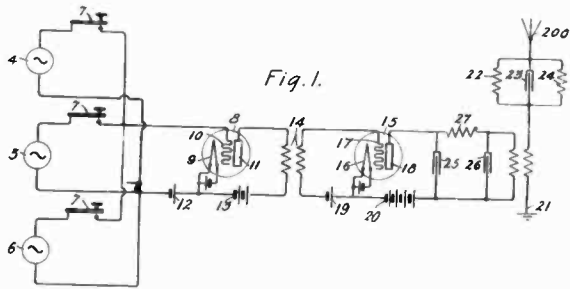

Fig. 1.

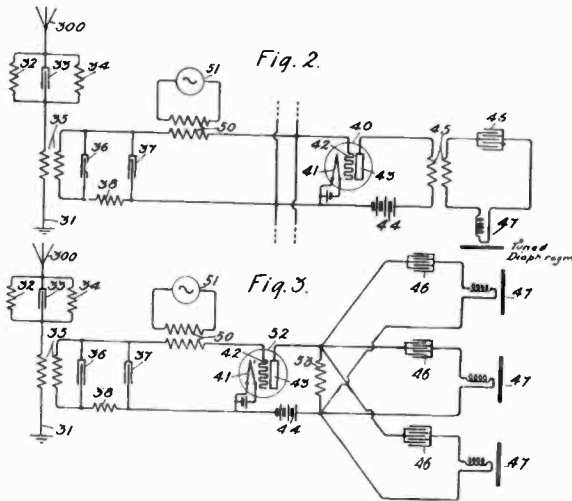
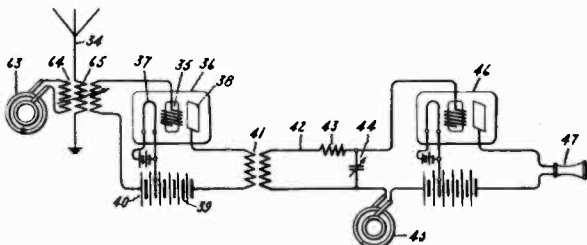

Fig. 2.

Fig. 3.

NUMBER 1,465,932—Multiplex Radio Telegraph System



NUMBER 1,465,961—Radio Signaling System

1,465,962—E. F. W. Alexanderson, filed April 19, 1916, issued August 28, 1923. Assigned to General Electric Company.

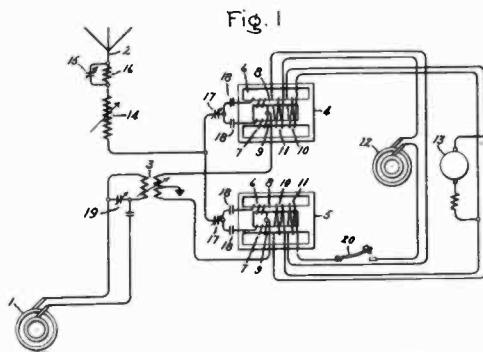

NUMBER 1,465,962—Radio Signaling System

RADIO SIGNALING SYSTEM for transmission of signals for reception free of the effect of static disturbances. The transmitter is provided with a source of sustained oscillations which is impressed on a divided antenna circuit. A magnetic amplifier is connected in each branch circuit, each opposite to the other, and both modulated from a source of lower frequency in such manner that signaling wave of two frequencies are emitted from the antenna system upon closing the controller circuit. One frequency may be higher than the main source by an amount equal to the frequency of the lower frequency generator and the other transmitting frequency may be higher than the main frequency by an amount equal to the lower frequency generator.

1,465,997—H. C. Rentschler, filed February 27, 1919, issued August 28, 1923. Assigned to Westinghouse Lamp Company.

ELECTRON TUBE APPARATUS for receiving circuits. A tube is described having its container filled with a medium exhibiting the phenomenon of resonance, that is, a medium in which electronic displacement occurs without the removal of an electron. The patentee points out that a particular gas or vapor has a certain resonance potential, that is, potential thru which the colliding electron must fall to acquire the necessary velocity to produce electronic displacement in the atomic system. Argon gas and certain metal vapors are described as exhibiting this phenomenon.

1,465,998—H. C. Rentschler, filed February 27, 1919, issued August 28, 1923. Assigned to Westinghouse Lamp Company.

DETECTOR TUBE, wherein the electrodes are contained in a medium exhibiting the phenomenon of resonance, that is, an atmosphere such as argon, with sources of potential so connected that the anode is maintained positive with respect to the cathode and the grid or screen is maintained positive with respect to the cathode and anode. The potential on the grid is so adjusted that the plate current is at a maximum or minimum value because of the effect of electron reflection or secondary emission from the anode. The grid is connected in the receiving circuit so that the potential thereon is modulated with respect to the cathode.

1,466,263. E. F. W. Alexanderson, filed April 10, 1922, issued August 28, 1923. Assigned to General Electric Company.

RADIO FREQUENCY SIGNALING SYSTEM employing an electron tube generator which is capable of producing oscillations of both audio and radio frequency. The apparatus is adjusted and arranged in such a way that radio frequency oscillations will be produced only during a portion of each cycle of the audio frequency oscillations. By proper adjustment of the apparatus the radio frequency oscillations produced may be made of substantially constant amplitude during the period when they are being produced. Radio frequency oscillations produced by this arrangement have a high decrement permitting more efficient signaling than in the case of modulated radio frequency oscillations.

1,466,841—L. Levy, filed August 7, 1920, issued September 4, 1923.

ANTI-PARASITIC SELECTING SYSTEM for radio reception. The receiving system is provided with an artificial line tuned to the frequency of a long wave train vibrating in stationary waves. The circuit has a number of elements for causing a short wave train to give only a free wave. A pair of thermionic valves are arranged in series in reverse directions and connected in series in the artificial line at the nodes of the current and in shunt at the nodes of the stationary wave for suppressing undesired parasitic currents from the receiving apparatus.

1,467,154—J. H. Hammond, Jr., filed June 7, 1912, issued September 4, 1923.

SYSTEM OF RADIO DIRECTIVE CONTROL, wherein a body rota-

table about a predetermined axis carries a motor which is caused to revolve in either one direction or an opposite direction selectively depending upon the relative position of the transmitting station and the body to be controlled.

1,467,318—W. J. Herdman, filed August 17, 1920, issued September 11, 1923.

ELECTRON DISCHARGE DEVICE which does not employ a third electrode or grid interposed between the anode and cathode to achieve a modulation of the space or thermionic current. In lieu of grid control, the phenomenon of magnetostriction is utilized to effect a movement of the anode or plate with respect to the cathode or filament thereby to decrease or increase the distance between the filament and plate and likewise to decrease or increase the effective plate area to produce an extremely wide variation of the plate current.

1,467,398—E. E. Schumacher, filed March 19, 1920, issued September 11, 1923. Assigned to Western Electric Company, Incorporated.

PROCESS OF COATING for a thermionic cathode of an electron tube. A base metal core is dipped in a molten bath of alkaline earth hydroxide. The core may be iron, tungsten, molybdenum, carbon and alloys of chromium or tantalum, which becomes thermionically active as a result of the coating derived from the bath and the alkaline earth hydroxide.

1,467,776—P. E. Demmler, filed January 16, 1919, issued September 11, 1923. Assigned to Westinghouse Electric and Manufacturing Company.

CONDENSER AND METHOD OF MAKING THE SAME, in which a strip of metal foil is coated with varnish which is first dried and then the strip wound with an uncoated strip about a pair of plates of insulating material with the inner ends of the strips spaced from each other between the plates. One of the condenser strips is of different width than the other and they are substantially insulated from each other by the coating of hardened varnish which is supplied over the wider strip.

1,467,777—P. E. Demmler, filed February 15, 1919, issued September 11, 1923. Assigned to the Westinghouse Electric and Manufacturing Company.

CONDENSER AND METHOD OF MAKING THE SAME, in which the condenser is built up of a plurality of alternate strips of metal foil and strips of flexible self-sustaining sheets of hardened varnish. The strips of metal foil are disposed in staggered relation so that the edges of alternate foil sheets project from the opposite sides of the completed unit, which is then embedded in wax.

1,467,988—C. A. Hoxie, filed March 16, 1922, issued September 11, 1923. Assigned to General Electric Company.

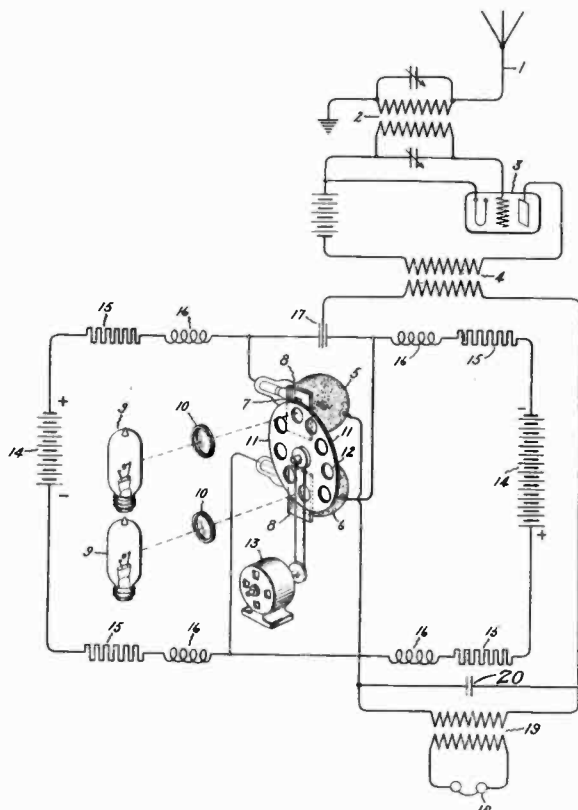

NUMBER 1,467,988—Radio Frequency Signaling System

RADIO FREQUENCY SIGNALING SYSTEM for continuous wave operation. A receiver is employed which has a circuit containing a light sensitive device or devices which has the property of permitting current to flow therethru when an electrode thereof is subjected to the influence of light. A rotating shutter is provided for varying or interrupting the illumination of this device

in such a way that the signaling current flowing in the circuit may be interrupted periodically in a predetermined desired manner and a rectifying effect may thereby be produced which will cause the current flowing in the circuit to be capable of operating a suitable form of indicator.

1,468,049—A. H. Taylor, filed October 9, 1918, issued September 18, 1923. Assigned to Radio Corporation of America.

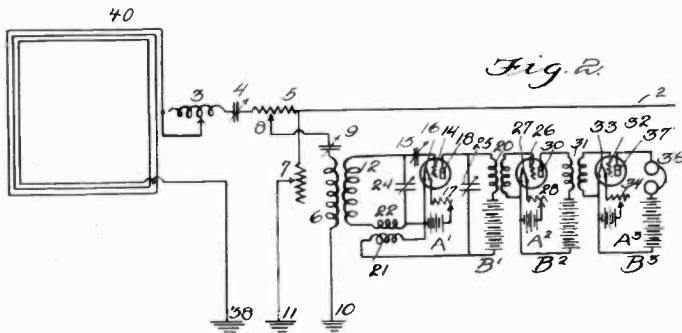

NUMBER 1,468,049—System for Receiving Radio Signals

SYSTEM FOR RECEIVING RADIO SIGNALS, in which a pair of opposed collectors of the incoming signal energy are employed with a circuit arranged between the collectors for balancing out strays. One collector may be in the form of a loop and the other an extended ground wire. One end of the loop may be connected with ground and the other end through a phase-adjusting device in circuit with a resistance with the opposite extended conductor. A high ohmic resistance is connected to ground and to the junction of the extended conductor with the phase-adjusting circuit. The receiving apparatus is connected between the phase-adjusting circuit and ground. The collectors have an inherently different signal—stray ratio enabling them to be balanced one against the other, eliminating the strays and retaining the signal.

1,468,059—R. A. Weagant, filed February 7, 1919, issued September 18, 1923. Assigned to Radio Corporation of America.

METHOD AND APPARATUS FOR RADIO SIGNALING for eliminating static interference in radio reception. A pair of collecting systems is provided. One portion of the antenna system is so positioned with respect to the horizontal plane and relatively to the direction of the transmitting station as to collect substan-

tially static only, while both static and signals are collected in the other portion of the antenna system. The currents due to static in the two antenna portions are opposed and balanced out while retaining the signals.

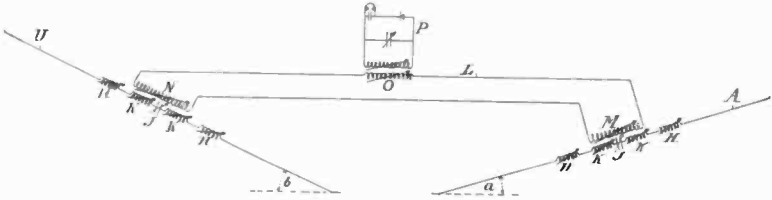

Fig. 2

NUMBER 1,468,059—Method and Apparatus for Radio Signaling

1,468,060—R. A. Weagant, filed July 19, 1917, issued September 18, 1923. Assigned to Radio Corporation of America.

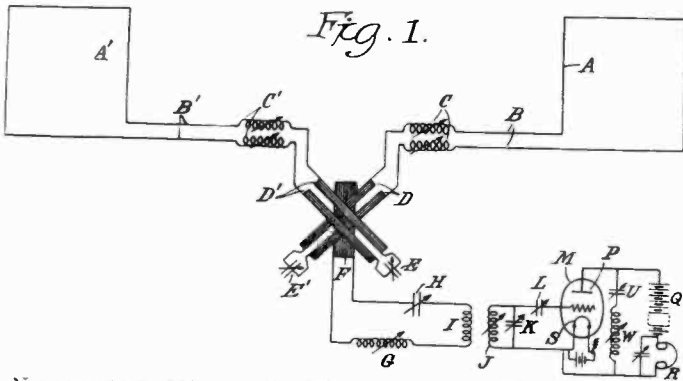
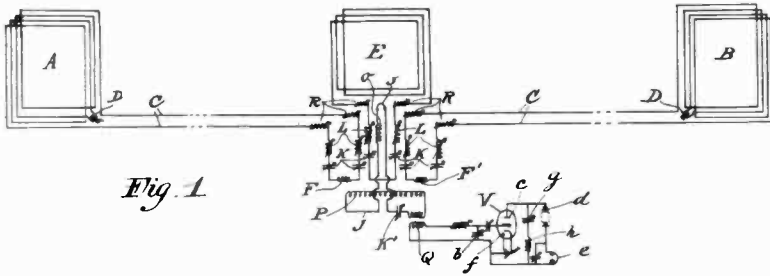

Fig. 1.

NUMBER 1,468,060—Process and Apparatus for Receiving Radio Signals

PROCESS AND APPARATUS FOR RECEIVING RADIO SIGNALS, free from interference due to strays. The receiving system has a plurality of antennas separated by an appreciable fraction of a wave length and connected to coupling coils which are arranged in non-inductive relation to each other. The receiving circuit is connected to a third and independent coupling coil in inductive relation to both of the other coils.

1,468,061—R. A. Weagant, filed February 7, 1919, issued September 18, 1923. Assigned to Radio Corporation of America.



NUMBER 1,468,061—Method and Apparatus for Radio Signaling

METHOD AND APPARATUS FOR RADIO SIGNALING, for minimizing the effects of static disturbances. A plurality of antennas are utilized. The system is tuned to the signal frequency and signal effects substantially eliminated while retaining the static. In another portion the signal effects and some static effects are received. The static effects in the first portion are then utilized to neutralize static effects in the second portion, leaving the signal effects which are amplified and observed.

1, 468,062—R. A. Weagant, filed July 12, 1918, issued September 18, 1923. Assigned to Radio Corporation of America.

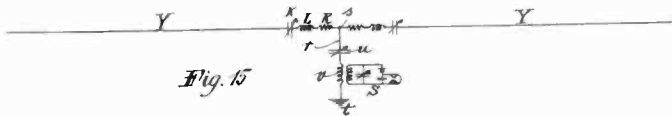

NUMBER 1,468,062—Radio Signaling Apparatus

RADIO SIGNALING APPARATUS for reducing interference of static disturbances. A plurality of antennas are provided, tuned to the same wave length but having different ratios of static strength. A circuit common to the antenna systems is provided for balancing out the static while retaining the signal.

1,468,116—I. Langmuir, filed December 10, 1914, issued September 18, 1923. Assigned to General Electric Company.

METHOD OF AND MEANS FOR AMPLIFYING POTENTIAL VARIATIONS without responding to the effects of static. In the operation of a receiving system arranged in accordance with this invention all of the potential variations of the received waves of radiant energy on a strongly damped antenna may be amplified in their proper proportions. The amplified potential variations thus obtained may be impressed upon a current-limiting device which

will eliminate all of the current impulses above a predetermined value and in this way the effect of heavy static discharges may be avoided. After the large impulses have thus been removed, suitable tuning apparatus may be employed to select the impulses of the frequency sent by the station from which it is desired to receive.

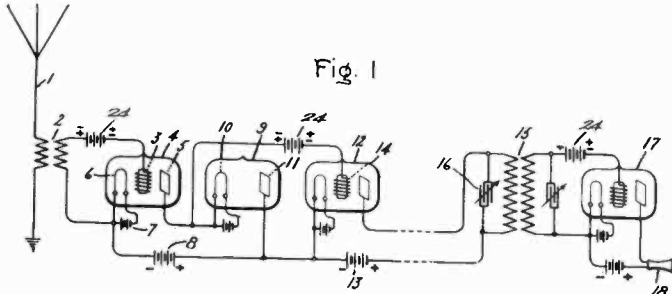

NUMBER 1,468,116—Method of and Means for Amplifying Potential Variations

1,468,250—S. O. E. T. Trost, filed June 21, 1921, issued September 18, 1923. Assigned to Radio Corporation of America.

TRANSMITTER FOR RADIO TELEPHONY, in which two or more sets of oscillations are set up in different circuits which normally tend to neutralize each other. A microphone is arranged in one of the circuits for varying the relative phases of the oscillations for the production of the signals which are radiated from an antenna system.

1,468,653—C. D. Tuska, filed July 30, 1923, issued September 25, 1923.

CONDENSER of inexpensive construction comprising a fixed plate and a rotatable plate. Each plate is constructed of a thin metallic semi-circular foil sheet interposed between a pair of flexible circular sheets which may be paper stock. One of the disks is rotatable with respect to the other for varying the mutual position of the semi-circular foil sheets.

1,469,075—H. E. Dunham, filed March 23, 1921, issued September 25, 1923. Assigned to General Electric Company.

ELECTRON DISCHARGE APPARATUS for receiving continuous wave signals. An electron tube circuit is shown having a tuned circuit between the cathode and controlling grid. Oscillations are produced which automatically cause the grid to vary in poten-

tial periodically at the frequency of the oscillations produced. A constant positive potential is impressed upon anode 3, and a smaller positive potential on third electrode 4. Secondary electrons are emitted from third electrode 4 which are attracted to anode 3. The normal operating potential of the third electrode 4 is such that an increase thereof will cause a decrease in the number of secondary electrons which will be given off from the third electrode.

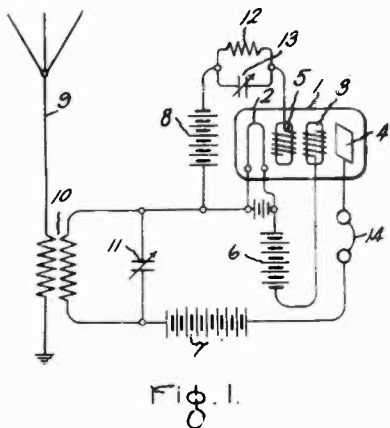

FIG. 1.

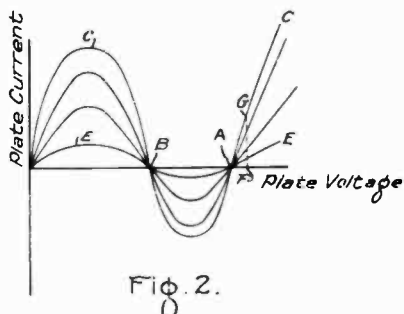

FIG. 2.

NUMBER 1,469,075—Electron Discharge Apparatus

1,469,328—E. Mayer, et al, filed August 3, 1922, issued October 2, 1923. Assigned to Gesellschaft für drahtlose Telegraphie m.b.H., Hallesches of Berlin, Germany.

CIRCUIT ARRANGEMENT FOR RECEIVING RADIO ENERGY in which an electron tube is connected with both the primary circuit and the secondary circuit. Either tube may generate oscillations and serve as a detector, and in determining the proper wave length either tube circuit may be used. When the proper wave length is chosen, the tube circuit connected with the secondary may be used for reception while the tube circuit associated with the primary is used as an oscillator for reducing the apparent resistance of the primary circuit for the frequency being received, thereby reducing the damping of the received energy.

1,469,349—A. L. Wilson, filed April 1, 1921, issued October 2, 1923. Assigned to Westinghouse Electric and Manufacturing Company

RADIO CONTROL SYSTEM for operating an electromagnetic

switch or a relay from a distant point. The transmitter is arranged to effect the radiation of a plurality of groups of waves having different wave lengths, each group of which is modulated in a predetermined series of impulses. The receiving system is provided with a rotary switch for varying the tuning to permit the reception of the different groups of waves which operated upon the receiver for selectively closing a circuit.

1,469,561—M. R. Hutchinson, filed January 21, 1920, issued October 2, 1923.

SIGNAL RECORDING AND TRANSCRIBING METHOD AND APPARATUS in which the signals are transmitted at a high rate of speed at a low tone frequency of the order of 320. At the receiver the signals produce a note at least three times as high as is required for phonographic reproduction. The signals are then recorded on a phonograph and then transcribed at a speed approximately one-third the recording speed. The object of the invention is to provide a method of transmitting signals at high speed for reception on a phonograph and transcription at a slow speed. The patentee points out that ordinarily the slowing down of the phonograph for transcription so lowers the tone frequency that it becomes confused with the normal scratching of the phonograph.

1,469,889—E. L. Chaffee, filed April 25, 1918, issued October 9, 1923. Assigned to John Hays Hammond, Jr.

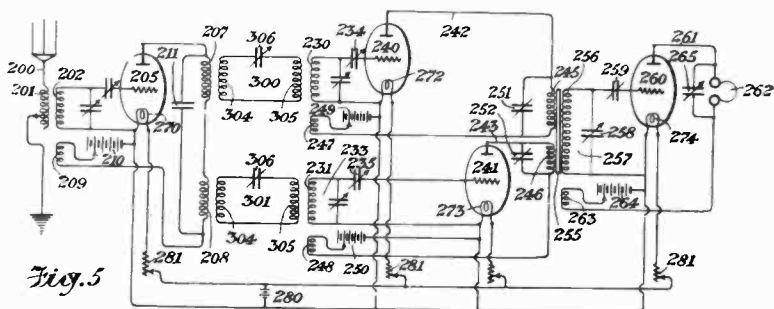

NUMBER 1,469,889—Receiving System for Radiant Energy

RECEIVING SYSTEM FOR RADIANT ENERGY, adapted to receive waves of radio frequency having impressed thereon a series of periodic variations of a different frequency or a plurality of series of periodic variations of frequencies different from each other and

from the radio frequency for improving the selectivity of reception. The selectivity is secured in the receiving circuit by means of an initial circuit responsive to the working predetermined frequency, a modulator for developing therefrom a secondary frequency with a local generator having a frequency differing from the secondary frequency arranged to produce beats which operate the responsive device.

1,469,905—R. E. Hall, filed August 13, 1919, issued October 9, 1923. Assigned to Hall Research Corporation.

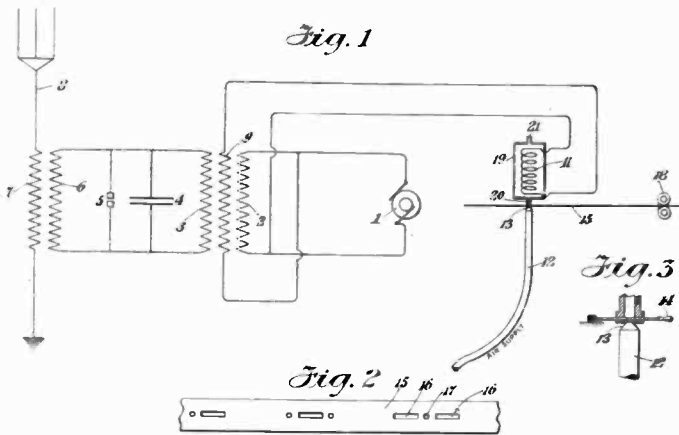

NUMBER 1,469,905—Circuit Controlling Means

CIRCUIT CONTROLLING MEANS for a radio transmitter. The transmission of signals takes place automatically from a perforated dot and dash tape which passes adjacent a compressed air jet opposite a heating coil. The spaces in the tape enable the jet to act upon the coil to cool the coil, which decreases its resistance momentarily. The coil is arranged in a circuit to modulate the transmitter for emitting wave trains in accordance with the cooling of the coil.

1,470,088—F. Lowenstein, filed November 29, 1918, issued October 9, 1923. Assigned to William Dubilier, of New York.

ART OF COMMUNICATION utilizing audio frequencies as distinguished from radio frequencies for transmission of signals. A multiple frequency generator of any one of several frequencies below 10,000 cycles is provided at the transmitter

in combination with a switching arrangement for selectively energizing the primary of a step-up transformer. The secondary of the transformer is sharply tuned and delivers audio frequency energy to the antenna system for transmission.

1,470,781—P. Thomas, filed October 3, 1917, issued October 16, 1923. Assigned to the Westinghouse Electric and Manufacturing Company.

ROLLED CONDENSER in which the condenser structure is built up with a plurality of leads for each pole of the condenser and the structure impregnated and then all of the similar leads comprising each pole spot welded firmly, connecting the condenser plates of similar polarity.

1,470,955—W. E. Booth, filed November 22, 1919, issued October 16, 1923. Assigned to Western Electric Company, Incorporated.

ELECTRICAL WAVE TRANSMISSION SYSTEM for transmitting and receiving, wherein a single switching element is used in the antenna circuit for changing from transmission to reception. The apparatus comprising both the transmitter and the receiver is compactly arranged. The direct current used in the microphone circuit is obtained from the same electrical source which is used for one or more other purposes in the system. During transmission one of the receiver amplifying tubes is connected in the microphone circuit.

1,471,165—L. L. Israel (now by judicial change of name L. L. Jones), filed July 19, 1920, issued October 16, 1923.

RADIO RECEPTION in which desired signals are received to the exclusion of disturbances of all kinds resulting from waves or pulses of relatively high damping or from waves differing in frequency from the signal waves. Two antennas having low damping and approximately the same electrical characteristics are employed. The antennas are set in close proximity to receive in the same direction. Electrostatic shields are provided to eliminate transfer of energy between the antennas. One antenna is tuned to the signal wave and the other slightly detuned therefrom. The currents generated in the antennas are rectified and the opposing forces combined, operating an indicator by the resultant force.

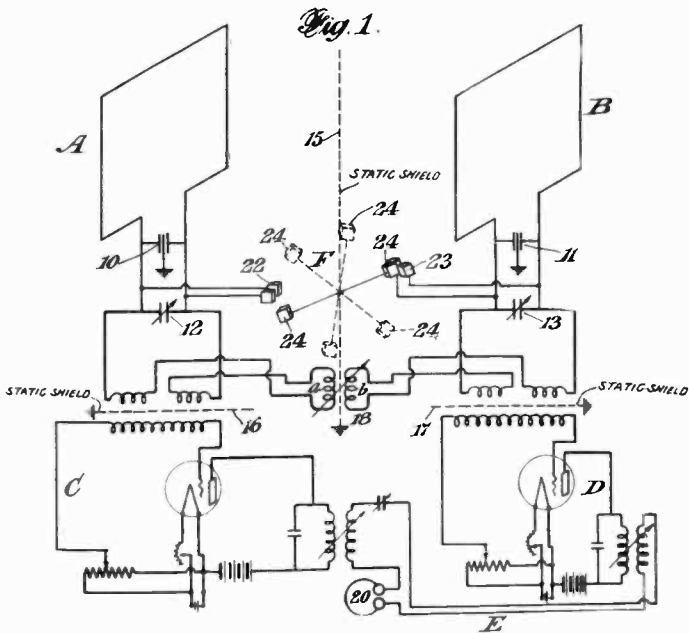

NUMBER 1,471,165—Radio Reception

1,471,319—H. Pratt and E. B. Murphy, filed January 3, 1921, issued October 16, 1923. Assigned to A. Taylor, of San Francisco, California.

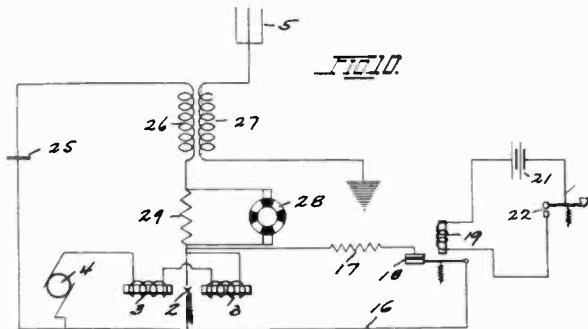

NUMBER 1,471,319—Radio Telegraphy Signaling System

RADIO TELEGRAPHY SIGNALING SYSTEM, using the arc generator as a source of sustained oscillations at the transmitter. The antenna circuit is arranged to be modulated at an audio frequency, thereby breaking up the continuous wave into time-spaced groups at such a frequency that the group frequency is

within the range of audibility. An energy-consuming circuit is alternately inserted and withdrawn in the arc oscillatory circuit at an audio rate whereby the arc is extinguished and re-ignited at this rate.

1,471,342—L. Logan, filed April 30, 1920, issued October 23, 1923.

MEANS FOR CONTROLLING PROCESSES OF PRODUCTION by radiant energy. The invention refers to a variety of production processes wherein an inanimate material during its process of manufacture undergoes some change which may be brought about by radiant energy control. The patentee mentions the manufacture of sulphuric acid and the application of radiant energy control means for indicating existence of constituents or progress of said manufacture.

1,471,406—F. S. McCullough, filed July 25, 1919, issued October 23, 1923. Assigned to Glenn L. Martin, Cleveland, Ohio.

RADIO TELEGRAPHY receiving system wherein the direction of a transmitting station is determined by a visual indication of the strength of the received signals. The system is particularly described as applied to a direction finder on air craft where the audible method of determining direction by radio bearings is subject to interference from machine noises. The directional antennas used in the system are encased in evacuated tubes.

1,471,418—J. F. Rodgers, filed May 26, 1922, issued October 23, 1923. Assigned one-half to Charles Hanselmann, Brooklyn, New York.

TUNING TRANSFORMER utilizing a pair of slides along a greater and a smaller coil provided with a slide with connections for placing an accurate number of turns of the coil in the tuning circuit.

1,471,756—W. B. Schulte, filed October 17, 1919, issued October 23, 1923. Assigned to Burgess Battery Company, Wisconsin.

WAVE SIGNALING SYSTEM utilizing a "B" battery construction for the electron tube circuit in which the battery comprises a case, a nest fitted therein, a set of vertical cells arranged in the nest and spaced at their lower ends from the bottom of the case a water-repellant wrapper completely encasing each cell, and a seal anchoring the cells in said nest and the wrappers to said cells.

LIST OF RADIO TRADE MARKS PUBLISHED BY PATENT OFFICE
PRIOR TO REGISTRATION

(The numbers given are serial numbers of pending applications)

- 164,075—"RADIOCEIVE" for telephone head sets, Radioceive Mfg. Co., Newark, New Jersey. Claims use since April 1, 1922. Published September 4, 1923.
- 169,814—Musical design for radio apparatus; Walter Lytton, Inc., Chicago, Illinois. Claims use since about January, 1922. Published September 4, 1923.
- 175,712—Letter "C" in ornamental design, for radio receiving sets; Continental Radio and Electric Corporation, New York City. Claims use since August 1, 1922. Published September 4, 1923.
- 178,612—"THE JIFFY CLIPS"—electrical connector clips for radio use; Herbert M. Hill, Leonia, New Jersey. Claims use since on or about December, 1922. Published September 4, 1923.
- 180,953—"NA-ALD" for radio apparatus; Alden Mfg. Co., Springfield Massachusetts. Claims use since April 1, 1923. Published September 4, 1923.
- 173,721—"REFLEX" for radio apparatus; Wm. H. Priess, New York City. Claims use since April 18, 1922. Published September 18, 1923.
- 163,608—"AIR LINE B-R" in ornamental design for adapters for connecting a receiver with a phonograph amplifying chamber. The Beckley-Ralston Co., Chicago, Illinois. Claims use since April 10, 1922. Published October 9, 1923.
- 176,792—"TESCO" in ornamental design for radio receiving apparatus. The Eastern Specialty Company, Philadelphia, Pennsylvania. Claims use since January 2, 1922. Published October 9, 1923.
- 179,091—"VARIOHM" in ornamental design for rheostats and grid leaks. Electrad Corporation of America, New York City. Claims use since February 1, 1923. Published October 9, 1923.
- 179,364—"ACMEDYNE" for radio receiving sets. Danziger-Jones, New York City. Claims use since April 9, 1923. Published October 9, 1923.

- 180,705—"K" in ornamental coat of arms for radio receiving apparatus. Colin B. Kennedy Co., St. Louis, Missouri. Claims use since April 1, 1923. Published October 9, 1923.
- 181,000—"AERADIO" in ornamental design for radio receiving apparatus. Charles A. Brichfield, New York City. Claims use since April 1, 1922. Published October 9, 1923.
- 182,271—"MONOTROL" for radio receiving apparatus. Sleeper Radio Corporation, New York City. Claims use since April 23, 1923. Published October 9, 1923.
- 182,606—"PIONEER RADIO CORPORATION" in ornamental design for variometers and variocouplers. Pioneer Radio Corporation, Galesburg, Illinois. Claims use since April, 1922. Published October 9, 1923.
- 183,162—"HEGEHOG" for audio frequency transformers. Premier Electric Company, Chicago, Illinois. Claims use since May 1, 1923. Published October 9, 1923.
- 151,150—"Esco" in ornamental design for radio apparatus. Electrical Specialty Co., Columbus, Ohio. Claims use since March 1, 1920. Published October 23, 1923.
- 179,466—"ANCHOR-ITE" for crystal detectors. The Anchor Company, Pittsburgh, Pennsylvania. Claims use since March 15, 1923. Published October 23, 1923.
- 181,439—"ERMCO LITE" in ornamental design for radio apparatus. Electric Regulator Mfg. Corporation, New York City. Claims use since April 21, 1923. Published October 23, 1923.
- 181,572—"MUSIC MASTER" in ornamental design for loud speakers. Sheip and Vandergrift, Inc., Philadelphia, Pennsylvania. Claims use since November 9, 1922. Published October 23, 1923.
- 182,353—"LITTLE TATTLER" for headsets. Marinette Electric Corporation, Marinette, Wisconsin. Claims use since May 1, 1923. Published October 23, 1923.
- 166,344—"BALDWIN" in ornamental design for radio apparatus; Baldwin Radio Electrical Mfg. Co., Inc., Brooklyn, N. Y. Claims use since March 28, 1922. Published October 30, 1923.
- 175,226—"VARIO-WAVE" for variocouplers and variometers.

G. H. Fischer & Co., Glendale, Long Island, New York. Claims use since August, 1922. Published October 30, 1923. Not subject to opposition.

175,332—"CONCERT GRAND" in ornamental design for radio receiving apparatus. True-tone Radio Mfg. Co., Chicago, Illinois. Claims use since February 28, 1922. Published October 30, 1923. Not subject to opposition.

181,254—Circular spot of red for plugs for use with radio apparatus. Dubilier Condenser and Radio Corporation, New York City. Claims use since April 26, 1922. Published October 30, 1923.

176,887—"TESCO" for radio apparatus. The Eastern Specialty Company, Philadelphia, Pennsylvania. Claims use since September 17, 1915. Published October 30, 1923.

PROCEEDINGS
OF
THE INSTITUTE OF RADIO
ENGINEERS
(INCORPORATED)

VOLUME 11

1923



EDITED BY
ALFRED N. GOLDSMITH, Ph.D

PUBLISHED EVERY TWO MONTHS BY
THE INSTITUTE OF RADIO ENGINEERS
(INC.)

140th STREET AND CONVENT AVENUE
NEW YORK, N. Y.

GENERAL INFORMATION

The PROCEEDINGS of the Institute are published every two months and contain the papers and the discussions thereon as presented at the meetings in New York, Washington, Boston, Seattle, San Francisco, or Philadelphia.

Payment of the annual dues by a member entitles him to one copy of each number of the PROCEEDINGS issued during the period of his membership.

Subscriptions to the PROCEEDINGS are received from non-members at the rate of \$1.50 per copy or \$9.00 per year. To foreign countries the rates are \$1.60 per copy or \$9.60 per year. A discount of 25 per cent is allowed to libraries and booksellers.

The right to reprint limited portions or abstracts of the articles, discussions, or editorial notes in the PROCEEDINGS is granted on the express condition that specific reference shall be made to the source of such material. Diagrams and photographs in the PROCEEDINGS may not be reproduced without securing permission to do so from the Institute thru the Editor.

It is understood that the statements and opinions given in the PROCEEDINGS are the views of the individual members to whom they are credited, and are not binding on the membership of the Institute as a whole.

COPYRIGHT, 1923, BY
THE INSTITUTE OF RADIO ENGINEERS, INC.
140TH STREET AND CONVENT AVENUE
NEW YORK, N. Y.

CONTENTS OF VOLUME 11

1923

NUMBER 1; February, 1923

	PAGE
OFFICERS OF THE INSTITUTE OF RADIO ENGINEERS	2
L. W. AUSTIN, "RECEIVING MEASUREMENTS AND ATMOSPHERIC DISTURBANCES AT THE UNITED STATES NAVAL RADIO RESEARCH LABORATORIES, BUREAU OF STANDARDS, WASHINGTON, SEPTEMBER AND OCTOBER, 1922"	3
WALTER HAHNEMANN, "THE OSCILLATION ENGINEERING DESIGN OF SUBMARINE ACOUSTIC SIGNALING APPARATUS"	9
C. R. ENGLUND, "NOTE ON THE MEASUREMENTS OF RADIO SIGNALS"	26
R. V. L. HARTLEY, "RELATIONS OF CARRIER AND SIDE-BANDS IN RADIO TRANSMISSION"	34
FURTHER DISCUSSION ON "RESISTANCE AND CAPACITY OF COILS AT RADIO FREQUENCIES," BY J. H. MORECROFT	57
JOHN B. BRADY, "DIGESTS OF UNITED STATES PATENTS RELATING TO RADIO TELEGRAPHY AND TELEPHONY, ISSUED OCTOBER 31, 1922-DECEMBER 19, 1922, TOGETHER WITH A LIST OF REGISTERED RADIO TRADE MARKS"	59

NUMBER 2; April, 1923

OFFICERS OF THE INSTITUTE OF RADIO ENGINEERS	74
J. H. DELLINGER, "THE WORK OF THE INTERNATIONAL UNION OF SCIENTIFIC RADIO TELEGRAPHY"	75
L. W. AUSTIN, "RECEIVING MEASUREMENTS AND ATMOSPHERIC DISTURBANCES AT THE UNITED STATES NAVAL RADIO RESEARCH LABORATORY, BUREAU OF STANDARDS, WASHINGTON, NOVEMBER AND DECEMBER, 1922"	83
ALBERT W. HULL, "A COMBINED KENOTRON RECTIFIER AND PILOTION RECEIVER CAPABLE OF OPERATION BY ALTERNATING CURRENT POWER"	89
HAROLD P. DONLE, "A NEW NON-INTERFERING DETECTOR"	97
S. T. WOODHULL, "A HIGH VOLTAGE MECHANICAL RECTIFIER"	111
RALPH BOWN, CARL R. ENGLUND, AND H. T. FRIHS, "RADIO TRANSMISSION MEASUREMENTS"	115
DISCUSSION ON "NOTE ON THE MEASUREMENT OF RADIO SIGNALS," BY C. R. ENGLUND, CONTRIBUTED BY L. W. AUSTIN	153
P. O. PEDERSEN, "SOME IMPROVEMENTS IN THE POULSON ARC, PART II"	155
J. F. J. BETHENOD, "DISTORTION-FREE TELEPHONE RECEIVERS"	163
JOHN B. BRADY, "DIGESTS OF UNITED STATES PATENTS RELATING TO RADIO TELEGRAPHY AND TELEPHONY, ISSUED DECEMBER 26, 1922-FEBRUARY 20, 1923"	169

NUMBER 3; June, 1923

	PAGE
OFFICERS OF THE INSTITUTE OF RADIO ENGINEERS	186
L. W. AUSTIN, "RECEIVING MEASUREMENTS AND ATMOSPHERIC DISTURBANCES AT THE UNITED STATES NAVAL RADIO RESEARCH LABORATORY, BUREAU OF STANDARDS, WASHINGTON, JANUARY AND FEBRUARY, 1923"	187
H. W. NICHOLS AND LLOYD ESPENSCHIED, "RADIO EXTENSION OF THE TELEPHONE SYSTEM TO SHIPS AT SEA"	193
Discussion on the above paper	240
FRANCIS W. DUNMORE, "CONTINUOUS-WAVE RADIO TRANSMISSION ON A WAVE LENGTH OF 100 METERS, USING A SPECIAL TYPE OF ANTENNA"	243
VALERIAN BASHENOFF, "PROGRESS IN RADIO ENGINEERING IN RUSSIA, 1918-1922"	257
JOHN R. CARSON, "SIGNAL-TO-STATIC-INTERFERENCE RADIO IN RADIO TELEPHONY"	271
D. C. PRINCE, "VACUUM TUBES AS POWER OSCILLATORS, PART I"	275
JOHN B. BRADY, "DIGESTS OF UNITED STATES PATENTS RELATING TO RADIO TELEGRAPHY AND TELEPHONY; ISSUED FEBRUARY 27, 1923-APRIL 17, 1923"	315

NUMBER 4; August, 1922

OFFICERS OF THE INSTITUTE OF RADIO ENGINEERS	332
L. W. AUSTIN, "RECEIVING MEASUREMENTS AND ATMOSPHERIC DISTURBANCES AT THE UNITED STATES NAVAL RADIO RESEARCH LABORATORY, BUREAU OF STANDARDS, WASHINGTON, MARCH AND APRIL, 1923"	333
W. R. G. BAKER, "DESCRIPTION OF THE GENERAL ELECTRIC COMPANY'S BROADCASTING STATION AT SCHENECTADY, NEW YORK"	339
ROBERT H. MARRIOTT, "INTERFERENCE"	375
E. O. HULBERT, "ON SUPER-REGENERATION"	391
L. W. AUSTIN, "LOOP UNI-DIRECTIONAL RECEIVING CIRCUITS FOR THE DETERMINATION OF THE DIRECTION OF ATMOSPHERIC DISTURBANCES"	395
J. B. DEMPSTER AND E. O. HULBERT, "STANDARDS OF CAPACITY PARTICULARLY FOR RADIO FREQUENCY CURRENTS"	399
D. C. PRINCE, "VACUUM TUBES AS POWER OSCILLATORS, PART II"	405
JOHN B. BRADY, "DIGESTS OF UNITED STATES PATENTS RELATING TO RADIO TELEGRAPHY AND TELEPHONY; ISSUED APRIL 24, 1923-JUNE 19, 1923"	437

NUMBER 5; October, 1923

OFFICERS OF THE INSTITUTE OF RADIO ENGINEERS	458
L. W. AUSTIN, "OBSERVATIONS ON LAFAYETTE AND NAUEN STATIONS IN WASHINGTON, MARCH 1, 1922, TO FEBRUARY 28, 1923"	459
FRANCIS W. DUNMORE AND FRANCIS H. ENGELS, "A METHOD OF MEASURING VERY SHORT RADIO WAVE LENGTHS AND THEIR USE IN FREQUENCY STANDARDIZATION"	467
CHARLES A. CULVER, "AN IMPROVED SYSTEM OF MODULATION IN RADIO TELEPHONY"	479
Discussion on the above paper	493
W. W. BROWN, "RADIO FREQUENCY TESTS ON ANTENNA INSULATORS"	495
Discussion on the above paper	523

	PAGE
D. C. PRINCE, "VACUUM TUBES AS POWER OSCILLATORS")PART III(527
MARIUS LATOUR AND H. CHIREIX, "THE EFFICIENCY OF THREE-ELECTRODE TUBES USED FOR THE PRODUCTION OF CONTINUOUS WAVES IN RADIO TELEGRAPHY, TAHT IS, THE CONVERSION OF DIRECT CURRENT INTO ALTERNATING CURRENT"	551
JOHN B. BRADY, "DIGESTS OF UNITED STATES PATENTS RELATING TO RADIO TELEGRAPHY AND TELEPHONY; Issued June 26, 1923-August 21, 1923	550

NUMBER 6; December, 1923

OFFICERS OF THE INSTITUTE OF RADIO ENGINEERS	578
L. W. AUSTIN, "RECEIVING MEASUREMENTS AND ATMOSPHERIC DISTURBANCES AT THE BUREAU OF STANDARDS, WASHINGTON, D. C., MAY AND JUNE, 1923"	579
J. C. WARNER, "RECENT DEVELOPMENTS IN HIGH VACUUM RECEIVING TUBES—RADIOTRONS, MODEL UV-199 AND MODEL UV-201-A"	587
W. R. G. BAKER, "COMMERCIAL RADIO TUBE TRANSMITTERS"	601
H. H. BEVERAGE AND H. O. PETERSON, "RADIO TRANSMISSION MEASUREMENTS ON LONG WAVE LENGTHS"	661
A. PRESS, "STATIONARY WAVES ON FREE WIRES AND SOLENOIDS"	675
JOHN B. BRADY, "DIGESTS OF UNITED STATES PATENTS RELATING TO RADIO TELEGRAPHY AND TELEPHONY; Issued August 28, 1923-October 23, 1923"	679

EVEREADY

Radio Batteries

—they last longer

Thirty years of Dry Cell experience and a large research organization are back of EVEREADY Radio Batteries. There is an EVEREADY Battery for every Radio need.

Dry Cell "A" Batteries—

Storage "A" Batteries—

"B" Batteries for all sets — from the smallest portable to the largest permanent installation.

"C" Batteries for improving quality of reception and increasing "B" Battery life.



EVEREADY "B" BATTERY

No. 766

In the new metal case

Manufactured and Guaranteed by

NATIONAL CARBON COMPANY, INC.

Long Island City, N. Y.

EVEREADY

Radio Batteries

— they last longer

Concerning **BURGESS BATTERIES**

The unique position of esteem and confidence occupied by Burgess Radio Batteries is a natural development of the conservative policy which has characterized the manufacture, advertising and sale of Burgess products.

It will be of interest to the thinking battery buyer to know that a Burgess product is neither advertised nor sold until its merit has been proven, not only by our own rigid tests, but also those of the foremost radio engineers, manufacturers and experimenters in the country.



Through friendly criticism and suggestions, together with extensive research and engineering by the C. F. Burgess Laboratories the efficiency of Burgess Batteries has increased to a degree which we believe is not equalled elsewhere.

"ASK ANY RADIO ENGINEER"

BURGESS BATTERY COMPANY

ENGINEERS - DRY BATTERIES - MANUFACTURERS
FLASHLIGHT - RADIO - IGNITION - TELEPHONE
GENERAL SALES OFFICE: MARSH TRUST BLDG., CHICAGO
LABORATORIES AND WORKS: MADISON, WISCONSIN

BRANCHES

NEW YORK BOSTON KANSAS CITY MINNEAPOLIS
WASHINGTON PITTSBURGH ST. LOUIS NEW ORLEANS

IN CANADA

PLANTS: NIAGARA FALLS AND WINNIPEG
BRANCHES: TORONTO MONTREAL ST. JOHN

A New Feature

The PROCEEDINGS now carries a Professional Engineering Directory (see advertising page XIV) for the use of radio and consulting engineers and organizations rendering testing or engineering construction service. A card in this section costs only \$5.00 per issue, or \$25.00 per year on contract. For further particulars address

D. V. WEED, Jr., *Advertising Manager*

THE INSTITUTE OF RADIO ENGINEERS

140th Street and Convent Avenue

New York, N. Y.

Brandes



Table-Talker

TRADE MARK REG. U.S. PAT. 216

MORE than two years of intensive work in the Brandes laboratories. Two years of experimenting to perfect a loud-speaker device of peerless quality—to sell at a popular price.

And now—the *Table Talker*. Worthy of the Brandes name. Worthy of the reputation of the world-famous *Matched Tone* Headset.

True of tone—clear, resonant, mellow.

Fine in design—fine in finish.

A phenomenal buy—at \$10.

\$10

C. BRANDES, Inc.
237 Lafayette St., N. Y. C.

Matched Tone Radio Headsets

© C. Brandes, Inc.



DAILY RADIO Programme for Saturday and

JUST PUBLISHED!

THE OUTLINE OF RADIO

By JOHN V. L. HOGAN

This modern, authoritative and easily understood book will answer many of the questions which puzzle you.

"The text is unusually instructive and written in most interesting informal style . . . it presents a picture of modern radio, and particularly broadcasting, which cannot fail to satisfy the broadcast listener or amateur who wants to get a real insight into the subject."—*Alfred N. Goldsmith, Ph.D., Director of Research, Radio Corporation of America.*

"What appeals to me particularly in this book is the success with which scientific accuracy is combined with simplicity of statement."—*Professor L. A. Hazeltine, Stevens Institute of Technology.*

This is not just another of those radio handbooks with which the bookstores have been plenteously loaded, but a fascinating little treatise."—*Christopher Morley, in The New York Evening Post.*

You will want to read it and to recommend it to your friends.

\$2 at all Booksellers

Boston **LITTLE, BROWN & COMPANY** Publishers

BRACH VACUUM LIGHTNING ARRESTER



For 17 Years a Leader in the Field of Protective Apparatus



L. S. BRACH MFG. CO.

NEWARK, N. J.



MAGNET WIRE & WINDINGS

FOR RADIO

WRITE TODAY FOR PRICES AND SAMPLES

DUDLO MANUFACTURING CO., FORT WAYNE, IND.

Pacific Coast Representative

A. S. Lindstrom, 111 New Montgomery St., San Francisco, Cal.

Murdock

Radio Headphones

STANDARD SINCE 1904

Announcing New Prices

2000 OHM SETS . . .	\$4.00
3000 OHM SETS . . .	4.50

*Better Made Now
Than Ever*

WM. J. MURDOCK CO.

WASHINGTON AVENUE

CHELSEA, MASS.

PROFESSIONAL ENGINEERING DIRECTORY

For Consultants in Radio and Allied Engineering Fields

ELECTRICAL TESTING LABORATORIES

Electrical and Mechanical Laboratories

Tests of Electrical Machinery, Apparatus and Supplies, Materials of Construction. Coal, Paper, etc. Inspection of Material and Apparatus at Manufactories.

80th Street and East End Ave.
New York

MONTAGUE FERRY

38 So. Dearborn St., Chicago

*Radio Apparatus
Design*

THE J. G. WHITE Engineering Corporation

Engineers—Constructors

Builders of New York Radio Central

Industrial, Steam Power and Gas Plants, Steam and Electric Railroads, Transmission Systems.

43 Exchange Place, NEW YORK

*Your Card Here
Will Be Seen
By Over 2,500
I. R. E. Members*

ARISTOS

"COPPERWELD" WIRE

TRADE MARK REG. U. S. PAT. OFF.

(Made by the Molten Welding Process)

**ADOPTED AND USED BY THE LARGEST
RADIO COMPANIES IN THE WORLD**

**For aerials, Copperweld has advantages over
solid copper or bronze**

Radio frequency currents, because of "skin effect," flow along the exterior of wires. The smooth exterior thickness of copper on Copperweld Wire gives it practically the same high electrical conductivity as a solid copper wire (see Letter Circular No. 62, U. S. Bureau of Standards).

Greater strength is given by its steel core. No. 14 Copperweld Antenna Wire has *50% greater strength* than No. 14 hard-drawn copper or 7-No. 22 stranded copper wires. It stays up under severe loads when copper and stranded copper wires sag and break.

For ANTENNA, No. 14 Bare Copperweld Antenna Wire

For LEAD-IN, No. 17 Rubber Insulated Copperweld Wire

For GROUND Wire, same as Lead-In Wire

For GROUNDING to earth, Copperweld Ground Rods, ½" diam.

Larger sizes for commercial stations

Copper Clad Steel Company

New York

San Francisco

Chicago

Mills and Main Office, Braddock P. O., Rankin, Pa.

THE DeForest name
has been in the fore-
front of radio research
for twenty-three years.
DeForest invented the
three-electrode vacuum
tube which makes
present-day radio pos-
sible. The sets and
parts made to-day by
the DeForest Company
are worthy of the
DeForest name.

DeFOREST

*Reg. U. S. Pat. Off.



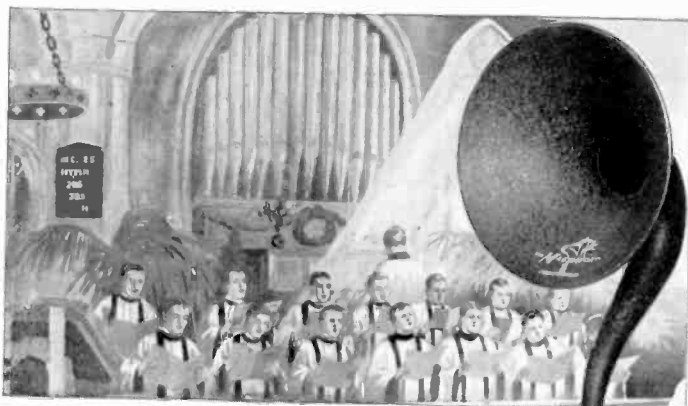

*Magnavox brings you the
Voice of all Christmastide*

THE Art of Radio Reproduction is enjoyed by every Magnavox owner. Despite the ever-increasing quality and variety of Broadcast Programs, many a receiving set gathers dust unlamented because of insufficient sensitivity or an unsatisfactory "loudspeaker."

Every Magnavox owner is a master of the art of radio reproduction—the results obtained by the use of Magnavox Reproducers and Power Amplifiers cannot be equalled with apparatus constructed in the ordinary way.

The special attention of dry battery receiving set owners is called to the new Magnavox Reproducer M1, illustrated above.

Magnavox Reproducers

R2 with 18" horn . . . \$60.00
R3 with 14" horn . . . 35.00
M1 for dry battery sets . . . 35.00

Combination Sets

A1-R Reproducer and 1-stage
Amplifier . . . 59.00
A2-R same with 2-stage . . . 85.00

Power Amplifiers

A1-One-stage . . . 27.50
AC-2-C-Two-stage . . . 55.00
AC-3-C-Three-stage . . . 75.00

*Magnavox Products can be had of
good dealers everywhere.*

THE MAGNAVOX CO.
Oakland, Cal.

New York Office: 370 Seventh Avenue
Perkins Electric Ltd.; Toronto, Mon-
treal, Winnipeg, Canadian Distributors

MAGNAVOX PRODUCTS

12-R

There is a Magnavox for every Receiving Set

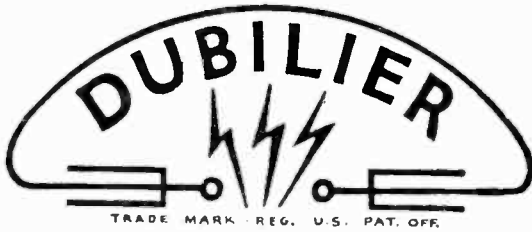

If the right condenser
is the problem.

THE Dubilier Condenser &
Radio Corporation is the
largest manufacturer of
condensers in the world.

Its long experience in meet-
ing the special requirements
of governments and manu-
facturers may be freely
drawn upon by radio en-
gineers.

DUBILIER CONDENSER AND RADIO CORP.

48-50 West Fourth St., New York

Branch Offices in the Following Cities

Los Angeles, Cal.

Atlanta, Ga.

Chicago, Ill.

St. Louis, Mo.

Huntington, W. Va.

Pittsburgh, Pa.

Washington, D. C.

Distributed in Canada by Canadian General Electric Company, Ltd., Toronto

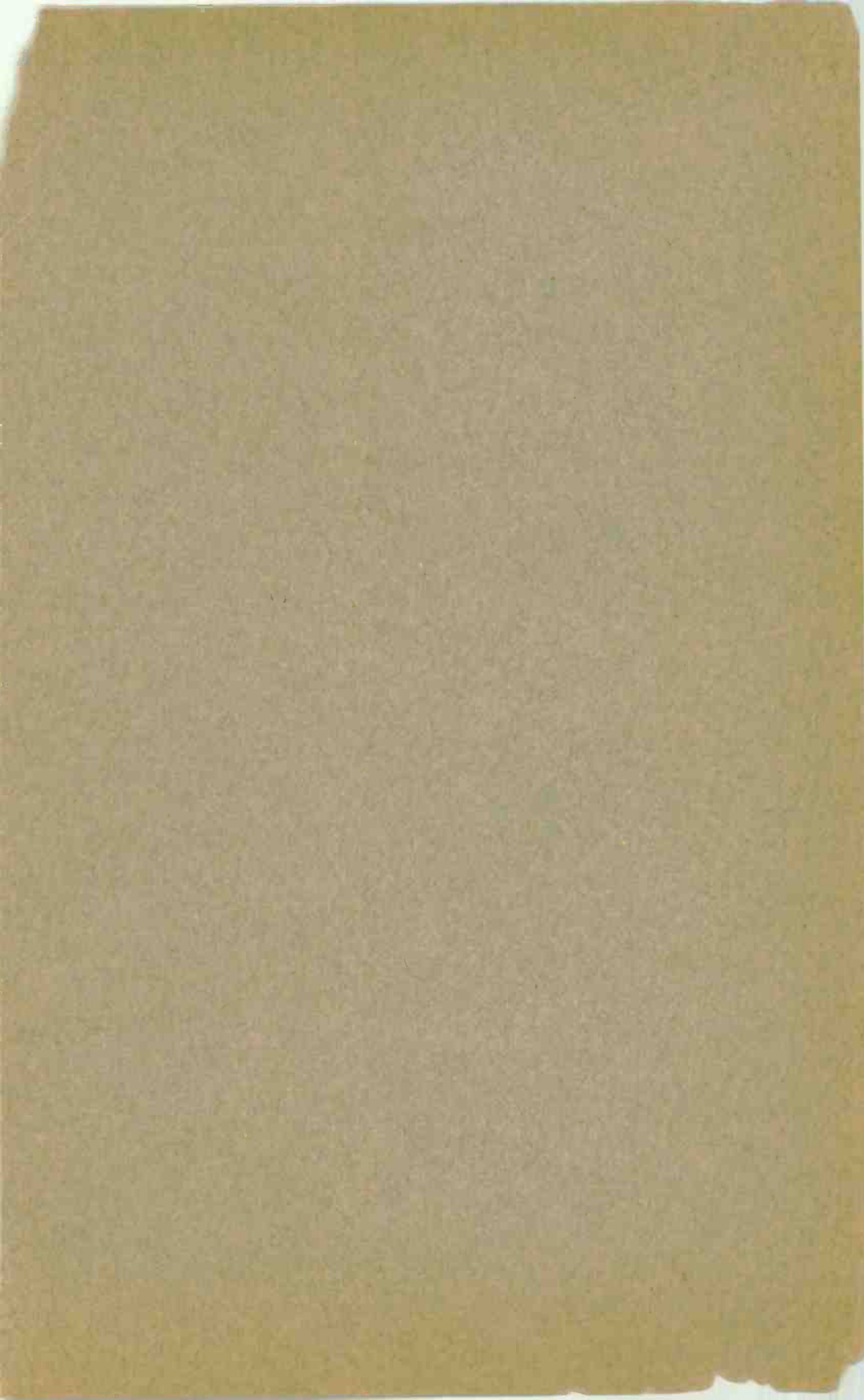

18 Stock Sizes
Radion Panels

6 x 7	7 x 21
6 x 10½	7 x 24
6 x 14	7 x 48
6 x 21	9 x 14
7 x 9	10 x 12
7 x 10	12 x 14
7 x 12	12 x 21
7 x 14	14 x 18
7 x 18	20 x 24



The Supreme Insulation
RADION
Panels
are easiest
to drill, saw
or engrave

Radion being an insulation material especially made for wireless use, has the lowest phase angle difference, lowest dielectric constant, highest resistivity and supreme moisture, gas and acid-repelling properties.

American Hard Rubber Co.
11 MERCER STREET - - - - NEW YORK