

# PROCEEDINGS OF The Institute of Radio Engineers

---

---

Volume 10

JUNE, 1922

Number 3

---

---

## CONTENTS

	PAGE
OFFICERS OF THE INSTITUTE OF RADIO ENGINEERS . . . . .	152
LOUIS W. AUSTIN, "THE MONTHLY AVERAGES OF SIGNAL STRENGTH OF NAUEN IN WASHINGTON, 1915-1921 AND THE MONTHLY AVERAGES OF ATMOSPHERIC DISTURBANCES IN WASHINGTON, 1918-1921" . . . . .	153
LOUIS W. AUSTIN, "RECEPTION MEASUREMENTS AT NAVAL RADIO RESEARCH LABORATORY, WASHINGTON" . . . . .	155
GREENLEAF W. PICKARD, "THE DIRECTION AND INTENSITY OF WAVES FROM EUROPEAN STATIONS" . . . . .	161
JULIUS WEINBERGER, "THE RECORDING OF HIGH SPEED SIGNALS IN RADIO TELEGRAPHY" . . . . .	176
JOHN B. BRADY, "DIGEST OF UNITED STATES PATENTS RELATING TO RADIO TELEGRAPHY AND TELEPHONY, Issued February 28, 1922- April 25, 1922" . . . . .	205

---

---

## GENERAL INFORMATION

The PROCEEDINGS of the Institute are published every two months and contain the papers and the discussions thereon as presented at the meetings in New York, Washington, Boston, Seattle, San Francisco, Philadelphia, or Chicago.

Payment of the annual dues by a member entitles him to one copy of each number of the PROCEEDINGS issued during the period of his membership.

Subscriptions to the PROCEEDINGS are received from non-members at the rate of \$1.50 per copy or \$9.00 per year. To foreign countries the rates are \$1.80 per copy or \$9.60 per year. A discount of 25 per cent is allowed to libraries and booksellers.

The right to reprint limited portions or abstracts of the articles, discussions, or editorial notes in the PROCEEDINGS is granted on the express condition that specific reference shall be made to the source of such material. Diagrams and photographs in the PROCEEDINGS may not be reproduced without securing permission to do so from the Institute thru the Editor.

It is understood that the statements and opinions given in the PROCEEDINGS are the views of the individual members to whom they are credited, and are not binding on the membership of the Institute as a whole.

---

PUBLISHED BY  
THE INSTITUTE OF RADIO ENGINEERS, INC.  
THE COLLEGE OF THE CITY OF NEW YORK

EDITED BY  
ALFRED N. GOLDSMITH, Ph.D.

# OFFICERS AND BOARD OF DIRECTION, 1922

(Terms expire January 2, 1923; except as otherwise noted.)

---

## PRESIDENT

FULTON CUTTING

## VICE-PRESIDENT

E. LEON CHAFFEE

## TREASURER

WARREN F. HUBLEY

## SECRETARY

ALFRED N. GOLDSMITH

## EDITOR OF PUBLICATIONS

ALFRED N. GOLDSMITH

## MANAGERS

(Serving until January 2, 1923)

ROBERT H. MARRIOTT

MAJOR-GENERAL G. O. SQUIER

EDWIN H. ARMSTRONG

LOYD ESPENSCHIED

DONALD McNICOL

(Serving until January 2, 1924)

EDWIN H. COLPITTS

JOHN V. L. HOGAN

(Serving until January 6, 1926)

MELVILLE EASTHAM

JOHN H. MORECROFT

## ADVERTISING MANAGER

DE WITT V. WEED, JR.

---

## WASHINGTON SECTION

### ACTING EXECUTIVE COMMITTEE

#### CHAIRMAN

B. R. CUMMINGS

Navy Department,  
Washington, D. C.

CAPTAIN GUY HILL

War Department,  
Washington, D. C.

LOUIS W. AUSTIN

Navy Department,  
Washington, D. C.

COMM. A. HOYT TAYLOR

Navy Department,  
Washington, D. C.

## BOSTON SECTION

#### CHAIRMAN

GEORGE W. PIERCE

Harvard University,  
Cambridge, Mass.

#### SECRETARY-TREASURER

MELVILLE EASTHAM

11 Windsor St.,  
Cambridge, Mass.

## SEATTLE SECTION

#### CHAIRMAN

ALBERT KALIN

Seattle, Washington

#### SECRETARY

C. E. WILLIAMS

8326 13th Avenue  
Seattle, Washington

#### TREASURER

HOWARD F. MASON, 3335 33D AVENUE, SOUTH,  
SEATTLE, WASHINGTON

## SAN FRANCISCO SECTION

#### CHAIRMAN

MAJOR J. F. DILLON.

526 Custom House,  
San Francisco, Cal.

#### SECRETARY-TREASURER

D. B. MCGOWN,  
Custom House,  
San Francisco, Cal.

---

COPYRIGHT, 1922, BY  
THE INSTITUTE OF RADIO ENGINEERS, INC.  
THE COLLEGE OF THE CITY OF NEW YORK  
NEW YORK, N. Y.

THE MONTHLY AVERAGES OF SIGNAL STRENGTH OF  
NAUEN IN WASHINGTON, 1915-1921  
AND  
THE MONTHLY AVERAGES OF ATMOSPHERIC  
DISTURBANCES IN WASHINGTON, 1918-1921\*

By

L. W. AUSTIN

(UNITED STATES NAVAL RADIO LABORATORY, WASHINGTON, D. C.)

*(Communication from the International Union for Scientific Radio  
Telegraphy)*

Daily observations on the electric field intensity (electric gradient) in Washington, produced by the German high power station at Nauen have been made at the U. S. Naval Radio Research Laboratory at The Bureau of Standards since 1915, with only slight interruptions. The wave length is 12,500 m. The observations up to the present have been made by the well-known audibility method (PROCEEDINGS OF THE INSTITUTE OF RADIO ENGINEERS, volume 5, page 239, 1917). The accuracy of the single audibility observations is about twenty per cent. under good conditions, while under the influence of heavy atmospheric disturbances or noise in the laboratory the apparent audibility may be reduced to one half or less of the true value.

Observations on the strength of the atmospheric disturbances or static have been made twice daily since early in 1918 between the wave lengths of 3,000 and 18,000 meters. The audibility of the disturbances was assumed to be the setting of the audibility meter for which the disturbances could be heard three times in ten seconds. Here 100 audibility corresponds roughly to 10 microvolts per meter field intensity. This method takes no account of the different types of disturbances, but a record is now kept of the occurrence of the crashing non-directional type which seems to have a different source from the more common rumbling variety. The single disturbance measurements are probably accurate to about thirty or forty per cent.

Sufficient data have now been collected to make it seem worth while to publish the results in the form of curves representing the monthly averages with some sample curves of single months showing the changes from day to day.

\*Received by the Editor, April 14th, 1922.

Up to 1921, the receiving set was calibrated by signals of known strength in the laboratory (PROCEEDINGS OF THE INSTITUTE OF RADIO ENGINEERS, volume 5, page 239, 1917). Since early in that year calibration has been made by comparison with signals of known intensity from a station more than a wave length away with a few milliamperes in the antenna.

With the end of 1921, audibility measurements at the laboratory have been given up, at least for the measurement of signals, and have been replaced by a comparison method of measuring the current in the telephones by impressing a known alternating electromotive force of the frequency of the signals on the telephone circuit.

Figure 1 shows the monthly averages of Nauen. The Nauen antenna current, according to present information, was about 240 amperes from July, 1915, to August, 1917; 320 amperes from August, 1917, to November, 1919; and since then about 380 amperes. The curves do not show any regular increase corresponding to this increase in current. It will be seen that during 1916 and 1917 the curve is high and irregular. During 1918 and 1919, lower and more regular, and during 1920 and 1921, higher and relatively regular. If the observations are correct, we must assume that the atmospheric conditions have, to a large extent, masked the effects of the change of transmitting power. The monthly averages of the atmospheric disturbances at 12,000 meters (Figure 2) show 1918 and 1919 to have been years of weak disturbance, compared with 1920 and 1921. It is also known that the summer of 1917 showed extremely heavy disturbances in the afternoons, altho no complete record was kept during that year (PROCEEDINGS OF THE INSTITUTE OF RADIO ENGINEERS, volume 9, page 28, 1921.) On a number of days in August the audibilities, brought within the range of the audibility meter by inserting resistance in the antenna, showed a strength of between 10,000 and 15,000 audibility. This all indicates that the years of strong disturbance intensity are also years of strong signal intensity. Of course, it may be charged that the differences are due to errors of calibration in our receiving apparatus, altho, in view of the efforts for accuracy, it does not seem possible that errors of this amount could exist. With our present method of measurement this would, of course, be out of the question.

**SUMMARY:** The monthly averages of the signal strength of Nauen in Washington from 1915 to 1921, and the monthly averages of atmospheric disturbances, in Washington during 1918-1921, are given graphically. The methods of measurement used are described and analyzed.

MICRO-VOL



2 J A S O N D J F M A M J J A S O N D J F M A M J J A S O N D J F A M J J A S O N D J F M A M J J A S O N D J  
 85 96 97 99 92

MONTHS

3000

2500

2000

1500

1000

500

AUDIABILITY

Fig 2  
 AVERAGE STATIC AUDIBILITY  
 FOR EACH MONTH  
 λ = 12000 m

----- STATIC 5.00 PM  
 - - - - - STATIC 10.00 AM

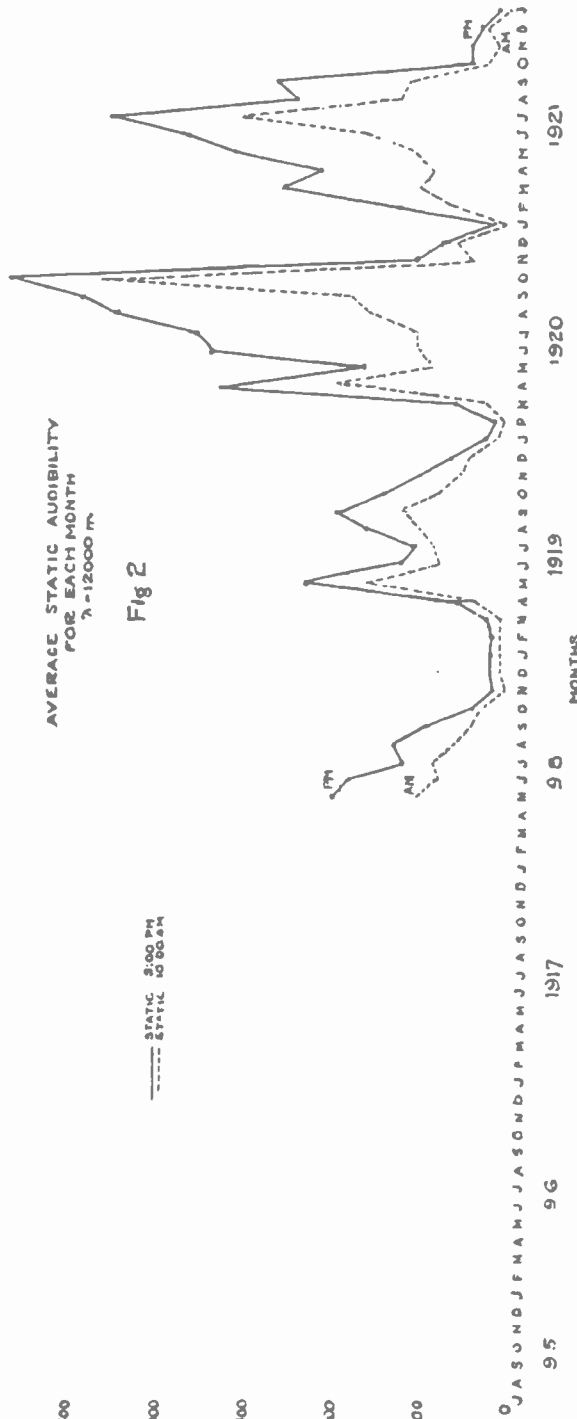

MONTHS

0 J A S O N D J F M A M J J A S O N D J F M A M J J A S O N D J F M A M J J A S O N D J  
 95 96 97 99 92

FIGURE 2

FIGURE 2

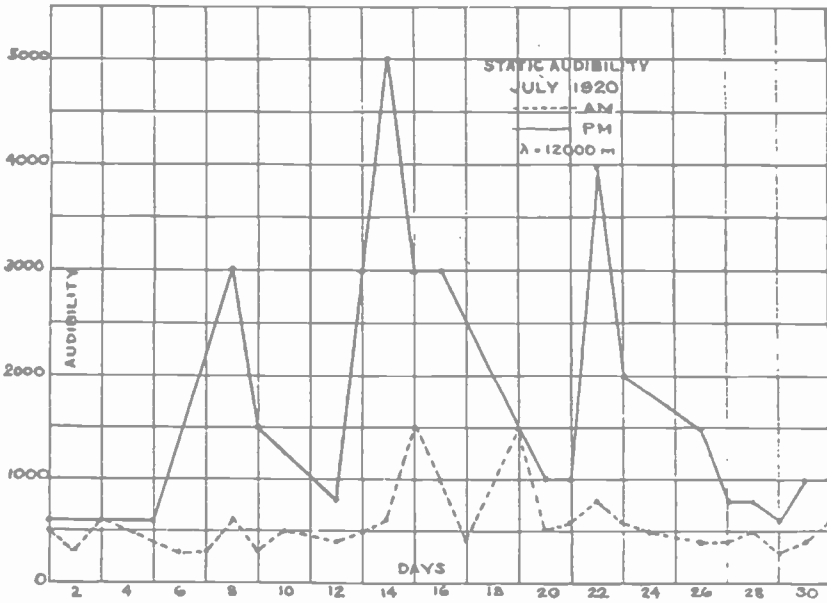

FIGURE 3

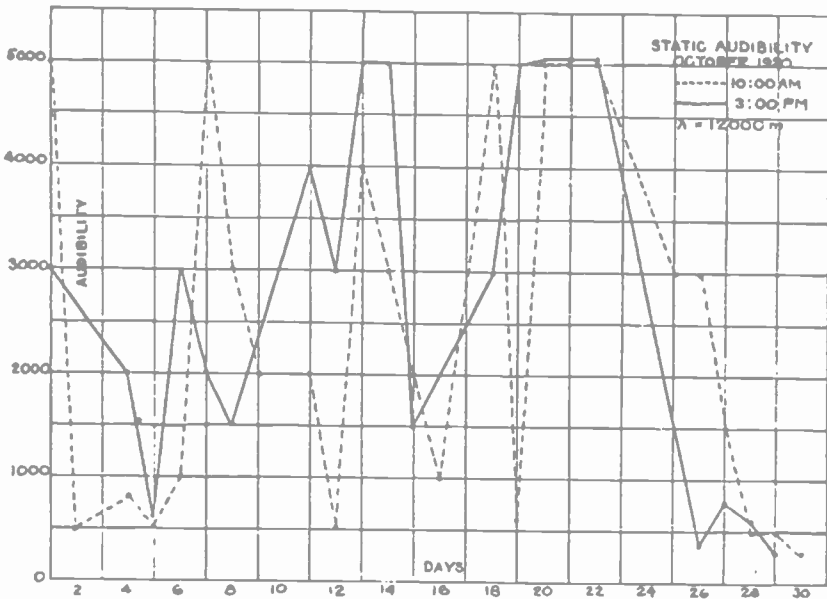

FIGURE 4

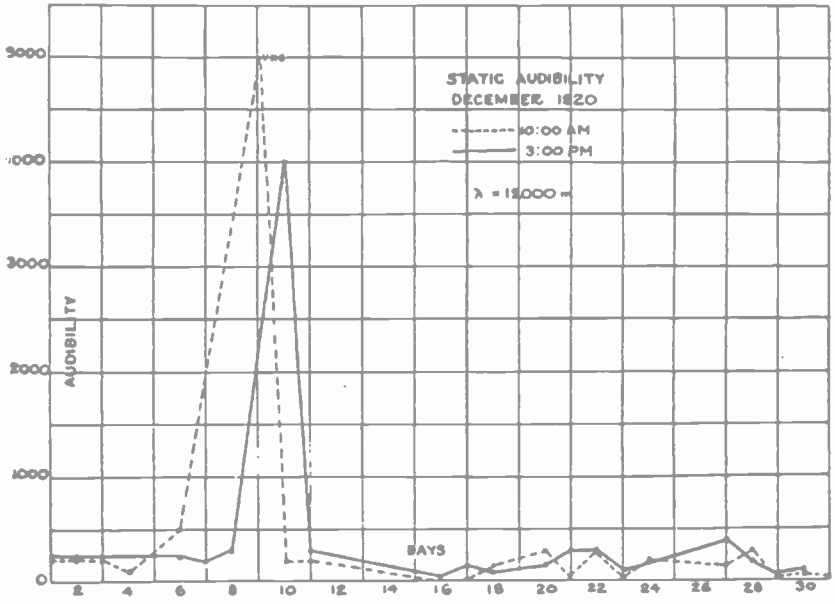

FIGURE 5

# RECEPTION MEASUREMENTS AT NAVAL RADIO RESEARCH LABORATORY, WASHINGTON\*

BY

L. W. AUSTIN

(UNITED STATES NAVAL RADIO LABORATORY, WASHINGTON, D. C.)

*(Communication from the International Union for Scientific  
Radio Telegraphy)*

The observations in the tables were taken by comparison of the telephone current due to the signal with that due to a known audio frequency electromotive force impressed on the telephone terminals. The signals were received on an antenna having an effective height of 15.5 meters (51 feet). The receiver was of the inductively back-coupled autodyne type without amplification. The system was calibrated frequently by receiving feeble signals of known intensity from the Washington Navy Yard and from the Naval Air Station.

At the same time that the U. S. R. I. (International Union for Scientific Radio Telegraphy) tests Table I were being carried out in the afternoon, measurements were also made on Nauen, Lyons, and Lafayette in the forenoon, Table II. In general, the forenoon is preferable in Washington for the measurement of European signals, on account of the fact that there is daylight over the whole path. In summer the signals would be generally two to ten times stronger at 10 A.M. than at 3 P.M.

Data for calculation.

	Lafayette	Lyons	Nauen
Sending current..... $I_s$	480 amp.	250 amp.	380 amp.
Sending height..... $h_1$	170 meters	150 meters	150 meters
Wave length..... $\lambda$	23,400 meters	15,000 meters	12,500 meters
Distance..... $d$	6,160 Km.	6,460 Km.	6,650 Km.
$\epsilon - Ad$ .....	0.148	0.081	0.059
Receiving resistance. $R$	94 ohms	56 ohms	54 ohms

Electric field intensity

$$E \text{ (calculated)} = 120 \pi \frac{I_s h_1}{\lambda d} e^{\frac{-0.0000475d}{\sqrt{\lambda}}} \text{ (volts, meters, amperes, ohms.)}$$

$$E \text{ (observed)} = \frac{B I_t \sqrt{R}}{h_2}$$

\*Received by the Editor, April 14, 1922.



$I_t$  = telephone current.

$B$  = constant = 180 for our apparatus.

$h_x$  = effective height = 15.5 m.

9:30 TO 11:30 A.M. WASHINGTON TIME

Date	Lafayette		Lyons		Nauen	
	Aud.	Volts/ Meter	Aud.	Volts/ Meter	Aud.	Volts/ Meter
Feb. 17	....	....	215	19.0 $\cdot 10^{-6}$	470	41.0 $\cdot 10^{-6}$
18	....	....	172	15.0	385	34.0
20	640	75.0 $\cdot 10^{-6}$	215	19.0	430	38.0
21	....	....	300	26.5	....	....
23	470	55.0	260	23.0	385	34.0
24	430	50.0	....	....	430	38.0
25	385	45.0	215	19.0	300	26.5
27	568	65.0	172	15.0	260	22.5
28	515	60.0	215	19.0	300	26.5
Mar. 1	515	60.0	260	23.0	430	38.0
2	470	55.0	215	19.0	340	30.0
3	493	58.0	172	15.0	300	26.5
4	430	50.0	172	15.0	300	26.5
6	515	60.0	260	23.0	385	34.0
7	430	50.0	....	....	260	22.5
8	600	70.0	300	26.5	385	34.0
9	770	90.0	260	23.0	430	38.0
10	770	90.0	215	19.0	430	38.0
11	568	65.0	....	....	300	26.5
13	430	50.0	260	23.0	340	30.0
14	515	60.0	260	23.0	385	34.0
15	600	70.0	215	19.0	340	30.0
16	640	75.0	260	23.0	385	34.0
17	640	75.0	....	....	515	45.0
18	568	65.0	215	19.0	300	26.5
20	385	45.0	....	....	....	....
21	430	50.0	130	11.5	260	22.5
22	568	65.0	260	23.0	340	30.0
23	600	70.0	340	30.0	515	45.0
24	770	90.0	340	30.0	560	49.0
25	430	50.0	300	26.5	385	34.0
27	515	60.0	215	19.0	300	26.5
28	....	....	260	23.0	385	34.0
29	600	70.0	385	34.0	770	68.0
30	568	65.0	260	23.0	385	34.0
31	470	55.0	....	....	90	7.8
Average	542	63.0 $\cdot 10^{-6}$	244	21.5 $\cdot 10^{-6}$	375	33.1 $\cdot 10^{-6}$

## 3:00 P.M. WASHINGTON TIME

Date	Lafayette U.R.S.I.		Lyons		Nauen	
	Aud.	Volts/ Meter	Aud.	Volts/ Meter	Aud.	Volts/ Meter
Feb. 17	470	55.0·10 <sup>-6</sup>	172	15.0·10 <sup>-6</sup>	430	38.0·10 <sup>-6</sup>
18	730	85.0	.....	.....	.....	.....
20	685	80.0	260	23.0	340	30.0
21	515	60.0	.....	.....	.....	.....
23	470	55.0	.....	.....	.....	.....
24	515	60.0	.....	.....	.....	.....
25	568	65.0	215	19.0	.....	.....
27	470	55.0	.....	.....	.....	.....
28	430	50.0	.....	.....	.....	.....
Mar. 1	515	60.0	.....	.....	.....	.....
2	568	65.0	.....	.....	.....	.....
3	430	50.0	215	19.0	300	26.5
4	340	40.0	.....	.....	.....	.....
6	470	55.0	172	15.0	300	26.5
7	385	45.0	.....	.....	.....	.....
8	730	85.0	260	23.0	385	34.0
9	430	50.0	.....	.....	.....	.....
10	730	85.0	260	23.0	340	30.0
11	515	60.0	.....	.....	.....	.....
13	470	55.0	215	19.0	340	30.0
14	470	55.0	.....	.....	.....	.....
15	385	45.0	215	19.0	430	38.0
16	515	60.0	215	19.0	300	26.5
17	600	70.0	130	11.5	215	19.0
18	730	85.0	.....	.....	.....	.....
20	515	75.0	.....	.....	.....	.....
21	470	55.0	215	19.0	300	26.5
22	430	50.0	215	19.0	300	26.5
23	470	55.0	.....	.....	.....	.....
24	430	50.0	260	23.0	430	38.0
27	470	55.0	215	19.0	340	30.0
28	300	35.0	215	19.0	300	26.5
29	340	40.0	.....	.....	340	30.0
30	770	90.0	.....	.....	.....	.....
31	340	40.0	.....	.....	150	13.0
Average	505	59.3·10 <sup>-6</sup>	215	19.0·10 <sup>-6</sup>	326	28.8·10 <sup>-6</sup>

**SUMMARY:** Signal intensity using an autodyne receiver was measured by comparison of telephone current with that produced by a known audio frequency electromotive force. The signals from Bordeaux, Lyons, and Nauen were measured during February and March, 1922, at approximately 10 A.M. and 3 P.M. The results are given.

# THE DIRECTION AND INTENSITY OF WAVES FROM EUROPEAN STATIONS\*

By  
GREENLEAF W. PICKARD

(CONSULTING ENGINEER, THE WIRELESS SPECIALTY APPARATUS COMPANY,  
BOSTON, MASSACHUSETTS)

It has been known for over thirteen years that the apparent bearing of a distant station, as taken by the radio compass, often differs widely from the true bearing. The writer discovered in his early work with the coil aerial that unsymmetrically distributed conductors on the earth's surface, such as buildings, trees, and bodies of waters, often caused large deviations from the true bearing, even approaching  $90^\circ$  at certain receiving points, particularly when these were near a river. In an account of these observations published in 1908<sup>1</sup> is given a map showing the result of a radio compass survey around a transmitting station, which is reproduced in Figure 1.

The heavy black lines on this map are the projections of the compass coil when in the minimum or null position, and the effect of a stream of water is strikingly shown at the right of the map, near the junction of the Powow and Merrimack Rivers.

The extended use of the radio compass during the war has not only confirmed the writer's early observations, but has brought to light another variety of error, apparently not due to fixed obstructions, but varying from day to day, hour to hour and even from minute to minute. These variations, which for moderate distances and wave lengths are of the order of a few degrees, appear to increase with wave length and to some extent with the distance of transmission, until with the waves involved in trans-Atlantic working there have been reported deviations of over  $45^\circ$ . The bibliography of this subject, at least so far as the publication of actual observations is concerned, is not only lamentably limited, but is practically entirely confined to the past two years, the first publication I have so far found of actual determinations being by Taylor in 1919<sup>2</sup>. This observer, with a compensated receiving coil at Washington, D. C., found large

\* Received by the Editor, October 25, 1921.

deviations in the waves from Annapolis, New Brunswick, and Sayville, in one instance approximating  $90^\circ$ , and also that there were times when no definite minimum or null point could be found. The transmission was in all cases entirely overland, and the distances ranged from 55 to 280 kilometers (34 to 174 miles).

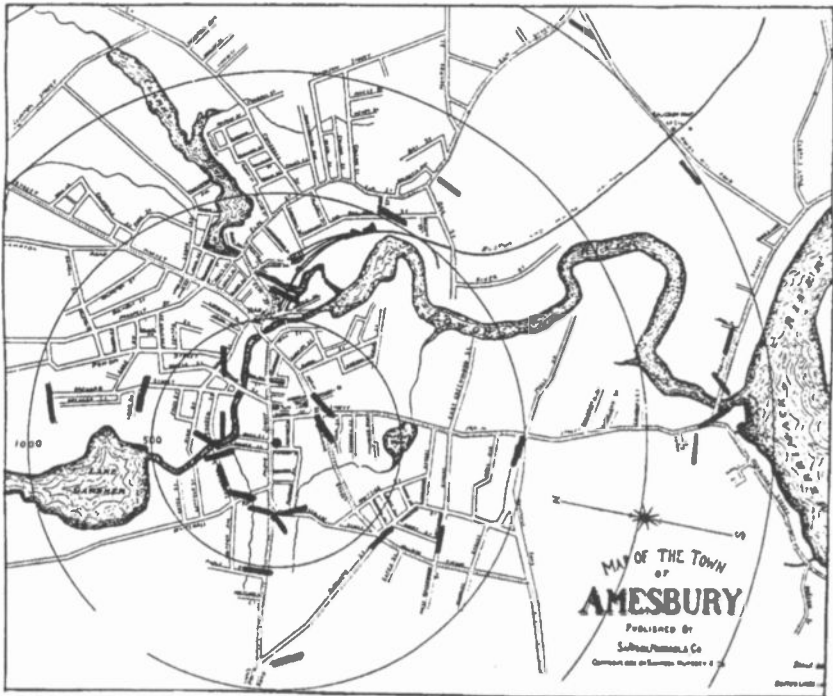

FIGURE 1

Kingsley and Sobey,<sup>3</sup> with goniometric stations at three widely separated inland points, Houlton, Maine, Tucson, Arizona, and McAllen, Texas, also found large deviations, in one instance over  $56^\circ$ , and not infrequent instances when no definite minimum could be found. The greater part of their observations were taken on waves which had travelled entirely over land, and as their stations were all inland, all of their reception involved transmission over a considerable stretch of land at the receiving end. Fessenden<sup>4</sup> states that errors of  $45^\circ$  are sometimes found, and that over water and parallel to a coast line the waves will bend inland. He also says that the true direction can be determined by taking observations on different wave lengths; if they agree, the apparent bearing is the true one. The writer's observations this summer, given below, are hardly in accord with this state-

ment. European stations with wave lengths of 12.6 and 23.4 kilometers having been found to vary simultaneously from the true bearing by over ten degrees. The remainder of the brief bibliography of this subject is given at the end of this paper. On one point, at least, there is a practical consensus of opinion: almost to a man the various writers lay the errors on the broad shoulders of the Heaviside Layer.

During the spring and summer of 1918, the writer had occasion to determine the apparent bearing of the European stations from Otter Cliffs, Maine. A number of observations were made with a large solenoidal coil, and no deviation greater than ten degrees from the true bearing was found. During the winter of 1918-1919, and at intervals during the summer of 1919, a series of bearings were taken on Nauen, Germany, from the roof of the Board of Trade Building, Boston, Massachusetts, in which a large constant deviation was observed, apparently due to the proximity of the Custom House Tower, a steel frame structure some 160 meters (524 feet) high, and about 100 meters (328 feet) due east from the receiving point. Nauen's apparent bearing was also due east, an error of over  $45^{\circ}$ .

During the month of August, 1921, the writer undertook a prolonged series of radio compass bearings of European and other stations from a receiving point located at Seabrook Beach, New Hampshire, North  $42^{\circ} 52' 24''$ , and West  $70^{\circ} 49' 4''$ . Seabrook Beach is a low, sandy strip of land, some three meters (10 feet) above high tide level, running nearly north and south between the Atlantic Ocean on the east, and a wide salt marsh on the west, and is apparently, at least in so far as local obstructions are concerned, an ideal receiving point. Until one has plotted a number of great circle bearings, it is difficult to appreciate the fact that there is no point on the Atlantic coast of the United States, save only the tip of Florida, which is entirely free from obstacles in the path of the waves from European stations. In general, a great circle passing thru the chosen receiving point and such a station as Nauen, Germany, will run grazingly north-east along our coast, and will cut thru parts of Nova Scotia and Newfoundland, as is shown in Figure 2, which gives the great circles passing thru Seabrook Beach, Nauen, Germany, and Bordeaux, France. In this Figure is also shown the great circle passing thru Seabrook Beach and San Diego, California. It will be noted that the great circle bearing of San Diego from Seabrook is nearly due west, and the waves from the station at San Diego, if they followed the great circle, would pass thru the gap between

the Catskill mountains to the south and the foothills of the White Mountains to the north, some 150 kilometers (93 miles) west of Seabrook. Actually, as will be seen from the observations below, the waves arrived from San Diego with a mean apparent bearing of over ten degrees to the north of the true direction, while the waves from Nauen and Bordeaux came in on Seabrook with a mean deviation from true bearing of four degrees to the east.

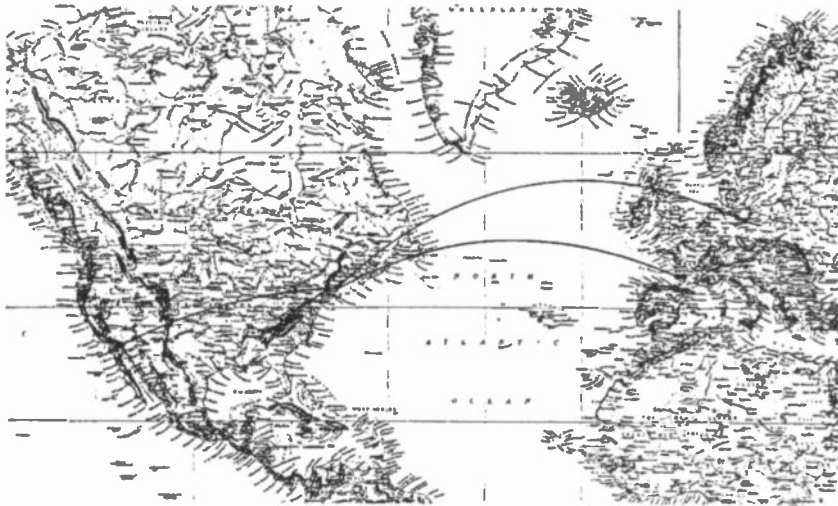

FIGURE 2

At a point fifty meters (164 feet) to the west of high water mark at Seabrook Beach, a solenoidal compass coil was erected, wound on a square frame 305 centimeters (10 feet) on a side, with twenty turns of 7 strands of number 22 copper wire,\* spaced 2.5 centimeters (1 inch) apart, and supported by bakelite combs at the four corners of the frame. This loop, with a measured inductance of 2.65 millihenrys, was connected in series with a coupling coil of 0.77 millihenry and a variable mica and air condenser for tuning. As the observations were confined entirely to wave lengths over ten kilometers, the tuning capacity was large, ranging from 0.013 microfarad for Nauen to 0.045 microfarad for the Lafayette station at Bordeaux. Preliminary tests indicated that a small ratio of inductance to capacity gave marked freedom from antenna effects, and the polar curve was found to be very symmetrical, as will be seen from Figure 3, taken on the Marion station, some 150 kilometers (93 miles) to the south.

\* Diameter of number 22 wire = 0.025 inch = 0.063 cm.

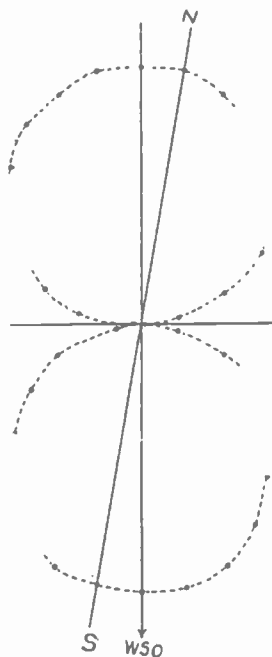

FIGURE 3

The coil was mounted on a wooden platform, with the lower wires of the loop 180 centimeters (5.9 feet) above the ground, and leads were taken into a wooden hut nearby, which housed a receiving circuit with four stages of radio and two of audio frequency amplification, an external heterodyne, and a shielded local source of oscillations for intensity measurements. A small open antenna was also erected for unilateral working, in combination with the loop. Figure 4 shows the coil and hut, looking north along the beach, while Figure 5 shows the interior of the receiving hut.

Bearings were taken to the nearest degree, and sometimes to the nearest half degree. Over a thousand determinations were made, principally on Nauen and Bordeaux, and in no single instance was there any uncertainty as to the null point, such as has been reported by other observers. Occasionally severe static would bury the signal for five or ten degrees on either side of the null point, and on a few occasions the unsymmetrical distribution of the static (stronger on one side of the null point than on the other) made the bearing uncertain by as much as seven or eight degrees. Observations made under such conditions are not included in the results reported in this paper.

No sudden changes in direction were observed, the bearings

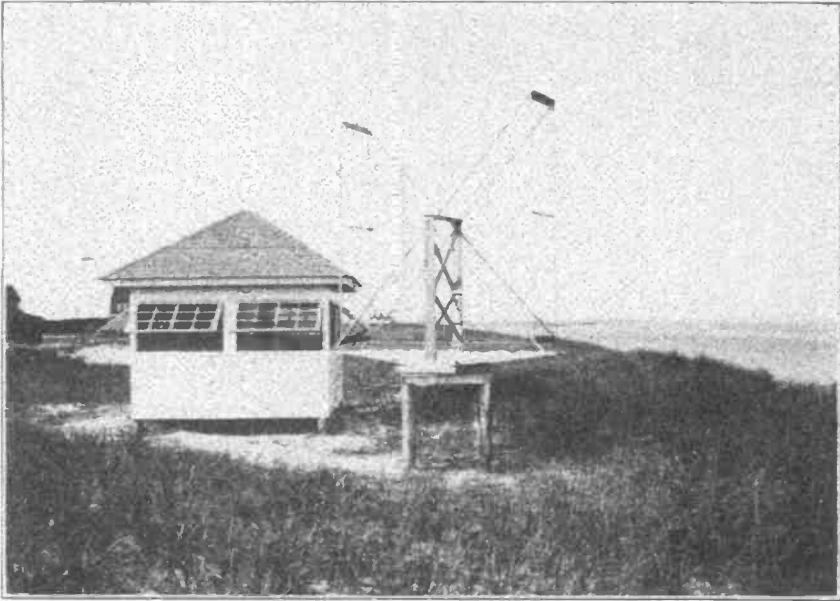

FIGURE 4

simply drifting slowly from side to side of the mean bearing for the period. This is well shown by a portion of the Seabrook station log, reproduced below, of August 15, 1921.

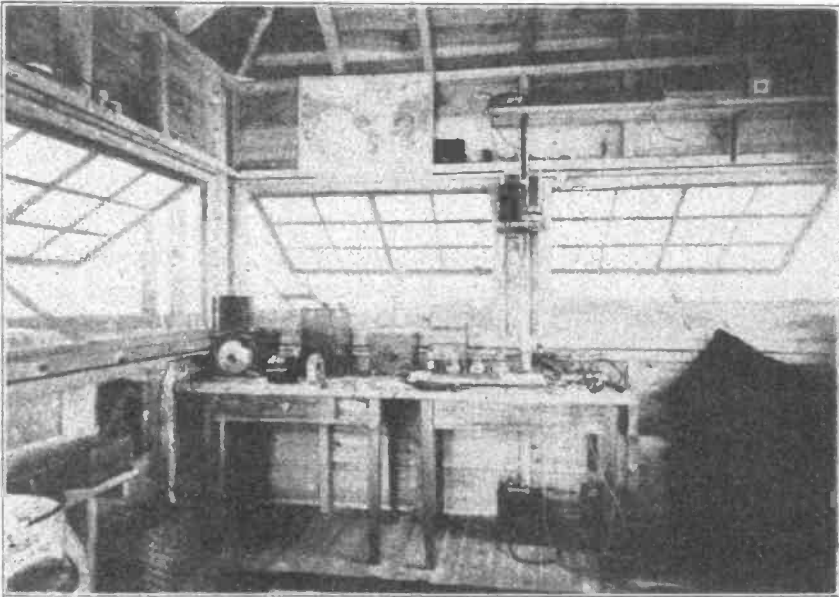

FIGURE 5



Time 75th Mer.	Station	Bearing	Intensity Volts per Meter $\times 10^{-5}$
10.03 A.M.	Nauen	N49E	1.8
10.05 A.M.	"	48	
10.15 A.M.	"	48	
10.19 A.M.	"	50	
10.40 A.M.		52	
10.43 A.M.		51	
10.45 A.M.		50	
10.49 A.M.		50	
10.52 A.M.		51	
10.54 A.M.		50	
10.55 A.M.		50	
10.57 A.M.		50	
10.59 A.M.		50	
11.01 A.M.		50	
11.07 A.M.	"	50	
11.10 A.M.	"	50	
11.14 A.M.	"	51	
11.17 A.M.		51	
11.18 A.M.		52	
11.22 A.M.		51	
11.30 A.M.	"	50	
11.33 A.M.	"	50	
11.42 A.M.		50	
11.44 A.M.	"	51	
11.46 A.M.		51	1.3
12.40 P.M.	"	50	
12.44 P.M.	"	51	
12.48 P.M.	"	50	
12.52 P.M.	"	50	
12.58 P.M.	"	50	
1.03 P.M.	"	50	
1.06 P.M.	"	50	
1.09 P.M.	"	51	
1.12 P.M.	"	50	
1.19 P.M.	"	50	
1.21 P.M.	"	51	
1.26 P.M.	"	51	
1.35 P.M.	"	51	
1.43 P.M.	"	51	
1.48 P.M.	"	52	
1.52 P.M.	"	52	
1.57 P.M.	"	52	1.2
2.09 P.M.	Bordeaux	N65E	4.7
2.13 P.M.	"	65	
2.15 P.M.	"	62	
2.19 P.M.	"	60	

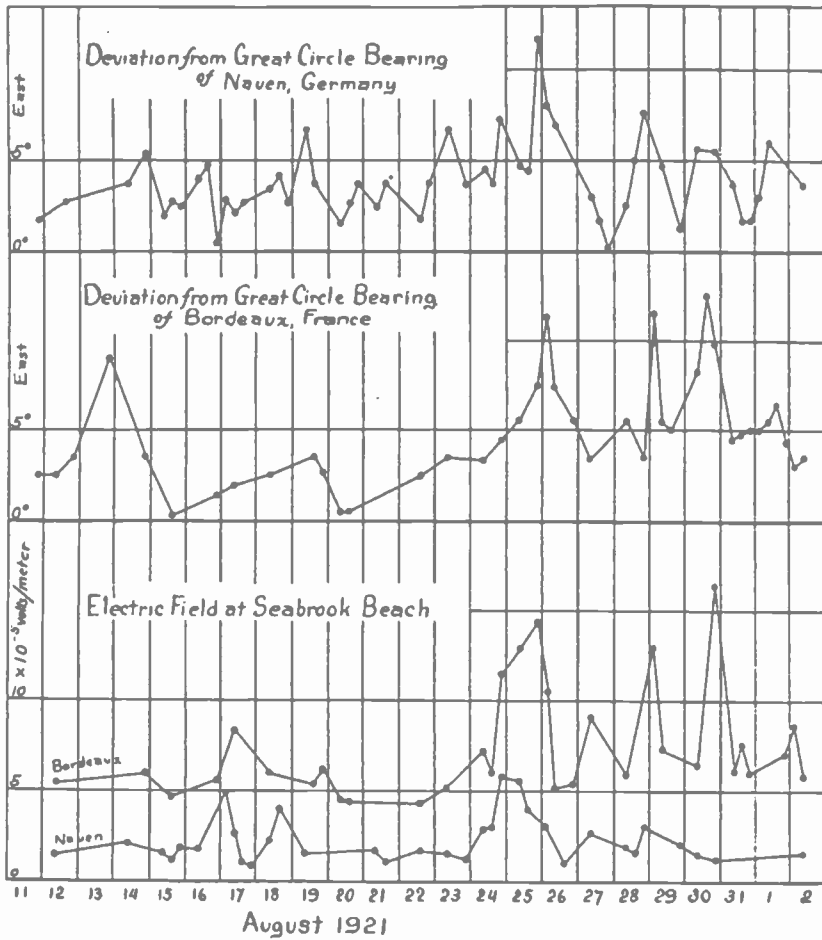

FIGURE 6

August, coincidentally with the periods of maximum deviation from true bearing. These intensity measurements are given in volts per meter at Seabrook, and were taken by a method devised by the writer, which avoids the complications and uncertainties of the Vallauri method, and gives readings directly in terms of the electromotive force produced in the receiving circuit. The arrangement employed is shown in Figure 7.

A tube-driven wave-meter circuit C1 L1 (L1 being a toroidal air core inductance) is coupled by way of a secondary coil L2 with a non-inductive resistance network R1, R2, R3. R1 and R3 are small resistances, usually about half an ohm each, while R2 is variable between sufficiently wide limits to give any desired fall of potential across R3. A hot wire meter, HWM, giving full scale deflection on about 0.07 ampere, with a reading microscope focused

on the pointer, can be inserted in either the secondary circuit  $L_2$ ,  $R_1$ , or, by throwing the switch  $SW$  to the left, into a direct current circuit  $B$ ,  $MA$ ,  $R_4$ , the current in this circuit being read by the milliammeter  $MA$ . When  $R_4$  is so adjusted that the meter  $HWM$  shows no change of deflection on throwing  $SW$ , it is obvious that the oscillating current flowing thru  $R_1$  is equal to the current read by  $MA$ . With an oscillating current of the

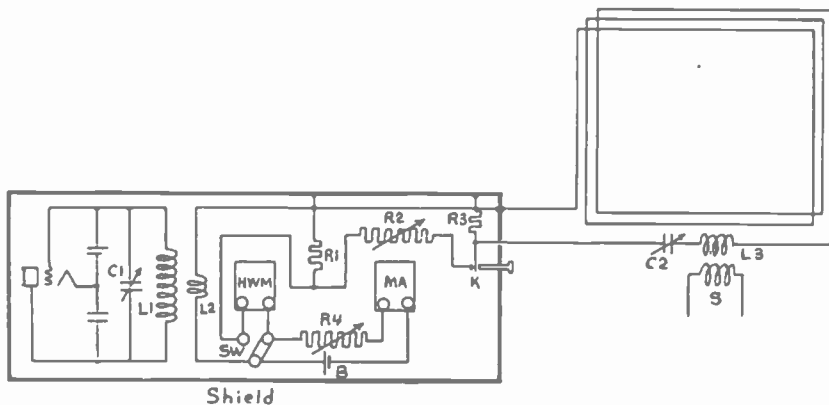

FIGURE 7

order of 0.01 ampere, this arrangement is sensitive enough to check the current to within about 1 percent; an ample precision for any aural comparison method. With the distant station sending, the oscillating circuit  $C_1$ ,  $L_1$  is tuned exactly to the same frequency, as checked by the beat note in the detector circuit. Then, by tapping the key  $K$  so that short signals from the shielded local circuit may be intercalated with the signals from the distant station, and varying  $R_2$  until the intensity of the two signals became observably equal, the electromotive force across  $R_3$  is equal to that produced in the loop by the distant station, and may be found by a simple calculation from the known constants of the resistance network. Also, from the electromotive force produced in the circuit, the electric force in the wave-front is easily calculated from the wave length, number of turns and size of the coil aerial.

On the night of September 1-2, 1921, a strong aurora developed at about 9.30 P.M., and persisted thruout the night and even after dawn. During the greater part of this time, the Bordeaux station was sending, and the writer made a series of bearing and intensity measurements to determine whether the aurora had any effect upon radio waves. The results of this measurement are set forth in the table below.

OBSERVATIONS DURING THE AURORA OF  
SEPTEMBER 1-2, 1921

Time 75°M	Bear- ing	Devia- tion	Inten- sity ×10 <sup>-5</sup>	Notes
P.M. 9.50				Strong auroral arc, center N5E, 115° wide. Static S70W.
10.15	N67E	4.5E		Bordeaux sending.
10.30	67	4.5		Aurora increasing.
10.40	67	4.5		
10.44	66	3.5		
10.48	67	4.5		
10.55	67	4.5		Second arc above original one.
11.00	66	3.5	7.6	
11.09				Ends of lower arc developing hooks.
11.10	67	4.5		
11.14	68	5.5		
11.20	66	3.5		Upper arc develops hook at E.
11.26	66	3.5		Upper arc changes to vertical brush. Aurora fading.
11.32	67	4.5		
11.36	67.5	5.0		
11.40	67	4.5		Static S70W.
11.47	67	4.5		Aurora wing-like, center N.
11.54	66	3.5		Aurora fading.
11.58	67	4.5	6.6	
A.M.				
12.05	67	4.5	10.2	Aurora strong, and now a simple arc.
12.08	67	4.5		
12.13	67	4.5		Aurora fading slightly.
12.20	66	3.5		
12.25				LY stops sending. At 1.20 aurora began to flicker, culminating at 1.30 in a magnificent flame-like effect which covered the entire northern half of hemisphere.
1.53	67	4.5	6.0	Static S65W. Aurora fading slightly. Static S80W.
1.57	65	2.5		
2.03	65	2.5	4.1	
2.09	64	1.5		
2.13	65	2.5		
2.17	65	2.5		
2.21	65	2.5		
2.26	65	2.5		Aurora fading.
2.30	65	2.5		Aurora increasing.
2.34	65	2.5		Aurora fading.
2.37	65	2.5		Aurora strong in NW.
2.41	65	2.5		Aurora increasing.
2.44	65	2.5		Aurora fading slightly.
2.47	65	2.5		Aurora weak.
2.51	66	3.5		Only a few patches of aurora left.
2.54	66	3.5		
2.58	65	2.5		Static S60W.
3.01	66	3.5	7.2	Aurora increasing.
3.05	66	3.5		Aurora faint.
8.40	66	3.5	5.8	

The aurora seemed to be without effect upon either the bearing or intensity of Bordeaux, and even that cratic element, static, came in from about its normal bearing, and with its usual intensity, thruout the display.

In addition to the many measurements made upon Nauen

and Bordeaux, a few bearings were taken from time to time on stations in the United States, and these are given in the table below.

Date	75th Mer. Time	Station	Bearing	Deviation
Aug. 12	9.00 A.M.	New Brunswick	S56W	5.7W
13	10.15 A.M.	Annapolis	S42W	7.0S
13	10.30 A.M.	New Brunswick	S48W	2.3S
13	10.05 P.M.	Annapolis	S52W	3.0W
13	10.12 P.M.	Glace Bay	N58E	5.3N
14	11.50 A.M.	Marion	S2.5E	0.9E
14	12.10 P.M.	Annapolis	S42W	7.0S
14	12.25 P.M.	New Brunswick	S53W	2.7W
15	9.05 P.M.	Glace Bay	N60E	3.3N
16	11.05 A.M.	Marion	S5E	3.4E
17	3.22 P.M.	New Brunswick	S52.5W	2.2W
19	4.51 P.M.	Marion	S10E	8.4E
23	10.00 P.M.	Annapolis	S57.5W	8.5W
24	9.07 A.M.	Marion	S4.7E	3.1E
24	12.03 P.M.	Annapolis	S53W	4.0W
24	12.07 P.M.	"	S53W	4.0W
25	10.03 P.M.	"	S46W	3.0S
25	11.37 P.M.	San Diego	W7N	9.5N
25	11.58 P.M.	"	W10N	12.5N
26	12.21 A.M.	"	W 5N	7.5N
26	1.54 A.M.	"	W 8N	10.5N
26	2.03 A.M.	"	W 7N	9.5N
26	3.33 A.M.	"	W10N	12.5N
26	4.28 A.M.	"	W10N	12.5N
26	4.40 A.M.	"	W 9N	11.5N
26	4.45 A.M.	"	W 7N	9.5N
26	4.50 A.M.	"	W 7N	9.5N
26	5.07 A.M.	"	W 5N	7.5N
26	5.11 A.M.	"	W 5N	7.5N
26	5.15 A.M.	"	W 7N	9.5N
26	5.18 A.M.	"	W 6N	8.5N
26	5.38 A.M.	"	W 7N	9.5N
26	5.50 A.M.	"	W 7N	9.5N
26	5.57 A.M.	"	W 6N	8.5N
26	12.04 P.M.	Annapolis	S52W	3.0W
27	10.44 P.M.	San Diego	W15N	17.5N
27	11.28 P.M.	"	W13N	15.5N
27	11.58 P.M.	"	W12N	14.5N
28	8.42 A.M.	"	W12N	14.5N
28	12.11 P.M.	Annapolis	S55W	6.0W
29	10.45 A.M.	Tuckerton	S40W	1.7S
29	1.03 P.M.	Annapolis	S52W	3.0W
29	10.03 P.M.	"	S47W	2.0S
30	12.04 P.M.	"	S52W	3.0W
31	12.01 P.M.	"	S52.5W	3.5W
Sept. 1	12.01 P.M.	"	S51.5W	2.5W

With the exception of Glace Bay, all of these stations were received entirely overland, and it will be noted that, with the exception of San Diego, the deviations are small and of the same order as those observed for the European stations.

The averages for the entire month, and of both night and day observations, are given in the table below.

Station	True Bearing	Deviation
Annapolis.....	S49W	0.5W
Tuckerton.....	S41.7W	1.7S
New Brunswick.....	S50.3W	2.1W
Nauen.....	N48.3E	3.8E
Marion.....	S1.6E	4.0E
Bordeaux.....	N62.5E	4.2E
Glace Bay.....	N63.3E	4.3N
San Diego.....	W2.5S	10.6N

It is to be regretted that these observations did not cover a much greater period, and it is to be hoped that before long someone will undertake continuous observations of this character. It is only thru the accumulation of such data that we can hope to correlate these variations in direction and intensity with meteorological and other terrestrial elements, and in this way arrive at an understanding of their causes. Heaviside Layer hypotheses are of little value unless supported by a firm foundation of data, and as Lord Kelvin said:

“When you can measure what you are speaking about and express it in numbers, you know something about it, and when you cannot measure it, when you cannot express it in numbers, your knowledge is of a meagre and unsatisfactory kind. It may be the beginning of knowledge, but you have scarcely in your thought advanced to the stage of a science.”

**SUMMARY:** The deviations of radio goniometric readings from the true bearing of distant and nearby stations were measured at a suitable location with a coil antenna and receiver. In addition to errors due to physical obstructions in the path of the incoming wave, errors varying with the time of day were measured. Radio goniometric measurements were also made during an intense aurera. The intensity of the field of the incoming signals was also measured by means of a resistance network, and the necessary apparatus is described.

## BIBLIOGRAPHY

1. "Determination of Wireless Wave Fronts," Pickard, "Electrical Review," New York, October 3, 1908, pages 494-495.
2. "Varying Directions of Radio Waves," Taylor, "Bulletin of the Bureau of Standards," 15, pages 419-433, July, 1919.
3. Wireless Direction Changes and Variation of Audibility," Kinsley and Sobey, PROCEEDINGS OF THE INSTITUTE OF RADIO ENGINEERS, 8, pages 299-323, August, 1920.
4. "The Fessenden Wireless Compass," Fessenden, "Electrician," 83, pages 719-721, December, 1919.  
"Direction and Position Finding," Round, "Journal of the Institute of Electrical Engineers," 58, pages 224-247, March, 1920.  
"Refraction of Electric Waves," Eckersley, "Radio Review," 1, pages 422-428, June, 1920.  
"Measurement of the Electromagnetic Field of Waves Received During Trans-oceanic Radio Transmission," Vallauri, PROCEEDINGS OF THE INSTITUTE OF RADIO ENGINEERS, 8, pages 286-296, August, 1920.  
"Local Errors in Wireless Direction Finding," Hollingworth and Hoyle, "Radio Review," 1, pages 644-649, October, 1920.  
"Recent Progress in Radio-Telegraphy," Eccles, "Journal of the Institute of Electrical Engineers," 59, pages 77-84, October, 1920.  
"The Errors of Direction Finders," Bellini, "Electrician," 86, pages 220-222, February 18, 1921.  
"Effect of the Heaviside Layer upon the Errors of Direction Finders," Eckersley, "Radio Review," 2, pages 60-65. February, and pages 231-248, May, 1921.  
"Radiogoniometry and Atmospheric Influences," Rothe. "Comptes Rendus," 172, pages 1345-1347, May 30, 1921.  
"Radiogoniometric Studies," Ferrie, Jouast, Mesny, and Perot, "Comptes Rendus," 172, pages 54-58, January 3, 1921.  
"The Heart-shaped Polar Diagram and its Behavior Under Night Conditions," Wright and Smith, "Radio Review," 11 pages 394-403, August, 1921.  
"The Radio Compass," Ballantine, "The Year Book of Wireless Telegraphy and Telephony," 1920, pages 1131-1147.

# THE RECORDING OF HIGH SPEED SIGNALS IN RADIO TELEGRAPHY\*

BY

JULIUS WEINBERGER

(RESEARCH ENGINEER, RESEARCH DEPARTMENT, RADIO CORPORATION OF AMERICA)

## INTRODUCTION

In this paper it is proposed to deal with the development and operation of a practical system for the handling of radio telegraphic traffic at high speed, particularly in trans-oceanic communication. By high speed working we refer to operation at speeds greater than those customarily employed for telephonic reception, that is 20 to 25 words per minute by average good operators.

With the continually increasing expensiveness of equipment, and the tendency towards increase of transmitting power (so as to insure reliable communication at all times), it has become apparent that the profitable operation of a long distance radio system depends greatly upon working at a rate of speed in excess of that obtainable by hand. Most of the high power radio transmitters of today are equipped with relay systems capable of sending as high as 100 words per minute, and there is no particular reason why, if necessary, powerful vacuum tube amplifiers could not be built to take the place of relays and be worked at considerably greater speed. The limitation of working speed is practically confined to the receiving side of the radio system, so that it is obvious that increased speed possibilities must be obtained entirely by the development of receiving apparatus.

In order to understand the conditions under which high speed recording apparatus must work, it will be well to describe briefly the manner in which communication is carried on over the trans-Atlantic circuits of the Radio Corporation. Figure 1 illustrates the method of duplex working. It will be noted that the operation is from New York City, while the transmitting and receiv-

---

\* Received by the Editor, November 12, 1921. Presented before THE INSTITUTE OF RADIO ENGINEERS, New York, December 7, 1921.



ing stations are placed at some suitable distant point; and it is intended to concentrate most of the Atlantic Coast transmitters in a central plant at Port Jefferson, Long Island, while most of the receivers are concentrated at Riverhead (about 18 miles (29 km.) from Port Jefferson). All control of the various trans-

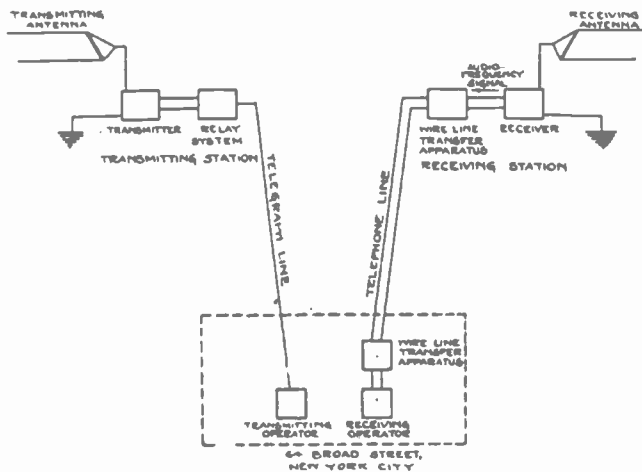

FIGURE 1—Radio Corporation of America: Method of Centralized Operation

mitters and receivers is from New York City, the sending operator controlling a transmitter via telegraph line and the receiving operator having the received audio frequency signal brought to him via telephone line. The transmitting and receiving operators are located close to one another (at a common table), so as to facilitate duplex operation. The receiving operator can thus instantly communicate with the distant transmitter, if desired, in order to control the speed of transmission, or stop the transmission in case of trouble. The operators themselves handle no apparatus whatsoever; the receiving and transmitting apparatus is handled by engineers at the respective stations, and such apparatus as is necessary for wire line transfer at Broad Street is placed in a room separate from the operating room and maintained by men of suitable qualifications.

#### REQUIREMENTS OF HIGH SPEED RECORDING APPARATUS

The foregoing operating arrangement, as well as certain service standards, imposes a series of requirements upon high speed recording apparatus which are given below:

1. Minimum delay between the time of recording and the time of transcribing the signals. This is of importance in

(a) Successful duplex operation: In case of trouble (for example, bad relay adjustment in the transmitting station) or for other reasons, it may become necessary to stop the distant transmitter. If the record is not immediately perceptible, a considerable quantity of traffic might be sent which was not properly recorded, and which would then have to be repeated, with consequent loss of circuit time and delay in delivery.

(b) Prompt delivery of messages to the customer

(c) Observation of the effect of adjustment of the receiving or transmitting apparatus. It is essential that a minimum delay shall occur between the time a change of adjustment is made and the time the effect of the change is perceived.

2. The cost of recording must be as low as possible—not over a few hundredths of a cent per word. This is important since a large class of reduced-rate traffic, such as press matter, deferred delivery messages, and the like, is handled at high speed. Furthermore, the future operating of short distance radio circuits with low rates must be taken into consideration, since the equipment designed for long distance working should be standardized for all classes of service if possible. Therefore the initial cost of the equipment must be low, as well as the operating and maintenance charges.

3. The recording equipment must be as simple and rugged as possible, and require no continuous attention; since it must be located near the receiving operators and handled by the telegraph supervisors, who generally do not have extensive technical or engineering qualifications. The parts of which the equipment is constructed should be capable of easy repair in case of breakage, as far as possible, by the men and facilities available in the operating rooms, and spare parts should be capable of easy installation by such men. This is more important when recording equipment is furnished to stations other than those located in New York City (such as those in Hawaii or on the Pacific Coast), to which it would be manifestly very expensive to send expert repair men.

4. A record capable of preservation is highly desirable, so as to check up errors, and for use as a means of traffic study and general service improvement.

5. The tone signal which is sent over the telephone line from the receiving set may be anywhere between 500 and 1,500 cycles. (Altho the lines will transmit, theoretically, frequencies up to

2,200 cycles, it has been found in practice that better transmission is secured by keeping signals below about 1,500 cycles). The recording equipment must be capable of accepting any given frequency in this range, and allow for a considerable fluctuation above or below this frequency. It has been found in practice that at present frequency fluctuations of several hundred cycles must be taken into account with some European transmitters; the improvements in this respect no doubt will be made. A fluctuation of signal intensity of the order of perhaps 2 to 1 must be taken into account, due to accidental changes in line conditions, amplifier adjustments, or during tuning of the receiving equipment at the distant station.

6. Speed Limitations: Present practice in long distance high speed working is on the basis of from 40 to 50 words (200 to 250 letters) per minute, and at times higher speeds, up to 80 words per minute, have been commercially handled. The limitation lies in relay trouble at the transmitting end and strays at the receiving end of the circuit. It is probable that working at 100 words per minute will eventually become the rule though not for a number of years. Hence, a recording system should be able to handle easily speeds up to 80 words per minute, and be so designed that extension to higher speeds (say, up to 200 words per minute) can be accomplished by simple modifications, for use on short-distance circuits. It is interesting to note, in this connection, that European short-distance radio circuits (for example, London-Paris, and London-Berlin), are understood to be operating regularly at 60 words per minute, and operation up to 100 words per minute has been carried on at times.

7. The perception of the recorded signal by the operator should be made as easy as possible. The operator has not the time to study the record, and an easily perceived record at lower speeds is preferable to one at a higher speed which requires study on his part. For example, in graphic recorders the contrast between recorded signal and background should be great, the letters clean-cut, so that the operator perceives them instantly, and static eliminated from the record to the maximum extent consistent with accuracy. In acoustic recorders (such as the phonograph or the telegraphone) the signal heard by the transcribing operator must be clear and loud, free from musical static and with firmly-formed dots and dashes. It is difficult to overestimate the importance of this requirement; it has a great influence on commercially successful operation, for the speed at

which operators will handle traffic depends considerably on the clearness of the signals with which they deal.

8. The effort necessary, on the part of the operator, to distinguish the signal from such record as may be produced by static, in the ideal case, should be equal to or less than that necessary for aural reception with head telephones.

9. Continuous operation of the recording equipment is essential. In the case of acoustic recorders, where it takes some time to place a new record on the machine, two overlapping recorders must be used, one being started just before the record is removed from the other. But the installation of two machines is uneconomical and continuous operation should be provided for, in the ideal recorder, in a single machine.

#### AVAILABLE TYPES OF RECORDING EQUIPMENT

When the Research Department started on the development of a commercially practical and modern high speed reception system there were available a number of different types of recording apparatus, which were taken under consideration. These may be divided into two general classes, namely acoustic and graphic recorders. We will consider these below:

##### (A) ACOUSTIC RECORDERS

This type of recorder is connected to the radio receiving set in place of the operator's telephones; and generally some audio frequency amplification ahead of the recorder is required so as to overcome the losses occurring in the recording and reproducing process. The particular advantage in acoustic recording methods is that the experience of the operators in reading signals thru strays by ear is utilized. When recording high speed signals, the tone of the received signal is raised to a high pitch at the receiving set by appropriate adjustment, and the machine run at its maximum speed; for reproducing, the speed of the machine is lowered and the tone of the reproduced signal is, of course, lower in proportion. For example, in phonographic recorders it is customary to reproduce with the record rotating at about 100 revolutions per minute at a note of, say 800 cycles, and a speed of about 15 words per minute. Then when recording 80 words per minute, the record as rotated at 400 revolutions per minute, and a recording tone of 3,200 cycles must be used.

A typical acoustic recording and transcribing installation comprises two recording machines (so as to afford continuous operation) and numerous reproducing machines. The records

are distributed from the recorders to operators at the various reproducers for transcription.

Two types of acoustic recorders have been used to some extent in radio practice. The first of these is the well-known Poulsen telegraphone, in which a steel wire runs at high speed past a pair of electromagnets thru which the audio frequency current to be recorded flows. The record is in the form of magnetic charges which remain fixed on the wire. In other types, which were not available in this country, the record is made on a disk, or on a cylinder, similar in nature to the records used in disk or cylinder phonographs. It is possible to erase the record by a suitable uniform magnetisation of the steel. Figure 2 shows the type of wire telegraphone which has been used for radio reception.



FIGURE 2—Steel Wire Telegraphone

The second type of recorder is the phonograph; this has been employed in the form of an ordinary office dictating machine (in this country the "Dictaphone" and the "Ediphone" have both given good service) with cylindrical wax records. The signal from the receiving set is brought to a special telephone receiver (hav-

ing a highly damped diafram so as to reduce the musicality of the record due to strays) after passing thru an amplifier giving several hundred times voltage amplification. This receiver is mounted directly on the intake of the recording head. In Figure 3, the method of recording and, in Figure 4, the method of transcribing are shown.



FIGURE 3—Phonographic High Speed Recording

Both varieties of acoustic recorders have a number of inherent defects and disadvantages. These are considered under the following headings:

(1) DELAY IN OBTAINING TRANSCRIBED MESSAGES

In the steel wire telegraphone, as ordinarily constructed for office work, a very large amount of wire is supplied; so that a period of approximately half an hour elapses before the recorded

signals are available for transcription. This length of time is quite prohibitive from an operating standpoint.

In the phonograph, from four to six minutes elapse between the time of recording and transcription, which is still considered as unsatisfactory. In both these cases the time is objectionable because of the delay in the delivery of messages and the difficulty of adequate supervision of the quality of the recorded signal.



FIGURE 4—Transcribing Phonographic High Speed Records

## (2) Cost

An acoustic recording installation requires two recording machines and from four to six transcribing machines; in operation, one man is required to attend the recorders (put on and take off records), one man to erase previous records (operating shaving machine in the case of phonographs or erasing machine with telegraphones) and distribute records to the transcribing operators, and four or six transcribers. Thus the installation and operating cost of this type of system is extremely high. As will be shown later, cost is reduced to a minimum in the present type of recording system developed by the Research Department.

## (3) LACK OF PERMANENT RECORD

This is an important disadvantage in acoustic recording systems. It is highly desirable to preserve a record of the received messages, so as to place responsibility for errors, and as a means of studying the quality of received signals. If this were done with acoustic recording systems, the operating cost would be prohibitive, because of the expense of the record blanks.

Thus, it is necessary to erase the recorded messages (by shaving in the case of the wax phonograph cylinder, or magnetic erasure on the telegraphone wire); and this is generally done immediately after transcribing, so that operation may be carried on with a minimum quantity of blanks.

#### (4) MECHANICAL DISADVANTAGES:

In the telegraphone, the steel wire running at high speed sometimes breaks. When this happens it is possible that it may become rather badly snarled and it may be impossible to recover a considerable quantity of the tangled wire in order to transcribe it, while the repairing of the broken wire necessitates rather expert attention.

In the phonographic office dictating machines considerable ingenuity has been expended to make them "fool-proof;" but they still require careful and continuous attention in order to make them give the best records.

Both the telegraphone and phonographs require an expert repair man in case of trouble, contain a multitude of parts, and should have a periodic overhauling. In the case of control-station operation in New York City this is not so serious, but it is undesirable for more isolated stations.

#### (5) LIMITATIONS OF USEFULNESS IN CENTRAL STATION OPERATION WITH WIRE LINE TRANSFER

In the method of operation shown in Figure 1, it has been mentioned that it is advisable to remain below 1,500 cycles for the pitch of the audio frequency signal transmitted over the telephone line. This imposes a serious speed limitation on acoustic recording systems because of the necessity of lowering the pitch for transcribing. Assuming transcription to occur at 800 cycles and 20 words per minute, this system would be limited at best to a speed of about 40 words per minute.

#### (B) GRAPHIC RECORDERS

Two main classes of graphic recorders may be taken under consideration:

(1) The photographic type, in which the signals are recorded on photographic paper.

(2) The stylographic type, in which the signals are written down with ink on ordinary paper, either in the form of a wavy line or as dots and dashes.



## (1) PHOTOGRAPHIC RECORDERS

In this class, there were available the Einthoven galvanometer type and the Hoxie recorder of the General Electric Company. The former had been used to some extent by European radio companies, and the latter by the United States Navy, as well as on commercial work in Radio Corporation stations. Since the Hoxie apparatus was immediately available and obviously superior to the Einthoven galvanometer in type of record, mechanical construction, and so on, our attention was restricted to it.

The Hoxie recorder has already been discussed before this Institute and a description may therefore be omitted. This instrument has a number of advantages as a radio recorder; it delivers a fairly faithful record of the received signals and strays, has extraordinarily high speed capabilities (far in excess of what is actually required) and will work directly on a current of an order of magnitude the same as that used for good telephonic signals (15 microamperes). Thus it may be used directly in place of the operator's telephones, requiring no extra amplification, and forms a valuable instrument for purposes of research or oscillographic investigation where records over long periods of time (one or more hours) are desired, and the expense of the photographic tape is not objectionable.

## (2) STYLOGRAPHIC RECORDERS

This class includes the Morse inker, and the siphon recorder. Both of these have been long used in telegraph and cable practice, and meet the important commercial requirements of instantaneous visibility of the recorded signal, cheapness, permanence of record, and continuous operation. Such other requirements as were not fulfilled by existing types of this apparatus (speed capability and mechanical simplicity) could obviously be met by further development; and, accordingly, we concluded that our attention should be centered along these lines.

### (a) MORSE INKER (WHEATSTONE AUTOMATIC RECORDER)

Essentially, the Morse inker may be considered as a telegraph sounder (or polarized relay) carrying a small sharp-edged wheel on the end of the sounder armature, the edge of the wheel being kept moistened with rather thick ink, and with paper tape moving under the wheel. When the sounder magnets are energized by direct current the armature comes down and the inked wheel makes a dot or dash on the paper, depending upon the length

of time the current remains on. The current required to operate a typical instrument is about 50 milliamperes, the resistance of the magnet windings being of the order of 1,000 ohms (an energy requirement of about 2.5 watts). It will be recalled that the Morse inker and coherer formed the first type of radio receiving system ever used, and in Europe, to-day, the Morse inker is again being employed in high speed radio reception.

Two methods of connecting the inker to the receiving set have been used. In one, the audio frequency signal is amplified to an extent such that energy of the required order of magnitude may be furnished; but this is very cumbersome (since for this comparatively large amount of energy, power tubes and amplifiers using several hundred volts of plate battery are necessary) and really unnecessary in view of the type of record; so that it is generally more customary to operate the inker thru a relay. The simplest method is to place the magnet winding of a sufficiently sensitive telegraph relay in the plate circuit of a detector tube, so that when the direct plate current of the tube varies with the audio or radio frequency voltages impressed on its grid, the relay armature is operated, and the inker may be worked from the relay armature contacts. More complex, but also more reliable methods than this have been developed, and some of these are described in publications given under "Bibliography."

The Morse inker has the disadvantage that the record which it makes can only be a dot or dash. Thus, if strays in the form of individual clicks are present, in sufficient strength, a dot will be printed for each stray click. If the strays are more or less continuous (in the form of rapidly successive clicks or crashes) a continuous dash will be made. Therefore, the reading of a message thru static has been found by experiment to be much more difficult on Morse inker than on siphon recorder tape (in which the record is in the form of a wavy line). When the inker is operated thru a relay, the latter is tripped or held closed by the strays so that the inker is falsely operated; the effects of strays in this arrangement are even worse than if the inker is merely operated thru an amplifier.

It was judged most advisable, therefore, to work along the lines of the siphon type of record and to develop an instrument which, with a moderate amount of amplification, would record directly the rectified audio frequency current of the operator's signal. The requirements determined upon were that the instrument should work on a rectified current of a few milliamperes, and be capable of recording readily at the rate of 100 words per

minute, with the capability of eventual extension to higher speeds by small alterations of the parts.

### (b) SIPHON RECORDER

An examination of the existing types of siphon recorders was then made. All the commercial forms that we were aware of consisted essentially of the parts shown in Figure 5. In this instru-

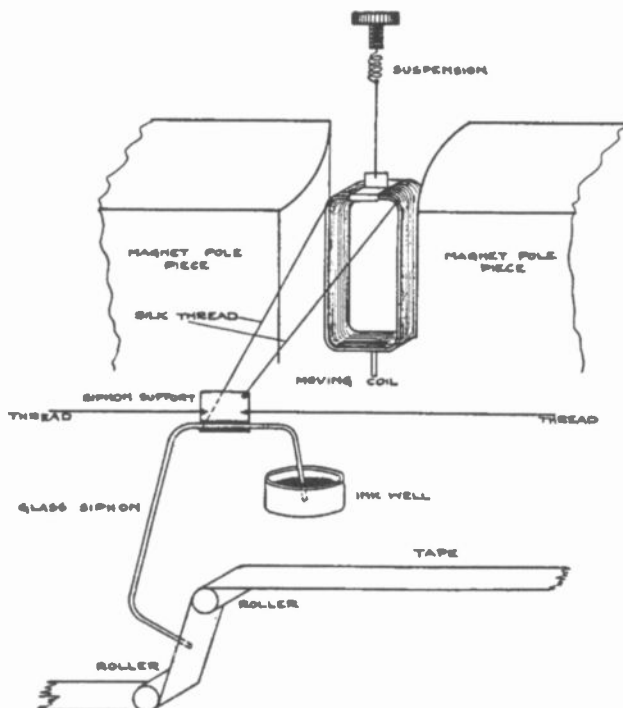

FIGURE 5—Elements of Siphon Recorder, Cable Tape

ment a galvanometer coil is placed between the poles of a powerful magnet so that when the current to be recorded passes thru the coil, it turns on its vertical axis; threads are attached to the upper corners of the coil form, which pull a small fiber piece called the "siphon support" as the coil rotates, so that the glass siphon travels back and forth over the moving tape. The siphon consists of a fine glass tube having a hole of the order of 0.01 inch (0.25 mm.), bent as shown in the figure, and secured to the support by wax. An ink well is placed above the tape and the end of the siphon allowed to dip into it; since the end of the siphon on the tape is lower than that in the ink well, the ink is caused to flow thru continuously. Adjustments for the height and angle of the tape,

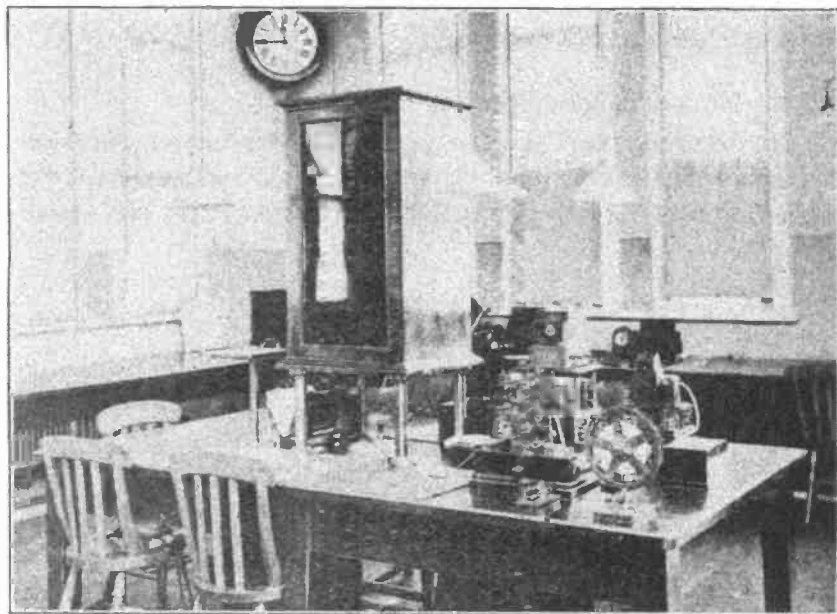

FIGURE 6—Cable Type of Siphon Recorder Installation

and for the tension and position of the various threads and suspensions are also provided. These will be best seen in Figures 6 and 7, which are photographs of the type of siphon recorder used in cable stations.

This type of recorder will deliver good signals on a few hundred microamperes; but because of the cumbersomeness of the moving parts, its speed is limited to less than 50 words per minute.

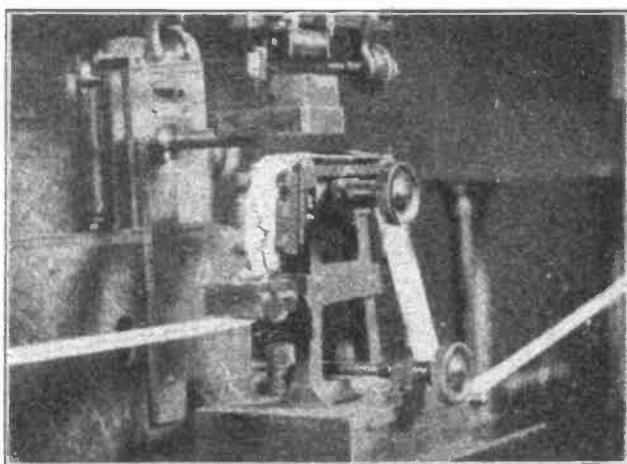

FIGURE 7—Cable Type of Siphon Recorder, Pen, and Tape Mechanisms

Similar instruments, called "undulators," may be obtained which will record up to 100 words per minute, but which require currents of the order of 50 milliamperes, and would therefore have to be operated thru a relay as in the case of the Morse inker. In either case, the recorded signals at the higher speeds are badly rounded (instead of rectangular); a series of dashes appears as a set of "V's" following each other. Figure 8 indicates the type of record given by the cable type of siphon recorder on successive dashes at the comparatively moderate speed of 60 words per minute.



FIGURE 8—Record of Dashes at 60 Words per Minute on Cable Type of Siphon Recorder

In addition to the speed limitations, and poor type of record, the mechanical features of the siphon recorders which were available in the open market rendered them quite unsatisfactory for radio use. For example, the long glass siphon requires skill to make and mount, and in case of breakage or clogging it takes considerable time to put on a new one; while in connection with the various adjustments and general construction of parts it was felt that improvements could be made which would render the instrument more simple, convenient, and better adapted to meet the rather rough usage such a device would receive in radio stations.

Accordingly, it was next decided to undertake the development of a mechanical form of recorder having the desired characteristics. The form which was developed was a distinct departure from the old cable type, and became known later on as the "Ink Recorder," by which title we shall refer to it hereafter.

#### MECHANICAL DEVELOPMENT OF INK RECORDER

The original idea and the mechanical development of this recorder are due to Mr. Edward Blakeney; and the design of the commercial apparatus to Mr. Blakeney and Mr. Samuel C. Miller, of the Research Department.

Without going into the various development models, with their usual record of small detailed changes, it will be best to describe only the final commercial type, since the essential parts remained practically the same thru the development.

The essential parts of the recording system are indicated in Figure 9. A small circular coil is placed in the radial field produced by a powerful solenoid type of electromagnet; rising from the coil frame a link engages the pen arm. The latter is supported at one end by a thin, wide steel spring (called the fulcrum spring) and carries at its outer end a short piece of metal tubing, about half an inch (1.27 cm.) long, called the pen. This pen takes ink from a device called the "ink feed" at one end and writes on the paper tape at the other. The coil frame, pen arm, and link are made of thin aluminum sheet; the pen is a small size of brass tubing.

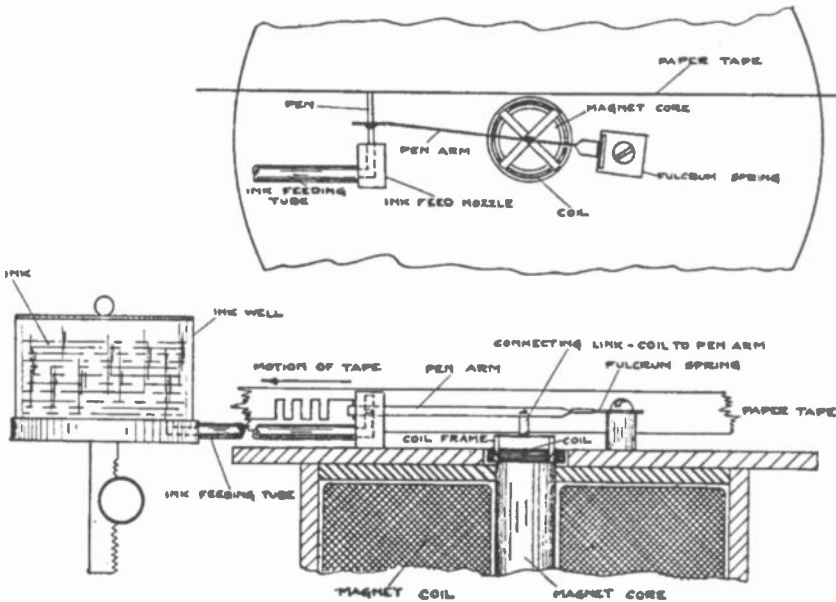

FIGURE 9—Essential Elements of Ink Recorder

The ink feeding arrangement consists of a piece of brass having a deep rectangular slot along the end near the pen, and is known as the ink feed nozzle. The slot is connected thru a hole to the side of the nozzle, where a rubber tube is attached. This tube connects to an inkwell fixed at one side of the recorder. The inkwell may be regulated in height, with respect to the ink feed nozzle, by means of a rack and pinion. The level of the ink in the nozzle is at the same height as its level in the inkwell; but since the slot is only about one-sixteenth of an inch (1.58 mm.) wide, surface tension keeps the ink from spilling out of the slot and it forms a long rectangular bead on the face of the nozzle into this bead the pen dips. If the magnet is energized and

signal current passes thru the small coil, it is pulled upwards. The link therefore pushes the pen arm up; the pen moves upward in the bead on the face of the ink feed nozzle, supplying itself with ink, by capillary action, as it goes, and makes a vertical line on the slowly moving tape. When the signal current stops, the restoring force of the fulcrum spring sends the coil back to its starting position.

The recorder coil has about 600 turns, a direct current resistance of 1,000 ohms, and the pen will produce a full-size record ( $\frac{1}{8}$  inch = 0.32 cm.) with about 4 milliamperes thru the coil up to a speed of 100 words per minute. For higher speeds, the fulcrum spring is changed, and with 8 milliamperes, 200 words per minute may be recorded.

The arrangement of parts here indicated makes it possible to provide a much simpler and more rugged instrument than the old type of siphon recorder, while at the same time gaining in speed and sensitivity. Instead of the wide air gap in the magnetic circuit, as in the old recorders, a narrow gap is used and a very powerful field can be provided with a relatively small magnetizing force. The moving elements are reduced to a minimum in weight and size, giving the instrument high speed capability and sensitivity. In place of the long breakable glass siphon, a short metal one is used, which is made up as a unit with the pen arm. In case of trouble, a spare pen arm can be inserted in a few moments. All parts are easily dismantled and are also readily accessible for adjustment or repair without dismantling.

The commercial model of recorder is shown in Figures 10 (top view) and 11 (cross-section). On these it will be noted that in addition to the essential elements of Figure 10, there have been provided the following:

- (a) Four threads, with height and tension adjustment screws, which are used to center the recorder coil.
- (b) An adjustable tape guide, consisting of a brass form in which the tape is held taut and smooth, so as to afford a good writing surface for the pen.
- (c) Clamps and adjustments for various parts.
- (d) Brushes for cleaning paper dust from the tape before it enters the tape guide (to prevent clogging the pen).
- (e) A glass-topped cover over the recording mechanism.
- (f) A "damping device."

The last-named part requires some explanation, and is illus-

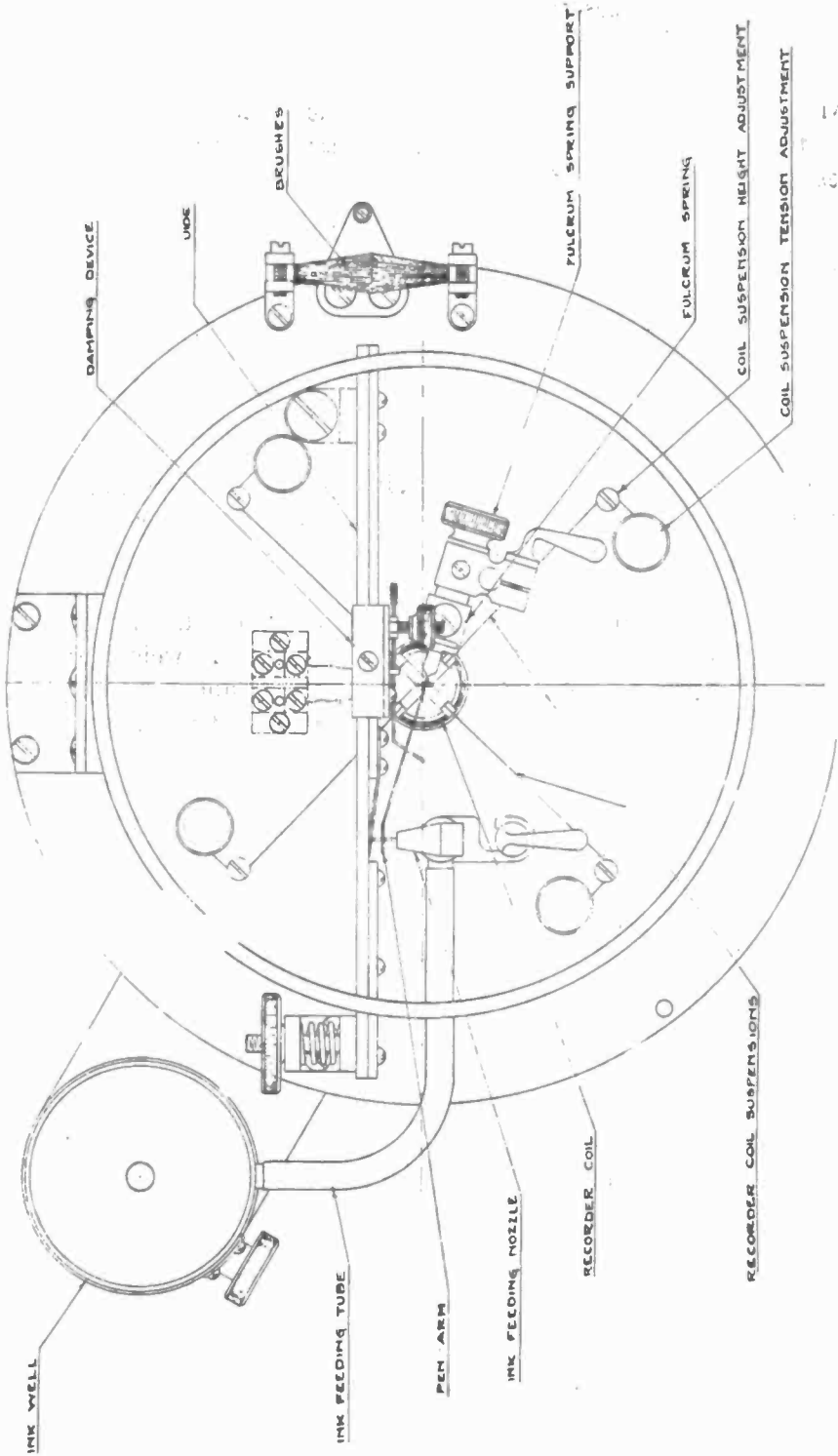



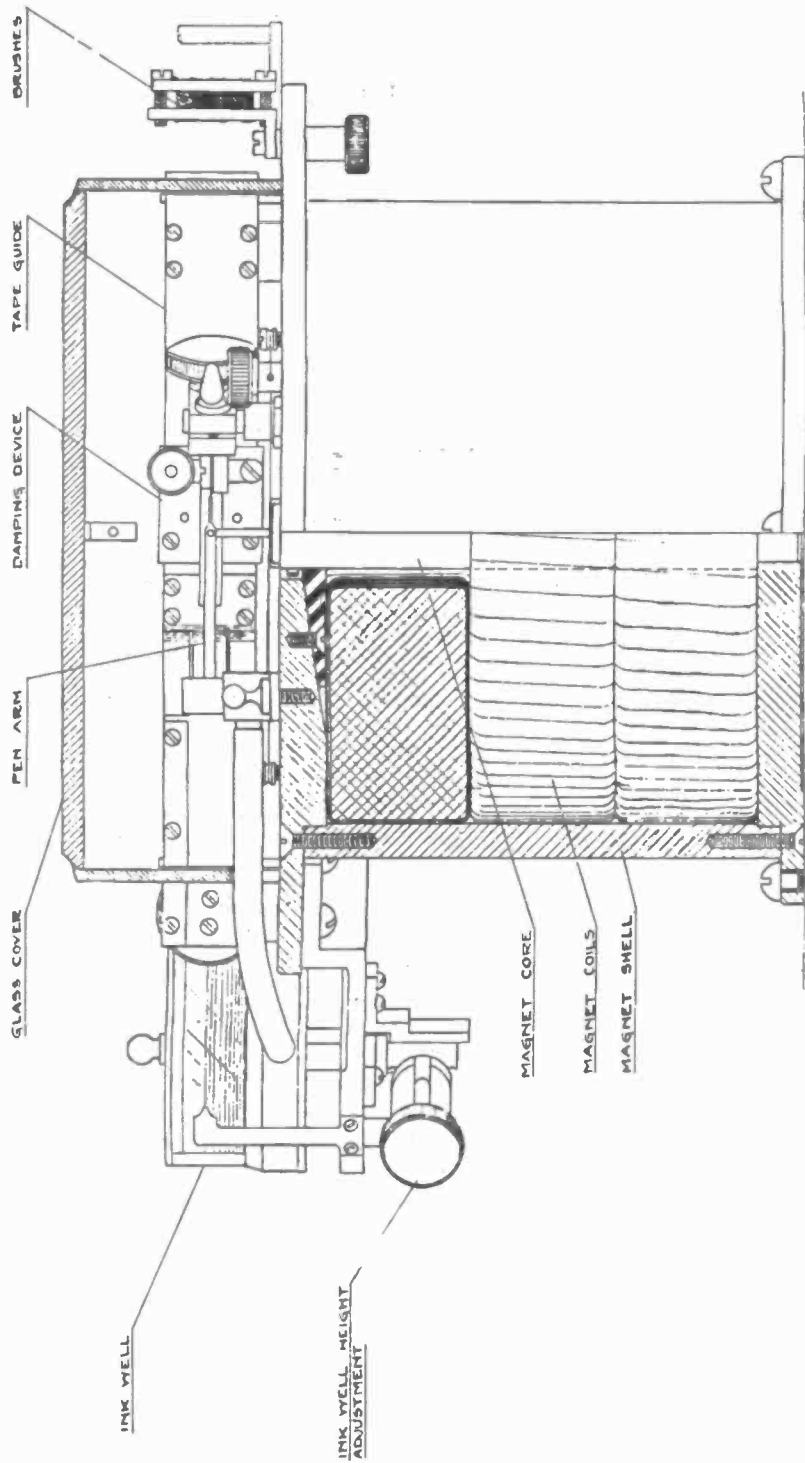

Figure 11—Ink Recorder, Commercial Model, Section

trated in greater detail in Figure 12. Its purpose is to square off the tops and bottoms of dots and dashes, by stopping vibratory motions which would otherwise occur at the end of the stroke of the pen arm, due to the free mechanical oscillations of the recording system (coil, link, fulcrum spring, and pen arm)

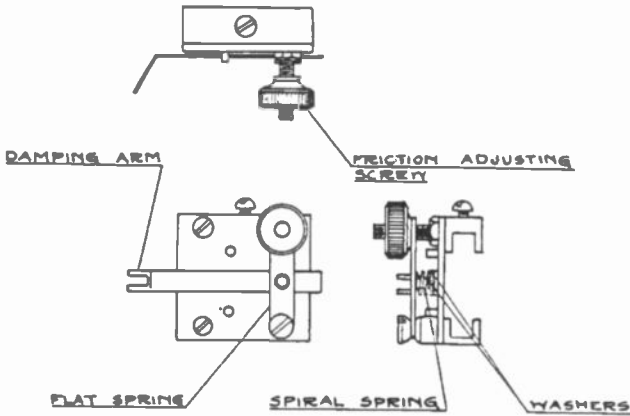

FIGURE 12—Ink Recorder Damping Device

This system has a natural frequency of about 35 cycles and a logarithmic decrement of about 0.7 (when equipped with a fulcrum spring for use below 80 words per minute;—for higher speeds a heavier spring is used having a considerably greater natural frequency). When allowed to operate without any damping other than that due to the friction of the paper against the pen, the record of the signal will appear as in Figure 13 (A); that is, at the end of its stroke the pen arm overshoots, and then falls back to the full amplitude or zero line, as the case may be. In order to damp this tendency to overshoot, without, however, exerting a damping effect thruout the entire stroke (which would reduce the amplitude of the entire record), the damping device of Figure 12 was designed.

It consists of an aluminum arm pivoted at a point near one end, and cut into two prongs at the other end. A brass counter-

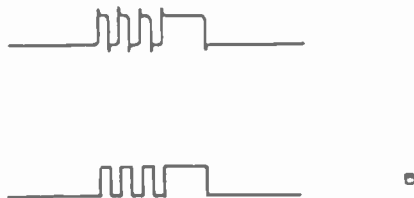

FIGURE 13—Effect of Damping Device

weight on the short end serves to balance the arm about the pivot. The pen arm rests between the two prongs (see Figure 10), the space between these being sufficiently large so that the pen arm has a free movement of about  $1/16$  inch (1.6 mm.) without touching either prong. When the pen arm moves further than this, however, it strikes one or the other of the prongs and tends to carry the damping arm along with it. The freedom of movement of the damping arm is controlled by means of friction exerted by washers which press against the arm at its pivot, the pressure of the washers being regulated by means of a spiral spring which is compressed by a knurled-headed screw. Thus the motion of the pen arm is gradually checked as it approaches the end of its stroke and the signal can then be made to appear

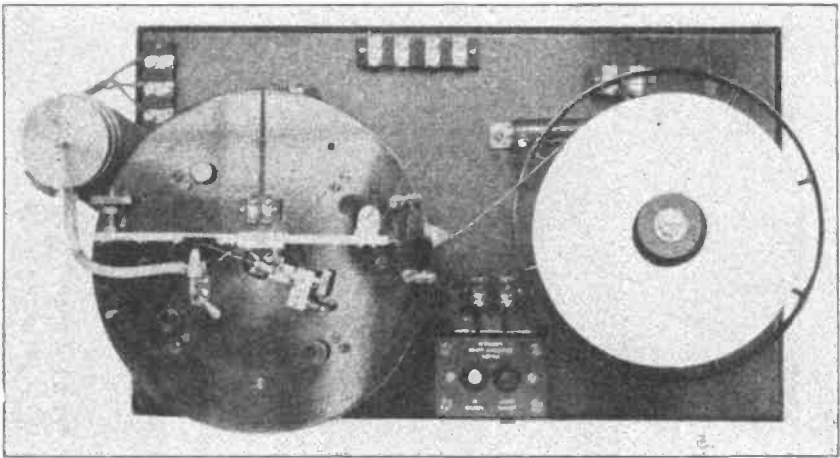

FIGURE 14—Ink Recorder and Tape Reel, Top View

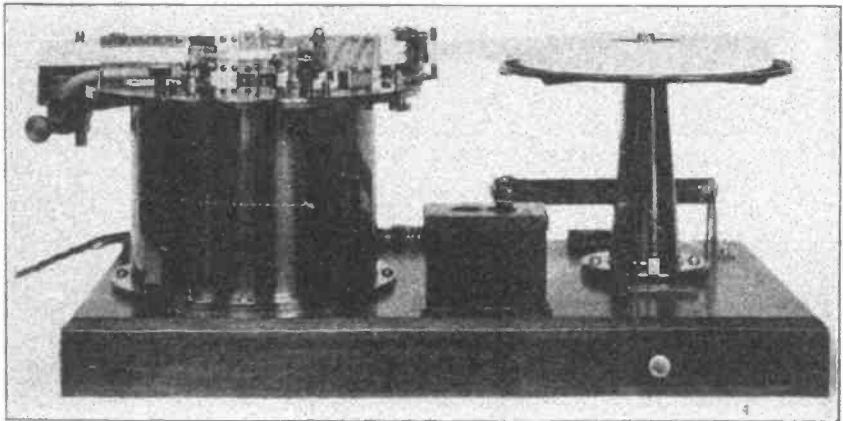

FIGURE 15—Ink Recorder and Tape Reel, Front View

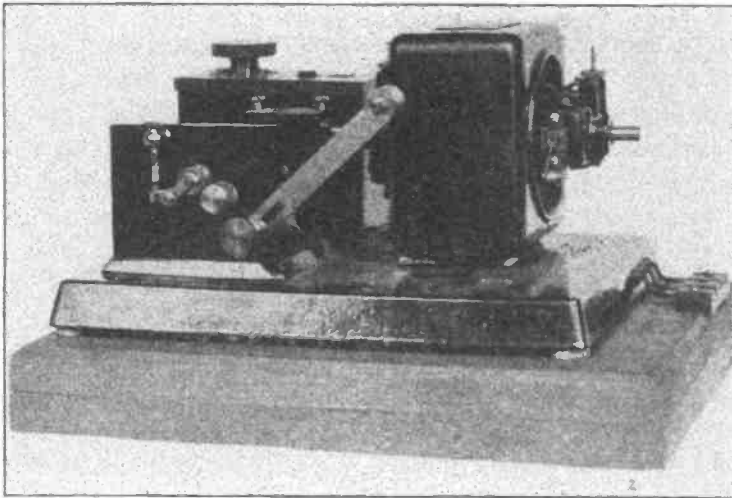

FIGURE 16—Tape Puller, Front View

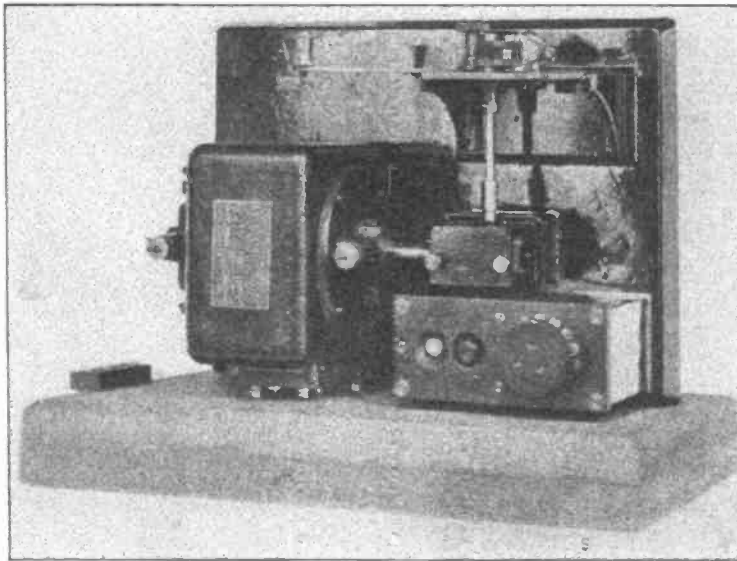

FIGURE 17—Tape Puller, Top View

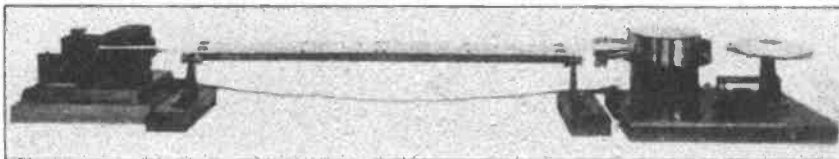

FIGURE 18—Assembly of Ink Recorder, Tape Puller, Reel, and Table

square, as in Figure 13 (B). The finished commercial recorder and some of its accessory parts are shown in the photographs, Figures 14, 15, 16, 17, and 18. Figure 14 is a top view of the recorder assembled on a common base with the tape reel, Figure 15 the front view of the same, Figure 16 the machine for pulling the tape through the recorder (a standard commercial article known as a tape puller), Figure 17 a top view of the tape puller showing the motor speed control rheostat and gear box for reducing the motor speed to an appropriate value for the tape-pulling wheel, and Figure 18 an assembly of the recorder and tape puller with a "tape table" between them. The tape passes over the latter, and the operator's typewriter is placed in a well below the middle of the tape table, so that he may typewrite directly from the tape.

#### AMPLIFIERS ASSOCIATED WITH THE INK RECORDER

While the development of the recorder was being carried on, experiments were conducted simultaneously to determine a suitable amplifier system, the input of which was to be connected to the radio receiving equipment in place of the operator's telephones and the output of which was to supply the recorder with a direct current of 2 to 4 milliamperes, thru the 1,000 ohm recorder coil. Aside from furnishing the required amplification, it was desired to utilize the amplifier circuits to secure as great a discrimination as possible between the signal audio frequency and strays.

For this purpose a number of amplifier circuits were set up and comparative records made on two identical recorders simultaneously, the signals from a local oscillator<sup>1</sup> being sent into a receiving antenna and their intensity regulated so that any desired ratio between signals and natural strays could be obtained. The amplifier under test was connected to one recorder, and a standard amplifier to the other recorder; the output of the receiving set being fed to both amplifiers at once. In this fashion an accurate and quick determination of the merits of any particular amplifier circuit could be made. This method of comparison yields much more dependable results than the method of taking sequential records on the same recorder with different amplifiers; strays are so exceedingly variable in their intensity and character from one minute to the next that the sequential method will lead to quite erroneous conclusions—as we found by experience.

<sup>1</sup>J. Weinberger and C. Dreher: "An Oscillation Source for Radio Receiver Investigations," PROCEEDINGS OF THE INSTITUTE OF RADIO ENGINEERS, volume 6, page 584, 1919.

The amplifier circuits which were tested are shown in Figure 19. In every case, the tubes used were the Radio Corporation's type UV 202 (filament, 7.5 volts, 2.35 amperes, internal resistance 7,000 ohms), which are the standard receiving tubes in our stations; the plates were supplied from 220 volts, direct current, the local power lines being used thru suitable filters (to diminish line hum). The last amplifier tube always fed a step-down transformer, which was connected to a rectifier tube in series with the recorder.

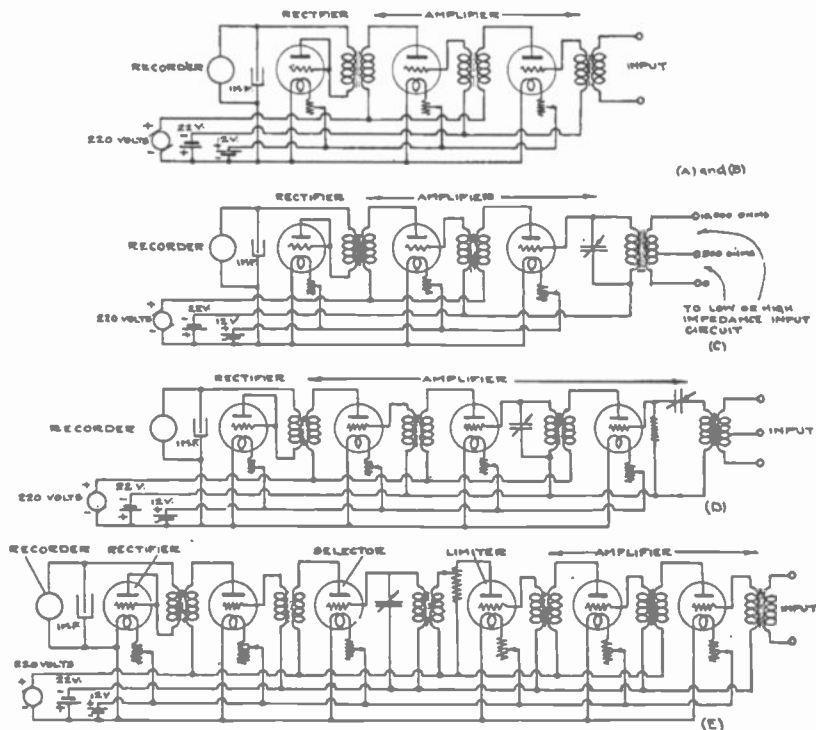

FIGURE 19—Experimental Ink Recorder Amplifiers

Five types of audio frequency amplifiers were tried, viz.:

(A) Two stages of untuned, air-core transformers known as the "Century" type, made by the Federal Telephone and Telegraph Company, Buffalo, New York, having the following constants: primary, 5,300 ohms direct current resistance, 3.4 henrys inductance, 9,700 turns of 3 mil (0.076 mm.) enameled wire; secondary, 37,000 ohms direct current resistance, 75 henrys inductance (at 800 cycles), 58,000 turns of 3 mil (0.076 mm.) enameled wire. This amplifier was built in order to deter-

mine whether the signal-stray ratio of the air-core transformers was superior to that of iron-core transformers.

(B) The same as (A) but with closed *iron*-core transformers instead of air-core. These transformers were the Radio Corporation's type UV 712, having the following constants: Primary, 430 ohms direct current resistance, 3 henrys inductance at 1 milliampere and 800 cycles; secondary, 5,100 ohms direct current resistance. Ratio of turns, 9 to 1.

(C) One stage having a tuned transformer followed by one stage having an untuned transformer (type UV 712, as in case B). The tuned transformer consisted of two coils, the primary having 8,400 turns with a tap at 1,200 turns (for use in high or low impedance input circuits respectively); the secondary having 29,000 turns of 3 mil (0.076 mm.) enameled wire, on a common laminated iron core 3.5 inches (8.85 cms.) long and 0.5 inch (1.27 cm.) square. With a variable condenser of 0.001 microfarad capacity across the secondary the transformer could be tuned to any frequency in the range from 700 to 1,600 cycles. This transformer was the result of previous experiments along similar lines, and its tuning was sufficiently broad to take account of the normal fluctuations in frequency which might be expected at present in the reception of foreign alternator stations (approximately 100 cycles above or below a mean frequency of 1,000 producing a reduction of current to 75 per cent of full amplitude, or equivalent to a logarithmic decrement of about 0.6).

(D) One stage having a tuned transformer circuit of very high resistance, the resistance chosen being 0.7 of the critical damping resistance for the circuit; this followed by the same type of two-stage amplifier as in case of (C), that is, one tuned and one untuned stage. The purpose of this arrangement was to make a practical test of the following theory:

The natural frequency at which a circuit will oscillate, if shock excited, is given by the well-known expression

$$f = \frac{1}{2\pi} \sqrt{\frac{1}{LC} - \left(\frac{R}{2L}\right)^2}$$

However, if the circuit is subjected to a sustained alternating electromotive force, the maximum current will flow when

$$f = \frac{1}{2\pi} \sqrt{\frac{1}{LC}}$$

That is, the resistance plays a part in determining the natural

frequency of the transient circuit oscillations, but does not affect the "resonance" frequency. Hence, if the resistance is made as large as 0.7 of the critical damping resistance, the circuit will still oscillate, but at a frequency 0.7 that of the "resonance" frequency. With the particular tuned transformer used, this resistance was 300,000 ohms. Now, if this circuit was followed by a comparatively sharply tuned circuit, it was expected that the free oscillations due to strays would be at a frequency of 700 cycles when the signal frequency was 1,000 cycles, and the tuned circuit (set at 1,000 cycles) would respond more strongly to the signals than to the strays.

(E) An amplifier circuit involving "limiting" action, followed by audio frequency selection. This was based on the theory that if strong strays were reduced to an amplitude equal to that of the signal, by means of a "limiting" tube, then it would be possible to gain an advantage in signal-stray ratio by "picking out" the signal (which would have a definite audio frequency) with a sharply tuned circuit from amongst the strays (which would be of equal amplitude but of no definite frequency). To secure this result, a two-stage amplifier containing untuned air-core transformers was placed ahead of the limiting tube, and the latter was followed by an amplifier of type (C). A potentiometer in the plate circuit of the limiter controlled the amount of energy fed to the selecting circuit, so that the tube connected thereto would not be overloaded.

The conclusions drawn from numerous experiments with the above amplifiers were as follows:

(1) Air-core versus iron-core amplifying transformers (type A versus type B amplifier): No essential difference in behavior was found towards strays; it was concluded that the particular types of transformers tested could be used interchangeably in this work.

(2) Tuned versus untuned amplifier (type C versus type A): The tuned amplifier is moderately superior to the untuned one, on heavy strays. The advantage is not a great one, and during conditions which are suitable for high speed working (that is, light strays) there is no particular loss in dispensing with tuning. However, there is an advantage in the use of tuning, namely, that of discrimination against other interfering sustained audio frequencies, such as the compensation wave in the reception of arc transmitters, or the elimination of telephone line noises due to power line induction (which must be reckoned with in any system using wire line transfer of the received signals). It must



also be remembered that the sharpness of tuning permissible in the amplifier transformer was limited by the fact that a certain amount of frequency fluctuation of the transmitter had to be reckoned with; it is possible that with very sharply tuned circuits greater advantages might be gained.

(3) Tuned amplifier type (C) versus tuned amplifier type (D): No appreciable difference in the behavior of these two types was found in the circuit under test and with this type of recorder; it was therefore concluded that there was no special advantage in the extra complication of type (D).

(4) Tuned amplifier type (C) versus limiting followed by audio frequency selection (type E): In the circuits shown, it was found that the strays had a slight tendency to mutilate the letters more badly with type (E) than with the simple tuned amplifier. This effect might have been due to the fact that a stray crash consists of many overlapping impulses, and when the signal was added on to these, the limiter temporarily passed on no signal for the audio frequency circuit to select. Hence, a letter would be broken more badly in this case than in the tuned amplifier employing no limiting ahead of the selecting circuit.

Therefore, it was decided that the tuned amplifier of type (C) was the best to use with the recorder for the present.

It is probable that a more extended investigation into the subject of amplifiers for the reduction of the stray-signal ratio would lead to profitable results, particularly on the assumption that a frequency constant to within one-tenth of one percent in foreign transmitters may be expected in the future; and this work is being continued.

#### TYPICAL INK RECORDER INSTALLATIONS

The method of installation employed at outlying receiving stations is indicated in Figure 20. The recorder, tape puller, and tape carriage are mounted on a common table, and a typewriter well is placed so that the operator may copy directly from the tape. The amplifier is mounted on a panel conveniently near the recorder, so that tuning or other adjustments may be made while their effect on the record is observed.

In the central station at 64 Broad Street, New York City, the layout and method of operation of which is due to the Traffic Department of the Radio Corporation, the amplifier equipment is placed in an apparatus room separate from the operating room. Here a special amplifier is employed in which the ampli-

fications necessary both for wire line transfer and recording are combined. The recorder is placed beside the operator.

The above method of having one operator copy directly from the tape is suitable up to a speed of about 45 words per minute. Above this speed several operators may read the tape in succession, in the manner used in cable offices. That is, one man is placed near the recorder, a second perhaps ten feet (3 meters) along the tape, and a third man ten feet further along. The

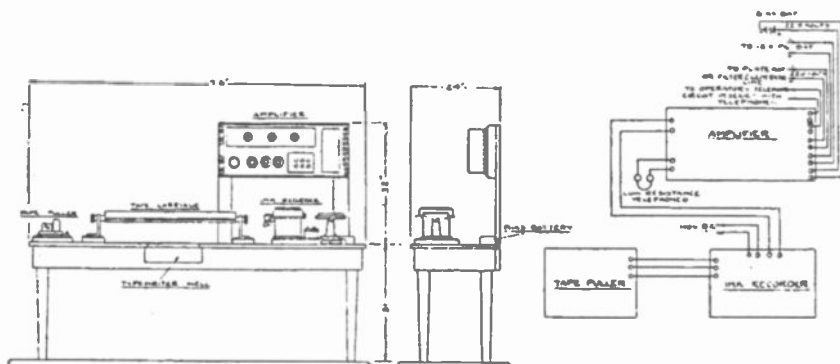

FIGURE 20—Ink Recorder System: Typical Installation at Outlying Stations

first man copies from the tape, which is moving faster than he can keep up with, until he reaches a point such that the signals are nearly out of easy sight. He then stops copying, marks the point on the tape at which he stopped, and starts in again as near the recorder end of the tape as he can see easily and marks on the tape the point at which he has started again. The second man then starts copying at the point at which the first man left off and copies the intervening material, either up to the point at which the first man started again, or else as far as he can. If he cannot read all the material omitted by the first man he also marks the point at which he left off, and the third man completes the copy of the omitted material. By this method the transcription of traffic at 100 words per minute by three men is readily possible.

Figure 21 is a photograph of part of the Broad Street operating room, in which some of the recorders may be plainly seen. In this office, a recorder is placed on each trans-oceanic receiving circuit, and, in addition, arrangements are being made to keep a record of the outgoing signals from each transmitter. This is accomplished by means of an antenna on the roof of the building, connected to receiving sets and recorders in the apparatus

room; this equipment easily receives all of the local transmitting stations, and the signal leaving the sending operator's key or Wheastone transmitter may thus be directly compared with the signal radiated from the transmitting station's antenna. In this way, line or relay faults, trouble in the transmitting station, and the like, may be instantly noticed, and a check also kept on operating errors.



FIGURE 21—Part of Operating Room, Broad Street (New York City) Office Radio Corporation of America

#### TYPICAL RECORDS

In Figure 22 a number of typical tape records taken on the ink recorder are reproduced. These show plainly the speed capabilities of the instrument and the clearness of the records obtainable. The first three illustrations are of a series of test letters, "YI5," recorded at various speeds (these letters having been arbitrarily chosen because of the manner in which they display the operation of the instrument on various dot and dash combinations). All but one of the remaining illustrations are of various European transmitters recorded in the United States, while the last one is a record of the valve transmitter at Geneva (Switzerland), used on the Geneva-London radio circuit, taken on the ink recorder system at an English station.

The author desires to acknowledge his gratitude to the following: Dr. Alfred N. Goldsmith, Director of the Research Department, for his kindly encouragement during this development and his valuable suggestions; Messrs. Edward T. Dickey and Carl Dreher, of the Research Department, for their thoro and painstaking assistance and their supervision of the laboratory and field tests of the system; Mr. W. A. Winterbottom, Traffic Manager, and the officials of the Traffic and Engineering Departments, of the Radio Corporation, for their criticism and support; and finally, the operating staff of the Belmar station, who contributed much practical and encouraging criticism during the field tests of the first models.



Y I 5 Y I  
 TEST LETTERS "YI5" AT 25 W.P.M.



Y I 5 Y I 5  
 TEST LETTERS "YI5" AT 50 W.P.M.



Y I 5 Y I 5 Y I  
 TEST LETTERS "YI5" AT 100 W.P.M.



5 8 L N I 2  
 TRAFFIC FROM CARNARVAN TRANSMITTER,  
 ENGLAND AT 40 W.P.M.



F 4 5 9 P A R I S  
 TRAFFIC FROM BORDEAUX TRANSMITTER,  
 FRANCE AT 40 W.P.M.

FIGURE 22—Typical Ink Recorder Tapes



B E R L I N U R G E N T  
TRAFFIC FROM NAUEN TRANSMITTER,  
GERMANY AT 40 W.P.M.



7 6 9 B E R G E N  
TRAFFIC FROM STAVANGER TRANSMITTER,  
NORWAY AT 40 W.P.M.



5 2 E S S E N 2 8  
TRAFFIC FROM EILVESE TRANSMITTER,  
GERMANY AT 40 W.P.M.



O F F A T H E R L A N D  
TRAFFIC FROM GENEVA TRANSMITTER,  
SWITZERLAND, RECEIVED IN ENGLAND  
AT 50 W.P.M.

O F H U M A N I T Y



FIGURE 22—Typical Ink Recorder Tapes

**SUMMARY:** The requirements of a system to be used for recording high speed signals in commercial trans-oceanic radio telegraphy are discussed. Available methods are described and their advantages and disadvantages pointed out. The development of a new system, utilizing as the recording element a device known as the "Ink Recorder," is described, and typical installations as well as specimen records are shown.

## BIBLIOGRAPHY

### GENERAL DESCRIPTIONS

J. A. Fleming: "The Principles of Electric Wave Telegraphy and Telephony" (Third Edition), pages 708-719.

E. Nesper: "Handbuch der drahtlosen Telegraphie und Telephonie," (J. Springer, Berlin, 1921), volume 2, pages 243-252.

### TELEGRAPHONE

P. Dosne: "Recording Radio Signals by Means of the Telegraphone," "Comptes Rendus," volume 158, pages 473-474, February 16, 1914.

### PHOTOGRAPHIC RECORDERS

T. Wulf: "Employment of the String Electrometer in Wireless Telegraphy," "Physikalische Zeitschrift," volume 15, pages 611-616, 1914.

H. Abraham: "Application of a Microgalvanometer with Continuous Photographic Registration," "Soc. Int. Elect. Bull.," 3rd Series, 3, page 649, 1913.

H. Simon: "The Electromagnetic Photographic Recorder as Receiving Instrument in Radio Telegraphy," "Jahrbuch d. drahtl. Tel. und Tel.," volume 2, pages 409-416, 1909. (Photographic Recorder of the C. Lorenz Company).

C. A. Hoxie: "A Visual and Photographic Device for Recording Radio Signals," PROCEEDINGS OF THE INSTITUTE OF RADIO ENGINEERS, December, 1921.

### STYLOGRAPHIC RECORDERS. (MORSE INKER, SIPHON RECORDER, AND THE LIKE)

(In the following, references concerning the early use of coherer and Morse inker are omitted.)

A. Turpain: "Graphic Registration of the Eiffel Tower Signals," "Revue Electrique," volume 18, pages 211-214, 1912.

A. Turpain: "Reception of Wireless Signals in Morse Script by the Aid of Extra Sensitive Relays," "Soc. Int. Elect. Bull.," volume 3, 3rd Series, page 299, 1913.

A. A. Campbell Swinton: "Recent Improvements in Recording of Signals in Wireless Telegraphy," "Electrician," volume 72, page 687, 1914. (Cable type siphon recorder with S. G. Brown's relays.)

Raymond Barker: "Recording Radio Signals," "Electrician," volume 72, page 783, 1914. (Morse inker and Orling cable relay.)

A. A. Campbell Swinton: "Wireless Telegraphic Printing on

the Creed Automatic System," "Wireless World," (London), volume 8, page 641, 1920.

F. Kiebitz: "Recent Researches in Radio Telegraphy," "Telegraphen und Fernsprechtechnik" (Berlin), volume 9, page 88, 1920. (Special relay and vacuum tube circuits with Morse inker.)

"The Hall Recorder." "Science and Invention," New York, page 1099, February, 1921. (Special type of hot-wire acoustic relay, and siphon recorder.)

#### MODERN PRACTICE IN OPERATION OF HIGH SPEED RADIO SYSTEMS

H. Verch: "High Speed Telegraphy at High Power Radio Stations," "Telefunkenzeitung" (Berlin), March, 1921, page 7. (Recent German developments in apparatus.)

F. Banneitz: "Experiments and Results in High Speed Radio Telegraphy," "Telegraphen und Fernsprechtechnik" (Berlin), volume 9, page 90, 1920. (Experiences of the German National Telegraphic Research Laboratory in the development of national radio services, and the Berlin-London Radio Circuit.)

"The Geneva-London Radio Circuit," "Radio Review," (London), volume 2, page 535, 1921.

"The Paris-London Radio Circuit," "Radioelectricité" (Paris), volume 1, page 404, 1921, and volume 2, page 60, 1921.

DIGEST OF UNITED STATES PATENTS RELATING TO  
RADIO TELEGRAPHY AND TELEPHONY\*

ISSUED FEBRUARY 28, 1922—APRIL 25, 1922

BY

JOHN B. BRADY

(PATENT LAWYER, OURAY BUILDING, WASHINGTON D. C.)

1,408,053—R. J. Wensley, filed August 8, 1919, issued February 28, 1922.

**HOT CATHODE APPARATUS** for rectifying alternating currents. The rectifier employs double anodes and a cathode of relatively massive structure which is initially raised to incandescence by the passage of a relatively high voltage discharge by means of an auxiliary anode. Upon the attainment of incandescence at the main cathode, current flow takes place thereto from the main anodes and the resultant flow of working current suffices to maintain the cathode at the necessary temperature. By use of a saturation transformer the auxiliary anode is substantially de-energized upon the initiation of load current flow, thus conserving the starting current.

1,409,352—S. E. Adair, filed February 20, 1918, issued March 14, 1922. Assigned to Western Electric Company, Incorporated.

**ELECTRICAL COIL** winding for radio apparatus. The winding comprises a plurality of symmetrical polygon turns, the adjacent turns having their dihedral angles angularly displaced with respect to each other to obtain a coil having a low distributed capacity. The coil is formed on a frame having a base and a plurality of spindles perpendicular to the base. The turns are supported on the spindles in such manner that adjacent turns do not lie next to one another but cross one another at a rather blunt angle at frequent intervals around the circumference of the winding.

1,409,717—P. C. Hewitt, filed October 29, 1915, issued March 14, 1922.

---

\* Received by the Editor, May 3, 1922.



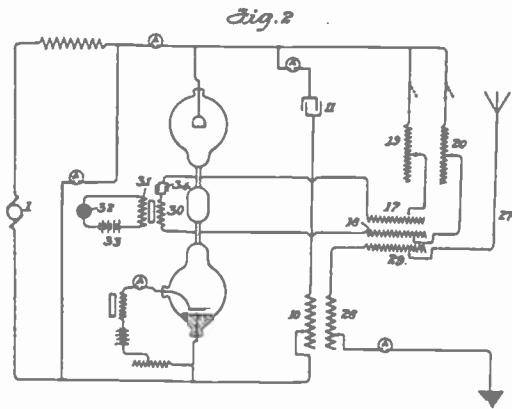

NUMBER 1,409,717—System of Transforming Energy

SYSTEM OF TRANSFORMING ENERGY, employing a pulsator illustrated in the drawings as of the mercury vapor type. The pulsator produces electric impulses in only one direction. An oscillating circuit is inductively related to the pulsating circuit, interlinked by a controlling inductive circuit. The oscillating circuit may be inductively coupled to an antenna ground system for transmission of signals.

1,410,062—G. Holst and E. Oosterhuis, filed May 10, 1920, issued March 21, 1922. Assigned to Naamlooze Vennootschap Philips' Gloeilampenfabrieken.

RECTIFIER FOR ALTERNATING CURRENTS, in which the electrodes are filamentary in form so that they can be used successively either as incandescent cathodes or as anodes. In case the incandescent filament is burnt out, one of the other electrodes can be used as a filament while the defective incandescent filament can be used as an anode.

1,410,730—R. R. Beal, filed January 5, 1920, issued March 28, 1922. Assigned to Augustus Taylor.

RADIO OSCILLATION GENERATOR. This patent relates to a construction of arc converter having a lower steel section and an upper steel section hinged thereto. The two sections form a closed shell with a magnet pole in each section. Each pole carries a field winding. The arc electrodes are mounted in the lower section and have their ends disposed between the magnet poles within the arc chamber.

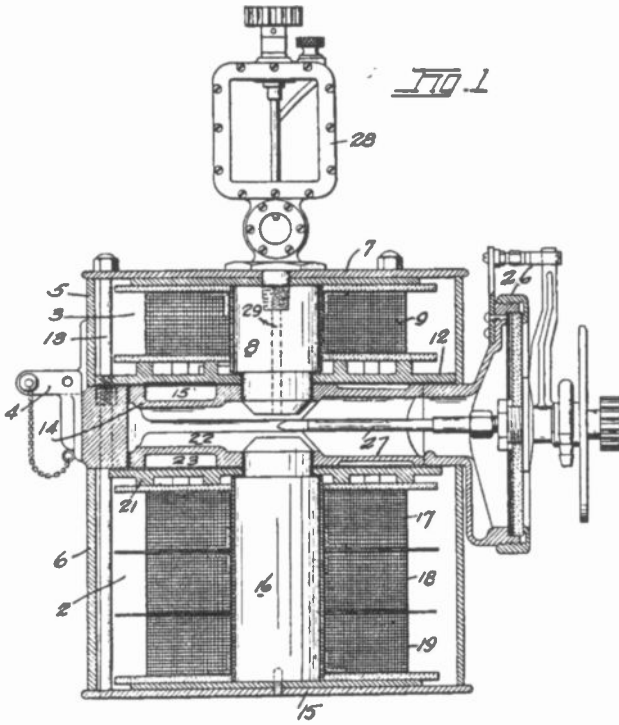

NUMBER 1,410,730—Radio Oscillation Generator

1,410,793—A. Bonnefont, filed November 9, 1920, issued March 28, 1922.

CRYSTAL DETECTOR FOR WIRELESS TELEGRAPHY. The patent shows a construction of crystal detector containing a crystal mounting and contact point entirely within an insulated stand. A mechanical arrangement is shown for moving the exploring point to different parts of the crystal.

1,411,814—H. M. Stoller, filed April 30, 1918, issued April 4, 1922. Assigned to Western Electric Company.

Fig. 1.

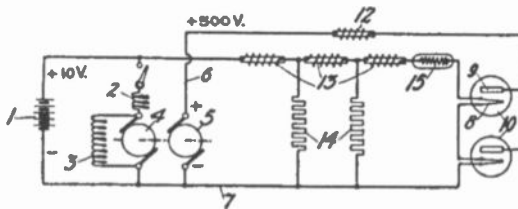

NUMBER 1,411,814—Power System for Radio Apparatus

**POWER SYSTEM FOR RADIO APPARATUS.** The patent relates to an arrangement of motor generator for supplying filament-heating current and the plate voltage for aircraft radio transmitters. Light weight and small volume are features considered in this invention. The system includes a low voltage battery operating a motor and a high voltage generator driven by the motor. The battery supplies the filament-heating current for electron tube operation and the generator supplies the high voltage plate circuit for the electron tubes.

1,412,385—T. W. Case, filed November 17, 1920, issued April 11, 1922.

**SIGNALING SYSTEM,** for communicating by light rays. At the receiver the transmitted rays effect a light-responsive device producing an audible signal in a telephone receiver connected in an electron tube circuit. The invention makes use of a three-electrode tube containing a gas at a pressure between 0.1 of a millimeter of mercury and 5 millimeters of mercury.

1,412,567—J. Mills, filed December 30, 1916, issued April 11, 1922. Assigned to Western Electric Company, incorporated.

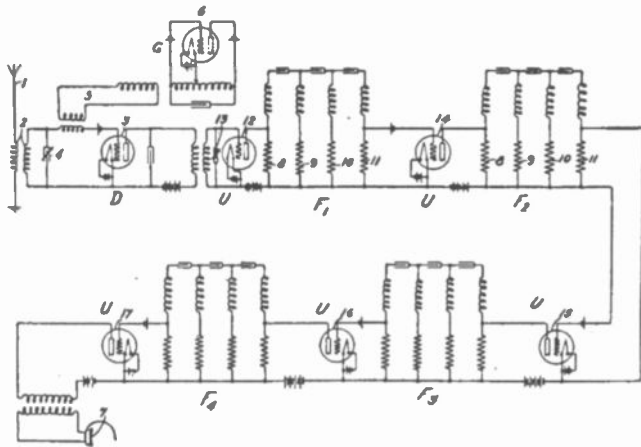

NUMBER 1,412,567—Means for and Method of Wave Transmission

**MEANS FOR AND METHOD OF WAVE TRANSMISSION.** The invention relates particularly to a receiving circuit with means for eliminating impulsive or static disturbances. The circuit comprises an electron tube detector, a local generator coupled thereto, and a plurality of recurrent network connected between stages

of electron tube circuits, including the responsive device in the last output circuit. The networks comprise a plurality of sections, each including inductance, capacity and resistance. These circuits freely transmit the audio frequency signal currents but highly attenuate and substantially extinguish the audio frequency disturbing currents. The audio frequency interfering currents supplied by the detector 3 will be converted into pulses by means of the filters  $F^1$ ,  $F^2$ ,  $F^3$ , and  $F^4$ , which have their natural modes of vibration critically damped. The interfering currents are successively attenuated in each filter, and the plurality of filters connected in tandem insure that the attenuation may be sufficient to reduce the interfering currents to a negligible value. The audio frequency signaling currents, however, delivered by the detector 3, acting as forced vibration, are freely transmitted from the several filters, so that these signaling currents are received by the signal device 7 to the exclusion of the interfering currents.

1,414,232—A. H. Taylor, *et al.*, filed August 12, 1919, issued April 25, 1922.

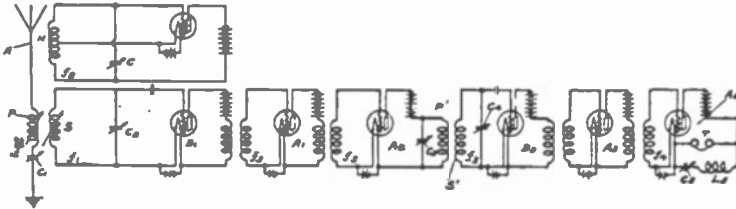

NUMBER 1,414,233—Method of Receiving Radio Signals with the Compound Heterodyne

**METHOD OF RECEIVING RADIO SIGNALS WITH THE COMPOUND HETERODYNE**, in which a circuit is employed having a primary detector, stages of electron tube amplification after the detector, and then a secondary detector followed by a plurality of stages of electron tube amplification. A single local source of oscillations is arranged to act a plurality of times on a single received signal to produce a plurality of beat currents of different frequencies. The last beat current operates the telephone receivers.