

VOLUME 4

JUNE, 1916

NUMBER 3

PROCEEDINGS
of
**The Institute of Radio
Engineers**
(INCORPORATED)

TABLE OF CONTENTS

PROCEEDINGS OF THE SECTIONS

TECHNICAL PAPERS AND DISCUSSIONS



EDITED BY
ALFRED N. GOLDSMITH, Ph.D.

PUBLISHED EVERY TWO MONTHS BY
THE INSTITUTE OF RADIO ENGINEERS, Inc.
ONE HUNDRED AND ELEVEN BROADWAY
NEW YORK

THE TABLE OF CONTENTS FOLLOWS ON PAGE 213

GENERAL INFORMATION

The right to reprint limited portions or abstracts of the articles, discussions, or editorial notes in the Proceedings is granted on the express condition that specific reference shall be made to the source of such material. Diagrams and photographs in the Proceedings may not be reproduced without securing permission to do so from the Institute thru the Editor.

Those desiring to present original papers before the Institute of Radio Engineers are invited to submit their manuscript to the Editor.

Manuscripts and letters bearing on the Proceedings should be sent to Alfred N. Goldsmith, Editor of Publications, The College of the City of New York, New York.

Requests for additional copies of the Proceedings and communications dealing with Institute matters in general should be addressed to the Secretary, The Institute of Radio Engineers, 111 Broadway, New York.

The Proceedings of the Institute are published every two months and contain the papers and the discussions thereon as presented at the meetings in New York, Washington, Boston or Seattle.

Payment of the annual dues by a member entitles him to one copy of each number of the Proceedings issued during the period of his membership. Members may purchase, when available, copies of the Proceedings issued prior to their election at 75 cents each.

Subscriptions to the Proceedings are received from non-members at the rate of \$1.00 per copy or \$6.00 per year. To foreign countries the rates are \$1.10 per copy or \$6.60 per year. A discount of 25 per cent. is allowed to libraries and booksellers. The English distributing agency is "The Electrician Printing and Publishing Company," Fleet Street, London, E. C.

Members presenting papers before the Institute are entitled to ten copies of the paper and of the discussion. Arrangements for the purchase of reprints of separate papers can be made thru the Editor.

It is understood that the statements and opinions given in the Proceedings are the views of the individual members to whom they are credited, and are not binding on the membership of the Institute as a whole.

COPYRIGHT, 1916, BY
THE INSTITUTE OF RADIO ENGINEERS, INC.
ONE HUNDRED AND ELEVEN BROADWAY
NEW YORK, N. Y.

CONTENTS

	PAGE
OFFICERS AND PAST PRESIDENTS OF THE INSTITUTE	214
COMMITTEES OF THE INSTITUTE	215
PROCEEDINGS OF THE SECTIONS OF THE INSTITUTE	217
ALBERT H. GINMAN, "RADIO IN ALASKA"	221
Discussion on the above paper	232
ELLERY W. STONE, "AN IMPULSE EXCITATION TRANSMITTER"	233
Discussion on the above paper	248
LOUIS W. AUSTIN, "EXPERIMENTS AT THE U. S. NAVAL RADIO STATION, DARIEN, CANAL ZONE"	251
Discussion on the above paper	259
FRITZ LOWENSTEIN, "THE MECHANISM OF RADIATION AND PROPAGA- TION IN RADIO COMMUNICATION"	271
Discussion on the above paper	281
E. LEON CHAFFEE, "AMPLITUDE RELATIONS IN COUPLED CIRCUITS"	283
Discussion on the above paper	301
LEONARD F. FULLER, "SUSTAINED WAVE RECEIVING DATA"	305

OFFICERS AND BOARD OF DIRECTION, 1916

(Terms expire January 3, 1917; except as otherwise noted.)

PRESIDENT

ARTHUR E. KENNELLY

VICE-PRESIDENT

JOHN L. HOGAN, JR.

TREASURER

WARREN F. HUBLEY

SECRETARY

DAVID SARNOFF

EDITOR OF PUBLICATIONS

ALFRED N. GOLDSMITH

MANAGERS

(Serving until January 1, 1919.)

EDWIN H. ARMSTRONG

WILLIAM H. G. BULLARD

(Serving until January 2, 1918.)

LOUIS W. AUSTIN

JOHN HAYS HAMMOND, JR

(Serving until January 3, 1917.)

LLOYD ESPENSCHIED

ROBERT H. MARRIOTT

GUY HILL

JOHN STONE STONE

ROY A. WEAGANT

ADVERTISING MANAGER

LOUIS G. PACENT

WASHINGTON SECTION

EXECUTIVE COMMITTEE

CHAIRMAN

COLONEL SAMUEL REBER

War Department,
Washington, D. C.

SECRETARY-TREASURER

GEORGE H. CLARK

Navy Department,
Washington, D. C.

CHARLES J. PANNILL
Radio, Va.

BOSTON SECTION

CHAIRMAN

A. E. KENNELLY,
Harvard University,
Cambridge, Mass.

SECRETARY-TREASURER

MELVILLE EASTHAM,
11 Windsor Street,
Cambridge, Mass.

SEATTLE SECTION

CHAIRMAN

ROBERT H. MARRIOTT,
715 Fourth Street,
Bremerton, Wash.

SECRETARY-TREASURER

ALEXIS A. PAYSSE,
Hotel Burke,
Seattle, Wash.

PAST-PRESIDENTS

SOCIETY OF WIRELESS TELEGRAPH ENGINEERS

JOHN STONE STONE, 1907-8 LEE DE FOREST, 1909-10
FRITZ LOWENSTEIN, 1911-12

THE WIRELESS INSTITUTE

ROBERT H. MARRIOTT, 1909-10-11-12

THE INSTITUTE OF RADIO ENGINEERS

ROBERT H. MARRIOTT, 1912 GREENLEAF W. PICKARD, 1913
LOUIS W. AUSTIN, 1914 JOHN STONE STONE, 1915

STANDING COMMITTEES

1916

COMMITTEE ON STANDARDIZATION

JOHN L. HOGAN, JR., <i>Chairman</i>	Brooklyn, N. Y.
E. F. W. ALEXANDERSON	Schenectady, N. Y.
LOUIS W. AUSTIN	Washington, D. C.
FERDINAND BRAUN	Strassburg, Germany
A. A. CAMPBELL SWINTON	London, England
GEORGE H. CLARK	Washington, D. C.
WILLIAM DUDELL	London, England
LEONARD FULLER	San Francisco, Cal.
ALFRED N. GOLDSMITH	New York, N. Y.
GUY HILL	Brooklyn, N. Y.
LESTER ISRAEL	New York, N. Y.
FREDERICK A. KOLSTER	Washington, D. C.
GEORGE H. LEWIS	Brooklyn, N. Y.
VALDEMAR POULSEN	Copenhagen, Denmark
GEORGE W. PIERCE	Cambridge, Mass.
JOHN STONE STONE	New York, N. Y.
CHARLES H. TAYLOR	Kahuku, Hawaii
ROY A. WEAGANT	Aldene, N. J.
JONATHAN ZENNECK	Munich, Germany

COMMITTEE ON PUBLICITY

GEORGE S. DAVIS, <i>Chairman</i>	New York, N. Y.
JOHN L. HOGAN, JR.	Brooklyn, N. Y.
ROBERT H. MARRIOTT	Seattle, Wash.
LOUIS G. PACENT	New York, N. Y.
CHARLES J. PANNILL	Radio, Va.
DAVID SARNOFF	New York, N. Y.
ROBERT B. WOOLVERTON	San Francisco, Cal.

COMMITTEE ON PAPERS

ALFRED N. GOLDSMITH, <i>Chairman</i>	New York, N. Y.
GEORGE H. CLARK	Washington, D. C.
MELVILLE EASTHAM	Cambridge, Mass.
JOHN L. HOGAN, JR.	Brooklyn, N. Y.
ALEXANDER MEISSNER	Berlin, Germany
SIR HENRY NORMAN	London, England
WICHI TORIKATA	Tokyo, Japan

SPECIAL COMMITTEES

COMMITTEE ON WAVE LENGTH REGULATION

JOHN STONE STONE, <i>Chairman</i>	New York, N. Y.
E. F. W. ALEXANDERSON	Schenectady, N. Y.
LOUIS W. AUSTIN	Washington, D. C.
H. BOEHME	New York, N. Y.
WILLIAM H. G. BULLARD	Radio, Va.
LEE DE FOREST	New York, N. Y.
MELVILLE EASTHAM	Cambridge, Mass.
LLOYD ESPENSCHIED	New York, N. Y.
LEONARD FULLER	San Francisco, Cal.
ALFRED N. GOLDSMITH	New York, N. Y.
JOHN L. HOGAN, JR.	Brooklyn, N. Y.
FREDERICK A. KOLSTER	Washington, D. C.
RALPH A. LANGLEY	New York, N. Y.
FRITZ LOWENSTEIN	Brooklyn, N. Y.
EMIL E. MAYER	Tuckerton, N. J.
GREENLEAF W. PICKARD	Boston, Mass.
SAMUEL REBER	Washington, D. C.
DAVID SARNOFF	New York, N. Y.
FREDERICK SIMPSON	Seattle, Wash.
T. LINCOLN TOWNSEND	Washington, D. C.
ROY A. WEAGANT	Aldene, N. J.
ARTHUR G. WEBSTER	Worcester, Mass.
LEONARD D. WILDMAN	Fort Leavenworth, Kans.

COMMITTEE ON INCREASE OF MEMBERSHIP

JOHN L. HOGAN, JR., <i>Chairman</i>	Brooklyn, N. Y.
WARREN F. HUBLEY	Newark, N. J.
DAVID SARNOFF	New York, N. Y.

PROCEEDINGS OF THE SECTIONS OF THE INSTITUTE OF RADIO ENGINEERS

WASHINGTON SECTION

On the evening of January 26, 1916, the annual meeting of the Washington Section was held at the Commercial Club in that city. The pleasantly informal speeches were preceded by a dinner. Lieutenant Louis M. Evans (Secretary of the Washington Section for 1915), presided in the absence from Washington of Lieutenant S. C. Hooper (Chairman of the Washington Section for 1915). The toastmaster of the evening was Captain W. H. G. Bullard. He introduced in succession the following speakers: Brigadier-General Scriven, U. S. A., Rear-Admiral Griffen, U. S. N., Mr. V. Ford Greaves (on behalf of Secretary of Commerce Chamberlain), Captain Gibbs, U. S. A., Professor Alfred N. Goldsmith, and Mr. George H. Clark (Secretary of the Washington Section for 1916). The subjects of the various addresses were as follows: "Radio Work of the Signal Corps," "Radio in the Naval Service," "Radio Regulation," "The Radio Stations at Honolulu," "The Institute and Advance in Radio," and "Review of the Activities of 1915." The Committee on Arrangements, which was largely responsible for the highly successful character of the evening, were Messrs. T. Lincoln Townsend and Charles J. Pannill. The following toast, by Mr. Townsend, was felt to voice clearly one aim of the Institute:

TO THE ENGINEER OF TO-MORROW

Here is a toast that we want to drink to a fellow we'll never know—
The fellow who's going to take our place when it's time for us to go.
We wonder what kind of a chap he'll be and we wish we could take his hand,
Just to whisper, "We wish you well, old man," in a way that he'd understand.
We'd like to give him the cheering word that we've longed at times to hear;
We'd like to give him the warm handclasp when never a friend seems near.
We've gained our knowledge by sheer hard work, and we wish we could pass
it on
To the fellow who'll come to take our place some day when we are gone.

On the evening of February twenty-ninth, a joint meeting of the American Institute of Electrical Engineers and the Washington Section of The Institute of Radio Engineers was held at

the Cosmos Club, Washington. A paper by Captain W. H. G. Bullard, Superintendent of the Naval Radio Service, on "Recent Developments in the Naval Radio Service" was presented. It was fully illustrated by slides, and was widely discussed.

On the evening of March twenty-ninth, a meeting of the Washington Sections was held at the laboratory of Mr. J. H. Rogers, Hyattsville, Md. The meeting was devoted to the consideration of certain current radio problems.

On the evening of April twenty-eighth, a meeting of the Washington Section was held in the State, War, and Navy Building, Washington. An informal address on certain recent radio litigation was made by Mr. Frederick A. Kolster of the Bureau of Standards. This was followed by a number of informal speeches and general discussion.

BOSTON SECTION

On the evening of January 27, 1916, a meeting of the Boston Section was held in the Cruft High Tension Laboratory, Harvard University, Cambridge, Mass. Professor Hidetsugu Yagi presented a paper on "Arc Oscillations in Coupled Circuits," this being followed by a Braun tube demonstration of impact excitation by Dr. E. L. Chaffee. There were ninety-one present. The chairman was Professor G. W. Pierce, Past Vice-President of the Institute. The discussion was carried on by Professor J. E. Ives, Mr. Fulton Cutting, Dr. E. L. Chaffee, and Mr. Melville Eastham, Secretary of the Boston Section.

On the evening of March thirtieth, a meeting was held at the Cruft Laboratory. Professor George W. Pierce presented a paper on "The Radiation Characteristics of Flat-Top Antennas." This was followed by a discussion in which, among others, Professor J. E. Ives and Mr. Fulton Cutting participated. The attendance was seventy-eight.

On the evening of April twenty-eighth, a meeting was held at the Cruft Laboratory. A paper by Professor A. E. Kennelly (President of the Institute), and Mr. H. A. Affel on "Skin Effect in Conductors at Radio Frequencies Up to 100,000 Cycles per Second" was delivered. The evening being inclement, fifty-nine were present. The paper was discussed by Professor J. C. Hubbard and Mr. Melville Eastham.

SEATTLE SECTION

On the evening of January eighth, a dinner of the Seattle Section was given, Mr. Robert H. Marriott (chairman of the section), presiding. The attendance was nineteen. Financial matters were considered after the dinner, and there was a discussion on the question of the control of radio transmitters and receivers on vessels lying in harbors.

On the evening of March fourth, a meeting of the section was held in Denny Hall, Washington University. Messrs. T. M. Libby and F. M. Ryan conducted a number of demonstrations of experiments dealing with the physical aspects of radio communication.

On the evening of March eighteenth, a dinner was given at the Butler Hotel, Seattle, to the following visiting members of the Institute and guests: Messrs. L. F. H. Betts, Lieutenant, E. J. Blankenship, D. N. Cosgrove, Philip Farnsworth, A. H. Ginman, V. Ford Greaves, Frederick A. Kolster, Dr. Carl E. Magnusson, Judge Jere Neterer, Dr. Frederick A. Osborne, Greenleaf W. Pickard, Frank N. Waterman, and Roy A. Weagant. The dinner, which was largely attended, was a most pleasant and instructive occasion.

RADIO IN ALASKA*

By

A. H. GINMAN

(GENERAL SUPERINTENDENT, PACIFIC COAST DIVISION, MARCONI WIRELESS
TELEGRAPH COMPANY OF AMERICA)

In the development of all new countries, the telegraph has always been one of the most important factors of progress. In Alaska, the progress of colonization has been very slow; short seasons and lack of transportation facilities having retarded general progress and also, perhaps, the conservative policy of those who have hitherto governed the territory. The advent of the Marconi Company into Alaska gave rise to the now familiar spectacle of radio communication successfully competing with a submarine cable by giving fast and accurate service at reduced rates; and this in face of the fact that radio telegraphy has, until recently, been considered by the public as the most expensive telegraph service of all.

Besides its mineral resources, which have only been partially developed, Alaska has agricultural possibilities, which have been computed by experts as capable of supporting a population of five million engaged solely in dairying and grazing. When these various potential resources are developed, and this will probably be within a few years—for our Government is at present engaged in the construction of hundreds of miles of railroad in that country—Alaska will indeed be able to compare favorably with her sister states. It is in this development that the Marconi Company proposes to play its part.

In Alaska can be found almost every topographical formation and geographical arrangement known, and it can readily be understood what tremendous difficulties are encountered in the building of telegraph lines and the laying of submarine cables. In that country, this method of communication was primarily intended for military purposes, but it has been utilized to a far greater extent by the Alaskans for commercial purposes, as it was their only means of outside communication.

Volcanic disturbances are of frequent occurrence along the

* Received by the Editor, December 24, 1915.

Coast; and while only of a mild character, are a continual source of trouble to cable authorities. The only cable repair vessel assigned to this duty is stationed at Seattle, and repairs are consequently delayed until that vessel can locate the trouble, which may take two days or two weeks. Thus it would seem that not only is radio a valuable asset to Alaska, but the only logical and efficient method of communication. The Government, thru the Navy and Military Departments, has established radio stations at convenient points thruout the North, and localities hitherto unserved are now connected by an organized system. Numerous canneries and mining companies have installed Marconi equipments, thus enabling them to keep in touch with the outside world, which, in the pre-radio days, they were unable to do without great loss of time, it being not unusual for them to send messages by boat from a mine to the nearest cable or radio office.

Two years ago, the Marconi Company decided to extend its activities in Alaska, and to-day it has semi-high-power stations at Ketchikan, the first port of entry into Alaska, at Juneau, the capital city, and at Astoria, Oregon, U. S. A., thus forming the nucleus of a system that will eventually extend along the Alaskan peninsula when the volume of business justifies the step. These stations were put into commission in July of this year and are maintaining a fast and reliable day and night service. As an instance of this may be mentioned the experience of a mine owner in Juneau, who dispatched a message from there to Los Angeles, California, and received a reply forty minutes after filing the original message at Juneau.

The country in the vicinity of Ketchikan is of volcanic origin, with a sub-soil from eighteen to thirty-six inches (45 to 90 cm.) deep, of a very soft character, (the underlying rock being of shaly composition), and found to be easily excavated by the construction engineers. Facing a strip of water known as the Tongass Narrows, four towers of the self-supporting type have been erected to carry the antenna, these towers being so located that they outline a rectangle three hundred by six hundred feet (91 by 182 meters). One of these is shown in Figure 1. The long axis is in the true direction of Astoria, Oregon. This was so arranged in order to obtain maximum radiating and receptive qualities, for it has been found that such an aerial has directional radiating power. Each tower is three hundred feet (91 meters) high and surmounted by a wooden top mast projecting fourteen feet (4.3 meters) above the head of the steel

portion. Upon these are mounted 80,000 volt, triple petticoat insulators, carrying the antenna made of two silicon bronze wires, each having seven strands of number 18 wire,* the tension of which can be adapted to meet any conditions of abnormal strain, due, for example, to high wind storms, sleet or ice. This antenna serves a double purpose, being used as a transmitting aerial for the



FIGURE 1—Ketchikan, Alaska Radio Station

marine service and a receiving aerial for the 5 and 25 kilowatt sets. A twenty wire antenna is suspended on triatics† between the towers, and leads to the reinforced steel concrete power house, located approximately three hundred feet (91 meters) from the two lower towers, where it is connected to the 25 kilowatt transmitter. A two mile transmission line carrying 2,200 volts, single phase current, at a frequency of 60 cycles connects the Ketchikan city power house with the radio station, and about three hundred feet (91 meters) from the power plant it is brought into the building by means of an underground conduit, a precaution deemed

* Diameter of number 18 wire = 0.0403 inch = 0.102 cm.

† (A triatic stay consists of two pendant portions attached to the two masts, their other ends being usually provided with thimbles reeved in place; thru these thimbles the main wires between the masts pass—EDITOR.)

necessary to avoid trouble which might arise from the proximity of the antenna to the overhead transmission line. Here it is connected to the high tension switchboard and thence distributed to the various units: transmitting apparatus, and light-



FIGURE 2—20 wire aerial terminal, showing high tension porcelain insulation, 20' wood strain insulation, and 2 Bradfields

ing and heating transformers. A synchronous rotary converter is used for furnishing 70 volt direct current for the operation of the solenoid keys and side disc motors and by means of an extended shaft drives a rotary discharger, which controls the number and duration of the spark discharges. The disc discharger embodies the latest improvements found desirable for handling such currents. The disc is thirty inches (76 cm.) in diameter and rotates at 1790 revolutions per minute. Close to its periphery are inserted brass studs equally spaced around the disc, which, in rotating, pass between two side discs set to give a clearance of $1/32$ of an inch (0.8 mm.). The discharge takes place across this small air gap, that is, between the side discs and each of the revolving studs in turn. The discharger is shown in operation in Figure 7. As the discharger is rotated

synchronously with the alternator which supplies energy to the condenser which is discharged, it is necessary to time the discharge to occur at or near the peak of the voltage wave in the alternator. The correct point on the voltage curve depends on



FIGURE 3—"Tower C,"
Ketchikan Radio Station



FIGURE 4—Tower safety stops, showing complete arrangement, (winch or crab, and the galvanized iron nailed to top of stump to preserve the same. Note steel halyard slack; Manila links shackled to a short piece of steel halyard which in turn is clamped to the halyard; ship cleat bolted to stump with 12" lags. Ketchikan.

several factors and arrangements are provided to permit adjustments being made of the interval between the time at which the revolving stud passes the side discs and the time when the machine voltage is at its highest, thus obtaining maximum effects.

The condensers consist of glass and zinc plates placed in earthenware containers, filled with oil, a bank of thirty units being used in the circuit. Copper bus bars of ample dimensions lead from the condenser bank to the inductive coupler and to the disc discharger. The coils of this coupler are wound

with a specially designed cable, and so arranged that each strand carries the same amount of current, thus decreasing heat losses.

The receiving office is seventy-five feet (23 meters) from the power house and contains the operating key and the usual equip-

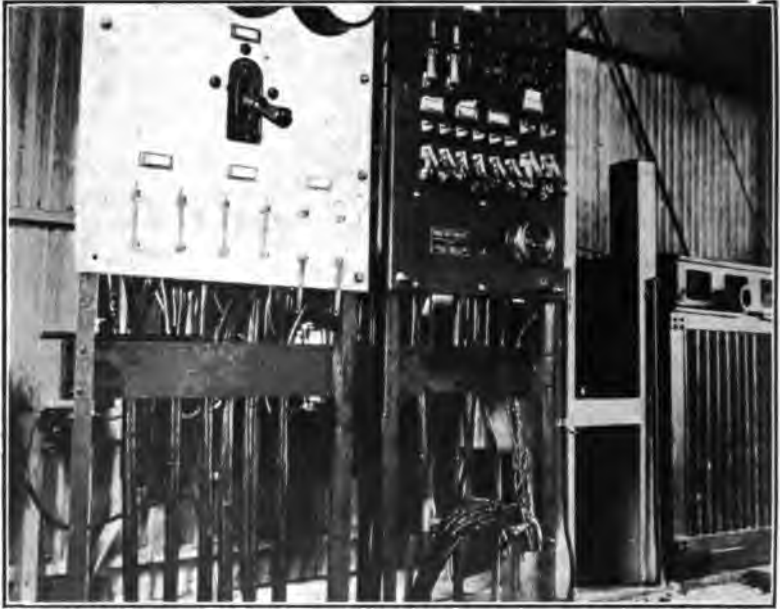

FIGURE 5—Ketchikan Station Switchboards

ment, supplemented by two loose-coupled receivers (fitted for crystal and valve detectors), having ranges from one hundred to four thousand meters and from one hundred to seven thousand meters, respectively. A difficulty met with, even in the use of power as low as 25 kilowatts, for radio telegraphic purposes, is that of controlling the current so that speedy manipulation is possible. For satisfactory service, the operator must be able to handle the key as if it were controlling no more power than is usually required to operate a land line key. This means that every time the key is depressed, power to the extent of 25 kilowatts must be supplied to the radio circuits and the delivery of power must cease as soon as the key is lifted; and, moreover, the starting and stopping of this flow of energy must be as nearly as possible instantaneous. This is accomplished by means of a solenoid key in the 22,000 volt leads, which is actuated

by the operator's key, the solenoid key being provided with an air blast for blowing out arcs which might be formed. Thus it will be seen that the operator can control the apparatus while far removed from the disturbing noise of the power house.

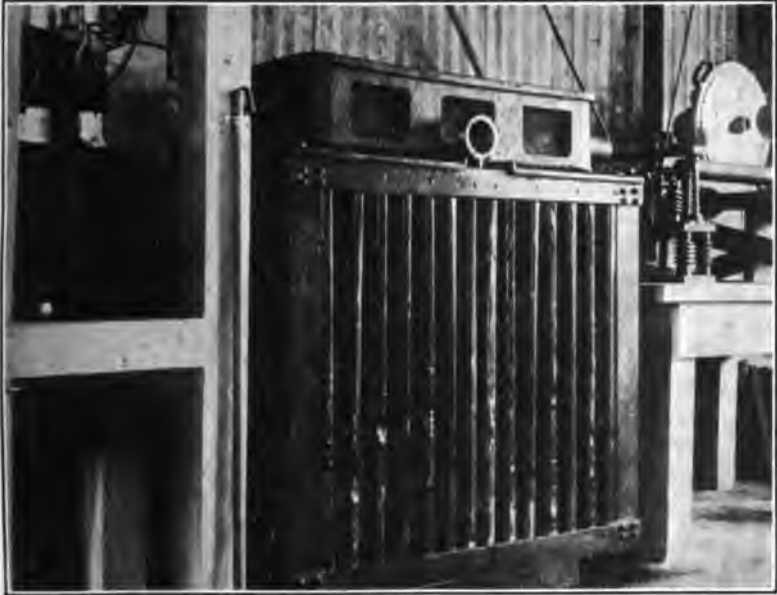

FIGURE 6—On right, blowers, high tension solenoid key; center, K. W. transformer; left, remote control oil switch

The living quarters for the staff contain all modern conveniences, and are furnished in a liberal manner. The water supply is obtained from a 12,000 gallon reservoir, located on high ground to the rear of the station, fed by springs the source of which is in the nearby hills and virgin forests that surround the station. The forests added greatly to the difficulties of our construction engineers, when coupled with the fact that the rainfall in that vicinity averages one hundred and sixty-eight inches (4.3 m.) yearly. However, this excessive rainfall is of great advantage as regards the ground system which consists of three thousand pounds (1,400 kg.) of zinc plates buried in a circle around the power house, supplementing which are a number of four feet (1.2 meter) strips running out on the beach to mean low tide level, thus insuring at all times a good electrical ground.

To the north two hundred and fifty miles (400 km.) is the Juneau Station which, when completed, will be a counterpart of the one at Ketchikan, with the exception that it will have only two three hundred foot (91 meter) towers. In the interim, the old station has been remodeled with a 10 kilowatt plant.



FIGURE 7—25 K.W. spark; note synchronism of disc indicated by the stud near top of disc. Exposure 20 seconds during which time disc made 597 revolutions. Ketchikan

Radio conditions existing in Alaska are not to be found, I believe, in any other part of the globe. This is due possibly to the geographical situation of Alaska, and the continuous daylight during the summer months. It frequently happens that a vessel in Alaskan waters, while in communication with another station seven hundred miles (1,100 km.) distant, is unable to communicate with a station in the opposite direction more than twenty miles (30 km.), even tho the latter is at the same time able to communicate with a station seven hundred miles (1,100 km.) distant from it. Another phenomenon worthy of comment was noticed during the first few weeks of our operations. At Astoria (where strays are much more intense than at either of the Alaskan stations) the atmosphere would be quite

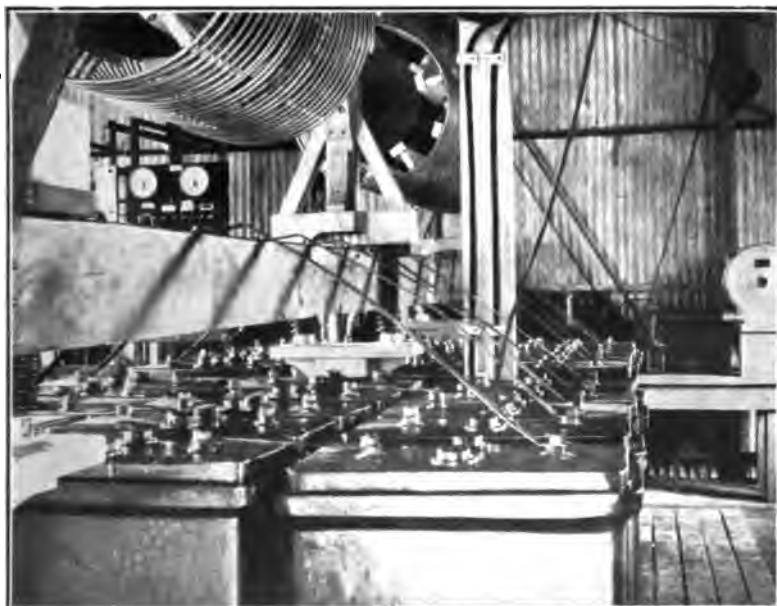

FIGURE 8—25 K.W. condenser bank; in upper left corner can be seen the secondary reactance between 25 K.W. transformer and condenser.



FIGURE 9—Receiving room at Ketchikan. On top of table, center is the 4000 meter marine tuner; on extreme right in corner is change over switch; underneath table is a wooden switchboard, mounted on which are: (starting at left,) a D.P. switch acting as two S.P. switches for disc and blower motors, 220 volt mains for converter, 4 pole starting switch, 5 K.W. rotary switch.

clear of strays until noon; in fact so much so that one obtained the impression that the antenna was disconnected or that the receivers were out of adjustment. However, at noon each day, strays put in an appearance and gradually increased in intensity

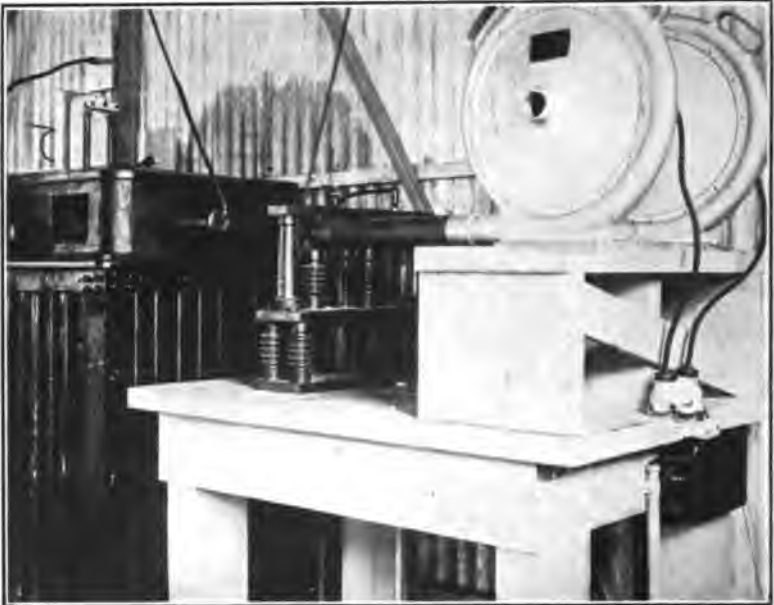

FIGURE 10—Blowers (A.C.) on right; center, solenoid key; left, 25 K.W. transformer. Ketchikan

until 1 P. M., when they reached a maximum, remaining so until 5 P. M. Thence until midnight, atmospheric conditions were those usually prevailing at similar stations. Altho the evening period of decrease varied from time to time, the mid-day rise in the stray curve appeared to be constant until the season had passed, as it suddenly did on August 28th.

On short wave lengths the results were not favorable, but on working up to twelve hundred meters communication was easily maintained, and the longer the wave length the better were the results at the distant stations. Reception of signals at Ketchikan has been remarkably good, messages having been received intact from the west, from Siberia, Japan and Honolulu; from the north, all Signal Corps stations; from the south,

Darien (in the Canal Zone), and all Pacific Coast stations; from the east, from Tuckerton, Sayville, Arlington, Key West, and at times messages from the Hanover Station, in Germany. *

December 24, 1915.

SUMMARY: The chain of semi-high-power stations (25 K.W.) established by the Marconi Company at Ketchikan, Juneau, and Astoria in Alaska are described. The masts, insulation, antenna, power supply, rotary converter, discharger, and relay key of these stations are considered in detail. The climatic and radio stray conditions are shown to be unusual. Remarkable directive absorption is encountered. The favorable receiving conditions are illustrated.

* (The distance from Eilvese, Hanover to Ketchikan, Alaska is approximately 4,600 miles or 7,400 km.—EDITOR.)

DISCUSSION

Charles J. Pannill (communicated): I think Mr. Ginman has ably covered the situation in respect to radio in Alaska as operated by his company. He has however overlooked the various other systems of radio in Alaska that have been in operation for a number of years. The first point-to-point commercial operation of radio, I believe, was between Nome and St. Michaels, a comparatively short distance across water, but looked upon with pride in the early days of radio. These stations were erected by the Signal Corps and used in connection with their cable system. The Naval Radio Service maintains a chain of shore stations along the coast of Alaska from Sitka to St. Paul. Our stations in Alaska are open to commercial traffic both for radiograms to and from ships at sea, and domestic business between Alaskan points, and between United States and Alaskan points. We recently inaugurated a night letter service and a night service over our circuits. Traffic agreements have been entered into with the land line companies in the United States and the Marconi and cable systems in Alaska. There are several circuits between Alaskan points and United States points reached by the Postal and Western Union offices, via the cable transfer point at Seattle connecting with us at Sitka or Cordova, via our station at North Head, Wash., reached by the Western Union, via the Marconi service at Astoria to Ketchikan and to Sitka, and via Vancouver Canadian service. I do not agree with Mr. Ginman that traffic via their Astoria circuit is handled more cheaply than via other circuits into Alaska. A careful study of the prevailing rates indicates that traffic may be handled by us thru North Head to Sitka and thence to the cable (paying a loop charge of 25-2 between Sitka radio station and Sitka cable office) to some points in the eastern part of Alaska at less than via their Astoria circuit. I followed the erection of the Ketchikan station with a great deal of interest and I am glad that the work of Mr. Arthur A. Isbell, who erected the Marconi stations was so well performed.

AN IMPULSE EXCITATION TRANSMITTER*

BY

ELLERY W. STONE

(ASSISTANT RADIO INSPECTOR, DEPARTMENT OF COMMERCE.)

The "Preliminary Report of the Committee on Standardization of the Institute of Radio Engineers" for 1913 defines "impulse excitation" as follows:

"The term applied to a method of producing free alternating currents of relatively small damping by means of the actual or equivalent removal of a source of highly damped free alternating currents from the coupled secondary circuit. As a special case, the primary current may be very highly damped, but in all cases there must be in effect, a suppression of reaction between the circuits."

It is this "special case" with which we are concerned in the contemplation of the present systems of impulse excitation. However, the term "impulse excitation," as defined by the Standardization Committee, is quite broad, including as it does, all forms of quenched gap operations instead of limiting it to that particular form of quenched gap action with which it has of late been most generally associated. I refer to that form of transmitter in which the oscillations of the primary circuit are so abruptly damped out as to produce but single half cycles or impulses, causing a shock or impact excitation of the secondary circuit.

With the Telefunken and kindred quenched gap transmitters, the quenching action of the gap is confined to damping out the oscillations in the primary circuit when the current in the first *group* has become nil. In the strictly impulse excitation transmitter, the quenching properties of the gap are such as to damp out the current in the first *oscillation* or first *half cycle* before it passes thru zero, or at most, to prevent not more than one or two half cycles to follow, so that by far the greater portion of the energy is in the first half cycle. The difference between quenched gap excitation and impulse excitation, using the restricted meanings of these terms, is seen to be solely one of degree—of degree of damping of the primary current.

* Received for publication December 24, 1915.—EDITOR.

However, in practice, it is not customary to leave the attainment of high damping of the primary current to the gap alone.

The three constants in any alternating current circuit are resistance, R , inductance, L , and capacity, C . The proper value of R in the primary circuit is determined chiefly by the construction and action of the gap, that of L by the number of turns in the primary of the oscillation transformer, and of C by the capacity of the charging condenser.

From the formula $d = \frac{R}{2fL}$,

we may obtain $d = \frac{\pi R}{2\pi fL}$

$$= \frac{\pi R}{\omega L}$$

$$= \pi R \omega C$$

(where f is the frequency); or that the logarithmic decrement or damping of the free alternating current in a closed non-radiative circuit is a direct function of R and C and an inverse function of L . Hence, a decrease in the inductance and an increase of the resistance and the capacity of the primary will result in increased damping. A related conclusion may be drawn from Thomson's formula: namely, that when

$$R > 2\sqrt{\frac{L}{C}},$$

the current in the primary circuit is non-oscillatory. It may be seen from this formula as well, that the values of resistance and capacity must be high as compared to that of inductance to approach a condition of aperiodicity in the primary.

Mr. John Stone Stone, in a paper entitled "The Resistance of the Spark and its Effect on the Oscillations of Electrical Oscillators," in the December, 1914 issue of the PROCEEDINGS, takes exception to the logarithmic decrement theory as applied to those circuits in which the spark resistance constitutes the major resistance of the circuit, and hence to those formulas quoted above. However, Mr. Stone states on page 322 of his paper, "A great many oscillation circuits, and probably the majority of oscillation circuits, are intermediate between the two classes mentioned, and I hope soon to present a paper giving the theory of such circuits in some detail." (The "two classes" referred to are those two types of oscillation circuits to which the logarithmic decrement and Mr. Stone's linear decrement theories of current decay are respectively applicable.) Con-

sequently, until the advent of Mr. Stone's new paper, one is in a quandary as to which theory to quote, but as far as the case at hand is concerned, there is little conflict.

In place of the Thomson formula

$$R > 2\sqrt{\frac{L}{C}},$$

Mr. Stone substitutes

$$R > \frac{2}{\pi}\sqrt{\frac{L}{C}};$$

but the same conclusions are to be drawn from his formula as from Thomson's, i. e., that to approach a condition of aperiodicity in the primary circuit, the values of resistance and capacity must be large as compared to that of inductance.

There is still another point to be considered. The absorption of energy from the primary by the secondary results in increased damping of the current in the former circuit; so that, other things being equal, an increase in the coefficient of coupling between the two circuits will also increase the damping.

While L and C in the primary circuit remain constant, R does not, since R primarily is the resistance of the gap. For a quick discharge of the condenser, the resistance of the metallic circuit of the primary must be low, the surface of the gap large, the initial resistance of the gap high, and its recovery to its initial resistance rapid.

Before going into the details of a transmitter designed by the writer to incorporate these properties, a reference to previous work along these lines will be found of value.

From what information on impulse excitation the writer has been able to obtain, Mr. Roy E. Thompson, of the Kilbourne & Clark Mfg. Co., Seattle, seems to have been the pioneer in this work in the United States at least, having designed and constructed an impulse transmitter as far back as 1910. The writer must acknowledge his indebtedness to Mr. Thompson for most of the preliminary data gathered on the subject in the preparation of this paper.

A wealth of material covering this subject is to be found in the December, 1913 issue of the PROCEEDINGS in a paper entitled "The Multitone System" by Dr. Hans Rein. The values of inductance, capacity and resistance in a typical primary circuit are given, together with an excellent theoretical exposition of the principles of the Lorenz and other systems, with numerous photographs showing their practical application. Not the least

interesting is the appended discussion. Mr. Eastham's paper in the December, 1914 issue of the PROCEEDINGS will also be found to be of considerable bearing on the subject.

In the spring of 1913, the writer made some experiments on a rotary quenched gap of the Clapp Eastham type described in Mr. Eastham's paper. Recognizing the similarity between this gap and the Peukert gap, which latter employs a thin film of oil between the sparking surfaces, experiments were tried to see what effect would be realized by the introduction of oil into the Clapp Eastham gap. The only result noted was a decrease in antenna radiation, possibly due to excessive carbonization of the oil, and the experiments were temporarily discontinued.

In the spring of 1915, the subject was again taken up, utilizing a larger and an improved type of gap to see what effect the introduction of a liquid hydrocarbon would have on the quenching properties of the gap.

The experiments were conducted as follows. From the simple formulas quoted above, and from the work of Dr. Rein and others, the necessity of large capacity, high gap resistance and low inductance were recognized, so a primary circuit containing one turn of inductance and enough capacity to bring the circuit to about 670 meters was utilized. The necessity for a transformer giving a flat topped secondary wave to simulate a D. C. wave has long been appreciated in operating impulse transmitters on alternating current. Accordingly, a 2 kilowatt, 60 cycle transformer with a secondary voltage of 2,500, so designed as to secure a maximum of leakage and of iron saturation, was built and used in this work.

It was not possible with the facilities at hand to note the number of oscillations in the primary, so it was found necessary to resort to the following method to determine the degree of damping. Probably the most significant phenomenon attending the operation of impulse transmitters is the absence of necessity for resonant tuning between the primary and antenna circuits. As a matter of fact, with true impulse excitation, it is almost impossible to measure the wave length of the primary circuit even tho uncoupled, a resonance curve of the primary being practically without a peak. By the substitution of a plain gap, however, the wave length of the primary may be easily measured; and this procedure was followed in the present case, the primary being tuned to 670 meters, as previously noted. With true impulse excitation, it should be possible to detune the primary

and secondary circuits by any amount without a very great decrease of current in the secondary circuit and with the appearance of but a single frequency in that circuit.

The evolution of a gap to realize this state of affairs may be found of interest.

The first experiment tried was to tune the primary and antenna circuits to resonance, as in the usual type of quenched transmitter, to note the damping of the current in the antenna circuit, which would give some idea of the quenching properties of the gap. The coupling was extremely tight, the single turn of primary inductance being placed directly over one turn of the secondary winding. With a motor speed of 1,800 R. P. M., the logarithmic decrement of the oscillations in the antenna circuit, measured with a Kolster decimeter, was found to be 0.15, an exceedingly high value for a quenched gap, considering that the aerial employed was of the average ship type.

An increase of the motor speed to 3,400 R. P. M. reduced the logarithmic decrement to 0.06. From this, the quenching properties of the gap, without the introduction of gases, would seem to be a function of the speed of the revolving discharger. However, the impression should not be gathered that a speed below 3,400 would cause less damping of the primary oscillations or that a speed in excess of this would increase the damping. Good quenching, as determined by the logarithmic decrement of the secondary oscillations, was not obtainable until a speed of about 2,400 R. P. M. was reached. This gave a logarithmic decrement of 0.06 in the antenna circuit. From that speed up to 4,000 R. P. M., the limit of the motor, the logarithmic decrement remained constant at 0.06.

The next experiment was to detune the two circuits about 100 meters, with the result shown in the resonance curve, Figure 1. It was evident from the presence in the antenna circuit of the primary hump that impulse excitation had by no means been attained.

A light transformer oil was then introduced into the gap, flooding the gap completely, to see if the increased resistance would enhance quenching. But here, a mechanical difficulty asserted itself. Because of the presence of the oil (light as it was), the confined space in which the sectored plates revolved and the excessive churning up of the oil prevented the gap from coming up to speed with the size motor used, with the result that the sparking was irregular, the tone poor, and the condensers so overstrained as to cause puncture.

A gap was then constructed in which the sparking surfaces were mounted on an open frame instead of being enclosed in the usual casing. This open frame was then lowered into an earthen receptacle into which oil was poured. It was hoped by this new construction to overcome the friction caused by the violent

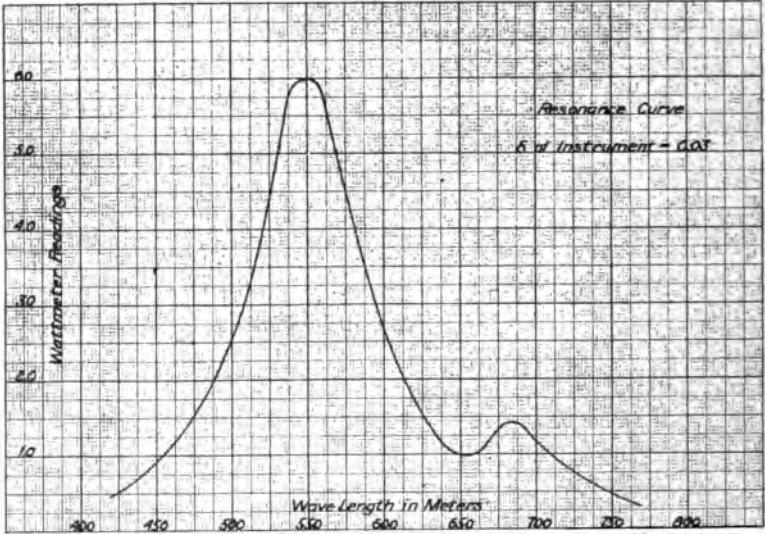

FIGURE 1

disturbance of the oil in so confined a space. The gap was more nearly brought up to speed, as had been expected, but the oil was freely thrown from the container, and air bubbles found their way into the sparking area with consequent explosions which caused the sparking to be so irregular as to make quantitative measurements with the decimeter impossible.

It was decided to return to the original type of enclosed gap, using a much larger motor to bring the gap up to the desired speed. But the largest motor at hand, 0.75 horse-power, failed to effect this; so the oil was removed by a pet-cock at the base of the gap and alcohol substituted in the hope that the lighter liquid would cause less friction. However, alcohol, when subjected to a potential difference of 2,500 volts across a distance of a few thousandths of an inch, exhibits slight insulating qualities, as was discovered; and leaked so badly as to prevent the passage of a spark.

The alcohol was accordingly allowed to run out of the gap, and measurements were again taken to confirm the results of the second experiment—to see if it were still impossible to detune the circuits without the generation of two frequencies in the antenna circuit.

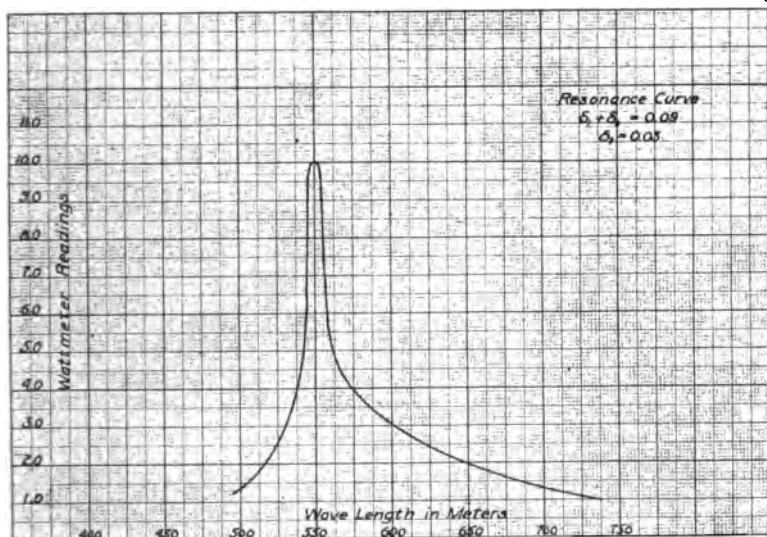

FIGURE 2

The same results as shown in Figure 1 were again obtained. To see if the gap were inadequately cooled, the spark was allowed to run five minutes, and when a resonance curve was taken at the expiration of that period, the curve shown in Figure 2 was obtained, showing a logarithmic decrement of 0.06.

The explanation was at once apparent. The pet-cock at the base of the gap was so mounted as to leave a small quantity of the alcohol in the base of the casing or housing. This, because of the heat of the spark, vaporized; thus enhancing the quenching properties of the gap. This action has been previously noted by Scheller, Poulsen, Eccles and Makower, and others.

Additional resonance curves were taken to check the first reading, the spark being allowed to operate continually. However, after ten minutes, sparking in the chamber became irregular, and was replaced by occasional and later by continuous sparking across the condenser safety gap, the electrodes of which

were separated a distance of 1.5 centimeter. It was of course obvious that the pressure of the alcohol vapor within the chamber had been so greatly increased by the continuous sparking, and consequent liberation of heat, as to reach a dielectric strength sufficiently high to prevent the passage of the spark.

To reduce the pressure within the gap, and thus to allow sparking to take place, the pet-cock was opened and a small quantity of the vapor allowed to escape. The high pressure within the spark chamber was clearly demonstrated by the almost explosive force of the escaping gas. Sparking again occurred but stopped after a few minutes because of the pressure again rising to too high a value. This condition was relieved by opening the cock a second time. The vapor was purposely ignited this time and burned quietly a distance of several centimeters from the opening, exhibiting by the great heat and colorless flame the presence of what appeared to be almost pure hydrogen.

The necessity for an automatic device to provide for a reduction of the gas pressure when it should reach too great a value was obvious. Accordingly, the pet-cock was removed, and an adjustable, poppet, release valve substituted. When the gap was again put into operation, this also served to handle the first explosion caused by the admission of air into the chamber when making alterations on it. This preliminary explosion is encountered in the operation of Poulsen arc transmitters, when air has been admitted into the arc chamber thru the replacement of a carbon.

The release valve was set so as to allow vapor to escape when the pressure reached a value beyond which a further increase in pressure would prevent the passage of the spark.

The quenching properties of this gap are thus seen to be wholly within the control of the operator or engineer, a unique feature, which, to the writer's knowledge, has not been used before.

The vaporization of alcohol or other hydrocarbons in a quenched gap is by no means a recent innovation. Poulsen, Scheller, Rein and others have vaporized the alcohol directly within the gap, and the Japanese have blown alcohol vapor, formed by passing a stream of air thru a sponge saturated in that liquid, into their quenched gaps. However, it is believed that the working of the hydrogen vapor within the gap at such an extreme pressure as to prevent sparking therein, except by automatic reduction of same, is a feature hitherto unused, and

which is solely responsible for the efficient performance of this gap for impulse excitation work.

The quenching properties of the usual quenched gap depend greatly on the extent to which the gap is cooled. With the gap herein described, the more heat generated within the gap, the greater is the gas pressure formed, so that the one action automatically compensates for the other. Cooling of the spark dischargers themselves is to be desired, and this is effected, as far as the stationary plate is concerned, by mounting radiating plates on the posts holding the plate to the casing.

Figure 3 illustrates the gap proper. The alcohol drip cup is shown at the top of the gap. This is equipped with a pressure equalizer, a tube running from the inside of the spark chamber to the top of the cup, to insure a steady flow of alcohol. With such an arrangement, it is necessary to keep the cap, by which alcohol is poured into the cup, air-tight. The safety release valve is shown at the bottom of the gap. As previously explained, the hand wheel on the valve is adjusted so as to keep the vapor pressure just below that value which prevents sparking. A rubber tube, not shown, serves to conduct the vapor from the mouth of the valve, acting as an exhaust pipe. The complete casing is of iron, leads being carried into the gap thru bakelite bushings. The construction of the stationary and movable plates is similar to that of the Clapp Eastham gap.

Figure 4 shows the complete 2 kilowatt transmitter. All wiring is done within the frame itself. Four variations of primary input are possible, being controlled by the switch at the right of the panel. At the rear of the panel are mounted the closed core transformer and the condenser. The latter is built up in one unit, using copper sheets with thin Belgian picture glass for dielectric, the whole impregnated in a non-hygroscopic compound. The low secondary voltage effectually prevents puncture, but the condenser is so mounted as to permit of the immediate substitution of a spare unit should any unforeseen accident to the condenser occur.

A closer view of the oscillation transformer is shown in Figure 5. Since tuning between the primary and secondary circuits is not necessary, the primary inductance is made non-adjustable. In the set shown, it consists of two turns. The greater coupling gained by using two turns instead of but one increased the antenna radiation, and did not seem materially to affect the damping of the primary current, the increased absorption by the secondary circuit probably compensating

for the less favorable effect of increased inductance in the primary.

Since all of the energy is to be delivered in one half cycle, or as nearly that as possible, it is necessary to have the resistance of the metallic circuit as low as practicable, and to have as



FIGURE 3

much of the primary inductance as possible effective in inducing energy in the secondary. One end of the primary inductance connects with the gap as shown, the other end to the condenser thru merely the thickness of the panel, 2.5 centimeters. The remaining lead from the gap to the condenser is about 8.0 centimeters in length.

The antenna loading inductance is mounted independently of the panel. This inductance is wound in the usual helical form and taps are taken from this to four plugs marked $\lambda=300$, $\lambda=400$, $\lambda=500$, $\lambda=600$, respectively. The position of these taps is of course determined by wave meter, being dependent on the fundamental wave length of the antenna. This inductance



FIGURE 4

is mounted so as to permit of immediate change from one wave length to another. Since the primary wave length remains constant for any wave length it is desired to radiate from the antenna circuit, it is only necessary to insert the aerial-lead handle in any of the plugs mentioned.



FIGURE 5

In operation, the tone of signals received from this transmitter is clear and piercing altho accompanied by a slight "feathery" tone, to use operator's nomenclature. This is probably due to the fact that discharges cannot always take place when the gap sectors are opposite each other, due to the non-synchronous revolution of the gap. However, this slight roughness is by no means displeasing; and even with local signals, the impulse group frequency of about 1,000 is not accompanied by the 60 cycle supply tone.

An antenna radiation curve of this transmitter is shown in Figure 6. In a true impulse excitation transmitter, other things being equal, one would expect, from Dr. Rein's paper, that the radiation would be constant, irrespective of the difference in wave length between the primary and antenna circuits. In other words, with the primary adjustment fixed, a curve of radiation current readings, plotted against different wave length settings of the antenna circuit, should be a flat linear curve, as against the sharp peak radiation curve of a resonant quenched transmitter. In Figure 6, the point at $\lambda=300$ is not

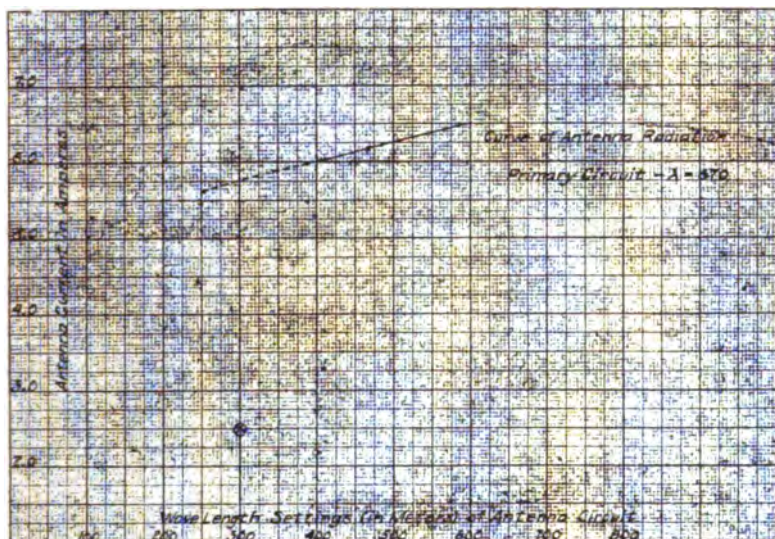

FIGURE 6

significant, since the fundamental wave length of the antenna necessitated the interposition of a series condenser in the antenna circuit for this wave length setting with the usual consequent decrease in radiation. The slight rise in the curve from 400 meters upward may be due to the diminishing antenna resistance at longer wave lengths just as much as to the fact that an approach to 670 meters in the antenna circuit places the primary and antenna circuits in resonance. This curve is similar to curves previously taken of the impulse excitation transmitters of the Kilbourne & Clark Mfg. Co.

Experiments were also conducted to observe the effect of

shunting a tone circuit across a gap, employing smooth discs in place of the usual sectored dischargers. The results were interesting. Without the tone circuit, the note obtained was a smooth, hissing one; signals being received far better on a Poulsen tikker than with the crystal or audion detector. The impulse frequency is above the limit of audibility, and that the spark is audible at all is due to the fact that the condenser is charged with alternating current instead of the direct current which should be used for ideal impulse excitation. This results in a somewhat irregular impulse frequency, due to the fact that the charging E. M. F. passes thru the zero point 120 times per second and also to the fact that the secondary wave of the transformer is probably not a perfectly rectangular flat-top one.

The quenching properties of the smooth gap seemed to be greater than those of the sectored gap, as evidenced by curve b of Figure 7. This curve is a resonance curve of the antenna

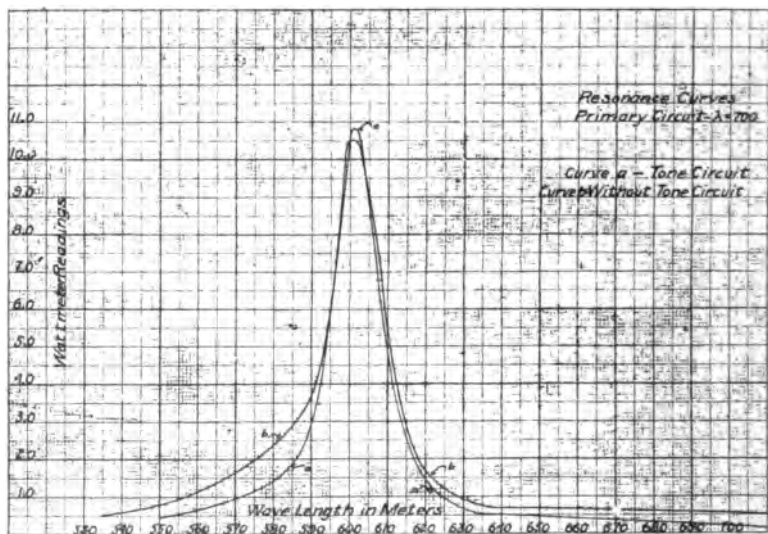

FIGURE 7

circuit, the logarithmic decrement being 0.052 as against the 0.06 decrement of the curve in Figure 2. The increased decrement is probably due to the larger gap or discharge surface.

A tone circuit, the capacity and inductance of which were determined by trial, was shunted across the gap, causing increased damping of the primary current as shown in curve a

of Figure 7, the decrement of which is 0.050. The absorption of energy by the tone circuit apparently assists in increasing damping in the primary circuit in the same fashion as the absorption of energy by the antenna circuit. While the antenna current was reduced about 1.5 per cent. by the use of the tone circuit, the height of curve *a* in Figure 7, when compared to that of curve *b*, shows that the energy at the oscillation frequency of the antenna circuit is slightly greater. (The coupling between the antenna circuit and the decremeter was constant in taking the data for both of these curves.)

Due to the alternating current, the note obtained with the tone circuit was not musical, but nevertheless was shrill, clear and piercing. At a receiving station, signals with the tone circuit were many times louder than without this circuit. Possibly, the note may be improved by the use of a higher frequency alternating current, say 500 cycles. Experiments will be undertaken later to observe this.

The tone circuit was then tried in conjunction with the sectored gap, but the resultant tone was poor. Certain speeds of the gap were found which tended to improve the tone greatly, but at no time was the note as clear as when the tone circuit was omitted. (These critical gap speeds were probably those which placed the impulse group frequency in resonance with the oscillation frequency, or a multiple thereof, of the tone circuit.)

On the whole, of all the experiments herein described, the best results were obtained using the smooth discs and the tone circuit. The addition of the tone circuit did not change the appearance of the transmitter as shown in Figure 4, the additional inductance and capacity being mounted on the rear of the panel.

SUMMARY: Ideal "impulse excitation," as opposed to the usual quenching gap phenomena, is described. The best conditions for impulse excitation are explained.

The development of a rotary sectored gap of small separation operating in a hydrocarbon atmosphere is considered. A 2,500 volt, 60 cycle transformer charges a large capacity which discharges thru the gap and a small inductance. Effective impulse excitation requires about 2,400 R. P. M. of the gap or more. Using alcohol vapor, an adjustable pressure, (safety) valve must be fitted to the gap to prevent excessive pressures which raise the gap voltage inordinately.

A complete 2 kilowatt transmitter of this type is described. The antenna circuit need not be in tune with the closed circuit; hence wave changing is accomplished by merely shifting the antenna lead along the antenna loading inductance. The radiation remains constant over a wide range of wave lengths without closed circuit tuning.

Smooth-disc gap experiments are also described.

I hope, at some time, to present a paper dealing with the development of the impulse transmitters manufactured by the Kilbourne & Clark Mfg. Co. and to describe certain phenomena encountered in the development of this apparatus, which I believe will prove of interest to radio engineers.

Mr. Stone's paper is undoubtedly a valuable contribution to this most interesting subject, and it is hoped that he will give us the benefit of his further contemplated work along these lines.

EXPERIMENTS AT THE U. S. NAVAL RADIO STATION DARIEN, CANAL ZONE*

By

LOUIS W. AUSTIN

(HEAD, U. S. NAVAL RADIO TELEGRAPHIC LABORATORY ; PAST PRESIDENT
OF THE INSTITUTE OF RADIO ENGINEERS.)

The three towers for the Darien radio station were completed early in 1915. These towers are of the self-supporting type, each 600 feet (182 meters) high and approximately 900 feet (273 meters) apart, forming a triangle. The acceptance tests of the station gave another opportunity for carrying out long distance experiments in radio transmission which are, in a sense, a continuation of those earlier experiments carried on at Brant Rock and at Arlington which have already been described.¹

The experimental work was begun in March, 1915. At this time the permanent antenna which consists of a triangular net of wires without spreaders, having a capacity of 0.01 μ f. and an effective height of 480 feet (146 meters), was not in place, so the receiving during the first month was carried on with a 4-wire, flat-top antenna 400 feet (122 meters) long and 10 feet (3 meters) wide, stretched between two of the towers. The effective height of this antenna was calculated to be 480 feet (146 meters), and its capacity 0.003 μ f. The ground system of the station consisted of a buried wire net covering the whole space inside the towers and extending to a considerable distance outside.

In the receiving experiments, a de Forest oscillating audion² with beat tone reception was used as a detector. This form of detector had been under investigation at the Naval Radio Laboratory for about a year before the Darien experiments were begun and had been found to give practically uniform sensitive-

*Presented before the Washington Section of The Institute of Radio Engineers, November 27, 1915.

¹"Bulletin, Bureau of Standards," 7, p. 315. Reprint 159, 1911.

"Bulletin, Bureau of Standards," 11, p. 69. Reprint 226, 1914.

²"Proc. Inst. Radio Engineers," 3, pages 215 and 261, 1915.

"Journ. Amer. Soc. Naval Engineers," 27, page 358, 1915.

ness when properly adjusted,¹ except in the case of bulbs which, on account of imperfect exhaustion, behaved abnormally. Careful comparisons had been made of the relative sensitiveness of the oscillating audion and the electrolytic, the experiments showing that the normal oscillating audion gives from five hundred and one thousand audibility (depending on the telephone note) for unit audibility with the electrolytic.² It was also found that while the electrolytic and non-oscillating audion give telephone audibilities proportional to the square of the received current, the oscillating audion responds in proportion to the first power of the received current. Aside from the matter of telephone note, the sensitiveness seems to be the same for undamped and for damped oscillations, except when the spark trains are very short.

Figure 1 shows the circuits used for reception. It will be noted that the secondary receiving circuit is connected to the

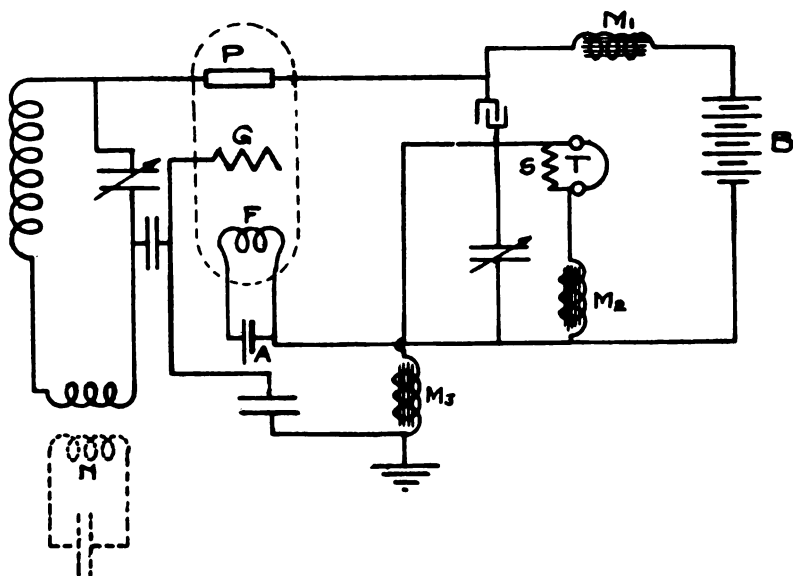

FIGURE 1

intermediate or grid electrode *G* in the audion, and to the plate electrode *P*, forming the ultraudion connection. The fila-

¹The adjustment for greatest sensitiveness requires special skill on the part of the operator. Quantitative readings taken by untrained men will give considerably lower sensitiveness.

²"Bulletin, Bureau of Standards," 11, page 77. Reprint 226, 1914.

ment F is heated to incandescence by the storage battery A , while a steady flow of electrons is produced by the dry battery B . The telephones used in the experiments are placed in a shunt circuit in parallel with the audion, instead of in series with it as the more usual custom. The atmospheric disturbances are slightly less troublesome with this connection, and the sensitiveness to signals remains the same. The circuit described is designated the plain audion circuit, and for its best action the coupling between the antenna and secondary must be close, since the oscillating audion reaches its full sensitiveness only when the local oscillations are reduced in intensity by withdrawing energy into some neighboring circuit.

The sensitiveness may be increased some three or four times above that of the plain audion circuit by the use of a sensitizing circuit N for reducing the amplitude of the local oscillations. This consists simply of an inductance and capacity coupled to the secondary and tuned close to the resonance point. By the use of this circuit it is possible to work with a looser antenna coupling without loss of sensitiveness.

The strength of the received signals was measured by the shunted telephone method, the audibility of the signals being expressed in telephone current. The non-inductive resistance S (Figure 1) is placed across the telephone leads and the resistance reduced until the signal just remains audible. The unshunted telephone current is then

$$A = \frac{t+S}{S}$$

where t is the effective telephone resistance for the telephonic frequency used and S is the value of the shunt. The audibility A represents the ratio of the actual telephone current to the least audible telephone current of the same frequency. When the non-inductive shunt is placed across the telephones, it is necessary to have a choke coil M_2 or a second pair of telephones in series. On account of the effect of the observer's body, it is also necessary if the signals are strong, to earth one of the telephone leads thru a proper choke (2,000 ohm telephones). Which telephone lead should be earthed must be determined by trial.

Table I gives some of the results of the receiving experiments at Darien. As Arlington was the only station on which daily observations were made, the observations on its signals should be given much greater weight than the others in the table.

TABLE I

STATIONS RECEIVED AT DARIEN

	Distance Km.	I_s Amp.	λ Meters	h_1 Meters	R Ohms	W (Calc.) Watts	Audibility Calculated	Audibility Observed
Arlington.....	3,330	60	6,000	61 ²	23.2	$6.85 \cdot 10^{-8}$	7,500	5,000
Tuckerton.....	3,430	115	7,400	150	25.	$1.25 \cdot 10^{-6}$	32,000	10,000
Sayville.....	3,520	140	9,400	100	14.	$1.26 \cdot 10^{-6}$	32,100	7,500
San Diego.....	4,670	35	3,800	68	26.5	$1.63 \cdot 10^{-9}$	1,150	0-100
San Francisco (Federal).....	4,820	40	6,500	120	23.5	$4.65 \cdot 10^{-9}$	2,050	0-1,000
Honolulu ¹ (Federal).....	8,500	60	10,000	120	13.5	$4.16 \cdot 10^{-10}$	580	150
Nauen.....	9,400	150	9,400	150	29.	$9.95 \cdot 10^{-10}$	900	200
Eilvise.....	9,160	140	7,400	150	25.	$5.67 \cdot 10^{-10}$	705	200

¹Received on large antenna.² h_1 corrected from short range observations. For other stations h_1 is uncorrected.

All of the signals of less than one thousand audibility were very much affected by the atmospheric disturbances, probably being inaudible many times on this account alone.¹ Column 1 gives the approximate distances of the various stations from Darien, Column 2 the strength of sending antenna current. This, however, was not known reliably in all cases. Column 3 gives the wave length, 4 gives the estimated effective height of sending antenna, 5 the total effective resistance of the receiving system for the given wave length, 6 gives the calculated received watts, 7 the calculated audibility, and column 8 the observed audibility.

TABLE II

Audion Audibility	Received Watts	Audion Audibility	Received Watts
5,000	$3.05.10^{-8}$	60	$4.41.10^{-12}$
4,000	$1.96.10^{-8}$	50	$3.05.10^{-12}$
3,000	$1.11.10^{-8}$	40	$1.96.10^{-12}$
2,000	$4.40.10^{-9}$	30	$1.11.10^{-12}$
1,500	$2.75.10^{-9}$	25	$7.66.10^{-13}$
1,000	$1.23.10^{-9}$	20	$4.40.10^{-13}$
800	$7.84.10^{-10}$	16	$3.14.10^{-13}$
600	$4.41.10^{-10}$	12	$1.765.10^{-13}$
500	$3.05.10^{-10}$	10	$1.23.10^{-13}$
400	$1.96.10^{-10}$	8	$7.84.10^{-14}$
300	$1.11.10^{-10}$	6	$4.41.10^{-14}$
250	$7.66.10^{-11}$	5	$3.05.10^{-14}$
200	$4.50.10^{-11}$	4	$1.96.10^{-14}$
160	$3.14.10^{-11}$	3	$1.11.10^{-14}$
120	$1.765.10^{-11}$	2.5	$7.66.10^{-15}$
100	$1.23.10^{-11}$	1.0	$1.23.10^{-15}$
80	$7.84.10^{-12}$		

Table II gives the received watts corresponding to the various audibilities using the oscillating audion without sensitizing circuit, as deduced from the experiments at the Naval Radio Laboratory which showed that for unit audibility with the electrolytic, the oscillating audion gave an audibility of 1,000. The watt sensitiveness of the electrolytic was taken to be 12.25×10^{-10} watts² using telephones of 2,000 ohms resistance and a current

¹The normal disturbances at Darien except in the morning were so strong that with the telephones on the table a crackling rumble could be heard in all parts of the receiving room. To prevent the breaking down of the local oscillations due to these heavy atmospheric discharges, it was found necessary to earth the grid electrode of the audion thru a small capacity.

²"Bulletin, Bureau of Standards," 11, page 69, 1914. Reprint 226.

sensibility of 5.10^{-10} amperes at a frequency of 1,000 per second. This table cannot lay claim to perfect accuracy as applied to the Darien receiving set, since it was derived from experiments with a different receiver, and it might be supposed that the sensitiveness of the oscillating audion might probably vary with the ratio of inductance and capacity. Experiments thus far made, however, do not indicate with certainty that there is any such variation. At any rate, it is safe to say that the values given in Table II are approximately correct.

All of the observations recorded in the table, except those on Sayville and Honolulu, were taken on the small receiving antenna during the month of March. A series of daily observations extending over a period of a week were taken on Honolulu early in May, using the large antenna. Tuckerton was measured about every second day during March, San Francisco, Nauen and Eilvase were measured only a few times so these observations have comparatively little value. San Diego with its short wave length coming all the way overland could not be expected to approach its calculated over-sea audibility. It will be noted that Arlington is the only station in which the observed audibility approaches the calculated, but in this case Arlington's effective height h_1 , was determined experimentally from observations made at near-by stations and is only about one-half of the height to the geometric center of capacity. If the effective heights of Tuckerton, Sayville and Honolulu were reduced in the same ratio, the agreement of their observed and calculated values would be nearly as good. The great weakness of the day signals from Nauen and from Eilvase is astonishing, as in Washington they come in with their full calculated audibility.

Beginning with May, regular observations on the received signals from Darien were taken at the Naval Radio Laboratory at the Bureau of Standards. The signals were received on a flat-top antenna 450 feet (130 meters) long, having a capacity of $0.00155 \mu f$ and an effective height of 100 feet (30 meters). This effective height is practically the same as that of the old harp antenna described in former papers, and has the advantage over the harp of having a much lower ground resistance at the longer wave lengths.

TABLE III

**DARIEN RECEIVED AT THE U. S. NAVAL RADIO LABORATORY,
BUREAU OF STANDARDS**

$h_1 = 146$ m. $h_2 = 30$ m. $I_s = 100$ amp. $\lambda = 6,000$ m.
 $d = 3,330$ Km. $R = 75$ ohms. Calculated audibility = 3,600

	OBSERVED AUDIBILITY				Number of Obser- vations
	Total Average	Maximum	Minimum	Normal Average*	
1915					
May.....	8,700	20,000	1,000	3,100	11
June.....	33,000	100,000 (Estimated)	300	3,700	11
July.....	9,000	50,000	600	3,800	12
August.....	4,100	20,000	400	2,300	19
September.....	1,330	2,000	300	1,330	13
October.....	1,460	3,000	400	1,460	9
November.....	21,500	40,000	5,000	4
December.....	13,750	30,000	5,000	4

Table III gives the monthly averages of the results of these observations. A large number of measurements were made between May first and November first, and since that time have been taken weekly. During the summer, except in June, the general intensity was between 1,000 and 3,000 audibility, with occasional periods of greater intensity, going up to 30,000 or 40,000 audibility while on one or two occasions the intensity has been so great that the signals could be heard a hundred feet from the telephones without the use of any amplifying device. Since the first of November, the signals have been uniformly strong. The calculated value of audibility is given at the top of the table.

September and October are seen to be the months with the lowest averages. This is due not so much to exceptionally weak signals as to the fact that there were no periods of extraordinary intensity such as occurred in the other months.

One of the most interesting points in this table is the astonishingly high occasional values of the audibility, observed during June, July and August, a time of year which is generally supposed to be especially unfavorable for radio communication.

*The normal average excludes the occasional excessively high peaks of the audibility curve which are supposed to be produced by the same causes which produce the irregular and strong signals at night at shorter wave lengths. U. S. Naval Radio Laboratory.

Comparing the calculated values¹ of the Navy formula

$$I_R = 377 \frac{h_1 h_2 I_s}{\lambda d R} \epsilon^{\frac{0.0015d}{\sqrt{\lambda}}}$$

and that of the Sommerfeld purely theoretical formula,

$$I_R = 377 \frac{h_1 h_2 I_s}{\lambda d R} \epsilon^{\frac{0.0015d}{\sqrt[3]{\lambda}}}$$

we find that the Sommerfeld formula would give 15 times audibility for Eilvese received at Darien, and 20 times audibility for Honolulu received at Darien. These values are so far below those observed as to support the conclusion in the paper last cited that, in order to represent the usual observed values an additional term must be added to the theoretical formula, representing energy reaching the receiving station by reflection.

It seems possible that the Sommerfeld formula represents the very lowest values of received signals, and that these are ordinarily strengthened by energy from the upper atmosphere the intensity of which would probably depend on the wave length. On this supposition, the scattering term of the empirical formula would represent the sum of these two effects which in their combination might very possibly introduce the square root of the wave length instead of the cube root, as indicated by theory.

U. S. Naval Radio Laboratory,
Washington, February, 1916.

SUMMARY: The results of measurements of the strength of received signals at Darien from a number of stations are given. A specially modified ultraudion circuit is used. The Austin-Cohen formula is found to give much closer agreement with the observations than the Sommerfeld formula. Relations between received current and audibility are given for the audion and ultraudion.

¹"Bulletin of the Bureau of Standards," 11, page 269. Reprint 226, 1915.

DISCUSSION

John L. Hogan, Jr.: This interesting paper of Dr. Austin's would have been of more value to me, and I think possibly to others of us, if a few specific points had been cleared up. I am sorry that Dr. Austin himself is not with us this evening, since he could without doubt explain the several relations of detector-organization sensitiveness which appear confusing.

The paper states that the oscillating audion, or auto-heterodyne, has been found to have from 500 to 1000 times the sensitiveness of the electrolytic detector, the exact ratio depending upon the telephone note. I do not understand whether this reference is to grouped-wave or to sustained wave reception. If the grouped waves were received, was the audion in the oscillating condition, and the group frequency tone destroyed, or was the tube in a critical condition and was amplification secured by regenerative action? If sustained waves were used for the comparison, was the electrolytic detector excited according to the heterodyne method, or was a chopper used?

At the end of the third paragraph of the paper it is stated that the oscillating audion or auto-heterodyne has the same sensitiveness, aside from the matter of telephone note, for slightly damped and for sustained waves. How are these measurements made, and what relation have they to the figures quoted above? Further, does this equality of sensitiveness hold when the sensitizing circuit N of Figure 1 is added? It is stated that the presence of this absorbing circuit increases the sensitiveness of the self-excited audion heterodyne by three or four times, giving apparently a total improvement in sensitiveness to a point some 4,000 times that of the electrolytic detector.

Since the ordinary amplification ratio of the single audion bulb is usually taken to be in the neighborhood of five, it would appear that Dr. Austin's work has been done under conditions in which the signals were continuously amplified by regeneration. This adjustment of circuits is notoriously unstable, and with it quantitative results showing consistent performance are very difficult to secure. The variation from day to day, or from one adjustment to an attempted repetition of it at some later time, is likely to be especially great when the regenerative audion is used to take measurements according to the shunted telephone.

With regard to table 1, it may be noted that the observed audibility ranges from one twentieth to one third the calculated

audibility. If the effective heights of the transmitting stations were halved, as suggested, somewhat better agreement would of course be secured. It appears to me, however, that one should consider the desirability of decreasing the assumed ratio of detector sensitiveness. If the sensitiveness of the ultraudion is taken to be only 500, instead of 1000 times that of the electrolytic, better agreement can be secured without the necessity of departing from the earlier conception of effective height. Until these measurements can be confirmed with so constant a device as the tikker, it would seem wise not to overthrow the relation between geometric and effective height which has been found to agree so well with quantitative results of many earlier observations.

This matter of checking ultraudion observations against tikker reception might also be borne in mind in attempting to pin down the causes for such tremendous variations in intensity as are indicated by table 3. Changes in received power so great as those implied by the observations of table 3 seem to indicate variations in net sensitiveness of the receiver, as well as changes of the medium between the two stations. Further, the effect of strong atmospherics, in reducing the apparent sensitiveness of receiving apparatus for telephone shunt observations, must not be underestimated.

The fact that in spite of a measured intensity of 5,000 audibility, it is very difficult for Darien to copy messages transmitted from Arlington, confirms the earlier indications that large numerical values of audibility to signal are useless in commercial radio telegraphy unless the intensity of response to strays is limited. In the absence of severe atmospheric disturbance, one can of course amplify feeble signals indefinitely, and in that way read messages which were entirely inaudible before successful telephone or radio frequency relays had been produced. When strays co-exist with the signals, however, amplification of the ordinary sort becomes futile. This indicates the need of a measurement of signal intensity which is based upon the ratio of signal strength to that of normal strays, for a given detector organization, rather than upon the mere audibility of signals in the absence of strays.

Leonard F. Fuller (communicated): Dr. Austin's work upon transmission formulas has required a vast amount of exacting and tedious measurement under difficult conditions. This was especially true at Darien where the atmospheric disturbances were very severe. Probably those who have attempted

such measurements can best appreciate the amount of detail, the trying difficulties and the chances of error.

The shunted telephone method is the only practical means developed at present for taking such data and since it involves the human ear, it is not surprising that results taken by different observers, or even the same observer at different times, vary widely. Furthermore, it involves telephone impedance which is determined by telephone resistance and reactance and is a function of the audio frequency.

In the reception of damped waves the group frequency is fairly constant and reasonably well known at the receiver, hence the correct telephone impedance value may be chosen reasonably well for the calculation of "observed audibility." In the reception of undamped waves, however, using an oscillating audion, with beat tone reception, as a detector, the audio frequency is altogether dependent upon the receiver adjustment and may be varied at the will of the receiving operator. In this case, therefore, choice of the proper value of telephone impedance is not an easy matter.

The determination of the correct resistance of the receiver is also a source of error and measured values of h_1 and h_2 are rarely available.

One should bear all these difficulties of observation and chances of error in mind when commenting upon such data as are given in Dr. Austin's paper, and should attempt to adjust the mind to consider differences of 100 per cent. between calculated and observed audibilities as we consider errors of 1 per cent. in many laboratory electrical measurements.

I believe Dr. Austin's formula gives a better approximation of actual results than any yet published. While the formula involving $\epsilon^{-\frac{0.0045d}{\lambda^2}}$ discussed in the paper on "Continuous Waves in Long Distance Radio Telegraphy," "Proceedings A. I. E. E.," Volume 34, number 4 was derived from data taken with considerable care and while it checked Honolulu, San Francisco and Tuckerton, San Francisco data very nicely, it gives absurdly high values of calculated received watts when compared with the values observed in the receiving experiments mentioned by Dr. Austin.

The following experiments, involving the reception of Darien at Honolulu may be of interest, inasmuch as they cover signals in the reverse direction over the same path of 8,500 kilometers mentioned in Dr. Austin's paper.

On May 30, 1915 from 3 to 3:30 P. M., Washington time, (9:30–10 A. M., Honolulu time), Darien transmitted upon a wave length of 15,000 meters and observations of received signal strength were made at Honolulu using an oscillating audion receiver. The variables in the transmission formula were as follows:

$$d = 8,500 \text{ km.}$$

$$\lambda = 15,000 \text{ m.}$$

$$h_1 = 146 \text{ m.}$$

$$h_2 = 120 \text{ m.}$$

$$I_s = 90 \text{ amps.}$$

$$R_r = 25 \text{ ohms approx.}$$

The calculated audibility was 1,000.

The observed audibility was determined as follows:

Honolulu reported a shunt of 51 ohms on telephones having an impedance of 5,000 ohms per pair at 500 cycles with a telephone resistance of 2,400 ohms per pair. This gives a reactance of 4,385 ohms on 500 cycles or 8,770 ohms on 1,000 cycles, hence the impedance is 9,070 ohms at this frequency and the observed audibility 180.

Darien was audible at South San Francisco but unreadable.

Prior to and after this test Darien was received at Honolulu many times on wave lengths from 6,000–18,000 meters with similar results, but inasmuch as no previously planned tests were conducted, no further specific statement of observations is possible. It is reasonably probable, however, that during the test of May 30, 1915, conditions were approximately normal between Darien and Honolulu.

On March 27 and 28, 1916, 2:30 to 3:00 P. M., Washington time (9–9:30 A. M., Honolulu time), Darien transmitted in pre-arranged tests to Honolulu. The variables in the transmission formula during these tests were as follows:

$$d = 8,500 \text{ km.}$$

$$\lambda = 10,000 \text{ m.}$$

$$h_1 = 146 \text{ m.}$$

$$h_2 = 120 \text{ m.}$$

$$I_s = 79 \text{ amps. on March 27, 1916.}$$

$$70 \text{ amps. on March 28, 1916.}$$

$$R_r = 26 \text{ ohms. approx.}$$

This gives a calculated audibility of 610 on March 27, 1916, and 537 on March 28, 1916.

The observed audibilities calculated in the same manner as the May, 1915, test were 110 for March 27, and 180 for March 28, 1916.

Since it was earlier in the year, the overland transmission over Mexico was considerably better than in May, 1915, so that whereas in May, 1915, Darien was barely audible at South San Francisco, in March, 1916, the signals were easily readable. Darien was also audible but unreadable on a small downtown office receiving antenna in San Francisco in this year's tests.

Continued tests during the months of May and June, 1915, wherein the Darien signals received at Honolulu were expressed in terms of commercial value rather than measured audibilities gave the following results with daylight over the entire path of transmission:—

Honolulu reported consistently that with a radiation of 75 amperes or below, the signals were weak but readable without interference; from 75 to 80 amperes fair, and from 85 to 100 amperes good readable signals. This referred to cipher and code on wave lengths of 10,000 meters and above.

Wave lengths of 15,000 and 18,000 meters gave an audibility ten times that observed on 8,000 meters. The 6,000 meter wave was a little weak but as a rule no great change in signal strength was noticeable from 6,000 to 10,000 meters, the great gain being from 10,000 to 18,000 meters.

At San Francisco the 15,000 and 18,000 meter waves gave better received signals than were obtained on waves of 10,000 meters and below, but on account of the increase in atmospheric disturbances they were no more readable than the shorter waves.

It is to be noted therefore that at Honolulu in March of this year, a 10,000 meter wave gave the same observed audibility as waves of 15,000–18,000 meters in May, 1915, and at San Francisco a considerably greater audibility.

Dr. Austin's Darien observations show calculated audibilities approximately four times the observed, suggesting as he mentions, the possibility of correcting h_1 and h_2 in the ratio found necessary at Arlington. However, the observed and calculated values check very well when receiving at the Bureau of Standards.

In the tests of Darien received at Honolulu, it is again to be observed that if calculated audibilities are altered by correcting h_1 and h_2 in the Arlington ratio the results approach more nearly the observed values.

The receiver resistance values for the receiving experiments at Honolulu are altogether approximations. I believe it would be of interest to many of the members of The Institute of Radio Engineers if Dr. Austin would describe in detail the method he used in determining this value in his work. A statement of his ideas on the error introduced by telephone impedance changing with audio frequency and the probable percentage error in his observations neglecting any errors in the h_1 and h_2 values would be most valuable.

Edwin H. Armstrong: Before discussing this paper, I would very much like to have a little more information about the operation of the apparatus that Dr. Austin used. I am fairly familiar with the regenerative audion and its use as a self-heterodyne, but nothing seems to have been published about the manner of operation of this so-called "ultraudion." This occasion is the first opportunity I have had for getting some first hand information about it, so I am going to ask Dr. de Forest if he will not be good enough to explain how it works. In the absence of an explanation by Dr. de Forest, I wish to advance the following explanation.

You might expect from the name that there is something super-mysterious about the action of this device, and from the manner in which the ultraudion circuit is drawn there is good ground for this belief. But when the circuit is re-drawn as in the accompanying sketch, it becomes at once evident that it is an ordinary regenerative circuit, dependent for its operation on a coupling between grid and wing circuits.

The wing circuit is coupled with the grid circuit thru the combined electrostatic and electromagnetic coupling of the condenser C and telephones T which are located in the common part of both circuits. Thru the medium of this coupling, some of the energy of the radio frequency current set up in the wing circuit by an incoming signal is transferred back into the grid circuit in the manner explained in my paper of March, 1915, in which the identically same form of coupling is shown.

That the arrangement regenerates can be shown experimentally (for the non-oscillating state), by measuring the current set up in the grid circuit by an incoming signal first with the audion disconnected from the rest of the circuit and second, with the audion connected and condenser C adjusted so that the system is fairly close to the point of oscillation. It will be found that the current will have increased very many times over

its value with the audion disconnected. Obviously the audion is supplying energy to the grid circuit and the only source from which this energy can come is the wing battery *B*. A current amplification of 50-fold can be obtained by adjustment of the coupling condenser *C* before the system begins to oscillate.

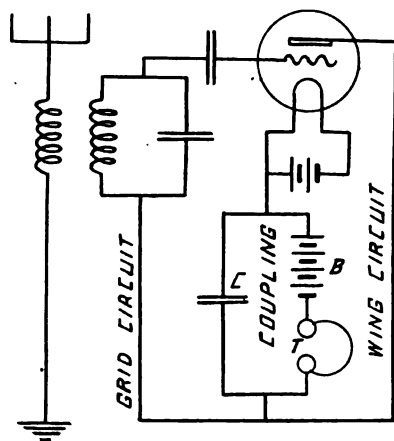

FIGURE 1

After local oscillations start the amplification can no longer be measured in this simple manner, but both theory and practical results show that the amplification due purely to the regenerative action apart from the added heterodyne amplification is markedly increased.

The sensitizing circuit of Dr. Austin is a very ingenious and interesting thing. In the non-oscillating regenerative circuit one can tune the grid circuit exactly to the incoming frequency so that (for continuous waves and loose coupling) the impedance of the circuit is equal to the effective resistance. When you make the system oscillate and receive by the beat principle then the circuit can have zero reactance for the local frequency only, and must oppose a definite reactance for the signaling frequency. The impedance of the circuit for the signaling frequency may thereby be greatly increased, particularly for the longer wave lengths, when the percentage mistuning necessary to produce a note of 1,000 cycles is considerable. What Dr. Austin does to the grid circuit by coupling another circuit to it is to give it two periods so that the reactance of the circuit is zero for two frequencies differing from each other by 1,000-

1,500 cycles. By adjusting the system to oscillate in one of these frequencies and having the other coincide with the signaling frequency the increase in signal strength is secured. It is possible to secure the same effect without the use of the sensitizing circuit by getting the two periods thru the medium of the antenna coupling, but as Dr. Austin points out this requires a relatively strong coupling. Despite the additional adjustments necessary, the use of the extra circuit is well worth while.

Lee De Forest (communicated): I would like to say that I also am in full agreement with the remarks made this evening concerning the uncertainty of audibility measurements. I cannot see that when "audibilities" of from 5,000 to 20,000 or 100,000 are obtained, we can be expected to handle them mathematically at all. With audibilities in amount up to one or five thousand this is possible, but above that I think we need a new unit. Where audibility comparisons are carried on, extending over a period of several weeks or months, and where different bulbs must be used and adjustments are changed, even if the circuits remain the same, the comparisons must be little better than guesses.

As to replying to any remarks of Mr. Armstrong's, I stated on a former occasion that I must refuse to be drawn into any discussion.

However, I wish to point out that it must be obvious to anyone examining, for example, circuit 1 of the de Forest-Logwood "ultraudion patent," No. 1,170,881, that the ultraudion circuit is not and cannot be a "regenerative circuit." There is only one oscillating circuit. This circuit is such that a sudden change of potential impressed on the plate produces in turn a change in the potential impressed on the grid of such a character as produce, in its turn, an opposite change of value of potential on the plate, etc. Thus the to-and-fro action is reciprocal and self-sustaining. It is "regenerative" in the sense that a reciprocating engine with piston and slide valve is "regenerative," or in the sense that an ordinary electric bell or buzzer, is "regenerative." If any member can obtain comfort from calling the ultraudion circuit "regenerative," he is entirely welcome so to do.

Louis W. Austin (by letter): I think that Mr. Hogan must have forgotten that in connection with the Arlington-Salem tests in 1912, experiments were carried out at the Bureau of Standards and at several other stations within ten miles of

Arlington in which the absolute received currents were measured, and in this way the field strength due to Arlington's radiation was determined. It was found that Arlington radiated like an ideal antenna or semi-doublet of less than half the height of the actual antenna, probably on account of the metal towers. (See "Bureau of Standards Bulletin," Reprint 226, page 74.) This is why the effective height of Arlington is taken as one-half the actual height. It seems probable that most land stations like Arlington and the Washington Navy Yard station have actual radiating heights less than the geometric heights. This may be brought about by imperfect ground conductivity under and near the antenna, or by the losses in the metal masts or towers now ordinarily used in radio installations.

The approximate equality of sensitiveness of the oscillating audion to damped and continuous oscillations was shown by a galvanometer arrangement which I described in the "Journal of the Washington Academy," 6, page 81, 1916. The loudness of signal in the telephones can of course also be compared even tho the notes are not the same, using a sending circuit which is first excited by a buzzer and then by an audion, the radio current in the circuit and the wave length remaining the same. In this case owing to the difference in note the audion signals seem to be about three to four times stronger than those from the buzzer.

It is perhaps not generally known that the remarkable sensitiveness of the oscillating audion depends very little on the presence of beats. Using broken up audion excitation with the receiving circuit tuned so closely to the incoming signal that no beats are heard, the signal is about one-third as loud as when the sending waves are not broken up but are received by the beat method with the best note for telephone sensitiveness.

The constancy of the audion when the circuits are adjusted in a perfectly uniform manner is remarkable, being quite equal, I believe, to the electrolytic. Different bulbs, except when evidently abnormal, also give sensibilities which agree within 20 or 30 per cent. The apparent variations are usually the result of imperfect adjustment. In this work the regular bulb was frequently tested by replacing it by a second bulb which could be instantly connected.

The first estimate of the absolute sensibility of the oscillating audion, assuming that it was 1,000 times as sensitive as the electrolytic at unit audibility, and that the electrolytic with the same telephones would respond to 1.225×10^{-9} watts in the antenna, gave 1.225×10^{-15} watts as its sensitiveness. Since

that time, further determinations have been made employing several different bulbs and different wave lengths. The method employed was the comparison of the deflection of a galvanometer connected to a silicon detector with the audibility observed with the oscillating audion. The same secondary circuit was used in both cases and the audion or detector thrown in by means of a two way switch, adjustments for tuning and best coupling being independently made in the two cases. The detector was calibrated by comparison with a thermo-element in the artificial antenna immediately before each experiment. The sending apparatus was a wave meter excited by a powerful audion. The average value of the energy for unit audibility on the audion was found by this method to be 1.5×10^{-15} watts in the receiving system. A paper on this and some connected lines of work is now in preparation.

As Prof. Zenneck suggests, it would of course be desirable to use a detector and galvanometer in all measurements of received signals, but in general for long distance work this is impossible.

If the detector is sensitive enough to produce deflections for weak signals, the atmospheric disturbances during a great portion of the time will make the readings even more unreliable than those taken with shunted telephones. I fully realize that the telephone method is far from satisfactory, altho it has been shown that telephone audibility, as taken by our methods, is proportional to the received antenna current in the case of the audion. This is shown in the following table of observations taken in the Naval Radio Laboratory with an artificial antenna.

Audibility	Radio Current	Audio Current
250	11	23
400	16	25
1,500	58	26
2,500	99	25
4,000	148	27
4,500	160	28

The experimental errors of the audibility measurements under station conditions amount frequently to 30 per cent. and the observation may sometimes be incorrect in the ratio of two to one, but except when the signals are nearly masked by heavy atmospherics, I do not believe that the errors are greater

than this. Bad as this is, it is certainly much better than no observation at all. The most disappointing fact in our work is the great irregularity in the signal strength which renders any comparison with the theory extremely unsatisfactory.

In heat reception, the telephone sensibility rises with the pitch of the note, but this is partly counteracted by the secondary circuit becoming more and more out of tune with the signal as the note rises. In addition, the audibility reading is lowered, due to the increase in telephone impedance. Thus, these effects to a considerable extent counterbalance each other over the range where the loudest signals are heard. If the operator readjusts for loudest signal after the audibility meter is set near the point of silence, the error due to these causes is not great, as is shown by our direct comparison of audibility and sending current using artificial circuits.

The resistance of the receiving system can be best determined, where continued oscillations are available, by exciting the antenna from a loosely coupled undamped circuit and then introducing enough resistance to reduce the antenna current to one-half. As the audibility meter is calibrated by comparison with a silicon detector and galvanometer, the amount of coupling resistance added in the calculations is that due to the silicon detector circuit. This, for best coupling, is always roughly seven-tenths of the antenna resistance.

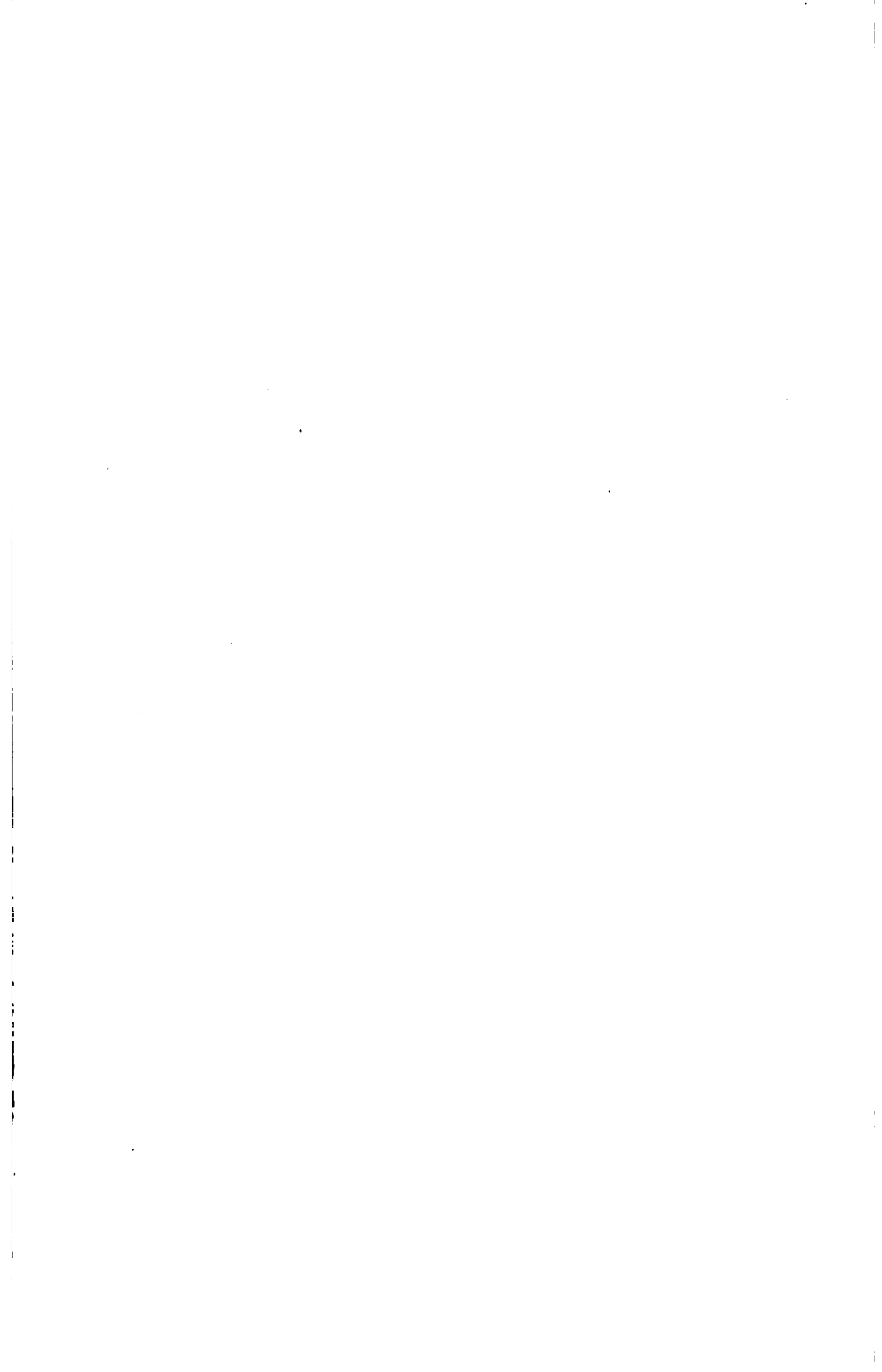

THE MECHANISM OF RADIATION AND PROPAGATION IN RADIO COMMUNICATION*

By

FRITZ LOWENSTEIN

The energy to be transmitted by radio (high) frequency currents exists at the transmitter station alternately in the form of electric and magnetic energy. The electric energy is concentrated in that portion of the field which closely surrounds the transmitting antenna.

As many lines of force emanate from the antenna vertically upward as downward, as shown in Figure 1. This is so because

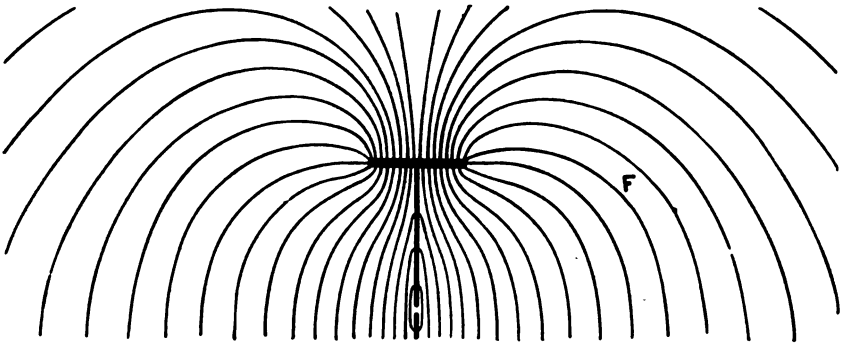

FIGURE 1

in an electric field whose two terminal surfaces are vastly different in size, the electric energy is concentrated near the smaller terminal surface (the antenna in this case), and the distribution of the electric lines near the smaller terminal surface is independent of the location of the larger terminal surface.

For a clear understanding of the distribution of the electric energy distribution in a field which ends in two terminal surfaces greatly different in size, I have shown in Figure 2 the field

* Presented before The Institute of Radio Engineers, New York, December 1, 1915.

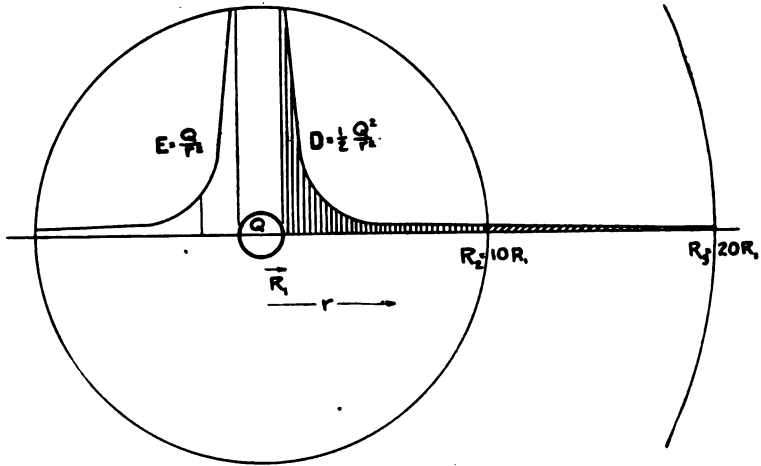

FIGURE 2

between two concentric spheres the radii of which are in the ratio of 1 to 10, and also for a ratio of 1 to 20.

The electric intensities are shown by the graph on the left side in Figure 2, wherein E represents the electric intensity in terms of r , the distance from the center. On the right side of Figure 2, D represents the lineal energy density:

$$D = \frac{1}{8\pi} E^2 \cdot 4\pi r^2 = \frac{1}{2} E^2 r^2 = \frac{1}{2} \frac{Q^2}{r^2}$$

The vertically shaded surface indicates, therefore, the total energy in the field; whereas the outward continuation of this area, shaded slantingly, gives the energy which would be added to the field by increasing the radius of the outside terminal to a value $R_3 = 20 R_1$. It is readily seen that the change of position of the larger terminal surface involves only a very slight change of the total energy, and therefore practically no change in the distribution of the field lines emanating from the smaller surface.

Such a comparison will appear still more striking if the smaller terminal surface be composed of conductors of a radius of a few millimeters and the distance between them and the ground be of the order of 100 meters.

The electric energy in the space closely surrounding the antenna will cause an effect in the receiving antenna in essentially the same way when radio frequencies are used as when the charge on the antenna is a stationary one. In Figure 3, Q may designate the quantity of electricity given to the antenna,

and h the height of the charge above ground. The force on a unit charge at the receiving point R will be equal to $\frac{Q}{r^2}$. The image of the charge Q produces an equal force F' . The resulting electric intensity is therefore

$$E = 2 \frac{Qh}{r \cdot r^2}.$$

In a system of electrostatic transmission, the received intensity is therefore proportional to the electric moment Qh impressed at the transmitter station, and diminishes proportionately to the cube of the distance.

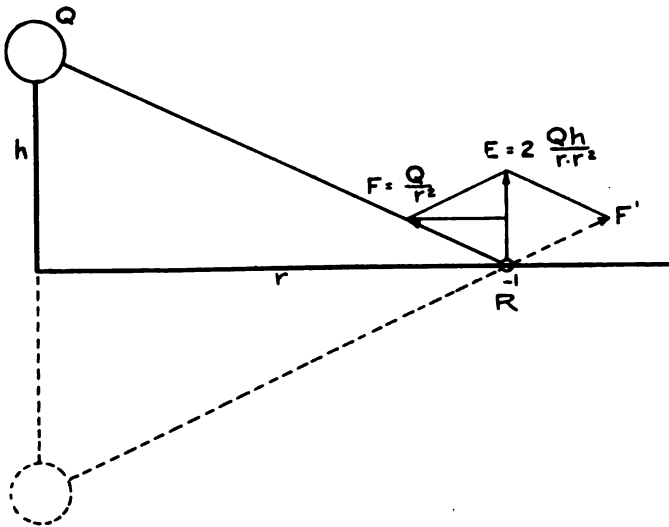

FIGURE 3

With a radio frequency current of value I flowing in the transmitting antenna, the received electric intensity is equal to

$$E = 4\pi \frac{Ih}{\lambda r} \cdot \frac{1}{3(10)^{10}}.$$

Substituting in this equation:

we have $I = 2\pi nQ = 2\pi \frac{v}{\lambda} Q,$

$$E = 2 \frac{Qh}{r \left(\frac{\lambda}{2\pi} \right)^2},$$

where $v =$ velocity of light $= 3(10)^{10}$ cm./sec.

Comparing this intensity obtained by radio frequency transmission with the value of the intensity obtained by the electrostatic method, we find that the intensity in both cases is proportional to the electric moment, inversely proportional to the transmitting distance r and inversely proportional to the square of the distance of the receiver from the charges producing the field.

In the case of the electrostatic transmission, this distance of the charge is identical with the transmitting distance. In the case of radio frequency transmission, it is the mean distance of the electrical charges near the receiving station from that station, and is expressed by $\frac{\lambda}{2\pi}$.

This analysis, I think, shows the beauty and advantage of substituting for the static method that of radio frequency currents, which latter method we owe to Mr. Nikola Tesla. My comparison above shows the great superiority of radio frequency currents for transmission in that the distance of electric action has been reduced from the total transmitting distance to a part of the wave length.

In view of the foregoing comparison between the various methods, it seems not out of place to review the history of the art of radio communication. Thomas A. Edison in 1885 applied for a patent, which was issued in 1891 as No. 465,971, wherein he proposed to use the static method. An electrostatic field produced at an elevated transmitting capacity is a source of electrostatic lines of force, which cut the receiving aerial, and a device is used for registering the potential difference which exists between the top of the receiving aerial and the ground, caused by the presence of lines of force. It must be borne in mind that the lines of force which strike the receiving aerial actually emanate from the transmitter capacity, and have a path starting from the transmitter capacity and ending on the ground near the receiving aerial.

In February, 1893, Nikola Tesla described before the Franklin Institute in Philadelphia, and again before the National Electric Light Association in St. Louis, in March, 1893, his system of "high" frequency radio transmission. In this paper he states that if radio frequency currents be caused to surge to and from an elevated capacity connected to ground by a vertical wire, it would not require a great amount of energy to produce a disturbance perceptible at great distances, or even all over the surface of the globe, particularly if the receiving circuit be

properly adjusted by means of inductance and capacity so as to be in resonance with the transmitted frequency.

In Edison's method, the electric action on the receiver came from the transmitter station directly; and therefore the distance of electric action was identical with the actual distance from the transmitter to the receiver.

Tesla's introduction of radio frequency transmission had the effect of bringing a considerable amount of the antenna charge into close proximity with the receiver, so that the electric intensity at the receiver was enhanced as the square of the ratio of the transmitter distance to the wave length of transmission.

The comparative analysis here given is the result of a conversation with Lieut.-Comm. A. J. Hepburn, U.S.N., to whom I hereby express my thanks.

The analysis of the complex wave form, found when transmitting over poorly conducting ground, as given by Sommerfeld, is of great value and interest. So are also the calculations of the effect caused by the spherical shape of the earth and of the effect of absorption, as given by the able treatment of Poincaré, Nicholson, Austin and Zenneck.

The fundamental question remains, however, whether we may designate the method now used as a transmission by Hertzian waves similar to those emitted by the Hertzian oscillator of the early Marconi apparatus, or as true conduction along the ground, as was proposed by Tesla in 1893. Sommerfeld's work only increased this doubt, inasmuch as the poorly conducting ground assumed to exist in his analysis led him to decompose the total wave action into a space wave and a surface wave. Thus the belief has been established in the minds of many radio engineers that transmission of the energy was carried on by two distinct and different phenomena.

To decide this question of principle, I assume the ground as plane and of good conductivity, an assumption absolutely permissible in the case of transmission over sea water.

The received electric intensity

$$E = 4 \pi \frac{I h}{\lambda r} \cdot \frac{1}{3(10)^{10}}$$

may be expressed as

$$E = 8 \pi^2 \frac{Q h}{r \lambda^2} \dots \dots \dots (1)$$

If we designate by Q the electric charge in the antenna and by q the electric charge of each half wave length gliding along

the earth, then we find the mean density of charge on the zone Z (Figure 4) to be

$$\sigma_m = \frac{q}{2\pi r \frac{\lambda}{2}}$$

and the maximum density at the crest

$$\sigma = \frac{\pi}{2} \sigma_m = \frac{q}{2r\lambda}$$

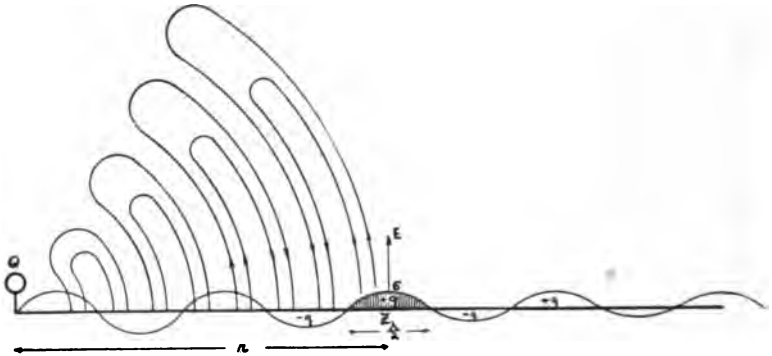

FIGURE 4

Therefore the electric intensity is

$$E = 4\pi\sigma = 2\pi \frac{q}{r\lambda} \dots \dots \dots (2)$$

From a comparison of equations (1) and (2), we find the radiated charge to be

$$q = 4\pi \frac{h}{\lambda} Q$$

and therefore independent of the distance.

We may therefore describe the phenomenon of transmission as follows. A maximum charge Q in an antenna oscillates to the ground and back, causing in every half oscillation the emission along the ground of a radiated charge q , where the ratio of that radiated charge to the full antenna charge,

$$\frac{q}{Q} = 4\pi \frac{h}{\lambda},$$

may be called the radiation factor, and appears to be independent of the distance.

The surging to and fro of the electric charge of the antenna entails, of course, a magnetic field, which represents part of the detached energy. During this process of detaching of energy, the magnetic energy is preponderant. Figure 5 shows the electric and magnetic intensities at various distances. At a distance of one-sixth of the wave length, the magnetic intensity M is 40 per cent. greater than the electric intensity E , at a distance

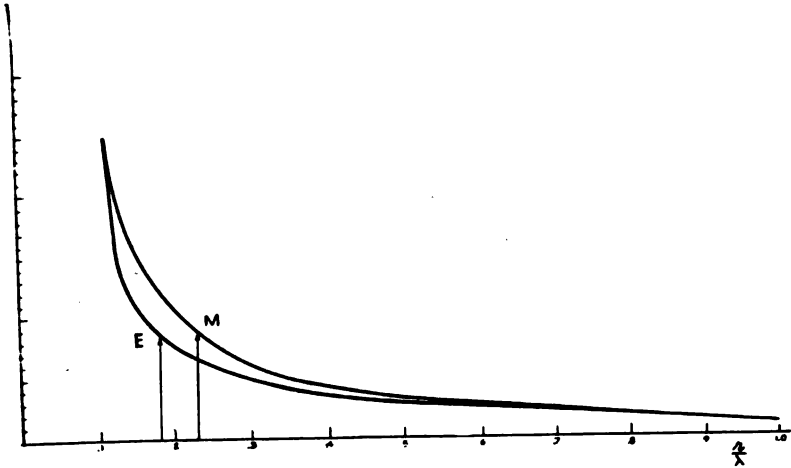

FIGURE 5

of one-half of the wave length the preponderance of magnetic over electric intensity is only 5 per cent.; and at a distance equal to the wave length there is practically no difference between the two intensities.

For convenience of computation of the values used in Figure 5 I have arranged the formulae for the electric and magnetic intensities as follows:

$$E = 2 \frac{Qh}{r^3} \sqrt{1 - 4\pi^2 \left(\frac{r}{\lambda}\right)^2 + 16\pi^4 \left(\frac{r}{\lambda}\right)^4}$$

$$M = 2 \frac{Qh}{r^3} \sqrt{4\pi^2 \left(\frac{r}{\lambda}\right)^2 + 16\pi^4 \left(\frac{r}{\lambda}\right)^4}$$

In a Hertzian oscillator, no electric charge or electrons move along the equatorial plane, whereas they do actually flow thru the ground in radio transmission and carry with them the energy which actuates the receiving devices.

Also, in view of the curvature of the earth, does it not seem more natural to speak of a conducted radio frequency current and to look upon the electric and magnetic field travelling with it as its accompanying result, than to designate radio transmission as identical with the radiation of a Hertzian oscillator *modified* by a conducting equatorial plane *and* by bending of radiation lines due to the earth's curvature *and* to the existence of the conducting upper strata?

I have thought it of advantage to the development of radio art if the knowledge of our atmosphere, as herein given, be brought before every radio engineer who is in a position to make quantitative observations.

Figure 6 shows the chemical composition and pressure and the temperature of the atmosphere arranged for the varying heights.

Measurements of the intensity of light taken at sunset show three distinct discontinuities, when the last rays become tangent to the layers of air at the height of 11 kilometers, 75 kilometers, and 220 kilometers. In fact, test balloons with registering apparatus clearly show a very distinct change at the 11-kilometer height. The temperature which fell close to the earth at the rate of 5 degrees per kilometer, and at the height of 10 kilometers at the rate of 9 degrees per kilometer, suddenly becomes constant in regions from 11 to 75 kilometers, the mean temperature being minus 55 degrees Centigrade. A glance at the last graph of Figure 6 will make this discontinuity very apparent. The reason for the uniformity of temperature may lie in the fact that the pressures to which the atmosphere is subjected at these altitudes are suited to electric conduction, as may be seen from inspection of the graph in the center of Figure 6, wherein the pressures are given with their corresponding altitudes. This lower point of discontinuity (11 km.) has been further proven to exist by tests of chemical composition of the atmosphere.

I have indicated in the graph to the left of Figure 6 that the volumetric analysis of the atmosphere, as to its relative proportions of nitrogen and oxygen shows a constant proportion in this first layer of 11 kilometers, the reason being that air currents rise and fall therein, providing for thoro mixing, and not permitting the two gases to arrange themselves according to their densities.

This lower layer of 11 kilometers in thickness, the troposphere, is shown in the diagram by a vertical line, denoting a constancy of mixture up to 11 kilometers. Above that point, in the stra-

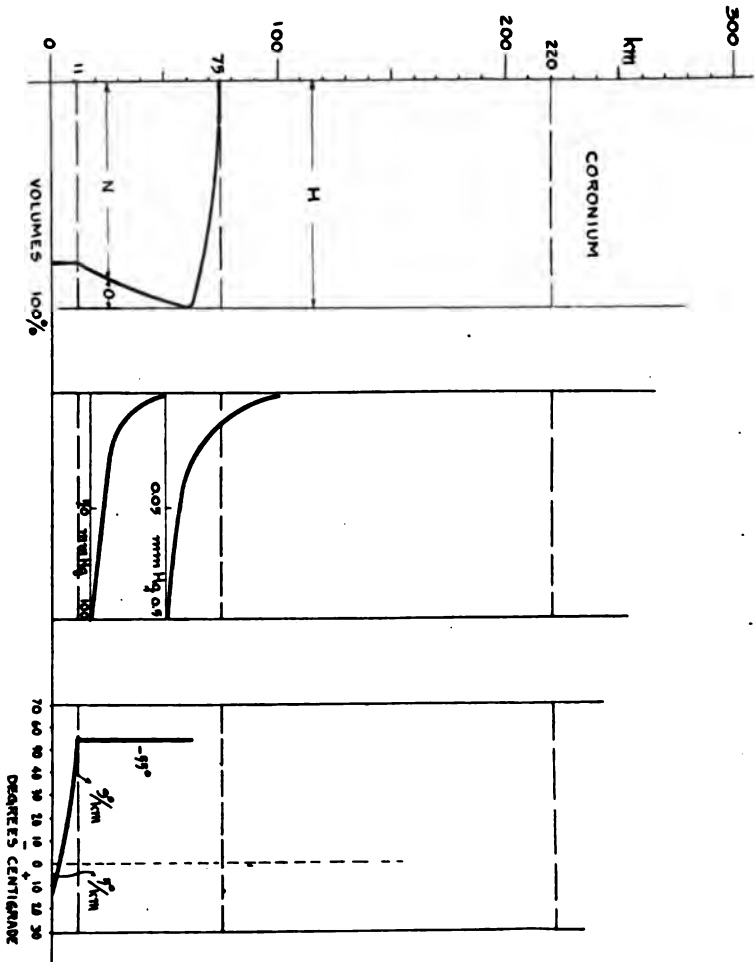

FIGURE 6

tosphere, the two gases adjust themselves according to Dalton's Law, the heavier oxygen losing and the lighter nitrogen gaining in relative proportion. At 60 kilometers, the oxygen has practically disappeared, and the hydrogen becomes prominent. Because of the very great difference of density, however, the mixture of nitrogen and hydrogen extends over a comparatively thin layer of 15 kilometers only, and, as shown in the graph, there is a rather abrupt change from nitrogen to hydrogen at 75 kilometers.

The third sudden change in light intensity at sundown occurs when the last sun rays pass tangent to a layer at a height of 220 kilometers. Up to that moment, the sky has appeared blue by reason of the illumination of the hydrogen atoms which are able to send the shorter rays of the sun's spectrum to our eyes. The sudden disappearance of blue is due to the rather sudden disappearance of hydrogen from the atmosphere, a stratum of coronium beginning at that height.

It remains to consider the bearing of these various changes on the transmission of electric energy thru the space. The high pressures prevailing in the troposphere make it a perfect dielectric. The stratosphere is the layer of highest conductivity, bounded above by strata of such low pressures as to constitute practically dielectrics. *Gradual* changes of conductivity would entail considerable loss if they gave rise to marked reflections in electric wave propagation, and consequently a considerable amount of argument has been brought to bear against the possibility of efficient reflection by the upper strata. The *abrupt* changes shown to exist in the atmosphere certainly permit us with less hesitancy to ascribe strong variations of received signal intensities (according to the wave length employed), to efficient reflection.

SUMMARY: The intensity of the electric field at a distance from a statically charged antenna is calculated from elementary considerations. The same quantity is derived for the case in which the charge is oscillating at a radio frequency. It is shown that the total charges acting on the receiver in the two cases have a ratio equal to the square of the ratio of the transmitting distance to a certain part of the wave length; and hence the great advantage of the radio frequency transmission.

The theories of Edison, Tesla and Sommerfeld are historically considered. It is shown that there is no physical justification for the separation of the wave into surface and space waves. The electric and magnetic intensities at various distances from the antenna are calculated, and it is shown that they become practically equal at a wave length away. The author prefers to regard radio transmission as due to conducted radio frequency earth currents rather than modified Hertzian oscillator waves. The three distinct portions of the atmosphere: the troposphere, the stratosphere, and the coronium layer, are described, and their effect on radio transmission considered.

DISCUSSION

J. Zenneck: As regards the question whether the energy emitted by a transmitting antenna is propagated by conduction currents in the ground or by electromagnetic waves in the air, I agree with Mr. Lowenstein that this is largely a matter of expression. As a matter of fact, if a transmitting antenna is placed on the surface of the earth, at all distances from the antenna an electromagnetic field is present in the air as well as in the ground. It is therefore a matter of taste whether one describes the propagation of energy as taking place by means of earth currents or whether one describes it as being caused by electromagnetic waves in the air. Both of these descriptions are incomplete; the earth currents are always accompanied by electromagnetic waves in the air and the electromagnetic waves in the air always by currents in the ground.

Louis W. Austin (communicated): There are one or two points in Mr. Lowenstein's exceedingly interesting paper on the "Mechanism of Radiation" on which I would like to comment. In discussing the difference between the electrostatic field produced by the oscillator, and the electromagnetic, he substitutes the electrostatic expression for current in the electromagnetic equation for the electric intensity at the receiving station, and obtains a term which he calls the mean distance of the electrical charges from the receiving station. I am unable to give this any real physical interpretation, and unless this can be done, it hardly seems that the conception can be considered useful.

In the discussion of the transmission of the electrical waves along the surface of the earth, the paper might lead one to believe that the choice in theories lay between electromagnetic waves above the earth's surface or conduction along the surface; while as a matter of fact, under the given conditions neither can exist without the other, just as the current in a wire must always be accompanied by a field surrounding it. Hertzian waves will, I believe, always ground themselves on any conducting plane in their immediate neighborhood lying parallel to the direction of propagation. The moving charges on the grounded ends of the electrostatic lines of force will then produce currents such as are spoken of in the paper.

I am very glad that Mr. Lowenstein has called attention to the composition of the atmosphere in its different layers and the probable bearing of this on the variation in strength of the radio signals.

AMPLITUDE RELATIONS IN COUPLED CIRCUITS*

BY

E. LEON CHAFFEE

The importance of a clear understanding of the action of coupled oscillatory circuits need not be emphasized. The theory of coupled oscillatory systems in general is not only applicable to electrical problems but is of interest in other branches of physics.

There has been a vast amount of material written on different aspects of the combined action of coupled circuits. Much of the work has been devoted to the relations between the coefficient of coupling, the natural wave lengths of the two circuits, and the resulting or "coupled" wave lengths. The effects of resistance in the circuits and the methods of measuring damping have been the subjects of many theoretical and experimental investigations. One might mention in this connection the work of Bjerknes¹, Oberbeck², Wien³, Drude⁴, and others.⁵ It has seemed to the writer, however, that the *amplitudes* of the oscillations in coupled circuits has been less clearly set forth than have the other aspects enumerated above.

In the following paper the history of the changes in the amplitudes of the four component oscillations in coupled circuits as the constants of the circuits are changed are deduced and shown graphically. The results are derived directly from the familiar theory but the method of presentation may have in it some new features.

Figure 1 represents two circuits (1) and (2) made up of condensers C_1 and C_2 , and inductances L_1 and L_2 as shown. The two inductances have a mutual inductance M or a coefficient of coupling $\tau = \frac{M}{\sqrt{L_1 L_2}}$. The resistances in the two circuits are

* Presented before the Boston Section of The Institute of Radio Engineers, November 24, 1915.

¹ V. Bjerknes; "Wied. Ann.," 55, p. 121.

² Oberbeck; "Wied. Ann.," 55, p. 623.

³ M. Wien; "Ann. d. Phys.," 25, p. 625; "Wied. Ann.," 61, p. 151 "Ann. d. Phys.," 8, p. 685.

⁴ P. Drude; "Ann. d. Phys.," 13, p. 512.

⁵ L. Cohen; "Jahrb. der Drahtlosen Teleg.," 2, p. 448.

neglected in order to simplify the solution of the problem, but it can be shown that the relative results obtained are little affected by resistance unless the resistance is large.

If q_1 and q_2 represent the charges at time t on condensers C_1 and C_2 , respectively, then the following equations express the performance of the two circuits:

$$\left. \begin{aligned} (1) \quad L_1 \frac{d^2 q_1}{dt^2} + M \frac{d^2 q_2}{dt^2} + \frac{q_1}{C_1} &= 0 \\ (2) \quad L_2 \frac{d^2 q_2}{dt^2} + M \frac{d^2 q_1}{dt^2} + \frac{q_2}{C_2} &= 0 \end{aligned} \right\} \text{and} \left\{ \begin{aligned} i_1 &= -\frac{dq_1}{dt} \\ i_2 &= -\frac{dq_2}{dt} \end{aligned} \right.$$

It may be noted for future reference that according to the convention adopted above the currents in the two circuits have the same sign if they produce fluxes in the same direction thru the coaxial coils L_1 and L_2 .

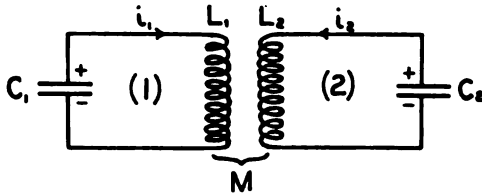

FIGURE 1

The above equations yield the two following equations, each involving a single dependent variable:

$$\left. \begin{aligned} (3) \quad (L_1 L_2 - M^2) \frac{d^4 q_1}{dt^4} + \left(\frac{L_2}{C_1} + \frac{L_1}{C_2} \right) \frac{d^2 q_1}{dt^2} + \frac{q_1}{C_1 C_2} &= 0 \\ (4) \quad (L_1 L_2 - M^2) \frac{d^4 q_2}{dt^4} + \left(\frac{L_2}{C_1} + \frac{L_1}{C_2} \right) \frac{d^2 q_2}{dt^2} + \frac{q_2}{C_1 C_2} &= 0 \end{aligned} \right\}$$

These equations may be abbreviated giving the two equivalent equations:

$$\left. \begin{aligned} (5) \quad (1 - \tau^2) \frac{d^4 q_1}{dt^4} + (\omega_1^2 + \omega_2^2) \frac{d^2 q_1}{dt^2} + \omega_1^2 \omega_2^2 q_1 &= 0 \\ (6) \quad (1 - \tau^2) \frac{d^4 q_2}{dt^4} + (\omega_1^2 + \omega_2^2) \frac{d^2 q_2}{dt^2} + \omega_1^2 \omega_2^2 q_2 &= 0 \end{aligned} \right\}$$

where $\omega_1^2 = \frac{1}{L_1 C_1}$, and $\omega_2^2 = \frac{1}{L_2 C_2}$.

The solutions of equations (5) and (6) are of the form

$$(7) \quad q_1 = A_1 \cos(\omega' t + \phi) + B_1 \cos(\omega'' t + \psi)$$

$$(8) \quad q_2 = A_2 \cos(\omega' t + \phi) + B_2 \cos(\omega'' t + \psi), \text{ where}$$

$$(9) \quad \omega' = \sqrt{\frac{\omega_1^2 + \omega_2^2 + \sqrt{(\omega_1^2 + \omega_2^2)^2 - 4\omega_1^2\omega_2^2(1-\tau^2)}}{2(1-\tau^2)}}$$

$$(10) \quad \omega'' = \sqrt{\frac{\omega_1^2 + \omega_2^2 - \sqrt{(\omega_1^2 + \omega_2^2)^2 - 4\omega_1^2\omega_2^2(1-\tau^2)}}{2(1-\tau^2)}}$$

Equations (7) and (8), when differentiated, give the expressions for the currents in the two circuits, and they are

$$(11) \quad i_1 = A_1 \omega' \sin(\omega' t + \phi) + B_1 \omega'' \sin(\omega'' t + \psi)$$

$$(12) \quad i_2 = A_2 \omega' \sin(\omega' t + \phi) + B_2 \omega'' \sin(\omega'' t + \psi) \quad \text{or}$$

$$(13) \quad i_1 = I_1' \sin(\omega' t + \phi) + I_1'' \sin(\omega'' t + \psi)$$

$$(14) \quad i_2 = I_2' \sin(\omega' t + \phi) + I_2'' \sin(\omega'' t + \psi)$$

Referring to expressions (9) and (10), it will be noted that ω'' is the smaller of the two angular velocities, and hence the length of the wave corresponding to ω'' is longer than the wave corresponding to the angular velocity ω' . In expressions (13) and (14) for the currents in the two circuits, there are four amplitudes: I_1' and I_2' are the amplitudes in circuits (1) and (2), respectively, of the *shorter* wave, and I_1'' and I_2'' are the amplitudes of the *longer* wave. The results which will first be derived are the four ratios of amplitude given below:

$$\frac{I_2'}{I_1'} \left[\frac{\text{Short in (2)}}{\text{Short in (1)}} \right] \quad \frac{I_2''}{I_1''} \left[\frac{\text{Long in (2)}}{\text{Long in (1)}} \right]$$

$$\frac{I_1''}{I_1'} \left[\frac{\text{Long in (1)}}{\text{Short in (1)}} \right] \quad \frac{I_2''}{I_2'} \left[\frac{\text{Long in (2)}}{\text{Short in (2)}} \right]$$

Derivation of Amplitude Ratios $\frac{I_2'}{I_1'}$ and $\frac{I_2''}{I_1''}$.

If expressions (7) and (8) be substituted in one of the original equations, say (1), there result the relations:

$$(15) \quad A_1 \left(\frac{1}{L_1 C_1} - \omega'^2 \right) = \frac{A_2 M \omega'^2}{L_1}$$

$$(16) \quad B_1 \left(\frac{1}{L_1 C_1} - \omega''^2 \right) = \frac{B_2 M \omega''^2}{L_1} \quad \text{or}$$

$$(17) \quad \frac{A_2}{A_1} = - \frac{\omega'^2 - \omega_1^2}{\tau \omega'^2} \sqrt{\frac{L_1}{L_2}}$$

$$(18) \quad \frac{B_2}{B_1} = \frac{\omega_1^2 - \omega''^2}{\tau \omega''^2} \sqrt{\frac{L_1}{L_2}} \quad \text{and}$$

$$(19) \quad \frac{I_2'}{I_1'} = - \frac{\omega^2 - \omega_1^2}{\tau \omega'^2} \sqrt{\frac{L_1}{L_2}} \quad \text{short waves}$$

$$(20) \quad \frac{I_2''}{I_1''} = \frac{\omega_1^2 - \omega''^2}{\tau \omega''^2} \sqrt{\frac{L_1}{L_2}} \quad \text{long waves}$$

Since ω'^2 is always greater than ω_1^2 , and ω''^2 always less than ω_1^2 , it is evident that $\frac{I_2'}{I_1'}$ is always negative, while $\frac{I_2''}{I_1''}$ is always positive. This shows that the short waves in two coupled circuits are, neglecting resistance, always opposite in phase whereas the long waves are always in the same phase. In other words, the magnetic fluxes due to the short wave components of the currents in the two coils L_1 and L_2 of the oscillation transformer are opposite and give a small resultant flux, while the magnetic fluxes due to the long wave components are in the same direction giving a resultant flux equal to the sum of the two component fluxes.

For some purposes it is more convenient to express the ratios of amplitudes in terms of wave lengths instead of angular velocities as in (19) and (20). If λ' and λ'' are the wave lengths corresponding to ω' and ω'' , respectively, then

$$(21) \quad \lambda' = \frac{2\pi V}{\omega'} \quad \text{and} \quad \lambda'' = \frac{2\pi V}{\omega''}, \quad \text{where } V \text{ is the velocity of light.}$$

Similarly, if λ_1 and λ_2 are the wave lengths of the natural free vibrations of circuits (1) and (2), respectively, then

$$(22) \quad \lambda_1 = \frac{2\pi V}{\omega_1} \quad \text{and} \quad \lambda_2 = \frac{2\pi V}{\omega_2}$$

Using relations (21) and (22), expressions (9) and (10) become

$$(23) \quad \lambda' = \sqrt{\frac{\lambda_1^2 + \lambda_2^2 - \sqrt{(\lambda_1^2 - \lambda_2^2)^2 + 4\tau^2\lambda_1^2\lambda_2^2}}{2}}$$

$$(24) \quad \lambda'' = \sqrt{\frac{\lambda_1^2 + \lambda_2^2 + \sqrt{(\lambda_1^2 - \lambda_2^2)^2 + 4\tau^2\lambda_1^2\lambda_2^2}}{2}} \quad \text{or}$$

$$(25) \quad \frac{\lambda'}{\lambda_1} = \sqrt{\frac{1 + \left(\frac{\lambda_2}{\lambda_1}\right)^2 - \sqrt{\left[1 - \left(\frac{\lambda_2}{\lambda_1}\right)^2\right]^2 + 4\tau^2\left(\frac{\lambda_2}{\lambda_1}\right)^2}}{2}}$$

$$(26) \quad \frac{\lambda''}{\lambda_1} = \sqrt{\frac{1 + \left(\frac{\lambda_2}{\lambda_1}\right)^2 + \sqrt{\left[1 - \left(\frac{\lambda_2}{\lambda_1}\right)^2\right]^2 + 4\tau^2\left(\frac{\lambda_2}{\lambda_1}\right)^2}}{2}}$$

Similarly the expressions (19) and (20) are transformed by use of relations (21) and (22) into

$$(27) \quad \frac{I_2'}{I_1'} = -\frac{1 - \left(\frac{\lambda'}{\lambda_1}\right)^2}{\tau} \sqrt{\frac{L_1}{L_2}}$$

$$(28) \quad \frac{I_2''}{I_1''} = \frac{\left(\frac{\lambda''}{\lambda_1}\right)^2 - 1}{\tau} \sqrt{\frac{L_1}{L_2}}$$

Since the values of $\frac{\lambda'}{\lambda_1}$ and $\frac{\lambda''}{\lambda_1}$ are used in the calculation of (27) and (28), the equations (25) and (26) have been plotted for various values of τ and the results appear in Figure 2.

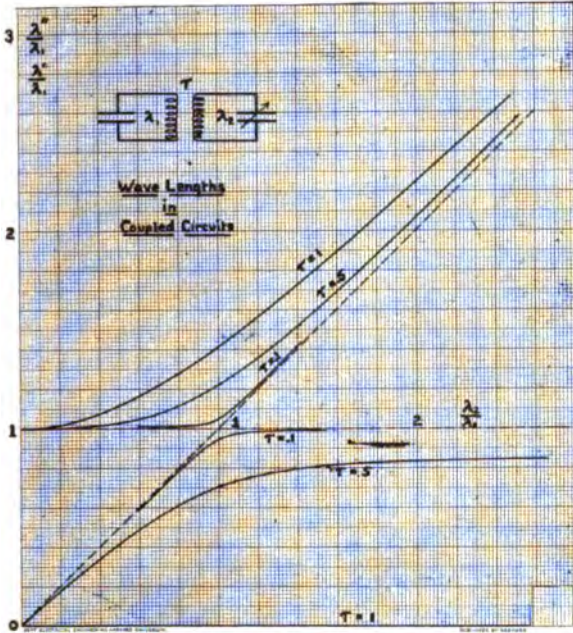

FIGURE 2

The abscissas are the values of the ratio $\frac{\lambda_2}{\lambda_1}$, and the ordinates are the corresponding values of $\frac{\lambda'}{\lambda_1}$ and $\frac{\lambda''}{\lambda_1}$. The coördinates of these curves are ratios of wave lengths and, therefore, the plots are applicable to any two circuits. It is simplest to think of λ_1 as remaining constant and that λ_2 is varied by changing C_2 .

The relations (27) and (28) are plotted in Figure 3. Here again the coördinates are independent of the particular circuits and give the relation between the amplitudes of the same wave in the two circuits as the capacity in one circuit is changed.

The abscissas are as before the values of the ratio $\frac{\lambda_2}{\lambda_1}$, and the

ordinates the values of the ratios $\frac{I_2'}{I_1'} \div \sqrt{\frac{L_1}{L_2}}$ and $\frac{I_2''}{I_1''} \div \sqrt{\frac{L_1}{L_2}}$. For any particular case it is only necessary to multiply the ordinates by $\sqrt{\frac{L_1}{L_2}}$.

Experimental Determinations of Ratios $\frac{I_2'}{I_1'}$ and $\frac{I_2''}{I_1''}$.

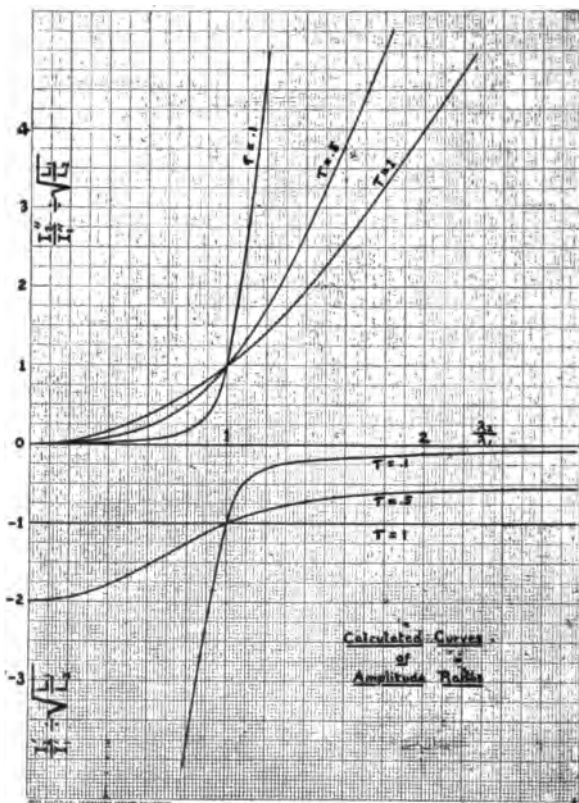

FIGURE 3

The ratios of amplitudes, as shown in Figure 3, of corresponding waves in the two oscillatory circuits can be easily obtained experimentally. Two very small coils of but a few turns each are set accurately with their planes at right angles. The coils of the particular apparatus used were each wound with six

turns in two layers of number 16 B. and S. wire,* forming a coil about an inch and an half (3.8 centimeters) in diameter. One of these coils were placed in each of the oscillatory circuits. A third larger coil (6 inches (15 centimeters) in diameter) of many turns, similar in shape to the coil of a tangent galvanometer, is mounted so that it can be rotated about its vertical diameter, this diameter being coincident with the common diameter of

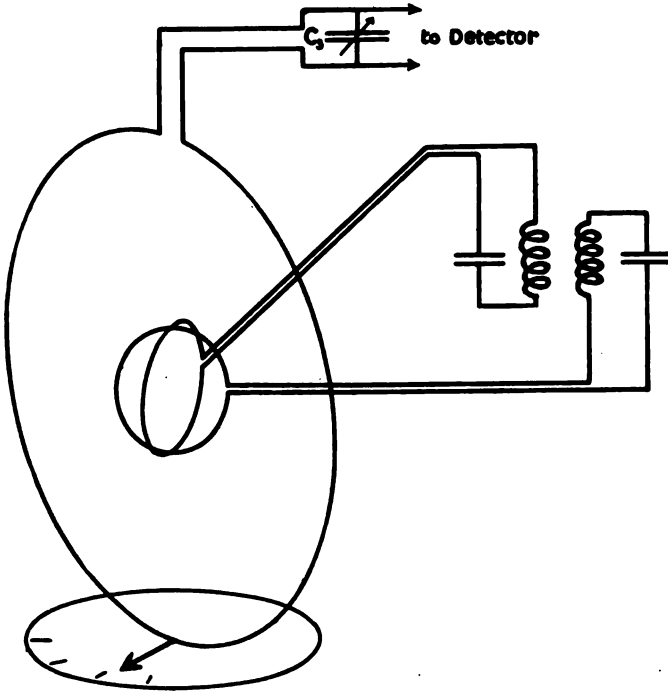

FIGURE 4

the two smaller coils. The latter are placed centrally inside the larger coil. The angle thru which the large coil is rotated can be accurately read on a scale. The arrangement is diagrammatically shown in Figure 4. The large coil is connected with a small variable condenser C_3 and to an audion detector.

Let a_1 be the direction and the maximum value of the flux due to a current in the small coil in circuit (1), and similarly, a_2 be the corresponding vector for circuit (2). R , the resultant of a_1 and a_2 , is then the resultant flux if the fluxes have the same

* Diameter of number 16 B. and S. wire = 0.0508 inch = 0.129 centimeter.

period. If the plane of the movable coil is in the direction α_1 there will be no response of the detector connected to this coil due to currents in circuit (1). Similarly for the position parallel to α_2 . When both coils are active, there will be zero response of the detector in the third circuit when the direction of the plane of the large coil is parallel to the resultant R , and if θ is the angle from position (1) then

$$\tan \theta = \frac{\alpha_2}{\alpha_1} = \frac{I_2}{I_1}.$$

If circuits (1) and (2) are coupled with mutual inductance M , there will be two waves in each circuit. In order, therefore, to separate the two waves, the third circuit is resonated by means of C_3 to the particular wave, the amplitude of which is being measured. Either circuit (1) or (2) may be excited and in fact it will be found convenient to excite one circuit for some observations and the other circuit for others.

The curves of Figure 5 were obtained in the manner outlined above.

Derivation of Amplitude Ratios $\frac{I_1''}{I_1'}$ and $\frac{I_2''}{I_2'}$.

The ratio of the amplitudes of the two waves in each circuit depends upon which one of the two circuits is excited and upon the mode of excitation. There are two modes of excitation, namely: the condenser in the excited circuit may be charged and allowed to discharge, or the electromagnetic field associated with the inductance of this circuit may be suddenly released so that its energy goes to establishing oscillations in the circuit. In the first case the excited or primary circuit possesses potential energy at the start, while in the second case the circuit possesses kinetic energy when time equals zero. The methods used in radio telegraphy of exciting the primary circuit of the transmitting station is an example of the potential energy method of excitation, while the familiar method of the production of oscillations in a circuit by means of a buzzer illustrates the inductance excitation.

(a) **Condenser Excitation.** The relation between A_1 and B_1 and between A_2 and B_2 of expressions (11) and (12) can easily be obtained when oscillations are excited by the discharge of the primary condenser by imposing the initial conditions for this case. These initial conditions are

$$\text{when } t = 0 \left\{ \begin{array}{l} q_1 = Q_0 \\ q_2 = 0 \\ i_1 = 0 \\ i_2 = 0 \end{array} \right.$$

Supplying these values in (7) and (8) it follows directly that

$$Q_o = A_1 \cos \phi + B_1 \cos \psi \quad 0 = A_1 \omega' \sin \phi + B_1 \omega'' \sin \psi$$

$$0 = A_2 \cos \phi + B_2 \cos \psi \quad 0 = A_2 \omega' \sin \phi + B_2 \omega'' \sin \psi$$

It is apparent that $\phi = 0$, and $\psi = 0$.

The desired ratios of current amplitudes are, therefore,

$$(29) \quad \frac{I_1''}{I_1'} = \frac{\omega'^2 - \omega_1^2}{\omega_1^2 - \omega''^2} \cdot \frac{\omega''^3}{\omega'^3} = \frac{1 - \left(\frac{\lambda'}{\lambda}\right)^2}{\left(\frac{\lambda''}{\lambda}\right)^2 - 1} \cdot \frac{\left(\frac{\lambda'}{\lambda}\right)}{\left(\frac{\lambda''}{\lambda}\right)}$$

$$(30) \quad \frac{I_2''}{I_2'} = -\frac{\omega''}{\omega'} = -\frac{\left(\frac{\lambda'}{\lambda_1}\right)}{\left(\frac{\lambda''}{\lambda_1}\right)}$$

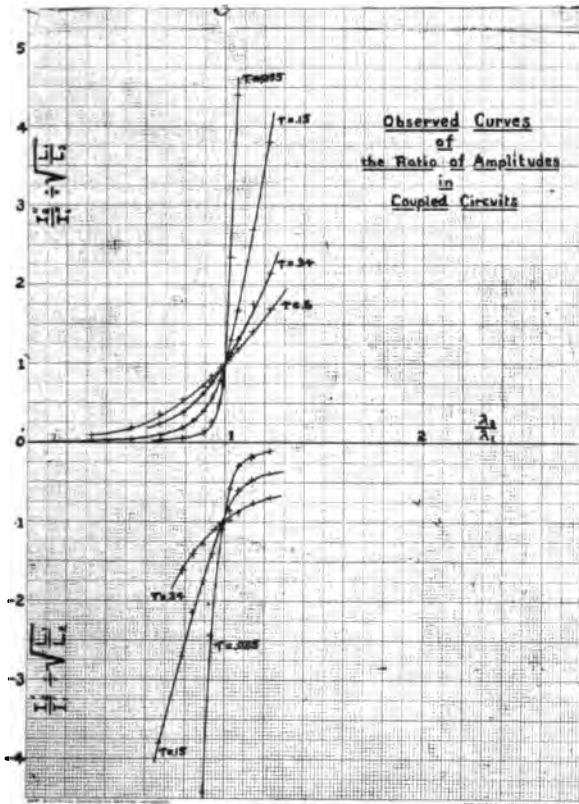

FIGURE 5

These ratios are independent of the particular circuits used, and are only dependent upon the coupling. They are shown plotted for a few values of τ in Figure 6. The negative sign

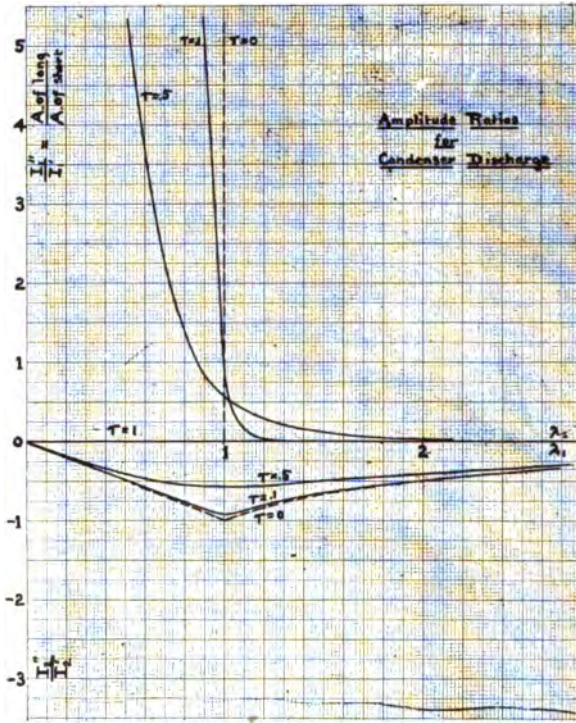

FIGURE 6

means that at the start the two waves are opposite in phase. The actual values of $A_1, B_1, A_2,$ and B_2 are easily obtained and are as follows:

$$(31) \quad A_1 = \frac{Q_0 (\omega_1^2 - \omega'^2)}{(\omega'^2 - \omega'^2)} \cdot \frac{\omega'}{\omega_1^2}$$

$$(32) \quad B_1 = \frac{Q_0 (\omega'^2 - \omega_1^2)}{(\omega'^2 - \omega'^2)} \cdot \frac{\omega'^2}{\omega_1^2}$$

$$(33) \quad A_2 = -\frac{Q_0}{\tau \omega_1^2} \cdot \frac{(\omega_1^2 - \omega'^2) (\omega'^2 - \omega_1^2)}{(\omega'^2 - \omega'^2)} \sqrt{\frac{L_1}{L_2}}$$

$$(34) \quad B_2 = \frac{Q_0}{\tau \omega_1^2} \cdot \frac{(\omega_1^2 - \omega'^2) (\omega'^2 - \omega_1^2)}{(\omega'^2 - \omega'^2)} \sqrt{\frac{L_1}{L_2}}$$

The expressions for the currents in the primary and secondary circuits are

$$(35) \quad i_1 = \frac{2\pi V Q_o}{\lambda_1} \left\{ \frac{\left(\frac{\lambda''}{\lambda_1}\right)^2 - 1}{\left(\frac{\lambda''}{\lambda_1}\right)^2 - \left(\frac{\lambda'}{\lambda_1}\right)^2} \cdot \frac{1}{\left(\frac{\lambda'}{\lambda_1}\right)} \sin \frac{2\pi V}{\lambda'} t \right. \\ \left. + \frac{1 - \left(\frac{\lambda'}{\lambda_1}\right)^2}{\left(\frac{\lambda''}{\lambda_1}\right)^2 - \left(\frac{\lambda'}{\lambda_1}\right)^2} \cdot \frac{1}{\left(\frac{\lambda''}{\lambda_1}\right)} \sin \frac{2\pi V}{\lambda''} t \right\}$$

$$(36) \quad i_2 = \frac{2\pi V Q_o}{\lambda_1} \sqrt{\frac{L_1}{L_2}} \left\{ - \frac{\left[1 - \left(\frac{\lambda'}{\lambda_1}\right)^2\right] \left[\left(\frac{\lambda''}{\lambda_1}\right)^2 - 1\right]}{\tau \left[\left(\frac{\lambda''}{\lambda_1}\right)^2 - \left(\frac{\lambda'}{\lambda_1}\right)^2\right] \left(\frac{\lambda'}{\lambda_1}\right)} \sin \frac{2\pi V}{\lambda'} t \right. \\ \left. + \frac{\left[1 - \left(\frac{\lambda'}{\lambda_1}\right)^2\right] \left[\left(\frac{\lambda''}{\lambda_1}\right)^2 - 1\right]}{\tau \left[\left(\frac{\lambda''}{\lambda_1}\right)^2 - \left(\frac{\lambda'}{\lambda_1}\right)^2\right] \left(\frac{\lambda''}{\lambda_1}\right)} \sin \frac{2\pi V}{\lambda''} t \right\}$$

These expressions may for brevity be written.

$$(37) \quad i_1 = \frac{2\pi V Q_o}{\lambda_1} \left\{ K_1' \sin \frac{2\pi V}{\lambda'} t + K_1'' \sin \frac{2\pi V}{\lambda''} t \right\}$$

$$(38) \quad i_2 = \frac{2\pi V Q_o}{\lambda_1} \sqrt{\frac{L_1}{L_2}} \left\{ K_2' \sin \frac{2\pi V}{\lambda'} t + K_2'' \sin \frac{2\pi V}{\lambda''} t \right\}, \text{ where}$$

$$(39) \quad I_1' = \frac{2\pi V Q_o}{\lambda_1} \cdot K_1' \quad I_1'' = \frac{2\pi V Q_o}{\lambda_1} \cdot K_1''$$

$$(40) \quad I_2' = \frac{2\pi V Q_o}{\lambda_1} \cdot \sqrt{\frac{L_1}{L_2}} \cdot K_2' \quad I_2'' = \frac{2\pi V Q_o}{\lambda_1} \sqrt{\frac{L_1}{L_2}} \cdot K_2''$$

The values of K_1' , K_1'' , K_2' , and K_2'' are plotted as full lines for several values of τ in Figures 8, 9, 10 and 11, and are interesting in showing how the four amplitudes vary as the secondary circuit is made to approach and pass resonance with respect to the primary circuit.

(b) **Inductance Excitation.** If the primary circuit is inductively excited, the initial conditions are

$$\text{When } t=0 \quad \begin{cases} i_1 = I_o \\ i_2 = 0 \\ q_1 = 0 \\ q_2 = 0 \end{cases}$$

These conditions supplied in equations (7), (8), (11) and (12) give

$$\left. \begin{aligned} 0 &= A_1 \cos \phi + B_1 \cos \psi \\ 0 &= A_2 \cos \phi + B_2 \cos \psi \\ I_o &= A_1 \omega' \sin \phi + B_1 \omega'' \sin \psi \\ 0 &= A_2 \omega' \sin \phi + B_2 \omega'' \sin \psi \end{aligned} \right\}$$

In order to satisfy these equations $\phi = 90^\circ$ and $\psi = 90^\circ$.

The last two relations in conjunction with equations (17) and (18) give for the amplitude ratios

$$(41) \quad \frac{I_1''}{I_1'} = \frac{\omega'^2 - \omega_1^2}{\omega_1^2 - \omega''^2} \cdot \frac{\omega''^2}{\omega'^2} = \frac{\lambda_1^2 - \lambda'^2}{\lambda''^2 - \lambda_1^2}$$

$$(42) \quad \frac{I_2''}{I_2'} = -1$$

These expressions are plotted in Figure 7.

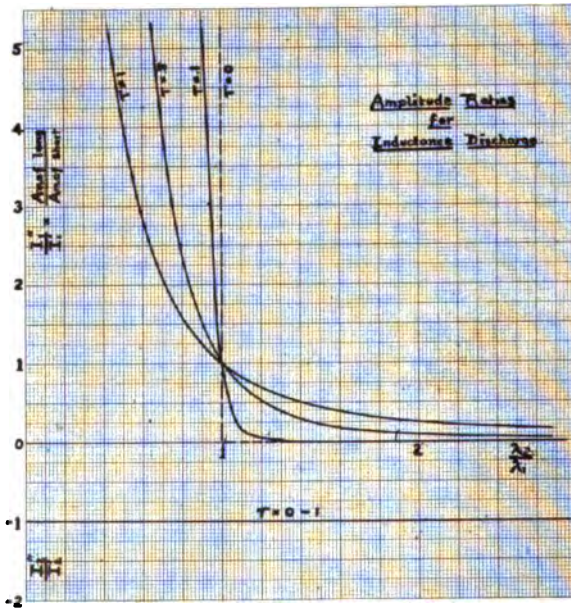

FIGURE 7

The expressions for the primary and secondary currents for this case are

$$(43) \quad i_1 = I_o \left\{ \frac{\left(\frac{\lambda''}{\lambda_1}\right)^2 - 1}{\left(\frac{\lambda''}{\lambda_1}\right)^2 - \left(\frac{\lambda'}{\lambda_1}\right)^2} \cos \frac{2\pi V}{\lambda'} t + \frac{1 - \left(\frac{\lambda'}{\lambda_1}\right)^2}{\left(\frac{\lambda''}{\lambda_1}\right)^2 - \left(\frac{\lambda'}{\lambda_1}\right)^2} \cos \frac{2\pi V}{\lambda''} t \right\}$$

$$(44) \quad i_2 = -I_o \sqrt{L_1} \left\{ \begin{aligned} & \left[\left(\frac{\lambda''}{\lambda_1} \right)^2 - 1 \right] \left[1 - \left(\frac{\lambda'}{\lambda_1} \right)^2 \right] \cos \frac{2\pi V}{\lambda'} t \\ & \tau \left[\left(\frac{\lambda''}{\lambda_1} \right)^2 - \left(\frac{\lambda'}{\lambda_1} \right)^2 \right] \\ & - \left[\left(\frac{\lambda''}{\lambda_1} \right)^2 - 1 \right] \left[1 - \left(\frac{\lambda'}{\lambda_1} \right)^2 \right] \sin \frac{2\pi V}{\lambda''} t \end{aligned} \right\} \text{ or}$$

$$(45) \quad i_1 = I_o \left\{ P_1' \cos \frac{2\pi V}{\lambda'} t + P_1'' \cos \frac{2\pi V}{\lambda''} t \right\}$$

$$(46) \quad i_2 = I_o \sqrt{\frac{L_1}{L_2}} \left\{ P_2' \cos \frac{2\pi V}{\lambda'} t + P_2'' \cos \frac{2\pi V}{\lambda''} t \right\}$$

$$(47) \quad I_1' = I_o P_1' \qquad I_1'' = I_o P_1''$$

$$(48) \quad I_2' = I_o \sqrt{\frac{L_1}{L_2}} \cdot P_2' \qquad I_2'' = I_o \sqrt{\frac{L_1}{L_2}} \cdot P_2''$$

The values of P_1' , P_1'' , P_2' and P_2'' are shown as broken-line curves in Figures 8, 9, 10 and 11.

Conclusion and Remarks

An examination of the results given lead to certain interesting conclusions.

Mention has already been made of the fact that the fluxes of the long waves in the two coils are together in phase while those of the short waves are opposite in phase. Looking again at expressions (27) and (28) it will be seen that at resonance $\frac{I_2'}{I_1'} \sqrt{\frac{L_2}{L_1}} = -1$ and $\frac{I_2''}{I_1''} \sqrt{\frac{L_2}{L_1}} = 1$, or *at resonance the magnetic fluxes of corresponding waves are equal in magnitude.*

If the coils L_1 and L_2 are placed coaxially, then the flux change due to the long wave is greatest along the axes of the coils, while the change of flux due to the short waves is greatest in a plane between the coils and is zero if the coupling is 1. This explains the reason why it is possible with a wave meter to find one of the two coupled waves when the wave meter coil is in one position while for the other wave another position of the wave meter coil will usually give louder response.

The amplitudes of the oscillations in both circuits alternately increase and decrease as the two waves are alike and opposite in phase, giving rise to the phenomenon of beats. The energy surges between the primary and secondary circuits so that

KEY TO FIGURES 8, 9, 10 AND 11

	SHORT WAVE	LONG WAVE
Condenser Excitation	$I_1' = \frac{2\pi V Q_0}{\lambda_1} \cdot K_1'$	$I_1'' = \frac{2\pi V Q_0}{\lambda_1} \cdot K_1''$
	$I_2' = \frac{2\pi V Q_0}{\lambda_1} \cdot \sqrt{\frac{L_1}{L_2}} \cdot K_2'$	$I_2'' = \frac{2\pi V Q_0}{\lambda_1} \cdot \sqrt{\frac{L_1}{L_2}} \cdot K_2''$

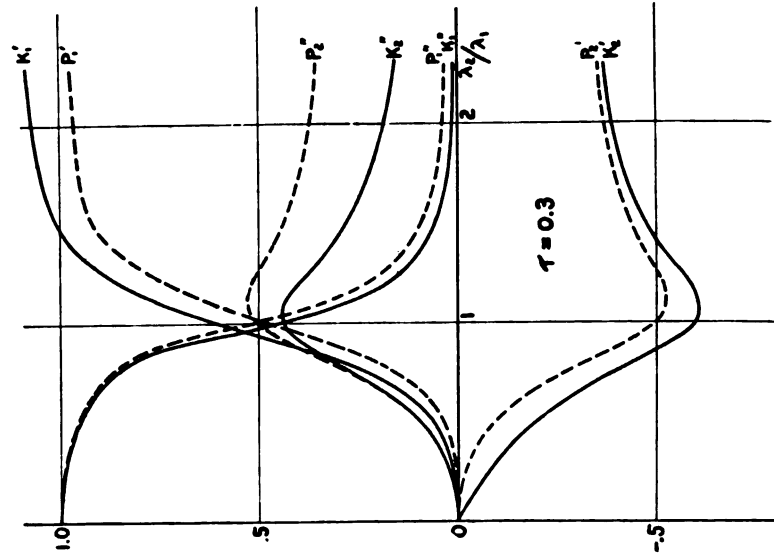

FIGURE 9

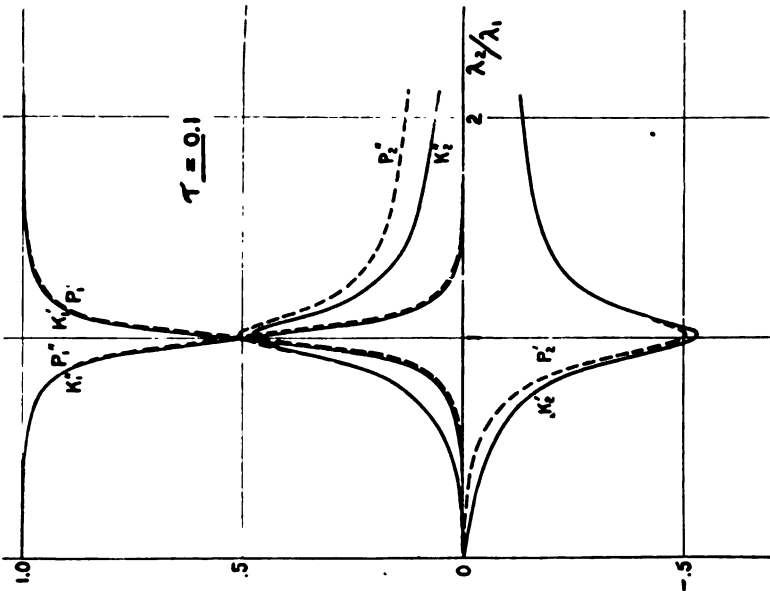
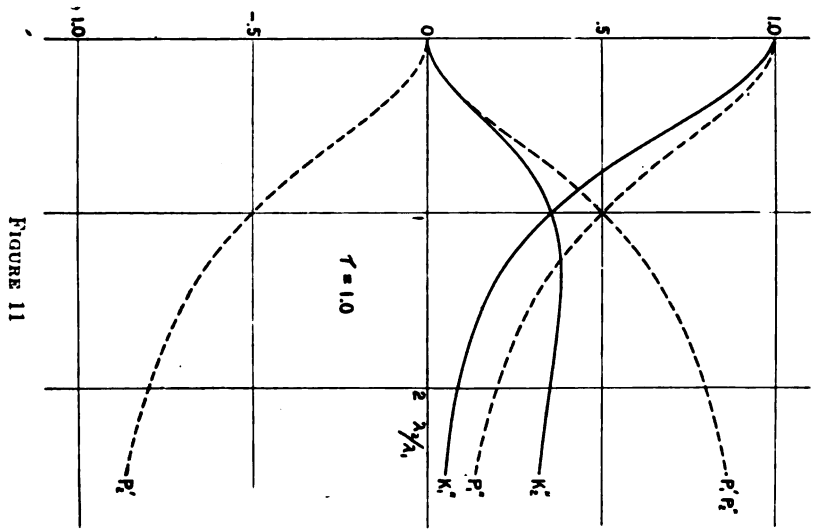
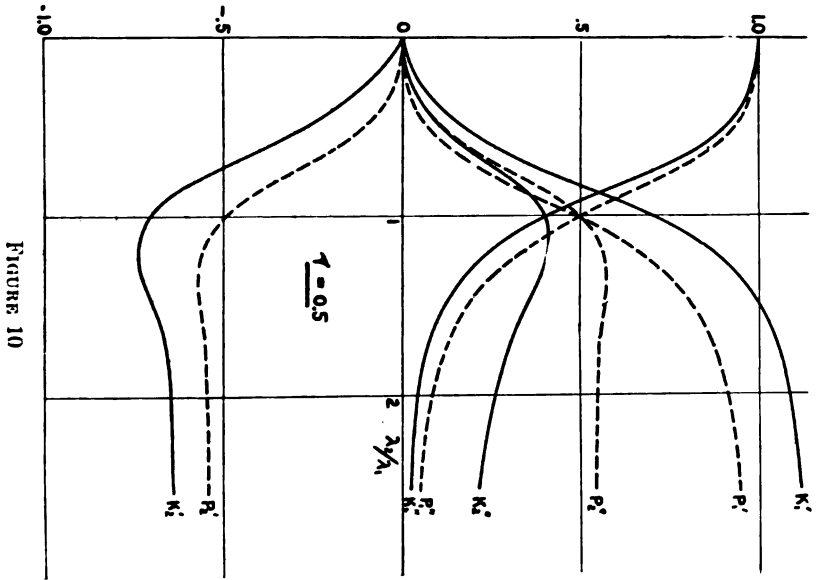

FIGURE 8

KEY TO FIGURES 8, 9, 10 AND 11 (Continued)
 SHORT WAVE LONG WAVE

Inductance Excitation $\left\{ \begin{array}{ll} I_1' = I_0 P_1' & I_1'' = I_0 P_1'' \\ I_2' = I_0 \sqrt{\frac{L_1}{L_2}} \cdot P_2' & I_2'' = I_0 \sqrt{\frac{L_1}{L_2}} \cdot P_2'' \end{array} \right.$



when the amplitude of the one circuit is greatest and equal to the sum of the component amplitudes, the amplitude of the current in the other circuit is a minimum and equal to the difference of the component amplitudes. The closer the coupling and the more $\frac{\lambda_2}{\lambda_1}$ differs from 1, the more rapid are these beats.

It will be seen on examination of Figures 8, 9, 10 and 11, that when the primary is excited by a discharge of the magnetic field of the inductance, the secondary component amplitudes are equal. The amplitude of the secondary current, therefore, for this case periodically becomes zero, whereas, if the primary is excited by a condenser discharge the secondary amplitude never becomes zero because the short wave component always has a greater amplitude than that of the long wave. Similarly, the beating of the primary current, in the case of inductance excitation, causes the amplitude periodically to vary between 1 and zero, whereas for the condenser excitation the primary current amplitude changes between a maximum value *greater than 1* and a minimum value *greater than zero*.

Furthermore, it is to be noted that the maximum amplitudes of the component oscillations in the secondary circuit and, therefore, the maximum amplitude of the current is obtained when $\frac{\lambda_2}{\lambda_1}$ is somewhat *greater than 1*, the value depending upon the coefficient of coupling. In other words *the maximum effect in the secondary is not obtained when the natural periods of the two circuits are the same*. If the expression for the amplitude of the secondary wave, in the case of inductance excitation, be differentiated with respect to $\frac{\lambda_2}{\lambda_1}$ to find what value of the latter ratio will give a maximum amplitude, the result is

$$(49) \quad \left[\frac{\lambda_2}{\lambda_1} \right]_{max.} = \frac{1}{\sqrt{1-2\tau^2}} \Bigg|_{\tau=0}^{\tau=\frac{1}{\sqrt{2}}}$$

This expression is applicable between $\tau=0$ and $\tau=\frac{1}{\sqrt{2}}$.

For values of τ above $\frac{1}{\sqrt{2}}=0.707$, the secondary amplitude has no maximum except at $\frac{\lambda_2}{\lambda_1} = \infty$. Equation (49) is plotted in Figure 12. The points on the curve show experimental verification of the above relation. A similar relation could be deduced

for the condenser excitation but it is evident from the curves of Figures 8, 9, 10 and 11 that the value of $\left[\frac{\lambda_2}{\lambda_1}\right]_{max.}$ for this case would be always less than the corresponding value for the inductance excitation.

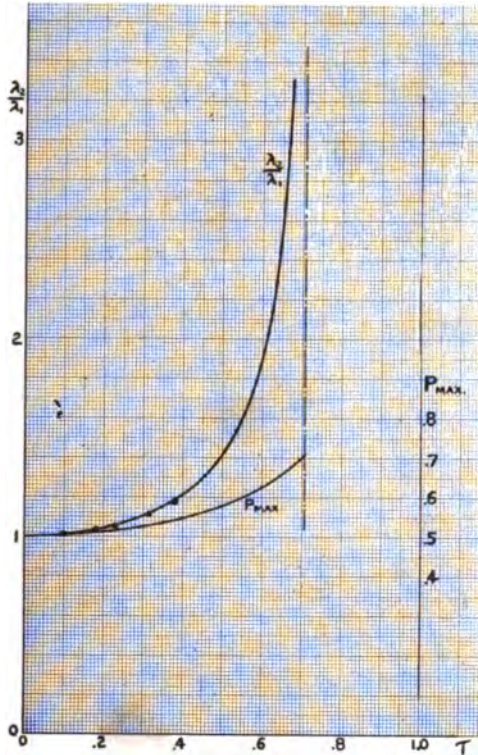

FIGURE 12

The above consideration is very important in the use of a wave meter. If the coupling between the wave meter and the circuit, the wave length of oscillations of which is being measured, is appreciable, the setting of the wave meter will be in error. A coupling of 0.1 will cause over 1 per cent error in the determination.

If (49) be substituted in the expression for the amplitude in

the case of inductance excitation, the maximum value of the amplitude will be given and is

$$I_2''_{max.} = I_2'_{max.} = I_0 \sqrt{\frac{L_1}{L_2}} \cdot \frac{1}{2\sqrt{1-\tau^2}} \bigg|_{\tau=0}^{\tau=0.707} = I_0 \sqrt{\frac{L_1}{L_2}} \cdot P_{max.}$$

The value of $P_{max.}$ is plotted in Figure 12.

If Figures 8, 9, 10 and 11 be once more examined it will be seen that the secondary component amplitudes rise to a maximum much more sharply for values of $\frac{\lambda_2}{\lambda_1}$ less than 1 than for

values greater than 1, where $\frac{\lambda_2}{\lambda_1}$ is plotted on a uniform scale.

If the secondary circuit (for instance a wave meter) be tuned by varying its capacity, the change of $\frac{\lambda_2}{\lambda_1}$ is not proportional to the angle thru which the variable capacity is rotated but increases less rapidly as the capacity becomes greater. This would even more accentuate the difference in steepness, with reference to variations in C_2 , of the amplitude curve on the two sides of the maximum. It is, therefore, evident why, as the capacity of a wave meter or similar circuit coupled with an oscillating circuit is increased thru the resonant value, the current in the wave meter rises very rapidly as resonance is approached and then decreases very gradually as the capacity passes its resonant value.

Cruft Laboratory, Harvard University.

SUMMARY: An historical survey of previous work on coupled circuits is made.

There are formed, in general, in coupled circuits two waves in both primary and secondary circuits. The amplitude ratios of the longer two of these waves and of the shorter two of these waves are calculated. Neglecting resistance, the shorter waves are opposite in phase, the longer waves in phase.

A simple experimental method for rapidly verifying the theoretical relations is described.

The ratios of the amplitude of the longer to the shorter primary wave and of the longer to the shorter secondary wave are theoretically determined for both condenser excitation and inductance excitation.

It is shown that at resonance the magnetic fluxes of corresponding long or corresponding short waves are equal numerically. It also appears that maximum secondary effect is not obtained for equal natural periods of the circuits.

The extent to which wave meter close coupling affects accuracy of wave length determination is considered. An explanation of dissymmetry of resonance curves about the resonance point is also given.

All relations deduced are graphically illustrated.

DISCUSSION

H. G. Cordes (communicated): It may be of interest to supplement Dr. Chaffee's paper by discussing the amplitude relations in a direct coupled circuit. A different notation will be used, but the results can be readily compared with those given.

Figure 1 represents a direct coupled circuit in which there is no mutual inductance between L_1 and L_o .

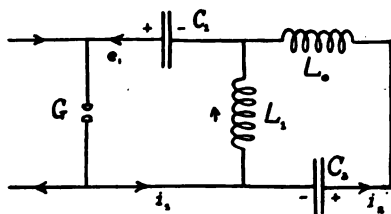

FIGURE 1

In the figure L_1 , C_1 , G represents the primary and L_o , L_1 , C_2 represents the secondary oscillating current circuit. The initial ($t=0$) condition is represented by current I flowing into condenser C_1 , an initial charge, $e_a (=e_1)$ and $e_p (=e_2)$, on condensers C_1 and C_2 respectively, and an initial current, $i_p (=i_2)$ in the secondary circuit. The condensers when charged as indicated will be considered positively charged, and current in the direction of the arrows will be considered positive.

$$\text{Let } L_1 = \rho L_o$$

$$\text{" } C_1 = a C_2$$

$$\text{" } v = \frac{a\rho + \rho + 1}{2a\rho}$$

$$\text{" } u = \frac{\sqrt{(a\rho + \rho + 1)^2 - 4a\rho}}{2a\rho}$$

$$\text{" } r = \sqrt{v+u}$$

$$\text{" } s = \sqrt{v-u}$$

$$\text{" } \omega = \frac{1}{\sqrt{L_o C_2}}$$

$$\text{" } \omega_o = \frac{1}{\sqrt{(L_1 + L_o) C_2}}$$

Referring to equation (14) of Mr. Chaffee's paper

$$\text{Let } I_2' = \sqrt{A^2 + B^2}, \quad I_2'' = \sqrt{C^2 + D^2}, \quad \omega' = \omega r, \quad \omega'' = \omega s,$$

$$\phi = \tan^{-1} \frac{B}{A}, \quad \psi = \tan^{-1} \frac{D}{C}.$$

These conditions are satisfied when

$$A = \frac{C_2 \omega_o \sqrt{1 + \rho}}{2u \cdot 10^6} \left[\frac{a(1 - s^2) + 1}{ar} \cdot e_p + r e_a \right]$$

$$B = \frac{a(1 - s^2) i_p - I}{2ua}$$

$$C = \frac{C_2 \omega_o \sqrt{1 + \rho}}{2u \cdot 10^6} \left[\frac{a(r^2 - 1) - 1}{as} \cdot e_p - s e_a \right]$$

$$D = \frac{a(r^2 - 1) i_p + I}{2ua}$$

If C_2 is expressed in microfarads, e_a and e_p in volts, and i_p and I in amperes, i_2 will be expressed in amperes.

To obtain the equation for i_1 from i_2 , substitute the following in equation (13)

$$I_1' = a(r^2 - 1) I_2' \quad \text{and} \quad I_1'' = a(s^2 - 1) I_2''$$

Certain relations of s , r , a and ρ may be noted.

When $a\rho = 1,$

then $sr = 1.$

$$\frac{a(r^2 - 1) - 1}{as} = \frac{a(1 - s^2) + 1}{ar}$$

$$a(1 - s^2) + 1 = a(r^2 - 1)$$

$$s(r^2 - 1) = r(1 - s^2)$$

In all cases $rs = \frac{1}{\sqrt{a\rho}}.$

and $\omega = \omega_o \sqrt{\rho + 1}.$

For resonance $v = 1$

$$\rho a = \rho + 1$$

$$u = \sqrt{\frac{1}{a}}$$

$$r = \sqrt{1 + u}$$

$$s = \sqrt{1 - u}$$

$$A = \frac{C_2 \omega_o r \sqrt{\rho+1}}{10^6 \cdot 2} \left[e_p + \sqrt{a} e_a \right]$$

$$B = \frac{1}{2} (i_p - uI)$$

$$C = \frac{C_2 \omega_o s \sqrt{\rho+1}}{10^6 \cdot 2} (e_p - \sqrt{a} e_a)$$

$$D = \frac{1}{2} (i_p + uI)$$

Let (27a), (28a), etc., be the equations of the ratios of amplitudes corresponding to equations (27), (28), etc., of Mr. Chaffee's paper.

$$(27a) \quad \frac{I_2'}{I_1'} = \frac{1}{a(r^2-1)}$$

$$(28a) \quad \frac{I_2''}{I_1''} = \frac{1}{a(s^2-1)}$$

which is negative since s is less than unity.

$$(29a) \quad \frac{I_1''}{I_1'} = \frac{s(1-s^2)}{r(r^2-1)}$$

$$(30a) \quad \frac{I_2''}{I_2'} = -\frac{s}{r}$$

For inductance excitation consider all initial conditions zero except I , which is flowing when the spark gap, G , is short-circuited.

$$(41a) \quad \frac{I_1''}{I_1'} = \frac{1-s^2}{r^2-1}$$

$$(42a) \quad \frac{I_2''}{I_2'} = -1$$

For resonance $a(r^2-1) = a(1-s^2) = \sqrt{a}$

“ “ $r^2-1 = 1-s^2 = u$

In comparing the phase relations in inductively coupled circuits with those of conductively coupled circuits it is evident that when there is mutual inductance between L_1 and L_o , the effects due to the mutual inductance are in phase with the effect due to the conductive coupling.

From the conclusion reached in the case of inductively coupled circuits it would appear that a circuit coupled to L_1 would give a loud response to the long waves and a feeble response to the short waves, since the current in this coil is the resultant of the primary and secondary currents.

The curves shown were plotted for condenser excitation where $\alpha=5$, $\rho=0.2$, and $\omega_0=2\pi\times 10^5$. Curve "R" is plotted for $\omega_0 t=0^\circ$ to 400° , and is for reference only. Curve "P" is the primary current, while curve "S" is the secondary current

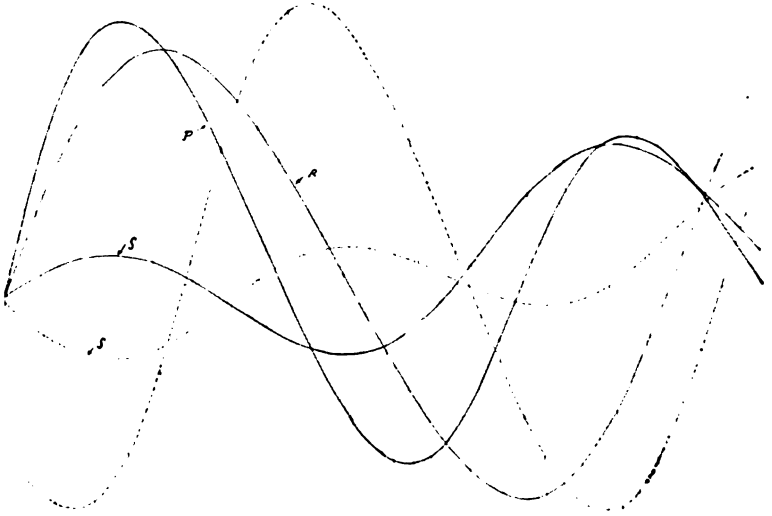

FIGURE 2

for the interval $\omega_0 t=0^\circ$ to 400° . Curves P' and S' are the primary and secondary currents respectively during the interval $\omega_0 t=2,000^\circ$ to $2,400^\circ$.

Inspection of these curves shows how the resultant frequency is continually changing. Curves P' and S' show the phase relations of the resultant current at a point of re-transfer of energy.

SUSTAINED WAVE RECEIVING DATA *

By

LEONARD F. FULLER

(CHIEF ELECTRICAL ENGINEER, FEDERAL TELEGRAPH COMPANY.)

On September 1, 1915, the steamer "Ventura" of the Oceanic Steamship Company left San Francisco for Sidney, Australia. Installed on the ship was a 5-kilowatt Federal-Poulsen arc set. At San Francisco a 30-kilowatt set was used. The antenna current was 50 to 60 amperes, and the wave length 8,000 meters. The following reception was accomplished on the "Ventura":

A distance of 3,830 miles (6,150 km.) from San Francisco, the signals could be copied on the typewriter, in September, 1915, by daylight.

At a distance of 4,200 miles (6,750 km.), the messages could be copied by pencil in daylight thru heavy strays.

At a distance of 5,140 miles (8,260 km.), the messages could be copied by pencil in daylight thru light strays.

In the early evening in September, 1915, the ship being on a course between Hawaii and Samoa, the signals from Tuckerton, N. J. were copied on the typewriter in the early evening. The "Ventura" was then 3,840 miles (6,180 km.) from San Francisco.

Evening signals in September, 1915, from Tuckerton were copied by pencil on the "Ventura" when 530 miles (850 km.) southwest of Samoa, 5,320 miles (8,550 km.) from San Francisco, and approximately 8,000 miles (13,000 km.) from Tuckerton.

This reception from Tuckerton was often duplicated. Tuckerton used a 60-kilowatt arc set and an antenna current of 100 to 120 amperes. The signals from the Tuckerton alternator were also received when 3,840 miles (6,180 km.) from San Francisco.

In May, 1915, the steamship "Sierra," 1,700 miles (2,600 km.) west of San Francisco, copied messages from Nauen, Germany, by pencil, the total distance being approximately 8,600 miles (14,000 km.).

In December, 1914, the South San Francisco station copied

*Presented before The Institute of Radio Engineers, Washington Section, December 29, 1915.

by pencil in daylight the Nauen, Germany, signals at a distance of approximately 7,000 miles (11,000 km.).

Eilvese, Germany, has also been heard 1,700 miles (2,700 km.) west of San Francisco on board ship and at night at the Honolulu station of the Federal Telegraph Company.

All the above data relative to the reception of messages from South San Francisco and Tuckerton have been frequently duplicated, and are not to be classified as "freak" work. The signals from Nauen were not duplicated frequently, and are to be classified as more or less "freakish" or erratic.

SUMMARY: The shipboard reception by daylight of sustained wave signals from a 30 kilowatt arc at distances of the order of 4,000 miles (7,000 km.) and from a 60 kilowatt arc at distances of approximately 7,000 miles (11,000 km.) in the evening are instanced.