

THE HORN SPEAKER

Radio News for September, 1924

68 METERS

KDKA's Powerful Short Wave Station

The Station with a Vertical Antenna of Copper Tubing

Very little has been told of the wonderful work that the Westinghouse engineers have accomplished on the short wave transmission. Something of the work they have done manifests itself between the lines of this description.



The new Westinghouse experimental building in which is located KDKA's short wave transmitting station. The unique vertical antenna, consisting of about 50 feet of copper tubing, is seen at the right.

is large and spacious and having windows on all four sides is well lighted by day.

The rectifier which furnishes high voltage to the plates of the water cooled tubes is mounted in a specially designed frame so that every part of the apparatus is accessible. Replacement and observations can be conveniently made because every part of the unit is in full view of the observer. The rectifier has a capacity which can be pushed to 150 kilowatts, if it is necessary, and is the result of the several years' experimenting and pioneering of the Westinghouse company in short-wave broadcasting. The rectifier is of the three-phase type, having a tube on each side of the line of six water-cooled rectifier tubes. In front of each tube is a helix of rubber tubing to permit the use of city water to cool the tubes. On the front of the panel is a row of knife switches used to regulate the voltage of the transformers, thus governing the output of the rectifier.

The oscillator panel is of the same general construction as the rectifier panel and makes use of Westinghouse high-power, water-cooled, copper-anode transmitting tubes. They are not ordinarily subjected to maximum capacity, but are usually paralleled. Thus each tube is subjected to about half of its rated capacity and an unusually long life in tubes results. Another reason for paralleling tubes is that operating on the high frequency waves causes unusual stresses and strains to develop, not encountered in the ordinary broadcast wave-lengths and some safety factor is desirable. Immediately behind the tubes is the tuning inductance. In the front of the panel are located the various indicating meters. As in the case of the rectifier, every part of the oscillator panel can be observed and replacements made without difficulty. The modulator panel, using the same general type of tubes, has a switching arrangement whereby the number of tubes used and the amount of power used can be regulated. Indicating meters are mounted on the front of the panel and there is also a modulation meter which shows how strongly the energy generated by the oscillator is being modulated.

Adjoining the main room and extending a few feet into it is the control room. The front and extended sides of the room have glass windows so that every part of the apparatus room may be constantly seen by the operator. This room is equipped with amplifying apparatus consisting of two units, one using five-watt tubes, and the other using 50-watt tubes. The start and stop control switches, line terminals, amplifying connections, etc., all are located in this room. Thus the engineer at his desk can control everything in the station. He also can listen in and hear the signals, thus judging them for quality.

Other rooms on the floor include the main office, sleeping room and shop.

One of the most distinctive marks of the station is the extremely unique short-wave antenna, a special type perfected by Frank Conrad, assistant chief engineer of the Westinghouse company, and the man who made most of the present records possible through short wave development. The antenna is a copper tube erected vertically with respect to the ground and supported from a pole about 50 feet high. The antenna, which has a ball on its one end, is quite rigid, to prevent its swaying. Extremely fine results have been obtained from this perpendicular type of antenna. Though only one is now installed, there will be several erected at various points about the station to take advantage of the directional effects possible through the different locations.

Wonderful results have been obtained from broadcasting from the new site of the short-

THOROUGHLY aware that short-wave or high frequency wave broadcasting will bring forth the greatest future development in radio broadcasting, the Westinghouse Electric & Manufacturing Co. has completed and has been operating for some time past a new specially designed radio experimental building, erected at a cost of several hundred thousand dollars. The new building is a one-story concrete and brick structure located on the Greensburg pike, about a mile east of the Westinghouse company's East Pittsburgh works. The site chosen is within a few feet of being the highest spot in Allegheny county, and is one of the level spots available on the hills which dot the locality.

The new site of the short wave station of KDKA is in direct contrast to its former location where, despite some known drawbacks, transmitting with Hastings, Neb., and England was carried on nightly. When first installed, the short wave transmitter was located on the top of a nine-story building directly in the heart of the East Pittsburgh works. Steel buildings known to have a decided absorbing effect on radio waves, completely surrounded the set and, in addition, it was located in a valley with hills on three sides. As a matter of fact, the main transmitter of KDKA is still located in the same place and it is a matter of radio history that all of KDKA's transmitting achievements have been accomplished from this set. However, there is a probability that the 326 meter transmitter will be moved to the very desirable new location.

The new radio experimental building has been so designed that all apparatus contained within it is located symmetrically with respect to all other apparatus.

The basement is divided into several rooms. The main basement chamber contains the

high-power transformer plant, motor generator sets, filters, chokes and other apparatus. One of the rooms contains a transformer station of the Duquesne Light Co. The remainder of the basement is occupied by the battery room, furnace room and storage battery. Power is brought into the basement through underground ducts from two separate sources, both of which are 4,000 volts, three phase, 60 cycles. This current supply

may be stepped up or down as required. The available power supply is in the neighborhood of 250 kilowatts, which can be increased, however, should it be necessary.

With this basement arrangement all bulky apparatus is located out of the transmitting room and is never in sight.

The main apparatus room on the first floor of the building in which are located the oscillator, modulator and rectifier panels

The power room, showing the large transformers and conjunctive apparatus that supply the power to the transmitter. The available power supply is in the vicinity of 250 kilowatts.

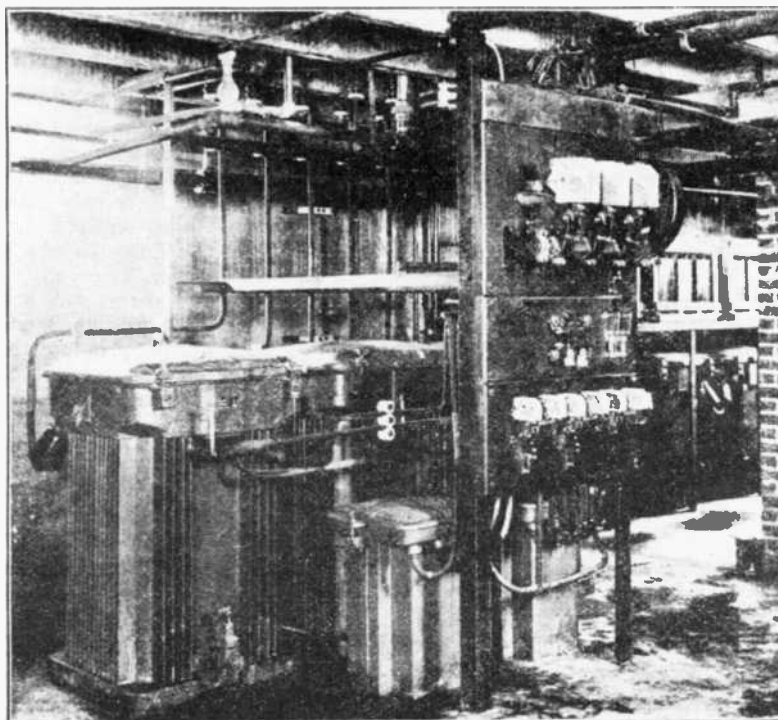

Radio News for September, 1924

293

wave station. As an example, it is only necessary to state that daylight transmitting was successfully carried on between this station and station KFKX at Hastings, Nebraska, in order to repeat from Hastings, the Republican Convention proceedings at Cleveland and the Democratic Convention proceedings at New York. Such a feat of daylight broadcasting would not have been believed possible on any wave-length by radio experts a year ago. It is quite safe to say that there is no other station in the world now capable of doing such work.

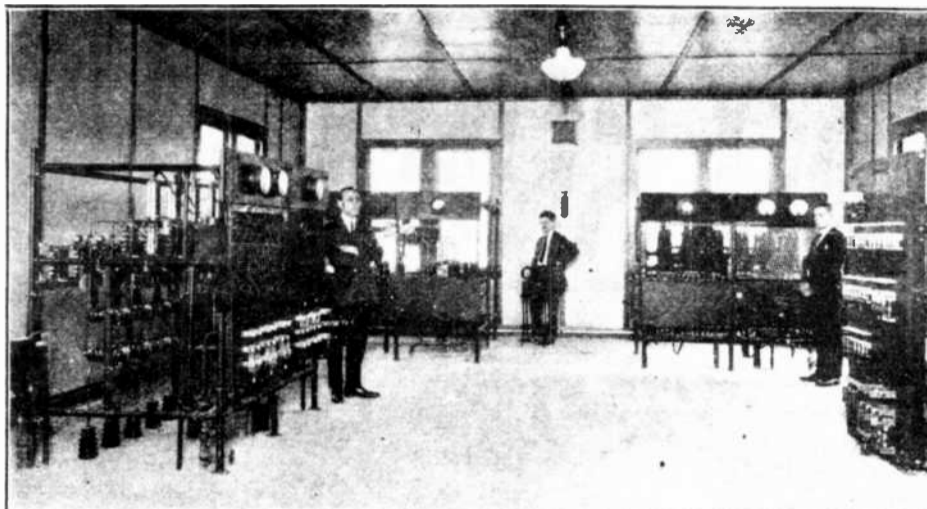

KDKA's short wave transmitting apparatus. This room contains the oscillator, modulator and rectifier panels. Note the elaborate insulation to the rear of the panel in the left of the photo.

PARS, Pittsburgh Antique Radio Society, is quite involved with Frank Conrad and KDKA projects. If you are interested in contacting any of their members on the history of radio in the Pittsburgh area, try calling Seth, KC3YE, if you are a ham radio operator, on the Antique Wireless Association Net at 2:30 p.m. est, Tuesdays, 14.274 Mhz. or write: David W. Kraeuter, secretary, 506 E. Wheeling Street, Washington, Pennsylvania 15025.

METAL TUBES

Are metal tubes worth while? This review of the first season of metal tubes, based on interviews of tube and set manufacturers, engineers and dealers, indicates an affirmative answer.

JULY, 1936

JUST one year ago, the idea of metal tubes was introduced to the public and shortly thereafter receivers using metal tubes were offered for sale. For some months the question as to whether metal tubes were worthwhile was clouded by propaganda for and against. Between the enthusiasts and the pessimists among the manufacturers and dealers, the public was left pretty much to make up its own mind as to whether it believed in the new development—or whether it would insist on glass tubes. The answer of Mr. and Mrs. Public was unanimous and spectacular.

TODAY there can be no question about the status of metal tubes in the mind of the average radio-set purchaser, but it is nevertheless interesting to review the phenomenal rise of the metal tube. Its development and acceptance have not been entirely a path of roses. In the first few months of production there were many complaints, concerning mainly the short life of certain types of metal tubes. The principal reason for this condition was that the tremendous demand resulted in a premature rush of production in the tube factories which kept them going at high speed twenty-four hours a day. The second reason was that several different types of tubes were introduced simultaneously and all of them put into immediate heavy production.

It is a safe guess that had an equal number of new glass tubes been brought out simultaneously, and suddenly rushed into high-speed production, just about the same amount of trouble would have been encountered.

Previously the glass tubes had been introduced one at a time and in each case their acceptance by set manufacturers was slow enough to permit the

By The Staff

"bugs" of production to be ironed out before a sizable demand developed. This is a logical course of procedure, as no new vacuum tube type can be fully perfected until it has gone through its "baptism of fire" in actual receiver circuits under conditions of normal use.

Under the circumstances, the tube manufacturers really did a remarkable job. They faced an unprecedented situation. They could not introduce metal tubes one type at a time because it would be a little bit ridiculous for set manufacturers to develop receivers which would use one or two metal tubes and glass tubes for the balance. Moreover, set manufacturers would have been hampered in going into full production because they would have to re-vamp their designs from week to week as additional types of metal tubes were introduced. Also, the inclusion of one or two metal tubes in a radio receiver would offer little buying appeal to the public, whereas the introduction of all-metal-tube receivers undoubtedly contributed very largely to the tremendous radio sales experienced during the past ten months.

Early Criticisms

Much of the early criticism of metal tubes was unquestionably justified. From the standpoint of metal tube proponents, however, it is only fair to state that metal tubes received the blame for all sorts of failures for which they were not responsible.

During the season just closed there were of course some manufacturers who were unwilling to use the metal tubes. Some of the more conservative pre-

ferred to wait until the metal tubes had proven themselves. They produced some mighty fine glass-tube sets. Others had completed their production plans before metal tubes were available and decided to carry on with glass tubes rather than undertake the expense involved in altering these plans. Most of this latter group of set manufacturers did subsequently change over to metal tubes and others are planning to do so next season.

Favor Metal Tubes

The general acceptance of the metal tube has definitely put the production plans for the coming year on an even more extensive scale than last year. A check was made on this point among engineers who have been and are now engaged in designing receivers for the 1936-7 season. The engineers consulted favor the metal tubes to the last man. The editors believe without any question whatsoever that metal tubes have arrived but that glass tubes will be used on some special jobs and as replacements in old receivers. This opinion is based on rather extensive inquiries and investigation among set manufacturers, dealers and tube manufacturers.

The investigation made by RADIO NEWS included a visit to the RCA Radiotron plant at Harrison, New Jersey, with the object of looking into the whole question of metal tubes versus glass from a technical and a tube production standpoint and to review the metal tube development now that the heat of controversy has subsided. Following are some of the conclusions reached. The metal tube is not radically revolutionary in its effectiveness as compared with similar glass types. It has several advantages, each in





A later version of the "Jot 'Em Down Store" reproduced by The National Broadcast Museum. As almost all old radio fans know the above type of scene was the center of the Lum and Abner show which was first produced over NBC on April 26, 1931. Photo by Jim Long.

itself perhaps rather minor, but accumulated they reach rather important proportions. Perhaps the most striking argument in favor of the metal tube is that the use of metal for the envelope of a tube opens up a whole new line of development. The glass-enclosed vacuum has been under investigation and development for the past forty years, first in the incandescent lamp manufacturing plants and laboratories and later by radio tube manufacturers. The result is that its development had been perfected to what now appears to be the highest possible degree. In the case of the metal tube all of the problems encountered in the development of the glass tube have been overcome in a few short months. If this period of time had only succeeded in bringing the metal tube up to the glass tube standard it would be distinctly worth while, but actually the metal tube has progressed somewhat beyond this point and it is a practical certainty that the next year or two will see further developments in metal tubes which have not been accomplished with glass. As a matter of fact, there are two metal tubes shortly to be introduced, one of which has already progressed beyond the possibilities of glass construction—and this is only the starting point for metal tubes.

The foregoing is at the moment perhaps a somewhat intangible point in favor of the metal tubes, but it must nevertheless be recognized as an extremely important one if vacuum-tube and therefore radio development is to continue to progress. There are a number of other, definitely tangible points worthy of consideration. The metal tube, for instance, carries its own shield. Shielding accessories are therefore not required and the shielding is more effective. Moreover, the variations in capacity and resistance in critical r.f. and i.f. circuits, resulting from improperly replaced tube shields, are eliminated. With glass tubes many of the complications which are so hard to track down in a new design, even in audio amplifiers, are due to inadequate tube shielding. This source of trouble is automatically eliminated when metal tubes are used.

The smaller size of the metal tubes is an obvious advantage. Then, too, the shell is unbreakable and the entire internal structure is stronger and more rigid due to special spring bracing and to wider spacing of the internal leads between the elements and the tube base.

Many believed that it was not possible to maintain a high vacuum in a metal shell, but actual development work on this one problem has been carried to a point where the metal tube, as now being made, is equal if not superior to the glass tube in this respect. Actual life tests also show that the modern metal tube can be depended upon to average at least as many hours of service as its glass equivalent.

The skeptics brought up numerous points when metal tubes were introduced, supposedly, to prove that metal tubes had inherent drawbacks. It would be interesting to look back on some of these in the light of the experience of the past year. One point was that one could no longer tell whether the filaments were lighted in a receiver. This is obviously a fact, but is of little consequence, as a metal tube will remain cool if the filament is unlighted. If a tube is warm to the touch after the filaments have been turned on for a few minutes it is certain that the filament is lighted. Another objection was that the metal tubes run hotter to the touch than do glass tubes. It is true that the metal tubes feel warmer, but in no case does their actual temperature reach unusual proportions. The metal is a better conductor and radiator of heat. Obviously, the amount of heat generated for a vacuum tube is the same regardless whether the shell be glass or metal. Neither glass nor metal tubes become hot enough to be in any way dangerous and the feel of the tube is of little importance. No tube that is handling any appreciable amount of power is comfortable to handle in any case. More important is the fact that the metal shell radiates heat better than glass.

Higher internal capacity was prophesied for metal tubes and has materialized. For certain applications—particularly in ultra-high-frequency operation—this actually proved to be a drawback, but so far as operation on frequencies up to 30 megacycles is concerned it is by no means a serious consideration. Moreover, this characteristic is one which can be altered when and if the popularity of the ultra-high-frequencies warrants.

This brings us to the one feature that makes the metal tubes less desirable than glass at the present time and that is the matter of price.

It would seem that even the most pessimistic of unprejudiced observers will have to agree that in view of the fact that metal tubes are amenable to future development, whereas basic improvements in glass tubes had just about come to a standstill, the advantages of the metal over the glass mark the season of 1935-1936 as one of distinct fundamental progress so far as tubes are concerned.

WANTED: B-ELIMINATOR, '01A tubes; quote prices, specifications. T.C. Day, 215 W. 7th St., Waybesboro, PA 17268

about 1920

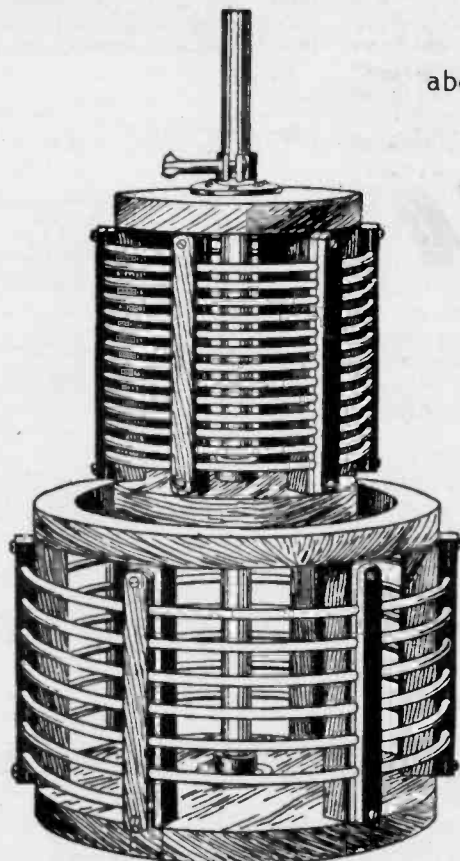

Oscillation transformer. The secondary moves up and down the rod, inside the primary.



The National Amateur Wireless Association

Founded to promote the best interests of Radio Communication among Wireless Amateurs in America extends a cordial invitation to all amateurs and clubs to affiliate with a forward moving organization of amateurs

GUGLIEMO MARCONI, Pres.
J. ANDREW WHITE, Acting President **HARRY L. WELKER, Secretary**
 Headquarters: 326 BROADWAY, NEW YORK, Room 303
 National Advisory Board of Vice Presidents
 Prof. Arthur E. Kennelly, Harvard University. Prof. Alfred N. Goldsmith, College of the City of New York. Rear Admiral W. H. G. Bullard, U. S. N., Director of Naval Communications. Maj. Gen. G. O. Squier, Chief Signal Officer U. S. Army. Prof. Charles R. Cross, Mass. Institute of Technology. Elmer E. Bucher, Instructing Engineer.

The N. A. W. A. was the first amateur national organization in the country.

It stands for all that is progressive—for everything that will benefit the cause of amateur radio.

Big programs; big broadcasting events; co-operation between amateurs and official Washington.

JOIN NOW

You should be a member of the organization that is doing real things for the advancement of amateur radio. You will want to know what we are going to do next—what the programs will be and when we are going to do it.

We want you with us—we want to feel that we have the biggest and best list of active members that can be enrolled, so that when our big events come off we have all the "reliables" we need to make more amateur history.

Yearly Dues, \$2.50. This includes subscription to our official organ, THE WIRELESS AGE.

APPLICATION BLANK

Date.....

NATIONAL AMATEUR WIRELESS ASSN.,
 326 Broadway, Room 301, New York:

Here's my \$2.50. Count me in on the good work.

Signature Age.....
 Street Ad Call.....
 Town and State

HISTORICAL SPECIMENS TO THESE QUESTIONS

1. Have you ever been a member of a radio club (give number.....) or do you propose applying for membership.....
2. If you are under 21 years of age, please give your parents' names and addresses as to character: Reference.....
3. If you are a member of an association, please give the name of the association.....

Desdemona Radio Club, May 18-1922

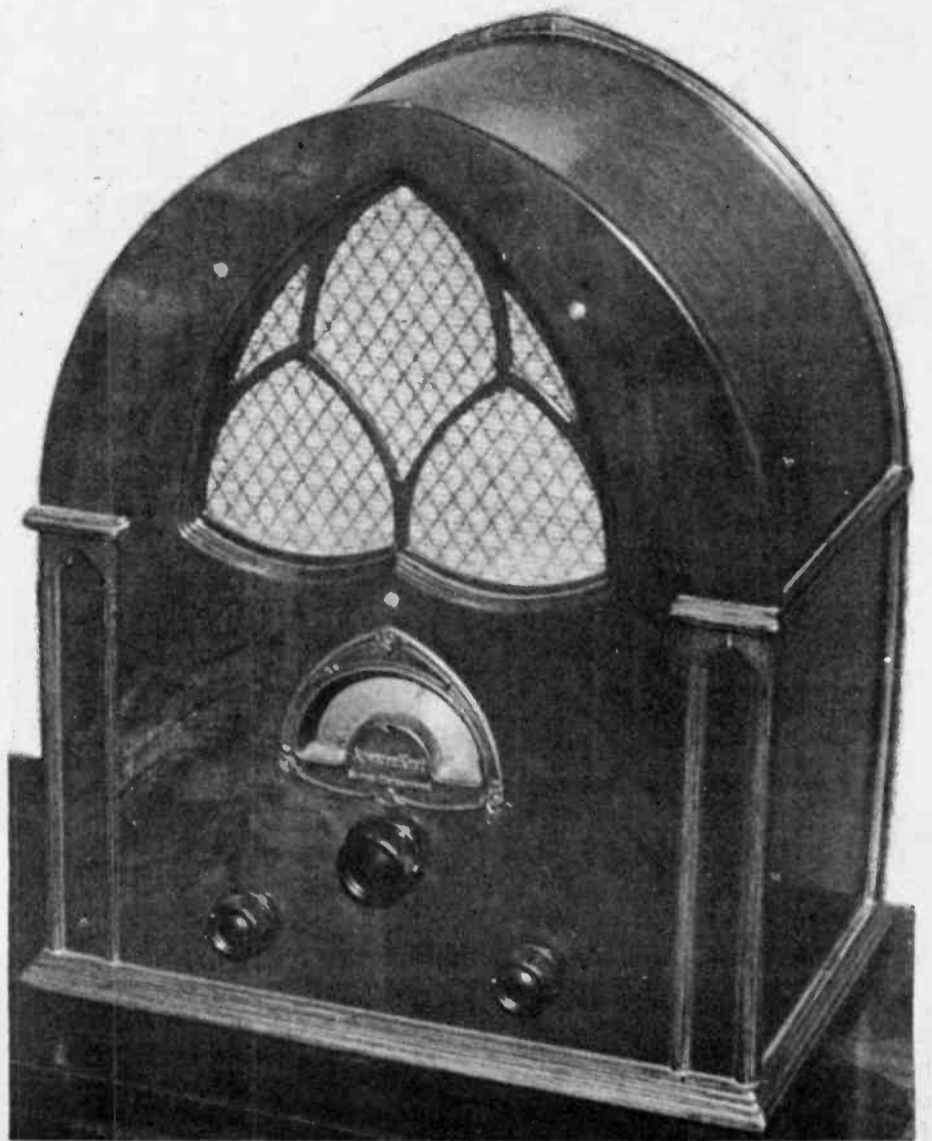

This beautiful old Atwater Kent model 84 belongs to the fine radio collection of Steve Chapman.

The Classic Radio

by J. W. F. Puett

McMurdo Silver's Masterpiece II was my second set when I started collecting radios in 1968. I purchased it for \$7.50 in a garage sale in Tyler, Texas, where I was teaching Electronics at Tyler Junior College. In the back of my mind I remembered an ad in an old National Geographic magazine. After searching through about a hundred issues—there it was—"the official general-coverage receiver for the Byrd second antarctic expedition." Then my memory drifted back to the high-school radio class and my teacher Hal Palmer who told me of the quality of McMurdo Silver radios. This was a special kind of nostalgia for me, although I was only one year old when the Masterpiece II was manufactured.

The Masterpiece II was a product of the major design features of the original Masterpiece (I) and certain design features recommended by a famous eastern university which acted as a radio consultant to Admiral Byrd. The changes were made to insure satisfactory results in the unusually severe weather encountered during the expeditions two year stay in the Antarctic. Both the tuner and amplifier/power-supply chassis were chrome plated. The receiver featured one rf amplifier stage followed by a separate mixer and oscillator. The rf line up was completed with three stages of IF amplification. A beat frequency oscillator was provided for cw reception. The final audio amplifier featured two type 2B6 tubes. The McMurdo Silver Masterpiece

II and the Lincoln were perhaps the only two sets to utilize the 2B6 tube. The Masterpiece II was later offered to the public in a number of beautiful cabinet styles. It was produced for only one year,

to be followed by the Masterpiece III in November of 1934. I wonder how many of these historically significant sets are still waiting in attics and cellars of old homes for some collector to claim them?

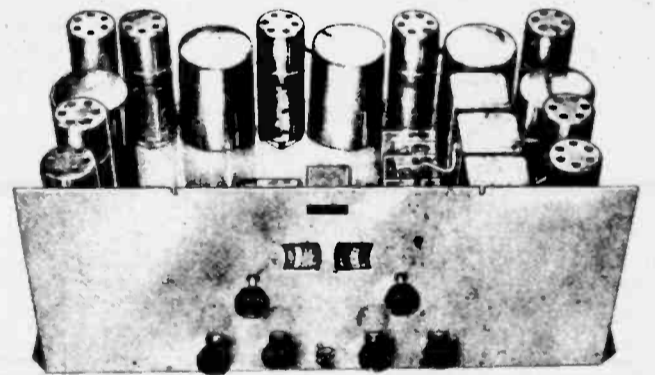

The Masterpiece II, designed by McMurdo Silver, which covers all waves from 13 to 570 meters; It has "band-spread" tuning.

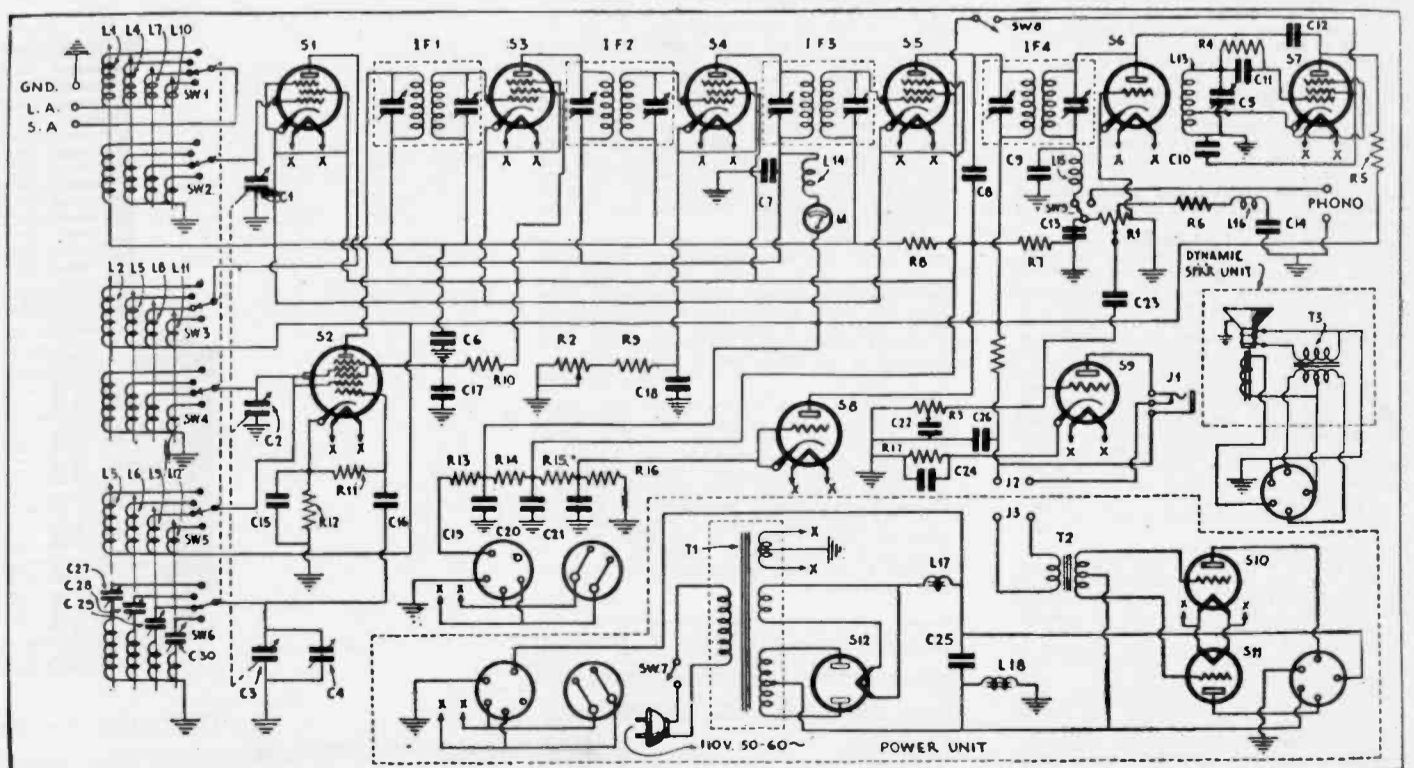

Here we have the schematic circuit diagram for the new McMurdo Silver "Masterpiece II" All-Wave Superheterodyne Receiver.

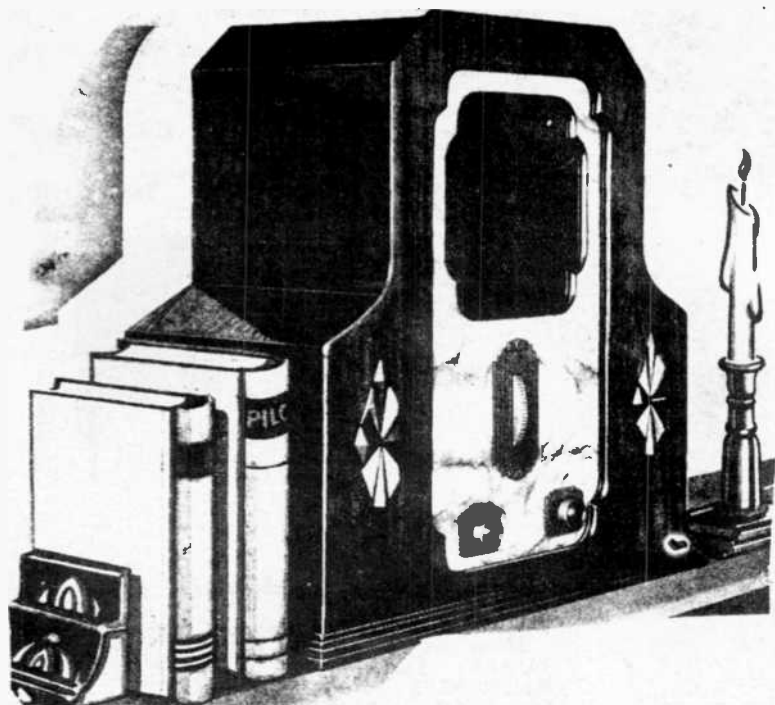

PILOT RADIO

LETTERS

flea market

Dear Jim:

I have been a radio collector for over 35 years and I enjoyed every minute of it. I want to thank THE HORN SPEAKER for the wonderful job they did over the past years. If it wasn't for THE HORN SPEAKER I would never have met and had contact with so many nice people out there. I have made friends from Honolulu to the east coast. I still sell some radios and speakers only on the basis of satisfaction, guaranteed or money back. I am not connected with anyone else selling radios. I am on my own.

Thanks again for a job well done.

Sincerely,
Russell Schoen
E. 7340 Nietzsche Rd.
Clintonville, WI
54929

Dear Jim:

The advertising in THE HORN SPEAKER has been effective. A filing cabinet had to be purchased just to hold the response of incoming requests and letters.

Thank you sincerely,
Jimmie grisson
AMAZING MUSIC MACHINES

BLEND OF PROGRAM AND TECHNICAL

Paul Crum, W9LC, a collector and writer of articles for big "slick" magazines, has sent an article to us about early broadcasting with a skillful mixture of engineers and program content. It is a rather lengthy article with lots of good solid grit. I know you will like it.

WANTED HALLICRAFTER SX-71 OR NATIONAL NC-183 in excellent condition. Please state price and condition when corresponding. Roy Schmitt, Rt. 1, Box 800 Lot 84, Converse TX 78109 (512) 659-0094.

ADVERTISE IN THE HORN SPEAKER
Box 53012, Dallas, TX 75253 (lower price per square inch—compare)

AD SPACE:
Full page \$75.00
Half page \$37.50
Quarter page \$16.25
Business size
card ads \$1.00
Space per square
inch \$0.60

CLASSIFIED ADS .. 15 cents a word.
(first 20 words free)
PHOTO ADS \$5.00 extra.

FOR SALE

ANTIQUE BEEHIVE WHITE INSULATORS - \$1.00 EACH — HEAVY DUTY T.V. REPLACEMENT TRANSFORMERS, NEW BOXED AT \$20.00 EACH. — 50 YEAR COLLECTION OF VACUUM TUBES LOW LOW PRICES. INQUIRE M. LEVY, 101 EAST DRIFTWOOD #44, FBG, TX 78624 TEL (512) 997-2534.

FOR SALE. SERVICE DATA, PARTS, TUBES, TEST EQUIPMENT. LIST #2-86. SASE. KRANTZ, 100 OSAGE AVENUE, SOMERDALE, NJ 08083.

ACME 'ACMEFLEX' (1925, VG TO EXC, UNTRIED, BOTH AUDIOS OK) \$75 — PHILCO 43B (1932, EXP REF'D, WORKS) \$190 — PHILCO 70B (1931, NICELY REFINISHED, SMALL VENEER PATCH ON THE TOP REAR OF CABINET, WORKS) \$190 — BULB SHAPED TUBES AND RADIO BOOKS — SEND LARGE 2 STAMP S.A.S.E. FOR COMPLETE AND UP-TO-DATE PHOTO LIST. — RON BOUCHER, 376 CILLEY ROAD, MANCHESTER, NH 03103. (603) 669-1698.

CRYSTAL, TUBE EXPERIMENTER'S catalog - \$1.00 - None free. Sets, kits, handbooks, plans, coils, supplies, obsolete tube quotat-

ions. Laboratories, 1477-H, Garden Grove, CA 92642.

50 YEAR COLLECTION HARD TO FIND TUBES: LOW LOW PRICES, INQUIRE, M. LEVY, 101 EAST DRIFTWOOD #44, FBG, TX 78624.

SCOTT ALL WAVE RADIO w/ speaker and power supply \$275.00, Silvertone 12" x 15" metal speaker \$15.00, 1910 Dictaphone Transcriber, shaving machine \$75.00, Radiola 28 on four legs, \$100.00, Radiola 25 w/loop \$55.00, Radiola 60 cabinet only w/jewel box made inside \$40.00, 12" x 12" rd. temple style speaker \$40.00, Magnavox R3 speaker \$65.00, Radiola 18 w/tubes \$40.00, Riders 10, 12, 13, \$10.00 ea., Plus U.P.S., Larry Chambers, 5026 Suter Drive, Nashville, TN 37211 (612) 833-2448.

FOR SALE— UNUSED AND USED TUBES, CAPACITORS, speakers, etc. Send S.A.S.E. for lists. C. Elmer Nelson, 11 S. Church St., Princeton, IL 61356.

PHILCO CATHEDRAL, AK 46, RADIOLA AR812, Radiola 18, Crosley Show-box, CASE, RCA T62, speaker AK-F4, quack home diathermy machine, B & K tube tester, wood cased test equipment, John Kendall, 600 Remington Road, Fallston, MD 21047. SASE for pictures and more information.

FOR SALE. RIDERS, HOWARD SAMS, RCA, PHILCO, GE SERVICE MANUALS, TUBES, TEST EQUIPMENT, SPEAKERS, KNOBS, PARTS. SASE FOR LIST. KRANTZ, 100 OSAGE AVENUE, SOMERDALE, NJ 08083.

TRANSFORMERS— POWER— HEAVY DUTY— T.V. AND RADIO REPLACEMENT TYPES, STANCOR AND MERIT, NEW BOXED AT \$20.00 EACH. LARGE COLLECTION VACUUM TUBES, LOW, LOW, PRICES. INQUIRE M. LEVY, 101 EAST DRIFTWOOD #44, FBG, TX 78624, TEL. (512) 997-2534.

FOR SALE— RIDERS MANUALS, ABRIDGED (VOL. 1-5) AND VOL. 6 THROUGH 16 \$275.00. VOL. 9, 10, 14 \$20.00 EACH. ANTIQUE RADIO SERVICE, O. H. McDONALD, 2535 WEDGLEA #124, DALLAS, TX 75211.

ELECTRON TUBES: Receiving, transmitting, microwave.. all type available. Large stock. Next day delivery, most cases. Daily Electronics, P. O. Box 5029, Compton, CA 90224 (213) 774-1255.

CHASSIS— RCA 88K, 8 TUBES, EYES, CLOCK- TYPE DIAL, 3 BANDS, SPEAKER, SOME RUST, \$30.00 — PHILCO 112, 11 TUBES, \$30.00 — MOTOROLA HS-253, 8 TUBES, AM-FM, LOOP \$20.00 — RADIOS —

AK-33, E3 SPEAKER \$60.00 — ZENITH 5R303, 5 TUBE AC, WOOD, PUSHBUTTONS \$20.00 — PHILCO E-812-124 YELLOW PLASTIC, 5 TUBE, AC/DC \$15.00 — SETCHEL - CARLSON 49-6, PAY RADIO, LESS COIN MECHANISM, 5 TUBE AC/DC \$15.00 — COMMUNICATION RECEIVERS

— NATIONAL HRO-W, 5 COILS, POWER SUPPLY \$60.00 — HRO 5TAI, 3 COILS, POWER SUPPLY \$40.00 — NC-183D SPEAKER \$60.00 — HALLICRAFTERS SX-28, CABINET (NO CHROME) \$60.00 — HEATHKIT AR-3 \$15.00 — HEATHKIT HR-1680, SPEAKER \$30.00 — TEST EQUIPMENT — RIDER CHANALYST, PROBES, MANUAL \$40.00 — PRECISION E-200-C GENERATOR, MANUAL \$20.00 — ALL COMPLETE WITH TUBES, SHIPPING EXTRA. JOE WATSON, 3300 ARROWHEAD CIRCLE, ROUND ROCK, TX 78681 (512) 255-7962.

FOR SALE: TEST EQUIPMENT for radio and telephone. SASE for TE list. Serge Krauss, 141 Homan Avenue, Elkhart, IN 46516.

FOR SALE: RADIOS, PHILCOS & RCA cathedrals, Kennedy, Radiolas, Atwater Kents, King and others. No. 199 radio tubes and others. Clifford Schoen, 549 Fulton Street, Seymour, WI 54165. Phone (414) 833-2429.

FOR SALE - 20 SW SETS— LIST SW87. PARTS, TUBES, SERVICE DATA, TEST EQUIPMENT, SASE FOR LIST E86, HARD TO GET TUBES, AK BB PARTS, TUBE SAGA, RADIO NEWS 1920 - 1945. SASE FOR LIST # OFFER 1987. PLUS MORE. KRANTZ, 100 OSAGE AVENUE, SOMERDALE, NJ 08083.

LONG ISLAND ANTIQUE RADIOS— For sale and repair. All prices. "Reasonable, come to AA Electronics, 178 I. W. Willets Road, Albertson, NY; 11542 at Albertson R. R. Station. Call first, (516) 741-4212.

CONSOLES— 10 NICE RADIOS FOR SALE. PHILCO, RADIOLA, MARSHALL, MAJESTIC, KELLOG — SASE FOR LIST. RUSS OLMSTED, 608 W. THOMPSON LANE, MURFREESBORO, TN 37130.

TUBES AND POWER REPLACEMENT TRANSFORMERS... LOW LOW... PRICES: MINATURES AT \$1.00... OCTALS AND LOCTALS AT \$2.00... INQUIRE ON OTHERS.... M. LEVY, 101 EAST DRIFTWOOD #44, FREDERICKSBURG TX 78624. TEL. (512) 997-2534.

RADIO RELATED TIE CLASPS, LAPEL PINS, R.C.A. - G.E. - PHILCO, ETC. FULL ENAMEL EMBLEMS. SEND S.A.S.E. FOR LIST. YOU WILL BE GLAD YOU DID. MR. MICHAEL S. SABODISH, SR., 11-A MATAWAN AVENUE, CLIFFWOOD, NJ 07721.

ROTARY SPARK GAP, medium power. Works fine. \$95; Hallicrafters S-85 Receiver. Excellent. \$85; Three coil mount with honeycomb coils. \$45; Bodine loop antenna. Beautiful. \$75. All plus UPS. Paul C. Crum, W9LC, 6272 N. Cicero Avenue, Chicago, IL 60646. 1 (312) 282-3033



TRADE NAME: "Somerset Stratford."
 MODEL: 4-A.
 TYPE: One stage of tuned radio frequency amplification, detector and two stages of audio frequency amplification.
 TUBES: Four.
 BATTERIES: None furnished; may be self-contained in cabinet.
 CONTROLS: Two.
 AERIAL: Indoor or outdoor.
 PRICE: \$65.00 without accessories.
 MANUFACTURER'S NAME: National Air-phone Corp.

TRADE NAME: "Splitdorf."
 MODEL: R-100.
 TYPE: Tuned radio frequency.
 TUBES: Five.
 BATTERIES: None furnished.
 CONTROLS: Three.
 AERIAL: Inside or outside.
 PRICE: \$150.00 without accessories.
 MANUFACTURER'S NAME: Splitdorf Electrical Company.

TRADE NAME: Superdyne.
 MODEL: 305.
 TYPE: One radio, detector and two audio.
 TUBES: Four.
 BATTERIES: None furnished.
 CONTROLS: Two.
 AERIAL: Outside or inside. Loud speaker built in.
 PRICE: \$275.00 without accessories.
 MANUFACTURER'S NAME: The C. D. Tuska Company.



TRADE NAME: "Splitdorf"
 MODEL: R 102.
 TYPE: Tuned radio frequency with built-in loud speaker.
 TUBES: Five.
 BATTERIES: None furnished.
 CONTROLS: Three.
 AERIAL: Inside or outside.
 PRICE: \$235.00 without accessories.
 MANUFACTURER'S NAME: Splitdorf Electrical Company.

TRADE NAME: Superdyne Jr.
 MODEL: 301.
 TYPE: One radio, detector, one audio reflexed and one straight audio.
 TUBES: Three.
 BATTERIES: None furnished.
 CONTROLS: Three.
 AERIAL: Outside or inside.
 PRICE: \$85.00 without accessories.
 MANUFACTURER'S NAME: The C. D. Tuska Company.



TRADE NAME: "Somerset Shelbourne."
 MODEL: 4-B.
 TYPE: One-stage tuned radio frequency amplification, detector and two stages of audio.
 TUBES: Four.
 BATTERIES: Full-size 6-volt storage "A" battery; can be self-contained in cabinet.
 CONTROLS: One.
 AERIAL: Indoor or outdoor.
 PRICE: \$85.00 without accessories.
 MANUFACTURER'S NAME: National Air-phone Corp.

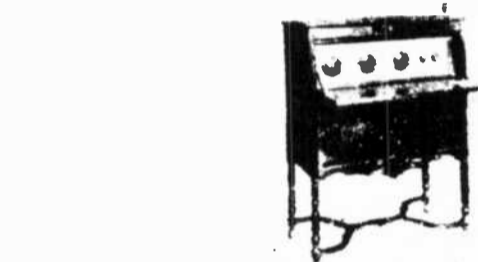

TRADE NAME: "Superflex Portable."
 MODEL: J-X.
 TYPE: One-stage radio frequency amplification, detector and two-stage audio frequency amplification (reflexed).
 TUBES: Three.
 BATTERIES: Not furnished.
 CONTROLS: Three.
 AERIAL: Indoor or outdoor.
 PRICE: \$75.00 without accessories.
 MANUFACTURER'S NAME: Benson Engineering Co.



TRADE NAME: "Somerset Standish."
 MODEL: 4-C.
 TYPE: One-stage tuned radio frequency amplification, detector and two stages of audio.
 TUBES: Four.
 BATTERIES: Full-size 6-volt storage "A" battery; can be self-contained in cabinet.
 CONTROLS: One.

TRADE NAME: "Standardyne Receiver"
 TYPE: Two tuned radio, detector and two audio.
 TUBES: Five.
 BATTERIES: Dry cell or storage.
 CONTROLS: Three.
 AERIAL: Outdoor or indoor.
 PRICE: \$60.00 without accessories.
 MANUFACTURER'S NAME: Standard Radio Corp.

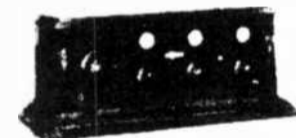

TRADE NAME: "Sonoradio."
 MODEL: 241, built-in with phonograph.
 TYPE: Two radio, detector, and two audio.
 TUBES: Five 199 type.
 BATTERIES: "A"-J dry cells, "B"-90 volts.
 CONTROLS: Two.
 AERIAL: Outdoor or indoor.
 PRICE: \$475.00 complete with phonograph, but without radio accessories.
 MANUFACTURER'S NAME: Sonora Phonograph Company, Inc.

TRADE NAME: Stromberg-Carlson
 TYPE: Hazeltine neotrodyne.
 MODEL: No. 1A.
 TUBES: Five.
 BATTERIES: Not furnished.
 CONTROLS: Three.
 AERIAL: Indoor, outdoor.
 PRICE: \$180 with headset; no other accessories.
 MANUFACTURER'S NAME: Stromberg-Carlson Mfg. Co.

TRADE NAME: "Superflex Loop Receiver."
 MODEL: 4-X.
 TYPE: Reflex.
 TUBES: Four.
 BATTERIES: Not furnished.
 CONTROLS: One.
 AERIAL: Loop.
 PRICE: \$90.00 without accessories.
 MANUFACTURER'S NAME: Benson Engineering Co.

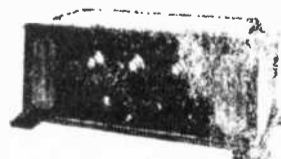

TRADE NAME: "Sonoradio."
 MODEL: 242, built-in phonograph.
 TYPE: Neotrodyne, reflex radio frequency.
 TUBES: Three UV-199.
 BATTERIES: "A"-3 dry cells, "B"-90 volts.
 CONTROLS: Two.
 AERIAL: Inside or outside.
 PRICE: \$235.00 without accessories.
 MANUFACTURER'S NAME: Sonora Phonograph Company, Inc.

TRADE NAME: "Summerset Mars."
 MODEL: 5-A.
 TYPE: Two stages of tuned audio frequency amplification, detector and two stages of audio.
 TUBES: Five.
 BATTERIES: 6-volt "A" storage can be self-contained in cabinet; "B" 60 to 90 volts, can be self-contained in cabinet.
 CONTROLS: Three.
 AERIAL: Outdoor or indoor.
 PRICE: \$75.00 without accessories.
 MANUFACTURER'S NAME: National Air-phone Corp.

TRADE NAME: "Super-Flex."
 MODEL: Console.
 TYPE: Reflex; built-in loud speaker.
 TUBES: Three.
 BATTERIES: None furnished.
 CONTROLS: Three.
 AERIAL: Outside.
 PRICE: \$89.50.
 MANUFACTURER'S NAME: Bossertian Radio Laboratory

INDIANA HISTORICAL RADIO SOCIETY
information and membership appli-
cation send SASE to: IHRS, 245 N.
Oakland Avenue, Indianapolis, IN
46201

FOR SALE: PHILCO 87. ZENITH 10S160.
Silvertone. R101. Crosley fiver.
Crosley 515. Airline "Movie Dial"
and others. List. W0IAZ, P. O. Box
141, Goodman, MD 64843. (417)
364-7936.

RARE FIND— TAKING BIDS— TWO C. R.
LEUTZ SUPER DX SEVEN — SUPER DX
EIGHT — TYPE L SER. NO. 518—
LONG ISLAND NY PROTOTYPES —
EVERETT BERRY, C/O — 2008 E. SEWARD
STREET, TAMPA, FL 33604.

FOR SALE OR TRADE: CBS 190 COLOR
SET 1953 uses 15GP22 in excellent
original working condition.. Altec
Lansing 230B mixing console near
mint with original Altec book. Also
have many 20's battery sets and
horns. See wanted ad this issue.
Ward Kremer, 301 SW 16st., Ft.
Laud., FL 33315. (305) 772-1608.

WARD'S WANTED AD

WANTED: DISK CUTTING EQUIPMENT,
Rek-O-Kut, Presto, Meumann, etc.
Also need idler wheel or measure-
ments for Federal PR-12 disc cut-
ter. Old pro mikes RCA 44's, 66's,
AKG, etc. Ward Kremer, 301 SW
16st., Ft. Laud., FL 33315, (305)
772-1608.

AMATEUR RADIO RECEIVERS AND
TRANSMITTERS — MAGAZINES — TUBES
PHOTOS — .50. SASE FOR LIST —
SEND YOUR WANT LIST. K4UJZ, RUSS
OLMSTED — 608 W. THOMPSON LANE,
MURFREESBORO, TN 37130.

COLLECTION OF Radio, Popular
Science, Science and Invention,
etc. magazines, 320 in all for
\$750. or best offer; 81 antique
radio tubes for \$225. or best
offer, Emerson and Sentiel TV's
\$125. each. Large number of an-
tique radios and phonographs for
sale. Call Charles Rakes at (501)
273-5340 or send a large SASE for
list of items for sale to: Charles
Rakes, P. O. Box 445, Bentonville,
AR 72712.

RCA CT-100, fully restored 1954
COLOR TV, Bill Russell, 3236 Laurel
Canyon, Santa Barbara, CA 93105.
(805) 682-8115. Send \$1.00 and SASE
for color picture.

NEW BOOKS ABOUT OLD RADIOS, PHON-
OGRAPHS. 6 page catalog. Long SASE
to Sound Box, Dept. HS, Box 226,
Ettrick, WI 54627.

FOR SALE, NEW AND USED RADIO TUBES.
Late 1920's thru early 1940's. SASE
for list. FOTHE, 10 JACKSON ST.,
SLOATSBURG, NY 10974.

FOR SALE; UNUSED AND USED TUBES,
capacitors, speakers, etc. Send

SASE for lists. C. Elmer Nelson, 11
S. Church Street, Princeton, IL
61356.

FOR SALE: BOOKS, MANUALS, Tubes
from 1930's to 1970's at 75 cents
each. SASE for lists. Bruce
Harbeck, 13408 Westwood Lane,
Omaha, NE 68144. Phone (402)
333-9013.

AVAILABLE: DUPLEX, PHONOGRAPH,
\$4000/BO. Proposed deals involving
pre-war TV's will receive priority.
Jim Clark, 1 (517) 323-9595.

FOR SALE: OLD QST AND ARRL RADIO
HANDBOOKS. SEND SASE FOR LIST. K.
M. MILLER, K6TR, 16904 GEORGE
WASHINGTON DRIVE, ROCKVILLE, MD
20853.

HIGH FIDELITY magazine, 1940s;
MUSIC AT HOME, AUDIOCRAFT maga-
zines; old RCA theremin, early
oddball hi-fi stuff. Have trade
items. Hal Layer, P.O. Box 27116,
San Francisco, CA 94127.

CAPEHART 112N2 has unusual record
changer— \$325; Neutrowound Super 6
— \$185; Zenith 6S229 — \$85; AK-20 —
\$75; and others. Rosenthal, 507
South Maryland Avenue, Wilm., DE
19804.

BROWNING DRAKE KIT \$65.00, (no
case) A K E speaker \$25.00, Sono-
chorde spkr (fair) \$20.00, Philco
16 cathedral \$175.00, Philco 650
(refin) \$65.00, SHIPPING EXTRA.
Richard Foster, 12 Shawmut avenue,
Cochituate, MA 01778. (617)
655-2056.

WESTINGHOUSE CONSOLE MODEL WR7,
depression era 1929-1930. Built- in
phono and record cutter/ recorder
w/ original hand mike, manual and
dealer's documents. Great condition
- it works! pick up only \$250.00.
Frank, K2RLG, 117 Cathedral Avenue,
Florham Park, NJ 07932.

SELL: FOUR CATHEDRALS: RCA 18, AK
47, Crosley 515, speaker RCA cabi-
net #104, Music Master gooseneck 12
inch bell. All complete, refinished
and operating. Phone (904)
683-7202. Charles Kaelber, P. O.
Box 3335, Spring Hill, FL 33526.

FOR SALE: ABOUT 150 differermt SAMs
sets, most complete at 25 cents
each or offer for all and postage.
Radio and TV tubes from 30s to 70s,
25 cents to \$2.00 each. NOS and
used. SASE, Craig Larson, 2122 45th
Avenue, Minneapolis, MN 55421.

PHILCO PHANS: unusual chairside
"BAR RADIO" with swing out bar has
Philco model 38-10 chassis (5
tubes) \$50.00. Philco 112 chassis
(11 tubes) \$30.00. Motorola HS-253
chassis (8 tubes), AM-FM, loop
\$20.00. COMMUNICATIONS RECEIVERS:
National NC-183D, speaker \$60.00,
Hallicrafter SX-28, cabinet, no
chrome \$60.00. Heathkit HR-1680,
speaker \$25.00. Joe Watson, 3300
Arrowhead Circle, Round rock, TX
78681. (512) 255-7962.

FOR SALE: UNUSED AND USED TUBES,
capacitors, speakers, etc., send
SASE for lists. C. Elmer Nelson, 11
S. Church street, Princeton, IL
61356.

FOR SALE:: KENNEDY MODEL 5 \$199.00,
Hallicrafter 7" TV \$149.00, Air
Service (Rambler) that uses 199
tubes — \$79.00, Atwater Kent model
52 — \$59.00. Stan Jacobs, 232
Highbrook Avenue, Pelham, NY 10803.
(914) 738-3483.

FOR SALE: "B" POWER SUPPLY for RCA
model 18 R.C.A. tube manual — com-
plete 1950. Sylvania tube manual —
good — 1956. Heathkit tube test
equipment from 40's — like new and
manuals. Chas. Kaelber, P. O. Box
3335, Spring Hill, FL 33526.

FOR SALE: SILVER COCKADAY receiver
\$90.00, Radiola 17 & 18 \$50.00
each, GGH Bakelite Horn (Mint)
\$90.00, Newcomb-Halley drum speaker
\$40.00, Arbocone speaker (mint)
\$45.00 and other cathedrals, horns,
tubes, AC sets, Rider manuals,
parts and literature. Send SASE for
upcoming list. Fireside Wireless,
1507 Ridge Avenue, New Castle, PA
16101. (412) 654-9335.

FOR SALE N.O.S. TUBES IN ORIGINAL
BOXES NAME BRANDS. 6AWA 6X5 6SA7
6SF5 12SK7 12SQ7 25L6 50A5 may be
met. g. or gt. mix or match. 12 for
\$15.00 P.Pd. in the 48.

R.C.A. WT110a tube tester with
between 400 and 500 cards also
master card, a few blank cards and
puncher for making additional
cards, and owners manual. This is
the automatic tester you drop in
the card instead of using a tube
chart. It test 7, 9, pin octal and
loktal tubes in good working order.
\$50.00 plus shipping for 30 pounds.
SASE for parts list. C. F. England,
98 Montague Avenue, South Zanes-
ville, OH 43701.

BEAUTIFUL, COLORFUL, ENAMEL
radio-related tie clasps and label
pins with emblems of Philco, G. E.,
R.C.A. and others. Must see to ap-
preciated. Send a L.S.A.S.E. for
completely illustrated list. Mr.
Michael S. Sabodish Sr., 11-A
Matawan Avenue, Cliffwood, NJ
07721.

SWAP — OLD RADIOS, TUBES, LIT., FOR
OLD FIDDLES AND OR FIDDLE PARTS,
CASES. NEED LID FOR AERIOLA SR MADE
BY WESTINGHOUSE. CECIL BOUNDS, STAR
RTE. 1, BOX 420, CARLSBAD, NM
98220. (505) 785-2363.

CONSOLE FOR SALE: ATWATER KENT
model 70 \$95.00, in good operating
condition. Pick-up only. Ross
Smith, 1133 Strong Avenue, Elkhart,
IN 46514.

OVER 100 AUTO RADIOS, most are tube
type, as is, \$15.00 to \$50.00, re-
stored to \$100.00, list for SASE.
Test equipment for SASE. Interested
in buying Carter Genemotor, James
Fred, Cutler, IN 46920.

SELL / TRADE: AK-60/ KIEL TABLE

— TRADE: AK-92, VICTOR 9-15, Bob
Nicholson, 3423 Long, Topeka, KS
66605.

CROSLEY 51 \$65.00 — CROSLEY 52
\$85.00 — Ace type 5 \$175.00 —
Neutrowound \$225.00 — Chelsea ZR4
\$175.00 — Overland 1 tube \$130.00
— Lambert xtal set \$165.00 —
Patrick Henry xtal set \$85.00 —
Wemco xtal set \$220.00 — Vogue
microphone in box \$40.00 — Phil-
more microphone in box \$25.00 —
and fancy chrome hand mike \$75.00
— Anthony Caserta, 47 Vista
Lane, Levittown, NY 11756.

THORARDSON YOKES AND FLYWHEELS— 2
thru 167 \$15.00 each, postpaid, Don
Aldred, 39 East Eighth Street,
Jacksonville, FL 32206.

CRYSTAL RADIO BLACKBIRD \$175; ANI-
MATED SMALL VICTOR CLOCK WINDUP
MINT CONDITION \$165; RARE TERPO-
PHONE COLLAPS. PHONO \$165; TRADES
CONSIDERED. PAYMENT BY U.S. POSTAL
MONEY ORDER ONLY. SHIPPING INSUR-
ANCE FREE. — S. LEONARD, BOX 127,
ALBERTSON, L.I. NY 11507. TEL.
(516) 742-0979 8 AM OR 5 PM E.S.T.

NATIONAL HIGH FREQUENCY RECEIVER
TYPE HRO-STA-1 WITH FOUR COILS.
ASTATIC MIKE MODEL D104-B832121 697
NATIONAL POWER SUPPLY. NATIONAL
SPEAKER W/8" JENSEN SPEAKER. QST'S
1929 TO 1943, OK CONDITION. GONSET
REC-TRANS- PA WITH TUNING EYE AND
SWITCH FOR TRIPLER WITH XTAL
MEISNER DELUX SIGNAL SHIFTER—
ABOVE UNITS WERE USED ALL TOGETHER.
AND NICE CONDITION OHMITE DUAL
SCALE RESISTANCE INDICATOR. FROST
FONES NO 172. HOWARD MODEL 430 UNIT
ELECTRICALLY OK BUT NEEDS CASE.
RESTORATION.. 2-3J1, 2-3B1 CR'S.
2-TYPE 450 TH VT108, EIMAC TRANS.
TUBES. 1-WE 211E... STEVE, 1 (201)
462-7987 — 6-7 EST, BEST OFFER.
CASH OR TRADE.

FOR SALE: 3 PAGE LIST OF battery
and A C radios. Send large S A S E
stamped envelope. Donald Juleen,
6252 Ledge Road, Sturgeon Bay, WI
54235. Phone 1-414-743-7922.

FREE — FOR NEWLY ISSUED FLYER,
no.187A. Send 2 stamp SASE to: Olde
Tyme Radio Company, 2445 Lyttons-
ville Road, Silver Spring, MD
20910.

FOR SALE: GOOD USED RADIO TUBES.
Have a good supply in stock.
27's-\$1.00, 39/44's-75 cents,
41's-\$1.25, 42's-\$1.25, 43's-\$1.25,
56's-75 cents, 57's-75 cents,
76's- 75 cents, 77's-75 cents,
78's-75 cents, 84/674- 50 cents,
6A7's-50 cents, 6C6's-75 cents,
6D6's-50 cents, 12Z3's-75 cents—
FOR SALE: RADIO BATTERY SETS, HORN
SPEAKERS AND DYNAMIC SPEAKERS OF
THE 1920's. Plus postage. LSASE for
list. H. Fothe, 10 Jackson Street,
Sloatsburg, NY 10974.

SPARK TRANSMITTER — "one Kw" from
early parts, Thordarson Type R
spark transformer, old flat ribbon
oscillation transformer, beautiful
composite rotary gap with old mo-

tor. Used for lectures and display. Phone for description. \$500 firm; DeForest loop antenna, nice \$60; Very accurate replica Clapp Eastham navy type loose coupler. \$90. All plus UPS. Paul C. Crum, W9LC, 6272 N. Cicero Avenue, Chicago, Illinois 60646. (312) 282-3033.

PHILCO 90's, 70's, 37-66s, Crosley Repwoods, Catalins, Zenith consoles, chrome and deco sets, foreign sets. — Bill Moore, 1005 Fieldstone Court, HSV, AL 35803 (205)880-1207.

ZENITH TRANSOCEANIC R-7000, 12 band, 2 meters, good condition. Best offer. Bill Thompson, 1095 NW 147 St., Miami, FL 33168. (305) 685-1993.

SAMS CB VOL. I THROUGH 80 \$4.00 each postpaid. Carbon dot resistors, 1/2 watt to 5 watt, assorted \$1.00. SASE for list. Englands, 98 Montague, Zanesville, OH 43701.

PHILCO EARLY TINY PORTABLE MIRROR projection TV "Safari" in mint condition. \$175. no shipping. S. Leonard, Box 127, Albertson, L.I. NY 11507. (516) 742-0979.

FOR SALE: UNUSED AND USED TUBES, capacitors, speakers, etc. Send SASE for lists, C. Elmer Nelson, 11 S. Church Street, Princeton, IL 61356.

30 OLD RADIOS, as a lot unit from early 20's to 40's. Write for list. Wayne Heise, 3965 Princeton Avenue, St. Louis Park, MN 55416.

FOR SALE: GREBE CR8 \$350.00. Original and works. Write or call, (516) 496-2339.

SUBSCRIBE TO "antique Radio Collectors Newsletter," 6 issues for 1987 are \$7.50, sample copy \$1.00. Antique Radio Laboratories, R 1, Box 41, Cutler, IN 46920.

QUALITY MULTIBAND TRANSISTOR RADIOS, TEST EQUIPMENT, OLD TUBES, MAGAZINES, LARGE SASE FOR LIST. ZENITH TRANSOCEANIC, R-7000, 12 BAND, GOOD CONDITION, BEST OFFER. BILL THOMPSON, 1095 NW 147 ST., MIAMI, FL 33168. (305) 685-1993.

TAKING OFFERS ON ATWATER KENT MODEL 10. Also have several other sets priced to sell, of other makes. No shipping. Send SASE for an answer. FLOYD W. COOK, 410 HAMILTON, WASHINGTON, IL 61571. Phone (309) 444-2155.

STROMBERG CARLSON MODEL 601, 6-01As INCLUDED, HAS VOLTMETER IN PANEL, \$175.00. KELLOGG MODEL 510 WITH TUBES, TOP OF THE LINE 1928, \$175.00. LYRIC 7 TUBE MODEL 60, \$100.00 — RAY MINER, 1215 AVE. B, FORT MADISON, IA 52627 - (319) 372-1271.

VERY NICE KIEL TABLE / AK-60 - \$350.00 O.B.O. — Victor 9-15 \$150.00 — Bob Nicholson, 3423 Long, Topeka, KS 66605 (913) 266-9473.

TIE CLASPS LAPEL PINS
 PHILCO-G.E.-R.C.A.-GRUNOW-&-MORE
 "COLORFULL ENAMEL EMBLEMS"
 MANY  STYLES
 "ENGRAVE WITH STATION CALL SIGN"
 SEND L.S.A.S.E. FOR
 COMPLETE ILLUSTRATED LIST!
 MICHAEL SABODISH 11-A MATAWAN AVE. +
 CLIFFWOOD, N.J. 07721.....
 "MAKES A GREAT GIFT" 3/87

3 Crosley 5ers #716 or 715, cabinets in various conditions of very good to lousy. Philco and Zenith chairsides with bad veneer. 2 Zenith oceanics that work. Others. SASE for any inquiry. Arthur Mechler, 2724 Wagner Street, Cin., OH 45225. (513) 241-0843.

FOR SALE, MAKE OFFER::: RCA 1946 621 TS 7" tv, working w/ schematic — RCA 1950 9T 246 10" tv, working w/ instruction booklet and advertising literature. — RCA Sampler video disc "Selectavision" & lit. — Various brochures advertising color tv from 1960's — Eight "Radio & Television Retailing" magazines loaded with pictures and articles on radio and tv dated Nov. 1944, Nov. Dec. 1946, March, July, Oct., Nov., 1947 and Jan. 1948.

— 1 - Rek O Kut model R8B disc recorder — 2 - Rek O Kut model R8A disc recorders less covers. — Book "How to Make Good Recordings" 1959, — Audio Devices — 2 - Books "The Recording & Reproduction of Sound" — 1st ed. 1949, 2nd ed. 1952 Howard W. Sams — Television table 1950 w/ swivel top — Polaroid 10" tv filter, 1950 — John Schellkopf, 1344 Goucher Street, Pacific Palisades, CA 90272

75 FARM RADIO TUBES - OLD - NEW, RCA, BOXED 33- 2B7- 34- 2A6- 37- 6S7- 6V7- MANY TV.- 7A7- 7A4- 7C5- OTHERS. MANY ZENITH 1LA6- 1LH4- 1LC6- 1LN5. — 55 FORD RADIO- 48 MOPAR UNIVERSAL 6V. AUTO RADIOS- 12 V. TUBE RADIOS — ALSO RCA MODEL 17- GOOD CONDITION — WORKING ALSO STEWART WARNER- 3 DIAL- USING (01A TUBES) — MANY CONSOLES- TABLE MODELS- ELECTRIC 1928- 1940 — SERVICE BOOKS- SHEETS- HOME COURSES- SOME RIDERS — SEND S.A.S.E. FOR COMPLETE LIST. — Allen MacKay - R3 - Box 13 - Winchester, NH 03470 — 1- (603) 239-4544.

STROMBERG CARLSON MODEL 601, 6-01A's INCLUDED, HAS VOLTMETER IN PANEL, \$175.00. — KELLOGG MODEL 510 WITH TUBES. TOP OF THE LINE 1928, \$175.00 — LYRIC 7 TUBE MODEL 60, \$100.00 — RAY MINER, 1215 B. FT. MADISON, IA 52627 — (319) 372-1271.

FOR SALE: A. J. EDGEComb NAVY TYPE TUNER FROM "THE WIRELESS SHOP." CIRCA 1917. MINT. AUTHENTIC TAG FROM THE GREENWOOD COLLECTION. MAKE

OFFER. F.A. NICHOLS, 720 E. ELDORADO ST., APPLETON, WI 54911.

FOR SALE, AERIOLA SR. receiver type RF, with original paper in cover. One I, Radiola type AC manufactured by Westinghouse, original metal plate in lid. Cases are excellent. Selling as is, two units for \$200.00. Cleon L. Boothe, Box 235, Cohocton, NY 14826.

FOR SALE — JULIETTE VOICE OPERATED MIKE NOS \$6.00. — ANTENNA SW. DPDT CONTACTS MTD. ON 1X1 SQ 2 IN. HIGH CERAMIC POST 4"X6" OLD, BUT GOOD CONDITION \$10.00 — ARGONNE AR-81 DUEL NEEDLE TURN OVER PHONO CART. FOR 33 OR 78 RPM \$4.00. ADD SHIPPING. SASE FOR PARTS LIST. ENGLAND, 98 MONTAGUE, ZANESVILLE, OH 43701.

RADIO RELATED TIE CLASPS AND LAPEL PINS— ALL NEW LISTS— MANY NEW ITEMS— PUT YOUR FAVORITE RADIO ON A 2 1/4 INCH PLASTIC BUTTON. SEND L.S.A.S.E. FOR DETAILS AND ILLUSTRATED LIST. MR. MICHAEL S. SABODISH, 11-A MATAWAN AVENUE, CLIFFWOOD, CLIFFWOOD, NJ 07721.

CONSOLE RADIOS: CROSELY MOTOR DRIVEN art deco, Zenith Black Dial, Majestic 91, Majestic 131, Zenith Super IX. All for \$350.00 negotiable. Battery sets: Echophone V3 \$150. Crosley 52-S hard to find, restored \$125. Phonos: Columbia Eagle \$250, Columbia QQ \$250. Trade: Grebe CR12 for AR10, Ozarka portable for what have you? Craig Ball, 10101 Oak Hollow Circle, Austin, TX 78758. (512) 835-7292.

ANTIQUA RADIOS, three single tube DC sets, regeno three #140, one partial 1 tube set, one radio device?, three unique speakers. All for \$300. — RADIO, 29 SOUTH AVENUE, WHITMAN, MA 02382.

10T4 GE TV 10 inch 1949 complete. Trade for 2 wood cabinet table radios 1 must be an RCA complete. George Arth, 2412 Washington, Lexington, MD 64067

ZENITH TRANS - OCEANIC collection, all are AC tube type. Chassis types 6A40 (2), 7G605, 5G740 (2), 5H40, \$300 for all six. Eugene E. Folger, RADIO, 29 South Avenue, Whitman, MA 02382

HOWARD TABLE MODEL RADIO model 575 and other table models. Two 1917 WWI books. Russell Schoen, E 7340

Nietzhe Road, Clintonville, WI 54929.

EDISON C2 RADIO / PHONO, 1928, good cond. Manual and warranty card present, not running, needs work, \$400. Eugene E. Folger, RADIO, 29 South Avenue, Whitman, MA 02382.

RADIOS, TV's, related items. Send SASE for list. John Kendall, P. O. Box 436, Fallston, MD 21047.

BLACK and WHITE new yokes and fly-backs 2 thru 167 — \$15. postpaid— Don Aldred, 39 East 8th Street, Jacksonville, FL 32206.

WANTED

WANTED: B-ELIMINATOR, 01A tubes; quote prices, specifications. T. C. Day, 215 West 7th Street, St. Waynesboro, PA 17268.

TELEVISIONS BOUGHT! Buying 12" and smaller pre 1950 sets, plus Predictas, early color, etc. Paying \$40- 350. Buying pre- WW II TV's- TRK's, Dumont, TT5's, Fadas, more. Paying \$1200- 4000! Books, TV novelties- wanted. Harry Poster, Box 1883, So. Hack., NJ 07606 (201) 794-9606.

WANTED: DUMONT TELEVISION, table model with continuous tuning and FM. Jack Kashak, 139 E. Saemann, Chesterton, IN 46304. (219) 926-7240.

WANTED: EDISONIC D. D. REPRODUCER. Edison antique finish dance reproducer — picture records — record dusters — Contact: Jimmie Grissom, 246 Keene Street, Henderson, NC 27536.

WANTED: CABINET TOPS FOR RADIOLA 20 or 25 and 104 speaker unit. DeForest tubes and cans, early tubes and light bulbs. Bruce Harbeck, 13408 Westwood Lane, Omaha, NE 68144. (402) 333-9013.

WANTED: WOOD FRONT PANELS for Radiola 20, large tuning knobs for A.K. 35. Mark Oppat, 167 Caster, Plymouth, MI 48170.

S.A.S.E. is a self addressed stamped envelope.

WANTED COAXIAL OR TRIAXIAL SPEAKERS of Jensen, Trusonic, Tannoy, Altec 604's. Western Electric equipment (tubes, amps., drivers, horns, speakers, microphones and parts). Radio tubes (50's, 211, 845, 8005) David Yo, P. O. Box 832, Monterey Park, CA 91754. Tel. (818) 576-2642.

CATHEDRAL RADIOS, MUST BE NICE AND WORKING CONDITION. WILL PAY TOP DOLLAR. ALSO WANT OTHER UNUSUAL AC RADIOS. HAROLD PERKINS, 4468 SUN VALLEY DRIVE, LAS VEGAS, NV 89121.

WANTED — RCA CREDENZA'S, Edison windups - speaker systems and

components, JBL Hartfield, Paragons- Altec Laguna, Magnificent, 515A/B, 288B/C, 604B/C/D/E, E.V. Patricians, Tannoy Autograph, GRF - Red/ Silver/ Gold, Jensen G610, Western Electric theatre equipment, speakers, drivers, horns, electron tubes, mixers, x-formers, x-overs, tubes, round top 45, 50 - W.E. 252A, 300A/B, 350B, etc. Charles Dripps, 4331 Maxson Road, El Monte, CA 91732. (818) 444-7079.

WANTED — GRANDFATHER CLOCK RADIO and Radiola IV. Gordon Wilson, 11108 - 50 Avenue, Edmonton, Alberta, Canada, T6H 0H9

WANTED— OLD 1960s or 70s large Allied Radio Catalogs. Earl Phillips, 311 David Lane, Maryville, TN 37801.

WANTED: BOOKS; buy, beg, borrow, rent or steal. Twining, "Wireless Telegraphy and High Frequency Electricity;" Curtis, "Construction of Induction Coils & Transformers;" Collins, "The Amateur Electrician's Handbook;" and other books with Tesla coil projects. Need data for forthcoming bibliography. TCBA, RD 3, Box 181, Glens Falls, NY (518) 792-1003.

WANTED— OLD 1960s or 70s large Allied Radio Catalogs. Earl Phillips, 311 David Lane, Maryville, TN 37801.

WANTED: INFORMATION OR EQUIVALENT CHARTS ON MUTER BRAND BALLAST TUBES. OLD CATALOGS MAY LIST THEM. ANTHONY JACOBI, 8053 MAYWOOD, RALSTON, NE 68127.

WANTED - New or used OA2 voltage regulator tubes. Need 1200, must be reasonable. Tom Burgess, Box 9769, Little Rock, AR 72219 - (501) 565-1750 evenings.

WANTED: GRANDFATHER CLOCK RADIO, AK, Philco, etc. Gordon Wilson, 11108 - 50 Avenue, Edmonton, Alberta Canada T6H 0H9.

RADIOLA Balanced amplifier— RADIOLA IIIA. whole— parts— junk. State price and condition when corresponding. B. Block, 2118 Winn, Kemah, TX 77565.

RADIOLA ITEMS WANTED: Vocarola, RE, AR, Concert Receiver; Radiola IV, VI, VII B / IX grand; any of AA series. CASH OR TRADES. Rosenthal, 507 South Maryland Avenue, Wilmington, DE 19804

WANTED: SET OF RIDER MANUALS, Vol. 1 thru 8. Must be realistic price. Michael Sabodish, 11A Matawan Avenue, Cliffwood, NJ 07721. (201) 566-1486.

HR-3 RCA ELECTRON TUBE HANDBOOK. Industrial, receiving and transmitting tube technical bulletins by GE, Sylvania, etc. Nick Tusa, K5EF, 129 Somerset, LaPlace, LA 70068 (504) 652-4904.

WANTED: LARGE HIGH VOLTAGE VARI-



YOUR SOURCE for TUBES, PARTS, & BOOKS

Our 1987 catalog contains the most extensive listing of parts and supplies available for early radio, with 20 pages of tubes, capacitors, transformers, lamps, grill cloth, repro parts, books and more.

Write or call for 20 page wholesale catalog.
ANTIQUE ELECTRONIC SUPPLY

688 W, First St., Tempe, Arizona 85281, 602/894-9503

ABLE CAPACITOR. TCBA, RD 3, Box 181, Glens Falls, NY 12801

WANTED: COLORFUL "CATALIN" plastic radios; Fada, Emerson, DeWald, Addison, etc. Top prices paid. Mint condition only. R. W. Oliver, 355 Highwood Avenue, Leonia NJ 07605 (201) 944-0777.

WANTED— ANY McMURDO SILVER ELECTRIC set with or without cabinet. Masterpiece I, II, III, IV, V, VI 14-15, 15-17. Any literature, McMURDO SILVER TIMES OR FORUM Magazines. Also 1935- 1939 Zenith consoles. We pickup most areas of U. S. and Canada. Frank and Mary Rasada, 12507 Pinegrove Lane, Cerritos, CA 90701. Days: (714) 951-9591. Evenings: (213) 926-6722, leave message for return call.

WANTED— INFORMATION / DATA on the "SHELDON RADIO COMPANY" that was active in Los Angeles 1925-1931. Ed Sheldon, 656 Gravilla Place, La Jolla, CA 92037.

WANTED: INFORMATION ON PEERLESS wireless, Milo Bailey, Thomas E. Clark (TECLA), and any other pre 1930 Michigan manufacturers: brochures, ads, articles. photocopies ok. Tips welcomed. Oran Sauder, 316 Wellington, South Lyon, MI 48178. (313) 437-4413.

SPARK EQUIPMENT— Especially 25,000 volts Commercial Spark Condenser, Rotary gap or complete sets. Paul C. Crum, 6272 N. Cicero Avenue, Chicago, IL 60646. 1(312) 282-3033.

WANTED: RADIO CORRESPONDENCE course kits. AC or battery. Leo Teply, geddes, SD 57342.

WANTED: DON'T THROW AWAY THOSE ELECTROMECHANICAL POWER SUPPLIES

AND PARTS 6 VOLT AND 12 VOLT VIBRATORS, OZ4's, TRANSFORMERS. CASH PAID OR TRADES. MARVIN ROTH, 14500 LaBELLE, OAK PARK, MI (313) 399-5993.

A GERMAN MADE RADIO. Small table model— working condition. Phone or write. PETERSONS, 3115 North 61st Street, Lincoln, NE 68507. (402) 466-7548.

HALLICRAFTERS SX-88, parts or junker. Gene Mottern, 313 Royal Drive, Kingsport, TN 37663.

WANTED: A.K. BREADBOARD PARTS; antenna coils, type 11 tuner coil-tube unit, detector unit, potentiometers. 3 tube detector amplifier unit, switches, highest prices paid. Delwitt L. Bills, 5237 Upton Avenue North, Minneapolis, MN 55430. (612) 521-7109.

WANTED: LARGE HIGH VOLTAGE variable capacitor. Books and magazines on electricity, medical electricity and wireless telegraphy. Want list available. TCBA, RD3, Box 181, Glens Falls, NY 12801.

WANTED: LID FOR RADIOLA 20 and ATWATER KENT 20C, power supply for U.S. Radio and Television model 80. Richard Peterson, 3940 Lolan Ct., Marrero, LA 70072.

WANTED— A COPY OF SCHEMATIC for portable radio. R.E. 8000 - Ross Electronics and Manual. Michael J. Doback, 592 Southlawn, Birmingham, MI 48009.

CHELSEA MODEL 102 AF transformer, working or not. Will buy junker set to get one. Transformer nameplate says Songbird Midgie. P. A. Kinzie, 713 E. Beale Street, Kingman, AZ 86401.

WANTED: FANCY LOOKING GRANDFATHER CLOCK RADIO. Also AK models 558, 217, 165, 246, 944. Also Radiola IX, Airline 20 and Philco 20B. Need dud WD11 tubes. Gordon Wilson, 11108-50 Avenue, Edmonton, Alberta, Canada T6H 0H9.

WANTED: RADIOLA X CHASSIS FOR PARTS. Gordon Wilson, 11108 - 50 Avenue, Edmonton, Alberta, Canada T6H 0H9.

TV's BOUGHT — NEED 10", 7", etc. — pre 1950+ Predictas, early color, paying \$40 - \$350. PRE-WAR TV's - TT5, TRK, LOTS MORE - \$1200 - \$4000. Books on TV's, pre 1948. Harry Poster, Box 1883H, So. Hack., NJ 07606. (201) 794-9606.

WANTED— WIRING CIRCUIT for RADIO-DYNE WD17- 5 tube radio, made, (Western Coil and Electric) Co., Racine, Wisconsin, a copy, a tracing or anything to get the wiring hookup. Herb DeGarmo, 203 3rd Street, Early, IA 50535.

WANTED: PHILCO 60 CHASSIS. Rheostat knob for a Crosley 51. Marc Ingenthron, 9215 W. 83rd Street, Overland Park, KS 66204.

WANTED: DRIVER AND METAL PARTS FOR MUSICMASTER HORN SPEAKER. HALLICRAFTER SX-17 AND SPEAKER. CHARLES FURTA, 241 OAK, ELMHURST, IL 60126.

WANTED — DeForest Interpanel. Richard C. Foster, 12 Shawmut Avenue, Cochituate, MA 01778. (617) 655-2056.

WANTED: QST 1950-59 BOUND LIBRARY VOLUMES. ALSO MINT WRL GLOBE SCOUT (820). M. GRIMES, 3805 APPOMATTOX, PLANO, TX 75023. (214) 867-6373

WANTED TO BUY. A 1927 AC only Zen-

ith table model radio. Must be in original condition, Cabinet also original finish. Will pay top price for a nice one. Thanks. Ron Burtzos, 915 Crane Drive, Apt. 703, DeKalb, IL 60115.

WANTED: ANY GREBE DETECTOR OR DETECTOR AMP AND GREBE CR-6 AND CR-7. JIM COLLINGS, 12005 VICTORIA PL., OKLAHOMA CITY, OK 73120

CASH OR TRADE OLD RADIOS, tubes, speakers, literature, etc. for old fiddles, bows, cases or parts. Cecil Bounds, Star Rte. 1, Box 420, Carlsbad, NM 88220. (505) 785-2363.

WANTED: 75P-4 CRT'S — FRED EMERSON, 627 ILLINOIS AVENUE, ELGIN, IL 60120

WANTED: NATIONAL HRO 60 coils: 15 meters (AC), 6 meters ((AD), E, F, G, H, J, others, dead or alive. Please write giving condition and price. Art W6ZNO, 18151 Rancho Street, Tarzana, CA 91356.

WANTED — GREBE CR18, HALLICRAFTER SX11, SX16 SKY CHIEF. RCA ACR 136, HOWARD 430. HT6 TRANSMITTER. K4UJZ, 608 W. THOMPSON LANE, MURFREESBORO, TN 37130 (615) 893-5344.

WANTED— CABINET FOR MY MADISON-MOORE RECEIVER. PANEL SIZE 7" X 26". MUST BE DEEP ENOUGH FOR A CHASSIS 10 1/2" DEEP. ALSO WANT CABINETS FOR RADIOLA II AND FOR ECHOPHONE V-3. DAVID MCKENZIE, 516 SOUTH EXETER STREET, EUSTIS, FL. 32726. (904) 589-0149.

WANTED: MAJESTIC 3 TUBE PORTABLE MODEL 130 — oak case for Supreme model 385 set tester, chassis for American Beauty radio. Delmer Woodley, Rt. 3 Box 13, Milford, IA 51351.

RCA-103 SPEAKER with poor cloth grill or none. Must be in working condition. Contact — Ken Ericksen, 1049 Felspar #33, San Diego, CA 92109.

SCHEMATIC FOR CRESCENTYNE 5 tube T R F radio. Also need parts for Bremer-Tully Counterphase T R F radio. Arnold G. Schmidt, Rt. no. 5, Jamestown, ND 58401

AK-90, 558, 708 AK— breadboard parts, sell/trade: AK-92, Victor 9-15, Bob Nicholson, 3423 Long, Topeka, KS 66605.

ZENITH 16A61. Will pay top dollar for very good to mint condition. Call or write. James E. Bragg, 14217 Runnymede, Van Nuys, CA 91405. (818) 787-6255.

WANTED— 1920 to 1939 radio's, working or not. Send condition, model and price. Johnnie's T.V., 476 Nordale Road, North Pole, AK 99705.

TELEVISIONS WANTED! 170 TV'S to trade, sell or we'll buy yours. Paying \$25.00 — \$500.00 up for many pre 1960 sets. Paying over \$1,000 for pre war TV's. Harry Poster, Box 1883H, So. Hack., NJ 07606. (201) 794-9606.

WANTED; Complete restorable chassis w/ speaker for AK 228. Also tube cover for Crosley model 53, approximately 9" x 9" x 5" high. Plugs into top of chassis. Anton Johannes, R.D. #3 Box 253, Pine Bush, NY 12566.

WANTED: JUNKER HORNS for parts, Burns and/or Music Master— condition of bell not important. Also wanted any original ads or literature featuring AK breadboard radios. Please write; J. L. Wilson, 6706 Winters Hill Court, Doraville, GA 30360

WANTED: Pre 1960 German and foreign sets, Pilot radios, Midwest radios, Atchison, Aztec, Steinite, Midwest and Fred Stein radios. Tube Hi-Fi gear. — Bill Moore, 1005 Fieldstone Ct., HSY AL 35803. (205) 880-1207.

WANTED — AMPLIFIER SECTION FOR RCA RADIO PHONO MODEL RE 45. METAL TAG ON AMP READS: "VICTOR AMP TYPE 245 VICTOR TALKING MACHINE DIVISION RADIO VICTOR CORPORATION OF AMERICA," OR A POWER TRANSFORMER FOR THE 245 AMP., H. E. SUTTON, 1163 FURMAN DR., SUMTER, SC 29154.

WANTED: TV's! I bought 30 last month. Sell me yours. Jim Clark,

1006 Pendleton, Lansing, MI 48917. (517) 323-9595.

WANTED: GOOD SPEAKER FOR AK MODEL 85. E. A. THOMPSON, 2322 SHERATON LANE, FLORENCE, AL 35630. PHONE (205) 766-5260.

WANTED: TELEPHONE TV model TV-357— Don Peck, P. O. Box 1353, Temecula, CA 92390.

WANTED— RCA model R37 chassis and speaker. Atwater Kent model 84, chassis only, Phil Guinan, 106 Page Road, RFD 7, Litchfield, NH 03051. Tel. (603) 889-6213.

WANTED— FIL CONTROL & VOLUME control for Tompson U-50, tuning control knob for Kennedy XXX type 435, large tuning control knob for Kennedy XV type 430, grandfather clock radios, cabinet for Federal type "D" — LEE Williams, 7301 N.E. 175th Street, Bothell, WA 98011.

WANTED: POWER SUPPLY UNIT "only" for Radiola 17, 18 or 33 (prefer 18). Must be complete but need not be working, burned out transformer is OK. Might consider entire radio, if price is reasonable. Rich Kahnberg, 162 Bluebird Drive, Windsor, CA 95492. (707) 838-7868.

WANTED: REPRO DeFOREST LOOP. Tracing of DeForest D-12 grille, Paragon DA-2 amplifier, detector. Edison mod. "O" reproducer. Wayne B. Wright, Rt. 4 Box 220, Bluefield, WV 24701.

WANTED: ZENITH RADIOS from the mid 1930's. These have wooden cabinets, circular dials, but without push buttons. I have other Zeniths and battery sets to trade. Arie Breed, 510 Lake Drive, Ottumwa, IA 52501. (515) 682-6925.

WANTED: AMPLIFIER SECTION (less tubes) for RCA model RE 45 radio phono. metal tag on amp reads: "Victor amp type 245 Victor Talking Machine Division Radio Victor Corporation of America," or a power transformer for the 245 amp. H. E. Sutton, 1163 Furman Drive, Sumter SC 29154.

WANTED: ONE EACH WORKING and rea-

sonably priced RCA tubes type 1898 and 5527 for collection. F. G. Suffield, 817 West Fir, Sequim, WA 98382.

WANTED: TEN TEC EQUIPMENT. State price and condition. H. F. Schnur, Rt. 3 Box 151, Greenville, NC 27858.

WANTED: CABINET for Crosley model 58; National Radio Institute home study booklets. Patrick Coyle, 533a Balboa Street, San Francisco, CA 94118. (415) 668-5280.

WANTED::: COLORFUL CATALIN PLASTIC RADIOS; Fada, Garod, Emerson, RCA, DeWald, etc. Top prices paid. R. W. Oliver, 355 Highwood Avenue, Leonia, NJ 07605. (201) 944-0777.

WANTED: R. E. THOMPSON HORN SPEAKER, GOOD EXCELLENT CONDITION, WRITE. — PAUL O'PATIK, 316 RUTHERFORD AVENUE, FRANKLIN, NJ 07416.

HIGH FIDELITY MAGAZINES, 1940s: MUSIC AT HOME, AUDIOCRAFT magazines; old RCA theremin, early oddball hi-fi stuff. Have trade items. Hal Layer, P. O. Box 27116, San Francisco, CA 94127.

WANTED: CROSLY MODEL 59 CHASSIS IN ANY RESTORABLE CONDITION TO COMPLETE MY CROSLY GRANDFATHER CLOCK RADIO. BURNETTE B. KERCHNER, 27 WILLOW ST., LENHARTSVILLE, PA 19534. PHONE (215) 562-8772.

WANTED::: COPY OF INSTRUCTIONS OR any info on supreme 333 Deluxe Analyzer or western Electric 14A "Loudspeaking Telephone Outfit." John Kendall, P. O. Box 436, Fallston, MD 21047.

WANTED — DIAL FOR STROMBERG CARLSON model 240. — Cathedral cabinet for Philco 90. — Any or all parts and cabinet for Zenith Stratosphere 1,000 Z — except upper tuner chassis. — Art Corbus, 5704 — 11th N W, Seattle, WA 98107, (206) 783-6151.

OZARKA V-16 OR CHASSIS ONLY. WILL PAY CASH OR TRADE OTHER RADIOS. RAY MINER, 1215 AVE. B, FT. MADISON, IA 52627. (319) 372-1271.

NEW

PUETT ELECTRONICS

P.O. BOX 28572 DALLAS TX 75228

NEW

GET THIS

WORLDS!

GREATEST

RADIO

CATALOG

CATALOG 7 SEVEN

48 - PAGE CATALOG \$2.00 POSTPAID

A \$3.00 DISCOUNT COUPON WILL BE SENT WITH YOUR CATALOG IF YOU INCLUDE THIS CODE NUMBER WITH YOUR CATALOG ORDER -- HS007-7.

OUR NEW CATALOG --- MORE THAN 1,000 ANTIQUE RADIO PUBLICATIONS - BOOKS, INSTRUMENT MANUALS, COMMUNICATIONS RECEIVER MANUALS, CATALOGS, SERVICE DATA, SALES BROCHURES, TECHNICAL DATA, FACTORY SERVICE MANUALS, AND OUR NEW REPRODUCTIONS OF MANY FAMOUS BOOKS AND OTHER LITERATURE, PRINTED ON BOTH SIDES OF THE SHEET AND WITH ATTRACTIVE COVERS! HUNDREDS OF OLD-TIME-RADIO-PROGRAM CASSETTES, HUNDREDS OF DIFFERENT TYPES OF TUBES WHICH ARE USED IN ANTIQUE RADIOS, RIDER MANUAL INDEXES, TUBE MANUALS, TUNING DRIVE BELTS, LARGE LIST OF CLASSIC RADIO LITERATURE, SCHEMATIC DIAGRAMS ON NEARLY ANY RADIO RECEIVER, DIRECTORY OF ANTIQUE RADIO SERVICES, APPRAISALS, ATWATER KENT FACTORY MANUALS --- MASTERCARD & VISA AVAILABLE!! ANTIQUE RADIO TOPICS, A 14-SERVICES PUBLICATION, SUBSCRIBERS GET 15% OFF ON ALL CATALOG ITEMS EXCEPT TUBES, 20% OFF ON TUBES! 6 FREE SCHEMATIC DIAGRAMS, MUCH MORE!! SUBSCRIPTION RATE \$15.00 POSTPAID!!

VINTAGE TV'S FOR SALE

We have over 225 sets--- & we need room!

Prices: sets working, clean, picked up. (we can pack/ship).

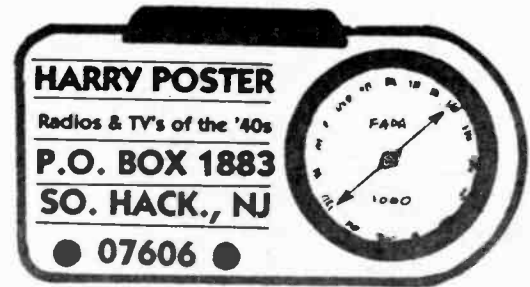

(201) 794-9606

- RCA: TRK-12 (1939)- call.
- TRK-120 (1940)- call.
- CT-100 (1st color)- call.
- 621 TS - \$650
- 630 TS - 349
- 721 TS - 299
- 721 TCS - rare console - call.
- 730 TVI combo - not working - \$100.
- 8TS30 - \$299
- 648 projection - \$399.
- 9 PCS41 projection - \$399.

- Dumont: Chatham - \$249.
- Admiral: 7" - \$199.
- Motorola: 7" - \$199.
- 8" (scarce) - \$249.
- Philco 10" combo - \$199.
- Zenith pothole combo - \$299.

We buy plexiglass, mirror, catalin & novelty radios.....
and TV's

LIMITED TIME OFFER

BACK ISSUES

BEGINNING - July 1, 1987

ENDING - SEPTEMBER 1, 1987

ANY YEAR'S GROUP OF ---

10 back issues of.....

THE HORN SPEAKER

FROM 1980 through 1986....

WILL BE AVAILABLE FOR..... ONLY \$5.00

ALL SEVEN YEARS.. only \$35.00

ANY 1987 BACK ISSUE \$1.00

ALL BACK ISSUES SENT POSTPAID

THE HORN SPEAKER
Box 53012
Dallas, TX 75253

(214) 286-1673

hobby BOOK corner



DIRECTORY OF RADIO COLLECTORS AND SUPPLIERS
Nearly 2000 entries. 29 pages. Item P-1 \$4. □



ARS GUIDE TO FINDING SERVICING INFORMATION
Determine age and manufacture of sets. Find service data easily. Item P-2 \$2. □



PRACTICAL RADIO MATHEMATICS
Explains many electronic terms and concepts. Useful formulas too. GA-3 \$4. □



HOW TO USE DIAGRAMS IN RADIO SERVICING
Helps read early circuitry, find problems and replace parts. Item P-3 \$2. □



MASTER INDEX to Supreme Publications Annual Servicing Books 1926-1970. 49 pages. Item I-1 \$8. □



SPECIAL VOLUME DEAL
Five pounds of electronic data, publications, diagrams, etc. SD-1 \$4.95 □



AN INTRODUCTION TO RADIO
Explains radio theory and circuitry. Terrific starter guide. Item P-4 \$3. □

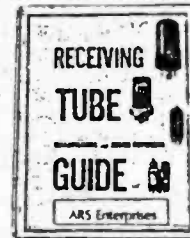

RECEIVING TUBE CHARACTERISTICS AND SOCKET CONNECTION GUIDE
Tube diagrams, function, voltage and current readings, etc. Item P-5 \$4. □



COMMUNICATIONS! From Smoke Signals To Satellite
Entertaining story about Morse and Vail developing the Morse Code and much more. GA-5 \$1.50 □



RECORDED SOUND
Popular booklet following the development of music boxes, player pianos, gramophones and the phonograph. GA-4 \$2. □

SEND CHECK, MONEY ORDER OR USE CREDIT CARD

Total for books ordered.....\$ _____
8.1% Tax (WA State only)..... _____
Shipping & insurance..... 2.00
TOTAL DUE.....\$ _____

PAYMENT: -Ck or MO -VISA -Mastercard
CARD # _____ EXP. _____

SIGNATURE _____

NAME _____

ADDRESS _____

CITY _____ STATE _____ ZIP _____

ARS Enterprises
P.O. Box 997
Mercer Island, WA 98040

H
S
3

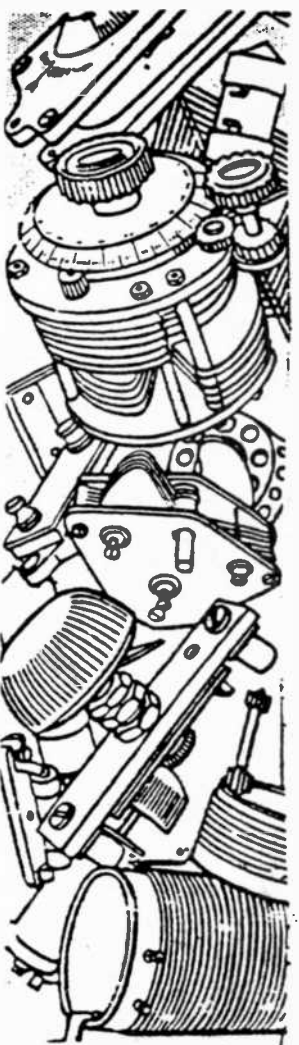

OLDE TYME RADIO CO.

Need hard to find Olde Tyme Radio parts such as:

- *Vintage Tubes
- *AK Style Battery Cable
- *Olde Tyme Hookup Wire
- *Brown Silk Type Power Cord
- *Audio Transformers
- *Power Transformers
- *Headphones
- *Headphones & Speaker Cords
- *ANT. RF. (I)S.C. IF Coils
- *Speaker Grill Cloth
- *Pilot Lamps
- *XTAL Set Parts

ALSO CAN PROVIDE REPRINTS OF THE FOLLOWING
OLDE TYME RADIO PUBLICATIONS:

- Atwater Kent Instruction Manual
- Atwater Kent Equipment Catalog
- Radiola IIIA Manual
- Vintage Radio Identification Sketchbooks by D. H. Moore (See Flyer for details)
- Radio Horn Speaker Encyclopedia by F. Paul

and much, much more; also as a convenience to you, we can provide copies of those ever popular books VINTAGE RADIO and FLICK OF THE SWITCH in soft covers. Schematics for many radio during the 1920's thru the 1950's are available. For free Flyer send 2-stamp SASE to The OLDE TYME RADIO COMPANY, 2445 Lyttonsville, Road, Silver Spring, MD 20910.

Wish to reach us by phone? The number is (301) 585 8776. Please call between 10:00 a.m. and 10:00 p.m. local time.

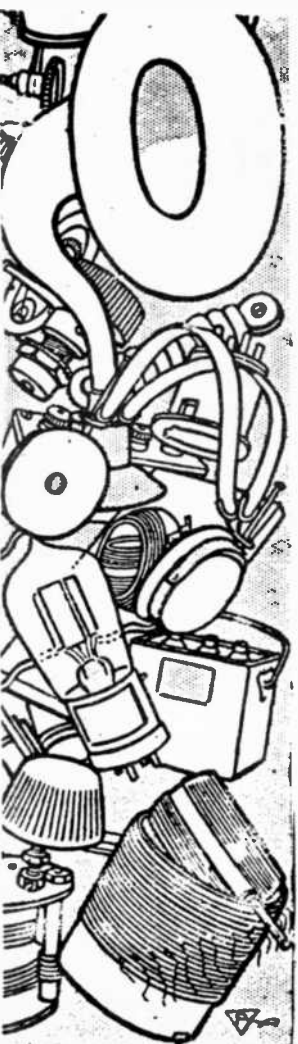

June

July

August

THE HORN SPEAKER

1987

September, 1924

W O R K R I T E R A D I O S E T



5987 MC C
MR. GLENN MC CRODY
924 WEST SIXTH
STORM LAKE IA 50568