

# FM-TV RADIO COMMUNICATION

Price 35 Cents

Aug. '51

★ ★ Edited by ★ ★  
Milton B. Sleeper



**WMIT IS BACK AGAIN,  
NOW RADIATING 325 KW.**  
ALSO FEATURED IN THIS ISSUE  
*After the Thaw: a Log-Jam  
Audio Demonstration Rooms  
Growing Importance of Tape*

11th Year of Service to Management and Engineering

**GREATER VALUE**

*WITH*

# **BENDIX ELECTRICAL CONNECTORS**

**PRESSURE TIGHT SOCKET CONTACTS**

**PLUS**

- Moisture-proof
- Radio Quiet
- Single-piece Inserts
- Vibration-proof
- Light Weight
- High Insulation Resistance
- Easy Assembly and Disassembly
- Fewer Parts than any other Connector
- No additional solder required

*Pin and socket arrangements available for all sizes of contacts.*

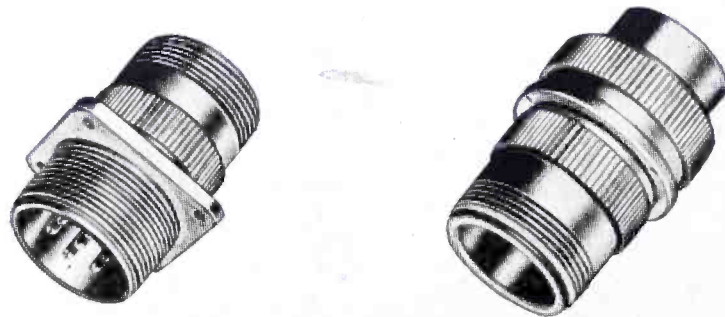

Outstanding design and precision workmanship assure completely pressurized electrical connectors for all sizes of contacts. A truly important feature, but only one of the many exclusive advantages that contribute toward making Bendix outstanding in the electrical connector field. Increased resistance to flash over and creepage is made possible by the use of Scinflex dielectric material—an exclusive development of Bendix. In temperature extremes, from  $-67^{\circ}\text{F.}$  to  $+300^{\circ}\text{F.}$  performance is remarkable. Dielectric strength is never less than 300 volts per mil. Remember, for the greatest value in electrical connectors, it pays to specify Bendix. Our sales department will gladly furnish complete information on request.

**PLUS**

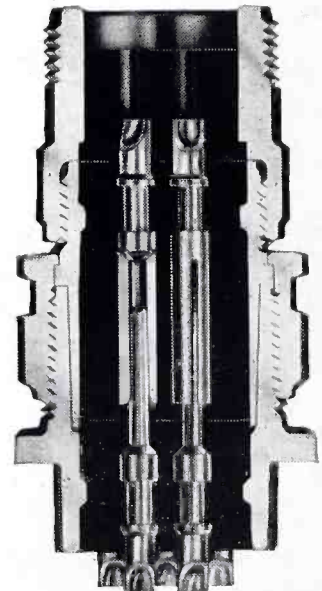

**SHELL**  
High strength aluminum alloy . . . High resistance to corrosion . . . with surface finish.

**CONTACTS**  
High current capacity . . . Low voltage drop.

**SCINFLEX ONE-PIECE INSERT**  
High dielectric strength . . . High insulation resistance.

**Bendix**

**SCINTILLA MAGNETO DIVISION of  
SIDNEY, NEW YORK**

Export Sales: Bendix International Division, 72 Fifth Avenue, New York 11, N. Y.

FACTORY BRANCH OFFICES:

117 E. Providencia Avenue, Burbank, California • Stephenson Building, 6560 Cass Avenue, Detroit 2, Michigan  
Brouwer Building, 176 W. Wisconsin Avenue, Milwaukee, Wisconsin • 582 Market Street, San Francisco 4, California



# Send 'em Back to School the Zenith Way

♪ School days, School days, ♪  
♪ they are Zenith selling days —

There's something for everyone here on this page—high-flying students, book-wormish profs. It's famous Zenith Quality in Radios, Radio-Phonographs and Portables. Just showing 'em sells 'em . . . and lets you capitalize on an August bonanza of back-to-school prospects you'll treasure the rest of your Dealer Days. Try it and see! Send 'em back to school the . . . Zenith way!



The new Zenith "Saratoga" with Cobra-Matic Record Player and 7½-Inch Speaker —The largest speaker ever in a Zenith table radio-phonograph! With the famous Cobra-Motic for new record-playing thrills . . . powerful Zenith AM radio. Perfect for on or off the campus fun! Model H664



The famous Zenith Super Trans-Oceanic for world-wide entertainment and information —Better than ever before! Features six Short Wave Bands, famous Zenith Long Distance AM and Marine and Weather Coverage. Tunes in the war capitals and listening posts of the world. Keeps students up-to-date on international news and events! Model H500

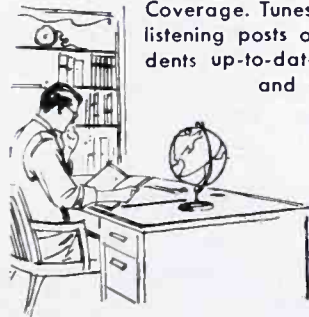

Write Your Distributor for Zenith's Complete Back to School Promotion Package Now!



The new Zenith "H401" Portable with tone and performance incomparable—A joy to behold—to hear—to carry anywhere . . . that's what the young folks say. Its brand new Dial Speaker design and tone circuits bring a revelation in tone and sensitivity unmatched in a portable so small. Model H401

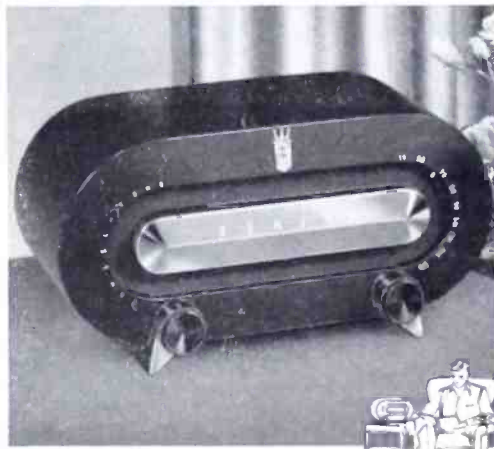

The new Zenith "Tournament" for all around good looks and rich tone—Bound to be radio's most copied design! Scientifically created to turn all its power into rich, glorious new tone quality and volume. Plenty of eye-appeal for school boys and girls in its Black, White or Swirl Walnut Plastic cabinet. Model H511

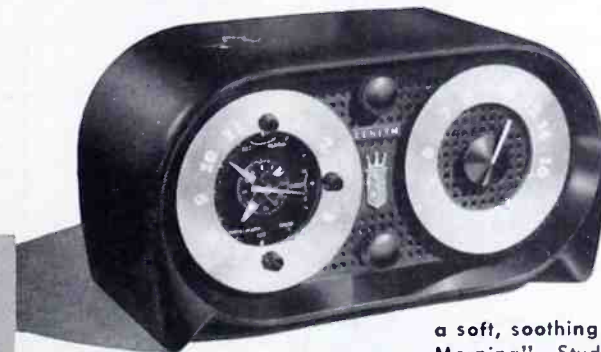

The popular Zenith Clock-Radio for a soft, soothing "Good-Night" and a cheery "Good Morning"—Students love it! A superbly-toned radio that lulls them to sleep at night . . . wakes them gently in the morning. Automatically turns coffee maker, bed lamp, heating pad or electric fan on and off. Sells on sight! In Ebony, Ivory or Walnut plastic. Model H516

**ZENITH**  
LONG DISTANCE RADIO  
and TELEVISION



Zenith Radio Corporation, Chicago 39, Illinois • Also Makers of Fine Hearing Aids

# DUMONT

## VIDEO SWITCHING AND MIXING EQUIPMENT type TA-178-A

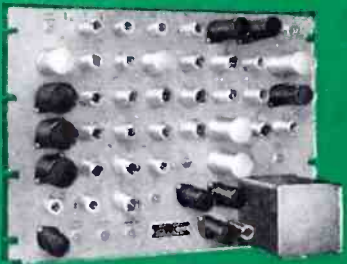
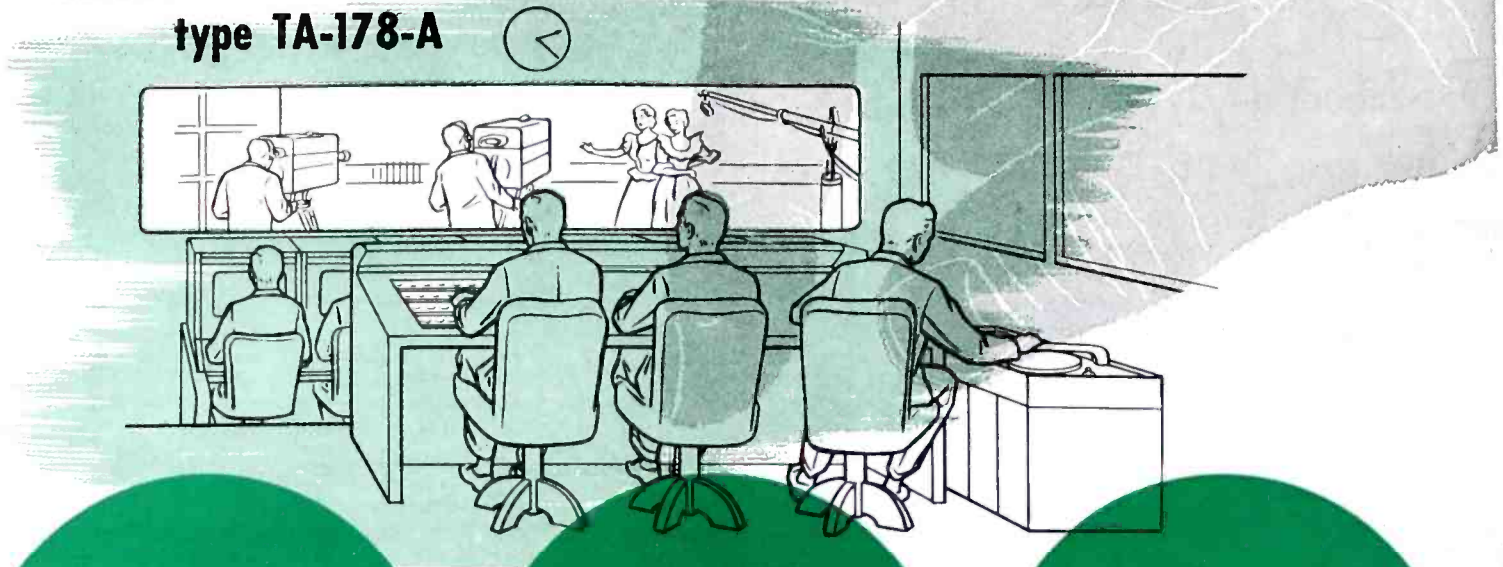

MIXER LINE  
AMPLIFIER

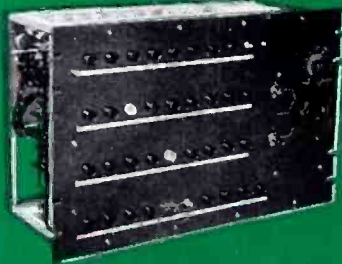

NINE CHANNEL  
SWITCH UNIT

**SIMPLIFIED  
FINGER-TIP CONTROL  
FOR  
VIDEO SWITCHING**

Comprising the Nine-Channel Switch Unit (5262-A), Mixer Line Amplifier (5263-A) and Low Voltage supply (5019-A).

Variety of special effects, achieved quite simply with the provisions in the Mixer Amplifier, can be previewed before being put on the air. Single Mixer Control at Switching unit permits smooth transition from one channel to another. Again, another control at Switch Unit determines bus cutoff voltage cross-over point, so that any degree of fading, lapping or superimposing of two signals can be accomplished. Provision is made available in the Mixer Amplifier for insertion of special blanking to create special effects such as wipes, montages, etc.

While main line is feeding transmitter, the mixer amplifier output can be used to feed, simultaneously, a different mixed studio show to an audition circuit. The Mixer Amplifier has three identical program outputs which may be fed to transmitter, network cable and master line monitor.

*First with the Finest in Television*

## TELEVISION TRANSMITTER DIVISION

ALLEN B. DU MONT LABORATORIES, INC.

1000 Main Avenue, Clifton, N. J.

### FEATURES

Switch Unit available for mounting in standard 19" relay rack or in console. Mixer Line Amplifier and its power supply are rack-mounted.

All channels take either local or remote signals.

Lap, fade or super are achieved with single control. Facilities for inserting special blanking (horizontal wipes, montages, etc.). Preview for special effects.

Sync insertion on local signals, controlled by pushbuttons. No switching transients on main-line switching. Automatic pedestal setup incorporated in mixer amplifier.

Frequency response of preview monitor No. 1 amplifier, mixer amplifier and main-line amplifier flat within 0.5 db to 8 MC: less than 6 db down at 10 MC. Preview Monitor No. 2 amplifier flat within 0.5 db to 6 MC: less than 6 db down at 8 MC.

Lucite, pushbuttons lighted internally when button is pressed.

FURTHER DETAILS and QUOTATIONS ON REQUEST

FM-TV, the JOURNAL of RADIO COMMUNICATION

# FM-TV RADIO COMMUNICATION

Formerly *FM MAGAZINE*, and *FM RADIO-ELECTRONICS*

VOL. 11                      AUGUST, 1951                      NO. 8

COPYRIGHT 1951, by RADIOCOM, INC.

## INDUSTRY NEWS

**TV-AM-FM Set Production**  
Compiled from figures released by RTMA ..... 4

**Spot News Notes**  
Items and comments about people and companies ..... 6

## FM AND TV BROADCASTING

**WMIT Is Back on the Air**  
Milton B. Sleeper ..... 11

**After the Thaw: A Log-Jam**  
Roy Allison ..... 16

## ENGINEERING

**Basic Electrical Standards**  
Francis B. Silbee ..... 17

## COMMUNICATIONS

**Mobile Radio News & Forecasts**  
Jeremiah Courtney ..... 20

**3,000-Mile Microwave Relay**  
Description of the AT & T system ..... 22

**Quick-Change Dynamotor Design**  
Robert W. Carter ..... 24

## AUDIO SECTION

**Acoustics of Small Studios**  
James Moir ..... 32

**Design Data for AF Amplifiers**  
No. 12: Power amplifiers, Part 2 ..... 34

**Profit in Tape**  
Charles Fowler ..... 35

## SPECIAL DEPARTMENTS

*Professional Directory* ..... 8

*Special Services Directory* ..... 9

*News Pictures* ..... 21

*Advertising Index* ..... 39

THE COVER DESIGN AND CONTENTS OF FM AND TELEVISION MAGAZINE ARE FULLY PROTECTED BY U. S. COPYRIGHTS, AND MUST NOT BE REPRODUCED IN ANY MANNER OR IN ANY FORM WITHOUT WRITTEN PERMISSION

**MILTON B. SLEEPER, Editor and Publisher**

ROY F. ALLISON, *Associate Editor*  
WILLIAM GRANT DOWNIE, *Western Manager*  
LILLIAN BENDROSS, *Circulation Manager*  
SOPHIE FORTY, *Production Manager*  
Published by: RADIOCOM, INC.

Publication Office: 264 Main St., Gt. Barrington, Mass. Tel. Gt. Barrington 500

Chicago Office: 3035 Lake Avenue, Wilmette, Ill. Tel. Wilmette 5654

RADIO COMMUNICATION Magazine is mailed on the 15th of each month.

Subscriptions: Should be addressed to 264 Main St., Great Barrington, Mass.

Single copies 35c—Subscription rate: \$6.00 for three years, \$3.00 for one year in the U. S. A.—Canada, add 50c per year postage—foreign, add \$1.00 per year postage.

Contributions will be neither acknowledged nor returned unless accompanied by adequate postage, packing, and directions, nor will *FM-TV* Magazine be responsible for their safe handling in its office or in transit.

Entered as second-class matter August 22, 1946, at the Post Office, Great Barrington, Mass., under the Act of March 3, 1879. Additional entry at Post Office, Boston, Mass. Printed in the U. S. A.

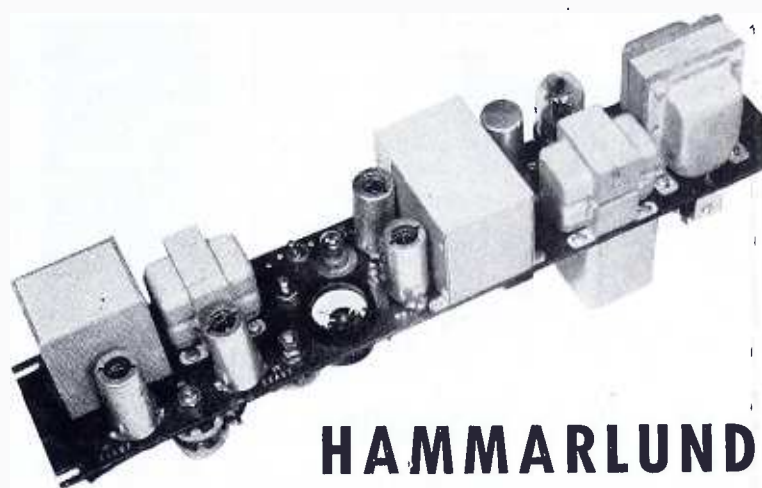

## HAMMARLUND Automatic Signal Transmitter Operating on Voltage Changes

The Hammarlund RSCT-1A Automatic Signal Transmitter is a special unit designed to give immediate notice of low battery voltage at remote, unattended radio transmitters or microwave relay stations, by transmitting an audio signal to one or more control points. An associated receiver can then be used to operate an aural or visual warning signal.

This unit can be adapted to many applications where it is desirable to transmit notice of slight voltage changes by wire, radio, or microwave channels.

**Specifications: Rack panel measures 3½ by 19 ins.**

**Supply voltage 105 to 125 volts, 50 to 60 cycles, single phase.**

**Power input 50 watts maximum.**

**Low-voltage drop-out control is adjustable from 26 to 34 volts, DC.**

**Differential from drop-out to drop-in is less than 1 volt.**

**Time interval of operating delay adjustable from 1 to 30 seconds.**

**Output of 600-cycle tone generator adjustable from 0 to 3 volts into a 600-ohm line.**

**Inquiries are invited as to the adaption of the RSCT-1A to your specific operating requirements.**

# HAMMARLUND

MFG. COMPANY, INC.

460 W. 34th St., New York City, N.Y.

CIRCULATION AUDITED BY  
HENRY R. SYKES  
CERTIFIED PUBLIC ACCOUNTANT  
SYKES, GIDDINGS & JOHNSON  
PITTSFIELD, MASSACHUSETTS



# Low Power Radiotelephones for Industrial Plant Protection and Civil Defense



**MOBILE** equipment for ambulance, fire, or police vehicles operated within the plant area.

**PORTABLE** units for all services requiring communication with men on foot.



**AC** units for use at fixed locations, and for the control point.

**25 to 50 & 152 to 174 mc.**

**LOW POWER 2-WAY RADIO LIMITS RADIATION TO THE APPROXIMATE PLANT AREA. GIVES GOOD COVERAGE WHERE WANTED WITH MINIMUM INTERFERENCE TO OTHER PLANTS OPERATING ON THE SAME FREQUENCY**

**Communication Equipment & Engineering Co.**

TELEPHONE EQUIPMENT MANUFACTURERS SINCE 1930

5646 W. Race Ave., Chicago 44



**D**URING the month of May, television receiver production, according to RTMA figures, dropped to a point of 61% below the all-time high of last March, and 33% below the 1950 average. Since RTMA showed only 234,522 sets shipped, 104,610 sets must have gone into warehouses. That amounts to almost one-third of the month's production, indicating a dangerous accumulation of surplus.

Since TV has not had a year that can be considered normal, it is not possible to predict, with any degree of certainty, whether or not these sets will be cleaned out in the fall. If buying is slow then, the outlook for disposing of inventories is not good. These sets must be turned into cash long before it will be possible to open any additional markets by putting new VHF stations on the air.

There's no telling what effect, if any, UHF and color have had or will have on the purchase of TV sets. So those who can guess right in this confused situation will be smart, and those who don't will really be out on a limb.

AM receivers, on the other hand, are making a remarkable showing. But here again the details must be examined in order to get the true picture. In May,

for the first time, auto sets outnumbered home models. Presumably, that is because cars are being sold with radio as standard equipment, so people get them whether they want them or not. And some of the less expensive radio-phonograph models have been given away as bait for TV sales.

FM sets dropped a little in May. Also, TV sets equipped with FM tuning were down, probably because most TV models produced were the very cheapest types.

One positive inference to be drawn from the May report is that television is not killing off interest in audio broadcasting. And of all the manufacturers, those who are making FM and FM-AM chassis for custom installations are operating nearest to their peak production capacity.

No report was received from RTMA on receiver-tube production during the month of May.

Picture tubes sold to set manufacturers amounted to 229,250 units, valued at \$5,120,553. This was 49,705 below the April total. Rectangular tubes represented 96% of the month's production. RTMA did not report the number of tubes sold for replacement, or for industrial equipment.

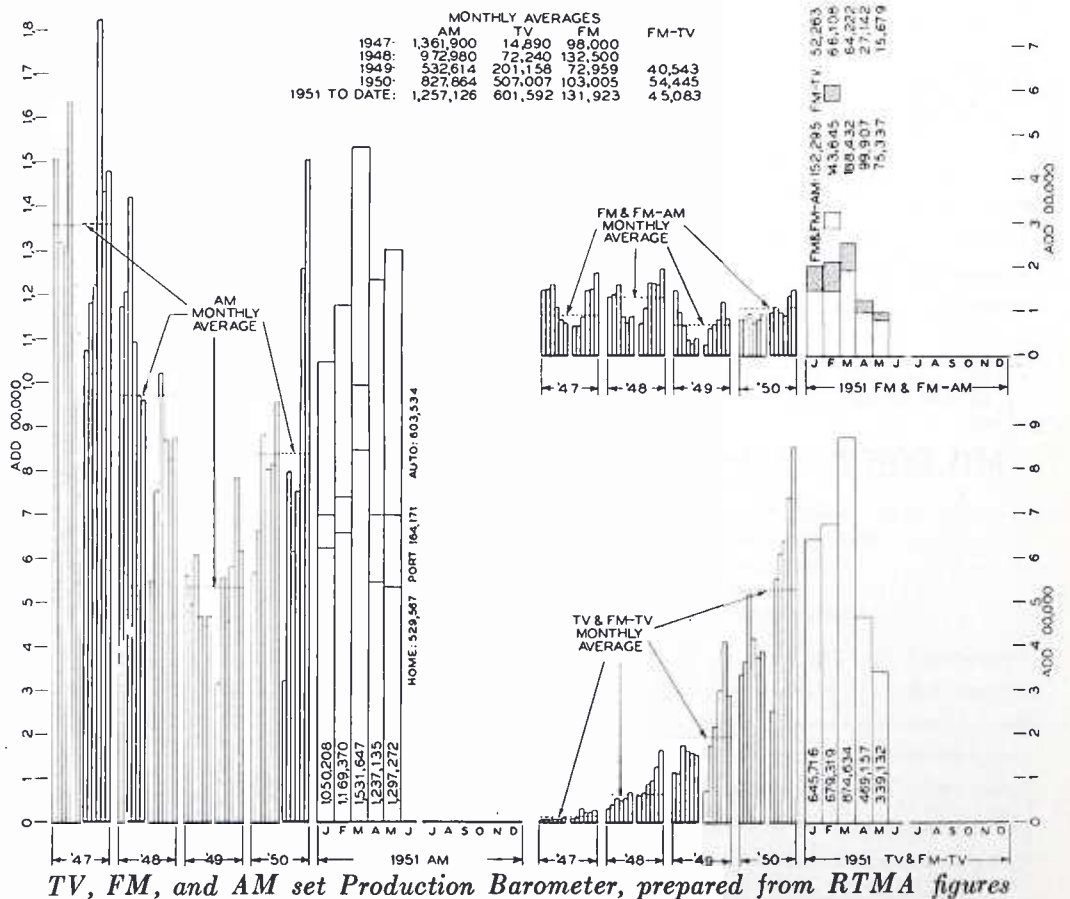

# IMPORTANT BOOKS

## for your

# REFERENCE LIBRARY

To help you in your selection of basic reference works, we have checked hundreds of engineering and technical books. One or more of these will provide the answer of your questions and problems in radio, television, UHF, mobile radio, microwaves, and sound reproduction. For prompt delivery, use the coupon below.

### TELEVISION

- TV Standards and Practice—by Donald Fink. No. 1.....\$5.50**  
405 pages, 5½ by 8¼ ins., cloth. Official standards set by NTSC for use by engineers in the TV industry.
- Practical TV Engineering—by Scott Helt. No. 2.....\$7.50**  
708 pages, 6 by 9 ins., cloth. Fundamentals and methods of efficient TV practice for engineers, students, and technicians.
- Television—Zworykin and Morton. No. 3 .....\$7.50**  
646 pages, illus., 6 by 9¼ ins., cloth. An authoritative treatment of fundamentals and practice for TV engineers and service men.

### FREQUENCY MODULATION

- Frequency Modulation—by August Hund. No. 4.....\$5.50**  
375 pages, 6 by 9 ins., cloth. An engineering text covering basic principles as well as design of commercial apparatus.
- FM Simplified—by Milton S. Kiver. No. 5.....\$6.50**  
347 pages, 5½ by 8 ins., cloth. An excellent book for the layman who wants to learn about FM transmission and reception.
- Frequency Modulation—by Nathan Marchand. No. 6.....\$5.00**  
409 pages, illus., 6 by 9, cloth. The fundamentals, circuits, and equipment used in FM explained using a minimum of mathematics.

### UHF

- UHF Techniques—Edited by J. G. Brainerd. No. 8 .....\$6.00**  
534 pages, 6½ by 9½ ins. cloth. A text designed primarily to train engineers and physicists in ultra-high-frequency research work.
- UHF Transmission—by Nathan Marchand. No. 9.....\$4.50**  
322 pages, 6 by 9¼ ins., cloth. For practicing engineers using UHF, the principles given are applicable to particular problems.
- Communication at UHF—by John Thomson. No. 10.....\$4.50**  
203 pages, 5½ by 8½ ins., cloth. Covers radio communications at these frequencies with emphasis on development possibilities.

### MICROWAVES

- Introduction to Microwaves—by Simon Ramo. No. 11 \$2.50**  
138 pages, 5½ by 8½ ins., cloth. An excellent non-mathematical treatment of the concept of microwaves for the novice.
- Understanding Microwaves—by V. J. Young. No. 12.....\$6.00**  
385 pages, 5½ by 8¼ ins., cloth. The underlying principles thoroughly explained for engineers, researchers, and students.
- Microwave Electronics—by John C. Slater. No. 13 .....\$6.00**  
406 pages, 6 by 9 ins., cloth. A highly technical treatment of wartime and post-war development in microwaves.

### RADIO COMMUNICATION

- Mobile Radio Handbook—by M. B. Sleeper. No. 15.....\$2.00**  
185 pages, 8¼ by 11½ ins., paper. Invaluable references for all concerned with mobile radio and point-to-point communications.

### AUDIO REPRODUCTION

- Sound Reproduction—by G. A. Briggs. No. 16.....\$2.25**  
144 pages, illus., 5¼ by 8½ ins., cloth. In non-technical terms, an outline of the techniques of sound reproduction in the home.

- Sound Recording—by Frayne and Wolfe. No. 14.....\$8.50**  
686 pages, illus., 6 by 9¼, ins., cloth. For designer, engineer, and technician, covers basic problems in recording and reproducing.
- Recording and Reproduction—by Oliver Read. No. 7.....\$5.00**  
364 pages, 6 by 9 ins., cloth. For anyone interested in sound, a complete coverage of the field in terms easily understood.
- Loudspeakers—by G. A. Briggs. No. 17.....\$1.25**  
88 pages, 5 by 8 ins., paper. A thorough yet concise account of the "why" and "how" of good reproduction in simple language.
- Motion Picture Sound Engineering—AMPAS. No. 18 \$6.50**  
547 pages, 6 by 9 ins., cloth. Theory, design, and practice in motion picture sound. Also a good reference on sound in general.

### INSTRUMENTS

- Modern Oscilloscope—by J. A. Ruiter, Jr. No. 19 .....\$6.00**  
326 pages, 5¾ by 9 ins., cloth. A description of equipment and operational methods for engineers, servicemen, and teachers.
- Vacuum-Tube Voltmeters—by John F. Rider. No. 20.....\$4.50**  
432 pages, 5½ by 8¼ ins., cloth. Only source book devoted exclusively to this subject. For engineers, technicians, and teachers.
- Encyclopedia on Oscilloscope—by J. F. Rider. No. 21.....\$9.00**  
992 pages, 8½ by 11 ins., cloth. Truly encyclopedic in coverage, this book shows, in detail, efficient use of the scope.

### ACOUSTICS

- Acoustic Measurements—by Leo L. Beranek. No. 22 ... \$7.00**  
914 pages, 5½ by 8½ ins., cloth. Discusses techniques, apparatus, and theory of acoustic measurements for technicians.
- Acoustic Design in Architecture—by Knudsen & Harris. No. 23 .....\$7.50**  
457 pages, 5½ by 8¼ ins., cloth. For engineers and students, a discussion of principles, procedures, and specific applications.
- Acoustic Design Charts—by Frank Massa. No. 24. ... \$4.00**  
228 pages, 6 by 9 ins., cloth. Quick, handy reference for those interested in design or construction of electro-acoustic apparatus.

### REFERENCE BOOKS

- The Radio Handbook—Edited by R. L. Dawley. No. 25. \$3.00**  
320 pages, 6½ by 9¼ ins., cloth. Detailed constructional information on a wealth of radio communication equipment; all new.
- Broadcast Operators Handbook—by H. E. Ennes. No. 26, \$3.30**  
265 pages, 5¼ by 8½ ins. cloth. A complete guide to operating and maintenance practice for broadcasters and technicians.
- Data for Radio Engineers—Federal T. & R. No. 27. \$3.75**  
675 pages, 5½ by 8½ ins., cloth. Revised edition of this comprehensive reference giving data on all phases of radio engineering.
- Radio Eng. Handbook—by Keith Henney. No. 28... \$10.00**  
1,197 pages, 6 by 9 ins., cloth. The 4th edition contains the latest revisions on all material pertaining to electronics and radio.
- Electrical Eng. Handbook, Vol. 2—Pender. No. 29.....\$8.50**  
1,564 pages, 5½ by 8½ ins., cloth. Covers field of communications, including facsimile, FM, TV, and latest pulse techniques.
- Radio Engineers Handbook—Terman. No. 30.....\$8.00**  
1,019 pages, 6 by 9 ins., cloth. A wealth of technical information, specially selected for application toward practical radio problems.

### MISCELLANEOUS

- Radio and TV Almanac—by O. E. Dunlap. No. 32 ... \$4.00**  
211 pages, 5¼ by 8 ins., cloth. A chronological record of facts, dates, and people important in the history of radio and television.

Book List Department, RADIO COMMUNICATION, Great Barrington, Mass.										
I enclose \$ ..... for which please send me the books indicated by circled numbers below. (No C.O.D.'s, please.)										
1	2	3	4	5	6	7	8	9	10	11
12	13	14	15	16	17	18	19	20	21	22
23	24	25	26	27	28	29	30	31	32	33
Name .....										
Address .....										

# MONITOR ANY 4 FREQUENCIES

Between 25-170 Mc

Check Frequency Deviation and  
Percentage of Modulation Simul-  
taneously—with .0015% Accuracy

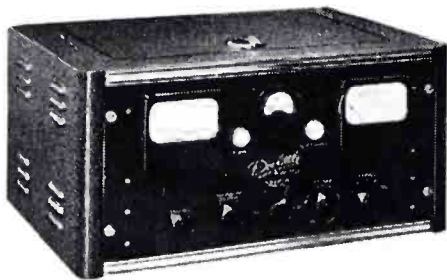

*Doolittle*

## FD-12 FM FREQUENCY and MODULATION MONITOR

Now, just *one* Monitor for all FM radiotelephone services. With this single direct reading Monitor, you can handle one, two, three or four frequencies . . . or any combination up to four . . . on the same or different bands . . . anywhere between 25 Mc. and 170 Mc. And you can check not only frequency deviation, *but also your percentage of modulation!* Meets all FCC requirements. Assures utmost convenience, accuracy and reliability.

● Also available now—Increased range *litlefone* Portable FM Radiotelephones: PJZ-4 Two-Watt (25-50 Mc); PJZ-14 One-Watt (150-175 Mc); PJZ-2 Three-Quarter Watt (25-50 Mc); PJZ-12 Half-Watt (150-175 Mc).



### THIS MONTH'S COVER

Tape equipment sales are coming to represent a substantial volume of business for dealers and parts jobbers specializing in the hi-fi trade. And professional custom set builders report that they are using more and more tape units.

This month's cover shows a very complete installation in the home of Tom White, president of Jensen Manufacturing Company. It is made up of an FM-AM tuner, TV tuner, tape recorder, and record-changer, with a speaker system from you-know-where.

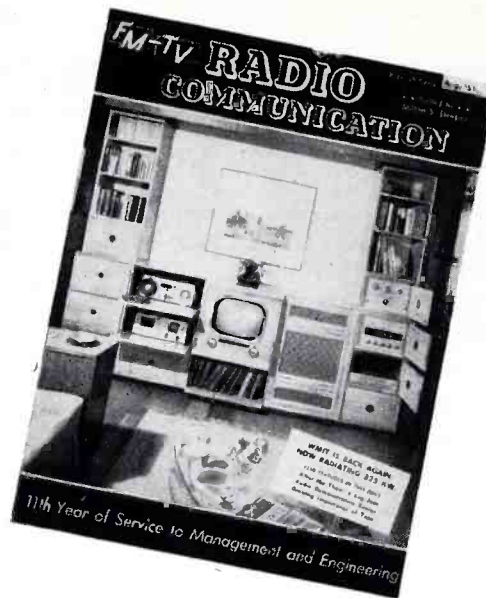

## SPOT NEWS NOTES

ITEMS AND COMMENTS, PERSONAL AND OTHERWISE, ABOUT PEOPLE AND COMPANIES CONCERNED WITH RADIO COMMUNICATIONS

### Tape Library:

First catalog of tape recordings we have seen has been issued by A-V Tape Libraries, Inc., 730 Fifth Avenue, New York 19. Reels are supplied for 7½ or 3¾ in. speed, single or double track. Each carries 30 minutes of music. Prices are comparable to LP records.

### Where Is Main Street?

Commenting on our recent piece about mentioning street locations but not the cities on FM commercials, one of our readers recalled an occasion when former FCC Chairman Denny was listening in at Atlantic City. Commercials referring to Blank's Store on Blank-Blank Street were run in frequently on a disc-jockey show, but no station identification was given until, after more than an hour, the call letters of a South Carolina station were heard. Soon thereafter, the management was cited for failing to observe FCC Rules. Probably the FM transmitter was newly added to an AM station with very limited coverage.

### Roy Allison:

Having completed his tour of duty in the Naval Reserve, our Associate Editor is coming back to RADIO COMMUNICATION and, effective with the September issue, he will take over as Editor, thus enabling our Publisher to divide his activities between this magazine and HIGH-FIDELITY. All our gang will be glad to have Roy back again. We understand that, while he has been away, he has hatched some new ideas which will appear in forthcoming issues of RADIOCOM.

### TV Present and Future:

Robert Sprague, RTMA president, testifying before the Senate Finance Com-

mittee: "Before the imposition of the 10% tax, factory [TV] sales average was 318,000 sets per week. For the month of June [1951] they averaged 39,000 sets. . . . The 1950 expansion of sales came largely from the income groups below \$5,000. This income group comprises 83% of all taxpayers, and it is estimated that more than 50% of this group were in the bracket under \$3,000."

FCC information release on August 1 states that "despite the freeze on new TV construction, 107 out of the 109 authorized TV broadcast stations are operating, and more than 400 applications for new stations are authorized."

### Printed Circuit Data:

Very useful reference guide on standard printed circuit assemblies has been issued by Centralab, 900 E. Keefe Avenue, Milwaukee 1. Data on 19 types is given, with circuits and values, and replacement information on various models and makes of receivers.

### FM in Germany:

Comment from returning member of the International Radio Consultative Committee: "Germany now has about 20 operating FM stations, with a goal of 44. Interference is such as to make AM useful only in small areas."

### New York-Chicago:

Newark Electric Company of New York City has changed its name to Hudson Radio & Television Corp., and has moved to new and very handsome headquarters at 48 West 48th Street. However, Newark Electric Company of Chicago, a completely independent concern, is doing business as usual at 323 West Madison Street.

(Continued on page 7)



## SPOT NEWS NOTES

(Continued from page 6)

### Expansion:

La Pointe Plascomold has purchased the Sculli Machine Company of East Hartford, manufacturer of precision aircraft parts. This will provide La Pointe with an aircraft division.

### Audio Fair:

Whether you are interested in audio reproduction as an engineer or a hobbyist, you'll find the 1951 Audio Fair a tremendously interesting event. It will be held at Hotel New Yorker, New York City, November 1 to 3. Some 200 exhibits will occupy the entire 5th and 6th floors. RADIO COMMUNICATION and HIGH-FIDELITY Magazines will present the latest development of the FAS system in Room 641. If you want to hear your own tape or records, bring them along.

### New Slant to Old Slogan:

Salvage price list from Eitel-McCullough carries the slogan: "Old Eimac tubes never die."

### Storm Tests New System:

Eight days after RCA completed the new police and fire system at Philadelphia, an 80-mile gale hit the city. Chief Grim of the Electrical Bureau reported that more emergency calls were handled than at any other time in his 32 years experience. Dispatches to 272 police vehicles were handled at the rate of 4 per minute for 13 hours. Fire apparatus was routed directly from one scene to another, in response to 67 alarms. Rescue squads made 25 runs.

### AEPEM Officers:

John Cashman, of Radio Craftsmen, has been elected chairman of the Association of Electronic Parts & Equipment Manufacturers, succeeding Rockwell M. Gray of Rauland-Borg. Francis F. Florsheim, Columbia Wire & Supply, is vice chairman, and Helen Quam, Quam-Nichols, is treasurer. Kenneth C. Prince continues as executive secretary.

### Theatre TV:

Although Little Rock has no TV broadcast service, residents will see television at the local Center Theatre, where a GPL Simplex system will be installed. Programs will be brought in by coaxial cable as soon as the Little Rock link is installed.

### Glen McDaniel:

RTMA president, addressing dealers at the NAMM Chicago convention on July  
(Continued on page 8)

## PUT OUT A STRONGER SIGNAL... INCREASE YOUR SERVICE AREA

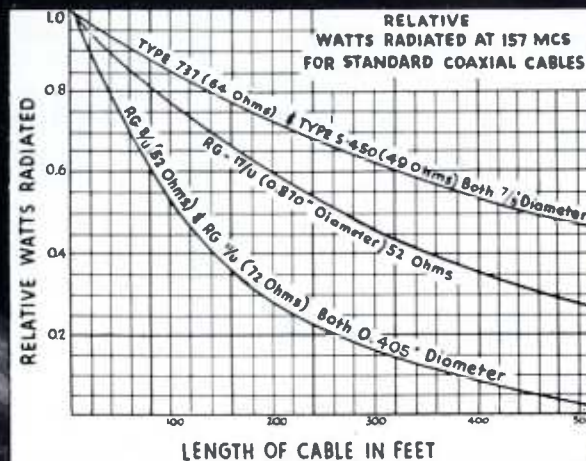

## with ANDREW Low Loss, High Economy Coaxial Cable

- 1/3 to 1/2 Less Loss than same diameter plastic type cables because 96% of insulation is air—the most effective insulation.
- No maintenance or operational costs. This advantage far offsets slightly greater original cost. Seamless cable and fittings remain completely gas tight and weatherproof indefinitely.
- Maintains original characteristics indefinitely. Lasts practically forever.
- TO INSTALL — JUST UNCOIL INTO PLACE. Each coil contains up to 2,000 feet of seamless semi-flexible tubing. No soldering. No splicing. Bends easily around corners or obstructions. Shipped under gas pressure at no extra cost when pressure-tight end fittings are ordered.



Low loss and economical operation will add extra miles to your service radius as well as give you a stronger signal in your present area. There's no waste. You get the greatest possible range and strength from your available power.

Whether you need transmission line for your Communications,

AM or FM transmitter, Directional Antenna System, or Rhombic Receiving Array, the solution to your problem is ANDREW low loss, high economy, semi-flexible transmission line. Write for further information on Types 737 and S-450 TODAY.



WORLD'S LARGEST ANTENNA EQUIPMENT SPECIALISTS  
TRANSMISSION LINES FOR AM-FM-TV • ANTENNAS • DIRECTIONAL ANTENNA EQUIPMENT  
ANTENNA TUNING UNITS • TOWER LIGHTING EQUIPMENT

## Professional Directory

### Jansky & Bailey

Consulting Radio Engineers

**EXECUTIVE OFFICES:**

970 National Press Bldg.,  
Washington 4, D. C. ME 5411

**OFFICES AND LABORATORIES:**

1339 Wisconsin Ave., N.W.  
Washington 7, D. C. AD 2414

Member AFCCE

### GARO W. RAY

CONSULTING RADIO ENGINEERS

Standard, FM and Television Services

HILLTOP DRIVE  
STRATFORD, CONN.

Tel. 7-2465

### ANDREW ALFORD

Consulting Engineers

ANTENNAS & RF CIRCUITS

Laboratory and Plant:

299 Atlantic Ave., Boston 10, Mass.

Phone: HANcock 6-2339

### GEORGE C. DAVIS

Consulting Radio & Television  
Engineers

501-514 Munsey Bldg.—Sterling 0111

Washington 4, D. C.

### WELDON & CARR

Consulting Radio Engineers

WASHINGTON, D. C.

1605 CONNECTICUT AVE.

DALLAS, TEXAS SEATTLE, WASH.  
4212 S. BUCKNER 4742 W. RUFFNER

### McNARY & WRATHALL

CONSULTING RADIO ENGINEERS

906 National Press Bldg. DI. 1205  
Washington, D. C.

1407 Pacific Ave. Phone 5040  
Santa Cruz, California

## SPOT NEWS NOTES

(Continued from page 7)

18, offered little hope that color TV sets of the CBS type will be produced in significant number this year. He said: "There are a few people, of course, who would buy color television sets immediately if there were only 15 minutes a week of programming available, but I do not believe they constitute a quantity market."

### Off the Beam:

Says Transit Radio of article in July *Readers Digest*: "Worst of all, the *Digest* published a cartoon showing five bus-riding individuals looking obviously unhappy in the presence of bus radio. Inasmuch as all the polls in many cities have indicated 5% or less disapproval, this is simply pure misrepresentation typical of slanted reporting in its most lowly state."

### Morrison L. Gable:

Appointed radio systems engineer of Bendix Aviation Corporation's radio division, Towson, Md. He will be responsible for planning railroad radio and other communication system.

### FM for AT & T Relay:

Bell Laboratories arrived at the use of FM for the transcontinental relay the hard way. Prior to 1936, the Laboratories had shown to their own satisfaction that FM had no future. The first relay between New York and Boston started with pulse-time operation. Then FM was used with Klystrons. Later, they were replaced with the 416-A developed by Bell Laboratories. These tubes, operating with FM, are now used throughout the system. It is interesting to note that Major Armstrong, in a press interview reported in the newspapers on April 26, 1935, made the statement that TV programs could be carried from city to city by FM, and he referred to work that had been done on 4-channel multiplex FM operation.

### New Plant:

General Radio has started construction of a factory at Concord, Mass., to provide 72,000 square feet of space. This will accommodate 200 workers, in addition to the 500 now employed at the Cambridge plant.

### Improved Camera Chain:

Many design refinements are represented in Du Mont's TA-124-E image orthicon chain. Intended for field, studio, and film pickup service, improvements have been made in the camera and monitor, the pickup aux-

(Concluded on page 9)

## Professional Directory

### KEAR & KENNEDY

Consulting Radio Engineers

1302 18th St., N. W. HUDson 9000

Washington, D. C.

### GEORGE P. ADAIR

Consulting Engineers

Radio, Communications, Electronics

1833 M St., N.W., Washington 6, D. C.

EXecutive 1230

### RUSSELL P. MAY

CONSULTING RADIO ENGINEERS

★ ★ ★

1422 F Street, N.W., Wash. 4, D. C.

Kellogg Building Republic 3984

Member AFCCE

### Winfield Scott McCachren

Radio Engineering Consultant

UHF-TELEVISION SPECIALISTS

2404 Columbia Pike Arlington, Va.

GLEbe 9096

### RATES FOR PROFESSIONAL CARDS IN THIS DIRECTORY

\$12 Per Month for This Standard  
Space. Orders Are Accepted  
for 12 Insertions Only.

### THE WORKSHOP ASSOCIATES

INCORPORATED

Specialists in  
High-Frequency  
Antennas



135 Crescent Road  
Needham Heights 94, Mass.  
NEedham 3-0005

## Special Services Directory

**16mm  
maurer  
mill**

16-MM Professional Motion Picture  
Production Equipment

**J. A. MAURER, Inc.**

37-07 31st Street, Long Island City 1, N. Y.  
Tel. STillwell 4-4601

**Paul W. Klipsch**  
Professional Engineer  
Acoustic development  
and consulting

**Klipsch and Associates**  
building the authentic  
**KLIPSCHORN**  
world's finest sound reproducer

Hope, Arkansas

Tel. Hope 995

### RATES FOR PROFESSIONAL CARDS IN THIS DIRECTORY

\$12 Per Month for This Standard  
Space. Orders Are Accepted  
for 12 Insertions Only

## MEASUREMENTS CORPORATION



*Research &  
Manufacturing  
Engineers*

Specialists in the Design & Development  
of Electronic Test Instruments  
**BOONTON, N. J.**

### Radio Wire Television Inc.

Specialists in high-fidelity audio  
equipment of all standard makes.  
Send for Catalog R-51. Complete  
stocks are carried at each of these  
Audio Headquarters stores:

100 Sixth Avenue, New York City  
110 Federal Street, Boston, Mass.  
24 Central Avenue, Newark, N. J.

### RADIO OFFICERS WANTED

For large Philadelphia Oil Company's  
tanker fleet. \$409.50 per month to  
start; 64 days per year paid leave and  
vacation; disability benefits. FCC radio  
telegraph license required. Reply to  
P.O. Box 8138, Philadelphia 1, Pa.,  
and show complete experience.

## SPOT NEWS NOTES

(Continued from page 8)

iliary has been simplified by the elimi-  
nation of 12 tubes, operating features  
have been added to the mixer ampli-  
fier, and a time-totalizer is provided to  
register the operating hours of the  
tubes.

### CC Mobile Service Channels:

Since the FCC denied the use of 470 to  
500 mc. to common carrier mobile serv-  
ice, as reported last month, Bell Lab-  
oratories has suggested that the Com-  
mission provide space between 400 and  
470 mc. Among other space which  
might be reassigned is the 10-mc. citi-  
zens radio band.

### More TV Power:

Temporary authorization for increasing  
effective radiated video power has been  
granted by the FCC to the following  
stations:

KMTV	Omaha	from	11.7 kw.	to	16.5 kw.
KRLD-TV	Dallas		15.1		27.3
WAVE-TV	Louisville		7.0		24.1
WDEL-TV	Wilmington		.476		1.0
WGN-TV	Chicago		11.2		29.0
WHAM-TV	Rochester		16.7		22.0
WHEN	Syracuse		15.0		27.0
WJZ-TV	New York		3.0		18.0
WKTV	Utica		13.0		24.8
WOR-TV	New York		9.0		22.0
WPIX	New York		18.5		26.3
WSM-TV	Nashville		14.4		23.8
WTVN	Columbus		6.0		19.7
WXEL	Cleveland		21.0		25.6

### New Office:

GE has opened an office for handling  
mobile and microwave equipment at  
the International Trade Mart, New Or-  
leans. Merrill F. Chapin is in charge.

### Wherever There's a Disaster:

Heard on the "Telephone Hour": "Since  
the middle of last week, telephone  
people have been fighting around the  
clock to protect vital telephone lines  
and to supply emergency service wher-  
ever needed [in the flooded areas of  
Kansas, Oklahoma, and Missouri].  
They've thrown dikes of sandbags  
around threatened telephone offices.  
They've raised switchboards above the  
rising waters; brought in emergency  
power plants; rigged special toll lines  
and brought in mobile radio telephones  
to isolated towns. . . . 46 million con-  
ductor feet of exchange cable, 1½ mil-  
lion feet of drop wire, 25,000 tele-  
phones."

### More Production:

Molding presses and cable extruders are  
being set up in Amphenol's new plant  
No. 4, a building of 65,000 square feet.  
This will permit increased production  
of AN and RF connectors at the main  
plant, and add 300 employees.

## COMMUNICATION SYSTEMS in the U. S.

Including mobile, point-to-point, and  
relay installations

### No. 1: Registry of CC, LCC & Industrial Services

COMMON CARRIERS — PUBLIC UTILITIES  
LIMITED COMMON CARRIERS  
PIPE LINES — LOW-PRESSURE INDUSTRIAL  
FORESTRY — PRESS — MOTION PICTURE

### No. 2: Registry of Public Safety Services

POLICE — FORESTRY — FIRE  
HIGHWAY MAINTENANCE  
SPECIAL EMERGENCY

### No. 3: Registry of Transportation Services

TAXICABS - RAILROADS  
URBAN TRANSIT - BUSES  
TRUCKS - PUBLIC GARAGES

### No. 4: Registry of Aeronautical Services

AIRCRAFT - OPERATIONAL  
AIRDROME - FLYING SCHOOL  
FLIGHT TEST - UTILITY

PRICE: \$1.00 each, postpaid

Published by **RADIOCOM, Inc.**  
Great Barrington, Mass.

## BACK ISSUES OF

## FM-TV RADIO COMMUNICATION

Here is your opportunity to  
complete your files. The fol-  
lowing issues are available at  
25c each, postpaid:

- 1940: sold out
- 1941: except Feb. issue
- 1942: all issues available
- 1943: all issues available
- 1944: except Jan. & Feb.
- 1945: except Nov.
- 1946: except June
- 1947: all issues available
- 1948: except Jan.
- 1949: all issues available
- 1950: except April, May,  
Aug., Oct., Nov.

There are only two or three copies  
of some months. If any issue is  
sold out, your remittance will be  
returned.

**Radiocom, Inc.**  
Great Barrington, Mass.

# VERSATILITY!



**New *Gray* 108-B Arm for all records has new suspension principle . . . for perfect tracking without tone arm resonances**

Perfect tracking of records and virtual elimination of tone arm resonances are only two advantages of this versatile, specially-designed arm — the finest yet developed! It satisfies every requirement of LP reproduction, permits instant changing from 78 r.p.m. to LP (micro-groove) or

45 r.p.m., and *assures correct stylus pressure automatically*. GE or Pickering magnetic pickup cartridges are interchangeable and slip into place quickly and easily. Maintains perfect contact with bad records, accommodates records up to 16" in diameter.



### **106-SP Transcription Arm —**

Assures fidelity of tone for every speed record. Three cartridge slides furnished enable GE 1-mil, 2½ or 3-mil, or Pickering cartridges to be slipped into position instantly, with no tools or solder. Low vertical inertia, precisely adjustable stylus pressure.

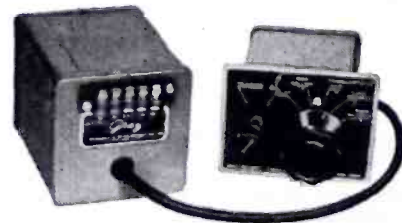

### **Gray Equalizers —**

Used as standard professional equipment by leading broadcast stations, these specially-designed equalizers assure highest tonal quality . . . new record reproduction from old records . . . constant velocity frequency response for conventional or LP records. Uses GE or Pickering cartridges.

Please write for bulletins describing the above equipment.

**GRAY RESEARCH**  
and Development Co., Inc., 16 Arbor St., Hartford 1, Conn.

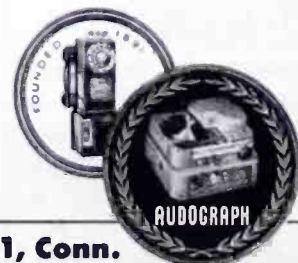

*Arthur E. Ottaviano*  
President

Division of The GRAY MANUFACTURING COMPANY—Originators of the Gray Telephone Pay Station and the Gray Audograph

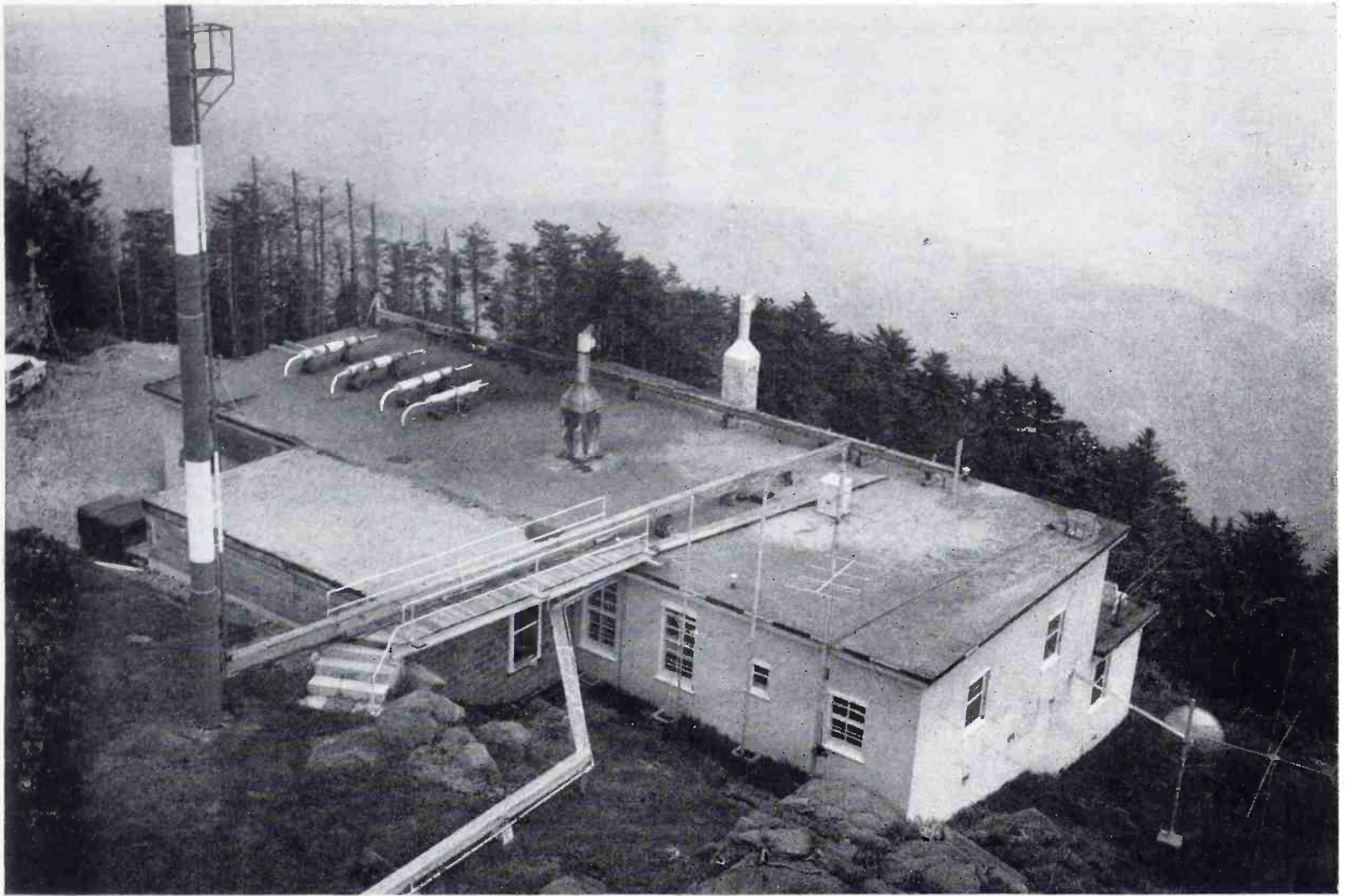

FIG. 1. LOOKING DOWN ON THE TRANSMITTER BUILDING FROM THE NEW TOWER. MUFFLERS FOR DIESEL ENGINES ARE MOUNTED ON THE ROOF, AT LEFT

## FM STATION WMIT IS BACK AGAIN

WITH INTERFERENCE-FREE, SOLID COVERAGE OF 100,000 SQUARE MILES, THIS IS WORLD'S MOST POWERFUL BROADCAST STATION — *By* MILTON B. SLEEPER

**F**LYING down to Charlotte, N. C., last June, an elderly farmer-lady boarded the plane at Washington and took the seat next to me. She held forth on various subjects until: "I suppose you have television up north. We don't get television where we live, but we have FM. We sure enjoy it too, but we miss WMIT since it quit."

To that lady, and many thousands of FM listeners in the six-state area that was served by Gordon Gray's station on Clingman's Peak, the news that WMIT has gone on the air again has been welcome indeed. The station was closed down in the spring of 1950 for the reason, as Gordon Gray explained then, that he had not had the time to develop it as a commercial enterprise.

Early this year, the property was purchased by a newly-formed group, organized as Mt. Mitchell Broadcasters, Inc., with headquarters in Charlotte. W. Olin Nesbet, Jr., a local investment banker, is the president. Vice president is John Erwin, who is also vice president of Alli-

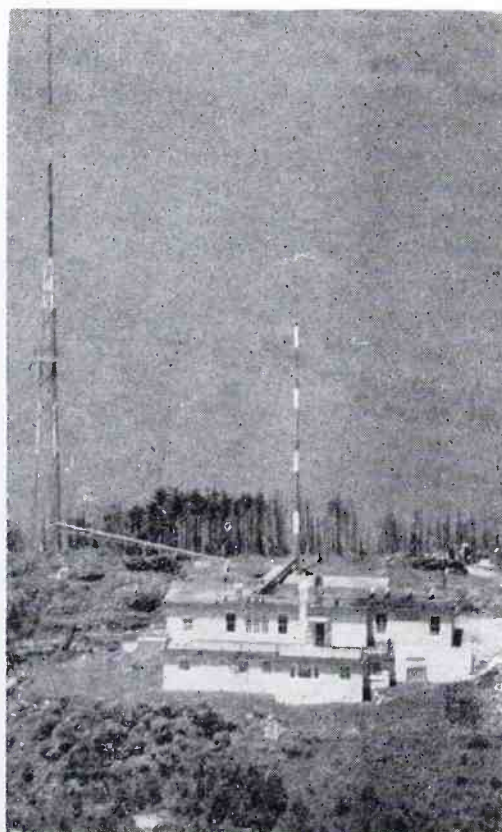

son-Erwin Company, a Charlotte wholesale hardware firm and distributors of Zenith radio sets. W. H. B. Simpson, the secretary and treasurer, operates the Belk-Simpson department store at Greenville, S. C., as well as 17 other Belk stores in the area.

In preparation for getting WMIT back on the air, one of the first steps taken by the new management was to add a 50-kw. stage to the original 10-kw. transmitter, and to replace the 4-bay antenna with a new one of 8 bays. These are shown in the accompanying illustrations. Now, WMIT has an effective radiated power of 325 kw.

### Coverage Area:

As a result, this FM station has a solid coverage area, day and night, of about 100,000 square miles. Just what this means in comparison to primary AM service is indicated in Fig. 3. The small circles represent the approximate inter-

FIG. 2. NEW AND OLD ANTENNAS CAN BE SEEN IN THIS AIRPLANE VIEW OF CLINGMAN'S PEAK

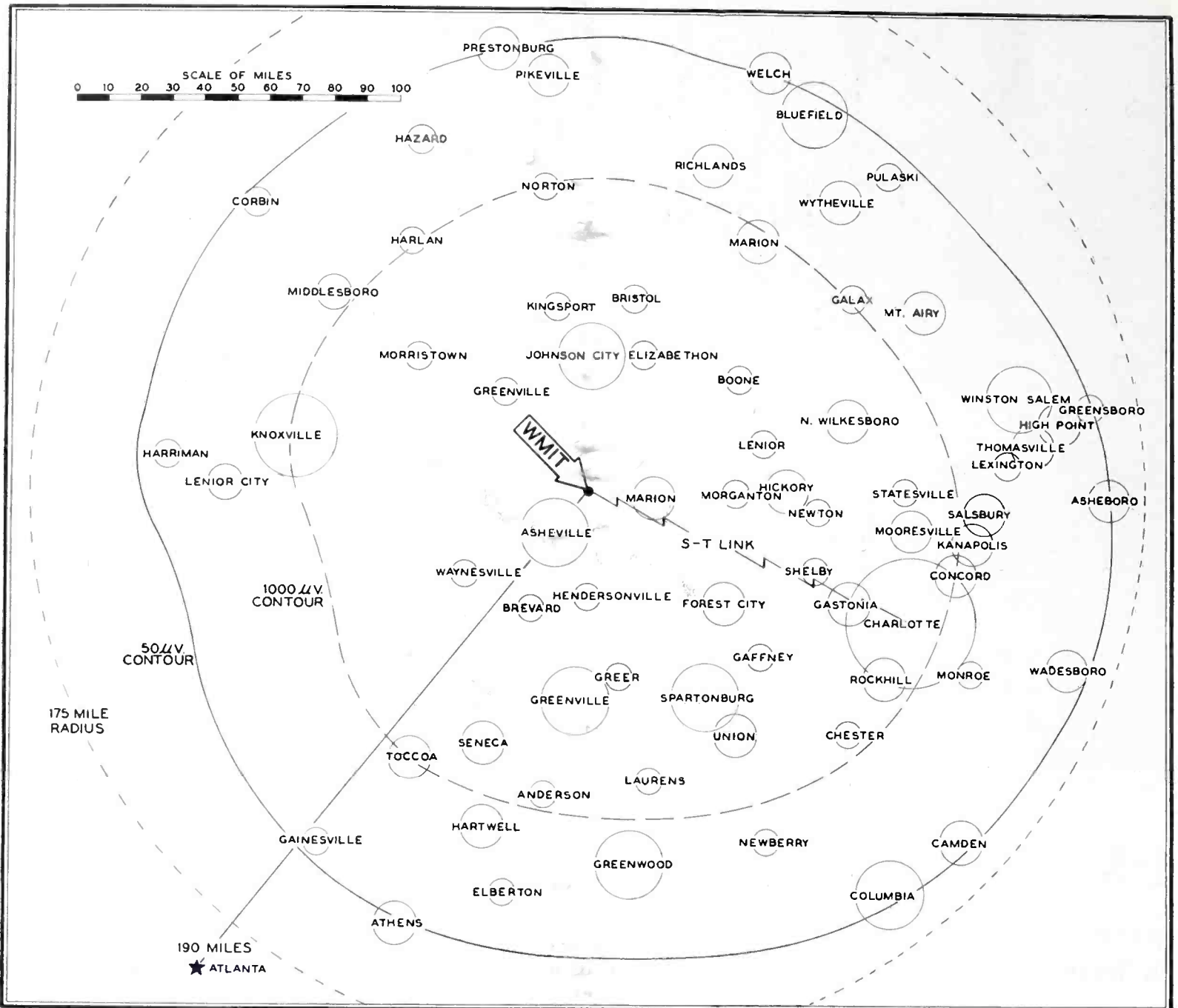
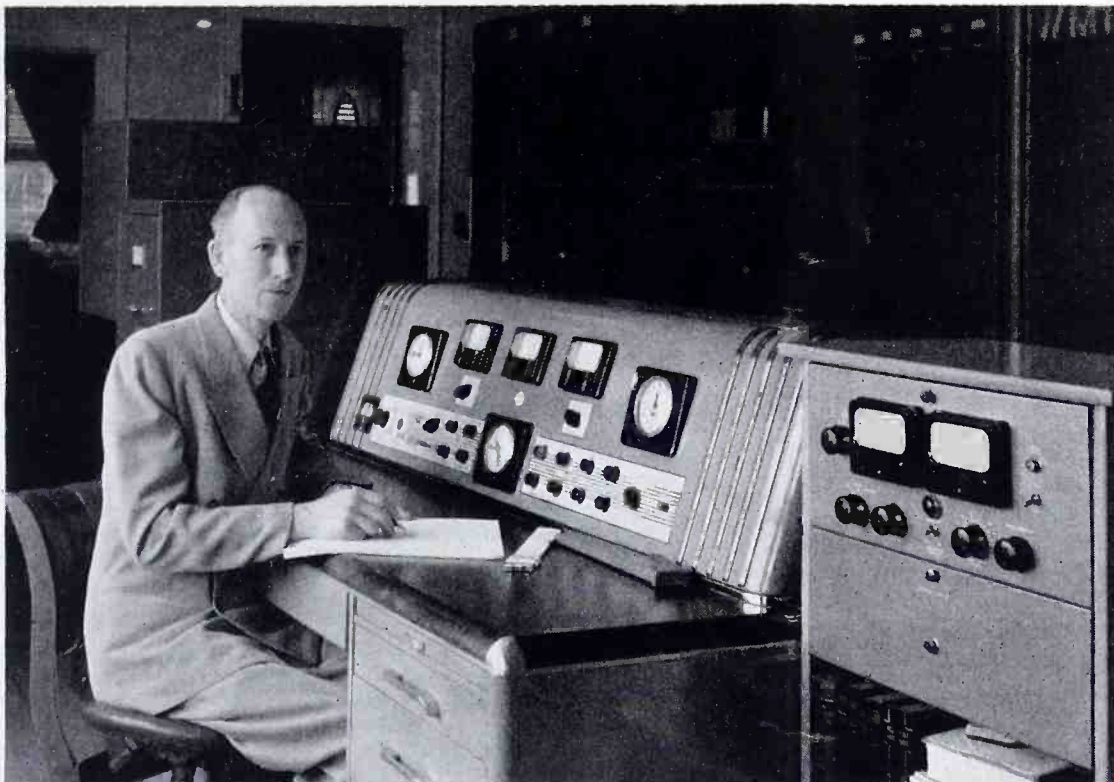

FIG. 3. SMALL CIRCLES WITHIN WMIT'S SERVICE AREA INDICATE APPROXIMATE NIGHTTIME COVERAGE OF MOST POWERFUL AM STATION IN EACH CITY

ference-free night time service areas of the most powerful AM stations in each city inside WMIT's 50-microvolt contour. These range from 4 miles radius for 250-watt stations, to 20 miles for 50-kw. WBT, at Charlotte. Actually,

W. OLIN NESBET, JR. IS PRESIDENT, AND JOHN ERWIN IS VICE-PRESIDENT OF WMIT. RIGHT: L. L. CARDLE, JR. IN CHARGE OF CHARLOTTE OPERATIONS





CHIEF ENGINEER JOSEPH L. McFARLAND AT THE CONTROL CONSOLE. THE FM TRANSMITTER RUNS ALONG THE REAR WALL. THE STUDIO, SHOWN IN FIGS. 4 AND 6, IS AT THE LEFT. MRS. McFARLAND, WHO IS THE ONLY WOMAN AT THE STATION, IS A WONDERFUL COOK, AND AN EXPERT ON AFRICAN VIOLETS

WBT's night time pattern is not circular, since the station must go directional to limit interference with KFAB in Lincoln, Nebr. Listeners in the important industrial city of Gastonia, 18 miles from the transmitter, do not get WBT at night for that reason.

WMIT, by way of contrast, puts an excellent signal into Atlanta, 190 miles away. The 50 and 1,000-microvolt contours in Fig. 3 were drawn from calculated values. Experience gained from actual surveys of FM coverage indicates that WMIT is delivering an interference-free signal that will provide full limiting on a well-designed FM receiver with an outdoor antenna at a radius of about 200 miles, reaching an area of some 125,000 square miles. This compares with about 56 square miles for a 250-watt AM station, or 1,200 square miles for a 50-kw. AM station at night.

Thus, a network comprised of AM stations in 70 cities within WMIT's 50-microvolt contour would cover only a small part of the area served by this single FM station. Total population served by WMIT is over 6,500,000, in the most prosperous part of the southeast, where profits from agriculture have increased greatly in the postwar years, and new industries are continuing to move in steadily. In this section, many people have no local AM program service at all, particularly in the summer, when static is severe. Fort Worth, Texas, for example, often fades in and out, but such signals afford little entertainment, and are of no value to listeners who want to know about tomorrow's weather!

The population and present FM set ownership within the 50-microvolt con-

tour breaks down this way:

N. Carolina	1,949,623 pop.	52,970 sets
S. Carolina	1,158,866	19,425
Virginia	341,368	10,237
Tennessee	829,240	19,048
Kentucky	407,392	8,970
Georgia	135,123	2,912
	4,821,612	113,562

#### Programs from WMIT:

Operating as a regional station on 106.9 mc., WMIT's programs are tailored strictly to the needs and preferences of the people it serves. The station goes on the air at 6:00 A. M., and closes down at 11:45 P. M. during the week, and at midnight on Saturdays and Sundays. Part of the programs are taken from the Liberty Network, but it is planned to draw on sources in Asheville, Knoxville, Winston-Salem, High Point, Spartanburg, Greenville, and Columbia to maintain a strong local flavor.

The studio at Charlotte is connected to the transmitter by an S-T link, as indicated in Fig. 3. This is a distance of 90 miles. Some programs are recorded from the link for delayed transmission. More than half of the local programs originate at the transmitter, including music on tape and discs, weather reports, announcements, and station breaks. WMIT makes a special feature of providing the farmers with weather information gathered at Charlotte and Atlanta.

There is a great popular demand for hill-billy music. Very little of it is available from the AM networks and the small independent AM stations have limited libraries. WMIT, however, gearing

its program strictly to the needs and preferences of its audience, is carrying about 3 hours of hill-billy songs every day. Also, a substantial amount of time is devoted to excellent programs of a classical and semi-classical nature for the benefit of those who prefer such music.

#### Setup on the Mountain:

Station WMIT is located on the summit of Clingman's Peak, within easy walking distance of the top of Mt. Mitchell. The latter point is slightly higher, but the 180-ft. tower, added to Clingman's altitude of 6,557 ft., makes the top beacon light the highest point east of the Mississippi. For FCC purposes, the antenna is calculated to be 3,300 ft. above average terrain.

On pleasant days, several hundred people are likely to visit the station. Starting at Marion, there is a fine state road winding upward to a National Park at the top. Only the last mile is rough going, over a road first cut in 1941 when the station was built.<sup>1</sup>

The first floor of the station is built into solid rock which drops off sharply, as can be seen in Fig. 1. It provides living quarters for the staff, and a kitchen and dining room. Getting food up the mountain is not a serious problem, for the road is open nearly all the time. Considerable space on the second floor is occupied by the generator room and an adjacent drive-in shop. There are additional quarters for the staff, usually totalling 12 in number. The remainder

<sup>1</sup>The construction of WMIT, then known as W41MM, was described in an article entitled "Progress Report on W41MM" by C. M. Smith, Jr., *FM Magazine*, April, 1942. Copies are still available.

of the second floor is taken up by the transmitter room and studio, both of which open on a broad porch that faces down the valley. Altogether, the station has the pleasant, comfortable atmosphere of a mountain-top hotel, and an invitation to be the guest of the McFarlands is one to be accepted with the anticipation of a most pleasant and interesting experience.

Not recommended, however, is a trip down from the summit to Charlotte in the Crosley driven by Chuck Erexson, the photographer who took these pictures. At speeds upward of 60 miles an hour, it can be compared to diving a Piper Cub from an altitude of 20,000 feet!

#### Transmitter Installation:

The addition of a 50-kw. stage to the original 10-kw. FM transmitter created two new problems. The diesel engines had been adequate previously, because it was not necessary to step up the 220-volt, 3-phase generators to their full rated power of 75 kva. When that was attempted, it was found impossible



FIG. 4. OPERATOR-ANNOUNCER LINDY SEAMON AT THE STUDIO CONSOLE FACING THE TRANSMITTER ROOM. FIG. 5. ANTENNAS FOR THE ORDER CIRCUIT AND THE S-T LINK. FIG. 6. ENGINEER-OPERATOR RALPH THOMPSON AT THE RACKS WHICH CARRY THE AUDIO EQUIPMENT, RELAY FM RELAY RECEIVER AND THE S-T LINK RECEIVER AND DUAL PRESTO TAPE RECORDERS



because of the high altitude of the installation. While a super-charger might remedy that situation, it was decided to run power lines up the mountain. These will probably be connected by the time this article appears in print.

Also, when the transmitter output was stepped up, trouble developed in the new 8-bay antenna, particularly as a result of rain and sleet.

M. H. Sabeff, who is General Electric's antenna expert, corrected this by replacing the flat plates on the doughnuts with short stubs, and by installing heating elements in the doughnuts.<sup>2</sup> It appears that the WMIT antenna is now the last word as to its ability to handle high power under extreme weather conditions.

The transmitter and studio installation follow con-

<sup>2</sup>Details and photographs of this antenna design will be presented in a forthcoming issue of RADIO COMMUNICATION.



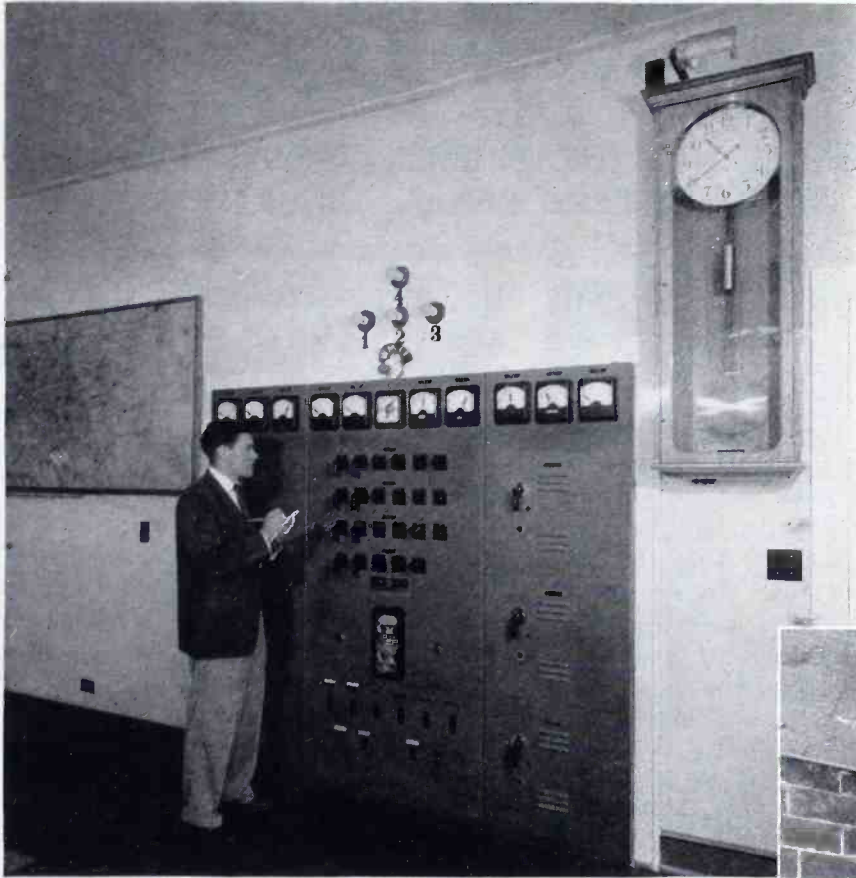
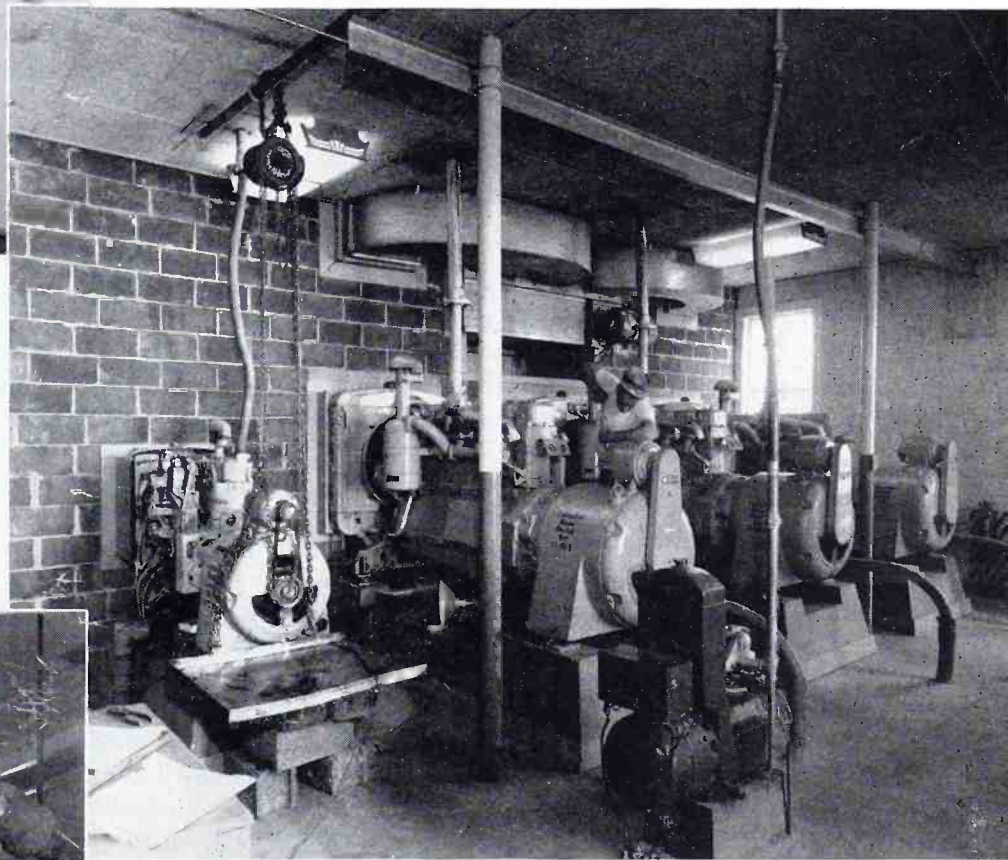
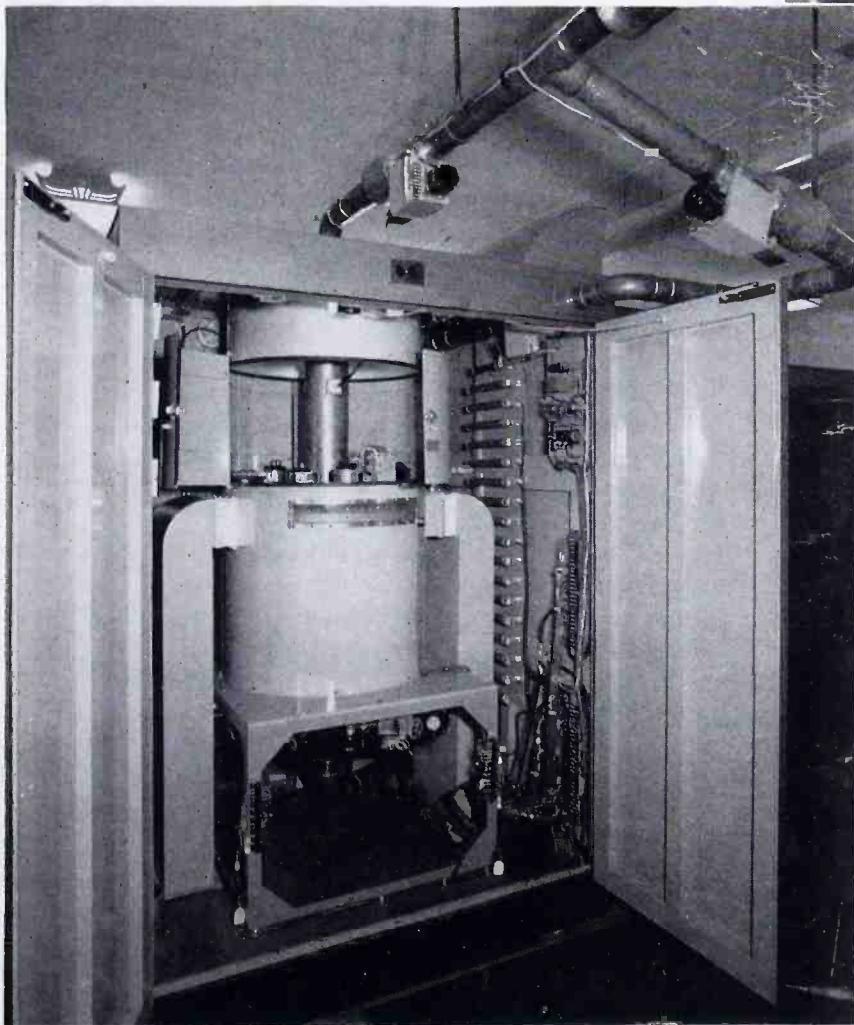

FIG. 7. THE CONTROL PANEL FOR THE ENGINE-DRIVEN GENERATORS IS IN THE TRANSMITTER ROOM. PAUL FLETCHER IS CHECKING THE METERS

FIG. 8. ALL POWER FOR THE TRANSMITTING STATION IS SUPPLIED BY THESE GENERATORS, DRIVEN FROM DIESEL ENGINES. LATER, POWER LINES WILL BE RUN UP THE MOUNTAIN, BECAUSE THE ENGINES DO NOT DELIVER THEIR FULL RATIO OUTPUT AT MOUNTAIN-TOP ALTITUDE

FIG. 9. THIS IS THE 50-KW. OUTPUT STAGE THAT WAS ADDED TO THE ORIGINAL FM TRANSMITTER BEFORE WMIT WENT BACK ON THE AIR



ventional practice, as indicated by the accompanying illustrations. For emergency use, a 1-kw. REL transmitter is connected to the original 4-bay antenna.

Contrary to some engineering opinion, the REL S-T link from Charlotte to the station has proved highly dependable. It works over a 90-mile hop on 94.3 mc., with 15 watts output from the transmitter. Fig. 5 shows the receiving antenna. This equipment, incidentally, has been in use since 1942.

Standard mobile radio units, operating on 26 mc., are used as an order circuit between Charlotte and the station. The present antenna, Fig. 5, will be changed to a Yagi in order to increase the gain.

According to the operators, everyone wants to know: "How is FM reception on Clingman's Peak?" Well, that is probably the No. 1 spot for people who like to fish for distant FM stations. Using a standard Zenith receiver and an indoor antenna, it is possible

to get a station at practically every channel on the dial. Surprisingly, there seemed to be neither co-channel nor adjacent-channel interference.

And there, perhaps, is the answer to people who complain that they can't get satisfactory FM reception: first, a sensitive receiver, and then enough antenna height to pick up reasonably strong signals. Considering the steady interference-free night-and-day service provided by FM stations, as more and more good FM sets are installed with adequate outdoor antennas, there will be less and less need for short-range AM broadcasting.

The new WMIT installation will be watched closely by FM and AM operators to see whether or not such a project can succeed financially. Certainly, it has many factors in its favor: it is ideally located for an FM station, it has wise programming and enthusiastic management personnel, and last but far from least, it is FM-only.

If it does meet with success, it may very well provide incentive to others who have been contemplating going into FM but have been disheartened by unfounded stories of FM's pending demise.

# AFTER THE TV THAW: A LOG JAM

UNLESS APPLICANTS ACCEPT AVAILABLE UHF CHANNELS, OPENING OF NEW STATIONS WILL BE DELAYED LONG AFTER FREEZE ENDS — *By* ROY ALLISON

SOMETIMES the effect follows the cause by such a long period of time that the reason for doing something no longer exists when people finally get into action. It was that way with audio broadcasting after the last war. Many businessmen discovered during the war that broadcasting stations earned profits all out of proportion to the capital investment necessary or the effort required to operate them, and decided forthwith to own stations as soon as the FCC was ready to accept new license applications.

What they didn't know was 1) that others in the same or adjacent areas were planning to do the same thing, 2) the AM band was already crowded to the point where service areas would be reduced progressively as new stations were licensed, and 3) the easy profits were due to the fact that Government paper restrictions had virtually eliminated magazines and newspapers from competition for advertisers' wartime advertising budgets.

The same thing may happen in television. Risk capital may shy away from wildcat oil wells and gold mines, but there seems to be plenty of money itching to finance television stations. Some of the new projects are being planned by organizations which include experienced management, engineering, and production executives, but all too many are inspired by fear of competition, or fostered by the blithe assumption that television is so hot that a VHF license is better than money in the bank.

## The Incautious Approach:

A typical example of the TV wildcatter was the man who called on us recently. He said: "I have a piece of land on the highest point in my section of the country. I've been in touch with a firm of engineering consultants (he mentioned one of the best) and they want \$12,000 to erect test equipment on my hilltop, and to make a television coverage survey. Now do you think that's necessary?"

Instead of answering that question, we asked: "Have you surveyed the cost of erecting, operating, programming, and maintaining TV station? And have you made a study of potential advertising revenue, and sales expense?"

He said: "No. You see there's a 250-watt AM station in my town, and the owner is trying to get permission to put a transmitter on another hill almost as high as my spot, but it's in a state park.

Besides, he's going to try to get a VHF channel, although the FCC has provided only one UHF channel in my area. Do you think he'll be able to get it? My consultant said that seven other towns are trying to get that VHF channel."

But he didn't want to think in terms of expense and income. He was only concerned over the fact that the FCC had provided only one channel for his town, and that he had a chance to get it. We insisted: "Perhaps, if you make a study that will show you how much profit you can realize from operating a television station in your area, you'll decide to let the other fellow lose his shirt. No doubt you need a coverage survey, and \$12,000 is probably a reasonable fee, but if you have the money to spend for that purpose, surely you should be willing to spend a fourth as much on a survey that will show you whether or not you can make money if you go into television. As for the VHF channel, how do you know that the UHF channel proposed won't give better service to the people in your area?"

## Preference for VHF Channels:

The FCC's television allocations plan<sup>1</sup> provided for only 170 more stations to be operated on the 12 VHF channels in cities of 50,000 or more population. Yet nearly a thousand requests have been filed with the FCC by those who want the plan modified so that they can get VHF assignments.

What's behind this clamor for VHF channels? Is it based on sound engineering information, or is it a matter of wanting to get something because everyone else seems to want it too?

We aren't going to discuss the theoretical considerations of VHF and UHF propagation, because there is no adequate background of operating experience from which to draw conclusions. But there is ample evidence available in the radio communication field to indicate that the lower frequencies have some drawbacks and that the higher frequencies have some advantages that should not be overlooked by TV applicants.

In 1945, the opinion was held generally by communication engineers that frequencies above 40 mc. were of no value for mobile services. Nevertheless,

Motorola built 118-mc. equipment which was installed for the police department at Miami, Fla. Lieut. Denby's report of the system and its remarkably fine performance was published in the May, 1945 issue of this magazine, but the experts were still dubious.

Later, when the FCC allocated 152 to 162 mc. to the mobile services, they said: "What good is that? The only way to meet congestion on 30 to 40 mc. is to extend the band at 40 mc. We can't get any useful coverage at 150 mc."

By the end of 1950, the mobile services were not only using the upper band, but several thousand new systems had crowded into it to the point where interference had become serious.

Meanwhile Bell Telephone Laboratories made an investigation of the 450 to 460-mc. band. Of course, everyone knew that that band was worthless for mobile communication. Its value for point-to-point communication, using high-gain, directional antennas, had been demonstrated conclusively but mobile radio, like broadcasting, requires omnidirectional transmission. That means using low-gain antennas and coverage so limited as to be ineffectual. At least, that was the opinion of the experts.

When the facts about operation on 450 to 460-mc. were determined by actual engineering tests, however, the performance was found to be so highly satisfactory that Bell Laboratories petitioned the FCC to assign the band from 470 to 500 mc. to common carrier mobile telephone service! Apparently, the FCC figured that if those frequencies were suitable for mobile radio, they would certainly do for television and, last July 11, the Commission announced its decision to give that band to TV.<sup>2</sup>

## Less Interference on UHF:

The communication engineers who scorned the use of frequencies above 40 mc. were thinking in terms of maximum transmitting range as providing the most dependable service. They were right—as long as the number of co-channel stations was small. Long-distance transmission, however, developed into co-channel interference as soon as a substantial number of stations came on the air at the same frequency, and

*(Continued on page 36)*

<sup>1</sup>This allocation plan was analyzed in detail in the April, 1951 issue of RADIO COMMUNICATION. Copies are still available.

<sup>2</sup>Complete text of this decision was published in "News from the FCC," RADIO COMMUNICATION, July, 1951.

# BASIC ELECTRICAL STANDARDS

HOW THE NATIONAL BUREAU OF STANDARDS DETERMINES AND MAINTAINS ACCURATE PRIMARY ELECTRICAL QUANTITIES — By FRANCIS B. SILSBEE\*

**P**RECISE electrical measurements are of fundamental importance to modern science and industry. This is true not only in the communication and power fields, but in many others. The flexibility and convenience of electrical methods have made them almost indispensable for the measurement of many non-electrical quantities. Thus, while in textbooks energy is often defined simply in terms of force and length or of mass and velocity, in actual practice the heat energy of fuels and the energy output of prime movers are measured with high precision by electrical methods. Likewise, the basic electrical units are used for the determination of nearly all the fundamental atomic constants, as well as for the daily measurements of heat, light, color, strain, acceleration, displacement, and chemical properties.

## Need for Precise Standards:

Some two billion dollars' worth of electrical machinery and apparatus is manufactured annually in this country. Were each manufacturing company to use an even slightly different value for the volt or the ohm, the apparatus made by its subcontractors would fail to function properly as parts of the final product. The result would be an impossibly confused situation, causing large financial losses. In the communications industry,

the multiplex transmission of intelligence over a relatively small number of circuits is dependent on the precise adjustment of capacitance, inductance, and other circuit components in such a way as to prevent the signals from straying into the wrong channels. This, again, requires precise uniformity in the measurement of the basic electrical units.

As the custodian of the national standards of physical measurements, the National Bureau of Standards has the responsibility of insuring that the units of measurement used in science and industry are constant through the years and uniform throughout the Nation. The Bureau has developed very precise standards of resistance and voltage, whose values are established by absolute measurements that fix the relations between electrical units and the fundamental mechanical units of length, mass, and time.<sup>1</sup> From these basic absolute electrical standards, the Bureau has derived other standards for all electrical quantities in use today.

<sup>1</sup>National Bureau of Standards Circular 475, *Establishment and Maintenance of the Electrical Units*, by F. B. Silsbee, available from the U. S. Government Printing Office at 25 cents a copy.

**FIG. 1, RIGHT: THIS SELF-INDUCTOR, WHOSE SELF-INDUCTANCE HAS BEEN CALCULATED ACCURATELY, MAKES POSSIBLE THE DETERMINATION OF THE OHM IN ABSOLUTE MEASURE TO AN ACCURACY OF A FEW PARTS IN ONE MILLION**

**FIG. 3, BELOW: COILS OF THE CURRENT BALANCE USED TO "WEIGH" CURRENT FOR THE ABSOLUTE DETERMINATION OF THE AMPERE**

Because of their technical difficulty, precise absolute measurements are carried out only in the national standardizing laboratories of a few of the larger countries. Sufficient accuracy in science and industry is obtained through accurate comparison of the secondary or working standards of other laboratories with these primary standards.

Each year a stream of about 2,000 high-grade electrical instruments, standard cells, and other measuring apparatus flows through the Bureau's electrical laboratories. Among the devices submitted are potentiometers, bridges, resistance boxes, volt boxes, capacitors, inductors, multimegohm resistors, instruments and meters of all kinds, precision shunts for large currents, instrument transformers, standard magnetic test bars, magnetic test coils, and standard cells of both the saturated and unsaturated types. They come from manufacturers of electrical equipment, from public utility companies wishing to assure that their fees are correct, from public service commissions which regulate the utility companies, and from communications laboratories, university laboratories, private commercial

\*Chief, Electricity Division, National Bureau of Standards, U. S. Department of Commerce, Washington 25, D. C.

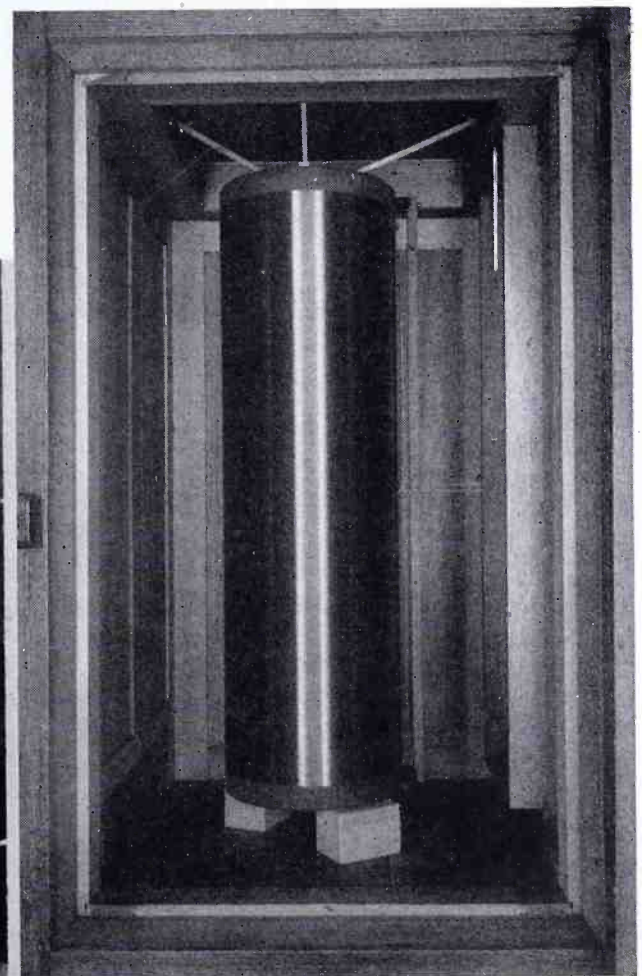
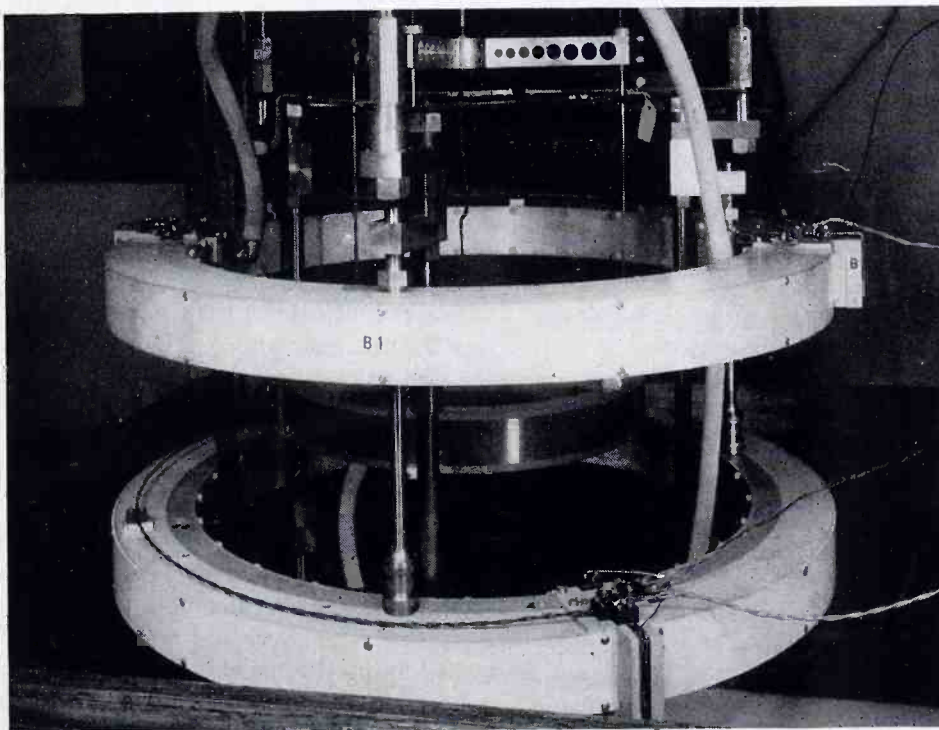

testing laboratories, and the many scientific laboratories of the Federal Government.

The demands of modern science and technology have made this work more and more exacting, not only as regards accuracy, but also in the range of values and variety of units in which measurements are made. Thus, the Bureau now measures precisely currents, voltages, and resistances having values up to tens of thousands of amperes, hundreds of thousands of volts, and millions of billions of ohms. This is done with DC, with AC of various frequencies up into the thousands of mc., and with surges of current lasting only a few microseconds.

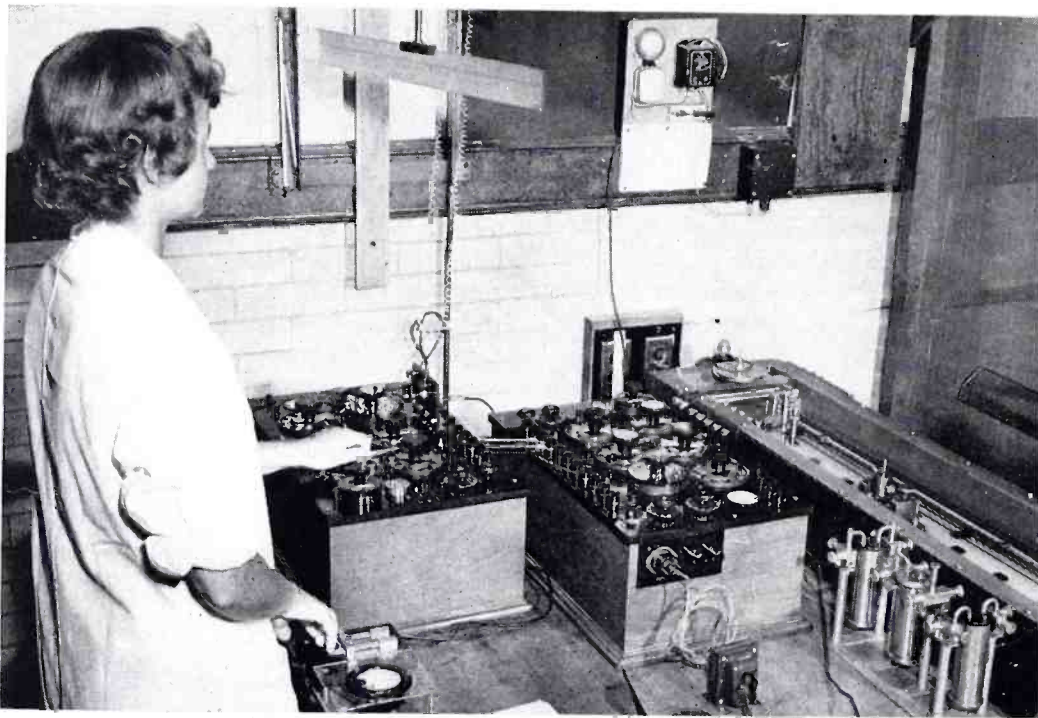

FIG. 2. SETUP USED FOR CALIBRATING A MUELLER BRIDGE TO A FEW PARTS IN A MILLION

### Establishment of Units:

The basis of the Bureau's standardization of electrical measurements is the establishment of values for the ohm and the ampere that bear the desired simple theoretical relation to the meter, the kilogram, and the second. However, since an electric current is by nature evanescent, the volt is derived from the absolute ampere at the time the latter is measured. This is embodied in the calibration of a group of standard cells which, together with the standard resistors for the ohm, are kept as permanent primary standards.

Determination of the ohm is carried out in two steps. The first is the construction of an inductor, either self or mutual, which is so designed that its essential dimensions can be measured mechanically with high accuracy and which is of such a shape that the inductance can be calculated from these measured dimensions. Such an inductor, 1 meter long and 35 cm. in diameter, can be seen in Fig. 1. Both self and mutual induc-

tors have been prepared at the Bureau by winding wire in lapped helical grooves on forms of glass, quartz, or porcelain.

The construction of the inductor illustrated in Fig. 1 was executed with such precision that its inductance could be calculated with sufficient accuracy to determine the ohm in absolute measure to a few parts in 1 million. The 1,000 turns of the coil are wound in a lapped, helical groove on a Pyrex form. The diameter and pitch of the coil were measured to 1 part in 1 million. Its inductance is 103 millihenries.

The second part of the process consists of an electrical experiment in which a bridge or equivalent circuit is used to

compare the reactance of the inductor at a known frequency with the resistance to be measured. When the resistance in absolute ohms of the resistors used in the bridge circuit has been determined in this way, the absolute resistance of other standard resistors can be found by comparison.

Fig. 2 shows a setup at the Bureau for calibrating a Mueller bridge. If the instrument is recalibrated frequently, it can measure resistance to a few parts in 1 million. A second bridge, at the left, is used to adjust the external resistance connected to the one under test.

A current is measured in absolute amperes by determining the mechanical force between two parts of the circuit in which it flows. In the center of two large fixed coils, Fig. 3, a small coil is hung from the arm of a precision balance. All three coils carry the current to be measured, but the current in the fixed coils can be reversed. The small electromagnetic force developed by the current in the coils tends to pull the movable coil downward for one direction of the

current in the fixed coils, and tends to lift it when this current is reversed. From the change in the force on the balance when the current is reversed, and from the measured dimensions of the coils, the value of the current in absolute amperes can be computed.

A variation of this experiment makes use of the standard current while it is being measured, or weighed to measure directly the EMF of a standard cell in absolute volts. This is done by arranging the standard cell so that its electromotive force is exactly balanced by the drop of potential produced in a known resistance by the standard current. The EMF of the cell is then computed by Ohm's law.

A group of 25 standard cells and another group of 10 carefully-constructed one-ohm standard resistors serve to preserve the values of the volt and of the ohm from day to day and from month to month. The various members of each group of standards are intercompared at intervals of a few months; as long as their relative values are constant, it is assumed that the absolute mean value of the group has also remained constant. If an individual standard is found to have drifted relative to the others in its group by a significant amount since the previous intercomparison, it is rejected and replaced by another standard which has a good record of performance. The process of comparing a resistor with the standard mutual inductor is so convenient that it is frequently used as an independent check on the constancy of the group of standard resistors. However, the mechanical measurement of the dimensions of the inductors and of the current balance is so very tedious and time-consuming that it is done only once a decade.

From the standard ohm and the volt thus maintained at the Bureau, the other electrical and magnetic units are derived by a variety of experimental procedures. The farad is precisely obtained by charging and discharging an air capacitor at a known rate in a Maxwell commutator bridge. The henry is determined by comparison with capacitors and resistors in a Maxwell-Wien bridge. The ampere is re-established, when desired, by measuring with a potentiometer the drop it produces in a known resistance. The ampere and the volt are combined to obtain the watt, and the joule and kilowatt-hour are derived by maintaining a known number of watts in a circuit for a measured length of time. The gilbert and the oersted are computed from the number of ampere-turns used in magnetizing a magnetic test specimen in a permeameter of known geometry. The gauss and maxwell are obtained from the deflections of a ballistic galvanometer which, in turn, is calibrated by reversing a measured current in a

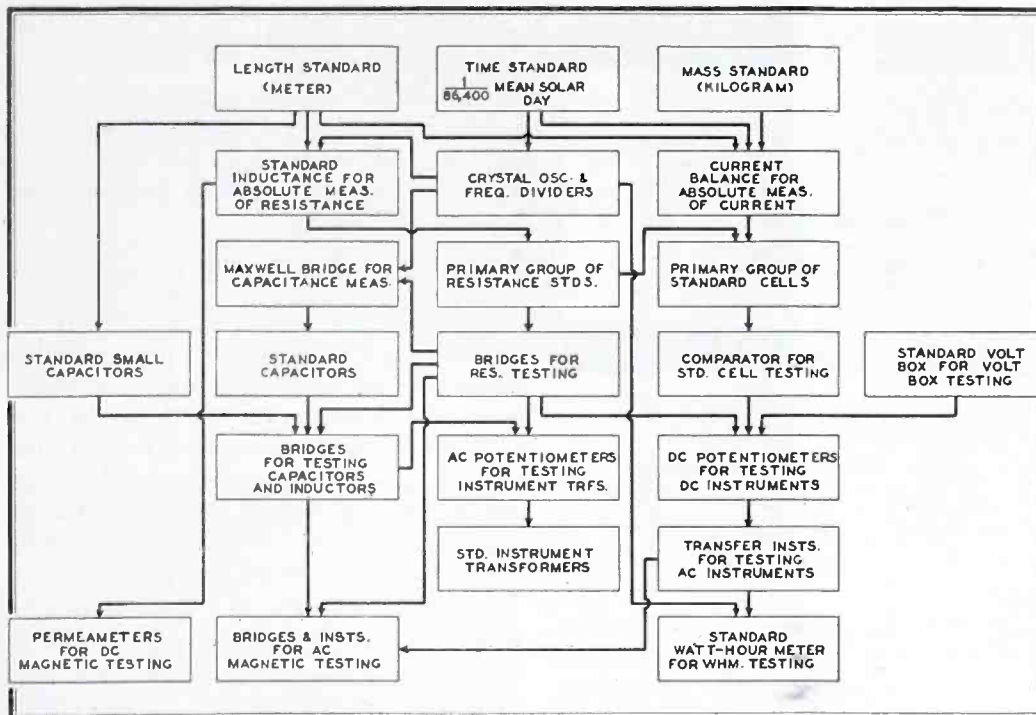

FIG. 4. VALUES FOR ELECTRICAL UNITS ARE DERIVED FROM STANDARDS OF LENGTH, TIME, MASS

known mutual inductor. Fig. 4 shows the steps employed in deriving values for all standard electrical quantities.

#### Extension of Ranges:

Extensions of the scale of measurement for any of the electrical quantities to other ranges is based, in large part, upon the establishment of a ten-to-one ratio in a highly accurate bridge. By successive application of this ratio, resistances as low as 0.00001 ohm or as high as ten million ohms can be measured accurately. Still higher resistances, up to  $10^{18}$  ohms, are measured by more complex methods, such as determination of the rate of charge accumulation in a known capacitor. Inductance and capacitance measurements are extended over wide ranges by means of ratio arms. However, determination of standard capacitances below 1 micromicrofarad is based upon an independent set of measurements, involving the construction of air capacitors of such shapes that their capacitance can be computed precisely from their dimensions. Such a capacitor is shown in section in Fig. 5.

This exploded view shows the "guard-well" type of capacitor designed at the Bureau to provide primary standards of extremely small capacitance from .1 down to .001 mmf.

Direct currents as high as 10,000 amperes are measured with a potentiometer and standard resistors of low value, so constructed that their resistances are not affected by the very considerable heat developed by large currents. Direct voltages up to 1,500 volts are measured by means of potential dividers, or volt boxes. The ratios of the dividers are derived by connecting in series groups of resistors whose relative individual values have been found by substitution methods.

Specially-constructed resistors, shielded to avoid corona discharge, are used in X-ray equipment testing to measure DC potentials as high as 1,400,000 volts. In the upper part of this range additional shields, maintained at appropriate intermediate potentials, are required.

The great bulk of electrical energy generated and utilized throughout the country is distributed as AC. The step from the DC standard cell to AC meas-

the loss in a capacitor which had been tested in a Schering bridge; such measurements have established the accuracy of the two electrodynamic instruments at frequencies up to 3,000 cycles. Directly or indirectly, the accuracy of practically all the AC instruments used depends on these two standard instruments. For tests of ammeters and voltmeters at 400 cycles and above, transfer circuits employing thermocouples are also used.

In commercial practice, the range of AC current is extended upward from 5 amperes by means of calibrated current transformers. Thus, an important part of the Bureau's service consists in the calibration of standard current transformers which, in turn, are used by manufacturers and electric utility companies to calibrate their working transformers. Special 4-terminal standard resistors, constructed so as to have negligible skin effect and a known computable inductance, hence a known phase angle, are used to measure the ratio and phase angle of transformers up to 2,500 amperes in a specialized form of AC potentiometer. Beyond this limit, up to 12,000 amperes, the unknown transformer is compared with a multirange standard transformer, which is calibrated on its lower ranges by the use of standard resistors and is then used as a standard on its higher ranges. Careful study of this standard transformer has given assurance

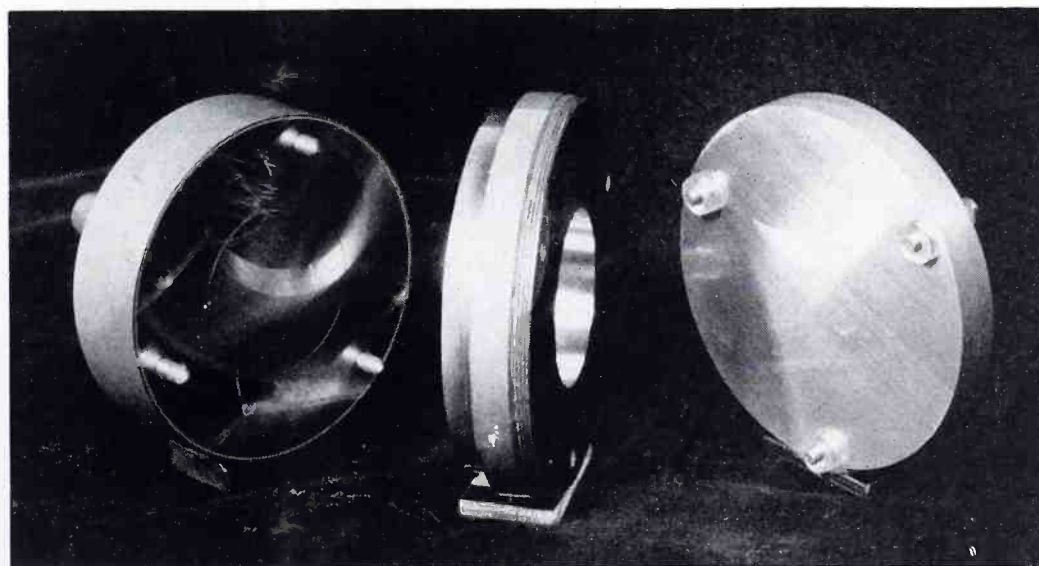

FIG. 5. "GUARD-WELL" TYPE OF CAPACITOR FOR PRIMARY STANDARDS FROM .1 DOWN TO .001-MMF.

urements of voltage, current, and power is therefore of fundamental importance. For 60-cycle work, the transfer is carried out by means of two specially-constructed astatic electrodynamic instruments, a wattmeter and a voltmeter. In these instruments the moving coils are supported by taut strip suspensions, and the position of the moving coils is indicated by a spot of light on a scale at a distance which gives an indication equivalent to that of a pointer 13 ft. long. The wattmeter has been carefully compared with both a quadrant electrometer and with

that its various ranges bear simple integral ratios to one another.

Similarly, the extension of the AC voltage scale above 150 volts is, in practice, based upon the use of voltage transformers. A shielded resistor, capable of operating at 30,000 volts, is used to measure the effective ratio and phase angle of voltage transformers up to this limit, and also to check the performance of standard multirange transformers when they are connected for 25,000 volts. These multirange transformers can then be con-

(Concluded on page 29)

# JEREMIAH COURTNEY'S MOBILE RADIO



## NEWS AND FORECASTS

IN a recent decision, the effects of which will not be fully realized for years, the Federal Communications Commission has held that the television broadcast service should be allocated the use of the 470 to 500-mc. band rather than the common carrier mobile and point-to-point services.<sup>1</sup>

The conflicting requests of these two industries for what the FCC correctly termed the "precious spectrum space involved" admittedly posed a most difficult problem for immediate solution. Probably no one is gifted with sufficient prescience to say with finality at this point whether the decision was right or wrong. However, the decision can certainly be chalked up as another and fulsome testimonial to the glamour of the TV medium that makes it difficult even to compare other services.

For, after finding that "the needs of each of the two services are compelling," the entire band in question — not half or two-thirds but the whole band — was assigned to TV, already enjoying great swatches of the spectrum (54 to 72, 76 to 88, 174 to 216, and 500 to 890 mc.). This all-out decision was reached, as Commissioner Walker mentioned in his dissent, despite prior findings by the full Commission that there was a genuine public demand and need for common carrier mobile radio service not accommodated by its prior allocations.

### Common Carrier Alternatives:

However, the majority felt that the needed space for common carrier expansion of service could be obtained in other ways than by the allocation of the 470 to 500-mc. band. Three alternatives were enumerated:

"1. Requiring smaller separations between frequency assignments in the bands below 162 mc., *i.e.*, 40 kc., 30 kc., or even 20 kc. frequency separation.

"2. Development and use of more efficient techniques of operation such as single side-band transmission, multiplex, etc.

"3. Utilization of geographic frequency sharing so as to obtain utilization of frequencies assigned to non-common carrier

services in critical population centers where such non-common carrier frequencies are not required for local use."

Considering alternatives 1 and 2 against the relative width of the common carrier and TV assignments (60 kc. against 6,000 kc.), it would seem that the possibilities for frequency saving through improved equipments and techniques should not be confined to the common carrier service. As a matter of fact, however, the 6-mc. TV channels are now protected even against mobile use outside the assigned TV channels, a practice which has rendered the valuable 72 to 76-mc. band of little use where it is most needed — in large population areas. Insofar as alternative No. 3 is concerned, it would appear to be based on the assumption that some of the relatively few mobile assignments will not be used in these critical population centers. Although the years to come may entirely prove out the soundness of the Commission's allocation in this instance, it is doubtful that any less appealing medium would have gained an equal victory at this point. Also, the Commission assumed, in its decision, that more than 2,000 TV stations will be able to achieve the self-supporting status necessary to continued operation if, indeed, that number is ever erected. At this point, such a circumstance seems improbable, although events may prove us wrong.

### Marine Rules Largely Finalized:

Except for the hearing of oral argument on certain of the more controversial of the proposed rules, the new Part 7 and Part 8 marine Rules (Stations on Land in the Maritime Services; Stations on Shipboard in the Maritime Services) were finally adopted by the Commission, effective July 23. One of the principal points of difference between marine Rules adopted and other mobile Rules is requirement of the former for type-acceptance of all equipments prior to application grant. Either manufacturer or station applicant may make request for type-acceptance of transmitter equipment. In other mobile services, general practice is for manufacturer to file specifications on equipment which relieves the applicant from supplying this technical data. Presumably, the responsibility for

obtaining type-acceptance of equipment will be undertaken by the manufacturers in most instances. Procedure may delay initial grants, however, for new facilities as well as reclassification of experimentally licensed facilities into regular services established.

### Rules Designated For Argument:

Most important and probably most controversial of the proposed Rules designated for oral argument was requirement for multi-channel equipment use in 152 to 162-mc. band. Proposed Rule would require all ship stations using telephony on 156.25 to 157.45 mc. to be capable of transmitting and receiving on 156.3, 156.8 and one additional frequency in this band. Ship stations licensed to use single-channel equipment prior to January 1, 1951 would be exempt from this requirement until January 1, 1953 under proposed Rule.

Also designated for oral argument were Rules prohibiting communications between land stations and land mobile units regardless of purposes served by land mobile communications; form of showing to be made for special temporary authorization; disposition to be made of station licenses when operations permanently discontinued; form of log to be kept by ship stations using telephony; whether a designated time limitation should be placed on any one exchange of public correspondence between a public ship station and a public coast station; method of station identification to be required of ship station using telephony or marine-utility station located aboard ship; and several other proposed requirements.

### Low Power Rule Amendments:

The Commission on its own motion has proposed an amendment to its low-power radio service Rules which should greatly encourage the use of small, light-weight varieties of transmitter-receiver units, through increase of permissible distance between transmitter and antenna. The service has been most widely used by materials handling companies within building or plant areas and by contractors at construction sites. The eligibility rules for the low-power radio service, however, are the most broadly drawn of any service. Any person or firm "engaged in a commercial activity or an industrial enterprise" can get a low-power license. Furthermore, the authorized radio system may be used not only for portable communication purposes and on mobile units but at fixed locations as well. This last feature is not generally understood because all authorizations, as a matter of most encompassing terminology, are issued in the mobile category.

(Continued on page 30)

\*908 20th Street, N. W., Washington 6, D. C.  
<sup>1</sup>Text of this decision was published in RADIO COMMUNICATION for July, 1951.

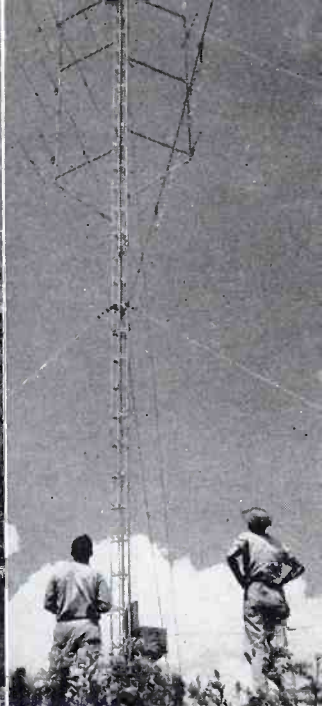
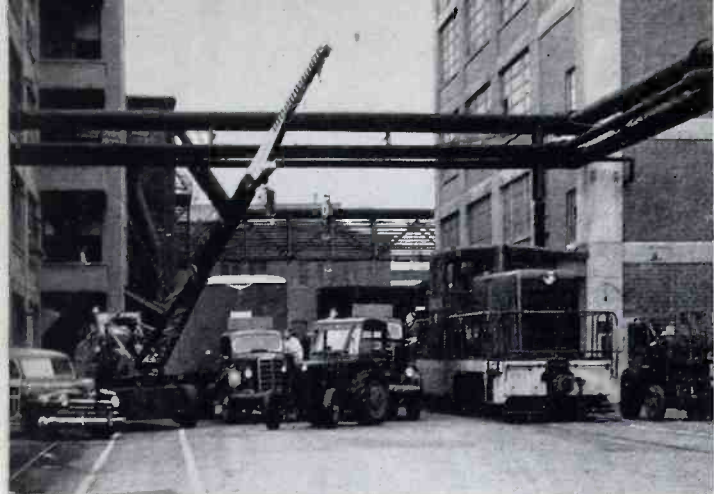

**LEFT ABOVE:** Eastman Kodak has equipped 24 material-handling vehicles with Motorola 2-way radio units. They include cranes, fork-lift trucks, and locomotives operating over the 434-acre Rochester plant. The system is coordinated with Civil Defense for plant protection purposes.

**ABOVE:** At Hazard, Ky., three antennas 1,000 ft. above the town pick up WSAZ-TV, WLW-TV, and WCPO-TV. Using amplifiers at the tower and along the 3,000-ft. Gonset-wire lead down the valley, signals are carried to a cable run on the power company's poles. Charges are \$150 to \$175, plus \$4 to \$6 for monthly service.

**LEFT:** The largest commercial radar antenna ever built has been delivered by Raytheon for installation at the Port of le Havre, France. Measuring 40 ft. wide, it is designed to withstand winds up to 100 mph. During tests made at Boston Harbor, pictures on the scope were so sharp that small craft, bouys, and channel markers were visible.

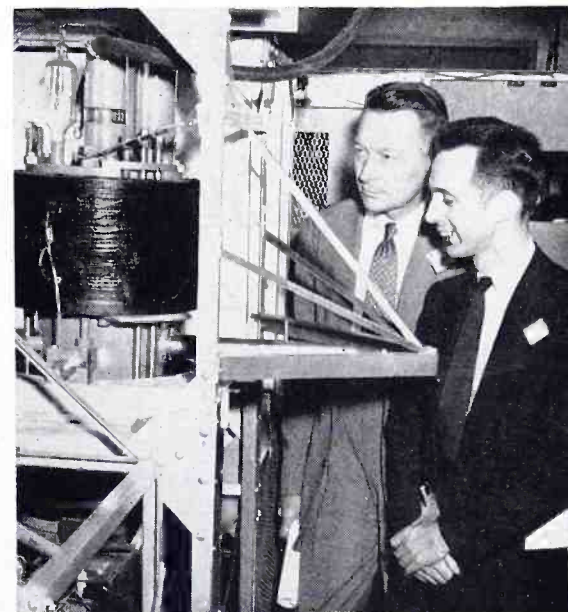
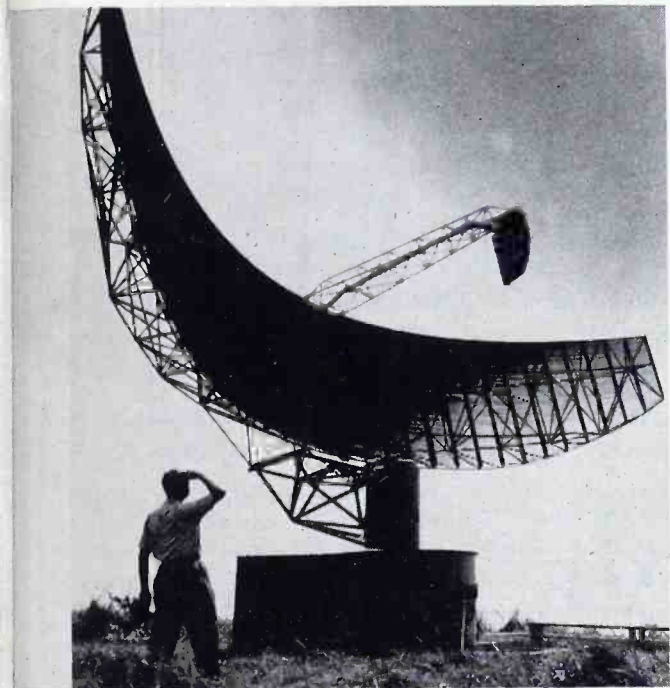

**ABOVE:** Curtis B. Plummer, Chief of the FCC Broadcast Bureau, right, and Edward W. Allen, Chief Engineer of the FCC, recently visited GE's Electronics Park to inspect a super-power UHF television transmitter now being operated experimentally at Syracuse.

**ABOVE:** For the second year, the University of Kentucky FM station WBKY is carrying a series of 30-minute documentary programs which present various activities within the state. Using a Magnecord tape machine, interviews are recorded with authentic background sounds of the activities involved, such as those at a railroad roundhouse or a lumber camp.

**BELOW:** On his WPTZ program "The Nature of Things," Dr. Roy K. Marshall, right, discussed the tiny camera used in RCA industrial TV. First, however, he went to Camden for a briefing on the equipment and the Vidicom tube by M. S. Klinedinst of RCA.

**LEFT ABOVE:** Among those attending the demonstration of UHF television reception at NBC's Bridgeport station were G. E. Gustafson, Zenith vice-president in charge of engineering, left, and H. C. Bonfig, vice-president and director of sales. The UHF tuning units shown were described in detail in the May, 1951 issue.

**LEFT:** This is RCA's new FM-AM receiver, with an 8-in. speaker. No reports have been received on its performance up to this time, but RCA emphasizes increased sensitivity on FM due to the use of a 3-gang condenser to provide tuned RF, and the thorough shielding of the tuner. Also featured is the reduction of radiation to what is described as a negligible minimum. Suggested retail price: \$79.50.

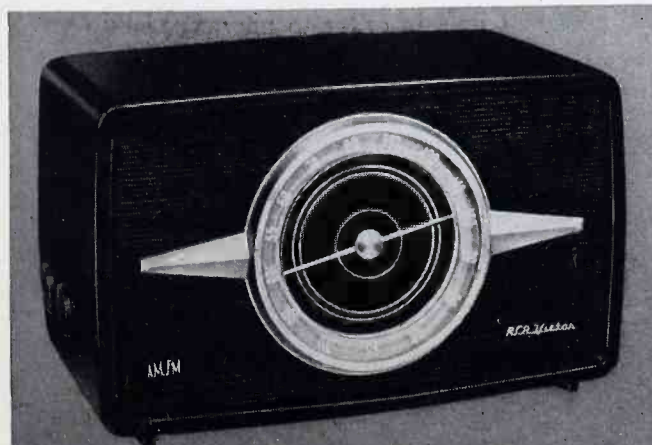

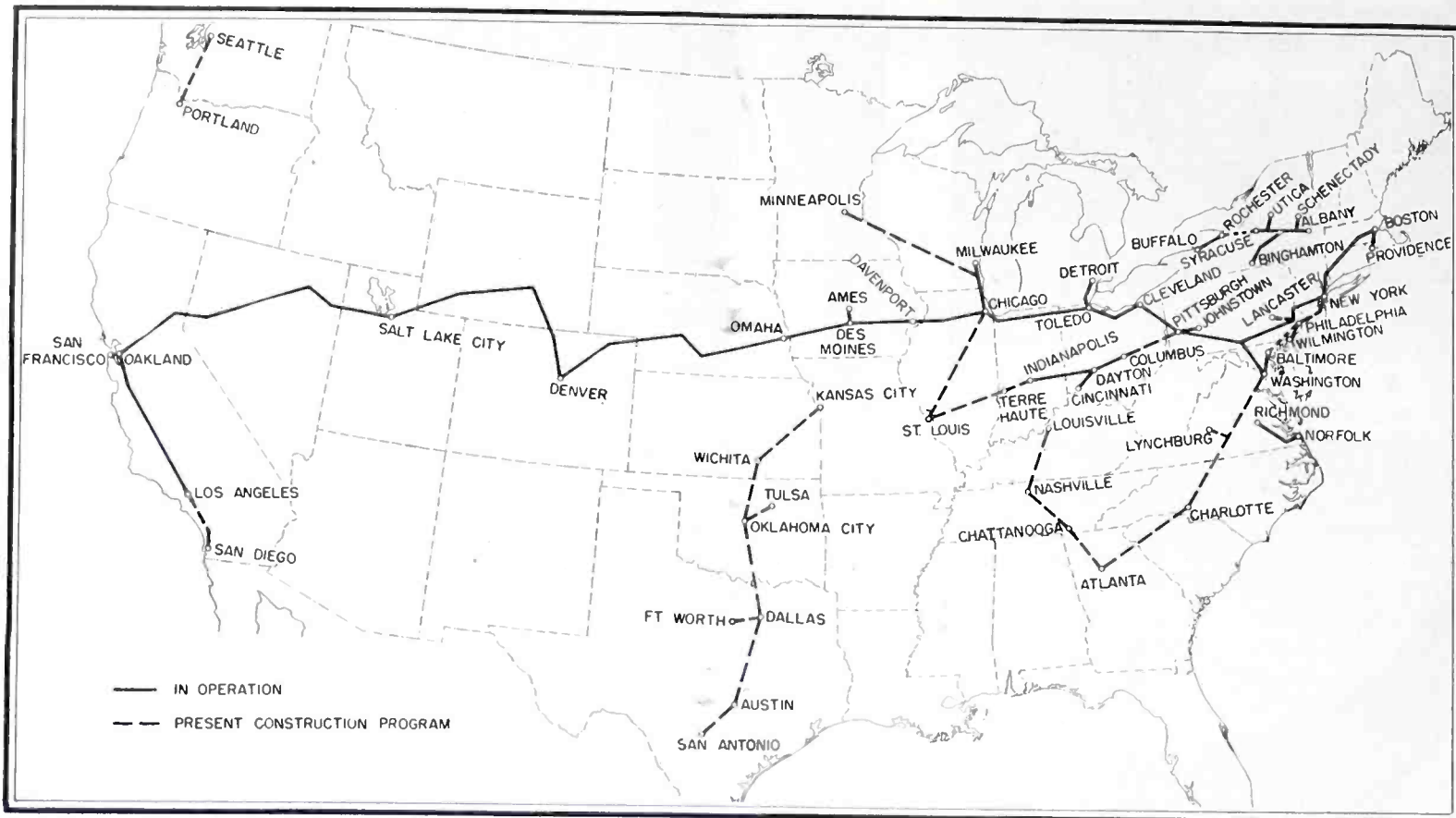

FIG. 1. ROUTE OF THE NEWLY-COMPLETED CROSS-COUNTRY MICROWAVE RELAY SYSTEM, WITH BRANCHES EXISTING AND UNDER CONSTRUCTION

## 3,000 MILE MICROWAVE RELAY

THE BELL SYSTEM'S TRANSCONTINENTAL FM RELAY NETWORK, COMPOSED OF 107 STATIONS OPERATING AT 4,000 MC., BEGAN SERVICE AUGUST 17th

THE Bell System's coast-to-coast radio relay system was opened officially on August 17 with a ceremony at the New York headquarters. Built at a cost of over \$40 million, the network has been under construction for three years. Its route takes it through many major cities between New York and San Francisco. Fig. 1 is a map of the complete system showing connections to other branches, some of which have been completed, while others are in the planning stage or under construction.

The cross-country network is made up of 107 stations spanning 2,992 miles. Operating frequencies are in the SHF band, from 3,700 to 4,200 mc. Eventually, 6 channels in each direction will be available, each capable of carrying a television program or several hundred telephone conversations.

Repeater stations are spaced from 19 to 50 miles apart, depending on terrain, with an average separation of slightly more than 28 miles. Each station provides signal amplification of over one million, yet has an actual power emission of less than 1 watt to the antenna for each channel.

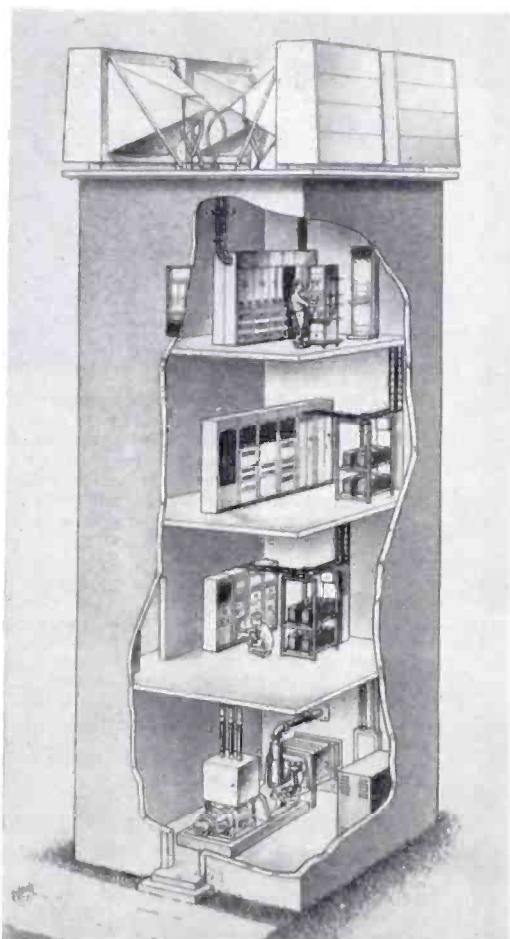

FIG. 2. TYPICAL PLAN OF A CONCRETE TOWER

### Relay Towers:

Various types of towers are used, according to the requirements of location, topography, weather, and height required. Structures of both steel and concrete are employed, varying in height from 2½ to 415 ft. When a concrete tower is used, as shown in Figs. 2 and 7, it houses the associated equipment. On the ground floor, Fig. 2, an emergency gasoline-driven generator is installed. Second and third floors are filled with batteries and power apparatus. Amplifying, control, and test equipment are located on the top floor.

Most towers are normally unattended. However, an alarm system is provided for signalling to a control point in case of faulty operation.

Towers are situated in a weaving pattern along the route, rather than in a straight line, in order to prevent pickup from stations other than the preceding one. To this end, also, two relay frequencies separated by 40 mc. are provided, and are employed alternately by succeeding transmitters. Thus, interference from skip transmissions is virtually eliminated.





FIG. 3. TOWER AT CRESTON, WYOMING. NOTE DIFFERENT ANTENNA LEVELS. FIG. 4. A RELAY STATION IN THE SIERRA-NEVADA MOUNTAINS

Some of the more interesting tower installations are shown on these pages. Fig. 3 is a view of the station at Creston, Wyoming, where best results were obtained by placing the antennas facing west at a different level than those facing east. At Cisco-Butte, California, the relay station is located high in the Sierra-Nevada Mountains. This installation can be seen in Fig. 4.

Fig. 5 shows the 200-ft. steel tower at Salt Lake City, which overlooks the City

and Great Salt Lake in the distance. In Fig. 6 can be seen the station at Mt. Rose, Nevada. This is the highest station in the chain, at an elevation of 10,075 ft. One of the concrete towers located between Chicago and Des Moines is shown in Fig. 7.

#### Repeater & Terminal Equipment:

Three distinct types of equipment are employed in the system, installed according to the function of the repeater sta-

tion concerned. The basic unit of equipment is the transmitter-receiver bay, consisting of a transmitter and a receiver mounted in a single 9-ft. rack. At repeater stations each 2-way channel requires two bays, one for transmitting in each direction. Only one bay, however, is required at terminal stations for each 2-way channel.

These bays are alike in most respects. Different connections are employed, of  
(Continued on page 29)

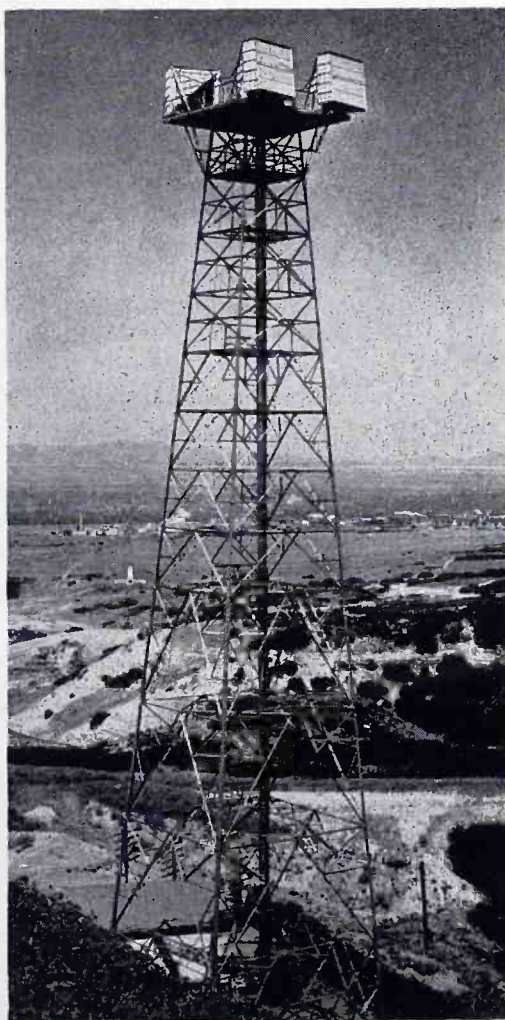
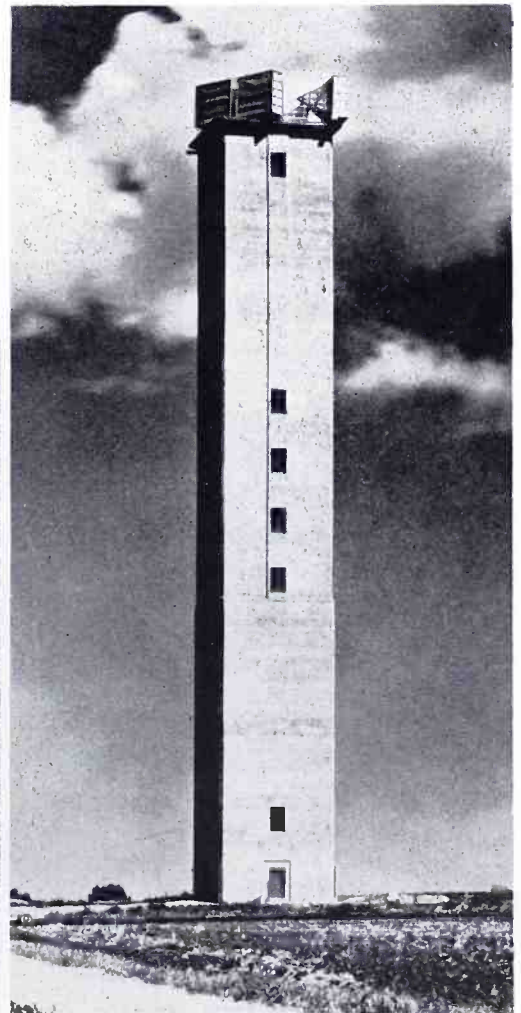
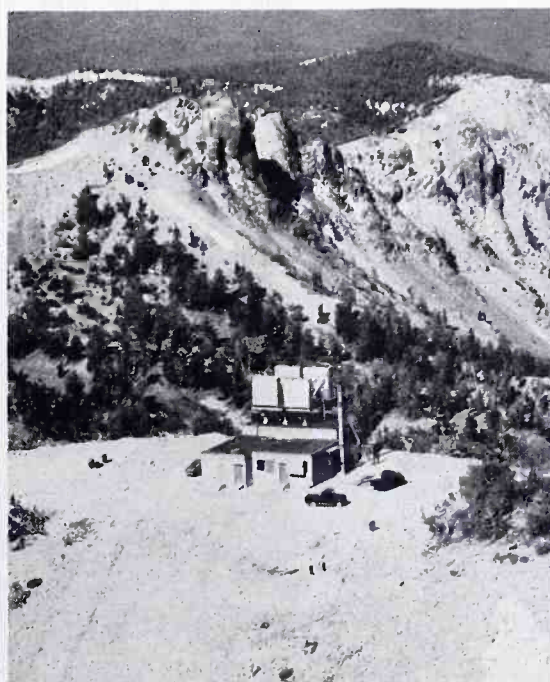

FIG. 5. LEFT: SALT LAKE CITY TOWER, 200 FT. HIGH ON A HILL OVERLOOKING THE CITY

FIG. 6. BELOW: RELAY STATION AT MT. ROSE, NEVADA, HIGHEST STATION IN THE SYSTEM

FIG. 7. RIGHT: A CONCRETE TOWER, SIMILAR TO FIG. 2, LOCATED ON A MIDWESTERN PLAIN



# A QUICK-CHANGE DYNAMOTOR

A DYNAMOTOR DESIGN FOR MOBILE RADIO INTENDED TO COMPETE AS TO EASY REPLACEMENT WITH PLUG-IN VIBRATORS — By ROBERT W. CARTER\*

WITHOUT going into the comparative merits of vibrators and dynamotors for use in mobile radio equipment, it must be conceded that the plug-in feature of vibrator design is important as a matter of convenience. This ease of replacement, plus the lower initial cost of a vibrator as compared to a dynamotor, certainly offer a point-of-sale advantage in favor of the former. In fact, this element of convenience is often emphasized without giving due consideration to the annual cost of vibrator replacements.

## High-Output Dynamotors:

For operating high-power mobile transmitters at 160 mc., however, it is necessary to use a dynamotor to obtain the output required. Accordingly, in designing the Carter type VSF6237M unit shown in Fig. 1, careful consideration was given to convenience features that would facilitate examination or renewal of the brushes, or permit quick replacement of the entire dynamotor. This project was undertaken in cooperation with Motorola engineers for their newest 60-watt packaged mobile equipment. Since this dynamotor represents a radical departure from conventional types as to mounting, space requirements, and quick-detachable connections, as well as meeting new performance specifications, a somewhat detailed description may be of interest to communication engineers.

## Mechanical Features:

In order to reduce the over-all height of

\*President, Carter Motor Company, 2644 N. Maplewood Avenue, Chicago 47, Ill.

the power supply, the old dynamotor base was eliminated and the frame lowered into a depressed channel in the transmitter power-supply strip, Fig. 2. As the motor frame was the largest component, this reduced the height by about 2 inches, and eliminated the cost of a base. A 10/32 stud projecting from the bottom of the frame fits into a hole in the chassis, and prevents the dynamotor from twisting due to starting torque. A mounting strap attached to the trans-

molded receptacle in the end plate, to which small banana plugs are fitted. These plugs are interchangeable to provide correct polarity of output regardless of battery connections.

Because the dynamotor is recessed in the power supply chassis, easy removal of the end covers presented a problem. After several designs were tried, bands similar to those on automobile generators proved ideal. The snap clamps permit instant removal of the band for inspec-

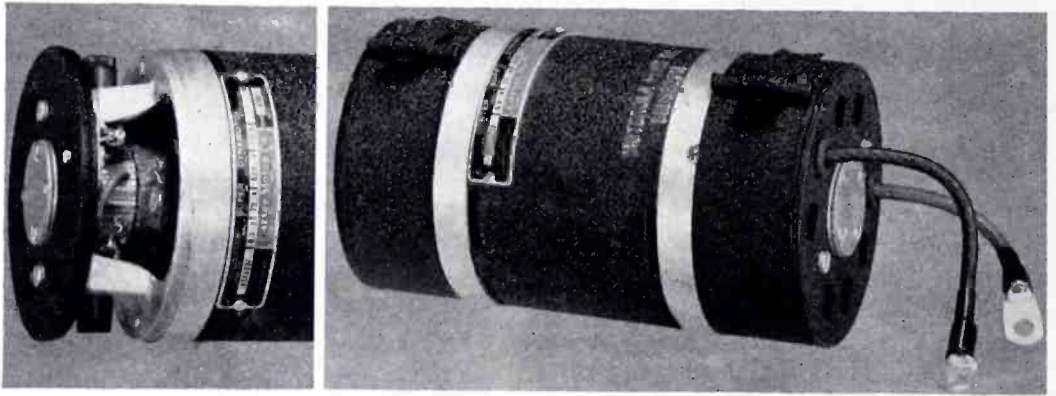

FIGS. 1 AND 3. NEW HIGH-OUTPUT DYNAMOTOR, WITH EASILY-REMOVED BAND-TYPE BRUSH COVERS

tion of brushes and commutators, as shown in Fig. 3.

mitter chassis holds the frame securely in its channel. With 70 battery amperes required to obtain such high power output, it is imperative to keep external voltage drops in the primary circuit to a very low level. Consequently, heavy copper lugs were used as primary connectors. These are attached directly to the chassis ground and to a heavy-duty starting relay contactor, and are the only two connections requiring a wrench for removal.

High-voltage is brought from the dynamotor by means of an Amphenol mica-

tion of brushes and commutators, as shown in Fig. 3.

## Commutator and Brushes:

For a 60-watt transmitter operating at 160 mc., a dynamotor output of 620 volts at 370 milliamperes was required. With allowance for battery cable and connector voltage drop, an input of 5.8 volts was taken as a reasonable nominal value. Under such conditions the input current, Fig. 4, must be about 70 amperes. This presented a formidable problem in brush and commutator design.

Hundreds of brush grades were tested and rejected before the optimum grade was discovered. It was found necessary, also, to super-polish the primary commutator. A diamond-lapping tool in a small high-speed lathe provides an extremely smooth finish, with a maximum eccentricity of .0005 in.

After polishing, the commutator cannot be touched by the hands. Perspiration left on the segments may impair proper commutation. A cupric oxide brush film is soon deposited on the segments to provide lubrication, protection, and insure spark-free operation. Carter input brush grade 25 and output grade 14 have been found to be most satisfactory, partly because of their high filming capabilities. Fig. 5 shows the effect

(Concluded on page 26)

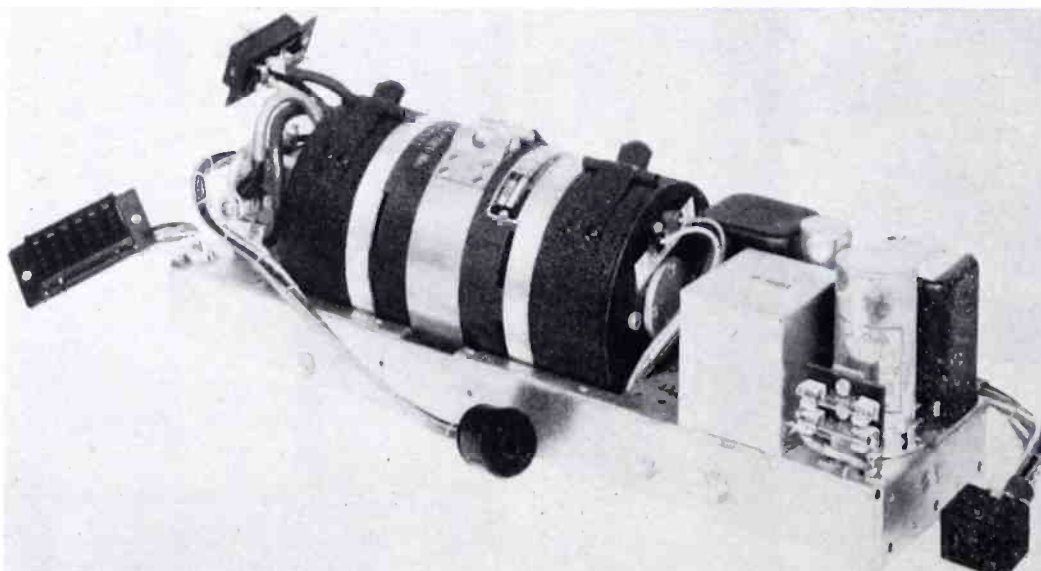

FIG. 2. POWER SUPPLY STRIP. DYNAMOTOR IS RECESSED IN CHASSIS, AND HELD BY ONE STRAP

# Radio TOWERS

- ★ BROADCASTING ANTENNAS
- ★ 2-WAY COMMUNICATION
- ★ TV-FM SUPPORT TOWERS
- ★ MICROWAVE RELAY TOWERS

## DIRECTIONAL ANTENNAS

BY **WINCHARGER**

SPECIFY *Genuine*  
**WINCHARGER TOWERS**  
for POSITIVE RESULTS

*Ahead of them All!*

**WINCHARGER**

### ENGINEERING SERVICE

AM-FM-TV-Short Wave or 2-Way Communication problems are all within the expert scope of Wincharger engineers. You'll get experience-seasoned advice on every phase of design, requirements, installation and maintenance. Write for free new booklet describing all types of Wincharger Towers in detail.

WRITE  
WIRE  
PHONE

### You have to be GOOD to be the LEADER

Well over 1,000 successful antenna tower installations from coast to coast testify to Wincharger's "know how" in radio tower design and construction. Many of the first directional antennas were pioneered on Wincharger drafting boards. The slender uniform cross section permits highly efficient radiation combined with surprisingly low initial and maintenance costs. A sleeker, streamlined tower with adequate high safety factor. Directional arrays of Wincharger Towers are efficiently serving many stations where strict adherence to a critical and complicated broadcasting pattern is most essential.

BE  
PREPARED  
the Minute  
New TV  
Channels  
are  
Available  
—  
write  
NOW!

**WINCHARGER** Corporation

TELEPHONE 2-1844 Dept. 2  
SIOUX CITY 2, IOWA, U.S.A.

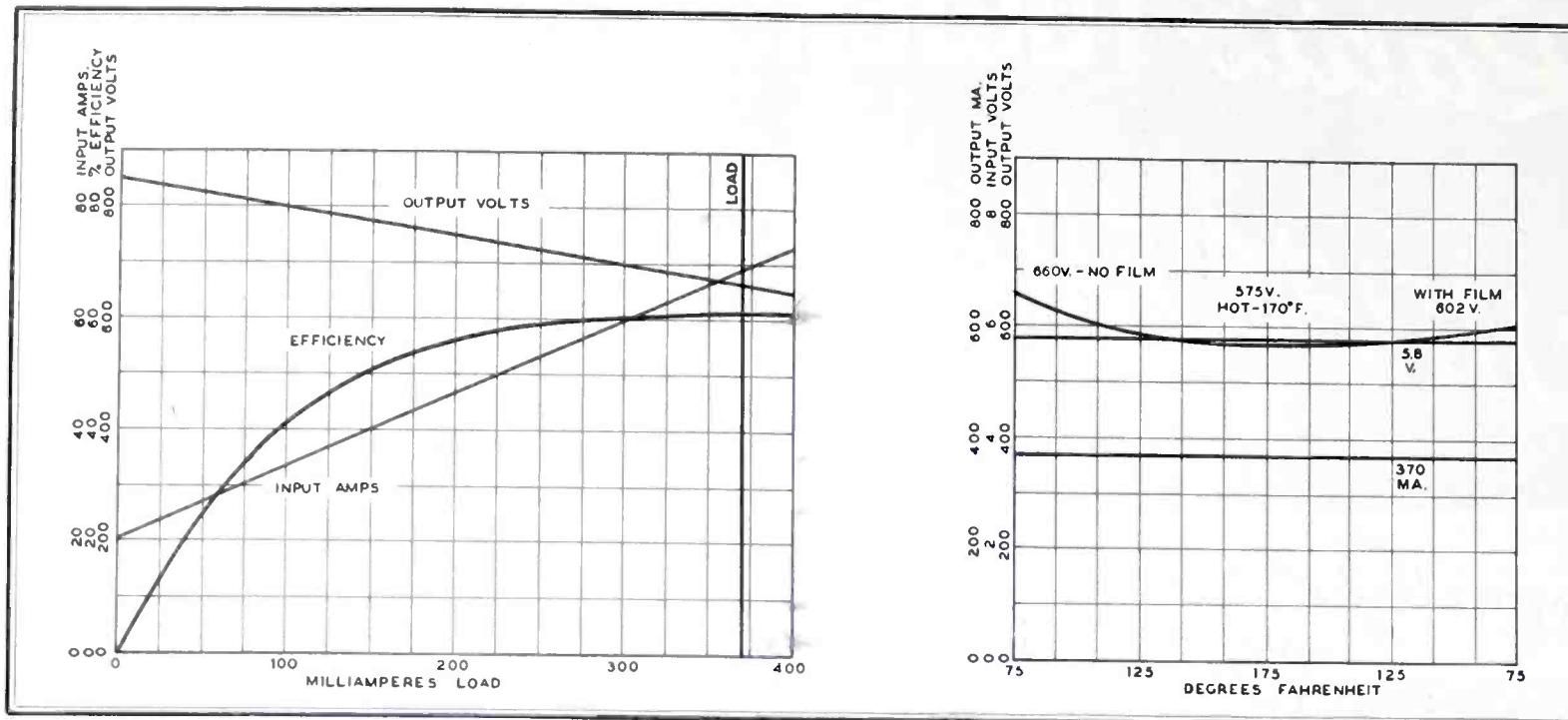

FIG. 4. INPUT AMPERES, OUTPUT VOLTS, AND EFFICIENCY AS FUNCTIONS OF LOAD. FIG. 5. EFFECT OF THE BRUSH FILM AT VARIOUS TEMPERATURES

## DYNAMOTOR DESIGN

(Continued from page 24)

of this film on output voltage at different operating temperatures.

As a result of painstaking design and extreme care in manufacturing processes, a brush replacement life of 20,000 ten-second ON and twenty-second OFF transmissions has been achieved. This is doubly remarkable when it is realized that the brush current density is over 450 amperes per square inch.

### Armature Design:

Cross-stacked, 21-gauge transformer laminations were selected for the armature.

lubricated and sealed for the life of the dynamotor in normal service. The extra seal prolongs life by preventing carbon brush dust, dirt, and other foreign material from entering the bearing races. Bearings are individually inspected, tested, and matched to the line-reamed dynamotor frames. Shaft tolerances, housing bore alignments, and bearing fits are held to .0002 in.

Early field tests proved that formvar insulated magnet wire alone on the high voltage windings did not provide absolute freedom from shorts. After several months of use, the contraction and expansion of the windings, caused by heat and cold cycles, resulted in a breathing

other. Many experiments with various enamels, synthetics, nylons, celanese, and silk were made. By actual test it was found that quadruple formvar with a silk wrap provided exactly the space factor required, and was a dielectric insulation that would permit the windings to breathe. The silk cover separates each wire by a few thousandths of an inch.

By counting carefully each secondary turn to an accuracy of one turn in several hundred, the clean DC output shown in Fig. 6 is obtained. Only a small oil capacitor filter across the output is necessary for noise-free operation, giving the virtually pure DC illustrated in Fig. 7.

Credit for the new design must be shared with the engineers of Motorola's communications division, who collaborated in its development.

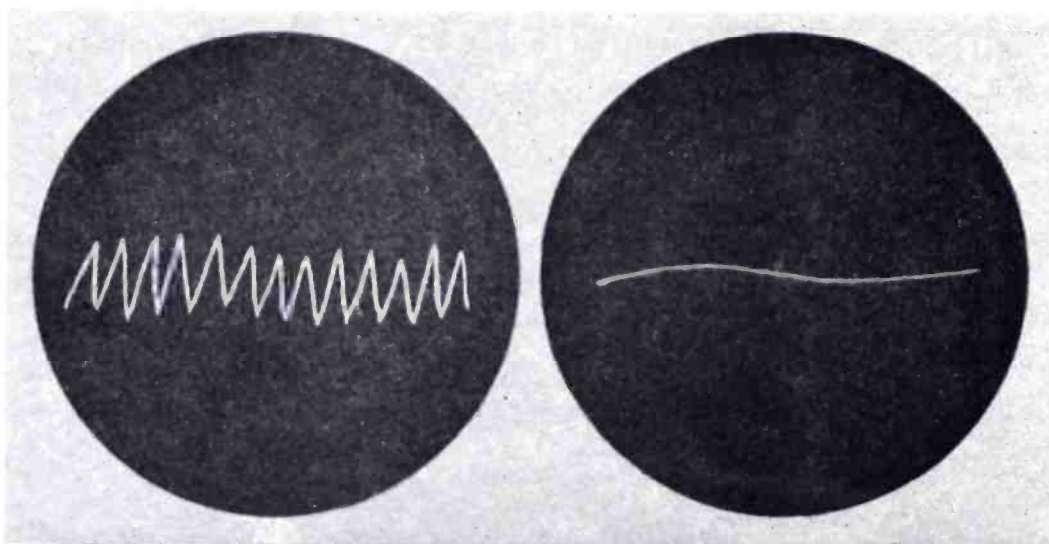

FIGS. WAVE FORMS OF DYNAMOTOR OUTPUT WITHOUT AND WITH ADDED FILTER CAPACITOR

Seventy-two grade steel was used to reduce eddy-current losses and increase efficiency, saving from 3 to 5 amperes battery drain compared to conventional electrical grades.

Double-sealed single-row ball bearings were selected. These bearings are manufactured to very close tolerance, and are

or sawing action in the hundreds of fine wires. If the formvar insulation varied in thickness and two relatively thin spots came together in winding, the condition was further aggravated. A separator of some sort was needed to permit natural expansion and contraction of the windings and to isolate each wire from the

## COMMUNICATION MEN TO MEET AT CHICAGO

THE Chicago area section of the IRE National Professional Group for Vehicular Communication will be host to the national conference of the association, which will be held at the Sheraton Hotel in Chicago on Oct. 25 and 26.

These dates were selected as a convenience to members who will attend the National Electronics Conference, scheduled to meet in Chicago Oct. 22 through 24. Also, the convention will be held just before a meeting of an associated group of the RTMA on Oct. 27.

R. V. Dondanville of Commonwealth Edison is chairman of the Chicago area group. Kenneth V. Glentzer of Illinois Bell is vice chairman, and William J. Weisz of Motorola is secretary. Arrangements for the convention are being handled by Eugene S. Goebel of Motorola.

# NEED A LICENSED RADIO OPERATOR YOU CAN COUNT ON? HERE'S WHAT TO DO...

## 1. Send for this FREE Material

It tells how easily a man of your choice can be trained at home in his spare time to get his FCC license.

TELLS HOW . . .

TO GO ABOUT SELECTING A MAN

- NOW WITH YOU
- WHO WILL STAY WITH YOU
- WHO WANTS TO GET AHEAD

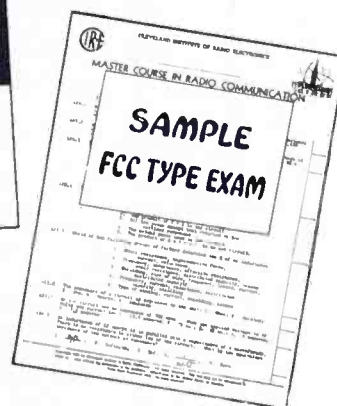
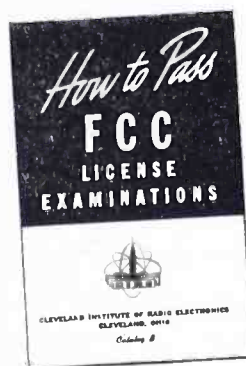

## 2. ENROLL HIM in this Guaranteed FCC License Training UNDER ONE OF THESE THREE PLANS

1. You Pay All, \$89.50 Cash
2. He Pays All (Terms Available)
3. You & He Split Cost

Send for Information on These Plans

**Cost is Minor Compared  
to the Security**

**WE GUARANTEE  
TO TRAIN AND COACH HIM AT  
HOME IN SPARE TIME UNTIL HE GETS  
HIS FCC LICENSE**

If he has had any practical experience — Amateur, Army, Navy, radio repair or experimenting.

Look How FEW HOURS OF STUDY MAY BE  
REQUIRED TO GET FCC LICENSE WITH OUR  
COACHING AT HOME IN SPARE TIME

Name and Address	License	Lessons
Lee Worthy, 2210 1/2 Wilshire St., Bakersfield, Calif.	2nd Phone	16
Clifford E. Vogt, Box 1016, Dania, Fla.	1st Phone	20
Francis X. Foerch, 38 Beucler Pl., Bergenfield, N. J.	1st Phone	38
S/Sgt. Ben H. Davis, 317 North Roosevelt, Lebanon, Ill.	1st Phone	28
Albert Schoell, 110 West 11th St., Escondido, Calif.	2nd Phone	23

Cleveland Institute of Radio Electronics  
Special Attention: Desk 12  
4900 Euclid Avenue  
Cleveland 3, Ohio

I want to know how a man of my choice can get his FCC ticket in a minimum of time. Send FREE booklet, "How to Pass FCC License Examinations" (does not cover exams for Amateur License), as well as a sample FCC-type exam, and information as to payment plans available.

Be sure to check here if you are an employer.

NAME.....

ADDRESS.....

CITY.....ZONE.....STATE.....

Paste on penny postcard or send air mail.

for  
**Quality**  
in...

**PREPAREDNESS  
PRODUCTION**

*Specify*

**AMPHENOL**

**CONNECTORS — CABLE**

Amphenol has always cooperated with government and civilian engineers in every phase of electronic endeavor involving research and development of cable and connectors. As a result—Amphenol has been the leader in the development and perfection of electrical connectors and low loss cable for power, signal and control circuits in aircraft and electronic equipment.

*Always Specify Amphenol for quality in:*

- ★ **RF Cables**
- ★ **Remote Control Cable**
- ★ **A-N Connectors**
- ★ **Submersion-Proof Connectors**
- ★ **Heavy Duty Power Plugs**
- ★ **Audio Connectors**
- ★ **100 Contact Connectors**
- ★ **Quick Disconnect Connectors**
- ★ **Cable Connectors**
- ★ **Power Plugs**
- ★ **Rack & Panel Connectors**
- ★ **Miniature Connectors**
- ★ **Sealed Relay Plugs**
- ★ **RF Connectors**
- ★ **Heavy Duty Radio Connectors**

**AMPHENOL**

**AMERICAN PHENOLIC CORPORATION**  
1830 SOUTH 54th AVENUE, CHICAGO 50, ILLINOIS

**VITAL EQUIPMENT RE-  
QUIRES RELIABLE TUBES**

**I**N a speech before the West Coast Convention of the IRE, E. Finley Carter, Sylvania vice president in charge of engineering, pointed out that electron tubes and circuit design practices employed for home radio and television applications are not adequate for critical military and navigational uses.

"In the commercial radio and television field," Carter stated, "tube manufacturers operate with a delicate balance between the cost of manufacture and the cost of field service. The war brought problems of a new magnitude. The enemy plane that is missed because of a tube failure may be carrying a bomb which will bring great destruction to one of our cities. . . . The lives of our men and vast sums invested in military equipment are being bet on the dependability of electronic gear, but the vital dependence on electronics is not limited to military equipment. People cannot fly across mountains and oceans, nor can planes be stacked over a busy airport, without reliance on properly-functioning equipment for which electronic engineers are responsible. . . . Engineers must discard some of the habits and practices which have been acceptable in the competitive economy which surrounds the radio and television industry. These practices are dangerous if carried over into the design of military, navigational, or other vital equipments.

**Predicting Reliability:**

"It is not fully realized that the tube, itself, is really a complex system. While practically all the known physical sciences contribute to its production, nevertheless much [depends on] manufacturing and processing. This is because the variables are so great that statistical analysis, similar to that employed by the life insurance actuary, is required to evaluate production and application probabilities."

To demonstrate this comparison Mr. Carter presented graphic data in which the life expectancies of human beings and electron tubes have been charted, revealing a striking similarity. He explained that both tubes and humans suffer from a small but significant period of high mortality in early life, and that when this early critical period is survived, chances for a normal long life are improved. He also stressed the fact that tubes, like humans, can be damaged beyond repair by overwork or overloading.

Carter exhorted engineers in all branches of the industry to allow suitable safety factors, to employ tubes from the AN preferred list, and to cooperate with tube designers in simplifying and improving tubes for increased reliability.



## BUREAU OF STANDARDS

(Continued from page 19)

nected for 50,000 or for 100,000 volts and used as standards at these latter ratings. A still larger standard transformer is calibrated with its coils in parallel at 100,000 volts and used with its coils in series as a standard up to 250,000 volts.

### Conclusion:

For all testing and calibration work, other than that performed for the Federal and State governments, the law requires the Bureau to charge an appropriate fee. These fees are high enough to avoid subsidized competition with private testing laboratories, but low enough to make it possible for all industrial laboratories to attain high accuracy in their work. In any event, the cost of the Bureau's electrical standardization services is slight to both government and industry, in comparison with the savings to the Nation which result from the program. For example, the electrical power industry has now grown to the point where the annual bill for electrical energy is approximately four billion dollars. If there were a consistent error of 1% in the standards used to calibrate the electric meters with which the industry calibrates its customer meters, either the power companies or the consumers would lose \$40 million each year. Yet the cost of maintaining the Bureau's service in this field is much less than 1 percent of the discrepancy.

The Bureau is currently making efforts to meet the ever-increasing volume and complexity of demands for electrical standardization work. Techniques are being developed for more accurate measurements of man-made lightning — very short-duration surges of high current — which are being used by electrical manufacturers to test high-voltage equipment. Methods are also being worked out for more rapid and economical checking of watt-hour meters, for testing of the very high resistances now used in measuring ion currents and other radiation effects, and for testing instruments and instrument transformers at 400 and 1,000 cycles, for use on aircraft and in induction furnaces.

## MICROWAVE

(Continued from page 23)

course, at the terminal stations. Also, at terminals and main repeater stations, separate temperature-controlled microwave generators are used as beat oscillators for transmitter and receiver sections of the repeater bays, while a single microwave generator and a 40-mc. oscillator are used as a transmitter and receiver beat oscillator in auxiliary repeater stations. This is because at terminals and

August 1951—formerly FM, and FM RADIO-ELECTRONICS

## HERE'S TOP PERFORMANCE IN A SINGLE RADIO PACKAGE!

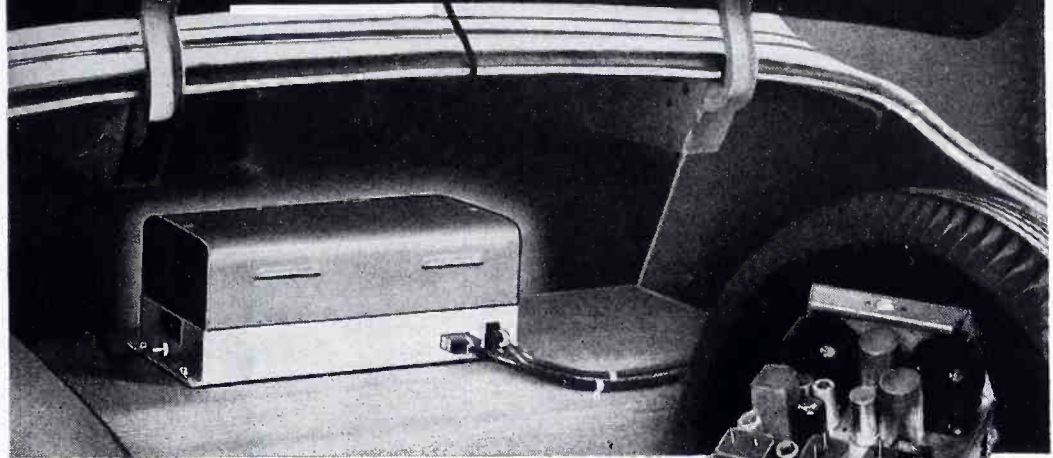

**KAAR  
RADIOPAK**

The four outstanding features for which Kaar equipment has long been noted have now been combined into a single mobile radiotelephone package that is far ahead in performance... yet competitive in price!

The Kaar RADIOPAK features ruggedness, simplicity of design, lowest battery drain, exceptional voice quality plus greater than ever stability and sensitivity, engineered selectivity that exceeds the standards set by FCC regulation — all in a single unit transmitter-receiver that is completely integrated for simplicity of installation, maintenance, and operation.

RADIOPAK is ideal for police, taxi, fire equipment, and trucking installations and is particularly suited for three-wheeled motorcycle use. **Don't be content with an ordinary radiotelephone system—specify RADIOPAK!**

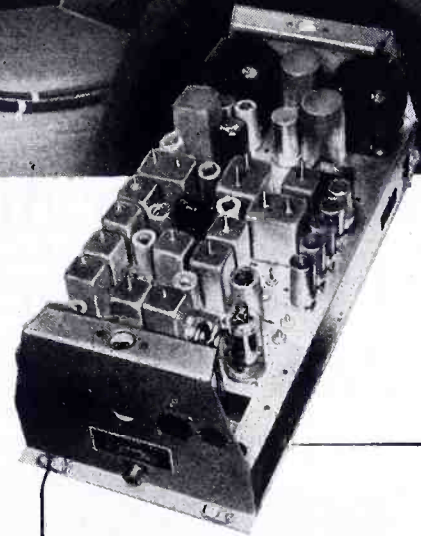

### Kaar RADIOPAK "in a nutshell":

FREQUENCY RANGE: 152-174 mc

POWER OUTPUT: 10-12 watts

BATTERY DRAIN: Standby 6½ amps;  
Transmitting, 15 amps

DIMENSIONS & WEIGHT: 6¾" high,  
8" wide, 18⅞" long; 24 lbs.

STABILITY: Better than .005% for a  
50° C temperature change with stand-  
ard Type E crystals

SPURIOUS EMISSION: Down at least  
70 db

SPURIOUS RESPONSE: Down over 85  
db

SELECTIVITY: 100 db down at 60 kc  
off resonance

SENSITIVITY: 20 db quieting on less  
than ½ microvolt of signal

AUDIO RESPONSE: ±3 db from 180  
to 3000 cycles

**KAAR ENGINEERING CO. • Palo Alto, California**

main repeater stations the received and converted signals may be patched, or filtered subcarriers intended for that station may be removed, while the only function of an auxiliary repeater station is that of amplification. This is made clear in the following section.

### Auxiliary Repeater:

Fig. 8 is a diagram of an auxiliary repeater. The incoming signal is fed to the 6 channel networks, which are tuned to accept the proper portions of the total signal and feed them to the corresponding repeater bays.

Assume that the signal for one channel

is centered on 3,730 mc. A microwave generator provides a signal of 3,840 mc. which is fed to a shifter converter. This converter stage is also supplied with a 40-mc. signal from a shift generator. The output of the converter is fed to a filter which selects the difference frequency for beating with the incoming 3,730-mc. channel signal. An IF of 70 mc. is formed and fed to an IF preamplifier, then to a delay equalizer. Equalization is necessary because of the wide bandwidth.

After equalization, the signal is brought to the main IF amplifier and then to the modulator, where it beats

(Concluded on page 30)

# REL

## RADIO ENGINEERING LABS., Inc.

PIONEERS IN THE CORRECT USE OF ARMSTRONG FREQUENCY MODULATION

### FM Receivers for All Broadcast Monitor and Network Services

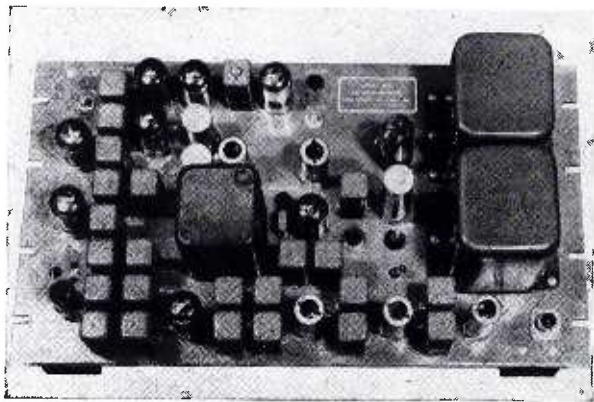

For Any Specified Frequency from 88 to 108 mc. The REL model 722 fixed-frequency FM receiver is finding wide application at FM studios and transmitters for program or Civil Defense monitoring, and FM networking.

Built to the highest standards of commercial performance and long-time stability, the 722 receiver has a frequency response flat to 1/2 db from 50 to 15,000 cycles, with less than 1/2% distortion. Sensitivity is such that the sputter point is under 2 microvolts, and spurious response more than 70 db below the desired signal. On special order, the 722 can be furnished to operate on any frequency from 40 to 216 mc.

Each receiver is adjusted to reject harmonic interference on the frequencies of transmitters adjacent to the location where it is to be installed. The complete receiver and power supply, as illustrated, are mounted on a standard rack panel 19 ins. wide by 12 1/4 ins. high. Deliveries are now being made on the REL model 722. For engineering data, price, and delivery schedule, write:

Engineers and Manufacturers of Broadcast, Communication, and Associated Equipment since 1920

## RADIO ENGINEERING LABORATORIES, Inc.

TEL: STILLWELL 6-2100 TELETYPE: N. Y. 4-2816  
36-40 37th Street, Long Island City 1, N. Y.

directly with the 3,840-mc. signal. The difference frequency of 3,770 mc. is 40 mc. removed from the incoming signal, as was mentioned earlier. At the follow-

temperature-controlled because it is not the determining factor in the output frequency. Effectively, it is subtracted and then added to the incoming frequency.

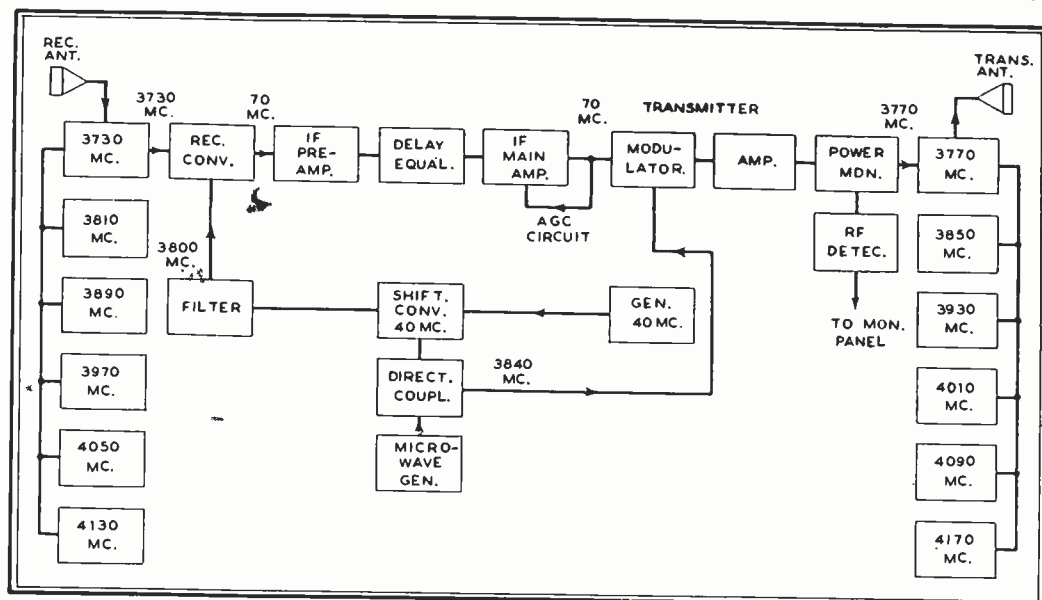

FIG. 8. TRANSMITTER-RECEIVER IN AUXILIARY REPEATER. 2 BAYS PER CHANNEL ARE REQUIRED

ing repeater station it is shifted back to 3,730 mc.

From the modulator the signal goes to a power amplifier, consisting of three 461A<sup>1</sup> triodes in a grounded-grid cavity assembly. The output signal of about 1/2 watt is combined with those of the other five channels and fed to the antenna.

An AGC circuit is included in the main IF amplifier section. The AGC is flexible enough to vary the IF gain from 40 to 65 db. A power monitor circuit sends an instant alarm to an alarm center should the output power drop below a fixed level.

The microwave generator need not be

<sup>1</sup>See "416A Tube for Microwave Relays," *FM-TV* August, 1950.

The 40-mc. shift generator does affect the final frequency, but it operates at such a comparatively low frequency that it can be made sufficiently stable without temperature control.

#### Completion Schedule:

The first service of the relay system was in providing the equivalent of 46,000 miles of telephone circuits. That figure will be increased to 500,000 miles within a few weeks. There is ample reserve for the time when circuit requirements increase still further.

Coast-to-coast television service will begin on September 30 with one west-bound channel. A west-to-east channel will go into operation about one month later.

### MOBILE RADIO NEWS

(Continued from page 20)

One of the principal drawbacks to wider use of this service has been the 3-ft. restriction on the distance from transmitter to antenna. The proposed amendment will increase to 25 ft. the limitation on the maximum permissible separation between a transmitter in this service and the radiating portion of its associated antenna.

At the same time the Commission proposed to assign certain microwave frequencies to the use of the low-power industrial service for industrial direction and range devices, mentioning specifically the approval of use that would thereby be possible for speed-meter devices such as those for which the Truck Insurance Exchange of Los Angeles had previously petitioned the Commission. When this proposed amendment is finalized, the Insurance Exchange will be

able to measure the speed of trucks traversing Pacific Coast routes. When a particular truck is observed in violation of speed limits, the owner of the truck will be notified by mail. While this type of private radio use is obviously non-controversial, some auto clubs are concerned with the possible abuse of radar devices for public speed law enforcement. Certainly the non-posted radar zone comes under the category of a speed trap, because the motor cop hiding behind the billboard or bushes would then be entirely effaced. Science can be carried too far! But, after such abuse, perhaps the FCC and its staff will not look upon the non-posted radar speed zone as representing a use of radio that meets the statutory test of public interest.

#### Miscellaneous Developments:

Proposed amendment of Section 10.255 of Public Safety Radio Services Rules would permit the use of 5,135 kc., with



## MOBILE RADIO NEWS

(Continued from page 30)

1,000 watts input power limitation, for radiotelephone by fixed police radio stations in Alaska. This would be in addition to presently authorized use for zone and interzone police stations operating with A-1 emission.

Commission has announced the revision of its non-broadcast 401 application form to show information called for under the new Part 17 antenna Rules. The new form became effective August 1, 1951. In announcing the revised form, the Commission cautioned all applicants that "use of the old, unrevised form after that date may result in failure to submit information required by the Commission, and thus necessitate return of the application with attendant delay."

Ship radiotelephone station license form 501-A has also been revised, effective July 23, to constitute a combined application and authorization form, both of which are completed by the applicant. Upon approval, authorization portion will be returned to applicant in a window envelope as his license.

In the first action of its kind, FCC has approved the use of a taxi company's mobile unit on the base station frequency for standby emergency use. The authorization provided that the mobile unit, when operating as a dispatching station in emergencies, must be used only at the base station location. The authorization is principally of importance to small cab operators, since most of the larger operators, placing great reliance on radio transmissions, have installed standby transmitters for use in emergencies.

Still awaiting FCC action is the petition of the American Trucking Association for amendment of highway truck radio service Rules so as to permit broader use of radio by trucking industry in defense effort. Petition pointed out that shortage of railroad freight cars, combined with labor and equipment shortages, has put a serious overload on the trucking industry. Experience of certain members indicates that this overload could be materially reduced by broadened radio use. Petition urged that prohibition on intra-city radio be lifted for truck lines serving inter-city truck lines, railroads, ships or airports. ATA also pointed out that intra-city pick-up and delivery operations of inter-city common carriers were an integral part of their operations authorized by the ICC, and asked that Rules be clarified to cover full radio use of this important type of trucking operation at least. Significant exhibit attached to petition showed 10 radio-equipped trucks as being equivalent in productive performance of 12 to 13 non-radio-equipped trucks.

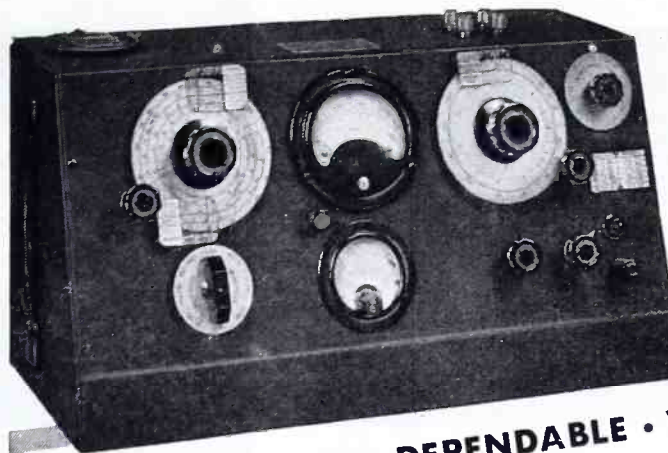

The **Q-METER**  
TYPE 160-A

### ACCURATE • DEPENDABLE • VERSATILE

For the measurement of Q, inductance, and capacitance, the 160-A Q-Meter is the universal choice of radio and electronics engineers. Its wide frequency coverage from 50 kc. to 75 mc. is an outstanding feature which makes possible the accurate and rapid evaluation of components and insulating materials at the actual operating frequency.

#### SPECIFICATIONS

**OSCILLATOR FREQUENCY RANGE:**  
50 kc. to 75 mc. 8 self contained ranges.  
**OSCILLATOR FREQUENCY ACCURACY:**  
±1%, 50 kc.-50 mc. ±3%, 50 mc.-75 mc.  
**Q-MEASUREMENT RANGE:** Directly calibrated in Q, 20-250. "Multiply-Q-By" Meter also at x2.5, extending Q-range to 625.  
**Q-MEASUREMENT ACCURACY:** Approx-

mately 5% for direct reading measurement, for frequencies up to 30 mc. Accuracy less at higher frequencies.

**CAPACITANCE CALIBRATION RANGE:**  
Main capacitor section 30-450 mmf, accuracy 1% or 1 mmf. whichever is greater.  
Vernier capacitor section +3 mmf., zero, -3 mmf. calibrated in 0.1 mmf. steps.  
Accuracy ±0.1 mmf.

Write for literature containing further details

**BOONTON RADIO**

BOONTON · N.J. · U.S.A.

Corporation



## MOBILE RADIO HANDBOOK

Practical Working Data on Mobile and Point-to-Point Systems

EDITOR: MILTON B. SLEEPER — ASSOCIATES: JEREMIAH COURTNEY, ROY ALLISON

**PLANNING:** How to plan a mobile or point-to-point communications system. This chapter covers the overall problems of power and topography, interference, city ordinances, public liability, operation, maintenance, expansion, and interconnection.

**FREQUENCIES:** FCC rules and allocations which became effective in July, 1949 provided for many new services. Complete details are presented on every service in the common carrier, public safety, industrial, and transportation groups.

**LICENSES:** How to apply for a construction permit, license, and renewal for a communications system. Complete FCC forms, filled out in the correct manner, are shown. This is of the utmost importance; incorrect forms may cause months of delay.

**EQUIPMENT:** Three chapters are devoted to the problems of selecting the right equipment for a particular system, specifications on transmitters and receivers of all makes, selective calling and fleet control and adjacent-channel operation.

**ANTENNAS, TOWERS:** The problems of planning antenna installations are covered very thoroughly in two chapters which explain the various special-purpose types of radiators, and the correct method of erecting a standard guyed, steel antenna tower.

**MAINTENANCE:** How to keep a communications system at peak performance. Methods and record forms that have been perfected by years of experience are described in detail. Proper balance between essential and superfluous maintenance is explained.

**OPERATORS:** The FCC is becoming increasingly strict about the observance of rules relating to operator requirements at communications systems. Official information is given, with a detailed explanation from FCC Secretary T. J. Slowie.

**HOW FM WORKS:** Advantages of FM over AM, coverage, interference, and static elimination, and circuit functions are explained pictorially in 83 illustrations. The use of mathematics has thus been avoided in this clear, practical presentation.

An elaborately illustrated reference book for executives, communications engineers, system supervisors. 190 pages, 8¾ by 11½ ins.

\$4.00 Cloth Bound - \$2.00 Paper Cover

Postpaid in the U.S.  
Elsewhere, 25c Postage

Published by Radio Communication Magazine

SAVINGS BANK BUILDING, GREAT BARRINGTON, MASS.

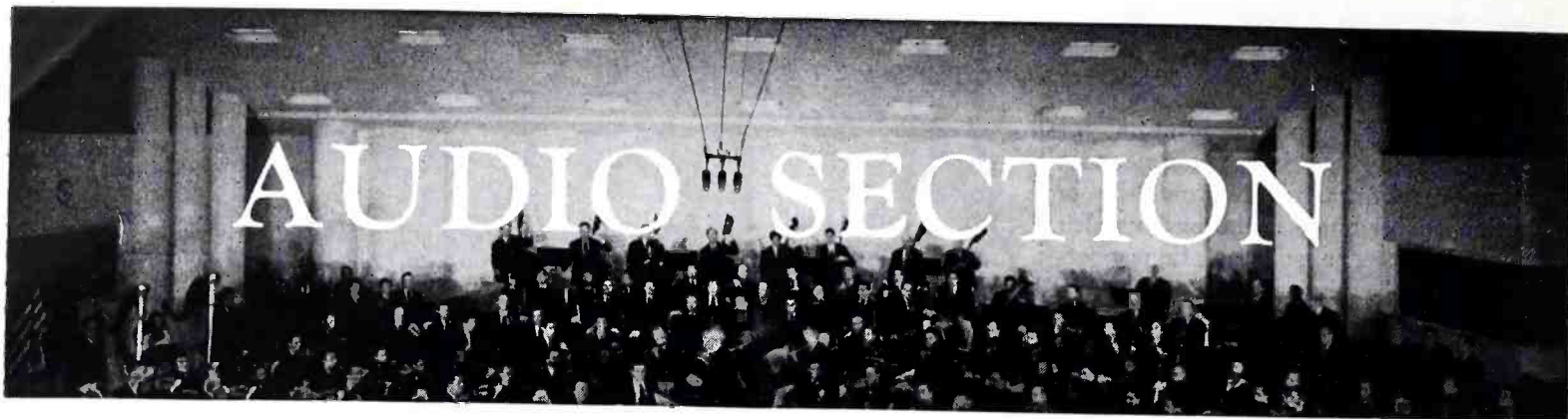

# BETTER MUSIC-ROOM ACOUSTICS

HOW TO PLAN AN AUDIO DEMONSTRATION ROOM OR A SMALL MUSIC ROOM FOR BEST EFFECTS. SIMPLE RULES FOR BETTER LISTENING — BY JAMES MOIR\*

HAVING dealt in the April issue with the problem of selecting loudspeakers, it seems logical to take up the problem of planning a room for listening, a matter that is of interest to broadcasters as well as dealers and high-fidelity enthusiasts. The problem is difficult enough when the designer can start with a vacant plot and a large bank balance, but it is doubly difficult when neither is available and compromise is necessary. In the following discussion we shall assume the ideal, and leave each reader to make his own compromise according to his circumstances.

First of all, consider the conventional approach along the lines of obtaining the optimum reverberation time. In the early 1900's, W. C. Sabine, called on to advise on the acoustic design of a new concert hall, made an investigation into the performance of several existing halls and small music studios, and concluded that the important factor was the rate at which the room boundaries absorbed the sound energy delivered to the air by the sound source. Intuition and common sense support this conclusion, as it is fairly obvious that severe interference will occur unless the sound energy contained in one syllable is largely dissipated before the next syllable appears.

Sabine developed a simple equation relating the area and properties of the surface materials, the hall volume, and a parameter he termed "reverberation time," defined as the time required for the diffuse sound energy to decay to one millionth of the original value. From tests in many small halls of good musical reputation he was able to suggest a relation between hall volume and reverberation time for optimum results. Subsequent workers have extended the relation down to volumes of 1,000 cubic feet, the volume of a very small listening

room. It is not proposed to deal in detail with the Sabine calculation as it is adequately covered in the standard texts, but the suggested optimum curve is reproduced as Fig. 1. This gives the optimum time at 500 cycles as a function of room volume but for good performance it is necessary that the reverberation time at other frequencies in the audio spectrum should bear a definite relation. This relationship, as indicated by curve A of Fig. 2, is derived from experience supported by calculation based on reasonable assumptions, but in recent years there has been a trend towards a preference for lower bass response as indicated by curve B of Fig. 2. Whether

Fig. 3, actually the measured result in the writer's lounge. This discrepancy is almost certainly due to absorption by the floor, ceiling, panelled doors, and glass windows vibrating in the low frequency range. The absorption of all the items mentioned, when measured in the standard reverberation chamber on small samples, shows little bass absorption, but when mounted as large surfaces free to vibrate, the bass absorption can be considerable.

Though in recent years there has been a general tendency to prefer the flattish curve of Fig. 2C, the writer's preference is for something more nearly approaching Fig. 2B as giving a fullness and roundness of tone which is lacking in the flatter curve of Fig. 2C. To some extent the absence of the bass rise in the reverberation time curve can be compensated by bass boost in the audio amplifier, but it should be noted that this adds the bass to the *direct* sound, whereas the bass is really missing from the indirect reverberative sound.

So far, this has been conventional theory well covered by numerous publications, but I doubt whether anybody in daily contact with the job of acoustical design really believes that rigid application of these well-worn curves and formulae will produce a good studio or listening room on every occasion. So let us take a look at some of the other factors that are largely ignored by the text books.

It has been shown that the reverberant sound in an enclosure does not decay in a diffuse manner, even if the sound energy at the instant of source cut off is uniformly distributed. Whatever the conditions at the instant the sound source stops, the decaying sound energy proceeds to distribute itself in a uniform pattern throughout the room, though this pattern will change more or less continuously during the decay period.

## DEALERS' AUDIO DEMONSTRATION ROOMS

It is essential that audio equipment dealers have demonstration rooms that are acoustically correct, for the performance of even the finest sound system can be ruined by poor acoustics. In this article, Mr. Moir presents concrete facts and offers practical suggestions for the improvement of music rooms. It is an article of real value to dealers planning to install demonstration rooms, and to those who are planning to modify their present facilities. In many instances, sales can be increased surprisingly by the application of some or all of the suggestions made here.

this is merely a fashion or a gradual change in preference, it is hard to decide, but it is sufficiently well marked to bias the designers of some recent European studios to go as far as curve C of Fig. 2.

Calculations from Sabine's formula, using published absorption coefficients, suggest that the average small studio or audio demonstration room should have a reverberation time vs. frequency characteristic somewhere between Fig. 2A and 2B, as the vast majority of domestic furnishing materials have very little absorption in the bass. But in fact, measurement of the reverberation time in many small rooms indicates that the curve falls away at the bass end, as shown in

\* 87 Catesby Road, Rugby, England.

The patterns or modes have resonant frequencies which are defined by the Rayleigh equation.

$$f = \frac{C}{2} \left( \frac{L^2}{A^2} + \frac{W^2}{B^2} + \frac{H^2}{D^2} \right) - \frac{1}{2}$$

where C = velocity of sound  
L = room length  
W = room width  
H = room height

and A, B and D are the integers 1, 2, 3, 4 . . . . . etc. inserted in turn in equation (1). This equation predicts that there will be an infinity of resonant frequencies having a frequency spacing which decreases as the frequency increases. As a typical example of the lower end of the frequency spectrum, Table 1 lists the first ten modes of the writer's lounge, the presence of most of them having been confirmed experimentally.

TABLE 1

No.	Freq.
1	36.8
2	51.1
3	63
4	69.6
5	73.9
6	77.8
7	85.6
8	89.7
9	93.15
10	100.7

Room approx.  
15.3 by 11 by 8.2 ft.

It will be seen that below 100 cycles they are all discretely spaced with quite a gap between them. In a room having all dimensions ten times as large, all the resonant frequencies would be ten times lower. The first modes would therefore be in the sub-audible region and of little account, and in the audible region they would be much more closely spaced than in the case of the small room. Thus, in

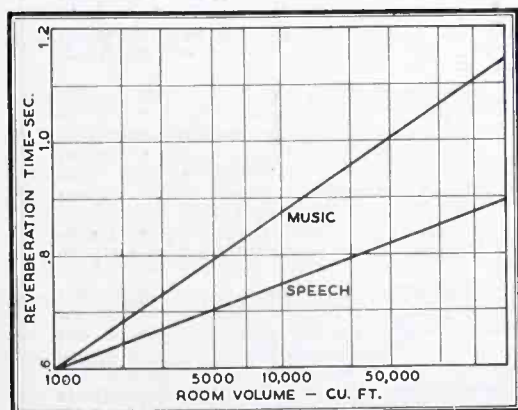

FIG. 1. ROOM SIZE VS. REVERBERATION TIME

the small listening room of domestic proportions, the reverberant sound decays not in random fashion but is concentrated in narrow frequency bands, the lowest being particularly prominent due to the gaps between adjacent frequencies. In the writer's room, believed to be a

typical case, the energy concentration at each mode frequency is never less than 15 to 20 db, i.e., the room frequency characteristic has nine peaks of 15 to 20 db between 50 and 100 cycles.

A loudspeaker with a frequency characteristic like this would be rejected immediately, and yet these peaks in another part of the system are rarely considered. Below 200 cycles, the room tone is entirely dominated by these resonances, and it is very doubtful whether the conception or measurement of reverberation time in this region is of any value or, indeed, has any meaning.

The question that immediately springs to mind is the obvious one: "What can we do about it?" If the building plot is still in the virgin state, something can be done to ease the situation, though the complete solution is beyond the scope of this short discussion. In producing these resonances, the room is merely acting as as three short organ pipes having lengths equal to the room length, room width, and room height respectively, and producing resonant frequencies in which these dimensions are one-half wave-

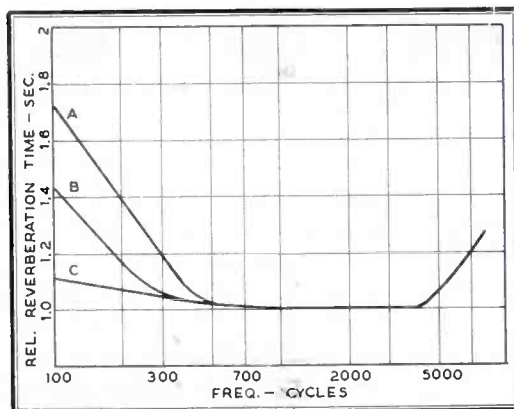

FIG. 2. BEST RELATIVE REVERBERATION TIME

length. It is immediately obvious that the worst shape of all is the perfect cube as this makes the length, width, and height mode frequencies all identical, and the sound build-up the maximum possible at this frequency and its harmonics. Following this line of thought, it would appear advantageous to arrange the dimensions so that the mode frequencies are fairly uniformly distributed throughout the lower audio range. This can be achieved by making all the dimensions bear a fixed ratio to the length. There is no uniquely advantageous ratio, but a width of 1.27 times the height, and a length 1.27 times the width produces a reasonable distribution. Thus a room 10 by 12.7 by 16.2 ft. is a suggested standard that can be scaled up or down according to circumstances.

At these low frequencies, acoustic absorbants are virtually useless, but absorbants of the Helmholtz type can be designed for narrow-band absorption.

A second important factor not usually discussed in the standard texts is the ef-

fect of structural vibration upon the effective reverberation in the studio. It is difficult to believe that a 9-in. brick or concrete wall can be set into vibration by an announcer's voice, but this actually happens and may have serious repercussion on the acoustical character of the room. Sounds striking the wall sur-

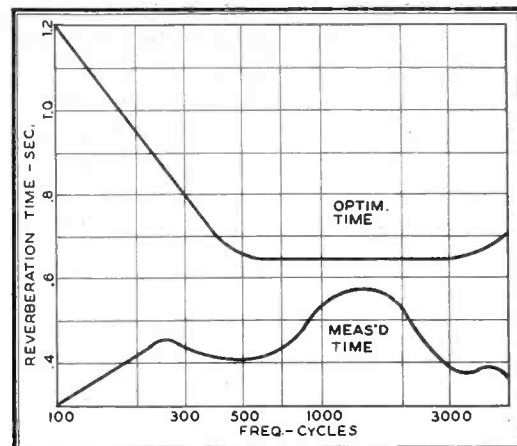

FIG. 3. OPTIMUM AND TYPICAL ACTUAL TIME

faces set the wall into vibration at its resonant frequencies. If the decay rate for the vibration is lower than the decay rate for the air contained in the room, sound will be returned to the air by the walls which continue to vibrate after the energy stored in the air has been dissipated. The structure thus has a reverberation time of its own which combines with the reverberation of the contained air, the overall result being rather similar to the acoustic effect obtained from two rooms having a communicating window. The importance of these structural resonances is becoming appreciated in England, and every step is taken to see that the structure is unlikely to produce undue coloration of the room tone.

Earlier in the discussion of air resonances it was pointed out that an obvious effect was the introduction of serious peaks in the frequency characteristic of the room, but there is a more subtle effect which is probably of equal importance in setting the room character. In a large room the resonances are so closely spaced that the effect is that of a more or less uniform distribution. Consequently, the reverberation that accompanies an instrument and produces room colour is at the frequency of the note sounded by that instrument.

In the small room this is not the case. The decaying sound energy is concentrated in narrow isolated bands around the room resonances and, unless one of these resonances happen to coincide with the note sounded by the instrument, the reverberation will take place at another frequency generally a few cycles away from that of the instrument note. During the decay period, beats occur between the note being played and the decaying sound energy in the nearest

(Concluded on page 34)

mode, an effect that is almost entirely absent in the large room. This is a rather depressing outlook for the high-fidelity enthusiast endeavouring to produce concert hall quality in domestic circumstances, because it does rather look as though there is little chance of success. However, it is interesting to see what can be done on the assumption that a fresh start is being made, and to consider some positive suggestions:

1. Keep the room as large as possible, 20 to 24 feet being an ideal minimum length, with the other dimensions in the ratio suggested earlier.
2. Stick to solid construction if possible, avoiding large areas of thin glass, thin curtains.
3. If the shape can be somewhat irregular it is advantageous, but do not make regular patterns of irregularity.
4. Covering the walls with half balls and half cylinders may be smart, but it is not necessary. If the listening room or studio can be furnished with a few open bookcases, easy chairs, a

table, a few pictures and some heavy curtains, so much the better. Avoid thin curtains.

5. Aim at making the reverberation time somewhere near the value appropriate to the room volume using the curves of Fig. 1.
6. If calculations indicate that further absorbent material is required, do not concentrate it all in one area, but

spread it out as much as practical.

It is impossible to deal adequately with such a monumental subject<sup>1</sup> in a short space, so further discussion is planned for a later article.

<sup>1</sup> Further information on this subject will be found in "Acoustics of Small Rooms," J. Moir, *Wireless World*, Nov. 1944. "Reverberation Time as an Index of Room Performance," J. Moir, "Acoustics Group Symposium, 1947" Physical Society, Lowther Gardens, Prince Consort Rd., London, S. W. 7.

## A NEW WILLIAMSON AMPLIFIER KIT

The Standard Transformer Corporation, 3850 Elston Avenue, Chicago 18, has issued a pamphlet describing a new low-cost Williamson Amplifier design. The basic Williamson circuit has been retained, but component values have been altered to permit the use of 807 output tubes rather than English KT66's.

A series of transformers has been developed for use in the modified Williamson circuit. These Stancor components include an output transformer, a heavy filter choke, and a power transformer.

According to the designers, tests made on an amplifier built from standard stock parts showed equivalent flat response from 20 cycles to 50 kc., measured at 0.5 watts and at 8 watts output. Intermodulation distortion measured 3% at 8 watts. Total harmonic distortion at 1 kc. was reported at about 0.1% below 10 watts.

Stancor bulletin No. 382, now available, includes templates, a schematic drawing, and a complete parts list. Copies can be obtained from parts dealers or by writing direct to the manufacturer.

# DESIGN DATA for AF AMPLIFIERS — No. 12 Power Amplifiers

## PART 2 — ADVANTAGES AND CHARACTERISTICS OF PUSH-PULL OUTPUT CIRCUITS, USING EITHER TRIODES OR BEAM POWER TUBES

DESIGN DATA Sheet No. 11 was concerned with the basic differences between triode and beam power amplifier tubes, and the dissimilarities in performance caused by these differences. Single-ended circuits were employed to illustrate the presentation conveniently. While such circuits are used extensively in commercial radios and radio-phonographs, they are limited in performance capability to such an extent that they are never incorporated in installations intended to deliver high-quality performance.

Rather, push-pull circuits of Fig. 1, or some variation of them, are invariably employed. They are termed push-pull circuits because they are driven by grid signals identical except for polarity. Thus, the current in one tube increases as that in the other tube decreases. The currents in the output transformer are therefore additive, each reinforcing the other and producing in the secondary winding a single current which is a combination of the two.

### ADVANTAGES OF PUSH-PULL

Reference to characteristic curves in a tube manual will show that plate current is never directly proportional to grid voltage over an extended range. This is true for all tube types.

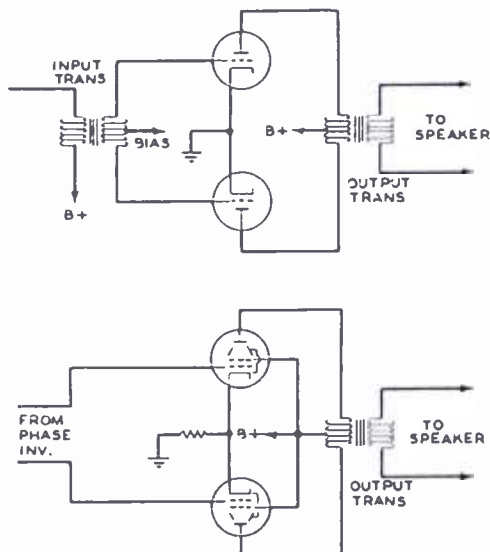

FIG. 1. BASIC PUSH-PULL POWER AMPLIFIERS

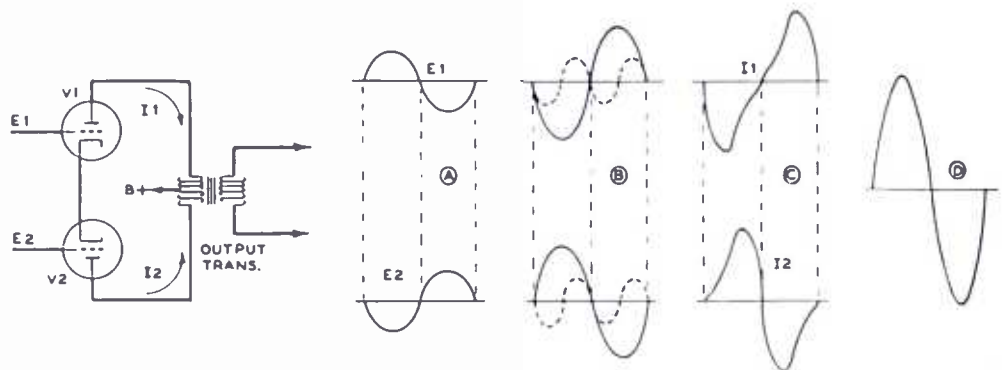

FIG. 2. HOW EVEN-ORDER HARMONICS AND HUM ARE CANCELLED IN A PUSH-PULL CIRCUIT

Since the output of a single tube is not a perfect replica of the input under those conditions, distortion must be present. This type of distortion is designated as amplitude or non-linear distortion, and results in the generation of harmonics of the original waveform. Of these, the second harmonic is strongest and most troublesome.

Fig. 2 shows the input and output waveforms of a typical push-pull stage, with only second-harmonic distortion considered. The grids of V1 and V2 are fed input signals of opposite polarity and equal amplitude, indicated at A as E1 and E2. If V1 and V2 were perfectly linear devices, the resulting tube currents would be as shown by the solid curves at B. However, second harmonics (among others) are generated, and these are indicated by the broken lines at B. The curves at C show the resultant currents through the output transformer. The absolute values of these currents are added to obtain the total output waveform, indicated at D. It is seen that the output of the push-pull stage is once again identical to the input waveforms. Here, then, is the first and major advantage of a push-pull circuit:

1. Cancellation of even-order harmonics: Third- and higher-order odd harmonics are not cancelled, but neither are they increased. Typically, total harmonic distortion is reduced from 10% to 2% by changing from single-ended to push-pull design.

2. Increased efficiency: Because of the radically reduced distortion, the load impedance in a push-pull circuit can be made much closer to the plate resistance of the tube, thus increasing the power output of each tube over that of a tube in a single-ended circuit. For example, 6L6 tube, single ended, delivers 6.5 watts in a typical

circuit. With the same electrode potentials, push-pull 6L6's provide 17 watts. Still further increases in power output can be obtained by biasing to Class AB or B, which is impossible in single-ended designs. This procedure is not recommended, however.

3. Hum cancellation: Any hum present in the power supply to the push-pull stage is cancelled in the same way as even-order harmonic distortion.

4. Elimination of the cathode bypass capacitor: As can be seen in Fig. 1, current for both tubes flows through the common cathode resistor. When the current in one tube is increasing, that in the other is decreasing. Their algebraic sum is constant, thus providing a constant DC bias for both tubes.

5. Adequate power: Estimates of the audio power requirements for a high-fidelity home installation range from 10 to 50 watts, with the most popular figure 20 watts. Only a push-pull design can supply this. No tube in general use can provide even the lowest figure, 10 watts, at reasonable distortion.

It can be appreciated that the advantages of push-pull design far outweigh its single disadvantage, the requirement of a phase inverter. (For discussion of phase inverters, see Design Data Sheet No. 5, October, 1950.)

When a cathode resistor is used in a push-pull stage, its value should be  $\frac{1}{2}$  that for a single tube, and its wattage rating double.

### CONCLUSION

The relative merits of triodes and beam power tubes hold in push-pull circuits as well as in single-ended designs. Both can be improved significantly by inverse feedback.

# PROFIT IN TAPE

EASE OF RECORDING ON TAPE, AND HIGH PLAYBACK QUALITY ARE BUILDING SALES BY PARTS JOBBERS TO AN IMPRESSIVE VOLUME — *By CHARLES FOWLER\**

IT'S not so long ago that magnetic tape for audio recording was very much of a novelty. In fact, the first commercial tape recorders built in this country used plastic tape imported from Germany. The first technical data on the equipment and its commercial uses was brought over here by Col. R. H. Ranger and a team of engineers sent to Europe after the last war by our Government to collect data on this particular development.

## Advantages of Tape:

From that point, refinements in the manufacture of tape and progress in the development of recorder-playback machines for commercial and home use were very rapid. Tape has five important advantages over discs for recording:

1. At a tape speed of 15 ins. per second, frequencies from 50 to 15,000 can be recorded with not more than a 2-db droop at the lower and upper extremes. There is no noticeable background noise, even at 15,000 cycles, if good equipment is used. Moreover, tape can handle a wider dynamic range than records.

2. Very little skill and experience, either technical or manual, are required to make high-quality recordings on tape. In fact, an unattended tape machine can be arranged to start and stop automatically if, for example, a particular radio program is to be recorded. And if the program outlasts one reel of tape, the amplifier can be switched automatically to a second machine to take up where the first stopped!

3. Once a disk recording has been made, it cannot be edited. Tape, on the other hand, can be cut and spliced to eliminate sections, or to make discontinuous recordings into one continuous program. Using large reels, one tape can be made to run as long or longer than one side of an LP disc.

4. If tape is used carefully, it can be played more times without deterioration of the audio quality than transcriptions or commercial pressings. And tape can be reused by merely erasing a previously recorded program. Where a second machine is available, excellent tape copies can be made, particularly if the original was recorded at 15 ips.

5. Of course, there aren't any 15,000-cycle disc recorders suitable for home use, but tape machines capable of re-

ording up to 5,000 or 8,000 cycles are less expensive than comparable disc recorders.

## Market for Tape Machines:

In number of models, moderately-priced tape machines predominate. They are priced from \$100 to \$275. Most are complete with microphone, amplifier, and at least a monitor speaker, ready to operate. Tape speeds vary from 1 7/8 to 7 1/2 ips., making the top recorded frequencies 7,000 to 8,000 cycles. There are a few models between \$350 and \$900, operating at 7 1/2 and 15 ips., so that they can record up to 15,000. Then come the more elaborate designs, intended for use in broadcast stations and sound studios, costing up to \$2,500 or more.

A surprising thing about sales of this equipment is the ease with which customers can be traded up to the more expensive models. This applies particularly to parts jobbers who specialize in high-fidelity equipment. In such stores, tape machines are the highest-price items carried. While these are bought for various professional uses, the hi-fi enthusiasts account for the majority of the sales. Single sales of \$1,000 to \$2,000 are not unusual.

The strong appeal of tape equipment seems to lie in the fact that such remarkably fine reproduction can be obtained without skill or technical knowledge. This is in contrast, for example, to the experiences of those who buy expensive complicated cameras only to find that the pictures don't turn out as well as those taken with a Brownie.

## Tape Equipment:

Dealers specializing in factory-built audio and television broadcast receivers find the readiest sale for portable tape machines. These are self-contained units, comprising recording and playback heads, an amplifier, and speaker. Those catering to the hi-fi enthusiasts find their greatest demand is for more advanced models suitable for built-in installations, and capable of operating at 7 1/2 and 15 ips.

Such customers are apt to prefer a tape machine that is supplied without an amplifier. The reason is that they may own good amplifiers already, or they may want to experiment with different types. The same thinking applies to FM-AM tuners. Some recorders, however, are designed with the tape mechan-

ism as one unit, and the electrical circuits in another, so that it is virtually necessary to purchase both. The range of standard models is adequate to suit all purposes and types of installations.

A great many parts jobbers have changed over their audio demonstration rooms in order to install tape machines permanently, connecting them into their switching systems so that they can make a sample recording from FM reception or a microphone, and play the tape through any speaker-amplifier combination. In that way customers can hear the tape reproduction from audio equipment similar to what they own already. After the demonstration, the recording can be erased, and the tape used again.

The advent of tape libraries promises to give further impetus to the sale of the machines. One company is already marketing tapes which carry a number of related compositions similar in character to LP records. At least a second company will enter this field shortly. Nearly all the stores handling audio equipment have kept away from phonograph records. However, they may prove to be the logical outlet for tape libraries because most record shops do not have tape machines.

What do people do with tape equipment? Surprisingly, many use it to record particularly good FM programs. Then they cut out the commercials, and make up their own programs to be played just the way they want them. Also, they make duplicates of their own tapes to swap for selections they haven't recorded themselves, or for better recordings of the same selections.

There are many other uses, ranging from piano, voice, and speech-making practice to documentary records of family activities, or entertaining unsuspecting friends with a tape reproduction of an evening's conversation. In many cases, one might suspect, the purchase of tape equipment is the next step for hi-fi enthusiasts who have exhausted the possibilities of experimentation with their radio-phonograph installations.

Actually, there are so many interesting things to do with tape machines that they offer an increasing volume of very profitable sales for dealers who undertake the serious promotion of this equipment. Moreover, there is subsequent and continuing profit in the sale of the tape itself to customers who have bought the machines to use it!

\* Editor, HIGH-FIDELITY Magazine, Great Barrington, Mass.

**For HEAVY DUTY  
WORK! Severe Electrical  
Services!**



P-506-CE  
Plug with Cap



S-506-DB  
Socket with  
deep Bracket

**JONES  
PLUGS &  
SOCKETS**  
500 SERIES  
*Proven  
Quality*

**For 5,000 Volts,  
25 Amperes per  
Contact Alter-  
able by circuit  
Characteristics.**

Socket contacts phosphor bronze, knife-switch type, cadmium plated. Plug contacts hard brass, cadmium plated. 2, 4, 6, 8, 10, and 12 contacts. Plugs and sockets polarized. Long leakage path from terminal, and terminal to ground. Caps and brackets, steel parkerized (rust-proofed). Plug and socket blocks interchangeable in caps and brackets. Terminal connections most accessible. Cap insulated with canvas bakelite.

Write for Jones BULLETIN 500 for full details on line.



**HOWARD B. JONES DIVISION**  
CINCH MANUFACTURING CORPORATION  
CHICAGO 24, ILLINOIS  
SUBSIDIARY OF UNITED-CARB FASTENER CORP.

# FREE NEW BIG RADIO CATALOG



Reserve your copy. Lists everything in radio, television, electronics. All the newest parts and equipment, as well as the old, standard lines. Fill out coupon now and paste on penny post card.

*Lafayette Radio*

DIVISION: RADIO WIRE TELEVISION, INC.

NEW YORK 13, 100 Sixth Ave.  
NEWARK 2, 24 Central Ave.  
BOSTON 10, 110 Federal St.  
BRONX 58, 542 E. Fordham Rd.

30  
YEARS  
OF  
VALUES

**LAFAYETTE RADIO, Dept. HH-51**

100 Sixth Avenue, New York 13  
Please rush Free catalog:

NAME.....

ADDRESS.....

CITY..... STATE.....

PASTE ON PENNY POSTCARD

## FAS AT AUDIO FAIR

AT the Audio Fair last year, an early version of the FAS Audio System attracted more visitors than any other exhibit.

Experiments have continued during the past year, and substantial improvements have been made. A series of reflex designs, extending the basic Air-Coupler idea, have been successful in lowering and smoothing the bass range still further. The latest reflex Air-Coupler will be included in a joint exhibit by RADIO COMMUNICATION and HIGH-FIDELITY Magazines at the 1951 Audio Fair, to be held Nov. 1, 2, and 3 at the Hotel New Yorker.

You are cordially invited to bring your own records to room 641 at the Fair, so that you, can compare FAS reproduction on a familiar recording.

## AFTER THE TV THAW

(Continued from page 16)

operators in California, for example, found that signals from their own cars, 20 miles away, were sometimes blanked out by stations in Florida!

On 152 to 162 mc., experience showed that solid coverage could be obtained over ample operating range, with a considerable reduction of co-channel and adjacent-channel interference due to transmission beyond distances necessary to the operation of the system. Of course these systems are permitted to employ only 50 to 250 watts.

The principal difference between 160 and 450 mc. is not as much in the solid-coverage area as in the sharper reduction of transmissions beyond the service contour. Shadow effects in a metropolitan area surrounding a 450-mc. transmitter are not a limiting factor, even though the mobile units operate with a short car-top antenna at the street level. The effect of shadows caused by high ground on open country are more noticeable, but it must be remembered that the output of the main stations used for these systems amounts to only a few watts. Moreover, solid reception can be obtained from low-level UHF signals because static interference, particularly from automobile ignition, is much less serious on UHF than VHF.

For communications service, dependable, solid coverage, free from interference within the operating range of the system, is a prime requirement.

Thus, in the main, because of the present crowded co-channel conditions, the direction of progress is toward the use of higher frequencies which can be repeated without causing interference, and the limitation of power to that required to cover the area served by each system.

(Continued on page 37)

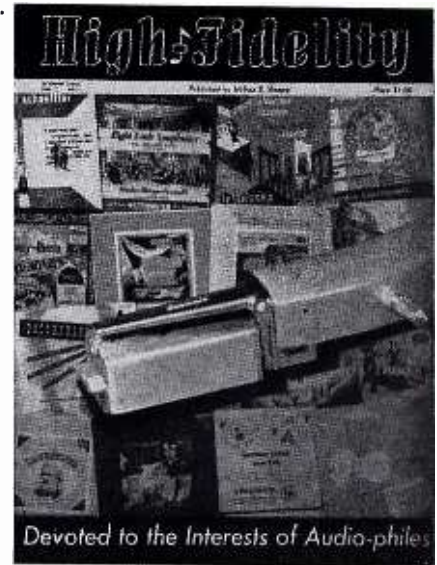

Devoted to the Interests of Audio-philis

## FOR ALL HI-FI ENTHUSIASTS

If you're interested in FM radio, phonograph records, and tape equipment, you will be amazed and delighted at the wealth of articles, illustrated with more than 100 photographs and drawings, in the fall issue of HIGH-FIDELITY Magazine.

THIS issue, to be mailed out September 15th, contains an increased number of pages more articles on equipment, installations, more record reviews, and more advertising of interesting products from new types of amplifiers and speaker cabinets to tuners and tape machines.

THE hundreds and hundreds of enthusiastic letters commenting on the first issue of HIGH-FIDELITY were summed up in a brief note which accompanied a subscription from T. C. Browne, of Palo Alto. He wrote: "Just saw your first issue. It's terrific! This publication fills a gap which has been getting wider and wider in the last few years."

If you, too, saw the first copy of HIGH-FIDELITY, you will be agreeably surprised at the progress represented by the coming issue. And if you aren't a subscriber already, mail the coupon below right now, so you can get the new issue without delay.

**HIGH-FIDELITY MAGAZINE**  
Milton B. Sleeper, Publisher  
Great Barrington, Mass.

Please enter my subscription for  
 1 year, \$3.00  
 3 years, \$6.00 (SAVE \$3.00)

Publication dates: Sept. 15, Nov. 15, Feb. 1, Apr. 15.

Start my subscription with the  
 Summer Issue  Fall Issue

Name .....

Address .....

.....

(Continued from page 36)

### Quality of TV Reception:

Policies of the TV broadcasters seem to be based on the long-established attitude of audio operators, namely: "I don't care how you receive my station, as long as you listen to it." That's why AM stations whose primary, interference-free radius at night may be no more than 20 miles publish coverage maps showing the number of listeners per county at distances a thousand miles or more from their transmitters. It's something of a mystery as to how those surveys are made. Anyway, advertising agencies buy time on the basis of the survey figures, without ever asking what per cent of the time a sponsor can expect his program to be heard at a given location, or how much of the time it will drop out due to co-channel interference or fading.

So, contrary to the philosophy of the communication services, audio broadcasting was, and television broadcasting is being set up on the theory that the highest rates can be charged by stations with the most power, operating on the lowest frequencies.

Now, insofar as television is concerned, there is reason to challenge that theory. Many AM listeners will agree that "The witticisms of Charlie McCarthy, for example, are just as humorous on a receiver whose frequency range is 200 to 3,000 cycles as on a higher fidelity system,"<sup>3</sup> but some of the funniest parts of the current TV programs must be seen to be appreciated. Charlie isn't funny, Dagmar isn't glamorous, and the key of a mystery may be lost when the picture is unexpectedly broken up by interference or fades into a snow scene.

In the beginning, owners of TV sets accept the effects resulting from the vagaries of coverage that is less than solid as part of the marvel of television itself. But soon a feeling of annoyance develops. It's like buying a subscription to a magazine from which a few pages are omitted in each issue.

There's another angle to less-than-perfect reception. Quietly, but with great determination and effect, the oculists are campaigning against poor picture quality. Their attitude cannot be discounted by broadcasters, because their concern is directed to children. When a child comes home from school with a note saying that he may need glasses, and the oculist says "no more television," the news travels far and fast.

To bring this discussion down to a factual basis, let's consider a specific ex-

(Concluded on page 38)

<sup>3</sup>See "Checking up on Audio Progress" a reprint of a 1944 statement from NBC, published in RADIO COMMUNICATION, July, 1951.

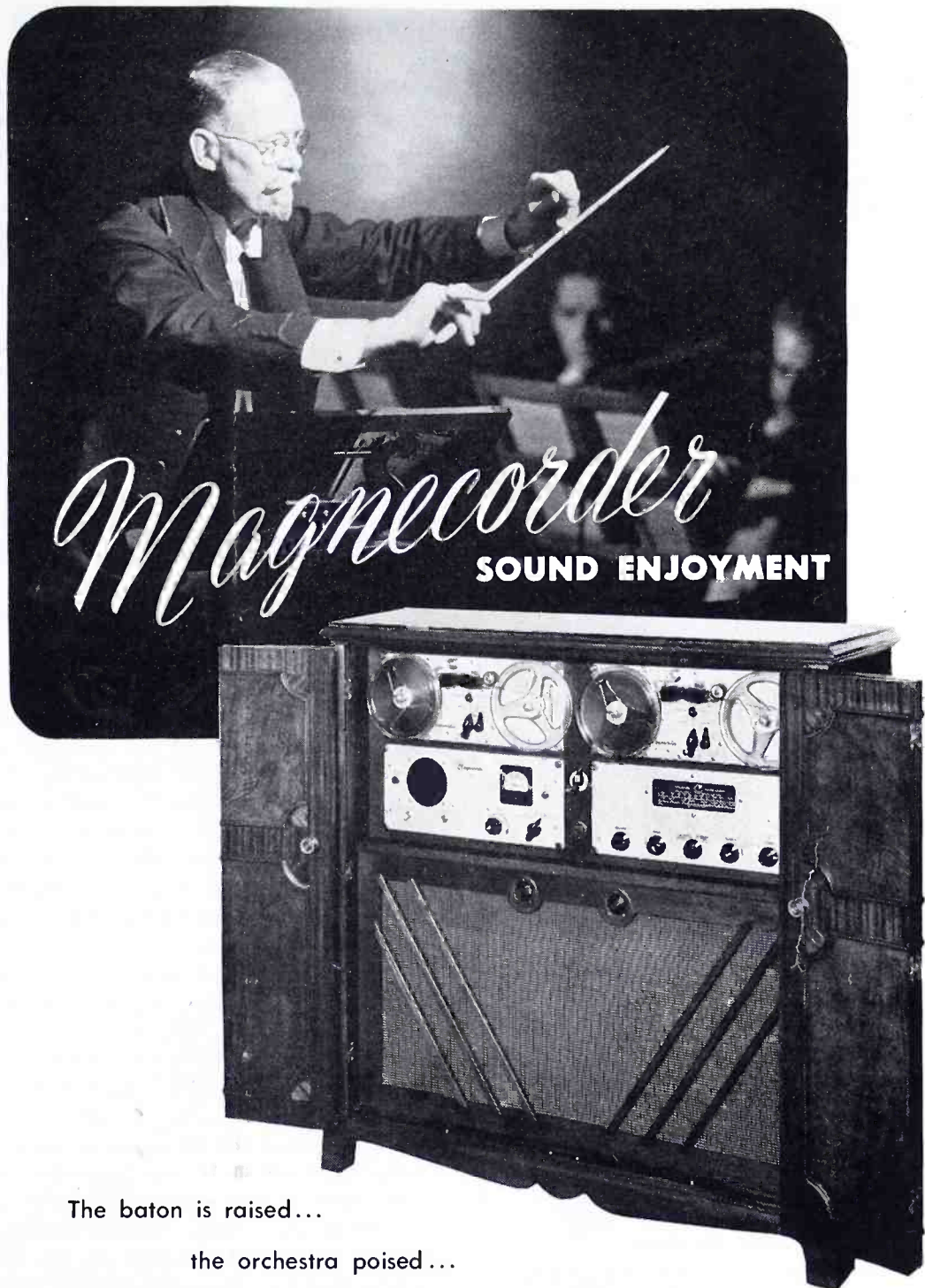

The baton is raised...

the orchestra poised...

then...the superb tones and rhythms of musical artistry. This thrilling moment is relived each time a Magnecord Tape Recorder brings "living sound" into your home.

Great music has greater charm when recorded and played with Magnecord clarity and concert-hall realism. Easily mounted in your cabinet or custom-built installation, these professional recorders put an unlimited musical repertory at your fingertips.

Listen and prove for yourself — the matchless high fidelity, full-range performance, and "presence" of Magnecorders.

### WRITE FOR NEW CATALOG

Name.....

Address.....

City..... Zone..... State.....

**M**agnecord, INC.  
Professional Tape Recorders

360 NORTH MICHIGAN AVENUE  
CHICAGO 1, ILL. • DEPT. FM-8

Design Data on the  
Internationally Famous

**WILLIAMSON  
AMPLIFIER**

A new book by D. T. N. Williamson, designer of this renowned audio amplifier, has been published by the "Wireless World" of London. The author, formerly of M. O. Valve Company, and now with Ferranti Research, Ltd., has added a considerable amount of information on high-fidelity reproduction, filters, and an automatic fader to reduce gain while records are being changed.

This book contains 36 pages with 31 photos and diagrams.

PRICE \$1.00 Postpaid  
in the U.S.A.

NOW AVAILABLE FROM

**RADIOCOM, Inc.**  
Great Barrington, Mass.

NO. 1 SOURCE



LEADING BRANDS  
**ELECTRONIC TUBES  
and EQUIPMENT**  
for ALL BROADCAST  
and INDUSTRIAL APPLICATIONS  
—For IMMEDIATE DELIVERY!

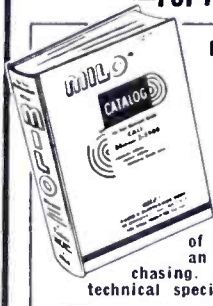

**PURCHASING AGENTS!  
CHIEF ENGINEERS!**  
Send For This!  
**FREE 1053 PAGE  
MILO CATALOG!**

Write today on your company letterhead for your copy of our gigantic buying guide — an invaluable aid in your purchasing. Completely illustrated, with technical specifications. Address Dept. FV.

**The NATION'S GREATEST STOCK!**  
CONDENSERS • RESISTORS • TRANSFORMERS  
CONNECTORS • SWITCHES • RHEOSTATS  
RELAYS • PLUGS • JACKS • CHASSIS  
TUBES, etc.

★ For PROMPT, PERSONAL ATTENTION  
PHONE • WRITE • WIRE—or TELETYPE!

**MILO RADIO  
& ELECTRONICS CORP.**

200 GREENWICH STREET, NEW YORK 7, N. Y.  
Phone BEekman 3-2980 • Teletype NY1-1839

**AFTER THE TV THAW**

*(Continued from page 37)*

ample of VHF broadcasting. In our Great Barrington area, few people can get WNBC-TV, even when they shift their antennas to face south. The air-line distance to New York City is about 90 miles. WRGB, Schenectady, some 60 miles northwest, gave generally excellent reception until the new WNBC-TV antenna was put into operation. Both use channel 4. Now, WNBC is still not strong enough for direct reception, but the increase has been sufficient to cause serious interference with WRGB. The stations are about 150 miles apart, and Great Barrington is a considerable distance from a direct line drawn between them.

**There's Much to Be Said for UHF:**

Judging from the 1,000-odd petitions filed with the FCC for changes in the allocation table by broadcasters who want VHF channels, UHF allocations aren't in much demand. Meanwhile, the VHF log-jam is delaying the end of the TV freeze. Until that is over, no effort will be made to tackle the backlog of petitions which, even when the hearings start, will drag along interminably through legal procedure.

In the end, only a few broadcasters will get VHF channels. Yet in terms of solid coverage, they will get little more than those who have spent lavishly of time and money, and are forced to settle for UHF assignments in the end.

The difference lies in fringe-area coverage. How much is that going to be worth? All things considered, there is much to be said in most cases for making plans to put a UHF station on the air quickly after the freeze ends, rather than going into the red for the expense and delay involved in hearings on a VHF petition. UHF or VHF-UHF sets aren't going to be any problem. Manufacturers will be pleased to move into any market with promotion and deliveries on anything that will mean sales.

Of course, this reasoning may be all wrong. Maybe the philosophy of AM broadcasting will prevail in TV, too. But experience in the communication field indicates that 1) solid TV coverage on UHF will be about equal to that on VHF with the same power, 2) automobile ignition noise and natural static will be less on UHF, so that weaker signals will give perfect pictures, and 3) co-channel interference from stations erected subsequently will be decidedly less on UHF. If the principal advantage of VHF lies in added fringe coverage, it's possible that TV applicants should back up and take a thorough look at the possibilities of UHF.

*You Are  
Cordially Invited*

*to an exhibit and  
demonstration of  
the justly famous*

**FAS**

*Audio System*

*presented jointly by*

*Radio Communication*

*and*

*High-Fidelity*

*1951 Audio Fair*

*room 641*

*Hotel New Yorker*

*November 1,2,3*

Bring your own records to  
try on the FAS System



# INDEX OF ADVERTISERS

FOR YOUR CONVENIENCE, TELEPHONE  
NUMBER OF EACH COMPANY IS SHOWN HERE



Adair, George P. ....	8
Washington, D. C.: Executive 1230	
Alford, Andrew ....	8
Boston: HAncock 6-2339	
American Phenolic Corp. ....	28
Chicago: Bishop 2-1000	
Andrew Corp. ....	7
Chicago: Triangle 4-4400	
Bendix-Scintilla ....	Inside Front Cover
Sidney, N.Y.	
Boonton Radio Corp. ....	31
Boonton, N. J.: Boonton 8-0795	
Cleveland Inst. of Radio Electronics ....	27
Cleveland, Ohio: EX 1-8888	
Communications Equip. & Engrg. Co. ....	4
Chicago: Estebrook 8-3110	
Davis, George C. ....	8
Washington, D. C.: Sterling 0111	
Doolittle Radio, Inc. ....	6
Chicago: Radcliffe 3-4100	
Du Mont Laboratories ....	2
Clifton, N. J.: Sherwood 2-7400	
Eitel-McCullough, Inc. ....	40
San Bruno, Cal.: San Bruno 4000	
General Apparatus Corp. ....	39
So. Egremont, Mass.: Gt. Barrington 560	
Gray Research & Development Co. ....	10
Hartford, Conn.: Hartford 33-1271	
Hammarlund Mfg. Co., Inc. ....	3
New York, N. Y.: Longacre 5-1300	
Help Wanted ....	9
High-Fidelity Magazine ....	36
Gt. Barrington, Mass.: Gt. Barrington 500	
Jansky & Bailey ....	8
Washington, D. C.: ME 5411	
Jones, Howard B., Division ....	36
Chicago: Nevada 2-2000	
Kaar Engineering Co. ....	29
Palo Alto, Calif.: Davenport 3-9001	
Kear & Kennedy ....	8
Washington, D. C.: Sterling 7932	
Klipsch & Associates ....	9
Hope, Ark.: Hope 995	
Magnecord, Inc. ....	37
Chicago: Andover 3-3737	
Maurer, Inc., J. A. ....	9
Long Island City, N. Y.: Stillwell 4-4601	
May, Russell P. ....	8
Washington, D. C.: Republic 3984	
McCachren, Winfield Scott ....	8
Arlington, Va.:	
Measurements Corp. ....	9
Boonton, N. J.: Boonton 8-2131	
Milo Radio & Electronics Corp. ....	38
New York City: Beekman 3-2980	
Motorola, Inc. ....	Back Cover
Chicago: Spaulding 2-6500	
Radcom, Inc. ....	5, 9, 31, 38
Gt. Barrington, Mass.: Gt. Barrington 500	
Radio Engineering Labs. ....	30
Long Island City, N. Y.: Stillwell 6-2101	
Radio Wire Television Inc. ....	9, 36
New York City	
Ray, Garo W. ....	8
Stratford, Conn.: Stratford 7-2465	
United Transformer Corp. ....	Inside Back Cover
New York City: Algonquin 5-3500	
Weldon & Carr ....	8
Washington, D. C.: Michigan 4151	
Wincharger Corp. ....	25
Sioux City, Iowa: Sioux City 8-6513	
Workshop Associates, Inc. ....	8
Newton Highlands, Mass.: Needham 3-0005	
Zenith Radio Corp. ....	1
Chicago: Berkshire 7-7500	

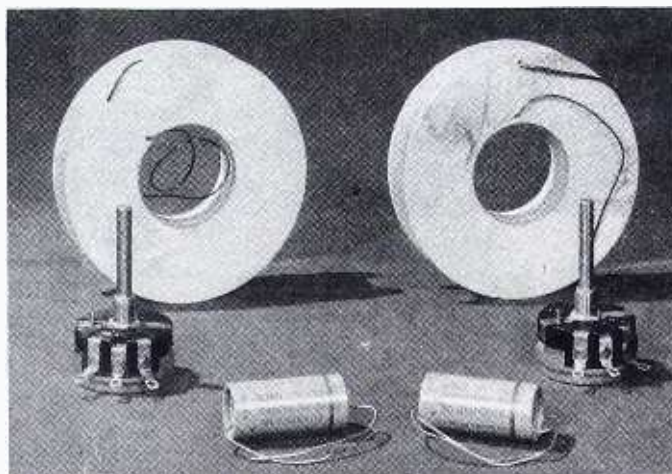

## G. A. Crossover Networks for BASS REINFORCEMENT

Choose the Crossover Frequency You Prefer

**SLOW-ATTENUATION NETWORK**, as described in *Radio Communication Magazine*, May, 1951: You can add an FAS Air-Coupler to provide bass reinforcement for your present speaker, operating at any crossover point listed below. Only one inductor is necessary, plus the associated condensers and level controls.

Choose the inductor according to the impedance of your bass speaker. Matching to your upper-range speaker can be accomplished with the level control after installation.

Crossover Frequency	Bass Speaker 4 Ohms	Bass Speaker 8 Ohms	Bass Speaker 16 Ohms
125 Cycles	Inductor B \$6.00	Inductor A \$10.00	.....
250 Cycles	.....	Inductor B \$6.00	Inductor A \$10.00
450 Cycles	Inductor C \$4.00	.....	Inductor B \$6.00

Add \$4.00 for the associated capacitors and the level controls

**SHARP-ATTENUATION NETWORK**, as described in *Radio Communication Magazine*, December, 1950: If you prefer sharp attenuation, order two inductors of the type listed below, according to the impedance of your bass speaker and the crossover frequency you prefer. Matching to your upper-range speaker can be accomplished with the level controls after installation.

Crossover Frequency	Bass Speaker 4 Ohms	Bass Speaker 8 Ohms	Bass Speaker 16 Ohms
85 Cycles	Inductor A \$10.00 each	Inductor A \$10.00 each	.....
170 Cycles	Inductor B \$6.00 each	Inductor A \$10.00 each	Inductor A \$10.00 each
275 Cycles	Inductor C \$4.00 each	.....	.....
350 Cycles	.....	Inductor B \$6.00 each	Inductor B \$6.00 each
550 Cycles	Inductor C \$4.00 each	Inductor C \$4.00 each	.....
1100 Cycles	.....	Inductor C \$4.00 each	Inductor C \$4.00 each

Add \$4.00 for the associated capacitors and the level controls

### SPECIAL AUDIO ITEMS — IMMEDIATE DELIVERY

6-ft. Air-Coupler parts, fine quality 3/4-in. plywood.....	\$34.50
Altec Lansing 600-B 8-ohm, 12-in. speaker .....	\$46.50
Peerless S-230Q output transformer .....	\$26.00
Peerless R-560A power transformer .....	\$16.90
Peerless C-455A power choke .....	\$10.70
English KT-66 output tube, to replace 6L6 .....	\$5.25

Cash must accompany your order. No C.O.D.'s. G. A. guarantees that each part will reach you in perfect condition, shipped in the original manufacturer's carton.

# General Apparatus Co.

South Egremont, Mass.

Phone Gt. Barrington 560



# FOR RUGGED SERVICE

the new Eimac ceramic 2C39 type triode



The new Eimac 2C39 type triode is specially constructed for service in which tubes are to be subjected to excessive physical and thermal abuse. Eimac engineers, in developing this improved version of the 2C39, have replaced glass with rugged ceramics. Through the use of new manufacturing techniques and ceramic materials, this new tube will operate at appreciably higher ambient operating temperatures than the glass-envelope type tube. Resistance to physical shock is also increased to a degree beyond that which is customarily associated with vacuum tube structures.

If you anticipate requirements for a tube of this type, we suggest you contact our application engineering department immediately.

**EITEL-McCULLOUGH, INC.**  
**San Bruno, California**

Export Agents: Frazar & Hansen, 301 Clay St., San Francisco, California

292

Follow the Leaders to

**Eimac**  
TUBES  
The Power for R-F

**Eimac ceramic 2C39 type triodes are another outstanding contribution to electronic progress.**



# ULTRA COMPACT UNITS...OUNCER UNITS

## HIGH FIDELITY... SMALL SIZE... FROM STOCK

UTC Ultra compact audio units are small and light in weight, ideally suited to remote amplifier and similar compact equipment. High fidelity is obtainable in all individual units, the frequency response being  $\pm 2$  DB from 30 to 20,000 cycles.

True hum balancing coil structure combined with a high conductivity die cast outer case, effects good inductive shielding.

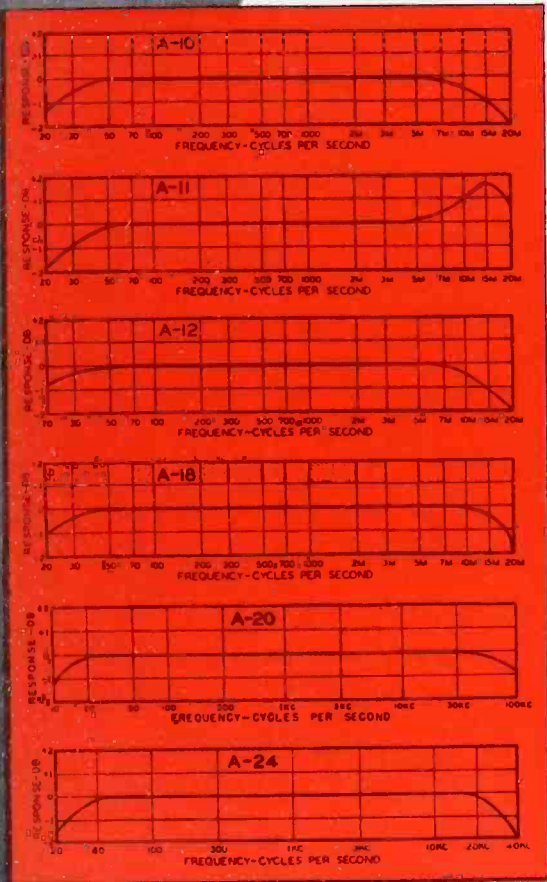

Type No.	Application	Primary Impedance	Secondary Impedance	List Price
A-10	Low impedance mike, pickup or multiple line to grid	50, 125/150, 200/250, 333, 500/600 ohms	50 ohms	\$16.00
A-11	Low impedance mike, pickup or line to 1 or 2 grids (multiple alloy shields for low hum pickup)	50, 200, 500	50,000 ohms	18.00
A-12	Low impedance mike, pickup or multiple line to grids	50, 125/150, 200/250, 333, 500/600 ohms	80,000 ohms overall, in two sections	16.00
A-14	Dynamic microphone to one or two grids	30 ohms	50,000 ohms overall, in two sections	17.00
A-20	Mixing, mike, pickup, or multiple line to line	50, 125/150, 200/250, 333, 500/600 ohms	50, 125/150, 200/250, 333, 500/600 ohms	16.00
A-21	mixing, low impedance mike, pickup, or line to line (multiple alloy shields for low hum pickup)	50, 200/250, 500/600	50, 200/250, 500/600	18.00
A-16	Single plate to single grid	15,000 ohms	60,000 ohms, 2:1 ratio	15.00
A-17	Single plate to single grid 8 MA unbalanced D.C.	As above	As above	17.00
A-18	Single plate to two grids. Split primary	15,000 ohms	80,000 ohms overall, 2.3:1 turn ratio	16.00
A-19	Single plate to two grids 8 MA unbalanced D.C.	15,000 ohms	80,000 ohms overall, 2.3:1 turn ratio	19.00
A-24	Single plate to multiple line	15,000 ohms	50, 125/150, 200/250, 333, 500/600 ohms	16.00
A-25	Single plate to multiple line 8 MA unbalanced D.C.	15,000 ohms	50, 125/150, 200/250, 333, 500/600 ohms	17.00
A-26	Push pull low level plates to multiple line	30,000 ohms plate to plate	50, 125/150, 200/250, 333, 500/600 ohms	16.00
A-27	Crystal microphone to multiple line	100,000 ohms	50, 125/150, 200/250, 333, 500/600 ohms	16.00
A-30	Audio choke, 250 henrys @ 5 MA 6000 ohms D.C., 65 henrys @ 10 MA 1500 ohms D.C.			12.00
A-32	Filter choke 60 henrys @ 15 MA 2000 ohms D.C., 15 henrys @ 30 MA 500 ohms D.C.			10.00

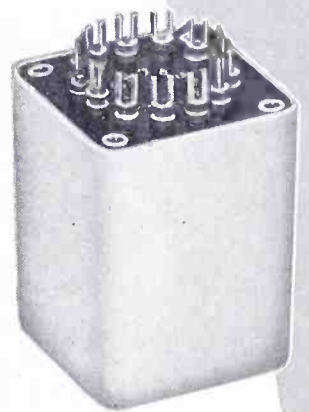

TYPE A CASE  
1 1/2" x 1 1/2" x 2" high

UTC OUNCER components represent the acme in compact quality transformers. These units, which weigh one ounce, are fully impregnated and sealed in a drawn aluminum housing 7/8" diameter... mounting opposite terminal board. High fidelity characteristics are provided, uniform from 40 to 15,000 cycles, except for 0-14, 0-15, and units carrying DC which are intended for voice frequencies from 150 to 4,000 cycles. Maximum level 0 DB.



OUNCER CASE  
7/8" Dia. x 1 1/8" high

Type No.	Application	Pri. Imp.	Sec. Imp.	List Price
0-1	Mike, pickup or line to 1 grid	50, 200/250, 500/600	50,000	\$14.00
0-2	Mike, pickup or line to 2 grids	50, 200/250, 500/600	50,000	14.00
0-3	Dynamic mike to 1 grid	7.5/30	50,000	13.00
0-4	Single plate to 1 grid	15,000	60,000	11.00
0-5	Plate to grid, D.C. in Pri.	15,000	60,000	11.00
0-6	Single plate to 2 grids	15,000	95,000	13.00
0-7	Plate to 2 grids, D.C. in Pri.	15,000	95,000	13.00
0-8	Single plate to line	15,000	50, 200/250, 500/600	14.00
0-9	Plate to line, D.C. in Pri.	15,000	50, 200/250, 500/600	14.00
0-10	Push pull plates to line	30,000 ohms plate to plate	50, 200/250, 500/600	14.00
0-11	Crystal mike to line	50,000	50, 200/250, 500/600	14.00
0-12	Mixing and matching	50, 200/250	50, 200/250, 500/600	13.00
0-13	Reactor, 300 Hys.—no D.C.; 50 Hys.—3 MA. D.C.,		6000 ohms	10.00
0-14	50:1 mike or line to grid	200	1/2 megohm	14.00
0-15	10:1 single plate to grid	15,000	1 megohm	14.00

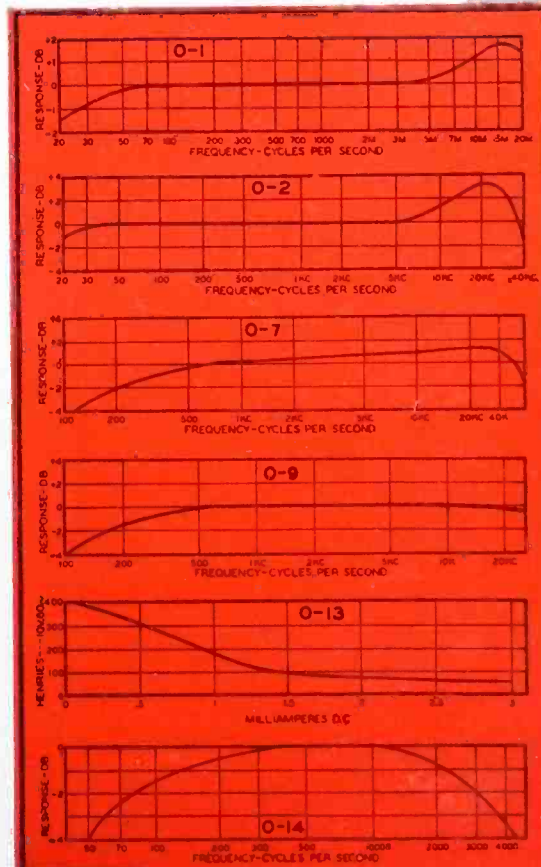

*United Transformer Co.*

150 VARICK STREET NEW YORK 13, N. Y.  
EXPORT DIVISION: 13 EAST 40th STREET, NEW YORK 16, N. Y., CABLES: "ARLAB"

it's revolutionizing 2-way radio

it's permanent!

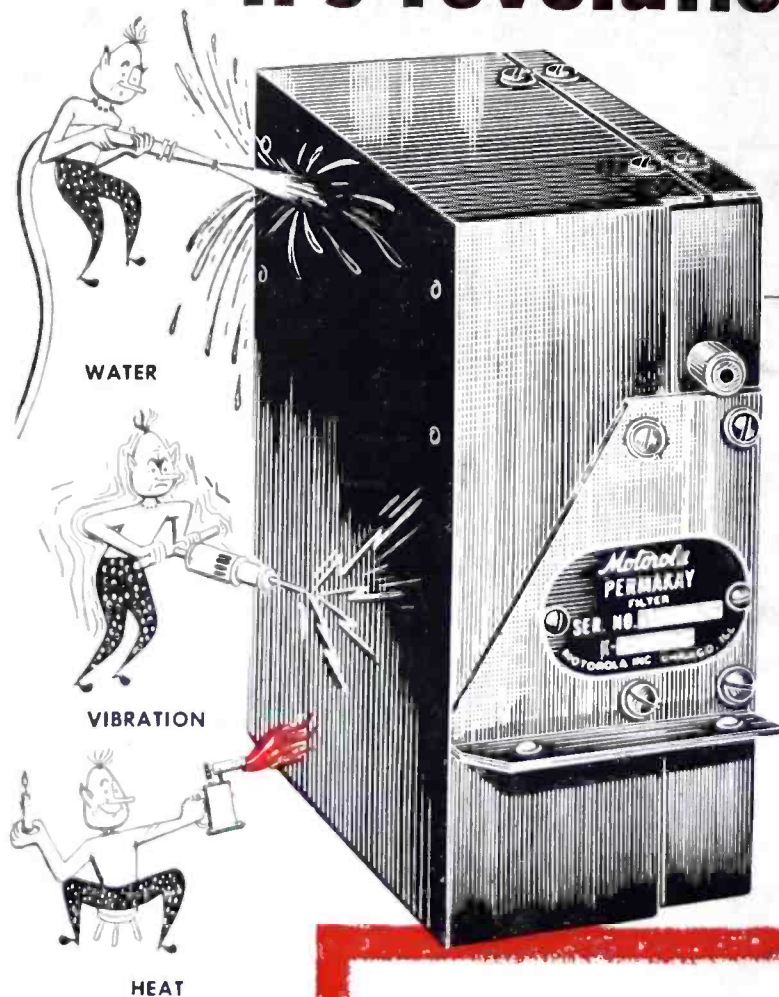

## Motorola's amazing invention . . .

THE SENSICON PERMAKAY FILTER FOR GUARANTEED PERMANENT SELECTIVITY! *Thousands*

*in the field, operating year in and year out, without failure.*



Permakay is here to stay as the keystone of the Sensicon Circuit

The Permakay I.F. Wave Filter for PERMANENT SELECTIVITY—*guaranteed for the life of the set!* This coil and capacitor filter network is noise-balanced for optimum signal-to-noise ratio, achieved by counterphasing. These super-precision elements are cast in solid waterproof plastic which will not melt, crack, loosen, or deteriorate. PERMAKAY thus assures *permanent* precision selectivity, reduces maintenance, and increases all-around serviceability of your Motorola equipment.

. . . AND HERE AGAIN THE MOTOROLA GUARANTEE provides perfect radio service today and protects against obsolescence tomorrow. When radio channels are split you need not buy a new receiver—simply exchange the standard-channel Permakay filter for a new split-channel filter and your receiver is up to date and ready for years of service.

## Motorola FIRSTS

TRUE ADJACENT CHANNEL

SPLIT CHANNEL

SENSICON CIRCUIT

PERMAKAY\*

static oscillator

iso q cavities

differential squelch

capacitance discriminator

instantaneous deviation control

bridge balanced crystal oven

SO INSIST ON SENSICON and protect your investment!

# Motorola

Communications and Electronics Division  
4545 AUGUSTA BLVD. • CHICAGO 51  
In Canada:  
Rogers Majestic Electronics Ltd., Toronto, Ont.

SPECIALISTS IN MOBILE RADIO FOR 21 YEARS