

Price 25 Cents

Sept. '50

FM-TV

RADIO

★ ★ Edited by ★ ★
Milton B. Sleeper

COMMUNICATION



7DB GAIN FROM A
Communications Antenna
ALSO FEATURED IN THIS ISSUE
Microwave Facsimile System
Speaker Performance Tests

10th Year of Service to Management and Engineering

World Radio History

SPECIAL TERMINAL BOXES for V-5 and V-10 VARIACS*

VARIAC users have frequently asked for special terminal boxes for facilities impossible to fit in the space provided by the standard "T" terminal box regularly used with all V-5MT, V-5HMT, V-10MT and V-10HMT VARIACS.

We now stock a new, larger rectangular terminal box with sufficient room for almost any special terminal arrangement desired. Unlike the standard "T" box, the new box has a removable cover for easy access to its interior.

The boxes for the V-5 and V-10 series are identical and can be put on existing VARIACS by the customer with no difficulty. Both V-5 and V-10 VARIACS are now stocked with the new terminal cases.

Two boxes are available. The "TC" unit, a plain box with four BX or conduit knockouts and a blank cover, and the "TE" box equipped with a 3-wire outlet, cord and 3-terminal plug and a two-pole switch.



V-5MTE

VARIACS WITH SPECIAL WINDINGS

We receive many requests to modify the winding on VARIACS to furnish output voltages or voltage ranges different from the standard models, or to provide special input or output tap arrangements.

Where the quantities involved are sufficiently large to warrant special production, at a price reasonably low, we welcome your inquiries for VARIACS of this type.

When requesting quotations for these VARIACS please supply complete information to facilitate our prompt reply.

*Trade Name ©



SPECIFICATIONS **V-5MTC**

Dimensions of ALL Boxes: 2 7/8" wide, 3 1/2" high, 2" deep.

TYPE	DESCRIPTION	PRICE
V-5MTC	V-5 VARIAC with 4 knockouts in box...	\$24.00
V-5MTE	V-5 VARIAC with 3-wire outlet box, 3-wire cord and plug, 2-pole switch...	33.50
V-10MTC	V-10 VARIAC with 4 knockouts in box...	39.00
V-10MTE	V-10 VARIAC with 3-wire outlet box, 3-wire cord and plug, 2-pole switch...	48.50
BASIC BOXES		
TC BOX	Plain box with 4 BX knockouts, blank cover...	\$ 3.50
TE BOX	3-wire outlet, 3-wire cord and plug, 2-pole switch...	13.50



V-10MTC



GENERAL RADIO COMPANY

Cambridge 39,
Massachusetts

90 West St., New York 6 920 S. Michigan Ave., Chicago 5 1000 N. Seward St., Los Angeles 38

HAMMARLUND

MULTI-GATE* Remote Supervisory Control Systems

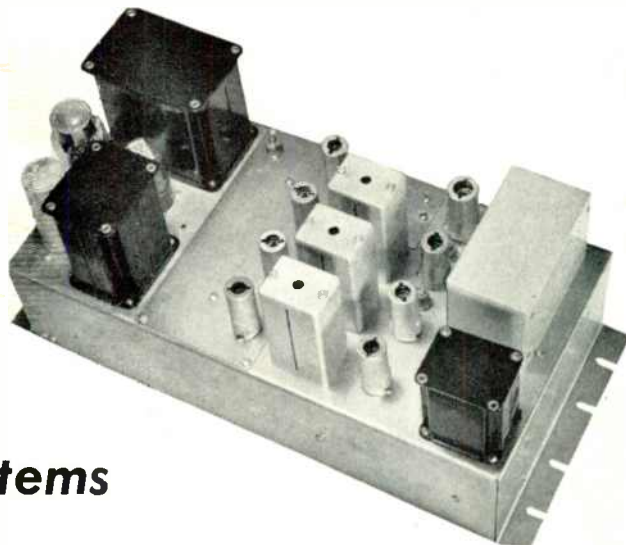

Hammarlund Multi-Gate* Systems save 50% in leased-line rental charges.

Hammarlund Multi-Gate Systems provide all-Electronic remote controls over either wire or radio circuits.

Hammarlund Multi-Gate Systems perform any desired number of separate functions, including manually- or automatically-controlled remote transmitter switching, monitor receiver selection, or any other remote functions.

Hammarlund Remote Supervisory Controls offer basic advantages of performance obtainable only through the use of the Multi-Gate principle:

- 1. No modification of the radio transmitters or receivers is required.**
- 2. Threshold of optimum operating level is established automatically, requiring no manual adjustment whatsoever.**
- 3. The only available equipment featuring absolute immunity to accidental operation by extraneous sources.**
- 4. Optimum operating efficiency is maintained through wide variations of line level, input balance, impedance, noise, and line reflections.**
- 5. Standard models provide for a minimum of 2 "on" and 1 "off" functions, to a maximum of 420 separate and distinct functions.**

Hammarlund engineers will assist in planning Multi-Gate equipment for all types of remote control applications, including selective return-beacons to verify completion, at the remote end, of any functional operations, as indicated on a headquarters indicator panel.

Write for literature on Hammarlund Selective Calling, and Multi-Gate Remote Supervisory Controls.

* Trade Mark applied for

HAMMARLUND MFG. COMPANY INC.

460 WEST THIRTY-FOURTH STREET, NEW YORK CITY, N. Y.

September 1950—formerly FM, and FM RADIO-ELECTRONICS

1

FM STATION OPERATORS!

Here's what one
FM broadcaster
says about
Zenith,
its distributors
and its dealers...

Radio WFMW Station

"The Radio Voice of The Messenger"

OWNED AND OPERATED BY
MESSENGER BROADCASTING COMPANY
INCORPORATED
Madisonville, Ky.
16 Mar. 50

PHONE
1655

Zenith Radio Corporation
Attention: Mr. Ted Leitzell
Chicago, Illinois

Dear Sir,

This station will broadcast all of the baseball games of the "Madisonville Miners"... a member of the Kitty League... on all of the road games. The baseball corporation will not allow us to broadcast the home games.

The Madisonville Miners is a farm club of the Chicago White Sox.

We had also planned to carry the St. Louis Cardinal games, however due to the fact that we are in a "Dry" territory and the sponsor is a beer company, we have had to drop these.

The games we carry will be sponsored by a local coal mining company, and we as well as the sponsor will welcome any other local corporation to

We also wish to take this opportunity to thank the Zenith Corporation for their untiring efforts in the promotion of FM broadcasts. YOUR PROMOTION HAS HELPED US PUT THIS STATION ON A PAYING BASIS IN LESS THAN ONE YEAR OPERATION.

Radio Station WFMW

H. W. Wells
H. W. Wells, Station Mgr

The Zenith Distributor in your territory is anxious to work with you to get more good FM sets throughout your listening area . . . to build bigger, better audience for you. Get in touch with him now . . . or write direct to Advertising Manager

ZENITH RADIO CORPORATION • 6001 Dickens • Chicago, Illinois



Formerly, FM MAGAZINE, and FM RADIO-ELECTRONICS

VOL. 10

SEPTEMBER, 1950

NO. 9

COPYRIGHT 1950, by Milton B. Sleeper

CONTENTS

TV-FM-AM Set Production

Compiled from figures released by the RMA 4

Spot News Notes

Items and comments about people and companies 6

What's New This Month

Discussion of FM meeting at NAB
A revolutionary system of audio reproduction 11

FM BROADCASTING

10-Watt FM Package

T. E. McConnell 12

COMMUNICATIONS

A New Communications Antenna

M. W. Scheldorf 14

Remote Supervisory Controls, Part 2

J. K. Kulansky 16

Mobile Radio News & Forecasts

Jeremiah Courtney 18

TELEVISION

FCC Issues Color TV Proposal

Official Text of the FCC Statement 20

AUDIO SECTION

Developments In England

James Moir 23

Design Data For AF Amplifiers, No. 4

Roy F. Allison 26

SPECIAL DEPARTMENTS

Professional Directory 8

Special Services Directory 9

News Pictures 19

Advertisers Index 35

THE COVER DESIGN AND CONTENTS OF FM AND TELEVISION MAGAZINE ARE FULLY PROTECTED BY U. S. COPYRIGHTS, AND MUST NOT BE REPRODUCED IN ANY MANNER OR IN ANY FORM WITHOUT WRITTEN PERMISSION

MILTON B. SLEEPER, *Editor and Publisher*

ROY F. ALLISON, *Associate Editor*
CHARLES FOWLER, *Business Manager*
LILLIAN BENDROSS, *Circulation Manager*
SOPHIE FORTY, *Production Manager*
Published by: FM COMPANY

Publication Office: 264 Main St., Gt. Barrington, Mass. Tel. Gt. Barrington 500
Chicago Office: Louis Reinig, 176 W. Adams St. Tel. Andover 3-5585
FM-TV Magazine is issued on the 10th of each month.

Subscriptions: Should be addressed to 264 Main St., Great Barrington, Mass.
Single copies 25c—Subscription rate: \$6.00 for three years, \$3.00 for one year in the U. S. A.—Canada, add 50c per year postage—foreign, add \$1.00 per year postage.

Contributions will be neither acknowledged nor returned unless accompanied by adequate postage, packing, and directions, nor will FM-TV Magazine be responsible for their safe handling in its office or in transit.

Entered as second-class matter August 22, 1946, at the Post Office, Great Barrington, Mass., under the Act of March 3, 1879. Additional entry at the Post Office, Boston, Mass. Printed in the U. S. A.



CIRCULATION AUDITED BY
HENRY R. SYKES,
CERTIFIED PUBLIC ACCOUNTANT
SYKES, GIDDINGS & JOHNSON
PITTSFIELD, MASSACHUSETTS



DEPENDABLE



and TROUBLE FREE VIBRATORS

Select your replacement vibrators wisely . . . and you, too will choose Radiart! Laboratory tests and customer reports prove that Radiart Vibrators give LONGER LIFE and trouble-free performance BECAUSE THEY ARE BUILT TO WITHSTAND RUGGED SERVICE! These extra hours of dependable performance are one of the factors that has made Radiart the leader. Superior engineering and design have made them THE STANDARD OF COMPARISON.

Get All Good Radio Parts Jobbers. Ask for the latest F-781 Sheet, listing Radiart Mobile Communications Vibrators



IT'S RIGHT WHEN IT'S RADIART

THE RADIART CORPORATION
CLEVELAND 2, OHIO



- ROTATORS
- VIBRATORS
- TV ANTENNAS
- AUTO AERIALS
- POWER SUPPLIES

MONITOR ANY 4 FREQUENCIES

Between 25-170 Mc

Check Frequency Deviation and Percentage of Modulation Simultaneously—with .0015% Accuracy

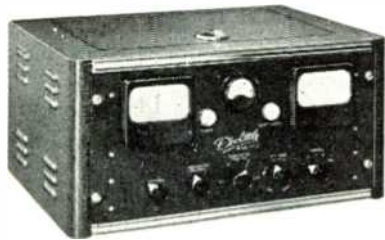

Doolittle

FD-12 FM FREQUENCY and MODULATION MONITOR

Now, just *one* Monitor for all FM radiotelephone services. With this single direct reading Monitor, you can handle one, two, three or four frequencies . . . or any combination up to four . . . on the same or different bands . . . anywhere between 25 Mc. and 170 Mc. And you can check not only frequency deviation, *but also your percentage of modulation!* Meets all FCC requirements. Assures utmost convenience, accuracy and reliability.

● Also available now—Increased range *littlefone* Portable FM Radiotelephones: PJZ-4 Two-Watt (25-50 Mc); PJZ-14 One-Watt (150-175 Mc); PJZ-2 Three-Quarter Watt (25-50 Mc); PJZ-12 Half-Watt (150-175 Mc).



THE steady transition from the 5-in. picture tube as the dominant prewar size, to tubes 14 ins. and larger may modify the plans for the whole future of television. RTMA figures for June show that all tubes under 14 ins. amounted to only 11% of the month's shipments to set manufacturers. If TV set production could continue at normal level, the 16-in. size might prove to be the minimum standard.

The circumstances created by public demand open up the question as to the adequacy of the present 525-line transmission standard. With 16-in. picture tubes as they are generally used, this provides about 50 lines per inch. However, received picture quality is distinctly below that theoretically attainable under the present standards. This is not due to limitations in TV transmitters, but to the limited band-width within which the transmission must be contained. Whether or not, in setting UHF standards, the FCC will recognize the need for wider channels to meet the public demand for bigger pictures and increased definition, only time will tell.

The latest figures on set production, as given in the Production Barometer,

are for the month of June. Consequently, they do not reflect the sudden demand built up by the Korean situation. Reports show that audio reception of news programs is greatly preferred over television. On the other hand, TV sales have been stepped up greatly since arrangements were made to enable Americans to see what manner of man Russia has sent to the UN to insult our national intelligence. If the manufacturers are able to keep up with the demand, July figures may establish new production records for this year.

Meanwhile, here are the June figures compared with the same month of 1949:

AM 952,749 up 102%
TV 388,962 up 142%
FM 101,707 up 151%

According to the FM broadcasters, FM set sales are now limited only by production. The demand for high-sensitivity models is far in excess of the supply in many areas. This is confirmed by some of the chassis manufacturers who report that, despite continued high-level production this summer, their backlog of orders is growing bigger each month. Incidentally, FM chassis are outselling FM-AM types.

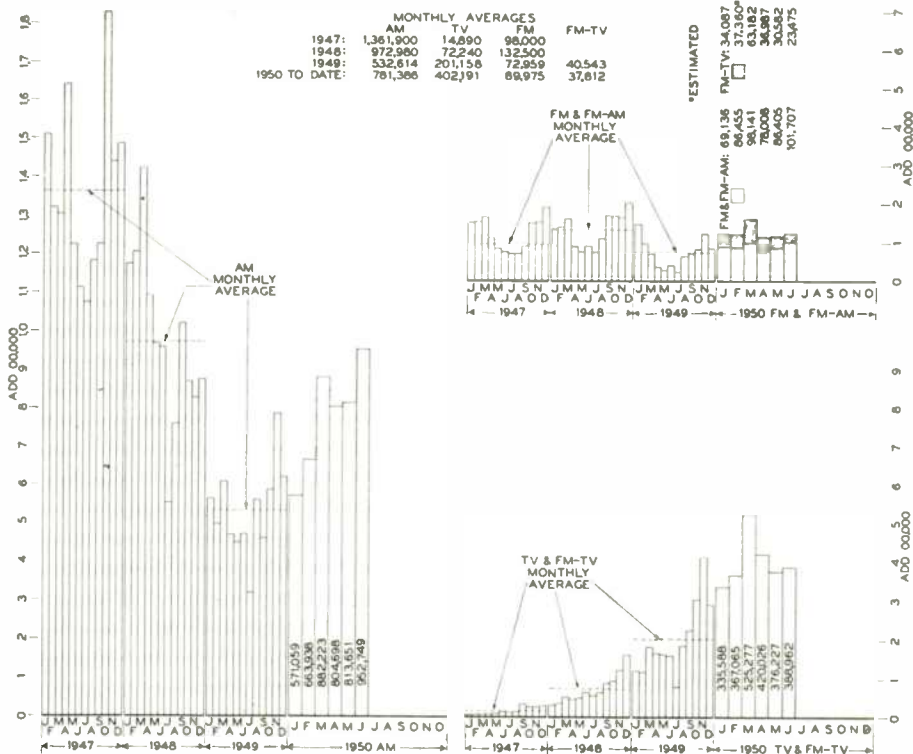

TV, FM, and AM Set Production Barometer, prepared from RTMA figures



**After unbiased comparative tests –
the STATE of FLORIDA
goes RCA!**

**Florida uses the complete
RCA Fleetfone System**



• Mobile Fleetfone 30 watts

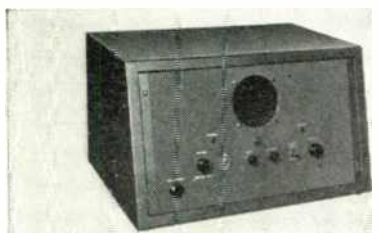

• Station Control

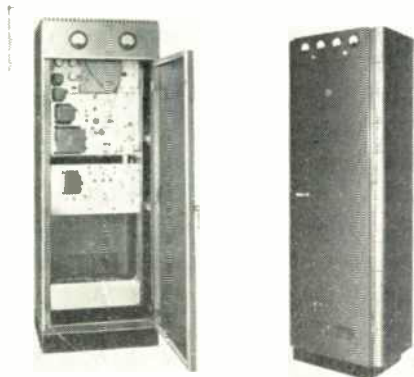

• Station Fleetfone
70 watts

• Station Fleetfone
250 watts

**RCA 2-way Fleetfone
radio chosen after tests by the
University of Florida Laboratories**

WHEN THE Florida State Highway Patrol prepared to expand its 2-way radio system to cover the entire state, competitive bids were invited and manufacturers were asked to submit equipment for tests.

The University of Florida Laboratories submitted these equipments to a series of gruelling tests to determine reliable car-to-car communication distance, adjacent-channel interference, and maximum headquarters-to-mobile range.

Result: Florida has ordered RCA Fleetfone 100%!

Plan your communicationssystem around *laboratory-approved* equipment. Go RCA. The RCA Fleetfone (for 30 to 50 mc operation) and its companion, the RCA Carfone (for 152 to 174 mc operation) offer the finest in mobile communications.

For information and help on any type of two-way radio system, call or write Dept. 381, RCA Engineering Products, Camden, N. J.

**MOBILE COMMUNICATIONS SECTION
RADIO CORPORATION of AMERICA
ENGINEERING PRODUCTS DEPARTMENT, CAMDEN, N. J.**

In Canada: RCA VICTOR Company Limited, Montreal

P
D
Q!

IMOS



Shown:
Bliley type MC-7

POLICE SERVICES DEMAND QUALITY!

Yes, all mobile services demand dependable crystal performance. Bliley engineering skill plus craftsmanship throughout production is quality. Your frequency control will be better with Bliley, the top choice for 20 years.

Bliley
CRYSTALS

BLILEY ELECTRIC COMPANY
UNION STATION BUILDING
ERIE, PENNSYLVANIA

THIS MONTH'S COVER

No, the radiators which can be seen on this month's cover picture aren't being mounted on the mast the wrong way! They are intended to provide vertical polarization for communication service. And they are arranged in bays to give a power gain of almost 5. This important contribution to antenna design for transmitters operating on 148 to 174 mc. comes from Andrew Corporation. Details will be found in a paper by M. W. Scheldorf, beginning on page 14 of this issue.



SPOT NEWS NOTES

ITEMS AND COMMENTS, PERSONAL AND OTHERWISE, ABOUT PEOPLE AND COMPANIES CONCERNED WITH RADIO COMMUNICATIONS

Mobile Systems in Trouble:

FCC inspectors are clamping down on mobile systems where service and maintenance work affecting frequency adjustments is not done by men holding required operator licenses. Several systems have been taken off the air recently for infraction of this Rule.

Audio Broadcasting Rates:

ANA efforts to effect a reduction of AM broadcasting rates has alerted stations to the importance of selling the coverage of their FM transmitters. While co-channel interference has cut nighttime AM coverage sharply, some stations have actually gained in total audiences by the increase in their FM listeners. In certain cases, the gain is enough to justify higher rates.

Marrion Hobbs:

Back in Washington, now as Deputy Executive Director, Electronics Division of the Munitions Board in the Department of Defense.

Transmitting Tubes:

Revised data sheets on 3 types have been issued by Eitel-McCullough, Inc., San Bruno, Calif. These cover the 3W-10000A3 VIII F power triode, the 529 general purpose triode which is a new type with Eimac, and the 3X2500A3 and F3 external-anode power triodes.

Emission Limitations:

FCC Rules effective in July, 1949, concerning police radio systems required that any spurious or harmonic emission appearing on any frequency removed from the carrier by at least 100% of the maximum authorized bandwidth shall be attenuated below the unmodulated carrier by not less than 40 db if the plate

power input to the final radio-frequency stage is 3 watts or less, or 60 db with 3 to 150 watts. This Rule has been changed to specify 40 db at 3 watts or less; 50 db over 3 watts up to 25 watts; and 60 db over 25 watts to 150 watts. Effect is to relax requirements on 10-, 15-, and 25-watt transmitters. Amendment does not refer to use by other services.

Smart Idea:

Under a plan announced by RCA, the purchasers of a \$12.95 changer for 45-RPM records can get a coupon book good for one free record each month for 6 months. Purpose is to get customers back to record shops. All records distributed by dealers under this plan will be replaced by the distributors in exchange for the coupons.

Controlling Interest:

Controlling interest in the Canadian Marconi Company is in the hands of England's Labor Government. This situation is the result of the nationalization of communications in England, since the English Marconi Company held control of the Canadian firm.

Field Intensity Meters:

Recognizing the importance of accurate measurements for FM and TV stations, the Bureau of Standards has provided facilities for calibrating field-strength meters on all frequencies from 30 to 300 mc. Information can be obtained by addressing the Bureau at Washington 25, D. C.

Adjustment of Advertising Rates:

New rates for FM-TV will go into effect October 1. Although the circulation audit for the first 6 months of 1950 shows
(Continued on page 7)

SPOT NEWS NOTES

(Continued from page 6)

an 18% gain over the last 6 months of '49, the principal purpose of adjusting the rates is to relate them more realistically to sales expense than in the past. For example, 1/2 page 12 times will cost only \$7 or 6% more, but the 1-time rate is up \$27, or 21%.

Standing-Wave Ratio Bridge:

Compact unit for measurements on coaxial lines of 52 or 75 ohms available from Millen Mfg. Company, Malden, Mass. Can be used with any low-range DC meter, such as a 0-1 milliammeter.

FM-TV Receiver Radiation:

Indifference on the part of manufacturers to powerful radiation from most TV sets and certain FM models has been worrying the FCC for some time. A complaint from the airport at Crawfordsville, Ind., about FM receiver interference gave the Commission an opening to go into action. The Crawfordsville situation was cleared up by shifting the frequency of WFMU. RTMA has maintained complete silence about it, but the FCC asked several manufacturers to submit receivers for test, and called on the Association to bring about prompt industry action. Fault in FM sets apparently lies in ratio detector models which do not have a tuned RF stage. All limiter-discriminator sets seem to be in the clear. Only data we have seen on TV sets was quoted from Chief Engineer Plummer's speech, August issue page 8, and Chairman Coy's RTMA address, August issue page 22.

Miniature-Tube Puller:

A clever tube-puller has been brought out by Hytron Radio & Electronics Corp., Salem, Mass. The soft rubber bulb at the top is depressed, and the neoprene collar slipped over the tube. Releasing the bulb creates suction, so that the collar holds the tube firmly. Also serves for inserting tubes. It's well worth the price of 75c.

Two Programs on One Channel:

On a recent trip to Washington, we heard Raymond Wilmotte's Bisignal system, working in his laboratory. The performance was very impressive. Two modulators fed one FM signal generator at relative levels of about 10 to 1. At the receiving end, two standard FM receivers delivered separate programs, although they were tuned to the same FM channel. This system makes it possible to transmit a regular broadcast program, plus another special-service program for rented sets equipped with the special Wilmotte Bisignal circuit.

(Continued on page 8)

Let's not go hog-wild!



Yes—let's not go hog-wild on advertising claims—after all, anyone with a dictionary can put a lot of words together and sound superior.

But—for superior sound—only you—the users of Soundcraft products are in a position to prove, for yourself, the consistent top-quality performance of all Soundcraft recording media—whether tape, discs, or styli.

All this advertisement can accomplish is to get you to *try* Soundcraft products.

Only by actually *using* Soundcraft constantly can you demonstrate, to your own satisfaction, the consistently better performance Soundcraft has to offer the recording industry.

**SOUNDCRAFT'S ONLY CLAIM IS
ITS PROOF OF PERFORMANCE**

Dear Soundcraft:

Please send your recording media catalog.
Our favorite disc distributor is _____

Name _____

Address _____

REEVES — "20 YEARS WITH SOUND RECORDING MEDIA."

REEVES Soundcraft CORP.

35-54 36th STREET, LONG ISLAND CITY 6, N. Y.

EXPORT—REEVES EQUIPMENT CORP. • 10 E. 52ND, N. Y. 22, N. Y.

Professional Directory

Jansky & Bailey

Consulting Radio Engineers

EXECUTIVE OFFICES:
970 National Press Bldg.,
Washington 4, D. C. ME 5411

OFFICES AND LABORATORIES:
1339 Wisconsin Ave. N.W.,
Washington 7, D. C. AD 2414

Member AFCCE

GARO W. RAY

CONSULTING RADIO ENGINEERS

Standard, FM and Television Services

HILLTOP DRIVE
STRATFORD, CONN. Tel. 7-2466

ANDREW ALFORD

Consulting Engineers

ANTENNAS & RF CIRCUITS

Laboratory and Plant:
299 Atlantic Ave., Boston 10, Mass.
Phone: HANcock 6-2339

DALE POLLACK

FREQUENCY MODULATION

development and research
transmitters, receivers
communications systems

Dayton Road Waterford, Conn.
New London 2-0760

GEORGE C. DAVIS

Consulting Radio Engineers

501-514 Munsey Bldg.—Sterling 0111

Washington 4, D. C.

AMY, ACEVES & KING, Inc.

Specialists in the
Design and Installation of

HIGH-GAIN
AM, FM, and TELEVISION
ANTENNA SYSTEMS

LONGacre 5-6622
11 West 42nd St., New York 18, N. Y.

SPOT NEWS NOTES

(Continued from page 7)

Variable Transformers:

A new technical bulletin from Superior Electric Company, Bristol, Conn., presents data on manually-operated and motor-driven Powerstats rated from 4 to 100 kv. output. Standard, oil-cooled, and explosion-proof types are included.

Taxicab Convention:

Annual meeting and exhibit of the American Taxicab Association will be held at Hotel Sherman, Chicago, October 8 to 11. Information can be obtained from program chairman Benjamin Samuels, Yellow Cab Company, Chicago.

H. F. Bersche

Estimates given at his NEDA address at Cleveland: The present 1,900 parts jobbers doing \$360 million volume in 1950 will increase in number to 2,600 by 1955, and their annual volume in components will be up to \$1 billion, exclusive of sets and appliances.

More Power for State Police:

FCC Rules have been amended to permit base stations rendering service to state police mobile units to use up to 10 kw. plate input power on 17 channels from 1,610 to 2,490 kc., and on 24 channels from 42.02 to 45.06 mc.

Audio Fair:

The Audio Fair will have technical papers and exhibits for everyone concerned with audio-frequency transmission, recording, and reproduction. The place is the Hotel New Yorker, 34th Street and 8th Avenue, New York City; the date, October 26 to 28; the time 9:00 A.M. to 6:00 P.M. on Thursday and Saturday, and 9:00 A.M. to 9:00 P.M. on Friday. In Room 639, FM-TV MAGAZINE will have the FAS equipment to demonstrate FM and phonograph reproduction.

Microphone Data:

A new microphone catalog has been issued by Electro-Voice, Inc., Buchanan, Mich. Information is presented on various types of dynamic, crystal, velocity and carbon mikes, and stands.

Transit Radio Rates:

FM stations offering transit radio service in St. Louis and Washington have announced rate increases effective October 1, and in Kansas City effective September 1. Service will be available in Trenton, N. J., on November 1, and in Minneapolis-St. Paul on October 1.

Sound on 16-Mm. Film:

Just recently we spent a whole morning
(Continued on page 9)

Professional Directory

McNARY & WRATHALL

CONSULTING RADIO ENGINEERS

906 National Press Bldg. DI. 1205
Washington, D. C.

1407 Pacific Ave. Phone 5040
Santa Cruz, California

KEAR & KENNEDY

Consulting Radio Engineers

1703 K St., N.W. STerling 7932
Washington, D. C.

GEORGE P. ADAIR

Consulting Engineers

Radio, Communications, Electronics

1833 M St., N.W., Washington 6, D.C.
EXecutive 1230

RUSSELL P. MAY

CONSULTING RADIO ENGINEERS

★ ★ ★

1422 F Street, N. W. Wash. 4, D. C.
Kellogg Building Republic 3984
Member AFCCE

RATES FOR PROFESSIONAL CARDS

IN THIS DIRECTORY

\$12 Per Month for This Standard
Space. Orders Are Accepted
for 12 Insertions Only.

LYNNE C. SMEBY

Consulting
Radio Engineers

820 13th St., N.W. EX 8073
WASHINGTON 5, D. C.

Professional Directory

RAYMOND M. WILMOTTE Inc.

*Consulting Engineers
Radio & Electronics*

1469 Church St. N. W. Decatur 1232
Washington 5, D. C.

WELDON & CARR

WASHINGTON, D. C.
1605 CONNECTICUT AVE.

DALLAS, TEXAS SEATTLE, WASH.
1728 WOOD ST. 4742 W. RUFFNER

McINTOSH
& **INGLIS**

Consulting Radio Engineers
710 14th St. N.W., Wash. 5, D. C.
METropolitan 4477

*Next Month — Complete
Data on the Amazing*

FAS

The new system of audio reproduction which has called forth such comments as:

"It sounds to me as if you have a new type of speaker with a flat efficiency characteristic down to 27 cycles, or an amplifier which increases enormously in output at the low end. But you tell me that you are using only a pair of 6L6's!"
(Only conventional, low-priced speakers are used, and standard audio components.)

"I can sell any number of jobs like this How long before I'll be able to get the parts necessary?" *(They are available now from any parts jobber.)*

The Series on the FAS will start in October issue of **FM-TV Magazine**

SPOT NEWS NOTES

(Continued from page 8)

listening to the finest sound-on-film reproduction we have ever heard. The methods of recording and processing are the results of new work done by J. A. Maurer. The audio range and dynamic range were remarkably wide, and the background noise lower than we had thought possible. Later, we heard some of the same film on one of the new heavy-duty Eastman model 25 projectors, and with the same high quality of performance. An article on the Maurer development is now in preparation for a forthcoming issue.

Washington-NY Color TV:

On August 7, RCA staged a demonstration of color TV carried by coaxial cable from WNBW Washington to WNBT New York City. The program was transmitted from WNBT on both VHF and UHF. The latter was picked up at NBC's experimental station at Bridgeport, Conn., for retransmission on UHF. Using a UHF receiver converted for color, O. B. Hanson, NBC chief engineer, picked up the program at his home in Westport, at a distance of 12 miles. Black-and-white sets produced perfect images.

Importance of FM Coverage:

Preliminary census figures for the 12 largest US metropolitan areas show a growth since 1940 of 6.5 million. Of great significance to broadcasters and sponsors is the fact that 72% or 4.7 million of this gain was in the surrounding suburban areas, outside noise-free AM coverage, but well within solid-signal range of the FM stations. Further, it should be noted that of the total population in the 12 metropolitan areas, 45% or 19 million live in the suburbs, where co-channel interference cuts down AM coverage sharply at night.

Record Quality on FM:

FM reception of recorded music is getting its share of criticism from high-fidelity enthusiasts. We are receiving letters asking: "What are the broadcast stations doing to their records? I get much better quality when I play a given record at home than when I pick it up by radio, using the same audio system." One of our recent visitors from New York City remarked that WABF is taking listeners away from WQXR-FM because the former plays records naked, while the latter gums them up with equalizers and a volume compressor. We have noted for a long time that record quality is considerably deteriorated at some stations, particularly those transmitting on both FM and AM. There will be a report on this in a forthcoming issue.

Special Services Directory



ANTENNA
EQUIPMENT
SPECIALISTS

Andrew
CORPORATION
363 EAST 75th STREET • CHICAGO 19

Paul W. Klipsch
Professional Engineer
Acoustic development
and consulting

Klipsch and Associates
building the authentic
KLIPSCHORN
world's finest sound reproducer

Hope, Arkansas

Tel. Hope 995

THE WORKSHOP ASSOCIATES

INCORPORATED



*Specialists in
High-Frequency
Antennas*

135 Crescent Road
Needham Heights 94, Mass.
NEedham 3-0005

MEASUREMENTS CORPORATION



*Research &
Manufacturing
Engineers*

Specialists in the Design & Development
of Electronic Test Instruments

BOONTON, N. J.

HAROLD M. HEIMARK

Communication Engineers

Specialists in the design of low
power portable & mobile two-
way radio equipment.

MANUFACTURING FACILITIES

734 N. Austin Blvd. Chicago phone
Oak Park, Illinois Estebrook 8-7047

**10mm
maurer**

16-1/2" Professional Motion Picture
Production Equipment

J. A. MAURER, Inc.

37-07 31st Street, Long Island City 1, N. Y.
Tel. 5Tillwell 4-4601

Mounting Bell's new microwave lens in a horn-antenna. Other blocks will complete the lens.

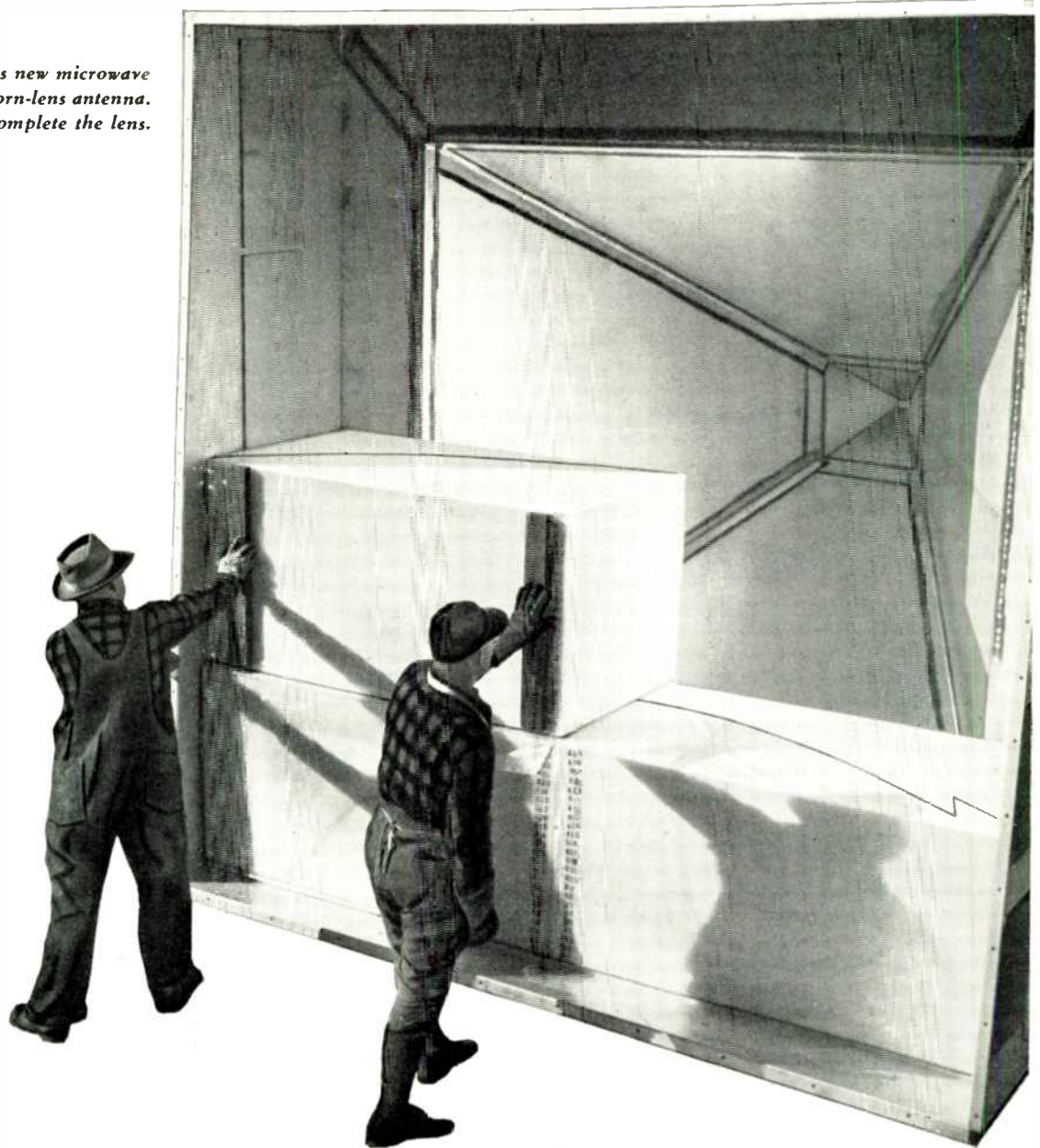

A focus on better, low-cost telephone service

In the new microwave radio relay system between New York and Chicago, giant lenses shape and aim the wave energy as a search-light aims a light beam.

Reasoning from the action of molecules in a glass lens which focuses light waves, Bell Laboratories scientists focus a broad band of microwaves by means of an array of metal strips. To support the strips these scientists embedded them in foam plastic which is virtually transparent to microwaves. Rigid and light in weight, the plastic is easily mounted on relay towers.

This unique lens receives waves from a wave guide at the back of the horn. As they pass across the strips, the waves are bent inward, or focused to form a beam like a spotlight. A similar antenna at the next relay station receives the waves and directs them into a wave guide for transmission to amplifiers.

This new lens will help to carry still more television and telephone service over longer distances by microwaves. It's another example of the Bell Telephone Laboratories research which makes your telephone service grow bigger in value while the cost stays low.



Laboratory model of the new lens. A similar arrangement of metal strips is concealed in the foam plastic blocks in the large picture.



BELL TELEPHONE LABORATORIES

Working continually to keep your telephone service big in value and low in cost.

WHAT'S NEW THIS MONTH

MORE BROADCASTERS MUST LEARN THAT AN FM LICENSE ISN'T A FREE-MEAL TICKET—THIS AUDIO SYSTEM MAY REVOLUTIONIZE CUSTOM INSTALLATIONS

THE FM broadcasters meeting held at NAB headquarters on August 7 to consider the ills of FM and their appropriate remedies was highly revealing. Boiled down to a few words, the all-day discussion failed to disclose anything basically wrong with FM broadcasting. In fact, even the operators who complained the loudest confirmed every claim that has been made for FM's superiority over AM as a means of public radio service.

Why, then, has FM not made more rapid progress in winning listeners? The answer should be obvious, although it was not mentioned at the NAB meeting: If the fault does not lie with FM as a system of broadcasting, then it must lie with the individuals who operate the FM stations! And that was the one source of weakness that no one proposed to remedy.

In case this seems to be a gratuitous comment, considering the source, we offer our own experience in justification. Back in 1940, when this Magazine was started, FM had already proved its worth as a broadcasting system capable of eliminating static and inter-station interference, and of giving more enjoyable reception over a much larger area than AM transmitters of substantially higher power.

We assumed that a magazine devoted to such an outstanding development would be welcomed with such enthusiasm by readers and advertisers alike as to insure its immediate success. But to our dismay, that proved not to be the case at all. The avalanche of subscriptions we expected simply didn't materialize. As for the advertisers, they asked us the same questions they would ask of any other publication: "What is your circulation?" and, "What data do you have on your readership?"

That was very embarrassing. Since we didn't have much circulation, we couldn't present very impressive readership data. Furthermore, it was ungrateful of advertisers to raise the question of readership. It costs time and money to build circulation, and that requires advertising revenue. Certainly a magazine devoted to the greatest development since broadcasting started deserved the support of the radio manufacturers. Let them give us the advertising and we'd give them the circulation!

Pretty screwy reasoning, wasn't it? But that's about the way we felt back in 1940. Probably we can claim the dubious

distinction of being the first to get the idea that we earned the right to succeed because we were giving FM a break. At least we were way ahead of all the broadcasters who went into FM with the same idea.

It took us a long time to learn that FM was no shortcut to success in the publishing business. Our confidence in the advantages of FM was so complete that we took it for granted that others would be fired by the same enthusiasm. So we didn't realize that, from the point of view of advertisers, we were only offering another advertising medium in a highly competitive field!

Many broadcasters have that same lesson to learn. At the recent NAB session, some were still wondering why advertisers don't buy FM time on their stations. They felt that somebody should do something about it. They wanted NAB to pass new resolutions. They wanted the FCC to make new rules. They wanted Congress to take a hand.

The FM-only operators felt that FM-AM stations should stop selling FM as a bonus. The FM-AM operators blamed the networks for not taking them in as affiliates. They both blamed the set manufacturers for not producing more receivers.

All this time we sat on the sideline wondering at whose door the unsuccessful AM broadcasters lay the blame for their troubles.

While we hear so much about the troubles of the FM stations, we are inclined to believe that, if all the figures were available, we would find the percentage of loss-operations about the same in both groups. An AM license is no guarantee of success. Neither is a contract for network affiliation. FM stations may have their program problems, but AM programs are the subject of much severe criticism, too. We recall the speech in which Charles Denny, then FCC Chairman, told the 1946 NAB Convention: "I take this occasion to deny that the Commission is planning to punish large numbers of wayward broadcasters by forcing them to listen to their own stations two hours every day. This would be clearly unconstitutional, as cruel and unusual punishment. (VIII Amendment)"

It isn't difficult for a smart FM operator to provide listenable, enjoyable, and interesting programs. Some FM broadcasters have developed features that com-

pete successfully with the best network talent. Notable among these are local sports events. Audience-building in cooperation with dealers handling good FM receivers has proved highly effective. As for getting data on listeners, it costs money, but stations that have made the investment have found that it pays off handsomely. If some agencies refuse to consider the purchase of FM time, it's possible that they are tired of listening to solicitors who talk about FM as if that were a substitute for market data.

In short, when FM broadcasters start to ask themselves, "What's wrong with me?" there won't be any more meetings called to consider, "What's wrong with FM?"

LAST June, we had a special section devoted to showing typical custom-built, high-fidelity radio-phonograph installations in private homes. Then in August, we had another section concerned with methods employed by leading parts jobbers to sell high-fidelity performance. Further evidence of increased interest in fine audio reproduction is the expansion of the Audio Fair to two floors of exhibits at the Hotel New Yorker, New York City, October 26 to 28.

In this issue, on page 9, you will find a detailed announcement of the promised series on a new system of audio reproduction. Here's an interesting sidelight on this system: The patent application was assigned, for a substantial consideration, to one of the long-established radio receiver manufacturers. However, the invention never materialized in production. When the inventor inquired about it, he was told that the company did not feel that there was a market for such luxury equipment. Furthermore, the same performance could be obtained by conventional methods.

Well, we have talked to a lot of people who have heard this system, and every one has said that the reproduction is decidedly superior to anything he ever heard from any conventional system. Our staff is of the same opinion. As for the cost, we can say that it is quite moderate, and we ought to know because we have built an installation to demonstrate at the Audio Fair. We'll have it in Room 639. It is constructed entirely of standard components, and there is sufficient latitude in the design that it isn't necessary to duplicate the parts we used. The

(Concluded on page 34)

10-WATT FM PACKAGE

FOR NEW EDUCATIONAL FM BROADCAST STATIONS
— By T. E. McCONNELL*

THE FCC amended its Rules recently to permit the use of 10-watt transmitters in the educational portion of the FM band, thus making it possible for small schools to operate FM stations. In order to provide an inexpensive and convenient means for them to take advantage of this opportunity, Collins Radio Company has prepared a complete 10-watt FM package, described in this article, which provides all equipment and accessories needed to go on the air with simple programming.

Educational stations make valuable instruction available to the public, provide training facilities for radio students,

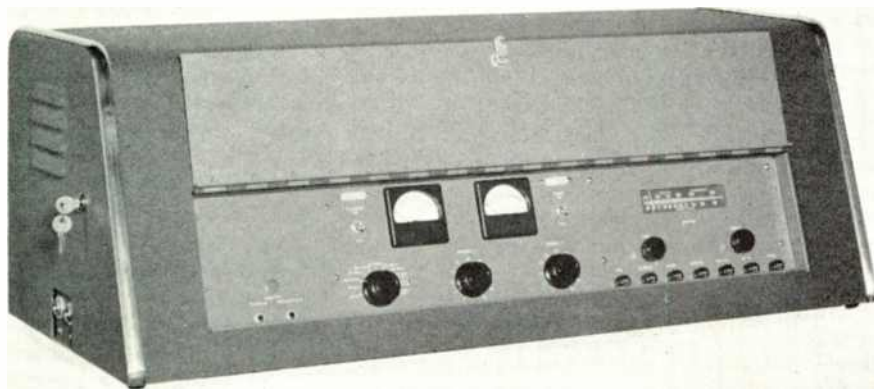

Fig. 2. Cabinet contains low-level AF stages, transmitter, and monitor receiver

and foster better public relations through broadcasting school and community activities. These benefits have long been recognized. While commercial stations are generous in providing program time for local educational institutions, economic considerations prevent them from presenting all school activities worthy of being broadcast. Then, too, the high costs incurred in the establishment and operation of high-power broadcasting stations have, in the past, limited ownership of these facilities to the larger colleges and universities. Ten-watt operation, with design and engineering costs eliminated through purchasing packaged equipment, provides a solution to these problems for thousands of small schools.

Petitions have been filed with the FCC on behalf of churches and other non-profit organizations also, requesting that

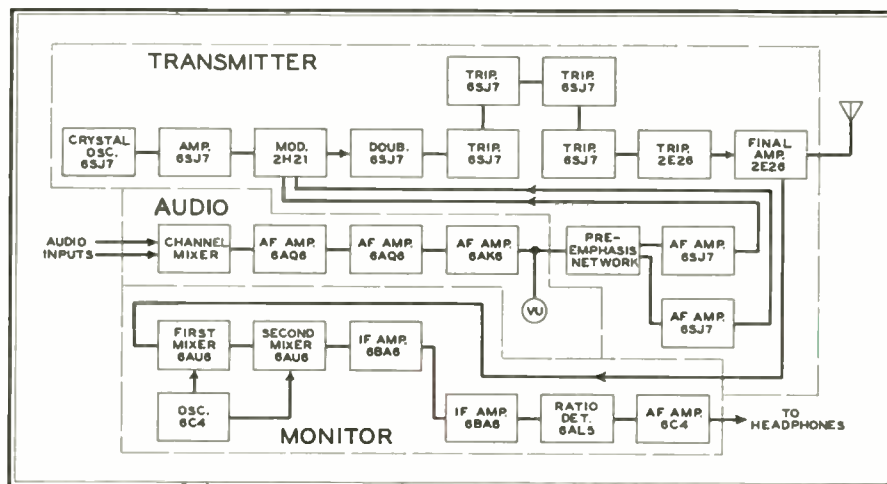

Fig. 1. The 738A transmitter. Model 738B is similar, but has no audio section

they be allowed to operate 10-watt stations on a status equivalent to educational institutions.

Advantages of 10-Watt FM:

While low initial equipment cost is possibly the most important feature of a 10-watt station, it is by no means the only

feature. Maintenance and adjustment costs are reduced to an almost negligible figure.

Proposed FCC Rules changes would permit operation of these stations by holders of third-class radio telephone licenses, without the supervision of second-class operators. Maintenance and adjustments when required would, of course, still be performed by second- or first-class operators.

Adequate coverage for most schools is provided by this power. Ranges of 3 to 10 miles are obtained, depending on antenna height and local noise conditions. At the same time, channel assignments can be duplicated at short geographic intervals.

Design Requirements:

Before attempting to plan equipment to satisfy the requirements for this type of service, a thorough study of these requirements was made. A number of prospective purchasers were interviewed. The results of this study are as follows:

1. Provision for simultaneous operation and mixing of two audio channels is desirable.
2. Simplicity and ease of installation, operation, and maintenance are essential.
3. Protection from tampering should be provided since, in many cases, the trans-

mitter is often used in a classroom or other public area. Frequency and modulation monitors are not required for stations of this size. The equipment can be housed easily in existing buildings, so that no land or extra buildings are required. Because of the simplicity of the equipment, mainte-

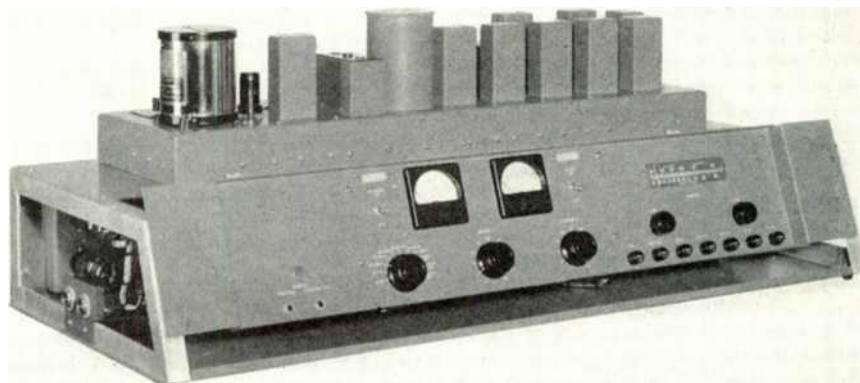

Fig. 3. Unlocked cover lifts off easily. RF and modulator sections are on small top deck

* Engineer, Collins Radio Company, Cedar Rapids, Iowa.

mitter would be unattended while not in use.

4. The equipment should be attractive in appearance, since it is likely to be installed where it will be seen by many people.

5. In view of the proposed change in FCC Rules, provision should be made for routine operation by third-class operators, permitting normal access to the on-off switches and audio level controls only.

6. Allowance for future expansion, in more elaborate programming facilities

the transmitter, exposing all components and tuning controls. This is shown in Fig. 3. The antenna and AC power connections are on the end of the chassis.

Two headphone jacks at the left of the front panel, Fig. 3, are connected to the audio amplifier output and the monitor receiver output. To the right of the headphone jacks is the metering switch, with its associated meter above. All critical voltages and currents can be measured directly. Immediately above the metering switch are the filament on-

of extractor-type fuses at the bottom.

The RF section is on an individual chassis at the top. The crystal oven and oscillator are at the left on the RF chassis, followed by a straight amplifying stage. Next is the phase-splitting network, which provides 3-phase RF for the 2H21 modulator tube. The modulator stage is protected by a heavy magnetic shield. Multiplier stages follow in sequence to the right, with the output stage just to the left of the far corner of the chassis.

Calibrated controls at the left rear section of the RF chassis include a trimmer for the oscillator adjustment, and bias and balance controls for the modulator.

The chassis is secured by a full-length hinge at the rear, and two wing nuts on the forward lip. As shown in Fig. 4, removal of the wing nuts permit lifting the complete chassis back on its hinge. Although the maximum potential in the RF unit is only 315 volts, an interlock is provided to open the plate supply when the chassis is raised.

Four Phillips screws hold the front panel in place, so that it can be separated entirely from the main frame. The box at the left, Fig. 4, is the remote amplifier unit. At the right can be seen the monitor receiver.

The power supply is mounted on the rear panel of the main frame. Transformers, filters, and rectifier tubes can be

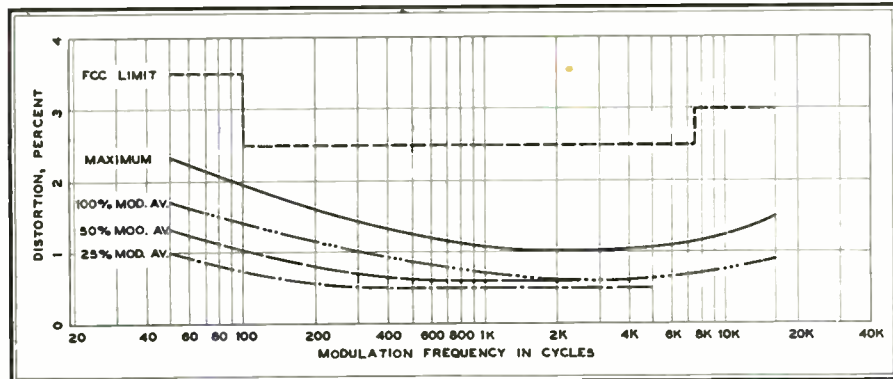

Fig. 5. Distortion characteristics of overall system are well below FCC limits

and higher power output, is considered desirable.

Since the FCC does not require frequency or modulation monitors for 10-watt stations, it was decided to furnish an FM receiver for headphone monitoring.

To meet the requirements listed, we selected the following equipment for our package: the 738A transmitter console with built-in monitor receiver and low-level audio stages; the 37Q antenna on a 20-foot mast with sufficient antenna cable for most installations; two dynamic microphones with one floor stand and one desk stand; crystal headphones; and microphone and AC cords. Thus, installation was simplified to the point of mounting the antenna and plugging in the antenna lead, microphone, and AC cords.

The 738-A Transmitter:

A block diagram of the transmitter console is given in Fig. 1. Only 10 tubes are used in the transmitter section proper, and the 2-channel audio system requires only 5 tubes from microphone level to modulator. The audio amplifier, a standard 212Y remote unit, can be removed and used as such if more elaborate audio facilities are desired. The monitor receiver is a Meissner 8C FM receptor.

Fig. 2 shows the console in its cabinet. Both end covers are provided with locks, and the hinged control-cover plate can be locked also to give complete protection from tampering.

When the end-covers are unlocked, the cabinet housing can be lifted up and off

off switch and pilot light.

The meter at the right is a VU indicator. The meter multiplier, located on the rear of the panel, is adjusted at the factory to indicate a reference level at

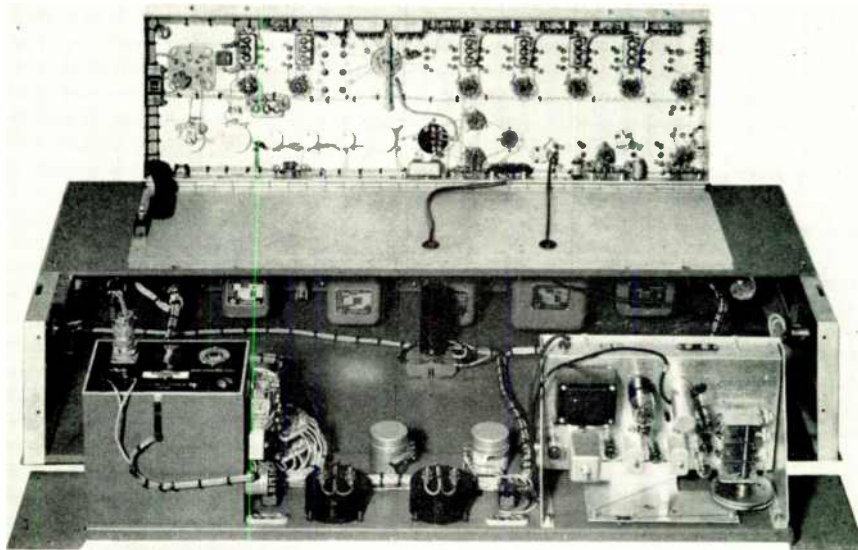

Fig. 4. RF deck raises on hinge. Front panel is separated by taking out 4 screws

100 per cent modulation. This affords a simple means of avoiding over-modulation. The plate voltage on-off switch and pilot light are to the right of the VU meter. If desired, both pilot-light circuits can be extended to provide remote indication of on-the-air condition.

Gain controls for the two audio channels can be seen below the VU meter. Monitor gain and tuning controls are at the far right end of the panel, with a row

seen in this view. Also, in the exact center of the base-plate, the plug-in pre-emphasis network is shown.

Provision for Expansion:

The RF unit was designed to be physically and electrically interchangeable with exciter units in Collins transmitters of higher power. Two alterations only are necessary — the replacement of one
(Concluded on page 33)

NEW COMMUNICATIONS ANTENNA

HOW CONVENTIONAL DESIGN LIMITATIONS WERE OVERCOME IN THE DEVELOPMENT OF THE ANDREW TYPE 3000 HIGH-GAIN ANTENNA—By M.W. SCHELDORF*

IN order to provide reasonably high power gain, VHF antenna elements must be stacked in some manner. For mobile communication service, which employs vertical polarization, antenna stacking has been achieved in the past by the use of concentric cylinders over a supporting mast structure. This method has inherent disadvantages, as is explained later, which limit the practicably-obtainable gain to a relatively low value. This article discloses how we, at Andrew Corporation, have succeeded in overcoming previous limitations by discarding the concentric-cylinder approach, and employing an entirely different method of stacking.

A number of patents have been issued¹ for antenna designs intended to solve the vertically-polarized stacking problem. Most of them have not been produced commercially. The predominant cause for their failure is that they employ the concentric-cylinder principle. These cylinders, or skirts, which must have considerable clearance from the mast for electrical isolation, present large wind-loading areas. Thus, a large mast diameter is required initially. The net result is an unreasonably bulky array.

Another disadvantage of this method is that feed lines must be brought up through the mast. Service of the junctions is difficult or impossible under these conditions.

One of the most annoying difficulties of the coaxial antenna is its tendency to couple power to the mast, with corresponding sensitivity to surrounding objects and height above ground. This can be minimized by the addition of parasitic

skirts below the main skirt, but only with a resultant increase in bulk and cost.

Consideration of these faults, plus improvements which were thought desirable, led to a choice of the following basic requirements for a proposed new antenna:

1. Circular horizontal pattern
2. Average power gain of 5
3. Minimum number of feed points
4. Minimum wind load
5. Negligible coupling to the mast

Development Procedure:

In our initial tests we isolated a long mast section, excited the section at its center with various element structures, and added parasitic elements above and below each exciting element. While experimenting with a folded dipole as an exciting element, we discovered that it had unusual freedom from coupling to the mast. This led us to continue experiments in that direction.

Fig. 1 shows the vertical radiation pattern for a folded dipole mounted on one side of a mast 4.66 wavelengths long. It is apparent that the pattern is similar to that which would be obtained from the same unit in free space. The dashed lines show the change in pattern obtained when an attempt was made to use the mast structure as part of the folded dipole. It is what could be expected from a long conductor excited at the center. The difference on opposite sides of the mast is, of course, due to the shielding action of the mast itself.

The vertical pattern obtained when the exciting element was a shunt-fed dipole is shown in Fig. 2. This pattern, also,

¹ Patent No. 2,113,136, Hansell; No. 2,199,375, Lindenblad; No. 2,234,234, Cork; No. 2,321,454, Brown; No. 2,323,641, Bailey; No. 2,455,224, Buchwalter; No. 2,486,597, Greene.

* Research Department, Andrew Corporation, 363 East 75th Street, Chicago 19, Illinois.

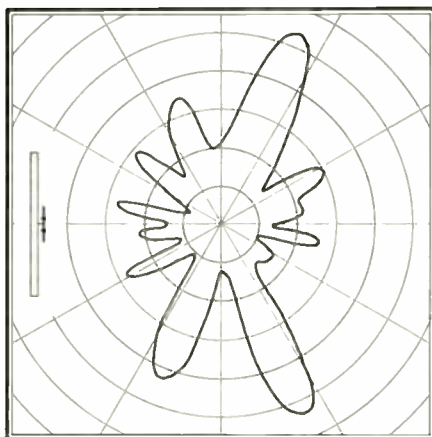
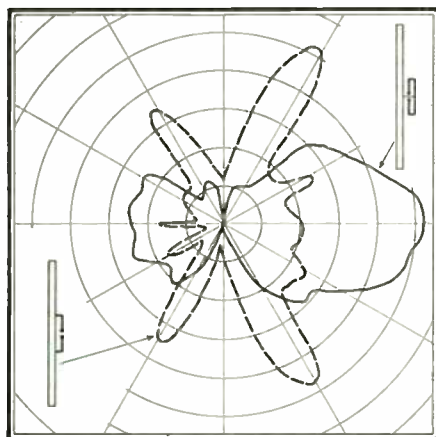

Figs. 1 and 2. Vertical patterns for folded and shunt-fed dipoles on long masts

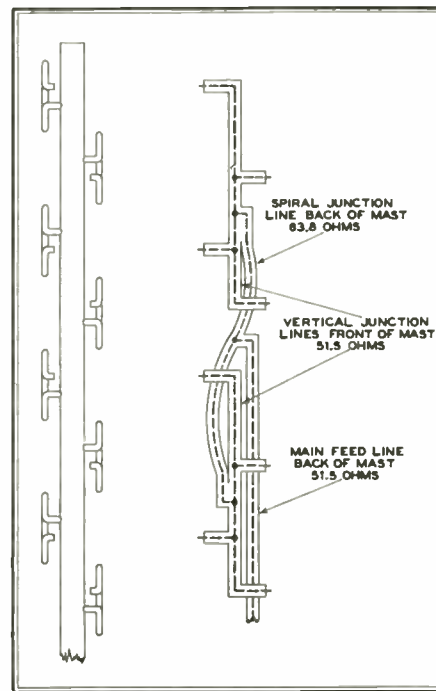

Fig. 3. Feed harness for type 3000 antenna

shows excitation of the mast. Carter² has demonstrated that, for a 5-wavelength conductor, the maximum peaks in Fig. 2 should occur at 24° from the axis of the conductor. The average of our experimental values was slightly less.

We were limited in these tests to consideration of elements which could be grounded for lightning protection. This accounts for the seemingly peculiar choices of elements.

The behavior of a folded dipole antenna, when used in the same manner as we employed it, was not entirely unexpected. Lehmann³ states that "The antenna of the present invention is in this sense a closed antenna, since the lines of force passing from one portion of the wire to the other remain in the immediate neighborhood of the antenna, and hence it is insensitive to local objects, and insensitivity that is completely proved by experience." While one may not agree with his explanation, his experience seems to have been similar to ours.

Application of the folded dipole element to an array was the next step. For a gain of the order desired, the height of the structure would be, in many cases, great enough so that a beacon light would be required. Thus, the mast size was determined in part by the wind load of

² Proceedings of IRE, October, 1931, pg. 1797.
³ Patent No. 2,285,669.

the beacon light. With a mast of the required size, as in Fig. 1, the horizontal radiation pattern remained circular but the center of radiation was displaced from the center of the circle. In order to alleviate this effect, it was decided to mount the elements alternately on opposite sides of the mast.

The simplest harness arrangements are obtained with antenna elements combined as the integral powers of 2, that is, 2, 4, 8, or 16. An 8-bay array does not quite achieve the desired power gain of 5. However, a 16-bay array is considerably more complex. In general, its size and expense are not warranted by the additional gain it provides. Fig. 3 shows the final arrangement chosen.

A folded dipole element can be fed successfully from a single hot terminal. This practice helps to simplify the harness. In order to reduce the number of junctions without affecting the performance seriously, we coupled pairs of elements with half-wave lines, fed at one junction of each pair.

The complete harness is shown in Fig. 3. At each T-junction there is a 1-to-2 impedance transformer, so that the standing-wave ratios in the feed lines are the same as for the lines being fed. Both 4-element harnesses and the end-seal assemblies are mounted on one side of the mast. The line joining them together twists around the mast, where the main feed line joins it on the opposite side. This arrangement keeps the main feed line and spiral junction line away from the elements, preventing unbalances and disturbances in the radiation pattern.

Performance Measurements:

A curve of the horizontal radiation pattern at 156 mc., Fig. 4, has been found to be representative of patterns obtained over the band from 148 to 162 mc. In order to depict adequately the vertical radiation, however, two curves are necessary. Fig. 5 shows the pattern in the plane of the feed line, and Fig. 6 the pattern in the plane of the antenna elements. In the first case, the elements are effec-

Fig. 4, right: Horizontal radiation pattern
Fig. 5, left: Vertical radiation pattern in plane of feed line has small side lobes

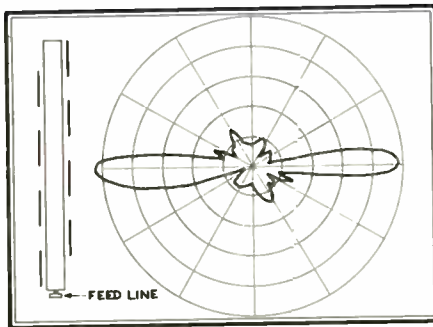
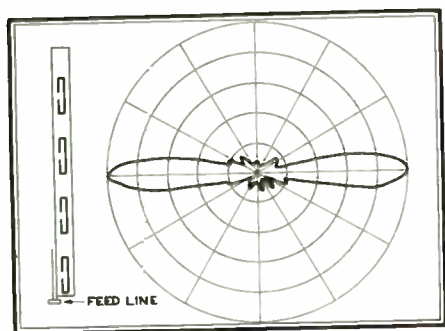

Fig. 6. Vertical pattern in plane of elements

tively in line, and the side lobes are small. In the latter case, half the elements are out of phase with respect to the other half and side lobes of appreciable size are produced. This accounts for the reduction in gain from the value obtained with 8 half-wave elements in line.

In the construction of commercial models we have had to support the folded dipoles at four points with insulators. This detail can be seen in the front-cover photograph. Considerable shunt capacitance has been introduced thereby. Because of symmetry, the action of the dipoles as radiators coupled to the mast was not changed. However, the impedance was disturbed seriously. The bandwidth was reduced to 2 mc., and we have had to resort to various dipole lengths in order to cover the band desired.

There are two mast and harness sizes in the commercial units: one for the band from 148 to 162 mc., and the other size to cover 162 to 174 mc. Since there are variations with frequency in the relative mast diameter, in the effective horizontal and vertical spacings of the dipoles, and in the effectiveness of the impedance matchers, we have provided tuning stubs at each end of the main matcher. This permits adjustment of the input standing-wave ratio, so that we are able to obtain a transmission-line SWR of better than 1.2 at any frequency.

The effective vertical spacing varies with frequency, which has a marked effect on the gain. This is one of the primary reasons for employing different

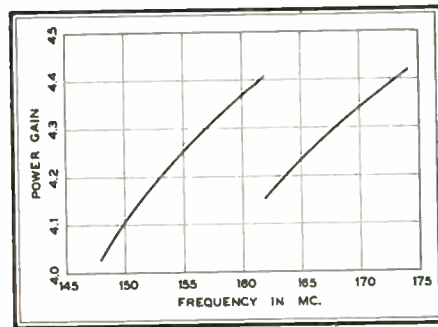
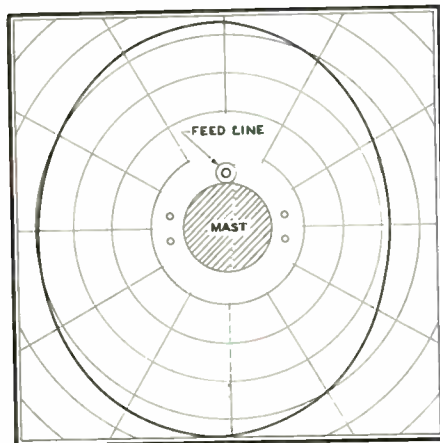

Fig. 7. Power gain over dipole

antenna dimensions for use in the upper and lower parts of the band. As Fig. 7 shows, this reduces the gain variation to about half what it would otherwise be. Gain values in Fig. 7 are based on one horizontal and two vertical radiation patterns, as explained previously.

Conclusion:

With this new array we have achieved, for practical purposes, every objective set up originally. It has the highest gain available in any commercial antenna for its intended field, and maintains this gain regardless of antenna height.

The assistance of H. M. Anderson and R. E. Green is gratefully acknowledged for construction and tests on preliminary models, and extensive measurements on the prototype unit.

NEW REGISTRY

The Registry of Land Transportation Services will be published in November, just two months from now. This Registry will include all communication systems operated by taxicab, railroad, highway truck, and urban transit companies; intercity bus lines; public garages, automobile associations, harbor boats.

Growth of the land transportation services has been tremendous. As an illustration: FCC Commissioner Webster, speaking before the American Taxicab Association at Atlantic City on June 19, said in part: "At the end of 1948 there were 1,400 taxicab systems in operation. Since then, this number has increased by over 800 to a total of 2,235. Before the end of 1950, we estimate that there will be approximately 3,200 taxicab radio systems throughout this country . . . there are currently authorized approximately 60,000 mobile units . . . we estimate that this figure will be increased by another 7,000 by the end of 1950."

Editorial contents in the November issue of this Magazine will present the latest developments in this fast-moving field. It will be of special interest to all concerned with mobile radio, and with the land transportation services in particular.

REMOTE SUPERVISORY CONTROLS

PART 2: WHY UNSTABLE LINE CONDITIONS, NOISE, AND INTERFERENCE DO NOT AFFECT THE OPERATION OF MULTI-GATE CONTROLS — By J. K. KULANSKY*

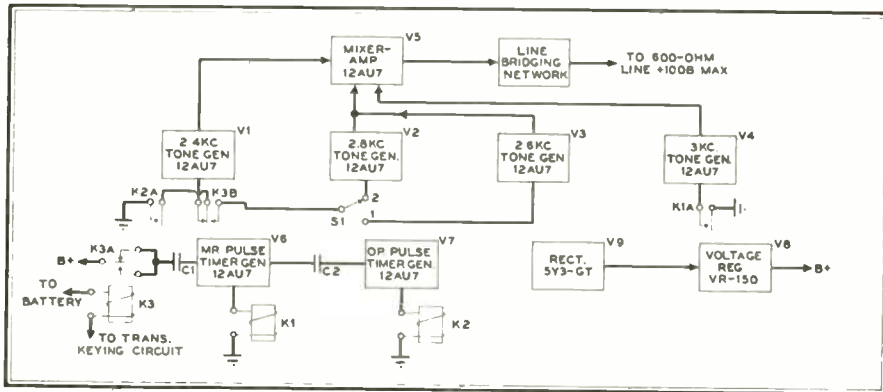

Fig. 1. The transmitter unit. Tone generators can be added for more control functions

THE performance of any resonant electrical or mechanical system is affected by variations of input level. When any conventional system is adjusted to a given input sensitivity, a substantial change in input level either reduces the output to a point where it cannot perform the required functions, or overloads the system until it is no longer selective as to frequency.

The limits of input level within which a resonant system will function properly at a given setting of input sensitivity are relatively narrow. Of course, manual adjustments can be made whenever the input level changes, provided the installation is under constant surveillance, but such means cannot be employed for remote controls at unattended locations.

*Mobile Systems Engineer, Hammarlund Manufacturing Company, Inc., 460 W. 34th Street, New York City.

Fig. 2. Receiver, left, and the transmitter unit for wire-line or radio operation

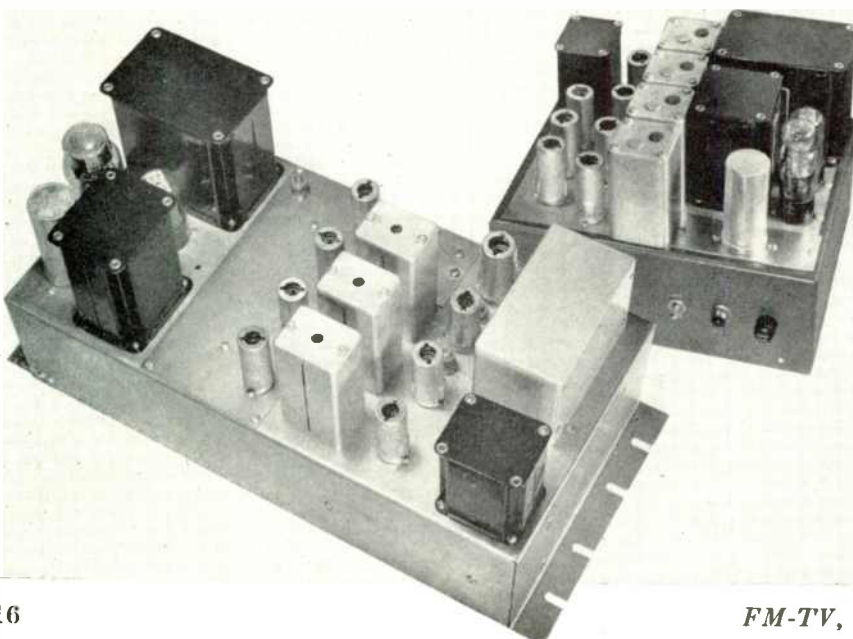

Conventional types of selective control devices operate within a range of input level up to approximately 20 db for a given adjustment of input sensitivity under optimum conditions. However, it is not possible to anticipate, when the initial adjustment is made, whether the tendency will be for the input level to rise or fall.

Even within the level range of 20 db, there is no certainty that other external line conditions will not degrade the performance of the system, such as high noise level, repeated short-time random impulses, or changes in line impedance.

Multi-Gate Characteristics:

The Hammarlund Multi-Gate system of remote control is designed to eliminate failures due to input level changes and other external factors of telephone line or radio transmission characteristics.

The features employed to attain this result will be described briefly at this point, and in more detail subsequently.

The receiving unit of the Multi-Gate control is protected by an automatic sensitivity adjustment equivalent in its operation to continuous manual adjustments to the instantaneous values of the line level. This is accomplished by a non-linear amplifying network so designed as to tolerate level variations in the order of -32 db to +10 db. Over this range, the optimum characteristics of the Multi-Gate system are maintained. Also, a special line-bridging circuit is employed to maintain the input sensitivity of the receiver unit within -4 db for a 50% decrease in input impedance below the nominal value, and 0 db for an almost unlimited high-impedance mismatch.

Operating signal frequencies used are between 2,000 and 3,000 cycles, comprised of pulse groups of different frequencies transmitted in sequence, not simultaneously.

In other words, the operating signals are made up of an initial master-gate pulse of one audio frequency, followed immediately by a shorter operative-gate pulse of a different audio frequency.

Voice-frequency energy within the range utilized is approximately 14 db below the energy level at 400 to 1,500 cycles.

The single-tone pulses allow full utilization of the signal energy, in contrast to simultaneous transmission of multiple pulses which introduce phasing difficulties. This also obviates the necessity of geometric selection of frequencies, as is necessary in the case of tuned reeds, to minimize the effects of phasing and sub-multiple operations.

Tuned electrical circuits are more efficient than reeds because they permit use of the full duty-cycle. Thus signals of shorter duration can be employed, as well as shorter time-delay constants. In addition, the non-linear amplifier eliminates failures from sub-multiple operation, as experienced with tuned reeds.

Other features of the Multi-Gate system and their advantages will be explained in the discussion of the circuit functions.

Fig. 1 presents a block diagram of the basic RCT transmitter unit, while the details of the commercial design are shown in Figs. 2 and 3. Similar illustrations of the RCR receiver unit are

shown in Figs. 4. and 5. As will be explained, transmitter sections can be added in accordance with the number of control functions to be performed.

Basic M-G Transmitter Unit:

The basic RCT transmitter unit is arranged to transmit signals over any telephone line or by radio, to open or close either of two circuits at a remote point. By way of illustrating the operation of the system, it might be considered that the RCT transmitter keying circuit is controlled by a microphone press-to talk switch.

When the keying circuit is closed, relay K3 is energized and closes contacts K3A to produce an impulse which turns on the master-pulse timer generator V6. This results in energizing relay K1. Relay contacts K1A close to key the 3.0-kc. tone generator V4 to transmit a timed master-pulse through mixer amplifier V5 and the line-bridging network, to the 600-ohm telephone line running to the remote point. In the case of radio operation, the output of the mixer amplifier would be connected to modulate the transmitter.

The master-pulse timer generator holds K1 for .3 second, the required duration of the master-pulse. At the end of this interval, an impulse is transmitted through capacitor C2 to the operative-pulse timer generator V7. This energizes relay K2 to key the 2.6-kc. tone generator V3 (or the 2.8-kc. tone generator V2, depending upon the position of selector switch S1), by closure of contacts K3B and K2A, for .15 second.

Thus a 2-pulse signal is generated, having a total time duration of .45 second, comprised of the master-gate pulse of 3.0-kc. followed by a 2.6- or 2.8-kc. op-

(Continued on page 30)

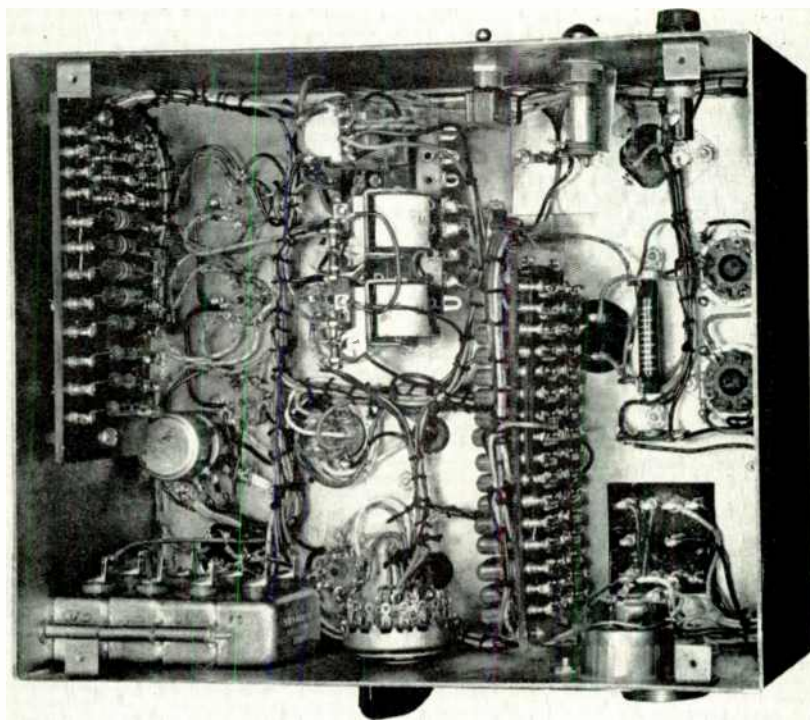

Fig. 3. Construction of the transmitter for controlling up to 12 remote functions

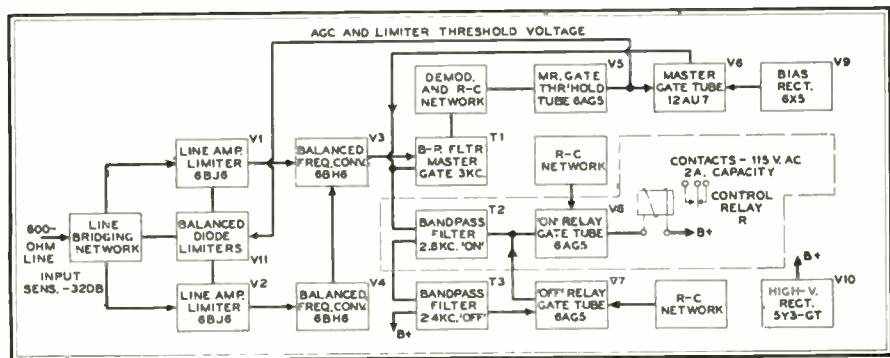
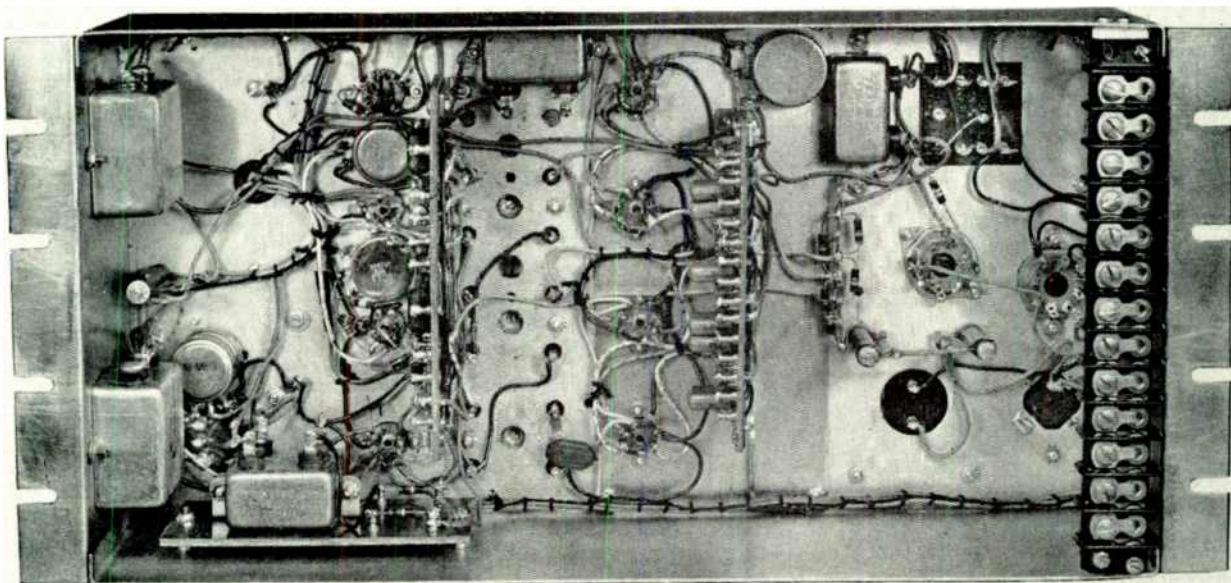

Fig. 4. Receiver diagram. Dotted line encloses parts duplicated for each added relay

Fig. 5, below: Under side of receiver. This is intended for mounting on a 19-in. rack



JEREMIAH COURTNEY'S*

MOBILE RADIO

NEWS and FORECASTS

THE great Experiment has begun in mobile radio application processing. As of August 1, and for the first time in its history, the Federal Communications Commission had separated the application-processing chores from the rule-making and regulatory functions of its staff.

Prior to August 1, the staff that wrote the Rules of the various mobile radio services interpreted, amended, and enforced them, and also passed on the applications presented for authorization in those services. The new and independent Authorization Analysis Division created for the sole purpose of handling all mobile radio applications, other than common carrier, is at once a tribute to the tremendous growth of mobile radio and to this age of specialization.

Defects of Old Method:

While it is still too early to appraise the merits of the new order, it is not difficult to see what gave rise to the staff reorganization in the Safety and Special Radio Services at least. The weakness of the old system was that members of the staff were equally conversant and daily concerned with all the Commission's varied functions. That condition was not apparent during the prewar period, for there was only a trickle of police, fire, and forestry applications. When the flood of postwar applications hit, the weakness became apparent. Application-processing suffered in many respects. The jack-of-all-trades staff was so tied up with preparing new Rules, turning over the desirability of amending old Rules, and handling frequency allocation and assignment problems that their attention was diverted from the application-processing chore. Before the war, such occasional diversions could go unnoticed. But the postwar application stream could brook no such delays.

The Industrial Radio Service workload really broke the camel's back. This new service not unnaturally presented the greatest Rule-making and interpretative problems. The staff assigned to this service, however, was just equal in number to that assigned to the more established

services. Result: Within a year the one or two months application-processing delay that went unnoticed (except for the usual impatient few) gradually slipped into three months. Then in a much shorter time the delay became four months, five months and finally six months. This brought the seriousness of the situation into the open. Contractors who applied for radio use on particular jobs were getting their radio grants after the jobs were completed! Oil companies, accustomed to getting grants in one or two months, faced a five- or six-month delay in anticipated radio use. Mobile radio sales suffered, and every manufacturer felt keenly the effects of the delays.

Timely Remedy:

The extent to which the Commission has recognized the full-time nature and the importance of its application processing function in the Safety and Special Radio Services is perhaps best indicated in the distribution of personnel assigned to the various Divisions: Office of the Bureau Chief, 9 members; Aviation Division, 11 members; Marine, 14; State-Local Government and Amateur Division, 10; Industry and Commerce Division, 10; Authorization Analysis, 82 members.

The Authorization Analysis Division now has more personnel than all the other Divisions, plus the Office of the Bureau Chief, put together. The personnel appointments and reassignments of the entire Safety and Special Services Division are listed here.

New Application Procedures:

Here is the way applications will be handled henceforth. Each application branch now has an Engineering Adviser. He will pass on all applications which, previously, required reference to the Engineering Department. If the Engineering Adviser is unable to make a decision on the question presented, the application will be referred to the Application Advisory Branch of the Authorization Analysis Division. If that Branch is not satisfied that the application may be properly granted, it will be referred to the appropriate Division for final decision.

SAFETY & SPECIAL RADIO SERVICES BUREAU

BUREAU CHIEF
Edwin L. White
Bureau Chief
Lester W. Spillane
Asst. Chief
Bernice Hase
Geraldine Havrilla
Ethel Mozley

Clarence S. Adams
Rachel M. Clindard
Martha G. Crandell
William Kosiski
Ottie S. Register
Earl W. Strayer
Marie A. Tomasi
Lewis Meriwether
Engineering Adviser

ENFORCEMENT UNIT

Marshall S. Orr
Division Chief
Irving Brownstein
Robert Fenton
Anne Donnelly

Land Transportation Group

Myrtle R. McMahan
Group Chief
Katherine Bancroft
John S. Napoli
Phillis Lazar
Cleo R. Parrish
Carl R. Gordon
Edward P. McDermott
Engineering Adviser

AVIATION DIVISION

John R. Evans
Division Chief
James D. Durkee
William Hawthorne
John J. McCue
Donald Mitchell, Jr.
John S. MacDonald
Robert H. Faul
Arthur Blooston
Dorothy C. Bass
Alice Irwin
Lois J. Arison

Industry & Commerce Group

Byron D. Runyon
Group Chief
David J. Bell
Lois E. Bogardus
Mabel M. Nash
Helen Stottlemeyer
Mabel H. Tucker
Benjamin E. Wiltshire
John R. Anderson
Edward P. McDermott
Engineering Adviser

MARINE DIVISION

William N. Krebs
Division Chief
William F. Minners
William E. Dulin
Harold R. Woodyard
Alfred DeLaCroix
Duncan D. Peters
Robert T. Brown
James T. Kyne
Thomas M. Stevens
John E. Wicker
Willie Herbert
Betty H. Dyer
Elizabeth A. O'Brien
Elizabeth L. Childress

State and Local Govt. Group

Marie J. Boggan
Group Chief
Mary R. Scheytt
Juanita R. Sanchez
Beatrice N. Bourne
Grace M. Nielsen
Helen E. Gasior
George R. Boardman
Engineering Adviser

STATE-LOCAL GOVT. & AMATEUR DIVISION

George K. Rollins
Division Chief
John D. Fulmer
Daniel H. Arnold
Herman Garlan
Ivan H. Loucks
John C. Currie
Violet L. Haley
Carol A. Elstad
Mildred Donaldson
Sophia W. Redler

Amateur Group

Frank Gentile
Group Chief
Paul W. Kiefaber
Mildred L. Barker
Lewis C. Freehauf
Gladys B. Carroll
Eliette G. Boudreau
Mary Ann Curry
Catherine M. Grady
Nora C. Macon
Goldie Ellerin
Wyman Parks
Eugene W. Flemister
William R. Ross
Alberta J. Blair
George R. Boardman
Engineering Adviser

INDUSTRY & COMMERCE DIVISION

Glen E. Nielsen
Division Chief
Milburne O. Sharpe
Alfred P. Miller
Charles I. Fonger
William H. Watkins
C. A. Higginbotham
Douglas Anello
Frances S. Klein
Sophia Niewicz
Nadine H. Wiemer

Application Advisory Branch

Robert W. Percy
Branch Chief
Albert J. Mantwill
Frank W. Cook
George J. Ikelman
Milo A. Pochop
Leo C. Haffsman
David Landis
Margaret Connolly
Robert Crain
Pearl W. Mason

AUTHORIZATION ANALYSIS DIVISION

Charles R. Weeks
Division Chief
Robert L. Stark
Asst. Chief
Eva E. Hocutt

CONTROL OFFICE

Application Control Section
William H. Irvin
Section Chief

Aviation Group
Anne B. Richmond
Group Chief
Esther M. Myers
Helen A. Boese
Georgia M. Compton
E. Celeste Highland
Thelma M. Nolen
Agnes P. Svanas
Lillis W. Cockrell
Engineering Adviser

Clara Olsen
Doris M. DiGirolamo
Julia K. Mathews
Hazel Jean Gariner
Procedures Section
Merle E. Floegel
Acting Section Chief
Ezra Chambers
Louis M. Manning
Francis C. Acree

Marine Group

Leonora E. Miller
Group Chief
Helen D. Luber
Leila Fowler
Virginia E. Hughes

Office Services Section*
Mildred L. Brown
Ida M. Emery
Marjorie McDiffett
Anna L. Connors
*Chief to be appointed

The result of the reorganization should
(Concluded on page 34)

*1707 H Street, N.W., Washington, D. C.

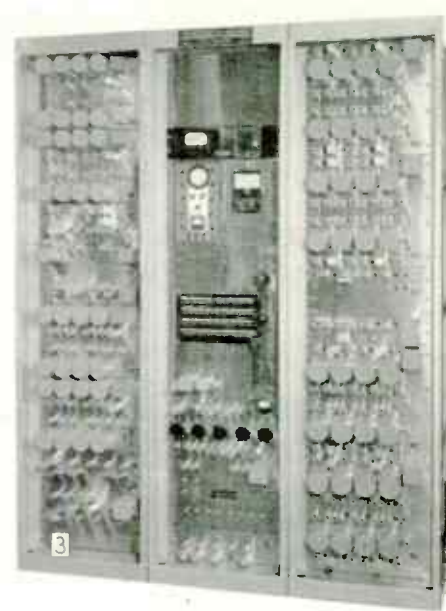

NEWS PICTURES

1. This microwave relay tower is one of 34 employed in A T & T's New York-to-Chicago relay system, in operation September 1. Service will also be provided to intermediate points. The 458-mile link from Chicago to Omaha, now being tested, will be ready September 30. Remaining western sections are expected to be in operation late in 1951.

2. Stations WCEC and WFMA, Rocky Mount, North Carolina, have recently installed this mobile transmitting unit for on-the-spot broadcasts of important community events. Equipment consists of an REL model 695 remote FM pickup link providing 50 watts on 153.11 mc., a 15-ft. rotatable antenna, power supplies, and microphones.

3. Philco's new multiplex terminal equipment provides for as many as 32 voice channels, and can be used for telegraph, telemetering or remote-control applications. Employing pulse amplitude modulation with time-division multiplexing, the equipment is described as being exceptionally free from cross-talk. Composite output of the 32-channel model is less than 300 kc. wide.

4. Altec Lansing of Hollywood has developed a new series of amplifiers to be used with the miniature condenser microphone. Power for the microphone impedance matching tube is obtained from the amplifier. Model A-332A, illustrated, has two microphone inputs and one reluctance phonograph input, each with variable gain and bass controls. A single treble droop control is provided. Output is 18 watts.

5. Stoddart Aircraft Radio Company, 6614 Santa Monica Boulevard, Hollywood 38, Calif., is making 4 models of interference and field-intensity meters, covering 14 to 250 kc., 150 kc. to 25 mc., 15 to 400 mc., and 375 to 1,000 mc. Equipment measures peak value of interfering pulse and interference per megacycle bandwidth, in addition to field intensity. Complete accessories are available. Pictured is the UHF model, NM-50A.

6. This all-triode amplifier is available wired or in kit form from Sun Radio & Electronics Company. Two switched inputs, for tuner and magnetic pickups, provide gain of 75 and 97 db with bass and treble controls flat. Distortion is less than 2.5% at 10 watts rated output. Frequency response is flat within 1 db from 20 to 15,000 cycles.

7. General Electric's new FM-AM model 408 is a low-priced table set, featuring high sensitivity with effective limiting. Also being produced in console radio-phonograph combinations.

8. RCA transmitter-receiver model CMV-4A, the Super-Carfone 50, provides 30 watts output in the 152- to 174-mc. band. Greater intelligibility is obtained by increasing average modulation level to 70%. Designed for adjacent-channel use, all spurious emissions are attenuated at least 85 db.

9. For storecasting and musicasting, REL model 720-3 provides single-frequency operation at any point in the FM band. Control circuits employ supersonic tones to mute or boost audio for announcements. Also, the user can make his own announcements as desired.

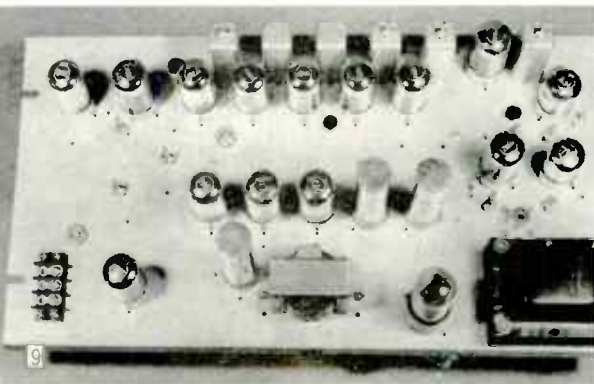

FCC ISSUES COLOR TV PROPOSAL

OFFICIAL TEXT OF THE FCC'S REVIEW OF ITS COLOR TELEVISION REPORT,
AND ITS NOTICE OF PROPOSED RULE MAKING, ISSUED ON SEPTEMBER 1, 1950

FCC REVIEW OF ITS REPORT ON COLOR TELEVISION

In a report issued on September 1, covering the color issues in the current television proceedings (Dockets 8736 et al.), the Federal Communications Commission announced, in substance, that on the basis of the color hearing record:

It is not adopting final color standards at the present time;

The color systems of the Radio Corporation of America and Color Television, Inc., fall short of the Commission's criteria for a TV color system.

The Commission believes that if a decision has to be made now, the CBS system meets the criteria for a color TV system. However, in its report the Commission indicates that, if a procedure can be devised whereby the compatibility problem is not aggravated if a decision is postponed, the Commission would feel more confident in postponing a decision so that it could look further into four matters. These are:

1. The utilization of direct view tubes larger than 12 $\frac{1}{2}$ ins. in size on the CBS system.
2. The use of horizontal interlace.
3. The use of long persistence phosphors.
4. The development of new compatible systems or improvements in compatible systems which have been informally called to the Commission's attention since the hearing record was closed.

Bracket Standards:

The Commission announced that a procedure exists whereby the compatibility problem can be held in status quo if the manufacturers were to build receivers employing bracket standards—that is, receivers that could handle the scanning of both the present system and the CBS system.

Accordingly, the Commission proposes:

Bracket standards for the present monochrome standards, one of which will be the current black-and-white standards and the other the CBS proposed standards.

Proposal to Manufacturers:

In this connection, manufacturers are requested to advise the Commission whether they will provide new TV receivers with a manual or automatic switch to accomplish this purpose. If the Commission is assured that a great majority of TV sets will be so equipped, it will adopt the monochrome bracket standards as final. If, however, the monochrome bracket

standards cannot be made final without a hearing, or if the response from manufacturers is insufficient, the Commission cannot postpone a color decision since each day that passes would aggravate the compatibility problem. In that event, the Commission will issue a final decision forthwith adopting the CBS field sequential color standards.

If, on the other hand, the monochrome bracket standards are adopted, the Commission will then postpone the color decision and instead will propose that color standards be adopted on the basis of the CBS system, with the same bracket standards applicable to color. In addition, field tests would be invited with respect to "horizontal interlace" (a proposed means of improving horizontal detail in the picture) for use in both monochrome and color TV. Comments will be received by the Commission on or before Jan. 5, 1951.

Other Color Systems:

Color systems different from that of CBS could be proposed if, by Dec. 5, 1950, the proponent of such a system delivers representative receivers to the Commission's laboratory for test and study and, further, by the December date has a signal on the air in Washington, D. C., for demonstrating his system.

The Commission points out that this procedure may necessitate reopening the color record, particularly if CBS desires to demonstrate a tri-color (3-color element) tube or other means of achieving large size direct view pictures. A hearing could also be required if an appropriate proposal is made concerning horizontal interlace, or if a color system is proposed which fully meets the Commission's criteria for a color TV system.

General Conclusions:

In its general conclusions, the Commission's report has this to say:

"The testimony and demonstrations in these proceedings leave no room for doubt that color is an important improvement in television broadcasting. It adds both apparent definition and realism in pictures. It opens up whole new fields for effective broadcasting, rendering life-like and exciting scenes where color is of the essence—scenes which in black and white television are avoided or, if telecast, have little appeal.

"Because color is such a fundamental improvement in television, the Commis-

sion is of the opinion that in establishing standards, a system must be chosen that produces a satisfactory color picture and is capable of operating through apparatus that is simple to operate in the home and is cheap enough in price so as to be economically available to the great mass of the American purchasing public. The Commission is of the firm opinion that it would not be in the public interest to establish a television system where only black and white receivers are cheap enough for the great mass of the American people and color television is available to those who can afford to pay luxury prices.

New Color Criteria:

"In order for a color system to be considered eligible for adoption, it must meet the following minimum criteria:

A. It must be capable of operating within a 6-megacycle channel allocation structure.

B. It must be capable of producing a color picture which has a high quality of color fidelity, has adequate apparent definition, has good picture texture, and is not marred by such defects as misregistration, line crawl, jitter or unduly prominent dot or other structure.

C. The color picture must be sufficiently bright so as to permit an adequate contrast range and so as to be capable of being viewed under normal home conditions without objectionable flicker.

D. It must be capable of operating through receiver apparatus that is simple to operate in the home, does not have critical registration or color controls, and is cheap enough in price to be available to the great mass of the American purchasing public.

E. It must be capable of operating through apparatus at the station that is technically within the competence of the type of trained personnel hired by a station owner who does not have an extensive research or engineering staff at his disposal and the costs of purchase, operation, and maintenance of such equipment must not be so high as unduly to restrict the class of persons who can afford to operate a television station.

F. It must not be unduly susceptible to interference as compared with the present monochrome system.

G. It must be capable of transmitting color programs over intercity relay facilities presently in existence or which may be developed in the foreseeable future.

New Attitude on Compatibility:

"It should be noted that the above criteria do not include compatibility. The Commission is of the opinion that if a satisfactory compatible system were available, it would certainly be desirable to adopt such a system. Compatibility would facilitate for the broadcaster the transition from black and white broadcasting to color broadcasting and would reduce to a minimum the obsolescence problem of present receivers. However, as will be developed more fully later on in this Report, no satisfactory compatible system was demonstrated in these proceedings and the Commission is of the opinion, based upon a study of the history of color development over the past ten years, that from a technical point of view compatibility, as represented by all color television systems which have been demonstrated to date, is too high a price to put on color. In order to make these systems compatible, the alternatives have been either an unsatisfactory system from the standpoint of picture quality, or a complex system, or both. A complex color system will have such formidable obstacles in its path that there is no assurance it would be acceptable to the American public. The Commission is compelled to reach the conclusion that no satisfactory compatible color system has been developed.

"The receiver aspect of compatibility, moreover, is merely a temporary problem which will decrease progressively each year once receivers are built incorporating new standards. Based upon an assumption of 7,000,000 sets in the hands of the public at the present time, the problem of compatibility would be diluted each year depending on the annual rate of production. It is not possible to forecast what the annual rate of production would be but, by way of illustration, if sets were continued to be manufactured at the present rate of production (e.g. five to six million sets a year) then one year after the adoption of an incompatible system approximately 40% of the receivers in the hands of the public should be capable of receiving these signals without any change whatsoever—they will have been built that way. (The Commission is aware that some manufacturers expressed a reluctance to build sets for an incompatible system if it is approved by the Commission. We believe that an informed public would demand receivers that are capable of getting programs from all television stations in the area and that the manufacturers would build such receivers.) The percentage will become progressively larger each year. So far as owners of existing receivers are concerned, if they make no change, they will still be

able to receive programs broadcast in accordance with present monochrome standards—there will undoubtedly be such for several years after a decision—or they can spend the relatively minor amount of money necessary to adapt their sets and thus be able to receive all programs in black and white or they can spend a slightly larger amount and get color programs in color. It would not be in the public interest to deprive forty million American families of color television in order to spare the owners of seven million sets the expense required for adaptation.

"The criteria set forth . . . likewise do not include any reference to convertibility or adaptability. Much of the reasoning applicable to compatibility applies likewise to convertibility or adaptability. While there is some doubt as to whether some of the color systems proposed here meet the test of adaptability and convertibility . . . contained in our Notice of July 11, 1949, no objection was raised by the Commission or any of the parties to the consideration of any of the color systems proposed herein and no objection is raised in any of the Proposed Findings or Replies. Accordingly, the three systems are considered on the merits.

Competition and Monopoly:

"During the hearing evidence was introduced to show the patent position which is held by RCA in the television field, and one of the parties urged the Commission to reject the RCA system in order to encourage competition and avoid monopoly. The Commission recognizes that if a monopolistic patent position exists in the radio field, it would tend to discourage fundamental research by other companies and would tend to foster concerted action on the part of the patent licensor and its licensees, which could result in control of receivers sold to the public. However, on the record in these proceedings we do not believe that we are called upon to make a decision as to whether RCA does have a monopolistic position in the radio field, as urged by some, or merely one of leadership, as contended by RCA, because the decision as to whether the RCA system should or should not be adopted is based solely on a consideration of the system on the merits. If the Commission should find that a monopolistic situation does exist or such a situation should develop, appropriate proceedings can be instituted, under the anti-trust laws or the Commission can seek from Congress legislation to prevent the building of monopolistic patent structures in the radio field, or both."

VHF and UHF Allocations:

The Commission's report is the first to

result from the comprehensive TV proceedings instituted May 5, 1948, as augmented by proposed rule-making of July 11, 1949. In addition to color, there is involved consideration of interference to present TV broadcast in the VHF (Very High Frequencies), opening 42 channels in the UHF (Ultra High Frequencies) to commercial TV, and establishing a new national TV allocation table accordingly.

A supplemental notice issued by the Commission today calls for hearing the second phase—general allocation issues—to commence October 2, 1950. In addition to proposed UHF television broadcast, this proceeding will embrace consideration of stratovision (TV broadcast from planes), polycasting (community service by a number of low-power stations), and reservation of channels for noncommercial educational TV stations. (This will not include specific allocations to specific communities.)

Freeze Will Continue:

Pending the outcome of all phases of the TV proceedings, a freeze on new commercial TV station construction has been in effect since September 29, 1948. Today's report on color does not disturb this ban.

Color Systems Considered:

The initial phase of the overall review of the television situation was limited to the color issues. Between September 26, 1949, and May 26, 1950, there were 62 days of such hearing, and 8 separate color demonstrations, which resulted in 9,717 pages of testimony not including 265 exhibits.

The CBS, RCA and CTI color systems were the only ones proposed for Commission consideration, though there was testimony on possible improvements such as the tri-color tube, long persistence phosphors, horizontal interlace, etc. The Commission's report explains and analyzes the three particular systems proposed. For non-technical quick-reference purposes, they may be indicated as follows:

CBS proposed a field sequential system employing a single tube only both at the camera and at the receiver. Most of the CBS receivers need a rotary disc. CBS also demonstrated a projection receiver. Existing receivers are unable to receive a black-and-white picture from CBS color transmissions without adapters.

RCA proposed a dot sequential system which scans each line in a series of dots rather than continuously. Three separate picture tubes are used both at the camera and at the receiver. These tubes are supplemented by an optical system consisting of dichroic mirrors and lens. RCA later demonstrated a direct view tri-color tube. Existing receivers can re-

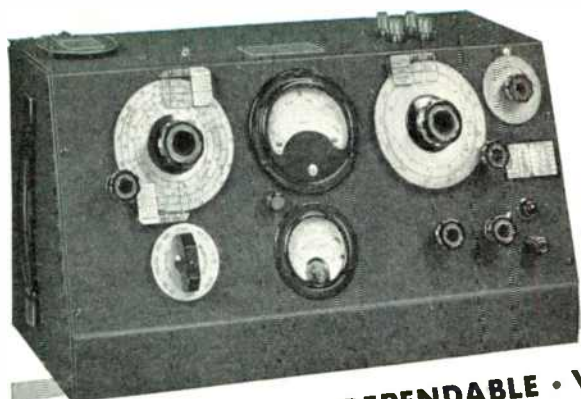

The **Q-METER**
TYPE 160-A

ACCURATE • DEPENDABLE • VERSATILE

For the measurement of Q, inductance, and capacitance, the 160-A Q-Meter is the universal choice of radio and electronics engineers. Its wide frequency coverage from 50 kc. to 75 mc. is an outstanding feature which makes possible the accurate and rapid evaluation of components and insulating materials at the actual operating frequency.

SPECIFICATIONS

OSCILLATOR FREQUENCY RANGE:
50 kc. to 75 mc. 8 self contained ranges.

OSCILLATOR FREQUENCY ACCURACY:
± 1%, 50 kc.-50 mc. ± 3%, 50 mc.-75 mc.

Q-MEASUREMENT RANGE: Directly calibrated in Q, 20-250. "Multiply-Q-By" Meter also at x2.5, extending Q-range to 625.

Q-MEASUREMENT ACCURACY: Approx-

mately 5% for direct reading measurement, far frequencies up to 30 mc. Accuracy less at higher frequencies.

CAPACITANCE CALIBRATION RANGE:
Main capacitor section 30-450 mmf, accuracy 1% or 1 mmf, whichever is greater.
Vernier capacitor section +3 mmf., zero, -3 mmf. calibrated in 0.1 mmf. steps.
Accuracy ± 0.1 mmf.

Write for literature containing further details

BOONTON RADIO CORPORATION
BOONTON • N.J. • U.S.A.

FREE

Send for **ALLIED'S NEW 1951 CATALOG!**

- **ELECTRONIC SUPPLIES for INDUSTRY**
- **BROADCAST STATION SUPPLIES**

World's Largest Stocks • Complete Expert Service from One Central Supply House

Simplify your purchasing problems—send your consolidated orders to ALLIED—the single, complete source for all electronic supplies. Rely on ALLIED for the world's largest stocks of parts, tubes, test instruments, audio equipment, accessories—complete quality lines of electronic supplies ready for immediate shipment from stock. ALLIED'S expert Industrial and Broadcast Station supply service saves you time, effort and money. Send today for your FREE copy of the 1951 ALLIED Catalog—the only complete guide to electronic supplies for industrial and broadcast station applications.

ALLIED RADIO CORP.

833 W. Jackson Blvd., Dept. 20-J-O • Chicago 7, Illinois

Everything in Electronics from ONE Source

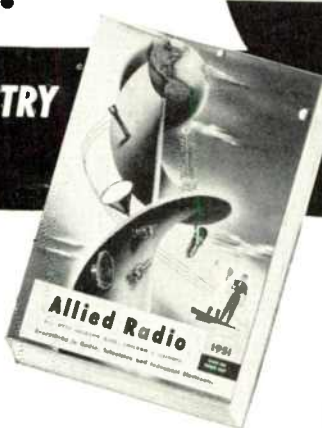

212 PAGES: Equipment for Research, Development, Maintenance and Production Operations

Send for **1951 ALLIED CATALOG**

WHAT'S NEW THIS MONTH

(Continued from page 11)

feature that will intrigue you most is the flexibility of the system, greatly simplifying the problems of making custom installations in homes where the equipment must not be in evidence.

MOBILE RADIO NEWS

(Continued from page 18)

be to free the personnel of the various Service divisions from a large part of the application processing duties they formerly assumed, as they will henceforth deal only with the problem applications. The time thus saved by these staff members should permit a much more prompt disposition of industry-wide problems than in the past. The staff of the various Services should also have a little more time for travel, so as to acquire a firsthand familiarity with the problems that exist in the field and the possibilities for their solution.

Long Range Effects:

Enabling the staff to deal with present and future problem areas in the various services will probably be the most important aspect, in the long run, of the new reorganization. There is little doubt that much better utilization could be made of available frequencies if appropriate exceptions were possible to the present pattern of nation-wide assignments. Limited time for adequately-considered decisions has prevented the drawing of finer lines in the past. With the top legal and engineering staff now able to consider the need for spot exceptions to the rough-justice plan of national frequency assignments, improved frequency utilization should result. This could perhaps be predicted more confidently if greater recognition had been accorded a few of the younger and highly competent engineers and lawyers on the staff.

Miscellaneous Notes:

FCC has finalized the proposed amendment to the Low Power Industrial Radio Service Rules, making the frequency 27.51 mc. specifically available for radio installations aboard aircraft for organizations requiring communications between air and ground personnel in crop-dusting, pipe-line patrol and similar activities. Proposed annual report form to be used by mobile radio common carriers has been universally approved. Proposed Rules for new Disaster Communications Service and a complete revision of Part 5 of the Experimental Radio Service Rules has been issued. Time for comments on Disaster Communications Service Rules and revised Experimental Rules is September 15.

FOR YOUR CONVENIENCE, TELEPHONE
NUMBER OF EACH COMPANY IS SHOWN HERE

Adair, George P.	8
Washington, D. C.: Executive 1230	
Alford, Andrew	8
Boston: Hancock 6-2339	
Allied Radio Corp.	34
Chicago: Haymarket 1-6800	
Altec Lansing Corp.	35
New York City: Algonquin 5-3636	
American Phenolic Corp.	31
Chicago: Rockell 2-4000	
Amy, Aceves & King Co., Inc.	8
New York City: Longacre 5-6622	
Andrew Corp.	9
Chicago: Triangle 6461	
Audio Devices, Inc.	Inside Back Cover
New York City: Plaza 3-0973	
Bell Telephone Labs.	10
New York City: Chelsea 3-1000	
Bliley Electric Co.	6
Erie, Pa.: Erie 2-2287	
Boonton Radio Corp.	34
Boonton, N. J.	
Browning Laboratories, Inc.	25
Winchester, Mass.: Winchester 6-2121	
Communications Equip. & Engr. Co.	33
Chicago: Estebrook 8-3110	
Davis, George C.	8
Washington, D. C.: Sterling 0111	
Doolittle Radio, Inc.	4
Chicago: Radcliffe 3-4100	
Eitel-McCullough, Inc.	36
San Bruno, Cal: San Bruno 4000	
Emsco Derrick & Equipment Co.	33
Los Angeles, Calif.	
FM-TV	9
Gt. Barrington, Mass.: Great Barrington 500	
General Radio Co.	Inside Front Cover
Cambridge, Mass.: Trowbridge 6-4400	
Gray Research & Development Co.	28
Hartford, Conn.: Hartford 33-1244	
Hammarlund Mfg. Co., Inc.	1
New York, N. Y.: Longacre 5-1300	
Harvey Radio Co.	30
New York City: Luxemborg 2-1500	
Heimark, Harold M.	9
Chicago: Estebrook 8-7047	
Jansky & Bailey	8
Washington, D. C.: ME 5411	
Jones, Howard B., Division	35
Chicago: Nevada 2-2000	
Kear & Kennedy	8
Washington, D. C.: Sterling 7932	
Klipsch & Associates	9
Hope, Ark.: Hope 995	
Maurer, Inc., J. A.	9
Long Island City, N. Y.: Stillwell 4-4601	
May, Russell P.	8
Washington, D. C.: Republic 3984	
McIntosh Engineering Labs.	26
Washington, D. C.: Juniper 7-9200	
McIntosh & Inglis	9
Washington, D. C.: Metropolitan 4477	
McNary & Wrathall	8
Washington, D. C.: District 1205	
Santa Cruz, Cal.: 5040	
Measurements Corp.	9, 32
Boonton, N. J.: Boonton 8-2131	
Motorola, Inc.	Back Cover
Chicago: Spaulding 2-6500	
Pollack, Dale	8
Waterford, Conn.: New London 2-0760	
Radiart Corp.	3
Cleveland, Ohio: Melrose 1-6660	
Radio Corp. of America	5
Camden, N. J.: Woodlawn 3-8000	
Radio Engineering Labs.	27, 32
Long Island City, N. Y.: Stillwell 6-2101	
Ray, Garo W.	8
Strafrod, Conn.: Stratford 7-2465	
Reeves Soundcraft Corp.	7
Long Island City, N. Y.: Astoria 8-6082	
Smeby, Lynne C.	8
Washington, D. C.: Executive 8073	
Superior Electric Co.	29
Bristol, Conn.: Bristol 3141	
Weldon & Carr	9
Washington, D. C.: Michigan 4151	
Wilmette, Raymond M.	9
Washington, D. C.: Decatur 1232	
Workshop Associates, Inc.	9
Newton Highlands, Mass.: Needham 3-0005	
Zenith Radio Corp.	2
Chicago: Berkshire 7-7500	
Zophar Mills, Inc.	35
Brooklyn, N. Y.: South 8-0907	

DEPENDABLE • HIGH QUALITY • DURABLE

MICROPHONES

by **ALTEC**



639* 633*

*Formerly manufactured by Western Electric Co., Inc.

DISPATCHED BY GRAYBAR

NOW AVAILABLE... The famous 639 type adjustable directional microphone, long recognized as the standard microphone of this type. Unequaled for many professional uses. • The popular 633 "Saltshaker," still the world's finest dynamic microphone, famous for its rugged dependability and smooth response. • These two indispensable mikes are again available for delivery. Each represents the finest in design, in construction and in performance. Compare their price... and their quality.

1161 N. VINE ST., HOLLYWOOD 38, CALIF.
161 SIXTH AVE., NEW YORK 13, NEW YORK

ALTEC

LANSING CORPORATION

INSURE
Proven Quality

with **JONES**
PLUGS & SOCKETS



P-306-CCT — Plug, Cable Clamp in cap. S-306-AB — Socket with Angle Brackets.

Series 300 Small Plugs & Sockets for 1001 Uses

Made in 2 to 33 contacts for 45 volts, 5 amps, for cop or panel mounting. Higher ratings where circuits permit. All plugs and sockets polarized. Knife switch socket contacts phosphor bronze, cadmium plated. Engage both sides of flat plug — double contact area. Bar type plug contacts hard brass cadmium plated. Body molded bakelite.

Get full details in Catalog 17. Complete Jones line of Electrical Connecting Devices, Plugs, Sockets, Terminal Strips. Write today.

Jones

HOWARD B. JONES DIVISION
CINCH MANUFACTURING CORPORATION
CHICAGO 24, ILLINOIS
SUBSIDIARY OF UNITED CARB FASTENER CORP.

ZOPHAR

WAXES COMPOUNDS and EMULSIONS



FOR
INSULATING and WATERPROOFING
of ELECTRICAL and
RADIO COMPONENTS

•

Also for
CONTAINERS and PAPER
IMPREGNATION

•

FUNGUS RESISTANT WAXES

•

ZOPHAR WAXES and COMPOUNDS
Meet all army and navy
specifications if required

•

Inquiries Invited

ZOPHAR MILLS, INC.
FOUNDED 1846
122-26th ST., BROOKLYN, N. Y.

Mr. Isberg Proves A Point . . .

. . . regardless of how tough the service, Eimac 4E27A pentodes perform better—longer.



R. A. ISBERG, CHIEF ENGINEER, KRON-TV

The 4E27A is by no means limited to service in TV transmitters. Its rugged internal structures and pyrovac plate provide, in conventional amplifier or oscillator service, even far greater tube life than is indicated in the severe tests reported by Mr. Isberg.

This new Eimac pentode is rated at 125 watts of plate dissipation. Low grid-plate capacitances make it exceptionally stable and its high power-gain characteristics enable delivery of relatively large output with low driving power.



TV AND FM SERVICES OF THE
SAN FRANCISCO CHRONICLE

KRON-TV KRON-FM
CHANNEL 4 DIAL 96.5

TELEVISION AFFILIATE OF THE
NATIONAL BROADCASTING CO.

June 13, 1950

Mr. O. H. Brown
Eitel-McCullough, Inc.
San Bruno, California

Dear Hank;

You will be interested to learn that the six Eimac 4E27A/5-125B tubes which were installed in the video modulator of our RCA TT-5A transmitter on March 11, one thousand hours, and from all indications they will continue to give good service for many more hours.

The life history of 4E27/500L tubes prior to the development of the improved version was uncertain; some tubes would fail within 100 hours of their installation and few would last more than 700 hours. This situation was especially aggravating in the picture modulator where six tubes are operated in parallel and the malfunctioning of any one tube could seriously degrade the picture or interrupt operation.

Following is a tabulation of the individual plate currents of the six tubes after approximately 1000 hours service in the picture modulator.

Tube No.	Plate Current
807	.178 Amperes
808	.171 "
809	.190 "
810	.173 "
811	.175 "
812	.185 "

We are happy that KRON-TV has been able to assist you in the "field test" of the new 4E27A and we feel that it will be welcomed by the television broadcasters because it will afford more reliable operation, reduce tube replacement costs, and promote greater satisfaction and confidence on the part of the operating personnel.

Kindest personal regards,

Sincerely,

Al Isberg
R. A. Isberg
Chief Engineer

RAI/md

901 MISSION STREET

SAN FRANCISCO 19

GARFIELD 1-1100

Follow the Leaders to

Eimac
TUBES

The Power for R-F

COMPLETE DATA ON THE EIMAC
4E27A BEAM POWER PENTODE
IS AVAILABLE UPON REQUEST.



EITEL-McCULLOUGH, INC.
San Bruno, California
Export Agents: Frazer & Hansen, 301 Clay St., San Francisco, California

263

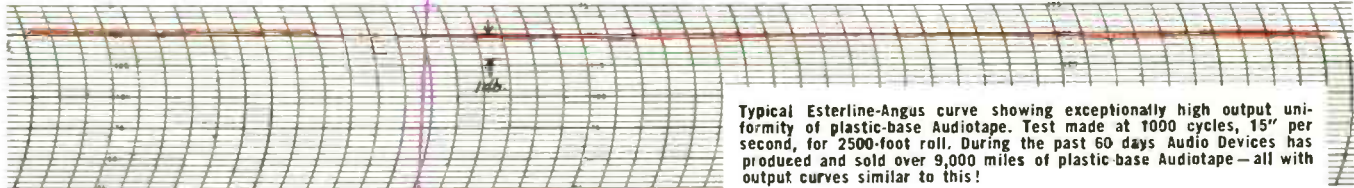
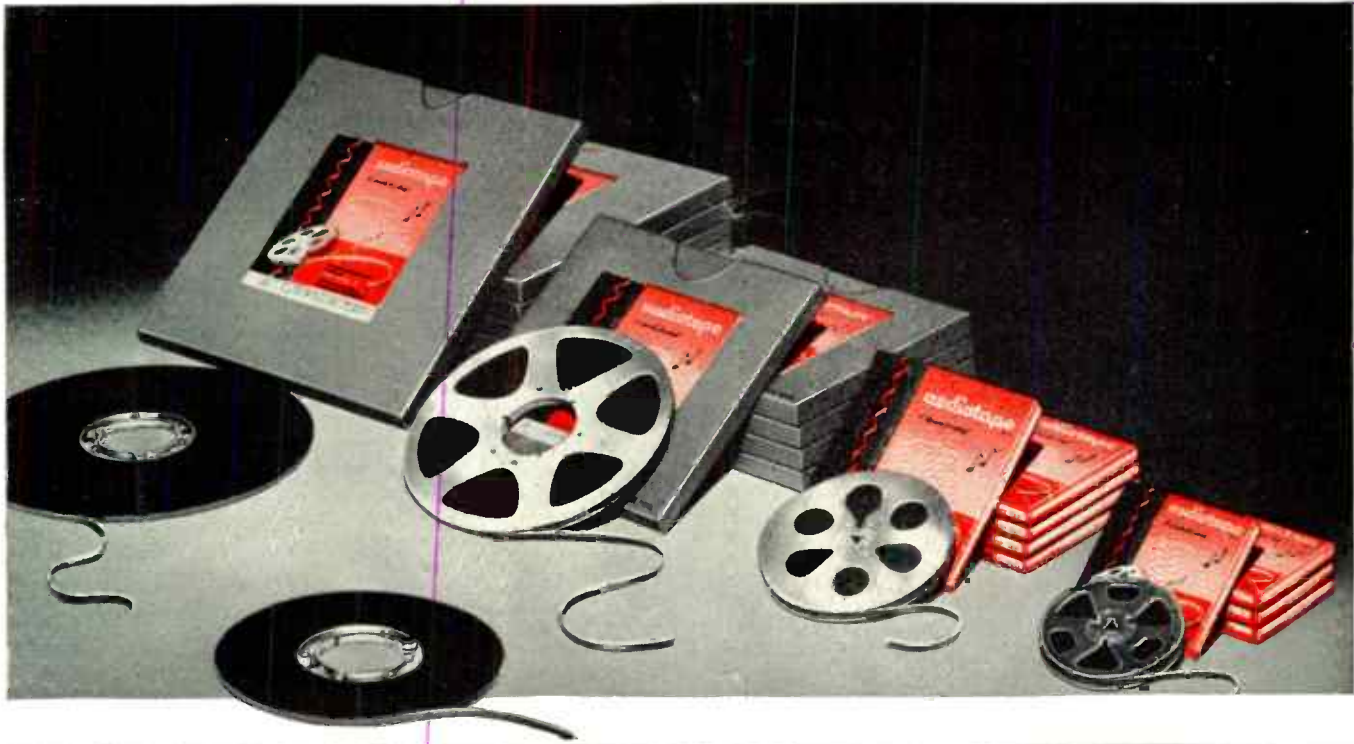

Typical Esterline-Angus curve showing exceptionally high output uniformity of plastic-base Audiotape. Test made at 1000 cycles, 15" per second, for 2500-foot roll. During the past 60 days Audio Devices has produced and sold over 9,000 miles of plastic-base Audiotape—all with output curves similar to this!

UNIFORMITY PLUS

that's what you get in every reel of

audiotape*

Unequalled uniformity of output volume is one of the outstanding advantages of Audiotape. This is especially important in professional work where shows are edited and assembled on tape. For even slight variations in output can become very objectionable when splicing brings high and low volume sections together.

Every 2500-foot reel of plastic-base Audiotape is *guaranteed* to have a volume deviation, at 1000 cps, of not more than $\pm 1/4$ db within the entire length—and not more than $\pm 1/2$ db from reel to reel. And these are *outside limits*, not averages. What's more, every 2500-foot reel is guaranteed to be en-

tirely free from splices!

This extremely high uniformity is made possible by Audio's specially designed coating machines, which permit control of coating thickness to within *five millionths* of an inch. During the past 60 days, these machines have turned out more than *9,000 miles* of plastic-base tape—with a volume deviation of not more than $\pm 1/2$ db!

Remember—when you use Audiotape, you can be *sure* of the results every time. For every foot of Audiotape is monitored for output, distortion and uniformity—your assurance of the finest, professional quality recording tape obtainable.

*Trade Mark

- **STRAIGHT-LINE SLITTING** that makes tape track and wind absolutely flat.
- **FREEDOM FROM CURL** that permits tape to maintain perfect contact with heads.
- **SMOOTH UNWINDING**, with no tendency to stick layer-to-layer.
- **NO FRICTION SQUEAL**. Smooth surface rides quietly over pressure blocks and tensioning devices.
- **LOW COST**. 2500-foot roll on NAB hub has list price of \$10—subject to Audio's usual discounts to professional users.
- **IMPROVED PACKAGING**. 2500 and 5000 foot rolls of Audiotape, on hub or complete reel, are boxed in special containers for easier and safer handling and storage. Folding inner section permits loading onto turntable without danger of spilling tape—also permits easy attachment of reel flanges on hub.

TEST IT—COMPARE IT

We will be glad to send you a free 200-foot sample reel of either plastic-base or paper-base Audiotape. It will speak for itself.

AUDIO DEVICES, INC

444 MADISON AVE., NEW YORK 22, N. Y.

Export Dept.: ROCKE INTERNATIONAL, 13 East 40th St., New York 16, N. Y.

Motorola—Precision-Engineered for
ADJACENT CHANNEL OPERATION

New "Uni-Channel"
Top performer in
low-cost 2 way radio



with the marvelous Sensicon circuit...

...for permanent selectivity—and 8 other Motorola improvements—Count on Uni-Channel through any routine or emergency to handle *whole* messages in heavy adjacent channel traffic (± 35 Kc. at 100 db. down, and ± 15 Kc. at 6 db. down)

your practical proof of superior *Motorola* equipment!

A marvel of mechanical convenience in one compact and accessible package. Just 4 screws install it in any vehicle. Or, as an emergency station, simply connect antenna* and power.*

Investigate Uni-Channel before buying.



BY THE WORLD LEADERS

BACKED BY 20 YEARS RESEARCH, EXPERIENCE, AND SPECIALIZATION IN MOBILE RADIO

FM 2-WAY RADIO

Motorola

COMMUNICATIONS DIVISION 4545 AUGUSTA BLVD., CHICAGO, in Canada: Rogers Majestic, Ltd., Toronto