

Price 25 Cents

Apr. '49

FMA-TV

★ Edited by ★
Milton B. Sleeper

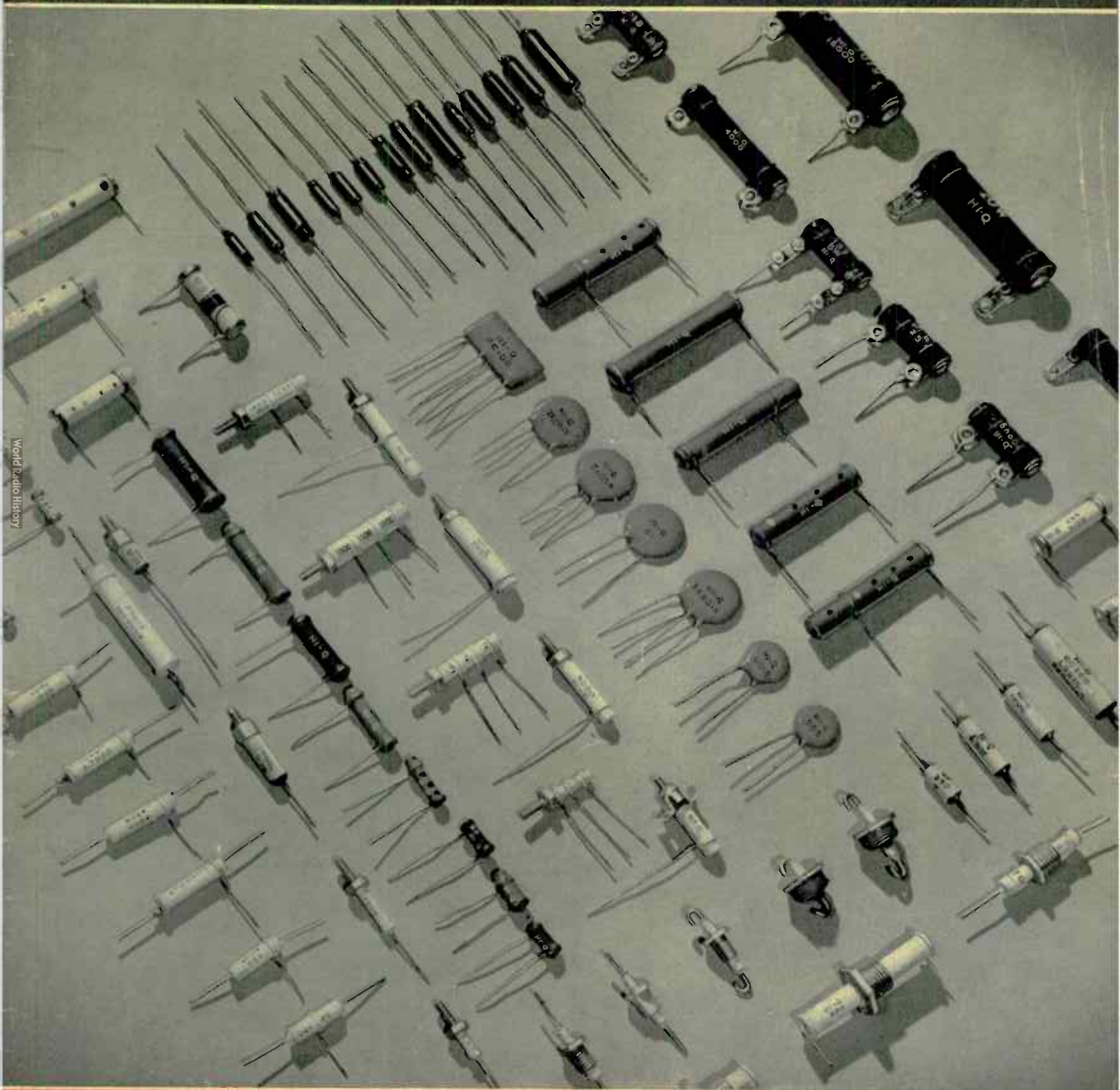

World Radio History

9th Year of Service to Management and Engineering



**hp 410A VACUUM
TUBE VOLTMETER
TAKES THE PLACE
OF 4 INSTRUMENTS**

**This single instrument
accurately makes most of the
important radio measurements**

4 PRECISION INSTRUMENTS IN ONE

VHF Voltmeter... Measures voltages from 0.1 to 300 volts at frequencies from 20 cps to 700 mc. Frequency response flat within 1 db over entire range. Extremely low input capacity — approximately 1.3 uuf — and very high shunt resistance means most circuits can be measured without detuning or loading. Is a convenient voltage indicator up to 3000 mc.

Audio Frequency Voltmeter... Measures voltages from upper limits of audio spectrum down to 10 cps. 6 ranges full scale: 1, 3, 10, 30, 100 and 300 volts. Effective input resistance is 10 megohms. Accuracy is within $\pm 3\%$ on sinusoidal voltages.

D-C Voltmeter... Measures voltages from 1 to 1000 volts — full scale sensitivity — in 7 ranges. The input resistance on all ranges is 100 megohms, so circuits under test are never appreciably loaded, and accurate

readings can be obtained even on circuits of high impedance. Polarity reversing switch saves time.

Ohmmeter... Measures resistances from 0.2 ohms to 500 megohms in 7 ranges; with mid-scale readings of 10, 100, 1000, 10,000, 100,000 ohms, 1 and 10 megohms.

Check These Added Advantages... Small diode a-c voltage probe reaches inaccessible components. Probe capacity is approximately 1.3 uuf. Removable probe head provides

short, direct connection to diode, makes possible uhf response, and facilitates use of adapting connectors in making special or uhf measurements. Rugged 1-mil meter has knife-edge pointer, 5 easy-to-read scales, and cannot be damaged by accidental overload. Two convenient switches select 27 measurement conditions. Specially-designed circuit minimizes drift caused by line-voltage variations, warmups, and tube changes. Constant readjustment is not necessary.

This *hp-410A* Vacuum Tube Voltmeter is the ideal general-purpose instrument for important measurements in the development, manufacture, or servicing of radio equipment. For full details and shipping information, write or wire today. Hewlett-Packard Company, 1381 F Page Mill Road, Palo Alto, California.

hp laboratory instruments
FOR SPEED AND ACCURACY

Noise and Distortion Analyzers	Wave Analyzers	Frequency Meters
Audio Frequency Oscillators	Audio Signal Generators	Vacuum Tube Voltmeters
Amplifiers	Power Supplies	Attenuators
Square Wave Generators	Frequency Standards	Electronic Tachometers

Vibration Control



Columbian Humming Birds, one of the famous drawings from nature by John James Audubon.

Wing vibration, nimbly controlled, keeps the humming bird in flight, enables it to feed without alighting.

Electric vibration is the essence of telephone transmission. Voice, music, pictures, teletype—no matter what type of signal—the story is told by the frequency and strength of not one, but many vibrations.

Learning how to control electric vibrations to pin-point accuracy has been one of the basic jobs of Bell Laboratories scientists in their development of the “carrier” art which enables the sending of many more conversations over existing

wires. Among their inventions have been oscillators, modulators, filters, coaxials, wave-guides, and radio lenses.

Constantly Bell Laboratories scientists discover new and better ways to control and adapt electric vibrations by wire or radio to the needs of the telephone user. Their pioneer work in this field is one important reason behind today’s clear, dependable and economical telephone service.

BELL TELEPHONE LABORATORIES



Pioneers in the research of FM radio and television, and active in developing improvements in both fields today.

Expected Changes in Wavelengths will not Obsolete Zenith Television

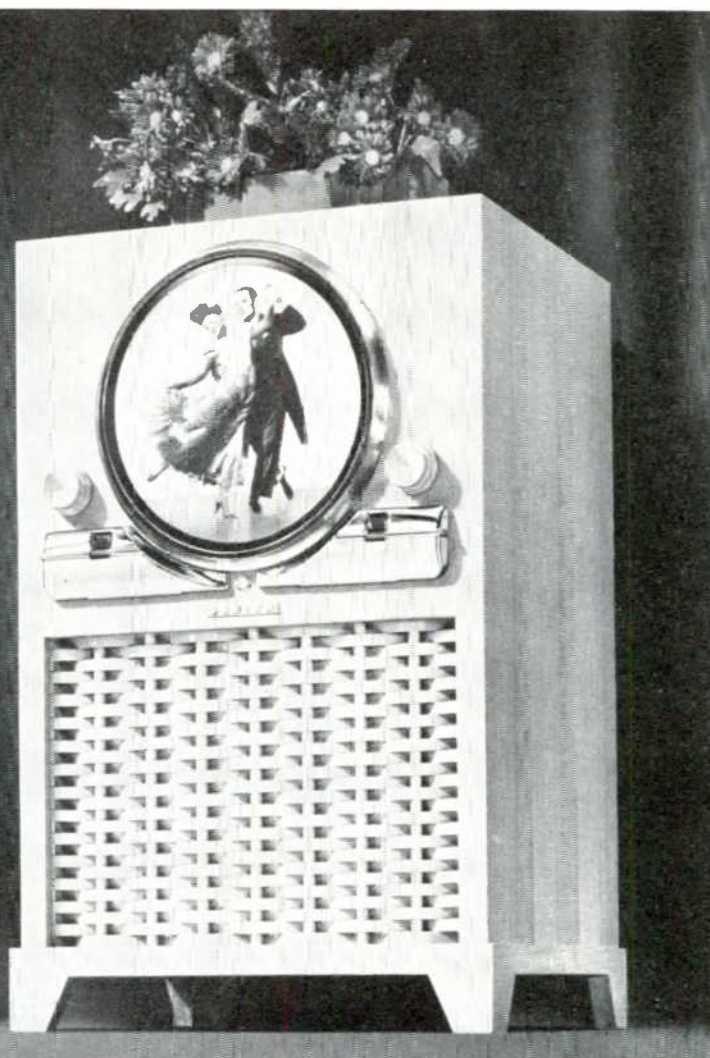

Some facts the Public is entitled to know

In a published letter written in the public interest by Senator Edwin C. Johnson, Chairman of the Senate Committee on Interstate and Foreign Commerce, dated February 15, 1949, to the Honorable Wayne Coy, Chairman of the Federal Communications Commission, Senator Johnson said among other things:

Quote: "Also, we are concerned deeply with respect to the marketing of television sets. Television-set manufacturers and spokesmen for some broadcasters have repeatedly declared that present-day sets will not be outmoded in the near future. Nevertheless, it appears obvious to us that when and if licensing is authorized in the ultra-high-frequencies and television develops in those frequencies, television sets being manufactured today will be obsolescent. While it is contended that an attachment can be made which will meet such a contingency, in part, we are not greatly impressed with the efficacy of similar attachments for FM frequency shifts. We note that no purchaser of a television set today is warned or advised that such an attachment may be necessary or, in fact, that in a matter of a few months or years, the set for which he is paying \$200 to \$1,000 may be junk. We wonder, therefore, if some action

cannot be taken by the Federal Communications Commission which would result in set-manufacturers making clear to such buyers that caveat emptor should not enter into the purchase of such a highly complex and intricate mechanism as a television set.

"We understand that the Federal Communications Commission has no present legal authority to compel such action. If the Commission is of this opinion also, or that suggestions to television manufacturers to correct this practice may fall on deaf ears, we would appreciate recommendations for legislation to meet this problem. The public requires protection." **Unquote.**

Chairman Wayne Coy, by direction of the Federal Communications Commission, in responding to Senator Johnson's letter on February 25th, said among other things:

Quote: . . . "The 12 channels presently available for television are not nearly enough to take care of the demand." ° ° ° "Of course, if ultra high channels are added there will be some obsolescence. To be sure, converters can readily be made which will alleviate the matter somewhat, but as recognized in your letter converters are not as satisfactory as regular receivers." **End of quote.**

In its May, 1945, published report the Federal Communications Commission stated, ". . . there is insufficient spectrum space available below 300 megacycles to make possible a truly nation-wide and competitive television system . . . development of the upper portion of the spectrum is necessary for the establishment of a truly nation-wide and competitive television system."

In a public notice issued on May 5, 1948, the FCC reiterated its opinion of May 1945, and pointed out that the 475-890 megacycle band would have to be used for television if this country were to have a nation-wide competitive system of television.

So public notice has been given by FCC.

FOR YOUR INSURANCE

EVERY Zenith television receiver is equipped with a specially designed *built-in* turret tuner with provision for receiving the proposed new ultra high frequency channels on the present standards.

With Zenith television no "converter" will be needed for proposed new ultra high channels.

ZENITH RADIO CORPORATION
Chicago 39, Illinois

FM AND TELEVISION



Formerly, FM MAGAZINE and FM RADIO-ELECTRONICS

VOL. 9 April, 1949 NO. 4

COPYRIGHT 1949, by Milton B. Sleeper

CONTENTS

INDUSTRY NEWS

TV-FM-AM Set Production
Compiled from figures released by the RMA 4

New Catalogs and Design Data
Review of new products and equipment 7

What's New This Month

1. Communications equipment
2. About FCC Commissioner Webster
3. Custom Set-Building in Florida
4. Paternalistic government 8

FREQUENCY MODULATION

Genuine FM Performance
G. E. Gustafson 13

FM for Buses, Part 2
D. G. Beachler 15

Fixed-Frequency FM Tuners
F. A. Spindell 16

TELEVISION

Obsolescence of TV Receivers
Milton B. Sleeper 22

FM and TV Antennas
George P. Kears 23

APPARATUS DESIGN

Subminiature IF Amplifiers
R. L. Henry and G. Shapiro 25

AUDIO SECTION

Audio Developments
Lawrence Olds 27

Stereophonic Sound Recording
L. D. Grignon 28

SPECIAL DEPARTMENTS

Television News 6

Special Services Directory 9

Professional Directory 10

Spot News Notes 20

News Picture 21

Classified Advertising 34

THE COVER DESIGN AND CONTENTS OF FM AND TELEVISION MAGAZINE ARE FULLY PROTECTED BY U. S. COPYRIGHTS, AND MUST NOT BE REPRODUCED IN ANY MANNER OR IN ANY FORM WITHOUT WRITTEN PERMISSION

MILTON B. SLEEPER, *Editor and Publisher*

CHARLES FOWLER, *Business Manager*
LILLIAN BENDROSS, *Circulation Manager*
Published by: FM COMPANY

Publication Office: 264 Main St., Gt. Barrington, Mass. Tel. Gt. Barrington 500
FM-TV Magazine is issued on the 20th of each month.
Single copies 25c — Yearly subscription in the U. S. A. \$3.00; foreign \$4.00.

Contributions will be neither acknowledged nor returned unless accompanied by adequate postage, packing, and directions, nor will FM-TV Magazine be responsible for their safe handling in its office or in transit.

Entered as second-class matter August 22, 1945, at the Post Office, Great Barrington, Mass., under the Act of March 3, 1879. Additional entry at the Post Office, Boston, Mass. Printed in the U. S. A.

SWITCHES



ENGINEERED BY DAVEN . . .

Built in a wide range of sizes, with varied arrangements of poles, number of positions, and decks, in shorting and non-shorting types. These switches feature low and uniform contact resistance.

Write Dept. FMT - 10
for our new Switch-Bulletin.



Coming

NEXT MONTH

Important information for every one in the radio industry:

Complete reports on the NAB engineering and business convention in Chicago, and the FMA conference in New York.

Don't miss this exclusive feature section in the May issue of

FM-TV MAGAZINE

MEMBER,
AUDIT
BUREAU OF
CIRCULATIONS



World Radio History

50
to
18,000
C. P. S. !



**THE NEW NC-108 RACK
FM TUNER-RECEIVER**

Now ... National offers an 88-108 Mc. band FM tuner-receiver designed to meet the most exacting demands. Flat from 50 to 18,000 cps, ± 2 db, when connected to external amplifier or line. Built-in speaker, audio output stage, standard de-emphasis switch, and tone control also permit use as ideal monitoring receiver. Built to National's famous standards of quality, the NC-108 is worthy of the finest in amplifiers and speakers. Nine tubes plus rectifier and tuning meter.

Write for complete specifications.



Set Production

FEBRUARY set production figures released by the RMA show the effects of changes now under way. One limiting factor is the shortage of large picture tubes. There are enough small tubes now, but the public doesn't want them, particularly right now when prospective purchasers are uncertain as to the real meaning of all the talk about the TV freeze, and possible changes ahead.

The sharp drop in FM marks the decision of several companies to raise the performance of their sets. The time for selling FM-AM models with 100 to 200 microvolts FM sensitivity is over. Recognition of this fact, and the considerable time required to develop new types and get them into production may well create a shortage of FM sets this spring.

AM is simply continuing the decline that started a year ago. January and February are 55% below the first two months of '48 and 63% below the same period of '47.

We made an error in the AM figure in

our Production Barometer last month. The RMA bulletin on January production showed the figure of 121,338 for TV sets, and stated: "RMA members reported manufacturing 709,633 radio receivers of all types, of which 147,733 were FM-AM or FM sets."

Maybe we're old-fashioned, but to us a "radio receiver" is one that receives radio signals, whether the signals are modulated at audio or video frequencies. Accordingly, we deducted 122,304 TV and 147,733 FM sets from the total figure of 709,633 leaving, we thought, a remainder of 440,662 AM sets.

The error came to light in the RMA bulletin on February production, which listed January AM sets at 561,900. In other words, RMA doesn't include TV models with "radio receivers of all types." This, we hold, is incorrect, and a most confusing practice.

Barometer figures in this issue have been changed to show 561,900 AM sets produced in January.

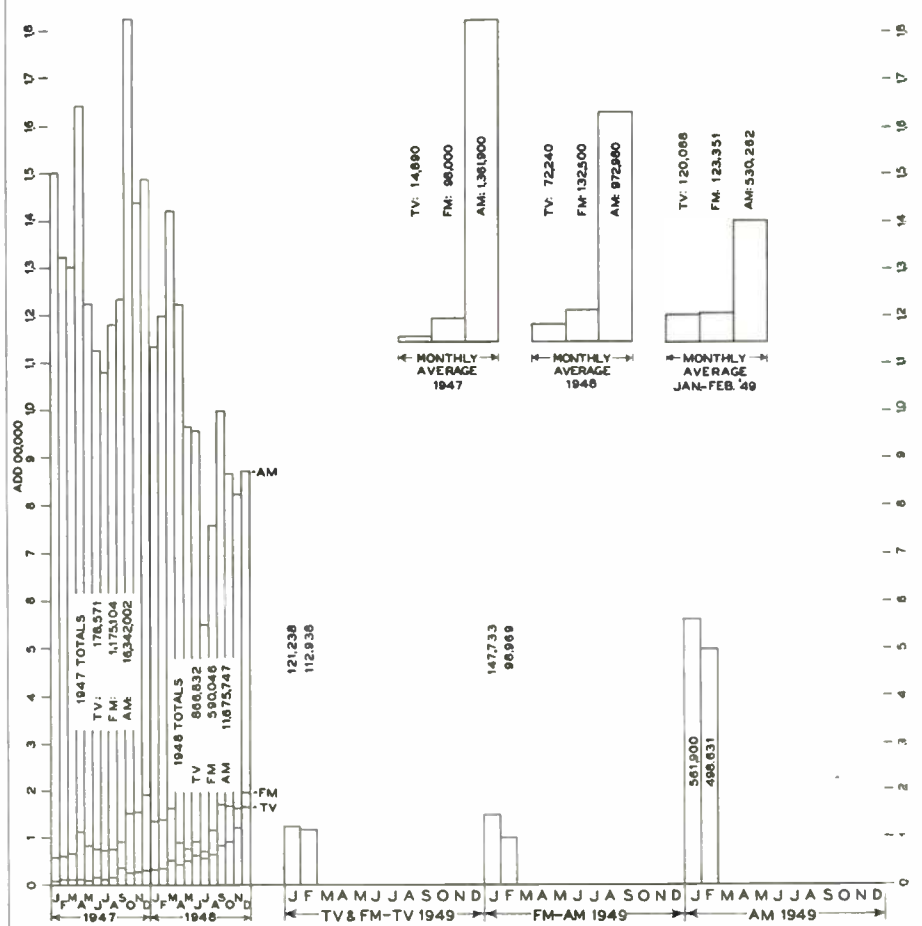

TV, FM, and AM Set Production Barometer, prepared from RMA figures.

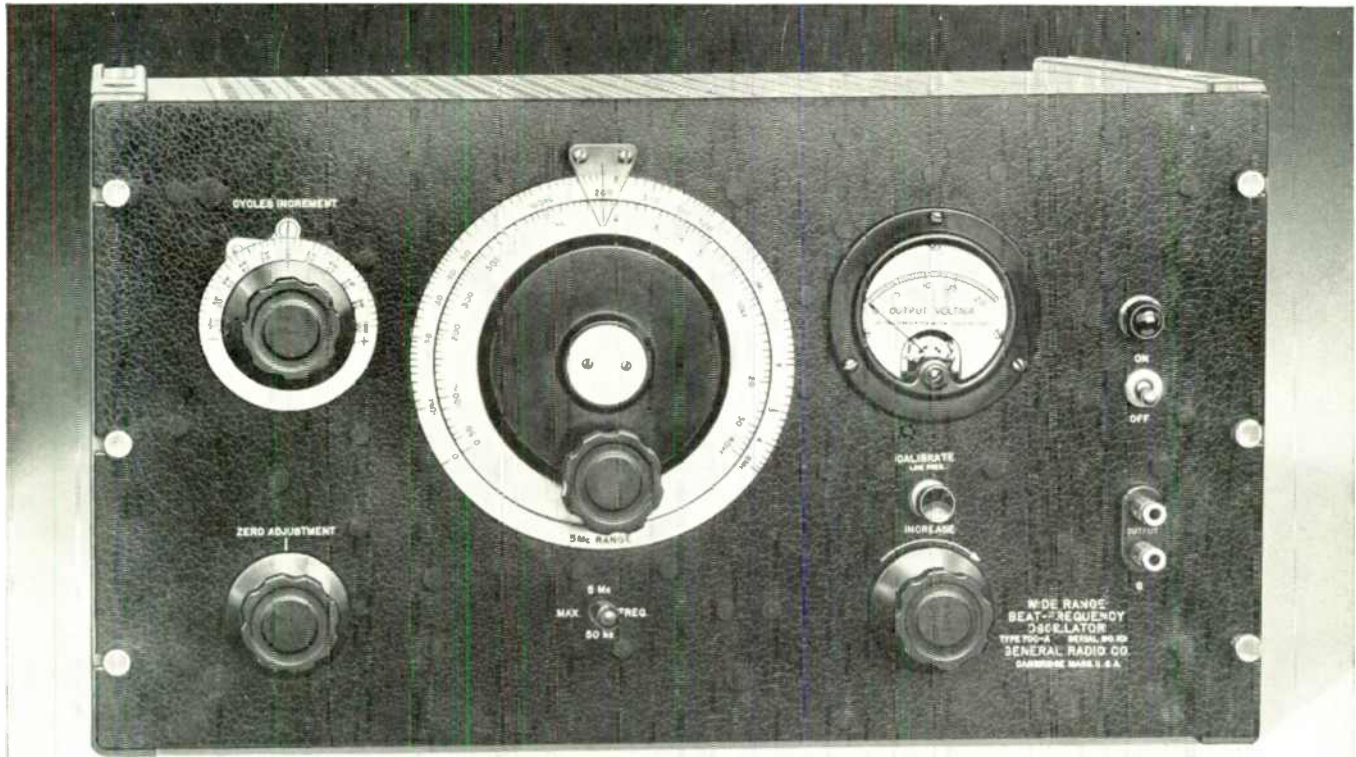

DIRECT READING from 50 Cycles to 5 Megacycles

THIS wide-range beat-frequency oscillator has a number of novel circuit arrangements which make it very valuable for use not only as a general-purpose laboratory oscillator but also for testing all sorts of wide-band circuits and systems.

- 1 The wide ranges are obtained with a single control knob and a two-position range selector switch
- 2 By means of an a-v-c circuit, the output voltage is held constant within ± 1.5 decibels over the entire range
- 3 Frequency drift is held to a very small value through carefully designed thermal distribution and ventilating systems
- 4 Any small drift remaining may be eliminated by resetting the oscillator to zero beat
- 5 A degenerative amplifier minimizes hum and distortion and also equalizes the frequency response
- 6 The output voltage is measured by a vacuum-tube voltmeter across the output terminals
- 7 One output terminal is grounded

For taking selectivity curves on tuned circuits over a wide range of frequencies this oscillator is especially useful in that these measurements may be made very rapidly and accurately with it.

TYPE 700-A WIDE-RANGE BEAT-FREQUENCY OSCILLATOR . . . \$700.00



GENERAL RADIO COMPANY

Cambridge 39, Massachusetts

90 West St., New York 6 920 S. Michigan Ave., Chicago 5 1000 N. Seward St., Los Angeles 38

April 1949—formerly *FM*, and *FM RADIO—ELECTRONICS*

FREQUENCY CONTROL AND CALIBRATION

The main dial is direct reading on two approximately logarithmic scales for 50 cycles to 40 kilocycles and 10 kilocycles to 5 megacycles. The incremental frequency control is calibrated between -100 and $+100$ cycles and -10 and $+10$ kilocycles for the two ranges. Any frequency change made with this dial is added algebraically to the reading of the main dial.

The calibration may be standardized at any time, by setting the instrument to zero beat with the zero adjustment, to within 5 cycles on the low range and 500 cycles on the high range.

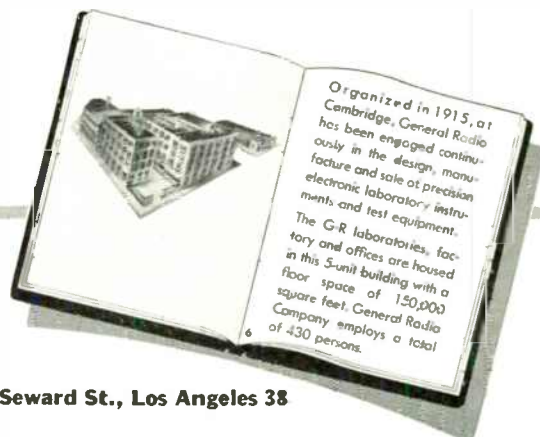

Organized in 1915, at Cambridge, General Radio has been engaged continuously in the design, manufacture and sale of precision electronic laboratory instruments and test equipment. The G-R laboratories, factory and offices are housed in this 5-unit building with a floor space of 150,000 square feet. General Radio Company employs a total of 430 persons.

IN THE PROFESSION, AN HONORED NAME

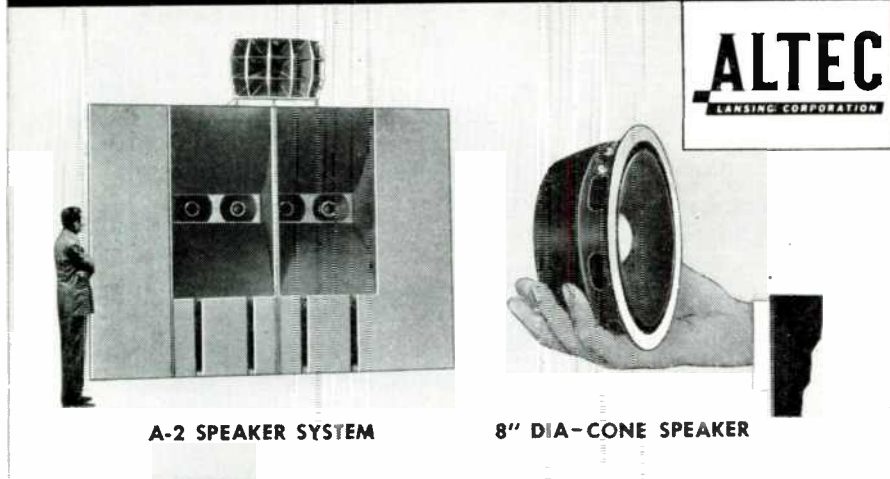

A-2 SPEAKER SYSTEM

8" DIA.-CONE SPEAKER

FROM THE LARGEST TO THE SMALLEST ALTEC LANSING IS FIRST IN QUALITY

To those familiar with the history of Altec Lansing, its reputation in the top-level quality field is easily understood. Altec Lansing is best known as the designer and manufacturer of massive motion picture theatre speaker systems where highest obtainable quality out-

weighs every other consideration. In the design and manufacture of a balanced line of speakers fulfilling every need for highest quality reproduction of sound—yet adaptable to more confined space, no compromise was made with quality. For the professional audio

world and for the electronics industry generally, the history of Altec Lansing is the clue to its reputation.

Write for Descriptive Brochure — Altec Lansing Corporation, 1161 North Vine St., Hollywood 38, Calif., 161 Sixth Ave., New York 13, N. Y.

NEW!
SIGNAL
FM GENERATOR
MODEL 202-B

FREQUENCY RANGE
54 to 216 MEGACYCLES

The model 202-B is specifically designed to meet the needs of television and FM engineers working in the frequency range from 54-216 mc. Following are some of the outstanding features of this instrument:

RF RANGES—54-108, 108-216 mc. \pm 0.5% accuracy.

VERNIER DIAL—24:1 gear ratio with main frequency dial.

FREQUENCY DEVIATION RANGES—0-80 kc; 0-240 kc.

AMPLITUDE MODULATION—Continuously variable 0-50%; calibrated at 30% and 50% points.

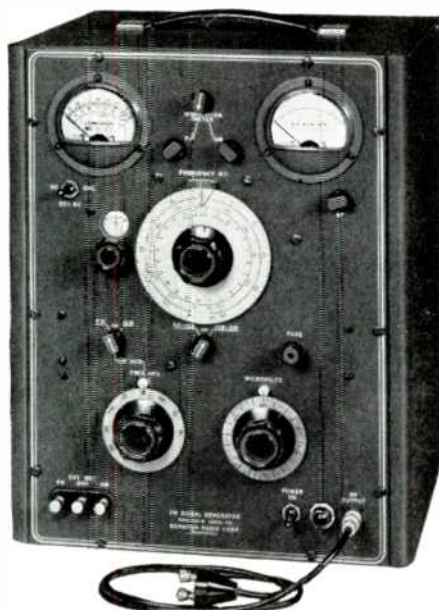

MODULATING OSCILLATOR—Eight internal modulating frequencies from 50 cycles to 15 kc., available for FM or AM.

RF OUTPUT VOLTAGE—0.2 volt to 0.1 microvolt. Output impedance 26.5 ohms.

FM DISTORTION—Less than 2% at 75 kc deviation.

SPURIOUS RF OUTPUT—All spurious RF voltages 30 db or more below fundamental.

Write for Catalog D

BOONTON RADIO Corporation

DESIGNERS AND MANUFACTURERS OF
THE Q METER · OX CHECKER
FREQUENCY MODULATED SIGNAL GENERATOR
BEAT FREQUENCY GENERATOR
AND OTHER DIRECT READING INSTRUMENTS



Lower Prices for TV Kits:

Reductions on kits for picture tubes of 10 to 20 ins. have been announced by Television Assembly Company, 510 Bushwick Avenue, Brooklyn 6.

TV Sets in Milwaukee:

Station WTMJ-TV reports that, on March 1, there were 17,400 sets in Milwaukee homes, and 1,600 in public places.

Increased TV Time Sales:

During 1948, commercial TV program hours on the NBC network increased from 33% in January to 63% in December.

Table Model TV Sets:

General Electric has announced a model 830 set, with 12½-in. tube, to retail for \$399.95, and a model 835, with a 10-in. tube at \$325.

Sets in Boston Area:

Survey by WNAC-TV and WBZ-TV show 49,200 TV sets in homes in the Boston area, and 4,400 in public places. These stations also serve 6,200 sets in Providence.

TV Station Breakdown:

FCC divides TV licensees, permittees, and applicants as follows:

Newspapers	31.3%	128 stations
Broadcasters	16.1	66
Motion Pictures,		
theatres	6.6	27
Radio mfrs.	6.1	25
Merchants	6.1	25
Manufacturers	4.4	18
Real estate	4.2	17
Oil producers	4.2	17
Schools	2.4	10
Misc.	18.6	76
	100.0	409

Not included above are 26 applicants on which no information is available.

Home Projector:

Using a modified lens system, the North American Philips Protelgram unit can project TV images 3 by 4 ft. on a conventional home movie screen, using the standard 3NP4 projection tube, recently reduced in price to \$39.95.

Sets in Cincinnati Area:

WLW-TV estimates that, on March 1, there were 17,000 TV sets within its service area. Private homes accounted for 15,300, with 1,700 in public places.

FM AND TELEVISION

NEW CATALOGS & DESIGN DATA

THE products listed here are described in new catalogs and bulletins now available. Unless otherwise noted, they will be sent on request, without charge.

Dual Midget Controls:

Variable resistors with concentric shafts can be adjusted separately. Thus, two controls can be mounted in the same panel space as a conventional single control. Advantageous for pre-set chassis controls. *P. R. Mallory, Indianapolis 6, Ind.*

DC Voltage Multiplier:

Multiplier for Sylvania Polymeter extends DC range to 10,000 volts. Probe, with safety flange, has 4-ft. lead insulated to 22,000 volts. *Tube Division, Sylvania Electric Products, Inc., 500 Fifth Ave., New York 18.*

Crystal Temperature Stabilizer:

Miniaturized plug-in crystal oven for military and commercial communications maintains crystal frequency to .0001%, and temperature to 75°C., plus or minus 2°. Heater draws 5.5 watts at 6.3 volts. For BH6 crystals of 1 to 100 mc. Model TCO-1. *Bliley Electric Co., Erie, Pa.*

High-Voltage Resistors:

Designated as type BTAV, new series of small carbon resistors are designed for continuous 2,000-volt operation, and to withstand surges up to 6,000 volts. Intended particularly for TV bleeder circuits and as meter multipliers. *International Resistance Co., Philadelphia 8.*

Transcription Tone Arm:

Has adjustment of needle force, and plunger-type contacts for magnetic or crystal pickup to eliminate soldering. Accommodates any cartridge not over 3/4 in. wide. Made in two sizes, for 12-in. or 16- and 17-in. records. *Clarkstan Corp., 11927 W. Pico Blvd., Los Angeles 34.*

Isolation Transformers:

Three types, delivering 50, 150, or 250 volt-amperes, with output voltages of 105, 115, and 125 volts. For correcting high or low line voltages to operate radio equipment, and to eliminate shock hazard during service work by isolating chassis grounds from line grounds. Female plug on secondary, 7-ft. cord on primary. *Chicago Transformer Division, Essex Wire Corp., 3501 W. Addison St., Chicago 18.*

TV-FM Antenna Compass:

For orienting antenna for maximum pickup. A meter and long extension cord, carried to the roof, shows maximum output of the set as the antenna is rotated. Thus, one man can make an antenna installation. Can also be used to peak RF and oscillator circuits on the station itself. *Simpson Electric Co., 5200 W. Kinzie St., Chicago.*

Decade Inductors:

For use in wave filters and tuned circuits at audio and supersonic frequencies. Each has 3 decade switches. In the four types, the largest steps are in increments of .01, .1, 1.0, and 10.0-henry steps, respectively. *Freed Transformer Co., 1718 Weirfield St., Brooklyn 27, N. Y.*

Floating Action! for all TV Cameras

"BALANCED" TV TRIPOD

Pat. Pending

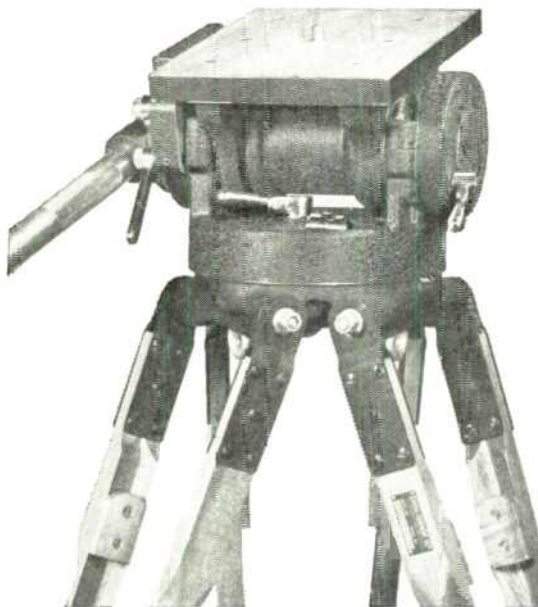

This tripod was engineered and designed expressly to meet all video camera requirements.

Previous concepts of gyro and friction type design have been discarded to achieve absolute balance, effortless operation, super-smooth tilt and pan action, dependability, ruggedness & efficiency.

Below:

3-wheel portable dolly with balanced TV Tripod mounted.



Complete 360° pan without ragged or jerky movement is accomplished with effortless control. It is impossible to get anything but perfectly smooth pan and tilt action with the "BALANCED" TV Tripod.

Quick-release pan handle adjustment locks into position desired by operator with no "play" between pan handle and tripod head. Tripod head mechanism is rustproof, completely enclosed, never requires adjustments, cleaning or lubrication. Built-in spirit level. Telescoping extension pan handle.

Write for further particulars



Three-Speed Turntable:

Quick-change controls provide 3 speeds and two types of needles for 33 1/3, 45, and 78 RPM records. A plastic spindle can be mounted readily on the turntable to take the large hole of the RCA records. *Admiral Corp., 3800 W. Cortland St., Chicago.*

TV Ballast Tube:

Hermetically sealed and filled with helium. Available with as many as 5 separate controlling elements, designed to withstand up to 2,000% overload. Voltage breakdown between elements is 1,300 volts. *Amperite Co., Inc., 561 Broadway, New York 12.*

Resistors and Controls:

New catalog lists complete line of units, with several new types, including ten different shaft designs for variable resistors. *Clarostat Mfg. Co., Inc., Dover, N. H.*

TV Antenna Tower:

Three-section welded tower, 30 ft. high, weighs 65 lbs., carries a 10-ft. pole. Two hinged mounting feet facilitates raising on flat or peaked roof. *Easy-Up Tower Co., 3800 Kinzie Ave., Racine, Wis.*

Microwave Mega-Match:

Displays reflection coefficients over the band from 8,500 to 9,700 mc. Includes a delay wave guide 75 ft. long formed into a space 8 by 1 ft., a calibrated X-band wavemeter, and the power supply and controls. Sweep on the display up to 30 mc. can be obtained anywhere in the X-band. *Kay Electric Co., Pine Brook, N. J.*

Capacitors:

Detailed data on condensers of all types for radio equipment. *Illinois Condenser Co., 1616 N. Throop St., Chicago 22.*

Link Transonic F.M. Receiver

for
Buses, Streetcars
Supermarkets
Stores, Hotels
Restaurants
and
Public Buildings

- **FIXED FREQUENCY**
Crystal Controlled
- **EXTREME SENSITIVITY**
Better Than 1 Microvolt
- **HIGH AUDIO OUTPUT**
Full 8 Watts
- **NEGLIGIBLE DISTORTION**
Less Than 5 Percent
- **HIGH FIDELITY**
Essentially flat 50-15,000 cycles
- **TONE CONTROL**
Bass and Treble Control
- **VOICE ACCENTUATION**
10 db Rise for Commercial Announcements
- **REMOTE CONTROL**
Audio Silencing under Control of Broadcasting Station
- **TAMPER-PROOF ASSEMBLY**
Equipment Sealed in Locked Cabinet

THESE AND MANY OTHER FEATURES ASSURE OUTSTANDING PERFORMANCE WITH A MINIMUM OF MAINTENANCE AND A MAXIMUM OF SERVICE. HERE IS A REALLY GREAT RECEIVER IN THE TRUE LINK TRADITION OF QUALITY THAT HAS MADE LINK COMMUNICATIONS EQUIPMENT "PREFERRED THE WORLD OVER."

Link Radio Corporation

125 W. 17th St., New York 11, N. Y.

THIS MONTH'S COVER

The display of components on this month's cover, arranged from products of the Electrical Reactance Corporation, shows typical examples of the newest items for FM and TV.

Looking back to the time when AM broadcasting was as new as FM and television are today, it is amazing to see how the design of components has been changed, their physical dimensions reduced, and how tolerances have been tightened, particularly by the introduction of temperature coefficient as a design factor. These changes will be highlighted in many exhibits at the Radio Parts Show, opening at Hotel Stevens, Chicago, on May 16.



WHAT'S NEW THIS MONTH

1. COMMUNICATIONS EQUIPMENT
3. CUSTOM SET-BUILDING IN FLORIDA

2. ABOUT FCC COMMISSIONER WEBSTER
4. WHOSE EATETH ANOTHER'S BREAD

1. Since the publication of our January Communications Directory, we have had a number of letters asking why we stopped showing the make of equipment used at each system.

In the beginning, that was easy to do because, in nearly every case, the complete equipment was bought from one company. However, FCC records show that, over a period of years, additional and replacement equipment has been bought by so many systems that the task of taking this information from the records has become extremely complicated. Some systems are now using equipment from four or five different manufacturers. In the past, we tried to list the two principal suppliers in such cases, since space limited us to that number. Last July, we had complaints from manufacturers and their representatives accusing us of everything from carelessness to discrimination. Since this situation will grow worse as more equipment is added and replaced, our only solution was to omit company identification entirely.

2. Communications men and engineers are counting heavily on FCC Commissioner Webster to help them meet the problems created by the tremendous growth of the Safety and Special Services. For their benefit, we are pleased to present here an account of Commissioner Webster's career, written by one of our readers who has had the opportunity and privilege of knowing him well enough to supply these details:

When Edward Mount Webster arrived on the FCC scene, April 10, 1947, the Commission was literally reeling under an unprecedented expansion of non-broad-

cast radio use for safety and industrial purposes, it was in the throes of revising all the domestic mobile service frequency assignments, and of getting plans under way for participation in probably the most important series of international radio conferences in which the United States had ever taken part.

No wonder, then, that his arrival took on a providential hue to Government and industry leaders alike for, at the very moment of direct need, there was at hand the man who nurtured most of the existing safety and industrial radio services, and who had an acknowledged international reputation for skillful and tactful negotiation gained through attendance at sixteen international radio conferences. Moreover, Commissioner Webster possessed an outstanding administrative capacity, signally demonstrated during his wartime tour of duty as Chief Communications Officer of the Coast Guard in the reorganization and expansion of the United States marine safety and distress communications system.

Scarcely had he been sworn into the FCC than he was off to attend the International Meeting on Radio Aids to Navigation in New York and later in New London. Then he went into session at what has undoubtedly been the most important radio conference ever held in the United States, the International Telecommunications Conference at Atlantic City where he spent practically the entire summer of '47 charting the international spectrum allocations.

Early 1948 found him in London attending the Preparatory Committee of Experts on Coordination of Safety at Sea

(Continued on page 9)

FM AND TELEVISION

WHAT'S NEW THIS MONTH

(Continued from page 8)

and in the Air, and a few months later he was in London again for the conference on Safety of Life at Sea.

That 1949 is not to witness any diminution of his round of international conference activities is testified to by the fact that this year had only begun when he was en route to Geneva to attend the International Telegraph Regulation Revision Preparatory Committee meetings, on behalf of the United States. There he was to formulate, for the benefit of the other international representatives, the basis upon which the United States proposes, for the first time, to become a party to international telegraph regulations. Interesting sidelight to his attendance at this latest international meeting, and silent testimonial to the unremitting pressure under which Webster has been working at the Commission was the fact that his office duties on the day he left for Geneva were so compelling that he was unable to squeeze in sufficient time to bid his wife goodbye before stepping on the plane for a two-week sojourn in Geneva.

However fast may move the treadmill, he is, by background and temperament, well equipped to maintain the pace now required. His boundless energy and decisive disposition belie his sixty years (born in Washington, D. C., February 28, 1889). In fact, the only acknowledgment he has been known to yield to the rigors of his job is the cheerful admission that he looks forward to these international radio conferences, because the time required to travel is a respite from the daily chores of office. There is no more arduous labor than these international conferences, for the days are given over to conferences and the nights to drafting, at which latter occupation Webster has become as skillful as the best of lawyers.

Graduated from the United States Coast Guard Academy in 1912, Web, as he is familiarly known, began a long tour of duty with the Coast Guard that took him through World War I and found him Chief Communications Officer upon his retirement from active duty in 1934. With scarcely a lost motion, he joined the FCC where, as Assistant Chief Engineer in charge of the Commission's non-broadcast radio services, he was to acquire his uniquely pervasive grasp of this field that has earned him worldwide recognition.

June 1, 1942 found him back in the Coast Guard as its Chief Communications Officer, with the rank of Captain. There he plunged into the task of establishing a radio and land line communications network along the U. S. coastline, operating in conjunction with coastal picket boats, beach patrols, and lookouts during the grave times when submarines

were close to our shores. When he left the Coast Guard (as Commodore Webster, awarded the Legion of Merit by the President "for exceptionally meritorious conduct in the performance of outstanding service to the Government of the United States, as Chief, Communications Division, Office of Operations, United States Coast Guard from June 1, 1942, to October 25, 1945"), he also left the communications arm of that service at the high point of its efficiency.

Within a month, Web was back in the saddle, this time as Director of Telecommunications of the National Federation of American Shipping, Inc. Although he had spent his adult life in government service, he had always enjoyed the best of relations with the regulated industry, not only because of his comprehensive grasp of their problems but because of his willingness, at all times, to hear their side of the story. Moreover, it is doubtful if, throughout his long governmental career, there was ever a sterner critic of bureaucratic red tape and delay than Web himself.

Named by President Truman to the FCC in April, 1947, this post offered the challenge of bringing order to the growing multiplicity of domestic safety and industrial radio stations, both administratively and through the fair parcelling-out of the inadequate available supply of domestic frequencies.

The proposed Rules already issued by the Commission in this field testify his spear-heading the Commission program for collecting homogeneous radio services in separate, self-contained parts of the Commission's Rules. When these Rules are finalized, there will be no more meaningless groupings such as the present Miscellaneous and Special Emergency Radio Services.

In the course of playing a lead rôle in the job of whipping into shape the growing services in the non-broadcast radio field, Web has become, perforce, an exponent of the panel system within the Commission. He claims, and not without considerable justification, that the greatly expanded communications field of today has room for three Commissions. One panel or division of Commissioners would then operate in each of the broadcast, common carrier, and safety and special service fields, with the full Commission continuing to sit on such general matters as overall rules and frequency-allocation problems.

In support of this contention, Web points to his own experiences. Appointed by the President to serve because of his accepted international reputation in the non-broadcast area, Web found about 80% of the Commission's time taken up in broadcast activities. There the case-

(Continued on page 10)

Special Services Directory

METHODS ENGINEERS

Materials & Methods engineers in America's leading manufacturing plants use Topflight's Printed Cellophane, Self-Adhesive Tape to meet A-N specs. - assembly line - follow through - instruction labels. Easy to Apply.
TOPFLIGHT TAPE CO. YORK PA.



"Guardian"

300 MM. Code Beacons
Obstruction Lights
Code Flashers
Packaged Lighting Kits

Send for Catalogue

HUGHEY & PHILLIPS

326 North La Cienega Blvd.
Los Angeles 36, Calif.

RANGERTONE

TAPE RECORDERS

HIGH-FIDELITY EQUIPMENT FOR
BROADCAST & RECORDING STUDIOS

RANGERTONE, INC.

73 Winthrop St. Newark 4, N. J.
Tel. Humbolt 5-2550

Collins Custom Components

The Very Finest

FM TUNERS FM/AM TUNERS
FM RECEIVERS

Custom Matched Components

Collins

Audio Products Co., Inc.

P. O. Box 368 Westfield, N.J.

RADIO-MUSIC CORP.

REPRODUCERS **R** TURNTABLES

AMPLIFIERS **M** **C** SPEAKERS

F. M. broadcast quality for custom
sound installations for the studio and
the home.

PORT CHESTER, NEW YORK

KAY ELECTRIC CO.

INCORPORATED

Manufacturers of:
Television Test Equipment
Laboratory Instruments
Electronic Devices

14 Maple Avenue Pine Brook, N. J.
Tel. CALdwell 6-3710

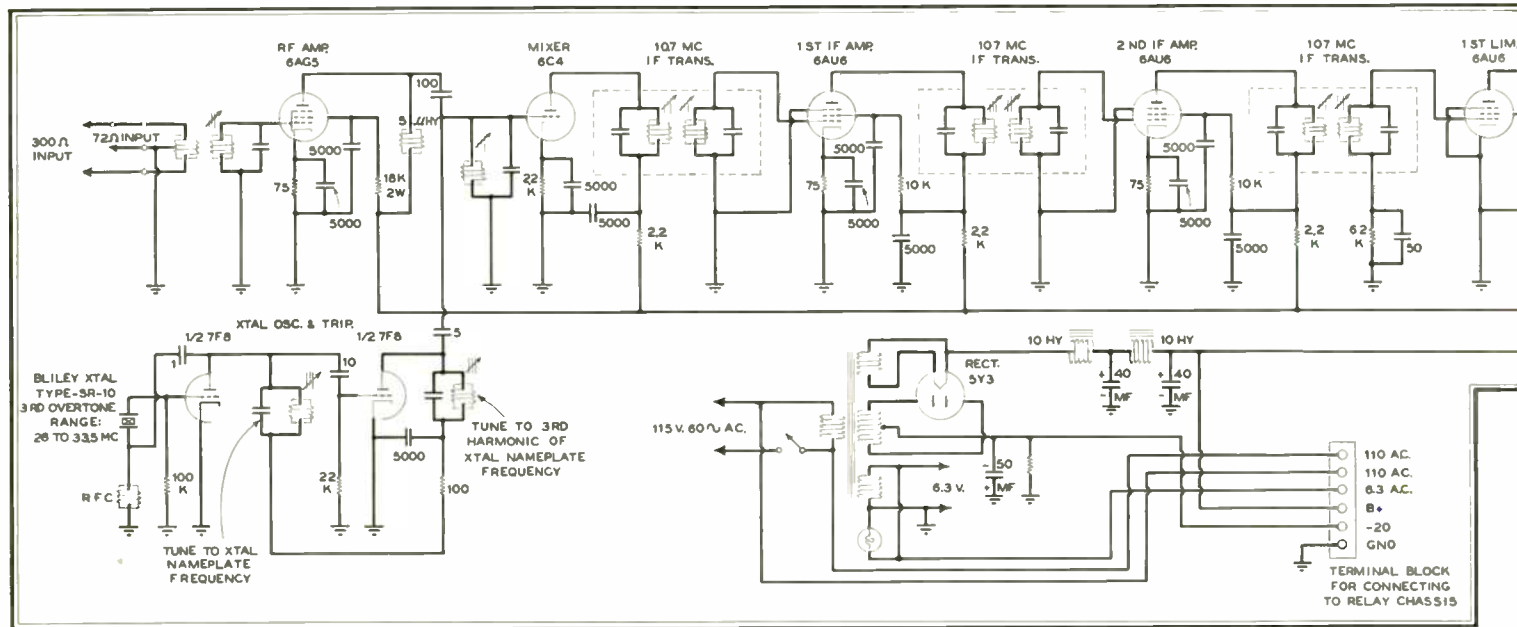

Fig. 1. Basic circuit of the Tricast tuner series. The terminal block provides operating voltages for the separate single or dual controls

FIXED-FREQUENCY FM TUNERS

BROWNING TRICAST SERIES INCLUDES MONITOR TYPE AND TONE-CONTROLLED MODELS DESIGNED TO PRODUCE REVENUE FOR FM STATIONS—By F. A. SPINDELL*

THE idea of transmitting specific audio frequencies to operate remote controls by radio has found many applications. The idea of applying any such system to AM broadcasting has been ruled out, however, because it would be necessary to employ audible frequencies that would cause annoying interference to the reception of speech and music.

On FM broadcasting, however, supersonic frequencies can be used to operate controls at receiving sets for any purpose, such as raising or lowering the audio output, or even cutting the speaker off entirely and switching it on again. Since the operating frequencies transmitted are above audibility, no interference is created with the program reception.

Uses for Supersonic Controls:

One of the first applications of supersonic controls operated from an FM station is in storecasting. This service calls for low-level-sound distribution, in order to provide an agreeable quality of music reproduction, without interfering with normal conversation. However, to make commercial announcements effective, the level must be increased for the duration of these spots. Obviously, the level control must be exercised by the station announcer.

To serve the purposes of the station

and the stores to best advantage, store-cast programs should not be planned for continuous transmission. The station must consider the program needs of other listeners. This calls for periods when the program content would not be suitable for store reception. Also, the stores want the music cut off at specific times on certain days. These cases call for an additional control, operated at the broadcast station, to cut the speakers in or out.

Another type of service that FM broadcasters are developing is musicasting for restaurants, bars, and public places. Sets can be installed and rented at a substantial profit, yet at a much lower cost to subscribers than wired music systems. This calls for silencing the speakers during commercial announcements. General practice is to arrange for the reception of call letters, however, as that is important to the station. It may even be worth while to step up the volume, to be sure that the call letters are heard distinctly.

Of course, there are many other applications for supersonic controls, to meet the needs of special conditions.

Tricast Tuner Designs:

Work on the development of supersonic controls and suitable receivers has been under way at Browning Laboratories for many months. Now the development has been completed on what we have called the Tricast tuner series.

Before the first circuit was drawn, it became obvious that, to fulfill the requirements of all the fixed-frequency services, three types of tuners would be needed. The basic model in this series, therefore, is a highly sensitive and stable broadband design, with crystal-controlled, fixed-frequency tuning, and an audio output at 600 ohms impedance. The second model provides for the addition of one transmitter-operated control to shift the output level from one preset value to another, while the third has terminals for two controls which shift the output level and also cut the speaker in or out.

The basic design, model RP-23, is intended for FM broadcast network relay or repeater operation, and for monitoring purposes. The RP-24 is exactly the same in circuit design and performance, plus a control circuit operated by any transmitted tone between 15 and 20 kc., to select in sequence either of two audio volume levels which can be preset manually from zero to full output. Model RP-25 is also similar to the basic model RP-23, but it has two control circuits to provide level-selection as in the RP-24, and also a switching arrangement to turn the audio on or off. In this unit, the controls are operated by transmitting supersonic tones of different frequencies and they are, therefore, independent. In the RP-24 and RP-25 models, control frequencies may be 15, 17.5, or 20 kc., as specified by the customer. Fig. 1 shows

*Chief Engineer, Browning Laboratories, Inc., Winchester, Mass.

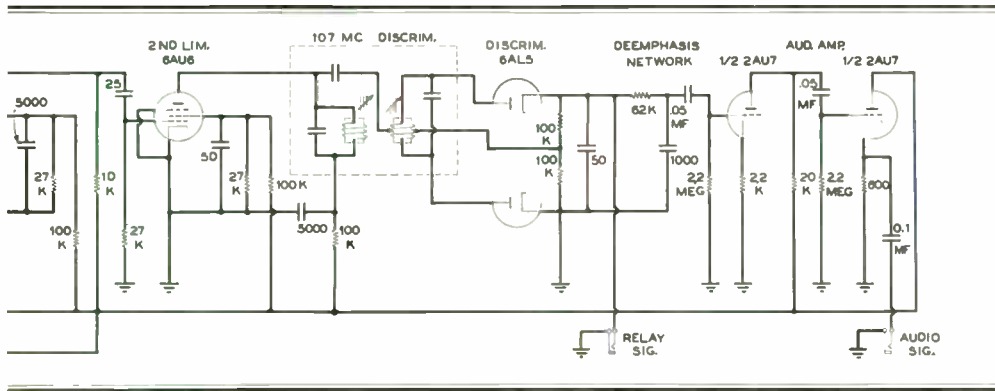

Straight relays or sequence relays can be employed with the tuners

the schematic diagram of the tuner only. The control sections are built as separate units, connected to the terminals provided on the tuner.

The design of fixed-frequency tuners for these services differs in many important details from conventional receivers. Accordingly, details of the circuits in the Tricast series are of special interest.

RF Amplifier and Converter:

In order to realize good gain in the 88- to 108-mc. band, a 6AG5 amplifier is used. The slug-tuned input coil has a tapped primary winding with leads brought out to a terminal strip where 72-ohm coaxial cable or 300-ohm twin-lead cable can be attached. The connections are such that the sheath on the 72-ohm cable is grounded, and provision is made to ground the sheath of 300-ohm shielded cable should it be used.

Numerous tests with various tubes as mixers indicated that the 7F8 or the 6C4 would be satisfactory. The 6C4 was finally selected, since an odd number of triodes was required in the front end.

Crystal Oscillator:

The circuit for supplying local high-frequency energy to the mixer, suggested by Biley Electric Company, uses one of their SR-10 overtone crystals. The output of the first oscillator triode consists only of the output of the crystal third overtone, in the vicinity of 30 mc. The second half of the 7F8 functions as a tripler, and develops voltage for mixing at a frequency which differs in amount by the frequencies of the IF amplifier and the incoming signal. Long-duration tests indicate excellent, stable operation, with no drift. Fixed-tuned circuits are not critical and, once tuned, require no readjustment. Since crystal frequencies and tuning of circuits depend upon the channel to be received, the tuners are preset at the laboratory for the customer's specified frequency.

IF Amplifier Circuit:

The IF amplifier works at 10.7 mc. and employs miniature components through-

out to minimize space requirements. Two 6AU6's are used as amplifiers, and dual cascade limiters are employed in the Armstrong circuit to assure noise-free reception. A type 6AL5 dual diode in the discriminator circuit feeds the audio amplifier through the de-emphasis circuit.

Audio Amplifier:

It was deemed advisable to bring out the audio output at 600 ohms, so as to conform to standard practice. To this

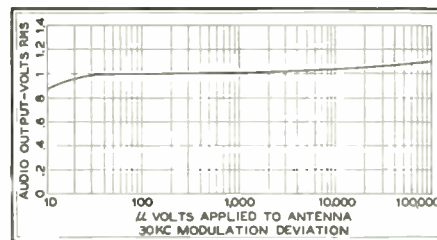

Fig. 2. Characteristic curve of limiter

end a 12AU7 dual triode is used in which the first half operates as a gain stage and the second half as a cathode follower, feeding the load. From this combination, an average output level of 1 volt RMS is obtainable without difficulty.

Control Circuits:

The single-function control unit of the RP-24 and the dual-function unit of the RP-25 operate as follows: The first half of a 12AX7 functions as an amplifier with a sharply-tuned bridged-T network providing degenerative feedback. By reason of this feedback, the circuit acts as an amplifier for only a narrow band of frequencies at the control-tone frequency. These are pretuned at the labor-

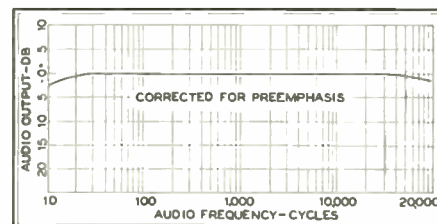

Fig. 3. Curve of overall audio fidelity

atory as desired to 15, 17.5 or 20 kc. The signal is amplified in the second half of a 12AX7, rectified in the first half of a 12AU7 and applied as control bias to the second half of the 12AU7 which actuates the sensitive plate circuit relay. The sensitive relay in turn energizes a sequence relay which performs the audio switching functions. The first tone impulse throws the relay contacts to one position providing one audio output level. The second impulse throws the relay contacts to the second position, selecting the second audio level. These conditions are repeated in sequence with successive transmitted tones. Due to the selectivity of the audio circuit and the time delay involved, the circuits will not trip except on sustained tones of approximately 3 seconds duration at 50-ke. deviation. This is controllable to a certain degree through bias and gain adjustments in the relay chassis.

The on-off control function utilizes the same circuit as the audio level selector up to the final sequence relay where, instead of selecting preset level potentiometers, a simple on-off contact arrangement is used.

If desired, the control circuit can be operated by a signal transmitted for the period that the relay is to be actuated, instead of using a sequence relay.

FM Performance:

The performance figures presented here have been taken from an engineering model and may be slightly modified in production units, although differences should be small. The sensitivity of the tuner section is such that 24 db of quieting results when a 10-microvolt signal is applied to the antenna terminals. This sensitivity is adequate for practically all applications. The actual audio output level obtained with 30-ke. modulation of this 10-microvolt signal is approximately 1.0 volt RMS. Signals up to 0.1 volt will increase the audio output signal only to 1.2 volts RMS, showing excellent limiting characteristics. The actual curve is shown in Fig. 2.

Of primary importance is the overall fidelity curve. Fig. 3 depicts the response from antenna to audio output. The curve was plotted using constant 30-ke. deviation established as a normal average, and applying standard transmitter pre-emphasis. This excellent response indicates that transmitted waveshapes will be faithfully reproduced at the audio output.

The use of crystal control in the local oscillator eliminates the problem of drift and, therefore, tuning of any sort is unnecessary to maintain the receiver on channel.

It will be noted that the signals used
(Concluded on page 32)

This new 5-kw FM Transmitter

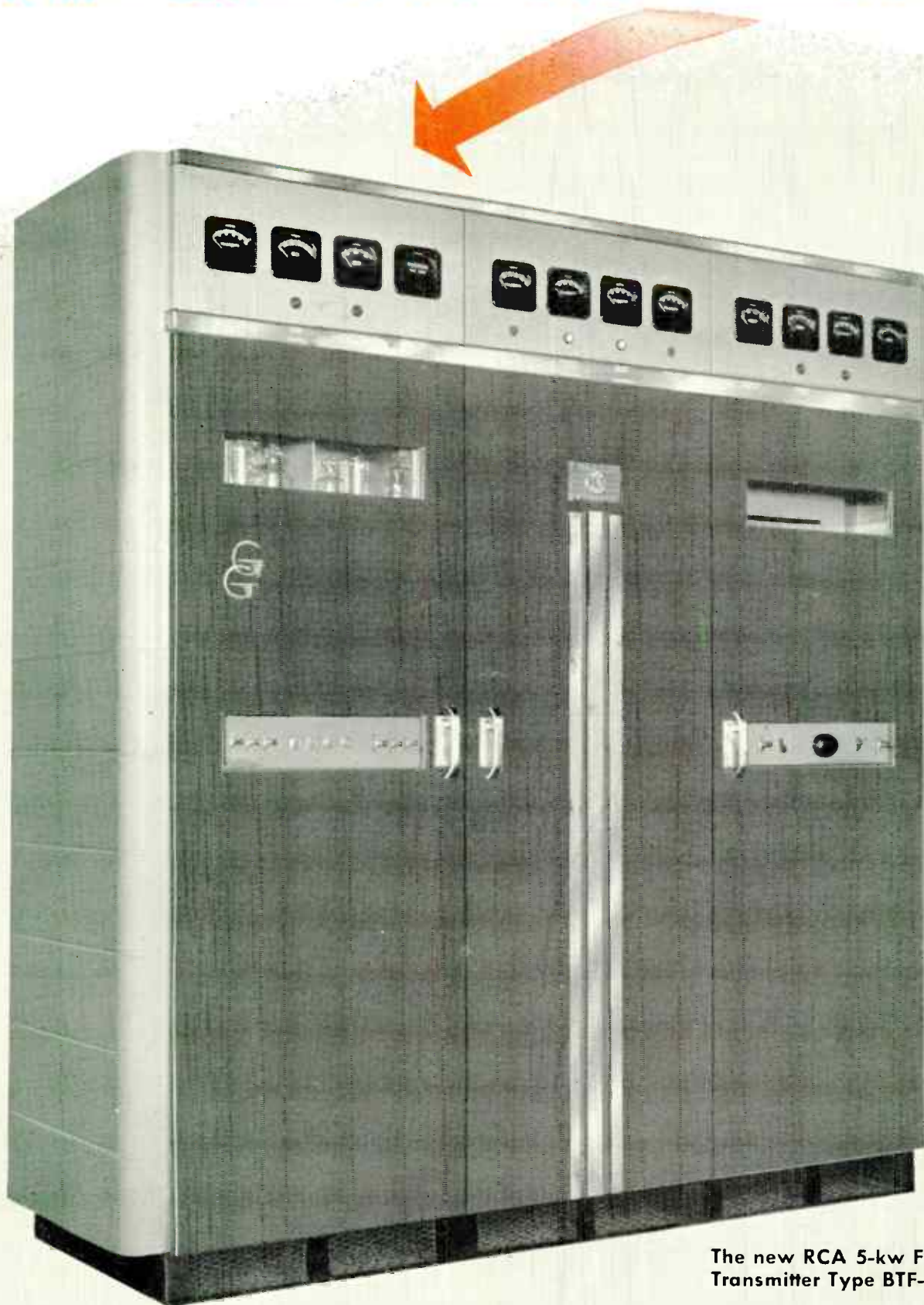

The new RCA 5-kw FM Broadcast Transmitter Type BTF-5A



BROADCAST EQUIPMENT
RADIO CORPORATION of AMERICA
ENGINEERING PRODUCTS DEPARTMENT, CAMDEN, N. J.

In Canada: RCA VICTOR Company Limited, Montreal

World Radio History

-and a 4-section Pylon

plus
gives you 20 kw ERP
... Economically

● For the broadcaster with an FM grant for 20 kilowatts, effective radiated power, this new transmitter . . . in combination with an RCA 4-section Pylon . . . *solves the problem economically.*

Here is the reason: a 4-section Pylon with a power gain of 6, steps-up the 5 kw to 30 kw (ERP) . . . allowing plenty of reserve power. This eliminates the costly choice of using either an expensive high-gain antenna structure with a low-power transmitter—or a higher power and more expensive transmitter with a conventional low-gain antenna.

Like all RCA's well-known FM transmitters, the BTF-5A uses RCA "Direct FM"—inherently capable of holding distortion and noise to extremely low levels. RCA power-saving Grounded-Grid circuits in the driver and final are designed to use the new RCA-5762 heavy-duty triodes. Both amplifiers require no neutralizing, are simple to tune, and are more stable than older and more conventional types. Type BTF-5A uses only 37 tubes and only 14 tube types. *Of these 37 tubes, only 21 tubes are required for emergency operation.*

All air-cooled, this transmitter includes every proved feature needed for efficient operation. It uses no trick circuits or gadgets—and it is simple to handle (inexperienced personnel can learn to run it in minutes). Unit construction makes the 5-kw FM transmitter easy to install. And if you now have an RCA 3-kw FM transmitter you can easily increase power to 5 kw by adding a simple conversion kit—now available.

For complete data on how this transmitter can radiate *from 20 to 60 kilowatts* of effective radiated power—and for information on the 5-kw conversion kit—see your RCA Broadcast Sales Engineer. Or write Dept. 38 D, RCA Engineering Products, Camden, N. J.

*Quick-Selection Chart for RCA Pylon Antennas
 (Choose the type for power gain needed)*

STANDARD PYLONS				
RCA 5-kw FM Transmitter	RCA Pylon Antenna			Maximum Effective Radiated Power
	Type	Gain	No. Sections	
BTF-5A	BF-11 A/B	1.5	1	7.5 kw
BTF-5A	BF-12 A/B	3	2	15 kw
BTF-5A	BF-14 A/B	6	4	30 kw
BTF-5A	BF-18 A/B	12	8	60 kw
HEAVY-DUTY PYLONS				
BTF-5A	BF-12 E/F	3	2	15 kw
BTF-5A	BF-14 C/D	6	4	30 kw

RCA 4-section Pylon delivers up to 30 kw (E. R. P.) with the BTF-5A transmitter!

SPOT NEWS NOTES

NOTES AND COMMENTS ABOUT SIGNIFICANT ACTIVITIES OF PEOPLE & COMPANIES



He's waiting for startling developments in antennas

WWVH Hawaii:

Has started to transmit standard frequencies on an experimental basis. Established by the Bureau of Standards on Maui Island, 400-watt transmitters on 5, 10, and 15 mc. will provide standard radio frequencies, time announcements, standard time intervals, and standard musical pitch.

Platter Battle:

Effective April 1, Columbia reduced prices on 78 RPM records as follows: Popular series, 10-in. size 60c, 12-in. size 85c. Masterworks series, 10-in. size 85c, 12-in. size \$1.00. Album sets have been reduced proportionately.

Educational TV Series:

Philco, in cooperation with the Philadelphia Board of Education, has launched a series of 39 programs over WPTZ which will be received in 20 schools on special large-screen sets. Dr. E. W. Adams, of the local school board, describes the possibilities opened up by this series as "absolutely unlimited."

The Public Is Pleased:

Station WBUZ-FM, Bradbury Heights, Md., completed its first 30 days of transiting by making a survey of commuters on the WM & A Motor Lines buses. Cards filled in by passengers showed 95% approval of music-while-you-ride programs. Also, cards disclosed that 72% of the passengers own FM receivers. WBUZ-FM reports that home listeners enjoy the type of music selected for transiting.

Decay of Radio Humor:

Columnist Robert C. Ruark quoting Fred Allen: "We're all at the finish of a

cycle. Benny's been on seventeen years, and so have I. We're sort of like John Gilbert and those other silent stars at the beginning of talking pictures. . . . We've been operating for years with pure sound gags as our stock in trade, and suddenly they're no good any more." Suddenly? Why, lots of listeners have known this for a long time!

Price Reductions:

Du Mont Laboratories has reduced prices on nine TV receiver models. A part of the reduction reflects the lower list prices on picture tubes. Line of models affected ranges from the mahogany Chatham at \$125 to the Colony at \$915.

Mike for Oscars:

Altec's little microphone did a big but altogether inconspicuous job at the presentation of awards by the Academy of Motion Picture Arts and Sciences. Usual battery of mikes was replaced by the new design for all the speeches, and for newsreel and ABC network pickup.

Department of Justice:

Would like to separate Western Electric from AT & T so that resulting competition for sale of equipment would enable AT & T to buy at lower prices. Bell Operating Companies now pay W. E. about 50% less for telephone instruments than other manufacturers charge their customers, 25% less for lead-covered cable, and 40% less for central office parts. Maybe Government economists can figure how the separation of W. E. from AT & T will reduce the production costs of the other manufacturers to the present W. E. level. If the Department of Justice men are that smart, why can't they figure out a way to reduce the cost of operating the Government, so we won't have to pay that 20% tax on every toll call?

New Teflon Plant:

Under construction by DuPont at Parkersburg, W. Va. Teflon, now available in limited quantities, is a machinable plastic of high mechanical strength, capable of withstanding temperatures of 550°F. Its electrical properties make it a superior insulator at UHF frequencies.

Paul Ware:

Inventor of the Inputuner used in Du Mont and other TV sets has been appointed head of Du Mont's new electronic parts division.

Duluth Likes Transiting:

Survey made for the National Association of Transportation Advertising in

Duluth reveals that 80% of riders want transiting continued, 18% don't care, and only 4% object. Programs are made up of music, news, weather reports, time signals, 20-second spots, and a few department store announcements running to 1 minute.

New Transmitters for WFIL:

Construction of a new transmitter building and FM-TV antenna has been started at Roxborough, 7½ miles northwest of Philadelphia's business center. Site was chosen after a survey of population movement projected for 20 years, to determine a central location. The 5-section RCA Super-turnstile will be 909 ft. above sea level. Calculated 500-microvolt contour of the new transmitters covers population of 4,206,000.

AM Set Prices Cut Deeply:

A sharp break in prices of many AM models has followed the current drop in demand. Among the deepest cuts are the Philco AM combination with dual-speed record changer advertised at \$40 off the \$159.95 list, and the \$14.95 table model offered at \$14.95 by Davega.

Walter F. Kean:

Former manager of Andrew's consulting division has set up a midwest office at 114 Northgate Road, Riverside, Ill. The new firm will handle FM, AM, and TV design and allocation work, and complete field engineering service, including field intensity measurements. Walter Kean is qualified by the FCC as a consulting engineer. Telephone at his new office is Riverside 2795.

Those TV Converters:

Sorry, but we can't go along with Jack Poppele, FCC Chairman Coy, and some of our other good friends who feel that converters will provide UHF reception on VHF receivers. Experience with short-wave converters and FM converters has shown that their performance is not satisfactory, and the public doesn't like the idea anyway. The converter idea limits UHF standards to those of VHF. Why not set higher standards for UHF while there's still an opportunity? And if VHF and UHF assignments are not made in the same area, there's no need to use the same standards.

More Powdered Iron:

General Aniline & Film Corporation will soon increase its production of Carbonyl iron powder for RF cores when a new plant at Huntsville, Ala., gets into operation. Production will continue at the Grasselli plant at Linden, N. J.

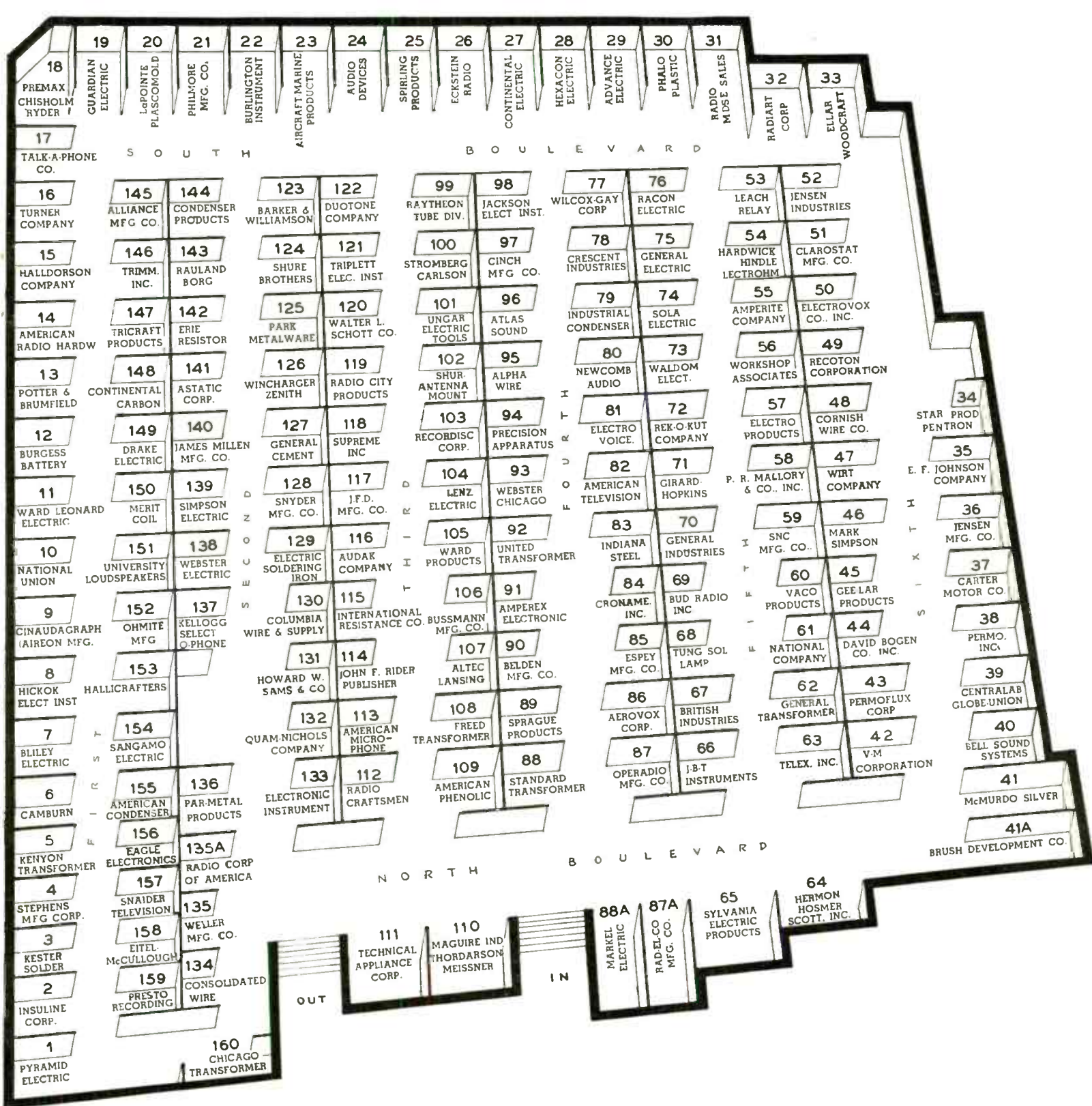

NEWS PICTURES

The Radio Parts Show, opening at Chicago's Hotel Stevens on May 16, will be the most interesting in the annals of the industry. New components will reflect developments and design work that have been keeping radio engineers on the job more hours per week than during the war years. New test equipment and tools for production and service will represent the specialized requirements of FM and TV sets. Booths will bristle with antenna arrays operating on FM and TV

frequencies. New audio systems and loudspeakers will offer a range in fidelity of reproduction at prices to suit every listener.

In short, there will be more to make a trip to the Parts Show worth while this year than ever before. Also, the management and the participating organizations have planned the program of activities throughout the week in such a way as to enable each guest to get the most out of his investment in time and expense.

With all the changes and progress brought about by public demand for FM and TV reception, attendance by parts

jobbers, dealers, and servicemen is expected to exceed previous records by a substantial figure.

The layout of the Show, pictured above, lists 164 manufacturers whose products will be displayed. And here's a suggestion: Before you start for the Show, make up a list from this diagram of the booths you want to visit. There will be so much to see, and so many others crowding in to look also, that unless you make your plan in advance, you may get bogged down and miss some of special interest to you.

OBSOLESCENCE OF TV RECEIVERS

THE ECONOMIC PROBLEMS OF UHF TELEVISION DO NOT INDICATE ANY EARLY OBSOLESCENCE IN CURRENT VHF RECEIVER DESIGNS — *By* MILTON B. SLEEPER

WE can't remember when any piece of advertising copy caused as much excitement throughout the industry as Zenith's full-page newspaper splurge featuring the headline: "Expected Changes in Wave-lengths Will Not Obsolete Zenith Television." This warning was emphasized in the text by the statement: "be sure that you buy a television receiver with positive built-in assurance that it will not be made obsolete by any contemplated changes in television channels." Also, there was the qualifying reference to UHF standards: "Zenith is the only television receiver on the market today with a specially designed built-in turret tuner with the provision for receiving the proposed new ultra-high frequency channels on the present standards."

This advertisement, sent to 41 newspapers in 36 cities having TV service, caught the papers, the FCC, and the set manufacturers with their UHF down. Eleven papers refused to run the Zenith copy, thereby drawing the fire from Senator Edwin C. Johnson, chairman of the FCC investigators. The Colorado Senator wrote FCC chairman Coy: "It is alarming to learn that 10 or more newspapers owning television licenses this week refused advertising which sought to caution the public concerning the usable life of television sets."

To put first things first, let's pass over the matter of Zenith receiver performance on UHF, or any question of ethics involved in the Zenith advertising, and get down to the basic issues involved.

Just four years ago, the FCC, under the chairmanship of Paul Porter, set up the VHF channel allocations now in use, and provided for further expansion by giving television also the band from 475 to 890 mc. in order, as was explained then, to provide for nation-wide, competitive service.

So matters stood until last summer when, first the FCC laid plans to more than double the assignments on the 12 VHF channels, and then subsequently admitted that its propagation data, used to set up the proposed expansion of VHF assignments, was not as realistic as the de Mars data published in the April and May, 1947 issues of *FM AND TELEVISION*. Later came the decision to freeze VHF television until FCC could equip itself with data accurate at least to the point of meeting the practical needs of VHF channel assignments, and to study the problems of UHF allocations and stand-

ards of the picture transmission system.

Up to the present time of writing, the FCC has had nothing specific to say about the progress of these studies. However, Chairman Coy has made a series of statements which, pieced together, are of the greatest significance to manufacturers, broadcasters, and the public:

JAN. 21 — "We hope to unfreeze the processing of television applications by April or early in May. We also hope that, before the year is out, we will be able to provide for utilization of the ultra-high frequencies. This makes it likely that many pending applications for frequencies in the VHF will have to be shifted to the UHF band, and offers the hope that many applicants can start construction this year, especially in cities where no provision has been made in the present band."

JAN. 25 — "Just a few comments about the need for additional channels in order that we may have a nationwide competitive system: I hold the need to be self-evident, and thus will dispose of that part of the problem. How many channels it takes to satisfy that need I do not know. My present thinking is that 50 to 70 channels may be required."

FEB. 25 — "Since it is not possible for most cities to have 4 television stations on the VHF band, the result will be that, in some instances, both VHF and UHF television stations will be assigned in the same city."

Well, there's plenty of meat in those official statements for the industry to sink its teeth into right now, without waiting for the allocations freeze to thaw out. The situation is comparable to audio broadcasting, in that the new FM band was put to use only because a superior method of transmission and reception was discovered. The conviction is growing that, within a few years, FM on the new band will replace AM on the old band. Meanwhile, the transition is taking place in a gradual, orderly manner.

Something similar will probably happen to television some day, but TV must progress a long way before that change can even start. This is not understood clearly by the public, the dealers, or even by some manufacturers. Zenith undoubtedly performed a useful service by jolting the industry into an awareness of the uncertainty and mystery that have enshrouded the subject of UHF television. Here are certain basic facts that should be understood by everyone:

1. It is unfortunate that television started on VHF frequencies where only 12 channels can be assigned, and in a band where transmitter, receiver, and antenna designs are very different from those required in the UHF band. All-UHF allocations would have been a relatively simple matter, because of the larger number of channels available. TV broadcasting will probably go to UHF eventually, but no one knows when that will happen. The only certainty is that, for better or worse, we have VHF transmitters and receivers now.

2. The 12 VHF channels won't permit the FCC to allocate enough frequencies for each important population area to have the number of stations consistent with the number of people. Nor will there be VHF frequencies available for rural sections.

3. The FCC may decide now to allocate both VHF and UHF channels in the same area, but who will want a UHF allocation where VHF stations are operating, and where people already own VHF sets?

Suppose UHF channels are assigned in New York, Philadelphia, Los Angeles, or in one of the smaller cities. Who would invest in a UHF transmitter, and then attempt to compete for an audience with VHF stations? The idea is an economic absurdity.

4. Obviously, then, the only areas where anyone will undertake to operate UHF television stations in the foreseeable future are those where there will be no VHF competition.

5. Until UHF sets are commercially available, no one will invest in UHF transmitters. And unless there are going to be UHF transmitters, who will undertake to develop and produce receivers? The FCC can't create UHF service by merely laying out an allocation plan.

6. So the start of UHF broadcasting may be postponed indefinitely unless the FCC plan provides only UHF for some important population centers. We are beginning to find out that New York City may not support seven stations.

7. This brings us to a final point. The possibilities for the further development of television are unlimited. Today, it is only in its initial stage as a public service. The industry is only beginning to raise its sights to look into the possibilities of UHF television. For all the limitations imposed by the 12 VHF channels,

(Concluded on page 32)

Performance Data On FM AND TV ANTENNAS

MORE PLANNING AND LESS GUESSING ARE NEEDED
IN SELECTING THE DESIGN — *By* GEORGE P. KEARSE*

FOR proper operation of an FM receiver there must be appreciable signal at the grid of the first tube. Mediocre performance results when the signal strength is below that required to produce quieting action. The less sensitive the receiver, the more efficient the antenna must be.

On the AM frequencies, it is common practice to wind large RF and antenna coils as loop antennas to intercept the oncoming wave front and produce a satisfactory input signal. However, the RF and antenna coils of FM receivers are too small to provide satisfactory results by this method. Attenuation through buildings and reflections from other large objects are also factors that result in poor reception from built-in antennas. Therefore, for best performance, an outside antenna should be used.

A large number of FM antennas are on the market today. The variety is so great that the customer can very easily become confused in selecting the best type to meet his requirements. There are plain dipoles, folded dipoles, mismatched dipoles and crossed dipoles. Some are adjustable for different types of polarization and others are bent in various weird shapes in an effort to achieve non-directional characteristics.

Antennas for FM:

The antenna requirements for FM are rather easily met. The frequency range

*Senior Engineer, American Phenolic Corporation, 1830 South 54th Street, Chicago 50, Ill.

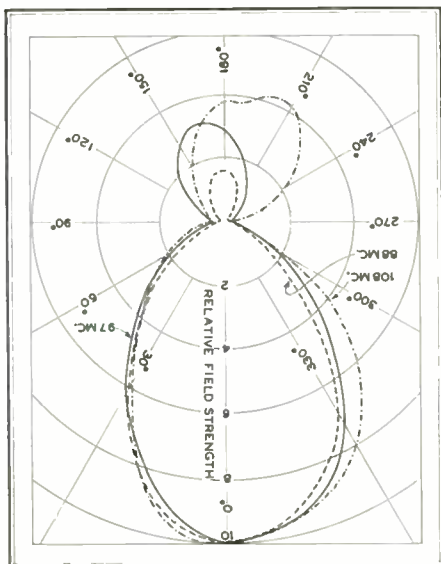

Fig. 3. Pattern of FM dipole and reflector

is narrow compared to the television band. Most any antenna that is cut to approximately the correct length and is reasonably matched to the transmission line will give satisfactory performance on a well-designed FM receiver.

A folded dipole produces a bi-directional radiation pattern that can be changed to a uni-directional pattern by adding a reflector. This type of antenna matches the popular 300-ohm transmission line and works well at FM frequencies.

The performance of the folded dipole, Fig. 1, is illustrated in Fig. 2. This curve compares the gain of a fixed folded dipole

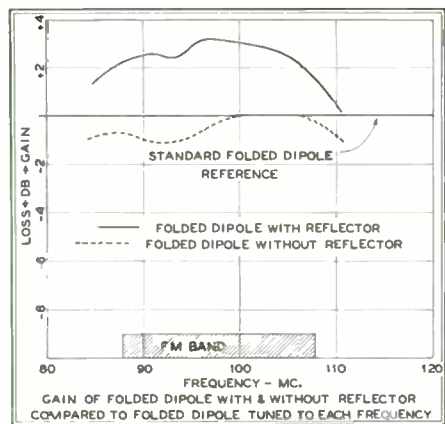

Fig. 2. Performance with and without a reflector over the band of 88 to 108 mc.

to one that is tuned to each measurement frequency. It is apparent that excellent results can be expected from the fixed-length folded dipole. Fig. 2 also shows the added gain obtained by using a reflector. The single direction radiation patterns are shown in Figure 3. With careful design a folded dipole and reflector will retain these patterns over the entire FM band.

The mis-matched dipole is also quite popular. This antenna is broadbanded by feeding a 70-ohm dipole with a 300-ohm transmission line. At resonance the gain is low because of a four-to-one mismatch. The impedance match improves on each side of resonance but off-resonant operation of the dipole causes the gain to remain low. It should be noted that this type requires a high signal level for best results.

If the coverage pattern of the single dipole does not conform with the topographical distribution of FM transmitters around the receiving point, then a crossed dipole design must be used. For all-direction coverage, the crossed dipole

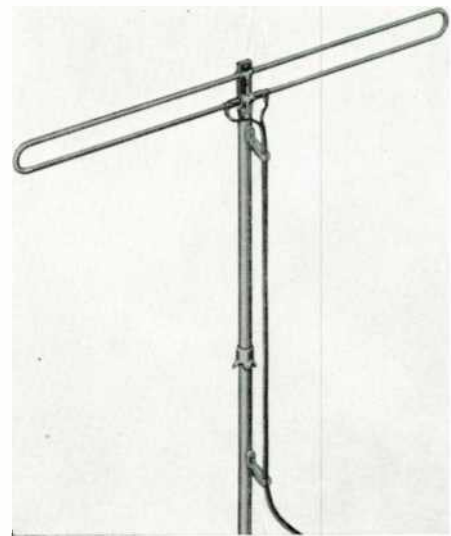

Fig. 1. Conventional folded dipole for FM

is adequate. However, this type of antenna is very frequency-sensitive due to the quarter-wave line needed to maintain a 90° phase difference between the two dipoles. This 90° phase difference produces a circular radiation pattern at only one frequency. This pattern changes as the frequency is moved to either side of resonance, the greater the frequency shift, the greater the change. The pattern approximates that of a plain dipole but is rotated 45°. Shifting the frequency to the other side of resonance will rotate the pattern to the other side by an equal amount. These variations in the radiation pattern are normal and will be present in any crossed dipole antenna. The gain will be slightly less than that of a dipole facing the transmitter over the entire frequency range, but will be greater for a station located off the end of a single dipole.

Television Antennas:

Television receiving antenna requirements are not easily met. The frequency range covered by all television channels is large, and the receiver sensitivity is

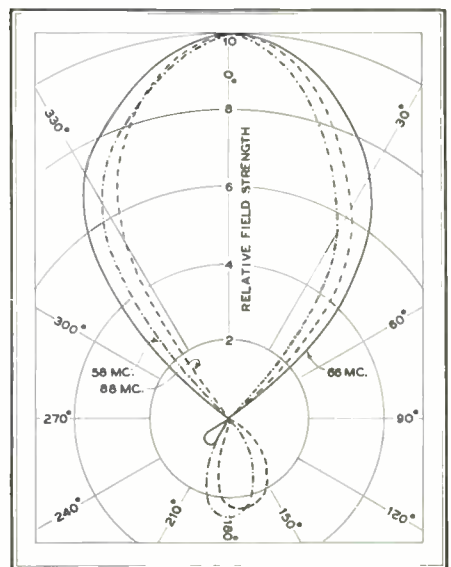

Fig. 5. Pattern on the lower TV channels



Fig. 4. Long and short dipoles are centered on the lower and upper channels. Fig. 11. Stacked array for high gain

much lower than FM or AM receivers, requiring 100- to 300-microvolt input signals. Ghost images, ignition noise, and man-made interference problems can be solved only by well-engineered antenna installations. In some cases indoor antennas, loops, and tuned loops deliver adequate signals to the receivers, but they are high-Q circuits, and do not reduce ghosts or provide the flat response curves required for optimum performance. Due to the line-of-sight propagation of television signals, consistent fringe-area reception is possible only with high-gain antenna arrays. Television stations normally provide a service area of approximately 20 to 40 miles radius, but it is generally possible to extend this service area by using a high gain receiving antenna.

There are a great many television antennas on the market, many of them produced without careful engineering design. The service engineer must, therefore, choose carefully in selecting antennas for his own and his client's protection. Comparative tests made by the author with various television antennas, offered with claims of full coverage from 44 mc. to 217 mc., prove that they fall far short of these claims. It is impossible for any single antenna to be completely insensitive to frequency variations and also retain a desired radiation pattern.

The two groups of television channels, 2 to 6 and 7 to 13, are so widely separated that a simple dipole cannot properly cover the entire range with a useful

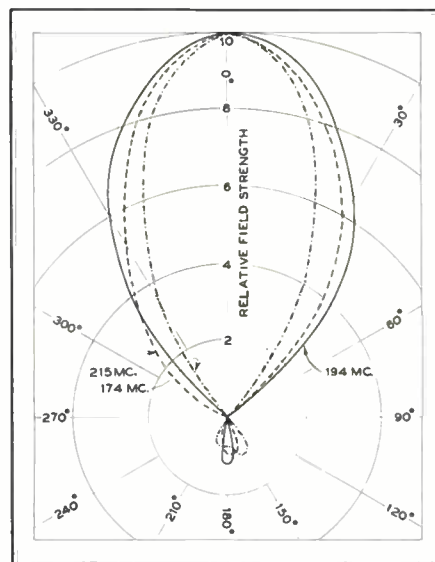

Fig. 6. Pattern on the upper TV channels

radiation pattern. It is much better to use a separate antenna for each channel or a properly-designed combination antenna. For those who may want to use simple dipoles and reflectors, a table of dimensions for each channel is presented in Fig. 10.

In the majority of installations, however, one is compelled to use a single antenna for all channels. Then a compromise design must be selected that incorporates reasonably high gain, wide band width, and single-direction radiation patterns over the television spectrum. One such antenna, designed by the author, is shown in Fig. 4. This consists of two folded dipoles and a reflector. Each array is broadbanded to cover its operating band and the two antennas are mounted so that the larger folded dipole forms the reflector for the small folded dipole. The two antennas are interconnected with a transmission line whose length is chosen for minimum loss on both bands. This type gives excellent radiation patterns that are uni-directional over all television channels. Figs. 5 and 6 show the definite uni-directional radiation patterns at three frequencies in each group of channels, while Figs. 7 and 8 show the gain as compared to a folded dipole tuned to each measurement frequency.

Many television installations are made using a folded dipole cut to channel 2 or 3 and operated over the entire group of low frequency channels. Fig. 9 compares the percentage gain of one of these folded dipole antennas to the array described above.

(Concluded on page 34)

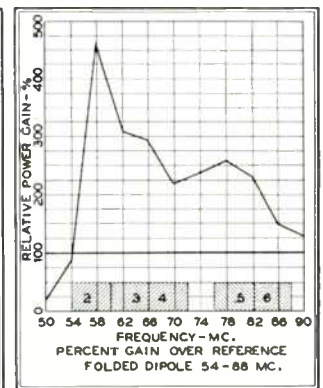
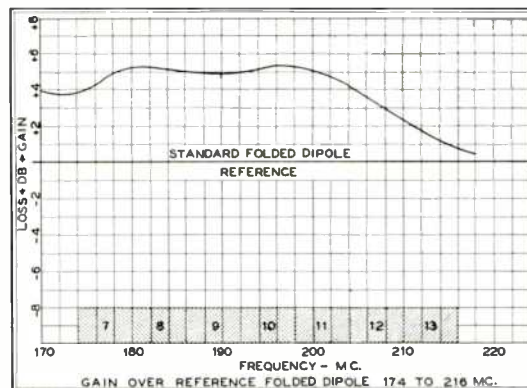
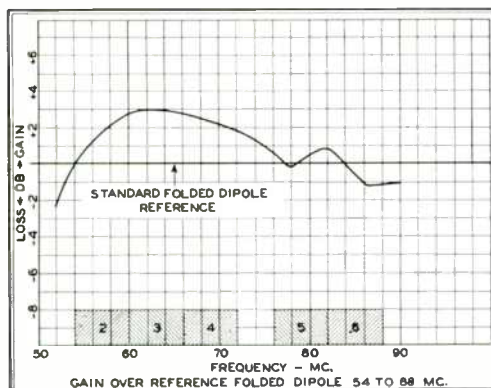

Figs. 7 and 8. Gain over plain dipole tuned to each of the lower and upper TV channels. Fig. 9 Percent gain on lower channels

SUBMINIATURE IF AMPLIFIERS

PROGRESS REPORT FROM THE BUREAU OF STANDARDS ON TECHNIQUES OF SUBMINIATURE DESIGN & MANUFACTURING — By R. L. HENRY AND G. SHAPIRO*

IN military applications of miniature radio apparatus, ease of mass production is as important as reduction in size. This requirement has motivated the search for new materials and manufacturing techniques. The National Bureau of Standards, under the sponsorship of the Bureau of Aeronautics, Department of the Navy, is engaged in adapting such techniques to the production of more complicated subminiature radio assemblies such as broad-band, high-gain, intermediate-frequency amplifiers for aircraft and missiles. An assembly is considered *subminiature* when its volume is compacted to a dimensional limit primarily imposed by the smallest available vacuum tubes.

Temperature Problems:

Extreme compactness brings about higher internal temperatures than are usually encountered in conventional assemblies. Some of the satisfactory high-temperature insulating materials are ceramics, vitreous enamels, and silicone-bonded bodies.

Ceramics of low dielectric-constant, such as steatite, are preferred to organic insulation. High-*K* titanate ceramics serve not only as satisfactory printed-circuit base materials, but also as miniature capacitor dielectrics. Ceramic dielectrics have been used throughout because of the potential scarcity of mica in times of national emergency. Fashioning high-*K* ceramic bodies into cylinders makes them stronger than they would be in flat shapes. These cylinders are made to play a multiple role as capacitors, tube shields, stand-off insulators, and base materials for printed wiring.

Also, because of the high temperature encountered in subminiature devices, special insulation is required for the wire, and special soldering or welding techniques. Three types of high-temperature insulated wire were examined by National Bureau of Standards engineers, and their advantages and deficiencies evaluated for various applications. These included ceramic, silicone-impregnated glass, and ceramic-Teflon.

IF Amplifier Design:

The IF amplifier illustrated here embodies a type of critical circuit layout which presents most of the typical problems. The miniaturized amplifier was de-

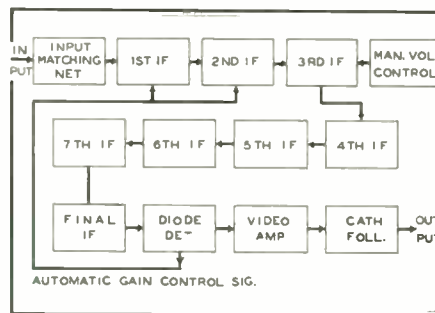

Fig. 1. Plan of the sub miniature unit signed to have 1) eight stagger-tuned IF stages, a detector, a video amplifier, and a cathode-follower output circuit, 2) more than 95 db gain from the IF input to the detector output, 3) manual and

The first was designed to use a maximum of miniature component parts based on standard design, so that it could be readily manufactured by techniques currently employed by the radio industry. The circuit for this amplifier was laid out in a straight line on a $1\frac{1}{8}$ -in. metal plate, with the interstage coupling network between the tubes. The subminiature tubes were mounted in spring metal clips which served as interstage shields, and improved the heat conduction from the tubes. The compartmentation due to the interstage shielding inhibits feedback through the wave guide formed by the amplifier enclosure.

The steatite inductor forms were wound with high-temperature insulated

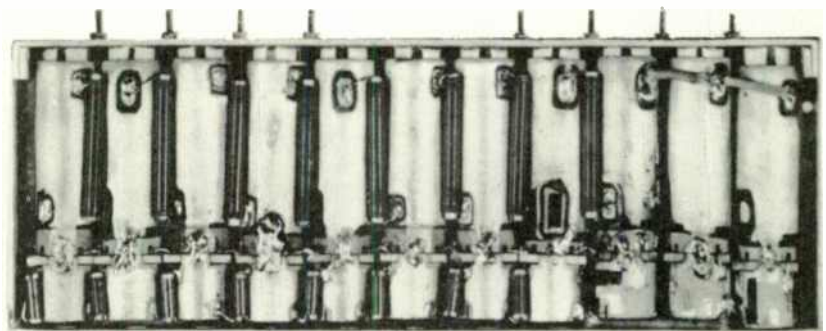

Fig. 2. All elements of the 11-tube circuit are contained in this $6\frac{3}{8}$ -in. assembly

automatic gain control, 4) a 60-mc. center frequency and a bandwidth of 10 mc., and 5) an assembly readily adaptable to mass production methods.

Two methods of fabrication were employed in the construction of these units.

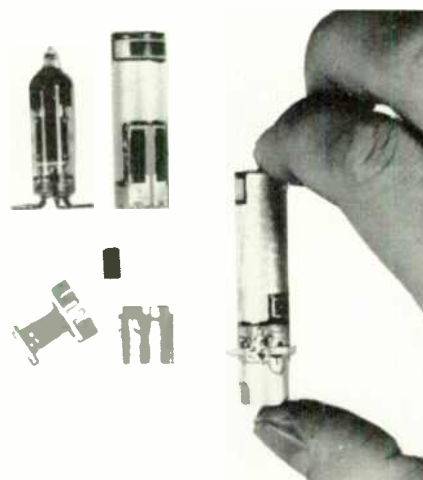

Fig. 3. Components of a single IF stage

wire, and have adjustable, powdered-iron cores which can be screwdriver-tuned. In order to dispense with separate resistor mounting brackets, the resistors were mounted directly in the inductor forms. The end plates of these forms were metalized with the required pattern to interconnect the resistors and circuit elements when soldered into place. Bifilar-wound inductors were used for interstage coupling networks in order to eliminate coupling capacitors with their associated high capacities to ground.

This amplifier design contains some 38 tubular high-*K* ceramic by-pass capacitors, most of which are located under the bases of the vacuum tubes. Most of the metal parts are inexpensive, light-gauge stampings, while the principal insulating material is steatite.

No attempt was made to achieve the absolute minimum size. Instead, compromises were made to facilitate conventional production practices. As a result, the overall dimensions came out $1\frac{1}{8}$ ins. high, $10\frac{1}{16}$ ins. long by $9\frac{1}{16}$ ins.

*Electronics Engineer, National Bureau of Standards, Connecticut Avenue and Van Ness Street N. W., Washington, D. C.

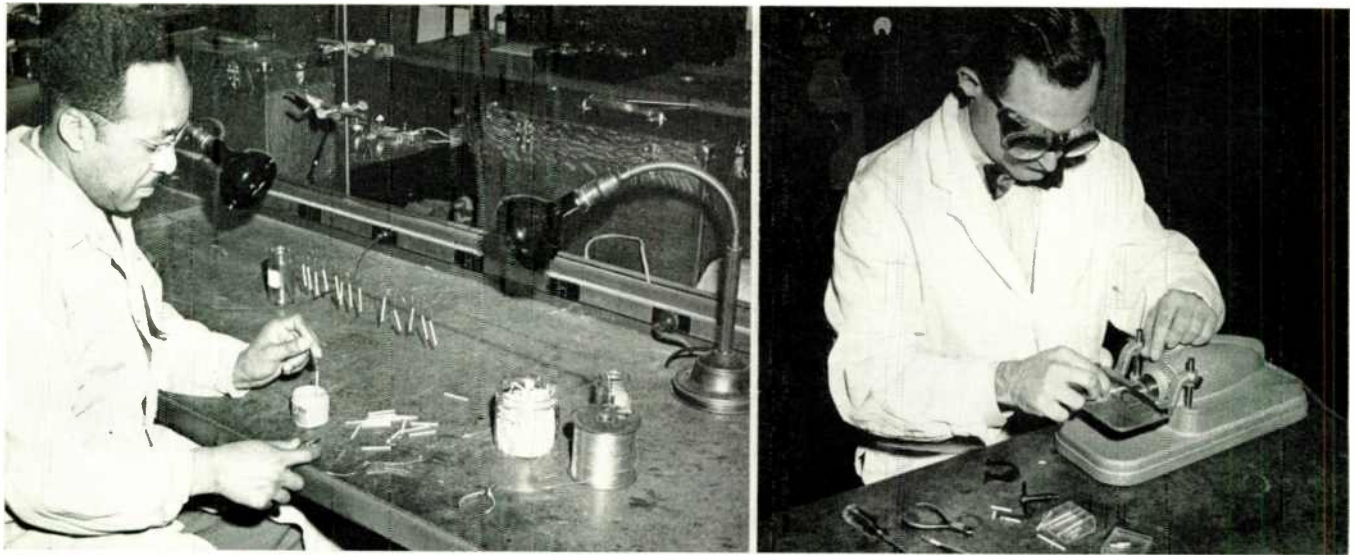

Fig. 4. The condensers are silver-coated tubes of high-*K* titanite Fig. 5. Tubes are cut to length for required capacitance

The second assembly, Fig. 2, was packaged in a hermetically-sealed container 2 ins. wide, $6\frac{3}{8}$ ins. long, and $\frac{3}{16}$ ins. thick, representing a reduction in cubic contents of 29%. The basic design is characterized by an individual stage assembly construction, employing changes in the printed circuitry, according to the function of the stage. This construction requires only four soldered connections between stages, making for fast production and simplified repair and maintenance.

As indicated in Fig. 1, the input of this unit has a network designed to match the impedance of the preceding microwave output mixer. The IF circuit consists of 4 staggered pairs of amplifiers. Gain in the first two stages is automatically controlled by feeding a control signal from the diode detector. The third stage has a manual volume control. The complete unit has 11 subminiature tubes, 17 RF chokes, 9 bifilar RF inductors, 3 monofilar RF inductors, 42 capacitors, and 32 resistors

The typical stage is an assembly of four major parts: three printed ceramic units and a vacuum tube, as shown in Fig. 3. This design is based upon the use of a high-*K* ceramic cylinder which just slips over the subminiature vacuum tube. On the surface of the cylinder is printed a major portion of all the capacitors, resistors, and associated circuitry. A bifilar-wound ceramic inductor form is attached to the subminiature tube base and to the bottom of the ceramic cylinder surrounding the vacuum tube. A fourth element, a short ceramic cylinder of high dielectric constant, fits over the inductor form. In the process of making electrical connection to the vacuum tube, all four parts are simultaneously soldered together in an interlocking assembly. The inside of the large ceramic tube is metalized, serving both as a ground plane for the multiple by-pass capacitors and as a shield for the vacuum tube. The exterior of the ceramic tube is covered with high-temperature insulation on which a metalized exterior shield coating is applied,

resulting in a completely shielded, individual assembly.

Further details are illustrated in Figs. 4 to 7. Tubular capacitors for use at high operating temperatures are made at the Bureau by coating high-*K* titanite ceramic tubing with silver-pigmented paint, Fig. 4. The tubes are heat-dried under infra-red lamps and then fired at 1,300° F. In Fig. 5, the operator is cutting the silvered tubes to length, according to the capacity required. To simplify production, the same size of tubing is used for all condensers in one assembly.

To print circuits directly on cylindrical titanite forms, an inverted rotary press is used, Fig. 6. In the method used now, the press is loaded and unloaded manually, but this screen-printing process could be developed for automatic operation. About 90% of the circuitry for an IF amplifier stage is printed on the cylinder which is slipped over the subminiature tube. Fig. 7 shows the testing jig and equipment used to align the completed IF assemblies.

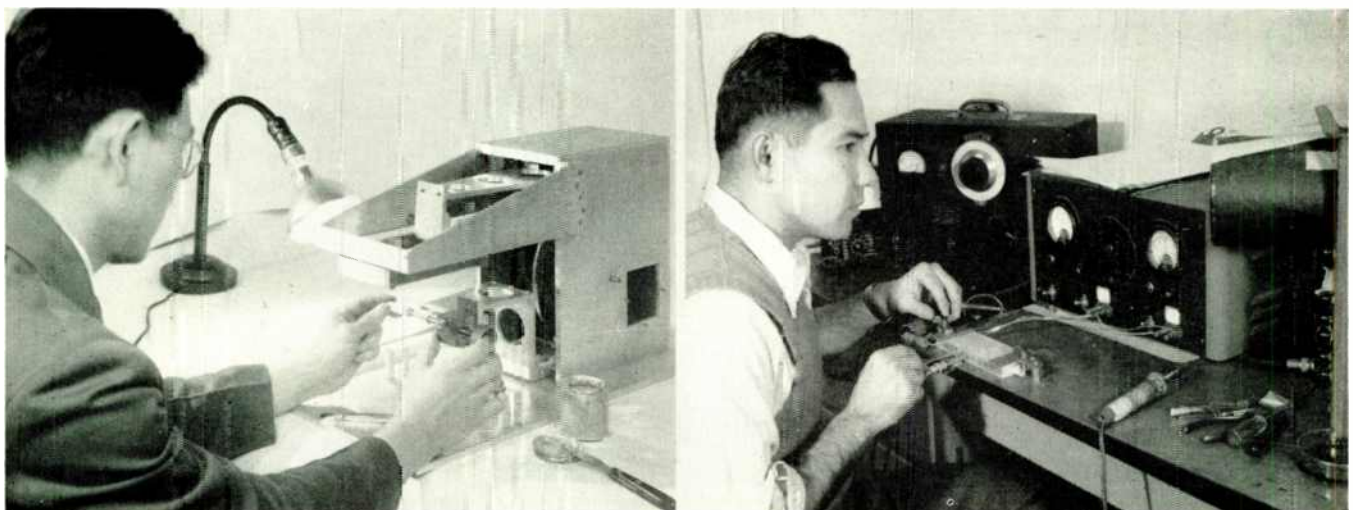
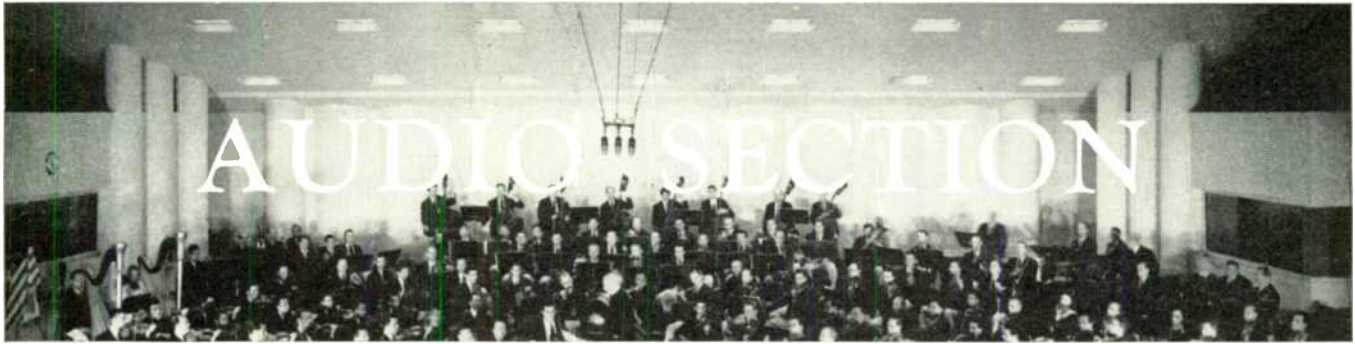

Fig. 6. A simple rotary press is used to print circuits on the titanite tubes Fig. 7. Setup for testing IF stage assemblies



AUDIO DEVELOPMENTS

DEVOTED TO THE INTERESTS OF THOSE WHO WORK WITH AUDIO FACILITIES — *Edited by* LAWRENCE OLDS

YOU know what has happened to bathroom fixtures and kitchen equipment in the last few years. You can see the promise of a start toward doing a similar job on radio set designs. It won't happen over night, but sure as the pin-base tube has supplanted the screw base and wire leads of the Audion, the change is on its way. One of these days, radio furniture will go the way of the claw-footed bath tub and the limestone sink.

Among those who are speeding the change is Robert Samuelson, idea-man of Voice & Vision, whose place of business is at 7320 Bennett Avenue, Chicago. Working with home owners and architects, Samuelson is doing with audio and video equipment the kind of a job that Bendix did on the wooden wash tub.

Then he's adding a special touch that will warm the hearts of high-fidelity devotees. When he plans installations in new or remodelled homes, he goes in for

acoustics, too. This doesn't call for fluted walls and angled ceilings. Sometimes it's just a matter of the location of a built-in loudspeaker, or the choice between reflecting or absorbing treatment for a single wall area. There are two considerations. First is improvement in program quality. Second is insulation of areas where quiet is required. They add up to pleasing effects which send more clients to V & V.

THIS writer hasn't seen it in the flesh, but from the photograph and description, the turnover changer illustrated here certainly seems to be a very practical solution to the problem of playing records on both sides. It is manufactured by the Lincoln Engineering Company, 5701 Natural Bridge Avenue, St. Louis.

The basic feature of the design is the use of suction cups for holding the records, in place of grippers and clamps.

This should make the handling of the records much more gentle, firm, and positive. Although the changer handles 7-, 10-, and 12-in. records, and operates at all of the three speeds now in use, there is less machinery in this unit than in some of the changers that play one side at one speed.

The table at the left holds up to 16 records. These are picked up one at a time by a suction cup on the transfer arm, and carried to the turntable at the right. After the first side has been played, the turntable, mounted on gimbals, is turned over, but the record is held in place by another suction cup until, at the end, air is admitted and the record is dropped to the tray below. There is no drive shaft, since the turntable is driven by a friction disc at the side. A control cuts out the turnover feature if it is desired to play the records on one side only at any time.

It looks simple, and it sounds simple, and if the mechanical design has been worked out as thoroughly as one would expect, there should be no difficulties from such failures as so frequently experienced with more complicated types.

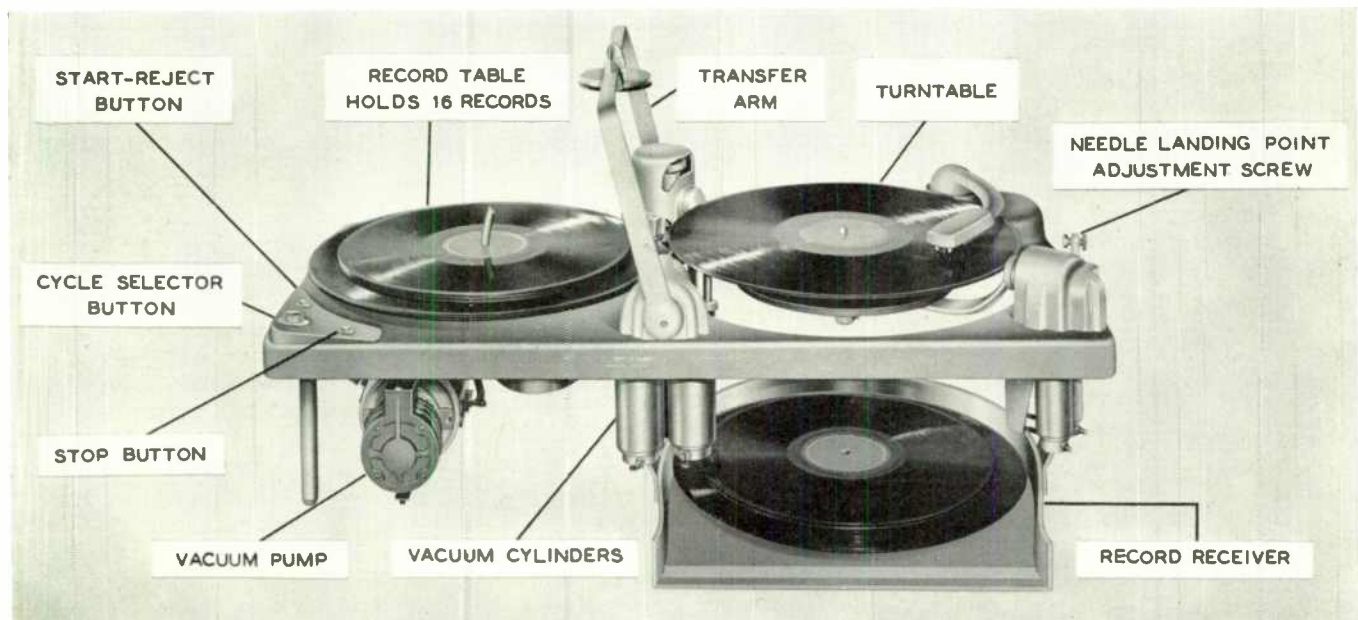

In this turnover changer, suction cups are used in place of mechanical grippers to move and hold the records

STEREOPHONIC SOUND RECORDING

EXPERIMENTS WITH MICROPHONE AND RE-RECORDING METHODS FOR MOTION PICTURES CAN BE APPLIED TO 3-TRACK MAGNETIC TAPE—By L. D. GRIGNON*

THE work reported here is an extension of the theory and methods for the use of stereophonic sound in motion pictures. The opportunity to investigate this possibility came about by a desire on the part of Twentieth Century-Fox management to evaluate possible technical improvements in motion pictures. Western Electric Company cooperated through Electrical Research Products Division by supplying film recording and reproducing equipment and other technical assistance.

Methods were devised for recording dialogue, and music for use in motion pictures, without basically changing accepted fundamental forms which include the use of long, medium, and close shots and intercutting techniques. This is not to say that present cutting philosophy for stereophonic motion pictures is entirely suitable, as there is evidence that indicates the need of some new approach. Re-recording, with added sound effects, prescore, and playback methods were all used. The end result of the experiment to be described was the production of two single-act plays, several full-orchestra numbers (one with picture), and a vocal rendition with accompanying orchestra.

It was concluded that stereophonic methods, with suitable modifications, can be applied to motion picture technique and result in a sound presentation considerably superior to methods now in use.

Microphone Technique:

The problem of pickup, particularly for dialogue, was first approached by setting up a three-channel monitoring system, using the amplifier and horn apparatus as installed in the test theater, and providing microphones and mixer equipment in an adjacent stage. On this stage a small living room set was constructed, and pickup tests were begun using stock players from the studio roster.

It was natural first to try the accepted method of having three microphones equally spaced and placed in some straight line in relation to the actors. This method failed immediately—the reasons being as follows:

1. The action was taking place in a restricted space.

2. Semi-nondirectional microphones were essentially useless because of the proximity to the sources and to acoustic

reflections from parts of the set which produced false apparent origins.

3. Actors generally play to other actors and do not face an audience as do public speakers. Methods were needed for giving sound placement to actors who are speaking at right angles to the camera axis and within a few feet of one another.

4. Since various camera lenses are used to give emphasis or localize action, magnifications or distance distortions exist,

phones by dashed lines with arrowheads giving direction.

For purposes of definition, consider a source which emits sound continuously and which is in constant movement. Then the reproduced sound must also move continuously in the same way without obvious dwells or jumps from position to position. This characteristic will be termed smooth sound placement transition.

The usual equidistant, in-line microphone technique can be used in long shots of large sets with wide separation of actors and broad movements. Even then, to have smooth dialogue transition, some microphone movement may be required, as illustrated in Fig. 1.

This method is also generally used for recording of effects. One experiment using such a pickup consisted in recording airplane takeoffs, wherein the microphones were placed along the runway. The microphones were spaced 150 feet apart!

When actors are not disposed closer than 6 to 7 ft. and are speaking directly to each other, the setup of Fig. 2 is used. Should either turn or move away and speak lines, then microphones must be moved accordingly. For example, should the right-hand actor turn 180° and speak lines, then the R microphone must be moved sufficiently to the right to give good pick-up and the C microphone readjusted to a somewhat central position, probably favoring the right-hand actor. Also, dependent upon set conditions, it is sometimes necessary to adjust the null directions of the L and R microphones on the opposing person. This change in pattern does not eliminate pickup into any microphone so adjusted, because the null is imperfect and sufficient energy arrives from other directions, thus satisfactorily meeting necessary pickup requirements.

In many instances microphones were grouped in a cluster tighter than shown in Fig. 2. This condition, carried to its limit, occurs where a close-up of two actors is used who are physically separated by only 3 to 4 ft. They will appear on the screen to be 8 to 10 ft. distant from one another, resulting in the crossed-over configuration of Fig. 3. Note that the L microphone is placed on camera right, but is actually picking up the left-hand actor, provided of course that it is adjusted to minimize pickup from the right-hand performer. The R microphone is also reversed, of course, as

3-TRACK TAPE RECORDING

Until the present time, the possibility of using stereophonic sound has been limited to the theatre, and this application has had only experimental consideration. Now, however, the development of magnetic tape, on which three sound tracks can be recorded simultaneously, opens up entirely new fields for stereophonic reproduction, particularly since means are available for making copies in large quantities.

As to the gain from this method of reproducing the original sound of orchestras and operas, it compares to conventional one-track tape and transcriptions as a simple photograph compares with the perspective effect of stereoscopic views.

There is an immediate market for stereophonic tape recordings and the associated equipment for both the public and private enjoyment of important music. As to the techniques of recording, Lorin Grignon's paper before the Society of Motion Picture Engineers offers many practical suggestions. While he was concerned primarily with work in the motion picture studio, the methods he describes are applicable to three-track tape recording.

and a similar effect was necessary in the sound pickup.

Using adjustable-directivity undirectional microphones and separate microphone booms for all further work, several basic microphone setups resulted.

In all of the following illustrations, actors will be depicted by a "V" within a circle, the apex of the letter indicating the speaking direction; microphones by a circle with the protruding arrowhead indicating the direction of maximum pickup and the inscribed letter stating the connected channel as left L, center C, or right R; movement of actors or micro-

*Twentieth Century-Fox Films, Beverly Hills, Calif. A paper presented at the Santa Monica Convention of the Society of Motion Picture Engineers.

indicated. This, obviously, is one of the most difficult types of pickup, as the microphone positions must be carefully chosen, the directivity nulls correctly used and, in particularly bad cases, the relative channel gain adjusted. It is sometimes wisest to abandon sound placement under these conditions and use the condition of Fig. 4, which is an effective means to maintain stereophonic quality without the feature of sound-origin placement. By proper choice of dimensions, unwanted sound placements can be eliminated. Average dimensions might be 5 ft. on each side of the triangle and 3½ ft. on the base.

Manifestly, it is no longer permissible to revert to the demands of early sound motion pictures that actors be fixed at specific positions for the delivery of dialogue. Therefore, motion of microphones is required. Combinations of all of the microphone configuration shown in the preceding figures have been used in many of the scenes recorded. The principal problem is one of smooth transition and proper apparent sources.

Two interesting and useful effects, not possible without stereophonic methods, have been used. The first creates the illusion that an actor is talking and moving within the set, but never being seen, while the camera shows a small portion of the set and another player. This off-stage illusion can be created by sound, unassisted by the visible actor who, without stereophonic sound, must describe the unseen action by following with his eyes. The second is the ability to make sounds from either side apparently very much offstage.

Recording and Reproducing:

The equipment used consisted of three essentially identical recording channels with a common film recording machine, placing three 200-mil push-pull variable-density tracks on a single 35-mm film. The three modulators were arranged in an arc, the two outside optical paths brought parallel with two sides of a front surface prism, and the center path passed through a hole in the same prism. Separate objective lenses were used for each modulator with a single cylindrical lens near the film for all channels. Pre- and post-equalization were utilized.

Monitoring was provided by earphones where each side channel was connected to single reproducers on respective ears and the center channel was split to both ear receivers in such a way as to supply 3 decibels less power to each ear than the corresponding side channel, the total power from the center channel being the same as the side channel outputs. Further, the side-to-side cross-feed was not permitted higher than -25 decibels from the direct source. This means of

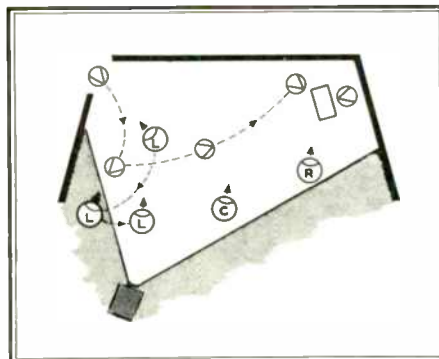

Fig. 1. Microphones must follow action

monitoring was used on all work and found satisfactory.

The film reproducers used a single exciter lamp, a fixed-aperture plate with large radius of curvature over which the film passed to maintain contact for focus, a single objective lens, three engraved slits, and associated photocells arranged in an arc to provide equal optical path length. Filtering was similar in principle to the newer mechanisms

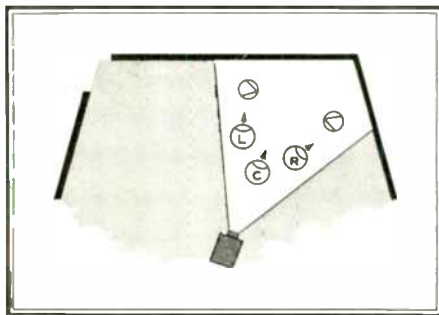

Fig. 2. Setup for actors 6 to 7 ft. apart

now being supplied and essentially equal in effectiveness.

The sound reproducers were two-way systems of good characteristics. One was located at screen center and the other two placed with their axes 2/3 screen width off-center. These dimensions are not inviolate. The best arrangement is determined by existing conditions and desired effect.

Re-Recording Methods:

In connection with one two-reel playlet which is used, it was necessary to add horse-hoof sounds, footsteps, cup crashes,

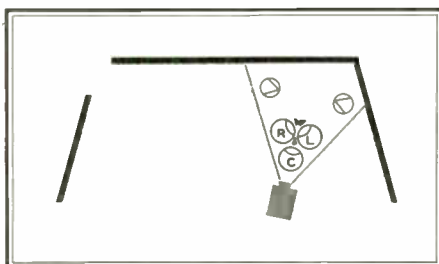

Fig. 3. Arrangement for closer grouping

and shots. All these effects, except the cup crashes, were re-recorded from stock library material. The equipment arrangements are given by Fig. 5. Note that mixers 1 and 2 are conventional 3-channel stereophonic units. Mixer 3 is a special control designed to transfer the single input to any of the three channels or to any two adjacent channels, meanwhile maintaining constant total power. With this control, it is possible to move a single source smoothly back and forth to create any desired illusion.

By the use of the special control, off-stage horses were made to sound as though they approached from a distance to the left and came to a point just off stage. Also, gunshots and footsteps were added and properly placed.

The use of re-recording retained the advantages of level smoothing, and permitted a small amount of placement correction. Dependence cannot be placed on re-recording for changes in placement of original material because placement, except in certain special cases, is not primarily due to intensity differences. This point is developed more fully later.

Music and Vocals:

Large orchestras (90 to 100 pieces) were recorded within a regular scoring stage. It was desired to obtain good separation of instruments. Due to the compactness of the arrangement, unidirectional microphones were again used, placed in a relatively close group. This also helped to minimize troubles from false origins due to room acoustics. A typical setup is shown in Fig. 6.

The recordings obtained from one such session were used for playback and the orchestra photographed in a large set. Various cuts and angles were used, and it was necessary to exercise caution to select angles and musical passages which were compatible. In some instances, minor sacrifices to correct sound placement were made to provide adequate camera freedom.

One vocal number was recorded experimentally at the time a regular production prescore and vocal recording session was in progress. The vocalist was performing in a small vocal booth, with the orchestra in the adjoining scoring stage. A separate microphone was provided for the vocalist and a stereophonic pickup of the orchestra arranged. The vocal and center-channel music microphone outputs were mixed at the time of the performance, thus obtaining a monaural vocal effect always on the center channel, and a stereophonic record of the accompanying orchestra. This track was later used for playback and the actress photographed, but since the vocal existed only on the center track it was necessary to frame the action so that the

performer was nearly always center screen.

It was noted that orchestra levels greater than normal could be used without destroying the effectiveness of the vocal selection. This might be explained as follows: The vocal is always reproduced as a single direct source, and is audibly compared to a stereophonically reproduced accompaniment, thereby increasing the perceptible aural differences and subjectively providing greater separation. No work of this type was done with both sources recorded by stereophonic methods, and until this is done and compared to the method reported here, no final conclusion can be reached.

General Observations:

Since this experiment was an integrated project involving all present motion picture production methods, demanding close correlation between each contributing group, it was possible to evaluate the effect that stereophonic-recording application might have on motion picture production and presentation in general and various phases in particular. Those effects, and other observations based on the work herewith reported and which presently seem of the greatest importance, will now be discussed.

From the microphone-pickup work come three cardinal points: sound placement matching corresponding picture, smooth placement transition of the sound from a moving source, and a third point, not previously mentioned, that to avoid major changes in quality some sound must be picked up in all microphones at all times.

The requirement of correct sound placement is obvious. It has been found that sound-intensity differences do not play the major role in determining placement except under unfavorable acoustic conditions. Those are situations in which high-intensity directive reflections occur and are then picked up by a microphone other than the one closest to the source create the exceptions. Under such circumstances there exists only a small intensity difference between the nearest and other microphones and an otherwise minor change in intensity adjustment can introduce a change in placement. With suitable acoustic conditions, intensity differences due to equipment maladjustment of 6 to 10 decibels do not destroy localization but loudness is of course affected. These observations would indicate that the greater contribution to sound placement is caused by phase differences which are a complex function of acoustics, frequency, and ratio of microphone spacing to frequency.

Smooth sound transition is necessary, otherwise sudden placement jumps occur which are very disturbing to any ob-

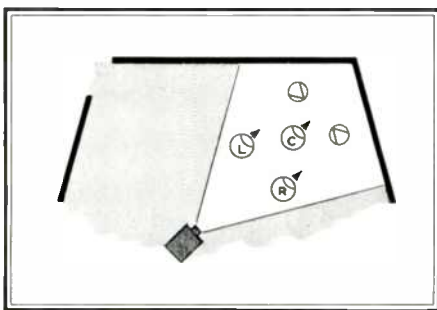

Fig. 4. Alternate setup for close grouping

server after a short acquaintance with stereophonic reproduction.

The third point concerning quality is related to the inherent improvement in stereophonic over monaural methods. It has been demonstrated that a two-channel stereophonic system does not provide the quality improvement afforded by a three-channel arrangement, as might be expected since the former approaches

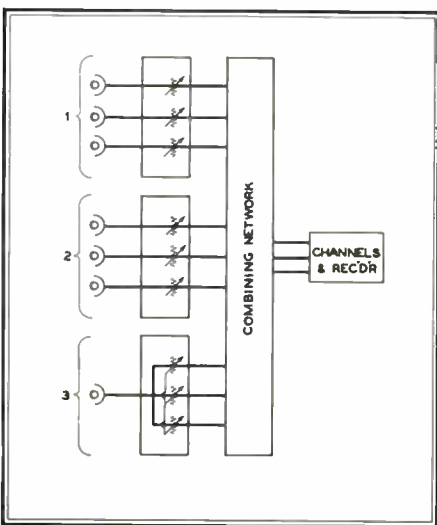

Fig. 5. Equipment used for re-recording has special arrangement for No. 3 mixer

closer to the inferior monaural condition. The quality difference between two- and three-channel systems is such as to establish the foregoing statement concerning pickup in all microphones.

In connection with recording on a production basis two specific items of equipment were greatly needed. The sound

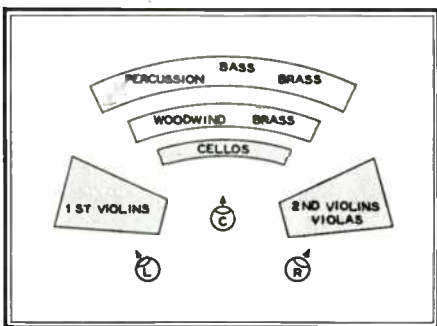

Fig. 6. Setup for an orchestra of 90 to 100 pieces on a regular scoring stage

mixer should have a picture monitor displaying the scene the camera is photographing. This apparatus will shorten rehearsal time and guarantee sound and picture match. Such devices are now available by television technique and are rapidly approaching practicality for motion picture use. Second, a better mechanical device than presently used microphone booms must be devised.

Conclusions:

1. Greatly improved sound quality can be obtained by the use of stereophonic methods. It is easily demonstrable that recordings more nearly reproduce the true conditions in the set when made stereophonically. This is still true when disregarding subjective sound placement.

2. Sound placement is affected only to a small degree by individual system gain differences, indicating that phase and not intensity differences play the major role in determining placement.

3. The three important points of stereophonic pickup are: 1) sound placement matching visible or desired implied action, 2) smooth sound-placement transition, and 3) some pickup in all microphones at all times.

4. Many more illusions can be created by sound alone, opening new dramatic, effective avenues for motion picture story presentation.

5. Just as the directions of visual action must be properly done to permit cutting, so must stereophonic sound directions be considered. Of a similar nature, since it pertains to camera angles and editing, prescoring for playback purposes should be planned to match the intended action and anticipated cutting. There is evidence that present editing practices would need modification.

6. With sufficient experience and certain desirable auxiliary equipment, production cost need not be greatly increased. Two of such auxiliaries are a picture monitor (remote viewfinder) for the sound mixer and more suitable microphone-handling equipment. The degree of perfection desired would be the largest cost factor.

7. Re-recording, technically, is no more difficult than at present but having introduced one additional degree of freedom, more manipulation will be required. Many stock library monaural tracks may be used, provided equipment is available for controlling placement of the desired sound.

As with any other subject of similar complexity, no one experiment answers all the questions. Much work remains to be done. Reproduction in various kinds of auditoriums has only been superficially explored. Some of the questions will only be fully answered by actual production experience.

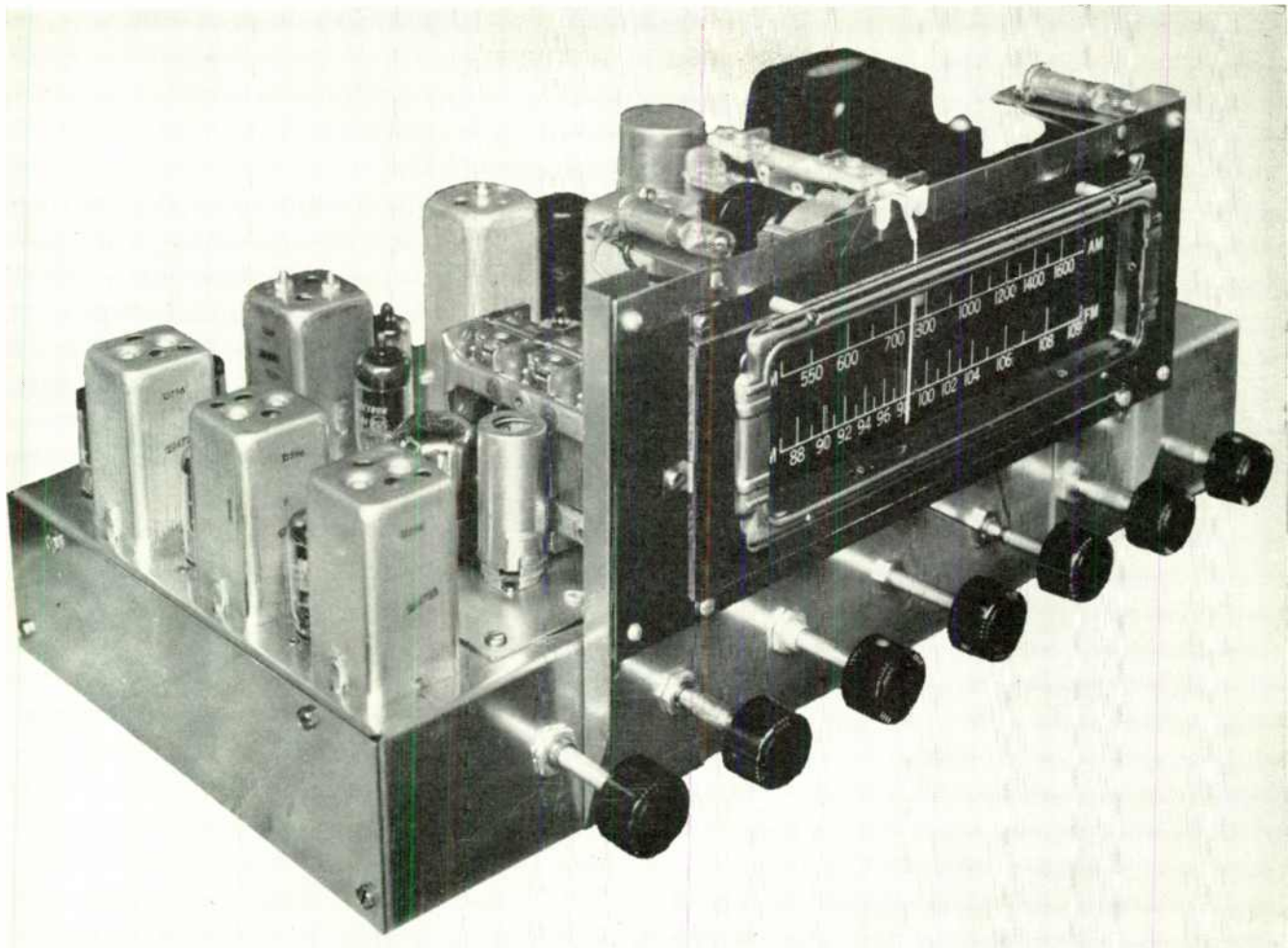

THE GENUINE ARMSTRONG FM CIRCUIT IN THIS RJ-20 FM-AM TUNER GIVES THE FINEST OVERALL PERFORMANCE OF ANY CIRCUIT AVAILABLE TODAY.

THERE ARE UNTAPPED PROFITS IN BROWNING TUNER INSTALLATIONS

Thousands of people are still using prewar AM sets because no enterprising dealer has told them how little it would cost to double their enjoyment of radio programs.

How? Simply by replacing the old chassis with a new BROWNING FM-AM tuner. Many sets have good amplifiers and speakers. Some need new amplifiers, such as the BROWNING all-triode model AA-20. Here are some of the advantages to be gained by modernizing old sets:

1. Improved reception of AM stations
2. Staticless FM reception in the summer
3. Reception of local and national baseball and sports programs which, in many areas, are only broadcast on FM
4. Better reception of network programs on FM than is available on AM
5. Clear, unfading FM quality that is the same day and night, summer and winter

6. Those who have fine radio cabinets need not discard them.

Use the model RJ-20 illustrated, or the compact RJ-12A with its separate power supply, where space is limited.

Don't pass up this untapped source of profit any longer. Write for Data Sheets FM-4. Performance curves will also be sent on request.



IN CANADA, ADDRESS:

MEASUREMENT ENGINEERING, LTD.,
ARNPRIOR, ONT.

EASY-ACTION HEAD FOR TV CAMERAS

If you have wondered why television images sometimes jiggle in an unaccountable way when the camera is being panned to follow the action in a baseball game, or the actors in a play, the reason probably lies in the construction of the head that holds the camera.

In contrast to the relatively lightweight of motion picture types, the TV cameras weigh 60-lbs. or more, and the

head under spring tension to counter-balance the camera. To make it easier to adjust the tilt, the handle can be extended for extra leverage, and the angle can be set and locked according to the height of the operator. The adjustment is at the left of the plate.

The most serious trouble with conventional heads has been with the panning. In this new head, smoothness of motion

even before entering the selective amplifiers. Within the selective amplifiers, separation of the relay tones is complete, and the sharpness of each filter is adequate. Control action is positive as the sequence feature is mechanical, one circuit closing on the first impulse, the second circuit closing on the next pulse, recycling in this order.

Mechanical Design:

All three types of tuners are rack mounted, and have engraved panels finished in black leatherette. The front panel of the RP-23 is quite plain, having only the on-off switch, volume control, and pilot lamp. The RP-24 single-function unit has level controls for both high and low output presetting, and a manual selector for establishing the proper operation sequence. The RP-25 dual-function unit has a second pushbutton selector for manually cycling the audio on-off feature as well as the level selection.

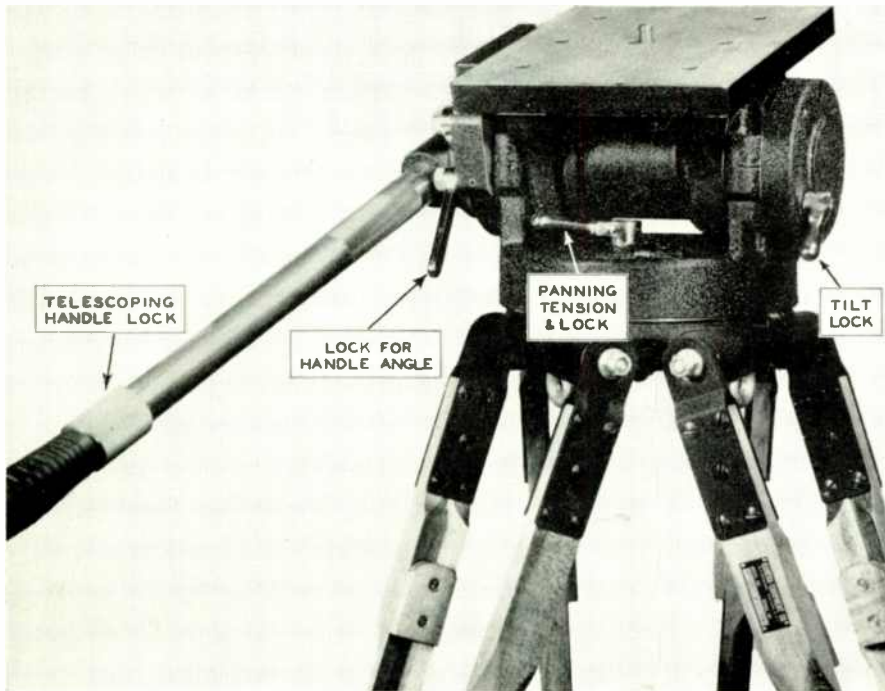

This head is designed for smooth action under the weight of a television camera

conventional heads just aren't built for such a load.

Accordingly, Camera Equipment Company has designed a completely new type of head, in order to provide smooth action for moving the extra weight of a television camera. This is shown in the accompanying illustration.

The mounting plate is not only carried on ball bearings, but the tilt is maintain-

ed with ball bearings and an adjustable tension which slows down the panning to any degree required, but still maintains a perfectly even action.

Both sets of ball bearings are dust-proof, and lubrication applied at the factory is adequate for a long period. Any of the standard tripods or the pedestals and dollies now in use at TV stations will take this head without modification.

TV OBSOLESCENCE

(Continued from page 22)

the present technical and economic situation is such that television will not start to use the higher band until there is a UHF system of such superior performance as to make VHF service obsolete by comparison. That achievement may be in the form of sharper detail for black-and-white images for both homes and theatres, or color reception, or cheaper sets and more simple antennas.

Until that time, UHF cannot compete commercially with current VHF equipment and the existing setup for broadcasting. Right now there's a major job

to be done to improve VHF television, to establish it as a success economically, and to expand the service to the limit of the 12 channels now in use.

Any plan for UHF television development must give consideration to the factors of scientific progress, government regulation, and economics. Thinking that does not comprehend all three may lead to erroneous conclusions.

FM TUNERS

(Continued from page 17)

for control operation are taken from a point in the circuit before de-emphasis. This results in some increase in these signals relative to ordinary modulation,

FM FOR BUSES

(Continued from page 15)

practical and reasonable solution to the problem. In buses, the mounting space is very limited, yet it is necessary to obtain complete coverage, with an even distribution of sound. This points rather conclusively to not much more than a 6-in. driver unit. In stores, markets, and other fixed installations, it may be possible to use driver units with relatively good fidelity characteristics, but the cost and desirability of even distribution of the sound without making the listener conscious of the source indicate a driver unit not more than about 8 ins. in diameter, while 6-in. units have proved very satisfactory when bass and treble are properly adjusted.

It is desirable, of course, to mount bus speakers flush. Flush mounting in the headlining of the bus provides an infinite baffle, and only a trimming face plate is necessary in place of a complete loud-speaker enclosure. If the space between the headlining and the roof is used for ventilation, as is largely the case, then the cone of the driver is exposed to dust, dirt, and wide humidity changes. One manufacturer has cleverly protected the cone by a Latex cover such as used by the Armed Services. A properly designed metal enclosure with 60-in. driver seems to be the best general solution, however, for it is small enough to satisfy the space restrictions and sturdy enough to resist tampering. This same unit has worked out very satisfactorily with ceiling projection in market installations. One secret of its success is in the use of a large number of units. It is believed that the more this general idea is carried out in trains, buses, stores, and markets, the

(Continued on page 34)



THE RECEIVING TUBES
YOU WANT WITH THE

*Quality
you expect!*

Whether your manufacturing or replacement requirements call for Lock-Ins, miniatures, sub-miniatures or standard glass radio receiving tubes, you can count on the Sylvania line for lastingly high-quality performance.

Sylvania Tubes are selected by leading makers of AM, FM and TV receivers . . . preferred by servicemen . . . enthusiastically endorsed by set-owners. See your Sylvania Distributor, or write Radio Tube Division, Emporium, Pa.

**SYLVANIA
ELECTRIC**

RADIO TUBES; CATHODE RAY TUBES; ELECTRONIC DEVICES; FLUORESCENT LAMPS, FIXTURES, WIRING DEVICES; ELECTRIC LIGHT BULBS; PHOTOLAMPS



FM FOR BUSES

(continued from page 32)

more satisfactory the overall results will be.

The number of speakers required in a bus may vary between 5 and 14. If it is a new bus with a low interior noise level, 5 speakers may be used in a small bus and 8 speakers in a large bus.

It seems better, however, to use a minimum of 8 to 14 speakers. Regardless of whether the speakers are placed along the center panel or the side panels of the headlining, they should be staggered so that two speakers are not directly opposite each other.

In stores and markets, ceiling projection is preferred over side-wall or corner mounting, with the speaker directly over the aisles rather than over the counters. Care must be taken that the sound coverage is not too heavy where conversation between customer and clerk is necessary, as at the cash register and meat counters.

In providing 8 watts output from the receiver, no auxiliary amplifiers are necessary to take care of the majority of installations. Not much less power can be tolerated, however. Above all, distortion must be negligible. Where a single

Economy vs. Profits:

There are those who argue the adequacy of a somewhat less costly receiver, which means a receiver made up of less stable and dependable components. However, any company attempting to use less than the best equipment will very quickly court financial disaster, due to high maintenance and service costs, to say nothing of loss of customer confidence through frequent equipment outage. It is of paramount importance to maintain continuity of operation, and keep maintenance at a very minimum. Then, with very low operating costs, the capital investment will yield substantial earning.

FM AND TV ANTENNAS

(Continued from page 24)

High-gain receiving antennas must be used in outlying areas where additional signal is required. There are no set rules as to whether or not some specific antenna array will operate satisfactorily in

any area. Transmitter power, receiver sensitivity, channel in use, antenna, gain, height, and propagation characteristics must be considered in an efficient receiving antenna. Usually, trial and error will determine whether or not an array will produce the required signal level.

The compromise antenna, shown in Fig. 4, is easily adapted to a stacked array as in Fig. 11. These arrays will retain the excellent uni-directional, horizontal radiation pattern characteristic of the single antenna. When constructing multiple-bay arrays, a symmetrical feed system will be less frequency-sensitive, and is to be preferred.

In areas of very high signal strength, inside antennas may give satisfactory results, but each installation is an individual problem. Most inside antennas on the market are some form of adjustable or tuned dipole. Tuned loops have not been too successful for they have sharp response curves that cause fuzzy or distorted pictures in most cases. The folded dipole made of twin-lead transmission line is usually the best inside antenna for television receivers. In some cases one antenna may cover several channels, in other cases two separate antennas may be necessary, especially if stations are assigned to both the upper and lower channels. These antennas should be cut for the mid-point of a single channel or group of channels, according to dimensions given in Fig. 10. They may be installed under rugs, on walls, or ceiling. Several different locations should be tried in order to find the one that produces the clearest picture. The antenna should be installed so that movements in the room will have the least effect upon the picture.

BETTER FM PERFORMANCE

(Continued from page 14)

vided to maintain pressure between the drive shaft and the slug springs. The result is a drive of surprising smoothness and accuracy.

Performance of the 7H918:

The combination of mechanical and electrical features represented by the 7H918

gives an FM receiver that is remarkable for its performance as well as its economy. We have been successful in meeting our dual targets of good sensitivity and the low retail price of \$39.95.

A comparison of figures showing the measured sensitivities of the 7H918 and the 7H822 brings out the first of these points. The sensitivity of this receiver is better than 10 microvolts and is more sensitive than any home type of set now available. This set is approximately ten times as sensitive as the average sets now being marketed. Measured performance of the two Zenith models is shown in the table following:

	7H918	7H822
Maximum sensitivity	3	6
Maximum deviation sensitivity	5	30
Quieting sensitivity	9	22

CLASSIFIED ADVERTISEMENTS

Positions Wanted: No charge. Use either your own name and address or FM and TELEVISION box number.

Other Advertisements: 20¢ per word, minimum \$2.00. One-inch advertisements in ruled box, \$10.

Copy received up to the 20th of the month will be published on the 15th of the month following.

Address replies to box numbers: FM and TELEVISION, Savings Bank Building, Great Barrington, Mass.

FOR SALE: Brand new RCA equipment still in original crates. Two turntables, type M1-1871-G 70-C2, price \$550 each. Two monitoring loudspeakers, type LC-1A M1-11401/M1-11411, price \$300 each. Two monitoring amplifiers, type M1-11223-B BA-1C, price \$110 each. Also Boom stand, VC meter panel and tube kits. Address Box 49 FM-TV.

FOR SALE four Presto 6N portable recorders, two Presto 85E recording amplifiers. All in first class condition. FM-TV, Box 46.

WANTED 225-ft. tower to support TV antenna. State manufacturer's price, type, condition. FM-TV, Box 47.

WANTED Guyed tower 100 to 150 ft. to carry communications antenna. Give details of make, type, condition, and original price. FM-TV, Box 43.

WANTED Bound volume containing first 6 issues of FM Magazine, Nov. 1940 to April 1941. Will pay premium. FM-TV, Box 48.

FOR SALE 1-kw. AM daytime station in large southern city. Full details on request. FM-TV, Box 45.

ENGINEER desires position in TV broadcasting station. Can coordinate TV and motion picture activities. 7 years administrative experience, 5 years motion picture engineering, 4 years electronic teaching. Detailed qualifications will be sent FM-TV, Box 42.

CHANNEL NO.	2	3	4	5	6	7	8	9	10	11	12	13
CENTER FREQ. MC.	57	63	69	79	85	177	183	189	195	201	207	213
FOLDED DIPOLE --- INS.	98 1/2	89	81 1/4	71	66	31 1/2	30 1/2	29 1/2	28 3/4	27 7/8	27 1/8	26 1/4
REFLECTOR LENGTH INS.	103 1/2	93 3/4	85 3/4	74 3/4	69 1/2	33 1/4	32 1/8	31 1/8	30 1/4	29 1/4	28 1/2	27 3/4
SPACING INS.	51 3/4	46 7/8	42 7/8	37 3/8	34 3/4	16 5/8	16 1/8	15 5/8	15 1/8	14 5/8	14 1/4	13 7/8

Fig. 10. Dimensions for folded dipole and reflector cut for each television channel

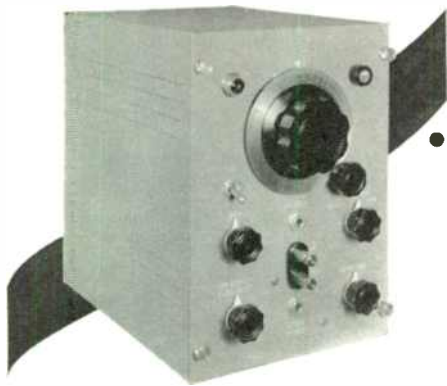

VISALGEN MODEL 205TS

FASTER, MORE ACCURATE VISUAL ALIGNMENT

Use the HARVEY Visual Alignment Signal Generator for IF and RF circuits in FM and AM mobile and broadcast receivers. With any oscilloscope, the HARVEY Visalgen shows overall frequency response on the screen. Speeds factory production tests, service work, and keeps mobile communications equipment at peak efficiency. *Write for Bulletin 53.*

HARVEY RADIO LABS., INC.
449 Concord Ave., Cambridge 38, Mass.

DIRECTORY OF COMMUNICATIONS SYSTEMS

Copies of **FM-TV** for January, 1949, containing the directory of radio systems operated by taxis, public utilities, and special services are still available.

This issue also contains the complete specifications of all makes of communications equipment.

PRICE 25c

FM-TV MAGAZINE
Great Barrington, Mass.

Advertisers' Index

Alair, George P.....	11
Alden Products Company.....	35
Alford, Andrew.....	10
Altec Lansing Corp.....	6
Amy, Aeeves & King, Co. Inc.....	10
Barone, S. A. Company.....	11
Bell Telephone Labs.....	1, 12
Boonton Radio Corp.....	6
Browning Laboratories, Inc.....	31
Camera Equipment Co.....	7
Collins Audio Products.....	9
Commercial Radio Equip. Co.....	11
Communications Research Corp.....	11
Daven Co., The.....	3
Davis, George C.....	11
Eitel-McCullough, Inc.....	36
Electrical Reactance Corp.....	Inside Back Cover
General Radio Co.....	5
Graybar Electric Co.....	1, 12
Harvey Radio Labs., Inc.....	35
Hewlett-Packard Co.....	Inside Front Cover
Hughey & Phillips Co.....	9
Jansky & Bailey.....	10
Kay Electric Co.....	9
Kear and Kennedy.....	11
Link Radio Corp.....	8
May, Russell P.....	10
McCahren, Winfield Scott.....	11
Melutosh, Frank H.....	11
McKey, Dixie B. & Assoc.....	10
McNary and Wrathall.....	11
National Co.....	4
North American Philips Co., Inc	Back Cover
Pollaek, Dale.....	10
Radio Consultants, Inc.....	10
Radio Corp. of America.....	18, 19
Radio Music Corp.....	9
Rangertone, Inc.....	9
Ray, Garo W.....	10
Sieck, Lewis W.....	35
Smeby, Lynne C.....	10
Sylvania Electric Pdts., Ins.....	33
Topflight Tape Co.....	9
Weldon & Carr.....	11
Western Electric Co.....	1, 12
Williams, Nathan.....	10
Wilnotte, Raymond M.....	10
Workshop Associates, Inc.....	11
Zenith Radio Corp.....	2

It's Alden — for . . . facsimile dispatching equipment

designed for your specific purposes. It may be for wire or for radio circuit. A pilot operation — or in quantity production

Our engineering provides for messages to be automatically picked up at scanner with recorder starting, stopping, and framing automatically, controlled by transmitter.

Alden Engineering experience covers the range of operations from low speed for narrow bandwidth wire lines to high speed large area equipment.

So whether you are dispatching a *memo* from office to office — or a *full size weather map* across the country — Alden has the system and will make to special order equipment that fits your needs. **For instance—**

200 cycle bandwidth	15KC bandwidth
Memo	Newspaper
with 4" width—50 LPI	with 18" width—100 LPI
2 in/min.	9 in/min.



Alden engineering opens new fields in impulse recording

Filling the gap between indicating instruments and the Cathode Ray Oscilloscope.

Giving a permanent record directly without photographic processes.

Alden Recording Equipment operates with Alfax Electrosensitive Recording Paper producing permanent recordings. Alfax is a sensitive high speed paper that does not require special packaging. It is stable in storage, and is permanent in its recording.

To solve that facsimile or impulse recording problem — write now to

ALDEN PRODUCTS CO.
Brockton 64FD, Massachusetts

Available Immediately

PACKED FOR SHIPMENT

**BRAND-NEW
ONE IDECO**

**SELF-SUPPORTING
300 FOOT**

**TRIANGULAR
STEEL TOWER**

**DESIGNED FOR
FM and/or TV**

Antenna Pole

F. O. B. Bridgeport, Conn.

Price \$9,500.00

Includes Top Beacon, all obstruction lights, and all required paint. For details, write

LEWIS W. SIECK
1063 N. Montana St.
Arlington, Va.

Follow the Leaders to

Eimac
TUBES
The Power for R-F

Imagination . . .

HELPS BUILD BETTER VACUUM TUBES



Though it would seem a strange place to look for a precious stone, each Eimac 3X2500A3 triode, and modifications of this tube type, contains three sapphires . . . making this Eimac triode a better vacuum tube . . . better able to do a superior job in communication, research, and industrial applications.

It became evident in the early stages of 3X2500A3 development that the structure which provided filament tension posed a problem. The source of tension was easy . . . by using a conventional pusher-spring at the cool end of the center-rod, transferring the pressure to the top of the rod, and then out to the filaments.

But . . . somewhere in the structure, between the filaments and the center-rod there must be a non-conducting material with the ability to remain inert under high temperatures (1500 degrees to 1600 degrees C). It must be unaffected by electron bombardment and it must be physically strong.

The imaginative foresight of Eimac engineers, after exhausting the possible use of conventional materials, brought synthetic jewels under consideration . . . the rest of the story is vacuum tube history.

As in the past, when better vacuum tubes are made they will first bear the trademark "Eimac" . . . the result of engineering foresight . . . skill . . . imagination . . . and research.

E I T E L - M c C U L L O U G H I N C.,

728 San Mateo Ave., San Bruno, California

Export Agents: Frazar & Hansen, 301 Clay St., San Francisco, California

Hi-Q COMPONENTS

Specified by FRANKLIN  CORPORATION

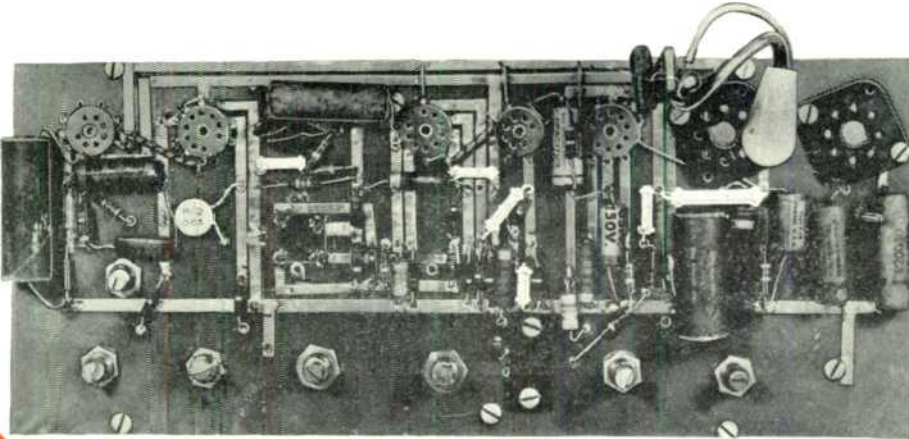

FRANKLIN AIRLOOP'S COMPLETE DEFLECTION CIRCUIT

● The great demand for lower cost television receivers is one of the big problems confronting engineers today.

Die stamped inductances as developed by the Franklin Airloop Corporation are a partial answer to reduced manufacturing costs. Truly a precision operation, its successful performance is dependent upon precision components.

Hi-Q components — noted for their *precision* — *dependability* — *uniformity* and *miniaturization* contribute their part, not alone to Franklin, but to all manufacturers whose standards demand these 4 Hi-Q features.

Our engineering department is available for consultation with your engineering staff in the design of new circuits and the application of Hi-Q components to them. Why not write us today?



The Hi-Q Disc Capacitor used in the above deflection circuit is a high dielectric capacitor designed for application where physical shape is more adaptable than tubular units. Close connections are easily made, reducing inductance to a minimum.

Hi-Q COMPONENTS
BETTER 4 WAYS

- PRECISION** Tested step by step from raw material to finished product. Accuracy guaranteed to your specified tolerance.
- UNIFORMITY** Constancy of quality is maintained over entire production through continuous manufacturing controls.
- DEPENDABILITY** Interpret this factor in terms of your customers' satisfaction . . . Year after year of trouble-free performance. Our Hi-Q makes your product better.
- MINIATURIZATION** The smallest **BIG VALUE** components in the business make possible space saving factors which reduce your production costs . . . increase your profits.

Hi-Q *Electrical Reactance Corp.*
FRANKLINVILLE, N. Y.

Plants: FRANKLINVILLE, N. Y. — JESSUP, PA. — MYRTLE BEACH, S. C.
Sales Offices: NEW YORK, PHILADELPHIA, DETROIT, CHICAGO, LOS ANGELES

Norelco PROTELGRAM

LIFE-SIZE
MORE
LIFE-LIKE
Television!

... from this 2½" tube



Chosen by these famous makers of quality projection TV receivers

**ANSLEY • EMERSON
FADA • FISHER
PILOT • SCOTT
STEWART WARNER
INTERNATIONAL
TELEVISION
BRUNSWICK**

and others soon to be announced

PROTELGRAM is the result of nearly fifteen years of research by the world's greatest electronics laboratories. This scientifically designed, optically correct projection system makes possible, for the first time, a life-size distortion-free picture of nearly 200 square inches (20" diagonal) ... a more life-like picture without glare or eyestrain. And from a tiny long-life, low-cost picture tube!

PROTELGRAM is the answer to the public demand for a bigger, clearer picture that is easier on the eyes. It produces a better than 16" x 12" non-reflecting picture that fills a flat screen *all the way to the corners*, and permits wide angle visibility, fatigueless viewing from 5 feet or 50! Small size and light weight make possible compact consumer units. Write to Dept. PC-4, North American Philips Company, Incorporated, 100 East 42nd Street, New York 17, New York.



PROTELGRAM

for
life-size,
more
life-like
television



An Exclusive Development of

NORTH AMERICAN PHILIPS