

Price 25 Cents

Mar. '49

FMA-TV

★ Edited by ★
Milton B. Sleeper

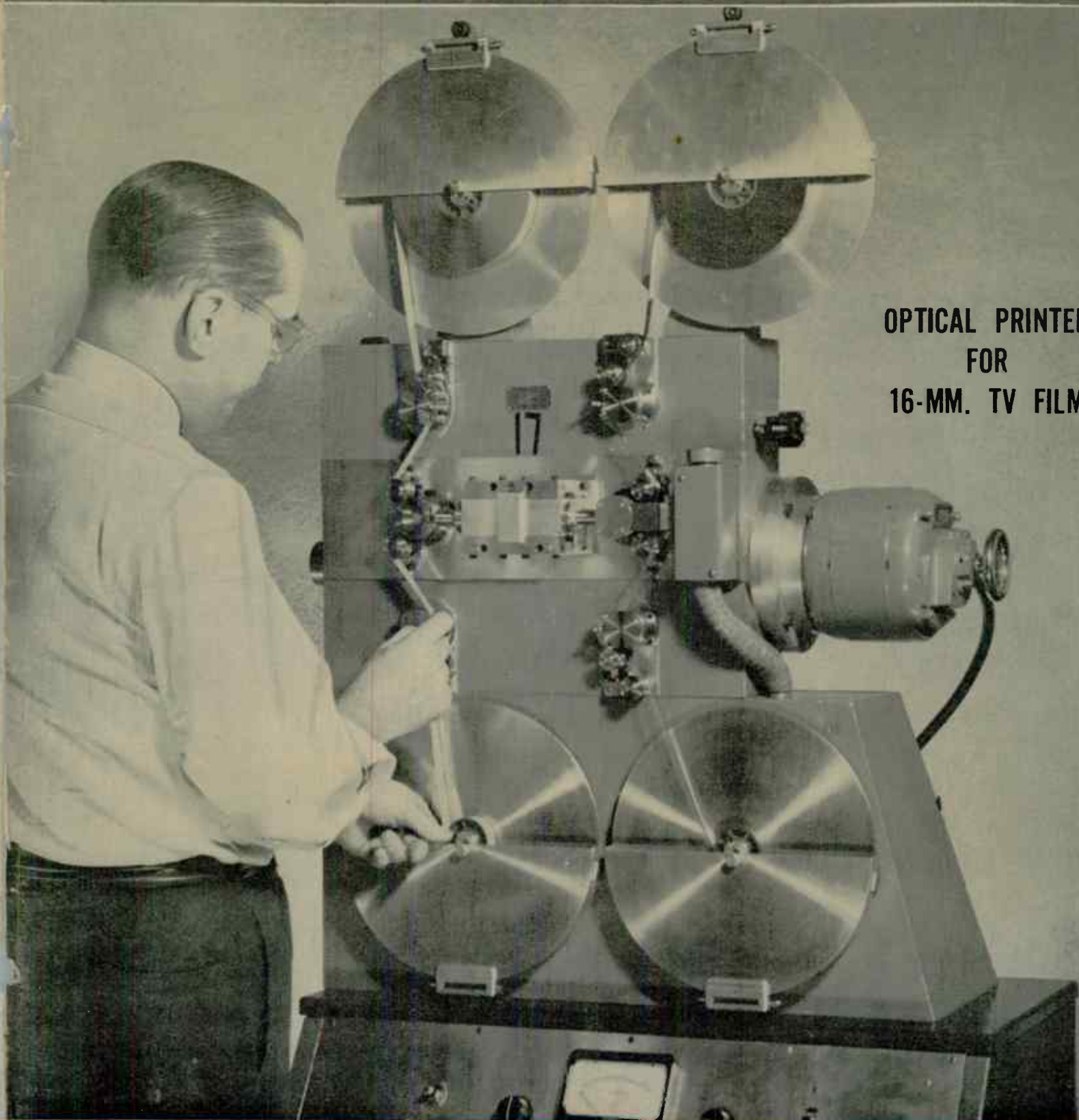

**OPTICAL PRINTER
FOR
16-MM. TV FILM**

9th Year of Service to Management and Engineering

World Radio History



SETS A NEW PERFORMANCE STANDARD!

YOU GET ALL THESE FEATURES
IN THIS NEW HIGH FIDELITY
SIGNAL GENERATOR



Voltage accurate within 0.2 db
Distortion less than 0.1 %
Continuously variable a-f voltage
Frequency range 20 cps to 20 kc
High stability of frequency

-hp- 206A Audio Signal Generator

For the first time all the features listed above are combined in one precision instrument, to give you signals of utmost purity and accuracy for high fidelity measuring work.

In addition, the new -hp- 206A Generator includes low-temperature coefficient frequency determining ele-

ments for high stability and unvarying accuracy over long periods of time. A precision attenuator varies output signal level in 0.1 decibel steps throughout 111 decibels.

quality audio circuits, the -hp- 206A is ideal for FM transmitter maintenance, studio amplifier and console testing, a source for bridge measurements, a-f voltage or transmission measurements; and for other applications requiring a very low distortion signal of known amplitude.

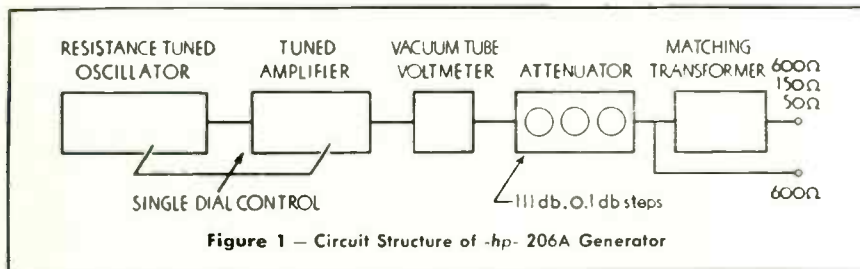

Figure 1 - Circuit Structure of -hp- 206A Generator

ments for high stability and unvarying accuracy over long periods of time. A precision attenuator varies output signal level in 0.1 decibel steps throughout 111 decibels.

Resistance-tuned Oscillator

The resistance-tuned oscillator is followed by an automatically tracked amplifier whose high selectivity reduces oscillator harmonics. Following the 111 db attenuator is a transformer which can be matched to loads of 50, 150 and 600 ohms. A 600 ohm single-ended output is also provided (Fig. 1).

Specially designed for testing high

Full details available on request

HEWLETT-PACKARD CO.

1640F Page Mill Road, Palo Alto, California
Export Agents: Frazer & Hansen, Ltd.
301 Clay Street • San Francisco, Calif., U. S. A.

SPECIFICATIONS

- FREQUENCY RANGE: 20 cps to 20 kc, 3 bands.
- CALIBRATION: Direct in cps on lowest band.
- STABILITY: Better than 2%. Low temperature coefficient frequency network.
- OUTPUT: +15 dbm into 50, 150, 600 ohms. Approx. 10 v into open circuit.
- OUTPUT IMPEDANCE: 50, 150, 600 ohms balanced. 600 ohms single ended. Matched internal impedances.
- FREQUENCY RESPONSE: Within 0.2 db, 30 cps to 15 kc, beyond meter, at all levels.
- DISTORTION: Less than 0.1% above 50 cps. Less than 0.25% below 50 cps.
- HUM LEVEL: 70 db below output signal, or 100 db below zero level.
- OUTPUT METER: Reads in dbm or volts.
- ATTENUATORS: 1:1 db in 0.1 db steps. Accuracy approximately 0.1 db.



- Power Supplies
- Frequency Standards
- Amplifiers
- Electronic Tachometers
- Frequency Meters
- UHF Signal Generators
- Square Wave Generators
- Audio Frequency Oscillators
- Attenuators
- Audio Signal Generators
- Noise and Distortion Analyzers
- Wave Analyzers
- Vacuum Tube Voltmeters

**Reduced studio operating budgets
...expanded program facilities...
with the DU MONT MONOCHROME
SCANNER Model TA-150-A...**

the magic lantern
of TELECASTING!

$$SD+QW = \frac{D}{FWFT}$$

(Simple Translation)

**SUPERIOR DESIGN plus
QUALITY WORKMANSHIP equals
DU MONT**

First With the Finest in Television



► Precisely, this latest Du Mont development, the Monochrome Scanner Model TA-150-A, is virtually "The Magic Lantern of Telecasting." It handles test patterns, commercials, station identification, still photographs, cartoons, graphs—any and all non-animated subjects in the only logical and really economical manner.

When driven from a sync generator such as the Du Mont Model TA-107-B, this unit develops an RMA standard composite signal from standard 2 x 2" glass slides. Still-image pickups become a simple, economical, one-man job. The need for costly film trailers and the operation of movie projectors for short bits, are minimized. The Monochrome Scanner soon pays for itself. Definitely, here's a "must" in the money-making telecast setup.

► **Early delivery predicated on previous orders**

DU MONT MONOCHROME SCANNER Model TA-150-A

A short-persistence Du Mont 10" C-R tube produces a light beam focused by a projection lens on to the glass slide. A condenser lens focuses that light beam after passing through the slide, on to a multiplier-type photo-electric cell. The signal voltage developed is amplified and mixed with blanking and sync pulses, resulting in the RMA standard composite picture signal.

An automatic slide changer handles up to 25 positive or negative 2 x 2" glass slides, operated from local or remote position. The equipment houses the C-R tube and necessary circuits for producing a bright, sharply focused raster on

the tube screen. The raster is kept in constant focus by the focus-stabilizer circuit. Sweep-failure protection is provided by automatically cutting off the high voltage to the tube. The raster is developed by sweep circuits driven by horizontal and vertical pulses.

A switch inserts sync if a composite signal is required, or leaves out the sync if only a video and blanking signal is required for video mixing purposes. Controls to set sync and blanking levels are provided. The control panel carries all necessary switches, fuses and fuse indicators. A fadeout switch sets the fading of the sig-

↑ UNIT CLOSED ↑ SAME UNIT OPEN

nal to black level when slides are changed for slow, medium or fast rate of change.

The unit is complete with its own high and low voltage power supplies. Operates on 115 v. 60 cycles. Approx. 8.0 amps.

Mounted in standard rack measuring 83½" h. x 22" w. x 18" deep.

© ALLEN B. DU MONT LABORATORIES, INC.

DU MONT

First with the Finest in Television

ALLEN B. DU MONT LABORATORIES, INC.
AND STATION WABD, 515 MADISON AVE.,
PLACE, NEW YORK 3, N. Y.

• TELEVISION EQUIPMENT DIVISION, 42 HARDING AVE., CLIFTON, N. J.
• DUMONT'S JOHN WANAMAKER TELEVISION STUDIOS, WANAMAKER
STATION WTTG, WASHINGTON, D. C.

• DU MONT NETWORK
HOME OFFICES AND PLANTS, PASSAIC, N. J.

Television
IS READY FOR
really good
films

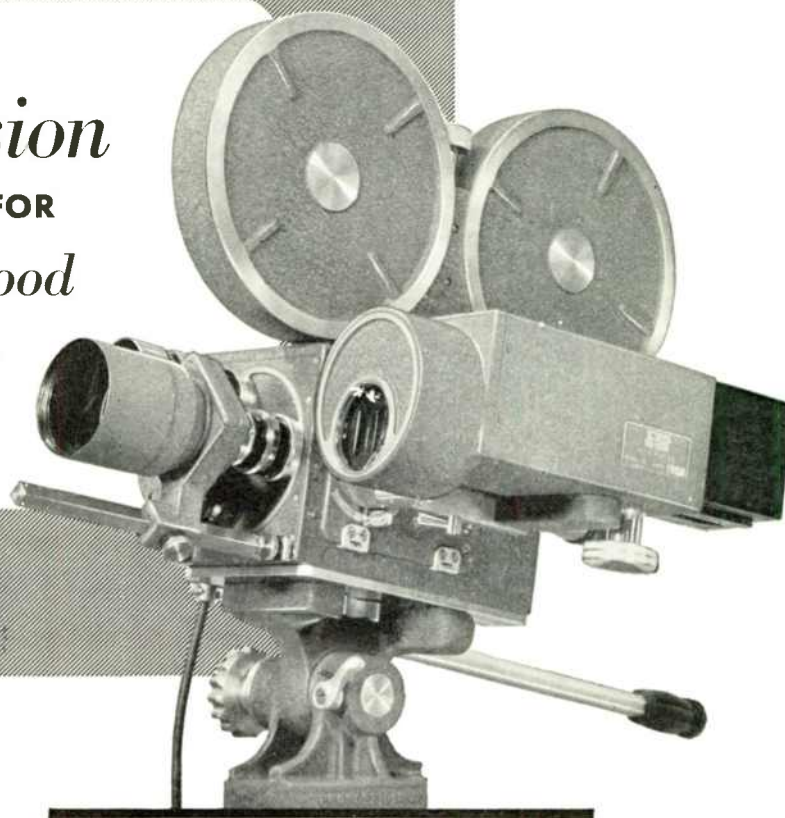

With television maturing so rapidly, it is becoming generally recognized that films cannot just be "adapted," but should be made specifically for television release — and of the finest quality consistent with allowable costs.

The producer, with a restricted budget, can meet both requirements most easily with Maurer equipment.

A copy of the new catalogue of Maurer post-war equipment will be mailed on request.

Maurer 16-mm Professional Motion Picture Camera — unapproached in the 16-mm field for accuracy — for versatility.

Maurer 16-mm Film Phonograph — a high-fidelity reproducer for re-recording, that provides a flat characteristic ± 1 db to 10,000 cps.

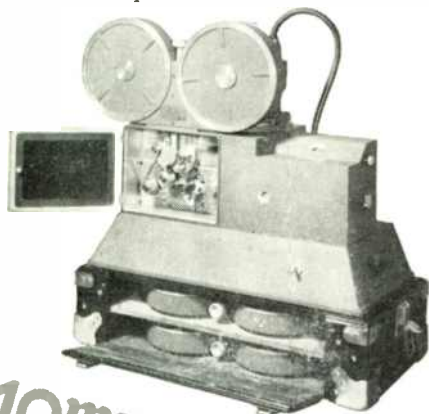

Maurer 16-mm Recorder provides sound tracks of the highest quality and fidelity, covering the full frequency range that standard projectors and television receivers are equipped to reproduce. A flat frequency range of 30 to 10,000 cycles is available.



16mm
maurer

J. A. MAURER, INC.

37-07 31st Street, Long Island City 1, N. Y.

Professional Motion Picture Cameras and Recording Equipment for the Production of Industrial, Educational and Training Films

FM AND TELEVISION



Formerly, FM MAGAZINE and FM RADIO-ELECTRONICS

VOL. 9

March, 1949

NO. 3

COPYRIGHT 1949, by Milton B. Sleeper

CONTENTS

INDUSTRY NEWS

TV-FM-AM Set Production Compiled from figures released by the RMA	4
What's New This Month	
1. New series of FM sets	
2. What's wrong with the radio industry	10
New Catalogs & Design Data Review of new products and equipment	9

FM BUSINESS

FM for Buses, Part 1 D. G. Beachler	15
VHF & UHF Amplifier D. L. Balthis	16

TV BUSINESS

Mobile Studio for WDTV Willis I. McCord	20
TV Station Monitor C. A. Cady	22
Low-Cost TV Operation Garo W. Ray	24

AUDIO SECTION

Audio Developments Lawrence Olds	28
Optical Sound-Track Printer J. A. Maurer	29
Multiple Tape Recorder	30

SPECIAL DEPARTMENTS

Television News	8
Special Services Directory	11
Professional Directory	12
Spot News Notes	18
News Picture	19
Classified Advertising	38

THE COVER DESIGN AND CONTENTS OF FM AND TELEVISION MAGAZINE ARE FULLY PROTECTED BY U. S. COPYRIGHTS, AND MUST NOT BE REPRODUCED IN ANY MANNER OR IN ANY FORM WITHOUT WRITTEN PERMISSION

MILTON B. SLEEPER, Editor and Publisher

CHARLES FOWLER, *Business Manager*
LILLIAN BENDROSS, *Circulation Manager*
Published by: FM COMPANY

Publication Office: 264 Main St., Gt. Barrington, Mass. Tel. Gt. Barrington 500
FM Magazine is issued on the 20th of each month.
Single copies 25c — Yearly subscription in the U. S. A. \$3.00; foreign \$4.00.

Contributions will be neither acknowledged nor returned unless accompanied by adequate postage, packing, and directions, nor will FM Magazine be responsible for their safe handling in its office or in transit.

Entered as second-class matter August 22, 1945, at the Post Office, Great Barrington, Mass., under the Act of March 3, 1879. Additional entry at the Post Office, Boston, Mass. Printed in the U. S. A.

MEMBER,
AUDIT
BUREAU OF
CIRCULATIONS



World Radio History

Announcing our new...

25-50 Megacycle FM 2-Way Radio Communication Systems

RAYTHEON

RADIOPHONE



(above)
VS 50-1—50 watt
Fixed Station. Oper-
ates on 117v 60 cycles
A. C. (25-50 mega-
cycles). Remote control
optional.



(below)
VM 30-1 (25-50 mega-
cycles)—30 watt. Compact
Mobile Station.

(not illustrated)
UM 15-1 (152-162 meg-
acycles)—15 watt (local
reception). Compact Ma-
bile Station.

Now Raytheon Radiophone offers dependable 2-way communication systems in both 25-50 megacycle and 152-162 megacycle. Whatever your needs, you can be sure that there is a Raytheon Radiophone to meet your requirements *exactly*—manufactured to Raytheon's high standard of excellence in electronics.

COMPARE RAYTHEON'S ADVANTAGES

NOISE-FREE RECEPTION
COMPACT—OUT OF SIGHT
OUT OF THE WAY
SIMPLIFIED INSTALLATION

COMPARE RAYTHEON'S PERFORMANCE

LOWEST BATTERY DRAIN
LOW MAINTENANCE
LONG LIFE

COMPARE RAYTHEON'S PRICE

LOWEST PRICE IN THE INDUSTRY

BELMONT RADIO CORPORATION

A Subsidiary of Raytheon Manufacturing Company

5939 W. DICKENS AVENUE • CHICAGO 39, ILLINOIS

Mail Coupon for Quotations and Information

Belmont Radio Corporation
5939 W. Dickens Avenue, Chicago 39, Illinois
I'd like to have full information on Raytheon Radiophone—

25-50 megacycle 152-162 megacycle

NAME _____

ORGANIZATION _____

ADDRESS _____

CITY _____ STATE _____



**THE NEW NC-108
FM TUNER-RECEIVER**

Now...National offers an 88-108 Mc. band FM tuner-receiver designed to meet the most exacting demands of high-fidelity enthusiasts! Flat from 50 to 18,000 cps, ± 2 db, the new NC-108 may be connected to your amplifier or the phono input of your radio. Built-in speaker, audio output stage and tone control also permit use as separate monitoring receiver. Built to National's famous standards of quality, the NC-108 is worthy of the finest in amplifiers and speakers. Nine tubes plus rectifier and tuning eye.

\$99.50
Amateur Net

For complete specifications see the National dealer listed in the classified section of your 'phone book, or write direct to



Set Production

THIS month the Production Barometer is set up for 1949, and shows the figures for the first month of this year. We have condensed the blocks for '47 and '48, to keep them for comparison purposes.

A new feature has been added. This is the separate set of blocks showing *average monthly* production of TV, FM, and AM sets. January '49 production is also represented. Now, from month to month, the 1949 blocks will be changed to show the averages for the year to date.

A quick look shows an average gain for TV and FM, and a loss for AM in '48 against '47. It also shows that TV and FM production in January '49 was above the 1948 average, while AM dropped.

To be exact: TV in January was up 68% or 48,998 sets above the '48 average; FM was up 11% or 15,233 sets above the '48 average; while AM was down 55% or 532,318 sets.

Obviously, the AM drop is not just a seasonal matter. As the Barometer shows, January '47 was 10% above the '47 average, and January '48 was 17% above the '48 average. In both annual periods, January was the third highest month. The first month of '49 is a definite indication that the public is losing interest in buying AM receivers.

Looking at the situation from another significant angle, production of FM sets exceeded comparable home broadcast AM models. The total January AM figure of 440,662 sets includes automobile, portable, amateur short-wave, and export types, of which there are no FM counterparts. While the exact figures are not available from RMA, the figure of 125,000 is an accurate estimate of home broadcast AM models. This compares with 147,733 FM sets. Within a few months, FM production will probably be twice that of similar AM receivers.

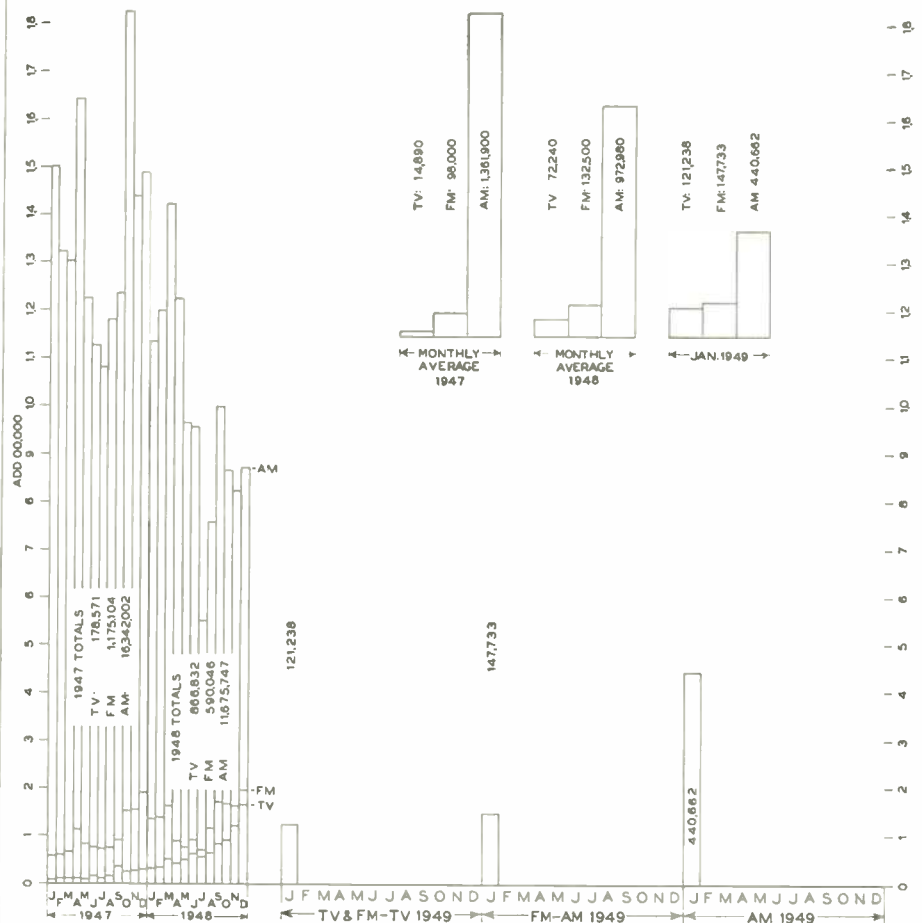

TV, FM, and AM Set Production Barometer, prepared from RMA figures.

AMPHENOL TV ANTENNA

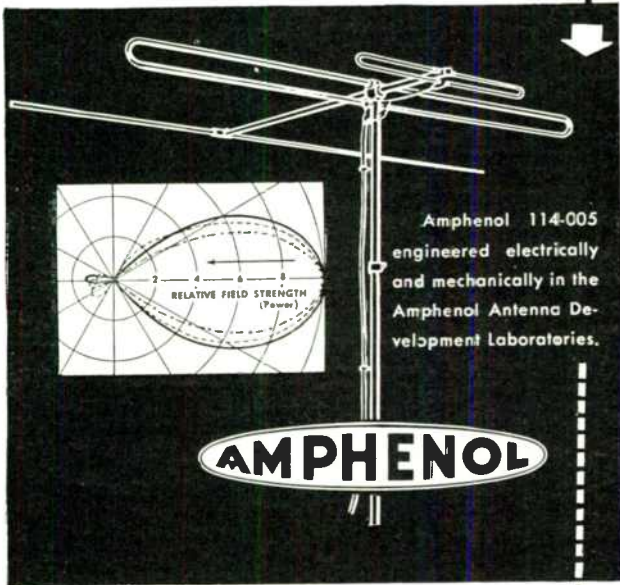

Streamlined and scientifically engineered for best reception and optimum gain, the Amphenol 114-005 Television Antenna incorporates two broadbanded folded dipoles and a low band reflector, with a common transmission line. Top performance is provided over all channels in both the high and low bands.

The radiation patterns as diagrammed are substantially unidirectional and maintain high front-to-back and front-to-side ratios over both bands.

The 114-005 is ideal for use with rotators.



MORE SIGNAL STRENGTH BRIGHTER PICTURES

Standard Amphenol TV Antenna in stacked array (Model 114-301 or 114-302) provides additional high-gain for fringe areas. Each bay of the antenna may also be individually oriented in areas requiring reception from different directions.

Amphenol Engineering News, containing latest developments in electronics, will be sent to you on your request.

AMPHENOL

AMERICAN PHENOLIC CORPORATION
1830 SO. 54TH AVENUE • CHICAGO 50, ILLINOIS

George P. Adair
Radio Engineering Consultants

FM, AM, and TV
Broadcasting

EXecutive 1230

EXecutive 5851

1833 M STREET, N. W.
WASHINGTON 6, D. C.

WJLS-FM

Beckley, W. Va.

WHIS-FM

Bluefield, W. Va.

WMIN-FM

Minneapolis
St. Paul, Minn.

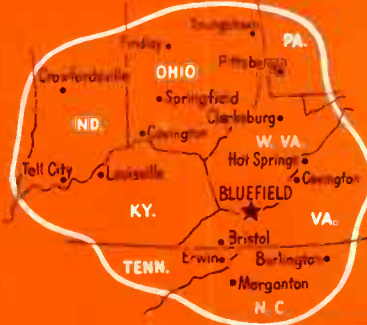
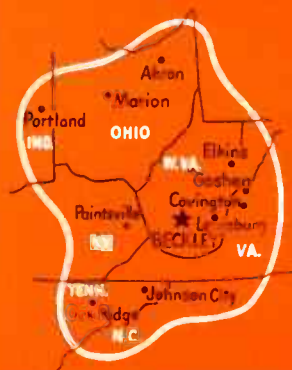
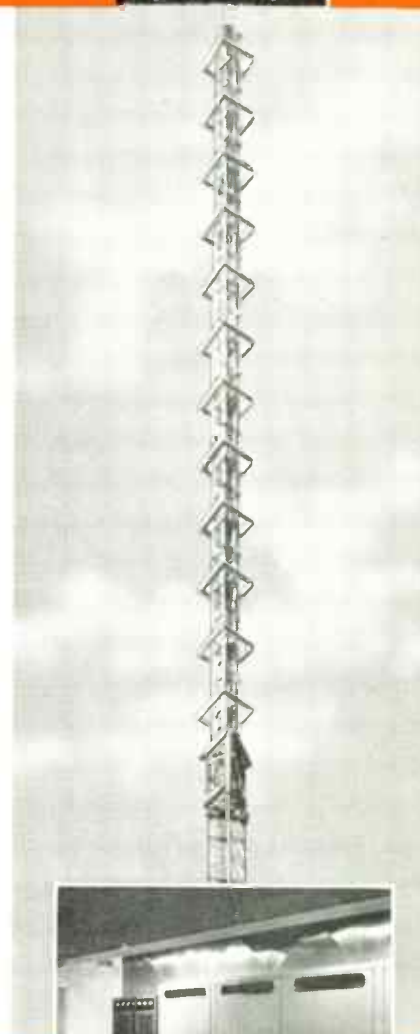
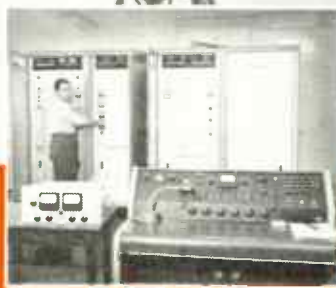
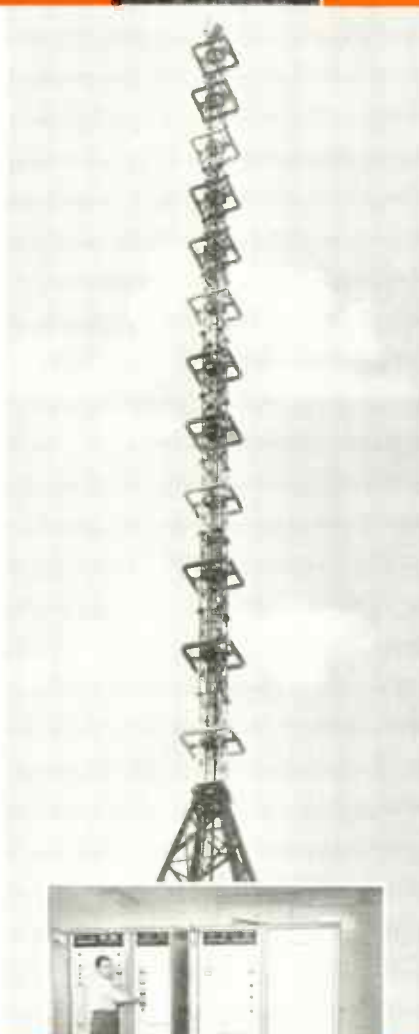
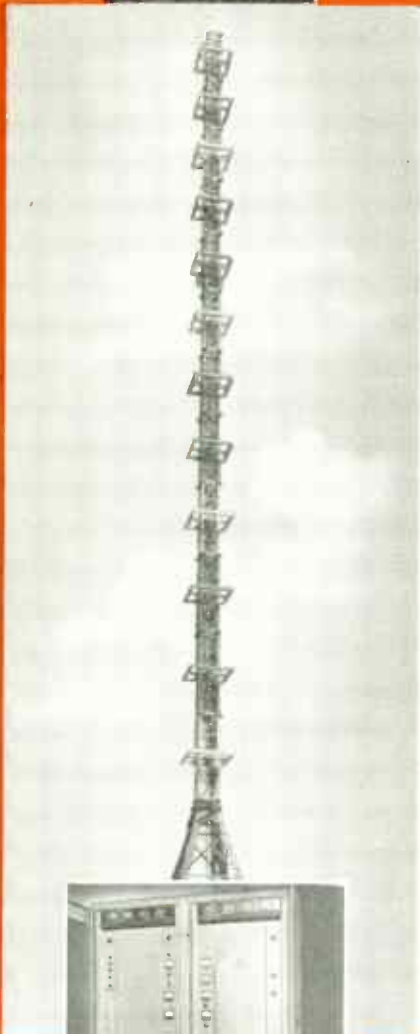

Look to **FEDERAL** for the Finest in
AM, FM and TV Equipment



Federal

KEEPING FEDERAL YEARS AHEAD... is IT&T's world wide research and engineering organization, of which the Federal Telecommunication Laboratories, Nutley, N. J., is a unit

WSAP-FM
Portsmouth, Va.

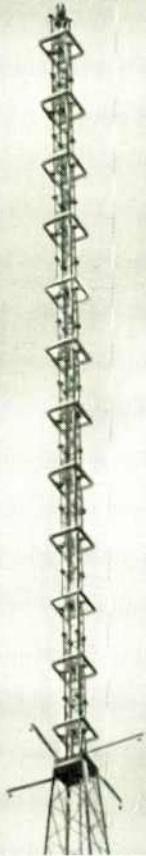

FEDERAL'S

Unbeatable

FM Combination

HIGH-GAIN SQUARE-LOOP ANTENNA

plus

"FREQUEMATIC"* TRANSMITTER

is setting new highs in

*Coverage
AND Performance...*

A Federal Square-Loop Antenna—for maximum coverage—plus a Federal "Frequematic" FM Transmitter—for dependable high fidelity performance—make an unbeatable combination.

It's a combination that is bringing dramatic results to many FM stations. Here are four outstanding examples! All four selected the Federal 12-element Square-Loop Antenna as best suited to their requirements. In all four instances, this antenna is achieving an effective radiated power more than twelve times the kilowatt output of the Federal FM Transmitter.

The coverage maps show how this power takes effect—over unusually large areas—providing outstanding FM performance to wide-spread audiences. Letters from listeners report excellent signal strength . . . fidelity . . . tone quality.

Federal's Square-Loop Antenna is available in multiples of 2, 4, 6, 8 or 12 elements, to meet the requirements of every FM broadcaster. Since it offers *the highest gain in the field*, this Federal antenna saves substantially in over-all station costs, and in reduced power and operating expense year after year. Federal's "Frequematic" FM Transmitter is available in outputs of 1, 3 and 10 kilowatts.

Federal also offers all necessary associated equipment for the complete installation of any size station. For information, write to Department B-920

*Trade Mark

Telephone and Radio Corporation

100 KINGSLAND ROAD, CLIFTON, NEW JERSEY

In Canada: Federal Electric Manufacturing Company, Ltd., Montreal, P. Q.

Export Distributors: International Standard Electric Corp. 67 Broad St., N. Y.



Model 260 in all-bakelite roll top carrying case

There are more
Simpson 260
 high sensitivity
 Volt-Ohm-Milliammeters
 in use today than all others
 combined! Your Parts Jobber
 can tell you why

SIMPSON ELECTRIC COMPANY

5200-5218 W. Kinzie St., Chicago 44, Ill. In Canada: Both-Simpson, Ltd., London, Ont

RANGES at 20,000 ohms per volt DC, 1000 ohms per volt AC

VOLTS: AC & DC—2.5, 10, 50, 250, 1,000, 5,000

DC CURRENT: 10, 100, 500 MA—10 AMP—100 MICRO AMP

OHMS: 0-2,000 (12 center), 0-200,000 (1200 center), 0-20 MEGOHMS (120,000 ohms center)

DECIBELS: (5 ranges) —10 to +52 DB

TELEVISION NEWS

TV Sets in Use:

Here is NBC's estimate of TV set distribution throughout the U. S. A.:

	TV Sta.	TV Sets In Use	Families, 40-Mi. Rad.
New York	6	410,000	3,597,000
Philadelphia	3	102,000	1,181,000
Los Angeles	5	79,600	1,372,000
Chicago	4	52,000	1,438,000
Baltimore	3	35,600	732,000
Boston	2	35,300	1,175,000
Detroit	3	32,000	839,000
Washington D. C. 3	3	30,500	691,000
Cleveland	2	22,300	695,000
New Haven	1	17,200	557,000
St. Louis	1	15,500	471,000
Milwaukee	1	14,200	327,000
Schenectady	1	13,800	258,000
Cincinnati	1	11,800	381,000
Buffalo	1	9,900	323,000
Minn.-St. Paul... 1	1	9,200	333,000
Dallas-Ft. Worth 1	1	6,000	516,000
Richmond	1	5,700	130,000
Toledo	1	5,100	241,000
Atlanta	1	5,000	233,000
San Francisco	1	3,500	825,000
New Orleans	1	3,500	225,000
Louisville	1	3,000	188,000
Houston	1	2,500	217,000
Memphis	1	2,200	177,000
Seattle	1	2,100	307,000
Salt Lake City.... 1	1	1,700	93,000
Syracuse	1	1,000	199,000
Albuquerque	1	300	22,000
29 Cities.....	51	932,500	17,782,000

RMA Television Plan:

Request to FCC to end the television freeze was accompanied by the following RMA recommendations:

1. Where practical without undue interference, extend the use of the 12 VHF channels as soon as possible.
2. Use sufficient UHF channels for black-and-white TV so that cities capable of supporting television but not having VHF channels can have competitive service.
3. Arrange channels for minimum overlap of VHF and UHF coverage.
4. Release promptly an allocation plan for VHF, and permit additional stations to be established without waiting for completion of the UHF allocations plan.
5. Use the same standards for UHF as are now established for VHF.

Joining in this RMA presentation were Dr. W. R. G. Baker, G. E.; H. C. Bonfig. Zenith; Dr. Allen DuMont, DuMont Laboratories; F. M. Folsom, RCA; P. V. Galvin, Motorola; and L. F. Hardy, Philco.

NEW CATALOGS & DESIGN DATA

26-Point Stepping Switch:

High-speed, spring-driven type has 1 to 10 banks, each of 26 contacts. Also available with 52 contacts and maximum of 5 levels. Operates on 48 volts DC. *C. P. Clare & Co., 4719 W. Sunnyside Ave., Chicago 30.*

Disc-Type Condensers:

Flat circular condensers with wire leads are designed to save space in FM and TV sets. Ratings up to .005 mfd. and working voltage of 600 are only 1/2 in. in diameter. *Radio Materials Corp., 1708 Belmont Ave., Chicago 13.*

Broadcast Studio Microphones:

Bulletin F144 describes dynamic microphones rated flat within 2.5 db from 40 to 15,000 cycles. A shock-isolating mounting is supplied with these instruments, and an impedance-selecting switch for 50 or 250 ohms. *Electro-Voice, Inc., Buchanan, Mich.*

Self-Heating Iron:

Soldering iron for making antenna connections and other outdoor work is heated by a small chemical cartridge. Working heat is reached in 5 seconds, and is retained for 6 to 8 minutes. Heat developed is equivalent to 250-watt electric iron. *Keumode Mfg. Co., 161 W. 18th St., New York 11.*

Multiple TV Receiver:

Up to 10 TV viewing units can be operated from one master tuner. System is designed for hotels, where reception is required in public rooms, or in large restaurants, where several units are required. *Belmont Radio Corp., 5939 W. Dickens Ave., Chicago 39.*

Sweep Signal Generator:

Service instrument for FM and TV alignment covers 2 to 240 mc. in 5 continuous bands, with narrow and wide sweep bands of 0 to 1 mc. and 0 to 10 mc. There is also provision for introducing an external sweep frequency. Two crystals provide frequency control. Type E-400. *Precision Apparatus Co., 92-27 Horace Harding Blvd., Elmhurst, N. Y.*

Miniature Lamps:

Sixteen different types for replacements in radio receivers. Packaged 10 lamps to a carton. *RCA Victor Division, Camden, N. J.*

Separable Connectors:

Neoprene connectors are molded integrally with connecting cable to avoid failure at the juncture. In final inspection, wire joints are examined in a fluoroscope machine. Use of Neoprene eliminates breakage or cracking. *Mines Equipment Co., Dept. A29, St. Louis 10, Mo.*

TV Service Mirror:

Portable mirror on adjustable metal stand enables serviceman to view images while making adjustments at the rear of a TV receiver. *Federal Engineering Co., 37 Murray St., New York 7.*

IF Signal Source:

Tunable AC-operated CW signal generator for IF alignment on 19 to 49 mc. Can also be used to produce an adjustable pip on oscilloscope. *Kay Electric Co., Pine Brook, N. J.*

Audio Equipment:

A 16-page catalog is devoted to sound equipment and accessories, including all types of FM-AM receiver chassis, speakers, amplifiers, turntables, tone arms, and recorders. *Terminal Radio Corp., 85 Cortlandt St., New York 7.*

UHF Signal Generator:

Direct-reading type covers 800 to 2,100 mc. RF output of .1 volt to .1 microvolt may be continuous, pulse-modulated, or frequency modulated at power supply frequency. External or internal modulation can be employed. Designed for measuring receiver sensitivity and alignment, signal-to-noise ratio, conversion ratio, standing wave ratio, antenna gain, and transmission-line characteristics. Model 614A. *Hewlett-Packard Co., Palo Alto, Cal.*

Semi-Flexible Coaxial Cable:

Electrical data on 7/8-in. cable is presented in a new bulletin, together with a complete listing of terminals, fittings, mounting brackets, and tools. *Andrew Corporation, 363 E. 75th St., Chicago 19.*

Split Guy Rings:

For clamping on pipe mast, to hold guy wires. This is a much-needed item for FM and TV antenna construction. *LaPointe-Plascomold Corp., Unionville, Conn.*

Yogi Beam TV Antenna:

Booklet describes the principles and construction of Yogi beams now being produced for high-gain, directional reception. *Roger Television, Inc., 86 Walker St., New York 13.*

RF Capacitance Meter:

For rapid testing of condensers up to .0012 mfd. at a frequency of 1 mc. Two ranges of 0 to 80 and 0 to 1,200 mmf. are provided, with a meter to indicate resonance. High-loss condensers can be recognized by low-meter deflection. Type 1612-A. *General Radio Co., Cambridge 39, Mass.*

Mobile Communications Unit:

Single-unit transmitter and receiver for 152 to 162 mc. Output 20 watts on 6.3 volts DC. Frequency stability rated at plus or minus .002% at minus 30° to plus 60°C. Case is 8 ins. high, 8 ins. wide, 26 ins. long. Weight 46 lbs. *General Electric Co., Electronics Park, Syracuse, N. Y.*

Connectors for FM-TV Antennas:

Complete line of silver-plated, solderless coaxial connectors and adapters for receiving antennas using 70-ohm line. *Workshop Associates, Inc., Newton Highlands, Mass.*

Cueing Amplifier:

For transcription turntables, provides a local audio signal for monitoring or cueing. Has push-pull stages and inverse feedback, with response flat to 1 1/2 db from 70 to 15,000 cycles. Transformer input of 10,000 ohms impedance permits grounded or ungrounded bridging across any low-impedance line without reflecting a mismatch. Output 3 watts. *Fairchild Recording Equipment Corp., Whitestone, N. Y.*

TV Receiver Kit:

Construction kits, complete and ready to assemble, for 10-in. and 7-in. receivers. Cabinet and tubes, including picture tube, available separately. *Electro-Technical Industries, 1432 N. Broad St., Philadelphia 21.*

FOUND!

the "MISSING LINK" to
**GOOD TV ANTENNA
INSTALLATIONS**

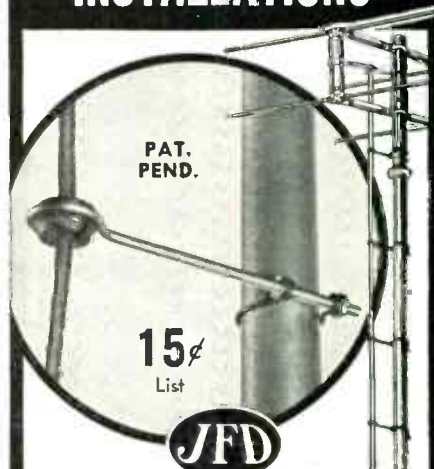

MAST CLAMP LEAD-IN SUPPORTS

Made with **POLYETHYLENE**
(the ultra-low loss insulation material)

Now you can make any old or new TV installation last longer, look neater, perform better with the unique JFD Mast-Clamp Lead-In Supports. These new Screw Eye Insulators are JFD-engineered to anchor lead-ins firmly in place and assure better TV/FM reception.



TL100-350
1" Clamp with 3/2" Screw Eye for Twin Leads.
Standard Ctn. 100 **15c** List



RG100-350
1" Clamp with 3/2" Screw Eye for Coaxial Cable.
Standard Ctn. 100 **15c** List



DTL100-350
1" Clamp with 3/2" Screw Eye for two Twin Leads.
Standard Ctn. 50 **35c** List



DBR18TL3
3/2" Screw Eye with wood-screw thread, for two Twin Leads.
Standard Ctn. 50 **28c** List

Mast Clamps are made in all sizes for all applications, individually designed to fit masts from 1/2" to 2" O.D. Screw Eyes range from 3/2" to 12" in length.

VISIT JFD BOOTH 117 AT
CHICAGO RADIO PARTS SHOW
JFD MANUFACTURING CO. Inc.
61-01 16th Avenue, Bklyn 4, N. Y.

WRITE TODAY
for Valuable 4-page Bulletin #DBR
© Copyright 1949 by JFD Mfg. Co. Inc.

FIRST in Television Antennas and Accessories

All rights reserved. No part of above work may be reproduced in any form except by written permission of the manufacturer.

WINCHARGER
SEC. U.S. PAT. OFF.

ANTENNA TOWERS

1st CHOICE*

* 1st CHOICE of new station applicants.
** 1st CHOICE of station operators.
*** 1st CHOICE of Police, Airlines, Government, and private communications systems.

There is a reason. VHF, FM, and standard AM broadcasters acclaim the structural excellence and all around low cost of Wincharger's performance proven towers. The precision of Wincharger vertical radiator's patterns is testified by the fact that over one hundred and twenty stations are now using Wincharger towers in directional arrays even six element arrays! Higher quality, wider versatility, lower cost have made Wincharger antenna towers America's first choice.

WINCHARGER Corporation
Sioux City 6, Iowa, U.S.A.

THIS MONTH'S COVER

Television is introducing the radio industry to a vast horizon of new techniques, in manufacturing, broadcast transmission, and programming. One much-needed improvement is in the quality of sound on film, with which radio engineers have had little contact in the past. Leading contributor, and logically so, is John Maurer who started in radio, and latter shifted to motion pictures. This month's cover shows the Maurer 16-mm. optical projection film printer, by means of which a great improvement of sound-on-film quality is obtained. Further information will be found on page 29.



WHAT'S NEW THIS MONTH

1. LOW-PRICE FM SETS

2. WHAT'S HAPPENED TO THE RADIO BUSINESS

1. There's heart-warming news this month for FM broadcasters and alert, sales-minded dealers. Zenith Radio has fixed a schedule for introducing three new table models with high-sensitivity, Armstrong FM circuits, to retail at \$39.95, \$49.95, and \$59.95.

We have been asked to withhold the exact figure of sensitivity on these models for the present, but we can say that, backed by the promotion Zenith will give them, two things will happen fast:

First, they will do more to accelerate FM audience growth than anything that's happened since the war.

Second, they will force other set manufacturers to design better FM circuits in sheer self-defense.

Probably it's just as well that the sensitivity figure is being withheld. Most engineers would refuse to believe it, anyway. Besides, what counts is performance, and Mr. and Mrs. Doakes can compare reception quality on FM sets without benefit of ever having met a micro-volt socially.

The timetable for releasing the three new models has been planned as follows:

MARCH 15: FM-AM model 7H921, retailing at \$49.95. This will be a duplicate of the current \$59.95 model 7H822, except that the speaker is a little smaller and the tone control and on-off indicator have been omitted.

APRIL 7: FM-only model 7H918, retailing at \$39.95. The performance of this receiver is such that AM sets aren't going to have much chance to compete against it. The sensitivity and limiting action will bring in clear, static-free reception when the FM sections of many expensive FM-AM consoles now on the market deliver only faint signals through a heavy rush of noise.

APRIL 7: FM-AM model 7H922, retailing at \$59.95. This set will be similar in appearance to the 7H921, but with a tone control, on-off indicator, and carrying handle. FM sensitivity will be the same as the straight FM model, and upwards of three times more sensitive than the current \$59.95 design.

How do we know so much about the performance of these sets? Well, we've been using one of the laboratory models. Here in Great Barrington, although we are not in the primary service area of a single AM station, we can pick up 14 FM stations with full limiting action. That gives us a choice of two stations for each of the four networks, plus the Rural Radio net, and five independent stations. We use a simple FM antenna about 25 ft. above the ground. Probably no antenna would be needed for local stations if we were in a metropolitan area. This raises the very logical question: Why should anyone listen to AM when, at such low cost, he can enjoy the advantages of genuine FM reception?

2. Whatever figures you use to follow the trends of the radio business, it must be apparent that a situation is developing that recalls Lawrence Fly's famous remark about the dead mackerel in the moonlight.

The danger signals are up not only for manufacturers and the retail trade, but for AM broadcasters and time-buyers. And the situation is deteriorating rapidly.

This is no secret. The information is public. It is supplied in the monthly RMA reports, and is presented graphically in the Set Production Barometer on page 4 of each issue of this Magazine. The picture of what is coming is indi-

(Continued on page 11)



for MAXIMUM PERFORMANCE

Jim Lansing Signature Speakers will provide an almost unbelievable realism. The experience gained through a quarter of a century of leadership in the sound reproduction field has gone into their development and design. For maximum dynamic range and frequency response compare Jim Lansing Signature Speakers before you buy.



**MODEL
D-130**

Designed especially for music systems and public address use. Has exceptionally high efficiency. Recommended for operation and frequencies from 60 to 6500 C.P.S. with a maximum useable range of 40 to 15000 C.P.S.



**MODEL
D-1002**

Two-Way System

Designed especially for F.M. Monitoring and high quality home sound reproduction. Housed in a beautiful console type cabinet.

Write for
Descriptive Catalog
Containing Complete
Specifications

SEE YOUR JOBBER
OR SEND DIRECT



**JAMES B. LANSING
SOUND INC.**

7801 HAYVENHURST AVENUE
VAN NUYS, CALIFORNIA

WHAT'S NEW THIS MONTH

(Continued from page 10)

cated by what has been going on since the beginning of 1947.

The disturbing fact disclosed by RMA figures is that, whatever people are spending their money for now, they are not buying AM radio sets. To express this shift numerically: the public bought 6,325,000 fewer AM sets in 1948 than in 1947. Nor was this drop in sales offset by FM and TV, which gained only 845,000 units in '48.

This cannot be passed off as a return to prewar buying levels, for AM sets production took the greatest drop of all in January of this year, registering a new low of 140,662 sets. In the same month of '47, the AM figure was 1,509,000, and 1,173,000 in 1948. The RMA announcement refers to this decline as following the "traditional post-holiday pattern."

That's just whistling in the dark. In '47 and '48, January was the third highest month of the year. If that pattern follows through in 1949, AM sets this year will total less than one-fourth the 1947 figure, or an average of only 370,000 per month.

To broadcasters and time-buyers, this represents a definite shrinkage in the listening audience for, taking 10 years as a generous estimate of the life of a radio set, at least 740,000 AM receivers must be produced each month to replace those going out of service.

Thus the present prospect is that the number of AM sets in use will drop some 4,500,000 this year.

A further examination of the facts make the AM picture still darker. Of the 440,000 AM sets manufactured in January, something less than 125,000 were home models for domestic sales. The rest were automobile, portable, amateur, and export types.

It might be said that FM and AM can be left to settle down in their own way, since the great public interest is in television. There's no doubt that television holds the spotlight, but *interest* isn't a salable commodity for manufacturers or broadcasters. Manufacturers and dealers only sell *sets*, and broadcasters only sell *audiences*. As of January 1, 1949, the Hooper figures gave television 2½% of the present radio audience, and audio broadcasting 97½%. That ratio will change during the next 10 years—no one knows how much. But meanwhile, if the radio industry's dollar volume is to be maintained, and if broadcasters are to hold their own against newspapers and magazines, all effort and attention can't be concentrated on television.

We hear it said very often, and particularly right now, that if there's a

(Continued on page 12)

Special Services Directory

METHODS ENGINEERS

Materials & Methods engineers in America's leading manufacturing plants use Topflight's Printed Cellophane, Self - Adhesive Tapeto meet A-N specs. - assembly line - follow through - instruction labels. Easy to Apply.
TOPFLIGHT TAPE CO. YORK PA.



"Guardian"

300 MM. Code Beacons
Obstruction Lights
Code Flashers
Packaged Lighting Kits
Send for Catalogue

HUGHEY & PHILLIPS
326 North La Cienega Blvd.
Los Angeles 36, Calif.

RANGERTONE

TAPE RECORDERS

HIGH-FIDELITY EQUIPMENT FOR
BROADCAST & RECORDING STUDIOS

RANGERTONE, INC.

73 Winthrop St. Newark 4, N. J.
Tel. Humbolt 5-2550

Collins Custom Components

The Very Finest

FM TUNERS FM/AM TUNERS
FM RECEIVERS

Custom Matched Components

Collins

Audio Products Co., Inc.

P. O. Box 368 Westfield, N.J.

RADIO-MUSIC CORP.

REPRODUCERS **R** TURNTABLES

AMPLIFIERS **M** SPEAKERS

F. M. broadcast quality for custom sound installations for the studio and the home.

PORT CHESTER, NEW YORK

KAY ELECTRIC CO.
INCORPORATED

Manufacturers of:
Television Test Equipment
Laboratory Instruments
Electronic Devices

14 Maple Avenue Pine Brook, N. J.
Tel. Caldwell 6-3710

Professional Directory

Jansky & Bailey

AN ORGANIZATION OF
Qualified Radio Engineers
 DEDICATED TO THE
SERVICE OF BROADCASTING
 National Press Bldg., Washington, D. C.

NEW HEADQUARTERS

GARO W. RAY

CONSULTING RADIO ENGINEERS
Standard, FM and Television Services
 HILLTOP DRIVE
 STRATFORD, CONN. Tel. 7-2465

ANDREW ALFORD

Consulting Engineers
ANTENNAS & RF CIRCUITS

Laboratory and Plant:
 299 Atlantic Ave., Boston 10, Mass.
 Phone: HAncock 6-2339

DALE POLLACK

FREQUENCY MODULATION
 development and research
 transmitters, receivers
 communications systems

352 Pequot Avenue New London, Conn.
 New London, 2-4824

Preliminary sur-
 veys, management
 and operational
 consulting service
 based on practical
 experience
 with AM, FM and
 Facsimile.



Phone: EExecutive 3929

RADIO CONSULTANTS, Inc.
 1010 VERMONT AVE., WASHINGTON 5, D. C.

AMY, ACEVES & KING, INC.

*Specialists in the
 Design and Installation of*

**HIGH-GAIN
 AM, FM, and TELEVISION
 ANTENNA SYSTEMS**

LOngacre 5-6622
 11 West 42nd St., New York 18, N. Y.

WHAT'S NEW THIS MONTH

(Continued from page 11)

wrong way to do anything, the radio industry always finds it and pursues it. That's undoubtedly so. But while that has been the record of the past, it isn't necessarily true of the future.

And since hindsight is a guide to foresight, there are lessons to be learned from an examination of the various mistakes that have been made since the war. They seem to line up in some such way as this, in chronological order:

During the war years, when manufacturers had no products to offer, their advertising promised great, new things to come. The public was prepared for some real improvement in radio. No one knew exactly what, but it was definitely assured by consistent implications.

Meanwhile, the broadcasters, favored by the limitations on newsprint and magazine paper, waxed rich and happy over increased time-sales revenue. There was more advertising money to be spent, and they got it because their chief competitors had to turn it down. AM broadcasting was easy-money business.

When, in 1945, it appeared that FM would be given enough channels to eventually replace AM, and upset the lush status quo, AM broadcasters ganged up to support the monkey-wrench plan of shifting the FM band.

Time has shown that they were ill-advised and short-sighted in this. If they had supported FM, its greater coverage would have given them an advantage over the hundreds of newcomers who rushed into AM, hoping to get rich quickly, but who succeeded mostly in crowding the narrow AM band to the point where all nighttime coverage has been reduced drastically.

As for the set manufacturers, they had an opportunity to make good on their war-time promises of radically better radio reception by building FM sets that would afford the most needed improvement of all — the elimination of static.

Instead, some chose to ignore it because there was a quick and easy market for AM sets. Others chose to fight FM. The principle means was the subtle method of making FM-AM sets with insensitive FM circuits and built-in antennas. When purchasers complained that they couldn't get any FM programs, the dealers simply said they would have to get their reception on AM until FM broadcasting was perfected, and the stations got up to full power.

That was an obvious way to discourage FM broadcasters for, without listeners, independent stations could hardly develop programs. AM operators did break down to the extent of duplicating their

(Continued on page 13)

Professional Directory

RAYMOND M. WILMOTTE Inc.

Paul A. deMars
 Associate

*Consulting Engineers
 Radio & Electronics*

1469 Church St., N. W. Decatur 1234
 Washington 5, D. C.

RUSSELL P. MAY

CONSULTING RADIO ENGINEERS

★ ★ ★

1422 F Street, N. W. Wash. 4, D. C.
 Kellogg Building Republic 3984
 Member AFCCE

LYNNE C. SMEBY

*Consulting
 Radio Engineers*

820 13th St., N.W. EX 8073
 WASHINGTON 5, D. C.

**CONSULTING
 RADIO ENGINEERS**

DIXIE B. McKEY
 &
 ASSOCIATES

1820 JEFFERSON PL., N.W. REpublic 7236
 WASHINGTON 6, D. C. REpublic 8296

RATES FOR PROFESSIONAL CARDS IN THIS DIRECTORY

\$12 Per Month for This Standard
 Space. Orders Are Accepted
 for 12 Insertions Only

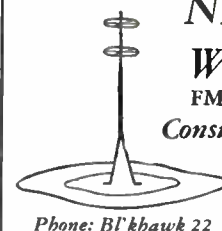

**NATHAN
 WILLIAMS**
 FM TV AM
Consulting Engineer

20 Algoma Blvd.
 Oshkosh, Wis.
 Phone: Bl'khawk 22

Professional Directory

FRANK H. McINTOSH

Consulting Radio Engineers
710 14th St. N.W., Wash. 5, D. C.
MEtropolitan 4477

WELDON & CARR
CONSULTING RADIO ENGINEERS

Washington, D. C.
1605 Connecticut Ave. MI. 4151
Dallas, Texas
1728 Wood St. Riverside 3611

COMMUNICATIONS RESEARCH CORPORATION

System Planning—Engineering
Research & Development
FM—TV—Focsimile
VHF—Communications

60 E. 42nd St., New York 17, N. Y.
Mu 2-7259

ELECTRONIC ENGINEERING MASTER INDEX

CONTAINS the most complete bibliography available on Frequency Modulation, Television, UHF, Broadcasting, Radar, and over 400 other topics.

1925-1945 edition\$17.50
1935-1945 edition\$ 7.50

Descriptive literature on request

ELECTRONICS RESEARCH PUBLISHING CO.

Dept. A 161 West 18th St., N. Y. 11



Radio Engineering Consultants,
Frequency Monitoring

Commercial Radio Equip. Co.

International Building • Washington, D. C.
603 Porter Building • Kansas City, Mo.

Winfield Scott McCachren
AND ASSOCIATES

Consulting Radio Engineers
TELEVISION SPECIALISTS

2404 Columbia Pike 410 Bond Bldg.
Arlington, Va. Washington, D.C.
GLebe 9096 District 6923

WHAT'S NEW THIS MONTH

(Continued from page 12)

programs on FM. That was one bright spot for FM, but the networks virtually eliminated the opportunity for listeners to compare 5,000-cycle quality with high-fidelity, live talent FM by requiring their affiliates to carry the full network schedules.

Early in '47, television got under way in earnest, and its initial success caught the public fancy quickly. By the year-end, although less than 200,000 sets had been produced, public interest spread far beyond the supply of receivers or the ability of broadcasters to get transmission on the air.

This undoubtedly affected the sale of AM sets. From a high in October '47, production dropped 50% in seven months. Poor AM reception, due to increased interference on the crowded AM band, further discouraged listening.

It began to look as if the ailing AM situation would be offset by the sale of TV and FM sets, and give both manufacturers and broadcasters a net gain. And so they might have done except for certain developments that had not been anticipated:

First, the production of picture tubes could not be stepped up fast enough. It wouldn't have been so bad if manufacturers had been content to concentrate on 7-in. tubes, or to add just 10-in. types. But enough 12- and 16-inch. sizes were made to give people the idea that they wanted big pictures. Thus, while small-tube capacity was being added, the demand switched to sizes that were in short supply, and will be for some time to come.

Then came the FCC decision to stop issuing TV construction permits until the matter of interference could be investigated. That brought up the matter of UHF operation, and its related complications. The TV freeze may yet prove beneficial to set manufacturers, but the UHF situation can be only vexing at this time. If the FCC accepts the recommendation of the Joint Technical Advisory Committee, that VHF and UHF channels be assigned in the same areas, resulting complications may delay nationwide television service indefinitely.

The third complication came from over-enthusiasm and wishful thinking. If manufacturers and dealers had planned carefully and conservatively, they would have promoted FM along with TV. It's an axiom of sales psychology to offer a choice, and the wider the choice the better the score of sales per hundred prospects. Instead, dealers let FM sales slip away in their enthusiasm over television. TV set manufacturers encouraged

(Continued on page 36)

Professional Directory

McNARY & WRATHALL
CONSULTING RADIO ENGINEERS

906 National Press Bldg. DI. 1205
Washington, D. C.

1407 Pacific Ave. Phone 5040
Santo Cruz, California

KEAR & KENNEDY

Consulting Radio Engineers

1703 K St., N.W. STerling 7932
Washington, D. C.

GEORGE P. ADAIR

Consulting Engineers

Radio, Communications, Electronics

1833 M St., N.W., Washington 6, D.C.
EXecutive 1230

GEORGE C. DAVIS

Consulting Radio Engineers

501-514 Munsey Bldg.—Sterling 0111
Washington 4, D. C.

WATKINS 9-0117-8-0

S. A. Barone Co.
Consulting Engineers

MECHANICAL—RADIO—ELECTRONIC
PRODUCT DEVELOPMENT & RESEARCH
Development Specialists in Circuits, Part
Lists, Models, Manufacturing Drawings.

143-145 W. 22nd ST., NEW YORK 11

THE WORKSHOP ASSOCIATES

INCORPORATED

Specialists in
High-Frequency Antennas

66 Needham St., Newton Highlands, Mass.
Bigelow 3330

The 25B is a mighty good buy!



Here are some of the reasons why

General Advantages:

1. The Western Electric 25B Speech Input Console provides highest quality studio control for AM, FM and TV audio.
2. It is versatile... handles two studios... provides duplicate channel operation without interference.
3. It's easy to operate... all controls are functionally located for convenience of operator in controlling programs.
4. It's a complete unit with its own table... attractive, sturdy, well designed... and it's moderately priced.

Technical Advantages:

1. It covers complete FM frequency range. Has high signal-to-noise ratio and exceptionally low distortion.
2. It is easy and economical to install... plug-in cables carry all external leads to wall boxes (included with 25B).
3. It's fully accessible... opens up to expose all components.
4. It includes 7-position mixer; line and microphone transfer keys; dual line amplifiers and volume indicators; separate built-in tube check meter; regulated power supply.

For immediate delivery of one or more 25B Speech Input Consoles, call your nearest Graybar Broadcast Representative—or write Graybar Electric Company, 420 Lexington Avenue, New York 17, N. Y.

Western Electric

— QUALITY COUNTS —

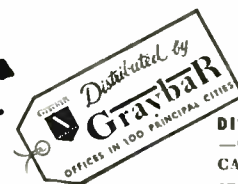

DISTRIBUTORS: IN THE U. S. A.
— Graybar Electric Company. IN
CANADA AND NEWFOUNDLAND
— Northern Electric Company, Ltd.

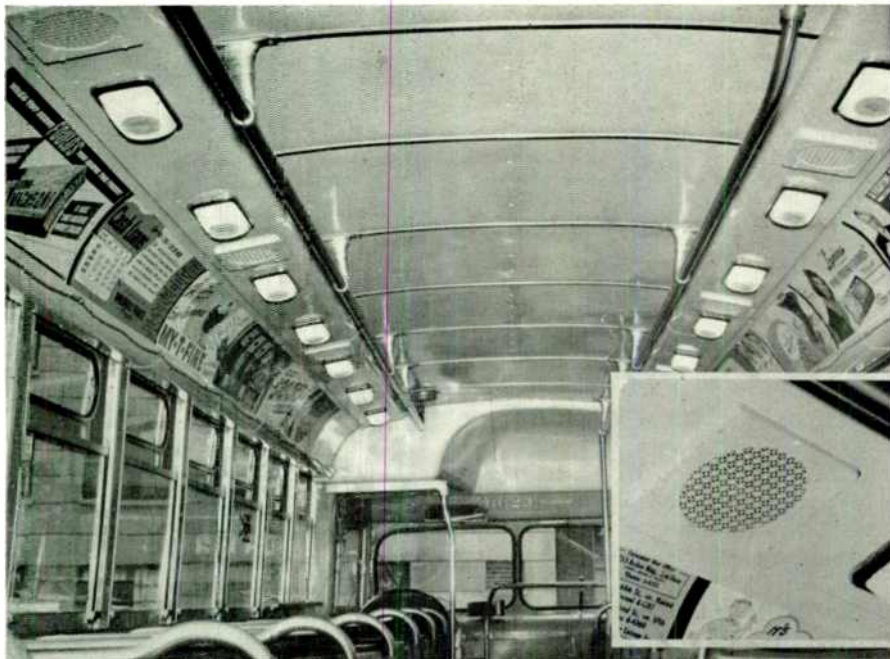

Fig. 1. Speaker installation in this bus is adequate to give good sound distribution at a low level. Insert shows detail of speaker mounting in the headlining

FM FOR BUSES

PART 1: DATA ON THE DESIGN OF RECEIVERS, AND THEIR INSTALLATION—By D. G. BEACHLER*

THE success of storecasting and transiting is already established by data on its effectiveness as a means of sales promotion for sponsors and of revenue for broadcasters. Such troubles as have been encountered are attributable to the use of receivers not properly designed for such services, or to lack of experience in the selection and placing of loudspeakers.

At Link Radio Corporation, our engineers have done a great deal of work on both storecasting and transiting. In this, they have been able to draw on their knowledge of mobile equipment, in which dependability of performance is a primary requisite.

Basic Specifications:

It might seem that receiver design for these new services would be simple enough. However, a review of types which have been employed shows that

most of them are inadequate in one or more of the following respects:

1. Insufficient sensitivity
2. Necessity for a special antenna
3. Insufficient stability
4. Necessity for constant retuning
5. Improper selectivity characteristics
6. Distortion with detuning or slight overswing
7. Insufficient audio output
8. No means of increasing level of announcements
9. No means for control of audio "on" and "off" from broadcast station

That a special type of FM receiver would be required for installation in a street car or bus may be taken for granted, as there are as yet no automobile FM broadcast receivers which might conceivably be adapted. If there were, however, they would perhaps suffer from much the same faults as outlined above. It is evident, therefore, that a special design is necessary. And it so happens that

basically sound design for a mobile installation produces an optimum design for fixed, AC operation. That is to say, if the receiver is adequate for transiting, it will then have all the desirable characteristics for storecasting.

Link Radio has had available for well over two years an ultra-sensitive, fixed-frequency, crystal-controlled mobile FM receiver with high-fidelity characteristics. A number of these receivers have been installed for broadcasters. In order to meet the primary requirements of FM receivers for buses, it was only necessary to make a wiring change in the filament circuit, and to provide adequate audio output. A mobile receiver is usually made for 6-volt operation, but buses are equipped with 12-volt batteries.

In modifying the output circuit, it was found possible to provide 8 watts output with less than 5% distortion. The receiver sensitivity is better than 1 microvolt which, of course, is excellent. This order of sensitivity is a must for adequate performance.

Power for the transiting receiver is provided by a dynamotor. This, together with the filter circuit, is mounted as a separate unit. The two units, receiver and power supply, are carried in a weatherproof case, placed under a seat or in any out of the way location within the bus. Provision is made for both ventilation and protection from water spray when the interior of the bus is flushed out.

Transiting in Duluth:

Some 35 of these receivers were installed in buses in Duluth, Minnesota many months ago, and the experience with them has been rather remarkable. Probably no situation could demand more of bus installations than the steep hills, ice furrowed streets, and extremes of noise and temperature in Duluth. Under these adverse conditions, maintenance has been so low that one man can handle service on about fifty receivers. It is also indicated that, in more favorable locations, one man could handle a much larger number of receivers.

The problem of antenna type and disposition was a matter of careful engineering study. Any installation on top of a

(Continued on page 34)

*Secretary, Link Radio Corporation, 121 W. 7th Street, New York City.

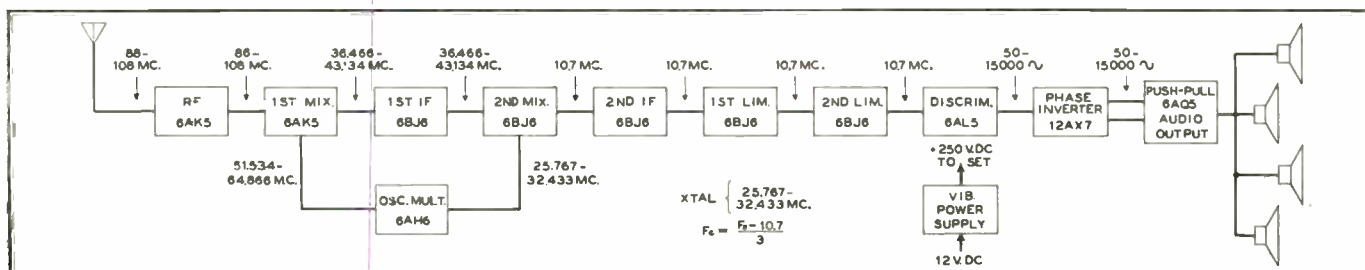

Fig. 2. Block diagram of the Link Transonic fixed-frequency receiver, showing the tube types and their circuit functions

VHF & UHF AMPLIFIER

WESTINGHOUSE 50-KW. SYMMETRON CAN BE ADAPTED TO VHF TELEVISION—By D. L. BALTHIS*

POWER amplification at high radio frequencies has always been a difficult technical problem. The higher the desired frequency or power level, the more difficult the task becomes. However, substantial progress has been made by Westinghouse engineers in obtaining increased power in the range of 50 to 1,000 mc. The method employs a circuit called the Symmetron amplifier, using conventional, light-weight, low-cost tubes, capable of delivering about 2 kw. output at 1,000 mc.

Circuit Development:

The general pattern followed by the industry in recent years has been to obtain high-frequency power amplification by a circuit commonly known as the *grounded-grid* amplifier.

Once it is recognized that it is not essential for the grid to be at RF ground potential in this kind of amplifier, present terminology does not describe the circuit adequately. The grounded-grid amplifier is actually a special case of what might be called the *grid-separation* amplifier family. Consequently, the term *grid-separation* will be adopted in describing the Symmetron amplifier. By removing the grounded-grid design restriction, the range of application and usefulness for amplifiers in the grid-separation family is extended.

The electrical advantages associated with all members of the grid-separation amplifier family are: 1) the grid plane,

interposed as a shield between plate and filament, reduces the plate to filament feedback capacitance C_{pf} . Thus the grid performs one function of the screen grid in a tetrode. This makes possible the use of triodes as VHF and UHF amplifiers, while avoiding the possibility of self-oscillation without neutralization. 2) the tube output capacity is lowered, and is approximately equal to the grid-to-plate capacity C_{gp} . This is much less than that associated with the normal capacity-neutralized amplifier and, at high frequencies, results in increased RF bandwidth capability and lower circulating kva. in the output circuit. 3) the driving power acts in series with the output tube to supply the load. This results in higher power output for a given tube type than would normally be expected.

Typical grid-separation amplifier circuits are shown in Fig. 1. The first of these, indicated as A, is the conventional grounded-grid amplifier. The second, B, is a grounded-plate amplifier. Basically, there is no difference between these circuits except for the point selected to be at RF ground.

The Symmetron Amplifier:

Realizing that the selection of any given tube element to be at RF ground potential is only a matter of design preference leads to the general grid-separation amplifier configuration shown in Fig. 1C. Here, no element is at RF ground potential. Such a design can be realized physically, with definite advantages, if each of the tube elements is isolated from RF ground

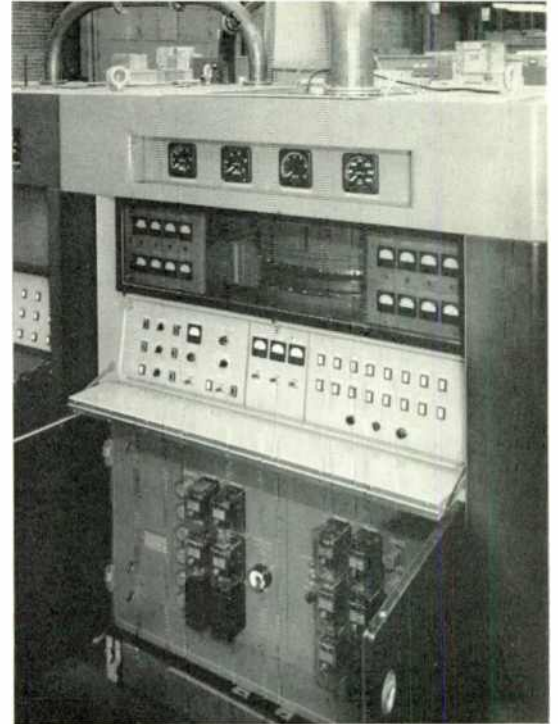

Fig. 4. The 50-kw. Symmetron amplifier by high-impedance techniques. The design of the Symmetron amplifier is based upon this general configuration.

The approximate equivalent circuit of the Symmetron amplifier for the 88- to 108-mc. FM band, using lumped constants, appears in Fig. 2, together with a cross-sectional view of the basic tank design. This amplifier is a cathode-coupled, grid-separation circuit of straight-forward design, with only three adjustable tuning elements. The input line is coupled directly to the cathode tank through the quarter-wave matching transformer that matches the cathode tank impedance to the input transmission line. The adjustable inductance elements are coaxial-line sections with conventional shorting-bar tuning techniques. The output coupling capacitor is an adjustable, air-dielectric type, coupling the output line between the grid and plate planes of the tank.

The cross-sectional view in Fig. 2 illustrates the basic mechanical configuration. The transition from the lumped constants of the approximate equivalent circuit to this mechanical configuration, utilizing linear circuit elements, is accomplished readily. This tank is a figure of revolution and, consequently, two coaxial transmission line sections are formed by the three cylinders extending downward from the plate, grid, and filament planes at the top. These coaxial line sections are tuned by ring-type shorting bars and, being less than one-quarter wavelength long, form the required plate and cathode inductive tank elements. The grid plane acts as a shield between filament and plate as in the approximate equivalent circuit.

50-Kw. FM Application:

The Symmetron design in practical form is employed in the Westinghouse 50-kw. FM amplifier. Its features, character-

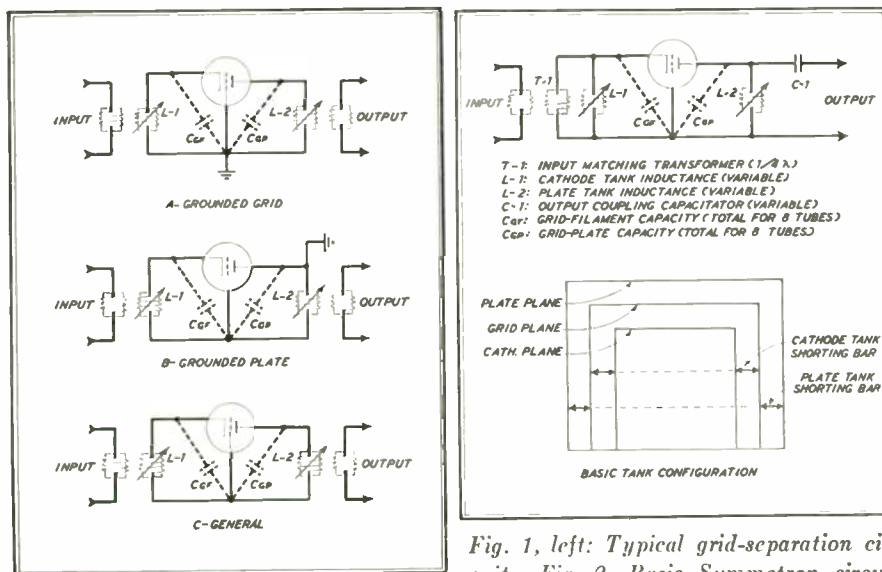

Fig. 1, left: Typical grid-separation circuits. Fig. 2. Basic Symmetron circuit

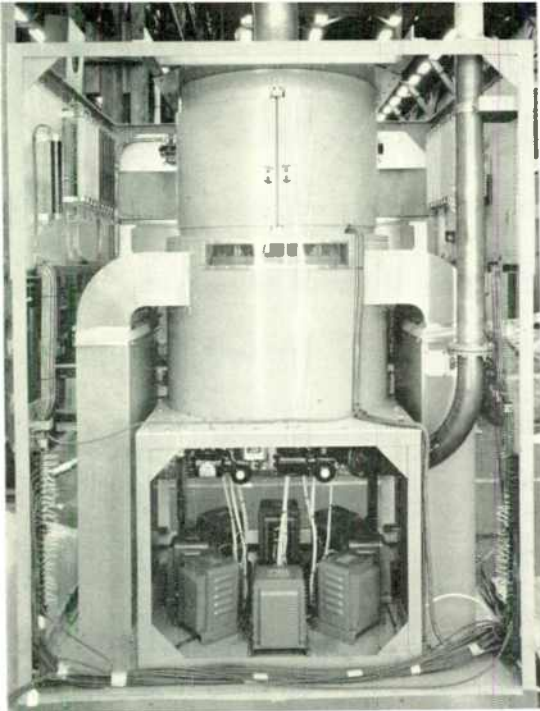

Fig. 5. Mechanical design of 50-kw. unit

istic of the Symmetron design, will be described in terms of the cross-sectional and plan views of Fig. 3. Views of the broadcast station equipment are shown in Figs. 4 and 5.

The Symmetron amplifier employs coaxial cathode and plate tanks arranged about a common axis to form a figure of revolution. The tubes are operated in parallel and are symmetrically inserted into the tanks about this common axis. Each tube, consequently, sees the same electrical and mechanical configuration for all operating frequencies. This design lends itself to multiple tube application.

Two to ten or more tubes can be operated in parallel without affecting the circuit symmetry. In turn, the required low-impedance tank elements are easily realized by using the coaxial transmission-line construction with proper selection of the tank parameters. The Symmetron tank shown in Fig. 3 employs eight WL-3X2500A3 tubes to provide a 50-kw. output, with a driving power of approximately 12.5 kw.

The Symmetron design is associated with simplified, wide-range tuning. Typically, the 50-kw. FM tank shown in Fig. 3 requires only three adjustable tuning controls: cathode tuning (shorting bar); plate tuning (shorting bar); and output coupling (capacitor). These controls are motor driven, and tune through the complete band of 88 to 108 mc. without mechanical adjustment of the tank.

The cathode and plate shorting bars, Fig. 3, are used for both coarse and vernier tuning of the tank. These bars consist of closely spaced phosphor-bronze contact fingers, mounted about the inner and outer peripheries of a circular supporting ring.

Capacitive or direct coupling is incorporated in the Symmetron design to preserve the overall circuit symmetry. Accordingly, in Fig. 3, adjustable coupling to the 6 1/8-in. output line is provided through the circular-plate capacitor in the plate cavity. The outer conductor of the 6 1/8-in. line is attached directly to the plate tank. The inner conductor is extended to the positionable capacitor

plate through a flexible metal bellows approximating the diameter of the inner conductor.

The input line is coupled directly across the cathode tank through a quarter-wave matching transformer. In turn, the matching transformer is centrally located to preserve the circuit symmetry.

The Symmetron design reduces danger to operating personnel from either RF or DC voltages, and minimizes stray RF radiation. Suitable blocking capacitors isolate the DC tube voltages from all the tank cylinders, RF voltages are confined to the interior of the tank, due to the basic electrical operating characteristics of cavity or coaxial-line tanks.

The plate blocking capacitor construction is also representative of that employed for the grid and filament capacitors. However, for purposes of individual tube metering, these respective elements are not tied together. The individual grid metering leads are brought directly downward from the individual grid contact rings, through the cathode cavity, and out through the top plate of the filament cylinder, using feed-through insulators, to RF chokes.

Future Applications:

Utilizing tube types available today, the Symmetron technique makes possible the following RF power levels: For FM broadcasting, 75 kw. in the 88- to 108-mc. band; for black and white TV, 25 kw. at 54 to 88 mc., and 10 kw. at 174 to 216 mc.; and for black and white or color TV, 1 to 2 kw. at 500 to 1000 mc.

Fig. 3. Arrangement of the eight amplifier tubes, and a cross-section of the tank circuits, with details of the construction

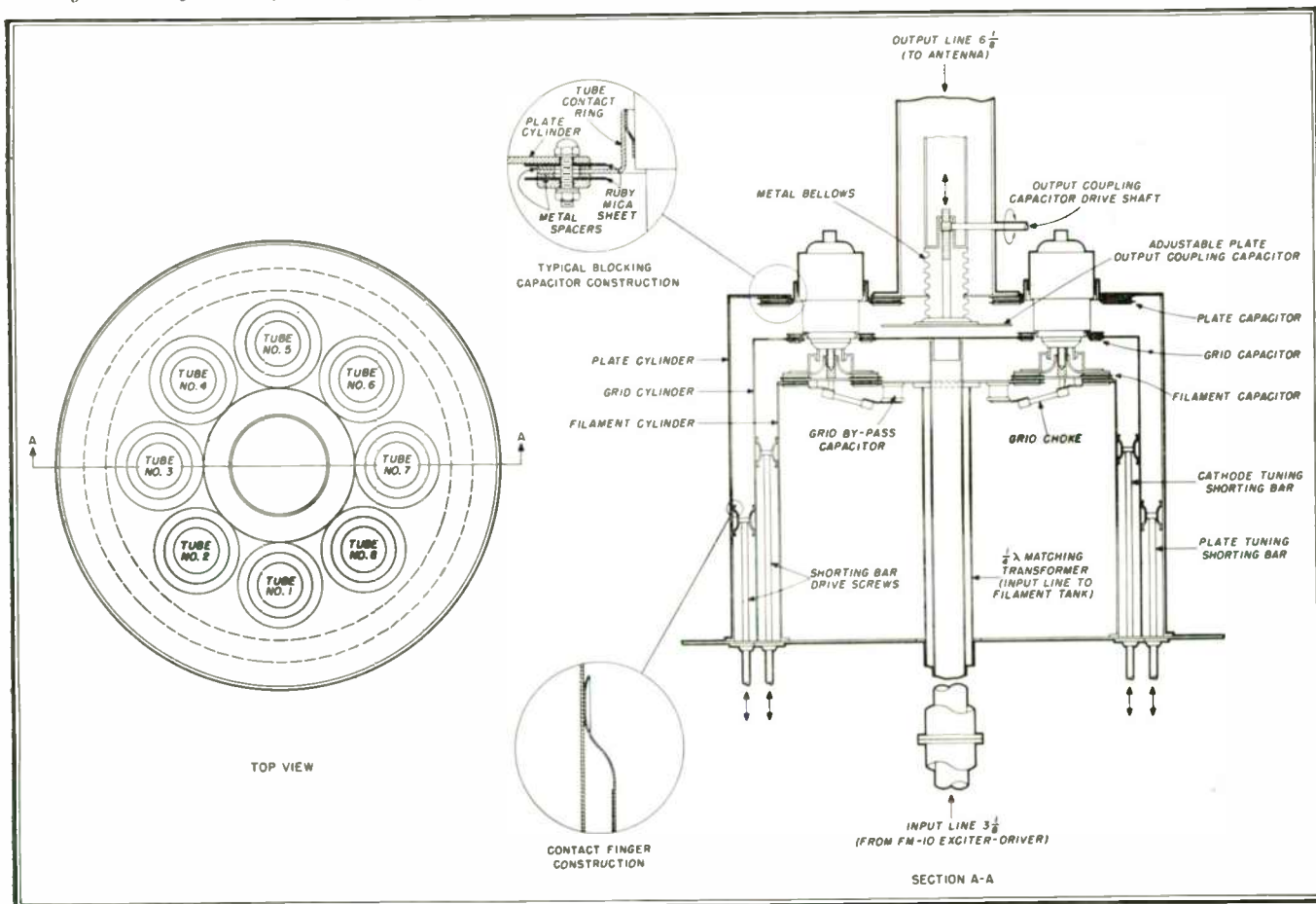

SPOT NEWS NOTES NOTES AND COMMENTS ABOUT SIGNIFICANT ACTIVITIES OF PEOPLE & COMPANIES



"Your captive audience won't get out!"

NAB Engineering Conference:

Biggest annual event for broadcast engineers is NAB conference, April 6 to 9, at Hotel Stevens, Chicago. On the 6th, Bill Halligan will be host to the engineers at the Hallcrafters factory. The three days following will be devoted solidly to technical papers and discussions. Here, in brief is the schedule:

APRIL 7, A. M.: Method of selecting an FM-TV transmitter site, E. S. Clammer, RCA; Practical solutions of TV installation problems, R. D. Compton, WOK-TV; Making and analyzing TV and FM field intensity measurements, G. P. Adair, consultant; Design, development, and operation of a TV mobile unit, W. I. McCord, DuMont; Operation of the Image Orthicon camera, J. H. Roe, RCA; 2,000-mc. TV relay, M. Silver, Federal.

APRIL 7, P. M.: AM, FM, and TV audio measurements, F. H. McIntosh, consultant; NAB recording and reproducing standards for disk and tape, R. M. Morris, ABC; Magnetic tape recording and reproducing, Dr. S. J. Begun, Brush; Properties of magnetic tape, R. Marchant, Minn. Mining; Portable audio amplifier for AM-FM-TV, W. W. Dean, G. E. The Manufacturers' exhibits open at 5:00 P. M.

APRIL 8, A. M.: Loop antenna system for TV broadcasting, A. G. Kandoian & R. A. Felsenheld, Federal; New, low-cost TV transmitting antenna, M. W. Scheldorf & L. R. Krahe, Andrew; Design problems in triodes and tetrodes for high-frequency operation, Dr. H. Doolittle, Machlett; Development, design, and application of super-power FM, J. E. Young, RCA; Automatic selection of

broadcast program circuits, J. A. Green & R. D. Essig, Collins; High-voltage rectifiers applied to broadcast transmitters, C. K. Hooper & N. B. Thorp, Westinghouse.

APRIL 8, P. M.: Iconoscope film pick-up systems, H. R. Smith, Du Mont; Improved 16-mm. Synchronitic projector, H. B. Faucher, G. E.; Kinescope recording, R. V. Little, Jr., RCA; C-R tube video scanner, R. D. Thompson, Du Mont; General-purpose TV studio lighting, R. Blount, G. E.; TV receiving antenna design & installation, L. Winner, Davis.

APRIL 9, A. M.: Training AM & FM engineering personnel for TV operations, W. M. Baston, NBC; advances in broadcast facsimile, J. V. L. Hogan, Radio Inventions; Progress report on UHF TV, Dr. T. T. Goldsmith, Du Mont; FCC-Industry Roundtable, moderator R. V. Howard, NAB. FCC representatives: J. A. Willoughby, E. W. Allen, Jr., J. E. Barr, C. M. Braum, E. W. Chapin, C. B. Plummer. Industry representatives: A. J. Ebel WMBD, E. K. Jett WMAR, K. W. Pyle KFBI, O. W. Towner WHAS, E. M. Johnson MBS, F. Marx ABC.

APRIL 9, P. M.: Open meeting of the NAB Recording & Reproducing Standards Committee, R. V. Howard, NAB and R. M. Morris, ABC, presiding.

More than 800 broadcast engineers are expected to attend this 4-day event.

Police on High-Power FM:

Experimental licenses have been granted for nine state police transmitters in Iowa, Kansas, and Missouri, to operate on 5 kw. maximum in the 30- to 42-mc. band. FCC seeks data on interference caused and transmitting range.

FCC Investigation:

Interim Report of the subcommittee of the Committee on Interstate and Foreign Commerce studying communications problems offers this comment on influences exerted to bring about past FCC decisions: "... only by such pitiless exposures can we hope to make certain that yet-to-be-made decisions of the greatest and most paramount importance to the American people in the field of electronics generally and radio television specifically will be really in the public interest and not for the benefit of vested interests."

16-In. Metal C-R Tube:

New RCA tube with high-chromium steel alloy cone and 3/16-in. glass face has remarkable resistance to mechanical and thermal shock. In one test, the glass face was put in boiling water and then quickly plunged into liquid air at -190° C. Al-

lowed to temperature-equalize in liquid air, it was plunged into boiling water again, but the glass did not break!

Where It Went:

RCA's annual report covering 1948 operations shows that its record income of \$357 million breaks down in this way: Materials, supplies, sustaining program talent, rent, sales and advertising, payments to affiliated stations, research, and administration 50.8%; wages and salaries 34.5%; depreciation and amortization 1.8%; interest .2%; taxes 6%; dividends 2.8%; carried to surplus 3.9%.

New TV Antenna:

Being installed on the Chrysler Building, New York, for WCBS-TV. Designed by engineering consultant Andrew Alford, it will have a power gain of 4.2. According to William Lodge, vice president in charge of general engineering, transition from the old to the new antenna will take place gradually. When completed, this will give WCBS-TV a substantial increase in service area.

Robert M. Hanson:

Former chief engineer for Thordarson has been appointed to the same post at Audio Development Company, Minneapolis.

Anti-Trust Suit Settled:

Long-standing claims by Scophony for a superior TV system may be put to test, now that the Scophony-Paramount-General Precision suit has been settled. Scophony says their system was demonstrated in London in 1939, but since then it's all been shrouded in mystery.

FMA Clinic at New York:

One-day session on FM time sales for advertisers, agency executives, broadcasters, and radio dealers will be held at Hotel Commodore on April 1, starting at 9:00 A. M.

Towers for Receiving Antennas:

Wincharger Corporation, Sioux City, Ia., has an excellent solution for roof-mounted towers to support FM and TV antenna masts. Four-sided, light steel structure 5 or 10 ft. high can be mounted on flat or sloping roof, and will carry 1½-in. pipe mast of 20 ft. or more.

Transitcasting in Washington:

Buses in the Capitol are being equipped to receive WWDC-FM. Installations at the rate of two a day will total 500 by the end of this year. Eventually 1,500 buses will be equipped to entertain 250,000 daily riders.



1. Demonstration board shows TV circuits in action. 2. FM speed logging operations. 3. Making plans for more mobile FM sales

NEWS PICTURES

1. RCA has set up a complete 30-tube TV receiver circuit on this demonstration board, superimposed on a wiring diagram. Designed for use at service clinics, this breadboard set is an actual working set, and images appear on the 10-in. tube at the top. Picture and sound paths can be traced readily, and reveal the effects of any faults in the circuits. Two hundred plug-in parts are used. The display was designed by John Meagher.

2. The Edward Hines Lumber Company, of Westfir, Ore., is using an FM system, supplied by Federal Telephone and Radio, for both mobile and point-to-point services. Mobile units are mounted on the big donkey loading trucks in weatherproof, detachable cases, so the equipment can be shifted quickly when any truck is laid up for repairs. FM is not only less expensive to install and maintain than wire lines, but it has the important factor of flexibility needed in emergencies such as fires and accidents.

3. At a sales conference in G.E.'s Elec-

tronics Park, E. H. Vogel, manager of marketing for the electronics department, told communications specialists that sales of equipment for FM systems should reach \$23.5 million this year. He estimated police radio purchases at \$6 million, taxi companies at \$5 million, public utilities \$4 million, and the petroleum industry at \$3.5 million. Also, he predicted a 25% increase in installations for forestry conservation, 50% for fire departments, 100% for highway maintenance, and 160% for lumbering. Left to right in this picture are G. L. Roark, New York; W. C. Walsh, Salt Lake City; N. F. Keefer, Los Angeles; G. F. Reed, Dallas; and Nat Gada and C. M. Heiden, Syracuse.

4. Although it is a commercial station, WCFM at Washington, D. C., is owned by 40,000 local listeners. According to general manager H. F. Kern, "Program policies are largely determined by listeners, whose opinions are voiced through a Listener Council which holds regular meetings. Our theory is that if we have listeners, sponsors' commercials are bound to bring good results." Using a 3-kw. Federal installation with an 8-

element square loop antenna on 99.5 mc., WCFM covers an 80-mile radius in which there are more than 183,000 FM sets. Photo shows E. J. Girard, Federal representative, at the transmitter.

5. Among the first TV sets using the new 16-in. RCA metal tubes is this Freed Radio console, recently introduced to the trade at a showing at the Ritz Carlton, New York.

6. Another Freed model with the 16-in. metal tube has AM and Armstrong-circuit FM tuning, and a switch to cut in an external record-player of any type. The cabinet work is exceptionally good, both as to design and finish.

7. The Fruit Belt Electric Cooperative at Cassapolis, Mich., has an FM repeater to retransmit calls on 153.71 mc. which it picks up from the main station and the service trucks, transmitting on 158.25 mc. In this way, dependable communication from headquarters to the trucks or between trucks is maintained over a radius of about 40 miles, using only 50-watt G.E. units at the fixed stations.

4. Listeners own this FM station. 5, 6. New sets using 16-in. metal tubes. 7. Power company operates relay-type FM system

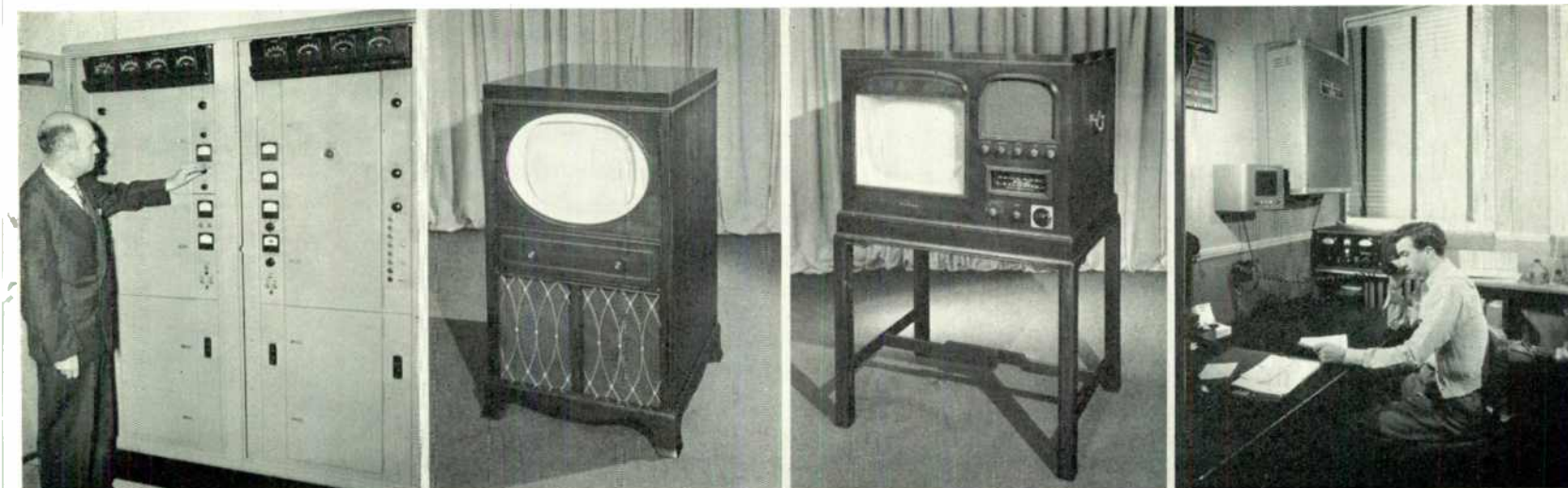

MOBILE TV STUDIO FOR WDTV

DU MONT'S ANSWER TO BALANCING FIELD OPERATING FACILITIES WITH QUICK SETUP, OPERATOR CONVENIENCE, AND SAFE TRANSIT—By WILLIS I. McCORD*

DESIGNING a mobile television studio is almost as complicated as planning the interior of a submarine. A tremendous amount of equipment must be accommodated, it must be installed securely yet it must be readily accessible, and the arrangement must allow for ease of operation, and provide for the comfort of the crew. Obviously, this calls for very considerable experience with actual operational requirements.

The Telecruiser, illustrated here in detail, is an unusual example of functional design geared to long experience with the requirements of remote program pickups, both as to the equipment provided, and the needs of operation, service, and the unexpected conditions encountered on location. Briefly, the new Du Mont mobile TV studio carries a complete Du Mont triple image-orthicon camera chain and all accessories in a ready-to-operate manner. This involves more than shock-proof mountings and storage facilities for the cameras and other delicate equipment. Protection against the hazards of

transportation actually begin with the riding qualities of the coach itself.

The body of the Telecruiser, Fig. 1, is divided into three main compartments. The forward section, Fig. 2, accommodates the driver and four passengers in very comfortable, reclining, red morocco leather coach seats. By means of an accordion-type folding door, this section can be isolated to serve as an announcer's booth, provision being made for mounting a portable television receiver. The announcer can either announce from behind this screen or, if circumstances permit, he can view the action through the large windshield. All AC lines, audio lines, video antenna, and mike input to this section are permanent and concealed, being accessible at conveniently located outlets.

Directly behind this section is the main compartment of the coach, Figs. 3 and 4. An operating desk, Fig. 3, extends cross-wise of the vehicle and supports the three control units (one for each camera), mixer amplifier, and the switcher. They are mounted on sturdy, pull-out drawer slides so that they are readily accessible for service or adjust-

ment. Power receptacles are within easy reach of the operator to accommodate soldering irons and trouble lights. Three chairs for the operators are located at this desk. Directly above the desk is a special bulkhead carrying 1) the control unit of the microwave relay transmitter; 2) a 12-in. monitoring receiver which can be line-driven or operated off the air; 3) a Du Mont cathode-ray oscilloscope for test purposes; and 4) a clock to be used in program timing.

A desk, at right angles to the video operating position, accommodates the audio field amplifier and auxiliary sound equipment. A convenient audio patch and an AC switching position which controls the power to various sections of the unit are built in the wall. Also, a desk is provided for the program director, from which he can view all camera monitors and the air monitor. Cabinets, drawers, and built-in storage compartments, of blond quartered oak, are also provided for the convenience of the operating personnel.

Video signals are fed to all positions in the coach, to exterior connections, and the relay transmitter through a 24-position video patch panel and a picture distribution amplifier. The latter unit is capable of converting from one to four bridged or terminated lines into multiple outputs. All video wiring is run through conduits, and can be removed easily for changing or replacement.

Heat, dissipated by the equipment in operation, is quickly removed by two large exhaust fans located on the bulkhead behind the control desk. These fans, due to collector action of the shelf above the desk, draw the hot air to this level and then empty it out through either side of the body.

The rear compartment of the Telecruiser, Fig. 5, houses five motor-driven cable reels. Three carry 250-ft. lengths of multi-conductor camera cables; one has 200 ft. of video relay control cable; and one has 250 ft. of No. 8, 4-conductor AC power cable. Smaller reels accommodate audio, video, and AC service cables. Camera and microwave relay tripods are carried in this compartment, along with the microwave relay transmitter, parabolic reflector, four weather-proof flood lights, and a collapsible dolly for handling cameras and other equipment that must be removed from the unit. Ports at roof level provide for cables to be run out of the rear either

*Engineer, Television Specialties Dept., Allen B. Du Mont Laboratories, Inc., 515 Madison Avenue, New York 22, N. Y.

Fig. 1. Mobile studio set up for an outdoor program. Dipole is for station monitor



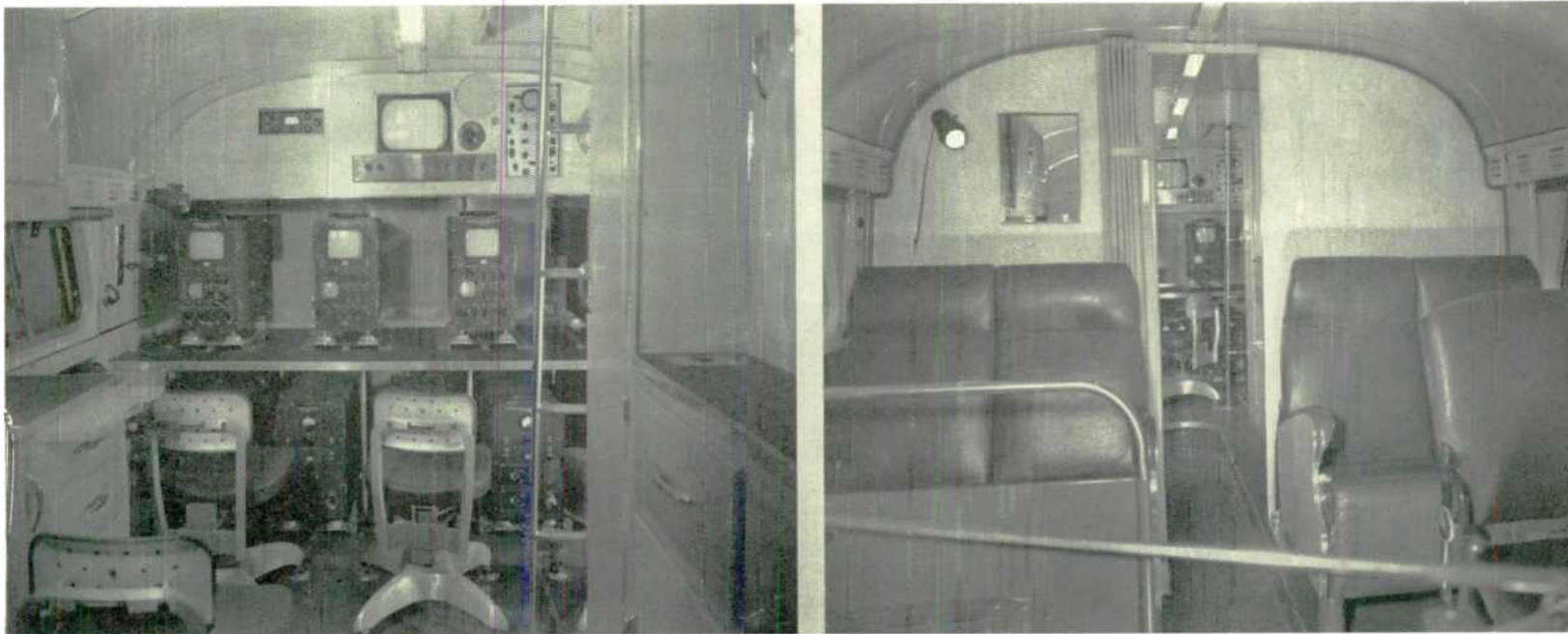

Fig. 2, right: Forward compartment for passengers and driver. Fig. 3, left: Operating desk with camera monitors has ample space

to the roof or to other camera positions.

Provision is made for the use of varying types of AC power through a master switch and a changeable link-type adapter block. AC is taken directly from this switch to the circuit breaker unit where it is distributed through a separate circuit and 20-amp. Variac which is provided for each camera chain. Lighting and service outlets are on separate circuits. All wiring is concealed and accessible at conveniently located receptacles. Twist locks and duplex locks have been provided at each position.

Audio facilities are wired into the body and terminate in a W. E. 24-position patch panel. There are eight telephone line connections; eight shielded audio lines with connectors on the exterior of the body; four microphone inputs; and three 2-circuit field telephone instruments permanently mounted in the unit.

The final tests of any mobile studio design have been found to be:

1. The time required to get it on the road after orders have been given the crew to start.

2. The time consumed in setting up when the objective has been reached.

3. The time taken to pack up, after the remote program is over, and to get the coach on the road.

First of all, quick action calls for furnishing the mobile studio with a complete complement of equipment and accessories. Then it is necessary to keep every item in its proper place.

The Telecruiser has been designed to afford every convenience to speed the work of unlimbering the equipment and setting it up for operation. Based on field experience, every detail has been planned carefully, from the locations and methods of storing and securing each demount-

able item to the arrangement of the operating positions. However, the time taken to set up depends upon the care with which the equipment was stowed away.

The coach itself is a model 25B1 type, manufactured by the Flexible Coach Co., Loudonville, Ohio. This design is admirably suited to use as a mobile studio, and provides the necessary maneuverability, dependability, and smooth riding qualities. The outside dimensions of the coach are:

Wheel base	182 ins.
Overall length	30 ft.
Overall width	8 ft.
Overall height	9 ft., 3 ins.
Turning radius	38 ft. 5 ins.

Ample power is supplied by a Buick model FB 320 engine of 144 H.P., located in the rear. Bendix-Westinghouse air brakes and all standard road equipment meet state and I.C.C. regulations. All replacement parts are of standard manufacture, available throughout the country.

Fig. 4, right: Floor-mounted units are carried on pull-out slides. Fig. 5, left: Rear section contains cables, microwave relay transmitter, flood lights, and dolly

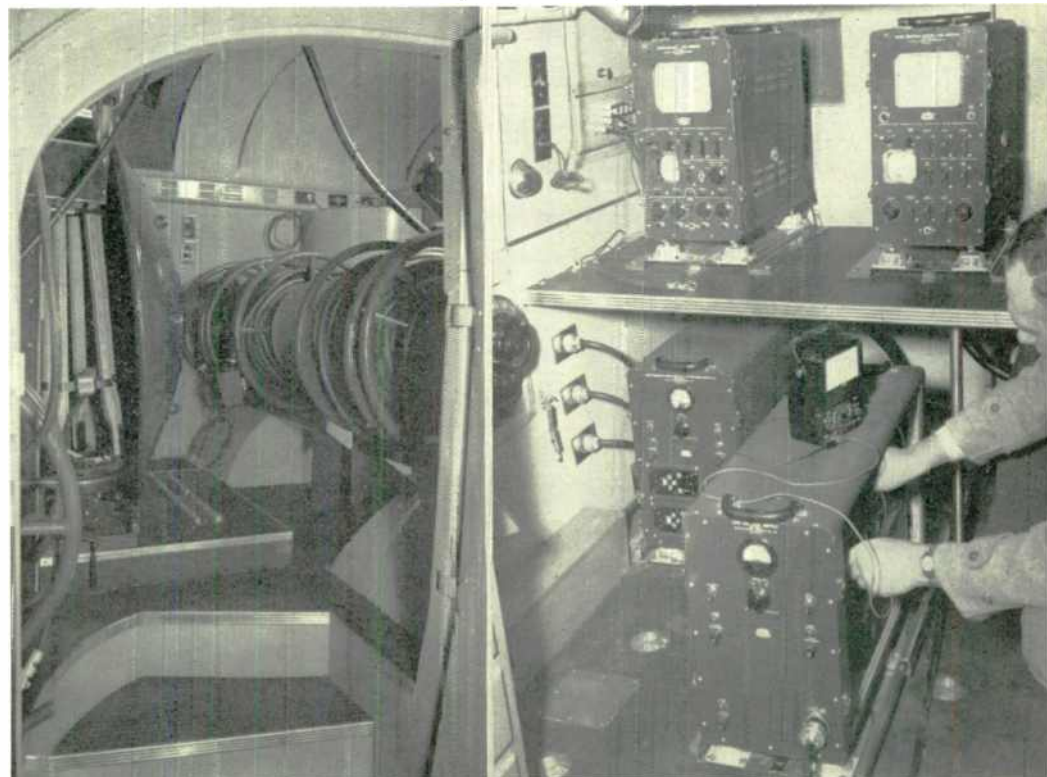

TV STATION MONITOR

A PULSE-COUNTER CIRCUIT IN AN OFFSET-TYPE MONITOR—By C. A. CADY*

THE requirements of video-transmitter frequency monitors have seen many changes since the first prewar television transmitters began operating. It was then generally accepted practice to use a heterodyne frequency meter, and to record measurements at discreet intervals. A transmitter frequency tolerance of perhaps plus or minus 0.01% was easily maintained by such procedure.

Post-war developments, and the increasing congestion of the high-frequency bands culminated in the issuance by the FCC of a frequency tolerance specification of plus or minus 0.001%, and the added requirement of continuous monitoring. These conditions could not be met with equipment then available.

Initial Monitor Design:

One of the simplest and most flexible methods of frequency monitoring consists of measuring the difference, or beat, frequency between a monitoring crystal oscillator and the transmitter carrier frequency. For high frequencies, a harmonic of the monitoring crystal is used. By employing a pulse-counter type of frequency meter, Fig. 1, to indicate the beat frequency, a very flexible arrangement is obtained, covering a wide range of carrier frequencies, and capable of measuring a considerable range in transmitter frequency error.

A monitor of this type was commercially available for FM broadcast and emergency services, and of a design readily adaptable for television. At that point, the limited demand did not appear to warrant development of a special-purpose monitor for television.

That monitor used the zero-beat system, with the monitoring oscillator set to the channel frequency, and a frequency meter indicating the audio beat between monitor and transmitter. There are two inherent disadvantages to such a system for services where narrow frequency tolerances are allotted: first, the monitor does not give a recognizable indication when the transmitter is exactly on frequency, and secondly, some auxiliary means such as a manually operated push button is required to determine whether the transmitter frequency is high or low.

*Engineer, General Radio Company, Cambridge 39, Mass.

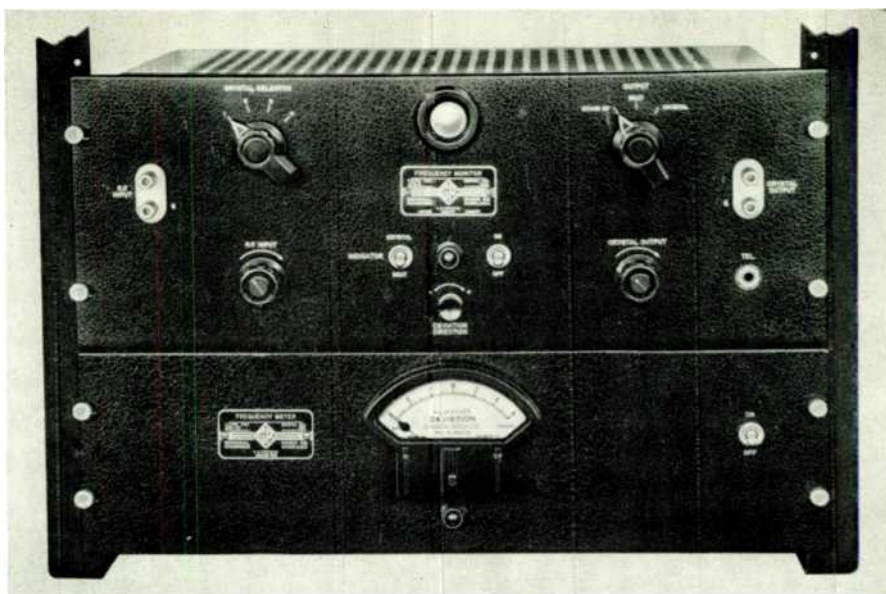

Fig. 1. The General Radio direct-reading frequency monitor for TV transmitters

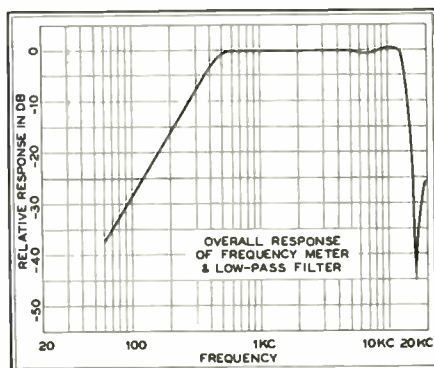

Fig. 2. Overall response of TV monitor

Offset-Frequency Type:

Offset-frequency monitoring is standard with other broadcast services, including the FM sound broadcast for tele-

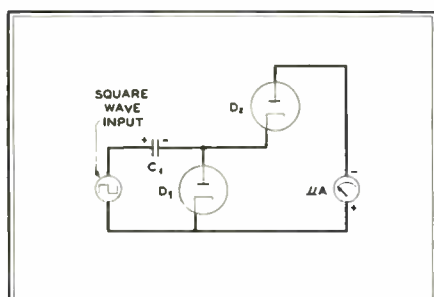

Fig. 3. Simplified pulse-counting circuit

vision,¹ and it was recognized that, as soon as performance requirements became more definite, an offset-frequency type of monitor would be needed for the video transmitter.

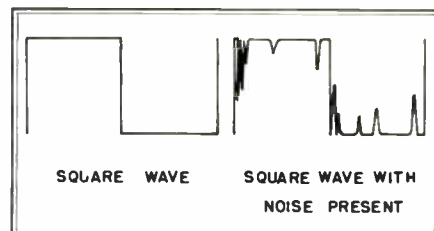

Fig. 4. Noise-peak effect on waveform

In the offset-frequency method of monitoring, the monitor frequency is offset from the channel frequency to give a known audio-frequency beat when the transmitter is exactly on frequency. The deviation meter scale is calibrated directly in transmitter frequency deviation, rather than in beat frequency.

Now, by the inclusion of the offset frequency feature and other refinements, the older high-frequency monitor has been redesigned to meet the specific requirements of picture transmitter monitoring. Fig. 1 is a panel view of the instrument.

The exact scale arrangement stems from present FM monitor practice, and has two ranges conforming to the transmitter channel frequency. Thus, for channels 2 to 6 the meter range becomes 3-0.3 kc; or for channels 7 to 13 it is 6-0.6 kc. By locating the crystal harmonic on the low side of the desired channel frequency, the resultant beat frequency increases with increasing transmitter frequency error toward the plus, or high side. While this mode of operation is somewhat arbitrary, it results in a meter scale reading from minus left, to plus right, in accordance with accepted practice.

If a monitor were designed to operate as just outlined, the limiting condition would appear when it was operated with an extreme frequency error on the minus or low side, where a 6-ke. deviation would correspond to zero beat. Erratic indications would be obtained as zero beat is approached. Fortunately, this limitation can be easily avoided. Without changing the scales, the amount of offset can be increased by an arbitrary amount, and electrical suppression of the meter at its extreme left, for mechanical-zero position, introduced. It is important to re-

¹"FM Monitor has Pulse-Counter Discriminator," by C. A. Cady, *FM AND TELEVISION*, December, 1947.

member that we still have essentially a frequency meter, even though it is no longer calibrated directly as such. The normal mechanical zero of the meter will thus be at the extreme left end of the scale, at the zero DC point. Making use of this fact, a small fixed bucking-potential can be introduced which will deflect the meter in reverse by a predetermined amount, in the absence of a beat frequency. As the beat frequency increases from zero, the meter will remain off scale, in reverse, until the DC potential developed by the pulse-counter circuit equals the applied fixed potential. Further increase in the beat frequency will cause a proportionate deflection up-scale on the meter.

The amount of zero-beat suppression should be sufficient to avoid operating within a range which includes most of the low-frequency video-synchronizing pulses. The maximum amount of zero-beat suppression is limited by the requirements of sensitivity, and linearity of the scale.

An arbitrary frequency suppression of 500 cycles for the lower range was chosen as a good compromise between obtaining the desired sensitivity and avoiding the majority of synchronizing-pulse frequencies. The actual beat frequency produced is thus 500-3500-6500 cycles on the lower channels, and 1000-7000-13,000 cycles for the higher channels. This makes for simplicity of initial calibration procedure, and with the use of reversible meter scales provides an easy method of changing ranges in the field.

The highest beat frequency obtained will be 13,000 cycles, when the deviation meter scale is indicating a transmitter frequency error of plus 6,000 cycles. To avoid interference from the line-frame video frequency of 15,750 cycles, a low-pass filter is used which has an attenuation peak at this frequency. Frequencies below 500 cycles are attenuated within the frequency meter itself.

Frequency Discrimination:

From the foregoing, it is evident in Fig. 2 that the monitor must operate with a beat-frequency range of 500 to 13,000 cycles maximum. The question now arises as to how the frequency meter can distinguish between the desired beat frequency and the normal television picture-video frequency components present within this range. For an answer to this, a consideration of the energy distribution in a television video signal is required. A large percentage of the energy contained in the video modulation consists of blanking and synchronizing pulses, occurring at a uniform rate, at frequencies below 500 cycles. Likewise, the 15,750- and 31,000-cycle video frequencies are a source of energy, at fixed frequencies.

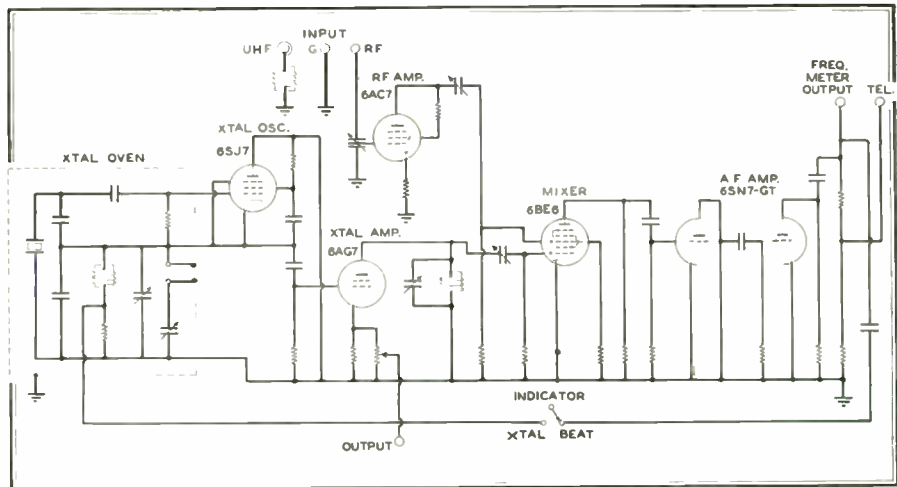

Fig. 5. Simplified schematic circuit diagram of frequency monitor unit

Within the range of 500-13,000 cycles, the energy consists of rapidly changing frequencies caused by the actual picture transmission, and hence is transient in nature. On the other hand, the beat frequency is steady and of large magnitude compared to any single transient compo-

ture, obtained by passing the beat-frequency through a series of limiting amplifiers. Noise peaks in the upward direction are thereby removed, and cannot affect the waveform. Noise peaks in the downward direction can affect the waveform as shown in Fig. 4. Since the capac-

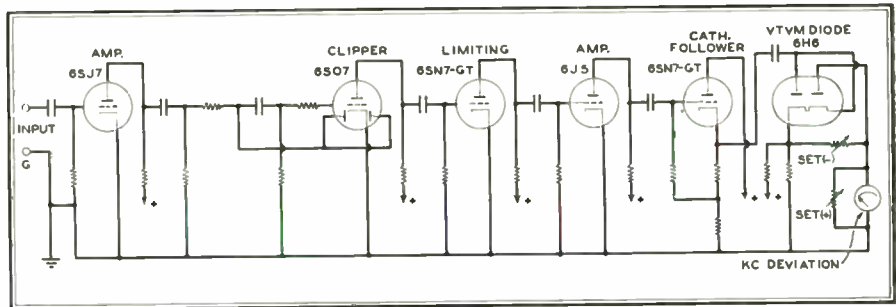

Fig. 6. Functional schematic of the frequency meter section of the TV monitor

ment. An analogy might be that of a steady-state signal in the presence of a moderate noise level of limited bandwidth.

Circuit Details:

The frequency meter is a pulse-counter type, as shown in Fig. 3. It is operated from a square wave of constant ampli-

tor C-1 is charged to the peak value of the square wave, the transient noise pulses can have only a minor effect upon the DC current through the microammeter.

The complete monitor is in two sections; one comprising a monitoring crystal oscillator, buffer amplifiers, detector (Concluded on page 27)

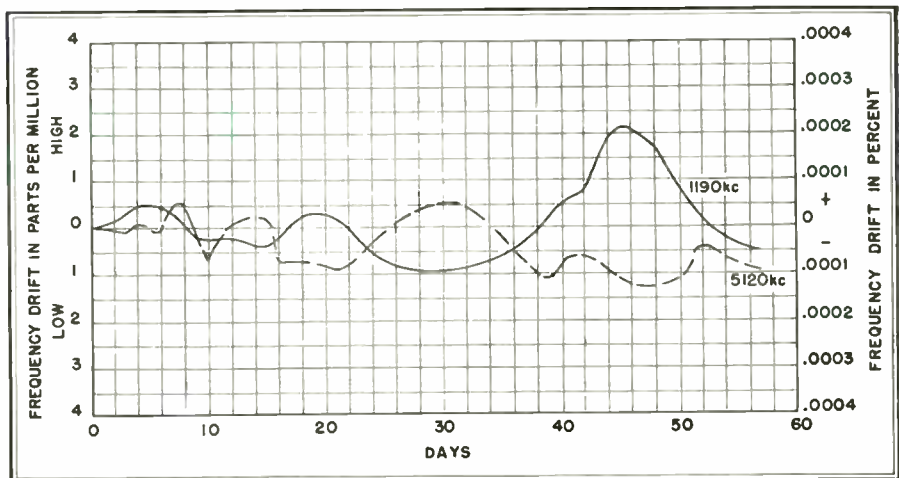

Fig. 7. Sixty-day record of frequency drift in a type 1182-T TV frequency monitor



Left to right: Chief engineer Vincent deLaurentis, secretary-treasurer Aldo di Dominices, and president Patrick J. Goode
 Fig. 1. Studio building faces Yale campus. Fig. 2. Gaylord Mountain transmitter house. The author stands third from left

LOW-COST TV OPERATION

HOW WNHC-TV, WITHOUT BENEFIT OR COST OF A CABLE CONNECTION, GIVES THE NEW HAVEN AUDIENCE THE BEST TELEVISION SHOWS — *By* GARO W. RAY*

THE cost of originating television programs and operating a metropolitan station has established the fact that this is a sure-fire way for those who have the money to lose it on a grand scale. But what of those who must think about going into television on something approaching a break-even basis?

Well, there are three angles to consider: 1) the possibility of hooking up with the coaxial cable network, if the proposed station is located where that is physically practical and possible. If not: 2) the possibility of programming the station with films portraying the Perils of Pauline and the Keystone Cops, which even a new audience will soon label as stinko. Or: 3) as WNCH-TV New Haven is doing with great success, repeating programs received by radio from one or more stations carrying top-rated shows. This, of course, assumes that a receiver can be located where it can pick up solid signals and relay them to the transmitter by direct connection or by microwave relay.

The WNHC-TV Operation:

WNHC was launched in 1944 as an independent station with 250 watts on 1,340 kc. From this beginning, president Patrick J. Goode and secretary-treasurer Aldo diDominices of the Elm City Broadcasting Corporation laid their plans to push on into FM and TV. This probably influenced their decision to acquire, in the beginning, a studio building of large proportions, Fig. 1, right opposite the Yale campus.

The FM application for 99.1 mc. was filed in the summer of 1947. A trans-

mitter site was chosen on Gaylord Mountain, 710 ft. above sea level, and 8 miles from the center of New Haven. After a road was built to the site, a modern building, Fig. 2, was erected to house a 10-kw. G. E. FM transmitter and "anything else that might come along." That, of course, meant television. Indeed, by the first of 1948, this third WNHC project had gone through the application stage, and a tentative date for starting channel 6 operations was being discussed.

The original plan was to purchase a DuMont Acorn package, but that acorn grew to the dimensions of a 5-kw. transmitter. Once started, the management determined that no time should be lost in getting on the air. DuMont responded with wholehearted cooperation, and soon trucks were rolling up the Moun-

tain with all the equipment and accessories. These even included the cameras, for it was decided that WNHC-TV would be on the air at the first minute possible, without waiting for the microwave ST link to be installed.

So, on June 15, 1948, chief engineer Vincent deLaurentis had both the FM and TV facilities ready to go. FM programs duplicated those of WNHC, but the plan developed for TV was quite another story. And here it is.

Low-Cost TV Programming:

The installation of a DuMont 16-mm. projector, Fig. 3, provided a means for handling commercial films of automobiles, soft drinks, and ladies' wearing apparel, but that is not the program material to build and hold a television audience. That requires the top-talent shows and special features originated in New York, or coming in there by network. No connection was available at New Haven to the N. Y.—Boston relay and, if it had been, there was a question as to whether, at least in the beginning, TV revenue would have justified the cost. So here is the plan that was worked out.

Although New Haven is 76 miles from New York City, and substantially beyond the primary service range of WABD, DuMont engineers were certain that solid signals could be picked up at a favorable location and fed to the WNHC-TV transmitter.

Accordingly, a receiver was installed on Oxford Hill, 8 miles from the transmitter, and a microwave ST link was set up. This very simple rig, described in detail in the next section, proved completely satisfactory. Only the picture signals from WABD are handled by this system.



Fig. 3. The 16-mm. projector, left; slide projector, center; kinescope at right

*Consulting Radio Engineer, Vice President, Elm City Broadcasting Corp., New Haven, Conn.

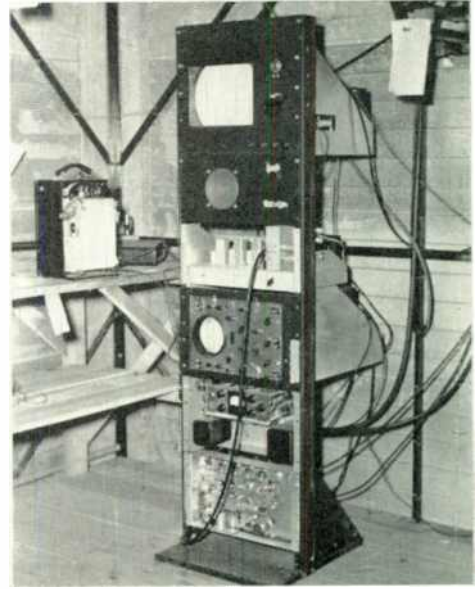
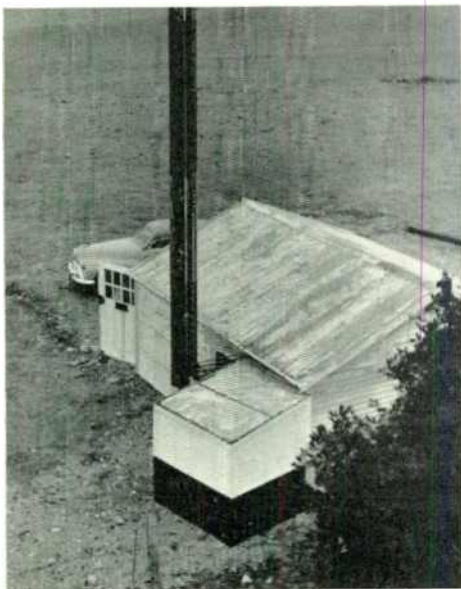

Fig. 5. At Oxford relay, microwave transmitter and face-up parabola are in cubicle at base of pole. Fig. 6. WABD receiving antenna at top, relay reflector below. Other gear belongs to Raytheon. Fig. 7. Receiver and controls at Oxford Hill

The audio signals are carried from the originating studio to the transmitter by a telephone line.

Then a contract was signed with DuMont under which WNHC-TV would be paid for commercial programs sold by the network, and would select others to be carried on a sustaining basis. This provided additional income for WNHC-TV, and gave the station the type of programs needed to build immediate acceptance for television in the New Haven area. And, not the least important fac-

tor of this operation, the cost of networking was only the small expense of the pickup and relay station at Oxford Hill.

Thus, a sound business setup, plus some smart engineering, added up to launch WNHC-TV with programs that were received enthusiastically by the local audience.

Subsequently, arrangements were made to take certain CBS and NBC shows, also. These details are handled from week to week by the Katz Agency in New York.

Engineering Details:

Fig. 4 shows the 5-millivolt and 500-microvolt contours of WNHC-TV, and the locations of the relay installation and transmitter. The WABD receiver is separated from the WNHC-TV transmitter because signals from the former come in on channel 5, while the latter operates on channel 6.

Figs. 5 and 6 show the building at Oxford Hill and the wooden pole which carries the WABD receiving antenna at the very top. The crystal-controlled receiver, Fig. 7, feeds the picture signals into an RCA microwave transmitter operating on 7,100 mc.

The parabola of the relay transmitter is mounted face up in the wooden structure at the base of the pole, Fig. 5, and directly below the sheet metal reflector, Fig. 6. Thus the 7,100-mc. signals are reflected horizontally, and in the direction of the receiver at Gaylord Mountain.

There is a practical reason for this somewhat unorthodox installation. Ordinarily, little maintenance is required for the microwave transmitter, but it is essential that it be readily accessible when it needs attention. Since the only available support was a wooden pole, service work in such an exposed position would be impossible. By using an angle reflector, it was possible to mount the transmitter on the ground. The resulting loss is negligible.

One problem was encountered, but that was met easily. Drifting snow that collected in the antenna dish did not affect transmission, but water leaked into the ashten at a point where the hooked waveguide at the center of the parabola joins the waveguide section leading to

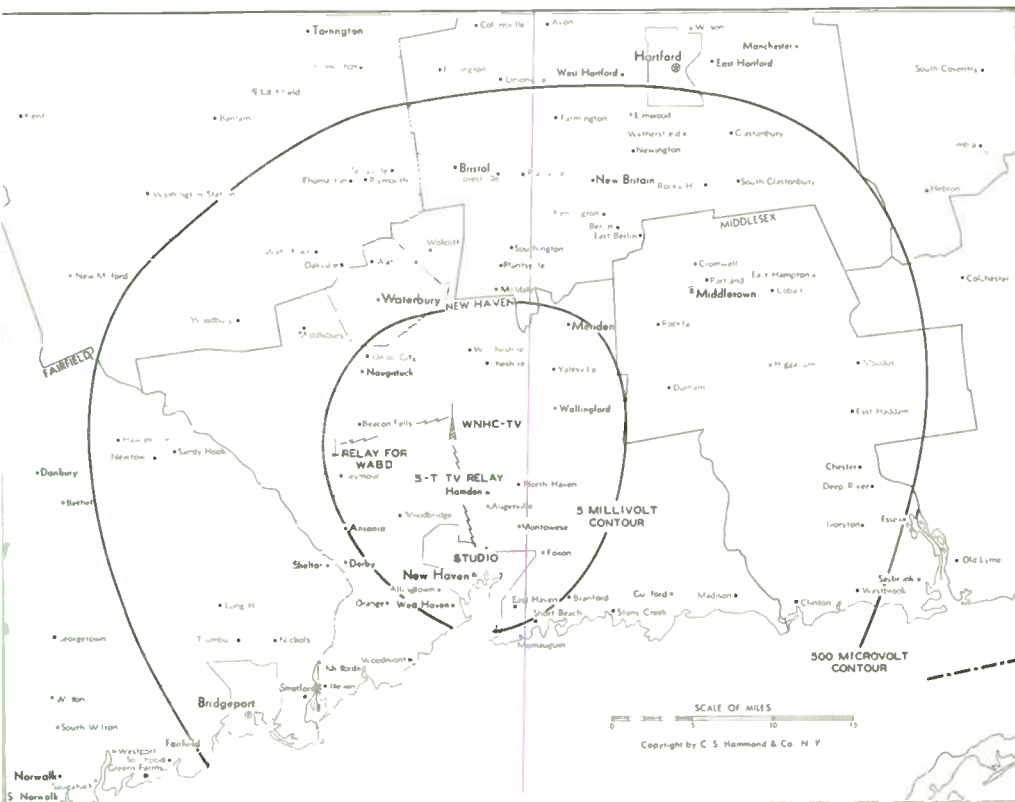

Fig. 4. Map showing TV contours and the Gaylord Mountain and Oxford Hill sites

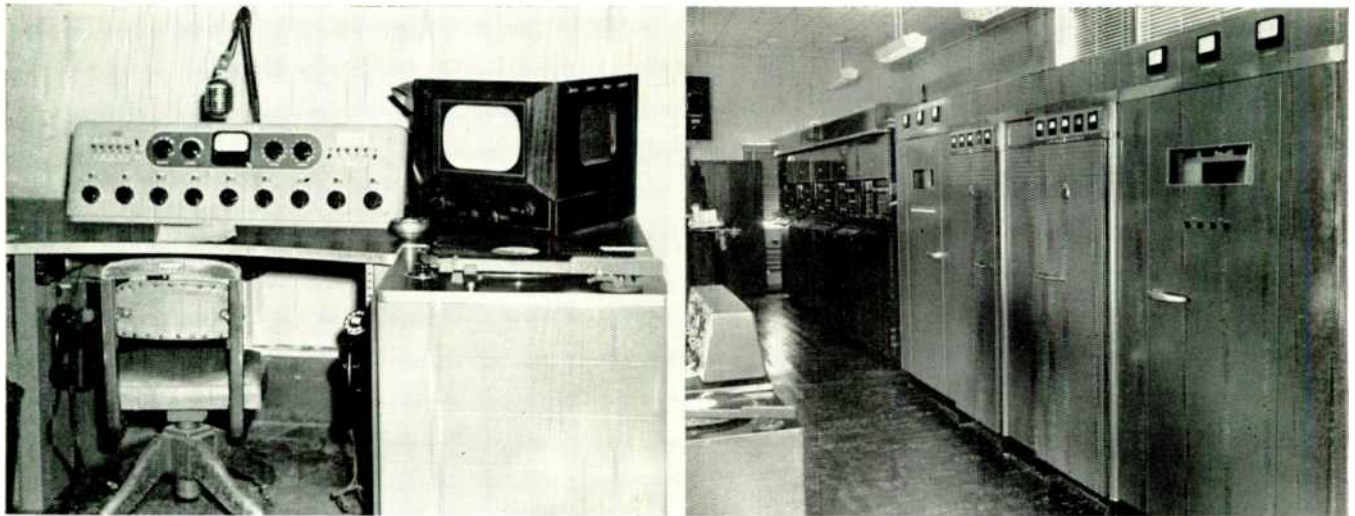

Fig. 8. Audio console and announcer's TV monitor at studio. Fig. 9 l. to r. transmitters for TV sound and picture, and FM

the equipment. There was similar trouble with the vertically-mounted units. However, a thin rubber gasket and a bit of paint around the joint stopped that trouble.

The relay system has proved excellent in performance and surprisingly reliable. It is normally unattended, for a time clock turns the equipment on and off according to schedule. A telephone line between Oxford Hill and Gaylord Mountain facilitates coordination between the two points when adjustments are necessary.

An Esterline-Angus recorder, at the left in Fig. 7, records the WABD field-strength, and any interruptions of the commercial electric power supply. Since the time of day is indicated on the chart, it can be determined whether any failure of the relay system is due to a breakdown in the equipment or to a power failure.

The audio portion of WABD comes up from New York by an AT & T land line, terminating at the television audio console, Fig. 8, at the New Haven studio.

A 15,000-cycle line, furnished by the Southern New England Telephone Company, runs from the studio to the TV transmitter. There are also a second 15,000-cycle line for the FM transmitter, and the usual order wires for routine operations.

Figs. 9 to 14 show the FM and TV equipment at the Gaylord Mountain station. The transmitters, Fig. 9, are installed together, with the 5-kw. DuMont TV units at the left, and the 10-kw. G. E. FM assembly at the right. The FM controls and monitor console can be seen in Fig. 10. Fig. 11 shows the TV controls and monitoring console at the right, and a separate shading console at the left for films and slides.

RCA diplexer and triplexer units, Fig. 12, feed the three transmitters into one antenna, Fig. 13. As you will see, the tower carries, in addition to the broadcast transmitting radiators, receiving antennas for picking up New York stations WCBS-TV and WNBT, and receiving parabolas for microwave transmitters at the New Haven studio and at Oxford

Hill. Thus the tower serves five purposes.

Since CBS and NBC programs come in on channels 2 and 4 respectively, no difficulty is experienced with receiving them at the transmitter. WNBT signal intensity is approximately 300 microvolts. WCBS-TV intensity is slightly lower, but this is compensated for by additional gain in the receiving antenna design. Both picture and audio signals are received on a Motorola VT-105 set, operated from a regulated power supply. The receiver is modified so that, instead of feeding the grid of the picture tube, signals are fed to a distribution amplifier.

This is, perhaps, the boldest engineering attack on a problem of this nature. However, by the use of a double-shielded room to house the receiving equipment, and a point-by-point job of cleaning up the signals, all the stray RF fields from the three transmitters were eliminated.

Two microwave receivers are used for the transmitters at the New Haven studio and at Oxford Hill. These can be seen in the first rack on the left in Fig.

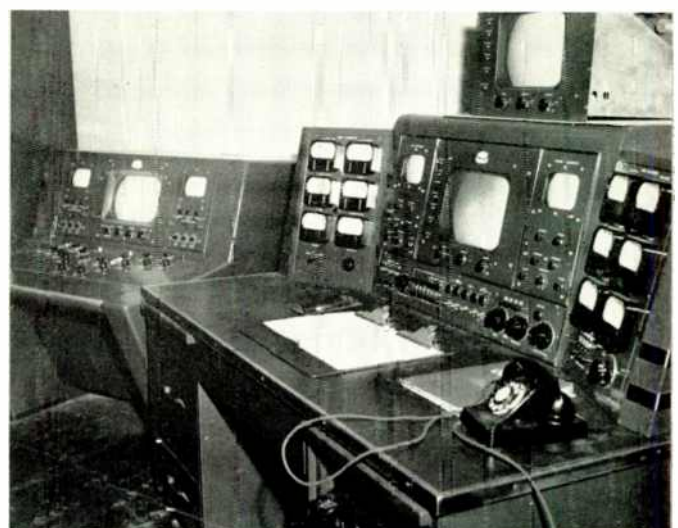

Fig. 10. FM transmitter control and monitor. Fig. 11. Shading console for film projector, and TV control and monitor right

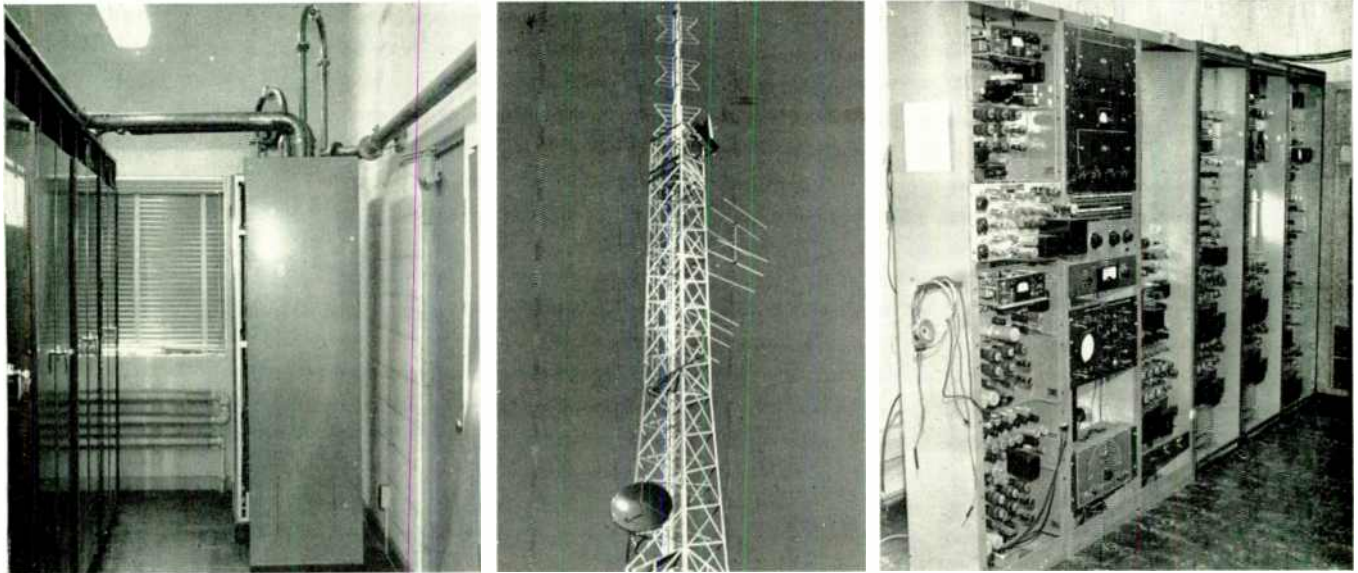

Fig. 12. RCA diplexer and triplexer units feed three transmitters into one antenna. Note the 90° delay circuit between two units. Fig. 13. FM-TV radiator, receiving antennas for WCBS-TV and WNBC, and receiving parabolas for Oxford and New Haven relays. Fig. 14. Picture and audio facilities at the transmitter. Left rack carries the two microwave receivers

14. The other racks carry picture and audio circuits.

One heartbreaking incident in connection with the ST relay is worth relating. After a study of the topographical map, it was determined that there was a line-of-sight path between the church belfry, Fig. 15, adjacent to the New Haven studios, and the tower on Gaylord Mountain. Accuracy of the map was confirmed by a check made at night with a red light. But when the transmitter and receiver were installed, although they were operating properly, no signal came through! A re-examination of the path showed that the line just cleared the top of an interposed hill. The map had shown the hill, all right, but not a thick, wide cluster of trees at the top of the hill. When the trees were chopped down, the signals came through without any further difficulty.

If this account indicates that the work at WNHC-TV has gone forward without a hitch or a headache, it is only because space does not permit presentation of more details. However, the skill, enthusiasm, and persistence of the engineering staff have been equal to every occasion. Now, with the station in full swing, facilities are being added and improved. And, it should be noted, this work is being done by the regular station personnel which handles FM and AM operations, also.

TV STATION MONITOR

(Continued from page 23)

and beat-frequency amplifier, and the other a series of limiting amplifiers and the frequency meter circuit.

An elementary schematic diagram of the monitor section is shown in Fig. 5.

The crystal oscillator circuit is a highly stable design, temperature-regulated to minimize frequency drift. Up to four crystals can be mounted within the oven.

An elementary schematic diagram of the frequency meter section is shown in Fig. 6. The beat-frequency is successively amplified and limited to develop a square waveform of constant amplitude. Below 500 cycles, the response of the amplifier drops rapidly. Power supply regulation is provided to minimize the effects of line-voltage variations. The square wave is applied to the pulse counter circuit, as previously noted. A bias voltage is derived from the plate supply, and is used to provide a zero suppression, and is adjustable via the SET + control. A DC meter shunt SET + is used to control the full-scale deflection of the meter. Once the instrument has

been calibrated, it is merely necessary to reverse the meter scale and halve, or double, the capacitor C-1, in order to change range. For convenience, this capacitor is made from two matched capacitors of equal value; one alone being used for the 6-0-6 kc. range and both in parallel for the 3-0-3 kc. range.

Provision is made for connecting remote meters, and adjustments are provided for setting the monitor reading in agreement with an independent frequency measurement. The accuracy of the monitor crystal frequency is 0.001%; but measurements indicate that the stability is considerably improved after the instrument has been in continuous operation for some time. This is apparent in Fig. 7, which shows the frequency drift of the monitor over a period of 60 days.

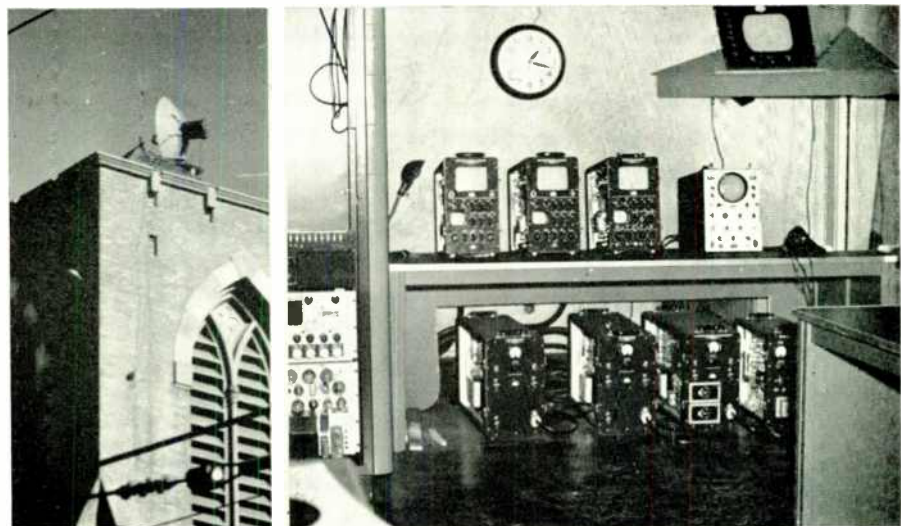
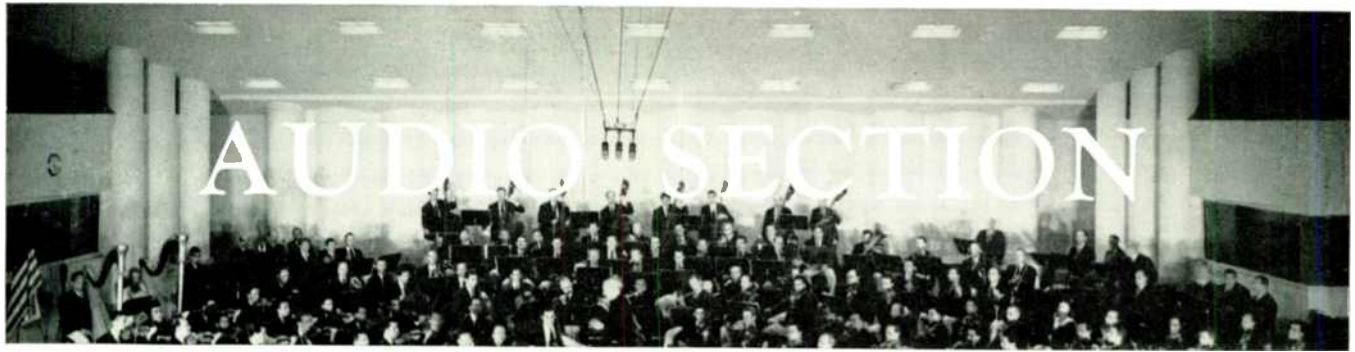

Fig. 15. Microwave relay on church carries studio programs to TV transmitter.

Fig. 16. Video controls at New Haven studio



AUDIO DEVELOPMENTS

DEVOTED TO THE INTERESTS OF THOSE WHO WORK WITH AUDIO FACILITIES — *Edited by* LAWRENCE OLDS

THE use of 15,000-cycle tape recording is being expanded by the Continental Network, according to Everett Dillard, as rapidly as techniques are worked out for new uses. We have some notes from him that will interest audio engineers at both FM and AM stations.

"During the national elections, Continental used a stunt that is worthy of consideration by other broadcasters, because it can be employed in several types of programs. A Rangertone tape machine was patched across two ordinary telephone lines coming into our studio. Various political figures were called by long-distance, and the conversations were recorded for subsequent broadcasting. This enabled the station to reach people all over the country at minimum expense. The reproduction at receiving sets did not represent high-fidelity tone, but it gave the realistic effect of eavesdropping on the telephone. Of course, beeps were introduced every 20 seconds to indicate that the calls were being recorded.

"WASH follows the generally accepted disc-transcribing practice of running two tape machines. Thus, two copies of each show are made available. Additional copies can be made from the better master, if they are needed. Good operating requires that an operator check the tape and all equipment before a recording is made. We have had some small trouble with the tape itself but this usually shows up if the tape is run through the machine as a test.

"We have encountered the problem of using tape recorded on the Rangertone machine for other makes, such as the Brush and Magnacord models. When we can anticipate such a situation, we record on the Rangertone at 15 ft. per second, instead of 30 ft. A tape cut on one type of machine can be played on another if the speed is correct. There may be some loss of quality. Sooner or later, however, the standardization of tape recording will be concluded, and most of our interchange troubles will be eliminated. Inci-

dentally, Continental is using both RR tape and the 111 tape manufactured by Minnesota Mining Company."

THE most intriguing development in audio equipment that this writer has seen in a long time is the new Altec-Lansing microphone. It's so tiny, as the accompanying illustration shows, that it could easily drop through a hole in your

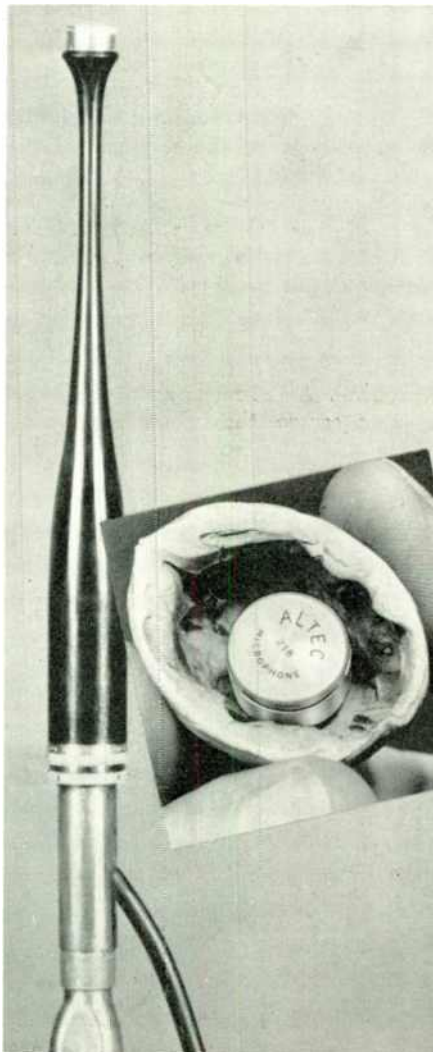

Broadcast mike is the size of a dime

pocket, yet it seems to have all the high-quality characteristics of the big studio mikes, plus some special advantages of its own. You can see and hear it in action at the Capital, Paramount, and Roxy theatres in New York right now. Sammy Kaye's orchestra is using this new model, and you'll agree that he really gives it a going over.

Not much technical information has been released by Altec-Lansing beyond stating that it is a condenser type. An examination reveals little more except that sounds do not enter at the top, flat surface, but through an interrupted slot around the side. This slot, which can be seen in the full-size insert picture, is only .03 in. wide. Beyond that, Altec engineers only say that the diaphragm really isn't so small, for it's as big as the diaphragm in the human ear.

Further, it is described as covering the complete audio range, both as to spectrum and loudness. Since it is blast-proof, there is no need to protect it against loud sounds or shocks which cause distortion or physical damage to other types of microphones. It is non-directional in the horizontal plane. Also, it seems to respond equally to sound sources above and below the level of the peripheral slot. A unit described as a power supply, presumably an amplifier, is required with the microphone, connected by a cable that can be run up to 440 ft.

In addition to the advantages of its electrical characteristics, the Altec mike offers a practical solution to the problem of providing an inconspicuous design for public speakers, ministers, and singers, who have had to duck around big microphones in order to see and be seen by their audiences. Mounted on a desk or floor stand, this diminutive design is hardly noticeable, particularly because the mike itself can be dropped down considerably below the level of the speaker's face.

IMPORTANT papers on audio subjects will be delivered at the NAB Conference in Chicago on April 7, with an open meeting of the Recording & Reproducing Standards Committee on the 9th. See page 18 for the list of papers.

OPTICAL SOUND-TRACK PRINTING

AN IMPROVED METHOD OF PRINTING FILM SOUND-TRACK THAT GIVES CLEAN, NATURAL AUDIO QUALITY FOR TELEVISION PROGRAMS—By JOHN A. MAURER*

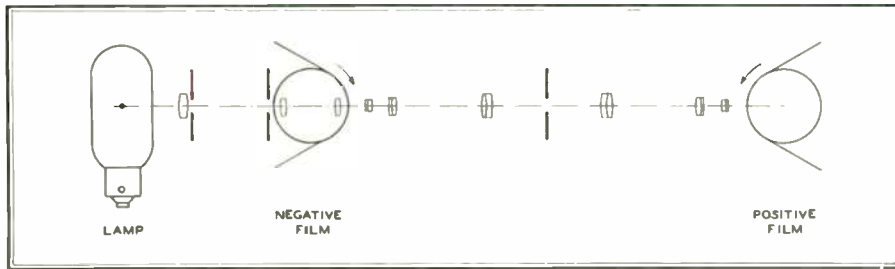

Fig. 1. Film-driving drums and optical system of the Maurer sound-track printer

AS films produced specifically for television broadcasting become more numerous, modern refinements in 16-mm. film laboratory technique will play an increasingly important part in improving the quality of television film presentations.

Most of these refinements are matters of detail, such as improved general cleanliness and better filtering of the processing solutions and wash water, higher standards of accuracy in the construction of equipment, and—a matter of great importance—the use of the film type best suited to each process. All these factors have contributed to a standard of print quality, both as to picture and sound, much higher than existed a few years ago, when many of the prints now

being used for telecasting were produced. One step that has been taken in the

always been the most serious loss of quality in the production of the sound track. This step was the introduction of the perfected optical sound track printer.

Ever since sound on film was first introduced, the motion picture industry has used sprocket-type, continuous-contact printing machines for printing both pictures and sound. Even today, most picture printing is done on machines of this type, though for the best grade of picture prints step printers, which have intermittent film movements like cameras, are used. Step printers produce

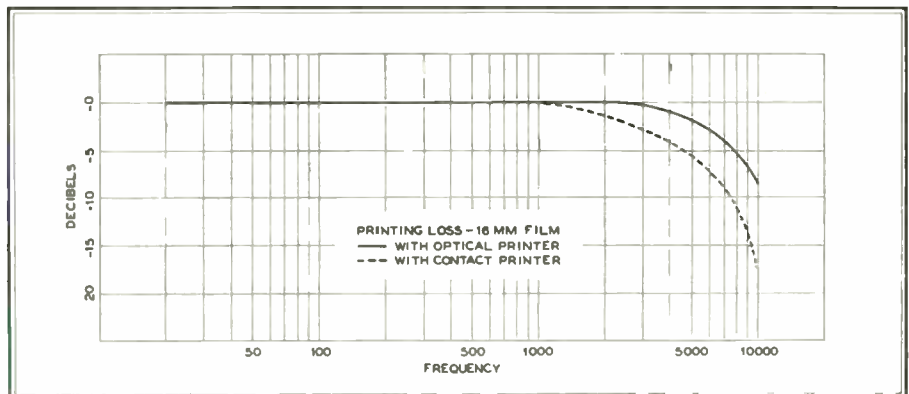

Fig. 2. Gain in audio response of optical method over the contact printing system

*President and Chief Engineer, J. A. Maurer, Inc., 37-01 31st Street, Long Island City, N. Y.

past year is of particular importance, because it has largely eliminated what has

appreciably sharper pictures than continuous printers, but they cannot be used for sound track printing because there must be no interruptions in the sound track.

The continuous sprocket-type printer fails in two important ways to do a satisfactory job of sound track printing. Both defects are due to the presence of the sprocket teeth which, unfortunately, must be used in order to keep the negative film and the positive printing stock in synchronous relation to each other. In the process of meshing and unmeshing the film perforations with the sprocket teeth, the two films slip relatively to each other and, as a result, the print is somewhat blurred. At the same time, these slippages introduce small but noticeable amounts of rapid flutter into the sound track.

The optical sound-track printer illustrated on the front cover of this issue operates on an entirely different principle. The sound-track negative and the positive film are driven separately in synchronism, on opposite sides of the machine, by means of constant-speed drives of the type used in recording machines.

(Continued on page 32)

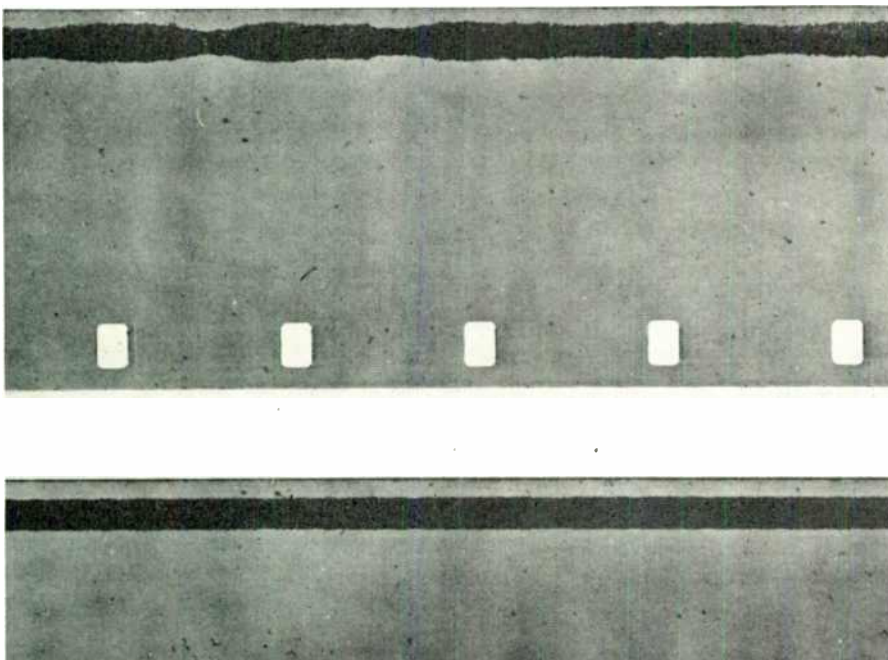
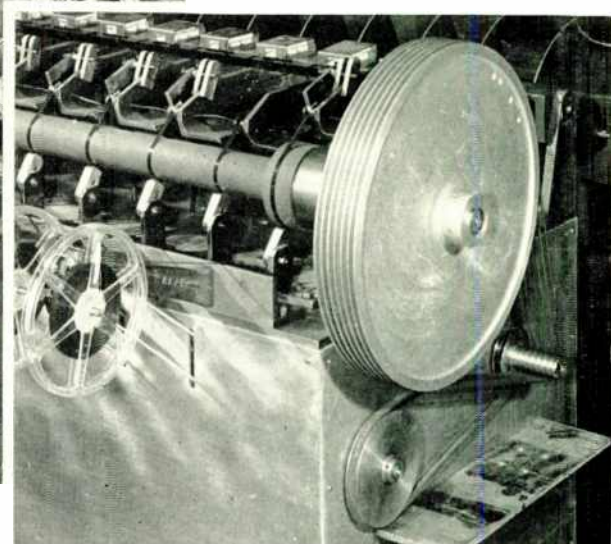
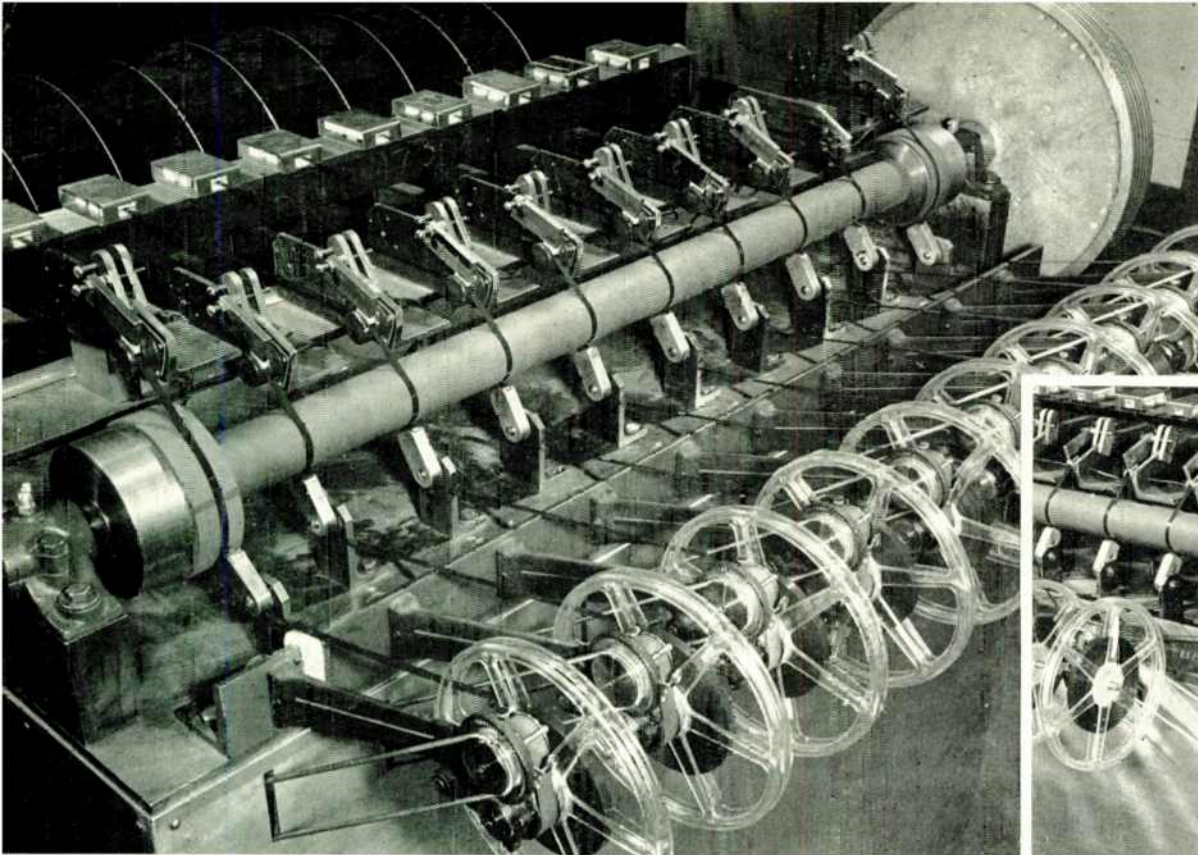

Fig. 3, above: Fluctuations in record of steady 7,000-cycle tone were introduced by contact printing machine. Below: There are no variations in this optical print



Multiple recorder opens up new possibilities for the use of tape recordings by producing eight copies simultaneously, with single or double sound tracks

MULTIPLE TAPE RECORDING

EIGHT TAPE COPIES, WITH SINGLE OR DOUBLE SOUND TRACKS, CAN BE RUN OFF SIMULTANEOUSLY ON THIS NEW RECORDING MACHINE—By MARTIN N. OLSON*

THE recent announcement of a machine developed by the Minnesota Mining and Manufacturing Company for the mass production of transcriptions on sound-recording tape has led to speculations which would perhaps benefit from a more thorough description of the machine and its capabilities.

Briefly, it is a machine which can produce up to 48 hours of recorded music on tape per hour by transferring the sound from a master tape to eight reels simultaneously, and without perceptible loss of quality. Its construction is shown in the accompanying photographs.

Uses for Multiple Recording:

The multiple recorder mass-produces recordings on 600- or 1,200-ft. lengths of tape, makes either single- or double-track recordings, and can turn out copies designed to run at speeds of $3\frac{3}{4}$, $7\frac{1}{2}$, 15 or 30 ins. per second. It can be adjusted by switch control for recording on reels of different lengths, and for different speeds.

The multiple recorder is in principle a high quality magnetic tape recorder capable of making several identical tape records simultaneously. This machine was

designed specifically to make multiple copies from a master magnetic tape record. Also, live shows or other types of recorded programs can be fed to the input. A single capstan drives all copy tapes as well as master tape. However, the speed ratio of copy to master is independent of capstan speed. Diameter of the capstan can be greater at the master channel, permitting use of high speed master to make lower speed copies.

Master records made at high tape speeds have inherently better wide-range fidelity than those made at lower tape speeds and, consequently, can be copied more faithfully than low-speed masters. Frequency, harmonic, and intermodulation distortion tests, as well as A-B listening tests, prove the copies to be accurate duplicates of the master when the higher tape speeds are used. It is practical, of course, to make low-speed copies of high-speed masters when a reduced fidelity is tolerable. Generally, a copy can have no better quality than that inherent to the master from which it is made; however, certain types of distortion present in the master can be corrected or reduced in the copying process so that a copy can actually sound better than the original record. Obviously, since distortion is inherent to low tape speed, it is less satisfactory to copy from a low

speed master to a low-speed copy, as the distortion would be cumulative.

It is also possible to make copies at a rate much greater than the basic playing speed. Copies to be run at $7\frac{1}{2}$ ins. per second can be made in half the actual playing time by doubling the process speed of master and copy tapes in synchronism, or copies to be run at $3\frac{3}{4}$ ins. per second can be processed at 3 or 4 times their playing speed.

Double-Pattern Tape:

By recording two patterns instead of a single pattern on the tape, the playing time on a particular reel can be doubled. Double-pattern tape has two parallel sound tracks, one track playing on the forward direction, and the other pattern on the reverse. Both forward and reverse patterns can be recorded simultaneously by the multiple recorder, so that double-pattern sound tape, with twice the playing capacity of the single-track tape, can be mass-produced at the same rate.

An idea of production rate is gained from the following: Using multiple recording, reels having 600 ft. of tape, double pattern, and a playing speed of $3\frac{3}{4}$ ins. per second can be turned out at the rate of 48 per hour, each reel having a full hour's playing time.

(Continued on page 32)

*Electrical Engineer, "Scotch" sound recording tape engineering laboratories, Minnesota Mining & Manufacturing Company, St. Paul, Minn.

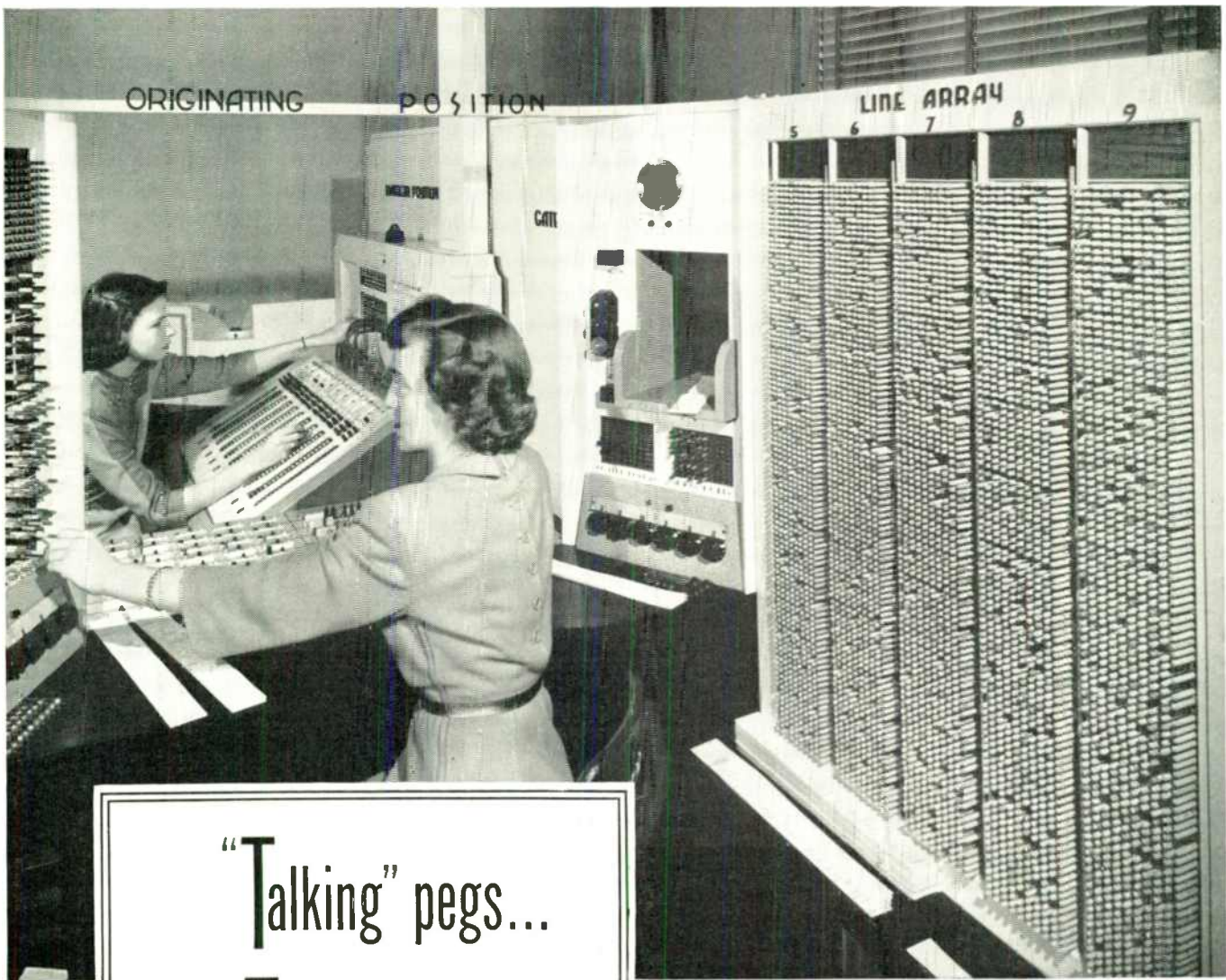

“Talking” pegs...
and Talking people

THERE ARE 10,000 pegs in this machine, representing 10,000 subscribers in a crossbar telephone exchange—the latest switching system which handles dial calls with split-second swiftness.

The pegs represent many types of telephone users—two-minute talkers and ten-minute talkers . . . people who dial accurately . . . those who make a false start or two. They are starting a journey through a unique machine which analyzes the performance of dial equipment in a typical central office.

But while an actual crossbar exchange connects your call in a matter of seconds, this counterpart moves far more slowly. It gives the Bell Laboratories engineers who built it time to observe what happens

to each call—where bottlenecks develop, which parts are overworked or underworked, which of the circuits are most used.

In a manual exchange, the number of operators may be changed to meet different traffic conditions. In crossbar, all switching is done by complex electro-mechanical devices, permanently built in. This machine shows how many devices of each kind there must be in a new exchange to give you the best of service with a minimum of expensive equipment.

This traffic-study machine is one of the many ingenious research tools devised by the Laboratories as part of its continuing job—finding new ways to give you better and better telephone service.



BELL TELEPHONE LABORATORIES

PIONEERS IN THE RESEARCH OF FM RADIO AND TELEVISION, AND ACTIVE IN DEVELOPING IMPROVEMENTS IN BOTH FIELDS TODAY

March 1949—formerly *FM*, and *FM RADIO--ELECTRONICS*

31

(Continued from page 30)

Reels with 1,200 ft. of tape, double pattern, and a playing speed of $7\frac{1}{2}$ ins. per second can be produced 32 per hour, with each reel having an hour of transcribed material.

Mechanical Design:

A non-synchronous induction motor is used for drive power. Accurate speed ratio of master to copy tape eliminates the necessity for precise motor speed control for copy work. Squirrel cage, line frequency, and line voltage fluctuation torque components are filtered by a flywheel incorporated in the system, plus a multiple plastic-belt drive. Frequency modulation in wow range due to dynamic natural periods of drive is prevented by use of multiple belts having a cross section and modulus of elasticity compatible with the mass of the motor rotor and capstan flywheel.

Special sleeve bearing design prevents wow due to climbing or rocking of the capstan shaft in bearings. The steel capstan shaft is of sufficient diameter to prevent whipping or deflection due to loading. Positive tape traction is attained by coating the capstan shaft with rubber having a high coefficient of friction relative to the tape surface. Variation in playback time due to tape traction loss is less than $\frac{1}{2}$ second in 15 minutes at 15 ins. per second. Frequency modulation distortion above wow range, due to torsion distortion of the rubber, is avoided by keeping the radial depth of the rubber small, and shore hardness high. The capstan surface is precision-ground to a wow less of than .1%. The use of pressure rollers at the capstan completely eliminates wow from tape tension variations in the wind-up system. Wind-up reel torque is compensated by the weight of the tape on the slipping belt take-up. This slipping belt is driven by a plastic belt transmission from the drive motor. Wow and higher-frequency modulation distortion due to elasticity of the tape and friction phenomena are minimized by using uniform tape tension control and locating the heads close to the capstan. Tape tension is sufficient to assure good conformity to the head gaps for high-speed tapes. Pressure pads are used at the heads for plastic-backed tapes operating at $3\frac{3}{4}$ ins. per second, and for all paper-backed tapes. Interchangeable head mounts permit the use of high-speed, single-track or double-track heads.

Circuits and Controls:

The electronic system provides complete dual channel amplification, equalization, and bias from a dual track master or two single track masters to sixteen record heads operating simultaneously for dual

track copies. Pre-amplifiers designed for 3,000 times voltage gain and low noise assure good dynamic range.

The equalizer system provides normal compensations to fit different tape speeds and heads, selectable by a switch. Additional flexible equalization is available for modifying the frequency characteristic of the copy. Record amplifiers of low noise level and high power capability permit operation on the low portion of the inter-modulation distortion curve to maintain a large recording current dynamic range.

To prevent bias beats, a common bias oscillator is used, with a separate amplifier for each channel (8-record heads per channel). Individual adjustment is provided for each head to maintain low distortion independent of record-head tolerances. A high bias frequency is used to reduce distortion. The magnitude of bias is adjusted in accordance with the tape speed, and the wave form of the bias is controlled for minimum distortion of recorded signal and minimum tape noise. DC power for the entire electronic system is regulated to less than .0001% ripple and voltage fluctuation noise, and the pre-amplifier supply is filtered to the same degree. No regulation of power for the drive motor is necessary for copy work.

As a result of this highly integrated mechanical and electrical design, faithfulness of reproduction in the multiple-recorded tapes can be held to such a high degree that they are virtually indistinguishable from the masters.

OPTICAL PRINTER

(Continued from page 29)

The sprocket teeth in this type of mechanism are not at the printing point, but operate above and below it to keep the two films in synchronous relationship. Such drives include unusually large flywheels which hold the motion constant to within 0.03%. The flywheels and sprockets on the two sides of the machine are driven by a common transverse shaft, which insures their keeping in step. An image of the negative soundtrack is formed on the positive printing stock by a train of highly corrected lenses, as is shown diagrammatically in Fig. 1. This image travels in the same direction as the positive film stock, and at the same speed. Therefore it prints without blurring.

The optical printer produces much sharper prints than the contact type of printer, and this difference appears as a major improvement in frequency response, shown in Fig. 2. In this figure, the solid curve shows the printing loss at different frequencies for the optical machine, while the dotted curve shows the much greater loss in prints made on a

contact printer in good adjustment. Many contact printers in commercial use give greater losses than are shown here. The losses that appear in the work of the optical printer are almost entirely due to the fact that the positive film does not have infinite resolving power. The increased losses shown for the contact printer are due to slippage occurring between the two films as they pass by the printing aperture.

Fig. 3 shows that this slippage is not regular, but highly irregular. In order to obtain these illustrations, a record of a steady 7,000-cycle tone was printed on the contact-type printer and also on the optical printer. These two prints were then re-recorded, using variable-area modulation. By doing this, any variations of sharpness in the print cause variations of output in reproducing it and, in the new negative that is obtained, these variations of level appear as changes in the width of the recorded wave. The upper sound track in Fig. 3 shows the 7,000-cycle wave as re-recorded from the contact print. The lower track was obtained from the optical print. It is immediately evident that the level of the high frequency signal from the contact print is fluctuating very rapidly over a range of at least 2-to-1 in level. Each sprocket hole represents $\frac{1}{24}$ of a second. Examination of the track shows that there is a decided tendency for the level to change at this same period. The level of the high frequency signal from the optically-printed track, on the other hand, is very nearly constant.

Listening tests, using prints of the same sound negative made optically and by the older method, show an improvement that is noticed immediately even by a non-technical audience. The sound from the optical print is brighter and more natural, and intelligibility of speech is substantially improved. Furthermore, the gain in definition of the very high frequencies is such that it becomes feasible to extend the frequency range of recording and reproduction by at least 3,000 cycles. This gives reproduction comparable to good disc transcriptions. That aspect of the subject was discussed in a previous article by the writer in *FM-TV*, for October, 1948.

The optical printer discussed here operates at a 1-to-1 ratio, since it prints on 16-mm. stock from 16-mm. sound negatives. Fortunately, similar improvements have been made in the printers now being made available for optical reduction printing from 35-mm. sound negatives. The newest of these machines have greatly improved mechanical filtering of the film motion, and their optical systems are better corrected than those formerly used, so that the 16-mm. prints produced by this method are

ZENITH brings you The Tops in FM-AM at Popular Prices

**The FM-AM
Table Sets that
are breaking
all records for
performance
and sales!**

The instant they appear in your store, they make you the leader in FM-AM with customer appeal! There has never been anything in table sets with the terrific tonal beauty, performance, and all-around quality of these new Zeniths† with Genuine Zenith-Armstrong FM. Their every feature offers a sure-shot demonstration that helps clinch the sale! So climb on the Zenith FM-AM bandwagon—get your share of the big profits these sets are making for stores from coast-to-coast.

SEE YOUR ZENITH DISTRIBUTOR

ZENITH RADIO CORPORATION
6001 Dickens Ave., Chicago 39, Illinois



THE "TRIUMPH"

Radio sensation of the year. No imitation, but genuine Zenith-Armstrong FM even at this low price. Glorious-toned, static-free FM with exclusive patented "Power Line" Antenna—just plug in and play. Long-Range AM reception, improved Wavemagnet.† Zenith-built Alnico "5" speaker. New "Cut-Away" Dial—so easy to see and tune. Swirl walnut, or black plastic cabinet. Plays on AC, DC.

\$59⁹⁵*
White Plastic
\$62.95*



THE "SYMPHONY"

Widely used by FM stations for demonstrations and monitoring broadcasts, the Zenith "Symphony" is famous for its rich, big console tone . . . tone that will make sales for you. Powerful 7½-inch speaker is made possible by Zenith's patented DialSpeaker design. New type Tone Control provides greater fidelity. Genuine Zenith-Armstrong FM with Zenith's patented "Power Line" Antenna gives glorious, static-free reception. Improved Wavemagnet. Rich swirl plastic cabinet. Plays on AC or DC.

\$79⁹⁵*
White Plastic
\$82.50*

ZENITH HAS THE GREAT VALUES

ZENITH
TELEVISION
and long distance RADIO

*Suggested retail price.
West Coast prices slightly higher.
Prices subject to change without notice.
†®

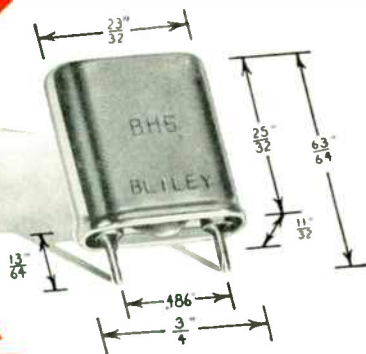

BH6

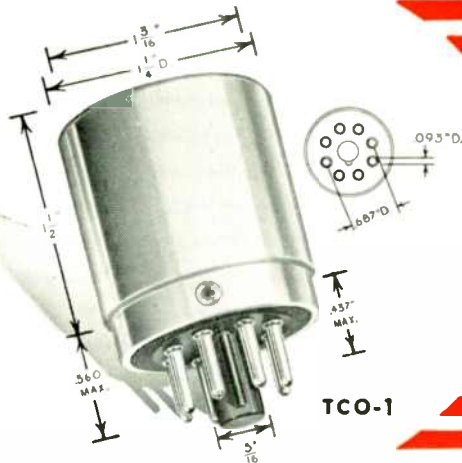

TCO-1

OPER. TEMP. 75°C · RATING 6.3V · 5.5W.

CRYSTAL CRAFTSMANSHIP in miniature

No need to sacrifice quality when space is limited. BLILEY Type BH6 crystal units pack small size and high precision into a hermetically sealed capsule. Supplied in the frequency range 1 mc to 100 mc with tolerances to meet all commercial or military specifications.

When you need extra stability specify BH6 units in TCO-1 or TCO-2 (single or dual) temperature controlled ovens. This combination will hold frequency within $\pm 0.0001\%$ between -55°C and $+70^{\circ}\text{C}$.

Both BH6 and TCO series units assure top performance with a minimum of weight and space. Both are built to BLILEY standards of craftsmanship, based on nineteen years of leadership in frequency control applications.

Bliley

CRYSTALS

BLILEY ELECTRIC COMPANY
UNION STATION BUILDING · ERIE, PA.

much superior to those to which the industry has been accustomed.

Since, as is shown in Fig. 2, there is some loss of high frequencies in printing even with the optical machine, it would appear at first sight that a further improvement could be made by producing all positive sound tracks by direct re-recording from a high-quality master. It is possible to do this by any one of several optical arrangements which yield what have been called direct positive sound tracks. These procedures, however, fail to produce as good overall quality as is obtained in prints from negatives, using the optical printer. The reason is that direct positives, whether made by the variable area or the variable density method, must be of considerably lower density than prints from negatives if they are to be reasonably free from distortion. This causes them to have approximately 10 db. higher background noise than properly-made prints. The amount of high frequency loss introduced by the optical printing process is easily made up by increasing the amount of pre-emphasis of the high frequencies, either in the original recording or in making the final mixed negative sound track for printing.

FM FOR BUSES

(Continued from page 15)

bus is subject to damage by cleaning brushes. This, no doubt, has led to front-mounted folded dipoles, window antennas, and others, all of which were abandoned after field tests by Link engineers. An optimum design was found in a special whip antenna, mounted on the front center of the bus just over the windshield. The cleaning brushes do not cause any damage to this antenna, and its simplicity and ease of installation make it almost ideal. The antenna mounting stud is shielded to prevent any ignition pickup by this relatively large fitting. Whips are readily replaceable should they be damaged.

The Link type 2388 receivers used in Duluth were not provided with means to raise the audio level of announcements over the music level. To a certain extent, this was taken care of by modulation control at the broadcasting station. Experience, however, shows the necessity for about a 10 db differential in level between music and announcements.

Two different devices to raise the audio level of music as gear shift and outside noises increase have been tried out as auxiliary units. It is not believed that devices of this kind will be very widely adopted, for they have been generally reported as unsatisfactory. No device of this kind is standard at the present time.

(Part 2 will appear next month)

"WRITE FOR OUR NEW PARABOLIC ANTENNA CATALOG"

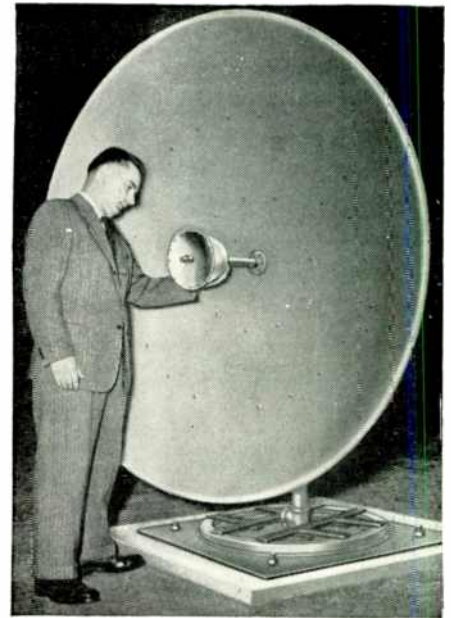

Immediate Delivery...

PARABOLIC ANTENNAS

FOR

- FM and AM Studio-to-Transmitter Link
- Television and Facsimile Relay Work
- Multi-channel Point-to-Point Relay
- Research and Development Laboratories

The Workshop can supply parabolic antennas in a wide range of types, sizes and focal lengths, plus a complete production and engineering service on this type of antenna.

Workshop test equipment and measurements for the determination of antenna characteristics is outstanding in the industry. These facilities, coupled with the wartime experience of its engineers on high frequency antennas, assure exceptional performance.

PARABOLAS — Precision-formed aluminum reflectors. Can be supplied separately, if desired.

MOUNTINGS — Various types of aluminum reinforced mountings can be supplied with all antennas.

R. F. COMPONENTS — Precisions machined and heavily silver plated. Critical elements protected by low-loss plastic radome.

PATTERN AND IMPEDANCE DATA — A series of elaborate measurements of both pattern and impedance are made to adjust the settings for optimum performance. Pattern and impedance data are supplied with each antenna.

POLARIZATION — Either vertical or horizontal polarization can be obtained easily by a simple adjustment at the rear of the reflector.

SPECIAL ANTENNAS — Parabolas can be perforated to eliminate wind resistance or sectioned to produce a specified antenna pattern.

OTHER ANTENNAS — FM and television receiving antennas. A complete line of amateur antenna equipment.

Prices on Request

The WORKSHOP ASSOCIATES, Inc.
65 NEEDHAM STREET
Newton Highlands, Massachusetts



FM AND TELEVISION

Trolley Service restored in a jiffy!

**CINCINNATI STREET RAILWAY
SPEEDS EMERGENCY WORK
WITH 2-WAY *Motorola* RADIO
and
SYLVANIA LOCK-IN TUBES**

NO time lost in restoring service on the lines of the Cincinnati Street Railway Company! 2-way Motorola equipment maintains constant communication between headquarters and mobile equipment—5 tower trucks, 2 wreckers, 2 general-purpose trucks, 7 official and 5 supervisors' cars. Needed repairs are under way usually in a matter of seconds!

For a job as vital as this, Motorola has found it can depend on Sylvania Lock-In Tubes. These sturdy tubes stay firmly in place—unaffected by jolting and jarring—offer outstanding electrical advantages too. Connections are short and direct . . . there are no soldered joints, few welded ones. Getter located on top . . . leakage reduced by separating getter material from leads. See Sylvania Distributors, or write Radio Tube Division, Emporium, Pa.

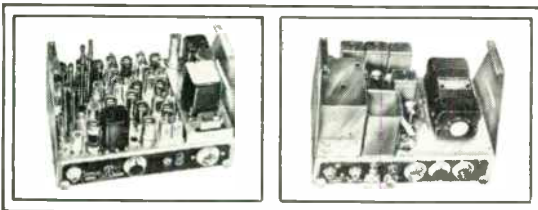

Transmitter and Receiving Unit used in Cincinnati Street Railway Company's mobile equipment, manufactured by Motorola, Inc., Chicago.

The famous Lock-In Tube's superiority makes it the ideal choice for equipment on the road, in the air, on the rails, marine radar, FM and television.



SYLVANIA ELECTRIC

March 1949—formerly FM, and FM RADIO--ELECTRONICS



Service restoration gets under way without delay as equipment responds to dispatcher's instructions.

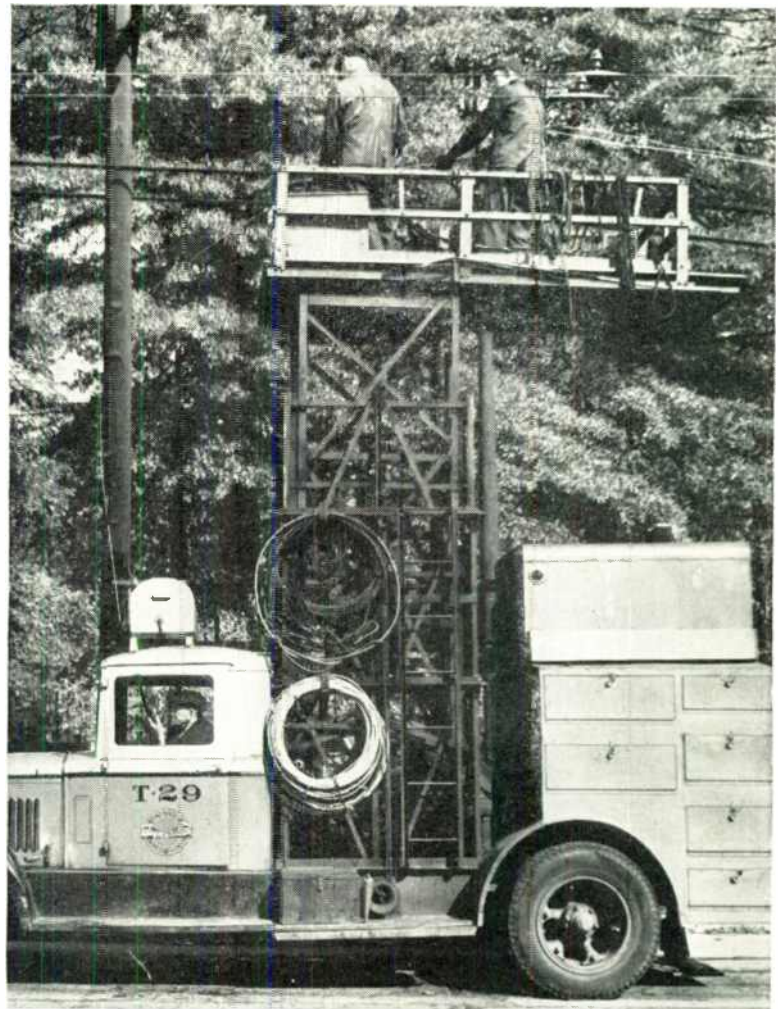

Headquarters can quickly direct the needed equipment to the scene of a tie-up.

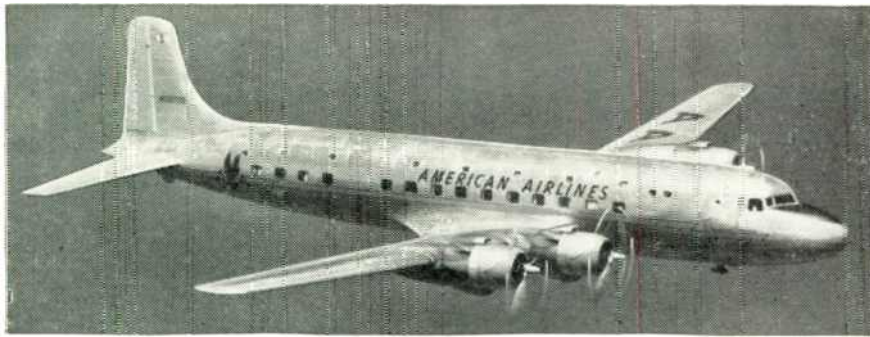

AMERICAN AIRLINES CHOOSES ALTEC LANSING 8" SPEAKERS FOR FAMOUS FLEET OF DC-6s

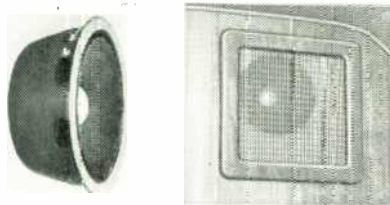

400 B DIA.-CONE SPECIFICATIONS:

Power Rating	12 watts
Voice Coil Impedance	8 ohms
Required Amplifier	
Output Impedance	4-8 ohms
Voice Coil Diameter	1 3/4"
Speaker Diameter	8 1/4"
Speaker Depth	3 5/8"
Weight	4 lbs.

After exhaustive competitive in-flight operating tests of Altec Lansing and other speakers, American Airlines' communications division engineers reported: "Observers all voted for the Altec system on the basis of quality and clearness." Entire passenger fleet of DC-6's will be Altec Lansing 8" 400B Dia-cone equipped.

Send for brochure describing entire Altec Lansing line of speakers, containing frequency response curves.



161 Sixth Avenue
New York 15, N.Y.
1161 North Vinc St.
Hollywood 38, Cal.

WHAT'S NEW THIS MONTH

(Continued from page 13)

them in this, to the point that they got dealers to stock television receivers far out in fringe-service areas where FM sets would have been sold more easily and profitably.

Many dealers who could have sold ten FM sets to one TV model didn't even try. They not only didn't try to sell FM sets. They didn't even go to the trouble of listening to FM broadcasting, and finding out what advantages it could offer their customers over AM. Yet they could have sold ten FM sets to one TV model. Even today, dealers in areas where there is no prospect of television service talk about TV instead of selling FM.

Broadcasters must share some of the responsibility for this. As recently as last November, James Shouse, president of Crossley Broadcasting Corporation, told the National Editorial Association: "At that time (in a previous address) I said that I did not think that the fact that through FM you could do substantially the same thing as with AM was an impelling reason to change systems of broadcasting. I said additionally, in connection with the high-fidelity claims made for FM, that they were erroneous . . . And that after the novelty wore off, I did not think that a great many people were going to spend money for FM receivers providing frequencies so high that the human ear could not detect them." Then said Mr. Shouse: "As a broadcaster, I do not think that television is going to supplement radio. I think that, with the exception of widely scattered and remote rural areas containing some small towns, television stands a good chance not of supplementing broadcasting as we know it today, but of replacing it."

Now, maybe, speaking "as a broadcaster," he had some sound reason for selling audio broadcasting down the river. That is not clear, inasmuch as Mr. Shouse heads up WLW. On the other hand, he is just one of many executives among the broadcasters and set manufacturers who are loudly proclaiming that television will replace audio broadcasting at a time when TV is years away from supporting the industry.

Specifically, broadcasters need something they can sell to meet the encroaching competition of newspapers and magazines. Set manufacturers need something that will replace the lost volume of AM receiver and phonograph sales. Television, for all the promotion that's behind it, can't serve this purpose now.

FM broadcasting and FM receivers can meet this need. Much valuable time

(Continued on page 38)

Square Wave Generator



MODEL 71

SPECIFICATIONS

FREQUENCY RANGE: 5 to 100,000 cycles.
WAVE SHAPE: Rise time less than 0.2 microseconds with negligible overshoot.
OUTPUT VOLTAGE: Step attenuator giving 75, 50, 25, 15, 10, 5 peak volts fixed and 0 to 2.5 volts continuously variable.
SYNCHRONIZING OUTPUT: 25 volts peak.
R. F. MODULATOR: 5 volts maximum carrier input. Translation gain is approximately unity—Output impedance is 600 ohms.
POWER SUPPLY: 117 volts, 50-60 cycles.
DIMENSIONS: 7" high x 15" wide x 7 1/2" deep, overall.

MANUFACTURERS OF
 Standard Signal Generators
 Pulse Generators
 FM Signal Generators
 Square Wave Generators
 Vacuum Tube Voltmeters
 UHF Radio Noise & Field Strength Meters
 Capacity Bridges
 Megohm Meters
 Phase Sequence Indicators
 Television and FM Test Equipment

MEASUREMENTS CORPORATION

BOONTON  NEW JERSEY



Early this year the one-billionth Sprague Capacitor rolled off the fast-moving production lines in North Adams.

Fittingly enough, this billionth unit was one of the revolutionary new molded paper tubulars. Throughout the years, it has been engineering progress as typified by this development that has enabled Sprague to attain its present position as one of the largest, most diversified and most dependable sources of capacitor supply.

Other important developments which have helped materially in swelling the total of Sprague production include *Vitamin Q capacitors for higher voltages, higher temperatures and higher insulation resistance; *Hypass 3-terminal networks; glass-to-metal sealed capacitors; molded *Prokar capacitors for sub-miniature assemblies; high-voltage coupling capacitors; electrolytics for dependable operation up to 450 volts at 85°C., and many other types of capacitors.

*T. M. Reg. U. S. Pat. Off

SPRAGUE

Pioneers of Electric and Electronic Progress

SPRAGUE ELECTRIC COMPANY • North Adams, Mass.

March 1949—formerly *FM*, and *FM RADIO-ELECTRONICS*

37



For Clear, Brilliant Reception on All Channels

Here's a *better* Television Antenna, engineered and built in the famous RAULAND quality tradition! The Model 155 demonstrates exceptional coverage and high-efficiency on *all* channels. Features dual-section design; low band section covers Channels 2 through 6 and FM band. High band section covers Channels 7 through 13. Unusually low standing wave ratio is maintained throughout all channels, and a highly efficient built-in coupling network contributes to maximum efficiency on all bands. Lightweight aluminum construction throughout withstands 80-mile wind with 1/4" sleet or ice load. With threaded flange for coupling to 1" pipe. Has lucite low-loss insulators. Special MT-500 heavy steel base available optional; fully adjustable from horizontal to vertical. Antenna can be permanently grounded for protection against lightning. Direct match to standard 300 ohm input. From every angle, the RAULAND Model 155 Television Antenna demonstrates superior performing advantages!

Rauland

Write for interesting descriptive bulletin

THE RAULAND CORPORATION
4263 N. Knox Ave., Chicago 41, Illinois

THREE TOWERS • 400-FOOT BLAW-KNOX 10% DISCOUNT

We recently purchased three 400' Blaw-Knox, SGN, constant cross-section, guyed towers. Then we had a change of plans, so now would like to dispose of them.

The three towers are brand new, have never been erected. They are completely galvanized, and all parts necessary for the installation, including insulators, are available.

We paid \$10,600 each for these towers—a total of \$31,800. Since then Blaw-Knox have increased their prices considerably. However, since we are reluctant to warehouse towers for which we have no immediate use, they are being offered at a 10% discount.

So here is your chance to purchase one, two, or all three of these towers at 10% off the purchase price, and save up to \$3,180.

IMMEDIATE DELIVERY — BOX No. 31

WHAT'S NEW THIS MONTH

(Continued from page 36)

has been lost already, but the radio industry can move fast once it starts. Perhaps the jump-off would be a switch from RMA's campaign for "A Radio Set in Every Room" to "An FM set in Every Home." And with that should go the promotion of an outdoor antenna for every FM receiver.

The foregoing review leads to the conclusion that, in the best interests of the industry and the public, FM and TV should be promoted side by side and with equal vigor.

However, that is not intended as a prediction of what is going to happen. 1949 may prove to be a very disastrous year for radio. It doesn't need to be. But we don't know anyone who has made up his mind how the score is going to add up next December 31st.

CLASSIFIED ADVERTISEMENTS

Positions Wanted: No charge. Use either your own name and address or FM and TELEVISION box number.

Other Advertisements: 20¢ per word, minimum \$2.00. One-inch advertisements in ruled box, \$10.

Copy received up to the 20th of the month will be published on the 15th of the month following.

Address replies to box numbers: FM and TELEVISION, Savings Bank Building, Great Barrington, Mass.

FOR SALE: Vibropacks. Mallory VP555. brand new \$25. Box 39, FM-TV.

FOR SALE: G. E. FM transmitter, 3 kw., model 4AF2B1, 42-50 mc. Consists of 250-watt unit and amplifier. Good operating order, with tubes. Adaptable emergency service. Make offer. WMIT, Winston-Salem, N. C.

CREATIVE PRODUCER, young, ambitious, 2 years TV experience, wants a permanent position in TV. If you're looking for such a man, you've found him. Address: Nathan Rutman, 456 E. 176 St., New York 57.

DIRECTOR or assistant for FM-TV station in midwest. Have had several years experience in motion picture production and engineering. Training in both photography and electricity. Full qualifications sent on request. Box 34, FM-TV.

RADIO PLANT EXECUTIVE, now employed, desires position as executive or assistant to top management. 20 years' experience in radio production, inspection, service, engineering, sales, cabinet manufacture. Government liaison, union bargaining. Age 43, grown children, will settle anywhere. Box 35, FM-TV.

TRANSMITTER MAINTENANCE engineer, operator, 20 years' experience AM-FM-TV. Can go anywhere in U. S. A. Box 36, FM-TV.

TV DESIGN engineer, 8 years' radio experience, familiar with Du Mont, RCA, G.E. equipment. Some station construction and operating experience. Box 38, FM-TV.

FM AND TELEVISION

ZOPHAR



WAXES COMPOUNDS and EMULSIONS

FOR
INSULATING and WATERPROOFING
of ELECTRICAL and
RADIO COMPONENTS

Also for
CONTAINERS and PAPER
IMPREGNATION

FUNGUS RESISTANT WAXES

ZOPHAR WAXES and COMPOUNDS

Meet all army and navy
specifications if required

Inquiries Invited

ZOPHAR MILLS, INC.
FOUNDED 1846
122-26th ST., BROOKLYN, N. Y.

DIRECTORY OF COMMUNICATIONS SYSTEMS

Copies of **FM-TV** for January, 1949, containing the directory of radio systems operated by taxis, public utilities, and special services are still available.

This issue also contains the complete specifications of all makes of communications equipment.

PRICE 25c

FM-TV MAGAZINE
Great Barrington, Mass.

Advertisers' Index

Adair, George P.....	5, 13
Alden Products Company.....	39
Alford, Andrew.....	12
Altee Lansing Corp.....	36
American Phenolic Co.....	5
Amy, Aeeves & King, Co. Inc.....	11
Barone, S. A. Company.....	13
Bell Telephone Labs.....	31
Belmont Radio Corp.....	3
Biley Electric Co.....	34
Browning Laboratories, Inc.....	Inside Back Cover
Collins Audio Products.....	11
Commercial Radio Equip. Co.....	13
Communications Research Corp.....	13
Davis, George C.....	13
Du Mont Laboratories.....	1
Eitel-McCullough, Inc.....	40
Electronics Research Pub. Co.....	11
Federal Tel. & Radio Corp.....	6, 7
Graybar Electric Co.....	14
Harvey Radio Labs., Inc.....	39
Hewlett-Packard Co.....	Inside Front Cover
Hughey & Phillips Co.....	11
JFD Mfg. Co.....	9
Jansky & Bailey.....	12
Kay Electric Co.....	11
Kear and Kennedy.....	13
Lansing Sound, Inc., James B.....	11
Maurer, J. A., Inc.....	2
May, Russell P.....	12
McCachren, Winfield Scott.....	13
McIntosh, Frank H.....	13
McKey, Dixie B. & Assoc.....	12
McNary and Wrathall.....	13
Measurements Corp.....	36
Motorola, Inc.....	Back Cover
National Co.....	4
Pollack, Dale.....	12
Radio Consultants, Inc.....	12
Radio Music Corp.....	11
Rangertone, Inc.....	11
Rauland Corp.....	38
Ray, Garo W.....	12
Simpson Electric Inst. Co.....	7
Smeby, Lynne C.....	12
Sprague Electric Co.....	37
Sylvania Electric Pds., Inc.....	35
Topflight Tape Co.....	11
Weldon & Carr.....	13
Western Electric Co.....	14
Williams, Nathan.....	12
Wilnotte, Raymond M.....	12
Wincharger Corp.....	10
Workshop Associates, Inc.....	13, 34
Zenith Radio Corp.....	33
Zophar Mills.....	39

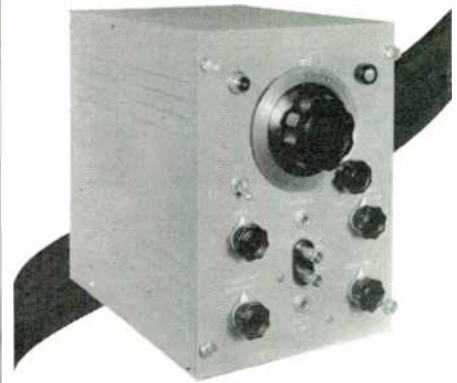

VISALGEN MODEL 205TS

FASTER, MORE ACCURATE VISUAL ALIGNMENT

Use the HARVEY Visual Alignment Signal Generator for IF and RF circuits in FM and AM mobile and broadcast receivers. With any oscilloscope, the HARVEY Visalgen shows overall frequency response on the screen. Speeds factory production tests, service work, and keeps mobile communications equipment at peak efficiency. *Write for Bulletin 53.*

HARVEY RADIO LABS., INC.
449 Concord Ave., Cambridge 38, Mass.

It's Alden — for... facsimile dispatching equipment

designed for your specific purposes. It may be for wire or for radio circuit. A pilot operation — or in quantity production

Our engineering provides for messages to be automatically picked up at scanner with recorder starting, stopping, and framing automatically, controlled by transmitter.

Alden Engineering experience covers the range of operations from low speed for narrow bandwidth wire lines to high speed large area equipment.

So whether you are dispatching a memo from office to office — or a full size weather map across the country — Alden has the system and will make to special order equipment that fits your needs. **For instance —**

200 cycle bandwidth	15KC bandwidth
Memo	Newspaper
Map	Map
with 4" width — 50 LPI	with 18" width — 100 LPI
2 in/min.	9 in/min.



or



Alden engineering opens new fields in impulse recording

Filling the gap between indicating instruments and the Cathode Ray Oscilloscope.

Giving a permanent record directly without photographic processes.

Alden Recording Equipment operates with Alfax Electrosensitive Recording Paper producing permanent recordings. Alfax is a sensitive high speed paper that does not require special packaging. It is stable in storage, and is permanent in its recording.

To solve that facsimile or impulse recording problem — write now to

ALDEN PRODUCTS CO.
Brockton 64FD, Massachusetts

Follow the Leaders to

Eimac
TUBES
The Power for R-F

Accepted

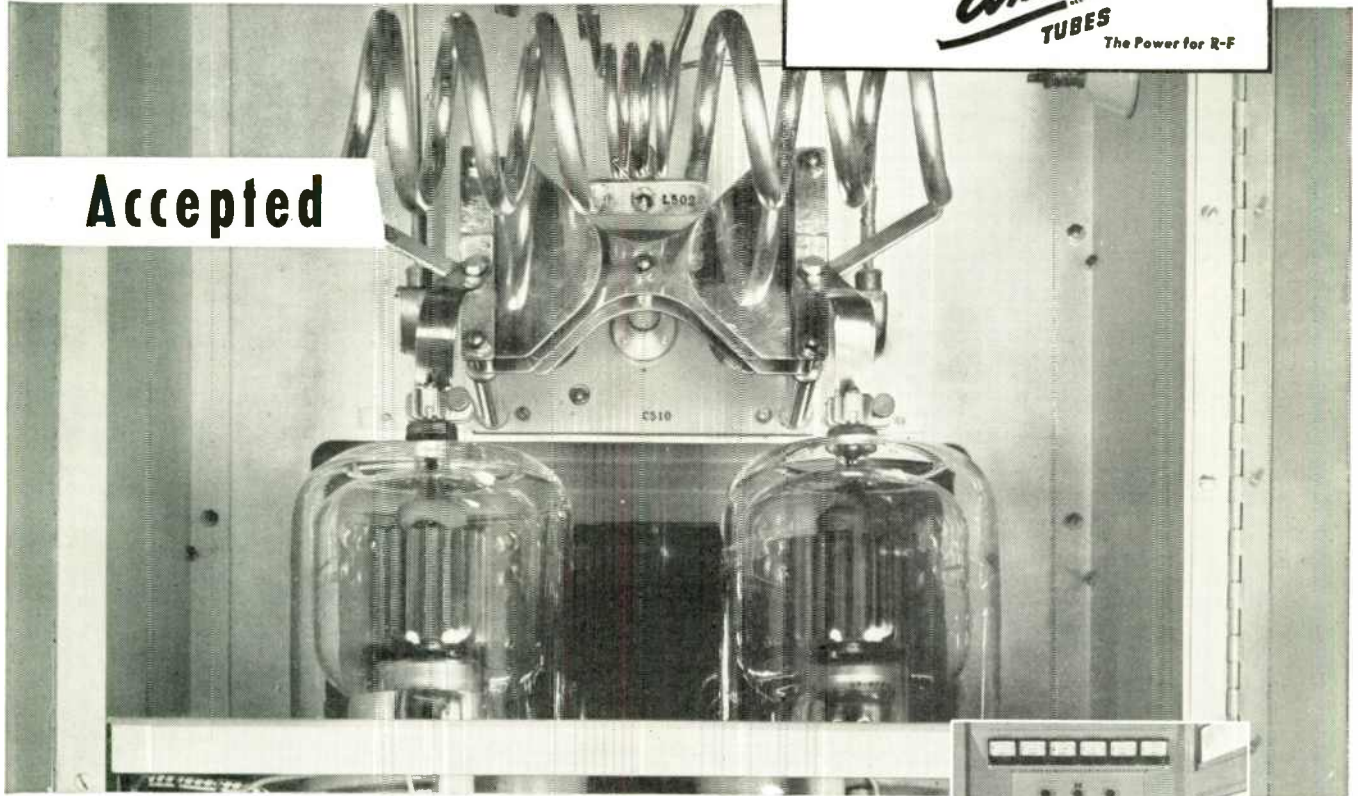

**For Emergency Services
The Link 3000UFS Transmitter
and Eimac 4-1000A Tetrodes**

Here's a team that fills the bill by providing the dependability of performance required by police and other emergency communication services.

Link Radio, well known manufacturers of radio communication equipment, in designing their 3 kw 30-50 Mc. FM transmitter choose Eimac 4-1000A tetrodes to power the final amplifier. The high power-gain of these tubes enabled Link to use their standard 50 watt transmitter as a driver. The resulting compact simplified transmitter is ideally suited for control through telephone circuits from remote locations. A single pair of telephone lines carries transmitter modulation, power control, overload relay reset, and frequency selection plus receiver output and selection.

Because of their power-gain abilities, stability and other exceptional characteristics, the 4-1000A tetrode offers the design engineer interesting potentialities . . . write direct for further information, data is available.



LINK 3000 UFS



EIMAC 4-1000A TETRODE

EITEL - McCULLOUGH, INC.

212 San Mateo Ave., San Bruno, California

Export Agents: Frazer & Hansen, 301 Clay St., San Francisco, California

ANNOUNCING THE BROWNING LABORATORIES

FM TRICAST RECEIVERS

Designed to produce Revenue for FM Stations

THE BROWNING LABORATORIES, pioneer manufacturers of genuine Armstrong limiter-discriminator FM receivers since 1940, now offer a new series of FM models designed specifically to produce direct revenue for broadcast stations. These new models, called Tricast receivers, are engineered specifically for three very important fixed-frequency services. They are:

1. Audio-Boost operation, for storecasting systems. When the announce microphone is switched on, a supersonic tone is transmitted from the FM station. This inaudible signal automatically raises the audio level of each type RP-24 Tricast receiver to any preset level, thus giving emphasis to commercial announcements.

2. Dual-Control operation, for reception in stores, restaurants, bars, hotels, and other public places where it is desired to raise the audio level for some announcements, and to suppress the loud-speakers entirely during other periods. Type RP-25 Tricast receivers are designed for this purpose. They are controlled by transmitting either or both of two supersonic tones. When tone No. 1 is transmitted, the audio level of all type RP-24 and RP-25 receivers is raised. However, if tone No. 2 is transmitted also, the speakers of all RP-25 sets are cut off until the same tone is retransmitted.

3. Local-Control operation, permitting the continuous reception of a single FM broadcast station. Type RP-23 Tricast receivers are designed for monitoring, relaying, and other special services.

THE BROWNING LABORATORIES offer complete engineering service in planning public installations of Tricast receivers, to be sold or rented by broadcast stations, service companies, or other organizations. Tricast receivers are tuned by crystal control to one station only. They offer the quickest, simplest, and most profitable means of audience-building. Your request for Bulletin F16 will bring complete information.

BROWNING LABORATORIES, INC.
WINCHESTER, MASSACHUSETTS

CANADIAN REPRESENTATIVE: MEASUREMENTS ENGINEERING ARNPRIOR, ONTARIO

what *Motorola's* "GOOD NEIGHBOR POLICY"

means to you...



Motorola  — Instantaneous Deviation Control
ANOTHER MILESTONE ALONG THE ROAD TOWARD ADJACENT CHANNEL OPERATIONS

Motorola Instantaneous Deviation control eliminates the severe nuisance interference that develops from channel "spill-over" by means of a new slope limiting device now an integral part of all currently manufactured Motorola transmitters. I.D.C., applied universally, will make close channel occupancy practicable. It is an *absolute solution*—not a conventional compressor amplifier or clipper-limiter compromise. Motorola's I.D.C. requires no "attack time," but controls carrier excursions instantly.

Motorola I.D.C. is available in kit form for all existing Motorola transmitters—mobile and base station. By installing I.D.C. in your transmitters—and urging your channel neighbors to reciprocate, you can enjoy new efficiency of communication.

what does for you

In addition to the "Golden Rule" benefits at left, I.D.C. gives you:

1. Eliminates the reduction of maximum range or received energy level normally caused by over-modulation.
2. New versatility in transmitter speech circuits. Optimum setting of modulation level will allow satisfactory modulation by female or deep-voiced male dispatchers.
3. New freedom from background noises. (Microphone can be held close to lips at I.D.C. tolerates wide ranges of volume.)

NEW PROOF OF MOTOROLA'S LEADERSHIP!

Years ahead against Motorola I.D.C. today brings your equipment into compliance with FCC regulations drafted for effect on July 1, 1950.

MAIL THIS COUPON TODAY

Motorola Inc. Communications Div.
 4545 Augusta Blvd., Chicago 31, Illinois

Dept. FM & T

Please send me additional information on Motorola I.D.C.

NAME _____
 COMPANY _____
 POSITION _____
 ADDRESS _____
 CITY _____ STATE _____

Motorola
FM 2-WAY RADIO
 MOTOROLA: World leader in mobile 2-way radio communications

Canadian Distributor: Rogers Majestic Ltd., Toronto - Montreal