

FMM

AND TELEVISION

MAY 1947

NEW APARTMENTS HAVE
FM ANTENNAS
(SEE PAGE 1 AND 2)

ARTICLES for

BROADCASTING:
 EXECUTIVES—Pgs. 4, 19, 21, 28, 40
 ENGINEERS—Pgs. 6, 24, 27, 28, 31, 35

MANUFACTURING:
 EXECUTIVES—Pgs. 4, 8, 19, 21, 34, 40
 ENGINEERS—Pgs. 6, 21, 24, 28, 31, 35,
 42

COMMUNICATIONS:
 SUPERVISORS and
 ENGINEERS—Pgs. 6, 19, 31

SALES & SERVICE:
 DEALERS and
 JOBBERS—Pgs. 4, 8, 19, 21, 40
 SERVICEMEN—Pgs. 21, 28, 35, 40

★ ★ Edited by Milton B. Sleeper ★ ★

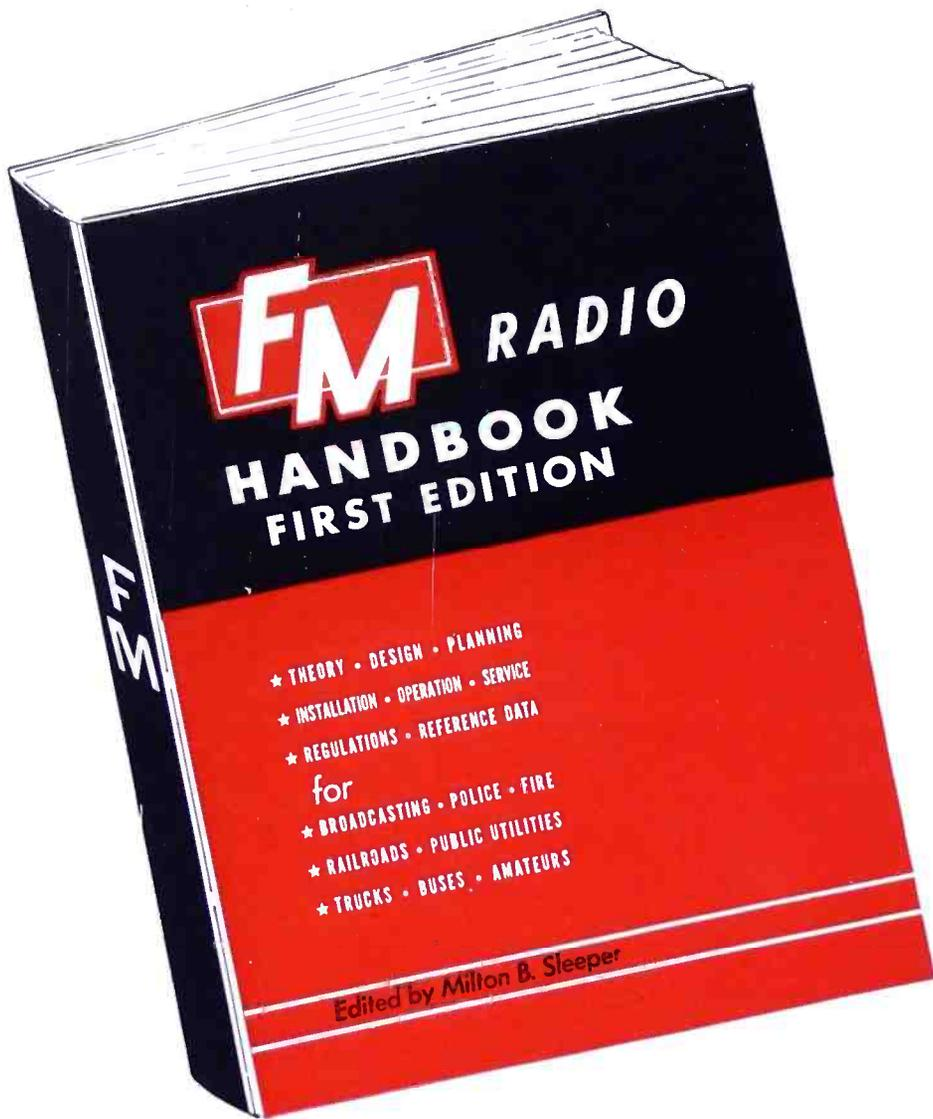

Just off
the Press!

\$4 postpaid in U. S.
elsewhere \$4.25
in the Lifetime Library Binding

the Industry's Most-Needed Source of Information
The STANDARD FM HANDBOOK

THE 15 chapters of the FM HANDBOOK were written by 14 outstanding FM engineers. This book, of 174 pages, 8¾ by 11½ ins., is equal to 300 pages of the ordinary handbook size. There are 218 photographs, wiring diagrams, and charts to illustrate the latest FM equipment and circuits. Here is a resume of the chapters:

1. Background of FM: as told by Major Armstrong to the Senate Interstate Commerce Committee in December, 1943. Also, excerpts from his log in 1934, '38, and '39.

2. Theory of FM: by Rene Hemmes. This is the most complete and understandable explanation of FM theory ever written. By using charts and diagrams, the functions of FM circuits are shown clearly, without recourse to mathematics. This chapter explains all the special features of receiver design, including AFC; and transmitter design, including the Armstrong dual-channel modulator.

3. Business of FM Broadcasting: by Milton B. Sleeper. Answers questions from those planning to enter FM broadcasting.

4. FM Studio Techniques: by D. W. Gellerup. Explaining fundamental differences between AM and FM techniques.

5. Coaxial Lines for FM Transmitters: by C. Russel Cox. A complete exposition, with working charts and mechanical layouts.

6. Audio Distortion and Its Causes: by Jerry Minter. A study of cross-modulation and its effect on tone quality.

7. High-Fidelity Reproduction: by John K. Hilliard. Describing the operation and design of coaxial speakers and high-fidelity amplifiers.

8. Antennas for Communications Frequencies: by James A. Craig. Covering all types of antennas for 30 to 44, 72 to 76, and 152 to 156 mc.

9. Selective Calling Methods: by Milton B. Sleeper. Explanation includes a call-number chart for individual and group calling.

10. Maintenance of Communications Systems: by Frank Bramley. How Connecticut State Police handles the maintenance of 332 cars and 11 main stations.

11. Alignment of FM Receivers, by Bernard J. Cosman. The fast, visual method for aligning FM broadcast and communications receivers.

12. WWV Signals for Frequency Checking, by Arthur Fong. Describing a receiver for checking circuits, meters, and modulators from WWV transmissions.

13. Railroad Radio Installations: by Arnold Nygren. Presenting factual data on their operation and performance.

14. Notes on Facsimile Equipment, by Frank R. Brick. Outline of progress for commercial and broadcast services.

15. FCC Standards of FM Engineering Practice, corrected to January 1, 1947.

NO OTHER BOOK LIKE IT

This is the first and **ONLY** Book ever written on FM which covers **BOTH** theory and practice. It answers questions for those engaged in manufacturing, broadcasting, communications, sales, and maintenance. Whatever your connection with the industry, you'll find that it contains the largest amount of practical useful information you have ever bought in any one book!

ORDER YOUR COPY NOW!

FM and TELEVISION

Savings Bank Bldg.
Great Barrington, Mass.

Please send me by return mail a copy of the Standard FM Handbook.

Enclosed are \$2.00 (paper edition)
 \$4.00 (cloth edition)

Name.....

Street.....

City.....

Postpaid in U.S.A. — Add 25¢ foreign postage

NEW

SOCKETS AND SHIELDS...

for miniature button base tubes

These new National sockets are of mica-filled natural molded Bakelite with silver-plated beryllium-copper contacts — designed for maximum dependability and adaptability. The contacts — either axially or radially mounted and removable for replacement — provide short leads and low inductance so vital to ultra-high frequency design. Sockets are built to JAN specifications — can be used with or without shields.

Made in three sizes to accommodate the various sizes of miniature tubes, the shields are of nickel-plated brass, with cadmium-plated phosphor bronze spring to provide correct tension to hold both tube and shield in place regardless of angle or vibration. Shield bases are of nickel-plated brass, with two 4/40" spade bolts mounting both socket and shield base.

You'll find hundreds of other parts, both new and old, to improve your apparatus in the new 1947 National Catalog.

XOA Socket
with XOS-3 Shield
and Shield Base

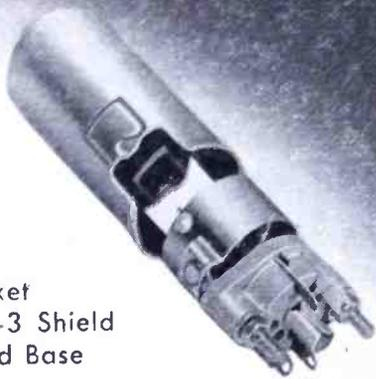

XOA Socket

XOR Socket



XOS-1 Shield
for 1 3/8" high
tube body
(6AK5 type)

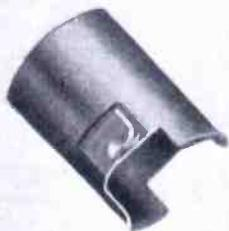

XOS-3 Shield for
2" high tube body
(OA2 type). Also
available: XOS-2
for 1 1/2" high tube
body (6C4 type)



Shield Base for
XOS-1, XOS-2
or XOS-3



NATIONAL
COMPANY, INCORPORATED
MALDEN, MASS.

MAKERS OF LIFETIME RADIO PRODUCTS

Over 100 Stations Fully Equipped by Raytheon in Less Than One Year

An enviable record based on advanced engineering and modern design

● More and more station owners every day are turning to Raytheon for the very finest in broadcast equipment. Raytheon is leading the way with simplified circuit design, thorough engineering and complete dependability.

Across the nation, enthusiastic station owners and engineers (both AM and FM) praise the high fidelity, servicing accessibility and low-cost maintenance of Raytheon broadcast equipment—from Single-Channel Remote Amplifiers to 5 KW Transmitters. With Raytheon equipment they find it far easier to set up programs—and operation is so simple and logical that errors are cut to a minimum.

Be sure you have *all* the facts before you buy. Investigate Raytheon's complete line of speech input equipment and both AM and FM Transmitters ranging from 250 to 10,000 Watts.

These superb Raytheon products assure the most practical application to *your* specific broadcast problem . . . bring you the finest in modern high fidelity and engineering excellence. Write or wire for illustrated specification bulletins, including complete technical data.

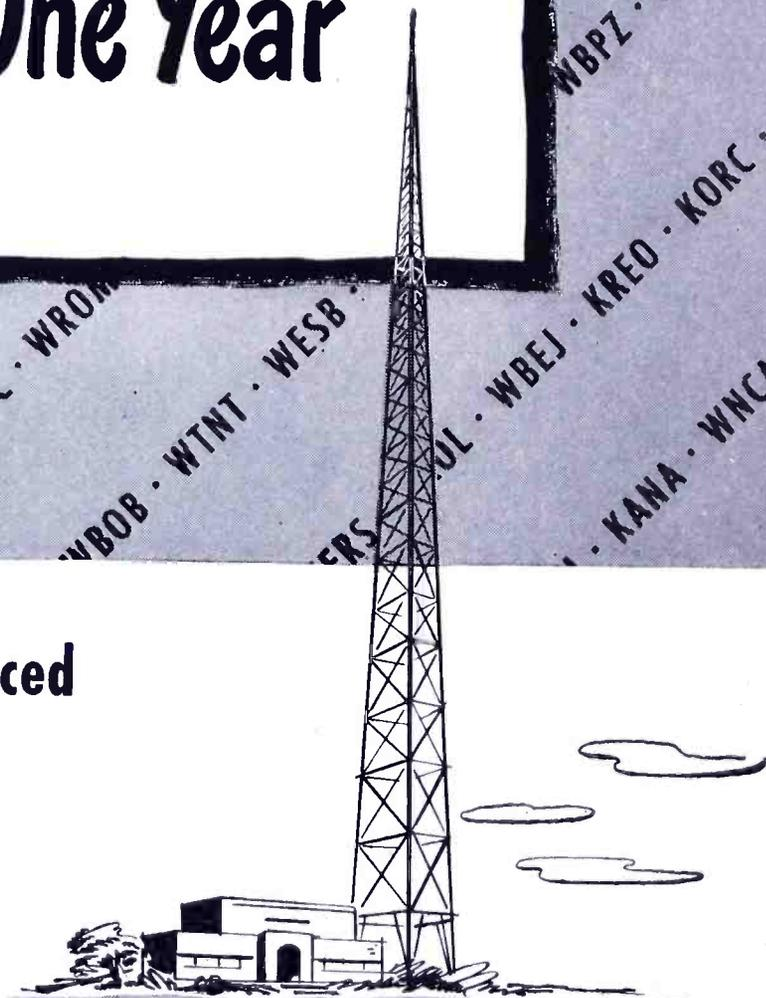

RAYTHEON

Excellence in Electronics

RAYTHEON MANUFACTURING COMPANY
BROADCAST EQUIPMENT DIVISION
7475 N. ROGERS AVE., CHICAGO 26

Devoted to Research and Manufacturing for the Broadcasting Industry



AND TELEVISION

FORMERLY, FM MAGAZINE and FM RADIO-ELECTRONICS

VOL. 7

MAY, 1947

NO. 5

COPYRIGHT 1947, Milton B. Sleeper

CONTENTS

WHAT'S NEW THIS MONTH

Bonfig statement on FM set production.....	4
FM CAN CUT AM NETWORK RATES	
Milton B. Sleeper.....	19
FM ANTENNAS FOR 12,497 APARTMENTS	
F. A. Klingenschmitt.....	21
PLUG-IN STUDIO AMPLIFIERS	
William M. Dallin.....	24
NEW FM BROADCAST ALLOCATIONS	
Official FCC Information.....	28
FM COVERAGE, PART 2	
Paul A. de Mars and Thomas A. Wright.....	31
DETAILS OF THE DU MONT RA-101 TELESET	
J. H. Ruiter.....	35
DON'T BLAME FM—PUT UP AN ANTENNA	
John Carl Morgan.....	40
MAGNETRON TUBES, 8TH INSTALLMENT	
J. B. Fisk, H. D. Hagstrum, P. L. Hartman.....	42
SPECIAL DEPARTMENTS	
Products & Literature.....	6
Engineering Sales.....	8
Spot News Notes.....	26
News Picture.....	27

THE COVER DESIGN AND CONTENTS OF FM AND TELEVISION MAGAZINE ARE FULLY PROTECTED BY U. S. COPYRIGHTS, AND MUST NOT BE REPRODUCED IN ANY MANNER OR IN ANY FORM WITHOUT WRITTEN PERMISSION

★ ★ ★ ★ ★

MILTON B. SLEEPER, Editor and Publisher

WILLIAM T. MOHRMAN, Advertising Manager

STELLA DUGGAN, Production Manager

LILLIAN BENDROSS, Circulation Manager

Published by: FM COMPANY

Publication Office: 264 Main St., Great Barrington, Mass. Tel. Great Barrington 500

New York: 511 Fifth Avenue, New York 17, Rel. VA 6-2483

Chicago: MARIAN FLEISCHMAN, 360 N. Michigan Ave., Tel. STAtE 4822

Pasadena: MILO D. PUGH, 35 S. Raymond Ave., Pasadena 1, Calif. Tel. Madison 6272

FM Magazine is issued on the 20th of each month.

Single copies 50¢ — Yearly subscription in the U. S. A. \$5.00; foreign \$6.00. Subscriptions should be sent to FM Company, Great Barrington, Mass., or 511 Fifth Avenue, New York 17, N. Y.

Contributions will be neither acknowledged nor returned unless accompanied by adequate postage, packing, and directions, nor will FM Magazine be responsible for their safe handling in its office or in transit. Payments are made upon acceptance of final manuscripts.

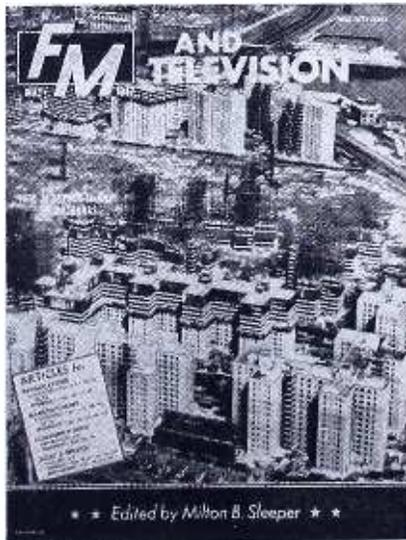

THIS MONTH'S COVER

Apartment-house owners can't eliminate the sources of interference which spoil AM reception, but they can provide multiple antenna systems that assure perfect FM reception. The Metropolitan Life Insurance Company, builders of the largest housing projects in New York City, have recognized this as not only an obligation but a sales promotion feature and a means of establishing good will.

As a result of installing multiple antennas in their 63 new buildings, 12,497 New York families will be prospects for FM receivers. No extra charge will be made for the antenna facilities. This is only the beginning, for it sets a precedent that owners of other apartment houses, old and new, will have to follow. For details, see page 21.

★ ★ Edited by Milton B. Sleeper ★ ★

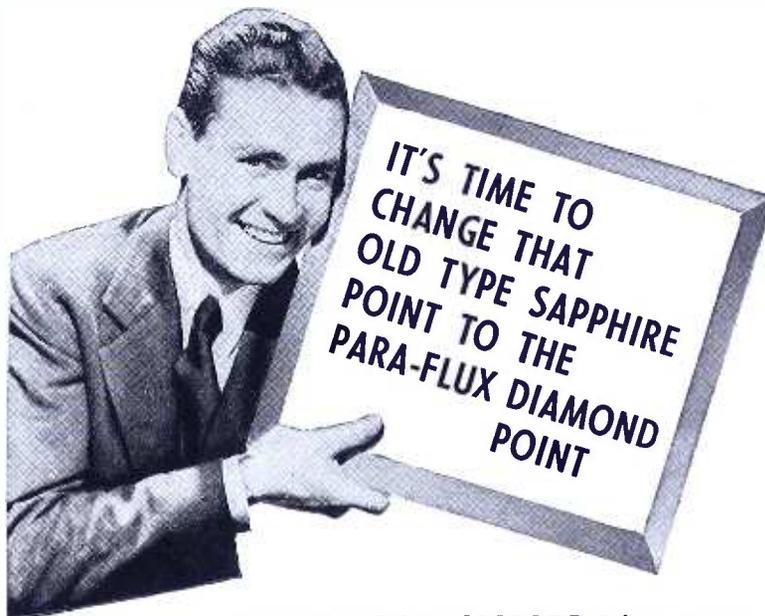

AVAILABLE IMMEDIATELY!

Remember, not too long ago, when African diamond points were not obtainable, and you were then glad enough to get sapphire points? Sure we could have supplied inferior diamond points, but only the real African diamonds would assure superior performance. Now, we are getting a continuous supply of the hard African diamonds.

Naturally, we want any user with an obsolete sapphire point to get our new, diamond point Reproducer. The diamond stylus is carefully selected, tested, highly polished and finished to tolerances of 1/10,000 inch. Its superiority is evidenced by the fact that now more than 1,000 diamond point PARA-FLUX REPRODUCERS are on the air over AM and FM stations.

You can replace your sapphire head for our modern design diamond point head with latest refinements . . . and at a special, low "exchange" price. And we'll make the exchange immediately, without any delay whatever. It's part of our QUICK SERVICE. Write today for special, extremely low replacement price. Also ask for Bulletin PR1 which gives full particulars of advanced type PARA-FLUX REPRODUCERS.

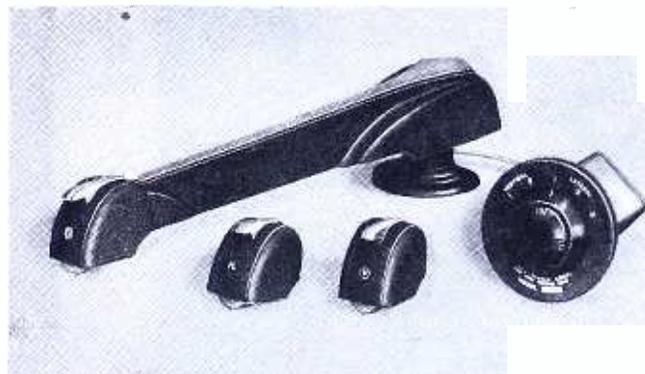

View showing Arm; Universal, Lateral and Vertical Heads and Equalizer

AVAILABLE THROUGH AUTHORIZED JOBBERS

Descriptive, illustrated Bulletin PR1, upon request

RADIO-MUSIC CORPORATION

EAST PORT CHESTER, CONN.

6

Entered as second-class matter, August 22, 1945, at the Post Office, Great Barrington, Mass., under the Act of March 3, 1879. Additional entry at the Post Office, Concord, N. H., Printed in the U. S. A.

MEMBER, AUDIT BUREAU OF CIRCULATION



3

ANDREW *Semi-Flexible* COAXIAL CABLE

BETTER ON 3 COUNTS

✓ **LOWER** loss than plastic 30% to 50% less loss than in plastic cables of same diameter.

✓ **GREATER** power capacity Insulation does not melt or soften . . . develops less heat than plastic cables.

✓ **LONGER** lasting Andrew cables are made entirely of copper and stone, two materials which have unlimited life and which impart the greatest resistance to crushing, corrosion and weathering.

ANDREW "FIRSTS" Here's proof of Andrew Leadership in the development of semi-flexible coaxial cables: 1) First to produce $\frac{3}{8}$ and $\frac{7}{8}$ inch soft temper cables in 100 foot lengths . . . 2) First to offer continuous coils of unlimited length with factory splicing . . . 3) First to offer lines shipped under pressure with all fittings attached.

Such continued leadership enables Andrew to offer *better* semi-flexible coaxial cables; cables that are better than those made from any other materials.

A complete line of coaxial cables, accessories, and other antenna equipment is produced by Andrew.

ANDREW CO.

363 E. 75th ST. • CHICAGO 19, ILL.

Pioneer Specialists in the Manufacture of a Complete Line of Antenna Equipment

These are the famous Andrew semi-flexible coaxial cables in $\frac{3}{8}$ and $\frac{7}{8}$ inch diameters (shown in actual size). Because of their better construction and design they are used throughout the world by thousands of broadcast, police, government, and military radio stations as the most efficient device for connecting antenna to transmitter or receiver.

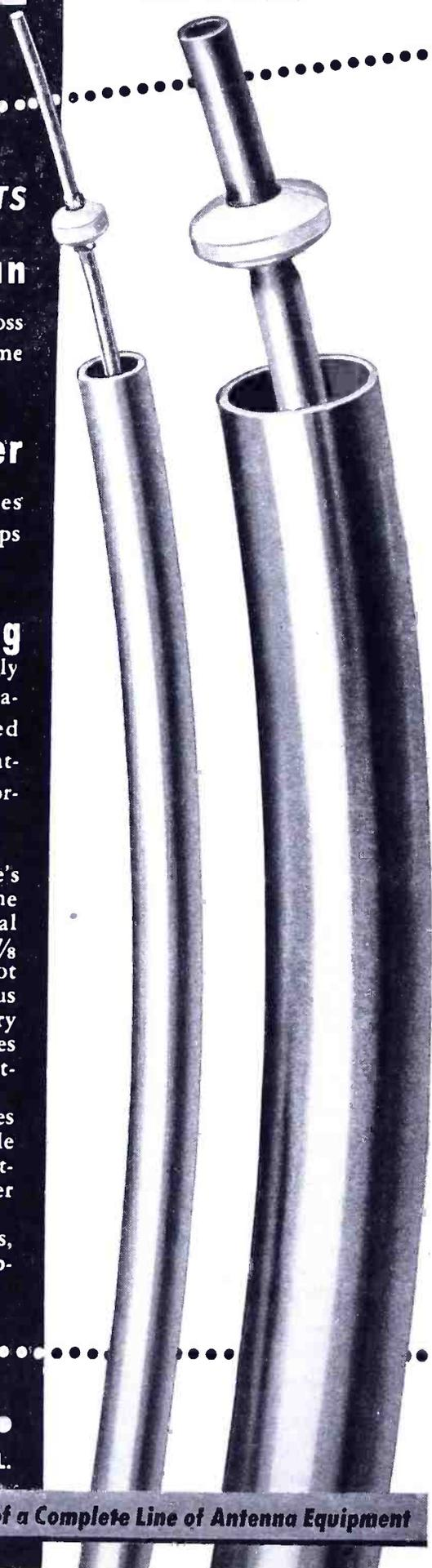

WHAT'S NEW THIS MONTH

FM SET PRODUCTION

What are the facts about the problems and the progress of FM set production? This question, of paramount importance to broadcasters, manufacturers, and the trade, was answered frankly, fully, and factually by H. C. Bonfig, vice president of Zenith Radio, in an address before the FM Association's regional meeting at Albany, N. Y., on April 14th.

Because the information presented covers the subject so completely, we publish here the entire text of Mr. Bonfig's address:

IT WAS with some trepidation that I accepted Leonard Asch's invitation to report to you on the outlook for FM receiver production. I have been warned that your enthusiasm for FM is just a little more intense than a woman's love for new clothes, and that an industry spokesman who even granted the existence of AM might be treated like a cattle rustler of frontier days. So here I stand, shaking in my boots, because the number of FM sets produced to date has not impressed any one of you.

This does not mean that the entire radio manufacturing industry is falling down on the job or that it is selling FM short. Even the FM skeptics of yesteryear are now adding FM to their lines. It simply indicates that the manufacture of FM sets is an entirely different kettle of fish than the manufacture of AM; that the problems caused by shifting FM from the 50-mc. to the 100-mc. band plagued designers of sets and slowed down production; and that manufacturers without previous FM experience are particularly handicapped in wrestling with the new production problems encountered in building FM receivers.

More FM Sets ★ I have with me the latest figures available on FM set production, together with an estimate of 1947 production made by RMA from a survey which has just been completed. It is less than one week since our RMA-FM liaison committee met in Washington, and had a long and exhaustive discussion of the problems confronting FM manufacturers.

The amazing factor is not that so few FM sets will be built in 1947, but that there will be so many. RMA statistics reveal an estimate of FM production for 1947 at slightly more than 2½ million sets, which is nearly 15 times the number

(CONTINUED ON PAGE 50)

INVISIBLE BUT INVALUABLE

The invisible part of any Blaw-Knox Radio Tower is the *accumulated experience* gained by this company in the installation of thousands of towers in many quarters of the globe. This experience counsels the use of better material instead of cheaper material, higher safety factors instead of lower, the best construction instead of "good enough" and, in a word, the best.

The Blaw-Knox Tower you buy contains this priceless element without extra cost to you. Let us discuss your requirements without obligation.

BLAW-KNOX DIVISION
OF BLAW-KNOX COMPANY
2046 Farmers Bank Building, Pittsburgh 22, Pa.

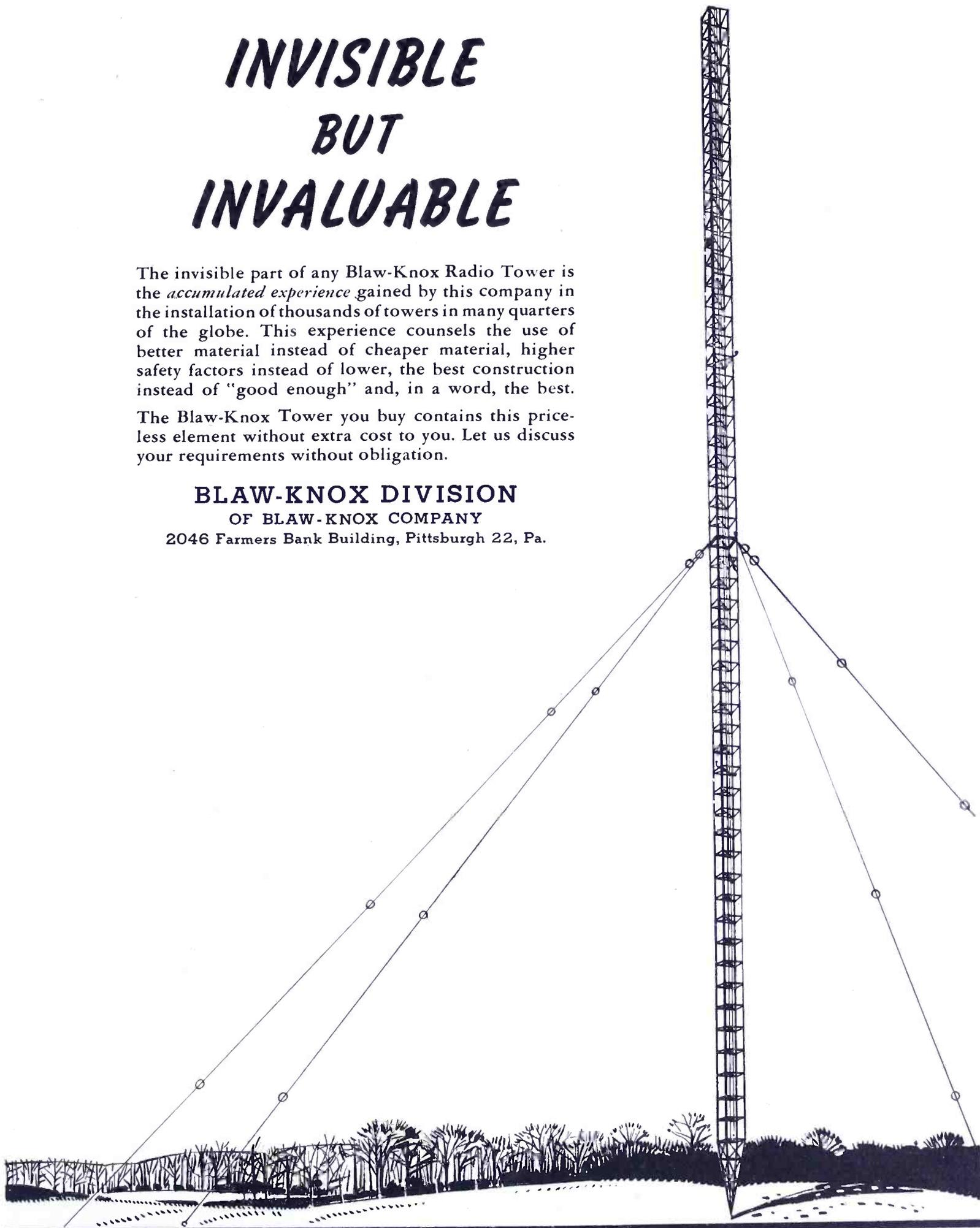

BLAW-KNOX ANTENNA TOWERS

PRODUCTS & LITERATURE

So many new instruments, components, and materials are being brought out that space does not permit us to publish illustrated descriptions of them all. Accordingly, rather than selecting a few each month, we have established this new department of Products & Literature so that a great number of brief descriptions can be published. From these, you can select items which interest you, and send for catalogs or bulletins. We'll appreciate it if you will mention FM and TELEVISION in your requests.

High Vacuum Furnace for the heat treatment of materials highly reactive to gases. Operates continuously in the region of 1,800° C, with three chambers where the treatment can be started in the first, preliminary pumping carried out in the second, while the third is being unloaded. Provides production vacuum as high as 5×10^{-6} mm. of mercury. — Eitel McCullough, 1570 San Bruno, Calif.

Snap-Action Switches for use in conjunction with relays control slow-moving mechanical devices and to provide quick make or break from a given stroke. Snap action eliminates chattering, arcing, and intermittent contact pressure. — Guardian Electric Mfg. Co., 676 St. Clair Street, Chicago 11.

Turn Table Console to carry transcription or recording turntable. Steel construction, 2-tone gray metallic finish, 32 ins. high, 24 ins. wide, 26 ins. deep. Outlets and terminal blocks mounted on motor board. Compartment holding 100 16-in. records has drop front. Screw jacks permit accurate leveling. Furnished separately, or with Rek-O-Kut turntable. — Rek-O-Kut Company, 146 Grand St., New York City.

Limiting Amplifier comprised of a fast-acting peak limiter preceded by an automatic gain-control amplifier with variable time constants. Used at broadcast stations, it is designed to give a higher percentage of modulation than can be obtained by a limiter alone. Trade name: Progar. — Langevin Co., 37 W. 65th St., New York 23.

Transformers and matching chokes for power supplies and audio circuits. Complete, new line features compound-filled steel cases for moisture protection, compactly designed and easy to mount. High-voltage plate transformers are mounted in heavy-duty frames and shields. Replacement-type transformers are mounted in standard shields, both vertical and horizontal. — Chicago Transformer Division, Essex Wire Corp., 3501 W. Addison St., Chicago 18.

FM Antennas, both folded and straight dipoles, with or without reflectors. Designed for 88-108 mc. and equipped with 60 ft. of 300-ohm collinear transmission line. Universal mounting base can be attached at any angle to roof or wall. All parts weather-proofed. — Ward Products Corp., 1523 E. 45th St., Cleveland 3, Ohio.

Oscillograph for television studios and transmitters. Rack-mounted panels carry 7-in. cathode-ray tube and complete operating and control circuits. Sweep-writing speed continuously variable from .25 to 2500 micro-seconds, with calibrating generator for 10, 1, and .2 micro-seconds. Delay range of 100 to 1,000 micro-seconds is provided for the linear time-base. — Allen B. DuMont Laboratories, Inc., Passaic, N. J.

Communications Receiver features tuning from 540 kc. to 31 mc. and 48 mc. to 56 mc., with band spreads at 6, 10-11, 20, 40, and 80 meters. AVC circuit and S-meter work on both phone and CW. Voltage regulation holds pitch of code signals. Adjustable threshold noise-limiter operates with great effectiveness through the use of extremely small time-constant. All bands have one RF stage, 1st detector, separate, stabilized oscillator, crystal filter, 2 IF stages, diode 2nd detector, audio limiter, 2 AF stages, AVC, BFO, voltage regulator, and rectifier. Operates on battery, 110-120 or 220-240 volts, 60 cycles. — Model NC-173, National Company, Malden, Mass.

Appliance Tester to measure volts, amperes, and watts on 60-cycle line. A pocket-size instrument in a molded case, it provides scales for reading 0-150 and 0-300 volts, 0-3 and 0-15 amperes, 0-300, 0-600, 0-1,500, and 0-3,000 watts. To test appliances, break-in plug is inserted in electric outlet, then appliance is connected into the break-in plug. — Model 390, Simpson Electric Co., 5218 W. Kinzie St., Chicago 44.

Tube Manual of 700 pages in an expanding binder. Covers application performance, characteristics, ratings, outline drawings, and basing diagrams of G. E. tubes. Prepared for broadcast, communications, and tube-application engineers, and servicemen. Price of \$5 includes additional sheets through 1948; subsequent sheets, \$1 per year. — General Electric Company, Tube Division, Building 267, Schenectady, N. Y.

Capacitors for FM and television transmitters and receivers. A complete, new series in all capacities and ratings, from high-voltage types with insulating bushings

down to flat and round cans and tubular containers. — Catalog 1083, Industrial Condenser Corp., 3243 N. California Ave., Chicago 18.

Pocket Ohmmeter contained in the handle of a test probe. Range is 0-10,000 ohms. Designed for service testing. — Sylvania Electric Products, Inc., 500 Fifth Ave., New York 18.

Contact Spring Assemblies for relays and jacks. New specification sheets show dimension drawings of various standard springs and contacts. Sheets are of tracing paper, from which blueprints can be made for shop use. — P. R. Mallory & Co., Inc., Indianapolis 6, Ind.

Instrument Manual for the Simpson Model 260 Volt-Ohm-Milliammeter. First of a series of instrument manuals for the instruction of engineers and servicemen, containing a compilation of data and detailed diagrams. — Simpson Electric Co., 5218 W. Kinzie St., Chicago 44.

Soldering Iron designed as a pair of pliers, with a handle the size of an electric razor. First squeeze closes carbon electrodes over the parts to be soldered. Additional pressure applies 6-volt heating current from a step-down transformer. Power consumption for heating is 250 w., standby power, 1 watt. Trade name: Pres-to-Heat. — Triton Mfg. Co., East Haddam, Conn.

DC Relays operated by amounts of power as low as 10 milliwatts. Eight types range from 10 to 180 milliwatts, 147 to 1470 milliamperes, and .07 to 67,000 ohms. Rating of single-pole, double-throw contacts ranges from 12 to 110 volts, AC or DC. At 24 volts DC the contacts handle 2 amperes non-inductive, or .5 ampere inductive. Soldering lug or plug-in connections. — General Electric Co., Apparatus Dept., Schenectady, N. Y.

DC Timing Motor, reversible and variable in speed from 2 to 1800 revolutions per hour, contained in welded housing $2\frac{1}{8}$ ins. diameter by $1\frac{1}{16}$ in. high. Rotor is aluminum cup with 7-coil winding; field is an internal Alnico magnet. Operates on less than 100 milliamperes from amplifier tube or flashlight battery. Life expectancy of replaceable brushes is 5,000 hours. — A. W. Haydon Co., 111 W. Main Street, Waterbury 32, Conn.

Sound Amplifiers of unit design, covering all requirements in sound recording, from portable use to multi-channel studio systems. Total of 12 units include power, microphone, and booster amplifiers, output and input switch panels, variable equalizers, mixers, and auxiliary power supply. Trade name: Unitized Amplifier System. — Fairchild Camera & Instrument Corp., 89-06 Van Wyck Blvd., Jamaica 1, N. Y.



GOOD DEAL? OR A BAD ONE?

SOMETIMES the selection of an FM transmitter is made not on the basis of engineering superiority of one make over another, but on some tempting concession by a manufacturer. While this may appear to be a *GOOD DEAL* for the broadcaster, in reality he is risking a short-change somewhere along the line, whether in higher-than-necessary original price, cheap components, or skimpy construction.

We believe your future in FM will be shaped largely by the kind of equipment you buy for your *initial* installation — equipment that will have to serve at its best during the coming years when FM listeners will form the majority of your audience. Be sure that any *GOOD DEAL* you buy today includes the following:

1. A transmitter design with the longest record of high-quality performance.
2. An installation in which close attention is given to the use of high-quality components, fine workmanship, and rugged construction.
3. The dependable, simplified Armstrong Dual-Channel Modulator.
4. Economy of initial price, but also assurance of low maintenance cost.

Don't buy a short-run Good Deal that turns out to have a long-run Joker.
If you want a pat hand in FM, deal yourself an REL transmitter.

IMPORTANT! WATCH FOR OUR ANNOUNCEMENT OF A STARTLING NEW DEVELOPMENT IN 10-KW. FM TRANSMITTER DESIGN — *the REL QUADRILINE*

Radio Engineering Laboratories, Inc.



Manufacturers of Armstrong Phase-Shift FM Transmitters Since 1935
Plant: 35-54 Thirty-Sixth Street, Long Island City 1, NEW YORK



FOR **VHF**

30 TO 200 MC

170-A

Q
METER

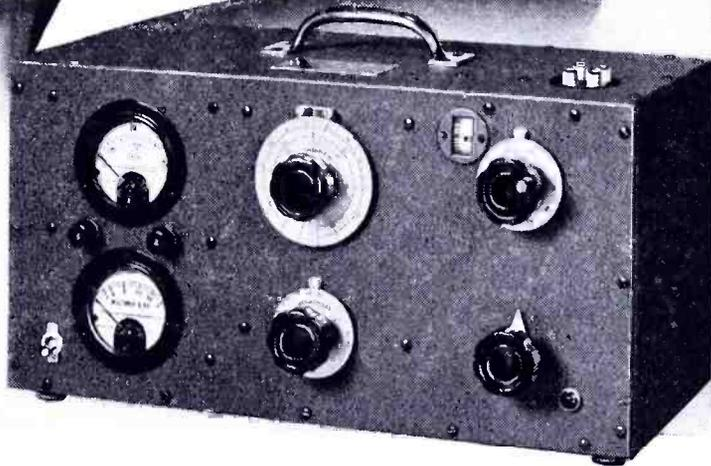

A ruggedly constructed direct reading laboratory instrument specially designed to measure Q, inductance, and capacitance values quickly and accurately. Invaluable in selecting proper low loss components for high frequency applications.

SPECIFICATIONS:—FREQUENCY RANGE: 30-200 mc, accuracy 1%

RANGE OF Q MEASUREMENT: 80 to 1200

Q CAPACITOR RANGE: 11-60 mmf; accuracy $\pm 1\%$ or 0.5 mmf, whichever is greater

WRITE FOR
CATALOG "D"

BOONTON RADIO

BOONTON · N.J. · U.S.A.

Corporation

DESIGNERS AND MANUFACTURERS OF THE "Q" METER . . . QX-CHECKER . . . FREQUENCY MODULATED SIGNAL GENERATOR . . . BEAT FREQUENCY GENERATOR . . . AND OTHER DIRECT READING TEST INSTRUMENTS

Look to
WARD
the Leader!

The world's leading producer of auto aerials presents models unsurpassed in . . .

DESIGN

Each smart looking model is engineered and equipped to fit every car on the road.

QUALITY

Every model has been tested and approved by car and radio set manufacturers.

DOLLAR VALUE

Always "most for the money" Ward aerials are going down in price Feb. 1, 1947. List prices will be from \$2.95 up.

Write us for full information!

IN CANADA: Atlas Radio Corp., 560 King Street, West, Toronto, Ontario, Canada
EXPORT DEPARTMENT: C. O. Brandes, Mgr., 4900 Euclid Avenue, Cleveland 3, Ohio

WARD

Aerials

THE WARD PRODUCTS CORP.
1523 EAST 45th STREET
CLEVELAND 3, OHIO



**ENGINEERING
SALES**

National Union: Rocke International Corporation, 13 E. 40th Street, New York City, has been named exclusive export representatives for National Union tubes.

RCA: Sales manager of RCA's newly consolidated communications and specialty section is Herbert M. Hucke, former manager of aviation radio sales. He will work under T. A. Smith, general sales manager of the engineering products division.

Andrew: James F. White is now assistant sales manager for Andrew Company, where his broad engineering experience at the M.I.T. Radiation Laboratories and as a Navy radar officer will be at the service of Andrew clients.

C. P. Clair: Has opened a sales engineering office at 681 Grant Street, Denver 3, Colo. Clyde P. Elliott is in charge.

Pittsburgh: I. and M. Sufirin, radio and appliance distributors at 1207 Muriel Street, have appointed George A. Hoever as general manager.

Phillips: Two new representatives for North American Phillips are Dan J. Connors Company, 833 Real Estate Trust Building, Philadelphia, and Harold J. Kittleson, 623 Guaranty Building, Hollywood. They will handle Phillips trimmer condensers, crystals and other components.

Westinghouse: Has appointed four new field service representatives who will work with radio distributors and dealers. They are Fred L. Bartley, Sunbury, Pa.; Ralph S. Kerstetter, St. Louis; Alfred H. Kuttruff, Chicago; Harold A. Loring, Atlanta.

Chicago: Frank Walsh, account executive who handles Hallcrafters advertising, has been appointed vice president of Burton Browne Advertising, 619 N. Michigan Avenue.

Philco: John M. Otter, formerly sales manager of Philco's radio division, is now general sales manager of Philco Corporation. Fred Ogilby, who has been general manager of the New York branch, will take the place left vacant by Otter's promotion, and Joseph Cohen has moved up from Philadelphia to become general manager at New York.

National Hollywood: Land-C-Air Sales, Inc., 14 Pearl Street, New York, have been appointed.
(CONCLUDED ON PAGE 50)

SYLVANIA RESEARCH NEWS



MAY

Prepared by SYLVANIA ELECTRIC PRODUCTS INC., Bayside, L. I.

1947

INTRICATE LABORATORY TECHNIQUES GUARD QUALITY OF TUNGSTEN IN SYLVANIA TUBES

Basic Studies of Wire Conducted at Each Stage of Production to Insure Electronic Tube Perfection

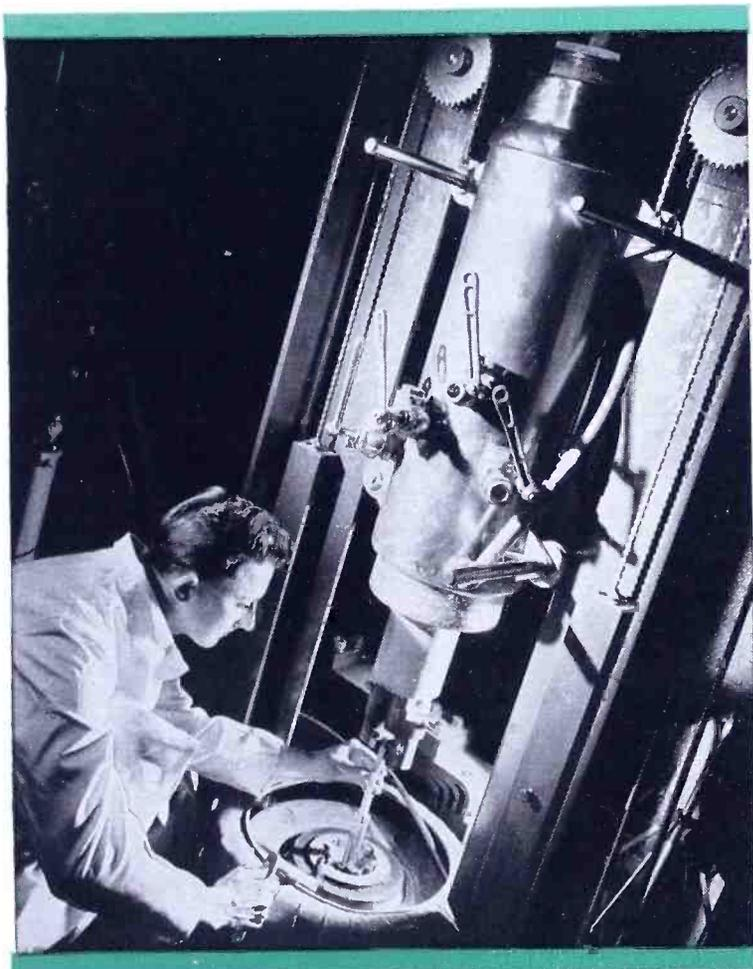

Tungsten for radio tubes (and incandescent lamps) is prepared by heating the powdered tungsten bars to incandescence in sintering bottle. Researcher is placing tungsten bar between electrodes which will pass 150 kw through slug and heat it to 6800° F. Hydrogen atmosphere prevents oxidation. During sintering operation the porous tungsten powdered bar is transformed into a homogeneous metallic slug which can be swaged and drawn down to wire of a diameter as low as .0004".

Two of the many metallurgical tests constantly carried on by Sylvania Electric are illustrated here.

To insure electronic tube perfection — to have Sylvania radio tubes measure up to long-established Sylvania standards — every important type of research technique is utilized.

Here electron microscopes, giving magnifications of thousands of times, are employed. Hardness testers, sag testers, gas analysis equipment, tensile testers are but a few of the methods used to guard the high quality of tungsten utilized.

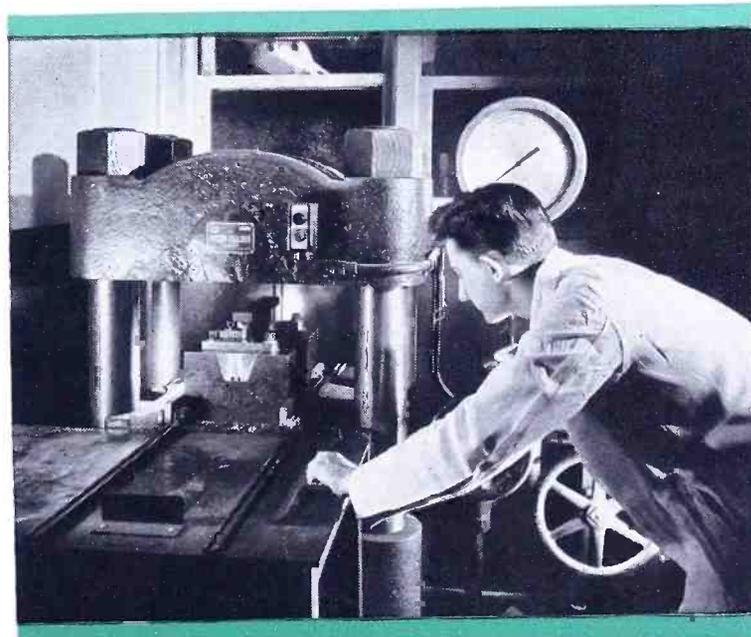

Prior to sintering operation shown at left, tungsten bars of approximately $\frac{1}{2}$ " square are prepared by pressing finely divided metal powder under hydraulic pressures of up to 300 tons. The equipment used to pursue such studies is illustrated in the above photograph.

Both of the photographs shown here are indicative of the fundamental studies that have resulted in the development and maintenance of tungsten wire of superior quality.

Radio Tube Division, Emporium, Pa.

SYLVANIA ELECTRIC

MAKERS OF RADIO TUBES; CATHODE RAY TUBES; ELECTRONIC DEVICES; FLUORESCENT LAMPS, FIXTURES, WIRING DEVICES; ELECTRIC LIGHT BULBS

May 1947 — formerly FM, and FM RADIO-ELECTRONICS

Why this team brings you better ELECTRON TUBES

1925. This was one of the earliest photoelectric cells. It was made by Western Electric for use in commercial picture transmission over telephone wires.

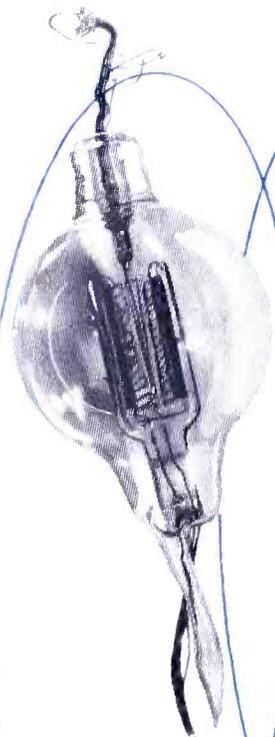

1912. The first effective high-vacuum tube, developed by the laboratories for long distance telephony, was capable of operation at both audio and radio frequencies, and thus marked the beginning of modern electronics.



1918. This "peanut" tube, the Western Electric 215A, was developed for service in World War I. It was the first commercial tube whose filament was powered by a single dry cell . . . made possible compact, light weight radio equipment.



1919. The introduction of the copper-to-glass seal made water cooled tubes practical. The resulting high power tubes were used for broadcasting and for transoceanic radio-telephony.



1940. The beating oscillator, used in the great majority of radar systems. This tube generated a wave in the receiver with which the received microwave was reduced in frequency for amplification.

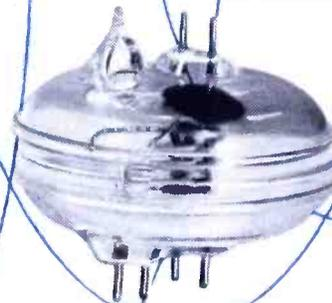

1937. This microwave generator, the 368A, was the first commercial tube to generate frequencies higher than 1500 mc. This type of tube was used by Western Electric in the first absolute altimeter.



—QUALITY COUNTS—

1940. Bell Laboratories produced the first American multicavity pulsed magnetron from a British model. The team of Western Electric and Bell Laboratories developed 75 new and improved magnetron designs by extending operation into the 10 cm, 3 cm and finally the 1 cm bands, and produced over 300,000 of these wonder tubes of World War II.

1942. This tiny 6AK5, operating in the vicinity of 400 mc, proved itself invaluable as an amplifier in radar receivers. Design specifications were supplied to other manufacturers by Western Electric to speed war production.

1945. The Bell Laboratories traveling wave tube, still in the research stage, amplifies over a band 40 times wider than present tubes—may be able to amplify dozens of color or black and white television programs simultaneously.

TODAY. These new forced air cooled FM transmitting triodes are among the latest in the line of tubes designed by Bell Telephone Laboratories and made by Western Electric. Their thoriated tungsten filaments, rugged construction, flexible terminal arrangements and many other features make them tops in performance in the 88 to 108 mc band.

OVER 34 years ago in the laboratories of Western Electric, De Forest's Audion was improved and developed into the high vacuum tube and put to work for the first time amplifying telephone and radio frequency currents. And for over 34 years Western Electric and its research associate Bell Telephone Laboratories have been foremost in designing new and better electron tubes. Every tube shown here and many developments basic to the tube art are examples of that leadership. More than 10 years ago, for instance, Bell Laboratories first used microchemistry to determine what gases were destructive to tube elements, and with Western Electric developed a manufacturing technique to keep these damaging elements out—thus increasing tube life many-fold. Every one of the more than 300 codes of electron tubes now being made by Western Electric from Bell Laboratories' designs has the same unequalled background of research and manufacturing skill.



BELL TELEPHONE LABORATORIES

World's largest organization devoted exclusively to research and development in all phases of electrical communications.

Western Electric

Manufacturing unit of the Bell System and the nation's largest producer of communications equipment.

KAAR

FIRST
with.

**INSTANT
HEATING**

FM

in ALL THREE Mobile Bands!

• 30-44

MC BAND

• 72-76

MC BAND

• 152-162

MC BAND

Kaar instant-heating mobile FM radiotelephones are now available in ALL THREE mobile bands! With Kaar instant-heating, the average power taken from the battery is cut approximately 90%, eliminating the need for special batteries or generators. Kaar 20, 50, and 100 Watt mobile radiotelephones powered by standard 6 volt vehicle batteries give you superior performance and more dependable service, at less cost.

Kaar precision engineering and expert craftsmanship have made possible amazing improvements in tone performance. All Kaar radiotelephones give you voice quality that actually permits recognition of a speaker's voice!

The rugged, compact Kaar radiotelephones are easily serviced or checked. A quarter turn of two airlock fasteners allows dust cover to be lifted off; the entire chassis may be removed by releasing two slide catches.

Write to Kaar Engineering Co., 603 Emerson Street, Palo Alto, California, for catalog describing the Kaar instant-heating radiotelephones and specify the equipment in which you are most interested. Write us today!



IMPROVED OVER-ALL FREQUENCY RESPONSE THROUGH KAAR FM TRANSMITTER AND RECEIVER

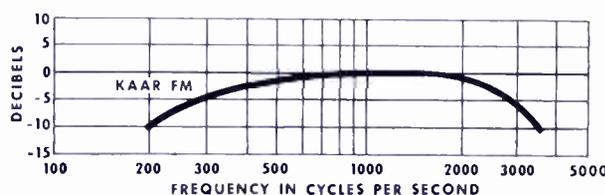

READY TO GO... INSTANTLY!

KAAR

KAAR ENGINEERING CO.



A SENSATIONAL NEW CLARE RELAY

Streamlined to Meet Modern Design Requirements

New CLARE Type "J" d.c. Relay Combines the Best Features of Conventional Telephone Type Relay With Tiny, Lightweight Aircraft Design Relay

• This new CLARE Type "J" Relay gives you unheard-of performance in the small size and light weight that meet modern streamlined design demands.

Sturdy construction, large contact spring capacity and adaptability to a wide range of specifications, are provided in a relay which weighs slightly more than two ounces, slightly more than two inches in length.

Here at last is a twin contact relay in which the chance of contact failure is reduced to the lowest possible limit. The long, flexible contact fingers of the bifurcated stationary springs allow the contacts to operate independently of each other. One contact is sure to close even when the other may be blocked by presence of dust or grit.

Twin contact points have high rated current carrying capacity of 4 amperes, 150 watts, permit use of standard twin-contact springs for most applications.

These are but a few of the remarkable features which make this new CLARE Type "J" Relay a valuable addition to the Clare line of "Custom-Built" Relays and Stepping Switches which most effectively meet tough relay design requirements. Clare Sales Engineers are located in principal cities to discuss relay problems with you. Look in your classified telephone directory or write: C. P. Clare & Co., 4719 West Sunnyside Avenue, Chicago 30, Illinois. Cable Address: CLARELAY. In Canada: Canadian Line Materials, Ltd., Toronto 13, Ontario.

CLARE RELAYS

"Custom-Built" Multiple Contact Relays
for Electrical and Industrial Use

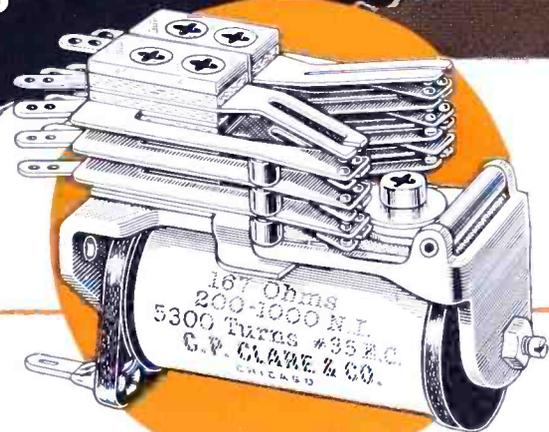

Outstanding Features of CLARE Type "J" d.c. Relay

Independent Twin Contacts: Dome shaped contacts on movable springs; flat discs on fixed springs

High Current-Carrying Capacity: Twin contact points of palladium contact material have rated current-carrying capacity of 4 amperes, 150 watts.

Concealed Wiring: All contact-spring terminals as well as coil terminals located at rear end of relay. Wiring concealed when relay is mounted on panel, base or mounting strip.

Large Armature Bearing Area: Hinge-type armature has bearing of completely new design which provides largest possible bearing surface. Pivot pin turns in cylinder of a different metal, which is full width of the heelpiece.

Efficient Magnetic Structure: Heelpiece and other magnetic iron parts are exceptionally heavy for the size of the relay, providing a highly sensitive and efficient magnetic path.

High Operating Speed: Designed for extremely fast operation . . . a minimum of one to two milliseconds.

Large Contact Spring Pileups: Both single and double-arm relays are available. Power and sensitivity permit handling of large spring loads . . . maximum of ten springs on single arm relay . . . 20 springs (10 in each pileup) on double-arm relay.

Coils . . . Single or Double Wound: Either single or double coil windings can be provided.

Dimensions: Overall length: 2 1/4"; Width: 1 3/4" (with 10 springs); Height: 1 1/8".

Weight: Net: 2 1/2 oz. (approx.).



ROUNDED
GRID for the best FM

RCA 1 KW FM
Broadcast Transmitter
BTF-1C

RCA KILOWATT FM
1

This is a Transmitter Man's TRANSMITTER

You know what is meant by a ballplayer's ballplayer. He looks good to the public. Sure... but more than that, he looks good to other ballplayers. He makes every play in just the right way—and he makes them look easy, not hard.

The RCA 1KW FM Transmitter (Type BTF-1-C) has a similar standing among transmitter men. It looks good (RCA has always been the leader in styling)—and it sounds good, too (performance specifications are unex-

celled). But more than that, it has the engineering features which your engineer appreciates and wants. Some of these features, such as the mechanical design and the control circuits, are common to all RCA transmitters and are already well-known to him. Other features, listed below, are particular to this new FM transmitter.

DIRECT FM-type exciter. No fussy, complicated circuits. No trick tubes. (There are only four r-f tubes—an oscillator, two triplers and a buffer amplifier). Frequency control circuits provide crystal-equivalent stability, but are completely independent so that a failure in these circuits does not affect modulation or take the transmitter off the air. Because it uses fewer tubes, does not involve phase multiplication, this exciter is inherently capable of lower noise and distortion than any type yet developed.

ONLY 8 R-F TUBES in the whole transmitter (one oscillator, two triplers, one doubler, four amplifiers). There are two audio tubes, and seven tubes in the power supplies (not including voltage regulators). Thus there are only 17 tubes whose failure can take the transmitter off the air (thirteen additional tubes in regulator and control circuits do not contribute to outages). The total of 30 tubes is, we believe, the lowest number of any similar transmitter of this power.

GROUNDING GRID CIRCUIT used in final amplifier, requires no neutralization, provides greater stability than can be obtained with older, more conventional amplifier circuits. This is the easiest transmitter to adjust that you've ever worked on. Can be tuned in a few minutes' time by inexperienced personnel.

DISC-SEAL TUBE, the RCA 7C24, especially designed for grounded-grid operation, is used in the final amplifier (and also in the final amplifier stages of the RCA 3KW and 10KW FM transmitters). Quantity produced, field-tested, rugged, and inexpensive—it is the best-suited tube yet designed for this use.

SHIELDED TANK CIRCUIT used in the final amplifier (and also in RCA 3's and 10's) is a concentric-line design in which the outer tube is at ground potential. Tube and inner line are completely enclosed providing near-perfect shielding. Only in this way can the flow of r-f currents in the cabinet be prevented. R-f radiation from the transmitter housing (and r-f pick-up in nearby audio circuits is less than with other tank circuit design).

SINGLE-ENDED OUTPUT is an important feature. Single-ended circuits are more stable and easier to adjust (no balancing) than push-pull circuits—particularly at FM frequencies. Moreover, single-ended circuits are more easily matched to the grounded transmission lines universally used in FM service.

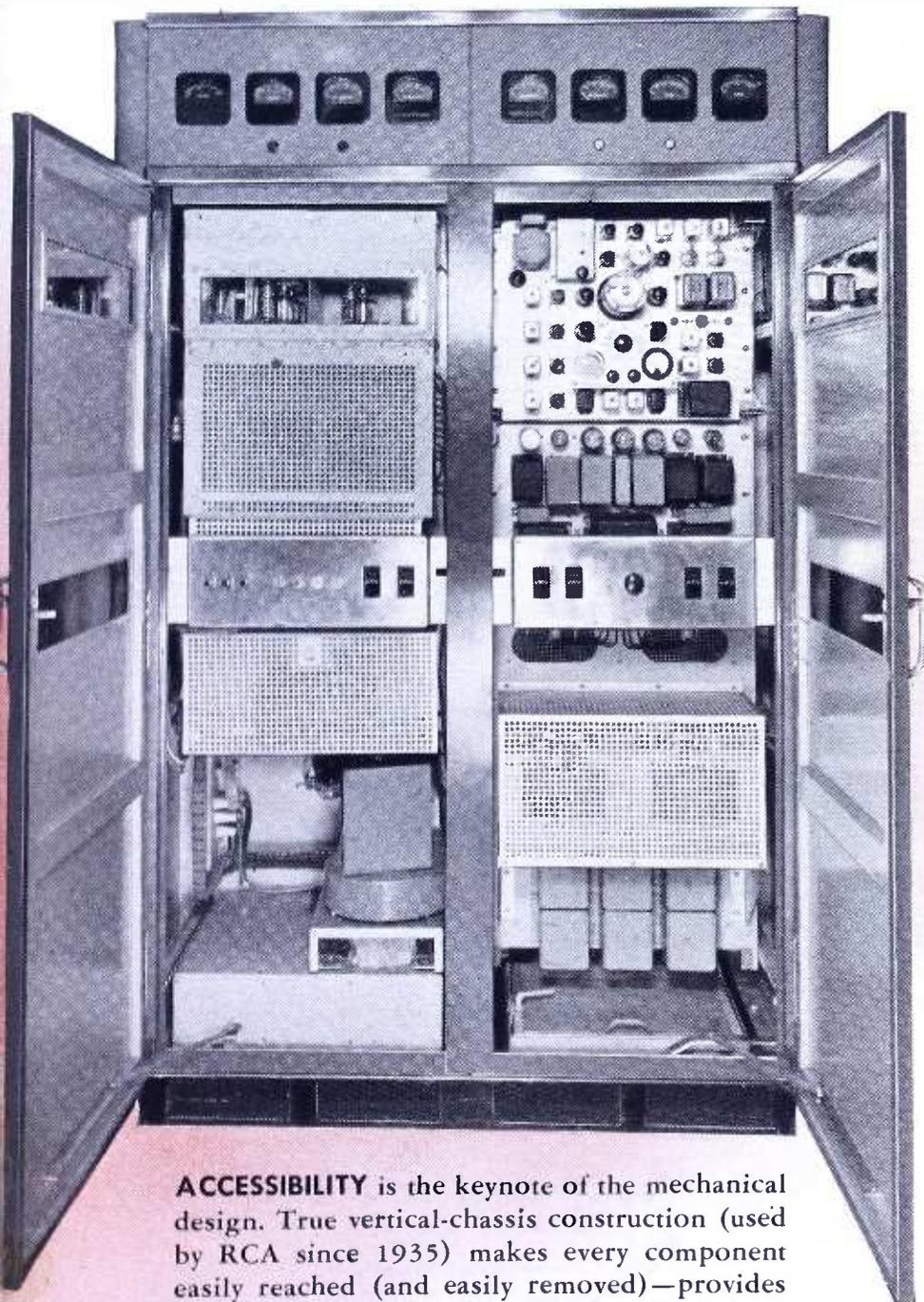

ACCESSIBILITY is the keynote of the mechanical design. True vertical-chassis construction (used by RCA since 1935) makes every component easily reached (and easily removed)—provides unimpeded up-draft ventilation. Unit-type assembly makes for easy installation, flexibility and simple modification for higher power.



BROADCAST EQUIPMENT
RADIO CORPORATION of AMERICA
ENGINEERING PRODUCTS DEPARTMENT, CAMDEN, N.J.

In Canada: RCA VICTOR Company Limited, Montreal

Professional Service Directory

Jansky & Bailey
 AN ORGANIZATION OF
Qualified Radio Engineers
 DEDICATED TO THE
 SERVICE OF BROADCASTING
 National Press Bldg., Washington, D. C.

RAYMOND M. WILMOTTE, Inc.
Consulting Engineers
Radio and Electronics
 PAUL A. DEMARS, Associate
 1469 Church St., N. W., Washington 5, D. C.
 Decatur 1234

FRANK H. McINTOSH
Consulting Radio Engineers
 710 14th St. N.W., Wash. 5, D. C.
 METropolitan 4477

ANDREW CO.
Consulting Radio Engineers
 363 EAST 75th STREET, CHICAGO 19
 Triangle 4400

RUSSELL P. MAY
 CONSULTING RADIO ENGINEERS
 * * *
 1422 F Street, N. W. Wash. 4, D. C.
 Kellogg Building Republic 3984

Preliminary surveys, management and operational consulting service based on practical experience with AM, FM and Facsimile.

 Phone: EXecutive 3929
RADIO CONSULTANTS, Inc.
 1010 VERMONT AVE., WASHINGTON 5, D. C.

• TELEPHONE BRIDGEPORT 5-2055 •
GARO W. RAY
Consulting Radio Engineers
 991 Broad Street, Suite 9-11
 Bridgeport 3, Conn.
 LABORATORY: Hilltop Drive
 Stratford, Conn. — Phone 7-2465
Instruments and Measurements

OUR 18th YEAR
Herbert L. Wilson
Consulting Radio Engineers
 1018 Vermont Ave., N.W. NA. 7161
 Washington 5, D. C.
 1000 No. Seward St. HO. 6321
 Hollywood 38, Calif.

H. V. Anderson
 AND ASSOCIATES
 • **Consulting Radio Engineers**
 715 American Bank Bldg. Tel. RAYmond 0111
 New Orleans 12, Louisiana

The
ROBERT L. KAUFMAN
 ORGANIZATION
 • Construction Supervision (FM-AM),
 Technical Maintenance, and Business Ser-
 vices for Radio Broadcast Stations.
 Munsey Building Washington 4, D. C.
 District 2292

CONSULTING
 RADIO ENGINEERS
DIXIE B. MCKEY
 &
 ASSOCIATES
 1730 CONNECTICUT AVE. N.W.
 WASHINGTON 9, D. C. ADAMS 3711

Radio Engineering Consultants,
Frequency Monitoring
Commercial Radio Equip. Co.
 International Building • Washington, D. C.
 603 Porter Building • Kansas City, Mo.

ERA COMPLETE Technical and
 Management
 Consulting Service
 Immediate FM and VHF
 Field Measurement Service Available
Engineering Research Associates, Inc.
 Washington, D. C. Office: Laboratories:
 1129 Vermont Av., N. W. St. Paul 4, Minnesota
 Phone: EXecutive 4742 Phone: NEstor 9601

**ENGINEERING AND
 PATENT LIBRARIES**
 Bound volumes No. 11 and 12 of
 FM AND TELEVISION for January to
 June, 1946, and July to December
 1946 are now being made up. Price,
 each, \$5.50 plus 25¢ shipping charges.

Custom-Built
SPEECH INPUT EQUIPMENT
U. S. Recording Co.
 1121 Vermont Avenue
 Washington 5, D. C.
 District 1640

**THE WORKSHOP
 ASSOCIATES**
 INCORPORATED
Specialists in
High-Frequency Antennas
 66 Needham St., Newton Highlands, Mass.
 Bigelow 3330

**FREQUENCY MEASURING
 SERVICE**
 Exact Measurements - at any time

 RCA COMMUNICATIONS, INC.
 64 Broad Street, New York 4, N. Y.

RATES FOR
PROFESSIONAL CARDS
 IN THIS DIRECTORY
 •
 \$10 Per Month for This Standard
 Space. Orders Are Accepted
 for 12 Insertions Only

Professional Service Directory

McNARY & WRATHALL
CONSULTING RADIO ENGINEERS

★ ★ ★

983 National Press Bldg. DI. 1205
Washington, D. C.

GEORGE P. ADAIR

Consulting Engineers

Radio, Communications, Electronics

1833 M St., N.W., Washington 6, D.C.

EXecutive 1230

KEAR & KENNEDY

Consulting Radio Engineers

1703 K St. N.W. REpublic 1951

Washington, D. C.

**FREQUENCY MEASURING
SERVICE**

Highest Accuracy — Anytime

STANDARD — MEASUREMENTS

Division of RADIO ELECTRONICS, INC.

Phone 2652

ENID, OKLAHOMA

WATKINS 9-5310

S. A. Barone Co.

Consulting Engineers

MECHANICAL—RADIO—ELECTRONIC
PRODUCT DEVELOPMENT & RESEARCH

Development Specialists in Circuits, Part
Lists, Models, Manufacturing Drawings.

143-145 W. 22ND STREET, NEW YORK 11

FM AM

**NATHAN
WILLIAMS**

Consulting Engineer

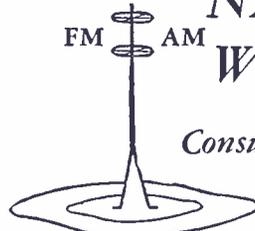

20 Algoma Blvd.
Oshkosh, Wis.

Phone: Bl'khawk 22

DALE POLLACK

FREQUENCY MODULATION

development and research
transmitters, receivers
communications systems

352 Pequot Avenue New London, Conn.
New London, 2-4824

WINFIELD SCOTT MCCACHREN

AND ASSOCIATES

Consulting Radio Engineers

TELEVISION SPECIALISTS

PHILADELPHIA:
809B Windemere Ave.
Drexel Hill, Pa.
Sunset 2537-W

410 BOND BUILDING
Washington, D. C.
District 6923

**RATES FOR
PROFESSIONAL CARDS
IN THIS DIRECTORY**

\$10 Per Month for This Standard
Space. Orders Are Accepted
for 12 Insertions Only

*What stations are most active
in developing FM broadcasting
and in promoting the sale of FM
receivers?—See pages 56, 58, 60.*

FM'ers

Are you still kiddin'
With grounded griddin'?
If you want to rise and shine,
Get yourself a QUADRILINE.

See REL's new 10-kw.
FM Transmitter
announcement in
the next issue of
this magazine!

Announcing!



. . . NEW 1304 CABINET TYPE REPRODUCER SETS

Here are two brand new Western Electric Reproducer Sets for broadcast stations, recording studios and other professional users—designed from the ground up to bring out the full quality of today's finest transcriptions and records.

The 1304A includes the popular 9A Reproducer; the 1304B has the new 9B. Both equipments are available, less cabinet, as the 304A and 304B Reproducer Panels respectively. An entirely new drive mechanism with a belt and one-step helical gear reduction at both $33\frac{1}{3}$ and 78 rpm provides constant-speed operation and extra long life. Mechanical filters isolate

the turntable effectively from vibration in the motor, the driving mechanism, and the cabinet.

A new, more efficient, *electrical* method of changing turntable speed, based on reversing the direction of rotation of the motor, eliminates the usual clash gears or planetary ball devices.

The attractively styled cabinet is adjustable in height to match various operating requirements. For full details, see your local Graybar Broadcast Equipment Representative — or write to Graybar Electric Company, 420 Lexington Avenue, New York 17, N. Y.

Designed by Bell Telephone Laboratories

Western Electric
— QUALITY COUNTS —



FM CAN CUT AM RATES

With Lower Line Costs, FM Nets Can Deliver High Fidelity at Less Than AM Rates, and Sell Big-Name Shows to Local Advertisers

BY MILTON B. SLEEPER

IT'S quite a while since we have held a forthright bull session¹ about what's going on in the FM field. So much has happened since then that it's time to survey the scene again. Let's take a look:

FM Network Programs ★ The most important recent event has to do with the inauguration of live-talent FM network service. There is a prevailing impression that if FM stations are going to broadcast network programs, they must come from one of the existing AM nets.

If you heard the current series of Wednesday night Continental Network FM programs originating in Washington, and distributed to stations all the way to Buffalo and Mt. Washington, you know that FM can do very well without any AM net, and without much help from the Telephone Company. You also know that Bing Crosby, Toscanini, Kate Smith, or any of the big name bands have never delivered to any AM listeners the quality of music and entertainment that the AAF orchestra and its soloists furnish the FM audience. — And that, compared to the way FM projects the personalities of the guest speakers on the AAF programs, Gabriel Heatter, Fulton Lewis, Jr., and the top announcers sound on AM nets like disembodied voices calling from the void. In fact, even a poor voice over FM sounds better than the best on AM, because it is the voice of a real human being.

Continental Network ★ The Continental Network, organized by Everett Dillard of WASH-FM and Major Armstrong, has expanded greatly in the course of a few weeks. The setup on April 16th is shown in the accompanying sketch in correct geographical arrangement.

Programs are carried by telephone line from Washington to Alpine, and from Alpine to Rochester and Buffalo. Transmission from all the other stations is a matter of rebroadcasting. That is, WBIB New Haven picks up Alpine signals, and rebroadcasts them on its own frequency. WDRC-FM at Meriden picks up WBIB or Alpine direct and rebroadcasts on its frequency. By a similar process, the program is furnished to WIXHR, WGTR, and WMTW.

Conditions are slightly different on the

New York leg. WBCA Schenectady can pick up W2XMN Alpine, even though the airline distance is about 140 miles. Then WIBX can get WBCA signals and pass them on to WSYR-FM. However, WHFM and WBEN-FM are at distances which require line service through Alpine, although WWHG can rebroadcast from WHFM.

Leonard Asch of WBCA told members of the FM Association at Albany that the cost of the equipment required for rebroadcasting was about \$100. It consists merely of a receiver with the output connected to the speech input of the transmitter!

Later, if one or two stations between Washington and New York City are added to the net, and when WSYR-FM and WHFM get up to full power, the present telephone lines can be eliminated entirely, together with the cost of renting those lines.

Economic Advantage ★ Therein lies one of the economic advantages of Frequency Modulation. In an AM net, each station must have a wire line connection. It's impossible to repeat AM signals because the effects of static and fading would be multiplied at each repeating point. That is why, when network stations carry a program originating abroad, the transoceanic signals are picked up at a special receiving point and then distributed over the Country by telephone lines.

Results on the Continental Network indicate that FM programs can be passed along from one station to another for a considerable distance. We don't know what the limit of rebroadcasting repeats will be. However, it is clear that a nationwide FM network operation would need only a skeleton of wire lines running to key stations, since each could serve as a distributing point for program distribution by rebroadcasting over a considerable area.

This saving in the number of miles of telephone lines required for a national network would probably offset the higher cost of 15,000 cycle facilities, compared to the 5,000-cycle lines now in use on all AM nets. In fact, FM network operation will probably be much cheaper than that of the low-fidelity AM nets.

So, when anyone says that FM will never compete with AM because the stations can't get AM network programs,

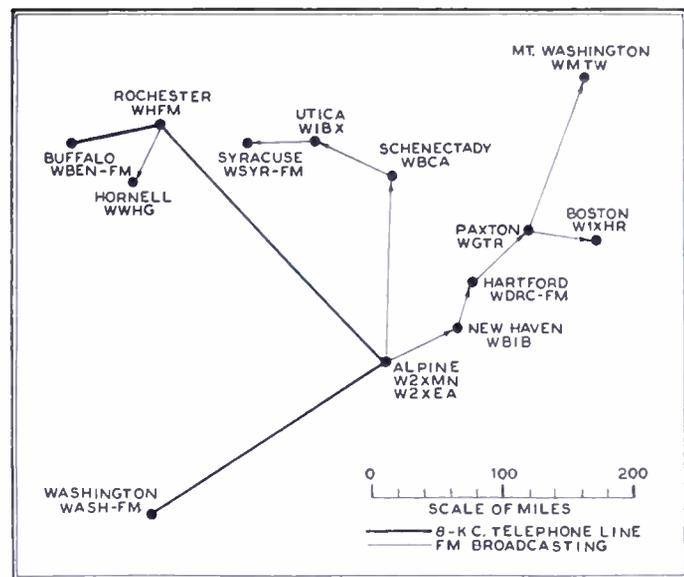

GEOGRAPHICAL DISTRIBUTION OF FM STATIONS IN THE CONTINENTAL NETWORK

don't take that too seriously. Sponsors are complaining right now over the high cost of network advertising. Given a little more time for FM stations to get up to full power, and for the production of FM sets to reach 2 or 3 million, and you may see FM nets taking business away from AM on a dollar-for-dollar basis! That could start to happen in 1948.

FM Via AT & T ★ We must confess to being disappointed in AT & T's contribution to the Continental Network. The Company has been talking about the availability of 15,000-cycle lines² for the past 6 years.

However, when Continental asked for a 15,000-cycle line from Washington to Alpine, the Company could only deliver 8,000-cycle facilities. Now the truth is that 15,000-cycle lines are available. Perhaps Company officials were caught off-base by being asked for them, because they came up with the old argument that listeners wouldn't be able to hear the difference between 8,000 and 15,000 cycles.

And here is a curious thing: On March 26th, we listened at Great Barrington to the first network program as it came from Alpine. That night, the AAF orchestra, the soloist, and the guest speaker were received with fidelity and realism that were almost breath-taking. The second show, on April 2nd, was almost as good. We missed the third, but the fourth, on April 16th, was distinctly flat on both music and speech, and we heard a continuous background hiss that was not present in the preceding program originating at Alpine.

To be sure, the poorer FM reception on April 16th was infinitely better than the AM hash and fading we get at Great Barrington, and the live-talent show was a tremendous improvement over recordings transmitted by FM.

However, there was so much difference in the quality of reception between the first and the fourth Continental Network broadcasts that it seemed to us that the line characteristics must have been changed. By comparison with AM, the fourth broadcast sounded as if the Washington-Alpine line was delivering 8,000

² See "AT & T Prepared to Serve FM" by F. A. Cowan, *FM*, March, 1941, and "Bell System Routes," a map of existing 15,000-cycle lines, furnished as a supplement to *FM AND TELEVISION*, Feb. 1945.

¹ The first was "Facts of Life about FM Sets" by Milton B. Sleeper, *FM AND TELEVISION*, January, 1947.

cycles all right. If that was so, then the line was carrying considerably higher frequencies the first night.

This criticism has not been confirmed by information from AT & T engineers. It is only based on personal listening experience and a comparison of program quality with the 15,000-cycle live-talent shows from Alpine which originate at the home of C. R. Runyan, Jr., in Yonkers, N. Y., and are beamed to Alpine by an FM link. These transmissions, incidentally, set a standard of fidelity for FM broadcasting today. It might be useful for telephone engineers to hear these programs, too, because telephone lines cannot be considered acceptable for FM until they can deliver signals equaling audio quality noise level to the Runyan demonstrations.

FM Makes Listeners Critical ★ If you ride a wagon over country roads, you are probably concerned only with transportation from one point to another. But if you drive a new automobile over a concrete highway, you probably hear every little squeak in the body, and every tick in the engine.

The same thing is true of radio listening. You don't complain about AM noise and distortion and fading. Your primary interest is in intelligibility. But when you listen to live-talent on FM, with a good receiver, the performance is so nearly equal to a seat in the broadcast studio that you become as annoyed when the sound of coughing comes from the loud-speaker as if the person who coughed were sitting right behind you, and not hundreds of miles away. When the level of a speaker's voice changes abruptly, you look up wondering if he turned away suddenly from the microphone, or if the operator was fiddling with the level control. If a little background hiss rides in, you want to write the Telephone Company and ask them why they can't do better than that. And at the end of a selection, you discover that you've been so absorbed in listening that you're liable to applaud, even though you remind yourself that the artist can't hear you!

Cheap FM Receivers ★ To be sure, receivers and speaker systems producing that degree of realism are high in price. You can't get a Cadillac ride in a Chevrolet automobile. It's an economic impossibility.

Fortunately, fine FM receivers don't cost as much as Cadillacs. They don't even cost as much as second-hand Chevies. Moreover, the first cost of an FM receiver is the total cost for years of enjoyment. There's no annual expense for a license and insurance and tires, no monthly expense for oil and greasing, and no weekly expense for gasoline.

FMA president Roy Hofheinz, speaking at the regional meeting at Albany, said \$200 is too high a price for FM receivers. Well, it is too much to pay for the reception of phonograph records. There's no doubt about it. But on live-talent recep-

tion there's a night-to-day difference between what comes out of a \$60 set and reception from a receiver priced at \$450 to \$600. Listening experience may show that a \$200 price is on the low side.

Much depends on the broadcasters. If they keep on grinding out phonograph records, there will certainly be no demand for sets with high-fidelity amplifiers and speakers. However, as competition develops between stations in the same area, the station that delivers live-talent programs will take the listeners away from the platter-turners so fast that it won't be funny.

As we see it, the solution of the price problem will come in 1949, when straight FM receivers, minus AM and phonographs, will provide high-fidelity reproduction in the \$250 bracket. It's likely that such sets will be styled after the designs proposed by Walter Buehr.³

Sets Vs. Markets ★ Any significant survey of coverage by a newspaper or radio station must break down coverage by income brackets. Families in the very low brackets are limited as to the products and services they can buy. AM radio coverage is very complete in the low-income brackets. That's why most of 1946 network billing went to manufacturers of tobacco products, candy and soft drinks, drugs and toilet goods, foods and beverages, and laundry soaps.

This also explains the growing contempt in which radio programs are held by people in the higher-income brackets who, though smaller in number, constitute the market for products above subsistence-level commodities.

AM has lost a large and increasingly larger part of the potential audience above the low-income bracket, to the extent that it is now a poor man's service. Moreover, AM station time is virtually monopolized by subsistence-level products.

Therefore, in making plans to develop FM audiences and time sales, there is a definite question as to whether the concentration of FM set production in brackets under \$200 would serve the best interests of the FM stations.

Set manufacturers generally have not proved to be smart merchandisers, as their prewar experience shows. However, Philco, the largest manufacturer of home radio sets in the world, reached its position in the industry during the prewar years by maintaining sales pressure on consoles, while most of the other companies were engaged in cutting each others' throats, as well as their own, by making AM sets cheaper and cheaper.

Today, as in 1941, the industry's great need is conversion to production and distribution methods that will make possible the establishment and maintenance of high unit prices.

³ See "High-Fidelity FM Designs at Mass-Market Prices" by Walter Buehr, *FM AND TELEVISION*, March, 1947.

It's up to the Broadcasters ★ If FM broadcasters develop programming that will justify the cost of high-fidelity receivers, they will recapture the interest of the minority group which spends the bulk of our national income.

Is that economically desirable from the broadcasters' point of view? Let's look at the figures. In 1946, broadcasting took a severe licking. According to the Publishers' Information Bureau, the gain in gross billing in radio, newspapers, and magazines for 1946 over 1945 was:

National radio networks	+ 1.2%
Other radio time	+ 4.8%
Total radio time sales	+ 3%
Newspapers	+ 24.3%
Weekly magazines	+ 23%
Monthly magazines	+ 19%
Women's service magazines	+ 28%

These figures show clearly the shift of advertising to newspapers which perform a community service, and to publications which serve groups above the low-income levels. They also show that successful FM station operation lies in promoting FM on its merits, and not by aping the AM'ers.

This brings us back to the question of networks. The public wants talent shows. Listeners are already discounting the value of staticless reception that is limited to continuous recordings. How, then, can an FM station be developed as an area or community service and meet the competition of the expensive talent provided on AM nets by national cigarette, drug, tooth paste, and cereal accounts. Or, to put it another way, how can local advertisers buy programs that will compete with the big-name network shows?

Well, FM has produced the answers to a great many other problems. Perhaps it can answer this one, too. Perhaps FM stations will buy network shows and sell the time themselves. Why not?

Suppose the equivalent of a half-hour AM show costs \$20,000 and is bought by 200 FM stations. The average cost per station would be \$100, adjusted in proportion to each station's coverage. Think what that would mean to local advertisers!

You say: "If it can be done on FM, why haven't AM stations done it already?" Actually, it is being done on AM now, but the plan has not been expanded because national advertisers have bought up most of the good time on AM through the networks. So there's been neither the reason nor the opportunity to expand this network-in-reverse method.

But it can be used by FM stations. It will be a relatively simple plan to set up, too. There are plenty of producing organizations already in existence and ready to deliver shows that can compete with anything the AM nets can offer.

There's no doubt about it: the changes that FM is bringing about aren't limited to transmitters and receivers. And as for programs, FM isn't going to be limited to phonograph records much longer.

FM ANTENNAS for 12,497 FAMILIES IN METROPOLITAN LIFE PROJECTS

Largest New York City Housing Projects Will Provide FM, AM, and Short-Wave Reception in Each Apartment

BY F. A. KLINGENSCHMITT*

THE landlord's obligation to provide this tenants with means for satisfactory radio reception has been given very significant recognition by the Metropolitan Life Insurance Company, which is now completing the largest postwar housing projects in New York City. These com-

Certainly, judging from advertising claims of the set manufacturers, that decision was well-founded. However, an examination of the building plans showed 1) heavy steel construction, and 2) the use of metal foil in the walls for insulation.

Experience has shown that steel fram-

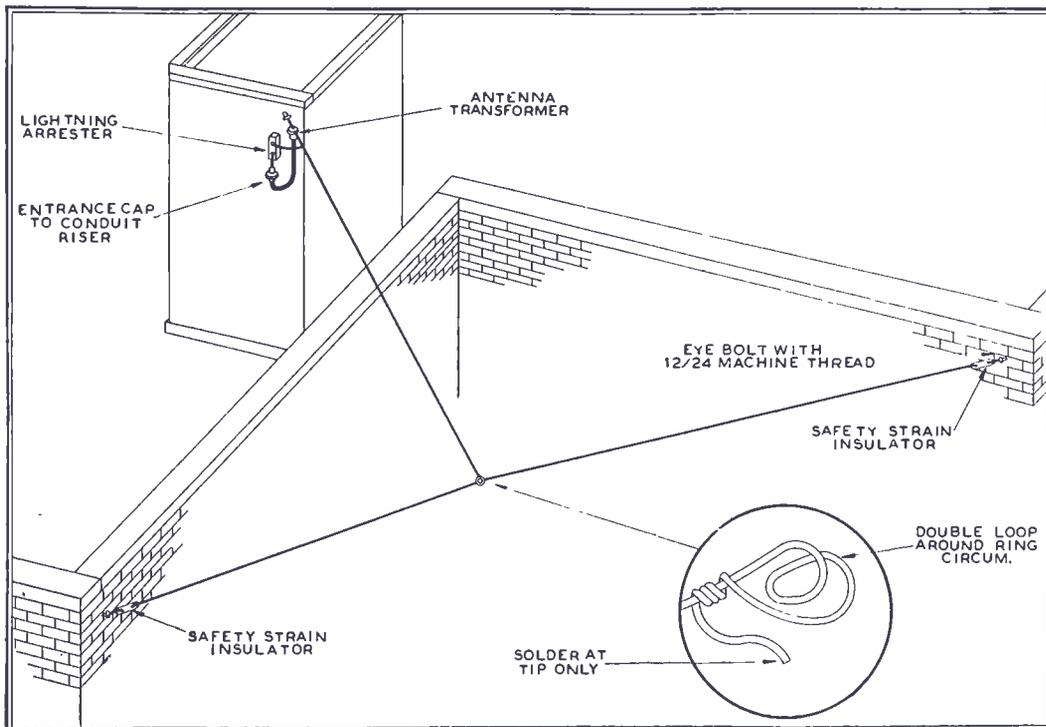

FIG. 2. ANTENNA IS STRUNG ACROSS COURT TO INCREASE THE EFFECTIVE HEIGHT

prise Stuyvesant Town, 35 buildings, and the Peter Cooper Project, 21 buildings, located on the East Side between 14th and 23rd Streets, and the Riverton Development, 7 buildings, between 135th and 138th Streets. Every apartment, totaling 12,497, will have connections to an antenna system capable of furnishing FM, AM, and short-wave reception.

Why Antenna Systems Are Needed ★ There is an interesting story behind the decision of the builders to install multiple antenna systems. When this plan was originally proposed, it was rejected. In a subsequent conference, the officials readily acknowledged that radio reception should be considered one of the essential utility services, but they expressed the opinion that outside antennas were no longer necessary because practically every set in use today is equipped with a built-in antenna.

*Sales Engineer, Amy, Aceves & King, Inc., 11 W. 42nd Street, New York City, N. Y.

ing or re-inforced concrete construction cuts down the signal-to-noise ratio to the point where sets with built-in antennas seldom give satisfactory service even from powerful local stations. But here was a case where metal foil insulation in the walls made virtual shielded rooms of the apartments!

It was fortunate indeed for the future tenants that this condition was recognized in time to include the specification of multiple antenna systems for the 63 buildings which make up the three Metropolitan developments!

Installation of Antenna Systems ★ The accompanying illustrations give the details of antenna construction methods and riser plans for outlets in typical types of apartment houses. The details are important because they disclose practices which have been developed by Amy, Aceves, & King from long experience with these installations.

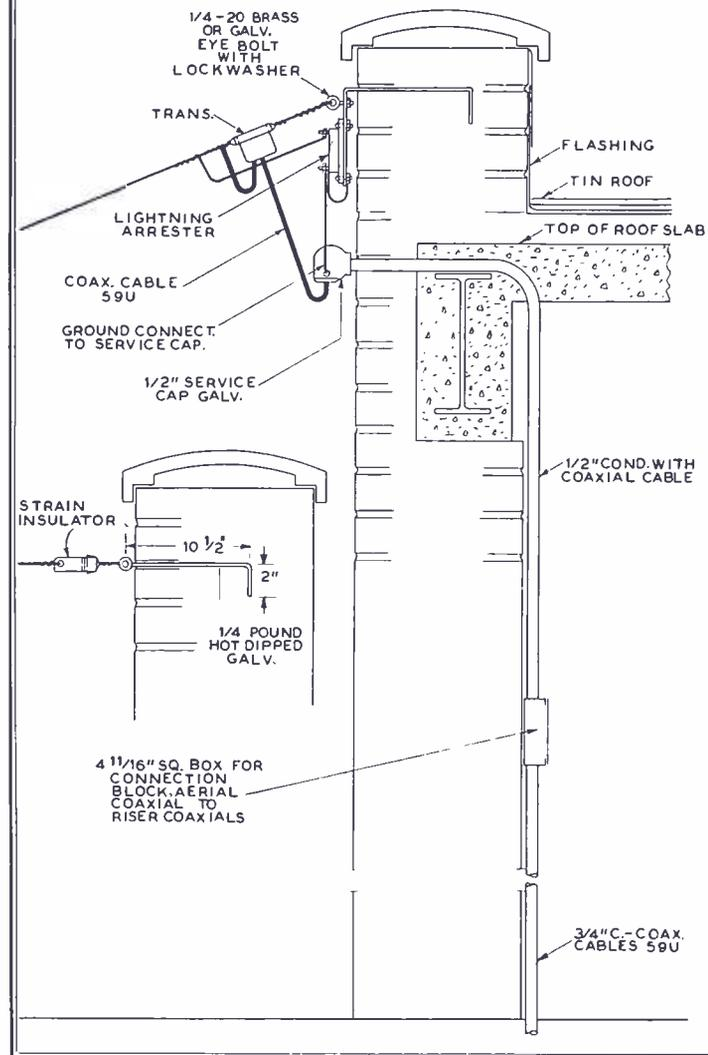

FIG. 1. TYPICAL ANTENNA INSTALLATION

Fig. 1 shows the arrangement of the antenna transformer, antenna anchor, lightning arrester, cable, conduit, and outlet box. It will be seen that the newest systems employ RG/59/U cable. This is necessary in order to handle FM broadcast frequencies up to 108 mc. While 1/2-in. conduit will carry the RG/59/U cable, we are now recommending the use of 3/4-

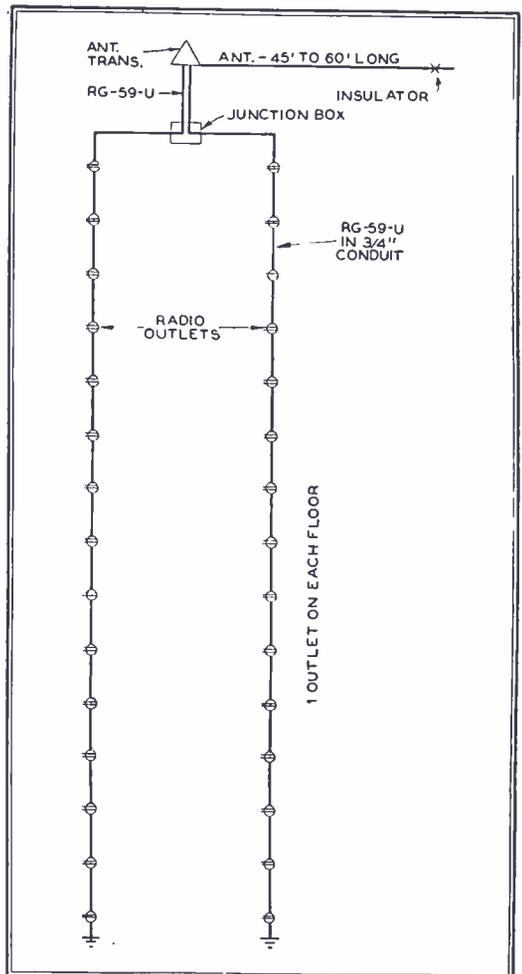

FIG. 3. ANTENNA RISER WITH 15 OUTLETS

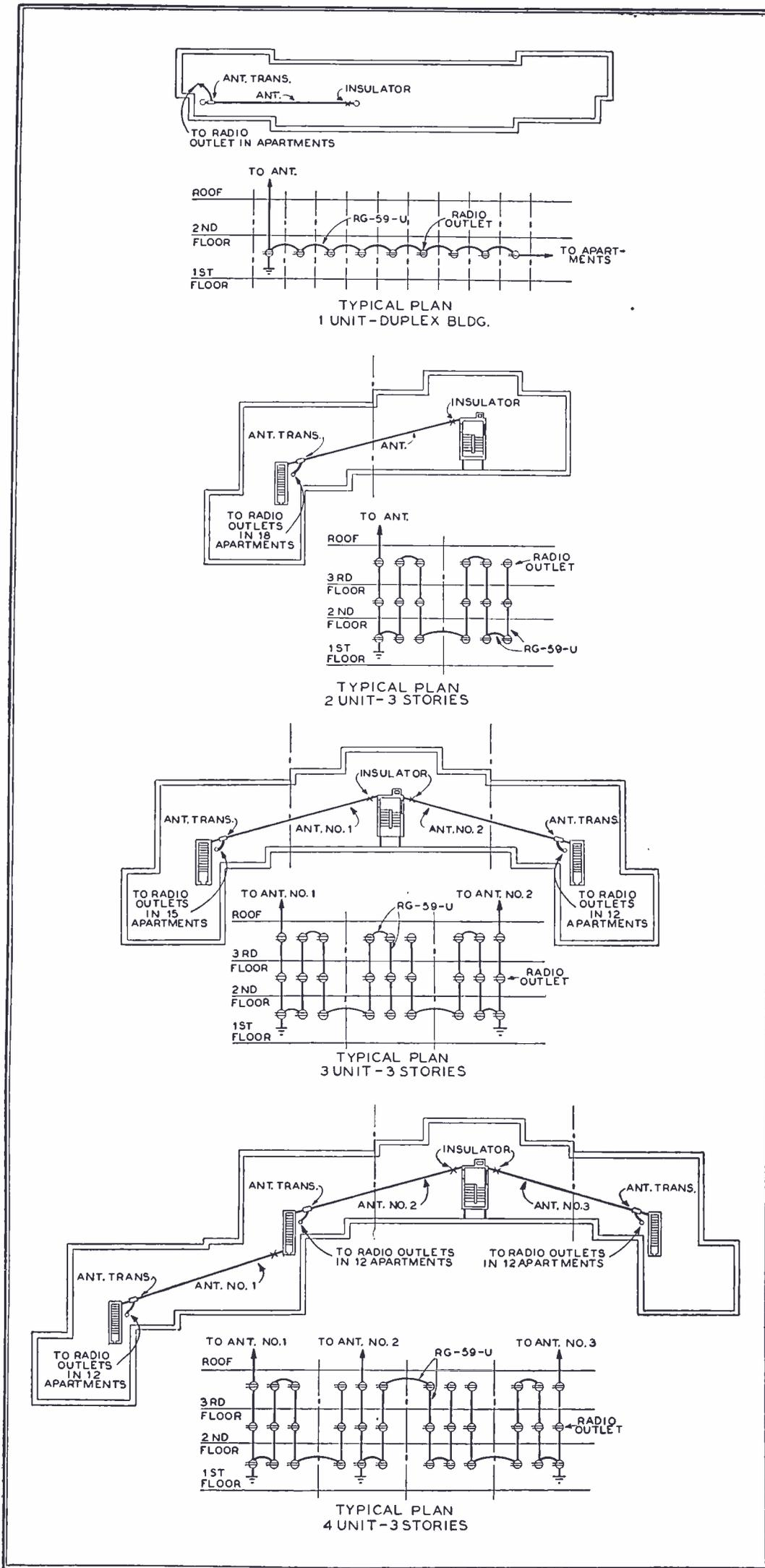

FIG. 4. FOUR TYPICAL ARRANGEMENTS FOR APARTMENT HOUSE ANTENNAS AND RISERS

in. conduit in most cases. The purpose is to permit adding a television antenna system at some future time. In that case, provision is made by furnishing 2-gang

plates with one side left blank until such time as a television antenna system is made available.

A typical antenna arrangement is illustrated in Fig. 2. The length is not critical, ranging from 45 to 60 ft. As far as possible, the antennas are stretched across open courts, since the effective height is greater than when the wires run above the roof. An important installation trick is detailed in Fig. 2. We have found that the lead should not be soldered directly to the antenna span, because the wire tends to crystallize and break at the soldered joint. Instead, we wrap each of the three wire sections around a brass sail ring, as indicated, and then make a separate joint of the three ends. Thus there is no solder at any point of mechanical strain.

At the Metropolitan Life buildings, each riser carries 15 outlets, Fig. 3, and each antenna is connected to 2 risers, as in Fig. 6. There you will see another method of making connections that we have used successfully. The outer insulation of the RG/59/U cables is stripped down to the braided shield. Then the shielding on the three cables is wrapped with No. 18 solid copper wire, and the joint soldered. Finally, the ends are formed into a loop, and the three inner conductors are twisted together and soldered. Both joints are well taped. In this way, the cables are relieved of strains that might break the wires or injure the insulation.

The connections between the cable and multicouplers at the outlet boxes, Fig. 5, are simple and positive. A copper lug on the G terminal of the multicoupler is used for a soldered connection to the shielding, and also serves as an anchor. Both ends of the inner conductor run to the A terminal. The multicoupler carries a polarized receptacle, making it impossible to reverse the antenna and ground leads from the radio set.

Riser Plans ★ The multicoupler system for providing apartment antenna outlets is very flexible. Arrangements vary in accordance with building requirements from the straight-line plan in Fig. 3 to those shown in Fig. 4.

In the case of the 2-unit building of 3 stories, there are 18 outlets on a single cable. This is about the maximum number recommended. The 4-unit building of 3 stories has 3 antennas, each feeding 12 outlets. In each case, the final determination depends upon special requirements and special conditions at each installation. Most systems, however, are variations of the examples illustrated.

System Specifications ★ For the benefit of engineering consultants who may be called upon to handle multiple antenna systems, a typical set of specifications is presented here. These will be helpful because they give effect to Building Code requirements in New York City, and provide for FM, AM, and short-wave reception.

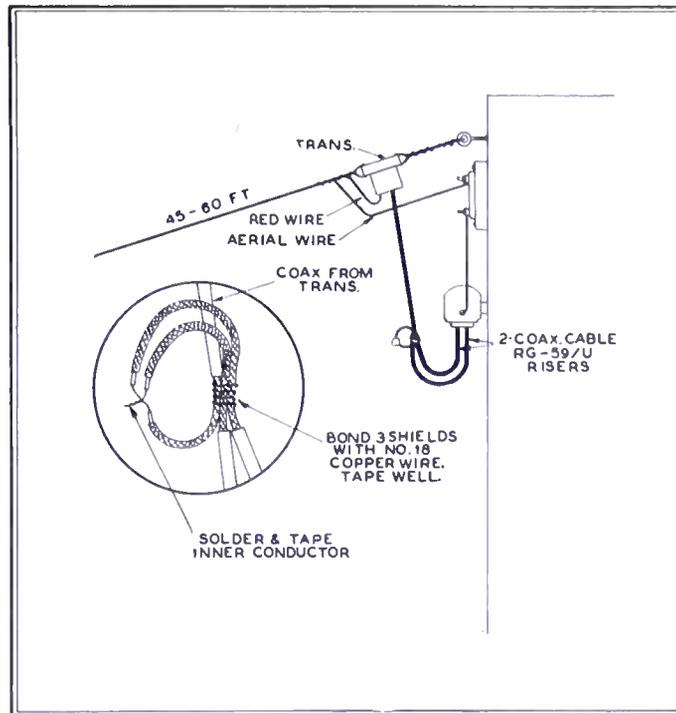
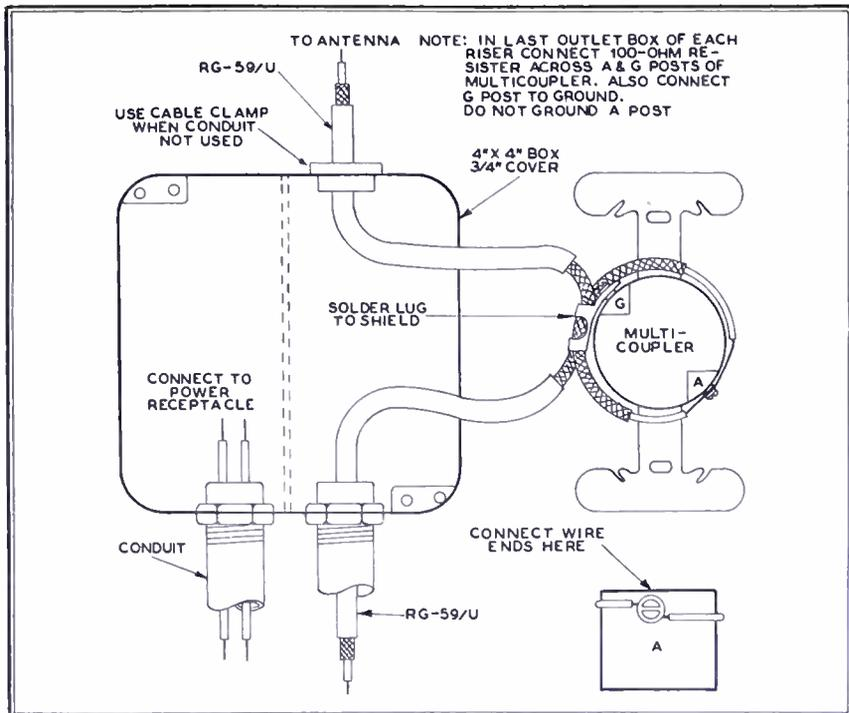

FIG. 5. DETAILS OF THE OUTLET BOX AND COUPLER CONNECTIONS.

FIG. 6. METHOD OF CONNECTING TWO RISERS TO ONE ANTENNA

SPECIFICATION FOR A MULTICOUPLER ANTENNA SYSTEM FOR BROADCAST, SHORT-WAVE AND FM RECEPTION

The contractor shall furnish and install a noise-reducing radio antenna and ground distribution system, including all antennas, conduits, wires, outlet boxes, and radio devices required to furnish combined antenna, ground, and power outlets in each apartment.

This system shall employ an antenna with impedance-matching transformers properly connected to a coaxial cable enclosed in 1/2-in. rigid conduit. A coupling device capable of providing short-wave, standard broadcast, and FM radio reception shall be installed in each radio outlet box. One antenna shall be capable of serving up to 20 radio outlets under average conditions.

The entire installation shall be made in accordance with the specifications and under the supervision of the engineering staff of the manufacturer furnishing this material, and shall be done in accordance with the Underwriters requirements and regulations of local governing bodies. The entire installation shall be made in a workmanlike manner and shall be left completely connected ready for tenants' use.

ANTENNAS: The contractor shall erect on the top of the building suitable antennas to serve each building. These antennas shall be installed in accordance with the specifications of the manufacturer furnishing the radio outlet material. Antenna transformers shall be equal to Arrow Hart-Hegeman Type No. 3126, or A.A.K. No. 3089 F.

RISERS: A riser system shall be furnished and installed, consisting of 1/2-in. conduit for each vertical tier of apartments. A coaxial cable, of a type which shall be in accordance with the specifications of the manufacturer furnishing the radio

outlet material, shall be pulled in the conduit, and shall run continuously from outlet to outlet. Where living rooms of two different apartments are adjacent to each other, separated by a partition or wall, a back to back arrangement can be used. Otherwise, two vertical risers shall be brought together at one point where a single 3/4-in. pipe, containing two coaxial cables, one from each riser, shall be brought through the roof. All risers shall terminate in a single conduit at least 10 ft. above the roof, in a suitable service fitting. In the last box of each riser there shall be a 100-ohm, 1-watt resistor across the inner conductor and shield, also connected to ground. Riser conduit shall be run in as straight and short a line as possible.

OUTLETS: There shall be installed in each apartment, at the location shown on the plans, a radio outlet, a 4-in. square box 3/4 in. deep, with cover and barrier, both of which shall be galvanized. The cover shall have mounted on it a 2-gang wall plate, provided with a duplex power receptacle and a multicoupler provided with a polarized antenna and ground receptacle, together with an antenna and ground plug. The radio outlet unit shall be equal to Arrow Hart-Hegeman Type No. 3120, or A.A.K. No. 208-F.

The contractor shall make all connections between riser wiring and the outlet equipment as instructed by the manufacturer of the radio antenna system.

FM Reception ★ Nowadays, we are asked frequently 1) is it necessary to use an outside antenna for FM reception in an apartment house, and 2) will the Amy, Aceves & King multicoupler system provide FM reception?

We have consulted FM station operators on the first question because they seem to be the best-informed source of

information on this point. The broadcasters are emphatic in saying that an outside antenna is required in apartment houses and private homes as well, to assure proper reception at the high frequencies used for FM. This is equally true of television, which employs channels below and above the FM broadcast band. The broadcasters point out that, while good reception from a built-in antenna is possible in some locations, FM listeners expect to get complete elimination of static, and that requires enough signal from the antenna to give full limiter action in the receiver.

As to FM reception from the antenna systems described here, we can say definitely that they can and do give highly satisfactory FM performance. This statement, however, applies to FM sets which afford the limiting action necessary to suppress static. We know from both FM and television experience that there is electrical interference at the high frequencies. Consequently, under normal receiving conditions, the elimination of static requires not only a good antenna but an FM receiving circuit that includes a limiter.

25,000 FM Sets per Week

Figures for the week ending April 18th show that FM production reached approximately 5,000 sets per day, or a monthly rate well over 100,000.

Meanwhile the bottom has fallen out of the market for AM sets. Some dealers ascribe this condition to a general buyers' strike. However, those who have put intelligent sales effort behind FM say that, while they are selling fewer AM models, the loss is more than offset by increasing FM sales. These dealers express the belief that the general public is coming to realize the superiority of FM over AM, and just isn't spending money for the kind of reception that is coming in on the overcrowded AM band.

PLUG-IN STUDIO AMPLIFIERS

Versatile Units Simplify Installation and Maintenance, and Permit Easy Modification of Facilities

BY WILLIAM M. DALLIN*

LOOKING back at the early broadcast studios, it is interesting to observe that, in almost alternate steps, new program techniques and the expansion of studio facilities called for more flexible mechanical and electrical design of speech equipment, and then, as the equipment was designed with greater flexibility, new program ideas were introduced which again taxed studio facilities.

There was a time, and not so many years ago, when studio equipment was planned with the thought of anticipating future needs to the extent that no further changes or alterations would be required. Experience has shown, however, that such plans are costly, and that the end result is never attained completely. Rather, the best present thinking is to make new installations in such a way that they can be modified easily, quickly, and at a minimum cost to keep studio facilities in step with the art and science of broadcasting.

Emphasis on Flexibility ★ This new attitude is expressed in the postwar series of units being introduced by the Langevin Company for broadcast studios and sound systems. That is, the designs are characterized by:

1. Small mechanical dimensions for compact grouping. The cubic contents of the units illustrated here is a small fraction of that required by equivalent amplifiers of what were considered the most advanced types a few years ago. The reduction of dimensions has also resulted in cutting down the weight substantially.

* The Langevin Company, Inc., 37 W. 65th Street, New York 23, N. Y.

2. Plugs for external circuit connections. One of the lessons learned from war experience is the value of plug-in connections to facilitate substitutions and replacements. Such arrangements have been made possible and practical by low-resistance, positive connectors. For example, the Langevin units employ Cannon plugs, made to Langevin specifications, with gold-plated, non-oxidizing terminals and, in the pre-amplifier and program amplifier, Twin-Ax input connections. As the illustrations show, the receptacles are secured to the rack-mounting frames. When the external wiring has been put in, there is no further work to be done at the racks. If trouble develops in any unit, it can be removed and replaced in a matter of seconds. Thus repairs are made in the shop, and not in the control room. Moreover, the plug-in arrangement permits removal for routine checking as a matter of preventive maintenance.

3. Frequency characteristics meet FM requirements. Since speech equipment installed now for FM broadcasting may be required to operate with FM transmitters later, these units are designed to meet FM needs as to harmonic distortion, noise, and flat frequency response. This is an important consideration in all new speech equipment, for the extra first cost is small compared to that of overhauling and replacing complete assemblies later, for FM operation.

A related factor of performance is a generous allowance to meet overload conditions as a protection to program quality and to guard against electrical failures.

4. The units and the rack mountings designed for them shown in the accom-

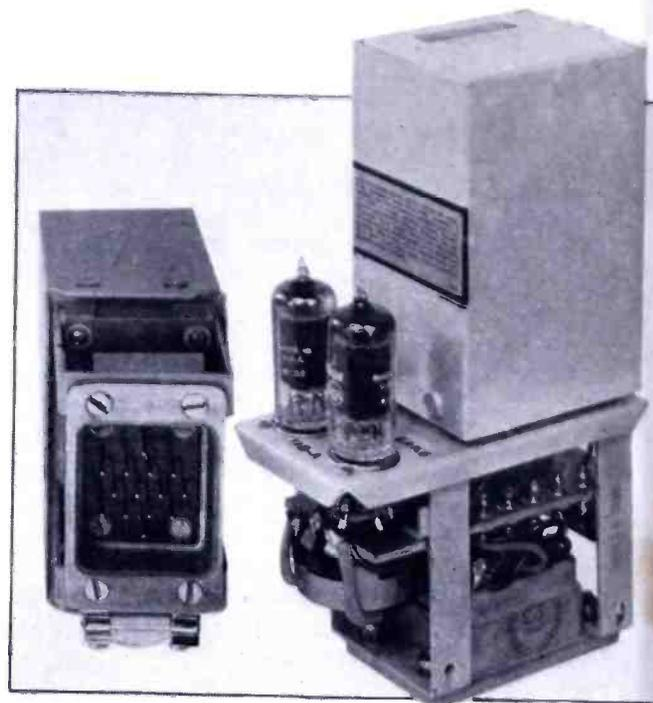

FIG. 1. THE ISOLATION BRIDGING AMPLIFIER CARRIES A PLUG ON THE BASE

panying illustrations can be used in an unlimited number of combinations for different circuit applications, installed in a minimum amount of space, and changed readily to meet future studio requirements.

Bridging Amplifier ★ The type 118-A isolation bridging amplifier, Fig. 1, operating from a 600-ohm line, provides 75 db isolation between line and buss at 15 kc., and 90 db at 50 cycles. It is a zero-gain device, with only sufficient gain to overcome the bridging loss. Two 6AK6 tubes are employed in a single-stage, push-pull circuit, operating with 6.3 volts at .3 ampere on the filaments, and 225 volts at 35 milliamperes on the plates. Output load impedance is 600 or 150 ohms.

The output power is +24 dbm (.25 watt) with total RMS harmonic distortion rated at less than 1% from 100 to 15,000 cycles, and less than 1.5% at 50 cycles. Output noise is 99 db below +24 dbm (75 db below .001 watt). Production tests show the frequency characteristic to be ±1 db from 50 to 15,000 cycles.

In size, this amplifier measures 6¹/₁₆ ins. high, 4¹/₈ ins. wide, and 6¹/₈ ins. long. Thus, as Fig. 2 shows, 4 units can be mounted on a standard mounting frame, and 3 of these assemblies, totaling 12 amplifier units, can be accommodated on a rack-mounting frame which requires only 10¹/₂ ins. of rack space. The connecting plug is carried at the bottom of unit, Fig. 1, and fits into a receptacle on the mounting frame. The total weight of each unit is only 2¹/₂ lbs.

Program Amplifier ★ Second in the series is the type 117-A unit that can be used as a program monitor, or booster amplifier. The gain is 50 db, operating from an input impedance of 30, 150, 250, or 600 ohms, and with an output impedance of 150 or 600 ohms.

Fig. 3 shows the amplifier and two typical circuit applications. Using two 1620 and two 6V6GT tubes, the output power

FIG. 4. THIS UNIT PLUGGING IN AT THE END, IS A PREAMPLIFIER OR BOOSTER. WIDTH IS ONLY 2 INS.

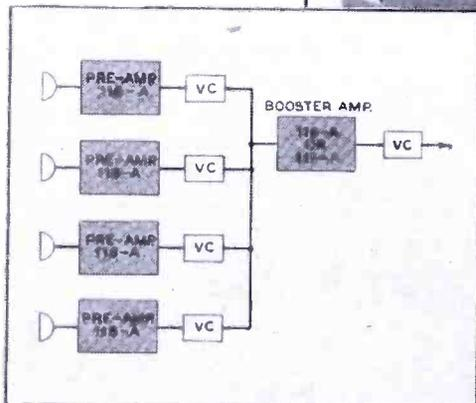
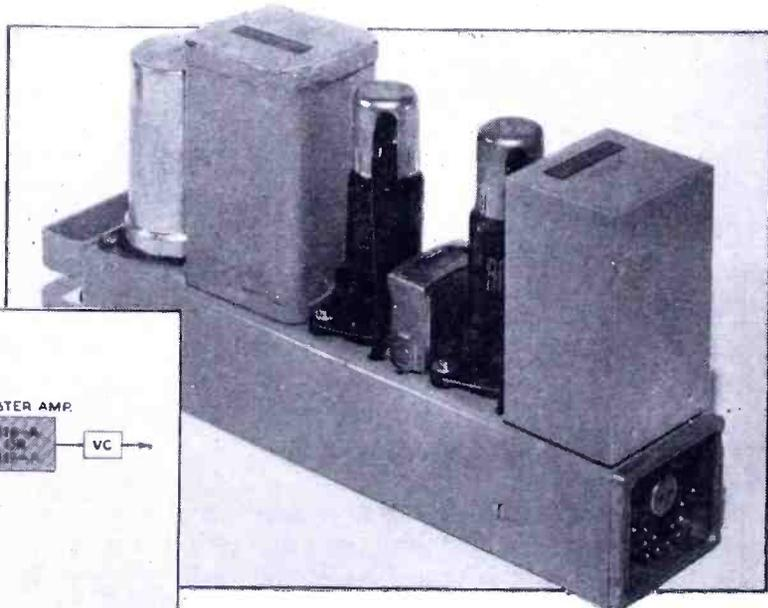

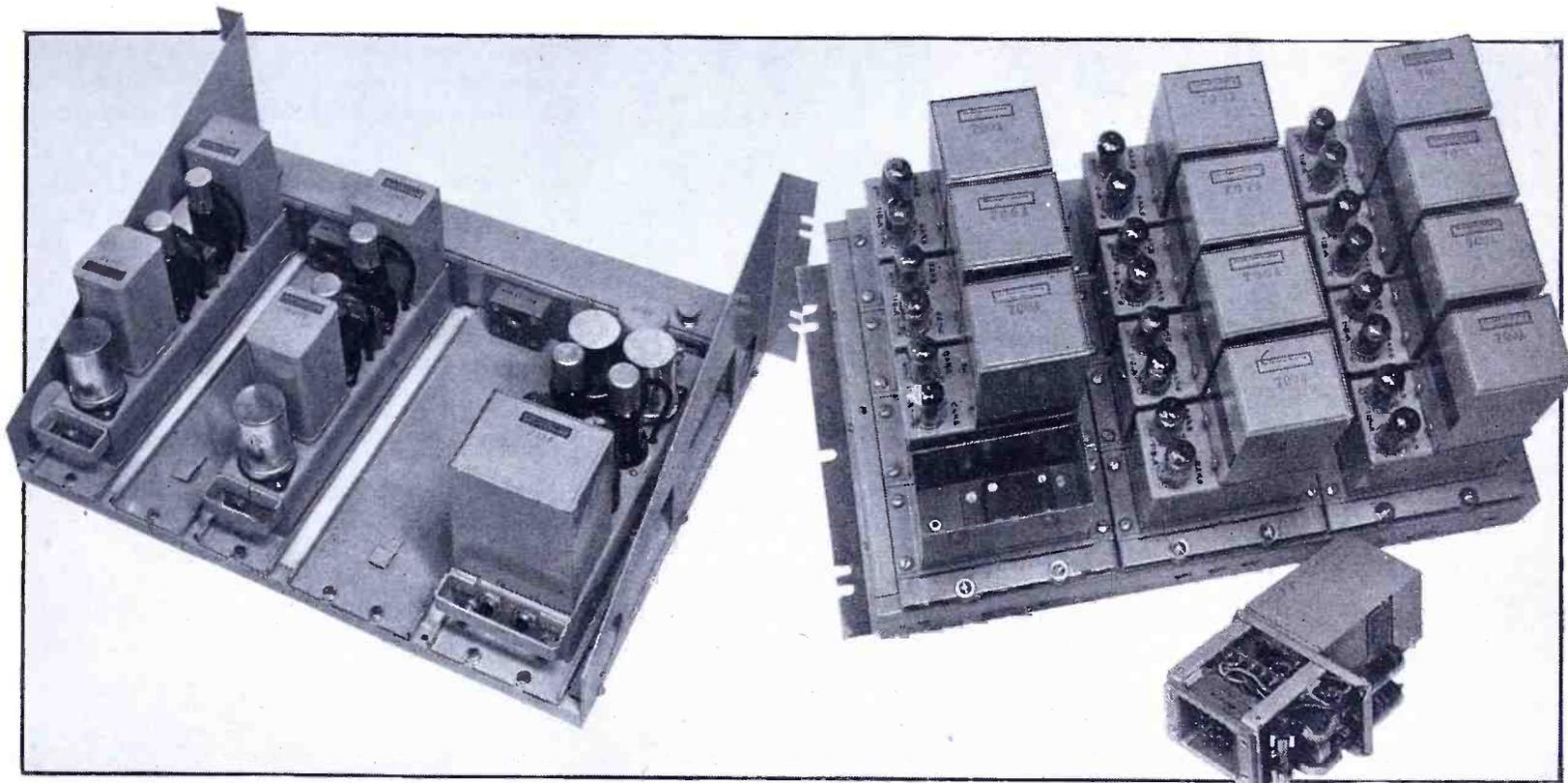

FIG. 2. TWO TYPES OF MOUNTING FRAMES PERMIT THE USE OF AMPLIFIER UNITS IN VARIOUS COMBINATIONS

is + 30 dbm with less than .5% total RMS harmonic distortion from 50 to 15,000 cycles, and less than 1% from 30 to 15,000 cycles. As a monitor amplifier, the output is + 39 dbm, or 8 watts, with less than 1% distortion from 50 to 10,000 cycles. Output noise is equivalent to an input signal of -110 dbm over a band of 20,000 cycles, or -114 dbm with selected input tubes. The frequency characteristic shows ± 1 db from 30 to 15,000 cycles. For power, the unit requires 6.3 volts AC at 1.5 amperes, and 300 volts DC at 70 milliamperes.

The connecting plug is mounted at the end of the chassis. Dimensions of this amplifier are $5\frac{1}{4}$ ins. high, $3\frac{1}{4}$ ins. wide, and 10 ins. long, with a weight of $6\frac{1}{2}$ lbs. Four of these units can be mounted in only 7 ins. of rack space.

Pre-Amplifier ★ Fig. 4 shows the type 116-A pre-amplifier or booster unit. It employs two 1620 tubes to give a gain of 40 db which can be adjusted to 34 db. Output power is + 18 dbm or .063 watts with less than .5% total RMS harmonic distortion from 50 to 15,000 cycles and less than 1% total distortion from 30 to 15,000 cycles. The input and output impedances and the frequency characteristics are the same as those of the program amplifier. The output noise is equivalent to an input signal of -120 dbm over a band width of 20,000 cycles or -124 with a selected input tube. Power requirements are 6.3 volts AC at .6 amperes, and 275 volts DC at 8 milliamperes.

These units are smaller than the program amplifiers, being 5 ins. high, 2 ins. wide, and 10 ins. long. Six pre-amplifiers, therefore, can be accommodated on the specially designed rack mounting frame.

Rack-Mounting Frames ★ Fig. 2 shows the

rack-mounting frames which carry the different units. The rack shown at the left carries removable trays, by means of which various combinations of pre-amplifiers or boosters and program or monitor amplifiers can be assembled.

All cabling is run in a channel behind the receptacles. While Fig. 2 shows the trays fastened to the frame so that the units are removed from the rear of the equipment rack, they can be reversed. Then, the amplifiers can be unplugged from the front. The frame occupies only 7 ins. of rack space.

The second frame is for bridging amplifiers, in any number up to 12. Access to the receptacles is obtained by removing any mounting plate.

Because of the flexibility of these new types of amplifiers, complete studio audio facilities can be worked out from microphone to transmitter input, with the important advantage that they can be altered quickly and inexpensively when new needs arise.

Circuit Alterations ★ The most common need for changing studio equipment now in use results from the need of meeting FM audio requirements. Economic considerations indicate the advisability of using 15,000-cycle amplifiers in all new installations. Even though there is no immediate intention of starting FM broadcasting, most AM stations will add FM transmitters before any new studio equipment will be old enough for replacement. For that reason, all the Langevin units are designed to meet the new specifications for frequencies up to 15,000 cycles.

In new stations, where complete studio facilities cannot be built because of limitations on construction, mounting frames to meet ultimate requirements can be installed and wired now. Then, as studios are added later, circuits can be completed and corresponding and the amplifiers put into service by merely plugging them into the jacks. It is almost that easy to make changes in accordance with unexpected, future needs.

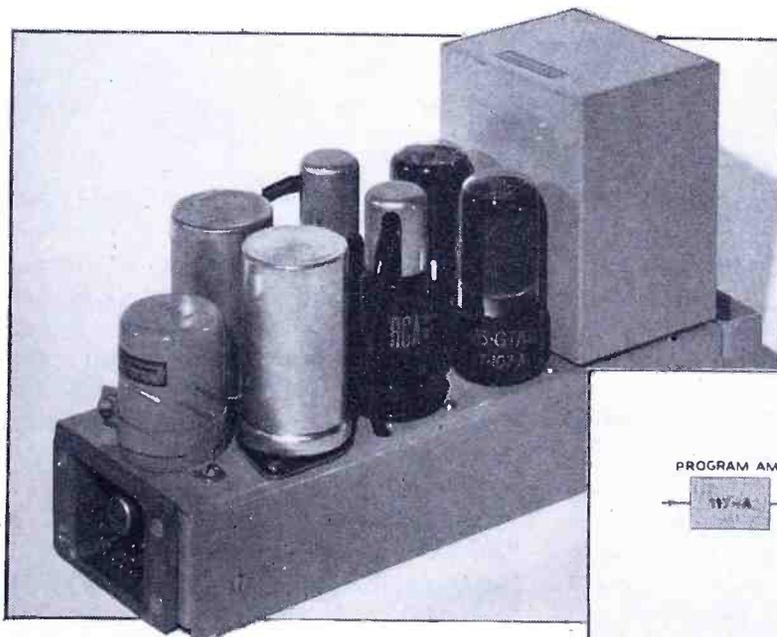
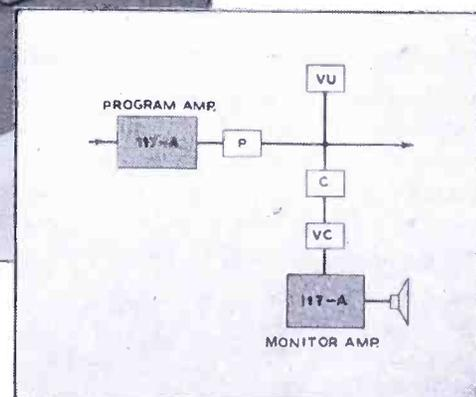

FIG. 3. THIS IS THE PROGRAM AMPLIFIER OR MONITOR UNIT, ALSO ARRANGED TO PLUG IN AT THE END



SPOT NEWS NOTES

Items and comments, personal and otherwise, about manufacturing, broadcasting, communications, and television activities

Chicago: Galvin Manufacturing Company has started construction on a new building of 22,000 square feet, located behind the present plant. It will be used for the production of TV receivers.

RMA Campaign: We don't know whether or not there's any anti-FM aspect to the \$50,000 campaign to sell "A radio for every room in the house", but a member of the organization hired to handle this promotion stated, when asked if it is intended to sell FM as well as AM sets: "Our answer is that if you want to hear Toscanini, buy an FM set. If you want to hear Bob Hope, get an AM set."

WABF: First national advertiser to buy FM time in New York City is Baldwin Piano Company. Agency is Ruthrauff & Ryan. Ira Hirschmann's WABF is carrying the program, a weekly recital at 8:45 p.m. on Fridays, features Sari Biro, Baldwin concert artist. We had the unusual experience of listening to the first half of the program in the studio and to the second half on an FM receiver. AM has never been able to do justice to the piano, but this direct studio vs. loudspeaker listening-comparison proved the ability of FM to reproduce piano music magnificently.

Price Changes: Freed Radio Corporation has announced substantial price reductions on their FM consoles. Bendix has issued to its distributors a guarantee of existing prices on its sets for the balance of the year. REL has upped the price of their FM monitor receivers.

New York: Offices of RKO Television Corporation have been moved to 625 Madison Avenue, New York City. Production facilities of RKO-Pathé are also located at that address.

WFRO: This independent FM station at Fremont, Ohio, was the subject of an article in the *Pathfinder*, April 23rd issue. The story explains the community services which can be performed by a class A station, and explains the manner in which FM is "revolutionizing" radio.

George A. Scherry: Is the new chief electrical engineer at Grayhill, Chicago manufacturers of switches and relays. He was formerly in charge of engineering and production at Garner Electronics.

Philadelphia: The Junto, founded by Benjamin Franklin in 1727 and now the largest adult school of its kind in America, has been granted a C.P. for an educational station. Present plans call for operation from 7:00 p.m. to midnight. Junto offices are at 16 S. 10th Street.

WGHF: Five live-talent shows have been added by Finch FM station in New York City. They range from a nightly news program at 7:00 p.m. to a weekly folk-song and square dance show on Fridays at 7:15 p.m. Frequency is 99.7 mc.

NEC Proceedings: National Electronics Conference has published the proceedings of the 1946 Chicago meeting in a 714-page volume which can be ordered from R.E.

CO-CHANNEL INTERFERENCE

IT WAS a simple matter for the FCC to anticipate any alternate-channel FM interference by merely shifting frequency assignments. But this brings up another question: What trouble may develop on ratio-detector receivers from co-channel interference? Such sets do not afford the capture effect which is one of the inherent advantages of the basic Armstrong FM system. Where an Armstrong-circuit receiver is not affected by co-channel interference unless the unwanted signal is at least one-half as strong as the unwanted signal, the ratio detector delivers hash from the reception of two transmitters on the same frequency, even though one is much stronger than the other.

Perhaps ratio-detector sets will be all right on the present co-channel frequency assignments. But suppose, as has happened on AM, more and more stations are crowded on the FM channels, on the assumption that all sets have the capture-effect protection against co-channel interference. Then what will be the plight of listeners whose sets employ ratio detectors? This matter should be opened up for engineering investigation and discussion now, and the FMA Liaison committee should put it on their agenda for discussion with the FCC without delay.

It is of special importance to manufacturers who are planning to use the ratio-detector on very low-priced sets, to be produced in large quantities, because of the great number of listeners involved.

Beam, Electrical Engineering Department, Northwestern University, Evanston, Ill. Price is \$3.50.

Cathode Follower Patents: A license under the cathode follower patents owned by Remco Electronic, Inc., 33 W. 60th Street, New York, has been issued to the Bell Systems and Western Electric Co.

Tomorrow's Radio Today: Initials of these words were chosen by Stanley Speer, president of Unity Corporation, Toledo, as call letters for his company's FM station. FCC has authorized this change from the old call of WTOD-FM. Announcements on affiliated AM station WTOD are being used in an aggressive campaign to promote WTRT.

Albert Danziger: Has entered the consulting field by organizing the Radio Engineering Company, 8 State Street, New York City, to specialize in home radio set design.

Television Programs: After setting 28 hours as the weekly minimum for television station programs, the FCC waived the rule. Waiver has just been continued until June 30th, 1947. Now TBA proposes 7 hours for a station in an area where there are up to 25,000 sets; 14 hours, 25,000-50,000 sets; 21 hours, 50,000-75,000 sets; 28 hours, over 75,000 sets.

William L. Barlow: Former publicity director at WLW and WINS has joined FMA, where he will handle the Association campaign to acquaint the public with the advantages of FM. We suggest as a slogan for this campaign: "If you want to hear Bob Hope at his best, ask your local station to put him on FM."

Complaint: Almost universal complaint of dealers handling FM sets is that there are no live-talent programs during the day. Result is that dealers cannot demonstrate FM reception at its best. Here's a matter on which dealers and broadcasters can get together to their mutual advantage.

Radio Sales to Latin America: If you are interested in South American business, get a copy of "Latin American Radio Receiver Markets, Merchandising Design Considerations, and Digest of Tariff Systems." It was prepared by the Department of Commerce, and can be obtained from the Government Printing Office, Washington 25, D. C. Price is 15¢.

North Carolina: Eight 1-kw. REL FM stations are on the air in this state. They are WMIT Winston-Salem, WRAL Raleigh, WBBB Burlington, WMFR High Point, WBT Charlotte, WGBR Goldsboro, WSTP Salisbury, and WGBG Greensboro.

Music Merchants Show: Will be held at the Palmer House, Chicago, on June 2nd to 5th, inclusive. Special interest will center around exhibits of FM sets, for the music merchants are better organized to sell high quality performance and to handle the higher units of sale than the majority of radio dealers. FM AND TELEVISION will be represented there.

Chicago: Gothard Manufacturing Company, Springfield, Ill., has taken over the tools and inventory of Pioneer Gen-E-Motor dynamotors and motor-generators. Harold Argue, formerly of Pioneer, has joined Gothard as chief engineer.

Syracuse: Transmitter production is under way at General Electric's Syracuse plant. Work of moving the entire transmitter division from Schenectady is scheduled for completion May 30th.



NEWS PICTURE

SOMETHING radically new in a television camera lens was demonstrated at NBC's New York studios on April 16th. Designed to replace the multiple-lens turrets now used, the single Zoomar lens shown here can be adjusted by a simple lever to any focal length desired, and con-

stant light transmission and definition maintained throughout the shift.

This performance was confirmed by NBC chief engineer O. B. Hanson, left above, after a demonstration by Jerry Fairbanks, right. When ball games, fights, and studio scenes are televised with ordinary lenses, at least two cameras are employed to provide quick transition from close-ups to long shots. With the Zoomar lens, a ball player can be followed con-

tinuously around the bases on a home run, for example. No interruption is occasioned by changing lenses or cameras.

The new lens was invented and perfected by Dr. Frank G. Back, an optical physicist who has been working in collaboration with Fairbanks. Zoomar lenses will be available within the next six months for 35-mm. motion-picture cameras. The Fairbanks laboratory is located at 6052-A Sunset Boulevard, Hollywood.

NEW FM ALLOCATIONS TO SPREAD STATIONS

Proposed Modifications of FM Broadcast Allocations, Rules, and Standards, Announced April 10, 1947

TO ELIMINATE the possibility of interference between FM stations operating on alternate channels in the same area, and to provide greater dial-spacing on receiving sets, the FCC has set up a new system of nation-wide FM broadcast frequency allocations. The new allocations, as well as modifications of FCC rules, were proposed in an announcement on April 10th, and a hearing was set for May 8th and 9th. While the hearing had not been held at this time of writing, it is expected that no objections will be raised, since the details were originally discussed between FCC officials and members of the FM Association's liaison committee.

The following paragraphs are quoted from the official text of the FCC announcement which accompanied the proposed modifications:

"At the present time, 34 stations in 13 cities are in operation on channels that are 400 kc. from other stations operating in the respective cities. Although listeners have reported few cases of interference to the Commission, several broadcast stations have reported such cases in their cities. In some instances, interference has not been reported, but difficulty has been experienced in identifying stations close together on the dial.

"Since FM receiver characteristics are, of course, a governing factor in FM allocation, the Commission is studying the selectivity and other characteristics of various types of present FM receivers and at the same time is endeavoring to anticipate the probable characteristics of FM receivers to be produced in the future. Provision is made for further revision of the interference standards upon completion of such studies.

"The changes proposed in the FM rules and standards would intersperse Class A and Class B stations in order to provide a normal minimum separation of four channels or 800 kc. between Class B stations in a city or immediate area. A minimum of 400 kc. separation would be used between Class A and Class B stations in adjacent cities in a few areas where the demand requires.

"It is expected, however, that only in a few areas will it be necessary to employ this minimum separation. In these cases it is expected that the difference in power between the two classes of stations will limit the interference to the Class B station to a small area around the Class A station, and will permit the Class A station to serve its community and adjacent area.

"The proposed changes would provide for the allocation of Class A stations in the

same manner as Class B stations with respect to interference contours, instead of the simpler mileage separation method now used for Class A stations. However, this is a minor procedural problem which would not appear to restrict the development of Class A stations.

"The proposed changes in the rules and standards would improve the performance of FM receivers now in use and would in no way retard FM receiver production. Likewise, the FM transmitters in use would require readjustment only, and new station construction would be slightly affected. In view of the limited number of FM stations that have completed full construction, it appears that changes in frequency assignments may be made at this time without causing substantial expense to the stations now on the air or under construction."

Proposed Revision of Tentative FM Broadcast Allocations Plan

The attached proposed revision of the tentative allocation plan for FM broadcast stations is based on the proposed changes in the FM rules and standards issued on this date. The present tentative allocation plan, as revised by the Commission on September 3, 1946 is based on assignments in a general area which are for the most part, on alternate channels (400 kc. apart). Recent developments appear to indicate that such operation results in interference in many of the receivers being produced at the present time. As a result, the proposed revision provides for a minimum frequency separation of class B stations in the same general area of 800 kc.

In no case has the number of class B channels in an area been reduced in this proposal from that listed in the previous plan. In addition, in instances where the need has developed, channels have been proposed to be added where possible, to provide assignments for applications which are now on file with the Commission. This proposed revision of the tentative allocation plan would be subject to revisions as the development of FM broadcasting might require, in the same manner that the previous allocation plan has been revised from time to time.

The proposed tentative allocation plan is expected to remain subject to Section 3.204 (c) of the Commission's Rules which provides for the reservation of certain class B channels until July 1, 1947. As in previous plans, it is emphasized that this allocation plan is to be tentative only and that deviations would be made wherever desirable or necessary. Conse-

quently, the lack of a channel listing for a particular locality does not necessarily mean that a channel cannot be made available there. For example, a channel listed for a particular area may be assigned to any of several cities within that same general area, provided that the geographical change will not result in objectionable interference.

The allocation plan is based on stations employing an effective radiated power of 20 kw. and antenna height of 500 ft. above average terrain. The separation of stations varies from that required by ground wave interference (principally the eastern United States) to the separation required for freedom from tropospheric interference one percent of the time or less (principally in the western areas). In general, the separation of stations increases toward the western part of the country where the expected demand for channels will be less and where added protection for weak signals will be provided. Since, under the Rules, Class B stations may vary considerably in power and antenna height, the interference may be more or less than that which would be indicated by this allocation plan.

It will be noted that only a few channels have been designated for a number of small cities, particularly in the West, since it appears that these will supply the probable demand. In such cases, more channels are available and will be provided as required. Examination will also reveal that in some sections of the country more channels are designated for certain areas than for others therein having comparable or larger populations. This results from the fact that areas near large centers of population usually contain a number of cities which require channels, while other areas are farther from dense population centers and thus involve no objectionable interference by the allocation of more channels in its section.

Inasmuch as this proposed plan includes changes in all areas of the country, no attempt is being made to tabulate such changes. Since certain Class B channels in this proposed plan are adjacent to Class A channels, the availability of Class A channels to a given area is governed not only by the number of previous Class A assignments, but also the number and location of Class B assignments in that area. However, in all areas examined to date the number of class A facilities is equal to or exceeds the number previously available.

Proposed Amendments to FM Broadcast Rules

The following are the proposed amendments to the indicated Sections of Part 3,

General Area and Channel No.

ALABAMA

Anniset 263
Bessemer (See Birmingham) 229, 250, 258, 273, 284, 295
Birmingham (Incl. Bessemer) 229, 250, 258, 273, 284, 295
Decatur 223
Dothan 225, 250
Gadsden 279
Huntsville 236
Lanett 275
Mobile 225, 235, 248, 260, 271, 300
Montgomery 233, 277, 298
Muscle Shoals 275, 287
Opelika (See Columbus, Ga.) 243
Selma 239, 293
Sylacauga (See Talladega) 270
Talladega (See Sylacauga) 246
Tuscaloosa 255, 267

ARIZONA

Globe 226, 262
Lowell 241, 279
Phoenix 238, 245, 253, 275, 295
Prescott 229, 284
Safford 247, 299
Tucson 234, 258, 270, 289
Yuma 236, 267

ARKANSAS

Blytheville (See Jonesboro) 241, 286
El Dorado 236, 287
Fort Smith 233, 235, 271, 281, 299
Helena 229, 262
Hot Springs & Hot Springs N. P. 227, 238, 258
Jonesboro (See Blytheville) 270, 300
Little Rock 231, 245, 266, 278, 297
Pine Bluff 222
Silvaco Springs 243, 289

CALIFORNIA

Bakersfield 223, 231, 243
Chico 266, 278
El Centro 227, 275
Eureka 234, 242
Fresno 229, 238, 250, 258, 262, 270, 274
Los Angeles (Metropolitan District) 222, 226, 230, 234, 238, 242, 246, 250, 254, 258, 262, 266, 270, 274, 278, 282, 286, 290, 294, 299
Marysville 254, 260, 268, 284
Merced 236, 248
Modesto 277, 281, 289
Monterey (See Salinas) 268
Palm Springs 264
Redding 230, 248
Riverside 248, 256
Sacramento 233, 241, 245, 293, 300
Salinas (Incl. Monterey, Santa Cruz & Watsonville) 223, 241, 245, 293, 300
San Bernardino 236, 260
San Diego 223, 231, 243, 268, 284, 298
San Francisco-Oakland (Metropolitan District) 227, 231, 235, 239, 243, 247, 251, 255, 259, 263, 267, 271, 275, 279, 283, 287, 291, 295
San Jose 222, 253
San Luis Obispo 227, 260, 279
Santa Barbara 268, 284, 298
Santa Maria 236, 256
Santa Rosa 229, 273
Stockton 225, 298
Visalia 254, 295
Tulare 264, 286
Watsonville (See Salinas) 223, 241, 245, 293, 300

COLORADO

Alamosa 255, 260
Colorado Springs 222, 227, 243, 274
Denver 231, 239, 247, 253, 258, 262, 270, 279, 286, 294
Durango 235, 278
Grand Junction 226, 298
Greeley 235, 290
La Junta 282, 300
Pueblo 236, 251, 266, 291
Sterling 245, 282

CONNECTICUT

Bridgeport (Incl. Danbury) 248, 260, 268
Danbury (See Bridgeport) 248, 260, 268
Hartford (See Meriden) 229, 243, 275, 279, 295

Meriden (See Hartford) 229

New Britain 291
New Haven 236, 256, 264, 300
New London 258, 266, 293
Waterbury 223, 273, 287

DELAWARE

Wilmington 229, 241, 258, 297

DISTRICT OF COLUMBIA

Washington 230, 242, 246, 254, 258, 262, 266, 278, 286, 290, 297

FLORIDA

Daytona Beach 233, 248
Fort Myers 245, 256
Fort Lauderdale 251, 293
Gainesville 281, 297
Jacksonville 229, 236, 241, 245, 259, 264, 270
Key West 238, 263
Lakeland 239, 295
Miami 226, 230, 235, 242, 247, 260, 268, 275, 286
Ocala 256, 267
Orlando 222, 231, 243, 262
Palm Beach 282, 298
Panama City 283, 299
Pensacola 223, 255, 266
St. Augustine 225, 291
St. Petersburg 250, 273, 284
Sarasota 258, 279
Tallahassee 246, 274
Tampa 227, 264, 289, 300
West Palm Beach 254, 271

GEORGIA

Albany 258, 266, 271
Athens 258, 273
Atlanta 225, 231, 238, 248, 253, 260, 277, 283
Augusta 279, 289, 298
Brunswick 275, 289
Cedartown (Incl. Dalton) 241, 289
Columbus (See Opelika, Ala.) 227, 236, 300
Cordele 230, 241
Dalton (See Cedartown & Rome) 241, 289
Dublin 234, 251
Gainesville 230
Griffin 268
La Grange 281
Macon 245, 256, 264, 291
Moultrie 278, 286
Newnan 222
Rome 293, 297
Savannah 238, 247, 255, 262
Thomasville 250, 294
Toccoa 275
Valdosta 223, 239
Waycross 283, 299
West Point 287

IDAHO

Boise 222, 251, 291
Idaho Falls 229, 277
Lewiston 247, 283
Nampa 235, 270
Pocatello 243, 266
Twin Falls 226, 259, 294
Wallace 238, 263

ILLINOIS

Alton 260
Aurora (Incl. Joliet) 256, 294
Bloomington 268, 297
Cairo (See Cape Girardeau, Mo.) 239
Carbondale 225
Carthage 225, 295
Champaign (See Urbana) 222, 226, 230, 234, 238, 242, 246, 250, 254, 258, 262, 266, 270, 274, 278, 282, 286, 290
Decatur 254, 271
East St. Louis (See St. Louis, Mo.) 239
Elgin (See Chicago) 239
Evanston (See Chicago) 239
Freeport 273
Galesburg 247, 251
Harrisburg 260, 264
Herrin 243, 253
Jacksonville 263, 291
Joliet (See Aurora) 256, 294
Kankakee 264
Mt. Vernon 231, 277
Peoria 223, 227, 231, 239, 243, 299
Quincy 258, 286
Rockford 248
Rock Island (See Davenport, Iowa) 255
Springfield 275, 279, 283
Tuscola 245, 287
Urbana (Incl. Champaign) 243, 277, 284
Waukegan 236

INDIANA

Anderson (See Indianapolis) 229
Columbus 229
Connersville 262
Crawfordsville 275
Elkhart 236, 264
Evansville (Incl. Henderson & Owensboro, Ky.) 223, 233, 241, 251, 258, 273, 297
Fort Wayne 241, 279, 287, 291
Hammond 300
Indianapolis (Incl. Anderson) 222, 226, 234, 238, 242, 246, 250, 254, 283
Kokomo 260, 299
Lafayette 236, 268
Marion 295
Muncie 273, 281
Richmond 258
Shelbyville 267
South Bend 267, 284
Terre Haute 260, 266
Vincennes 289, 293
West Lafayette 256

IOWA

Ames 238
Atlantic 293
Boone 251, 295
Burlington 253
Cedar Rapids 245, 293
Clinton 241
Davenport (See Rock Island, Ill.) 233, 279
Decorah 223, 230
Des Moines 222, 231, 247, 253, 262, 283
Dubuque 236, 263, 277
Fort Dodge 274, 287
Iowa City 229, 259
Keokuk 274
Marshalltown 270, 291
Mason City 266, 281
Ottumwa 242, 264
Shenandoah 277, 289, 297
Sioux City 235, 256, 271
Spencer 223, 259
Waterloo 254, 298

KANSAS

Atchison 239, 255
Coffeyville 236, 266
Dodge City 234, 293
Emporia 223, 245
Garden City 247, 270
Great Bend 242, 287
Hutchinson 226, 289
Kansas City (See Kansas City, Mo.) 229, 246, 253, 258, 262, 267, 271, 275, 281, 290, 294
Moorhead (See Fargo, N. D.) 230, 236
Northfield 251, 300
Rochester 234, 286, 297
St. Cloud 233, 284
St. Paul (See Minneapolis) 229, 259, 246, 253, 258, 262, 267, 271, 275, 281, 290, 294
Moorhead (See Fargo, N. D.) 230, 236
Northfield 251, 300
Rochester 234, 286, 297
St. Cloud 233, 284
St. Paul (See Minneapolis) 229, 259, 246, 253, 258, 262, 267, 271, 275, 281, 290, 294

KENTUCKY

Ashland (See Huntington, W. Va.) 229
Bowling Green 266, 281
Harlan 238
Henderson (See Evansville, Ind.) 230, 254
Lexington 225, 233
Louisville 236, 248, 259, 264, 268, 284, 300
Owensboro (See Evansville, Ind.) 227, 245, 262
Winchester 241, 251

LOUISIANA

Alexandria 245, 250, 273
Baton Rouge 251, 266, 282
Lafayette 241, 268
Lake Charles 248, 289
Monroe 277, 281, 295
New Orleans 222, 229, 239, 246, 262, 274, 287, 298
Shreveport 233, 243, 266, 275, 298

MAINE

Augusta 222, 267, 287
Bangor 226, 246, 281, 295
Lewiston 230, 275
Portland (See Mt. Washington, N. H.) 250, 270, 300
Presque Isle 242, 290

MARYLAND

Baltimore (Incl. Annapolis) 222, 226, 234, 238, 250, 256, 270, 274, 282, 294, 300
Cumberland 275, 295
Frederick 268
Hagerstown 284
Salisbury 248, 268

MASSACHUSETTS

Boston (Incl. Waltham) 225, 233, 241, 245, 253, 273, 277, 281, 289, 294
Fall River (Incl. New Bedford) 227, 251, 271
Fitchburg 284
Haverhill 223
Holyoke (Incl. Springfield) 226, 234, 246, 250, 254, 262, 270, 282

Lawrence 229
Lowell 258
New Bedford (See Fall River) 227, 251, 271
North Adams 284
Pittsfield 260, 268
Springfield (See Holyoke) 226, 234, 241, 251, 258, 273, 297
Waltham (See Boston) 225, 233, 241, 245, 253, 273, 277, 281, 289, 294
Worcester 236, 256, 264

MICHIGAN

Ann Arbor 254, 294
Battle Creek (Incl. Kalamazoo) 271, 289
Bay City (Incl. Saginaw) 233, 241, 251
Benton Harbor 260
Cadillac 253
Calumet 226, 268
Detroit (Incl. Pontiac, Royal Oak, and Wyandotte) 226, 234, 238, 242, 246, 250, 253, 262, 266, 270, 278, 282, 290, 298
East Lansing (See Lansing) 226, 234, 238, 242, 246, 250, 253, 262, 266, 270, 278, 282, 290, 298
Escanaba 234, 281
Flint (Incl. Lapeer) 236, 260, 264, 300
Grand Rapids 223, 229, 245, 273, 278, 286
Ironwood 270, 290
Jackson 222
Kalamazoo (See Battle Creek) 271, 289
Lansing (Incl. E. Lansing) 248, 256, 284
Lapeer (See Flint) 236, 260, 264, 300
Ludington 226, 238
Marquette 230, 256
Muskegon 293, 297
Pontiac (See Detroit) 226, 234, 238, 242, 246, 250, 253, 262, 266, 270, 278, 282, 290, 298
Port Huron 256, 284
Royal Oak (See Detroit) 226, 234, 238, 242, 246, 250, 253, 262, 266, 270, 278, 282, 290, 298
Saginaw (See Bay City) 233, 241, 251
Sault Sainte Marie, 226, 295
Traverse City 243, 268
Wyandotte (See Detroit) 226, 234, 238, 242, 246, 250, 253, 262, 266, 270, 278, 282, 290, 298

MINNESOTA

Albert Lea 226
Duluth (Incl. Superior, Wisc.) 222, 250, 264
Fergus Falls 242, 297
Hibbing 279, 286
Mankato 243, 278
Minneapolis (Incl. St. Paul) 229, 239, 246, 253, 258, 262, 267, 271, 275, 281, 290, 294
Moorhead (See Fargo, N. D.) 230, 236
Northfield 251, 300
Rochester 234, 286, 297
St. Cloud 233, 284
St. Paul (See Minneapolis) 229, 239, 246, 253, 258, 262, 267, 271, 275, 281, 290, 294
Moorhead (See Fargo, N. D.) 230, 236
Northfield 251, 300
Rochester 234, 286, 297
St. Cloud 233, 284
St. Paul (See Minneapolis) 229, 239, 246, 253, 258, 262, 267, 271, 275, 281, 290, 294

MISSISSIPPI

Clarksdale 248, 256
Columbus 226, 245
Corinth 268, 278
Greenwood 270, 283
Greenwood 235, 293
Gulfport 243, 268
Hattiesburg 250, 290
Jackson 233, 247, 258, 275, 286
Laurel 279, 295
McComb 226, 255
Macon 271, 281
Meridian 241, 253
Natchez 231, 264
Tupelo 233, 242
Vicksburg 238, 297

MISSOURI

Cape Girardeau (See Cairo, Ill.) 267, 291
Clayton (See St. Louis) 236
Columbia 233, 268
Hannibal 245, 300
Jefferson City 253, 277
Joplin 241, 287
Kansas City (Incl. Kansas City, Kans.) 227, 235, 251, 263, 271, 282, 290, 294, 299
Poplar Bluff 233, 279
St. Joseph 222, 284
St. Louis (Incl. Clayton) 229, 236, 241, 247, 251, 256, 266, 273, 281, 294, 298
Sedalia 259, 279
Springfield 225, 234, 238, 284, 297

MONTANA

Billings 230, 274
Bozeman 227, 270
Butte 235, 256
Great Falls, 250, 260
Helena 241, 281
Kalispell 223, 278
Miles City 233, 254
Missoula 245, 286
Sidney 233, 267

NEBRASKA

Freemont (See Omaha) 245
Grand Island 270, 291
Hastings 235, 279
Kearney 256, 294
Lincoln 229, 250, 275, 287
Norfolk 233, 273

North Platte 238, 274
Omaha (See Fremont) 225, 241, 254, 260, 266, 281, 300, 300
Scottsbluff 241, 277

NEVADA

Boulder City 229, 270
Las Vegas 250, 262, 289
Reno 226, 238, 262

NEW HAMPSHIRE

Claremont 291
Keene 300
Laconia 247
Manchester 239, 266
Mount Washington 235, 255, 263, 283
Portsmouth 297

NEW JERSEY

Atlantic City 235, 264
Bridgeton 255
Camden (See Philadelphia) 229, 250, 273, 294
Devil's Lake 226, 266
Fargo (See Moorhead, Minn.) 222, 260
Grand Forks 234, 254, 278, 299
Jamestown 239, 284
Mandan (See Bismarck) 223, 290
Minot 243, 290
Valley City 246, 270

NEW MEXICO

Albuquerque 225, 242, 264, 287
Carlsbad 226, 262
Clovis 255, 291
Gallup 222, 279
Hobbs 235, 266
Las Vegas 230, 275
Roswell 246, 277
Santa Fe 253, 295
Tucumcari 239, 270

NEW YORK

Albany (Incl. Schenectady & Troy) 222, 230, 238, 242, 258, 266, 274, 278, 286, 290, 294, 298
Auburn (See Syracuse) 226, 234, 238, 242, 246, 250, 254, 258, 262, 266, 270, 274, 278, 282, 286, 290, 294, 298
Batavia 235, 259
Binghamton 251, 263, 299
Buffalo (Incl. Niagara Falls) 225, 229, 241, 245, 253, 273, 277, 281, 293, 297
Coram (See New York or possibly Connecticut Channels) 229
Corning (See Elmira) 291
Dunkirk 233
Elmira (See Corning) 291
Gloversville 234
Hornell 287
Ithaca 230, 247
Jamestown 227, 284
Kingston 235
Massena 287, 295
New York (Incl. numerous adjacent cities) 222, 226, 230, 234, 238, 242, 246, 250, 254, 258, 262, 266, 270, 274, 278, 282, 286, 290, 294, 298
Niagara Falls (See Buffalo) 225, 229, 241, 245, 253, 273, 277, 281, 293, 297
Ogdensburg 279, 291
Olean 238, 264
Oneonta 256, 282
Oswego 284
Plattsburg 275, 281
Poughkeepsie 284
Rochester 223, 243, 250, 255, 267, 279
Rome 239
Saranac Lake 225, 247
Syracuse (Incl. Auburn) 226, 233, 241, 253, 273, 281, 297
Troy (See Albany) 222, 226, 230, 234, 238, 242, 246, 250, 254, 258, 262, 266, 270, 274, 278, 282, 286, 290, 294, 298
Utica 229, 245, 277, 289
Watertown 251, 263

NORTH CAROLINA

Ahoskie 270
Asheville 268, 273, 282, 291
Burlington 266
Charlotte (See Gastonia) 260, 278, 284, 299
Concord (See Salisbury) 243
Durham 286
Elizabeth City 231, 266
Fayetteville 251
Gastonia (See Charlotte) 270
Greensboro (See High Point & Winston-Salem) 222, 247, 254, 262
Greenville 250, 256
Henderson 297
Hickory 275, 295
High Point (See Greensboro & Winston-Salem) 238, 258
Kinston (See New Bern) 236, 245
New Bern (See Kinston) 236, 245
Jacksonville 225, 260
Raleigh 233, 241, 268, 273, 277
Roanoke Rapids (See Rocky Mount) 223, 253
Rocky Mount (See Roanoke Rapids) 264, 283

Reidsville 291
Salisbury 293
Statesville 289
Washington 275
Wilmington 230, 242
Wilson 290, 294, 300
Winston-Salem (See Greensboro & High Point) 226, 281

NORTH DAKOTA

Bismarck (Incl. Mandan) 229, 250, 273, 294
Devil's Lake 226, 266
Fargo (See Moorhead, Minn.) 222, 260
Grand Forks 234, 254, 278, 299
Jamestown 239, 284
Mandan (See Bismarck) 223, 290
Minot 243, 290
Valley City 246, 270

OHIO

Akron (Incl. Tallmadge) 239, 243, 248
Alliance (Incl. Canton) 227, 231, 235
Ashland 267, 273
Ashtabula (See Erie, Pa.) 227, 289, 293
Athens 297
Bellaire (See Wheeling, W. Va.) 226, 234, 238, 242, 246, 250, 254
Canton (See Alliance) 227, 231, 235
Cincinnati (Incl. Hamilton) 266, 270, 274, 278, 282, 286, 290, 294, 298
Cleveland (Incl. Lorain) 253, 258, 264, 271, 277, 281, 289, 293, 297
Columbus 222, 226, 234, 238, 242, 246, 250, 254
Dayton (Incl. Springfield) 236, 248, 256, 260, 264, 268, 284
Findlay 263
Fostoria 275
Freemont (See Toledo) 226, 234, 238, 242, 246, 250, 254
Hamilton (See Cincinnati) 266, 270, 274, 278, 282, 286, 290, 294, 298
Lima 271, 277, 293
Lorain (See Cleveland) 253, 258, 264, 271, 277, 281, 289, 293, 297
Mansfield 279, 287, 291
Marion 295
Newark (Incl. Zanesville) 262, 299
Portsmouth (See Huntington, W. Va.) 226, 234, 238, 242, 246, 250, 254, 258, 262, 266, 270, 274, 278, 282, 286, 290, 294, 298
Springfield (See Dayton) 236, 248, 256, 260, 264, 268, 284
Steubenville (See Wheeling, W. Va.) 226, 234, 238, 242, 246, 250, 254, 258, 262, 266, 270, 274, 278, 282, 286, 290, 294, 298
Warren (See Sharon, Pa.) 223, 300
Wooster 255, 283
Youngstown (See Sharon, Pa.) 223, 300
Zanesville (See Newark) 262, 299

Dubois (Incl. Clearfield) 256, 271
Easton (See Allentown) 225, 241, 254, 260, 266, 281, 300, 300
Glenside (See Philadelphia) 226, 281
Greensburg 297

Harrington (See Brownsville)
 Houston 239, 243, 250, 266, 275, 286, 291, 295,
 Huntsville 234, 262
 Kilgore (Incl. Longview & Tyler) 229, 247, 290
 Laredo 243, 267
 Longview (See Kilgore)
 Lubbock 242, 258, 300
 Lufkin 238, 281
 Midland 222, 281
 McAllen (See Brownsville)
 Odessa 248
 Palestine 225, 274
 Pampa 253, 289
 Paris 255, 273
 Pecos 230, 294
 Plainview 246, 297
 Port Arthur 270, 297
 San Angelo 233, 274
 San Antonio 225, 234, 242, 247, 251, 258, 263, 273, 281, 289, 297
 Sherman 236
 Sweetwater 226, 264
 Temple (Incl. Belton) 246, 298
 Texarkana 251, 264, 293
 Tyler (See Kilgore) 268
 Vernon 254, 271
 Victoria 230, 270
 Waco 254, 277
 Waxahachie (See Dallas & Fort Worth)
 Weslaco (See Brownsville)
 Wichita Falls 231, 247, 260, 293

UTAH

Cedar City 233, 297
 Logan 250, 290
 Ogden 234, 274
 Price 242, 282
 Provo 226, 299
 Salt Lake City 230, 238, 246, 254, 258, 262, 270, 278, 286, 295

VERMONT

Burlington 231, 289
 Rutland 271
 St. Albans 243, 267
 Waterbury 227, 251

VIRGINIA

Alexandria (See Washington, D. C.)
 Charlottesville (Incl. Staunton) 273, 293
 Covington 238, 286
 Danville 230, 250
 Fredericksburg (See Washington, D. C.)
 Front Royal 236
 Harrisonburg 227, 264
 Lynchburg 260, 300
 Martinsville 242, 271
 Newport News (See Norfolk)
 Norfolk (Incl. Newport News, Portsmouth & Suffolk) 243, 247, 255, 259, 273, 277, 287, 291, 299

Petersburg 229, 239
 Portsmouth (See Norfolk)
 Richmond 225, 233, 251, 271, 275, 281, 295
 Roanoke 235, 256, 279
 Staunton (See Charlottesville)
 Suffolk (See Norfolk)
 Winchester 223

WASHINGTON

Aberdeen 262, 293
 Bellingham 225, 281
 Centralia 229, 284
 Everett 241, 245
 Longview 234, 274
 Olympia 271, 279
 Port Angeles 233, 297
 Pullman 229, 270
 Pasco 253, 298
 Seattle 231, 235, 251, 255, 260, 264, 268, 275, 287, 291, 295, 300

Spokane 225, 236, 243, 251, 275, 287
 Tacoma 223, 227, 239, 243, 247
 Vancouver (See Portland, Ore.) 258
 Walla Walla 234, 268
 Wenatchee 281, 293
 Yakima 241, 248, 277

WEST VIRGINIA

Beckley 267, 289
 Bluefield (Incl. Welch) 227, 283, 298
 Charleston 225, 241, 248, 253, 258
 Clarksburg (Incl. Fairmont & Morgantown) 222, 236, 270, 287, 300
 Fairmont (See Clarksburg)
 Huntington (Incl. Ashland, Ky. & Portsmouth, Ohio) 229, 233, 263, 273, 281, 290

Logan 277, 294
 Morgantown (See Clarksburg)
 Parkersburg 293
 Welch (See Bluefield)
 Wheeling (Incl. Belaire & Steubenville, Ohio) 247, 254, 263, 278
 Williamson 222, 236

WISCONSIN

Appleton (Incl. Neenah) 253, 266
 Ashland 245, 254
 Beloit 300
 Eau Claire 222, 231
 Fond du Lac 247, 258
 Green Bay 222, 273, 289
 Greenfield Twp. (See Madison)
 Janesville 260
 La Crosse 233, 241
 Madison (Incl. Greenfield Twp.) 255, 268, 290

Mantowoc 233, 241
 Marinette 286, 298
 Medford 260, 300
 Milwaukee 223, 227, 231, 239, 243, 251, 271, 275, 279, 287, 291, 295
 Neenah (See Appleton)
 Oshkosh 225, 229
 Poynette 235
 Racine 264, 284
 Rice Lake 236, 242
 Sheboygan 262, 282
 Stevens Point 293, 299
 Superior (See Duiuth, Minn.)
 Wausau 238, 250, 264, 284
 Wisconsin Rapids 277

WYOMING

Casper 229, 264
 Cheyenne 226, 266, 298
 Powell 234, 258
 Rock Springs 236, 248
 Sheridan 262, 283

Subpart B, of the Commission's Rules governing Standard and FM Broadcast Stations:

3.203 Class A Stations

(a) A Class A station is a station which operates on a Class A channel and is designed to render service primarily to a community or to a city or town other than the principal city of an area, and the surrounding rural area. The transmitter power and antenna height of a Class A station shall normally be capable of coverage equivalent ² to a minimum of 100 watts and a maximum of 1 kw. effective radiated power and antenna height of 250 feet above average terrain, as determined by the methods prescribed in the Standards of Good Engineering Practice Concerning FM Broadcast Stations. Class A stations will not be authorized with more than 1 kw. effective radiated power. Standard power ratings of transmitters used for Class A stations shall be not less than 250 watts nor more than 1 kilowatt. Class A stations will normally be protected to the 1 mv/m contour; however, assignment will be made in a manner to insure, insofar as possible, a maximum of service to all listeners, whether urban or rural, giving consideration to the minimum signal capable of providing service.

(b) The following frequencies are designated as Class A channels and are assigned for use by Class A stations:

Freq. (mc.)	Channel No.	Freq. (mc.)	Channel No.
92.1	221	100.1	261
92.7	224	100.9	265
93.5	228	101.7	269
94.3	232	102.3	272
95.3	237	103.1	276
95.9	240	103.9	280
96.7	244	104.9	285
97.7	249	105.5	288
98.3	252	106.3	292
99.3	257	107.1	296

These channels are available for assignment (1) in cities which are not the central city or cities of a metropolitan district, and (2) in central cities of metropolitan districts which have fewer than six Class B stations.³

(c) The main studio of a Class A sta-

² For the purpose of determining equivalent coverage, the 1 mv/m contour should be used.

tion shall be located in the city served and the transmitter shall be located as near the center of the city as practicable.

(d) No assignments will be made on channels 224, 240, 272 and 288 until July 1, 1947.

3.204 (b) The following frequencies are designated as Class B channels and are assigned for use by Class B stations:

Freq. (mc.)	Channel No.	Freq. (mc.)	Channel No.
92.3	222	100.3	262
92.5	223	100.5	263
92.9	225	100.7	264
93.1	226	101.1	266
93.3	227	101.3	267
93.7	229	101.5	268
93.9	230	101.9	270
94.1	231	102.1	271
94.5	233	102.5	273
94.7	234	102.7	274
94.9	235	102.9	275
95.1	236	103.3	277
95.5	238	103.5	278
95.7	239	103.7	279
96.1	241	104.1	281
96.3	242	104.3	282
96.5	243	104.5	283
96.9	245	104.7	284
97.1	246	105.1	286
97.3	247	105.3	287
97.5	248	105.7	289
97.9	250	105.9	290
98.1	251	106.1	291
98.5	253	106.5	293
98.7	254	106.7	294
98.9	255	106.9	295
99.1	256	107.3	297
99.5	258	107.5	298
99.7	259	107.7	299
99.9	260	107.9	300

Proposed Amendments to Standards of Good Engineering Practice

1. Definitions

M. ANTENNA HEIGHT ABOVE AVERAGE TERRAIN: (1) The term "antenna height above average terrain" means the height of the radiation center of the antenna above the terrain ² to 10 miles from the antenna. (In general a different antenna height will be determined for each direc-

³ For the time being, until more FM broadcast stations are authorized, the Commission will not authorize Class A stations in central cities of metropolitan districts having four or more standard broadcast stations.

tion from the antenna. The average of these various heights is considered as the antenna height above average terrain.)

(2) Where circular or elliptical polarization is employed the antenna height above average terrain shall be based upon the height of the radiation center of the antenna which transmits the horizontal component of radiation.

2. Engineering Standards of Allocation

A. BASIS FOR FM ALLOCATIONS: Sections 3.202 to 3.206 inclusive of the Rules and Regulations describe the basis for allocation of FM Broadcast Stations, including the division of the United States into Areas I and II.

B. FIELD INTENSITY CONTOURS: FM broadcast stations shall determine the extent of their 1 mv/m and 50 μ v/m contours in accordance with the methods prescribed in those Standards.

C. FIELD INTENSITY REQUIREMENTS: Although some service is provided by tropospheric waves, the service area is considered to be only that served by the ground wave. The extent of service is determined by the point at which the ground wave is no longer of sufficient intensity to provide satisfactory broadcast service. The field intensity considered necessary for service is as follows:

TABLE I

AREA	MEDIAN FIELD INTENSITY
City business or factory areas	1 mv/m
Rural Areas	50 μ v/m

A median field intensity of 3 to 5 mv/m should be placed over the principal city to be served and for Class B stations a median field intensity of 1 mv/m should be placed over the business district of cities of 10,000 or greater within the metropolitan district served. A field intensity of 5 mv/m should be provided over the main studio of a Class B station except as otherwise provided in Section 3.205 of the Rules. The location of the main studio of a Class A station is specified in Section 3.203 of the Rules. These figures are based upon the usual noise levels encountered in the several areas and upon the absence of interference from other FM stations.

D. SATELLITES: A basis for all allocation of satellite stations has not yet been

(CONTINUED ON PAGE 48)

PRACTICAL CONSIDERATIONS OF FM COVERAGE

Part 2—Realistic Determination of Coverage—Effects of Terrain and Shadows

BY PAUL A. de MARS AND THOMAS A. WRIGHT

IN THE preceding presentation of the effect of the troposphere on FM signal intensities versus distance, a smooth spherical earth was assumed in order to simplify the subject. Now, in the case of propagation over actual terrain in the FM frequency band, the subject will be simplified by assuming constant meteorological conditions.

The propagation of radio frequencies above 30 mc. is not materially affected by the type of soil over which the transmission occurs, as in the case of the medium and low frequencies. However, while ground contour has only slight effect on the propagation of the standard broadcast band and lower frequencies, it affects propagation in the FM band profoundly.

The distribution of signal intensity versus distance in the VHF band is, as all who have made propagation measurements know, extremely complex. At this juncture there is admittedly a paucity of both experimental data and theoretical analyses. The subject of this article will be dealt with by first presenting the certain known fundamental propagation characteristics of the FM band, and then relate these to the effect of topographical irregularities.

Effect of Terrain ★ In the frequency band under consideration, the dependence of signal intensity at any distance on the height above ground of the transmitting antenna has been shown in Part 1, Figs. 4 and 5. In a like manner, the signal intensity at the receiving point is related to the height of the receiving antenna above ground. For horizontally polarized radio waves in the FM band and higher frequencies, the signal intensity increases linearly with the height above ground. A receiving antenna 10 ft. above the earth will intercept a field intensity of only one-third that of a 30-ft. antenna. A receiving antenna 60 ft. above ground will intercept a field intensity twice that of one at a height of 30 ft.

It has been common practice to present FM signal intensity versus distance characteristics upon the basis of an assumed receiving antenna height of 30 ft. The Federal Communications Commission's propagation charts entitled "Ground Wave Signal Range for FM Broadcasting" conform with this convention, as do Figs. 4 and 5 presented previously. Fig. 6 presents the receiving antenna height gain-correction factor numerically and in decibels referred to 30 ft.

Shadow Loss ★ When, in the idealized case of assumed smooth earth and a standard atmosphere, the radio horizon is the bulge of the earth, it is generally accepted that the theoretical signal intensity versus distance relation presented in the FCC charts is correct. When, however, in practice the radio horizon is an elevation of the ground, such as a hill or mountain, the signal intensity at a specified point beyond is usually less than that predicted for ideal conditions. In this case, the departure from smooth-earth theoretical values of signal intensity is commonly called *shadow loss*.

It is recognized that, under certain conditions, the field intensity behind a hill may be greater than would be obtained if the terrain between the transmitting and receiving antennas were level ground. Also, scattering and reflections from nearby hills near the straight-line path may have an appreciable effect.

In some cases, a stronger signal is obtained by devious routes than can be expected by diffraction over the straight-line path. Experience shows, however, that these exceptional cases occur too infrequently to be of importance in considering the coverage of a broadcast service.

Determination of Shadow Loss ★ An estimate of the probable shadow loss can be obtained from Fig. 7. This method is based on the theory of diffraction of plane waves

over a knife edge. This nomograph was contained in the publication entitled "Propagation Curves", October, 1944, by Division 15 of the National Defense Research Committee. Formerly restricted, it has since been declassified. Based upon thousands of miles of signal intensity recordings over hilly and mountainous terrain from Station WGTR, Paxton, Massachusetts, and Station WMNE, Mount Washington, the authors believe this chart presents shadow loss data to a fair degree of accuracy. It is the best information known to be available at this time.

Early experiments in the frequency bands above 30 mc. disclosed that the actual signal intensities versus distance over irregular terrain varied above and below the theoretical smooth earth values by large amounts. The measured departures in the FM band may be of the order of 10 to 20 decibels in hilly country, to 20 to 30 decibels or more in mountainous country.

In general, the departure from smooth-earth theoretical values, except for the effect of the troposphere, results from these two factors; the so-called shadow loss behind hills due to the quasioptical characteristics of FM frequencies, and the height gain-factor for receiving antennas located on elevations above the average terrain contours.

Realistic Estimate of Signal Intensity ★ By com-

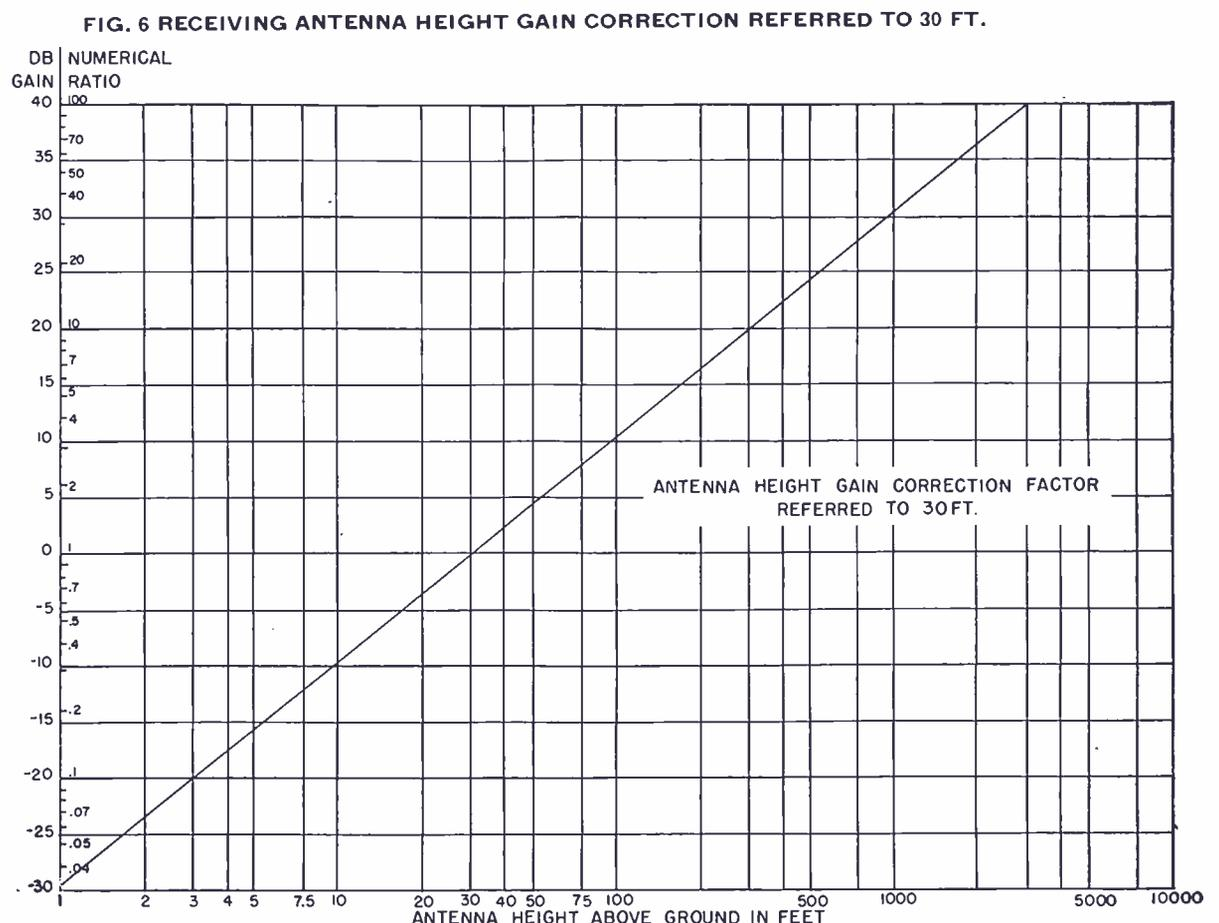

RADIATED POWER

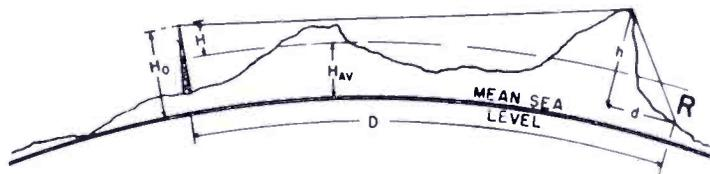
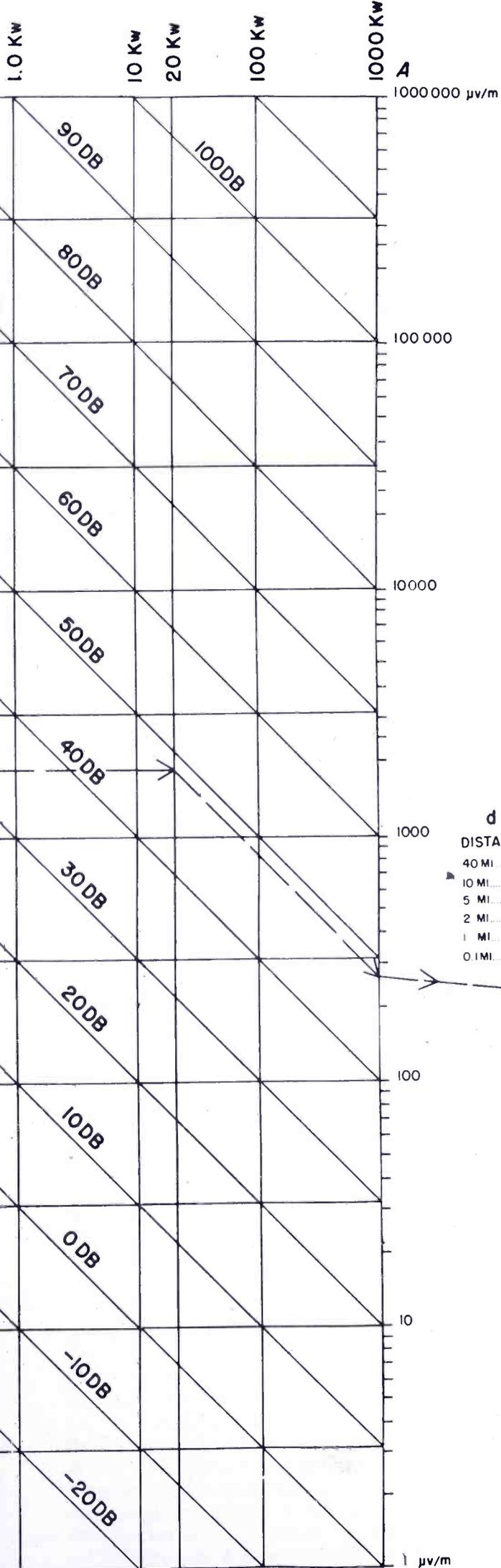

- H₀ ANTENNA ELEVATION ABOVE MEAN SEA LEVEL
- H_{AV} AVERAGE ELEVATION OF TERRAIN BETWEEN TRANSMITTER AND RECEIVER
- H ANTENNA HEIGHT ABOVE AVERAGE TERRAIN
- D DISTANCE FROM TRANSMITTER TO RECEIVER
- h HEIGHT FOR SHADOW LOSS ESTIMATE
- d DISTANCE FOR SHADOW LOSS ESTIMATE
- R RECEIVING POINT

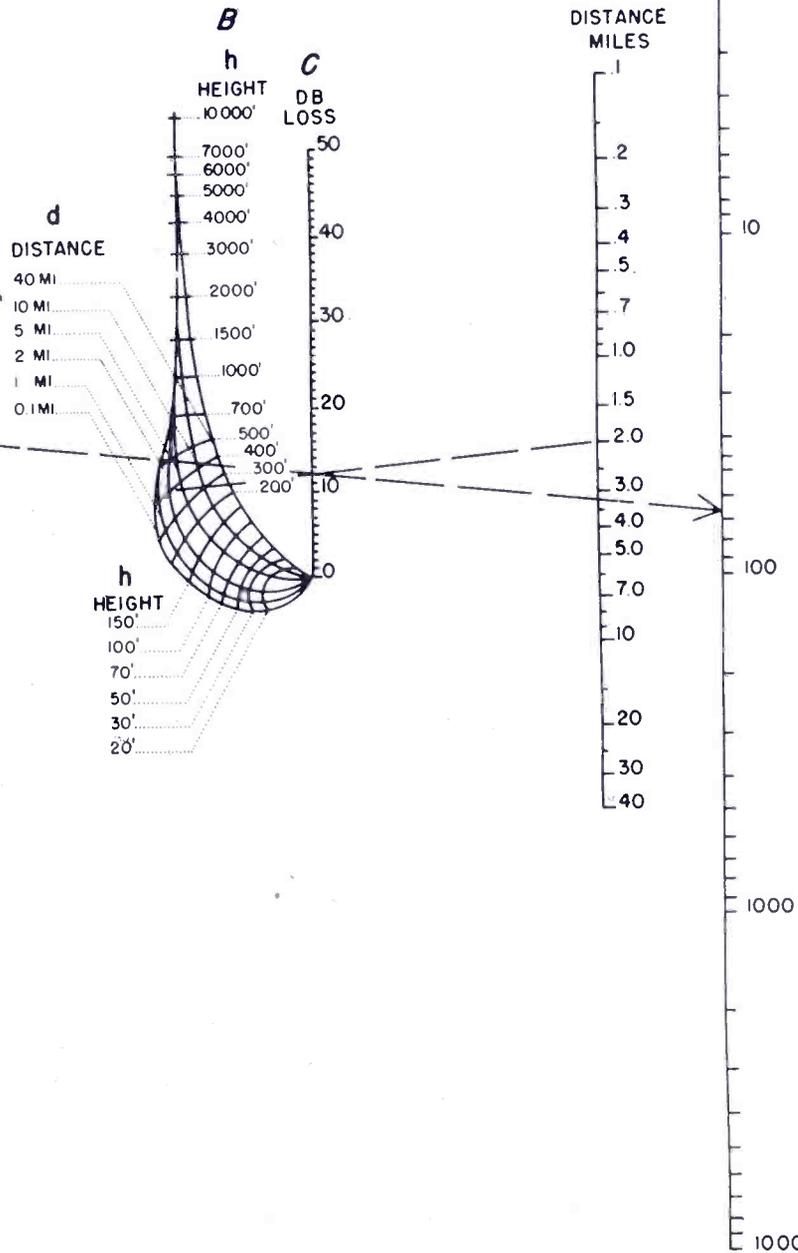

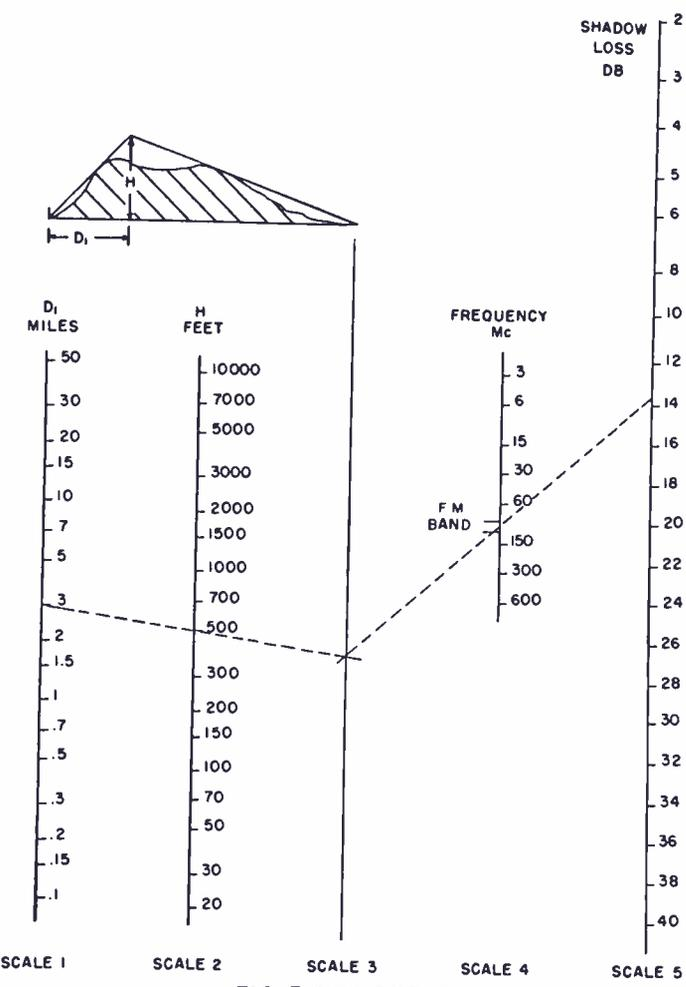

FIG. 7. NOMOGRAPH FOR SHADOW LOSS AT FREQUENCIES OF 3 TO 600 MC.

binning the transmitting and receiving antenna height gain-factors with shadow-loss estimates, it is believed possible to predict the probable signal intensity at a specified point with much greater accuracy than from propagation curves based upon an assumed smooth earth. Accordingly, Fig. 8, entitled "A Chart for Determination of Probable Signal Intensity Over Actual Terrain", has been prepared. This chart incorporates the receiving antenna height gain factor referred to previously and presented in Fig. 6, the shadow loss discussed above and evaluated by means of Fig. 7, together with the theoretical smooth earth propagation curves. This chart provides a convenient means of determining the probable signal intensity at a specified receiver location over actual terrain.

It is believed that a far more realistic estimate of service areas and the coverage characteristics of the FM band can be obtained by the use of this chart than by the use of presently-accepted methods where marked topographical irregularities exist between transmitter and receiver. Fig. 8 affords a means for obtaining a detailed estimate of coverage not provided by the use of the FCC ground-wave charts and procedure, or any other known source.

Theory predicts that for a specified transmitting antenna height and effective radiated power, the signal intensity at distances within the radio horizon over a smooth earth will increase linearly with frequency. Measurements over actual terrain do not support the validity of applying this increase in signal intensity with frequency above 40 to 50 mc. The average signal intensity over actual terrain is found to be about the same for all fre-

quencies, although the departures above and below the average increase as the frequency increases and as the topographical irregularities increase. Since measurements at about 50 mc. are in good agreement with the smooth-earth theoretical values, it seems probable in the light of the foregoing that the theoretical values for the FM band are about 6 decibels above actual values.

In Fig. 8, the final signal intensity scale has, therefore, been positioned to yield a 6 decibel loss. It is believed the resultant estimates of probable signal intensities obtained from the use of this chart will thereby be in closer agreement with actual values.

In constructing the chart shown in Fig. 8, it was assumed that the effective height of the transmitting antenna is that above the average ground elevation between the transmitter and receiver. Starting with this assumption, there has been added, by convenient nomographs, a relatively simple procedure to take into account the shadow loss and height gain-correction factor for specified receiver locations under actual conditions.

Typical Examples ★ Procedure for use of the chart in Fig. 8 is set forth in detail thereon. It will be noted that four examples illustrate the more common conditions encountered in practice.

CASE 1: A receiver is located behind a hill at an elevation below the average ground elevation between transmitter and receiver. The indicated procedure yields the resulting shadow-loss, and predicts the probable signal at the receiving point under such conditions.

CASE 2: A receiver is located on the forward slope of, or at, or near the top of a hill. It will be observed that no shadow loss occurs under the condition shown. The indicated procedure yields the height gain-correction, which results from the receiving point being above the average ground contour, and the probable signal intensity at the receiving point under such conditions.

CASE 3: The receiving site is subject to a shadow loss but is, at the same time, higher than the average terrain contour. The indicated procedure yields both the shadow loss due to the intervening hill, the height gain due to the receiver site being at an elevation above the average and, finally, the probable signal intensity at the point under consideration.

CASE 4: A condition frequently encountered which is not provided for directly in the published ground-wave signal-range charts, wherein the transmitting antenna appears to have a negative height. Fairly accurate results are obtained by assuming that the transmitting and receiving antennas are transposed. This procedure will predict the signal intensity that would result at the receiving point under the actual conditions.

On Fig. 8 is illustrated the procedure that is followed in obtaining a solution for the conditions shown in Case 1 and Case 2 by dashed-dot and dashed lines, respectively.

Attention is called to the fact that the solutions derived from Fig. 8 yield the signal intensity in microvolts per meter at a height of 30 ft. above ground. The signal intensities for receiving antennas at other heights can be obtained by reference to the height gain-correction factor presented in Fig. 6.

Special Conditions ★ It is virtually impossible to estimate with any degree of accuracy the signal intensities within dwellings, particularly within steel frame buildings, apartment houses, and dwellings situated among or near tall buildings. In general, indoor receiving antennas will intercept lower signal intensities than outdoor antennas located at the same height above ground.

In conclusion, the reader is warned that Fig. 8 is not to be construed as representing an accurate and precise means of estimating FM coverage. It does take into consideration the principal factors that determine signal intensities in the FM portion of the radio spectrum. It is the authors' belief that by its use the reader will be enabled to make a much more realistic estimate of FM performance than from any known published information.

The third and last part of this series will present the relation between FM station allocations and actual areas of coverage, based upon the propagation characteristics presented here and in the preceding part.

FACSIMILE IN PHILADELPHIA

The *Philadelphia Bulletin* is testing public reaction to facsimile in a way that is giving the mounted police a workout in controlling crowds. First demonstration was set up in a window of Gimbel's department store. The scene is a living room, where a chairside radio-facsimile set is operated by signals from WPEN-FM. This is a 4-in. recorder. In addition, a larger recorder delivers the same copy enlarged to 16-in. width. In this size, the copy is big enough to be read from the street. Still another machine reproduces full-size pages from the *Bulletin*.

Public interest is so great that additional displays will be installed at other locations. Meanwhile, people who stop to look are being interviewed to determine their interest in the program material, and the ownership of recorders.

The complete facsimile transmitting and receiving equipment was manufactured by Alden Products Company, Brockton, Mass. Tests now being conducted by various newspapers are producing the information required for facsimile standardization by the FCC.

DETAILS OF THE DU MONT RA-101 TELESET

Design and Circuits of Receivers with 15-In. and 20-In. Picture Tubes

BY J. H. RUITER*



FIG. 1. ONE OF THE 15-IN. TUBE MODELS

SOMETIMES we hear radio servicemen who have been studying television theory say: "I know how it works, but I still can't believe it's possible." Well, engineers who know all the answers get the same thrill of wonderment when they see every action of a scene at some distant point reproduced by television as it is taking place. Perhaps that is why television sometimes seems too wonderful to be true!

Yet the circuits and components, when you get behind the cabinet and examine them, are not much different from standard radio sets that the industry has been building for many years. There's nothing strange or mysterious about them except for the cathode-ray tube. And even that is just a large version of the small types that are in common use in oscillographs for radio laboratories and service shops.

Of course, the relative simplicity of present-day television sets has been achieved only through an enormous investment in research and engineering effort. What cannot be seen are the countless ideas that were tried and rejected to the end that practical, commercial designs could be achieved.

Receiver Models ★ The DuMont RA-101 receivers are produced in two series, the

*Engineer, Allen B. DuMont Laboratories, Inc., Passaic, N. J. Note: *Teleset* is a trademark of the DuMont Laboratories.

salon models, with 20-inch tubes, and the drawing-room models with 15-in. tubes. There are two cabinet styles for the former, and four styles for the latter. All employ direct viewing, in order to eliminate the loss of illumination which occurs in projection and reflection systems. The drawing-room models, such as that shown in Fig. 1, have a fixed tube mounting, while the salon models, as in Fig. 2, have a motor-driven tube-tilting mechanism which brings the tube up and forward into viewing position for television reception, or draws it back and downward when it is not required. Thus the lid, Fig. 2, drops down to meet the center doors when they are closed.

Unlike conventional designs, all DuMont models are equipped with what we call the Inputuner, a continuous tuning system covering 44 to 216 mc. This range included not only the 13 channels assigned to television, but FM broadcasting and portions of the spectrum allotted to communications, aviation, and amateurs. A separate tuner, with a stage of tuned RF, covers AM broadcasting.

Chassis Units ★ Although there is a difference in the physical location of the separate units, all models contain the same chassis and subassemblies. Fig. 3 shows their arrangement in the salon model, with a close-up view in Fig. 6, and a block diagram in Fig. 4. They are:

1. The audio amplifier chassis, containing the audio amplifier and its own power supply which also furnishes low voltage for the RF input system, the sound IF amplifier, and the focusing coil of the cathode-ray tube.

2. The sweep chassis, containing the sweep circuits, a power supply for low voltage and bias voltage for the sweep and RF-IF chassis, and the high voltage supply for the cathode-ray tube.

3. The sync stabilizer chassis, containing the horizontal automatic frequency control synchronizing circuits.

4. The RF-IF chassis, containing both the sound and video IF circuits, the video amplifier, the RF input system, and the following controls: sound volume, picture brightness, picture contrast, Tele-FM scan, and Tele-FM tuning.

5. The AM tuner chassis, containing the tuning unit for AM.

6. The tuning meter assembly with the Tele-FM tuning-meter plus the cable connecting it to the RF-IF chassis.

7. The tone selector assembly, consisting essentially of a push button switch

and the tone control attenuator circuits.

8. Record changer assembly, comprising motor, turntable, pick-up arm, and changing mechanism.

9. Cathode-ray tube assembly, consisting of the cathode-ray tube socket, cabling, focusing coil, and deflection yoke.

Details of these units and their operation are presented in the following sections:

AF Amplifier ★ The audio amplifier assembly contains the power supply for the audio amplifier and B+ to the AM Tuner, the RF and sound IF sections of the RF-IF chassis, and focusing current to the focusing coil of the cathode-ray tube. This is shown in Fig. 5.

The amplifier section itself contains two 6SN7 tubes, V1 and V2, and two 6V6 tubes, V3 and V4. The audio amplifier is resistance coupled. V1 is a dual triode with both sections connected as voltage amplifiers in cascade. Sound volume control is in the input circuit of the first stage, with the tone control in the plate circuit of the second half of V1. The first half of V2 is another voltage amplifier which in turn feeds the second half of V2. This is the phase inverter, containing balanced plate and cathode loads from which the signal is derived to drive the two 6V6's, V3 and V4, in push-pull.

Sweep and Sync Chassis ★ The sweep chassis, Fig. 7, contains the power supply which furnishes both B+ and bias voltages to the sweep chassis and to the video IF amplifier and the video amplifier on the

FIG. 2. THIS MODEL IS EQUIPPED WITH A 20-IN. PICTURE TUBE



RF-IF chassis. A negative voltage is also derived from this same power supply to bias both the sweep and RF-IF circuits. This low-voltage power supply contains two 5U4G rectifiers, V9 and V10, each of which is operated as a half-wave rectifier to produce full-wave rectification. A time delay relay in this power supply prevents the application of B voltage for about 30 seconds.

The sweep chassis also contains the high-voltage power supply. This power supply uses two Type 2X2 rectifiers, V11 and V12, operating as a voltage-doubler circuit, supplying the anode of the cathode-ray tube. Sweep circuits on this chassis generate both the vertical and horizontal sweep voltages for the deflection yoke of the picture tube. A toggle switch on the chassis is available to cut off the high voltage at the convenience of the serviceman.

V1 is a 6SJ7 which receives the horizontal sync pulses from the sync separator on the RF-IF chassis. V1 is a horizontal sync amplifier and clipper. It amplifies these pulses and feeds them to the sync stabilizer chassis.

V2, on the sync stabilizer chassis, is a 6H6 phase discriminator, to which horizontal sync pulses from V1 are applied.

A 6K6 electron coupled oscillator, V3, operates at line frequency. It also feeds into the phase discriminator to produce a DC control voltage determined by the

difference in phase between the oscillator and the horizontal sync pulses. This DC control voltage acts on the 6AC7 reactance tube V4 to control the frequency and phase of the oscillator in such a way as to lock it to the horizontal sync pulses.

plate of the electron coupled oscillator is then fed to V2 on the sweep chassis.

V2 is a 6SN7 connected as a driven sweep generator, sometimes called a sawtooth-wave generator. The signal from the sweep generator is then fed to the

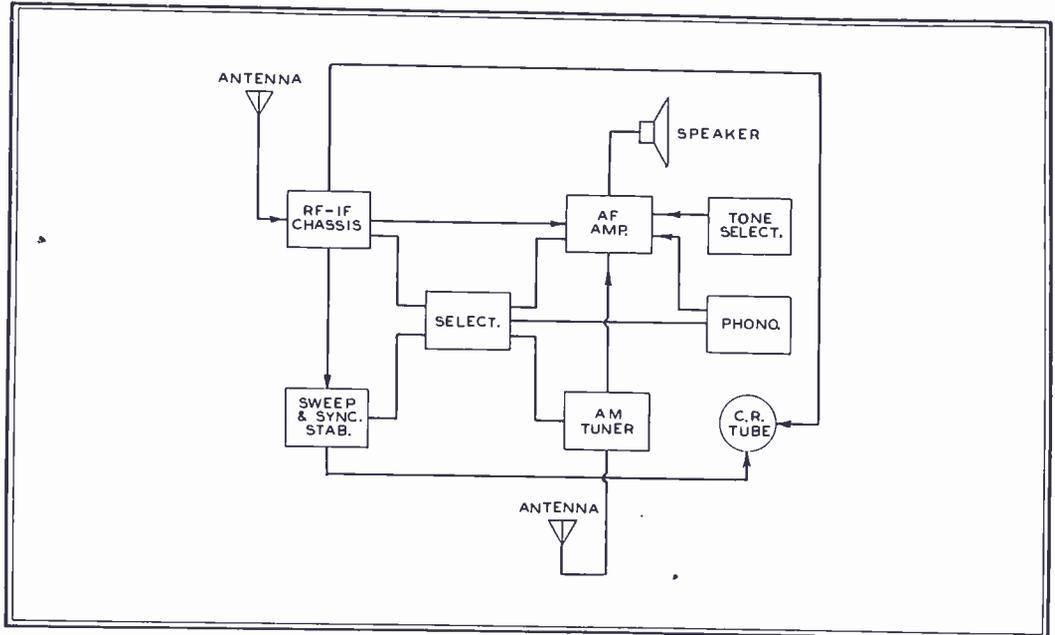

FIG. 4. BLOCK DIAGRAM OF THE ELEMENTS WHICH COMPRISE THE COMPLETE RECEIVER WITH THE 13 TELEVISION BANDS, FM AND AM BROADCASTING, AND A RECORD PLAYER

An integrating network acts upon the DC control voltage to prevent it from being affected by short-duration noise pulses, thus producing a flywheel effect that prevents the oscillator from being affected by noise. The signal from the

grids of two 807's, the horizontal deflection amplifiers, V3 and V4. They operate in parallel to drive the horizontal output transformer T2. Because of the relatively high frequency present in the horizontal sweep signal, it is necessary

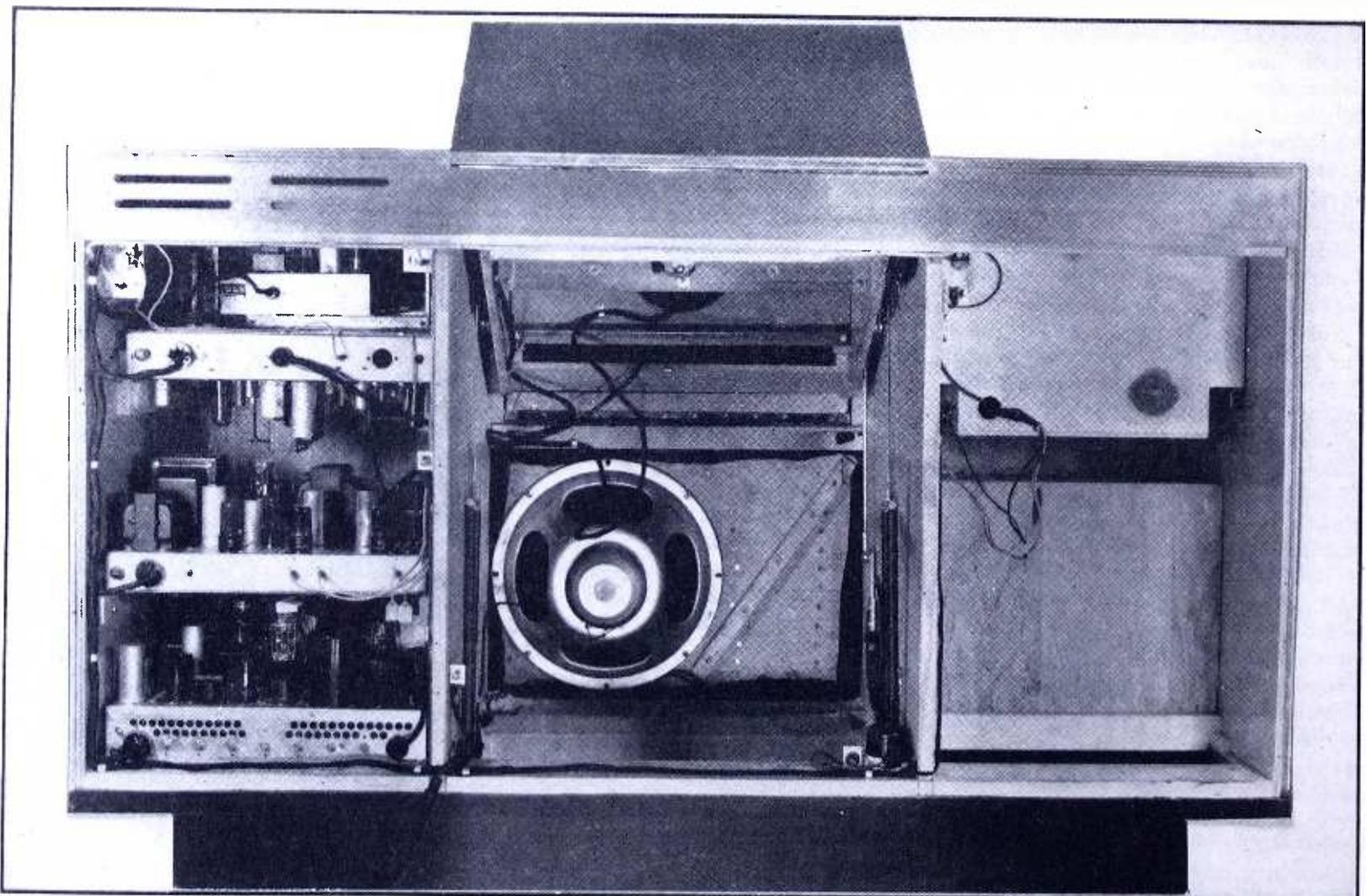

FIG. 3. REAR OF A SALON MODEL. ELECTRICAL CIRCUITS ARE AT THE LEFT; LOUDSPEAKER, PICTURE TUBE, AND ELEVATING MECHANISM IN THE CENTER; AND THE RECORD-CHANGER AND ALBUM SPACE ON THE RIGHT

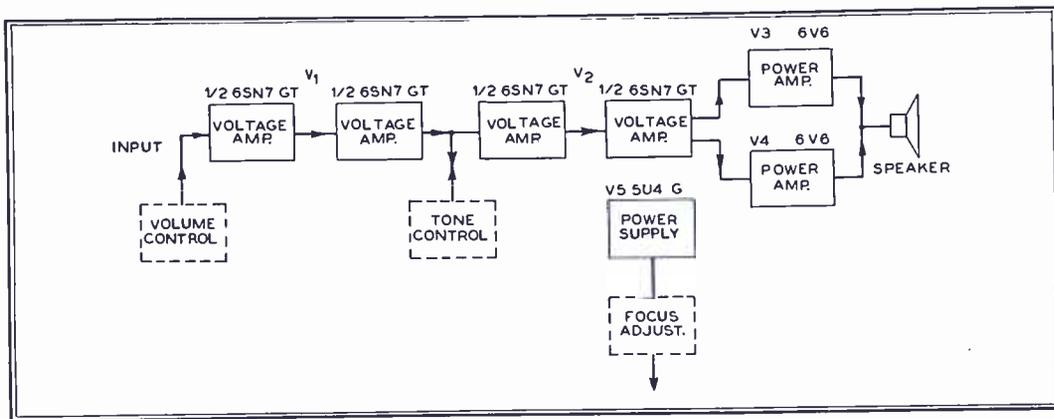

FIG. 5. THIS AMPLIFIER IS USED FOR THE FM TELEVISION SOUND CHANNEL, AND FOR FM AND AM BROADCAST RECEPTION. POWER SUPPLY ALSO FURNISHES FOCUSING CURRENT

that the primary of this output transformer have relatively few turns compared to the vertical deflection transformer, in order to keep the distributed capacitance within the transformer to a minimum. Also, much more power must be delivered to the horizontal deflection coils, due to greater energy losses. Thus, it is necessary to supply more current and power to the horizontal than to the vertical output transformer.

The horizontal damping tube, V5, is a dual triode, connected across the output of the horizontal output transformer. The function of the horizontal damping tube is to eliminate the oscillation which occurs from an overshoot on the sawtooth voltage. The horizontal sweep signal is then fed to the deflection yoke. Horizontal positioning is obtained by means of a potentiometer which injects a portion of the bias voltage into the secondary of the horizontal output transformer.

A 6SJ7, indicated as V6, operates as a vertical sync amplifier. It amplifies the vertical sync signal and transmits it to one of the windings of the vertical blocking-oscillator transformer. The vertical blocking-tube oscillator, V7, consists of one-half a 6SN7 triggering the sweep generator, which is the second half of V7. The vertical sweep signal from the sweep generator is fed to the vertical deflection amplifier, a 6SN7 with both halves operating in parallel. The vertical deflection amplifier drives the primary of the vertical output transformer. The vertical sweep is operated at 60 cycles because the distributed capacitance has much less effect than at 15,750 cycles, making it possible to use more turns of wire in T4. Thus the same number of ampere turns can be used in the horizontal output transformer, and the primary of T4 driven with less current. In this way, a 6SN7, with both halves operated in parallel, furnishes sufficient current as a deflection amplifier to operate the vertical output transformer. Vertical positioning is obtained by means of a potentiometer which injects a portion of the bias voltage into the secondary of the vertical output transformer.

The beam control amplifier, V13, is also on the sweep chassis. It is a dual triode, type 6SN7, which receives the

ducting and the other half is normally cut off. If either sweep fails, the half of the dual triode which is conducting becomes non-conducting. Since the solenoid of a relay is connected in series with the plate of the normally-conducting half of the tube, the relay contacts are then allowed to open. The opening of the contacts applies a positive voltage to the cathode of the cathode-ray tube, cutting off the beam of the cathode-ray tube, and preventing a stationary bright spot or line from appearing on the screen if the sweeps should fail.

signal from the vertical output transformer on one grid and a signal derived from the horizontal output on the other grid. One half of this tube is normally con-

RF Chassis ★ The RF tuning assembly, Fig. 8, is the complete input system. It consists of three separate variable inductors comprising the Inputuner which covers

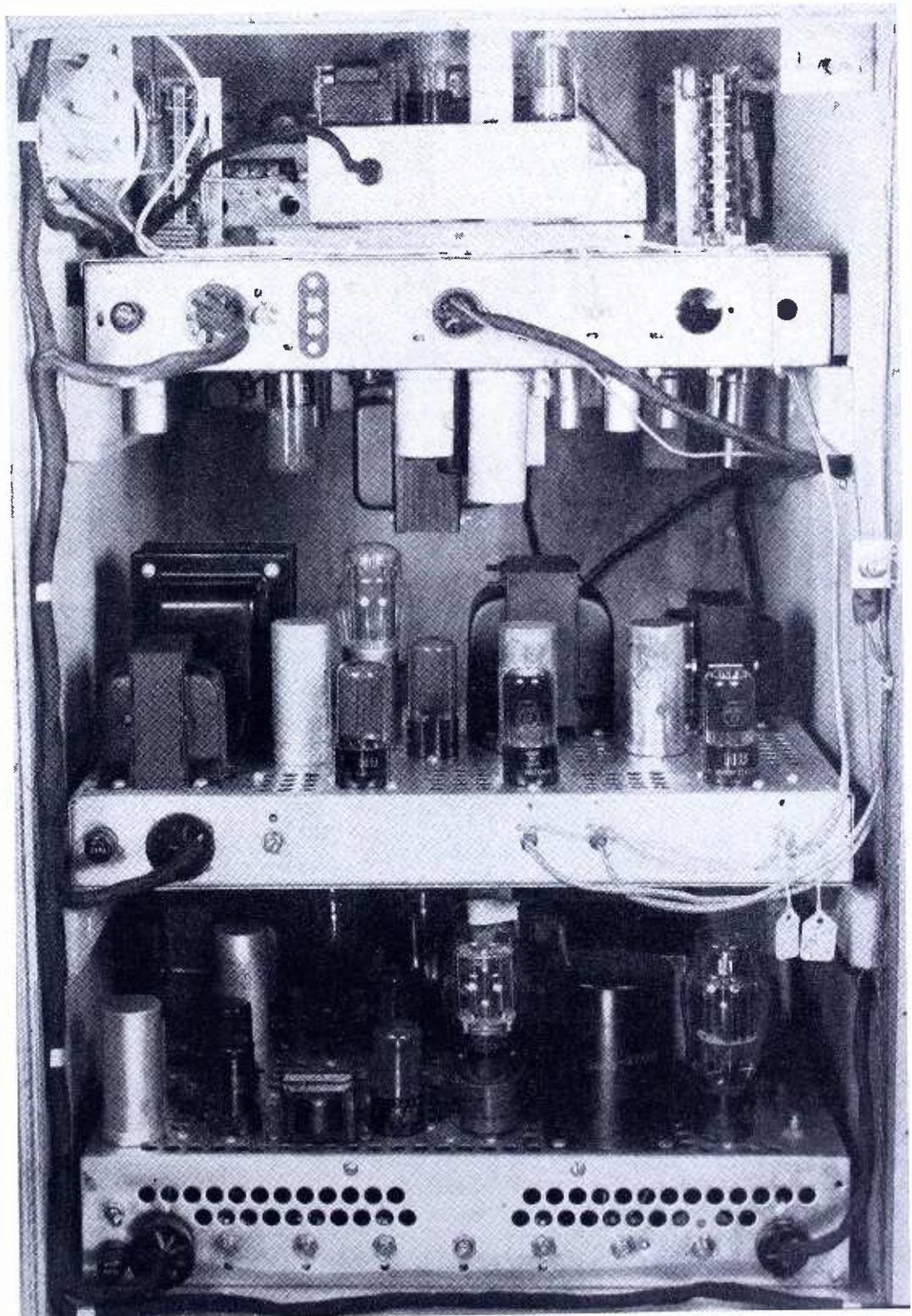

FIG. 6. TOP: AM TUNER ABOVE AND RF-IF CHASSIS BELOW. CENTER: AUDIO CHASSIS. BELOW: SWEEP AND SYNC CHASSIS. ALL CABLE CONNECTIONS GO TO PLUGS

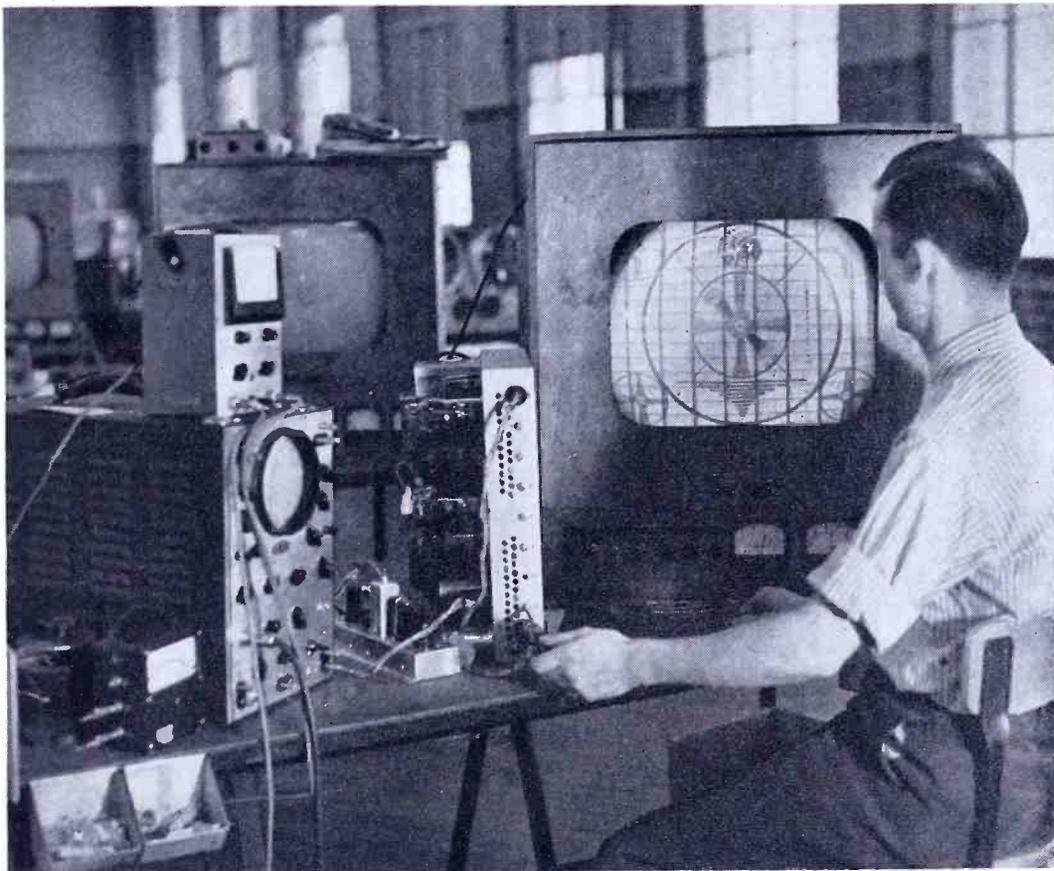

FIG. 10. SWEEP CHASSIS TEST POSITION AT THE DU MONT FACTORY. PERFORMANCE IS CHECKED BY ACTUAL RECEPTION OF A TELEVISION TEST PATTERN

detector and the other half as a cathode follower output. This chassis contains its own heater transformer but B+ is supplied to it from the audio chassis.

Tone Selector ★ The tone selector is a separate switch-assembly with five different RC circuits available for varying the quality of the audio signal. This separate assembly is located directly behind the front panel bezel.

Service Selector ★ The service selector is a push-button switch assembly which connects both AC and DC circuit voltages to the proper units depending upon the service selected. Simultaneously, it also switches the output of the three different chassis to the input of the audio amplifier.

Record Changer ★ The record changer is housed in a drawer, making it easily accessible. The output of the record changer is fed to the audio amplifier chassis through the service selector switch.

Cathode-Ray Tube Assembly ★ The cathode-ray tube for the Westminster and Hampshire cabinet styles is the 20-in. DuMont type 20BP4. It is mounted in a cradle which can be raised by a mechanical driving mechanism to bring the tube in to viewing position. The same tilt-mechanism, controlled by a switch on the lid, lowers the tube when it is not in use. The tube, its focusing coil, and deflection yoke are all firmly mounted in position on this cradle. The cathode-ray tube used in the Sherwood, Devonshire, Revere, and Plymouth cabinet styles is the 15-in. type 15AP4. This tube is mounted in a fixed position in the cabinet.

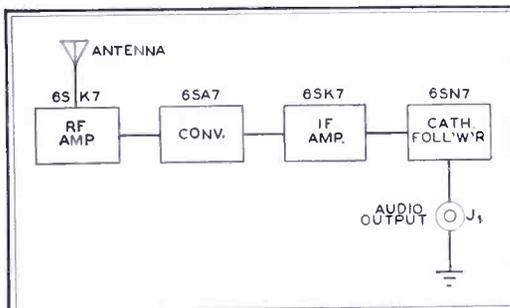

FIG. 9. BLOCK DIAGRAM OF THE AM RECEIVER CHASSIS. OUTPUT GOES TO AMPLIFIER CHASSIS

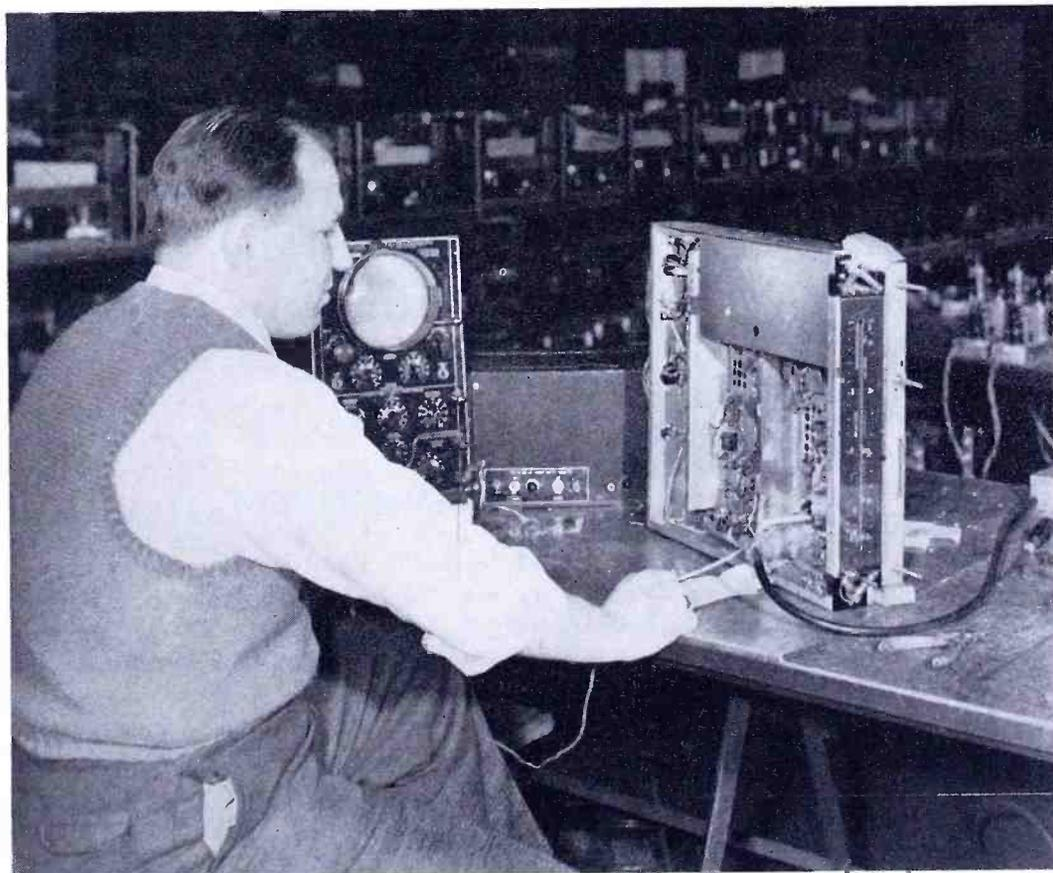

FIG. 11 ANOTHER FACTORY TEST POSITION, WHERE CIRCUITS IN THE RF-IF CHASSIS ARE ALIGNED. OSCILLOSCOPE IS USED TO SPEED ALIGNMENT OPERATIONS

From this review, it can be seen that, while the total equipment performs many functions, the individual circuit elements are neither mysterious nor forbidding. In fact, a little first hand experience quickly discloses the fact that they are surprisingly simple and straightforward.

TELEVISION HANDBOOK SERIES

Owing to a delay in the completion of the illustrations for this month's chapter of Madison Cawein's "Television Handbook" series, it will not appear until our June issue. We are sorry about this delay, particularly because the chapter is of special interest. It covers video and audio waves, and explains the manner in which video, audio, and synchronizing information are transmitted. Also discussed are the composite RMA standard wave, and methods of modulation. Look for the next part of the "Television Handbook" series in the June issue.

HIP POCKET CP'S

During the regional FMA meeting at Albany, president Roy Hofheinz brought into open discussion a matter which can't be a secret to the FCC. It's the AM broadcaster who keeps his FM construction permits filed in his hip pocket. Some AM'ers have been quite frank about admitting that they propose to stall until the very last minute. What Roy Hofheinz didn't mention is that some equipment salesmen are contributing to this situation by promising, as bait for placing orders now, to create a condition of indefinite delay in making delivery.

DON'T BLAME FM—PUT UP AN ANTENNA!

An Account of Field Experience That Holds a Lesson for Every Manufacturer, Dealer, and Serviceman

A LETTER FROM JOHN CARL MORGAN

UNDER the progressive crowding of the AM channels, the purchaser of a radio set, complaining about poor reception, elicits little more response from his dealer than a shrug of the shoulders and an indifferent "Yeah, I know. But it's all you can expect around here."

Unfortunately, dealers are right when they are referring to AM reception, but when they take that attitude toward FM, they are very, very wrong. Assuming that the complaint comes from the owner of a genuine FM receiver, there's a simple remedy: If the set does not have an outside antenna, put one on it. If the owner has a good antenna, properly installed, then raise it up still higher. Here is a very interesting letter that relates actual field experience with the antenna problem:

STATION WINC
ABC Affiliate
WINCHESTER, VA.

April 25, 1947

Dear Mr. Sleeper,

Since your very welcome visit here, we've run into something in this FM situation that really needs to be noised abroad. Mr. Lewis and I made a flying trip all about our WINC-FM service area, with an idea of talking up FM to the dealers. Frankly we came home somewhat down-in-the-mouth, and because of something that can be remedied easily.

It's the fact that neither dealers nor the public have been convinced of the almost mandatory necessity for using outside or, at least, attic dipole antennas. This is especially true when the receiver is in a rural area or in a heavily built-up urban area.

We ran into several towns 65 or 70 miles from our transmitter where AM reception is all but impossible in even moderately unfavorable conditions. FM is a real God-send in such areas, yet FM is getting a black eye. Listeners are disappointed and even belligerent about it. They just don't get real FM reception with the built-in things that the manufacturers are pleased to term *antennas*. Worse, these people all have friends and they do plenty of griping on this subject. Worst of all, the dealers, who should know better, and who certainly have everything to gain from an ascendent FM star, seem to be equally convinced that it's all the fault of the system, none of theirs.

After beating down the natural suspicion that we were trying to *sell* something, we did get two or three of them to agree

to put up outside antennas. In a couple of cases where the situation was mechanically suitable, we strung up a temporary folded dipole. To say that the people were amazed at the improvement is an understatement. They just couldn't believe that there could be such reception. Certainly they'll pass the information along, but they're only a small drop in a big bucket, which at present has a heluva hole in it.

Now for suggestions as to what can be done about it. First: and it's probably next to impossible to sell this idea to the manufacturers or dealers — *Include an antenna installation in the selling price of the receiver* (much as the TV boys are doing with their service and installation contracts). That would do it — since a man who has to pay for something is almost sure to use it in order to get his money's worth.

Second: This is probably the most practical — *don't build an FM antenna in any console or non-portable receiver*. A big red-printed tag should be attached to each receiver explaining that in most cases where the set is to be used in a steel-framed building or in a rural area more than 20 miles from an FM station, an outside dipole is necessary.

Third: And this may be most acceptable of all — *Furnish the confounded built-in antenna, but DON'T CONNECT IT*. Instead attach a conspicuous tag to the end of its lead-in explaining that in auspicious locations it can *possibly* be used, but explaining the necessity for an outside or attic installation in such areas as I named before.

Fortunately, right here in Winchester, our leading dealer is most progressive, and very FM conscious. The others have of necessity had to follow his lead. The result is that Winchester folks are most happy over FM. At present, they're getting perfect reception from not only WINC-FM, but from WINX-FM and WWDC-FM in Washington. Also, from my own personal observations while listening to their infrequent test broadcasts, WJEJ-FM Hagerstown, Md. and WFMD-FM Frederick, Md. will put excellent signals into this area, and I estimate that all other Washington stations will be eminently satisfactory here (70 miles away) when they get going on full power.

On the other hand, without an outside (or attic) antenna, the only signal that's even remotely usable in Winchester is WINC-FM, but that's as it should be

with 14 kw. of effective radiated power from our station.

A specific case at point, from many we could cite, is Fredericksburg, Va. It is 65 miles from both Washington and Richmond. There, with the usual built-in apology for an adequate antenna, reception at best is barely marginal, and at average is worthless. However, with just a simple dipole rigged broadside to WINC-FM, perfect FM reception also was experienced from WINX and WWDC Washington, and WCOD Richmond, as well as WINC. And yet, Fredericksburg dealers in general don't seem the least worried that most of the sets they have sold are utterly disappointing to their purchasers, all because they're installed without proper antennas. These same dealers just shrug it off with: "FM's highly over-rated — it'll never amount to much . . ."

I seem to have rambled around considerably, but naturally I feel very strongly on the subject, and I have no doubt but what you, as one of FM's biggest boosters, will agree that something must be done about it and quick.

After all, the back-bone of FM acceptance, I believe, will be the small-town listener who heretofore has had to depend almost completely on one local station, if that, and the rural or semi-rural resident whose only AM reception is from marginal ground-waves in the daytime and from skywaves, with attendant fading and such, at night. When there is summer static, they just leave their sets turned off.

While I haven't any figures to support me, I'm convinced that a good third of the American population does not get completely satisfactory AM reception from more than one station, if that. Right here in our front yard, within somewhat over a hundred miles radius from the WINC-FM transmitter, there are nearly 2,000,000 people who never hear really consistent AM reception. With FM receivers properly installed with adequate antennas, these folks have *perfect* reception from at least one, and in most cases from several, existing FM stations. So much for the harangue; Maybe you can lend your resources to convincing the manufacturers that the United States consists of something else besides four or five big cities, and that normal receiving conditions seldom duplicate the ideal set-up experienced in a laboratory.

If you've waded in this far, thanks for your patience. 73's.

JOHN CARL MORGAN

FM AND TELEVISION



Steatite-Insulated Connectors

Designed for aircraft use

No insulation damage from flashover

2 to 19 contacts

24 combinations

Floating contacts in Plugs

Small-size pin-plug contacts in Receptacles (shown below)



Two Views of Typical Receptacle

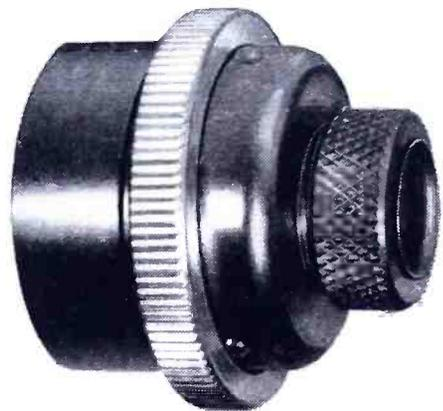

Two Views of Typical Plug



INDIVIDUAL PIN-PLUGS ARE ALSO AVAILABLE

Unique construction originated by A.R.C.

Used by the millions in war-time aircraft.

Minimum spring fatigue.

Conservatively rated at 10 amperes in small size, or 20 amperes in medium size.



(ACTUAL SIZE)

The beryllium-copper contact springs are riveted and soldered at the tip. The other ends are free yet are confined in an annular recess at the base of the Pin-Plug. The four springs provide eight wiping contacts.

Write on your letterhead for our Catalog describing these and our other Component Parts.

AIRCRAFT RADIO CORPORATION

DEPENDABLE ELECTRONIC EQUIPMENT SINCE 1928

Boonton, N. J.



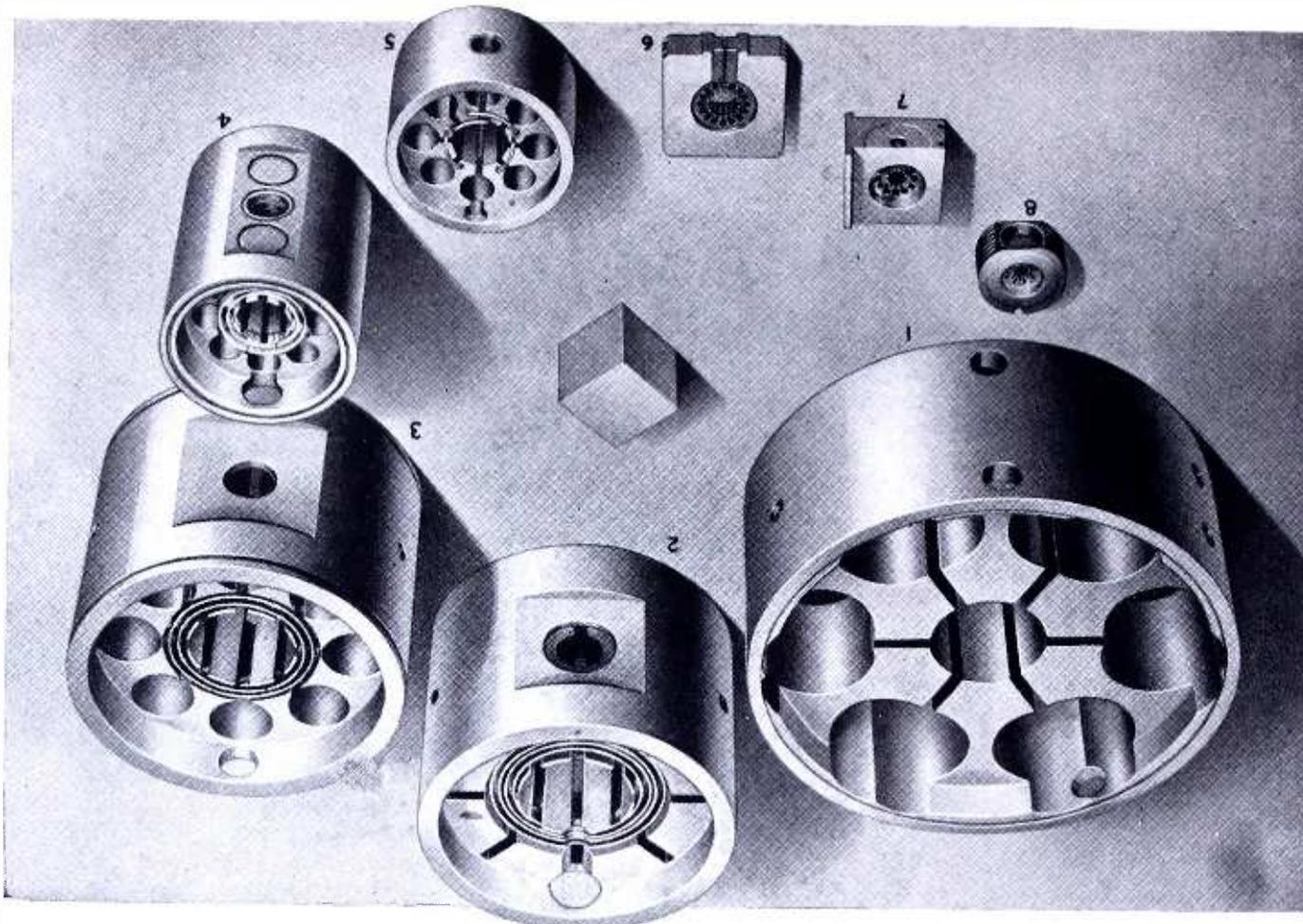

FIG. 41. Resonator blocks of centimeter-wave magnetrons developed at the Bell Telephone Laboratories. From the largest to the smallest these resonator systems are those of: 1) the 700 A-D magnetrons of fixed frequencies near 700 mc.; 2) the 5J26 magnetron, tunable over the frequency range 1,220 to 1,350 mc.; 3) the 4J21-30 magnetrons of fixed frequencies near 1,280 mc.; 4) the 720A-E magnetrons of fixed frequencies near 2,800 mc.; 5) the 706AY-GY magnetrons of fixed frequencies near 3,000 mc.; 6) the 4J50 magnetron at 9,375 mc.; 7) the 725A magnetron at 9,375 mc.; and 8) the 3J21 magnetron at 24,000 mc. Note the hole and slot type resonators of 1, 3, 4, 5, 6, and 7; the slot type resonators of 2; and the vane type resonators of 8. Note the double ring straps in 3, 4, 6, and 7; the double ring channel straps for tuning in 2; the early British type wire strapping in 5; and the unstrapped rising sun type structure of 8. A 1-in. cube has been included in this and other photographs for size reference.

MAGNETRON: GENERATOR OF CENTIMETER WAVES

The Theory of the Magnetron, and Its Development as a Practical Means for Generating Centimeter Waves—8th Installment

BY J. B. FISK, H. D. HAGSTRUM, AND P. L. HARTMAN

PART 2 — DEVELOPMENTAL WORK AT BELL LABORATORIES, 1940-1945

11. General Remarks ★ In the first part of this paper, the fundamentals of the theory of the magnetron oscillator have been discussed. The objective has been to establish for the reader a general picture of the nature of the electronic mechanism and of the rôle played by the RF circuit and load.

In the second part of the paper is traced the research and development work done at the Bell Telephone Laboratories on the magnetron oscillator during the war years, 1940-1945. The effort was directed, for the most part, toward the development of magnetrons to meet definite radar needs.

Fifteen different types or families of magnetrons were developed at the Bell Laboratories during the war. Included among these are some 75 separate West-

ern Electric Company or RMA code numbers. It has been found most convenient to discuss the work done on each type of magnetron as a unit, although, to be sure, there has been considerable interplay between projects. Something is said of the origin of each type, of the problems encountered in its development, and of the solution of these problems, in some cases involving studies and experiments of general interest. Special characteristics and general performance data for each type of magnetron discussed are given. Included also is a general discussion of the work done on magnetron cathodes which, although carried out on specific magnetrons, has been of general applicability to all.

Before proceeding with the detailed discussion, it would be well for the reader to recognize the general scope of the work to be described and the general

nature of the problems encountered. The work of the Bell Laboratories in the development of pulsed magnetrons for radar use has extended over practically the whole range of effort surveyed in the INTRODUCTION. Work has been done throughout the range of wavelengths from 45 cm. to 1 cm. and on magnetrons capable of developing over 1 megawatt peak RF power. It has included work on such features as tuning, coaxial and wave guide outputs, several types of resonator systems and strapping schemes, and on the incorporation of the magnetic circuit into the magnetron structure in so-called *packaged* types.

The scope of the developments to be described may be judged from Figs. 41, 42, 43, and 44. That part of a magnetron oscillator which perhaps best gives one an idea of size and wavelength range is the

resonator block. In Fig. 41 is shown a series of resonator blocks ranging in resonant frequency from 700 mc. to 24,000 mc.²³ In Fig. 42 is shown the external view of four magnetrons of operating frequencies distributed over the range in which work has been done. It illustrates both the coaxial and waveguide types of output circuits, the use or not of attached magnets, and the two types of input leads and cathode supports. In Fig. 43 is shown the group of tunable magnetrons developed as replacements for fixed frequency models with which they are electrically and mechanically interchangeable. Finally, in Fig. 44, are shown two magnetron oscillators, the 720A and 725A, mounted in their magnets. By comparison with Fig. 42, the space and weight saved by packaging may be seen. A fair comparison is that between the 725A and magnet of Fig. 44 and the 4J52, number 2 in Fig. 42. Both are 3.2 cm. models, the latter, moreover, being capable of generating higher power.

²³ In this and other photographs of Part 2 either a 1-in. cube or a 1-in. line has been included for size reference.

FIG. 42. Four fixed frequency magnetron oscillators. They are: 1) the 3J21 magnetron (60 kw., 24,000 mc.); 2) the 4J52 magnetron (100 kw., 9,375 mc.); 3) the 720A-E magnetron (1,000 kw., 2,800 mc.); 4) the 4J21-30 magnetron (600 kw., 1,280 mc.). Note the two types of output circuit, coaxial and waveguide; the use of packaged magnets; and the two types of input leads.

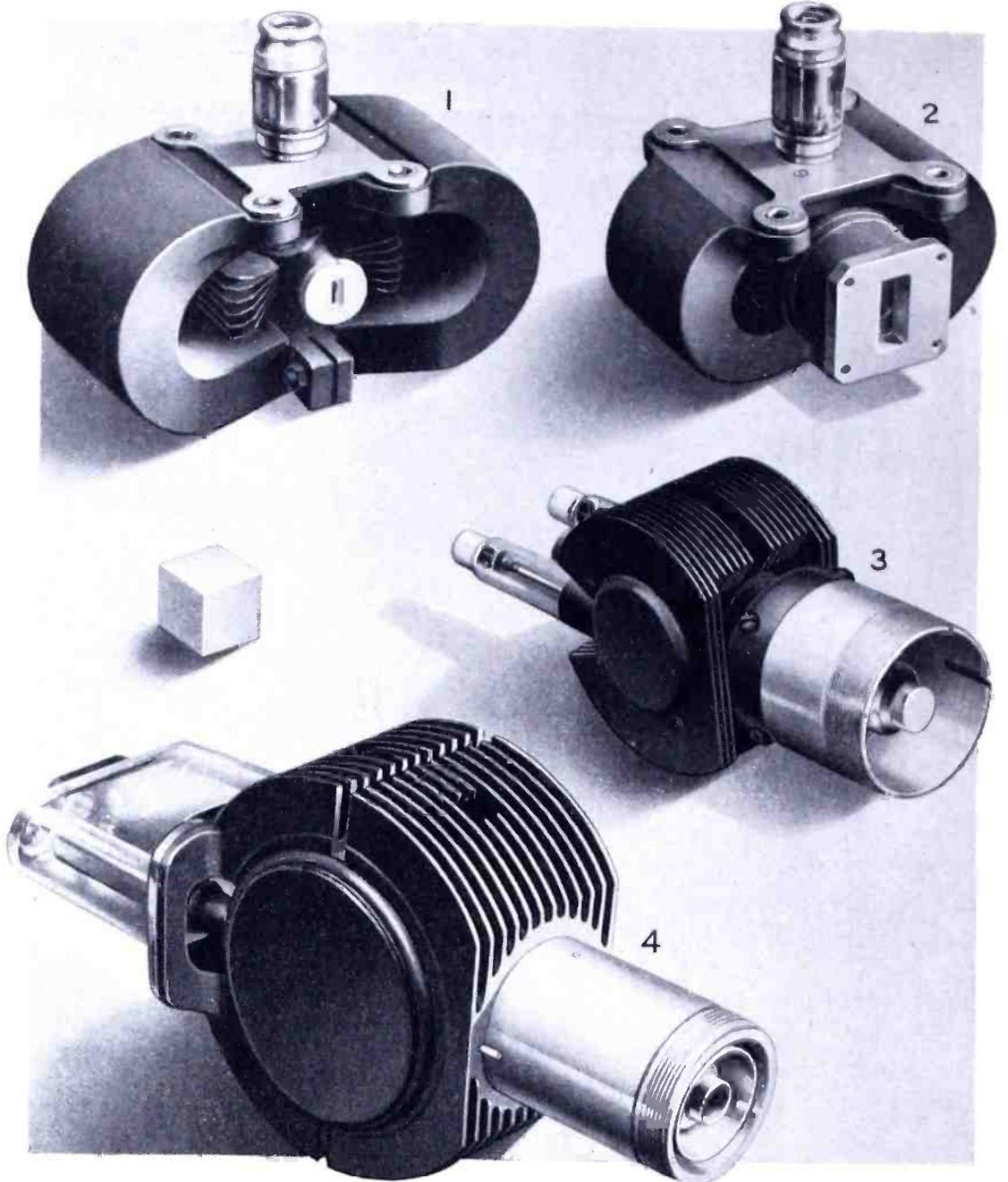

The designer of a magnetron oscillator is faced with a variety of tasks. If the magnetron is to be used in a specific application, he has at his disposal data concerning the amount of power available to drive the magnetron, the nature of the pulsing if such is to be used, the frequency of operation, mechanical features having to do with form and weight, and an idea of what the user hopes or expects to obtain in the way of output power, frequency stability, and operating efficiency. It is the problem of magnetron design to arrange the resonator system, output circuit, cathode, magnetic circuit, and mechanical features to meet these requirements if possible.

The design of the resonator system must be arranged to achieve the proper frequency of operation, proper characteristics regarding modes, the proper size of interaction space, and other characteristics which have a bearing on the electronic operation. In special cases a tunable resonator system must be provided.

In the design of the output circuit it is necessary to arrange the type of coupling to the resonator system, the necessary impedance transformation from resonator

FIG. 43. Four tunable magnetron oscillators. They are: 1) the 4J42 magnetron (40 kw., 660 to 730 mc.); 2) the 4J51 magnetron (275 kw., 900 to 970 mc.); 3) the 5J26 magnetron (600 kw., 1,220 to 1,350 mc.); and the 2J51 magnetron (55 kw., 8,500 to 9,600 mc.).

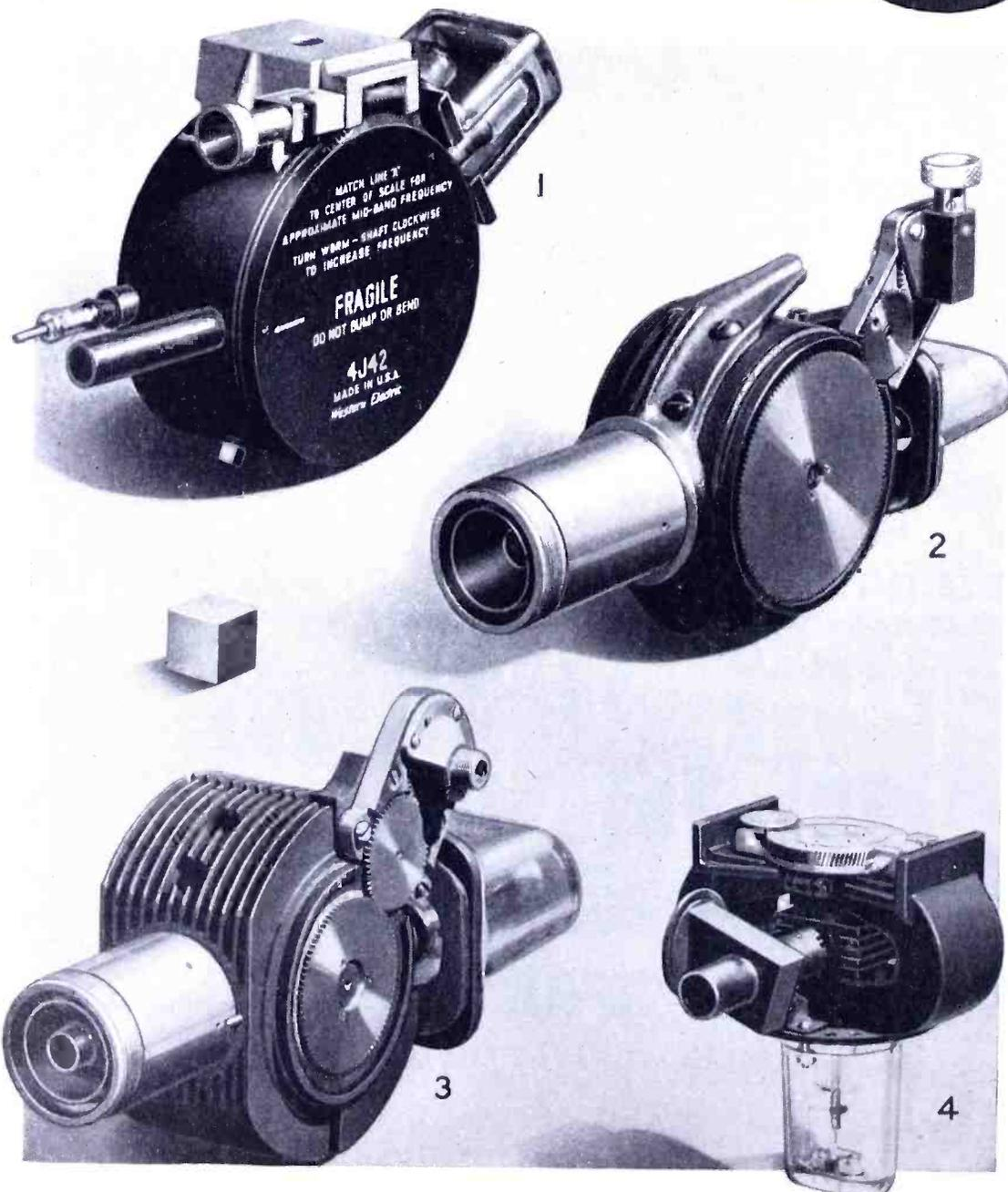

finch facsimile



Finch Telefax

**provides high-speed, accurate
communication . . . by wire or radio**

Finch Telefax Duplex Unit transmits or receives exact facsimiles of written or printed messages, drawings, photographs, signatures, etc. Leased wire rates are authorized under A.T.&T. tariff, F.C.C. No. 135, effective May 4, 1946.

Also Make:

**FACSIMILE BROADCAST TRANSMITTING EQUIPMENT
FACSIMILE HOME RECORDERS
MOBILE FACSIMILE RECORDERS
FACSIMILE DUPLICATING MACHINES
FINCH ANTENNAS FOR FM STATIONS**

FINCH TELECOMMUNICATIONS, INC.

Address all inquiries to Sales Office

10 EAST 40th STREET • NEW YORK 16, N. Y.

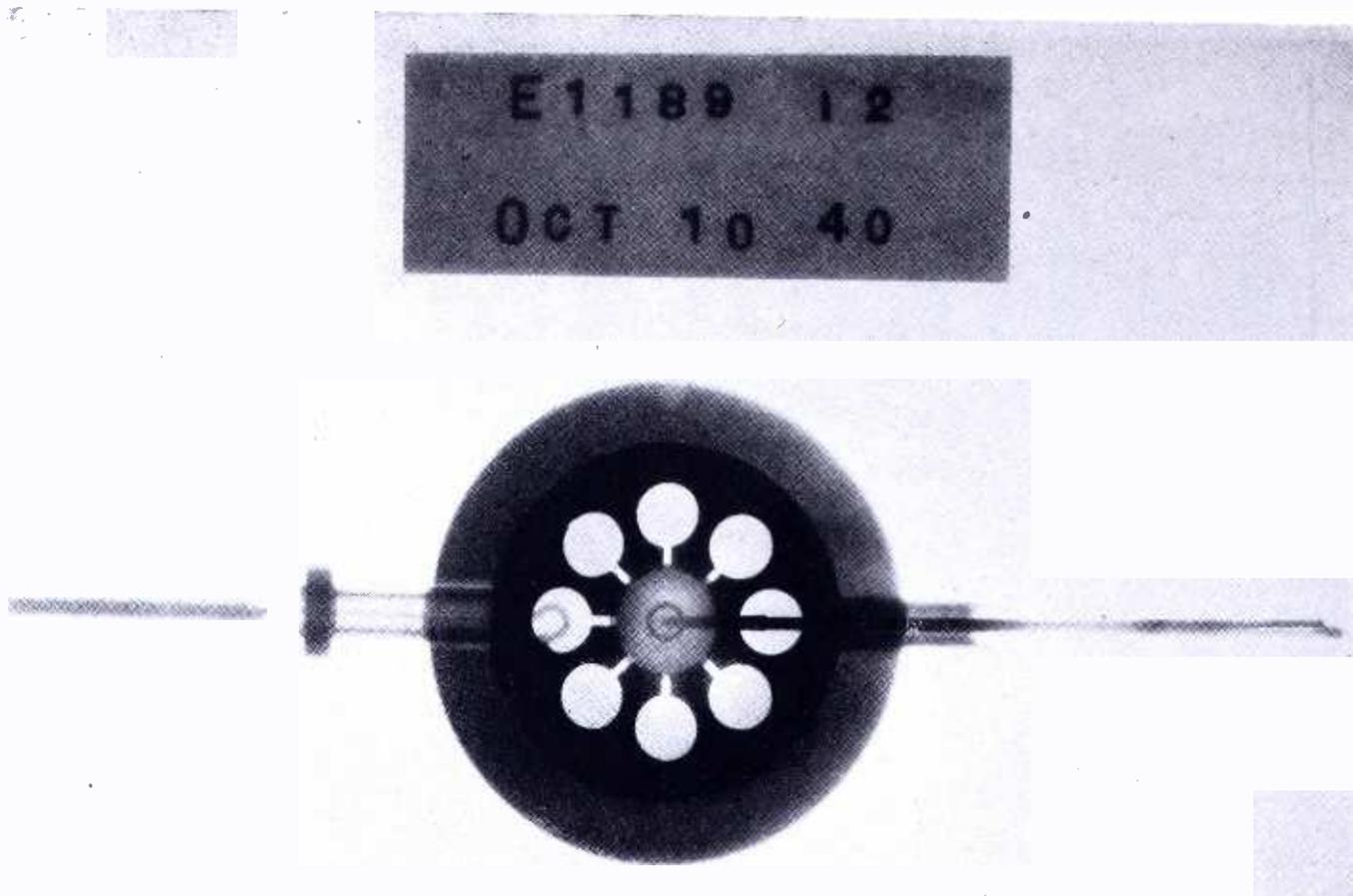

FIG. 45. An X-ray photograph of the 10-cm. magnetron oscillator brought to America by a British delegation in October 1940 and copied at the Bell Laboratories. It is the prototype of most magnetron oscillators developed in Great Britain and the United States during the war.

to load, the type of external coupling, a vacuum seal, and, generally, to take into account the possibility of electrical breakdown when the power delivered is high.

In the design of the magnetron cathode, attention must be paid to its surface and how it is equipped to meet the rigorous demands made of it. The cathode mounting and input leads must be designed for proper geometry at the cathode ends, heat dissipation, mechanical strength, and DC voltage breakdown strength.

The requirements put upon the magnetic circuit of a magnetron must be borne in mind throughout the design of the

magnetron itself. Considerable effort may be expended in arranging for the magnet gap, and hence the required magnet, to be as small as possible. In *packaged* magnetrons the magnet pole pieces, which are built into the magnetron structure, must be designed to produce a field of proper configuration and to make the necessary external magnets feasible.

12. Reproduction of the British Magnetron ★ The problem undertaken at the Bell Telephone Laboratories immediately after the visit of the British delegation in October 1940 was the reproduction of the 10-cm. mag-

netron for study and for general radar use at the Bell Laboratories and the Radiation Laboratory at the Massachusetts Institute of Technology. The data available were contained in a drawing of a magnetron having 6 resonators, and in an X-ray photograph of the magnetron used in the demonstration at the Whippany Laboratory, described in the INTRODUCTION. The X-ray photograph, reproduced in Fig. 45, showed a resonator system having eight resonators. Since this arrangement was known to operate, it was adopted as the starting point for the work here.

(To be continued next month)

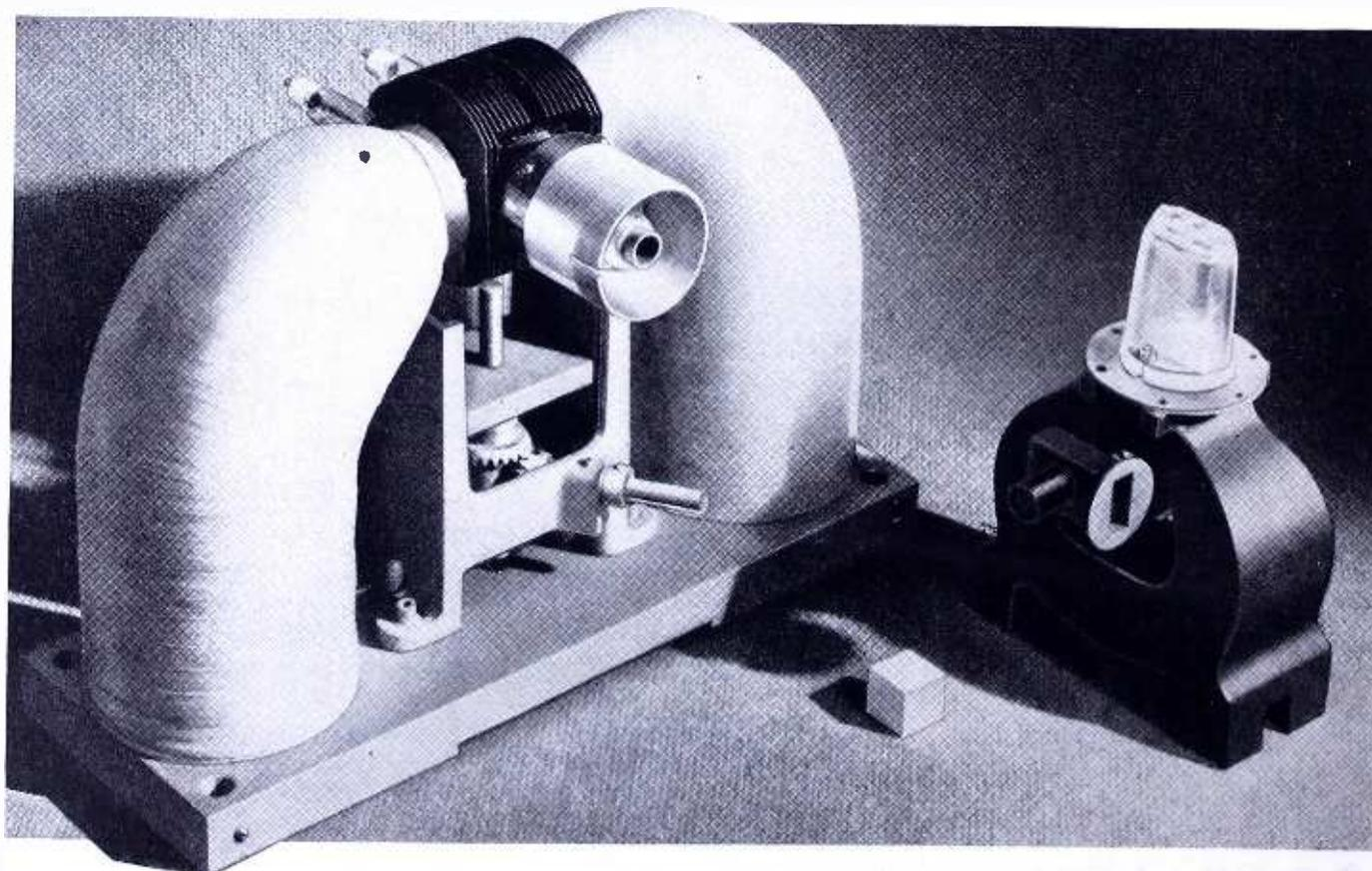
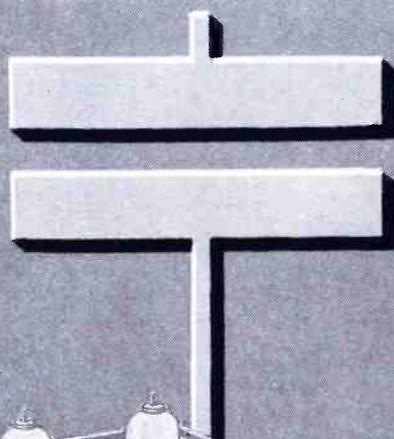

FIG. 44. The 720A-E (1,000 kw., 2,800 mc.) and the 725A (55 kw., 9,375 mc.) magnetrons, shown at the left and right, each mounted in its magnet.

SPRAGUE VITAMIN Q DIELECTRIC

(TRADEMARK REG. U. S. PAT. OFF.)



**HAS PERMITTED
SUBSTANTIAL RE-
DUCTIONS IN BOTH
THE SIZE AND WEIGHT
OF MANY OIL-FILLED
CAPACITOR TYPES**

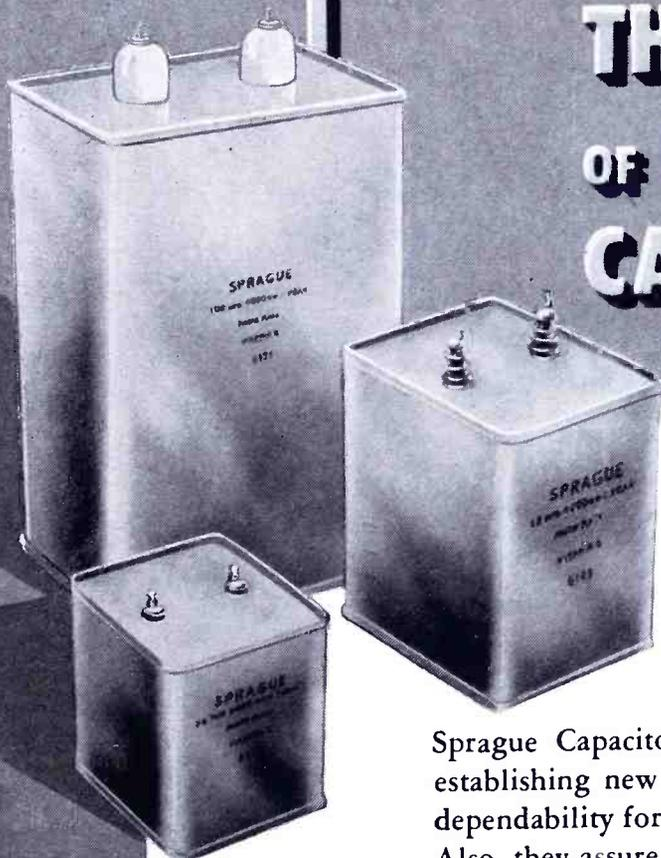

TYPICAL! Compact
Capacitors for Photoflash
and Energy Storage Uses

Sprague Capacitors with Vitamin Q dielectric have led in establishing new standards of compactness, light weight and dependability for electric flash tube (photoflash) photography. Also, they assure outstanding economies and greater efficiency for flash welding and time control circuits where duty cycles other than those used in photoflash work prevail. Write for Sprague Engineering Data Bulletin No. 3205.

SPRAGUE ELECTRIC COMPANY, North Adams, Mass.

PIONEERS OF ELECTRIC AND ELECTRONIC PROGRESS

determined. For the present, applications will be considered on their individual merits.

E. SERVICE AREA: The service area is predicted as follows:— Profile graphs must be drawn for at least eight radials from the proposed antenna site. These profiles should be prepared for each radial beginning at the antenna site and extending to 10 miles therefrom. Normally the radials are drawn for each 45° of azimuth; however, where feasible the radials should be drawn for angles along which roads tend to follow. (The latter method may be helpful in obtaining topographical data where otherwise unavailable, and is particularly useful in connection with mobile field intensity measurements of the station and the correlation of such measurements with predicted field intensities.) In each case one or more radials must include the principal city or cities to be served, particularly in cases of rugged terrain, even though the city may be more than 10 miles from the antenna site. The profile graph for each radial should be plotted by contour intervals of from 40 to 100 ft. and, where the data permits, at least 50 points of elevation (generally uniformly spaced) should be used for each radial. In instances of very rugged terrain where the use of contour intervals of 100 ft. would result in several points in a short distance, 200- or 400-ft. contour intervals may be used for such distances. On the other hand, where the terrain is uniform or gently sloping, the smallest contour interval indicated on the topographic map (see below) should be used, although only a relatively few points may be available. The profile graph should accurately indicate the topography for each radial, and the graphs should be plotted with the distance in miles as the abscissa and the elevation in feet above mean sea level as the ordinate. The profile graphs should indicate the source of the topographical data employed. The graph should also show the elevation of the center of the radiating system. The graph may be plotted either on rectangular coordinate paper or on special paper which shows the curvature of the earth. It is not necessary to take the curvature of the earth into consideration in this procedure, as this factor is taken care of in the chart showing signal intensities (Fig. 1).

The average elevation of the 8-mile distance between 2 and 10 miles from the antenna site should then be determined from the profile graph for each radial. This may be obtained by averaging a large number of equally-spaced points, by using a planimeter, or by obtaining the median elevation (that exceeded for 50% of the distance) in sectors and averaging these values.

To determine the distance to a particular contour, Fig. 1 concerning the range of FM broadcast stations should be used. This chart has been prepared for a frequency in the center of the band and is to

be used for all FM broadcast channels, since little change results over this frequency range. The distance to a contour is determined by the effective radiated power and the antenna height. The height of the antenna used in connection with Fig. 1 should be the height of the center of the proposed antenna radiator above the average elevation obtained by the preceding method. The distances shown by Fig. 1 are based upon an effective radiated power of 1 kw.; to use the chart for other powers, the sliding scale associated with the chart should be trimmed and used as the ordinate scale. This sliding scale is placed on the chart with the appropriate gradation for power in line with the lower line of the top edge of the chart. The right edge of the scale is placed in line with the appropriate antenna height graduations and the chart then becomes direct reading for this power and antenna height. Where the antenna height is not one of those for which a scale is provided, the signal strength or distance is determined by interpolation between the curves connecting the equidistant points.

The foregoing process of determining the extent of the required contours shall be followed in determining the boundary of the proposed service area. The areas within the required contours must be determined and submitted with each application for these classes of FM broadcast stations. Each application shall include a map showing these contours, and for this purpose sectional aeronautical charts or other maps having a convenient scale may be used. The map shall show the radials along which the profile charts and expected field strengths have been determined. The area within each contour should then be measured (by planimeter or other approximate means) to determine the number of square miles therein. In computing the area within the contours, exclude (1) areas beyond the borders of the United States, and (2) large bodies of water, such as ocean areas, gulfs, sounds, bays, large lakes, etc., but not rivers.

In cases where the terrain in one or more directions from the antenna site departs widely from the average elevation of the 2 to 10 mile sector the application of this prediction method may indicate contour distances that are different from those which may be expected in practice. In such cases the prediction method should be followed, but a showing may be made if desired concerning the distance to the contour as determined by other means. Such showing should include data concerning the procedure employed and sample calculations. For example, a mountain ridge may indicate the practical limit of service although the prediction method may indicate the contour elsewhere. In cases of such limitation, the map of predicted coverage should show both the regular predicted area and the area as limited or extended by terrain. Both areas should be measured as previ-

ously described; the area obtained by the regular prediction method should be given in the application form, with a supplementary note giving the limited or extended area. In special cases the Commission may require additional information as to the terrain in the proposed service area.

In determining the population served by FM broadcast stations, it is considered that the built-up city areas and business districts in cities having over 10,000 population and located beyond the 1 mv/m contour do not receive adequate service. Minor civil division maps (1940 census) should be used in making population counts, excluding cities not receiving adequate service. Where a contour divides a minor division, uniform distribution of population within the division should be assumed in order to determine the population included within the contour, unless a more accurate count is available.

4. Interference Standards

Field intensity measurements are preferable in predicting interference between FM broadcast stations and should be used, when available, in determining the extent of interference. (For methods and procedure, see sec. 5.) In lieu of measurements, the interference should be predicted in accordance with the method described herein.

Objectionable interference is considered to exist when the interfering signal exceeds that given by the ratios of Table II. In Table II the desired signal is median field and the undesired signal is the tropospheric signal intensity exceeded for 1% of the time.

TABLE II

CHANNEL SEPARATION	RATIO OF DESIRED TO UNDESIRE SIGNALS
Same channel	10:1
200 kc.	2:1
400 kc.	*
600 kc.	*
800 kc. and above	No restrictions ¹

In the assignment of FM broadcast facilities the Commission will endeavor to provide the optimum use of the channels in the band, and accordingly may assign a channel different than that requested in an application.

In predicting the extent of interference within the ground wave service area of a station, the tropospheric signal intensity (from co-channel and adjacent channel stations) existing for 1% of the time shall be employed. The 1% values for 1 kw. of power and various antenna heights are given in Fig. 2, and values for other powers may be obtained by use of the sliding

* To be determined.

¹ Intermediate frequency amplifiers of most FM broadcast receivers are designed to operate on 10.7 mc. For this reason the assignment of two stations in the same area, one with a frequency 10.6 or 10.8 mc. removed from that of the other, should be avoided if possible.

(CONCLUDED ON PAGE 50)

SENSATIONAL

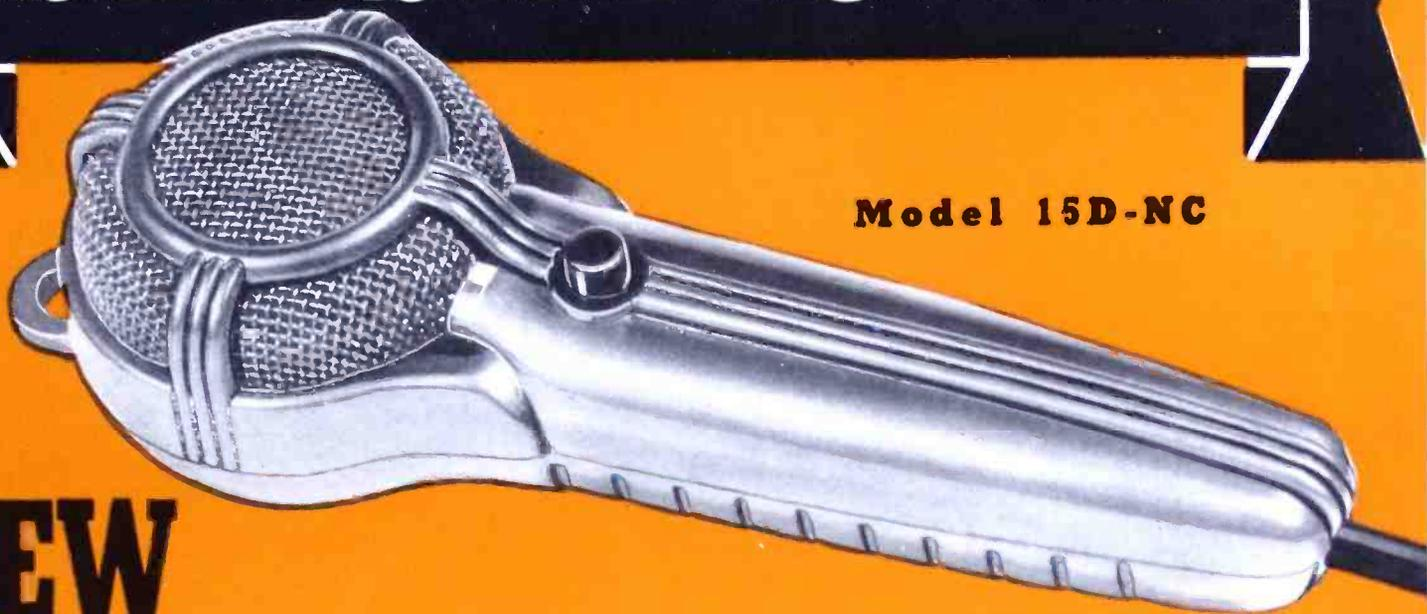

Model 15D-NC

NEW

Noise Canceling Microphone by TURNER

Transmits only when spoken to at close range

A new Turner development . . . Now factories, machine shops, engine rooms, trains, aircraft, etc., can have sharp, clear communications. Turner engineers have solved the problem of effective speech transmission under adverse noise conditions. The Turner Model 15D-NC is so expertly designed and balanced it amplifies only sound originating close to its specially engineered diaphragm. Random sound (noise) arriving from a distance strikes both sides of the diaphragm simultaneously and is canceled out. This new microphone transmits only when spoken to at close range from the front.

The LOUDER the noise—the BETTER the results
By speaking directly into the front side of the Turner Model 15D-NC clear cut results are achieved at ordinary levels of conversation. The din, clatter, and clang of machinery and other disturbances are canceled out. In fact, the higher the noise level, the more effective will be the results observed.

Designed for Convenience

The Model 15D-NC is a rugged dynamic built to stand severe operating conditions. It is housed in an attractive hand held case of light, tough alloy. When not in use, it may be hung on a hook. If desired, a "push-to-talk" thumb switch is built into the handle for on-off operation or relay work. Available in 50, 200, 500 ohms, or high impedance.

SPECIFICATIONS Turner Model 15D-NC

EFFECTIVE OUTPUT LEVEL, 56 db below 1 volt/dyne sq cm

FREQUENCY RESPONSE: 50 to 5000 c. p. s.

OUTPUT IMPEDANCE: 50, 200, 500 ohms, or high impedance

DIRECTIONAL CHARACTERISTICS: Close talking only

DIAPHRAGM: High quality corrosive resistant aluminum

MAGNETIC CIRCUIT: High energy magnetic circuit with moving voice coil. Both sides of diaphragm exposed to balance out random sound

CASE: Smooth, die cast alloy.

FINISH: Gray gunmetal enamel.

MOUNTING: Hand held. Hole provided at top of case for hanging on hook.

CABLE: 7 foot attached, single conductor, shielded.

DIMENSIONS: 7" long x 2 3/8" wide x 1 1/2" deep.

WEIGHT: Approximately 24 ounces.

OPTIONAL: "Push-to-talk" thumb switch for on-off or relay operation.

Also available as Model 15D semi-directional dynamic without noise canceling feature. Level: 56 db below 1 volt/dyne/sq. cm. Response: 40 to 7500 c. p. s.

*Visit the
Turner Exhibit at the
Parts Show Booth 49—
Stevens Hotel,
Chicago. May 13, 14, 15*

THE TURNER COMPANY

906 17th Street N. E., Cedar Rapids, Iowa

TURN TO TURNER FOR SOUND PERFORMANCE

Microphones licensed under U. S. patents of the American Telephone and Telegraph Company, and Western Electric Company, Incorporated. Crystals licensed under patents of the Brush Development Company



FIRST 50-KW. HIGH-BAND STATION

The first 50-kw. high-band FM transmitter went on the air April 23rd, at the Eitel-McCullough plant, San Bruno, Calif. It is operating into a turnstile antenna, giving effective radiated power of 200 kw.

Designed and built by Eitel-McCullough engineers, the transmitter is composed of the following units:

1. REL dual-channel modulator
2. 4 Eimac 4X500A tetrodes
3. 2 Eimac 3X2500A3's in a grounded-grid stage.
4. Push-pull Eimac multi-unit triodes in a push-pull grounded-grid stage.

This transmitter, owned by Radio Diablo, Inc., is operating on 97.7 mc.

6-STATION FM ORDER

The International Ladies Garment Workers' Union has contracted with RCA for six complete FM broadcast transmitters to be erected at Chattanooga, St. Louis, Los Angeles, New York, Boston, and Philadelphia. Five will be of 10-kw. rating, and one of 1-kw.

Construction has already started at Chattanooga, and the station is scheduled to go on the air by Labor Day. In St. Louis, land has been purchased, and construction will start in June. Four CP's have been issued already, and applications are pending for Boston and Philadelphia. Frederick Umhey, executive secretary of ILGWU, 1710 Broadway, New York, heads up this project, with Morris Novik as radio consultant. Paul A. de Mars, of Raymond M. Wilmotte, Inc., will handle the design and construction of the stations.

ENGINEERING SALES

(CONTINUED FROM PAGE 8)

pointed eastern representatives for National Hollywood discs and needles.

Olympic: Distribution of Olympic radios in New York City and Westchester will be handled by the newly-organized Olympic Appliances, Inc., with headquarters in

Long Island City. Jay Gardiner will head this factory branch.

Belden: H. W. Clough, vice president of Belden Manufacturing Company and long active in the management of the Chicago Parts Show, has completed 25 years at Belden.

Philadelphia: Earle C. Thompson, formerly advertising manager for International Resistance Company, has joined the John Falkner Arndt advertising agency as an account manager.

NEW FM ALLOCATIONS

(CONTINUED FROM PAGE 48)

scale as for Fig. 1. The values indicated by Fig. 2 are based upon available data, and are subject to change as additional information concerning tropospheric wave propagation is obtained.²

In determining the points at which the interference ratio is equal to the values shown in Table II, the field intensities for the two interfering signals under consideration should be computed for a considerable number of points along the line between the two stations. Using this data, field intensity versus distance curves should be plotted (e.g., cross-curves on graph paper) in order to determine the points on this path where the interference ratios exist. The points established by this method, together with the points along the contours where the same ratios are determined, are considered to be generally sufficient to predict the area of interference. Additional points may be required in the case of irregular terrain or the use of directional antenna systems.

The area of interference, if any, shall be shown in connection with the map of predicted coverage required by the application form, together with the basic data employed in computing such interference. The map shall show the interference within the 50 $\mu\text{v}/\text{m}$ contour.

² Fig. 2 will be available at some future date when sufficient measurements of tropospheric signals are available. Until that time, interference should be predicted on the basis of the ground wave chart (Fig. 1).

WHAT'S NEW THIS MONTH

(CONTINUED FROM PAGE 4)

that were manufactured from V-J Day, in the summer of 1945, to and through the year 1946. Such an expansion, in the face of the many difficulties that have beset FM, is an outstanding industrial achievement. If, as many of us in the industry hope, the figure is exceeded, we will have performed an industrial miracle that has few parallels in peace time manufacturing.

FM Production Problems ★ I realize that all of you are disturbed because FM production has not come up to your expectations, and that there have been many stories about manufacturers deliberately holding back FM production. Hence, I am going to go into some detail about the problems FM posed for radio manufacturers. Since I am in no position to speak for the other companies in the field, I shall have to draw largely upon our experience at Zenith.

When Japan surrendered, and production of civilian radio was authorized, we, like the rest of the industry, were optimistic about quick conversion. Then we ran into parts shortages, tooling delays, and a million and one unexpected problems, not the least of which was the impossibility of getting the kind of components necessary to build good FM sets. But by January, 1946, manufacture of small AM units was rolling merrily along.

Getting production started on FM proved to be much more difficult. We began tooling our entire line of radio sets — AM, FM, and auto radio — as soon as we possibly could, and turned out our first few FM sets in December, 1945. We went ahead as rapidly as possible, but it was months before we were rolling, and on June 1 last year our entire FM output was little more than 7,000 sets, although our total production by that time was several hundred thousand units. When you consider that FM was the backbone of our line of household radios and that, except

(CONTINUED ON PAGE 54)

FM BROADCASTERS: Long Island City 1, New York

When you've seen it
You'll mean it—
"Make mine QUADRILINE"

Note: See REL's announcement of a new 10-kw. FM transmitter in the June issue of this magazine

REL

Did You Receive Your Copy?

The B-A 1947 Catalog
84 Big Pages

Everything in Radio, Electronic supplies and Apparatus . . . for Trade — Industry — Communication — Public Utility — Experimental and Hobby Applications.

BURSTEIN APPLEBEE COMPANY
1012-14 McGee, Kansas City 6, Mo.
Please Mail My FREE Copy of your 1947 Catalog No. 471.

Name

Address

City..... Zone State

BA

Power Resistors on Short Delivery Cycle

Whatever your needs in power resistors there's an IRC resistor to do the job . . . readily available for immediate delivery. Four types of power wire wound resistors . . . each particularly suited to certain circuit or design applications . . . all unexcelled in essential electrical and mechanical characteristics . . . provide proven solutions to voltage dropping problems where power dissipation is necessary. Write for complete information regarding specifications, characteristics and delivery, stating products in which you are interested. International Resistance Company, 401 N. Broad Street, Philadelphia 8, Pennsylvania.
In Canada: International Resistance Company, Ltd., Toronto, Licensee.

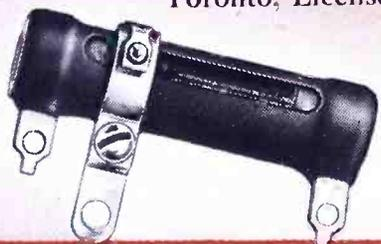
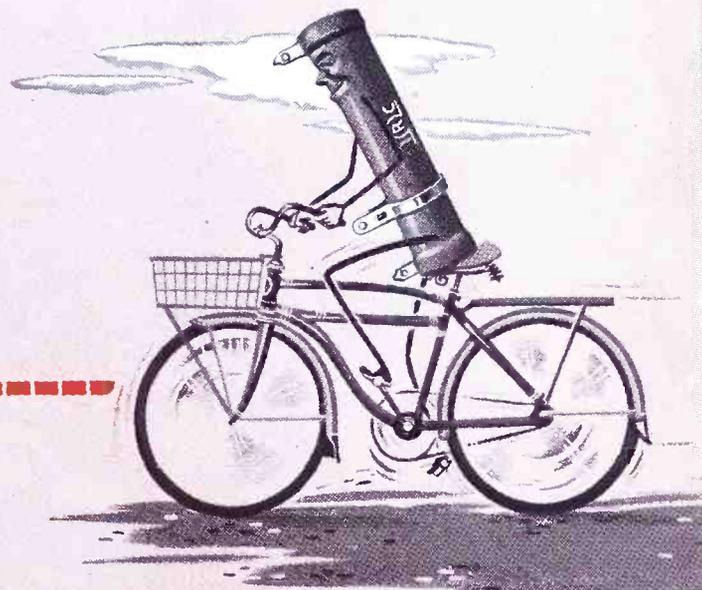

PWW Resistors

For exacting heavy-duty applications. Tubular power wire wounds of extreme mechanical strength. Available in two coatings for high temperature or high humidity conditions. Fixed, adjustable and non-inductive types in full range of sizes, ohmic values and terminals.



FRW Resistors

For voltage dropping in limited space applications. Flat power wire wounds of lightweight construction. Designed for vertical or horizontal mounting singly or in stacks. Mounting brackets serve as conductors of internal heat. Fixed adjustable and non-inductive types in full range of sizes and ohmic values.

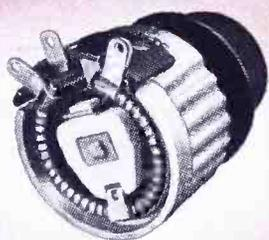

PR Rheostats

All metal construction permits operation at full load with as little as 25% of winding in use, with only slight increase in temperature rise. Available in 25 and 50 watt ratings. Type PR-25: diameter 1²³/₃₂" , depth behind panel 3¹/₃₂" , standard resistance values 1 to 5,000 ohms. Type PR-50: diameter 2²³/₃₂" , depth behind panel 1³/₈" , standard resistance values 0.5 to 10,000 ohms (higher values on special orders).

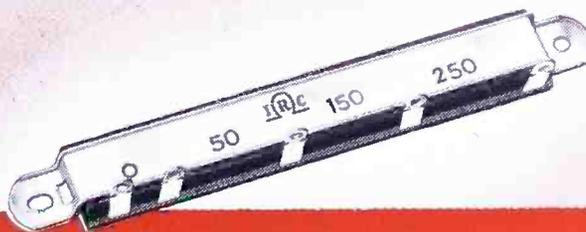

MW Resistors

For applications where low temperature rise, space and weight are vital factors. Encased in special phenolic compound for complete protection. Unique design of mounting bracket aids rapid heat dissipation. Multi-section feature permits exceptional flexibility for voltage dividing applications.

$$I = \frac{E}{IRC}$$

INTERNATIONAL RESISTANCE COMPANY



Power Resistors • Precisions • Insulated Composition Resistors • Low Wattage Wire Wounds • Rheostats • Controls • Voltmeter Multipliers • Voltage Dividers • HF and High Voltage Resistors



War Surplus electronic tubes, devices and equipment declared surplus by the armed forces are available for purchase through "Approved Distributors". The War Assets Administration put this plan in operation to expedite the disposal of needed materials.

If you are a manufacturer, jobber or dealer, contact one of the approved distributors listed here. They will know what and how much of this property is available for immediate delivery. This is your opportunity to obtain needed equipment at a considerably reduced cost.

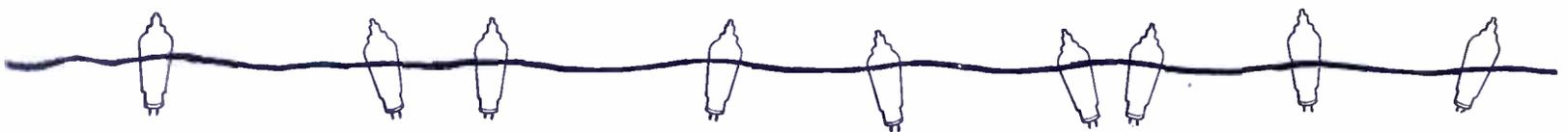

fast action

**WAA APPROVED DISTRIBUTORS OF
GOVERNMENT-OWNED SURPLUS
ELECTRONIC EQUIPMENT**
(wholesale only)

American Condenser Co.
4410 No. Ravenswood Avenue
Chicago 40, Illinois

Automatic Radio Mfg. Co., Inc.
122 Brookline Avenue
Boston 15, Massachusetts

Belmont Radio Corporation
3633 So. Racine Avenue
Chicago 9, Illinois

Carr Industries Inc.
40-22 Lawrence Street
Flushing, L. I., N. Y.

Communication Measurements Laboratory
120 Greenwich Street
New York 6, New York

Cole Instrument Co.
1320 So. Grand Avenue
Los Angeles 15, California

Tobe Deutschmann Corporation
863 Washington Street
Canton, Massachusetts

Electronic Corporation of America
353 West 48th Street
New York 19, N. Y.

Electro-Voice, Inc.
Carroll & Cecil Streets
Buchanan, Michigan

Emerson Radio & Phonograph Corporation
76 Ninth Avenue
New York 11, N. Y.

Essex Wire Corporation
1601 Wall Street
Ft. Wayne 6, Indiana

General Electric Company
Building 267, 1 River Road
Schenectady 5, New York

General Electronics Inc.
1819 Broadway
New York 23, N. Y.

Hammarlund Mfg. Company, Inc.
460 West 34th Street
New York 1, New York

Hoffman Radio Corporation
3761 South Hill Street
Los Angeles 7, California

Hytron Radio & Electronics Corporation
76 Lafayette Street
Salem, Massachusetts

Johanns & Keegan Inc.
62 Pearl Street
New York 4, N. Y.

E. F. Johnson Company
206 Second Avenue, S. W.
Waseca, Minnesota

Majestic Radio & Television Corporation
125 West Ohio Street
Chicago 10, Illinois

National Union Radio Corporation
57 State Street
Newark 2, New Jersey

Navigation Instrument Co., Inc.
P. O. Box 7001, Heights Station
Houston, Texas

Newark Electric Co., Inc.
242 West 55th Street
New York 19, New York

Radio Parts Distributing Company
128 W. Olney Road
Norfolk 10, Virginia

Smith-Meeker Engineering Company
125 Barclay Street
New York 7, N. Y.

Southern Electronic Company
611 Boronne Street
New Orleans, Louisiana

Standard Arcturus Corporation
99 Sussex Avenue
Newark 4, New Jersey

Sylvania Electric Products, Inc.
Emporium, Pennsylvania

Technical Apparatus Company
165 Washington Street
Boston 8, Massachusetts

Tung-Sol Lamp Works, Inc.
95 Eighth Avenue
Newark 4, New Jersey

W & H Aviation Corporation
Municipal Airport
Rochester 3, New York

ELECTRONICS DIVISION

WAR ASSETS ADMINISTRATION



Offices located at: Atlanta • Birmingham • Boston • Charlotte • Chicago • Cincinnati • Cleveland
Denver • Detroit • Grand Prairie, Tex. • Helena • Houston • Jacksonville • Kansas City, Mo.
Los Angeles • Louisville • Minneapolis • Nashville • New Orleans • New York • Omaha • Philadelphia
Portland, Ore. • Richmond • St. Louis • Salt Lake City • San Antonio • San Francisco • Seattle • Spokane • Tulsa

1062

WHAT'S NEW THIS MONTH

(CONTINUED FROM PAGE 50)

for portables and inexpensive combinations, we included FM in every Zenith that retailed for more than \$50, you can understand how anxious we were for large FM production. Nevertheless, it was mid-summer, six months after our first FM line started moving, before we had half-way respectable volume, and even then our output was far from satisfactory.

FM Production Figures ★ It is evident that other producers were having similar difficulties getting started, because as late as last October the industry output of FM was only 22,000 units, and many manufacturers were still months away from FM production. The October figure was nearly doubled in December, and passed the 50,000 mark in January. February showed an increase to 54,000, and March figures, just in, show a production of more than 67,000 sets — a substantial increase over anything to date. The percentage of sets produced with FM increased from 1.4% for the year 1946 to 3% for January 1947, and 5% for March. Within the next few weeks, as new models get into production and manufacturers gain further experience, output will spurt sharply to reach the 2½ million sets estimated by RMA members for 1947.

Compared to the 15 to 18 million sets of all types that the industry expects to produce in 1947, this estimate of 2½ million FM receivers seems very small. Actually, however, it represents close to 50% of the industry's total output, if that output is measured in terms of man hours and material instead of finished sets. A quick examination of 1946 figures will make this point clear.

FM Dollar Volume ★ In the entire year of 1946, manufacturers reporting to RMA produced about 181,000 FM sets, out of a year's total of more than 13 million receivers of all types. Sorry as these figures may seem from your point of view, they are not, actually, quite that bad. Of the 13 million receivers produced, more than

9 million were table models, most of them inexpensive, and many of which were flowing into consumers' hands long before there was any substantial production of larger sets. Battery operated and auto radios accounted for nearly 3 million more. Of the 924,000 consoles and console combinations manufactured, 165,000 — about 17% — contained FM. This year the ratio in consoles will probably be reversed, for manufacturers have learned quickly that expensive sets without FM simply will not sell. Since one console combination represents, in material and labor, from 10 to 20 table model AM sets, the actual FM output is by these standards much larger than figures based on sets produced would indicate. At Zenith, for example, FM represented only a small percentage of the total number of household radio sets we produced in 1946, but in terms of material and labor the sets containing FM accounted for one-third of our output. Lumped in the remainder of our production were portables, farm sets, AM combinations, and our inexpensive straight AM household receivers.

FM Production Experience ★ In the present state of the art, FM-AM sets are inherently much more complicated, costly, and difficult to manufacture than are AM. Again I will refer to our own experience. Before we had been in production more than a month or so, our AM chassis began pouring from the production lines like water from a hose. Rejections were low, complaints from the field even lower, and before long we were able to manufacture them on an uninterrupted schedule in the Wincharger Corporation factory, which had no previous radio assembly experience.

FM was a different matter. These sets have more parts, more complicated assembly operations, and minimum tolerances much finer than required for AM.

The first FM set we put into production was our \$59 table model. Before it began, we thought we knew our costs pretty well, but I can assure you that we were soon wrapping gold dollars with every set shipped. On our first run, some 90% were

rejects. We added more people, put inspectors and repairmen at intervals along the assembly line, but results were still somewhat worse than disappointing. It took bitter struggle over a period of many weeks to get 150 sets per day past inspection, and we were building 3 sets for every 2 we shipped. Production errors per set averaged nearly 6. But we kept at it, changed here, changed there, learned things about assembly and inspection that 25 years' experience with AM radio had not taught us. Today the same line, with fewer people and with no extra inspectors and repairmen, has no trouble knocking out 500 chassis a day, of much higher quality than the early models. The only major obstacle now is a still continuing series of interruptions caused by parts shortages. After more than a year, we are doing the sort of job we thought we could do from the very first. Nevertheless, each of these sets today represents more than twice the material and labor of a simple AM table model.

Breakdown of FM Models ★ Of the 2½ million FM sets estimated by the industry for 1947, 1½ million are console combinations, and 810 thousand are table models to retail for more than \$50. There are 103,000 straight FM sets without AM; 65,500 FM consoles without phonograph, and only 43,000 table sets to sell below \$50. From these figures, it is conservative to estimate that the average retail price of 1947 FM receivers will approach \$200, which is too high for the mass market. In 1941, for example, with prices at their prewar high, the industry produced some 13 million sets with an average retail price of less than \$35. The answer is that a very large percentage were table models, and that the several hundred thousand costly FM sets manufactured prewar represented a substantial portion of all high priced sets built.

A glance at the probable breakdown of total production in 1947 shows a similar trend. While estimates are not available from the industry, reports for the first 3 months show a trend similar to 1946. Of

(CONTINUED ON PAGE 56)

HOT TIP ON FM:
You'll make a
Feline Beeline
to **QUADRILINE**

P.S. The cat's out of the bag next month. See REL's 10-kw. FM transmitter announcement in the June issue.

Long Island City 1, New York

REL

Torsional MAGNETOSTRICTION

Pickup

- ★ Response—
50-10,000 c., ± 3 db.
With preamplifier.
- ★ Output—5 millivolts.
- ★ Low mechanical impedance.
- ★ Immune to severe shock.
- ★ Impervious to high humidity, temperature.
- ★ Osmium-tipped stylus.
- ★ Impedance—400 ohms.
- ★ Needle pressure—
12-20 grams.

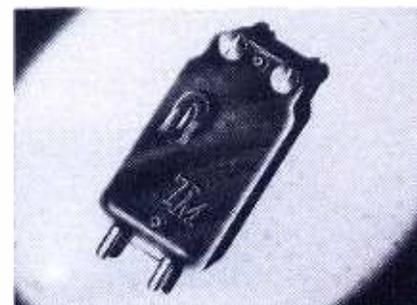

\$10 SEND CHECK
OR MONEY ORDER

MAGNETOSTRICTION DEVICES

739 Boylston St.

SALES COMPANY

Boston 16, Mass.

Amphenol

ALL-WAVE ANTENNA

GETS ALL THREE!

Purchasers of modern radios deserve good reception on all three bands—standard broadcast, short wave and frequency modulation. Until Amphenol engineers perfected this new all-wave unit, the only way to achieve this was to install three separate antennas, a costly and unsightly solution.

The FM section of this new 3-way antenna is a horizontally polarized dipole. It operates most efficiently between 88 and 108 mc.

A 65-foot length of Amphenol Polyethylene covered copper wire serves as the standard broadcast and short wave antenna. The polyethylene covering minimizes precipitation static and assures long life.

A specially designed series M derived low-pass filter automatically switches the energy from the proper antenna to receiver input.

Installation is simple. The mounting is a 1-inch steel mast 5-feet in length. All hardware is included. A guy clamp bolted to the mast provides for tripod guying.

Vinyl-jacketed Amphenol 52 ohm coaxial transmission line serves as a low-loss lead in and eliminates interference from transmission line pickup. Noisy areas are not a problem with this antenna.

In a comparative test with the best available standard double doublet (with matching transformer) the Amphenol All-Wave Antenna proved far superior in gain—as well as being interference free.

Write for complete technical data, or see your jobber for full information.

AMERICAN PHENOLIC CORPORATION
CHICAGO 50, ILLINOIS

COAXIAL CABLES AND CONNECTORS • INDUSTRIAL CONNECTORS, FITTINGS AND CONDUIT • ANTENNAS • RF COMPONENTS • PLASTICS FOR ELECTRONICS

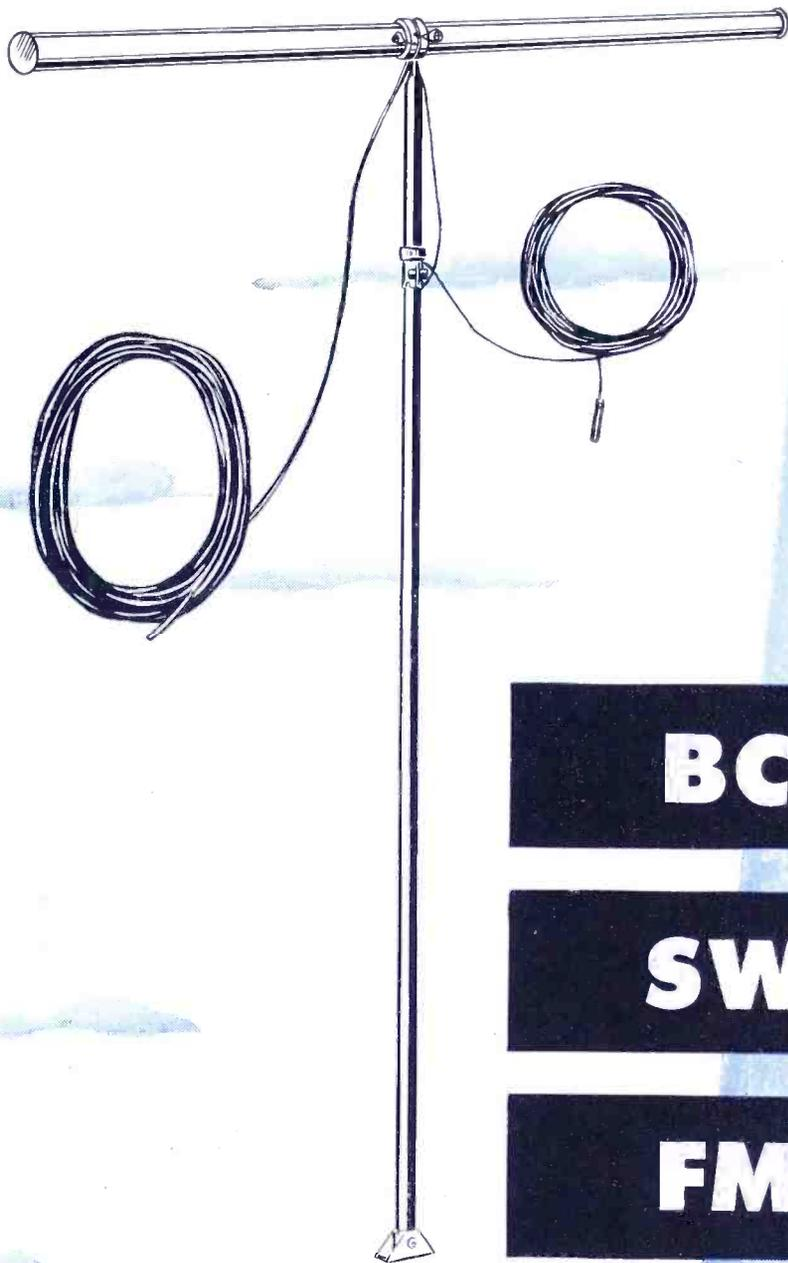

BC

SW

FM

AMPHENOL ALL-WAVE ANTENNA UNIT INCLUDES:

- ★ FM dipole with molded phenolic weatherproof filter housing
- ★ Steel mast 5-feet long with guy clamp and adjustable insulator
- ★ 50-foot Amphenol RG-5/U 52 ohm coaxial cable
- ★ Antenna wire polyethylene covered
- ★ Built-in M derived network

AMPHENOL

First and Foremost in FM!

Join FMA Now!

First with FM in West Virginia and the Southeast.

First in Fine Music (both popular and classical).

First in local programming and exclusive special events broadcasts.

First in the promotion of FM, radio's Finest Medium.

First to offer virtually perfect service to nearly 1,000,000 people in the Smokeless Coal Empire of Southern West Virginia, Virginia and Kentucky eight hours daily on 101.1 mc.

OUR FIRST RATE-CARD WILL SOON BE AVAILABLE!

3,000 WATTS

W C F C

BECKLEY, W. VA.

WHAT'S NEW THIS MONTH

(CONTINUED FROM PAGE 54)

the 4 million sets produced, nearly 60% were table models, of which only 21,000 contained FM, and more than one million were auto radios, portables, or battery operated. Of the 431,000 console combinations reported, 144,000 or 33% contained FM. That percentage is going to increase very rapidly.

The mass ownership of radio sets pre-war did not come from the purchases of \$300, \$200, or even of \$50 sets; it came from the inexpensive table models corresponding to those which retail today for from \$30 down. As yet, there is nobody in

the radio industry who knows how to build an FM set to sell for anything near that figure. To the best of my knowledge, no other manufacturer has yet begun to market any FM-AM set priced much below \$100. We don't know how to build an acceptable FM portable, or an acceptable FM auto set. In our laboratories, greatly expanded from prewar though they are, there is room for just so much development work. We are doing our best to get FM ready for portables, farm use, and auto radio, but nobody can predict when we will have those problems solved.

Advantages of High Unit Prices ★ There seems to be no question but what, for sometime

to come, the FM market will be pretty well confined to the quality field. From your point of view, this has many favorable points. First, it gives the broadcasters a sales story for sponsors that is unique in radio. It is the same sales story that through the years has been tremendously successful for a number of high quality magazines of limited circulation. You can't laugh off an audience of listeners who have paid, on the average, 5 or 6 times as much for their radio sets as have the run of the mill set owners, even though the audience is numerically small. Moreover, purchasers who have paid a lot of money to get FM will be listening to FM, while AM listenership will be divided among many stations.

Another advantage in the high average quality of FM sets being produced today is the fact that these sets will give a much more convincing demonstration of FM's superior performance than would cheap table models. This performance will set a precedent that will later make it difficult for anybody to palm off FM sets which have inferior performance. And, even though console sets in general have better tone quality than even good table models, don't make the mistake of underestimating the value to you of the FM table models now being produced. They are just as free from the inherent distortion characteristic of all AM sets as are the fifteen hundred dollar models. They have the same sensitivity and precision tuning as do the larger sets. People who hear our little table job without having a chance to compare it directly with a console set rave about the tone quality of its FM bands. As a matter of fact, I am personally rather fussy about tone quality, and I keep a table model FM set beside my bed so I can enjoy a few minutes of good music before dropping off to sleep. This is something I did not do in the days before FM.

Discussion of RMA Figures ★ The RMA estimate of 2½ million FM sets for 1947 is, in my opinion, very realistic. It was compiled from questionnaires sent to 105 members. Replies were received from 72. While I have no way of telling how our competitors arrived at their figures, I do know how we at Zenith reached our estimate. We surveyed available production space and personnel, made a thorough investigation of the cabinet and parts situation, and then figured production at our present level of efficiency, with no allowance for improvements such as have been shown in the past. My private opinion is that we shall probably exceed our own estimates, and that the same thing may be true of other companies.

¹Editor's Note: We presume that Mr. Bonfig referred to table models that have been designed with adequate FM circuits, such as the Zenith models. We have encountered some makes of table models which lack both sensitivity and the ability to limit static interference.

(CONTINUED ON PAGE 58)

ZENITH is building fm enthusiasm for You!

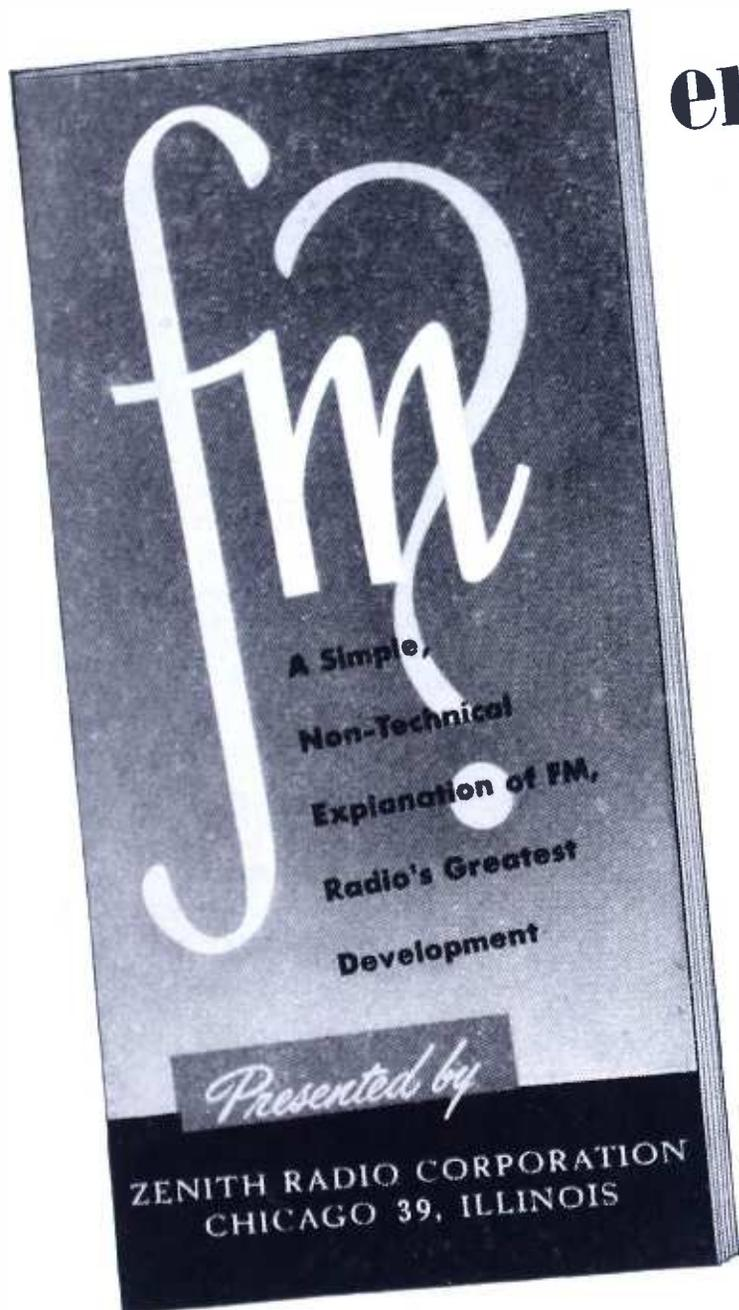

**Zenith's 22,000 Dealers
Throughout the Country
Are Now Distributing
This New FM Booklet
By the Thousands . . .**

*Zenith Dealers Know
About FM . . . Recognize
The Importance Of
This New Kind Of
Radio Broadcasting
. . . They Sell FM!*

**YES, ZENITH IS BACKING YOU UP
WITH AUDIENCE BUILDING PROMOTION**

We are sold on FM radio, and we are supporting our mounting production of FM receivers with a continuous educational campaign. We are helping you tell the story of the advantages of this kind of broadcasting to every radio dealer and prospective set buyer. In addition, one of these new, informative, non-technical folders is included with every Zenith FM receiver shipped from our factory. In this way, each purchaser of a Zenith FM radio will learn about the principles and features of FM, will use it and enjoy it himself, and, we feel sure, will be so enthusiastic about FM that he will *talk* about it and *demonstrate* it to his friends.

FM Station Operators: *If you have not already done so, we suggest that you contact the Zenith distributor and dealers in your vicinity. You will find these men willing and anxious to work with you, stimulating interest in FM radio.*



ZENITH RADIO CORPORATION

CHICAGO 39, ILLINOIS

May 1947 — formerly FM, and FM RADIO-ELECTRONICS

WGHF

THE FINCH FM-FACSIMILE STATION

Presenting more and more live-talent shows for listeners within 70 miles of New York City. Now operating on 2 kw., soon on full power of 7.2 kw. Hours of operation: 3:00 to 9:00 p.m.

FREQUENCY 99.7 MC.

Studios and Transmitter: 10 E. 40th St., New York City

Telephone Lexington 2-4927

WELD

Ohio's First FM Station, COLUMBUS

Established in 1940, WELD is the symbol of FM in Central Ohio.

Now on the air with 35,000 watts, WELD is the most powerful station in the nation on the higher FM band. When equipment is available, this power will be increased to 60,000 watts.

WELD offers "radio at its best" to 1,188,967 Central Ohio residents.

The Pioneer Continues to Lead!



35,000 WATTS, NOW!
60,000 GRANTED!

WHAT'S NEW THIS MONTH

(CONTINUED FROM PAGE 56)

Furthermore, the radio industry has always been a paradise for opportunists and, as the FM demand increases, I am sure that those companies which are now still lukewarm will attempt to revise their schedules upward. The situation is somewhat comparable to the days when we first manufactured superheterodynes. They were production nightmares, and some manufacturers ducked them. Then we learned more about how to build them. Somebody would make an improvement here; somebody else would find a shortcut there. Performance was so outstanding that public demand increased. As knowledge of improved methods spread through the industry, costs came down and productive capacity increased proportionately. I believe that something similar is going to happen to FM.

However, I cannot forget the problems that we, and the other pioneer companies with prewar FM experience, had in getting started. Of the 72 manufacturers who reported on the FM plans to RMA, only a few have actually manufactured FM sets. As knowledge of how to build spreads through the industry, newcomers should be able to hit their stride without such severe birth pangs as we have experienced. On the other hand, I believe that some may have been overly optimistic in their estimates, because nobody can anticipate accurately the problems of FM production until he actually gets started.

One other factor to consider in appraising the situation is the fact that in the first three months of this year the industry has produced only 172,000 FM sets. True enough, March showed an increase of 26% over February, but it would take a similar percentage increase every month to make 1947 total production pass the 2½ million mark, which would result in a December production of better than 400,000 sets, more than the entire FM production since V-J Day. Gentlemen, I do not believe the industry can get cranked up to that rate in the months ahead. Therefore, it is my considered opinion that the total for 1947 will be closer to 2 million than to 2½ million. However, production should continue at an excellent rate in 1948, to give us for that year a total of about 5 million FM sets, perhaps more. If I am in error I hope that it is on the low side.

FM Converters ★ We are still receiving inquiries about converters to make prewar FM receivers capable of receiving stations on the 100-mc. band, and I know that all of you would like to add the 400,000 prewar sets to your audience. You will recall that when FCC was holding hearings on its proposal to move FM upstairs from the 50-mc. band, there was much ado about the low-cost converters that would be produced. Such production has not

(CONTINUED ON PAGE 60)

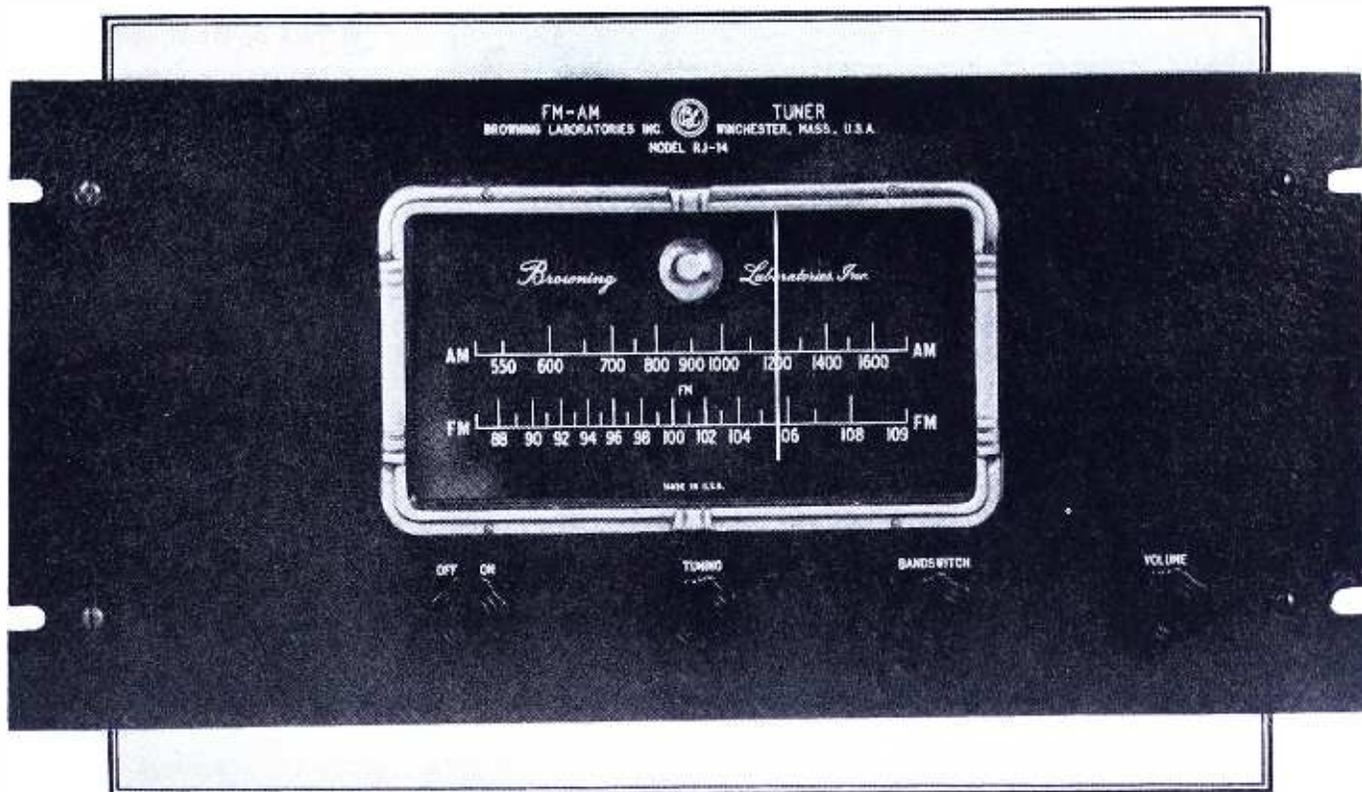

High-Fidelity Performance at Down-to-Earth Cost

BROWNING FM-AM TUNER

THE rack-panel BROWNING FM-AM Tuner illustrated above is an outstanding example of superb performance achieved by common-sense engineering design. Consider these advantages:

CIRCUITS: Genuine Armstrong FM circuits provide dual limiting for static elimination; capture-effect protection against co-channel interference; high sensitivity for distant reception.

ADAPTABILITY: The rack-panel BROWNING Tuner can be fitted into any type of case or cabinet, or standard rack. This facilitates its use in every kind of installation.

APPLICATION: Any amplifier and speaker system can be operated by the BROWNING Tuner. It is suitable for private homes, public buildings, or hotels. It offers progressive dealers and service men unlimited opportunities for new business.

PRICE: By eliminating the superfluous construction which makes cabinet sets so high in price, the BROWNING Tuner provides the utmost in performance at the very minimum cost. You simply add what you require for each specific job. With a little careful thinking, you'll find a dozen different ways to plan BROWNING Tuner installations.

Another Product of the

BROWNING LABORATORIES, INC.

WINCHESTER • MASSACHUSETTS

Canadian Representative: Measurement Engineering, 61 Duke St., Toronto

May 1947 — formerly *FM*, and *FM RADIO-ELECTRONICS*

TUNING RANGE: 88-108 mc. on FM; 535 to 1650 kc. on AM, the ranges established by the FCC.

SENSITIVITY: On FM, complete noise-limiting action is obtained at 15 microvolts. AM circuits respond to signals of 1 microvolt.

FM CIRCUITS: Separate high-frequency FM section employs tuned antenna and RF stages feeding a mixer with a separate oscillator tube. Local oscillator operates above signal frequency to minimize image interference. Output of the mixer feeds 2-stage IF amplifier, followed by dual limiter, where static and other amplitude disturbances are removed. Limiter output is applied to discriminator, producing demodulated audio signals for feeding into a separated power amplifier and speaker system.

AM CIRCUITS: An independent AM section provides a tuned antenna and RF stage to eliminate image response. This is followed by a converter stage, a high-gain IF stage, and a diode detector which furnishes AVC voltage and AF output to the amplifier. FM and AM output levels are approximately the same.

PHONOGRAPH: Phonograph pick-up terminals are at the rear of the chassis. A third position on the band switch cuts in the pick-up, and volume is regulated by the FM-AM volume control.

TUBES: One 6BE6, one 6C4, one 6BA6, three 6SG7's, two 6SJ7's, one 6H6, one 6SA7, one 6SF7, one 6E5.

Model RJ-14
RACK-PANEL TUNER.....\$165.60

Model RJ-12
UNMOUNTED TUNER.....\$143.90

Model PF-12
POWER SUPPLY UNIT.....\$15.78

(Prices include Federal Tax)

*A New ERA
in the Great Southwest!*

KERA

First FM station in the Southwest's Biggest Billion Dollar Market — Dallas and Fort Worth — operating nine hours daily with 14,000 watts radiated power.

94.3 Mc. **KERA-FM** Channel 232
Dallas, Texas



Buffalo's *Pioneer*
Frequency-Modulation Station

WBEN-FM

Another Radio Service of the

BUFFALO EVENING NEWS



WHAT'S NEW THIS MONTH

(CONTINUED FROM PAGE 58)

come to pass, and I do not believe that it will, because we have yet to see one that does not cause serious deterioration in quality of reception.

Straight FM Sets ★ Another question we often hear is, "When are you going to begin producing straight FM receivers without AM?" The answer to that one depends pretty much upon the broadcasters. We will welcome the time when there is a substantial market for straight FM sets, because it will be much simpler to produce sets of that type than combination FM-AM receivers. However, as manufacturers we must build to popular demand, and since we feel that it will be many years before an AM band is superfluous, we expect to be building FM-AM combinations for a long time to come. In the meantime, when enough stations are on the air with adequate power enough hours each day to provide sufficient program variety, there will unquestionably be a demand for straight FM, particularly in the low-priced field, where lies the mass market. When that day comes we will build them, and by that time we should know enough about FM to make them competitive in price with existing AM sets.

Effects of Tighter Buying ★ You may have noticed that in making my estimate of FM production I said nothing about the possible effects of a business recession. That was not an oversight, because I do not believe that the recession, if it comes, will cause any slowing up of FM. In fact, it might do just the opposite. CBS has just released results of a survey which show that fewer than half of the radios purchased for home use last year went into living rooms; the remainder were nearly all second or third sets in the home, used in the kitchen, bedroom, or dining room. In the face of FM's rising tide, a trend toward tighter buying would cause people to think again before purchasing even a second radio without FM. The result could be a noticeable slackening of willingness to purchase straight AM sets, and growing pressure for more with FM. Since, as I have pointed out, this radio business is an opportunist's paradise, competition might very well force greater attention to FM.

Distribution to Build Audiences ★ There is one more phase of this problem on which I should like to comment. Since there are physical limits on our production, and since each of you is anxious to build an FM audience as rapidly as possible, it is in the mutual interest of FM broadcasters and manufacturers to make the best possible use of all sets produced. We are attempting to do that by a program

(CONCLUDED ON PAGE 62)

Going places
(AGAIN)

hallicrafters

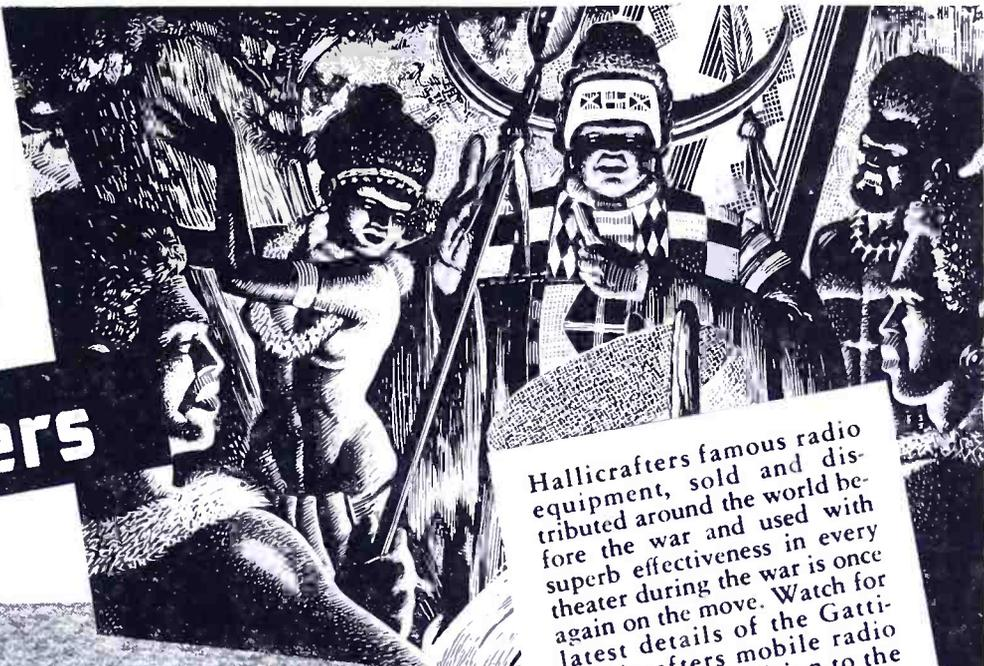

Hallicrafters famous radio equipment, sold and distributed around the world before the war and used with superb effectiveness in every theater during the war is once again on the move. Watch for latest details of the Gatti-Hallicrafters mobile radio equipped expedition to the Mountains of the Moon in deepest Africa—a new and exciting test for the ingenuity of hams and the performance of Hallicrafters equipment.

3

GREAT RECEIVERS designed and priced for hams who are going places, too



Model SX-42 Described by hams who have operated it as "the first real postwar receiver." One of the finest CW receivers yet developed. Greatest continuous frequency coverage of any communications receiver—from 540 kc to 110 Mc, in six bands. FM-AM-CW. 15 tubes. Matching speakers available. **\$275⁰⁰**



Model S-40A Function, beauty, unusual radio performance and reasonable price are all combined in this fine receiver. Overall frequency range from 540 kc to 43 Mc, in four bands. Nine tubes. Built-in dynamic speaker. Many circuit refinements never before available in medium price class. **\$89⁵⁰**



Model S-38 Overall frequency range from 540 kc to 32 Mc, in four bands. Self contained speaker. Compact and rugged, high performance at a low price. Makes an ideal standby receiver for hams. CW pitch control is adjustable from front panel. Automatic noise limiter. **\$47⁵⁰**

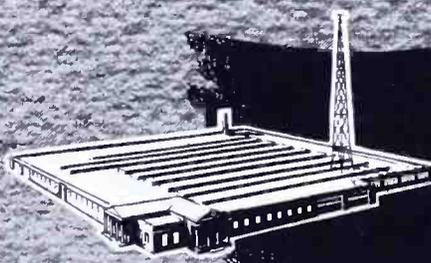

BUILDERS OF *Skyfone* AVIATION-RADIO-TELEPHONE

hallicrafters RADIO

THE HALLICRAFTERS CO., MANUFACTURERS OF RADIO AND ELECTRONIC EQUIPMENT, CHICAGO 16, U. S. A.

Sole Hallicrafters Representatives in Canada: Rogers Majestic Limited, Toronto-Montreal

WHAT'S NEW THIS MONTH

(CONTINUED FROM PAGE 60)

of working in close cooperation with all FM stations. Some months ago, we sent a promotion kit to all of our distributors suggesting that they contact all new FM broadcasters to give them benefit of our 7 years of FM broadcasting and promotion, and to work with them by spotting FM sets as advantageously as possible. So far, the results have been very favorable although, frankly, the program is still only in its initial stages. As we proceed further with it, we will be glad to supply to FMA full details of how it is working out.

I know that other manufacturers have instituted similar programs of cooperation with broadcasters, and believe that virtually all would be glad to do so. Therefore, may I be presumptuous enough to suggest that your Association make it a point to set up such a plan to enlist the cooperation of every FM receiver manufacturer, to the end result that FM will continue and accelerate its spectacular progress in public acceptance.

Hen and the Egg ★ As we stand here on the horizon of FM's tremendous future, I believe that this close liaison established between FM broadcasters and radio manufacturers is one of the healthiest signs possible. In the old days there was little cooperation between broadcasters and man-

ufacturers. Each went his not-always-merry way. Today, there is no question whatsoever about the mutual interest of broadcasters and manufacturers in the development of FM. For just about the first time in history the hen and the egg are off to an equal start. Or, if I may switch metaphors, locks and keys to fit are being developed simultaneously. As more of you get on the air, and as increased power gives wider coverage in city after city, you can count on every thinking manufacturer to channel his FM production where it will do the most good for the future of this brilliant new radio service.

Without FM, It's Obsolete ★ I can best express the advantages of FM by using the words of Bob Heinl, publisher of the *Heinl News Service*, who said, "The thing that I like best about FM is not what I hear, but what I don't hear. I appreciate most its freedom from static, freedom from cross talk, freedom from interference, and freedom from distortion. With these bad features of ordinary radio erased by FM, the service is wonderful."

In closing I say that as of today anybody who buys any radio set — other than a portable, inexpensive table model, or automobile set — that does not contain FM, is buying a radio that is already obsolete, and the American public likes nothing less than to miss that which they might have had.

5 FM, 4 TV STATIONS FOR N. Y.

Breaking the long deadlock of FCC hearings, the Commission has issued the following grants in New York City:

FM — New York *Daily News*, WMCA, American Broadcasting Company, Unity Broadcasting Corp. (ILGWU), and WPAT Paterson, N. J.

Television — New York *Daily News*, WOR, American Broadcasting Company, and WAAT, Newark, N. J.

It is expected that the grant to the *Daily News* will have a profound effect on FM broadcasting in the New York area, for the entire staff is eager to get the station on the air, and to test ideas for programs and time sales that have been under development ever since the paper's prewar application was stopped off by James Lawrence Fly's newspaper witch-hunt.

ABC is expected to hold off as long as possible, judging from lack of interest in FM expressed to its AM affiliates, whose inquiries about the network's FM plans have not even been acknowledged.

Unity Broadcasting Corporation (International Ladies Garment Workers' Union) may give the *News* some competition in being the first of the new grantees to go on the air. These two stations will do more than anything else that could have happened to bring an end to the indifference of AM stations in New York toward providing the full capabilities of FM to radio listeners.



the BIT that has the BITE!

The BIT on every VACO is scientifically designed...treated in just the right way to insure a firm "bite" and dependable service on jobs where the right kind of screw driver means the difference between first-class and second-rate production. Vaco handles are made of gleaming Amberyl plastic — shock-proof and break-proof.

There are 173 Types of VACO Screw Drivers

You will find, in the VACO line, a size and style of screw driver for all your needs. Write for catalog.

VACO 317 E. ONTARIO ST. CHICAGO 11, ILL.
CANADIAN WAREHOUSE: 560 KING STREET WEST - TORONTO 2, ONT.

FM INFORMATION HEADQUARTERS
at the
MUSIC MERCHANTS SHOW
Room 859
Palmer House, Chicago, June 2-5

FM AND TELEVISION

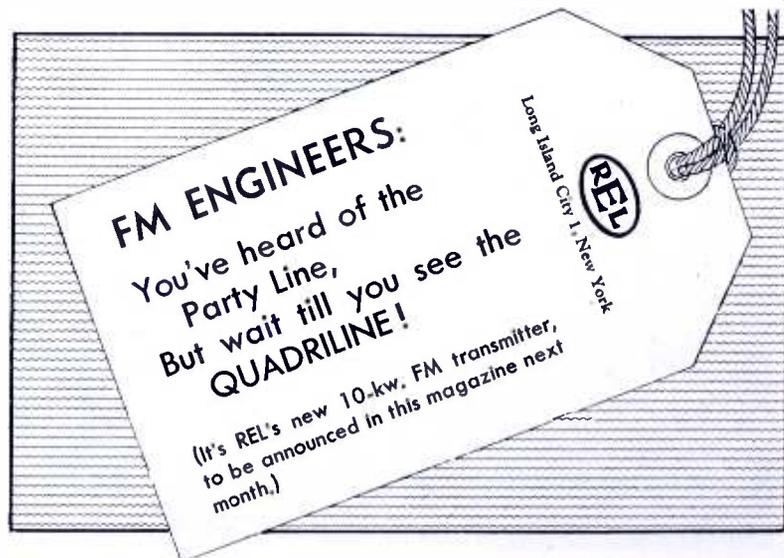

FM ENGINEERS:
You've heard of the Party Line,
But wait till you see the **QUADRILINE!**

(It's REL's new 10-kw. FM transmitter, to be announced in this magazine next month.)

Long Island City, New York
REL

ADVERTISERS INDEX

Adair, George.....	17
Aircraft Radio Corp.....	41
American Phenolic Corporation....	55
Amy, Aceves & King, Inc.....	63
Anderson, H. V., & Associates.....	16
Andrew Company.....	4, 16
Barone, S. A., Company.....	17
Bell Telephone Labs.....	10, 11, 18
Blaw-Knox Company.....	5
Boonton Radio Corp.....	8
Browning Laboratories, Inc.....	59
Burstein-Applebee Co.....	50
Clare, C. P., & Company.....	13
Collins Radio Company	
<i>Inside Back Cover</i>	
Commercial Radio Equip. Co.....	16
Eitel-McCullough, Inc.....	64
Engineering Research Assoc., Inc...	16
Federal Telephone & Radio Cor.	
<i>Inside Front Cover</i>	
Finch Telecommunications, Inc.....	45
FM Company.....	17, 62, 63
Galvin Mfg. Corp.....	<i>Back Cover</i>
Graybar Electric Co.....	10, 11, 18
Hallcrafters Co.....	61
International Resistance Corp.....	51
Jansky & Bailey.....	16
Kaar Engineering Co.....	12
Kaufman, Robert L.....	16
Kear and Kennedy.....	17
KERA-FM.....	60
Magnetostriction Devices.....	54
May, Russell P.....	16
McCachren, Winfield Scott.....	17
McIntosh, Frank H.....	16
McKey, Dixie B. & Assoc.....	16
McNary and Wrathall.....	17
National Company, Inc.....	1
Pollack, Dale.....	17
Radio Consultants, Inc.....	16
Radio Corporation of America....	14, 15
Radio Engineering Labs, Inc.	
7, 17, 50, 54, 62	
Radio Music Corp.....	3
Rauland Corporation.....	63
Ray, Garo W.....	16
Raytheon Mfg. Co.....	2
RCA Communications, Inc.....	16
Sangamo Electric Co.....	43
Sprague Electric Co.....	47
Standard Measuring & Equip. Co...	17
Sylvania Electric Products, Inc....	9
Turner Company.....	49
U. S. Recording Co.....	16
Vaco Products Co.....	62
War Assets Admin.....	52, 53
Ward Products Co.....	8
WBEN-FM.....	60
WCFC.....	56
WELD.....	58
Western Electric Co.....	10, 11, 18
WGHF.....	58
Williams, Nathan.....	17
Wilmotte, Raymond M.....	16
Wilson, Herbert L.....	16
Workshop Associates, The.....	16
Zenith Radio Corp.....	57
Zophar Mills, Inc.....	63

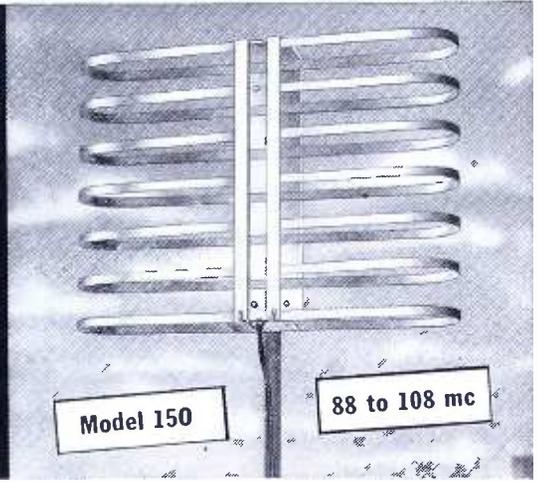
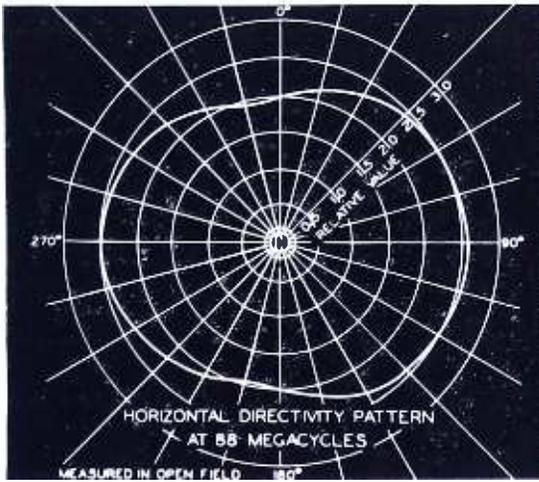

The New *Rauland* Omni-directional* FM ANTENNA!

- Non-Directional Pickup Pattern
- High Sensitivity & Signal Strength
- Reduces Man-Made Noises
- Compact, Light-Weight, Sturdy
- No Special Orientation Required
- Low Standing Wave Ratio
- All-Aluminum Construction
- Operates Indoors or Outdoors.

FIRST NON-DIRECTIONAL DESIGN!
 Graph above shows virtually circular horizontal directivity pattern at 88 mc; only slight elongation appears at 108 mc. Vertical directivity shows no response to automobile ignition and other man-made noises; gives maximum noise-reducing benefits.
 *Patent Applied For

Here is the *first* and *only* FM Receiving Antenna that picks up signals from *all* directions . . . the *only* antenna that makes possible strong reception even at the outer limits of the FM broadcast range where ordinary antennas fail. The exclusive design features of the RAULAND Model 150 FM Antenna make it the ideal antenna for optimum FM reception. Attractive, compact and sturdy (free from wind noises and with low wind resistance), the Model 150 is easy to erect outdoors; conveniently installed indoors. Matches standard 300 ohm FM input. Protected against lightning. Offers the finest FM reception at the lowest antenna cost.



Write for interesting descriptive bulletin . . .

THE RAULAND CORPORATION

4263 N. Knox Avenue, Chicago 41, Illinois

1 AERIAL

FOR A PLURALITY OF RADIO SETS

The New, Noiseless Multicoupler Antenna System including FM Reception

AMY, ACEVES & KING

Engineering Specialists in Apartment House Antenna Systems

11 W. 42nd ST., NEW YORK 18

ZOPHAR

WAXES COMPOUNDS and EMULSIONS

FOR INSULATING and WATERPROOFING of ELECTRICAL and RADIO COMPONENTS

- Also for CONTAINERS and PAPER IMPREGNATION
- FUNGUS RESISTANT WAXES
- ZOPHAR WAXES and COMPOUNDS Meet all army and navy specifications if required
- Inquiries Invited

ZOPHAR MILLS, INC.
 FOUNDED 1846
 122-26th ST., BROOKLYN, N. Y.

CAPABILITIES.....25 kw zero to 110 Mc.

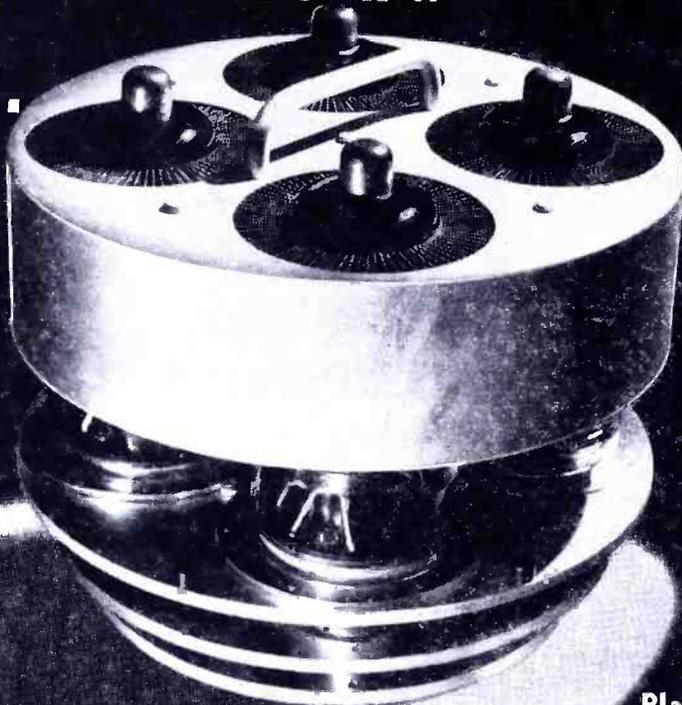

TYPE 3X12500A3

Plate voltage 5000 volts
Plate dissipation 12,500 watts
Transconductance 80,000 μ mhos

A REVOLUTIONARY NEW EIMAC TRIODE

YES... The 3X12500A3 is truly revolutionary... packaged power... that will fill not several, but all applications for a power-amplifier or oscillator from zero to 110 Mc. It will do a low frequency job better than "special low frequency" tubes. Its performance at vhf has long been the aim of vacuum tube researchers. The 3X12500A3 is smaller (over-all 11"x9") and lighter (net 32 lbs.) than any comparable tube... Yes, it is truly a revolutionary tube.

Audio

Induction heating

Broadcasting

Dielectric heating

Communication

Television

Industrial

FM Broadcasting

Research

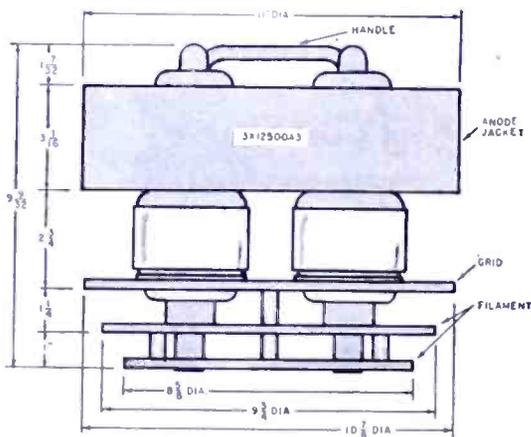

EXPORT AGENTS: FRAZAR & HANSEN, 301 CLAY ST., SAN FRANCISCO 11, CALIFORNIA

RADIO FREQUENCY POWER AMPLIFIER

Grounded-Filament Circuit

Class-C Telegraphy (Key-down conditions, per tube)

MAXIMUM RATINGS (Frequencies below 85 Mc.)

D-C PLATE VOLTAGE	-	-	-	-	5000 MAX. VOLTS
D-C PLATE CURRENT	-	-	-	-	8 MAX. AMPS.
PLATE DISSIPATION	-	-	-	-	12,500 MAX. WATTS
GRID DISSIPATION	-	-	-	-	600 MAX. WATTS

TYPICAL OPERATION (Frequencies below 50 Mc., per tube)

D-C Plate Voltage	-	-	-	3500	4000	5000	volts
D-C Grid Voltage	-	-	-	-420	-360	-400	volts
D-C Plate Current	-	-	-	7.2	6.4	8	amps
D-C Grid Current	-	-	-	2	1.7	1.9	amps
Peak R-F Grid Input Voltage	-	-	-	735	630	710	volts
Driving Power (Approx.)	-	-	-	1.3	0.95	1.35	kw
Grid Dissipation	-	-	-	480	350	590	watts
Plate Input	-	-	-	25.2	25.6	40	kw
Plate Dissipation	-	-	-	5.2	5.6	10	kw
Plate Power Output	-	-	-	20	20	30	kw

RADIO FREQUENCY POWER AMPLIFIER

Grounded-Grid Circuit

Class-C FM Telephony or Telegraphy

MAXIMUM RATINGS (Frequencies below 110 Mc.)

D-C PLATE VOLTAGE	-	-	-	-	4000 MAX. VOLTS
D-C PLATE CURRENT	-	-	-	-	8 MAX. AMPS.
PLATE DISSIPATION	-	-	-	-	12,500 MAX. WATTS
GRID DISSIPATION	-	-	-	-	600 MAX. WATTS

TYPICAL OPERATION (110 Mc., per tube)

D-C Plate Voltage	-	-	-	-	3700	4000	volts
D-C Grid Voltage	-	-	-	-	-450	-550	volts
D-C Plate Current	-	-	-	-	7.2	7.4	amps.
D-C Grid Current	-	-	-	-	0.9	1.1	amps
Driving Power (approx.)	-	-	-	-	6.4	7.6	kw
Useful Power Output	-	-	-	-	27.4	30	kw
Apparent Overall Efficiency	-	-	-	-	102	101	per cent

EITEL-McCULLOUGH, Inc.

1654 San Mateo Avenue, San Bruno, California

Follow the Leaders to

Eimac
REG. U. S. PAT. OFF.
TUBES
The Power for R-F



Jack Brickhouse, famous sports announcer

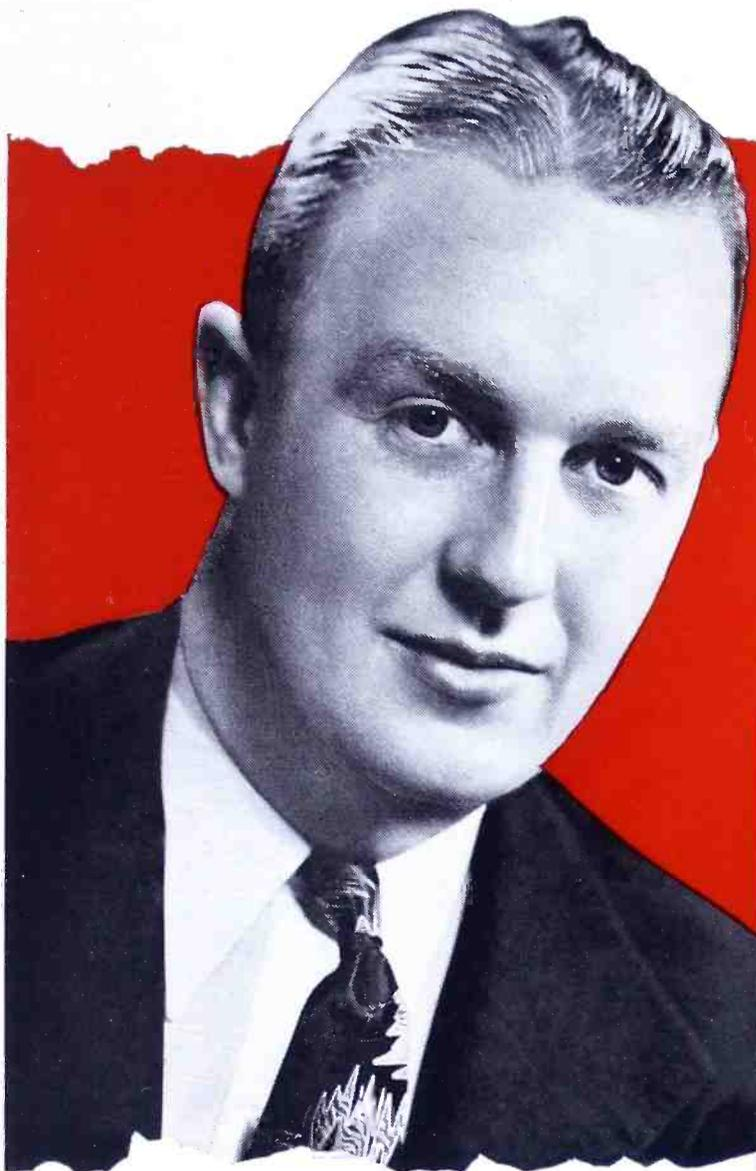

Use the Collins 12Z for all your Remote Pickups

Sports announcers, such as Jack Brickhouse, who are continually originating programs in the field, know the importance of convenience and reliability in their remote amplifier. The Collins 12Z offers these advantages:

1. Complete in One Package—Amplifier, mixers, and self-contained a-c and d-c power supplies. If the a-c power source should fail, the batteries are connected automatically into the circuit. The weight is only 28 pounds without batteries.

2. Four Microphone Channels—Four mikes can be used simultaneously, each with its own attenuator. In addition, there is a master gain control. Either 30, 50 ohms or 200/250 ohms input impedance is available.

3. Versatile Operation—Has a program monitor jack and a line monitor jack. Two line circuits are provided for program and telephone. Should the program line fail, the snap of a switch will reverse the lines. The VU meter is used in connection with a range switch to measure the output in VU, or to measure the operating voltages.

4. Suitable for Both FM and AM—The frequency response varies less than ± 1.0 db from 30-15,000 cps. Noise level and distortion are very low.

* * *

We can now give you immediate delivery. Order your 12Z today, and eliminate your remote pickup problems.

FOR BROADCAST QUALITY, IT'S . . .



COLLINS RADIO COMPANY, Cedar Rapids, Iowa

11 West 42nd Street, New York 18, N. Y.

458 South Spring Street, Los Angeles 13, California

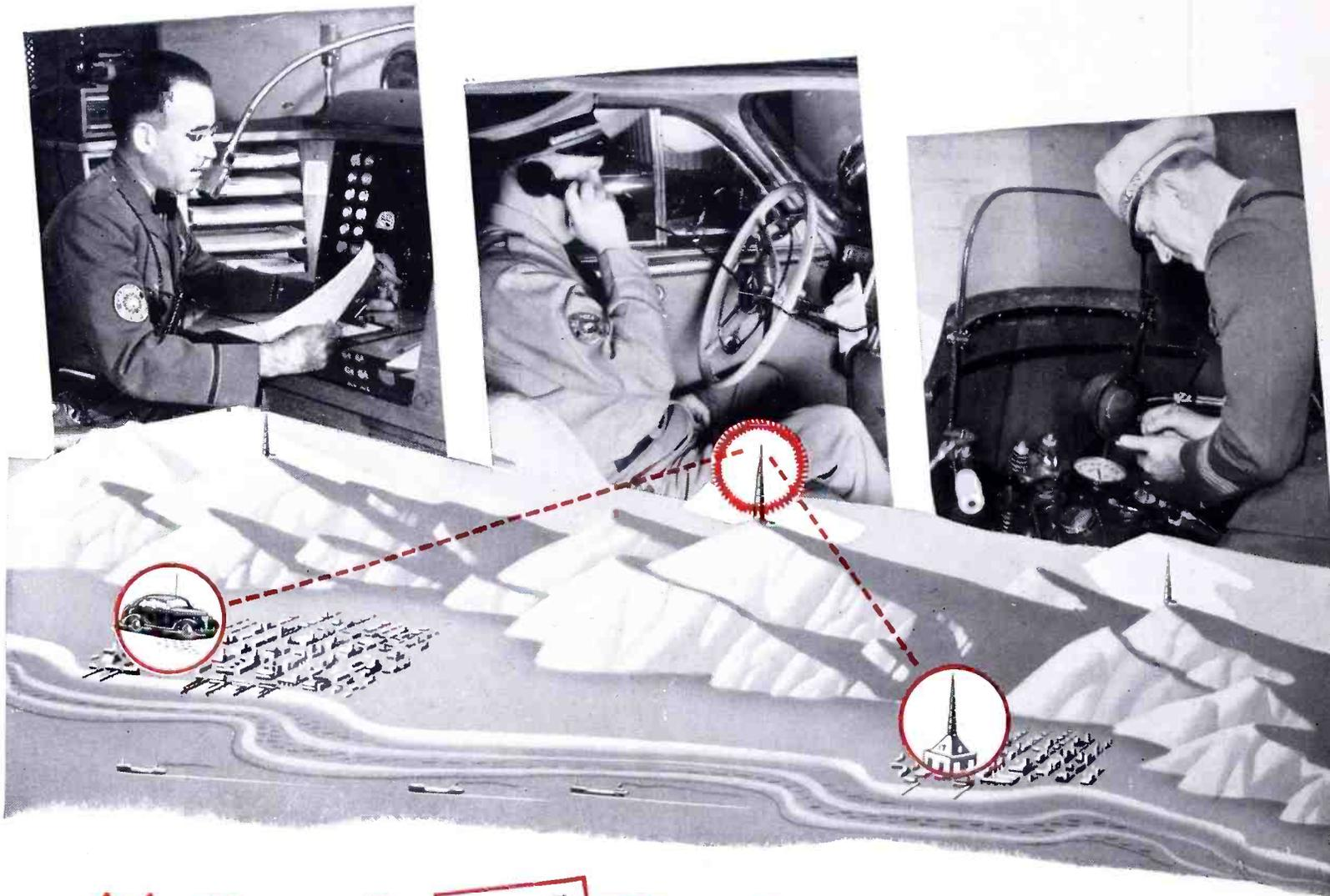

Motorola **F-M** Radio Makes MOLEHILLS out of MOUNTAINS!



When tremendous natural barriers like the lofty Sierra Nevadas presented seemingly insoluble problems in California's state-wide radiotelephone coverage . . . Motorola 2-Way F-M Radiotelephone units came through with all the answers.

Cloud-ringed giants like Mt. Whitney, Mt. Shasta, and Mt. Lassen were, as effective obstacles to transmission and reception, leveled to the ground. As a result, California's Highway Patrol radiotelephone

communications rank among the country's most efficient, with 485 two-way unit patrol cars and 377 one-way unit motorcycles patrolling 58 counties.

In 36 states and over 2,500 communities throughout the United States, Canal Zone, and Hawaiian Islands, police F-M 2- and 3-way radiotelephone installations have proved the remarkable skill and experience displayed by Motorola engineers. Your state, county, city or community can take advantage of this experience. For Full Details, Write Today.

GALVIN

MFG. CORPORATION • CHICAGO 51

COMMUNICATIONS AND ELECTRONICS DIVISION

F-M & A-M HOME RADIO • AUTO RADIO • AUTOMATIC PHONOGRAPHS • TELEVISION • F-M POLICE RADIO • RADAR • MILITARY RADIO