



FMM

JAN. 1947

AND TELEVISION

“The Commission has expressly authorized me to say to you again that it is our opinion that FM is the finest aural broadcast system obtainable in the present state of the radio art.”



ARTICLES for

BROADCASTING:

EXECUTIVES—Pgs. 4, 23, 30, 48
ENGINEERS—Pgs. 34, 39, 43, 46

MANUFACTURING:

EXECUTIVES—Pgs. 4, 23, 30
ENGINEERS—Pgs. 34, 39, 43, 50

COMMUNICATIONS:

SUPERVISORS and
ENGINEERS—Pgs. 24, 34

SALES & SERVICE:

DEALERS and
JOBBERs—Pgs. 23, 30, 34
SERVICEMEN—Pgs. 30, 34

★ ★ Edited by Milton B. Sleeper ★ ★

Chosen for Performance

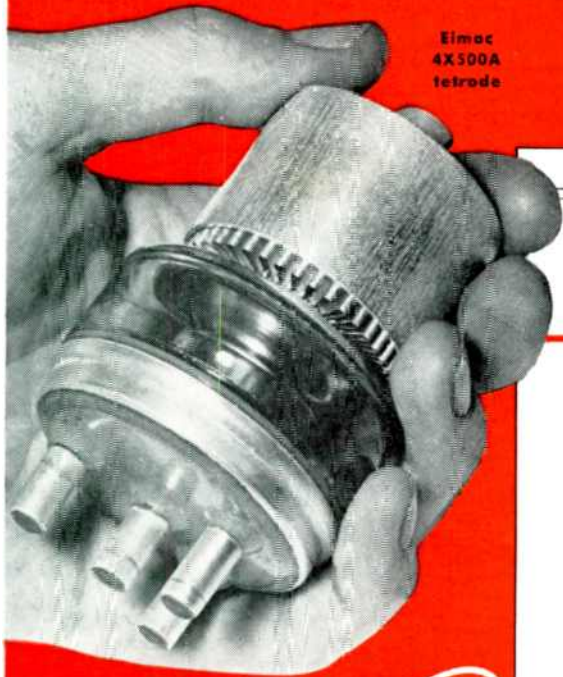

Eimac
4X500A
tetrode

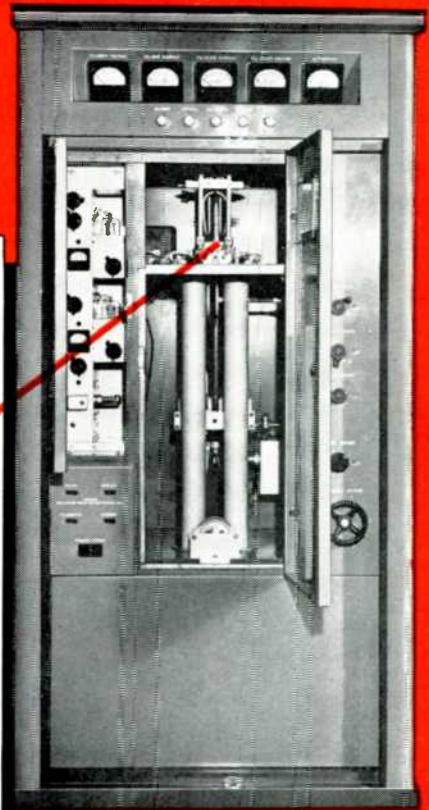
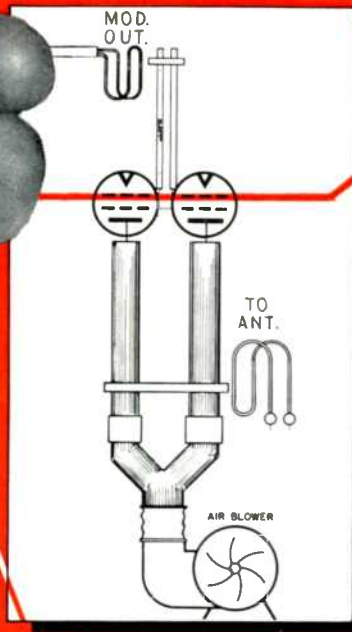

REL 1000-watt f-m transmitter

f-m

REL... the pioneer manufacturer of f-m transmitters, has been engineering gear around Eimac Tubes ever since 1939.

One of their latest designs is illustrated above at the right—the 1000-watt unit with Armstrong dual-channel direct-crystal-controlled frequency modulation. For the power amplifier, shown in the center, REL chose a pair of Eimac 4X500A tetrodes because of their remarkable power gain, stability to frequencies above 110 mc, and efficiency. Actually, 70 per cent of the input to the final amplifier is delivered to the load.

In the REL transmitter, less than 20 watts of drive produces the rated kilowatt. In fact, a pair of Eimac 4X500A's can deliver 1750 watts of useful output with only 25 watts of drive; while four tubes in push-pull parallel, taking 50 watts on the grids, put out 3500 watts.

Unwavering stability is achieved in these tubes by combination of exclusive Eimac emission-controlled grids and a concentric-ground-plane ring terminal for the screen grid. Visible in the accompanying illustration, this ring permits finger contact with chassis ground and effective isolation of input and output circuits. Self oscillation is minimized and neutralization, if necessary, is made simple.

FURTHER POINTS

GRIDS...Special treatment suppresses primary emission and controls secondary emission to add efficiency to stability. One hundred per cent useful structure, without interfering supports, and precise alignment between control grid and screen give maximum plate efficiency and low grid current.

FILAMENT...Special thoriated tungsten provides high electron emission at low temperature.

EIMAC 4X500A POWER TETRODE

Electrical Characteristics

Filament: Thoriated tungsten	
Voltage	5.0 v
Current	13.5 amp
Direct Interelectrode Capacitances (Average)	
Grid-plate	0.05 μ uf
Input	12.8 μ uf
Output	5.7 μ uf

Maximum Ratings

Plate voltage, d-c	4000 v
Plate current, d-c	350 ma.
Plate dissipation	500 w

Ask for full details on these and other Eimac tubes for f-m, a-m, television, and industrial applications in a comprehensive range of power and frequency capabilities.

EITEL-McCULLOUGH, INC.
1367L San Mateo Ave., San Bruno, Calif.
Export Agents: FRAZAR AND HANSEN
301 Clay Street, San Francisco 11, California, U.S.A.

Follow the leaders to



NATIONAL RADIO PRODUCTS 1947

THE NEW 1947 CATALOGUE

The new National Catalogue describes hundreds of parts designed for amateur use. Many items are new, some are unique. The old favorites are there, proved and improved over the years. New or old, the products in the new National Catalogue will improve your rig.

NATIONAL COMPANY, INC.
MALDEN, MASSACHUSETTS, U.S.A.



fm



Complete 1 KW or
3 KW Transmitter.



Complete 250 Watt
FM Transmitter. This
unit is also used as
the exciter for higher
powered transmitters.

but by

RAYTHEON

YES, there is a difference. FM by Raytheon is a greatly simplified, more dependable Phase Shift Modulation that is entirely new. Do not be satisfied with complicated, older circuits when Raytheon can give you this important improvement plus many more exclusive features—and at a lower price.

RAYTHEON MANUFACTURING COMPANY

Broadcast Equipment Division

7475 No. Rogers Ave., Chicago 26, Illinois

Devoted to Research and Manufacture for the Broadcasting Industry

New! . . . SIMPLIFIED PHASE SHIFT MODULATION and DIRECT CRYSTAL CONTROL

- **SIMPLICITY**—Recognizing Phase Shift Modulation as the best method of Modulating, Raytheon has engineered greater stability, and efficiency into this method by exclusive and greatly simplified circuit design.
- **RUGGED DEPENDABILITY**—Direct crystal control, independent of modulation, gives positive and automatic control of the mean carrier frequency. Simple linear type tank circuits are used for all stages operating in the FM band—cannot get out of tune or adjustment.
- **EFFICIENCY**—Every circuit is completely shielded to eliminate power losses by radiation, interaction and parasitic oscillation.
- **UNIT CONSTRUCTION**—Buy now only the power you need and add a unit for increased power later. All units are perfectly matched in size, styling and colors.
- **EASY INSTALLATION**—Unit dimensions have been held to convenient cubicle sizes for moving through standard doors, in elevators, etc.
- **LASTING ECONOMY**—Not only is the purchase price of a Raytheon transmitter less but your savings continue through lower operating costs achieved by greater operating efficiency, lower power consumption and long life quality tubes and components.
- **OPERATING SAFETY**—Complete power interlock and an automatic shut-off of power when rear doors are opened provide absolute safety for all operating personnel.

RAYTHEON

Excellence in Electronics

Astatic Microphones



**WHAT'S NEW
THIS MONTH**

1. COLOR TELEVISION
2. WAGES AND PRICES
3. FACTS ARE NEEDED

1. The FCC hearing on color television, called on December 12th, developed a great volume of conflicting testimony, with neither side willing to make any concessions. In all probability, attitudes of the witnesses expressed front-office policies. At the same time, it must be recognized that any engineering group that has worked hard, sincerely, and at great cost to management, has a natural reluctance to concede that their investment of man-hours and money should be discarded in favor of a different system developed by a competitor.

Basically, lines are drawn between the proponents of sequential color transmission, in which blue, green, and red for each frame are transmitted in succession, and those who champion the simultaneous transmission of the three colors. There is also difference of opinion concerning the mechanical color system used for sequential transmission and reception, and the electronic, simultaneous method.

The line-up of the teams shows the sequential system supported by Westinghouse, Bendix, Zenith, and Cowles Broadcasting, with CBS calling the signals. Favoring the simultaneous method, or opposing the establishment of any standards at this time, are RCA, NBC, DuMont, Philco, Farnsworth, and the Television Broadcasters Association.

FCC's purpose in holding the hearing was to consider the CBS plea to set color television standards, built around sequential transmission, right now. In fact, CBS threatened to drop its television work if color standards are not set in the immediate future.

It is anyone's guess as to why CBS insists on such action now, since there is no evidence that receivers can be made available at this time, and at prices within the means of any great number of people. Making an issue of color just when black-and-white television sets are starting to come out is bound to cause confusion, and to discourage the purchase of monochrome, low-band receivers. There is a strong feeling in some quarters that this is the CBS intention.

The opinion is held by others that color is not ready now, but if it were its introduction should be delayed until such time as black-and-white television has been put on a commercial basis in its

(CONTINUED ON PAGE 66)

Used Extensively FOR PAGING AND COMMUNICATING SYSTEMS

Among the countless applications for which Astatic Crystal and Dynamic Microphones are used, none is more general than paging and inter-communicating systems. Office, factory and hotel paging, the exchange of departmental messages, communications between ships and shore, planes and airfields, cabs and dispatchers... all employ types of microphones manufactured by Astatic... microphones with clear cut, voice-range characteristics, long used and favored for dependable service and high operating efficiency.

See your Radio Parts Jobber
or write for new Catalog

Model T-3
Crystal
Microphone
Mounted on
Grip-to-Talk
Desk Stand



"Conneaut"
Model 600
Crystal
Microphone



Dynamic
Model DN
Microphone



JT-Series
Crystal
Microphone



THE Astatic CORPORATION
CONNEAUT, OHIO

IN CANADA: CANADIAN ASTATIC LTD., TORONTO, ONTARIO
Astatic Crystal Devices Manufactured
under Brush Development Co. patents.

In Production!



G. E.'s NEW 5-KW TELEVISION TRANSMITTER

COMpletely self-contained, General Electric's new 5-kw television transmitter combines every modern improvement for producing the finest pictures and sound that money can buy. Built-in sweep oscillators and crystal monitors make circuit adjustments easy for any operator. Plate modulation assures maximum modulation linearity. Elimination of vestigial side-band filter increases power-amplifier efficiency. New type power-amplifier triodes in push-pull, grounded

grid circuit do away with neutralization and grid "swamping" resistors, speed up tube replacement, and cut tube costs. Important advancements like these are your assurance of unmatched program reliability, ease of control and maintenance, and lower operating cost.

See your G-E broadcast sales engineers for complete technical specifications or write today to the *Electronics Department, General Electric Company, Syracuse 1, New York.*

Higher-contrast pictures

Low-level plate modulation for greater modulation linearity over the full visual range. Video pre-emphasis unnecessary.

New advancements in circuit simplicity

Flat band-pass over full range • No vestigial sideband filter • FM sound transmitter designed with the famous Phasitron modulator • D-C insertion at low level.

Higher circuit efficiency

Pre-output shaping of vestigial side-band reduces power amplifier bandwidth 40 per cent—improves power amplifier efficiency • No power-wasting "swamping" resistors. • No high-power video stages.

Easy circuit alignments

Built-in sweep generator, and crystal detectors in each RF stage provide simple alignment of transmitter.

"Block-built" for higher power

Transmitter design is coordinated with G-E high-power linear amplifiers • Power may be increased later without need for transmitter modification.

Complete accessibility

Full-length doors front and rear • Compact space-saving vertical chassis.

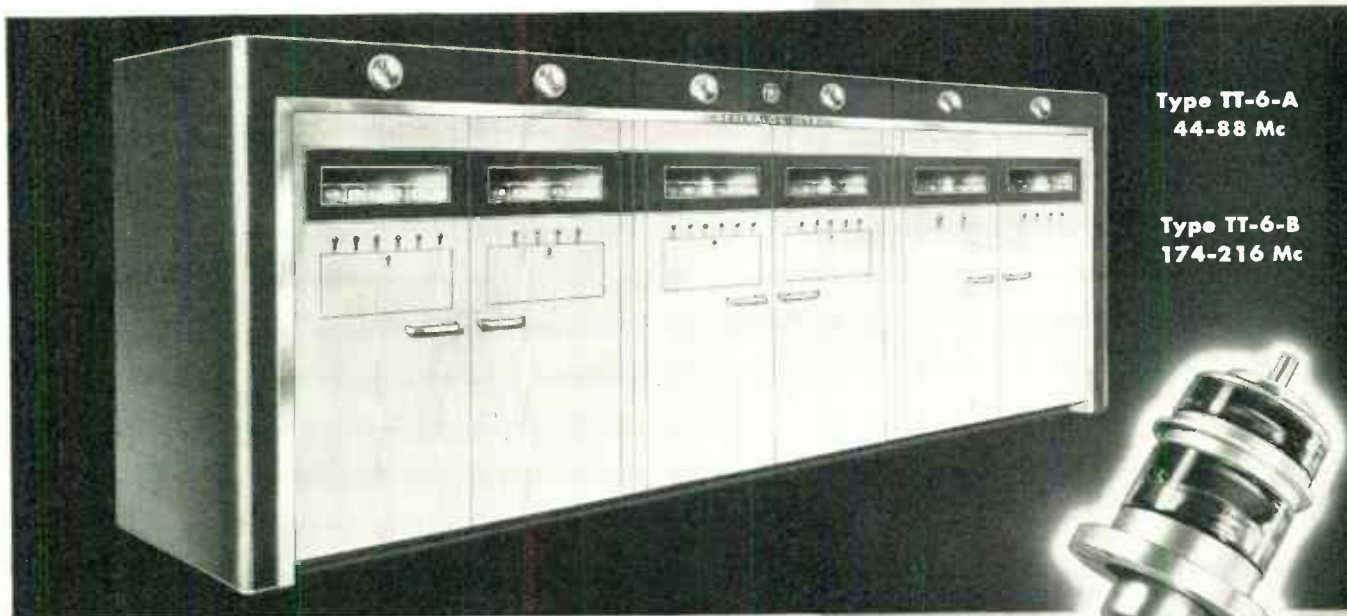

Type TT-6-A
44-88 Mc

Type TT-6-B
174-216 Mc

Write for these G-E Television Books

G-E Television Equipment Data Book—An illustrated description of G-E studio units, transmitters, and antennas. Will be sent free when requested on your company letterhead.

Television Show Business—246 richly illustrated pages of television "know-how" by Judy Dupuy. An indispensable guide to better television program operation. \$2.50 per copy.



Outstanding v-h-f Power Amplifier Triode GL-9C24

Two sturdy GL-9C24 triodes—running lightly—deliver 5-kw of peak power in the push-pull power amplifier of the TT-6-A and TT-6-B transmitters. GL-9C24 features: compact design for close side-by-side mounting, ring-seal construction for low lead inductance, maximum terminal contact area, only two pairs of water connections per tube, minimum cooling requirements with low-pressure water supply, and ease of replacement.

GENERAL ELECTRIC

156-ES-6912

Immediately Available

**AT
LONG
LAST!**

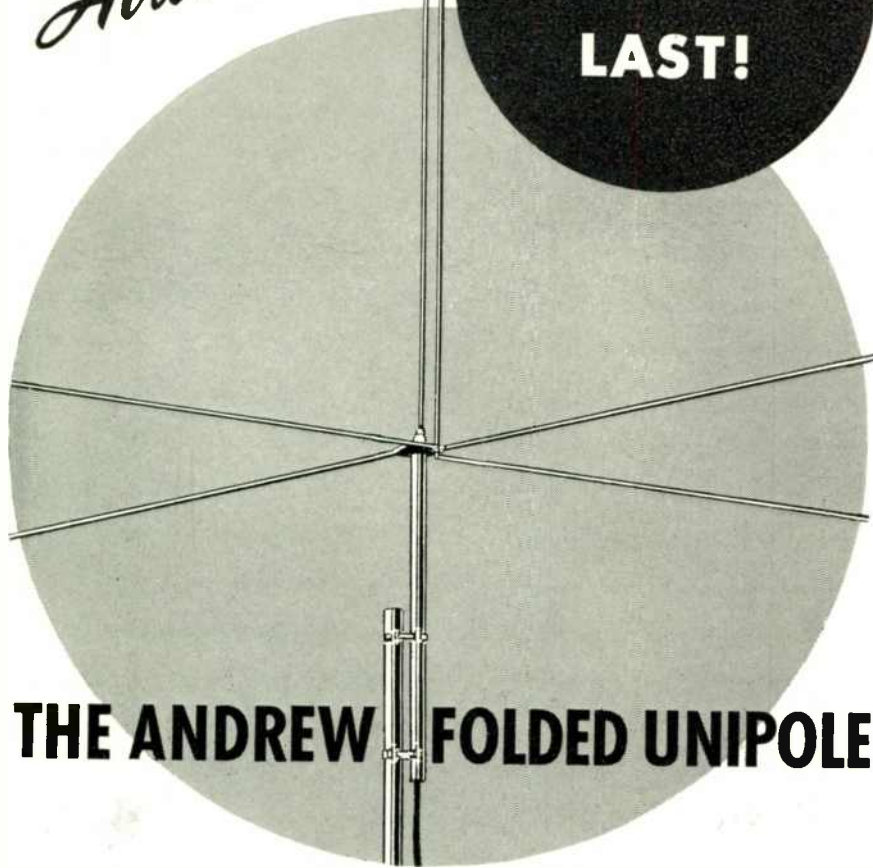

THE ANDREW FOLDED UNIPOLE

Greeted with a flood of orders when introduced last year, the popular Andrew Folded Unipole Antenna now is flowing off the production line at a rate which permits immediate shipment from stock.

Used for transmitting and receiving in the 30 to 44 MC and 72-76 MC frequency ranges, it easily outperforms other antennas selling at sev-

SEND IN YOUR ORDER NOW

eral times its price. Here is the ideal communications antenna for police, fire, forestry, railroad and aviation services.

Here's why this antenna is unusually satisfactory:

- Perfect impedance matching eliminates tricky adjustment of loading. Users report transmitter loads the same on antenna and dummy, regardless of line length.
- Improved signal strength over ordinary coaxial or other dipole antennas.
- Grounded radiating element provides static drain, improving signal to noise ratio and minimizing lightning hazard.
- Weighs only 20 pounds with clamps. Easy to install.
- Inexpensive. Antenna costs only \$60.00, mounting clamps \$6.00, transmission line adaptor kit \$6.00 (specify size and type of Line).



For effective solutions to your antenna problems consult Andrew Co., designers, engineers and builders of antenna equipment. Expert factory installation service available.

ADVERTISERS INDEX

Advance Electric & Relay Co.....	66
Alden Products Company	60, 61, 62, 63, 64
Altec Lansing Corp.....	53
American Phenolic Corporation....	59
Anderson, H. V., & Associates.....	20
Andrew Company.....	6, 20
Armstrong, Edwin H.....	36, 37
Artted.....	3
Astatic Corporation.....	4
Barone, S. A., Company.....	21
Blaw-Knox.....	14
Bliley Electric Co.....	57
Boonton Radio Corp.....	66
Brook Electronics, Inc.....	70
Browning Laboratories, Inc.....	67
Burstein-Applebee Co.....	71
Capitol Radio Eng. Inst.....	68
Chicago Transformer Corp.....	15
Clare, C. P., and Company.....	55
Collins Radio Company	
<i>Inside Back Cover</i>	
Commercial Radio Equip. Co.....	20, 58
Drake Mfg. Corp.....	68
Editors and Engineers, Ltd.....	21
Eitel-McCullough, Inc.	
<i>Inside Front Cover</i>	
Engineering Research Assoc., Inc...	20
Federal Telephone & Radio Corp....	13
Finch Telecommunications, Inc.....	12
FM Company.....	69
Freed Radio Corp.....	71
Galvin Mfg. Corporation...Back Cover	
General Electric Co.....	5, 18, 19
Hallicrafters.....	9
Institute of Radio Eng.....	72
International Resistance Corp.....	47
Jansky & Bailey.....	20
Johnson, E. F. Company.....	66
Kaufman, Robert L.....	20
Keel, John J.....	20
Kluge Electronics Co.....	20
May & Bond.....	20
McIntosh, Frank H.....	20
McKey.....	20
National Company, Inc.....	1
Newark Electric Company.....	70
Niagara Radio & Supply Co.....	68
Pollack, Dale.....	21
Radio Consultants, Inc.....	21
Radio Corporation of America.....	18, 19
Radio Engineering Labs, Inc.....	51
Ray, Garo W.....	20
Raytheon Mfg. Co.....	2
RCA Communications, Inc.....	20
Sangamo Electric Co.....	16
Standard Measuring & Equip. Co....	21
Sylvania Electric Products, Inc....	17, 56
Turner Company.....	8
U. S. Recording Co.....	20
Vaco Products Co.....	71
Ward Products Co.....	72
Western Electric Co.....	10, 11, 22
Williams, Nathan.....	21
Wilmotte, Raymond M.....	7, 20
Wilson, Herbert L.....	20
Workshop Associates, The.....	21
WQXQ.....	71
Zenith Radio Corp.....	65
Zophar Mills, Inc.....	72

Raymond M. Wilmotte Inc.

has been selected to design and construct a group of FM broadcast stations for the International Ladies' Garment Workers' Union, comprising one of the largest enterprises planned since the war and providing Metropolitan coverage to principal cities in Massachusetts, New York, Pennsylvania, Tennessee, Missouri and California.

In considering your plans for construction we invite you to share our experience and facilities as designers, constructors and consultants on radio broadcast projects.

All projects undertaken by the Wilmotte organization are under the personal supervision of Paul A. deMars, one of Radio's foremost engineers.

Our method of undivided responsibility, from preliminary design to dedication, gives you the benefit of sound engineering at every step, and results in maximum economies in construction and in station operation.

Our experienced engineering has made important savings for others: it will do the same for you.



RAYMOND M. WILMOTTE Inc.

CONSULTING ENGINEERS RADIO & ELECTRONICS

1469 CHURCH ST., N.W., WASHINGTON 5, D.C.

NEW YORK LABORATORIES - 236 W. 55TH ST., N.Y. 19, N.Y.

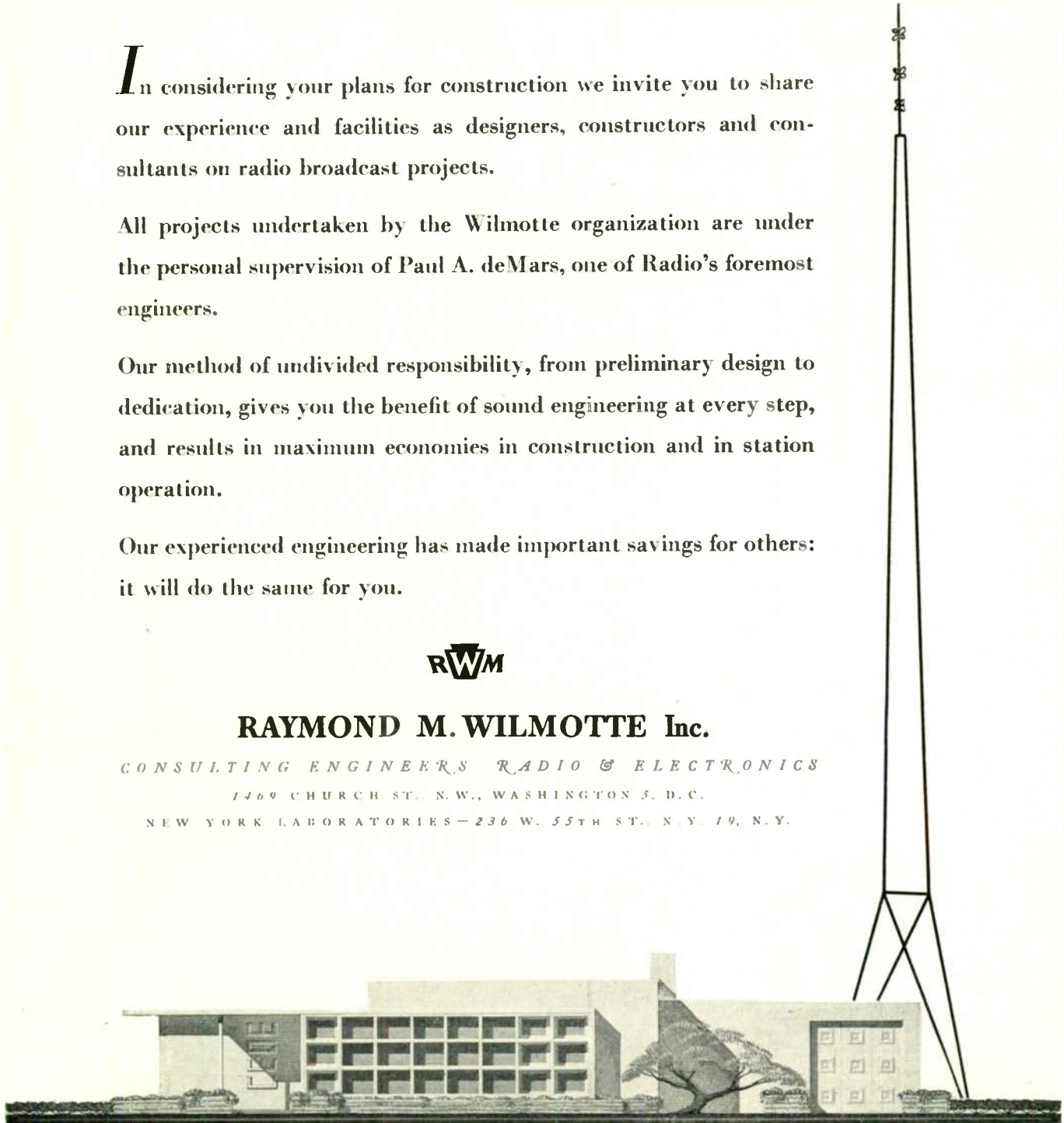

F • M • T R A N S M I S S I O N B U I L D I N G F O R T H E I • L • G • W • U

January 1947 — formerly FM, and FM RADIO-ELECTRONICS

ENGINEERING SALES



BE CONFIDENT WITH A MICROPHONE BY TURNER

Whether it's a general purpose unit for voice and music, or a unit for a specialized application you'll always be confident of accurate pickup and faithful reproduction when your microphone is a Turner. Turner Microphones are proving their superiority in design and manufacture to new users every day.

Illustrated is the Turner Model 33—a high fidelity all purpose microphone that combines high output with smooth response over a wide frequency range. Its matched acoustic design results in crisp, clear speech reproduction . . . music is full and round with tonal qualities faithfully retained. Furnished in a choice of high quality crystal or rugged dynamic circuits. It is recommended for studio recording, remote control broadcast, orchestra pickups, paging, dispatching and call systems, public address and communications work.

MODEL 33X CRYSTAL

Response: Flat within ± 5 db from 30-10,000 cycles.
Output Level: 52db below 1 volt/dyne/sq. cm.

Impedance: High impedance.

Crystal: High quality moisture sealed crystal.

Stand Coupler: Standard $\frac{1}{8}$ "—27 thread.
Cable: 20 ft. removable cable set.

MODEL 33 DYNAMIC

Response: Flat within ± 5 db from 40-10,000 cycles.
Output Level: 52db below 1 volt/dyne/sq. cm.

Impedance: 50 ohms/250 ohms/500 ohms/high impedance.

Magnetic circuit: Heavy duty dynamic cartridge.

Stand Coupler: Standard $\frac{1}{8}$ "—27 thread.
Cable: 20 ft. removable cable set.



THE TURNER COMPANY

906 17th Street N. E., Cedar Rapids, Iowa

Licensed under U. S. Patents of the American Telephone and Telegraph Company, and Western Electric Company, Incorporated. Crystals licensed under patents of the Brush Development Company.

TURN TO TURNER FOR THE FINEST IN ELECTRONIC EQUIPMENT

General Electric: Has leased permanent display and office space for its electronics department on the 11th floor of the Merchandise Mart, Chicago. Display will be devoted principally to radio and television receivers. George S. Peterson, central district manager, and his staff, have moved from 840 S. Canal Street to the new quarters.

Superior: A new 12-page bulletin of electrical and mechanical data on variable transformers, voltage regulators and power supplies has been issued by Superior Electric Company, Bristol, Conn.

Collaro: British-made Collaro record changers are now being distributed in the U.S.A. by Micro-Sonic Corporation, 44 W. 12th Street, New York City 11.

Mallory: Walter E. Harvey has joined P. R. Mallory & Company, Inc., as manager of the wholesale division. He will make his headquarters at the Indianapolis plant.

Weston: George T. Deaney, who joined Weston Electrical Instrument Corporation in 1926, has been named purchasing agent. He succeeds A. R. Briggs, recently retired after 45 years at Weston.

Dumping Ahead: Although cheap AM table model radios are still scarce in many of the smaller cities, storm warnings are set for dumping in metropolitan areas. While this may indicate uneven distribution, the condition is due principally to the poor performance of these models. Hence, in sections where listeners get only a part of their reception from local stations, dealers have been reluctant to commit themselves beyond their immediate needs.

Fairchild: Newly appointed representative in New Zealand for Fairchild Camera & Instrument Corporation is J. H. M. Carpenter, Ltd., Newmarket, Auckland.

Hammarlund: After 10 years with Hammarlund Manufacturing Company, George Stuart has resigned as advertising manager. Forsaking the North, he has moved to 3014 Beach Boulevard, Gulfport 7, Fla. His successor is Stephen T. Van Essen, W2OXD, who has been with Hammarlund for several years.

The Repts: At the annual meeting of the California Chapter of The Repts, the following officers were elected for 1947: Dick Huber president, Les Logan secretary-treasurer, and Russ Hiner chairman of the public relations committee. Les Logan's address is 530 Gough, San Francisco 2.

F.M. AND TELEVISION

hallicrafters PRESENTS THE

SX-42

Another first!
Greatest continuous frequency coverage of any communications receiver — from 540 kc to 110 Mc

This is the long-awaited Hallicrafters SX-42, a truly great communications receiver. The tremendous frequency range of the SX-42, greater than ever before available in a receiver of this type, is made possible by the development of a new "split-stator" tuning system and the use of dual intermediate frequency transformers. Packed with advance features that every ham and every other radio enthusiast desires, the SX-42 clearly lives up to the Hallicrafters ideal of "the radio man's radio."

From now on watch Hallicrafters — the name that's remembered by the veteran, preferred by the radio amateur. See your distributor for demonstration of the SX-42 and for colorful literature describing this great set in complete technical detail.



Because of the precise and thorough engineering that must be done on the SX-42 and because the parts supply has not been continuous, top production peaks have not yet been reached. In the immediate future deliveries will necessarily run behind the demand, but the SX-42 is definitely worth waiting for.

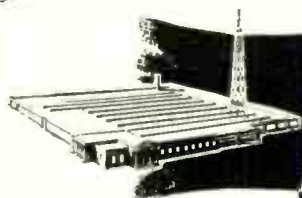

hallicrafters RADIO

THE HALLCRAFTERS CO., MANUFACTURERS OF RADIO AND ELECTRONIC EQUIPMENT, CHICAGO 16, U. S. A.

Sole Hallicrafters Representatives in Canada:
Rogers Maqestic Limited, Toronto-Montreal

BUILDERS OF

Skyfone

AVIATION RADIOTELEPHONE

Why this team is *Tops*



1915

The ocean, long a barrier to spoken communications, was conquered when Bell System engineers designed, built, and operated the transmitter which first sent the human voice across the Atlantic and Pacific.



1916

A Western Electric transmitter was used in one of the pioneer ship-to-shore radiotelephone experiments. Thirteen years later the first regular commercial service was established with Western Electric equipment.



1917

With the first airborne transmitter, Western Electric demonstrated two-way radiotelephony between a plane in flight and the ground. From this earliest experiment came commercial airline equipment in 1930.



1920

Western Electric radio became a part of the nation's telephone system when it was used to connect Catalina Island to the mainland. Seven years later, the Bell System offered commercial radiotelephone service to Europe.



1922

Western Electric manufactured and installed the first "high power" (500 Watt) commercial broadcast transmitter—for the Detroit News Station WWJ.



1930

Transmitter designed by Bell Laboratories first used for one-way contact with police cars. Police used Western Electric fixed station transmitters as early as 1922, and two-way mobile equipment from 1935.

From the basic developments pictured at the left, the team of Bell Laboratories and Western Electric continued to set the pace with the best in transmitting equipment. Among the later advances pioneered by this team were:

1928. The first 50 kw commercial broadcast transmitter, built by Western Electric, installed at WLW, Cincinnati, Ohio.

1935. A 50 kw Western Electric AM transmitter installed at WOR was the first to incorporate the Bell Laboratories-designed stabilized feedback circuit, since accepted as a broadcasting standard.

1937. The first single sideband transmitter was introduced for long distance point-to-point communications. The world-wide military communications network used in the war came directly from this development.

1938. Flying tests of the first VHF aircraft transmitter showed relatively static-free communication at all times. Modifications of the original Bell Laboratories design were used for basic Army-Navy aircraft radiotelephony in World War II.

1940. The first Synchronized FM transmitter installed at WOR enabled broadcasters to put top-quality FM programs on the air and keep them on their assigned frequency.

1941. First FM transmitter to use grounded plate amplifier circuit was Western Electric 10 kw installed at WOR.

1941. Twelve talking channels adjacent to each other, available for the first time on a single radio frequency band, used to connect telephone lines on either side of Chesapeake Bay. Envelope feedback developed by Bell Telephone Laboratories and applied to the carrier technique in radio telephony made this possible.

—QUALITY COUNTS—

for Radio Transmitters!

The experience gained during the war, when the Bell Laboratories-Western Electric team was the largest supplier of communications equipment, added greatly to the skill and knowledge acquired through 30 years of transmitter development.

This background, plus unequalled research and manufacturing facilities, provides assurance that there are no finer transmitters than those designed by Bell Telephone Laboratories and built by Western Electric—whether for AM or FM broadcasting, point-to-point radiotelephony, or any type of communication or mobile service.

1943. The ARC-1, a crystal controlled ten frequency transceiver, used by the Navy's fighter planes during the war, has been accepted as standard VHF equipment by U.S. airlines. Provides nine plane-to-ground frequencies and one plane-to-plane frequency.



1947. The Western Electric 238-type mobile radiotelephone system is providing dependable Bell System service between vehicles and any wire telephone in a growing number of cities and along trunk highways.

1947. The new TRANSVIEW design FM transmitter, being produced in 1, 3 and 10 kw units, for the first time provides the operator with an unobstructed view of all tubes while in operation. Incorporates Bell Laboratories-developed synchronized frequency control.

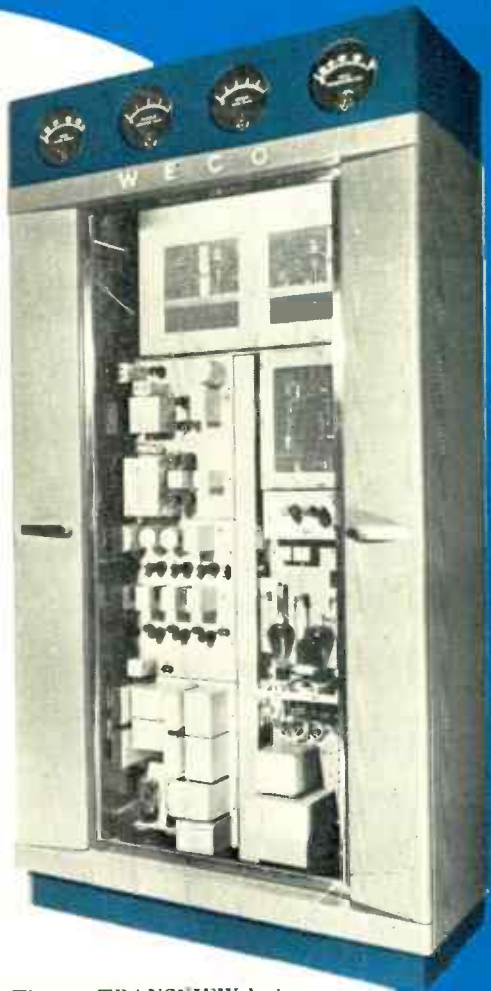

Distributed by
Graybar
OFFICES IN 95 PRINCIPAL CITIES



BELL TELEPHONE LABORATORIES

World's largest organization devoted exclusively to research and development in all phases of electrical communications.

Western Electric

Manufacturing unit of the Bell System and the nation's largest producer of communications equipment.

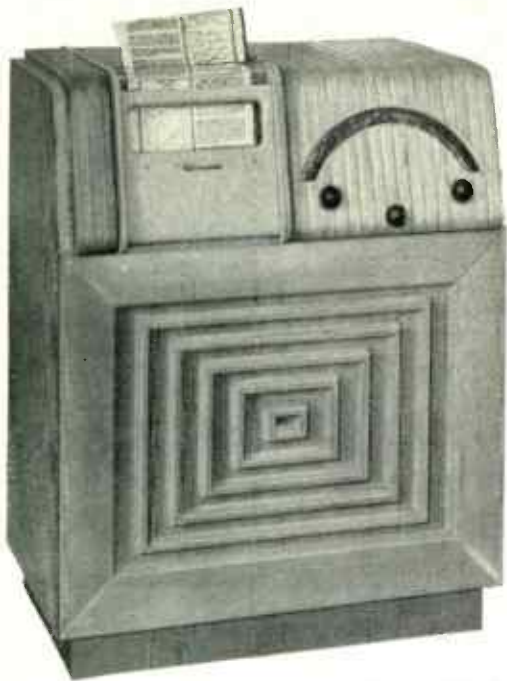

New Finch AM-FM Radio for receiving both sound and facsimile. Console model



New Finch AM-FM Radio for receiving both sound and facsimile. Table model

NEWEST

finch

FACSIMILE

Broadcasting

Equipment

**ORDERS PLACED
NOW WILL BE
GIVEN PRIORITY**

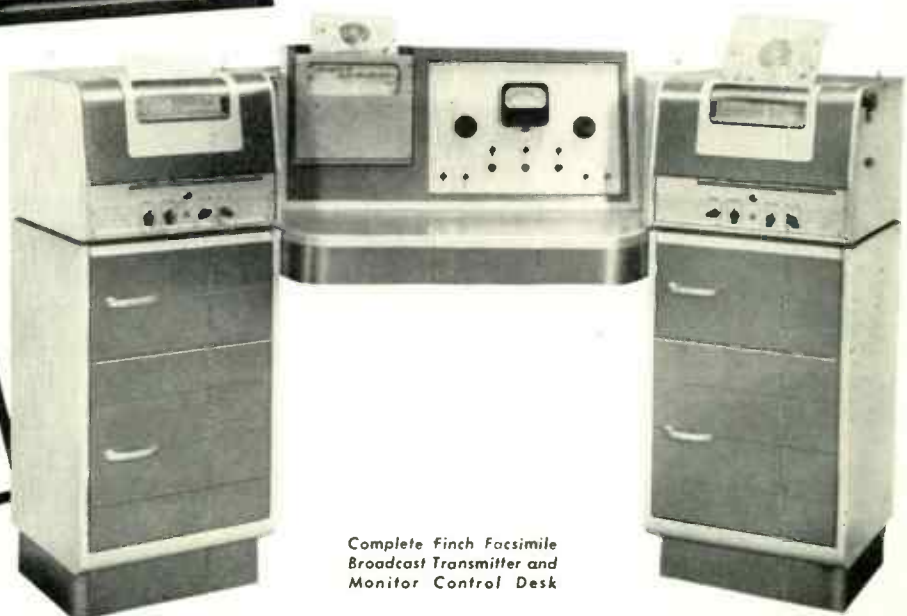

Complete Finch Facsimile Broadcast Transmitter and Monitor Control Desk

FINCH TELECOMMUNICATIONS, INC.

Address all inquiries to Sales Office
10 EAST 40th STREET • NEW YORK 16, N. Y.

Makers of Facsimile Broadcast Transmitting Equipment, Facsimile Home Recorders, Facsimile Duplicating Machines, and Finch Rocket Antenna for FM stations.

These Newspapers Have Selected

FM^{by} Federal

for their new Broadcast Stations



**ALL WILL BE ON THE AIR
BY EARLY 1947**

MEN WHO KNOW news pick the "big news in radio" — FM by Federal. From New York to Nebraska — from Wisconsin to Kentucky — these eighteen newspapers in eleven states are going on the air with new FM broadcasting stations. And — like so many major radio stations from coast to coast — they have all selected Federal equipment.

FM, in itself, means better broadcasting. But FM by Federal means FM at its best — the last word in center-frequency stability, radiation strength, and long trouble-free operation. Federal's 38 years of research and experience are at your service — to design, equip and install your complete FM station. Write today for detailed information. Dept. B120.

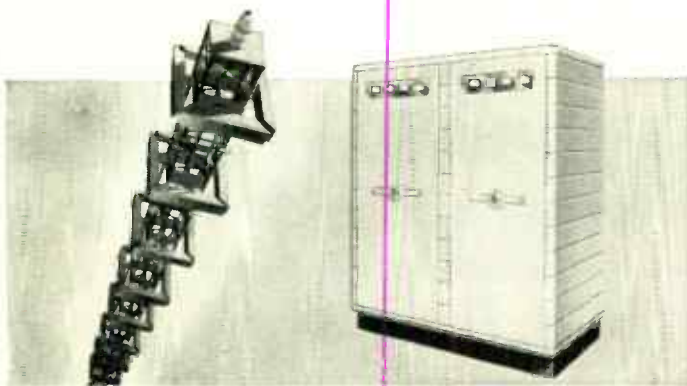

Federal's **SQUARE-LOOP ANTENNA** gives added effective radiation strength — up to 8 times that of the rated transmitter output.

The "**FREQUEMATIC**" MODULATOR is an exclusive feature of every Federal FM transmitter — assuring greater center-frequency stability, simplicity of operation and longer life.



Federal Telephone and Radio Corporation

In Canada:—Federal Electric Manufacturing Company, Ltd., Montreal.
Export Distributors:—International Standard Electric Corp. 67 Broad St., N. Y. C.



Newark 1,
New Jersey

January 1947 — formerly FM, and FM RADIO-ELECTRONICS

SANGAMO PAPER TUBULAR CAPACITORS

ARE NOW MOLDED IN PLASTIC

...just like micas!

Paper Tubular Capacitors, molded in Thermo-Setting Plastic! Designed for use in all circuits calling for Paper Tubulars. Plastic Molding means no leakage. Capacity values remain more stable and moisture is completely sealed out. No wax to run at

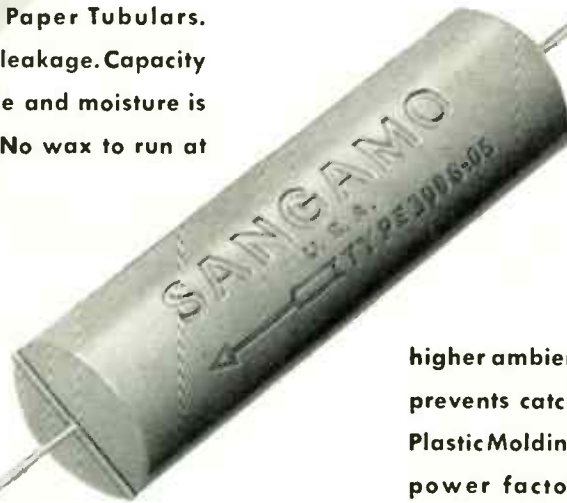

higher ambient temperatures. Smooth finish prevents catching dirt and dust. All in all, Plastic Molding assures longer life and lower power factor. Specify Sangamo Plastic Molded Capacitors wherever you use Paper Tubulars.

...try these tests

WITH SANGAMO PLASTIC TUBULARS



WRITE NOW for the New Sangamo Capacitor Catalog for full information on the Sangamo Line.

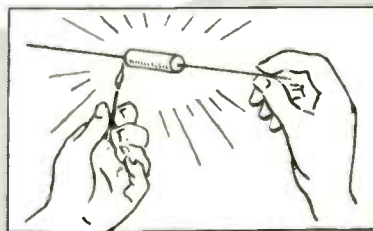

NO WAX TO MELT...even heat as intense as is encountered in soldering, will not cause leakage in the case or at the lead joint.

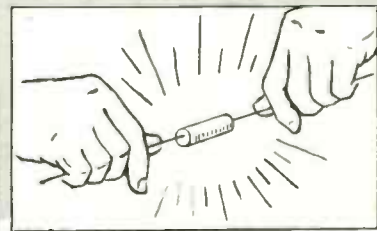

LEADS WILL NOT PULL OUT... Plastic Molding so tightly seals the leads in place, that under all conditions of normal use, leads will stay put.

SANGAMO ELECTRIC COMPANY SPRINGFIELD ILLINOIS

SYLVANIA NEWS

CIRCUIT ENGINEERING EDITION

JAN.

Prepared by SYLVANIA ELECTRIC PRODUCTS INC., Emporium, Pa.

1947

NEW OSCILLOSCOPE DEVELOPED TO HELP SOLVE PROBLEMS MET IN RADIO AND ELECTRONIC EQUIPMENT

Latest Sylvania Instrument Especially Useful For Rapid Receiver Alignment and Trouble-Shooting

In anticipation of the need for greater accuracy in trouble-shooting, alignment, distortion locating, etc., Sylvania has developed the Oscilloscope, Type 131. This accurate measuring device takes its place beside the numerous radio and electronic devices that have been Sylvania-developed to facilitate the solving of problems encountered in radios and electronic equipment.

CHARACTERISTICS AND SPECIAL FEATURES

1. **Sylvania 3AP1 Cathode Ray Tube** — Accelerating potential, 650 volts. Electrostatic deflection and focus. Tube is shock-mounted and well protected from stray magnetic and electrostatic fields by efficient shielding. Panel visor shades face of tube permitting oscilloscope use in well-lighted rooms. Removable calibrating screen also included.
2. **INPUT IMPEDANCES** —
Vertical amplifier — approximately 1 meg., 30 mmf. at full gain.
Horizontal amplifier — approximately 1 meg., 50 mmf. at full gain.

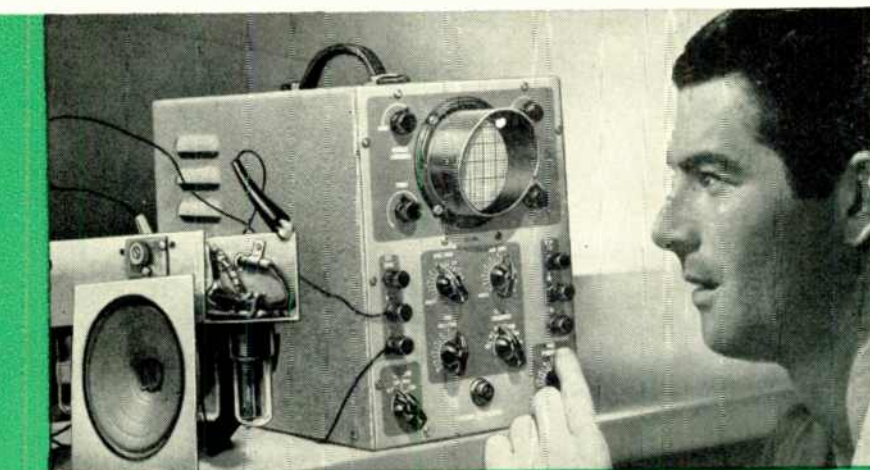

Oscilloscope, Type 131; cabinet is steel constructed, properly ventilated with louvers, finished in durable, attractive pearl-grey baked enamel.

3. **AMPLIFIER FREQUENCY RESPONSE** —
Sine wave uniform within 3 db. from 10 cycles to 100 kilocycles.
4. **DEFLECTION FACTOR** —
Through amplifiers — 0.5 volts per inch.
Direct — approximately 17 volts per inch.
5. **HORIZONTAL SWEEP** —
Direction — left to right.
Frequency range — 15 to 40,000 cycles.
Synchronizing signal sources —
Internal (vertical signal).
External; 60 cycles.
6. **POWER SUPPLY** —
105-125 volts, 50-60 cycles.
40 watts power consumption.
1 amp. line fuse provided.
7. **CABINET DIMENSIONS** —
10 $\frac{1}{8}$ " high, 7 $\frac{3}{4}$ " wide, 13 $\frac{3}{8}$ " deep.
See your Sylvania Distributor.

SYLVANIA ELECTRIC

Emporium, Pa.

MAKERS OF RADIO TUBES; CATHODE RAY TUBES; ELECTRONIC DEVICES; FLUORESCENT LAMPS; FIXTURES; WIRING DEVICES; ELECTRIC LIGHT BULBS

3 KW of

NEW G-E TYPE BT-3-A →

The 3-kilowatt FM broadcast transmitter
with the famous Phasitron Modulator

- ✓ FEWER TUBES
- ✓ FEWER CIRCUITS
- ✓ FEWER COMPONENTS

- ✓ FEWER MAINTENANCE MINUTES
- ✓ FEWER PROGRAM OUTAGES
- ✓ FEWER INVESTED DOLLARS

BUILT for performance and economy, General Electric's new BT-3-A offers to broadcasters a *completely self-contained* 3-kw FM transmitter with every electrical and mechanical feature required by modern broadcast station owners and engineers. Designed with the revolutionary Phasitron Modulator and with fewer stages and fewer tubes than 3-kw FM transmitters of

other design, here is 3000 watts of FM power that guarantees maximum audience and advertiser service—assures you lower cost per hour of operation.

For the full facts see your nearest General Electric broadcast sales engineer, or write the *Electronics Department, General Electric Company, Syracuse 1, New York.*

LOOK! New On-the-air reliability

Fewer stages • Fewer tubes • Fewer components • Fewer outages • Complete fuseless overload protection with fast-acting circuit breakers • Automatic power reclosure after power failure • Longer tube and component life with air-blower system and lifetime air filters • Highest quality components used throughout • Simple, straightforward, all electronic circuits • Delta-Wye switching with instantaneous high-low power transfer for uninterrupted programming • Power amplifier tubes **quickly interchangeable.**

New Electrical Features

Push-pull tetrode power amplifier using the new ring seal GL-7D21's • No intermediate amplifier between 250-watt exciter and 3-kw amplifier • Critical neutralization eliminated • Includes the Phasitron Modulator • Block-built design for combining units to meet future power requirements • Complete metering • Power supply 208/230 volts \pm 5%, 50/60 cycles, 3 phase.

New Accessibility

Completely self-contained • Full-length doors front and rear • Vertical chassis easy-to-get-at • Tubes, components,

adjustments and controls — at your finger tips.

New Ease of Installation

Only 75 inches high, 72 inches wide, and 25 inches deep • Two easily-joined space-saving units for convenient transportation through standard doorways and in elevators.

New Styling

Husky and handsome • Matches other G-E FM transmitter units • Stainless steel trim • Rounded corners • Baked synthetic enamel with beautiful opalescent finish • Utility and beauty contribute to station appearance.



FMM PERFORMANCE!

Economy!

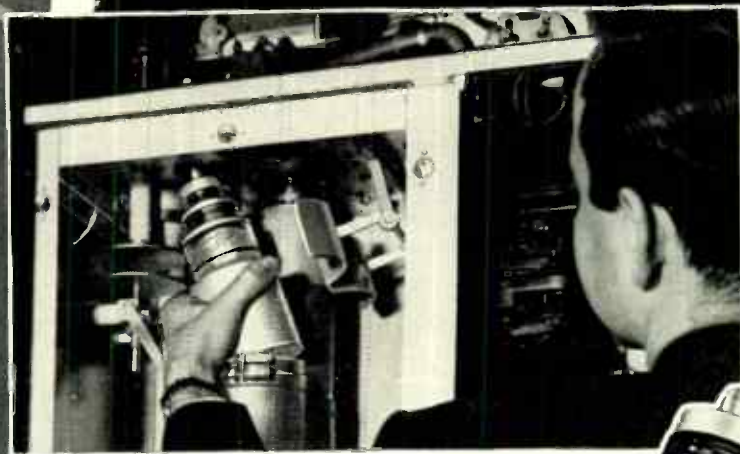
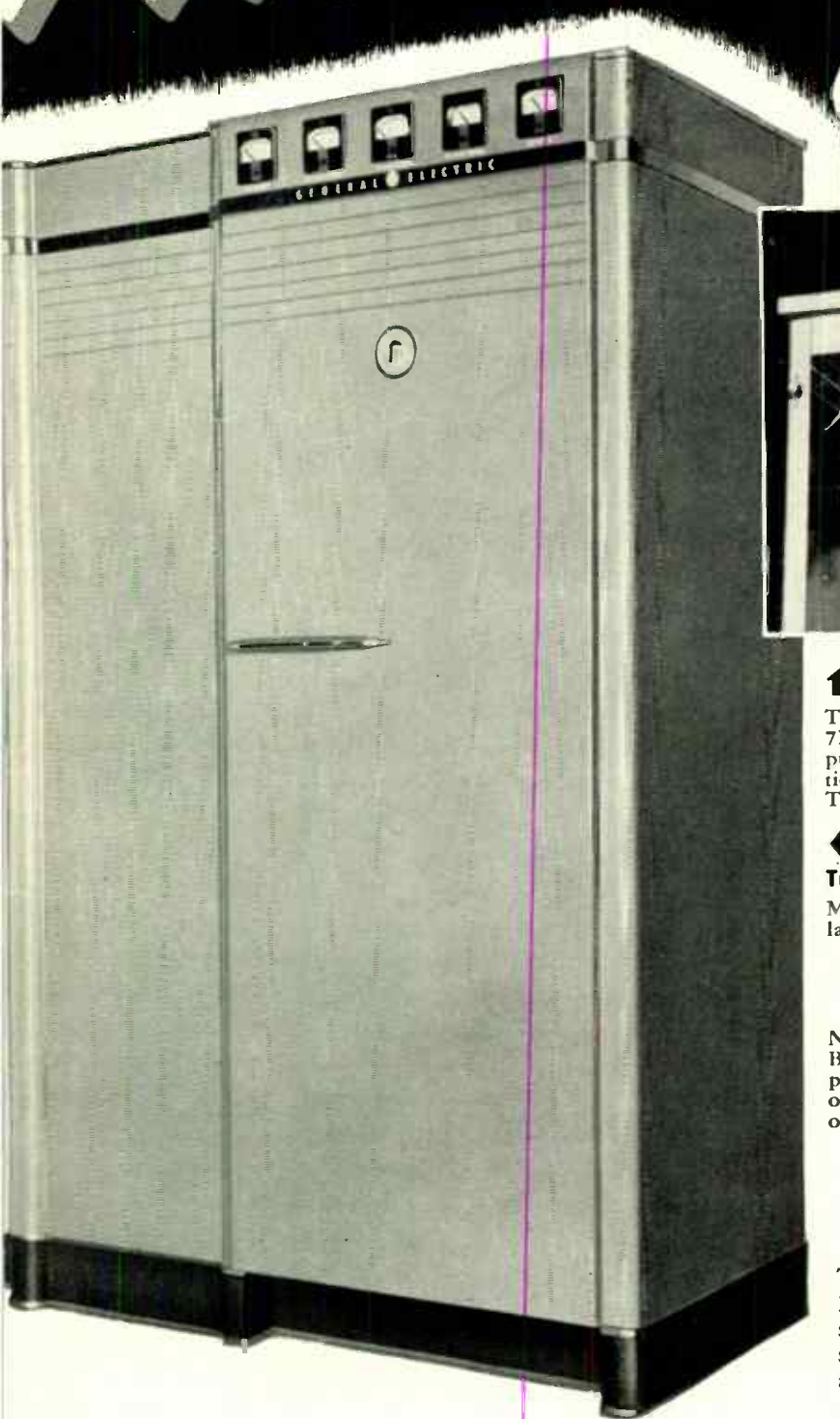

▲ Power Amplifier

Two plug-in, radiator-type GL-7D21's in clean-cut symmetrical push-pull circuit. Neutralization adjustment is unnecessary. Tubes are replaced easily.

◀ New G-E 3-kw FM Transmitter, type BT-3-A

Meets all FCC standards and latest proposed RMA standards.

Air-radiator type ▶▶ GL-7D21

New h-f tetrodes used in the BT-3-A power amplifier. In push-pull, delivers 3 kilowatts of power with only 120 watts of driving power.



Block-Build to higher power

The BT-3-A includes a G-E 250-watt FM exciter and a 3-kw FM amplifier. If you now own a 250-watt exciter, simply add a G-E 3-kw amplifier. And if you anticipate swinging ultimately to higher power, then simply add a G-E 10-kw FM amplifier to your 3-kw G-E unit.

In combining G-E FM Transmitter units, there is no expensive equipment duplication, no equipment obsolescence, no relocation of existing units. Simplified wiring insures easy inter-unit connections. Size and appearance of all G-E units are harmonious and adaptable to future additions for higher power.

GENERAL  **ELECTRIC**

World Radio History

160-E12-8814

Professional Service Directory

Jansky & Bailey
 AN ORGANIZATION OF
 Qualified Radio Engineers
 DEDICATED TO THE
 SERVICE OF BROADCASTING
 National Press Bldg., Washington, D. C.

RAYMOND M. WILMOTTE
Consulting Radio Engineer
 PAUL A. DEMARS
Associate
 1469 Church St., N.W., Washington 5, D. C.
 Decatur 1234

FRANK H. McINTOSH
Consulting Radio Engineers
 710 14th St. N.W., Wash. 5, D. C.
 METropolitan 4477

ANDREW CO.
Consulting Radio Engineers
 363 EAST 75th STREET, CHICAGO 19
 Triangle 4400

MAY & BOND
 CONSULTING RADIO ENGINEERS
 * * *
 1422 F Street, N. W. Wash. 4, D. C.
 Kellogg Building Republic 3984

JOHN J. KEEL
Consulting Radio Engineers
 Eorle Building
 NATIONAL 6513
 Washington 4, D. C.

• TELEPHONE BRIDGEPORT 5-2055 •
GARO W. RAY
Consulting Radio Engineers
 991 Broad Street, Suite 9-11
 Bridgeport 3, Conn.
 LABORATORY: Hilltop Drive
 Stratford, Conn. — Phone 7-2465
Instruments and Measurements

OUR 18th YEAR
Herbert L. Wilson
Consulting Radio Engineers
 1018 Vermont Ave., N.W. NA. 7161
 Washington 5, D. C.
 1000 No. Seward St. HO. 6321
 Hollywood 38, Calif.

H. V. Anderson
 — AND ASSOCIATES —
 • **Consulting Radio Engineers**
 715 American Bank Bldg. Tel. RAYmond 0111
 New Orleans 12, Louisiana

The
ROBERT L. KAUFMAN
 ORGANIZATION
 • Construction Supervision (FM-AM),
 Technical Maintenance, and Business Services
 for Radio Broadcast Stations.
 Munsey Building Washington 4, D. C.
 District 2292

CONSULTING
 RADIO ENGINEERS
DIXIE B. MCKEY
 &
 ASSOCIATES
 1730 CONNECTICUT AVE. N.W.
 WASHINGTON 9, D. C. ADAMS 3711

Radio Engineering Consultants,
Frequency Monitoring
Commercial Radio Equip. Co.
 International Building • Washington, D. C.
 321 E. Gregory Boulevard • Kansas City, Mo.
 Cross Roads of the World • Hollywood, Calif.

ERA COMPLETE Technical and
 Management
 Consulting Service
 Immediate FM and VHF
 Field Measurement Service Available
Engineering Research Associates, Inc.
 Washington, D. C. Office: Laboratories:
 1129 Vermont Av., N. W. St. Paul 4, Minnesota
 Phone: EXecutive 4742 Phone: NEstor 9601

FREQUENCY MEASURING SERVICE
 Exact Measurements - at any time
 **RCA COMMUNICATIONS, INC.**
 64 Broad Street, New York 4, N. Y.

Custom-Built
SPEECH INPUT EQUIPMENT
U. S. Recording Co.
 1121 Vermont Avenue
 Washington 5, D. C.
 District 1640

RATES FOR PROFESSIONAL CARDS
 IN THIS DIRECTORY
 \$10 Per Month for This Standard
 Space. Orders Are Accepted
 for 12 Insertions Only

 1031 N. ALVARADO • LOS ANGELES 26, CALIF.

The first step taken by any new group planning to enter FM is to subscribe to *FM AND TELEVISION*. That is why consultants who use this Directory are the first to reach new clients.

Professional Service Directory

Frequency Measurements

Highest Accuracy — Anytime

One of the best equipped monitoring stations
in the nation

STANDARD MEASURING & EQUIPMENT CO.

Phones B77-2652 Enid, Oklahoma
Since 1939

WATKINS 9-5310

S. A. Barone Co.

Consulting Engineers

MECHANICAL—RADIO—ELECTRONIC
PRODUCT DEVELOPMENT & RESEARCH

Development Specialists in Circuits, Part
Lists, Models, Manufacturing Drawings.

143-145 W. 22ND STREET, NEW YORK 11

ENGINEERING AND PATENT LIBRARIES

Bound volumes No. 11 and 12 of
FM AND TELEVISION for January to
June, 1946, and July to December
1946 are now being made up. Price,
each, \$5.50 plus 25¢ shipping charges

Since 1940, this Magazine
has been the broadcasters'
chief source of information
on FM activities and
progress.

THE WORKSHOP ASSOCIATES

INCORPORATED

*Specialists in
High-Frequency Antennas*

66 Needham St., Newton Highlands, Mass.
Bigelow 3330

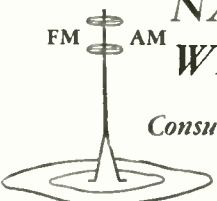

**NATHAN
WILLIAMS**
Consulting Engineer

20 Algoma Blvd.
Oshkosh, Wis.
Phone: Bl'khawk 22

DALE POLLACK FREQUENCY MODULATION

development and research
transmitters, receivers
communications systems

352 Pequot Avenue New London, Conn.
New London, 2-4824

RATES FOR PROFESSIONAL CARDS IN THIS DIRECTORY

\$10 Per Month for This Standard
Space. Orders Are Accepted
for 12 Insertions Only

RADIO BOOKS BY MAIL

OVER 125
TITLES
IN STOCK

SAME-DAY SHIPMENT ON 98% OF ALL MAIL ORDERS.
Books of nearly all radio publishers. If you don't know
price, send deposit and we'll ship C.O.D.

Send stamp
for catalog to **EDITORS AND ENGINEERS, Ltd.**
1309 Kenwood Road • Santa Barbara, California



RADIO CONSULTANTS INCORPORATED

A qualified group of associates offer a consultation and planning
service, for both proposed and operating FM, AM, Fac-simile and
Television broadcasting organizations.

Preliminary Planning
Application Preparation
Site Selections
Construction

Rate Structure
Program Structure
Personnel - Traffic
Station Promotion

Supplementary services accorded to your attorneys and engineers.
Experienced consultation, planning and engineering relative to all
phases of broadcasting.

Inquiries Invited

RADIO CONSULTANTS, Incorporated

Leonard L. Asch, Director

Denrike Building, 1010 Vermont Ave., NW
Washington, D. C., Executive 3929

LOOK AT THE *Western Electric* 25B CONSOLE

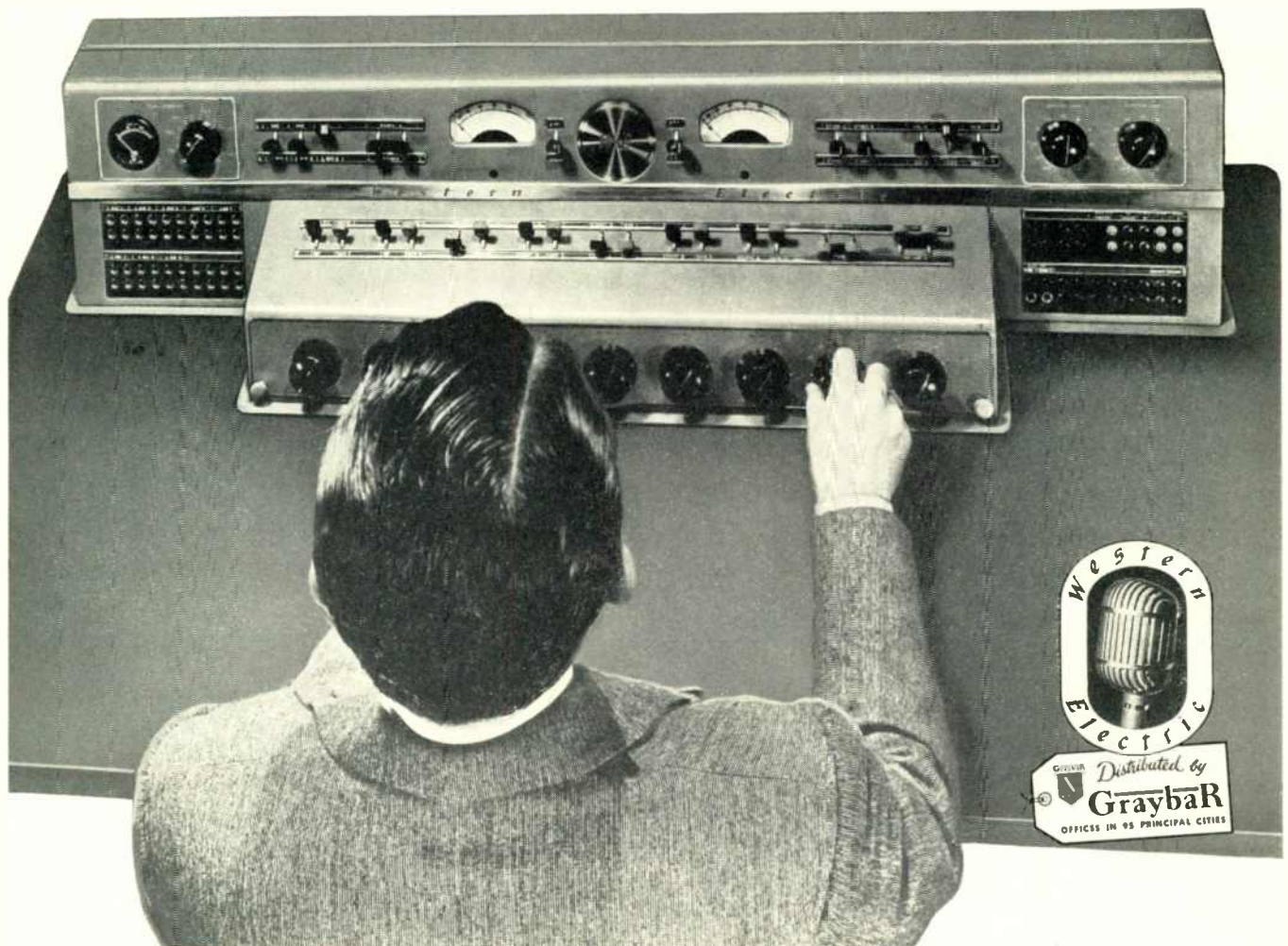

... from the operator's point of view

Look at those large mushroom type control knobs—made for finger-tip control and so easy to handle. Notice the flat type key handles, in two colors, with wide concave finger surfaces—and the easy-to-read volume indicators. See how all controls are functionally located for maximum ease in handling programs.

Designed by Bell Laboratories, the 25B handles AM and FM programs simultaneously—gives highest quality studio control. In the panel at right, you'll find more reasons why broadcasters go for this new Western Electric console.

For full information, see your local Graybar Broadcast Equipment Representative or write to Graybar Electric Co., 420 Lexington Ave., New York 17, N. Y.

Why broadcasters go for the 25B

Designed for both FM and AM broadcasting.

Frequency response ± 1 db 50 to 15,000 cycles.

Harmonic distortion less than 1 percent at +8 dbm single frequency output.

Noise 70 db below peak signal.

Minimum of lost air time—duplicate equipment permits instantaneous switching from one amplifier channel to the other.

Maximum accessibility to all equipment.

Complete equipment for 2-studio operation.

Seven channel mixer circuit can be used with four microphone inputs and three line level inputs simultaneously.

Operating controls arranged and coordinated for flexibility and convenience.

Compact—only 36" high, 55 1/4" wide, 28 1/4" deep.

Wired for plug-in connection to wall boxes.

Simple and economical to install.

QUALITY COUNTS

FM ASSOCIATION GIRDS FOR BIG JOB AHEAD

All-Industry FM Association Is Organized Seven Months After Plan Was Proposed in This Magazine

THE organization meeting of the FM Association on January 10th at Hotel Statler in Washington should set the wheels in motion to implement four developments of great importance to radio listeners. These are: 1) the expansion of FM service on a nation-wide scale through the cooperation of broadcasters and manufacturers, 2) dissemination of information on FM program and advertising techniques and coverage, 3) obtaining network service for FM stations, and 4) working with the FCC to provide for the future broadening of the FM band to accommodate a greater number of FM stations, and to assure contour protection.

Time Is Ripe ★ During the last eighteen months, without fanfare and the blowing of trumpets, the groundwork for FM broadcasting has been completed. This was an enormous task, for it meant rebuilding all that was destroyed by the FCC during Paul Porter's administration. However, the job has been done so well that, already, some 600 AM broadcasters, in addition to the newcomers, have filed FM applications.

The time is ripe for an all-industry association in which FM broadcasters and manufacturers can work together to their mutual advantage. Zenith Radio has already shown what can be achieved by such cooperation. Now the largest manufacturers of FM receivers by a large margin, Zenith has built its sales by teaming up dealers with their local FM stations. It's a natural combination because it results in more profitable, high-unit sales for the dealers, an accelerated increase in listeners for the stations, and it has given Zenith the leading position in FM set production.

Here, then, is proof that the thinking behind FMA is sound and practical.

Origin of FMA ★ The idea of a new FM association to replace FMBI was first proposed by *FM AND TELEVISION* in our June, 1946 issue. In the column "What's New This Month," we said in part, on page 44:

"Today, the need of an independent organization

of FM broadcasters is urgent. Little can be expected from NAB, for that association management has its hands full of many urgent AM matters, some of which are in direct conflict with FM interests.

"This was emphasized by Commissioner Durr when, on May 3rd, he said of FM broadcasting: 'Conditions could not be more ideal for launching a new service. But there seems to be a disturbing inclination on the part of radio to cling to its old system of aural broadcasting, rather than give free rein to a new system. The new system is admittedly superior, but it means newcomers and, hence, new competition.'"

In the months succeeding, while we pursued this idea in every issue, only one other publication had any comment to make on this highly important proposal, and that was limited to a few paragraphs. Meanwhile, after discussions and correspondence with industry leaders, our original suggestion of an organization of FM broadcasters was modified to include equipment manufacturers, contributing services, and engineering consultants. That was the plan finally adopted at the NAB Chicago Conference, following the demise of FM Broadcasters, Inc.

FMA Should Succeed ★ There is every reason to expect that FMA will prove highly successful and effective. RTPB's FM Panel was a dismal failure because about half its members were from organizations that were antagonistic toward Frequency

Modulation. FMBI was sold out to NAB because some of the FM-AM broadcasters who founded it lost their FM urge during the wartime period of easy AM profits.

The list of those who register at the first FMA meeting will be scanned in all quarters, including the FCC, both for the names of those present and for those who are not included. Some of those who will not attend have expressed a challenging let's-see-'em-get-anywhere-without-me attitude. Others, perhaps mindful of the fact that NAB dues are based on each station's income, have complained that a lot of small operators who haven't any money and won't do any work want the big fellows to give them a free ride. And one of the founders of FMBI said: "FM is doing all right. It doesn't need an association."

These views represent the thinking of NAB management, but we wonder how profound that thinking is. It doesn't seem to take into account the fact that FMA is an all-industry organization, in which manufacturers have a vital interest because FM means far more profits to them. In between, are the radio jobbers and dealers who have had to depend on electrical appliances and records to stay in business since AM set prices dropped so low. They are the ones who are in personal contact with radio listeners. If the broadcasters and manufacturers, working together, can show dealers how to make money by selling FM sets, the dealers will build FM audiences and send the dollar volume of receiver sales up to new record levels.

The AM broadcasters wouldn't know about this. They have profited enormously while manufacturers have been knocking themselves out building more and more sets at less and less profit from year to year.

It appears, therefore, that the operators who are looking for a free ride, without even contributing moral support, are those in the AM field. If FMA does an effective job, they will rush in to cry, "Me, too!" If FMA doesn't succeed, they will have risked nothing.

Network Service ★ For some
(CONCLUDED ON
PAGE 42)



MANY WEST COAST BROADCASTERS AND ENGINEERS SAW THEIR FIRST FM TRANSMITTER AT REL'S DEMONSTRATION AT SAN FRANCISCO

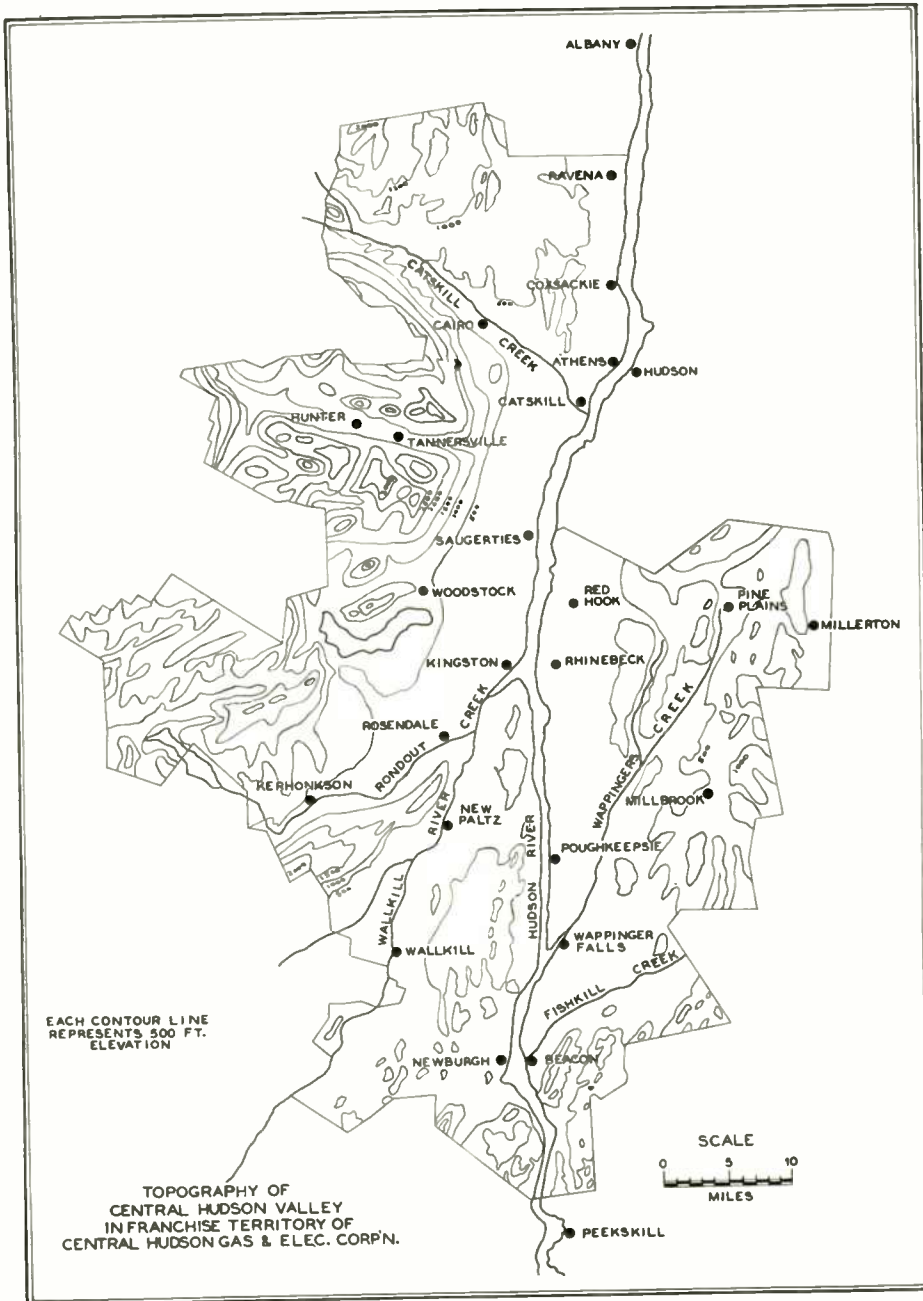

FIG. 1. THE AREA SERVED BY THE CENTRAL HUDSON IS 85 MILES LONG AND 60 MILES WIDE, RANGING IN ALTITUDE FROM NEARLY SEA LEVEL TO A MAXIMUM OF 3,000 FT.

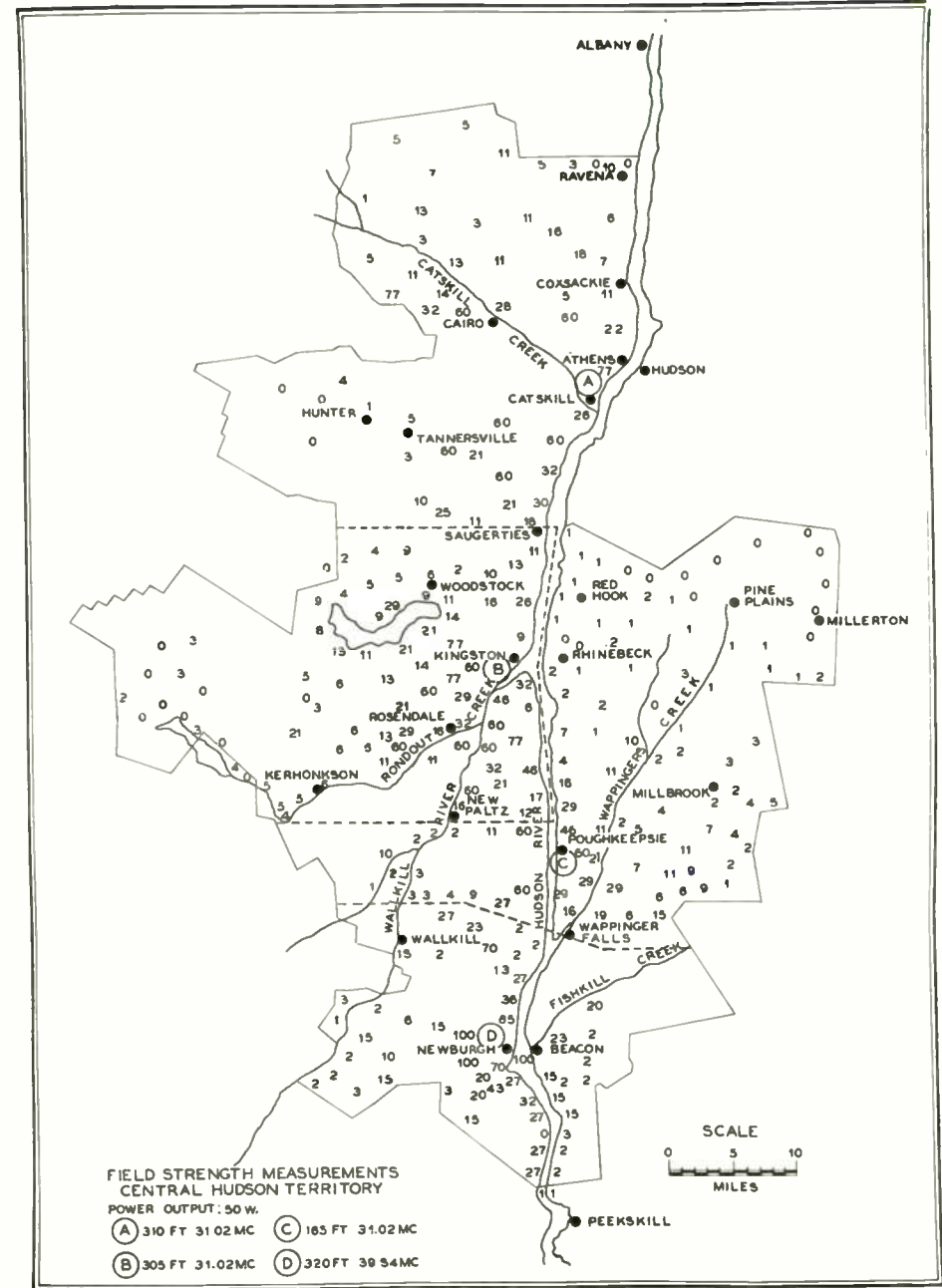

FIG. 2. FIELD-STRENGTH MEASUREMENTS IN MICROVOLTS WITH 50-WATT TRANSMITTERS OPERATING ON 31.02 AND 39.54 MC., AND LOCATED AT POINTS MARKED A, B, C, AND D

MOBILE SYSTEM FOR POWER UTILITY

Report of Tests Which Led to Adoption of 72- to 76-Mc. Band by Central Hudson Gas & Electric Corporation

BY G. H. UNDERHILL*

DURING July and August 1946, the Central Hudson Gas & Electric Corporation of Poughkeepsie, New York, conducted a series of extensive tests to determine the relative capabilities of the 30- to 40-mc. and the 72- to 76-mc. bands as the basis for a mobile radio system covering its entire franchise territory.

As a result of these surveys the 72- to 76-mc. band was adopted, and applications for 8 fixed, 10 portable and 150 mobile stations, operating on a frequency of 75.620 mc., have just been granted by the FCC.

The basic requirements, test procedures, results, and conclusions together with a description of the system adopted, are covered in the following discussion.

Local Conditions ★ Topography: The territory supplied by Central Hudson is located in eastern New York State, and extends along both sides of the Hudson River between Peekskill and Albany. It approximates 2,500 square miles, and in its greatest dimensions is about 85 miles long and 60 miles wide.

Fig. 1 shows the dominant features of the region. Aside from the river valley proper (the Hudson being at sea level throughout) these are 1) the Catskill Mountains which rise to peaks of 3,500 to 4,000 ft. along the western and north-western borders, and 2) the smaller valleys formed by five tributary streams as shown. These smaller valleys vary from 100 to 500 ft. in general elevation, and are separated by ridges with elevations of 1,000 to 1,500 ft. One of these high ridges, extending along the eastern and southeastern border, is cut by the Hudson between Beacon and Peekskill to form the famous Highlands of the Hudson.

Operating Requirements: The territory is divided into 4 Operating Divisions with local headquarters located at the principal city of each division as follows:

Catskill Division: Comprises all areas north of Saugerties on the west bank of the Hudson.

Kingston Division: Lies entirely on the west bank between Saugerties and New Paltz.

Poughkeepsie Division: Lies on both banks. On the west it extends from New Paltz to Wallkill and on the east bank it

includes all areas north of Wappinger Falls.

Newburgh Division: Lies on both banks south of a line through Wallkill and Wappinger Falls.

In all cases, operating headquarters are located directly adjacent to the Hudson River at elevations varying from 70 to 260 ft. above sea level.

During normal working hours each Division dispatches its own crews and it

IN 1932 the Central Hudson Company conducted extensive experiments on both 60 and 30 mc. to determine the feasibility of those frequencies for dispatching mobile field crews. In 1935, following limited-scale operations over a period of about one year, during which the practicability of such a system was amply demonstrated, the Company abandoned further use of the system because of the restrictions placed upon day-to-day use by the Special Emergency Regulations of the Commission.

This pioneer work, however, was instrumental in securing the allocation, in 1936, of a number of Special Emergency frequencies for use on a shared basis by power companies.

The recent action of the FCC in creating a new Utility Service Classification and in formulating less restrictive regulations applicable thereto, resulted in a reconsideration of Central Hudson's 1935 decision and led to the tests described here.

was considered essential that the radio system conform to this arrangement. During nights, week-ends and holidays it may be found possible to effect material economies by centralizing all dispatching at the Main Office in Poughkeepsie, and it was deemed desirable to provide for such future possibility.

In addition to conforming to the flexibility of this operating plan, there was the obvious requirement that a high degree of reliability be provided in the radio-communication system to insure its availability under the most adverse weather conditions.

The obviously desirable answer to these operating requirements was to locate a fixed transmitter at each of the operating headquarters where it would be provided with ample emergency power and where no telephone lines would be involved. Such an arrangement posed very serious propagation problems and careful study of the topographical difficulties led to the conclusion that neither the 152- to 162-mc. band nor the 72- to 76-mc. band could

possibly provide adequate service from the headquarters locations without resort to excessively high antenna structures. It was, therefore, decided to conduct initial tests from each of the four locations with 30- to 40-mc. equipment.

Initial Tests ★ Equipment: With the proposed fixed stations located only 16 to 20 miles apart, powers higher than 50 watts were ruled out and tests were made using 50-watt fixed and 30-watt mobile units.

General Electric equipment operating on 31.02 mc. was used at Catskill, Kingston and Poughkeepsie, and Link equipment operating on 39.54 mc. at Newburgh. Both used vertical, concentric dipoles. The antenna heights and elevations were as follows:

Location	Height	Elevation	Noise
Catskill	85 ft.	310 ft.	1.0 μ v
Kingston	45	305	1.8
Poughkeepsie	95	165	1.3
Newburgh	65	320	0.3

The mobile equipment was conventional, with the antenna mounted as high as possible on the side of a sedan delivery truck.

Procedure: The routes to be followed by the mobile unit were laid out in advance to cover all major highways and all substations and generating plants.

Readings of signal strength and noise (microamperes in 1st limiter grid) were taken at both mobile and fixed receivers, and later converted to microvolts input by calibration curves which were run on both receivers immediately after the tests.

Following these field tests, a fixed receiver was set up in Poughkeepsie and operated for several days on 39.86 mc. in order to determine the extent of interference which might reasonably be expected under conditions of actual operation on a channel allocated to power utility use, the experimental channels employed for the tests being practically unoccupied.

Results: The results of these field tests have been plotted on Fig. 2, which shows only a few typical readings out of the 535 taken in over 1,000 miles of road coverage. These should be related to Fig. 1, for proper interpretation.

In general, the coverage, although not satisfactory, was about as anticipated considering the low antenna elevations and the high noise levels at the fixed stations. In several vital remote locations the signal did not over-ride local noise at the

* Assistant to Chief Engineer, Central Hudson Gas & Electric Corp., Poughkeepsie, N. Y. Just after this paper was written, the FCC issued C.P.'s for the 70-mc. system.

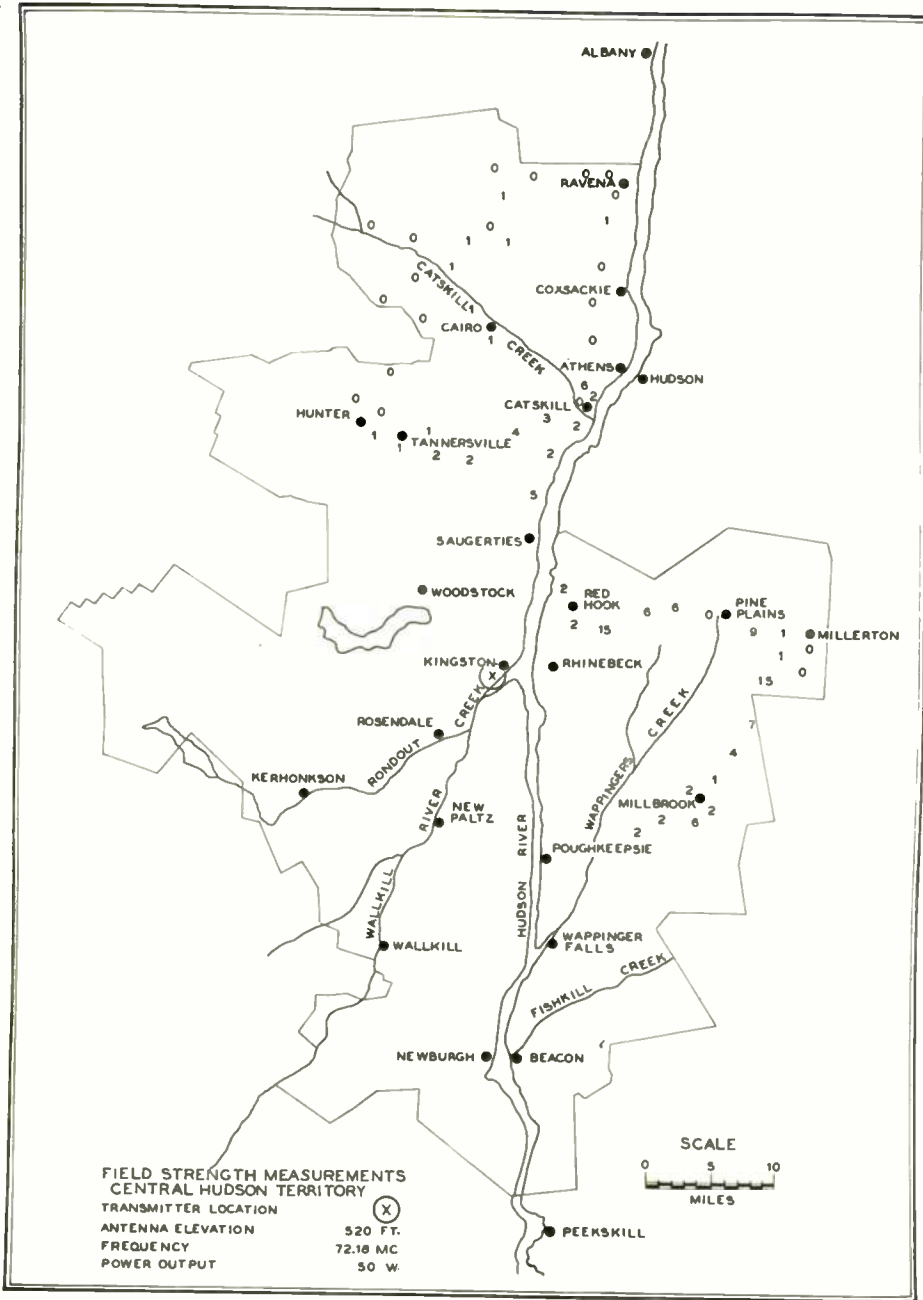

FIG. 3. SAMPLES OF READINGS, IN MICROVOLTS, DURING RECEPTION TESTS WITH A TRANSMITTER OF 50 WATTS OPERATING ON 72.18 MC. FROM A 520-FT. ELEVATION AT KINGSTON

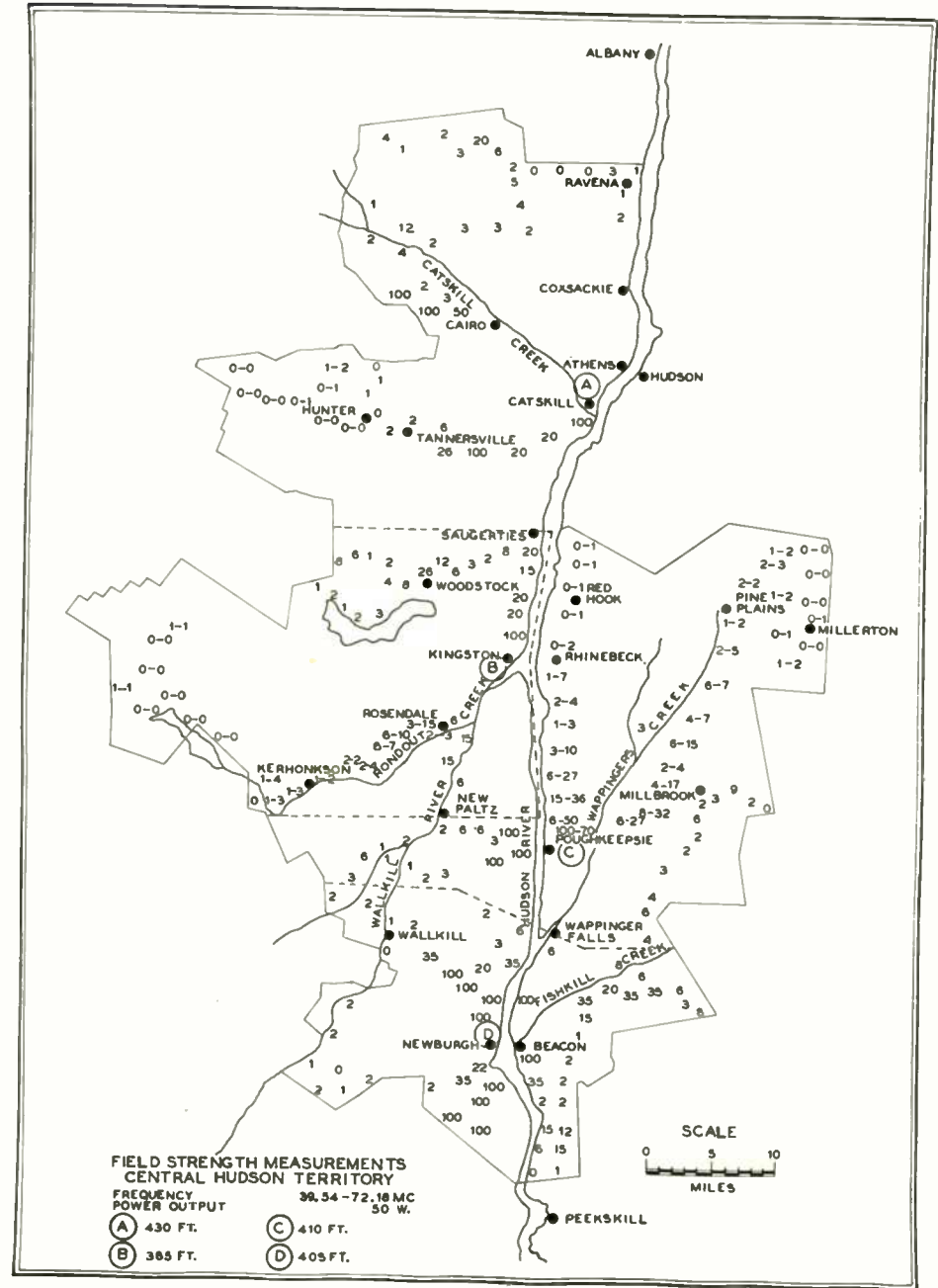

FIG. 4. COMPARISON OF RECEPTION ON 39.54 AND 72.18 MC. WHERE TWO VALUES ARE SHOWN, READING AT LEFT IS FOR 39.54 MC.; OTHERWISE, THEY ARE FOR 72.18 MC.

mobile unit. On the other hand, there were three major instances where a usable signal was received directly behind extensive ridges 1,000 ft. or more in elevation. These were at Tannersville out of Catskill; at Loyd, east of New Paltz, out of Poughkeepsie; and along highway U.S. 9, east of Beacon, out of Newburgh. Similar results, reported in many other tests, merely confirmed the belief that reflection opportunities in mountainous regions may provide satisfactory and unpredictable communication paths.

During the test reception on 39.86 mc., some 30 identified and numerous unidentified stations were logged. These were located at various points in the northeastern and north central U.S.A. at distances up to 900 miles. Over one 2-hour period, calls averaged more than one per minute. In very few instances, however, were signal strengths sufficient to possibly override signals from a local transmitter.

Conclusions: From these preliminary tests it was concluded:

1. That, except in the comparatively small Newburgh area, the fixed station locations were unsuitable for adequate coverage even at 30 to 40 mc.

2. That certain remote areas — Millerton, Hunter, and the upper Rondout valley — would require special treatment.

3. That further tests should be conducted from more suitable locations, radio-wise, using both 30- to 40- and 72- to 76-mc. equipment.

The decision to investigate the higher band was based upon the belief:

1. That the character of the territory, as evidenced by unusual results on 30 to 40 mc. at many locations, might permit satisfactory coverage at points far below line of sight paths.

2. That the 72- to 76-mc. band would provide comparative freedom from interference known to be serious on 30 to 40 mc. as a result of extended ground waves and skip.

3. That this advantage would more than offset the somewhat lower signal-to-noise ratio resulting from restricted deviation ratio required by the 40-ke. separation specified at 72 to 76 mc.

4. That less difficulty in local coordination of frequency assignments might reasonably be anticipated in the 72- to 76-mc. band. There are no allocations to the common carrier rural mobile service in this band, and it will probably not be utilized by local municipal police or fire departments. The areas of operation of the latter services in Central Hudson territory are sufficiently limited to permit the use of 152- to 162-mc. channels at such time as obsolescence requires major replacements of their present 30- to 40-mc. equipment.

Intermediate Tests ★ To explore the capabilities of the 72- to 76-mc. band before undertaking an extensive series of tests from the four locations, it was decided to

select a favorable central location and, in effect, partly circle the territory at the extreme range.

A 50-watt Link station unit operating on 72.180 mc. was accordingly installed at Kingston, with the antenna mounted

Division	Location	Height	Elev.	Noise
Catskill	Eastgate Hill	80 ft.	440 ft.	0.2 μ v.
Kingston	Hillcrest Ave.	65	385	0.3
Poughkeepsie	Beck's Hill	45	415	0.2
Newburgh	Marne Avenue	55	395	0.4

on top of a 160-ft. water tower at an elevation of approximately 520 ft. Noise at this location averaged less than 0.3 microvolt. A Link mobile unit with a roof-top antenna was installed in a sedan. As a control and emergency talking circuit, a 39.54-mc. circuit was also set up, using a 50-watt Link station unit feeding an antenna on a 35-ft. pole, near the base of the water tower (elevation 415 ft.) and a 30-watt Link mobile unit mounted in a small truck. Separate mobile units were used both to eliminate any possible distortion of the radiation pattern by an adjacent antenna, and to avoid excessive generator and battery loads.

Results: The 72.18-mc. field strengths produced by the mobile transmitter at the fixed location during this test are shown on Fig. 3. This, again, represents average samples of the 70 odd readings taken on 72.18 mc. in a 300-mile loop.

It was found impracticable to keep the two mobile units close together and, since strictly comparable readings were not obtained, no 39.54-mc. readings have been shown on Fig. 3. From the standpoint of usable communication, however, it was the opinion of all persons engaged in the test that the difference in fixed antenna elevations, some 105 ft., together with the higher output from the 72.18-mc. mobile unit, just about compensated for the difference in frequency. No location was encountered where either frequency would alone provide satisfactory communication. At the shorter ranges, within about 10 miles, the 72.18-mc. field strengths were consistently stronger. Between 10 and 20 miles, the 39.54-mc. signal was equal to or slightly better than the 72.18-mc. signal. Beyond 20 miles both signals were spotty. Numerous locations in that area were found where neither frequency would produce a usable signal. Also, there were a few spots where the 72.18-mc. signal could not be heard at all but where the 39.54-mc. signal was definitely present although below the noise level and unintelligible.

Conclusions: These results were so promising that it was decided to proceed with a new series of tests at or near the four operating headquarters for the purpose of determining whether the higher frequency could provide satisfactory communication throughout the local area and, if not, whether the lower frequency would.

Final Tests ★ Following out this plan, four new locations near the local offices were selected, and comparative tests conducted from each.

The antenna locations, heights, elevations and noise levels were as follows:

Apparatus Used: Link equipment was used throughout these tests. Two 50-watt station type units were mounted in a truck and supplied over a temporary 120-volt service cable run to the hilltops. To insure identical conditions at the fixed stations, the two antennas were mounted at opposite ends of a short piece of pipe supported by bearings attached to a steel mounting plate. The assembly, in the form of a half swastika with a short center section, was then adjusted so that the antenna tips were the same distance from the center shaft. This contrivance was then mounted on top a pipe mast, and arranged so that by operating ropes from the ground the arrangement could be rotated through 180° and back, and either antenna thus placed and held in a vertical position; the other one resting alongside the supporting mast, well out of the field. A circular radiation pattern was thus assured on both frequencies.

For the mobile installation, the two sets were mounted in one truck completely independent of each other, and arranged so that the antenna not in use could be quickly and completely removed.

Procedure: Since the primary object of the tests was to determine whether or not 72.18 mc. would provide satisfactory coverage, the routes were planned to permit 72.18 mc. to be used along a route radiating from the main station until a point was reached where marginal operation occurred. From that point out to the limits of the territory, careful note was made of the test locations, a time schedule was arranged, and the mobile unit proceeded to the end of the run, changed antennas, and started back using 39.54 mc., testing from the same locations used before.

To eliminate the effect of standing wave patterns, every test was made with the mobile unit in motion and with the field strength reading at the fixed location mentally averaged while the mobile unit traversed a distance of not less than 250 ft. In most instances, this procedure placed the body of the truck between the mobile antenna and the fixed station, with the result that the 39.54-mc. field strengths were usually noticeably above the average of readings taken while travelling in opposite directions across any given test location.

Results: In more than 2,000 miles of car travel, nearly 600 tests were made. As before, the test results were sampled and

they were plotted as is shown in Fig. 4.

A comparison of these two sets of data and, where 39.54 mc. readings are missing, of the 72.18 mc. results with those at 31.02 mc. shown on Fig. 3, confirmed the general results reached in the preliminary tests.

In tests at two locations, Catskill and Kingston, the effect of antenna height and trees and foliage upon signal strengths were brought out rather sharply. In the

to the south. This elevation placed it below the tops of the many trees thereabouts, and it was not until the antenna mast was raised 30 ft. to the top of a pole that satisfactory signals were received to the south, the ratio being roughly 3 to 1 in several locations. As well as could be determined, the trees constituted the only obstruction in that direction. The change made no difference in signal strength to the north, where the line of sight was clear

illustrate the fact that beyond line of sight, performance is unpredictable and must be determined by actual field tests.

Conclusions: As a result of these tests it has been concluded:

1. That with an output power ratio of 5/3 in favor of the 72.18-mc. mobile unit, the higher frequency will in general:

a. Provide higher signal strength over short ranges. (0-10 miles)

b. Provide essentially equivalent signal

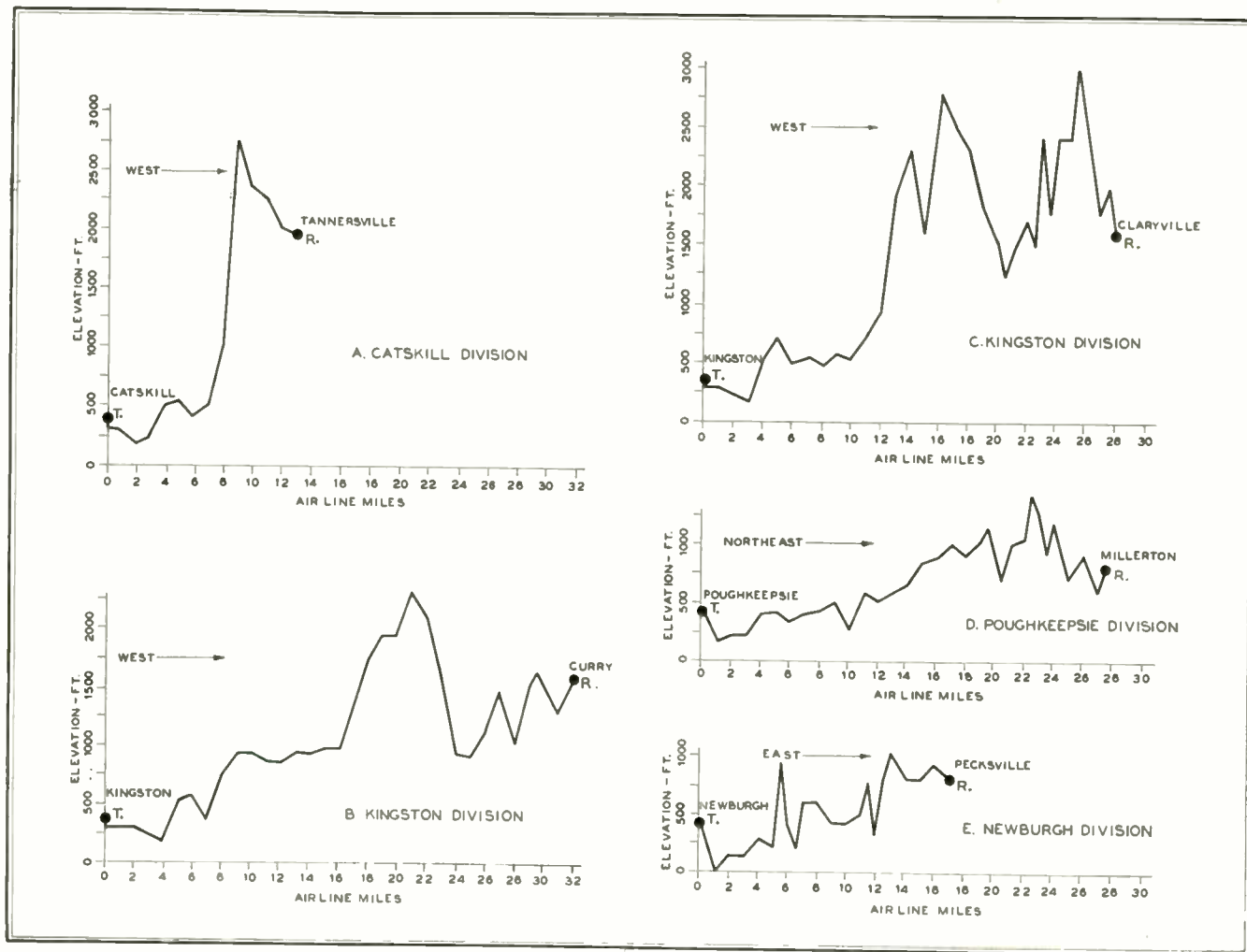

FIG. 5. IN THESE FIVE INSTANCES, COMMUNICATION WAS OBTAINED BETWEEN POINTS MARKED BYDOTS, USING 50 WATTS AT 72.18 MC.

Catskill test, a small hill was located about $\frac{1}{4}$ mile north of the antenna whose tip was roughly 100 ft. below the crest of the hill. Several miles to the north where there were no mountains to act as reflectors, the cut off behind the hill was found to be quite sharp on 72.18 mc., much sharper in fact than was noted behind larger hills located several miles to the west of the fixed station where nothing obstructed the line of sight for the first 3 to 5 miles. Raising the antenna some 50 ft. brought a very great increase in signal strength behind the close-in hill to the north, while no change was noted back of the more distant hills to the west.

At Kingston somewhat the same effect was noted except that there the fixed antenna was approximately 10 ft. above the average ground level of a flat plateau just

for 5 miles minimum.

In both cases the before and after variation in field strength on 39.54 mc. was considerably less than that experienced on 72.18 mc.

In several instances unusual results were obtained in mountainous territory where usable to satisfactory communication was unexpectedly obtained. As a matter of interest, five such instances have been plotted on Fig. 5, where the profiles and distances shown are along a straight line between transmitter and receiver plotted from U.S.G.S. Quadrangles, and not along the route followed by the mobile unit. In considering these, it should be remembered that there were many more similar locations where no communication whatever on either frequency could be obtained. The cases presented, therefore, simply il-

strength over medium ranges. (10-20 miles)

c. Provide less signal strength and somewhat poorer coverage at ranges beyond 20 miles.

2. That mountainous territory provides frequent opportunity for usable to satisfactory communication over paths which are both unusual and unpredictable.

3. That the successful performance of any system is vitally dependent upon the selection of fixed transmitter locations which provide:

a. Adequate heights

b. Minimum noise levels

c. Clear sight paths for 2 miles or more in all directions

None of these conclusions is new, startling, or in conflict with accepted theory. However, too little attention ap-

appears to have been given to the importance of securing an unobstructed path in the near vicinity of the fixed antenna. During the tests herein described, it was demonstrated conclusively that this factor should be given equal weight with the more generally accepted essentials of height and low noise.

important result to Central Hudson was that the higher frequency did provide satisfactory communication over most of the Company's franchise territory. Study of a complete plot of all data on a large-scale map led to the conclusion that, for the test locations chosen, a 72- to 76-mc. channel would, with few exceptions, pro-

strengths produced in the ring lying between the 15- and 20-mile limits were in many cases uncomfortably close to an acceptable minimum. In planning the final system, an effort was made accordingly to choose permanent locations at higher elevations and closer to the geographic center of the Division than were the test points. Furthermore, a comparatively low antenna height, 74 ft., was decided upon in order to avoid, so far as possible, any marking or lighting requirements of the CAA. This decision further emphasized the need for the careful selection of isolated hills rather than plateaus wherever possible.

Permanent System ★ Locations: As finally planned, the system will consist of 4 main and 4 emergency stations. Subject to FCC approval the main stations are to be as follows:

Catskill — 50 watts, 4 miles northwest of the test location, with an antenna elevation of 740 instead of 440 ft.

Kingston — 50 watts, 2 miles southwest of the test location, with an antenna elevation of 565 instead of 385 ft.

Poughkeepsie — 250 watts, 5 miles north of the test location, with an antenna elevation of 575 instead of 415 ft.

Newburgh — 50 watts, 4½ miles northwest of the test location, with an antenna elevation of 720 instead of 395 ft.

Power Supply: Each station will be normally supplied at 120 volts AC from the Company's lines, but will be equipped also with a 32-volt storage battery, trickle charger, and rotary converter which will provide 6 to 10 hours independent operation. Transfer to this emergency supply will occur automatically, and simultaneously a warning signal will be transmitted to the control point. Should it prove impossible to restore normal power service within the time limit, a 1-kw. portable gasoline engine driven alternator can be transported to the transmitter and operated indefinitely.

Telephone Lines: Each main station will be normally controlled over a single telephone circuit. The major portion of this will be in cable, but the open wire remainder will introduce a definite hazard.

To prevent extended disruption of radio service following possible failure of the telephone circuit, it is planned to base a 50-watt portable station at each of the control points which are to be located in the Division Headquarters.

Field tests have shown that a portable transmitter at any one of the headquarters can readily communicate both with mobile units operating in the most highly populated part of its own division, and with the main transmitter in the adjacent division. That transmitter, in turn, is expected to be able to reach the major portion of the territory deprived of radio service by telephone line failure. Should both possibilities prove inadequate, full

(CONCLUDED ON PAGE 66)

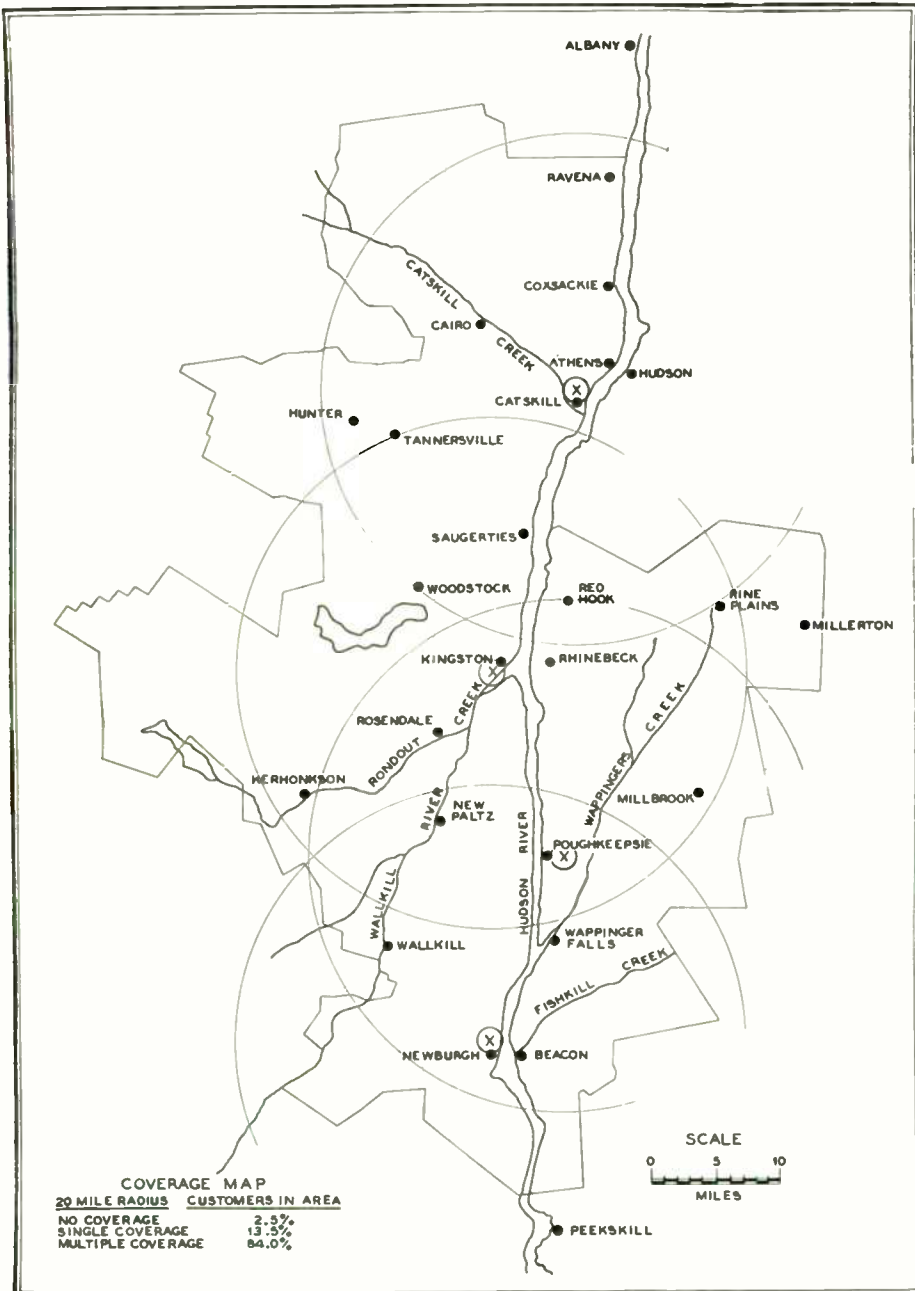

FIG. 6. OVER 85% OF THE COMPANY'S CUSTOMERS ARE WITHIN THESE 20-MILE CIRCLES, REPRESENTING DEPENDABLE COVERAGE ON 72 MC.

In other words, with other factors equal and with a comparatively low antenna height, a location on an isolated hill would seem to be preferable to one on an extensive plateau having a somewhat higher elevation. Although not thoroughly investigated in these experiments, this factor would appear to become more noticeable as the operating frequency increases.

General Conclusions ★ Although these findings may be of general interest, the more

vide satisfactory communication over a 20-mile radius.

Analysis of the number of customers served by the Company in the area covered by 20-mile radius circles centered on each transmitter (see Fig. 6), indicated that better than 85% are included in the area reached by more than one transmitter and that only 2½% lie outside the 20-mile circles of all transmitters. Although this coverage was deemed satisfactory, it was recognized that the field

FACTS OF LIFE ABOUT FM

Practical Information about Demonstrating, Selling, and Installing FM Receivers

BY MILTON B. SLEEPER

IN CASE you may be misled by the title above, let me explain that this discussion has nothing to do with the birth of Frequency Modulation. Major Armstrong is the only one who can write with authority on that subject, and he's probably willing to forget the trials he underwent in those days.

Instead, this is strictly a bull session for radio dealers who are interested in handling receivers that carry 3-figure price tags, and who are smart enough to realize that people will buy expensive models if they hear a sufficient improvement in what comes out of the loudspeaker.

What UHF Means to Dealers ★ The coming of Frequency Modulation has brought with it a fundamental change in the whole radio sales-and-service picture. When operating frequencies are measured in megacycles, as is the case with FM, facsimile, and television, dealers and their customers are confronted with a whole new set of conditions. The simplest explanation is this:

AM radios, operating on low frequencies, give some kind of results under almost any conditions. AM reception, at best, is none too good, but at worst there is at least a whisper or a squeal to hear.

FM, and the other services coming on ultra-high frequencies, give all-or-nothing performance. Results are either perfect, or else there are no results at all. There is practically no middle ground.

That is why an AM set stays sold even though the customer says: "It's not so good, but I guess it will do."

But when you sell an FM set, the customer will either say: "It's wonderful. I've never heard anything like it in my life, and the family is crazy about it!" or else: "Take that set out and give me back my money! My friends get beautiful FM programs, but I can't pick up a single station!"

The difference doesn't lie in Frequency Modulation. It's the difference in the characteristics of low frequencies, used for AM, and the ultra-high frequencies used for FM broadcasting, facsimile, and television.

So, if you feel that FM sets are too tricky to handle, and that you'd better stick to cash-and-carry AM sales, remember that you'll be cutting yourself out of facsimile and television, too. You'll really be stepping out of the radio picture entirely for, after 1947, production and sale of straight AM sets will amount to very little. In fact, you may be surprised to

know that a demand for straight FM sets is developing already, and that such models will be in production in 1947.

Common Mistakes ★ The foregoing, however, does not mean that radio dealers must become engineers in order to stay in business. On the other hand, they will be forced to learn a few new fundamentals, and to make some revisions in their methods.

Let me give you an example from my own town of Great Barrington, Massachusetts. The population is only some 5,000, but the dealers draw trade from a considerable surrounding area, and a surprisingly large number of families are sufficiently well-to-do that they can afford new sets in the brackets above \$200. AM reception is exceedingly poor here, but FM comes in beautifully from half a dozen stations.

Our leading radio dealer has had one of the top AM lines for many years. These sets, except for some low-priced models, have always had a stage of tuned RF. Thus, they have out-performed less expensive AM receivers with 2-gang condensers. That extra stage makes a lot of difference where conditions are unfavorable, as they are here.

So this dealer has needed little more technical knowledge than is required to sell a flatiron or a refrigerator. His success came mostly from knowing the right people.

His first FM set was a phono combination, priced at \$450. Two days after it was delivered, I stopped in to ask how it performed on FM. I was particularly interested in what he would have to say, because I knew he had never heard FM before that time. "Oh," he said, "that set went out before I had a chance to try it in the store."

"Well," I asked, "how did it work at the customer's home?"

"I tried it on the built-in FM antenna, but I couldn't hear anything. We're waiting for a dipole to come in. Then I guess it will work on FM. Anyway, the customer likes the phonograph, and the AM is OK."

Six weeks later, when I was in the store again, I saw another big set. This proved to be an FM-AM console. It wasn't even plugged into the AC, but I connected it, switched to low-band FM, and waited for the tubes to warm up. Then came a tremendous roar. I looked again to see if that was the AM band. It wasn't. The noise persisted all along the dial on both FM

bands. The AM band, however, brought in the usual number of stations, with the usual amount of noise, but the background level was much lower than the roar I heard on the FM bands. It occurred to me that the built-in FM antenna might have been disconnected, but it wasn't.

About that time, the dealer walked over. I asked him what was wrong with the set. Certainly in our town, an FM-AM set priced at \$250 should bring in Major Armstrong's low-band transmitter. Even before the war, I had brought in the Major's station at the home of a friend just down the street, using the single-wire antenna he had for his AM receiver.

The dealer told me: "I haven't tried this model. Anyway, they haven't shipped me any dipoles yet."

"What about that set you delivered six weeks ago? Haven't you put an antenna on it yet?"

"No. She uses the AM, and she likes to play records."

There you have the FM performance record of two sets in a line which had the top rating before the war, and before FM broadcasting: one set sold that didn't bring in a single FM station, and one on display that delivered nothing but a roar on both FM bands.

Down the street, there's another dealer. He's back in business after three years on radar in the Army. He came out as a technical sergeant. I knew he had sold one FM-AM console. I didn't know anything about that model from personal experience, but I had heard that it was good. So I stopped in to see the sergeant, feeling sure that a man of his experience would do a first-class FM installation job. I inquired: "How about that FM receiver you sold? How is the FM reception?"

"Pretty good," the sergeant said.

"How many stations does it bring in?"

"Well, only two, now."

"Didn't you install an antenna?"

"Oh, sure, I gave 'em a dipole. But it's just standing on the floor beside the set. I haven't had time to put it up yet."

The radio had been delivered a month back, and he'd been too busy to finish the job in that length of time.

There's another FM set in our town. It belongs to a young dentist who was in the Navy. He doesn't pretend to know anything about radio, but he has quite a reputation locally for his professional skill. He bought his set in New York City, and installed it himself. I ran into him the other day at lunch.

"How's your FM set, Doctor?" I in-

quired. His eyes lighted up. "Magnificent!" he exclaimed. "It's simply wonderful."

"How many stations do you get?"

"I get eight, in Hartford, Meriden, Schenectady, Alpine, and New York City. These are all high-band stations. My set doesn't have low-band tuning."

"Do you use a dipole?"

"Oh, sure. I put it up on the end of my house. It's about 30 feet above the ground. They told me when I bought my set I'd probably need one."

That set cost \$1,050. It was lucky for the Doctor that he got sound advice from his dealer, and followed it.

Receiver Sensitivity & Antennas ★ Perhaps the FM set manufacturers take it for granted that dealers understand the difference in the characteristics of broadcast frequencies and those used for FM and television. Or perhaps they are afraid to draw attention to the antenna problem because people are accustomed to built-in antennas on AM sets.

However, manufacturers of television receivers are sending out factory engineers to install antennas at dealers' stores, to make sure that demonstration sets will work perfectly. In addition, they are installing sets that the dealers sell, to assure satisfactory performance. Yet the television stations now on the air operate at frequencies below the new FM band!

How, then, can FM sets be expected to operate satisfactorily without proper antenna installations?

At the low frequencies, a built-in loop or a few feet of wire on the floor are enough to bring in some AM stations, even though the background noise is louder than the signals. But an FM set requires a certain minimum signal from the antenna in order to operate the limiter. On highly sensitive sets, this minimum is only a few microvolts. Others may require several hundred microvolts.

It is true that a very sensitive receiver may give perfect reception on a built-in antenna, provided it is near enough to an FM station. It is dangerous, however, to guarantee perfect reception on any set in any area without a good antenna until after it has been tried out in the customer's home. The reason is that the customer may be particularly interested in some station that does not happen to come in well where his home is located.

Again, the customer who uses only a built-in antenna may be entirely satisfied with the results until he compares notes with a neighbor who has an outside antenna. Then he will storm into the dealer's store with: "That set you sold me is a lemon! Why, so-and-so gets three stations I can't hear at all, and his receiver didn't cost half as much as mine!"

That's bad. The time to talk about putting up an antenna is not when the customer complains. By that time, he has lost confidence in the dealer, he feels he

has been misled, and in that frame of mind he wants the dealer to install the antenna without charge.

As to the kind of antenna required at a given installation, there is only one answer. It must pick up the weakest station the customer wants to hear, with a signal strong enough to operate the limiter on the set to which it is connected.

This situation is familiar to dealers and servicemen who have handled television. When a television set is installed, if the picture does not hold synchronism, the antenna must be improved, because the set isn't getting a signal of adequate strength. That's the answer, and there's no mystery about it. The answer is the

HOW GOOD IS FM?

IS FM really better than AM? Will I be able to hear it at my home? Do you advise me to get an FM set? These questions are being asked by radio listeners everywhere today.

Here are answers you can give on the authority of Charles R. Denny, Chairman of the Federal Communications Commission:

"The Commission has expressly authorized me to say to you again that it is our opinion that FM is the finest aural broadcasting system obtainable in the present state of the radio art.— Our long-range plans for FM look forward to the day when every square inch of every state from the Atlantic Ocean west to the middle of the Dakotas, Nebraska, Kansas, and Texas will be covered, night and day, with satisfactory FM signals. Similarly, FM signals will blanket the Pacific Coast states solidly."

So, except to listeners in the rural areas of the Rocky Mountain states, you can say with complete assurance of giving sound advice: "If you buy a radio without FM, it will be obsolete when you get it!"

same on FM, because both services work on ultra-high frequencies, and both have all-or-nothing operating characteristics.

As to the details of antenna design—that is not a subject for discussion here. Data is available from manufacturers of antennas, and from FM set manufacturers.

FM Models Vary ★ From time to time, every dealer and every radio engineer is asked the question: "What, in your opinion, is the best radio? What set would you advise me to buy?" If the answer is given without prejudice, it will probably be: "All AM sets are good today," or else "One AM set is about as poor as another," depending on the point of view.

That is not true of FM receivers, however. Different makes vary widely in FM performance as to 1) sensitivity, 2) noise limiting, and 3) audio quality. FM has brought back competition among manufacturers on the basis of performance. Some are excellent, some are good, and others are pretty poor. Price is not necessarily a criterion of FM results. But you can certainly tell by listening.

Better Methods Are Needed ★ It is amazing to see how many of the larger stores and radio departments have FM sets on display but either not operating at all, or not installed properly. At R. H. Macy's, in New York City, for example, we saw a very expensive FM set on display, but not in operating condition. In fact, we couldn't even pull out the phonograph because the shipping bolts had never been removed.

A friend we sent to John Wanamaker's for an FM set got this advice in the radio department: "You'd better take an AM model. The FCC hasn't settled the FM frequencies and, when they do, this FM radio may not be any good to you." The model in question, by the way, had both FM bands!

At Sloane's, rated as perhaps New York's finest furniture store, we found one of the best FM models on display, and plugged into the AC line. But what came out of the speaker when we turned it on would make the set over-priced at 50% off the list. We didn't find out what was wrong but, in that condition, it never should have been on the floor. As for information about local FM stations—we might as well have asked the clerk about the radar installations on the Jersey coast.

Perhaps methods at these stores have changed already, or will be corrected soon. We mention these examples to show how FM set sales can be lost by misinformation or the lack of it, and by indifference to the changing conditions which confront dealers as the result of opening up the ultra-high frequencies for public service.

Practical Suggestions ★ When the first automatic washing machine was introduced, dealers gasped at the price. But their customers didn't, because the new design could do things that the cheaper models couldn't. So the dealers who were able to master the demonstration, sale, and installation of the automatic washers stepped into bigger profits than they had ever realized before from this part of their business.

FM offers the same opportunity. But: *like the automatic washers, upper-bracket FM sets must deliver better performance than cheap AM receivers.*

Therefore, the dealer must first satisfy himself as to the superior performance of an FM line before he takes it on. Then, he must prepare to demonstrate the superiority of FM over AM in his store. Inci-

(CONCLUDED ON PAGE 69)

SPOT NEWS NOTES

Items and comments, personal and otherwise, about manufacturing, broadcasting, communications, and television activities

Networks for FM: Independent FM stations have a network affiliation problem. This is tied in with undisclosed AT & T plans for rates and availabilities of 15,000-cycle lines. Only information released so far is map of 15,000-cycle Bell System routes, furnished as a supplement to our February, 1945 issue. This problem is high on FMA agenda.

Fremont, Ohio: Robert F. Wolfe, owner of independent FM station WFRO, advises that his transmitter is now on the air 8 hours each day with 300 watts at 104.7 mc. Programs feature interesting line-up of local talent and activities.

Complaint Department: Author of "Monopoly Steals FM from the People" complains that we gave no editorial attention to his pamphlet. Asserting that "the American press is notorious in the suppression of news which the public should have in the United States," he asks: "Why, then, did FM AND TELEVISION deny its readers knowledge of the fact that this pamphlet was published and available?"

The answer is simply that we felt we had already covered the subject very completely in these pages. In this publication, we are so busy looking forward that we don't spend much time looking back. If Mr. Konecky and his Provisional Committee for Democracy in Radio, or anyone else, will come out with a study of the present FM allocations, and a plan under which the FCC can set up enough channels for the unrestricted expansion of FM service to radio listeners, we'll publish the text in full. With us, the line of action is forward!

Baseball Games: Those played at the Yankee Stadium in New York during 1947 will be televised by DuMont.

Called Off: The Broadcast Engineering Conference, sponsored annually by Illinois and Ohio State Universities, will not be held in 1947. Crowded conditions and shortage of personnel are given as reasons for cancellation.

Cambridge, Mass.: Work has been started on a 4-story addition to the General Radio plant. This structure, of 30,000 square feet, will give the Company a total of 140,000 square feet of office and manufacturing space.

The Milwaukee Journal: After switching television plans from black-and-white to color, and then abandoning the whole idea, *The Journal* has reapplied for black-and-white. Meanwhile, *The Journal* has been granted a CP for an FM station at Wausau, to cover north central Wisconsin,

and an application has been filed for a Green Bay station to cover north eastern Wisconsin.

William F. Cotter: Appointed chief engineer of Scott Radio Laboratories, Chicago, succeeding Marvin Hobbs, who is now engaged in consulting practice on broadcast equipment. Cotter, after 10 years with American Bosch, joined Stromberg-Carlson in 1935 as chief radio engineer, and later became radio consulting engineer. He is considered one of the ablest FM receiver experts.

TBA: Latest addition to membership of Television Broadcasters Association is Pulitzer Publishing Company, FM and AM broadcasters in St. Louis.

Rubbing It In: Our local Philco dealer, who has been tearing his hair over the shortage of FM sets for Christmas sales, is a Philco stockholder. The other day, he got a dividend check accompanied by a letter suggesting that he recommend Philco sets to his friends. Well, the radio business is like that!

Kenneth A. Norton: Appointed chief of the Frequency Utilization Research Section of the Central Radio Propagation Laboratory at the National Bureau of Standards. His Section will study noise, propagation, and transmitter-receiver characteristics which affect radio system performance, and advise U. S. agencies on the usefulness of various frequency bands for specific applications.

Tube Socket Guide: E. F. Johnson, Waseca, Minn., has published a list of some 900 different types of tubes, showing the base type and pin arrangement of each, with details of suitable sockets and caps. This extremely useful guide is available to engineers without charge.

Set Production: November RMA report shows total production of 1,496,482 radio and television receivers. FM-AM models accounted for 27,330, or 2% of the total, compared to 1½% in October. AM sets dropped 11% from October figure, while FM sets were up 15%. Of 1,844 television receiver, 1,551 were table models. Year's television total was reduced when RMA reported that, in September, 3,223 phono combinations had been erroneously listed as television sets. Correct figure was 19 for that month.

Knoxville, Tenn.: WROL-FM is on the air with 1 kw. at 93.1 mc. Meanwhile, according to station director F. C. Gow, work is proceeding on an 8-bay square-loop array to replace temporary single-bay antenna.

Authorized power is 76 kw. FM should show up to great advantage in this area because of the poor AM receiving conditions, both during the day and at night.

Arthur Church: Purchased 3-kw. FM transmitter which RCA exhibited at the Chicago NAB Conference. Equipment was shipped directly from Chicago to station KMBC, Kansas City, and is now being installed.

A. J. Eaves: Has been elected vice president of Finch Telecommunications, Inc. He will continue to head up sales on facsimile and associated equipment.

New Bedford, Mass.: First postwar FM station in New England is WFMR, operated by E. Anthony & Sons, publishers of *The New Bedford Standard-Times*. Operating with an interim 250-watt RCA transmitter and 4-bay square-loop antenna, the station is on the air from 3:00 to 9:00 p.m. daily. William R. Hutchins is manager and chief engineer.

Color Television Receivers: According to RCA's George L. Beers, all-electronic color television receivers comparable in performance to black-and-white receivers being sold today would be approximately double in cost.

\$50,000 Promotion: RMA appropriated this sum to sell radio listeners the Radio-in-Every-Room-of-the-House idea. Then the plan was held up in Committee, pending consideration of the use of this money to promote FM. Maybe RMA discovered that the sets now in use are adequate to demonstrate the shortcomings of AM. What this country needs most is a set in each home that will pick up one station at a time, and do a good job of it.

Decatur, Ill.: WSOY-FM is now operating 17 hours daily with a 250-watt RCA transmitter and an Andrew antenna atop the WSOY tower. Later, FM power will be stepped up to 31.2 kw., with a 3-bay turnstile on a 460-ft. Truscon tower. Merrill Lindsay is general manager, and Milburn H. Stuckwisch is chief engineer.

Theatre Television: Proposed to take the place of second features in British movie houses. That would make television available to those who cannot afford home receivers, and might answer the problem of paying the bills for television shows.

New York City: WCBS-FM now has a Rocket antenna, manufactured by Finch Telecommunications, on its tower at 500 Fifth Avenue. With a gain of 2.5, this brings WCBS-FM up to full authorized power.

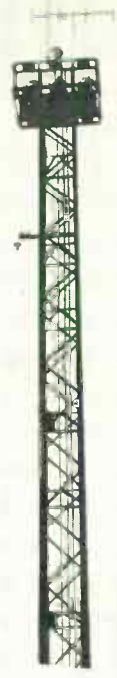

NEWS PICTURE

THESE views show part of the FM installation at the Kansas City freight yard of the Chicago, Rock Island, & Pacific Railway. Operating under a permanent frequency assignment of 161.61 mc., 5 engine units and 2 yard points have been equipped already. Final plans call for a

total of 30 mobile units, communicating with 6 control points distributed over the yard area.

The upper left picture, taken at the Kansas City-Amourdale Yards, shows the first operating crew. At the extreme right is Philip Yahn, Sperry Gyroscope engineer and specialist on railroad radio, and third from the right is Ernest Dahl, electronic engineer for the Rock Island. At the upper right is a picture of the bi-

directional antenna, mounted on a floodlight tower, which beams signals in line with the tracks.

Below are views of the engine cab installation, and of the Sperry FM railroad transmitter-receiver unit, mounted just forward of the cab. The new Amphentol-type antenna is directly above, on the cab roof where it is most effective as a radiator yet, since it is less than 12 ins. high, ample clearance is allowed.

ALL-PURPOSE FM-AM RECEIVER

This Hallicrafters Model Covers AM on .54 to 110 Mc., with FM on 27 to 110 Mc.

BY NELSON CASE*

ONE of the desires of the communication receiver designer is the achievement of the ultimate, with a receiver that will serve all purposes for all users. Over the past several years there has been steady progress toward this goal, with the result that present-day receivers are a far cry from those available a few years ago.

To be truly an all-band receiver, coverage of all the presently-used frequencies should be attained. Also, with the expansion of FM broadcasting at 88 to 108 mc., inclusion of this service is a "must." At the other end of the spectrum lies the standard broadcast band, with a low frequency limit of 540 kc. The magnitude of this design problem can be more easily understood when it is realized that the frequency range to be covered is approximately 200 to 1.

Between these two extremes, there lies the great middle band of frequencies to be covered, with their many and varied services including amateur short wave bands, emergency services using FM and AM, and a host of others requiring varied degrees of selectivity and audio response.

In the design of the Hallicrafters model SX-42, many problems not normally encountered in conventional receivers

*Chief Engineer, The Hallicrafters Company, Chicago 16, Ill.

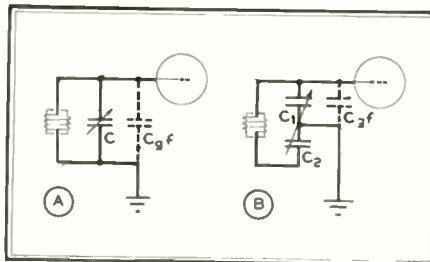

FIG. 1. METHOD OF REDUCING GRID-TO-GROUND CAPACITY WITH SPLIT CONDENSER

were met and solved. The problem of designing a receiver to cover the range from AM broadcasting to 30 mc. is not particularly difficult. However above 30 mc. the gain of conventional tubes suffers severely, as the input impedance goes down rapidly, and the old bugaboo of distributed capacity at high frequency becomes troublesome. It is readily apparent that different techniques are necessary over the range between 30 and 110 mc.

Several avenues are open to the designer to overcome these problems, but if the convenience of bandswitching is to be retained, most of those methods are impracticable. In addition, the total number of bands must be kept within reason. This requires a frequency range of at least 2 to 1 in all bands. In the SX-42,

the frequency coverage has been divided into six bands as follows:

AM	— 0.54-1.62
AM	— 1.62-5.0
AM	— 5.0 -15
AM	— 15-30
FM-AM	— 27-55
FM-AM	— 55-110

With the large tuning capacitor required to cover the broadcast and adjacent bands, it is obvious that some other method must be used for the higher frequencies. At these frequencies, the leads to the bandswitch itself constitute an appreciable part of the circuit inductance. This can be minimized by the use of coils mounted directly on the bandswitch, and the use of large conductors between the band switch and tuning capacitor. Silver plated copper strip is used in this particular receiver.

Minimum capacity of the tuning condenser is still a problem, however. We found that this could best be solved by the use of a split-stator condenser. This puts a lower minimum capacity across the tuned circuit than is obtained by any other method, as the two sections of the condenser are then effectively in series across the coil. The end result is that the grid-to-ground capacity of the tube is in series with one section of the split-stator condenser, resulting in only a small increase in the total circuit capacity. This can be seen readily by examining the two circuits shown in Fig. 1. Reduction of the minimum capacity allows the use of coils of considerably higher inductance, thereby securing additional gain.

The fundamental circuit used is shown in Fig. 2. As different capacity ranges are needed for various bands, the two sections of the split-stator condenser are not equal, C2 being made about four times as large as C1. Sections are used in series, in parallel, or singly, as required. An advantage in the use of the split stator is the equalizing of the gain-versus-frequency curve. Normally VHF amplifier circuits have the greatest gain at the high-frequency end of a range. An unbalanced split-stator circuit automatically compensates for this effect. As the two sections of the condenser form a voltage divider across the coil, and the minimum capacities of the two sections are similar, approximately half of the total voltage appearing across the coil is applied to the grid of the tube, with the condenser near minimum capacity. As the tuning capacities are increased, the larger section increases more rapidly than

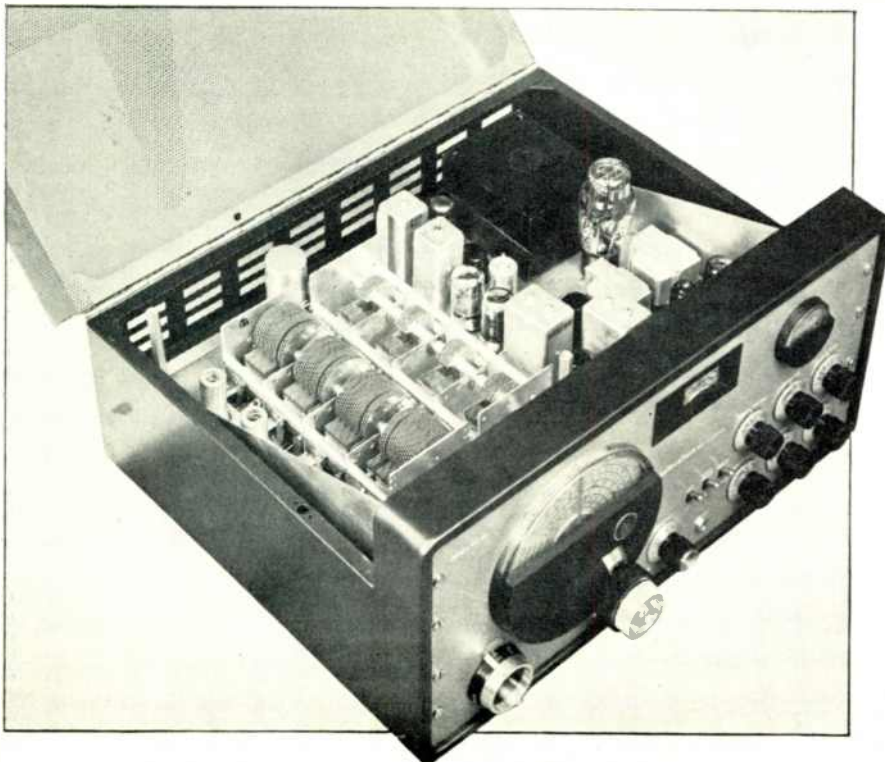

SHOWING FRONT PANEL ARRANGEMENT, AND CONSTRUCTION OF THE METAL CABINET

WHAT'S ALL THIS TALK ABOUT FM?

FM—FINE MUSIC? . . . FLAWLESS MELODY? . . . FREQUENCY MODULATION?

FM is a welcome new alphabetical symbol in this shorthand world in which we live.

For FM are the initials of **FREQUENCY MODULATION**—a new kind of radio broadcasting and reception which *banishes static* and for the first time permits the listener to hear fine music, actors' voices and other sounds *just as they are broadcast*.

In fact, FM can even broadcast *absolute silence* which is itself a "radio miracle." It could broadcast the sound of a pin dropping if anyone wanted to hear it. No static can hitch a ride on an FM radio wave. FM has taken radio out of its scientific swaddling clothes.

FM, or Frequency Modulation, was invented and patented in 1933, after 20 years of research, by Dr. Edwin H. Armstrong, Professor of Electrical Engineering at Columbia University. Dr. Armstrong refused to believe the old platitude that "static like the poor will always be with us."

Now, after 13 years of further experimentation and the overcoming of many natural as well as man-made problems, FM is with us on a practical commercial basis. Every week new FM transmitting equipment is being produced. New

stations are being authorized and are abuilding. New FM receiving sets are being produced and delivered to the public.

But, as with every new and better thing, FM already has imitators who hope to exploit the public's interest in scientific progress. While Dr. Armstrong has made the basic inventions covering "wide swing" Frequency Modulation, without the use of which it is impossible either to broadcast or to receive high quality FM radio signals, nevertheless, the public is already being offered "just-as-good" substitutes under beguiling titles like "Improved FM," "Superior FM," "John Smith's Better FM," etc., etc.

So, as the Romans used to say, *Caveat Emptor*—"Let the buyer beware."

If you buy an FM radio, beware to see that you get what you pay for.

As the buyer of an FM radio you are entitled to the Armstrong system of Frequency Modulation which represents the highest scientific development of the radio art.

On the opposite page are listed all of the receiving set manufacturers who are licensed under the patents covering Dr. Armstrong's invention of Frequency Modulation.



The companies listed below are authorized and licensed to build radio receiving sets containing genuine Armstrong Frequency Modulation:

- | | |
|---------------------------------------|---|
| Airadio, Inc. | Magnavox Company, Inc. |
| Ansley Radio Corporation | Maguire Industries, Inc. |
| Browning Laboratories, Inc. | Minerva Corporation of America |
| Espey Manufacturing Company, Inc. | Pilot Radio Corporation |
| Fada Radio and Electric Company, Inc. | Scott Radio Laboratories, Inc. |
| Freed Radio Corporation | Stewart-Warner Corporation |
| Garod Radio Corporation | Stromberg-Carlson Telephone Manufacturing Company |
| General Electric Company | Templetone Radio Company |
| Hallicrafters Company | Westinghouse Electric Corporation |
| Howard Radio Company | Zenith Radio Corporation |

FM's PUBLIC DEBUT—On November 5, 1935, Dr. Edwin Armstrong and his long-time friend, C. R. Runyon, fellow pioneer of early amateur days, went "on the air" with an FM transmitter (Station W-2AG) located in Mr. Runyon's home in Yonkers, New York. The occasion was a proof-of-the-pudding demonstration to a large and properly skeptical engineering audience, listening in a downtown New York auditorium, to hear if static had at last been really overcome. The FM broadcast, made on power scarcely sufficient to illuminate an ordinary light bulb, was received with "astonishing staticless clarity" from the home-made transmitter located 15 miles away.

AT ALPINE, NEW JERSEY—Dr. Armstrong operates his own experimental laboratory for continued research in FM broadcasting. Utilizing the heaviest steel radio tower in the world, two stations, W2XMN and W2XEA, are on the air daily. From Alpine, staticless FM signals are now being broadcast which can be clearly received 100 miles away.

ON DECEMBER 1, 1946

66 FM stations were in operation
564 stations had been authorized
by the F.C.C.

307 applications were pending
65% of all established AM stations
had already applied for FM licenses

FM, the Static-Free Radio of Tomorrow, Will Soon Replace the Old-Fashioned AM Radio of Today

inverter. As this condenser is of relatively low capacity, it blocks the passage of most of the bass frequencies, preventing degeneration of the bass while degenerating the higher frequencies.

With the switch in the high-fidelity position, a portion of the output is returned directly to the cathode, degenerating all frequencies, resulting in flat response of the audio system. In the medium

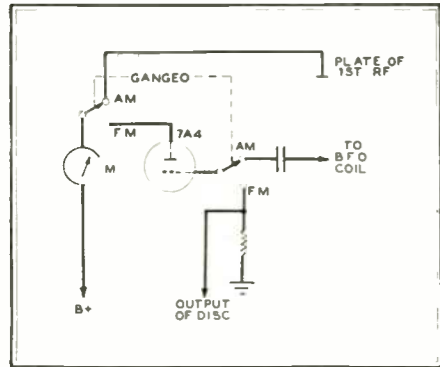

FIG. 3. SPECIAL CIRCUIT ARRANGEMENT USED FOR THE 7A4 TUBE

position, no degeneration is used, and the two 0.05-mfd. condensers in series with the 1,000-ohm resistor are connected from plate to plate of the output tubes, resulting in some attenuation of the high frequencies. The low position accomplishes the same type of result, giving greater attenuation of the highs, as one of the 0.05 mfd. condensers is connected directly from plate to plate of the output tubes.

With an excellent audio system available, the reproduction of phonograph recordings, as well as the newer methods of tape and wire recording, can be re-

produced to best advantage. To enable the user to take advantage of the audio section, a phono input connection has been provided. This jack is automatically connected into the circuit when the RECEPTION switch is turned to PHONO.

The SX-42 has eliminated these usual objections by styling the receiver in a pleasing, functional design, at the same time retaining the appeal to the professional or amateur operator. Use by the entire family is encouraged by marking

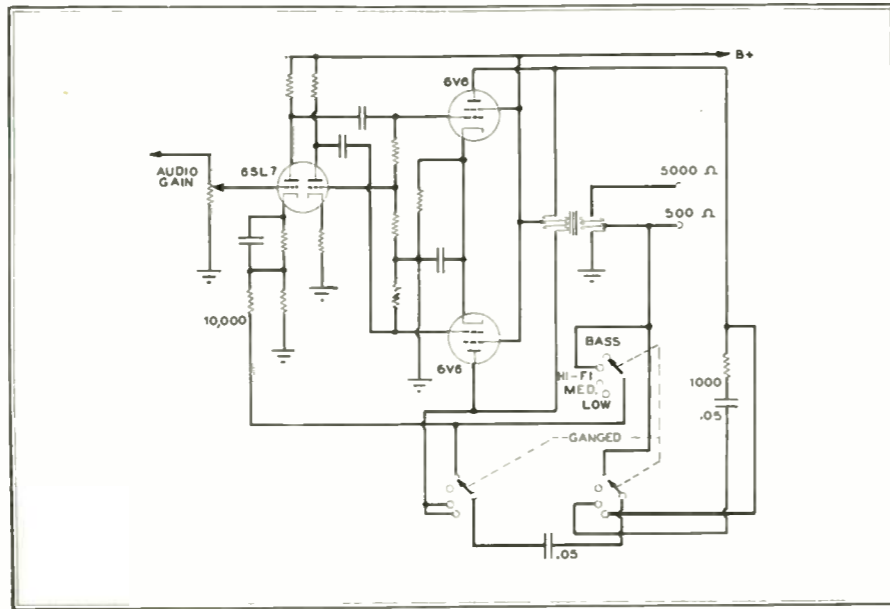

FIG. 4. METHOD OF USING INVERSE FEEDBACK IN THE FOUR-POSITION TONE CONTROL

It has been the practice of manufacturers in the past to emphasize the performance rather than the appearance of communication receivers. This has limited the use of many of these sets to cold basements or drafty attics. Also, the multiplicity of controls with their confusing markings has done little to sell the rest of the family on the value of the receiver as a medium of entertainment.

the normal positions of all controls with red dots for AM broadcast reception and green dots to indicate the correct positions for FM.

As a final bid for family favor, controls have been grouped for maximum convenience in operating, and eyestrain caused by glare has been eliminated by the use of indicators and a meter with translucent green scales.

NEW FM STATIONS

EVERY week brings news of new FM broadcast stations under construction, and of others starting scheduled transmission. Now, the relaxation of Government controls has given the green light to many projects that were held up for materials.

One of the most elaborate of the new FM stations is that to be built by the St. Louis Globe-Democrat. It is of particular interest because this newspaper does not operate an AM station.

The accompanying illustration shows an architect's drawing of the building. On the ground floor there will be four studios with a master control room and three secondary control rooms, in addition to offices for operational and maintenance personnel. The entire second floor will be occupied by the business and management department. Later, a theatre studio, seating an audience of 400, will be added.

As the illustration shows, the foundations for the 525-ft. tower will be a part of the building construction. This station has been authorized to operate on 92.9

mc. with radiated power of 53 kw.

Construction of a community station at Asbury Park, N. J., is now well along. This transmitter, using call letters WJLK, will be of G. E. manufacture, operating into a 4-section RCA pylon antenna. The assigned frequency is 104.7 mc.

Studios will be located in the building occupied by *The Press*, a daily and Sunday paper which owns the station.

Station KOAD, Omaha, which has been doing such an excellent job of featuring

local activities on its programs, reports that there are now 700 FM receivers within its service area. When the station first went on the air, last July, the total was exactly 20. A survey of listeners disclosed that most of the new sets came from Zenith, Stromberg-Carlson, and Scott. Local dealers report that FM set deliveries are running far behind demand, but promises of larger shipments early in 1947 indicate a rapid growth of the FM audience in this area.

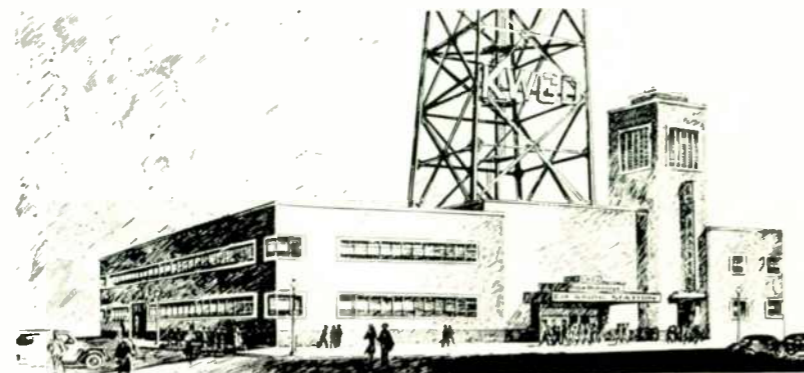

ARCHITECT'S DRAWING OF ST. LOUIS GLOBE-DEMOCRAT'S FM STATION KWGD

the smaller, resulting in a greater portion of the total voltage appearing across the grid of the tube, giving a greater relative gain.

The tube lineup selected for the RF section is: 6AG5 1st RF, 6AG5 2nd RF, 7F8 mixer and high-frequency oscillator. Use of these tubes with their low inter-electrode capacity, short leads, and high transconductance insures adequate gain where it is needed most. The excellent stability of the 7F8 as an oscillator contributes much to the handling ease of the receiver on the higher frequencies.

In any all-wave receiver, it is necessary to provide bandspread throughout the short-wave ranges for ease in tuning. With the bandspread condenser forming a definite portion of the total circuit capacity, some means must be provided to use a relatively large bandspread capacity when the circuit capacity is large, and a lesser amount when the circuit capacity is small.

Two methods can be used to accomplish this purpose. A condenser with sections of different capacity can be used, switching the various sections into the circuit as needed. However, this complicates the bandswitching and adds to the minimum capacities of the circuit.

An alternative method was used in this receiver. A condenser with specially-shaped plates is provided, capable of being rotated in both directions. As the condenser rotates in one direction, it engages specially-shaped stator plates giving relatively small capacity change. When rotated in the opposite direction, plates of greater area are engaged. The rate of capacity change per degree of rotation is thus dependent on the direction of rotation. In this manner, it is possible to obtain two different degrees of bandspread at any point in the range. Accurately calibrated bandspread is provided for all the amateur bands within the frequency range of the receiver.

To insure accurate calibration of the amateur spread bands, it is essential that the main tuning gang be set at a definite point. Tuning is accomplished by the use of two concentric tuning knobs, connected respectively to the main and bandspread gang. A clutch is provided to engage either of the knobs, locking the unused knob in position. The main tuning knob is provided with a calibrated scale viewed through a window in the main dial. In addition, the main tuning dial is provided with reference marks indicating the correct setting of the main tuning for accurate indications on the bandspread dial.

It is readily apparent that more than one intermediate frequency is necessary if satisfactory image ratio is to be obtained on the higher frequency ranges. In the SX-42, two IF channels are used, the lower being 455 kc., with variable bandwidth and a crystal filter that can be switched into the circuit when conditions require. Three degrees of selectivity are

provided, either with or without crystal, giving a total of six to cope with any conditions.

The two highest frequency bands use a 10.7 IF to insure adequate image rejection on these bands. Either AM or FM reception is available at the turn of a switch.

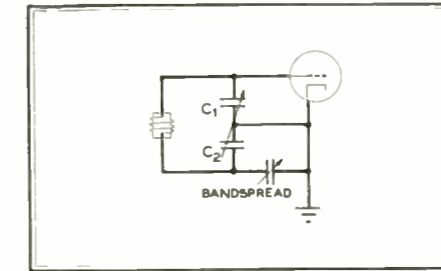

FIG. 2. FUNDAMENTAL TUNING CIRCUIT, WITH BANDSPREAD TUNING CONDENSER

With the switch in the FM position, the IF system consists of a 6SK7 1st IF, 6SG7 2nd IF, and two limiter stages using 7H7's. This is followed by a conventional 6H6 discriminator. In the AM position, the same two IF stages are used, in this case driving a 6H6 diode detector, AVC, and noise limiter.

A novel feature is found in the 7A4 tube used as a CW beat oscillator when code reception is desired. When the reception switch is thrown to the FM position, this tube becomes a DC amplifier, enabling the tuning meter to be used for indicating resonance or the point of center frequency of the received FM carrier. A simplified diagram of this portion of the circuit is shown in Fig. 3.

In the amateur band from 28 to 29.7 mc., FM transmission is authorized in the portion from 29.0 to 29.7 mc. In order to provide for both AM and FM reception in this band, an overlap has been provided between bands 4 and 5. The upper limit of band 4 is 30 mc., while band 5 begins at 27 mc., to allow either type of reception at will. By means of this expedient, a choice of either the selectivity of the 455-kc. IF or the broad characteristics of the 10.7-mc. IF is available. The 10.7-mc. IF also offers the advantage of better image rejection.

With a receiver of this type, audio quality deserves special consideration if the full advantages of FM reception are to be realized. The audio section is composed of a 6SL7 phase inverter coupled to push-pull 6V6's. The output transformer provides output impedances of both 500 and 5,000 ohms.

To satisfy the varied tastes of different listeners and to compensate for room acoustics, some tone compensation is necessary. Many forms of tone control are available. One simple method is the use of inverse feedback to serve the dual purpose of tone control and reduction of distortion. A simplified diagram of this portion of the receiver is shown in Fig. 4.

A brief description of the tone control circuit is probably in order. In the bass position, a small amount of the audio appearing across the output transformer is fed back through a condenser to the cathode of the first section of the phase

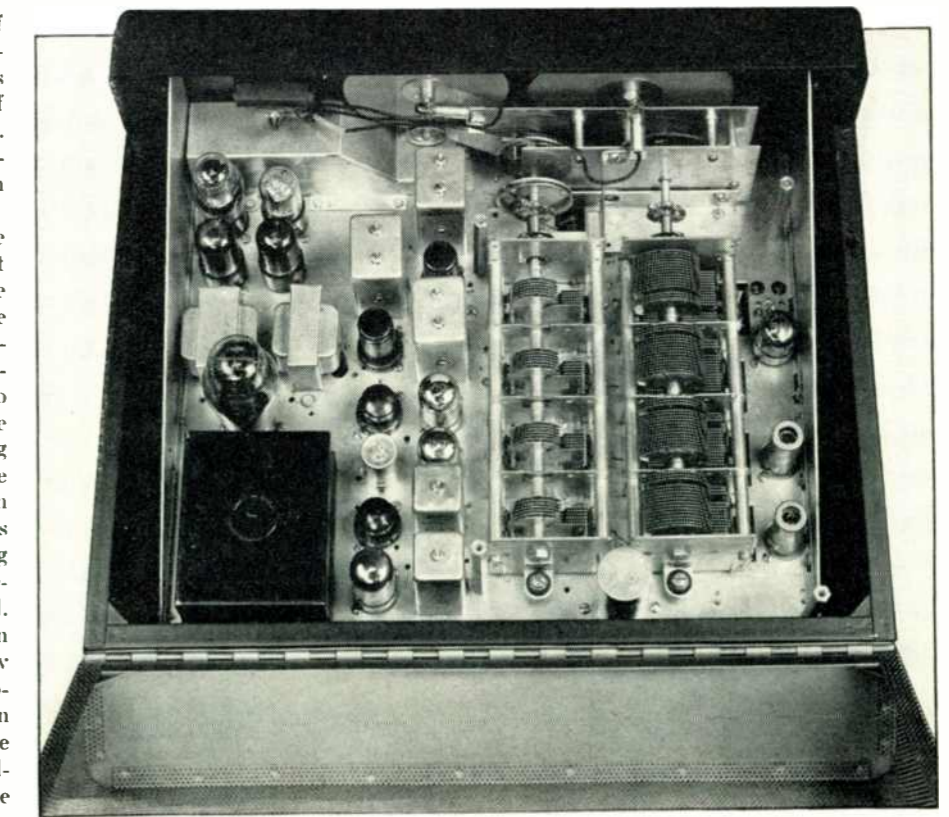

TWO-SECTION TUNING CONDENSERS AND BANDSPREAD CONDENSERS ARE SHOWN HERE

the smaller, resulting in a greater portion of the total voltage appearing across the grid of the tube, giving a greater relative gain.

The tube lineup selected for the RF section is: 6AG5 1st RF, 6AG5 2nd RF, 7F8 mixer and high-frequency oscillator. Use of these tubes with their low inter-electrode capacity, short leads, and high transconductance insures adequate gain where it is needed most. The excellent stability of the 7F8 as an oscillator contributes much to the handling ease of the receiver on the higher frequencies.

In any all-wave receiver, it is necessary to provide bandspread throughout the short-wave ranges for ease in tuning. With the bandspread condenser forming a definite portion of the total circuit capacity, some means must be provided to use a relatively large bandspread capacity when the circuit capacity is large, and a lesser amount when the circuit capacity is small.

Two methods can be used to accomplish this purpose. A condenser with sections of different capacity can be used, switching the various sections into the circuit as needed. However, this complicates the bandswitching and adds to the minimum capacities of the circuit.

An alternative method was used in this receiver. A condenser with specially-shaped plates is provided, capable of being rotated in both directions. As the condenser rotates in one direction, it engages specially-shaped stator plates giving relatively small capacity change. When rotated in the opposite direction, plates of greater area are engaged. The rate of capacity change per degree of rotation is thus dependent on the direction of rotation. In this manner, it is possible to obtain two different degrees of bandspread at any point in the range. Accurately calibrated bandspread is provided for all the amateur bands within the frequency range of the receiver.

To insure accurate calibration of the amateur spread bands, it is essential that the main tuning gang be set at a definite point. Tuning is accomplished by the use of two concentric tuning knobs, connected respectively to the main and bandspread gang. A clutch is provided to engage either of the knobs, locking the unused knob in position. The main tuning knob is provided with a calibrated scale viewed through a window in the main dial. In addition, the main tuning dial is provided with reference marks indicating the correct setting of the main tuning for accurate indications on the bandspread dial.

It is readily apparent that more than one intermediate frequency is necessary if satisfactory image ratio is to be obtained on the higher frequency ranges. In the SX-42, two IF channels are used, the lower being 455 kc., with variable bandwidth and a crystal filter that can be switched into the circuit when conditions require. Three degrees of selectivity are

provided, either with or without crystal, giving a total of six to cope with any conditions.

The two highest frequency bands use a 10.7 IF to insure adequate image rejection on these bands. Either AM or FM reception is available at the turn of a switch.

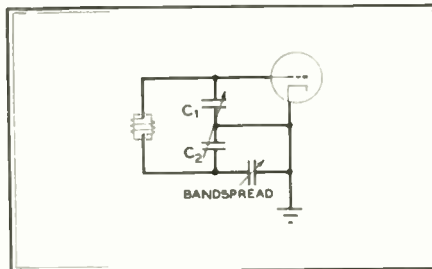
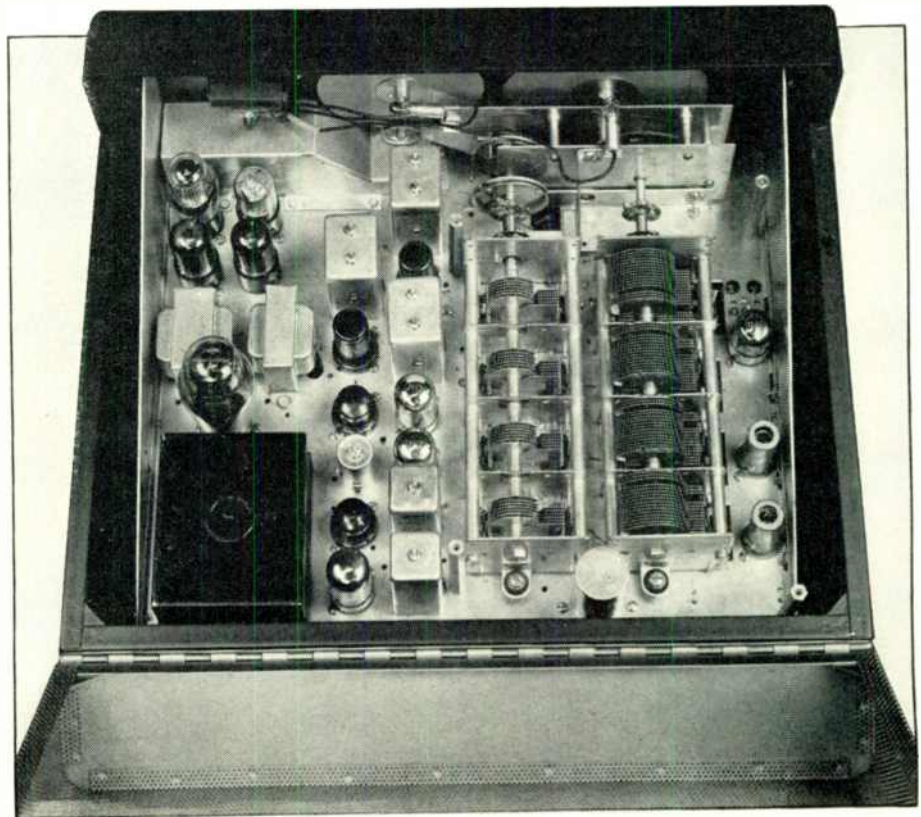

FIG. 2. FUNDAMENTAL TUNING CIRCUIT, WITH BANDSPREAD TUNING CONDENSER

With the switch in the FM position, the IF system consists of a 6SK7 1st IF, 6SG7 2nd IF, and two limiter stages using 7H7's. This is followed by a conventional 6H6 discriminator. In the AM position, the same two IF stages are used, in this case driving a 6H6 diode detector, AVC, and noise limiter.

A novel feature is found in the 7A4 tube used as a CW beat oscillator when code reception is desired. When the reception switch is thrown to the FM position, this tube becomes a DC amplifier, enabling the tuning meter to be used for indicating resonance or the point of center frequency of the received FM carrier. A simplified diagram of this portion of the circuit is shown in Fig. 3.



TWO-SECTION TUNING CONDENSERS AND BANDSPREAD CONDENSERS ARE SHOWN HERE

In the amateur band from 28 to 29.7 mc., FM transmission is authorized in the portion from 29.0 to 29.7 mc. In order to provide for both AM and FM reception in this band, an overlap has been provided between bands 4 and 5. The upper limit of band 4 is 30 mc., while band 5 begins at 27 mc., to allow either type of reception at will. By means of this expedient, a choice of either the selectivity of the 455-kc. IF or the broad characteristics of the 10.7-mc. IF is available. The 10.7-mc. IF also offers the advantage of better image rejection.

With a receiver of this type, audio quality deserves special consideration if the full advantages of FM reception are to be realized. The audio section is composed of a 6SL7 phase inverter coupled to push-pull 6V6's. The output transformer provides output impedances of both 500 and 5000 ohms.

To satisfy the varied tastes of different listeners and to compensate for room acoustics, some tone compensation is necessary. Many forms of tone control are available. One simple method is the use of inverse feedback to serve the dual purpose of tone control and reduction of distortion. A simplified diagram of this portion of the receiver is shown in Fig. 4. A choice of four degrees of tone compensation is available.

A brief description of the tone control circuit is probably in order. In the bass position, a small amount of the audio appearing across the output transformer is fed back through a condenser to the cathode of the first section of the phase

WHAT'S ALL THIS

FM — FINE MUSIC? . . . FLAWLESS MELODY? . . . FREQUENCY MODULATION?

FM is a welcome new alphabetical symbol in this shorthand world in which we live.

For FM are the initials of **FREQUENCY MODULATION**—a new kind of radio broadcasting and reception which *banishes static* and for the first time permits the listener to hear fine music, actors' voices and other sounds just as they are broadcast.

In fact, FM can even broadcast *absolute silence* which is itself a "radio miracle." It could broadcast the sound of a pin dropping if anyone wanted to hear it. No static can hitch a ride on an FM radio wave. FM has taken radio out of its scientific swaddling clothes.

FM, or Frequency Modulation, was invented and patented in 1933, after 20 years of research, by Dr. Edwin H. Armstrong, Professor of Electrical Engineering at Columbia University. Dr. Armstrong refused to believe the old platitude that "static like the poor will always be with us."

Now, after 13 years of further experimentation and the overcoming of many natural as well as man-made problems, FM is with us on a practical commercial basis. Every week new FM transmitting equipment is being produced. New

stations are being authorized and are abuilding. New FM receiving sets are being produced and delivered to the public.

But, as with every new and better thing, FM already has imitators who hope to exploit the public's interest in scientific progress. While Dr. Armstrong has made the basic inventions covering "wide swing" Frequency Modulation, without the use of which it is impossible either to broadcast or to receive high quality FM radio signals, nevertheless, the public is already being offered "just-as-good" substitutes under beguiling titles like "Improved FM," "Superior FM," "John Smith's Better FM," etc., etc.

So, as the Romans used to say, *Caveat Emptor*—"Let the buyer beware."

If you buy an FM radio, beware to see that you get what you pay for.

As the buyer of an FM radio you are entitled to the Armstrong system of Frequency Modulation which represents the highest scientific development of the radio art.

On the opposite page are listed all of the receiving set manufacturers who are licensed under the patents covering Dr. Armstrong's invention of Frequency Modulation.

FM's PUBLIC DEBUT—On November 5, 1935, Dr. Edwin Armstrong and his long-time friend, C. R. Runyon, fellow pioneer of early amateur days, went "on the air" with an FM transmitter (Station W-2AG) located in Mr. Runyon's home in Yonkers, New York. The occasion was a proof-of-the-pudding demonstration to a large and properly skeptical engineering audience, listening in a downtown New York auditorium, to hear if static had at last been really overcome. The FM broadcast, made on power scarcely sufficient to illuminate an ordinary light bulb, was received with "astonishing staticless clarity" from the home-made transmitter located 15 miles away.

FM, the Static-Free Radio of Tomorrow, Will Soon Replace the Old-Fashioned A

TALK ABOUT FM?



The companies listed below are authorized and licensed to build radio receiving sets containing genuine Armstrong Frequency Modulation:

- | | |
|---------------------------------------|---|
| Airadio, Inc. | Magnavox Company, Inc. |
| Ansley Radio Corporation | Maguire Industries, Inc. |
| Browning Laboratories, Inc. | Minerva Corporation of America |
| Espey Manufacturing Company, Inc. | Pilot Radio Corporation |
| Fada Radio and Electric Company, Inc. | Scott Radio Laboratories, Inc. |
| Freed Radio Corporation | Stewart-Warner Corporation |
| Garod Radio Corporation | Stromberg-Carlson Telephone Manufacturing Company |
| General Electric Company | Templeone Radio Company |
| Hallicrafters Company | Westinghouse Electric Corporation |
| Howard Radio Company | Zenith Radio Corporation |

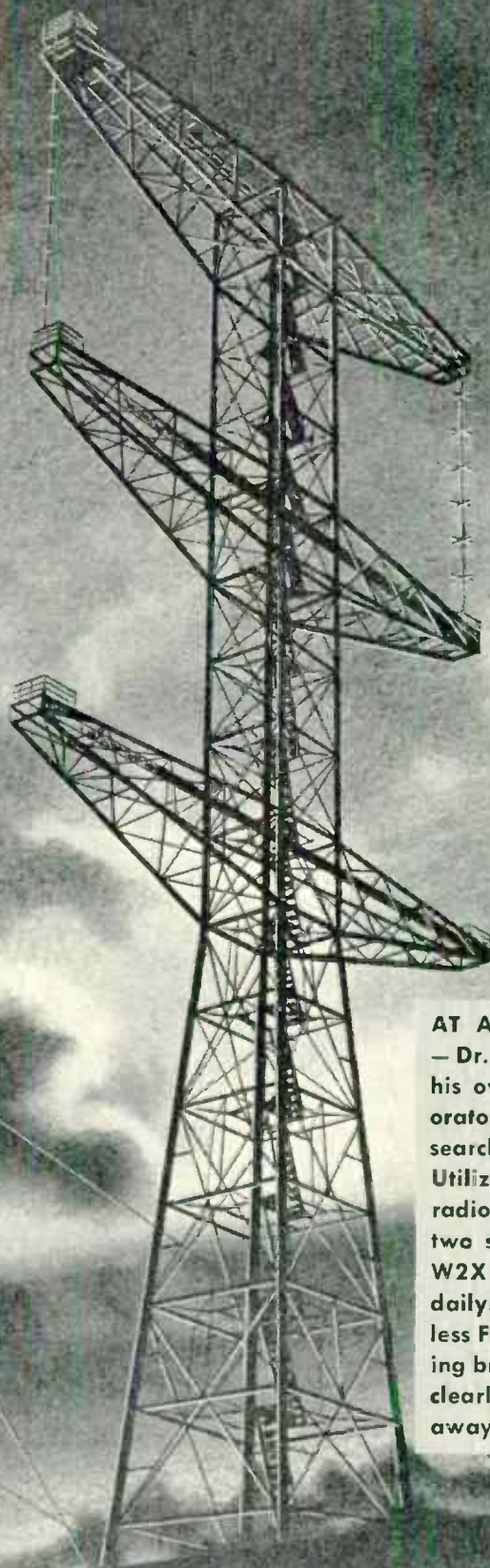

AT ALPINE, NEW JERSEY
— Dr. Armstrong operates his own experimental laboratory for continued research in FM broadcasting. Utilizing the heaviest steel radio tower in the world, two stations, W2XMN and W2XEA, are on the air daily. From Alpine, staticless FM signals are now being broadcast which can be clearly received 100 miles away.

ON DECEMBER 1, 1946

66 FM stations were in operation
564 stations had been authorized
by the F.C.C.

307 applications were pending
65% of all established AM stations
had already applied for FM licenses

FM Radio of Today

World Radio History

inverter. As this condenser is of relatively low capacity, it blocks the passage of most of the bass frequencies, preventing degeneration of the bass while degenerating the higher frequencies.

With the switch in the high-fidelity position, a portion of the output is returned directly to the cathode, degenerating all frequencies, resulting in flat response of the audio system. In the medium

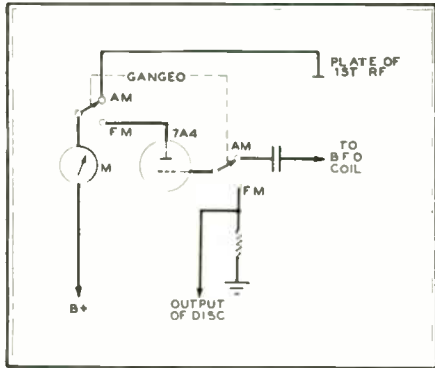

FIG. 3. SPECIAL CIRCUIT ARRANGEMENT USED FOR THE 7A4 TUBE

position, no degeneration is used, and the two 0.05-mfd. condensers in series with the 1,000-ohm resistor are connected from plate to plate of the output tubes, resulting in some attenuation of the high frequencies. The low position accomplishes the same type of result, giving greater attenuation of the highs, as one of the 0.05 mfd. condensers is connected directly from plate to plate of the output tubes.

With an excellent audio system available, the reproduction of phonograph recordings, as well as the newer methods of tape and wire recording, can be re-

produced to best advantage. To enable the user to take advantage of the audio section, a phono input connection has been provided. This jack is automatically connected into the circuit when the RECEPTION switch is turned to PHONO.

The SX-42 has eliminated these usual objections by styling the receiver in a pleasing, functional design, at the same time retaining the appeal to the professional or amateur operator. Use by the entire family is encouraged by marking

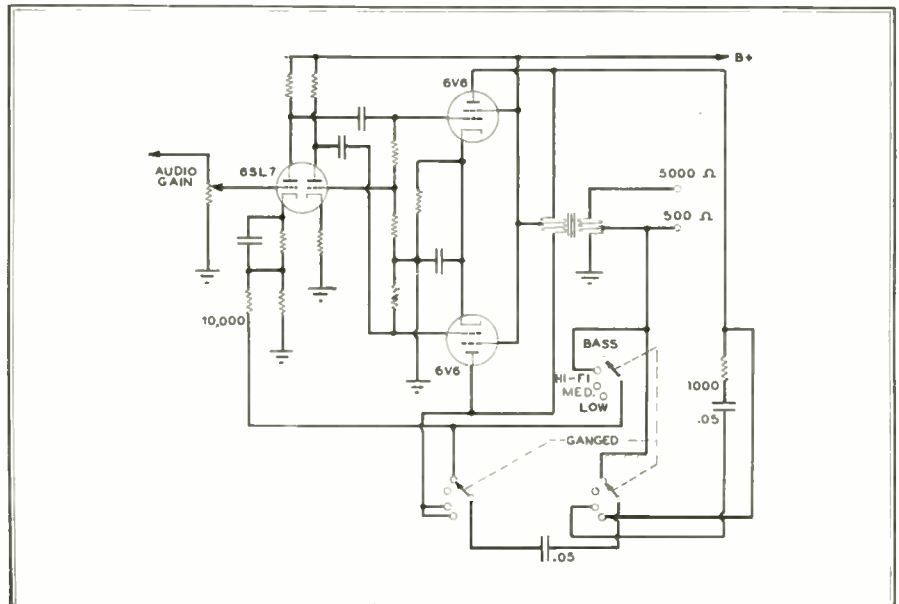

FIG. 4. METHOD OF USING INVERSE FEEDBACK IN THE FOUR-POSITION TONE CONTROL

It has been the practice of manufacturers in the past to emphasize the performance rather than the appearance of communication receivers. This has limited the use of many of these sets to cold basements or drafty attics. Also, the multiplicity of controls with their confusing markings has done little to sell the rest of the family on the value of the receiver as a medium of entertainment.

the normal positions of all controls with red dots for AM broadcast reception and green dots to indicate the correct positions for FM.

As a final bid for family favor, controls have been grouped for maximum convenience in operating, and eyestrain caused by glare has been eliminated by the use of indicators and a meter with translucent green scales.

NEW FM STATIONS

EVERY week brings news of new FM broadcast stations under construction, and of others starting scheduled transmission. Now, the relaxation of Government controls has given the green light to many projects that were held up for materials.

One of the most elaborate of the new FM stations is that to be built by the St. Louis Globe-Democrat. It is of particular interest because this newspaper does not operate an AM station.

The accompanying illustration shows an architect's drawing of the building. On the ground floor there will be four studios with a master control room and three secondary control rooms, in addition to offices for operational and maintenance personnel. The entire second floor will be occupied by the business and management department. Later, a theatre studio, seating an audience of 400, will be added.

As the illustration shows, the foundations for the 525-ft. tower will be a part of the building construction. This station has been authorized to operate on 92.9

mc. with radiated power of 53 kw.

Construction of a community station at Asbury Park, N. J., is now well along. This transmitter, using call letters WJLK, will be of G. E. manufacture, operating into a 4-section RCA pylon antenna. The assigned frequency is 104.7 mc.

Studios will be located in the building occupied by *The Press*, a daily and Sunday paper which owns the station.

Station KOAD, Omaha, which has been doing such an excellent job of featuring

local activities on its programs, reports that there are now 700 FM receivers within its service area. When the station first went on the air, last July, the total was exactly 20. A survey of listeners disclosed that most of the new sets came from Zenith, Stromberg-Carlson, and Scott. Local dealers report that FM set deliveries are running far behind demand, but promises of larger shipments early in 1947 indicate a rapid growth of the FM audience in this area.



ARCHITECT'S DRAWING OF ST. LOUIS GLOBE-DEMOCRAT'S FM STATION KWGD

TELEVISION HANDBOOK

CHAPTER 1—Part 1: Conclusion of Television

Definitions—Presentation of Image Fields

BY MADISON CAWEIN

CONCLUSION OF DEFINITIONS

pulse: short for impulse.

pulse width: the duration in time of the narrow part, or peak portion, of a pulse wave.

quadruple, staggered interlace: an interlace system in which four fields are scanned to complete each frame. The order of scanning is 1, 3, 2, 4 which causes the presentation of lines to jump about and prevents "crawl."

quantum: an elementary packet of energy associated with radiation, the value in ergs being equal to the product of frequency multiplied by 6.6×10^{-27} . This elementary amount of energy is always absorbed or emitted in chunks, when radiation reacts with matter.

quantum efficiency: the percent of light quanta effectively absorbed to produce photo-electrons by a photo-surface.

quasi-single-sideband: this refers to the transmission of parts of both sidebands according to the response characteristic shown in Fig. 5, to simulate single-sideband transmission.

radial field: a field of force directed toward or away from a point in space.

raster: the scanned area in a cathode-ray tube; more specifically, the illuminated rectangle on a fluorescent screen composed of all the horizontal scanning lines.

receiver characteristic: the receiver response required to receive properly a quasi-single-sideband transmission. This characteristic is shown in Fig. 6. It was designed for operation with the transmitter characteristic shown in Fig. 5.

redistribution: this refers to a process which goes on inside of an iconoscope which is responsible for the operation of this type of pickup tube. There is a cloud of secondary electrons knocked out from the mosaic islands by action of the scanning beam. These fall back on positively charged portions of the mosaic and tend to cancel part of the charge. This results in producing dark areas in the electrical image-field which are referred to as shading, or spurious signals.

reflections: this has two meanings in television: it refers to reflected waves from structures or other objects, and also to shadows in the picture produced by these reflected waves.

reflector: a dipole placed behind a dipole antenna, away from the transmitter, to intensify the received signal. No connection is made to a reflector. It is usually spaced away at one quarter-wavelength of the desired signal.

registry: the superposition of one image on top of another, or of a raster upon an image, so that identical lines fall one on

top of another throughout the images. Registry requires that both the horizontal and vertical scanning waveforms in each image be identical one to another.

reinsertor: a circuit for deriving background information from the amplitude of horizontal pedestals in a television signal, and

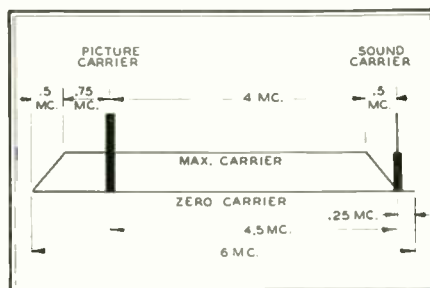

FIG. 5. QUASI-SINGLE-SIDE BAND TRANSMISSION CHARACTERISTICS

applying this to bias the cathode-ray-tube grid for proper average illumination in each scene.

relaxation oscillator: a generator of electric current waves whose amplitudes vary between negative cut-off and positive overload, as limits. In essence, a relaxation oscillator is a violently regenerative device for which many circuit arrangements exist in practice.

retrace: the return path of the electron beam as it is swept back across the raster on the cathode-ray-tube face after the completion of each scanning line, and field trace.

retrace ghost: (1) a ghost image appearing on the return lines of a television raster due to insufficiently-long blanking of the

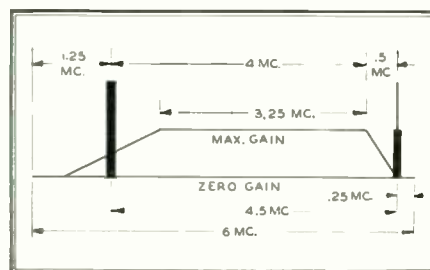

FIG. 6 RECEIVER RESPONSE REQUIRED FOR QUASI-SINGLE-SIDE BAND SIGNALS

cathode-ray tube; (2) a television signal originating on each return line of the camera due to insufficient blanking of the camera during the retrace.

RC circuit: a time-determining network composed of resistors and capacitors in which the time-constant is the product of resistance by capacitance.

resolution: the amount of resolvable detail in a picture and is usually expressed as a number of distinct lines alternately black and white which can be seen in a televi-

sion test chart. The total number of picture elements in a picture is a measure of the overall resolution. The horizontal and vertical resolution are usually expressed separately in terms of numbers of lines resolved.

resolution chart: same as resolution pattern.

resolution pattern: a chart usually with four wedge-shaped patterns of alternate black and white lines converging from the four sides of the picture toward the center. The number of lines of resolution is indicated at various points along the wedges. The principal use of a resolution pattern or chart is to check the overall resolution of a television system.

retina: a translucent, photo-sensitive mosaic as used in the orthicon or vericon.

return-time: the time required for retrace or fly-back of the electron beam at the end of the scanning of the raster.

RF response: this refers to the wide-band acceptance of signals in a television receiver, and defines the selectivity for signals lying outside of the channel being received.

rhombic antenna: a diamond-shaped pattern of conductors each of the same length and each one or more wave lengths long, joined together at three corners of the diamond with the fourth corner open for connection with a transmission line. The impedance of a rhombic antenna is approximately 800 ohms. Wires are located all in the same plane, which should be mounted parallel to the ground for best television reception. A rhombic antenna picks up a more intense signal than a dipole, and is used sometimes in regions of low field-strength.

RMA: the abbreviation for Radio Manufacturers Association.

RMA signal: a composite signal composed of video signals and RMA sync signals. It has been standardized by the Radio Manufacturers Association. The form of the RMA standard television signal is shown in Fig. 1.

RMA standard: anything in relation to television or radio standards which has been standardized by RMA.

RMA sync: composite synchronizing signal standardized for use in the United States by the FCC. It consists of horizontal sync signals, line-doubling sync signals, and a serrated vertical sync signal. The form of the RMA sync signal is shown in Fig. 1.

RTPB: an abbreviation for Radio Technical Planning Board.

sawtooth: the wave form of the deflection field used to deflect an electron beam in television practice, named because of the similarity of its appearance to that of the teeth in an ordinary saw. The sawtooth

form of a deflecting field is produced by a current of the same form flowing through deflection coils or by a potential of the same form applied to deflecting plates. The wave form is shown in Fig. 4.

scan: to look over a field of view in a regular predetermined pattern, such as a series of parallel lines equally spaced from one another, either by eye or by means of an electrical window in electronic apparatus.

scanning spot: an electrical window which scans an image-field. Usually, it refers to the size of the cross section of an electron beam used in a television pickup tube. In the image dissector, it refers to the size of the aperture across which the extended electron image is scanned. In mechanical systems of television, it refers to the cross section of a beam of light used to scan the actual field of view being televised.

Schmidt system: a catadioptric system composed of a spherical mirror, a curved image plate at the focal plane of the mirror, and a corrector plate for correcting the spherical aberration of the mirror. The Schmidt system constitutes a very fast optical system with great light-gathering power and can be used to pick up the scene with a properly-shaped television pickup tube or to project a television image from a properly-shaped cathode-ray projection tube.

screen: a surface either flat or curved for projecting a television image. This refers also to the viewing surface of a cathode-ray tube.

second anode: this usually refers in television practice to the highest-potential connection of a cathode-ray tube. Connections to the second anode supply the power for giving the electron beam its final, high level of energy.

secondary electron: an electron which has been knocked out of the surface of a metal during bombardment by other electrons, called primary electrons.

secondary emission: the phenomenon of knocking secondary electrons out of a surface by means of bombarding that surface with primary electrons. Secondary electrons usually have a velocity of 3 electron-volts on the average and may be knocked out by primary electrons having a velocity between 10 and 600 electron-volts.

sensitivity of photo-surface: the overall photo-current emitted per unit light-flux falling on a surface. It is expressed usually in microamperes per lumen, and sometimes in microamperes per watt.

separator: this refers to several classes of circuit which are used to separate synchronizing signals and video signals from a composite signal by means of clipping action, or to separate horizontal sync-signals from vertical sync-signals by differentiating and integrating action.

sequential color-system: the system of projecting a color image so that each color field contains information of one color only, and color fields follow each other in sequence, as for instance red, green, and blue. Thus, three separate and different color fields are projected in the three-color sequential system before a color is repeated. This makes the color-flicker rate only one-third of the field projection rate, but in a double-interlace system there is an interline color flicker at one-sixth of the field projection rate due to the fact that

the second red field, for instance, falls in an alternate interlace period to that occupied by the first red field.

sequential interlace: this refers to the technique in a multiple interlace system of projecting the interlaced fields in sequence so that the lines of one fall directly under the lines of the preceding field, as opposed to a staggered system in which the fields jump around and do not follow one another in sequence. (See quadruple, staggered interlace.)

series peaking: the technique of introducing a peaking coil in series with a resistor as the plate load of a vacuum tube to produce peaking at some desired frequency in the pass-band.

serrated pulses: field synchronizing pulses consisting of a block of relatively square-wave signals placed very close to one another in time as shown in Fig. 1 at level T, and each having a duration of approximately 0.4 lines. An integrating circuit will respond to these by building up a peak whose amplitude is greater than that built by horizontal pulses alone, due to the fact that the serrated pulses have a greater duration and therefore a greater storage effect than the line pulses.

serrated signal: a signal consisting of serrated pulses for field synchronizing, plus a preparatory period in which line-doubling pulses are inserted in order to alert the integrating circuit ahead of time to give equal peaks on alternate pulses.

shading: the dark areas in a picture caused by redistribution of secondary electrons over the mosaic in a storage type television pickup tube. The shading pattern varies from scene to scene and depends upon the distribution of light in the scene.

shading generator: shading can be removed from the picture by generating wave forms at horizontal and vertical frequencies having approximately the opposite wave form to that of the shading pattern. The shading generator, therefore, is used to generate these wave forms and consists of a multiplicity of outputs each with separate control. Correction of shading in the picture requires personal supervision of an operator at all times. The operator watches the monitor picture, and adjusts the shading controls to buck out the dark areas and to obtain substantially uniform illumination of the scene. Operation of a shading generator requires skill and experience.

shadows: spurious signals created by reflections which arrive at the receiver later than the direct wave, and produce a secondary, fainter image which is slightly displaced from the primary image in such a position as to give a bas-relief or shadow effect. They are usually called "ghosts."

shunt peaking: the use of a peaking coil in a parallel circuit-branch to feed signals from the output load of one vacuum tube to the input load of a following tube, for the same end purpose as a series-peaking circuit but with the added advantage of splitting up the distributed capacitances of the two tubes.

signal plate: the output electrode of a television pick-up tube.

silver sensitization: a process of depositing a thin layer of silver on photo-sensitive surfaces during formation, in order to increase the sensitivity.

single-ended: non-balanced operation in

which one side of a transmission line or of an impedance is grounded, while the other side of the line or end of the impedance is energized with the signal.

single sideband: transmission of a carrier and substantially only one sideband of modulation frequencies, usually the upper sideband in television practice.

size: the extension of the raster in the horizontal and vertical directions. Adjustment of size is usually provided in a receiver in order to make the raster fill the picture frame.

spectral response: distribution of sensitivity of a photo-surface over the spectrum.

spectrum: the frequency band over which radiations are spread. It is usually used in connection with light frequencies, but may refer both to visible and invisible radiations.

speed: this refers to frequency of a relaxation oscillator, usually. Synchronizing controls on television equipment are sometimes called speed-controls.

spot: this refers usually to the area on which an electron beam is focussed.

spot size: the size of the cross-section of an electron beam or the size of an aperture in a television tube.

spurious signal: this has two meanings, the primary meaning being in reference to unwanted reflections of television carrier waves, and the secondary meaning being in reference to undesirable shading signals such as generated in the iconoscope.

stage: this refers to an arrangement of vacuum tube electrodes and circuit elements for producing electronic amplification.

staggered circuits: circuits are said to be staggered when they are alternately tuned to two different frequencies, in order to obtain broad-band response. A complete stage of amplification in a staggered-circuit amplifier requires two vacuum tubes, the output circuit of each of which is tuned to a different frequency. The separation in frequency divided by the mean frequency of the two circuits is a coefficient of staggering and corresponds directly to coefficient of coupling in double-tuned circuits.

standard lamp: a lamp usually operated at 2870° Kelvin scale of temperature which is used to produce illumination for measuring purposes in determining the value of a standard lumen.

studio circuits: circuits having to do with the operation of a television studio, independent of the transmitter itself and of the receiver.

surge impedance: the characteristic impedance of a transmission line which is dependent on the diameter and spacing of the wire of the line and which may be considered to have a uniform resistance value when the line is terminated with an impedance equal to the surge impedance for a band of frequencies, or with a resistance which is equal to the surge impedance.

sweep: this refers to moving an electron beam at right angles to its direction of motion and has a similar meaning to "scan." Scanning circuits are frequently referred to as sweep circuits.

sync: this is an abbreviation for synchronization and applies to a timing signal for determining the point in time at which an electrical oscillation will start.

tearing: a synchronizing defect in which groups of lines of the picture are displaced in a haphazard manner.

telecine projector: a motion-picture projector adapted for use with a television pick-up tube.

telegenic: this refers to suitability for televising.

television: the process of the electrical transmission and reception of transient, visual images.

television chart: a test chart for use in checking television resolution.

television receiver: an equipment containing apparatus for receiving RF signals modulated with television signals, for converting these to picture signals, and for reproducing a picture from the converted signals.

television transmitter: an equipment for broadcasting an RF carrier modulated with television signals suitable for reception by a television receiver.

televisor: an early name for the device on which a television picture is viewed.

televize: the act of converting the light values of an image-field into television signals.

termination: an impedance for loading the end of a transmission line so that the input impedance of the line appears as pure resistance equal to its surge impedance over a predetermined band of frequencies.

test chart: same as a resolution chart.

test film: a motion-picture film printed with various densities of test patterns for checking the resolution of a telecine projector in conjunction with an overall television system.

test pattern: same as a resolution pattern.

tilt: (1) This refers to moving the television camera across a field of view in a vertical direction; (2) In England, it refers to the slope of the shading signals used to buck out the spurious signal from a television pick-up tube, due to redistribution. (These signals used to be referred to in England as tilt-and-bend signals.)

time-constant: the time required in an electrical circuit for potential or current to rise to approximately 63% of its steady, final value or to fall to approximately 37% of its initial value.

time-delay: the time elapse between an electrical occurrence at the start of a transmission and the reproduction of this occurrence at a remote point.

time-determining circuit: a circuit composed of energy-storage components having a time-constant designed to introduce a predetermined amount of time delay.

timer (generator): an equipment designed to generate standard sync signals for synchronizing all components of deflection apparatus in a television system.

time-sequence: the order of following occurrences in time.

trace: the path of a scanning spot across a field of view.

transient response: response of a circuit to changing potentials or currents as regards the time-delay introduced by time-determining circuit components.

transient signal: a changing signal or a signal which endures for a brief time only.

transmission band: the band of frequencies utilized for transmitting information electrically.

transmission line: a two-conductor circuit having uniform characteristics for trans-

mitting electrical signals.

transmitter characteristic: the amplitude response of the transmitter pass-band for a modulated television carrier which employs quasi-single-sideband transmission, as shown in Fig. 5.

tungsten light: light flux from a tungsten filament operated at 2870° Kelvin scale of temperature. The quality of this light, that is, the distribution of energy across the visible spectrum, is such as to give a proper value to the measurement of a lumen by means of light meters employing viscor filters which have the same response as the human eye.

twin-ax: a transmission line consisting of two parallel, equally-spaced wires inside of a cylindrical shield.

UHF waves: carrier frequencies in the ultrahigh frequency spectrum between 50 mc. and 500 mc. These limits are not very clearly defined, and are changing every day with the progress of the radio art.

velocity modulation: a system of television in which the speed of the scanning beam is changed as it travels across the trace of a line on the raster. The intensity of the beam is held constant, and changes in contrast are obtained by means of the time that the beam requires to traverse any distance rather than by changes in the intensity of the beam itself. The system is not in general use.

vericon: a Remington-Rand trademarked name for a television pick-up tube similar to the orthicon and having a diameter of approximately 2".

vertical: refers to the dimension of height in the picture, and is sometimes abbreviated as V.

vertical blanking: this refers to blanking signals which occur at the end of each field.

vertical resolution: the line-structure of the image, that is the number of lines or picture elements which can be resolved in the vertical direction.

vertical retrace: the return path of the electron beam across the raster at the end of each field.

vestigial side-band transmission: the system of transmitting a television modulated carrier in which one almost complete side-band is transmitted and vestiges of the other side-band are transmitted in such amplitude as to make up for that portion of amplitude which was incomplete in the first side-band. It is usual practice to transmit the upper side-band with a slight reduction in frequency components near the carrier and to transmit vestiges of the lower side-band in the region near the carrier as shown in Fig. 5.

video: this refers to a general qualitative characteristic pertaining to television signals used to reproduce a picture.

video amplifier: an amplifier for video signals used to reproduce a television picture.

video frequency: the frequency band necessary to transmit the information in a television picture.

video signal: a time-sequence of electrical pulses generated at the signal plate of a television pick-up tube, plus blanking.

video waveform: the portion of the waveform shown in Fig. 1 and labeled V, which corresponds to the light and dark values in the picture as they are transformed into

an electrical signal, but does not include the synchronizing waveform.

viewing distance: the best distance to view a television picture from the standpoint of seeing all the detail which the picture is capable of resolving.

viscor filter: an optical filter having a transmission characteristic for uniform, visible light identical to that of the human eye.

visible spectrum: that portion of the spectrum of electro-magnetic radiations which is visible to the human eye.

waveform: in general, this refers to the form of a periodic, functional relationship between the amplitude of some physical thing (such as electric current) and time.

wave-shaping circuit: a circuit which alters the form of an electric wave to a different form.

wedge: a convergent pattern of black and white lines equally spaced, and used as a television test pattern.

wide-band amplifier: an amplifier which will pass a wide range of frequencies with substantially uniform amplification.

width: this has two meanings in television, one of which concerns the horizontal extension of the picture, or horizontal size, and the other of which refers to duration of a pulse in time, or pulse width.

yoke: an arrangement of deflection coils, usually including two sets of two coils each, for producing the magnetic deflection field for the electron beam in a cathode-ray tube.

zero frequency: a frequency at which the amplitude of harmonic components of a wave fall to zero, usually called an elided frequency in reference to the reduction and elimination of high-frequency components in a television signal due to aperture or spot size.

There are, no doubt, a great many television expressions which need definitions, but which are missing from this list. However, while this list is not complete, it will serve as a guide.

2. Presentation of Image Fields ★ An image field has been defined in Section 1 as an area of points of light (picture elements) having various intensities arranged in a pattern usually recognizable as a picture of something or other. It is characteristic of an image field that it can be presented upon a plane surface which has two dimensions, usually height and width.

It may be thought that the image fields upon which we look with our eyes are relatively steady things, exhibiting no change unless we turn our heads from one direction to another. This is not strictly true. The fields of view on which we look are presented to us in sequence; that is, one identical field follows another in some interval of time, as for instance when we blink our eyes at a slow rate while gazing fixedly at a particular scene. Actually most people do blink their eyes more often than one thinks.

Between the blinkings of the eyes, however, no field of view is ever grasped in its entirety at a single glance, but the eye runs rapidly back and forth across points of interest, transmitting these to the brain for storage until the whole field has become

familiar enough for the eye to concentrate on some particular object which is of prime interest.

This process of looking at things between blinking periods may be said to constitute a presentation of image fields. All the devices which have been used by man throughout known historical ages for presenting visual entertainment have resorted to this device. For example, the magic lantern with which you were probably familiar in childhood presented pictures one at a time. The change was made by the laborious process of moving a glass slide in the lantern, much as is done today in the more modern slide-projector.

Early motion pictures achieved the illusion of motion by means of presenting image fields, similar to those of the magic lantern, at a faster rate. It was necessary to present these pictures at a rate so fast as to fool the eye, which has a persistence of vision of approximately $\frac{1}{8}$ second. Thus, early motion pictures had a presentation rate, called a frame repetition rate, of 16 image-fields per second. Modern motion pictures present image fields at a rate of 24 per second in order to create a better illusion of motion for fast-moving objects. Actually each projection of a frame in a modern motion-picture projector is interrupted once in its stationary position and once during the pull-down by means of a moving shutter in the projector. This shutter causes a complete interruption of the field twice during each frame projection, which results in a presentation rate of twice 24, or 48 fields per second.

This interruption of a motion picture frame during each presentation doubles the presentation rate and constitutes a very clever trick which has the practical result of preventing what is known as flicker. If you blink your eyes at a steady rate while looking at an object there is introduced into your field of view as presented to the brain the phenomenon of flicker, which means simply the going on and off of light. The faster the light goes on and off the less objectionable the flicker becomes from a psychological standpoint. Actually if the light, or the presentation of the image field, goes on and off at a rate of 8 to 10 times per second, the eye will achieve the impression of continuity of vision without interruption, but the psychological irritation of flicker will persist. This irritation occurs, in fact, for most people even in the case of image fields presented as fast as 40 times per second.

When the presentation rate is as great as 48 times per second the impression of flicker becomes relatively negligible. There are a few individuals, however, who can perceive flicker at a rate of 50 times per second, or 50 cycles as it is sometimes called. A person may test himself on this matter by glancing out of the corner of his eye at an electric light bulb which is operating on a 50-cycle power system, as for instance in certain railway stations

like the Long Island Railroad Station, at night. Some individuals claim to be able to perceive the flicker of an incandescent lamp operating on the usual 60-cycle power supply in the average American home.

It was one of the problems of television to surmount this obstacle of the irritating effect of flicker on the human eye, by interrupting the image fields presented by television systems at such a fast rate that flicker would be unobjectionable. It was not possible, however, to solve this problem in the same manner as it was solved in the motion picture industry, by interruption of an image field with a mechanical shutter. The reason for this will become apparent after the discussion in Section 3. It became necessary for the television system to present image fields at such a rate that flicker would not be present. Television solved this problem by a trick which was more clever than the trick resorted to in the motion picture industry.

An image field may be presented in the form of a number of strips, each parallel to the other, and separated by a finite distance. If the space of separation of the strips, which may be defined as the dark region, is greater than the width of each illuminated strip of the image itself, for instance, the illusion of a recognizable image can be obtained and retained by the eye during quick, successive flashes. If the dark spaces are equal to the light spaces, that is, if the spaces between the illuminated strips are equal to the widths of the strips themselves, the illusion of a complete image is very good. Television image-fields are constructed in this manner out of horizontal strips of illumination,

parallel to one another and separated by dark spaces whose width is approximately equal to the width of the illuminated strip.

In the older art of television, about 15 years ago, there were no discernible dark strips between the light strips in each image field, but strips followed one after the other in a consecutive fashion so that the eye could discern no space between the lines, as these strips are called. This older television was first presented commercially at a rate of 20 complete image fields per second and then later at 24 fields per second. The flicker of these television images was very bad.

In the early 1930's the trick was put into experimental practice which consisted of presenting only every other line of the picture during one image field, and of presenting the alternate set of lines, left out during one field, in the following field. The alternate lines were presented so that their location fell into the dark spaces of the preceding or first field, and the dark spaces of the second field occurred in the position occupied by the illuminated lines of the first field. This process became known as *interlacing*. Each presentation constitutes a complete image field but delivers only half of the total information in a complete picture frame. The fields following one after the other each present half of the information left out of the preceding (and of the next, following field) in the exact location in which it should be presented. The effect of this method of presentation is to eliminate flicker without increasing the required frequency band for transmission.

Next month: Scanning — Significance of Standards.

FM ASSOCIATION

(CONTINUED FROM PAGE 23)

reason, the Bell System has been very indifferent about the need for high-fidelity lines to handle FM programs.

Associated with this problem is the matter of network programs. Here, the networks have been put in a strong anti-FM position by the American Federation of Musicians who ask double pay for music broadcast by FM and AM. The networks have made no effort to break down this situation, and there is no indication that they would if they could.

Three things may end this impasse. The FCC may bring pressure to bear on this point. Newspaper operators of independent FM stations may undertake to set up a network of their own, and expand their operations to include others who need this service. Finally, advertising agencies will soon discover the greater impact that can be delivered by high-quality reception, free from static and fading. Then they will wake up to the fact that the double night-time rate they are paying for AM facilities is bringing less

and less coverage, while FM at night can exceed the daytime range of AM transmitters. Then advertisers are going to demand network distribution of their programs to FM stations.

The work of educating agency executives, by means of demonstrations and discussions, will be one of the major jobs for FMA. If it is carried out effectively FM operators need not worry about getting network programs. The advertisers will see to that.

Success of FM Is Assured ★ FM has behind it a remarkable record of weathering every storm that has beset its path. This was not an accident of good fortune, nor was it due to astute promotion or diplomatic manoeuvring.

FM has won out consistently against all opposition because it can give better service to radio listeners, it can restore profitable operation to set manufacturers, and it can put a new, firm foundation under the business of broadcasting. Whether much or little is accomplished by the FM Association, the success of FM broadcasting is assured by the fact that it serves the best interests of all concerned.

FM AND TELEVISION

CASCADE PHASE-SHIFT MODULATOR

Discussing the Relationship between Phase and Frequency Modulation, and the Theory and Operation of Raytheon's New FM Transmitter — Part 2

BY M. MARKS

The most important part of the basic phase shift stage is the device which converts the audio frequency modulating signal into a corresponding audio frequency variation of resistance. This device, which is known as the modulator or resistance tube, replaces R_2 of Fig. 7 in the practical circuit. To obtain low distortion, the characteristic of resistance versus control voltage of this device must be made to approximate the curvature of the phase angle characteristic, Fig. 8. As pointed out above, this requirement is im-

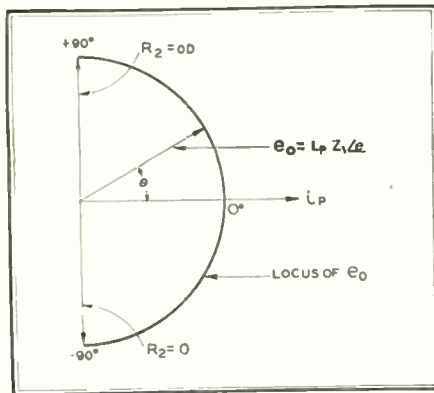

FIG. 9. LOCUS OF OUTPUT VOLTAGE FOR INTERMEDIATE VALUES OF R_2

portant mainly for low-frequency signals in the band from 30 to 50 cycles where a maximum phase shift of about plus and minus 25° per stage is required for full frequency deviation. Conventional vacuum tube circuits utilizing the dynamic plate resistance of a tube as a function of control-grid voltage cannot be used because the adjustment of bias becomes too critical when the above requirement must be met. Therefore, the circuit shown in Fig. 10 was developed to do the job of curve-fitting without the aid of critical adjustments. The mechanism of operation of this resistance tube T_2 can be described somewhat as follows:

Taking the point of view of the modulating audio frequency signal, e_m , with the RF voltage assumed to be zero, the circuit behaves not unlike a cathode follower. The plate is by-passed to ground through C_2 ; the signal e_s is applied between control grid and ground, across the shunt capacitance C_1 of the inverse frequency network; and an amplified output voltage (the gain is less than 1) appears between cathode and ground. For this condition of operation, the resistance looking into terminals 2 and 3 may be given as⁵

$$R = \frac{1}{\frac{1}{R_k} + \frac{1}{R_p} + \frac{\mu}{R_p}} \quad (5)$$

where

R_k is the resistance connected externally between cathode and ground

R_p is the effective plate resistance of the tube at its operating point

μ is the amplification factor of the tube at its operating point

It is now necessary to consider the circuit from the standpoint of the RF volt-

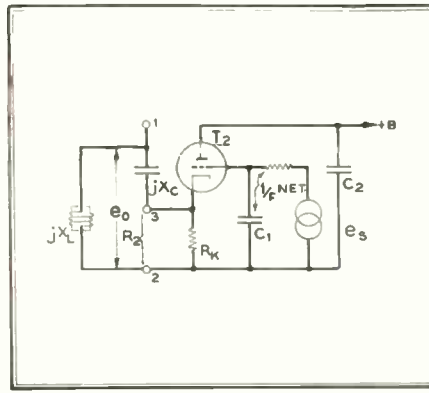

FIG. 10. CURVE-FITTING CIRCUIT USED IN THE RAYTHEON PHASE-SHIFT CIRCUIT

age e_0 which, it will be remembered, is the voltage across the constant impedance Z_1 , Fig. 5. Assuming the modulating signal e_m to be equal to zero, it is apparent that the circuit now behaves rather like a grounded-grid amplifier. This is so because the presence of C_1 , connected between control grid and ground, effectively puts the grid at ground potential for RF. Thus, any RF voltage between cathode and ground is also applied between the control grid and cathode of T_2 . Under normal conditions of operation, the relatively high value of R_k never allows grid current to flow during the positive portion of the RF cycle. However, if the RF grid-to-cathode voltage is high enough, the tube T_2 will be cut off during some part of the cycle, the point of cut-off being a definite function of the instantaneous grid-to-cathode voltage and the plate-to-cathode voltage.

The part played by the modulating AF signal, e_m , is now apparent. It determines the fraction of the RF cycle during which the plate current flows through T_2 . In other words, during the time the modu-

lating signal is positive, the angle of flow is increased, and during the balance of the modulating signal cycle, the reverse is true.

During the part of the RF cycle over which T_2 is cut off, R_2 is equal to R_k , and for the remainder of the RF cycle R_2 must be equal to R as defined by equation (5). In order to calculate the value of R_2 effective over a complete RF cycle, however, it would be necessary to apply a method of analysis similar to that which is used to find the effective RF resistance of a diode rectifier.⁶

The practical application of this resistance-tube circuit has led to a surprising result; no bias adjustment at all is necessary! It has been possible to change the curvature of the resistance tube characteristic over a range sufficient to match the shape of the curve in Fig. 8. This is accomplished, in practice, by the proper choice of RF voltage level and the value of R_k . Once these parameters are determined, the design of the modulator stage is fixed.

Cascade Phase-Shift Modulator ★ Fig. 11 shows the modulator portion of an FM transmitter using the Cascade Phase-Shift Modulator. Six cascade stages are used as described above. This is followed by several frequency multipliers with a factor M of 12. The final multiplier provides an M equal to 81, so that the overall M is equal to 972.

One of the important features of this modulator is the built-in tuning meter. While this in itself is not unusual for a transmitter, this device will enable an operator to make all the necessary adjustments without the aid of external measuring equipment. This will be best understood by following the tuning procedure for a typical modulator.

Assuming that the crystal oscillator stage is operating normally, the RF voltage level at the grid of each cascade amplifier (V_2 through V_9) is adjusted to a predetermined setting on the tuning microammeter. Although this meter reads the grid current, it acts as a peak-reading vacuum tube voltmeter. A variable capacitor in each amplifier grid circuit provides the means of adjustment by forming a simple voltage divider with the associated coupling capacitor. This RF voltage-level setting fulfills the requirement

⁵ "Cathode Follower Calculations" by Humbert P. Pacini, *Electronics*, October, 1944, p. 137.

⁶ "Theory of the Diode Voltmeter" by C. B. Aiken, *Proc. I.R.E.*, July, 1938, p. 859.

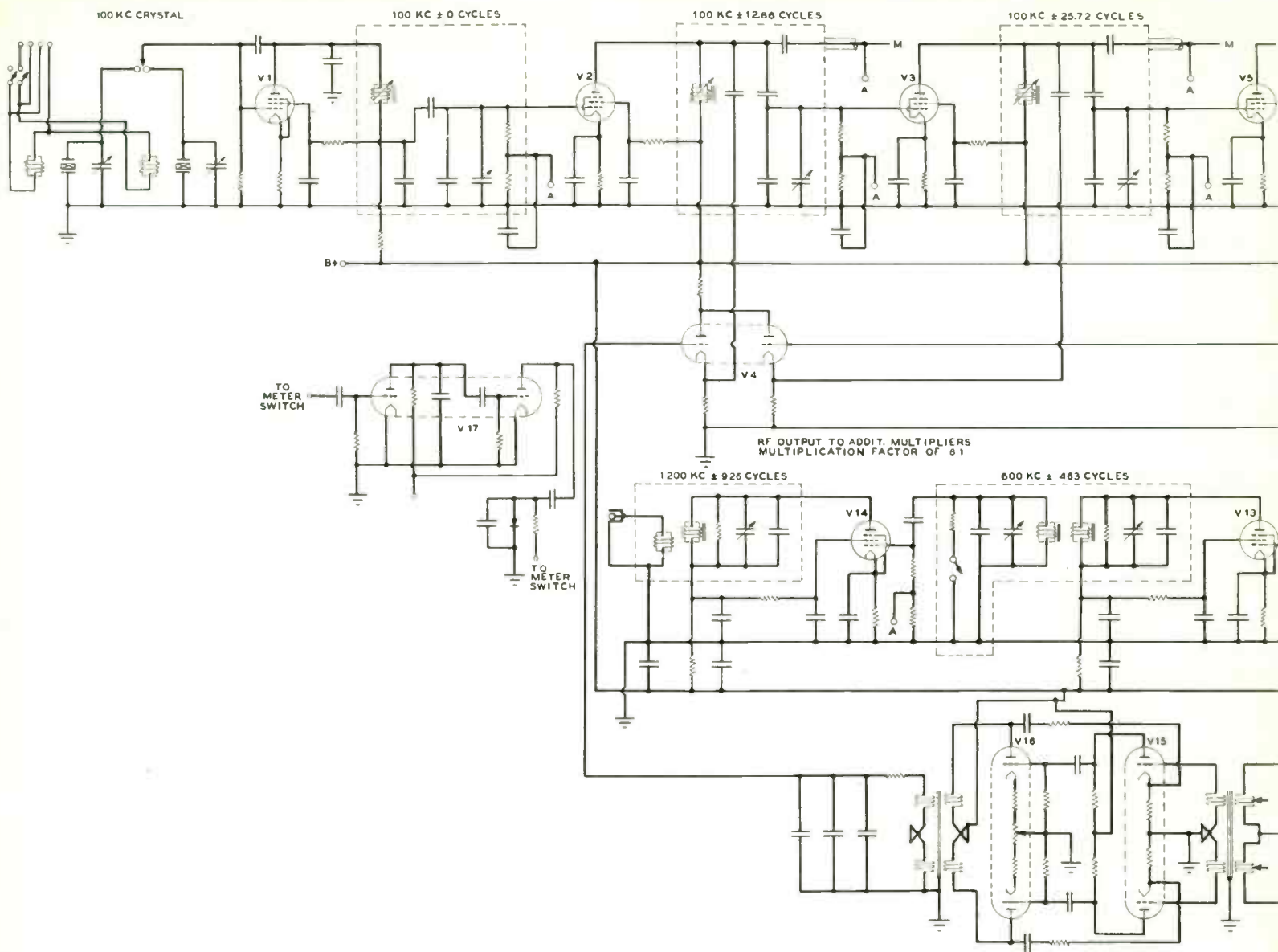

FIG. 11. SCHEMATIC DIAGRAM OF THE MODULATOR UNIT OF RAYTHEON'S FM TRANSMITTER, EMPLOYING CASCADE PHASE-SHIFT

for curve-matching of the resistance tubes as has been previously explained.

For the next step, the inductance X_L of the constant impedance network in each amplifier must be adjusted to conform with equation (4). Ordinarily this would present a difficult problem, because the coil cannot be peaked to the crystal frequency, the actual resonant frequency being the crystal frequency divided by $\sqrt{2}$. However, this difficulty can be overcome by taking advantage of the theory which states that a minimum of amplitude modulation will be observed at the plate of each amplifier tube when the inductance of its constant impedance network is adjusted correctly (X_L equal to $2X_C$). Accordingly, an audio-frequency modulating signal is applied through the normal audio-frequency channel, at a level sufficient to bring about full frequency deviation, and of a frequency low enough to produce a reasonably large phase shift in each modulator stage. Then use is made of a built-in amplitude-modulation detector and amplifier, the double triode V-17, which uses the microammeter as a

modulation indicator. Sample RF voltages from each phase-shift amplifier plate are piped over to this detector via the meter switch, and thus any plate can be selected at will. Starting with the first

stage, each inductance, in turn, is adjusted for minimum meter deflection of the amplitude-modulation indicator. Of course, if the coils are found to be so far out of adjustment as to materially alter

FIG. 13. CLOSE-UP OF THE MODULATOR UNIT, THE CIRCUIT OF WHICH IS IN FIG. 11

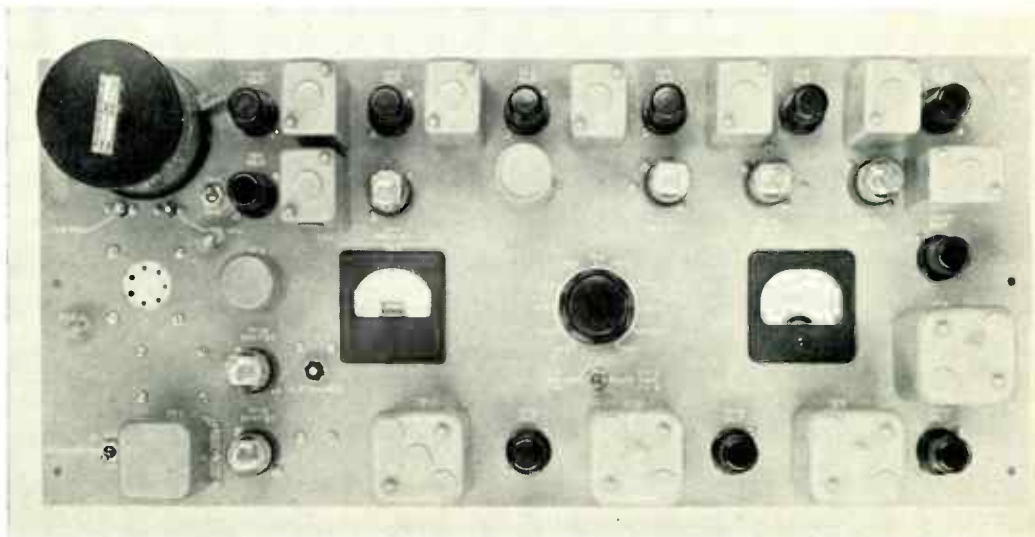

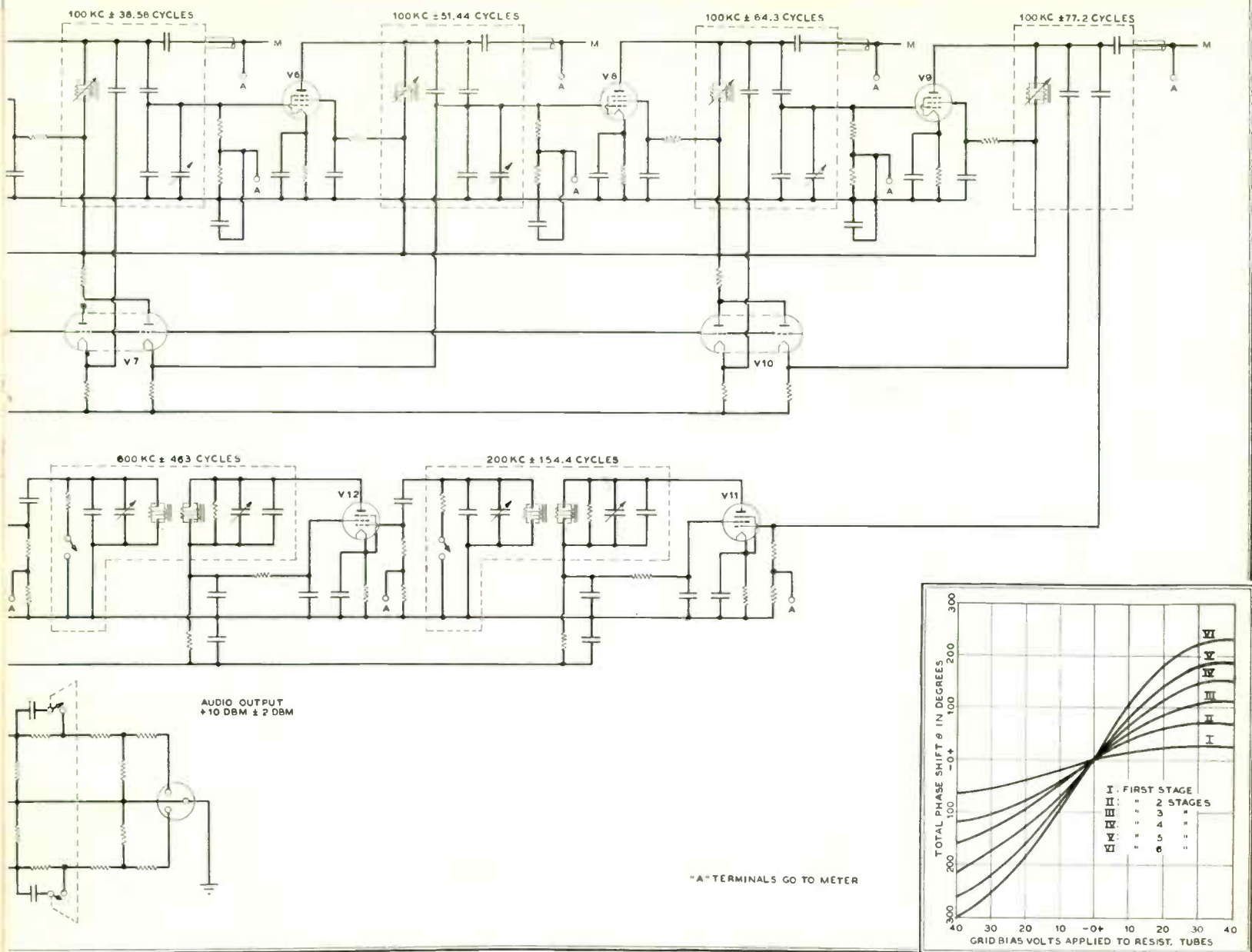

MODULATION. DETAILED CIRCUIT OF THE TEST METER IS OMITTED. FIG. 12. STATIC CHARACTERISTIC SHOWING TOTAL PHASE SHIFT

the RF voltage set up in the initial step, then both steps must be repeated. That is all there is to the adjustment of the modulator proper.

The only other adjustments are those of the multiplier and amplifier coupling transformers. These transformers are designed so they will pass a band wide enough to accommodate twice the highest modulating frequency, but attenuate the undesired adjacent harmonics produced in the preceding stages. These requirements usually lead to a slightly double-peaked selectivity curve corresponding to a coupling greater than critical.

Misalignment of such transformers invariably causes asymmetrical selectivity curves which usually increase the harmonic distortion and may even reduce the frequency deviation for the higher modulating frequencies. It is important, therefore, that overcoupled transformers be properly aligned.

There are various methods in use for aligning overcoupled transformers, but in practice they customarily require cumbersome external equipment ranging from the

use of oscilloscopes and sweep generators to the use of distortion meters for dynamically dipping the distortion when a high modulating frequency is applied to the transmitter.

The method of alignment of overcoupled transformers adopted for use in this transmitter is simple, requires no external equipment, and gives the right answers in terms of performance. A push button switch is provided on all overcoupled transformers. A damping resistance is permanently connected to the top of the secondary of each transformer, and when the push button switch is pressed, the free end of the damping resistance is grounded. This action has the effect of decreasing the secondary impedance. Because the ground side of the resistance is switched, there is no appreciable change of circuit capacitance due to the switching action. It is well known that a decrease of secondary impedance in an overcoupled transformer reduces the coupling. Thus, with proper choice of damping resistance, the coupling is reduced to a value below critical and the transformer

can be easily and accurately tuned for maximum output at the center frequency provided by the preceding stage. Upon releasing the push button, the transformer again becomes overcoupled, and gives the symmetrical pass band required for high quality performance. All band-pass transformers are aligned in this manner. Normal transmitter tuning technique is used for the higher-power portions of the transmitter. It is interesting to note that it is possible to adjust all tuning elements shown in Fig. 11 in less than ten minutes.

Performance ★ A static characteristic curve, giving the total phase shift in degrees as a function of the grid bias applied to the resistance tubes for 1, 2, 3, 4, 5, and 6 cascades stages, is shown in Fig. 12. The linearity of the curve for 6 stages is attested by the following harmonic distortion measurements:

Distortion for 75-ke. frequency deviation:

- 30 cycles — 1.25%
- 50 to 15,000 cycles — less than 0.6%

frequency, equal to half the difference in the two mode frequencies, increases, corresponding to the greater rate of interchange of energy between one resonator and the other.

In the multicavity resonator system of the magnetron these means correspond, on the one hand, to the increase of coupling by conductive connections between the resonators, or so-called straps, and, on the other hand, to the use of cavities tuned alternately to different frequencies. This latter method has been used in the so-called *rising sun* anode structure to be discussed presently.

7.2 Strapping of the Resonator System: The idea of strapping a magnetron anode appeared in a British attempt to lock the oscillation of the resonator system into the π mode by connecting alternate anode segments together with wire straps. Although the number of modes of such a strapped structure is not changed, since its N -fold symmetry remains, the so-called *mode-locking straps* did succeed in separating the modes and making for easier oscillation in the π mode alone. The frequency separation of the modes is not infinite, however, because the straps are not of negligible length compared to a wavelength, and thus have appreciable impedance between points on the structure to which they are connected. In most magnetron resonator systems today, straps of one form or other are employed.

In Fig. 24 are shown four types of strapping, including the early British

consider a double ring-strapped system like that of Fig. 24 (d). The role of the straps in determining mode frequency depends upon the relative magnitudes of their shunt inductive and capacitive ef-

straps are connected is the phase differences between points along the resonator system to which a *given* ring is connected. This determines the amount of current which the strap carries.

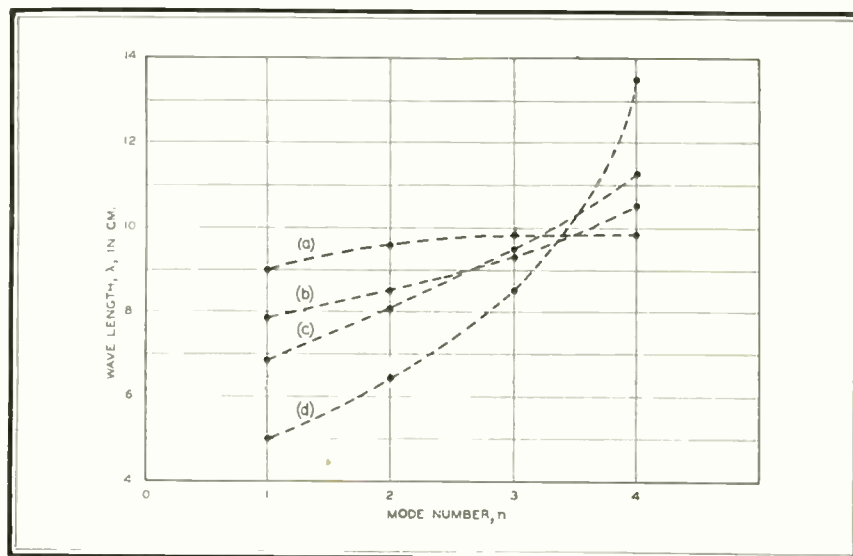

FIG. 25. Plots of the variation of mode wavelength with mode number for a resonator system, unstrapped, or strapped in different ways. Curve (a) is for the unstrapped anode structure. Curve (b) is for the same structure strapped as shown in Fig. 24 (a); curve (c) for the same structure strapped as shown in Fig. 24 (b); and curve (d) for the same structure strapped as shown in Fig. 24 (d). It is to be noted how the wavelength increases for large n and decreases for small n as the strength of strapping is increased.

fects. The capacitive effect of the straps for any mode depends upon the amount of shunt capacitance added relative to that already present in the resonators, and upon the positions in the system to which

In the case of the π mode, the two straps are π radians out of phase, each strap being connected to points which are in phase and at potential maxima. Compare Figs. 23 and 24 (d). Their effect is predominantly capacitive. The only currents flowing in the straps are the charging currents of the strap capacitances. If a resonator system having a total capacitance C , a total inductance L , and a π mode angular frequency ω_0 , is strapped by a strapping system which adds a total capacitance C_s to the resonator system, the new frequency is

$$\omega'_0 = 1/\sqrt{L(C + C_s)} = \omega_0/\sqrt{1 + C_s/C}.$$

The change in frequency is thus specified by the so-called *strength* or *tightness* of the strapping implied in the ratio of strap-to-resonator capacitance.

For modes of lower periodicity, $n < N/2$, the average potential difference between the straps, and thus their capacitive effect, is less because the straps connect points on the resonator structure differing in phase by less than π radians. This corresponds to the shunting of a resonant line by a capacitance nearer the voltage node, at which point it would have no effect. On the other hand, a *given* ring now connects points on the anode whose potentials differ in phase. The ring thus provides additional conducting paths for the circulating RF currents in the resonator system. These paths are essentially shunt inductances across the resonators, which reduce the over-all inductance of the resonator system, shifting the mode to shorter wavelength. As mode number

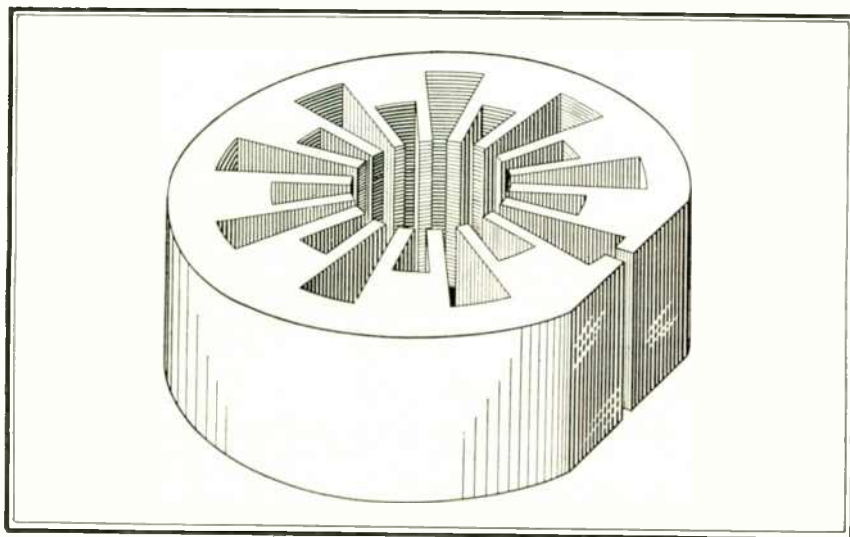

FIG. 26. A so-called *rising sun* type resonator system having eighteen resonators. The slit at the back of the resonator in the right foreground is to be connected to the output circuit. Compare this with the type of resonator construction shown in Fig. 30.

type. Fig. 25 shows the distributions of mode frequency for a typical resonator system unstrapped, and strapped with three of the types of strapping shown in Fig. 24.

It is possible to account, in quite simple terms, for the shift which takes place in the mode frequency distribution when the anode is strapped. For this purpose,

they are connected. This latter determines the average phase difference between the rings, and thus their potential difference per unit RF voltage excitation. Similarly, the inductive effect of the straps depends upon the magnitude of their shunting inductance relative to that in the resonators. However, the important consideration concerning the points to which the

Radio Manufacturers!

NOW YOU CAN USE ALTEC LANSING SPEAKERS . . . AN ADDITIONAL MARK OF QUALITY, ANOTHER SELLING POINT, FOR YOUR FINE RECEIVERS.



THE ALTEC LANSING DIA-CONE SPEAKER

Model No. 600

When a radio manufacturer we know heard the famous Altec Lansing Duplex, his first words were: "You ought to design a speaker like this for my better receivers . . . at a price I can afford." And here it is . . . a popular priced speaker with a carry-over of Altec Lansing's premium priced features. This new model, No. 600, is a 12-inch edition of the Altec Lansing line. Now you can identify your finer receivers with Altec Lansing quality. Send for further technical information on the No. 600.

MODEL No. 600: Specially designed for better radio-phonographs. This Altec Lansing Dia-Cone Speaker incorporates a metal high frequency diaphragm and a 12-inch low frequency cone, coupled by a unique mechanical dividing network to a 3-inch voice coil of edgewise wound aluminum ribbon.

ALSO AVAILABLE IN 15-INCH DIA-CONE WITH A MULTICELLULAR HORN FOR HIGHER PRICED COMBINATIONS

"KEEP ADVANCING . . ."



"WITH ALTEC LANSING"



Several recent full-page newspaper advertisements recorded in full size on the Alden 18-inch recorder.

BE YOUR OWN ANSWER MAN in Facsimile

By MILTON ALDEN

AMERICANS are so used to having all their thinking done for them that it is only natural that when it comes to facsimile they feel someone will have all the answers.

We are, however, finding that there are a considerable number of substantial companies who either want first-hand experience or wish to check the findings of others.

In this company and its associated companies we have given a great deal of thought to being in a position to supply equipment, the paper, and programs (if wanted); the equipment, in particular, to be in such form that tests can be run simultaneously for any kind of fact-finding by any radio or commercial interest.

At the present time FM stations can put out experimental facsimile programs. Until standards are actually set and approved, experimental programs within certain prescribed limits are possible. Tests for programs will be on the air shortly using recorders with a 4.1" effective recording or scanning line, as well as 8.2". The general specifications of this equipment are shown in our advertisement on the opposite page.

I have indicated in various articles on programming which have appeared in this magazine that I think the overall economics favor the 4.1" size recorder. This is because of the lower cost of the recorder, the set to operate it, the amplifier, the day-in-and-day-out costs of the

paper, as well as lower program costs and program risks. However, it is not our purpose to recommend any particular width of copy, but rather to emphasize that if facsimile is to succeed reasonably soon, day-in-and-day-out costs must not be forgotten; and further, that the only way costs will not be continually in the user's mind is for the program content to be so good that he doesn't want to miss it, and he thinks it is worth more than the cost of the paper.

Consequently, we are urging adequate field tests with quality programs before final standards are recommended.

There has been excellent thinking by all in the field as to what is needed. Much of this, however, has been based on theory, which is always speculative while the real answers lie in actual tests under actual conditions.

There have been two schools of thought as to the two widths of recording which would be acceptable. There is still a further group which thinks that perhaps the answer to home facsimile is equipment which may be in the hallway or in the kitchen and considered a home utility, and that such equipment should be capable of reproducing a full-size newspaper. We are illustrating at the top of the page actual copy received over such equipment. There is no reason why this equipment should not be tested out simultaneously with the other widths and the relative merits of all sizes evaluated in the near future.

Paper costs are predominantly in the minds of those who are concerned with home facsimile. The eventual cost of paper per sheet (the full size of a regular newspaper) may be 4¢ a sheet when paper is produced in quantity. It is possible that this home utility equipment complete with set would perhaps cost around \$500, and because of its high cost it might be that this equipment would be leased, rather than home owned.

The present full page ad trend in newspapers is indicated by the ads reproduced above, with a good deal of white space and large sketchy illustrations. This indicates that advertisers are willing to pay a larger sum of money than formerly to tell their story.

It is therefore perfectly possible, knowing that these facsimile ads will be definitely received in the home, and that when received over a recorder they will be read, that the advertising value would pay for the costs involved.

It would be perfectly possible for each advertisement to carry coupons which entitled the recipient to a rebate which might be paid by the station, and in turn paid for by the advertiser. Or again, the equipment might easily carry meters so as to indicate the particular station and programs received; the advertiser paying for the ads and programs which are actually proved delivered.

A study of the following pages will indicate how the equipment is suited to these varying tests.



Nominal — 4" • Useful recording line — 4.1" • Definition — 105 lines • Paper advance — 3.43"/min. • Element or keying frequency — 1475 cycles • Maximum sideband (subcarrier ratio 1.5) — 3687 cycles • Maximum sideband (subcarrier ratio 3) — 3900 cycles.



Above — Nominal — 8" • Useful recording line — 8.2" • Definition — 105 lines • Paper advance — 3.43"/min. • Element or keying frequency — 2950 cycles • Maximum sideband (subcarrier ratio 1.5) — 7375 cycles • Maximum sideband (subcarrier ratio 3) — 11,800 cycles.

Below — Nominal 18" • Useful reading line — 18" • Definition — 100 lines; 33 lines • Paper advance — 3"/min.; 9"/min. • Element or keying frequency — 4500 cycles; 1500 cycles • Maximum sideband (subcarrier ratio 1.5) 11250; 3750 cycles • Maximum sideband (subcarrier ratio 3) 18000; 6000 cycles.

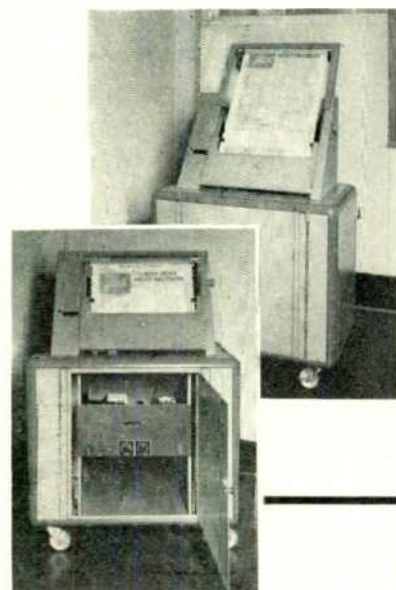

HERE IS THE FACSIMILE RECEIVING EQUIPMENT THAT WILL TELL YOU WHAT YOU WANT TO KNOW

Whether you are a set manufacturer who wants to know how your present FM set will operate facsimile, the coverage to expect with the set, the adaptability of the recorders to your manufacturing practices, costs, circuits and patents involved, and whether the subcarrier should be AM or FM. . . .

A broadcaster who wants to know coverage, test program content, predict audiences, or who wants his engineers to comprehend actual scanning and transmitting problems. . . .

An advertising or research organization which wants to know users' preferences and probable returns against cost. . . .

Or, the broadcast transmitter, or other manufacturer, who wants first-hand information as to coverage, multiplexing facsimile with sound, the ratio of the element or keying frequency to subcarrier. . . .

Universities, inventors, experimenters who wish to determine the ultimate in definition and the hundreds of unknowns in the practical application of scanning and recording, such as aperture distortion, definition, methods of modulation, optics, all in their practical relation to recorders, spot areas and paper characteristics.

ALDEN EQUIPMENT WILL GIVE YOU THE ANSWERS

What This Equipment Is —

The first two illustrations show the 4.1" and 8.2" width recorders, in a chairside cabinet housing recorder amplifier. They can be connected to the plate of the second detector tube of any set one wishes to test. Thus, you have the flexibility of testing any set in all kinds of surroundings; the audio of the set operating from its usual position, but the recorder where the user, observing the recorder casually, can flick a switch to reject or select any part of the facsimile program without having to leave his or her chair.

The 18-inch recorder—paper width 19"—is primarily designed for high speed communication use on ultra-high frequency relay station links, yet it is well suited for field tests for program acceptability and cost with the understanding that it can be built as a home utility model, using less space and going against a wall.



ALDEN PRODUCTS COMPANY

117 North Main Street, Brockton 64 FJ, Massachusetts



Alden Universal Scanner transmitting 18 inch copy with pre-loaded drums ready for immediate change to 4.1 inch or 8.2 inch copy transmission.



Alden Universal Scanner showing gears for quickly changing drum speed and scanning advance.



Alden Universal Scanner showing ease of removal and replacement of electronic chassis.

HERE IS THE FACSIMILE SCANNING EQUIPMENT ADAPTABLE TO PROVIDE SIGNALS TO ALL PRESENT (OR PROPOSED) RECORDERS

The basic thinking back of this scanner design is to be able to put out standard quality signals so that tests made with it will be conclusive; to build equipment with the ruggedness to stand abuse and flexible enough to carry out various tests; interchangeable enough so that improvements can be made without making the original scanner obsolete.

For example, with the Alden Universal Scanner, you can be on-the-air transmitting to 18-inch recorders and, in a matter of minutes, change to transmit to either 4.1 inch or 8.2 inch recorders. Again, in a matter of seconds, you could change from the 4.1 inch to the 8.2 inch standard.

With equal facility, you could change the subcarrier frequency by interchanging a plug-in oscillator.

Alden equipment is designed with plug-in and interconnect chassis unit construction. Any part can be replaced with a spare without serious loss of air time. This also makes it easy to substitute different modulating systems, different response characteristics in the scanning amplifier, different aperture sizes and characteristics for experimentation and test purposes.

All Alden equipment is accessible so that functions are easily understood. Color coding makes the tracing of signals and circuits a simple matter.

Here Is What You Do

The scanner is shown with an 18-inch drum in the illustration at the left. This can be quickly removed and the 4.1-inch drum, shown above in the illustration, substituted. Next, change the gears on the two motors shown in the middle illustration at the left, and perhaps change the plug-in oscillator. Next, set the precision focusing of the scanner head and you are ready to go on the air again.

In changing from the 4.1-inch scanner to the 8.2-inch, all you would have to do is change the drum and the focusing to a pre-set position.



Regulator chassis, indicating ease of replacement or substitution of subcarrier oscillator through plug-in construction.

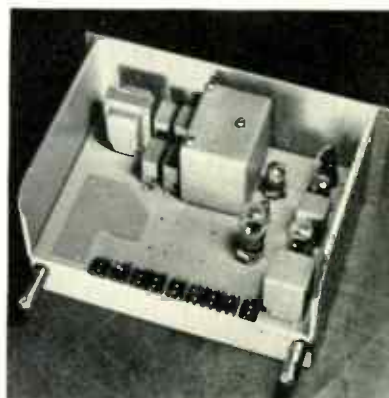

View of regulator chassis showing back connections with subcarrier oscillator in place.

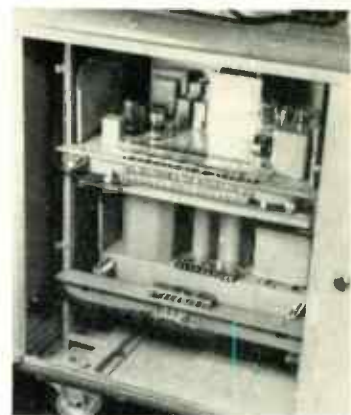

Rear view of Alden Universal Scanner with cabinet doors open. Back connectors, color coded leads and connectors, plus accessibility make quick signal tracing easy.

Direct Your Inquiries for Facsimile and Impulse Recording Equipment to

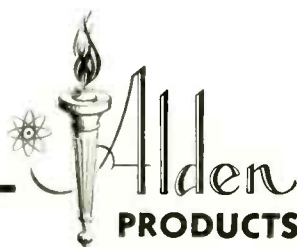

PRODUCTS COMPANY

117 North Main Street, Brockton 64 FJ, Massachusetts

ZENITH is building fm enthusiasm for You!

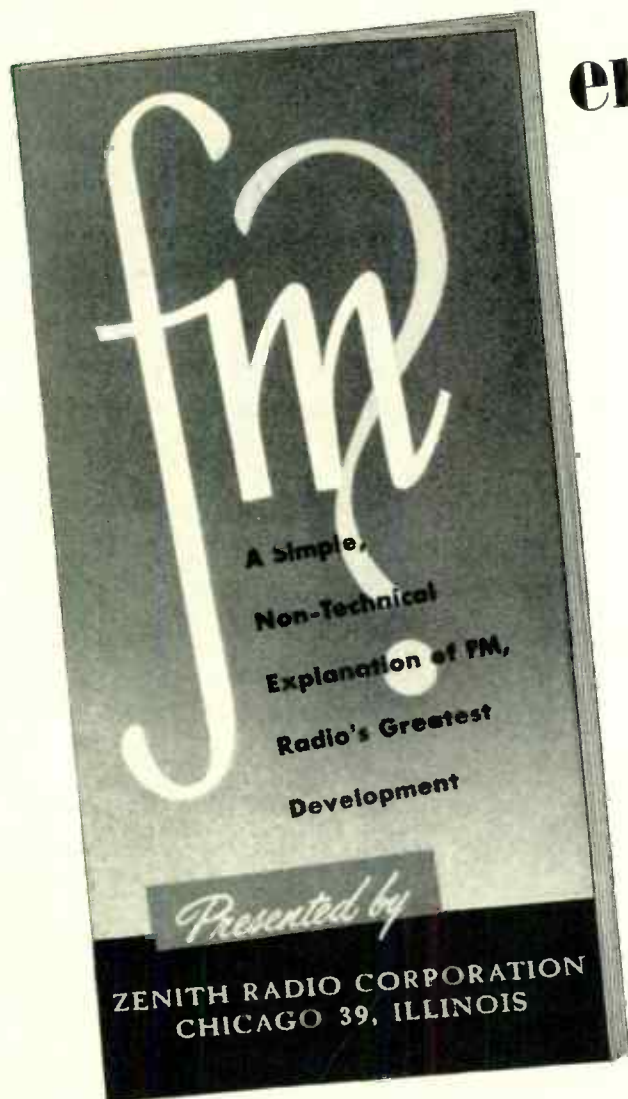

**Zenith's 22,000 Dealers
Throughout the Country
Are Now Distributing
This New FM Booklet
By the Thousands . . .**

*Zenith Dealers Know
About FM . . . Recognize
The Importance Of
This New Kind Of
Radio Broadcasting
. . . They Sell FM!*

**YES, ZENITH IS BACKING YOU UP
WITH AUDIENCE BUILDING PROMOTION**

We are sold on FM radio, and we are supporting our mounting production of FM receivers with a continuous educational campaign. We are helping you tell the story of the advantages of this kind of broadcasting to every radio dealer and prospective set buyer. In addition, one of these new, informative, non-technical folders is included with every Zenith FM receiver shipped from our factory. In this way, each purchaser of a Zenith FM radio will learn about the principles and features of FM, will use it and enjoy it himself, and, we feel sure, will be so enthusiastic about FM that he will *talk* about it and *demonstrate* it to his friends.

FM Station Operators: If you have not already done so, we suggest that you contact the Zenith distributor and dealers in your vicinity. You will find these men willing and anxious to work with you, stimulating interest in FM radio.



ZENITH RADIO CORPORATION

CHICAGO 39, ILLINOIS

January 1947 — formerly FM, and FM RADIO-ELECTRONICS

65

NEW!
FM SIGNAL GENERATOR
MODEL 202-B

FREQUENCY RANGE
54 to 216 MEGACYCLES

The model 202-B is specifically designed to meet the needs of television and FM engineers working in the frequency range from 54-216 mc. Following are some of the outstanding features of this instrument:

- RF RANGES**—54-108, 108-216 mc. \pm 0.5% accuracy.
- VERNIER DIAL**—24:1 gear ratio with main frequency dial.
- FREQUENCY DEVIATION RANGES**—0-80 kc; 0-240 kc.
- AMPLITUDE MODULATION**—Continuously variable 0-50%; calibrated at 30% and 50% points.

This instrument was described editorially in November ELECTRONICS—reprints available on request

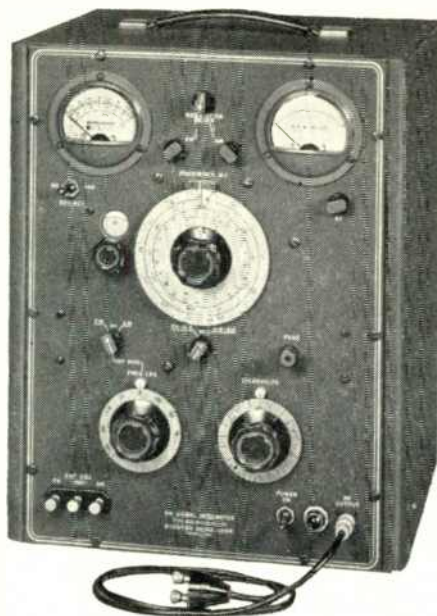

- MODULATING OSCILLATOR**—Eight internal modulating frequencies from 50 cycles to 15 kc., available for FM or AM.
- RF OUTPUT VOLTAGE**—0.2 volt to 0.1 microvolt. Output impedance 26.5 ohms.
- FM DISTORTION**—Less than 2% at 75 kc deviation.
- SPURIOUS RF OUTPUT**—All spurious RF voltages 30 db or more below fundamental.

Write for Catalog D

BOONTON RADIO Corporation
 BOONTON - N.J. - U.S.A.



DESIGNERS AND MANUFACTURERS OF
 THE Q METER - QX CHECKER
 FREQUENCY MODULATED SIGNAL GENERATOR
 BEAT FREQUENCY GENERATOR
 AND OTHER DIRECT READING INSTRUMENTS

MOBILE SYSTEM FOR UTILITIES

(CONTINUED FROM PAGE 29)

service can be quickly restored by sending an operator to the main transmitter and having him operate it as a manual relay station, the portable unit at headquarters then becoming the main transmitter.

This plan will be considerably cheaper and, by its use of portable equipment, more flexible than an alternate plan involving permanent relay links for emergency use.

It is confidently expected that the system, when installed, will provide essentially interference-free service of high quality and adequate reliability over better than 95% of the Company's franchise territory.

Acknowledgment ★ In conclusion, the author wishes to acknowledge the assistance rendered by the General Electric Company and the F. M. Link Company in furnishing equipment to make the tests, and the invaluable help, advice, and time freely given by their representatives Mr. R. G. Beyer of G.E. and Messrs. Roche and Bellingham of Link, in arranging for and assisting in the conduct of the tests.

FM IN MONTREAL

Word from S. M. Finlayson, general manager of the Canadian Marconi Company, is that the Department of Transport has granted a license to his company for the first high-power, commercial FM broadcast station in Canada. Operating in conjunction with AM station CFCF, Montreal, it will transmit on 106.5 mc. According to Mr. Finlayson, the transmitter is based on the Armstrong design, and was manufactured in the Marconi plant at Mt. Royal. Regular FM transmission is scheduled to start early in 1947. The station and tower are being installed in the Sun Life Assurance Building in Montreal.

WHAT'S NEW THIS MONTH

(CONTINUED FROM PAGE 4)

present form. Still another group believes that monochrome transmission should be moved to the upper band now, since a subsequent shift to color, requiring the higher frequencies, will render low-band sets obsolete.

It seems likely that the FCC will ask the broadcasters and manufacturers to pursue their research until they can agree at least on the basic form of color standards. That may take a long time. Meanwhile, existing plans for black-and-white broadcasting and set production will go forward.

2 On November 13th, 200 UE local union leaders unanimously approved the statement that "wages and salaries must be substantially increased in the interests of American wage earners and

(CONTINUED ON PAGE 68)

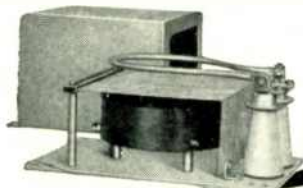

RF CURRENT TRANSFORMER

R. F. Current Transformers provide remote metering and antenna current readings at the antenna for power up to 50 KW.

R. F. Sampling Transformers (same in appearance) are highly recommended for phase sampling antenna current in directional systems with shorter towers. They're totally shielded from external stray fields and free of electrostatic coupling. Complete data and prices on request from department T



JOHNSON
a famous name in Radio

E. F. JOHNSON COMPANY • WASECA • MINNESOTA



TYPE-1000 Antenna Relay

by **ADVANCE**

This sturdy, compact, ceramic-insulated, type "1000" relay makes an excellent antenna changeover relay for transmitters up to 400 watts. Due to its small size it is ideal for use in close spaced open-wire transmission lines. It is well suited for compact marine, aircraft, mobile communication sets or fixed operations. To safely handle R.F. power, high dielectric "Ceramic Steatite" insulation is used throughout. All contact terminals are adequately spaced. All parts are replaceable; no connections are riveted on this model. Available for either AC or DC power—DPDT, DPST and other combinations as desired.

Write for Catalog and Price List

ADVANCE ELECTRIC & RELAY CO.
 1260 West 2nd Street
 Los Angeles 26, Calif., U. S. A.

A PLEDGE TO FM STATIONS

BROWNING UNIVERSAL TUNERS ARE DESIGNED TO GIVE YOUR LISTENERS THE FULLEST ENJOYMENT OF YOUR FM PROGRAMS, AND THE MAXIMUM BENEFITS AFFORDED BY FM BROADCASTING

THE BROWNING FM-AM Universal Tuner not only employs the genuine Armstrong circuits, but it has been engineered to deliver the maximum performance that can be obtained from these circuits.

For example, full limiting action is obtained on 15 microvolts, assuring clear FM reception, free of background noise and static. This high sensitivity is doubly important now, when most FM transmitters are operating on less than their assigned power.

It also gives the BROWNING tuner a greater receiving range, so that it can be operated successfully at distant points where less sensitive receivers bring in no FM signals at all. And in areas where signals are reasonably strong, The BROWNING Tuner requires only the simplest antenna for noise-free FM reception. For details, write:

BROWNING LABORATORIES, INC.

Engineers and Manufacturers

WINCHESTER • MASSACHUSETTS

Canadian Representatives

Measurements Engineering, 61 Duke Street, Toronto

January 1947 — formerly FM, and FM RADIO-ELECTRONICS

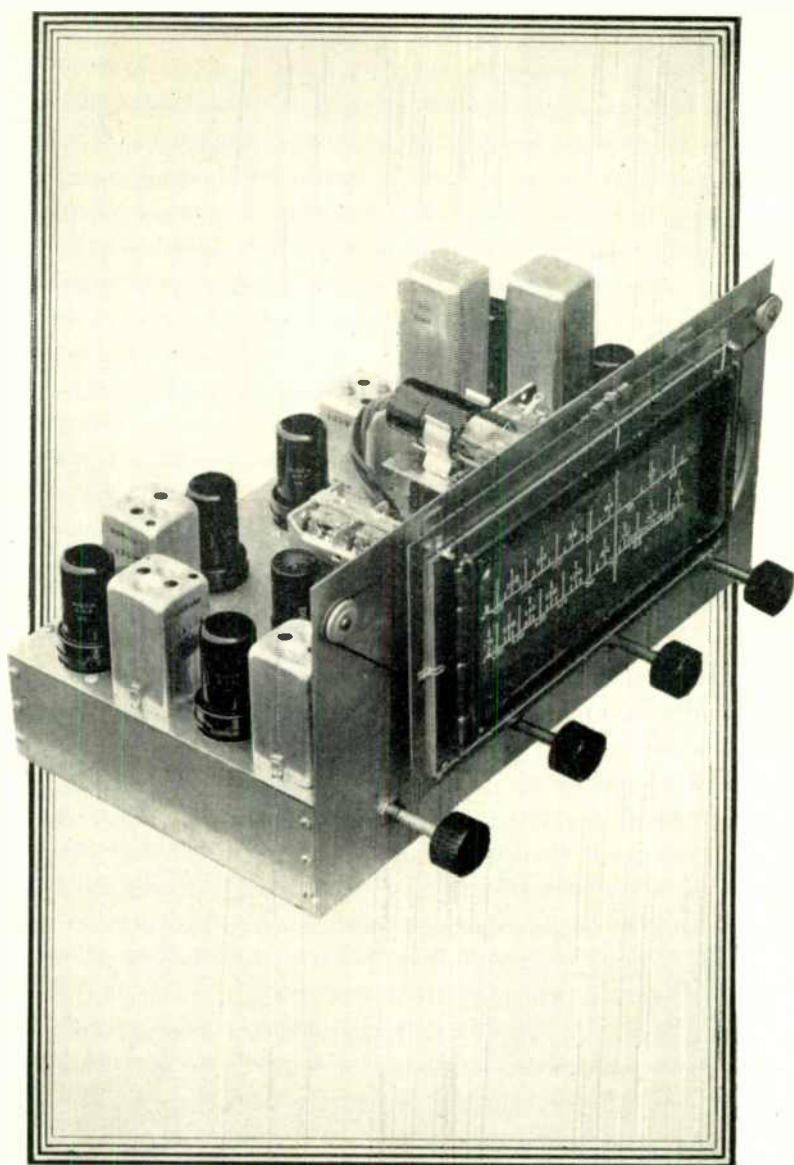

UNIVERSAL TUNER, MODEL RJ-12.....\$114.50
RACK PANEL TUNER, MODEL RJ-14.....\$134.80
POWER SUPPLY UNIT, MODEL PF-12.....\$ 14.75
(plus 10% Federal tax)

INFORMATION ON THE RJ-12 TUNER

The BROWNING Tuner covers 88 to 108 mc. on FM, and 535 to 1650 kc. on AM. It is intended to feed any type of high-fidelity amplifier and loudspeaker, according to the user's requirements.

Thus, the BROWNING Tuner provides sufficient flexibility to meet the needs of every type of installation, and at less than half the cost of a cabinet model of equivalent performance, but of less adaptable design.

This is as true for simple home installations as for schools and public buildings where phonograph turntables and sound equipment are required in conjunction with FM and AM radio reception.

Remember: When you use a BROWNING Tuner, you can give free rein to your ingenuity in planning an installation as simple and inexpensive or as elaborate as you choose. In either case, you are assured of the fine radio performance represented by the BROWNING name for nearly a quarter of a century.

Complete data on the BROWNING FM-AM Tuner and Power Supply will be sent upon request.

**FOR RADIO AND ELECTRONICS
PARTS • SETS • EQUIPMENT**
*ask NEWARK they'll
have it!*

IF YOUR NEEDS in radio or electronics parts, sets or equipment are available

★ Literature and full information on ANY manufacturer's products will be sent promptly on request. Wire or phone for quick action.

★ Our big bargain counters are loaded with new parts and unusual special equipment. Inquiring minds enjoy these displays.

anywhere, you'll save time by phoning or wiring Newark Electric. Tremendous, up-to-the-minute stocks are maintained in all three stores.

COMPETENT TECHNICAL MEN handle your inquiries intelligently and promptly and can quote prices and delivery dates on specific merchandise. Orders shipped same day. When writing address Dept. M5.

Mail orders filled from either New York or Chicago



N.Y.C. Stores: 115 W. 45th St. and 212 Fulton St.
Offices & Warehouse: 242 W. 55th St., N.Y. 19



NEWARK ELECTRIC COMPANY, INC. Dept. M5
Please send informative literature on the following:

NAME: _____
ADDRESS: _____
CITY: _____ STATE: _____

P.A. Depts. in all stores. Set & Appl. Depts. in N. Y. C.

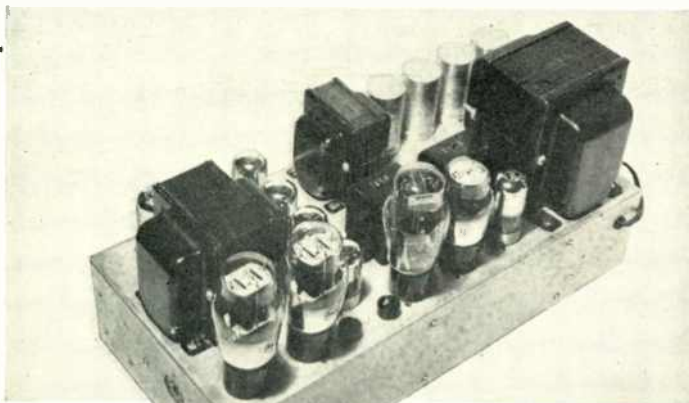

**The BROOK
High Quality Audio Amplifier**
Designed by Lincoln Walsh

Built to give the lowest possible distortion
AT 5 WATTS, 2nd harmonic is 0.6%—3rd harmonic is 0.3%.

Higher harmonics not measurable.
Cross modulation less than 0.2%.

AT 35 WATTS, total distortion is 6%.

No transformer saturation at 35 watts at 25 cycles. Frequency Response 20 to 20,000 cycles 0.2 db. Uses all low Mu Triodes "Receiver Type". Patented automatic bias control circuit.

BROOK ELECTRONICS, INC.
ELizabeth 2-7600 Elizabeth 2, N. J.

WHAT'S NEW THIS MONTH

(CONTINUED FROM PAGE 68)

1. Labor	\$ 30.00	30%
2. Material	30.00	30%
3. O, SE, T	33.00	33%
4. Profit	7.00	7%

\$100.00

Since the radio distributor generally gets 50 and 10% discount, the retail price on this set will be \$222.20. That is, the manufacturer gets \$222.20 less 50 and 10%, or \$100.00.

Now, comparative man-hour figures on prewar and postwar production show that the production of factory workers is about one-half of what it was in 1939! Is it too much to ask them to limit their conversation, time-in-the-toilet, walking around, and general lead-swinging to what they did in those days? Perhaps it is. So let's ask them to reduce their present wasted time and motions by only 40%.

Immediately the labor cost on that set will drop to \$24.00. And if the workers who produce the materials do the same thing, material costs will go down to \$28.20, carrying out the same proportions. Similar efficiency among other employees, and the percentage drop in commissions and taxes will reduce the O, SE, T total to 28.70, while the 7% profit will amount to only \$6.09. Thus we have:

1. Labor	\$24.00	28%
2. Materials	28.20	32%
3. O, SE, T	28.70	33%
4. Profit	6.09	7%

\$86.99 100%

Subject to the same 50 and 10% trade discount, the retail price of our radio drops to \$193.40, instead of \$222.20.

However, this represents no reduction in the hourly wage rate or take-home pay, but simply an increase in workers' efficiency.

Let us go back to The Brow's oratory and emotion. He says it's "a lie that price increases are caused by wage increases." Taking him at his word, let's up the wages 20% and see what happens to the cost of our radio set.

Labor will go from \$30.00 to \$36.00. Workers producing materials are entitled to the same increase. Using the same proportions, materials jump to \$31.80. Salaried workers are entitled to the 20% increase, also, and commissions and taxes will automatically rise, making the figure for O, SE, T \$37.29. The 7% profit becomes \$7.91. This gives us:

1. Labor	\$ 36.00	32%
2. Material	31.80	28%
3. O, SE, T	37.29	33%
4. Profit	7.91	7%

\$113.00 100%

Therefore, the radio set which must sell for \$113.00, with 50 and 10% discount, bears a retail price of \$251.10!

(CONCLUDED ON PAGE 72)

*The type you really need
... tiny tip or giant
size... You'll
find it
in*



**the
VACO**
screw driver line

There are 173 types... a size, a style, a blade or a tip to fill any industrial, farm, radio, or home need that can possibly arise. Vaco screw drivers have gleaming

Amberyl plastic handles... shock-proof and break-proof. Write for catalog.

VACO 317 E. ONTARIO ST.
PRODUCTS CO. CHICAGO 11, ILL.
CANADIAN WAREHOUSE
560 KING STREET WEST - TORONTO 2, ONT.



**Acclaimed by eminent
radio engineers as today's outstanding
example of FM performance**

As pioneers and specialists in FM, the makers of Freed-Eisemann have developed a new FM circuit. Radio authorities who have heard Freed-Eisemann FM have acclaimed it as today's outstanding achievement in fine FM engineering and reception. In addition to FM, the new Freed-Eisemann is equipped with standard and shortwave receivers, and with a superb phonograph. Housed in magnificent period cabinets.

The New High-Fidelity

Freed-Eisemann
with FM

ONE OF THE WORLD'S GREAT RADIO-PHONOGRAPHS
Freed Radio Corporation • 200 Hudson Street • New York 13, N.Y.

NEXT MONTH:

**Special Issue for the
I.R.E. SHOW**

**SEE YOU AT THE
GRAND CENTRAL PALACE**

W Q X Q

*New York City's
First FM Station*



WQXR and WQXQ
*The Radio Stations of
The New York Times*

WILLARD 2-VOLT

**COMPACT, RECHARGEABLE
Spill-Proof STORAGE BATTERY**

In an attractive Clear Plastic Case. Only 2 1/4" square and 6" overall height. About the size of the ordinary No. 6 Dry Cell. Rating 24 AH. Gangs nicely for other voltages in multiples of 2 volts. Ideal for many applications.

Shipped dry with electrolyte for each in separate container. (Can not be shipped Parcel Post.)

**CLOSE OUT PRICE While Our Stock Lasts.
Every One BRAND NEW!**

Stock No. 5A133. Only..... **\$2.95**

In Case Lots of 42. Each. **\$2.50**



BURSTEIN-APPLEBEE CO.
1912-14 McGee, Kansas City 6, Mo.

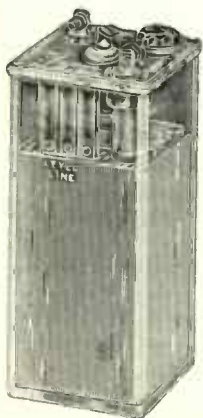



Every Ward model has been tested and approved by car and radio set manufacturers — your proof of quality inside and out.

WARD *Aerials*

World's largest manufacturers of antennas. We specialize in car, home, amateur and special communications applications, including FM and television. Write for full details.

THE WARD PRODUCTS CORPORATION

1523 EAST 45TH STREET
CLEVELAND 3, OHIO

In Canada — Atlas Radio Corp.,
560 King St., W., Toronto, Ont., Canada

WHAT'S NEW THIS MONTH

(CONTINUED FROM PAGE 70)

Now, to review these figures: If all union employees would reduce by only 40% the amount of time wasted today by the average worker, they could increase the buying power of their present wages by about 13%. Moreover, an increase of 20% in wages, representing \$7.80, as shown by the 1st and 3rd tables, would mean an increase of \$28.90 in the cost of the radio set under discussion, while slightly increased efficiency at the same wage rate would reduce the retail price \$28.80 without affecting the workers' take-home pay!

To put it differently, if workers continue at their present level of inefficiency, and are given a 20% wage increase, they will have to pay 30% more for the necessities and luxuries of life than if they keep their present scale and simply reduce, by only a reasonable amount, the hours now wasted during the working week.

Here then is the difference between reality expressed in simple arithmetic, and emotion supported by nothing more than rabble-rousing words carefully calculated to maintain a condition of antagonism and uncertainty between radio workers and the manufacturers.

If radio manufacturers or union officials have any fault to find with the figures used in this text, we shall be glad to restate this proposition, giving effect to their corrections.

3. Labor leaders can rave and shout, and the political economists can theorize at deadly length, but the realities of life remain as simple and inviolable as the multiplication tables.

We have never heard a more profound exposition of the wage problem than one we remember from the days of our childhood. One of the packers in our Father's shipping room wanted more wages. Father asked him: "If you get more pay, can you do more work?" The packer replied: "Sure I can!" Then Father told him: "Very well, let's see how much more you are able to do, and your pay will be raised accordingly." We don't know the outcome, but if he increased his production, it's certain that he got a raise. Our Father was a very just man.

We have grown up with most of the employers in the radio industry. There are some bad actors, but very, very few compared to those who are always ready to give their employees more than a fair break. So before UE members get too excited when The Brow shrieks about "the dishonesty of Big Business" and "unrestricted profiteering," it would be interesting to have him name some of the companies, and give out the figures of their profits. We suspect that he might then be disclosed as a sheep wearing wolf's clothing.

NEWS! YOUR 1947

RADIO ENGINEERING SHOW
to be at
GRAND CENTRAL PALACE
March 3-6

NOT at the 34th Street Armory. We outgrew that place and were lucky enough to get space at Grand Central Palace . . . the biggest exhibition hall in New York, for the biggest radio engineering show in history!

Admission to Grand Central Palace and all lectures free to members of The Institute of Radio Engineers. \$3.00 registration for non-members.

Have you made your plans yet to attend the show?

(Incidentally, better make hotel reservations well in advance!)

Wm. C. Copp, Exhibits Manager

THE INSTITUTE OF RADIO ENGINEERS

1 E. 79TH ST., N. Y. 21 Circle 6-6357

ZOPHAR



WAXES COMPOUNDS and EMULSIONS

FOR
INSULATING and WATERPROOFING
of ELECTRICAL and
RADIO COMPONENTS

Also for
CONTAINERS and PAPER
IMPREGNATION

FUNGUS RESISTANT WAXES

ZOPHAR WAXES and COMPOUNDS
Meet all army and navy
specifications if required

Inquiries Invited

ZOPHAR MILLS, INC.

FOUNDED 1846

122-26th ST., BROOKLYN, N. Y.

FM for the Best
in Broadcasting

Collins for the Best
in FM

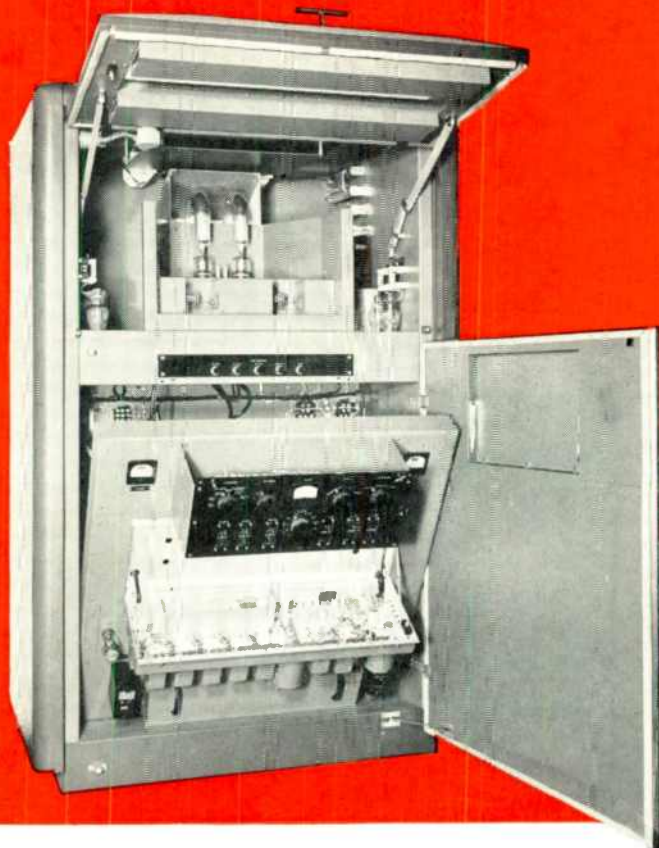

Collins Type 731A
250 watt FM transmitter

In FM, Collins gives you: advanced engineering, efficient operation, simplified design, Phasitron modulation, maximum accessibility, personnel protection, unit construction, flawless performance, dependability.

Collins FM utilizes the Phasitron modulation system. Direct crystal control of the carrier frequency eliminates complicated reference circuits, and permits the use of conventional quartz crystals, with simple temperature control. Only 6 multiplier tubes are employed to produce the transmitted frequency. FCC specifications are amply fulfilled in every detail. Unit construction facilitates increasing power at any time.

Years ago, Collins pioneered the use of vertical chassis construction for accessibility. Maintenance of Collins equipment is a simple task. All operating controls are easily

reached from the front of the cabinet, while the transmitter is on the air. Electrical and mechanical interlocks provide maximum personnel protection when doors are opened.

The 731A, shown above, is one of a line of Collins FM transmitters which reflect many years of successful experience in the design and manufacture of outstanding broadcast station equipment. Tell us about your plans and ask for descriptive literature covering our FM transmitters and studio equipment. We can supply your entire needs from microphone to antenna.

FOR BROADCAST QUALITY, IT'S



COLLINS RADIO COMPANY, Cedar Rapids, Iowa

11 West 42nd Street, New York 18, N. Y.

458 South Spring Street, Los Angeles 13, California

SOUTH DAKOTA'S BEAUTIFUL "BLACK HILLS" ARE ROUGH ON RADIO WAVES, SO...



The State Police chose



for DEPENDABLE communications

The gorgeous hills of South Dakota are a vacationist's delight—but a radio engineer's dilemma. State Police faced the problem of radio-blanketing 77,000 square miles of the worst radio terrain in the country, so they turned to Motorola—and got the solution!

Now patrol cars can talk 2-way from any point in the entire state—assuring the same speed and certainty of radio communications enjoyed by any single metropolitan area. Motorola accomplished this task with only *seven* fixed 250 watt transmitters strategically stationed throughout the state!

South Dakota is one of 36 states and over 1000 communities now enjoying the *dependable* coverage of Motorola Radio-telephone. During the past five years *over 80%* of all police radio installations have been Motorola! There's a reason for this outstanding popularity. It's Motorola's outstanding superiority.

Motorola engineers will be glad to make specific recommendations concerning the installation of Motorola Radio-telephone in your particular application. Write today. No obligation, of course.

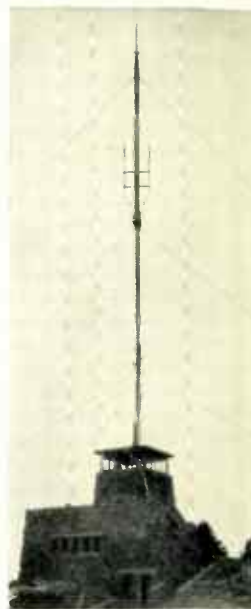

The 125-ft. antenna on Mt. Caalidge. Beam arrays are far communication with Rapid City.



Equipment at Mt. Caalidge. Left, Motorola beam transmitter and receiver. Right, Motorola 250-W. transmitter and receivers.



Dispatcher at Rapid City, can reach all cars in western South Dakota on this relay.

GALVIN

MFG. CORPORATION • CHICAGO 51

COMMUNICATIONS AND ELECTRONICS DIVISION

F-M & A-M HOME RADIO • AUTO RADIO • PHONOGRAPHS • TELEVISION • "HANDIE TALKIES" • POLICE RADIO • AIRCRAFT RADIO