

Communication Engineering

'53-5

Established as

FM
1940

Sept.-Oct. 1953

MILTON B. SLEEPER, *Publisher*

Price 65 Cents



9th FCC Chairman

United States Motors Corp. Announces...

MICRO

POWER

Communications Standby Power That Operates With
the Main Source. To Maintain Continuous . . .

UN-INTERRUPTED POWER

Here's NEW . . . Low-Cost . . . Automatic Standby Insurance . . . It's MICRO-POWER, developed by United States Motors Corporation especially for the Communications Industry,

IT'S AUTOMATIC! . . . because it operates in conjunction with the main source of power as a line voltage regulator and stabilizer. Dropping voltage is picked-up and maintained **BEFORE LOSS OF POWER TO ESSENTIAL EQUIPMENT** or complete power failure.

IT'S ECONOMICAL . . . because it replaces one or more units of costly, complicated equipment.

IT'S ESSENTIAL . . . to the communications industry. There are no time consuming load "transfers". No momentary "drags" or dropping voltage. **NO POWER OUTAGES, EVEN FOR PRECIOUS SECONDS.**

MICRO-POWER PROVIDES COMPLETELY AUTOMATIC, UN-INTERRUPTED SERVICE FOR THE COMMUNICATIONS INDUSTRY.

3KW and 5KW Micro-Power Units available for immediate installation.

Write **U. S. Motors Corporation, Oshkosh, Wisconsin**
for complete details and specification.

SEE MICRO-POWER UNITS
at the U. S. I. T. A. Convention
at the Conrad Hilton Hotel,
October 12, 13 and 14.



UNITED STATES MOTORS CORP.

OSHKOSH, WISCONSIN



PHILCO MICROWAVE:

Like a Super-Highway in the Sky, Philco microwave gives broad, clear communication channels, free of interference and interruption. Super-high frequency Philco microwave with Philco multiplexing equipment—either frequency or time division—offers wide band channels up to 3300 cycles and circuit design which provides freedom from cross talk and distortion.

Philco microwave is easily expanded to 24 voice channels, each divisible into 16 sub-channels for telemetering, control circuits, teletype circuits or any other signalling needs. These channels are in the high-antenna gain, interference-free 6000-7500 mc. frequency range which encompasses adjacent common carrier, government and industrial bands.

Philco microwave has the highest power output of any equipment in the 6000-7500 mc. frequency range. Philco brings common carrier reliability and long-range economy to industrial communications.

Look to Philco to answer your multi-channel communications requirements.

COMMUNICATIONS SUPER-HIGHWAY

An aerial photograph of a winding highway through a hilly, wooded landscape. A bright, shimmering path of microwave energy is superimposed over the highway, extending from the top right towards the bottom left. The path is flanked by several small, circular antenna-like structures. The text 'COMMUNICATIONS SUPER-HIGHWAY' is printed in large, bold, white letters across the top of the image.

For Complete Information Write to Department CE



PHILCO CORPORATION

GOVERNMENT & INDUSTRIAL DIVISION • PHILADELPHIA 44, PA.

formerly *FM-TV* RADIO COMMUNICATION

BLILEY BVA
BLILEY BVA



- ⊞ RESEARCH
- ⊞ ENGINEERING
- ⊞ CRAFTSMANSHIP
- ⊞ PRECISION
- ⊞ PRODUCTION
- ⊞ DELIVERY
- ⊞ QUALITY

The top frequency control choice in all electronic applications:

MILITARY ... MARINE ... AIRBORNE
MOBILE ... AMATEUR ... INSTRUMENTATION
ULTRASONICS ... STANDARD



BLILEY ELECTRIC COMPANY
UNION STATION BUILDING • ERIE, PA.

Communication Engineering

Formerly FM-TV and RADIO COMMUNICATION

Vol. 13 September-October, 1953 No. 5

COPYRIGHT 1953, by RADIOCOM, INC.

DEPARTMENTS

Systems Data	
Breakdown of new application information	4
Product Information	
New components, equipment, and literature	6
Companies and People	
Expansions, activities, appointments, awards	8
Meetings and Events	
Schedule of important shows and conferences	8
Communication Review	
General news of the industry	17

ARTICLES

Dispatching a Large Taxi System	
James A. Craig	19
Construction of a Remote Base Station	
H. V. Church	22
N1 Carrier Equipment Design	
W. R. Steeneck	26
FCC Assignment Philosophy, Part 2	
Edwin L. White	29
Frequency Stability of Dual Crystals	
Douglas A. Venn and George W. Arnold	30
Installation of Buried Cables	
Gerald W. Lee	33

THE COVER DESIGN AND CONTENTS OF COMMUNICATION ENGINEERING MAGAZINE ARE FULLY PROTECTED BY U. S. COPYRIGHTS, AND MUST NOT BE REPRODUCED IN ANY MANNER OR IN ANY FORM WITHOUT WRITTEN PERMISSION

ROY F. ALLISON, *Editor*

MILTON B. SLEEPER, *Publisher*

FRED C. MICHALOVE Eastern Manager CHARLES KLINE Western Manager EDWARD BRAND West Coast Manager

CLAIRE EDDINGS Production Manager LILLIAN BENDROSS Accounting WARREN SYER Promotion Manager ELEANOR GILCHRIST Art Director

Publication Office: The Publishing House, Great Barrington, Mass. Tel. Great Barrington 1300.

Chicago Office: 5449 W. Augusta Blvd., Tel. Columbus 1-1779.

New York Office: 6 East 39th Street, Room 1209, Tel. Murray Hill 5-6332.

West Coast Office: 1052 West 6th Street, Los Angeles, Tel. Michigan 1732. COMMUNICATION ENGINEERING MAGAZINE is mailed on the 20th of January, March, May, July, September, and November.

Subscriptions: Should be sent to Publishing House, Great Barrington, Mass. Single copies 65c. Sub. rates: 3 years—\$6.00; 2 years—\$5.00; 1 year—\$3.00.

Contributions will be neither acknowledged nor returned unless accompanied by adequate postage, packing, and directions, nor will COMMUNICATION ENGINEERING Magazine be responsible for their safe handling in its office or in transit.

Entered as second-class matter August 22, 1946, at the Post Office, Great Barrington, Mass., under the Act of March 3, 1879. Additional entry at Post Office, Boston, Mass. Printed in the U. S. A.

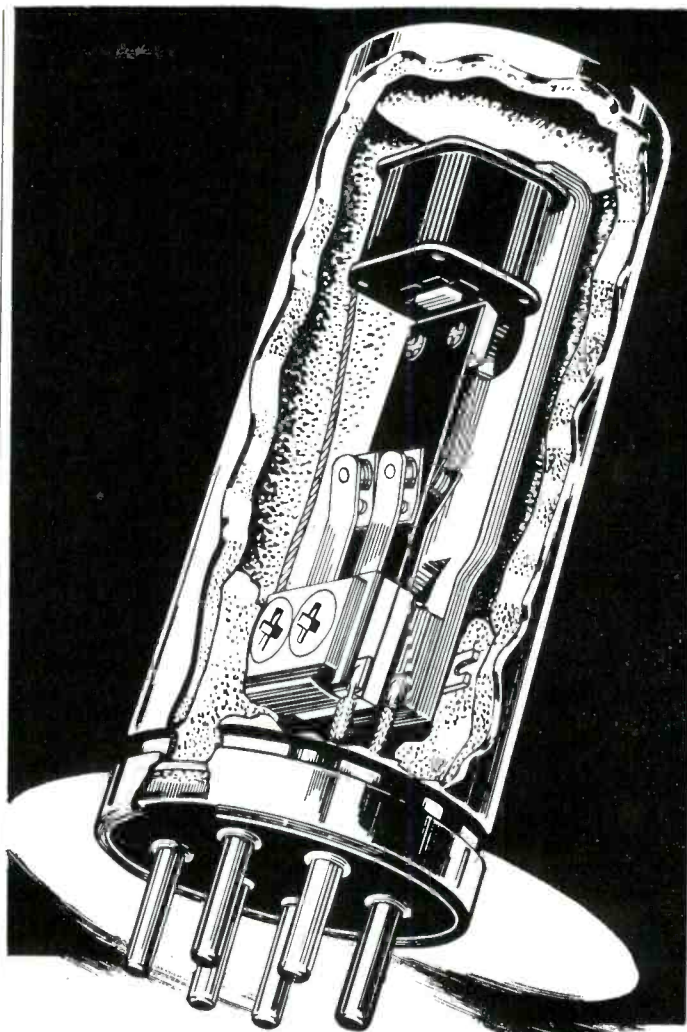

Specifically Designed For
Rugged Mobile Communications Service

DEPENDABLE
and Trouble-Free
VIBRATORS



Select your replacement vibrators wisely... and you, too, will choose Radiart! Laboratory tests and customer reports prove that Radiart Vibrators give LONGER LIFE and trouble-free performance BECAUSE THEY ARE BUILT TO WITHSTAND RUGGED SERVICE! These extra hours of dependable performance is one of the factors that has made Radiart the leader. Superior engineering and design have made them THE STANDARD OF COMPARISON.

At all good radio parts jobbers. Ask for the new Form F781 listing the latest replacement recommendations.



IT'S RIGHT WHEN IT'S RADIART

THE **RADIART** CORPORATION
CLEVELAND 13, OHIO



• VIBRATORS • AUTO AERIALS
• ROTORS • TV ANTENNAS • POWER SUPPLIES



CIRCULATION AUDITED BY
HENRY R. SYKES
CERTIFIED PUBLIC ACCOUNTANT
SYKES, GIDDINGS & JOHNSON
PITTSFIELD, MASSACHUSETTS



RADIO ENGINEERING LABS., Inc.

PIONEERS IN THE CORRECT USE OF
ARMSTRONG FREQUENCY MODULATION

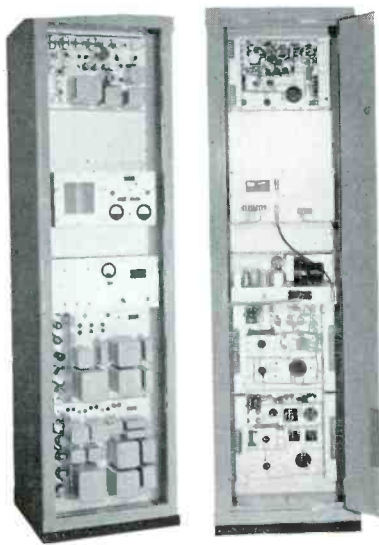

REL MULTIPLEX RELAY & POINT-TO-POINT EQUIPMENT

Typical of the standard transmitter and receiver designs developed by REL for high-quality multiplex and point-to-point radio circuits is the Type 755-C equipment for 152 to 174 mc.

The transmitter-receiver unit illustrated above functions as a 4-terminal network for frequency-division multiplexing of voice, program, telegraph, telemetering, remote control, and facsimile up to the equivalent of 5 voice circuits. Nominal output is 25 watts or 100 watts. Using the basic Serrasoid phase-shifter, performance specifications meet the highest requirements of standard telephone practice.

Operating records of this REL equipment in systems requiring continuously reliable service establish beyond question 1) the high degree of stability afforded by the electrical and mechanical tolerances built into REL multiplex equipment, and 2) the substantial savings in maintenance cost resulting from designs which reflect long experience with adverse conditions in all parts of the world. Standard specifications can be modified to suit special requirements. For engineering data, prices, and deliveries, address:

Engineers and Manufacturers of
Broadcast, Communication, and
Associated Equipment since 1922

RADIO ENGINEERING LABORATORIES, Inc.

TEL.: STILLWELL 6-2100 TELETYPE: N. Y. 2816
34-40 37th Street, Long Island City 1, N. Y.

SYSTEMS DATA

IT was hardly reasonable to expect that the number of mobile, base, and portable transmitters shown in this bi-monthly department would increase indefinitely. Nevertheless, a decrease in all three categories comes as a surprise. The significance of the change will not appear until another four months have passed. Then it will be known whether the peak volume has been passed, or if the July-August period was an exception.

This data is the most up-to-date and accurate picture of current activity available since the figures shown are for applications as they are filed at the FCC, and they are compiled from our Weekly Reports of Applications.¹ Totals for the first 8 months of this year show applications filed for 54,570 mobile units, 4,882 base stations, and 3,884 portable units for operation on 30 to 50 or 152 to 174 mc., representing a volume of about \$4 million per month. That figure does not include mobile, point-to-point, and relay systems on other frequencies, which may average nearly as much again.

Actual orders for mobile units probably amounted to substantially less than the total of 13,966 shown here, particularly because 1,755 units are listed for common carrier and miscellaneous common carrier service. Thus the figure represents

an expected number of subscribers over a period of time rather than the number going into use at once.

Following is a list of transmitters *not included* in the Table, because they will be operated outside the 30 to 50 and 152 to 174-mc. bands, for which applications were filed during August and September:

POLICE: 39 speedmeters on 2,455 mc.; 4 interzone CW transmitters on 1.6 to 7.0 mc.; 1 relay on 42 mc., 1 on 75 mc., 5 on 155 mc., and 2 on 450 mc.; 8 control transmitters on 159 mc.

FIRE: 1 mobile relay on 172 mc., relay on 160 mc., 2 relays on 458 mc., 1 control transmitter on 154 mc., 2 on 458 mc.

SPECIAL EMERGENCY: 35 mobile units and 10 temporary base transmitters on 3.19 mc.

FORESTRY CONSERVATION: 2 mobile relays on 172 mc., 1 relay on 159 mc., and 1 relay on 454 mc.; 1 control transmitter on 161 mc., and 1 on 454 mc.

HIGHWAY MAINTENANCE: 1 speedmeter on 2,455 mc.; 4 relays on 72 mc., 4 on 161 mc., and 2 on 454 mc.; 1 control transmitter on 72 mc., 4 on 156 mc., and 1 on 455 mc.

POWER UTILITY: 15 mobile units on 457 mc.; 3 mobile relays on 153 mc.; 3 relays on 72 mc., 1 on 451 mc., and 11 on 1,905 mc.; 4 control transmitters on 153 to 172 mc., 3 on 456 mc., 4 on 1,855 mc., and 72 on 6,585 to 6,785 mc.

(Concluded on page 12)

¹For information about this weekly reporting service, address Registry Department, COMMUNICATION ENGINEERING, The Publishing House, Great Barrington, Mass.

TABLE OF APPLICATIONS FILED JULY 1 TO AUGUST 30, 1953

	TOTAL MOBILE	TOTAL BASE	TOTAL PORT.	30 to 50 mc.			152 to 174 mc.		
				MOBILE	BASE	PORT.	MOBILE	BASE	PORT.
Police	2,079	116	82	1,185	67	15	894	49	67
Fire	893	82	153	690	64	16	203	18	137
Special Emergency	280	107	2	191	44	2	89	63	—
Highway Maintenance ..	276	29	—	226	26	—	50	3	—
Forestry Conservation...	786	44	40	541	25	40	245	19	—
Power Utility	1,042	103	5	583	71	5	459	32	—
Pipeline Petroleum	519	102	10	391	82	—	128	20	10
Special Industrial	2,280	232	10	1,643	190	—	637	42	10
Low-Power Industrial ..	—	—	467	—	—	122	—	—	345
Relay Press	3	—	2	—	—	—	3	—	2
Motion Picture	—	—	4	—	—	—	—	—	4
Forest Products	229	29	3	209	17	1	20	12	2
Taxicabs	1,689	114	—	—	—	—	1,689	114	—
Railroads	1,114	78	20	—	—	—	1,114	78	20
Highway Trucks	761	29	—	761	29	—	—	—	—
Intercity Buses	106	3	—	106	3	—	—	—	—
Transit Utilities	—	—	—	—	—	—	—	—	—
Auto Emergency	164	18	—	164	18	—	—	—	—
Radio Paging	—	26	—	—	26	—	—	—	—
Common Carrier	960	10	—	75	1	—	885	9	—
Misc. Common Carrier...	795	11	—	—	—	—	795	11	—
TOTALS	13,976	1,133	798	6,765	663	201	7,211	470	597

COMMUNICATION ENGINEERING September-October, 1953



COMMUNICATIONS SUPERVISORS:

get **\$25,000**
coverage for **\$700!**

Here are the plain facts that speak for themselves of \$24,300 savings.

To increase the "talk-back" range of one-hundred cars from 20 miles to 25 miles—corresponding to an increase of 50% in area coverage—one-hundred 15 watt transmitters must be replaced with 60 watt transmitters . . . at an approximate cost of \$25,000.

You can get the same coverage by installing an Andrew 3000-type antenna for only about \$700.

One postcard can save you over \$24,000. Before you buy, write us for a complete analysis of costs and antenna types to meet your needs.

Andrew
CORPORATION

363 East 75th Street • Chicago 19

formerly *FM-TV* RADIO COMMUNICATION

NEW...

POWER BOOSTER

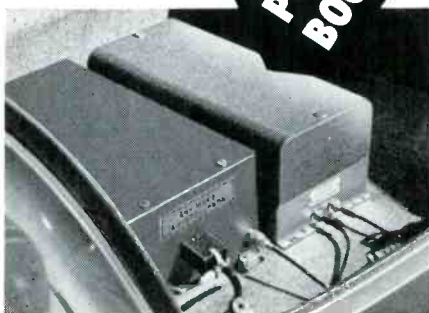

NEW POWER BOOSTER Boosts Power instantly!

Stronger signals and greater transmission range even in hilly country are now possible through use of the new Kaar Power Booster, which increases by six times the power output of any 8 to 10 watt mobile transmitter, without adding to standby battery needs—a recent, outstanding engineering achievement of the Kaar research laboratories.

**DEPENDABLE
MOBILE
COMMUNICATION**

RADIOPAK



Rugged construction... simplicity of design... lowest possible battery drain... exceptional voice quality—these are the features that make the Radiopak the most dependable single unit mobile radiotelephone available today. Furnished for both the 25 to 50 mc band and the 152 to 174 mc band, the Radiopak is ideally suited for use in police cars, taxis, fire department vehicles, trucks, and three-wheeled motorcycles.

● WRITE FOR
SUMMARY
CATALOG ON
ALL KAAR
MOBILE
EQUIPMENT

DEALERS!
Kaar Corp. is a major radiotelephone manufacturer selling through authorized dealers. Write for complete information.

KAAR

ENGINEERING CORP.
MIDDLEFIELD ROAD • PALO ALTO, CALIF.

PRODUCT INFORMATION

Tower Lighting: A 20-page booklet describes methods and materials necessary for installing obstruction lighting equipment on antenna towers. Includes layout drawings and complete bills of material for towers of all heights. Booklet 381-F available free on request to Crouse-Hinds Company, Syracuse 10, N. Y.

Rack-Mounted Oscillograph: Electrical equivalent of type 304-A is now available as a rack-mounted unit, known as type 304-AR. Requires 8¾ ins. of rack space. Full 4-inch deflection is obtained with inputs from 1 to 1,000 volts. Frequency response DC to 300 kc. Allen B. Du Mont Laboratories, Inc., Instrument Division, 760 Bloomfield Avenue, Clifton, N. J.

Subminiature Resistors: Type 1106 resistor 3/16 in. diameter by 7/16 in. long, is rated at .10 watt and is anti-humidity impregnated. Maximum resistance is 100,000 ohms when standard winding wires are used; other resistance wires with special temperature coefficients can be used, but maximum resistance is reduced. Tolerance to ±.05% can be obtained. The Daven Company, 191 Central Avenue, Newark, N. J.

Signal Generator: Providing continuous coverage on fundamentals from 125 kc. to 165 mc., model 292XAL Airline microvolt signal generator is built specifically for aircraft radio



service and maintenance. Can be modulated externally from 15 to 10,000 cycles. Accurate calibration of frequency and output level is claimed. Crystal controlled and temperature compensated. H. D. Johnson, The Hickok Electrical Instrument Company, 10530 Du Pont Avenue, Cleveland, Ohio.

Portable Towers: A new line of aluminum-alloy towers features very fast and simple erection, extreme rigidity. Towers up to 300 ft. high can be assembled from individual sections which fit one on top of another. are put together without tools. Wind loading up to 150 mph. is possible; guys are installed without turnbuckles or cable clamps. Up-Right, Inc., 1013 Pardee, Berkeley, Calif.

Components Symposium: Text of all papers presented at the 1953 Electronic Components Symposium is now available in book form. Thirty papers and three addresses cover General Component Problems; Environment

and Packaging; Tubes and Tube Reliability; Component Reliability; Resistors, Capacitors, and Dielectrics; and Devices and Materials. Copies can be obtained from the Symposium headquarters at Suite 1011, 621 South Hope Street, Los Angeles 17, Calif.

New UHF Equipment: A complete line of 2-way radio equipment for use in the 450 to 470-mc. band consists of the CMU-10A mobile assembly, shown here; the CSU-20A desk console; and the CSU-20ACR and CSU-100ACR

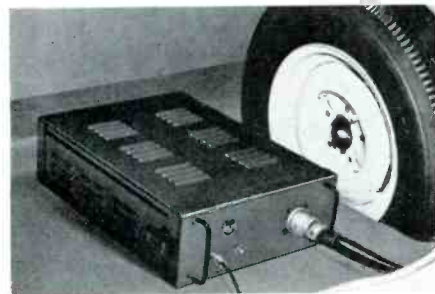

rack-mounted station equipments. Presumably, figures in model numbers indicate power output. Mobile case is 13½ by 5 by 17 ins., contains transmitter, receiver, and dual-vibrator power supply, RCA Victor, Camden, N. J.

Tiny Blower: Production has begun on the Minicube subminiature blower, which weighs 1 ounce including motor, measures only 1 by 1 by 1 inch, and delivers 3 cubic ft. of air per minute. Universal mounting permits application for spot-cooling or general circulation. Temperature range is -55° to +85° C; life expectancy is 1,000 hours. Hysteresis synchronous motor turns at 24,000 rpm; 1, 2, or 3-phase supply; source can be 6.3 volts at 60 cycles or 26 volts at 400 cycles. Sanders Associates, Nashua, N. H.

New Monitoradio: Model FMC1-L is a crystal-controlled fixed-frequency FM radio receiver for frequencies between 30 and 50 mc. New unit replaces model M-51, which was a tunable mobile receiver. Sensitivity has been increased to better than 1 microvolt, and band-width reduced, to make the new model useful as an inexpensive supplement to exist-

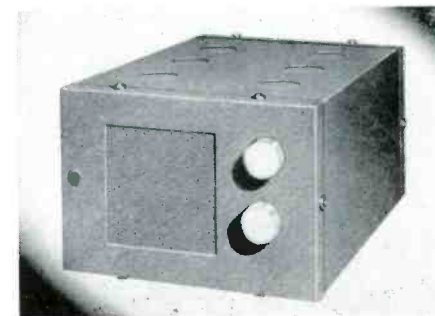

ing 2-way communication systems. Radio Apparatus Corp., 55 North New Jersey Street, Indianapolis, Ind.

Audio Catalog: Recently-issued general
Continued on page 10

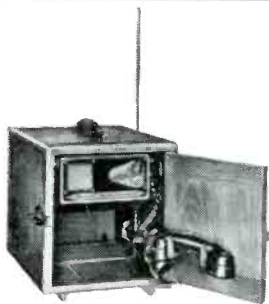
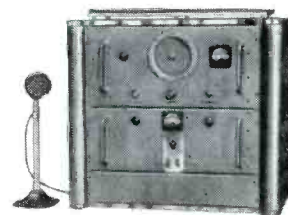
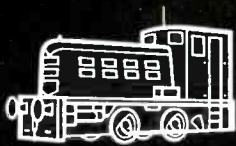

the right move . . .

In more than fifty countries Pye radio-telephones are indicating the right move. The next step, great or small, in divers undertakings.

In the engineering industry, immediate direct communications are vital. The deployment of resources to the fullest advantage demands contact. Contact swift and sure. Contact at speeds to match the action required.

Whenever men and machines are on the move Pye V.H.F. Radio-telephones will promote speed and efficiency.

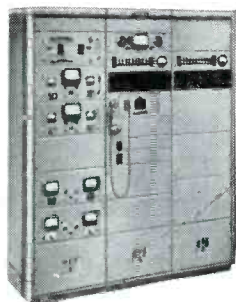
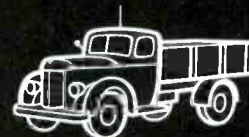
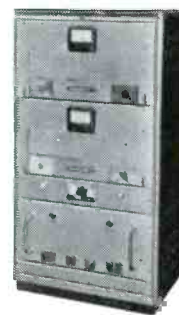

P Y E L I M I T E D · C A M B R I D G E · E N G L A N D

formerly *FM-TV* RADIO COMMUNICATION

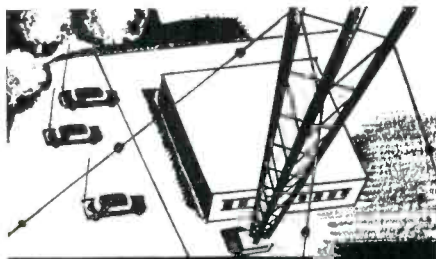

**NOW You Can
USE a LOW COST
TRANSMITTER
DIRECT FROM
YOUR AC SOURCE
for Fixed Stations with**



**MODEL "B"
POWER SUPPLY**

Pat. 2599718



Model B

No need to pay thousands for a fixed station transmitter when you can use a mobile transmitter with an *Electro Model "B"* DC Power Supply at a total cost of less than seven hundred dollars.

The *Electro Model "B"* is the only known DC power supply able to withstand mobile transmitter loads, as proven by actual use in the field. Simply plug into any 110 volt, 60 cycle outlet and convert AC to DC current to power these transmitters.

One *Model "B"* supplies up to 20 amperes at 6 volts for small mobile transmitters. Two *Model "B"s"* connected in parallel supply up to 40 amperes at 6 volts for larger mobile transmitters.

Offers big savings for:
Police, fire, civil defense, taxi, forestry, pipeline and military radio communication systems.

**Send for FREE
detailed Bulletin BCS654**

Electro Products Laboratories

4501-Cb Ravenswood Ave.,
Chicago 40, Ill.

Canada: Atlas Radio Corp. Ltd., Toronto, Ont.

THIS MONTH'S COVER

The appointment of Rosel H. Hyde as 9th Chairman of the FCC has been very favorably received by all the communication services, and affords well-deserved recognition of his long experience in this field, dating back to 1928, when he joined the FRC. Mr. Hyde was born at Downey, Idaho, in 1900. He was admitted to the bar of the District of Columbia in 1929, and was general counsel of the FCC when he was appointed a Commissioner in 1946. While his present term runs to June 30, 1959, his first appointment as Chairman runs only to May 4, 1954. It is generally expected, however, that he will be continued in his present post after that date.



COMPANIES & PEOPLE

Voice-Radar Identification: Experience with marine radar has shown that it can be used more effectively in combination with 2-way phone communication. Problem when two or more ships are within radar range is to know from which one voice signals originate. Identification device called Radent, developed by Sperry Gyroscope is being tested this summer. Also cooperating in this project are U. S. Coast Guard, FCC, Raytheon, Radiomarine, Federal, Westinghouse, Tropical Radio, Esso Shipping, Jansky & Bailey, Lake Carriers' Association, and National Federation of American Shipping.

Col. Edwin L. White: Chief of FCC Safety & Special Radio Services Bureau: "The number of microwave systems is growing. There are approximately 60 systems over 50 miles in length, in addition to possibly 75 or 80 other systems of 1 or 2 hops only. The longest is that of AT&T, linking both coasts for television and other common carrier purposes. Over 25 are pipeline systems, and over 15 are electric power systems. Eight pipeline systems approximate or exceed 1,000 miles in length. The system under construction by the Bonneville Power Administration, largest of the electric power systems, will extend nearly 1,000 miles."

Registry of Ship Radio Stations: Members of the COMMUNICATION ENGINEERING staff who compile the listings and revisions for our various Registries of communication systems will start work shortly on a Registry of U. S. Ship Radio Stations. This will include ocean-going, coastwise, Great Lakes, and Alaskan ships.

Processing of Applications: FCC has reduced time of processing applications

in the transportation service to a matter of 10 days. Petroleum service, however, is building a backlog, with 302 applications filed in June, only 164 grants issued, and 673 still pending. Special industrial, most active service of all, requires 2½ months to process applications.

RTCM Fall Meeting: Radio Technical Commission for Marine Services will meet on October 19 to 21 at the Edgewater Beach Hotel, Chicago. Technical papers will be devoted to electronic and navigational aids to shipping on the Great Lakes and inland waterways. Further information can be obtained from R. T. Brown, executive secretary, Federal Communications Commission, Washington, D. C.

List of Approved Transmitters: Now published as an appendix to COMMUNICATION ENGINEERING's revised Registry of Public Safety Systems, now off the press. This has been added because the FCC's list of approved transmitters is

Continued on page 18

MEETINGS and EVENTS

OCTOBER 2 - 11,
NATIONAL ELECTRONIC SHOW
Santa Monica Pier, Santa Monica, Calif.

OCTOBER 14 - 17,
AES CONVENTION, AUDIO FAIR
Hotel New Yorker, N. Y. C.

OCTOBER 19 - 21,
RTCM FALL MEETING
Edgewater Beach Hotel, Chicago

OCTOBER 20 - 22,
COMMUNICATIONS SECTION, AAR
Hotel Plaza, San Antonio, Texas

OCTOBER 26 - 28,
RTMA-IRE RADIO FALL MEETING
Toronto, Ontario, Canada

NOVEMBER 2 - 6,
AIEE FALL GENERAL MEETING
Muelebach Hotel, Kansas City, Mo.

NOVEMBER 12 - 13,
IRE PROF. GRP. ON VEHICULAR COMM.
Hotel Somerset, Boston, Mass.

JANUARY 18 - 22,
AIEE WINTER GENERAL MEETING
Statler Hotel, New York City

RCA MICROWAVE

RADIO-RELAY COMMUNICATION AND CONTROL

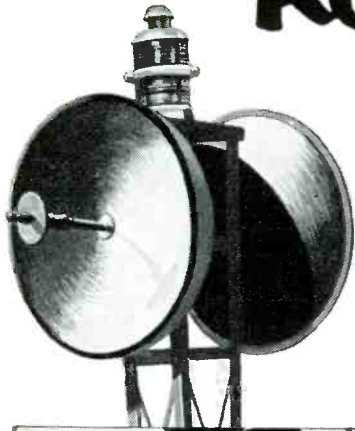

SPECIFY RCA 2-WAY RADIO for dependability in mobile communications.

AND REMEMBER, only RCA can provide the nationwide service facilities of the RCA Service Company.

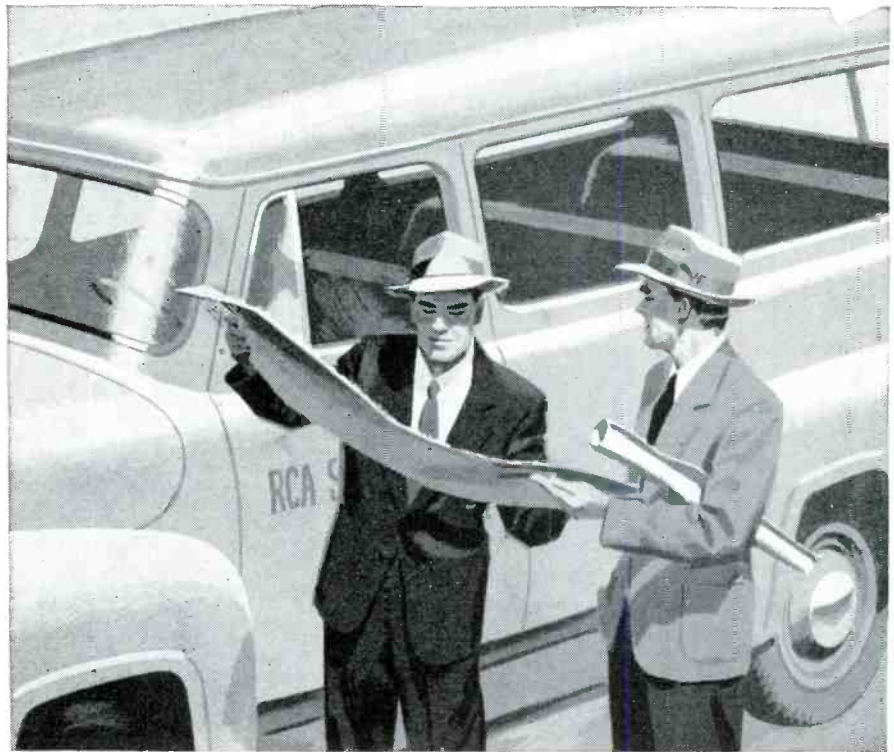

Complete installation service from survey to operation

For thoroughly dependable, 100%-controlled installation, RCA offers you the important benefits of its sound over-all planning and complete facilities.

For route planning, RCA provides the services of an expert aerial survey team—at a cost justified many times by its speed and accuracy. To help you over the rough spots in system planning, RCA offers the assistance of experienced Microwave field specialists. For successful in-

stallation, RCA will arrange and supervise all phases of construction, and will place your system in operation.

All, or any part of, the complete RCA Communications organization is available to you when you specify RCA Microwave.

For successful communication, call an RCA Communications representative located at your nearest RCA Regional Office, or mail coupon below.

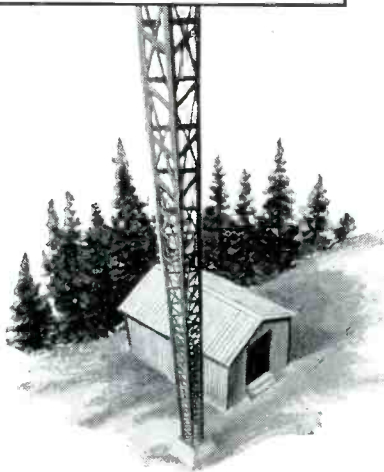

RADIO CORPORATION of AMERICA
COMMUNICATIONS EQUIPMENT

CAMDEN, N. J.



RCA Engineering Products
Dept. 132U, Building 15-1
Camden, N. J.

Please send me your free booklet on:

- RCA Microwave
- RCA 2-Way Radio

Name _____

Title _____ Company _____

Address _____

City _____ Zone _____ State _____

formerly *FM-TV* RADIO COMMUNICATION



PRODUCTS

Speeding Electronic Progress

through **crystal**
research



This new JK G-12 is designed for ultra stable frequency control in applications such as frequency standards, timing and counting circuits, broadcast equipment and frequency monitors. Electrodes are deposited directly on the large, precision-made quartz plate shockmounted in an evacuated glass envelope. Frequency range 500 kc to 1500 kc. Crystal may be designed for a minimum temperature coefficient of from 0°C to 50°C or for temperature controlled operation at 60°C with a JK07E-115V Oven. Approximate height above chassis, 2³/₄". Maximum diameter of octal base, 1³/₄". Consult us on specific applications.

JK STABILIZED G-12 CRYSTAL
For the "Difficult" 500 kc to 1500 kc Range

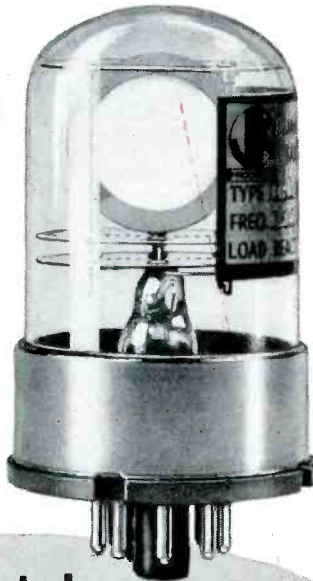

Tomorrow's Crystals



The increasing demand for ultra-stable frequency control to meet today's new requirements has necessitated a new approach to crystal design. Evacuated glass envelopes — for maximum protection and freedom from contamination — are a part of the new design of JK Crystals for the Critical. Consult us on your requirements for crystals of this advanced design.

**THE JAMES
KNIGHTS COMPANY,
SANDWICH, ILLINOIS**

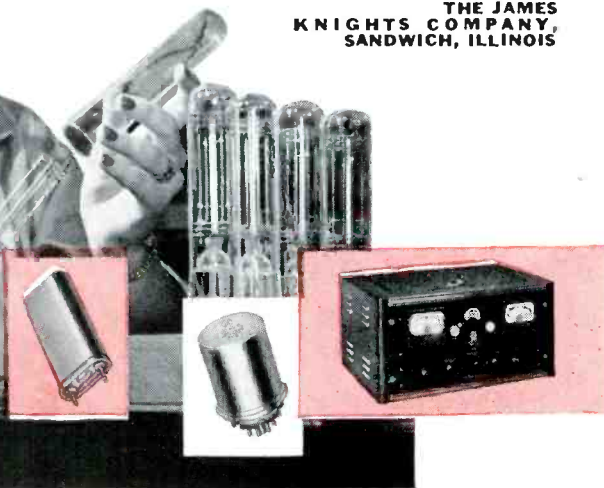

NEW PRODUCTS

(Continued from page 6)

catalog No. 44 has just been revised; catalog 44A now covers microphones, microphone parts and accessories, and wire and tape recording heads. Shure Brothers, Inc., 225 West Huron Street, Chicago 10, Ill.

Emergency AC Supplies: Up to 250 watts of 110-volt AC power can be obtained from 24 or 48-volt storage batteries with types 5060A and 5070A emergency power supplies. Rated load capacity is sufficient to handle

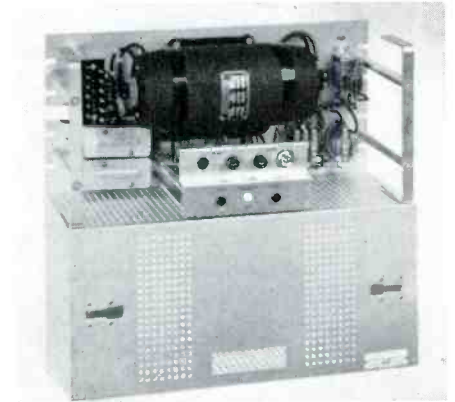

load of a 3-channel carrier terminal or repeater, or a low-power base station. Automatic transfer is completed within 1/2 second on failure of normal power source; load can be returned to normal source manually or automatically. Unit is wall-mounted or rack-mounted. Complete specs given in Bulletin 5060A-P2, from Lenkurt Electric Company, 1105 County Road, San Carlos, Calif.

Corrosion-Proof Coil Forms: Resin-impregnated coil forms are now available in all colors for color-coding of circuits and components. Volume resistivity, power factor,

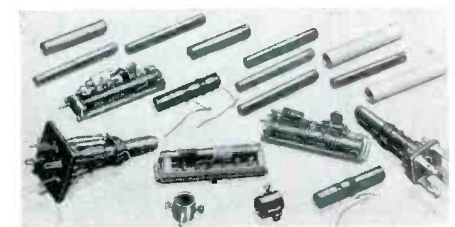

and thermal characteristics make Resinite AC forms ideal for VHF and UHF applications involving strenuous operating conditions. Available threaded inside or out, slotted, punched, or embossed. Complete information available from Resinite Corp., Dept. C-7, 2035 W. Charleston Street, Chicago 47, Ill.

AC Generators: Two new HQ engine-driven generators are rated at 10 and 15 kw., and are intended for primary and standby power applications. Both are driven by 4-cylinder water-cooled Continental engines; fuel consumption is said to be less than one quart per kwh. at rated load. Regulation is ±2%. Available in all standard voltages, frequencies, and phase numbers, housed or unhoused. D. W. Onan and Sons, Inc., Minneapolis, Minnesota.

Universal Mike Clamp: Fastening securely to virtually any type of surface ledge, round pipe, or irregularly-shaped stanchion, model SK-1 universal microphone clamp solves many

difficult problems of positioning. A microphone can be attached directly to a 3-in. tube supplied with the clamp. Full information available from Atlas Sound Corp., 1451 39th Street, Brooklyn 18, N. Y.

2 to 4-Mc. Oscillator: Extremely stable and accurately variable frequencies anywhere between 2 and 4 mc. can be obtained with an interesting new direct-reading master oscillator. Last 3 digits of frequency desired are set by switches; then dial is set to rough frequency, and exact desired frequency pulls in and holds with excellent stability. 100-ke. time-base oscillator is stable within .2 parts per million for any 12-hour period, or 1 part per million per month. Readability is better than 2.5 cycles. Northern Radio Company, Inc., 147 West 22nd Street, New York, N. Y.

Tubeless DC Supply: Nobatron MA6/15 DC supply, operating on magnetic amplifier principles delivers 100 amperes at 6 volts (adjustable to 7.7 volts) or 75 amperes at 12 volts (adjustable to 15.4 volts). Regulation is $\pm 1\%$ within rated variation in line and load. Sorenson & Company, 375 Fairfield Avenue, Stamford, Conn.

Polarity Switch: Model MS-1, designed specifically for use with the Simpson 260 tester, plugs into test-lead jacks on the meter and the standard test leads are then plugged



into it. Then, by merely throwing the toggle switch, the polarity of the connection can be reversed. Pomona Electronics Company, 524 East 5th Avenue, Pomona, Calif.

Standby Power Units: Described as "an entirely new concept of communications standby equipment," Micro-Power AC generators maintain continuous, uninterrupted service regardless of main source fluctuation or failure. Production is now under way on 3 and 5-kw. units; larger sizes are in development. Complete information can be obtained from United States Motors Corp., Oshkosh, Wis.

Foamed Resin: Low-density plastic foams made from XR1-543 resin have been found to be highly resistant to thermal shock, and can be foamed in place. Applications are those in which extreme temperature resistance without high compressive strength is needed, such as in vibration damping; electrical, acoustical, and thermal insulation; and buoyancy units. Density is 10 to 14 lbs. per cubic ft. Complete processing information and specifications can be obtained from Dow Corning Corp., Midland, Mich.

DC Bench Supply: A dual-output service bench DC supply, type 12RS6D, is equipped with an ammeter and a voltmeter. Output voltage infinitely variable from 0 to 8 volts at 10 amperes continuous or 20 amperes intermittent; or 0 to 16 volts at 6 amperes con-

Concluded on page 12

Had we but world enough and time

no one would need monitors but speed in communication is economy and often a life and death matter.



MODEL PR9 FOR 152-174 MC BAND

If you have a police, fire, forestry, pipeline, civil defense, taxi or any other vital 2-way radio system, here is how monitors pay off.

Says Chief McMurtry—of the Sheridan, Indiana, Volunteer Fire Department:

"In the past, the largest obstacles for our Volunteer Fire Department to overcome has been the method of determining the exact location of the fire and beating the traffic there. Speed of course is essential for the efficient operation of any Fire Department. Now, with the Town Police Radio Base Station located in the Department and with the use of 18 PR9 Receivers in the homes of our members we not only learn of the fire before the Town Siren is blown, but we in many cases arrive at the fire before the equipment... *We do not hesitate to recommend this Receiver to any Department!*"

Franchises available, write for information.

RADIO APPARATUS CORPORATION
FACTORY—55 NORTH NEW JERSEY STREET
INDIANAPOLIS 4, IND., PHONE: ATLANTIC 1624
SALES OFFICE: 1604 WEST 92ND STREET
CHICAGO 20, ILL., PHONE: BEVERLY 8-7770

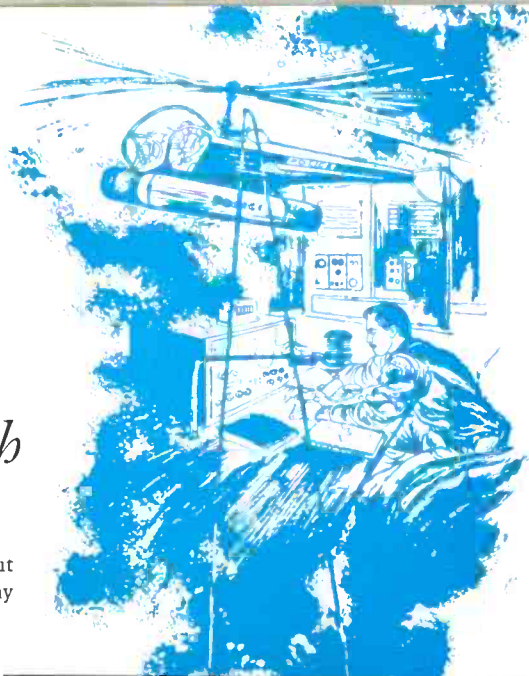

Chief McMurtry and members of Sheridan, Indiana, Volunteer Fire Department with John Oakley Vice-President of Midwest Fire and Safety Equipment Co. who supervised monitorradio installation.

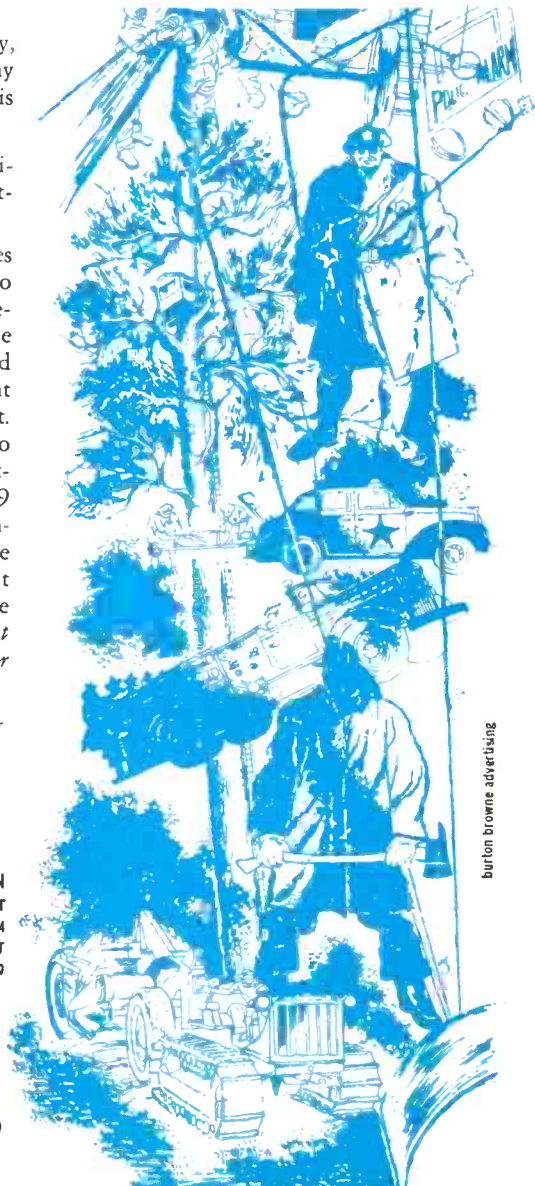

burton browne advertising

MONITORADIO

Here's why those in the know

-demand

CANNON PLUGS

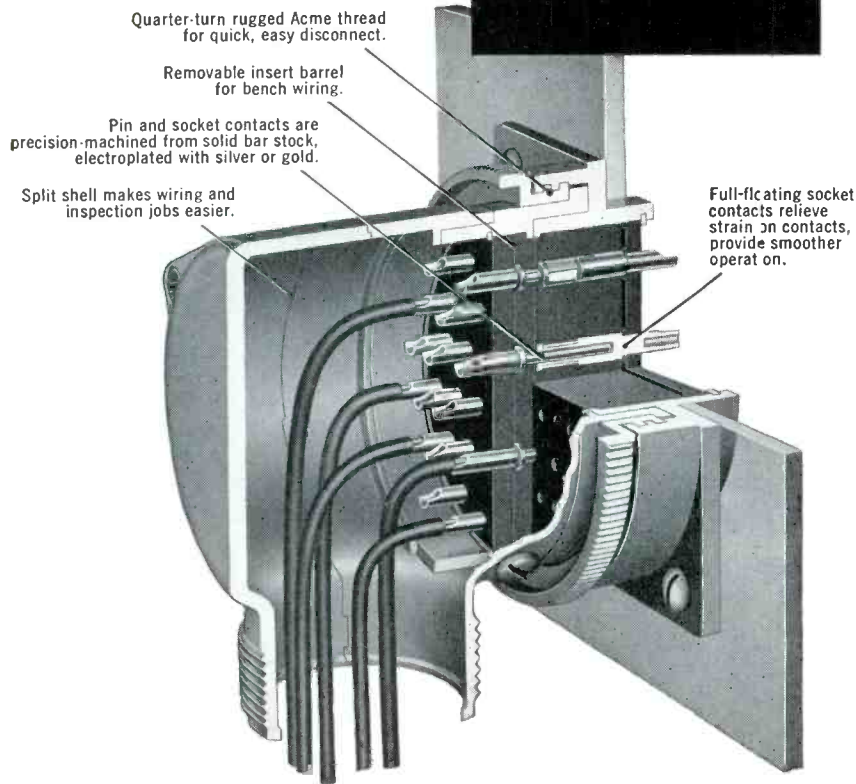

Recognition of Cannon's 36 years of sound engineering and fine, uncompromising construction has built the demand for Cannon Plugs. Here we take an inside look at the lightweight Type "K" 90° connector, forerunner of the Army-Navy Series. More features of the "K" were incorporated into the "AN" design than any other connector.

Constantly improved over the years, Type "K" is now used for numerous applications such as aircraft, radio, television, sound, phone recorders, motion pictures, geophysi-

cal research and widely used throughout the electro-mechanical and electronic instrument fields.

The design and construction details in the Cannon "K" Series are typical of the care Cannon takes in producing more than 18,000 precision, multi-contact connectors to serve the exacting needs of industry.

We will gladly send you engineering bulletins describing each of the many basic types of Cannon Plugs if you will briefly describe your applications.

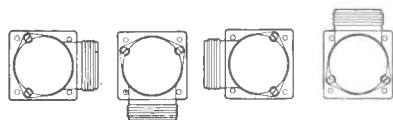

Diagram at left shows how the four positions of cable entry on the large 90° "K" endbell make the wiring job easier. Smaller Type "K" connectors have three positions.

CANNON ELECTRIC

Since 1915

Cannon Electric Company
Los Angeles 31
California

Factories in Los Angeles, Toronto, New Haven. Representatives in principal cities. Address inquiries to Cannon Electric Company, Department 1J-146 Los Angeles 31, California.



Type "K" and "RK" connectors are available in 7 shell types having 8 diameters. Inserts have more than 190 contact arrangements. Some of these have Coax, Twinax or Thermocouple contacts as standard. Integral cable clamps available in all "K" plug types.

SYSTEMS DATA

(Continued from page 4)

PIPELINE PETROLEUM: 46 mobile and 3 base transmitters on 1.62 to 2.39 mc., 40 mobile and 2 base transmitters on 451 mc.; 1 relay on 75 mc.; 1 control transmitter on 75 mc., and 2 on 456 mc.

SPECIAL INDUSTRIAL: 50 mobile units and 1 base transmitter on 2.29 mc., 2 base transmitters on 451 mc.; 1 relay on 30 mc., 3 on 73 mc., 1 on 154 mc., and 8 on 456 mc.; 1 control transmitter on 30 mc., 5 on 75 mc., 3 on 154 mc., and 14 on 457 mc.

FOREST PRODUCTS: 1 relay on 451 mc., 1 on 956 mc.; 1 control transmitter on 456 mc., and 1 on 959 mc.

TAXICABS: 100 mobile units and 2 base transmitters on 452 mc.

NEW PRODUCTS

(Continued from page 11)

tinuous or 14 amperes intermittent. Self-resetting overload protection is provided. P. R. Mallory & Company, Inc., 3029 E. Washington Street, Indianapolis 6, Ind. Inquiries should be addressed to W. H. Dunning.

Tubes & Components: Literature and technical data are available on the following:

CBS-Hytron, Danvers, Mass.— A comprehensive 8-page transistor manual is offered free of charge. Theory, data, and application (with specific circuit examples) are treated in an easily-understood manner.

RCA Tube Department, Harrison, N. J.— Premium tube type RCA-6101, a ruggedized and improved version of 6J6; RCA-5719, high-mu subminiature triode with flexible leads; RCA-5814, medium-mu 9-pin miniature twin triode; and RCA-5840, sharp-cutoff subminiature pentode with flexible leads. RCA-5A8P-1, -7, -11, oscillograph tubes featuring exceptionally high sensitivity and trace detail. RCA-5690, full-wave vacuum rectifier of Special Red type. 12AQ5, 7-pin miniature beam power amplifier for mobile receiver output stages, within ratings, electrically equivalent to 12V6-GT.

Radio Receptor Company, Inc., 251 W. 19th Street, New York 11, N. Y.— JAN type 1N34A germanium diode, in tapered case for easy polarity identification.

Sylvania Electric Products, Inc., Electronics Division, 1740 Broadway, New York 19, N. Y.— Two new point-contact transistor types: a 4-element unit, or tetrode, now available; and a 5-element unit, or pentode, expected later in this year. Tetrode designed primarily for switching and small-signal mixing and modulation applications.

Texas Instruments, Inc., 6000 Lemmon Avenue, Dallas 9, Texas— Hermetically-sealed junction transistors 200 and 201, both *n-p-n* triodes; minimum alpha for 200 is .90, for 201, .95. Bulletin DL-S 310. Also point-contact transistors 102 and 103, differing principally in cutoff time. Bulletin DL-S 312.

Transistor Products, Inc., Snow and Union Streets, Boston 35, Mass.— Type X-25 *n-p-n* junction amplifying photo transistor, first commercially available. Has power output sufficient to operate a relay.

Westinghouse Electric Corp., Electronic Tube Division, Dept. T-329, Box 284, Elmira, N. Y.— A 47-page booklet, RU-020, gives characteristics and ratings of over 300 Reliatron receiving tubes.

COMPANIES & PEOPLE

(Continued from page 8)

not available from the Commission. There are 713 different models from 38 manufacturers in the list as of May 1. Forthcoming editions of the Transportation, Industrial, and Air-Ground & Common Carrier Registries will also carry the list of approved transmitters, with changes and additions made by the FCC up to the time of publication.

Radio Speeds Materials: Mobile radio units are becoming standard equipment on fork-lift trucks and other material-handling vehicles in factories and plant yards. Here again, the investment in radio is being returned quickly by increasing the work capacity of each truck, and by eliminating expensive delays in getting materials and finished products where and when they are needed.

Factory managers who are not acquainted with the successful application of radio in this service seem to assume that reception is affected adversely by steel building construction and the presence of large masses of metal. Fortunately, that is not the case, for metal objects cause reflection and refraction of radio waves, thereby providing complete distribution, free of dead spots. Also there is the audible competition from noisy machines. In such cases, a loud-speaker of the reentrant-horn type, mounted behind the driver, is used for calling, and a handset for communication. When handset is picked up, the speaker is shut off.

Calls for trucks are made by ordinary telephone to the dispatcher. He talks to the truck drivers by radio, determining which one should be routed to the next job. This prevents arguments and accusations that the drivers are loafing. If a driver must leave his truck, he reports that to the dispatcher, and calls when he returns.

Incidentally, it is surprising to see how many women are employed to operate the trucks. Reason is that women are more careful!

Albert F. Watters: Vice president in charge of personnel for RCA Victor division: "Management is meeting the problem of professional recognition in a number of ways. There has been a wholesome reevaluation of the basis of engineers' compensation. One approach to the problem is elevating outstanding engineers to staff positions in which their specialized talents will be given full play, but which do not involve administrative responsibilities. This is a tangible recognition, making possible incomes comparing favorably with those at managerial levels. Another way is to designate out-

Continued on page 14

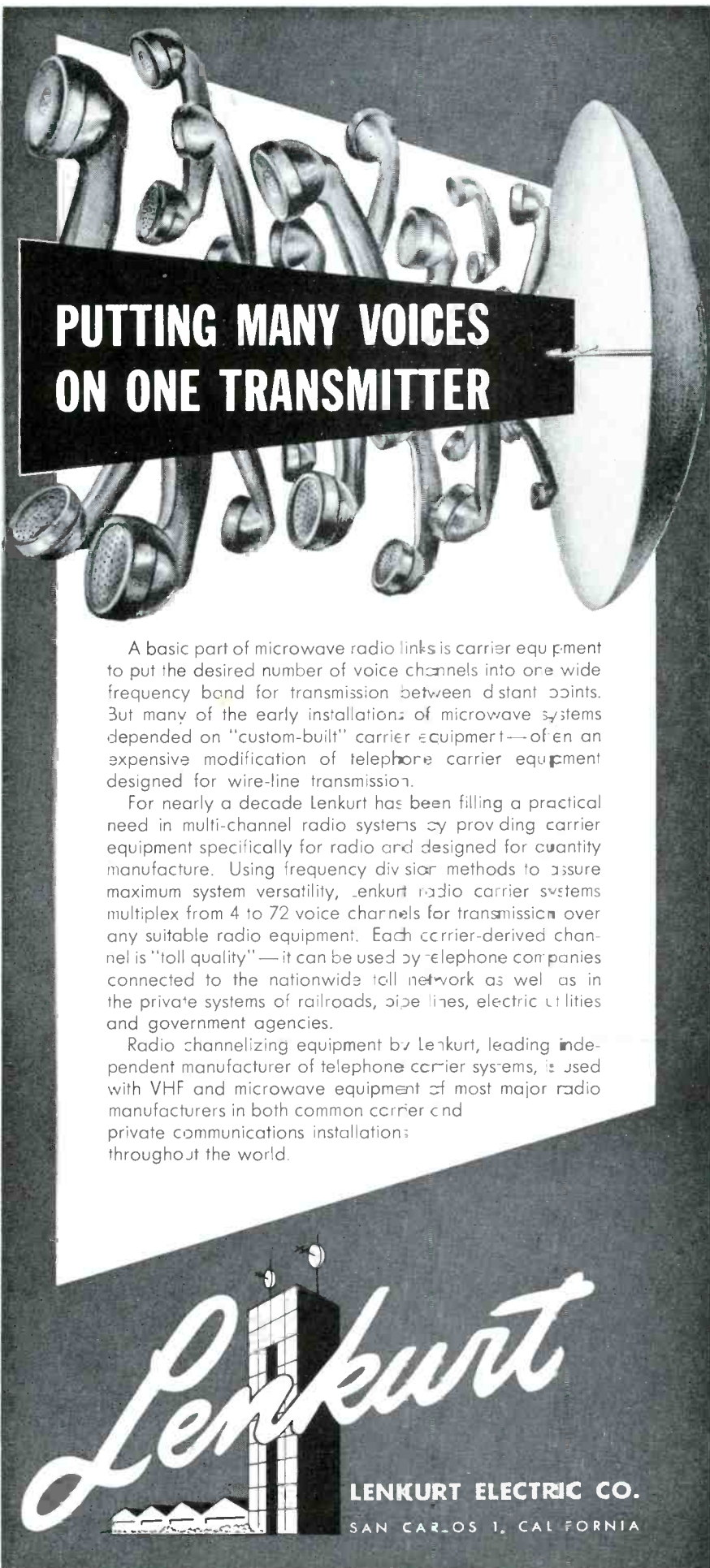

**PUTTING MANY VOICES
ON ONE TRANSMITTER**

A basic part of microwave radio links is carrier equipment to put the desired number of voice channels into one wide frequency band for transmission between distant points. But many of the early installations of microwave systems depended on "custom-built" carrier equipment—often an expensive modification of telephone carrier equipment designed for wire-line transmission.

For nearly a decade Lenkurt has been filling a practical need in multi-channel radio systems by providing carrier equipment specifically for radio and designed for quantity manufacture. Using frequency division methods to assure maximum system versatility, Lenkurt radio carrier systems multiplex from 4 to 72 voice channels for transmission over any suitable radio equipment. Each carrier-derived channel is "toll quality"—it can be used by telephone companies connected to the nationwide toll network as well as in the private systems of railroads, pipe lines, electric utilities and government agencies.

Radio channelizing equipment by Lenkurt, leading independent manufacturer of telephone carrier systems, is used with VHF and microwave equipment of most major radio manufacturers in both common carrier and private communications installations throughout the world.

Lenkurt
LENKURT ELECTRIC CO.
SAN CARLOS 1, CALIFORNIA

for superior
efficiency in
communications
circuits



rely on AMPHENOL components



COAXIAL CABLES

AMPHENOL Cables are designed and manufactured to meet the most exacting of military requirements. This insures a constant high standard of production for civil communication circuits, too. These cables have strict end-to-end uniformity, low RF loss and all-around superior mechanical efficiency. Polyethylene is the dielectric most used in AMPHENOL Cables due to its flexibility and low water absorption. For extreme heat conditions, Teflon* dielectric is used.

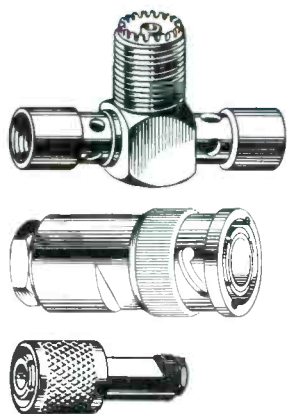

RF CONNECTORS

Important to communication continuity, cable connectors have to be of top quality. AMPHENOL RF Connectors are designed and built to preserve the desired transmission characteristics with a minimum of loss and interference—for years! Like AMPHENOL Cables, they conform to rigid military specifications. AMPHENOL RF Connectors are available in many types and designs; some with Teflon* inserts for covered equipment or other high temperature applications.

*E. I. DuPont Reg. trade mark

see your



distributor

AMERICAN PHENOLIC CORPORATION
chicago 50, illinois

Professional Directory

FRANK H. McINTOSH

Consulting Radio Engineer

1216 Wyatt Bldg., Washington 5, D. C.
MEtropolitan 8-4477

General Electric TWO WAY RADIO

- Systems Engineering
- Installation
- Contract Maintenance

Communications Engineering Co.

900 Dragon St.
Dallas, Tex.
PR 7508

6422 Long Dr.
Houston, Tex.
OL 8501

COMPANIES & PEOPLE

(Continued from page 13)

standing engineers as consultants, with remuneration based on their engineering prestige, rather than on established earning brackets. A third way is to name such engineers to positions of prestige outside the company, such as national and industry committees and agencies."

Transatlantic Telephone: In 1903. Prof. Michael Pupin expressed the opinion that transatlantic telephone service would not be economically successful. His reason was that such service would be used chiefly during a period of 6 to 7 hours on business days, but that would be reduced to a matter of 1 or 2 hours per day because of the 5-hour difference in time between New York and London and Paris.

IRE Vehicular Radio Group: Fourth annual meeting will be held at Hotel Somerset, Boston, November 12 and 13. Conference theme will be: Design, Planning and Operation of Mobile Communication Systems. Further information can be obtained from Col. Edwin L. White, chairman, Chief of the Safety & Special Service Bureau, FCC, Washington, D. C.

Julius G. Aceves, 1888-1953: Passed away in New York City on August 17. A native of Mexico City, he was graduated from Columbia University in 1913, continuing there as an assistant to the late Dr. Michael I. Pupin until 1927. The following year, he joined Ernest Amy and Frank King in organizing the firm of Amy, Aceves & King, specialists in the design and installation of master antenna systems.

Concluded on page 15

Professional Directory

Jansky & Bailey, Inc.

Consulting
Radio & Electronic Engineers

Suite 970 National Press Bldg.
Washington 4, D. C. ME 8-5411

Engineering Building
1339 Wisconsin Ave., N.W.
Washington 7, D. C. AD 4-2414

WELDON & CARR

Consulting
Radio & Television
Engineers

Washington, D. C. Dallas, Texas
1605 Connecticut Ave. 4212 So. Buckner Blvd.

JOHN D. TRILSCH CO.

TOWERS for
RADIO • TELEVISION
COMMUNICATION

1310 McKinney Ave., Houston, Texas
Phone: ATwood 9351



SINCE
1931

Professional 16mm Sound-On-Film Motion
Picture Cameras for Television Newsreels,
Commercials and other Television Filming.
Write for free illustrated catalog.

BERNDT-BACH, Inc.
7349 Beverly Blvd., Los Angeles 36, Calif.

RUSSELL P. MAY

CONSULTING RADIO ENGINEERS



1422 F Street, N.W., Wash. 4, D. C.
Kellogg Building Republic 3984

Member AFCEE

WORKSHOP ASSOCIATES DIVISION

THE GABRIEL COMPANY

Specialists in
High-Frequency
Antennas



Endicott Street Norwood, Massachusetts
NORwood 7-3300

COMPANIES & PEOPLE

(Continued from page 14)

Point-to-Point on 460 Mc.: First license for a 460-mc. point-to-point system was granted to the Swan Rubber Company, for use between its plants at Bucyrus and Carey, separated by 25 miles. It is expected that this band will come into wide use for such service, for it is inexpensive, dependable, convenient, and fast in operation. Motorola equipment was used for this installation.

Short Electric Waves: In a paper presented before the AIEE and IRE in June, 1922, Guglielmo Marconi said: "I feel — and perhaps you will agree with me — that the study of short electric waves, although sadly neglected practically all through the history of wireless, is still likely to develop in many unexpected directions, and open up new fields of profitable research."

Telephone Taxes: Operating and excise taxes paid by Bell System companies in 1952 amounted to more than one-half the amount paid out in wages. Excise taxes on phone calls are in some cases a persuading factor in consideration of installing privately-owned microwave systems.

John Stone Stone: According to Dr. Benjamin E. Shackleford, director of RCA's license department, back in 1904 John Stone Stone filed 47 patent applications in a single day. One was on permeability tuning.

Universal 6 or 12-Volt Units: New mobile units are being designed to work interchangeably on 6 and 12 volts. This means that they can be shifted between 6-volt passenger cars and 12-volt trucks. Also, they anticipate the use of 12-volt car batteries, which may become prevalent before new equipment reaches replacement age.

Col. Thomas Warner: Now back in Chicago, is heading up the National Bus Communication Committee, with offices in the Board of Trade Building. So far, this segment of the transportation radio service has not been particularly active, but it is expected to become so in the immediate future.

Jointly Operated Relay System: FCC has authorized Middle South Utilities Network to operate a communication system on behalf of five power companies. System will extend through Arkansas, Mississippi and Louisiana, and will be comprised of 16 repeaters and 4 terminal stations. The participating companies are already licensees in the industrial service.

Professional Directory

KEAR & KENNEDY

Consulting Radio Engineers

1302 18th St., N. W. HUDson 3-9000
Washington, D. C.

GEORGE P. ADAIR

Consulting Engineers

Radio, Communications, Electronics
1610 Eye St., N.W. EXecutive 3-1230
Washington 6, D. C.

antenna specialists

MANUFACTURERS OF RADIO COMMUNICATIONS ANTENNAS

12415 EUCLID AVENUE
CLEVELAND 6, OHIO
RAndolph 1-9575

16mm
maurer
mill

16-MM Professional Motion Picture
Production Equipment

J. A. MAURER, Inc.
37-07 31st Street, Long Island City 1, N. Y.
Tel. STillwell 4-4601

MEASUREMENTS CORPORATION



Research &
Manufacturing
Engineers

Harry W. Houck Jerry B. Minter
John M. van Beuren
Specialists in the Design and
Development of Electronic Test Instruments
BOONTON, N. J.

RATES FOR PROFESSIONAL CARDS

IN THIS DIRECTORY

\$12 Per Issue for This Standard
Space. Orders Are Accepted
for 6 Insertions Only

TIME PROVED

Eimac 4W20,000A gives 25 kw peak sync power output through channel 13 with only 500 watts driving power

TYPICAL OPERATION

Class-B Linear Amplifier—Television Visual Service
(Per tube, 5 mc bandwidth, 216 mc.)

Load Impedance	650 ohms
D-C Plate Voltage	7000 volts
D-C Screen Voltage	1200 volts
D-C Control-Grid Voltage	—150 volts

	Peak	Black Level
	Sync Level	
D-C Plate Current	6	4.5 amps
D-C Screen Current	230	100 ma
D-C Grid Current	90	45 ma
Peak RF Grid Voltage	280	220 volts
Driving Power	500	300 watts
Plate Power Input	42	32 kw
Plate Dissipation	16	16.5 kw
Useful Plate Power Output	26	15.5 kw

FOR THREE YEARS THE EIMAC 4W20,000A has been proving itself an outstanding power tube in a variety of electronic applications. In VHF-TV operation it gives an easy 25 kw peak sync power output with only 500 watts driving power. This high power output with low driving power requirements is typical of Eimac radial-beam power tetrodes. Rugged 4W20,000A construction includes a ceramic envelope that minimizes losses and increases operational life. In pulse service, FM and TV operation the 4W20,000A is the only time proved tetrode in its power class.



Information about the 4W20,000A or any of Eimac's complete line of electron power tubes can be obtained by writing our Application Engineering department.

The Power for TV

EITEL - McCULLOUGH, INC., SAN BRUNO, CALIFORNIA



COMMUNICATION REVIEW

ALTHOUGH it has not been finalized at this time of writing, it is certain that FCC assignments in the band from 450 to 460 mc. will follow a new plan which has not been employed previously. Each of the five services to occupy this band will have two widely-separated groups of channels. The lower group of each pair will be assigned to both base and mobile transmitters, while the upper group will be for mobile use only, as indicated below.

REMOTE BROADCAST PICKUP SERVICE

BASE & MOBILE		MOBILE ONLY	
450.05	450.55	455.05	455.55
450.15	450.65	455.15	455.65
450.25	450.75	455.25	455.75
450.35	450.85	455.35	455.85
450.45	450.95	455.45	455.95

INDUSTRIAL SERVICES

BASE & MOBILE		MOBILE ONLY	
451.05	451.55	456.05	456.55
451.15	451.65	456.15	456.65
451.25	451.75	456.25	456.75
451.35	451.85	456.35	456.85
451.45	451.95	456.45	456.95

LAND TRANSPORTATION SERVICES

BASE & MOBILE		MOBILE ONLY	
452.05	452.55	457.05	457.55
452.15	452.65	457.15	457.65
452.25	452.75	457.25	457.75
452.35	452.85	457.35	457.85
452.45	452.95	457.45	457.95

PUBLIC SAFETY SERVICES

BASE & MOBILE		MOBILE ONLY	
453.05	453.55	458.05	458.55
453.15	453.65	458.15	458.65
453.25	453.75	458.25	458.75
453.35	453.85	458.35	458.85
453.45	453.95	458.45	458.95

DOMESTIC PUBLIC SERVICES

BASE & MOBILE		MOBILE ONLY	
454.05	454.55	459.05	459.55
454.15	454.65	459.15	459.65
454.25	454.75	459.25	459.75
454.35	454.85	459.35	459.85
454.45	454.95	459.45	459.95

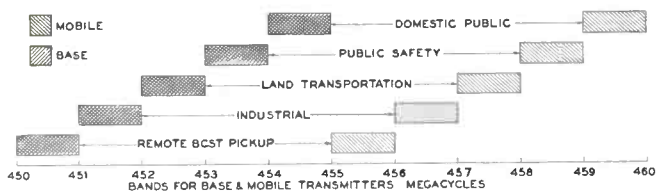

RELATIVE SPACINGS OF FREQUENCY GROUPS FOR THE 5 MOBILE SERVICES

Under this arrangement, systems using the same frequency to talk out and to talk back would be assigned to a channel in the lower group. Those using one frequency to talk out and another to talk back would be assigned one channel in each group. The groups are separated sufficiently to permit simultaneous transmission and reception without interference. This advantage in speeding message traffic is not generally available

on VHF because, even when two channels are assigned to one system they are so close, in most cases, as to make duplex operation impractical. It will be very interesting to observe the results under operating conditions of this effort by the Commission to effect an improvement in allocations to the communication services on 450 to 460 mc.

WITH more and more large companies formulating plans to use microwave relay and point-to-point communication systems, the question of interconnecting privately-owned facilities through Telephone Company PBX boards assumes greater importance as a factor of system engineering, initial cost, and operating expense. This, it should be explained, is only a matter of connecting telephone instruments at terminal or relay points over the radio circuits. It does not involve calls placed through the Telephone Company's central offices.

Accordingly, we asked AT&T for official information on Company policy on this subject. In reply, we received what is probably the only official, public statement that has been made by AT&T concerning this important matter:

"The American Telephone and Telegraph Company, Long Lines Department, issued on April 9 to become effective May 13, revisions in its Tariff F.C.C. No. 134 (General Regulations Tariff for Private Line Services and Channels) covering the conditions under which communication facilities of power and pipe line companies will be connected with facilities of the Telephone Company. Similar tariff revisions have been filed by most of the Associated Bell Telephone Companies.

"Power and pipe line companies have special communications requirements since these particular industries involve constant control of operations essential to the public welfare and extending along lengthy intercity physical rights-of-way which are frequently located without regard to hazard or inaccessibility to communication facilities of the Telephone Company.

"In earlier days, the only practicable way of meeting these requirements in many cases was for the power or pipe line company to provide its own communications facilities along its right-of-way which, as indicated, often involved inaccessible, remote, or hazardous locations. In such cases, where connections with Telephone Company facilities were required, these were arranged for under operating agreements.

"These arrangements, which in many instances contemplated exchange and toll connections for the right-of-way facilities, were necessary exceptions to the Bell System Companies' general undertaking of providing and maintaining all facilities required in furnishing exchange and toll telephone service to the public. The tariff provisions covering these connections were filed in the Telephone Companies' exchange tariffs, since the customer facilities were connected with facilities used for exchange service, usually private branch exchanges furnished to the customer by the Telephone Company.

"Today the Telephone Companies are in a far better position to supply the services needed by the power and pipe line companies. The Bell Companies are confident that, in cooperation with their connecting Independent Telephone Companies, they can do so in a manner thoroughly satisfactory to these customers, and they are prepared to take whatever steps are required. This applies to all services which the Bell Companies offer.

"Recently, the general matter of connecting with Telephone

Company facilities under present-day conditions has been discussed with committees representing the power and pipe line companies, as well as with individual companies in these fields, and modernized operating arrangements have been cooperatively developed for application where communication facilities of the power and pipe line companies are to be connected with Telephone Company facilities. These arrangements may be briefly summarized as follows:

"Where a power or pipe line company wishes to have the Telephone Company do the full communications job, the Telephone Company will undertake to do so. In the infrequent cases where it is impracticable for the Telephone Company to provide certain portions of the right-of-way facilities (due, for example, to such factors as inaccessibility, remoteness, or hazard) the Telephone Company will connect with the customer's facilities along such portions, including exchange and toll connections.

"Where a power or pipe line company wishes to have the Telephone Company provide the right-of-way facilities, and time is required to permit an orderly disposition of existing privately-owned facilities, the Telephone Company will provide additions and extensions to, and will connect with, such privately-owned facilities during the interim period, including exchange and toll connections.

"Where a power or pipe line company wishes to use its own right-of-way communications systems, whether wire or radio, the Telephone Company will connect for PBX station or private line use, but not for exchange and toll use except in emergencies.

"The tariff modifications recently filed cover these revised connection arrangements applicable to power and pipe line companies."

The tariff referred to above does not set forth any specific requirements or performance standards, but it covers that subject in these general terms:

"The magnitude and character of the voltages and currents impressed on the Telephone Company channel by the customer-owned equipment and wiring, and the operation and maintenance of such equipment and wiring shall be such as not to interfere with any of the services offered by the Telephone Company or interfere with others. The characteristics of the customer-owned apparatus shall be such that its connection to the Telephone Company channel does not interfere with service over other Telephone Company circuits or channels, or impair privacy of conversations over such circuits or channels. In cases in which additional protective equipment is required, this shall be provided by the customer or by the Telephone Company at the customer's expense. Such equipment shall be suitable to avoid hazard of damage to Telephone Company plant or of injury to Telephone Company employees or to the public because of the character or location of customer-owned apparatus and of sources of power to which it is connected.

"The Telephone Company may, upon suitable notification to the customer, make such tests and inspections as may be necessary to determine that the above requirements are being complied with in the installation, operation, and maintenance of customer-owned equipment. The Telephone Company may interrupt the channel if at any time such action should become necessary in order to protect any of its services because of departure from these requirements."

TWO papers on microwave systems, now in course of preparation for COMMUNICATION ENGINEERING, will merit special attention from readers concerned with system engineering. One will describe the Freeport Sulphur installation on the Mississippi Delta. In addition to many unique operational features, this installation is unusual in that so much of it extends over water.

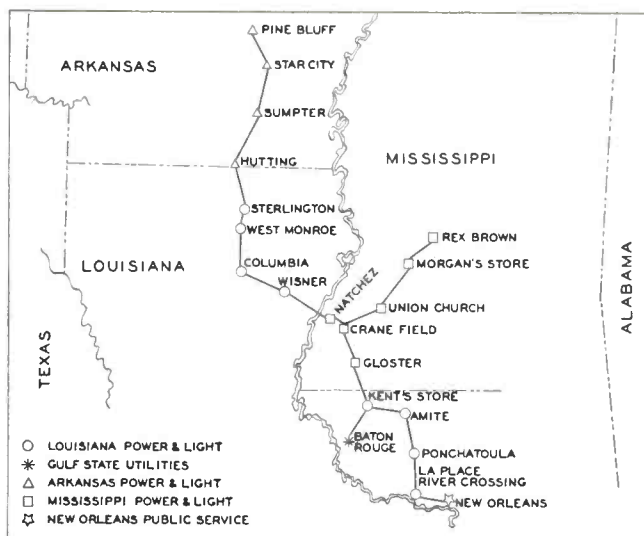

MIDDLE SOUTH MICROWAVE SYSTEM WILL SERVE FIVE POWER COMPANIES

The second paper will detail the system planning for the new \$500,000 microwave relay to be installed by Gulf States Utilities and Middle South Utilities. A total of 16 repeaters and four terminals will extend over 490 miles, but multiplexed circuits will provide 11,700 channel miles. These will be used for private and party-line telephone, teletype, telemetering, supervisory control, and communication with mobile units. Some 40 unattended substations will be operated by remote radio control. The accompanying map shows the extent of the system.

OFFERS by the Telephone Company to purchase public utility and pipe line radio systems, and to then rent such radio facilities to the original owners have more recently been extended to excursions into public safety and other special services. Such proposals have aroused strong opposition particularly among supervisors, chief engineers, and the maintenance men of state and municipal systems.

Principal argument against operation by the Telephone Company is that those now employed to operate and maintain radio systems would lose their jobs. That attitude is understandable, but it is not altogether realistic. If Bell System companies purchase and lease back such facilities, they will have to set up extensive radio installation and service departments, and they would undoubtedly find places for all the capable men displaced from their previous positions. As for wages—they would probably be higher. Thus, it does not appear that any reasonable objection can be raised on the basis of loss of employment.

There is, however, a totally different reason why each public safety, industrial and transportation radio system should be operated independently.

Presumably, strikes against the Telephone Company would affect the radio communication systems. In such an event, police protection of lives and property, and the operation of public utilities and transportation could be virtually paralyzed.

For example, municipal police radio plays an important part in quelling disorders. It would be such a simple matter to render a headquarters transmitter inoperative. State police and state highway patrol systems have many remote, unattended, and highly vulnerable transmitters. Public utilities, pipe lines, and industrial systems are using radio to an increasing extent as a means of operating remote, unattended controls. Fire and taxi systems are of vital importance under emergency conditions, particularly when any area must be evacuated. All these considerations add up to emphasize the necessity for independent, local operation.

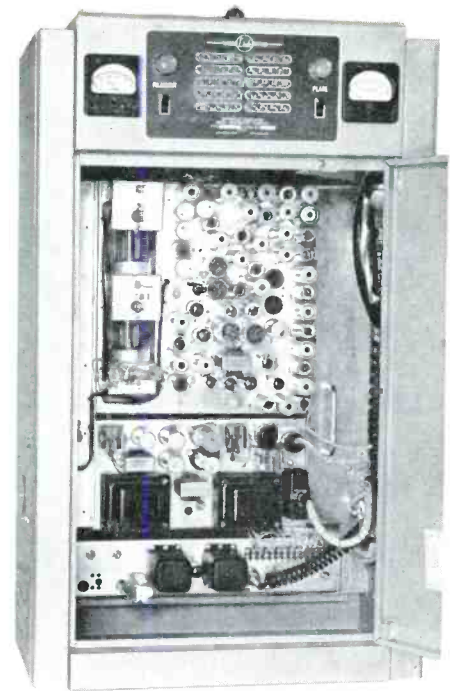
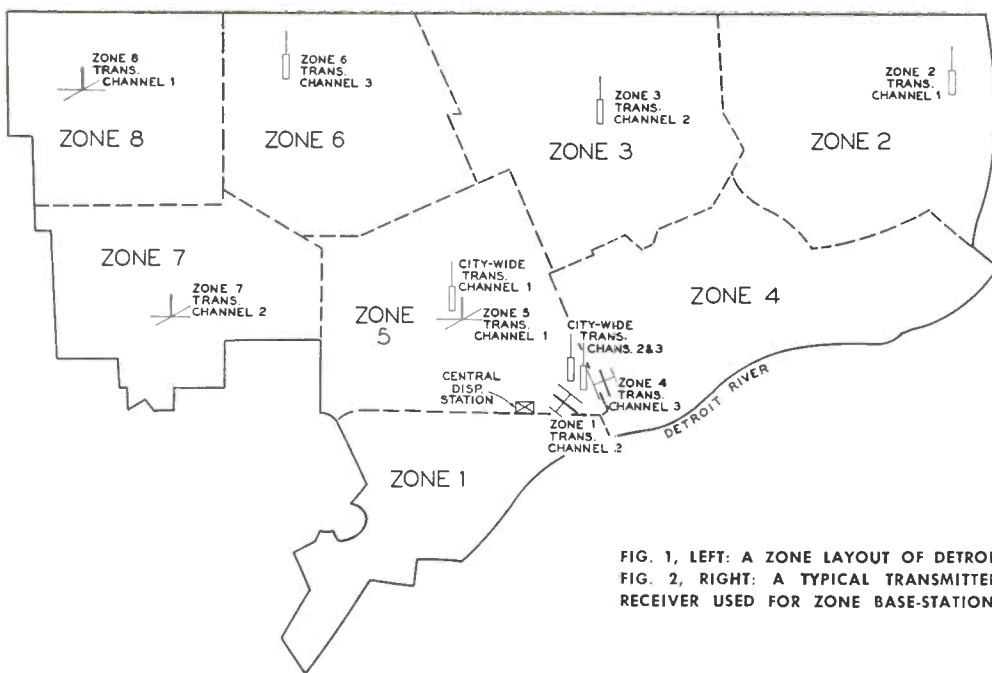

FIG. 1, LEFT: A ZONE LAYOUT OF DETROIT
FIG. 2, RIGHT: A TYPICAL TRANSMITTER-RECEIVER USED FOR ZONE BASE-STATIONS

Dispatching a Large Taxi System

HOW THE PROBLEMS OF LARGE FLEET DISPATCHING WERE SOLVED FOR THE DETROIT CHECKER COMPANY — SYSTEM DESCRIPTION — *By* JAMES A. CRAIG*

A little more than two years ago, the Link Radio Corporation was engaged by the Checker Cab Company of Detroit, Michigan, to design and install a 2-way radio system capable of handling the expected traffic. This was not a simple requirement to meet, since the fleet was made up of 897 taxicabs with an exceptionally high ratio of dispatched calls to cruising pickups. Our solution, therefore, may be of interest to others concerned with dispatching large fleets, and is accordingly narrated here.

System Facilities: Assuming that each cab worked two shifts per day, and handled 15 dispatched calls per shift, the radio system would have to be capable of handling 30 calls per cab per day, or a total of more than 25,000 calls per day.

However, since each day has its short peak-load period and longer slack periods, such a figure is not normally to be expected on a 24-hour basis. On the other hand, even if a 24-hour load of one half 25,000 calls per day were taken as representative, this would still mean over 500 calls per hour, or almost 10 calls per minute. Since peak loads could be easily double the average hourly rate, it became apparent quickly that this would be no ordinary radio system. One base station could not begin to handle such an amount of traffic. More important, the work load would have to be split up among many dispatchers. But to realize any advantage, dispatchers would have to be provided with simultaneous access to the radio facilities without mutual interference.

Working closely with cab company officials, we divided the city into zones. The ultimate number of zones and the area included in each zone was predicated on Checker Cab's traffic experience in Detroit. Every effort was made to distribute the traffic so that the present busy zones would not be overloaded and, at the same time, to provide zones in the outer fringes of the city that could absorb traffic growth to be ex-

pected from population shifts and the increased business accruing because of the advantages of taxi dispatching by radio.

After many changes in the quantity of zones and shifts in zone boundaries, the arrangement shown in Fig. 1 was made. It can be seen that eight zones are utilized and that three 425-mc. taxi channels are employed. Initially, two channels were planned, but it was impossible to arrange zones so that the same channel was not used in any adjacent zones. With three channels, zones operating on the same channel are always separated by a zone operating on a different channel.

Two requirements were given greatest importance in the development of the zone system: first, complete coverage of each zone by its associated transmitter; second, minimum signal overlap between common-channel zones. These requirements are virtually in direct opposition. A certain amount of overlap in one zone from another same-channel zone could be tolerated if unavoidable, provided that each transmitter signal would completely capture a receiver within its zone.

Meeting these requirements involved many experimental checks on antenna heights, locations, and configurations, and variations in transmitter powers. It soon became obvious that transmitter power played a minor role in determining coverage at 450 mc. If line-of-sight transmission existed on a given circuit path 2, 20, and 40 watts produced nearly the same results. Therefore, the zone transmitters were all made standard 20-watt equipments.

Pattern-shaping was attempted, using phased coaxial and ground-plane arrays, to provide coverage without overlap according to individual zone shapes. Here also the results were unimpressive, for the same reason that transmitter powers made little difference in coverage. In using phased arrays to produce figure-eight, cardioid, or other patterns, a boost in power in some directions is gained at the expense of a power loss in other directions. Such arrays are not intended to form a beam or to completely eliminate radiation in any sector. Even though power had been thus reduced in a certain direc-

*Assistant Chief Engineer, Link Radio Corp., 125 West 17th Street, New York 11, N. Y.

tion no loss was noticed in mobile contact within the affected area, since power in itself is relatively unimportant.

The most important factor affecting coverage, in virtually all cases, was antenna height. Indeed, at antenna elevations of 60 to 75 feet, the coverage could be tailored in terms of 4 or 5 city blocks by changing antenna elevation 4 or 5 feet.

While this discovery solved a lot of problems, each zone had still to be evaluated on its own merits and peculiarities. Referring to Fig. 1, in zones 7, 8, 6, 3, and 2, non-directional antennas are used at elevations of 60 to 110 feet. Zones 7 and 8 use unity-power gain ground-plane antennas. However, in zones 6, 3, and 2, available transmitter locations with proper antenna height are not centered in the zones. These zones employ stacked coaxial arrays, which produce low-angle radiation at a power gain of 3 times.

Zones 1, 4, and 5 all intersect in the loop area of Detroit. There are many tall buildings which produce propagation shadows. For that reason the zone 5 transmitter is located as shown on the map, at an elevation of some 300 feet. Overlap into zones 2 and 8 occurs to a minor degree, but this is offset by the fact that complete coverage of zone 5 including its loop area is accomplished with almost no dead spots. In the cases of zones 1 and 4, no structure of comparable height existed in zone 1 although one was available and used temporarily in zone 4. In either event, antenna elevation would have increased overlap difficulties, particularly from zone 1 into zone 7. The final decision in the cases of zones 1 and 4 was to locate both transmitters at the top of the 400-foot David Stott Building, located at the center of the loop district. These transmitters excite yagi antennae trained down the centers of the respective zones. Each yagi is equipped with a vertical V-shaped metal screen, to minimize leakage in back and to the sides of the array.

City-Wide Transmitters: In off-load periods such as the early-morning hours, when traffic can be handled by possibly 2 or 3 dispatchers, the simple zone system would necessitate switching on the part of the dispatchers in selecting the zone transmitter proper for each call. To eliminate this objection, three 100-watt city-wide transmitters, one on each of the three channels and each capable of city-wide coverage, were provided. At first, all three transmitters were placed on the same building in the loop district where the zones 1 and 4 transmitters are located. Situating the city-wide transmitters at the same location with two zone transmitters was permissible since, by the nature of the dispatching technique, the zone transmitters would not be used when the city-wide transmitters were in use, and vice-versa. However, the roof of the Stott Building shadowed the channel 1 signal in the extreme northwest

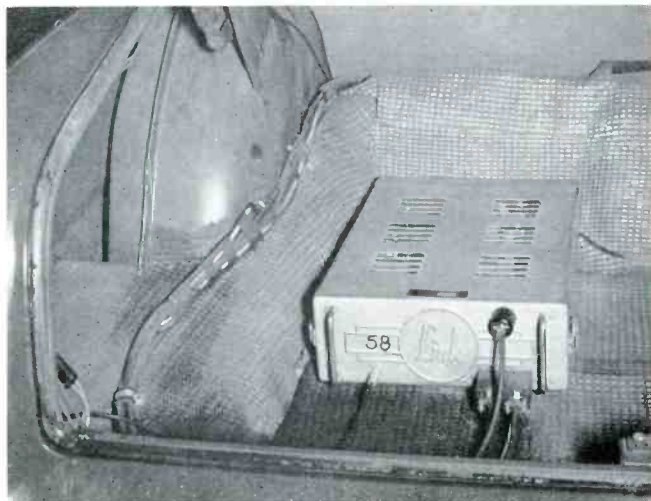

FIG. 3. ONE OF THE 450-MC. MOBILE INSTALLATIONS IN THE SYSTEM

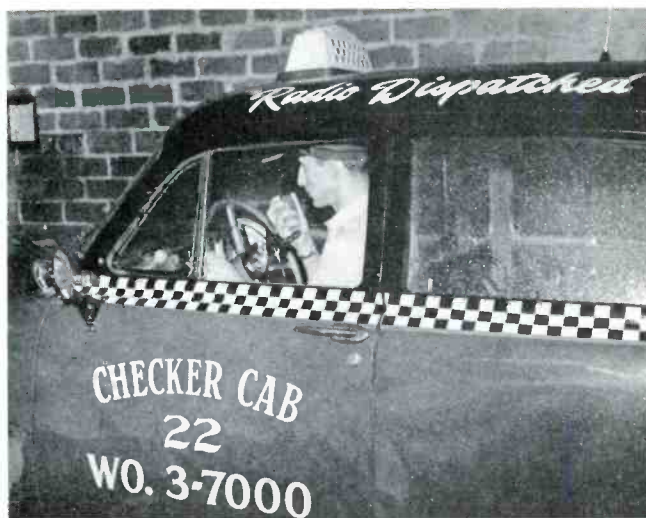

FIG. 4. ROOF-MOUNTED MOBILE WHIP IS LITTLE MORE THAN 1 FT. HIGH

corner of the city. This problem was overcome by the simple expedient of shifting the channel 1 city-wide transmitter to the location used for the channel 5 zone transmitter.

The three city-wide transmitters are used to provide three methods of operation: single-frequency coverage of the city on channel 2; east-west coverage on channels 1 and 2; and sector coverage, east, middle, and west, on channels 1, 2, and 3. This permits complete off-load servicing of the entire fleet by 1, 2, or 3 dispatchers, as required. In practice the east-west method of operation is normally used, although a city-wide transmitter can be temporarily pressed into service to cover for a disabled zone transmitter.

All city-wide antennas are stacked coaxial beacons with power gain of 5. No overlap problem exists under city-wide operation.

Equipment and Operation: The zone and city-wide transmitters are housed in 34 and 68-in. cabinets respectively. They are remotely controlled via leased two-wire lines from the central dispatching office, but can be operated locally by service personnel. A selector switch on the control panel of each transmitter is used to select remote or local operation, and also permits wire intercommunication between service personnel at the transmitter and the dispatching office. A zone transmitter-receiver cabinet can be seen in Fig. 2.

As required by the FCC, automatic instantaneous peak limiting circuits prevent deviation in excess of ± 15 kc. or any desired value below ± 15 kc.

All of the taxicabs are equipped with 10-watt transmitters using vibrator power supplies. Power drain is such that no heavy-duty generators or alternators are required. Each mobile transmitter-receiver is equipped with a selector switch located on the control head convenient to the driver. By means of this switch, a driver can instantaneously select any one of the 3 channels used in the system, depending upon his zone location. The operating frequency of the transmitter and the receiver are shifted simultaneously. Change of frequency is not accomplished by crystal switching, but by activating separate crystal-controlled oscillators through grounding the cathode of the desired oscillator. Fig. 3 shows a mobile installation in a taxicab luggage compartment. Mobile antennas are short whips mounted on the rooftops, Fig. 4.

In practice, each driver is given a zone map similar to that shown in Fig. 1 so that he will become acquainted with the zone boundaries and will use the proper channel corresponding to his location. After a period of about a week the driver has memorized the boundary streets of the zones, and the map is no longer required. Boundaries were so arranged as to neces-

sitate a minimum of channel switching in the cabs when traveling down most main streets or avenues.

As traffic loads decrease from a peak period when the zone system has been in use, and the intent is to shift to one of the three modes of city-wide operation, each zone dispatcher broadcasts a general call to that effect to all cabs under his control. A similar procedure is followed for any other mode shift.

Considerable study was devoted to the dispatching and remote-control facilities associated with this system. In addition to providing normal switching and audio facilities, it was necessary to furnish means whereby the proper zone and city-wide transmitters could be made available to dispatchers as required by hourly traffic changes. Fig. 5 shows the dispatching table layout in its final arrangement. It can be seen that position 4 is the master position, at which one dispatcher can control one city-wide and all eight zone transmitters. At positions 3 and 5 are tied in one of the other two city-wide transmitters and three zone transmitters. Three zone transmitters can be controlled at each of positions 1 and 6, and two transmitters at position 7. Since all eight dispatchers will be work-

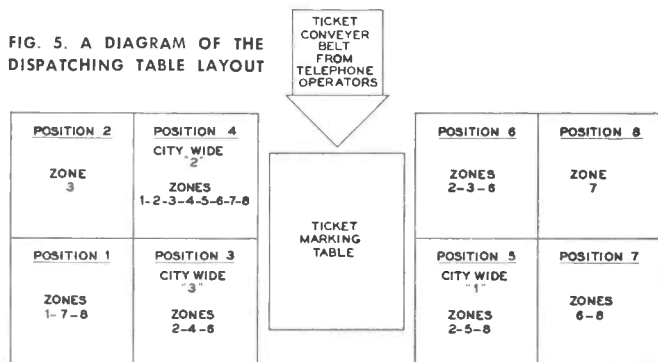

ing when positions 2 and 8 are in use, only one zone transmitter can be controlled at these positions.

At all multiple positions the dispatcher has a turret before him on which appears an upper row of green lamps. These light upon receipt of a call from a cab, so that the dispatcher can tell in which zone the cab is located at the time. Rectified audio from the received call is utilized to operate a relay which, in turn, lights an associated lamp at all positions at which this zone transmitter can be controlled. The master position and a four-transmitter position can be seen in Figs. 6 and 7, respectively.

Below the green lamps are receiver selector pushbutton switches. The dispatcher can operate any or all the buttons and listen to cabs in any or all zones whose transmitters are

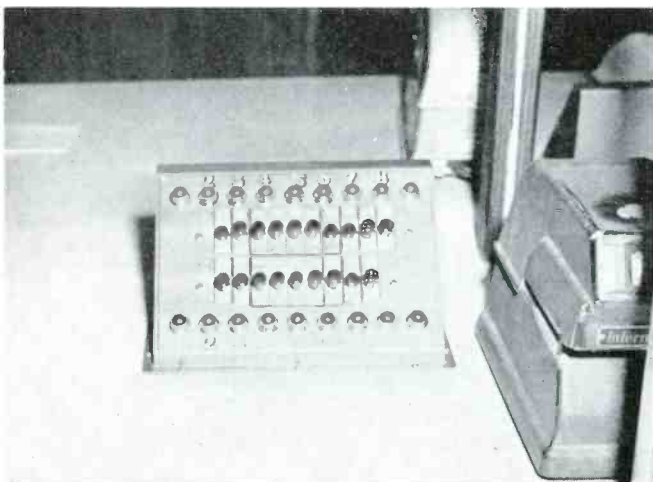

FIG. 6. CONTROL BOX AT THE DISPATCHING TABLE MASTER POSITION

formerly *FM-TV* RADIO COMMUNICATION

controllable from his position. The extreme right-hand button in this row trips all depressed buttons, cancelling prior selections.

Transmitter selector buttons are located in the next lower row, each with its corresponding red lamp in the bottom row.

By depressing a transmit button the dispatcher can elect to use any transmitter controllable from his position. No more than one transmit button can be depressed at a time, since each button releases any other previously depressed. Thus, it is impossible for any dispatcher to put more than one transmitter on the air at a time.

Each dispatcher is supplied with a personal Western Electric type 52-AW operator's headset and microphone, which may be plugged into any table position. Each position also has a parallel jack to accommodate a supervisor's operator's set, if so desired. A volume control at each position makes it possible for each dispatcher to regulate the earpiece volume to suit his own hearing acuity. Foot switches are used to key the selected transmitter, leaving both hands of the dispatcher free to handle call cards, to notate which cab took a call, and to time-stamp and file the cards. Calls taken by telephone opera-

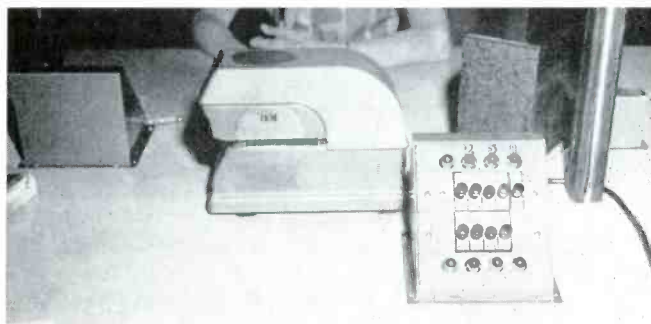

FIG. 7. TOP BUTTON ROW SELECTS RECEIVER, BOTTOM ROW TRANSMITTER

tors are carried by conveyor to markers, who distribute them to the radio dispatchers according to the zone in which each call is to be serviced.

The remote-control units proper are located in a separate room. Eleven units, one for each transmitter in the system, are mounted on an open rack adjacent to the leased line terminations. Spare units are available to replace quickly any remote chassis in case of trouble.

Cables connect the remote-control chassis to the dispatching table and are so arranged at the table that terminations can be made at any given positions quickly and without tools. This was incorporated in the design so that the zone control terminations could be redispersed at the various positions to meet any future changes in traffic and dispatching patterns.

Maintenance: The radio service shop, operated directly by the equipment manufacturer, is located in the Checker Cab Building. Facilities to repair and service all the equipments are available.

As is the case with almost all such systems when initially installed, the servicing problem was severe during the first few weeks of operation. Any latent defects in tubes, vibrators, or other components showed up then. However, after such a break-in period the servicing became a matter of periodic frequency checks and preventive maintenance. In fact, even though this system now has equipments in service for almost two years, the maintenance problem has turned out to be much simpler than expected for 450-mc. equipment.

As an example, the transmitters all use AX-9903/5894A tubes as tripler-amplifiers and power output tubes. Certain doubts existed as to the life expectancy of these tubes, particularly in mobile service. It has been found that they are much

Concluded on page 41

Construction of a Mountain-Top

Remote Base Station

OPERATING EXPERIENCE REVEALS FACTS OF LIFE ABOUT REMOTE TRANSMITTERS-By H. V. CHURCH*

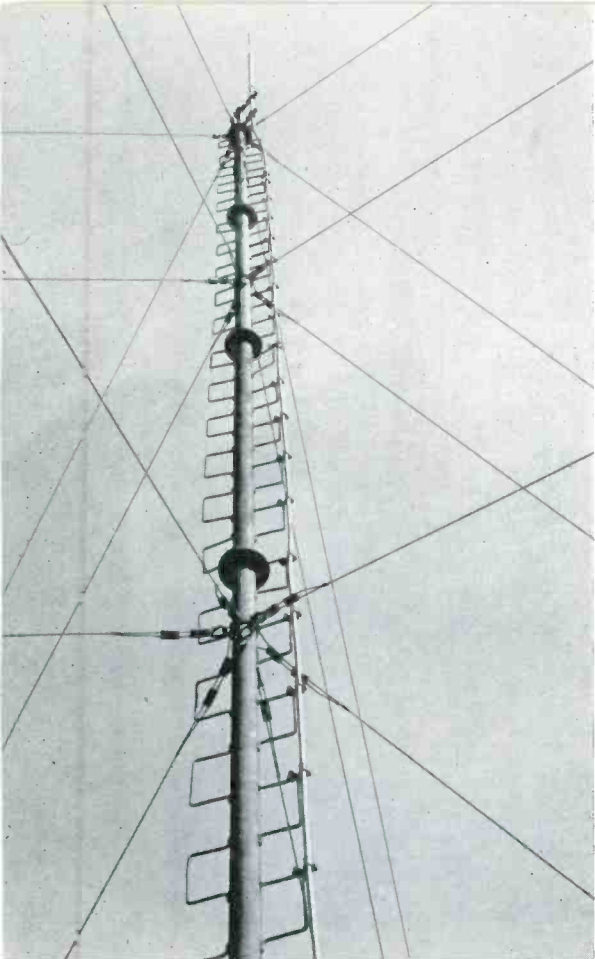

FIG. 2. THE SIXTY-FT. TOWER HOLDING MAIN DIPOLE HAS 18 GUYS

THE Central Vermont Public Service Corporation installed a two-way radio system in the summer of 1946. This company serves the state on both sides of the Green Mountains, as shown in Fig. 1, and some sections of New Hampshire along the Connecticut River. Sixty-watt remotely-controlled fixed stations were installed at Bennington, Cavendish, Bethel, and Bradford, Vt., and at Claremont, N. H. The system is tied together by a 250-watt main station on Pico Peak, 4,000 ft. above sea level and northeast of the operating headquarters at Rutland. Mobile equipment was installed at first in 12 trouble trucks; since then, 2-way units have been put in all trouble trucks, all division superintendents' cars, several heavy five-man cab line trucks, a radio maintenance car, and two pickups, bringing the number to thirty-five. Additional fixed stations have been built at St. Johnsbury, Brattleboro, Springfield, Middlebury, Poultney, Randolph, and Rutland to obtain complete coverage of Central Vermont's territory.

Day-to-day operations consist of directing trouble and construction crews, handling switching orders to cut down service interruption time, and dispatching purchased power when wire communication is inadequate. Emergency communication during such disasters as the flood which struck Rutland in June, 1947, and the hurricane of November, 1950, put a premium on reliable two-way communications. In each case the radio system paid for itself many times over in property, time, and possibly human lives saved by fast restoration of the power system to normal operation.

The system has now been in operation for 7 years, so that we have amassed a great deal of operating experience and have learned much about remote mountain-top transmitters, the hard way. This article is written primarily for those who may be concerned with such remote transmitters.

Surveys and Procurement: Plans were made to establish a 250-watt main station on Pico Peak after a survey indicated that several smaller but more accessible hills nearer Rutland were not high enough to provide coverage into the Connecticut

Valley. Although a temporary station in Sherburne Pass at 2,190 ft. gave fair coverage into the Connecticut Valley and good coverage into the Otter Valley west of the Green Mountains, the higher land north and south of the pass cut off coverage in those directions.

A test from the top of Pico was conducted in 1946, using for power a portable motor-generator set, and a 60-watt station transmitter. The equipment was transported a difficult 2½ miles on snow up the Long Trail with a horse and bobsled. A half-wave antenna was rigged a few feet above the ground, and communication was conducted with a mobile unit which traveled most of the outlying sections of Central Vermont's territory. Results indicated that Pico was indeed an ideal location, since there were very few areas where solid communication could not be obtained.

The idea, quite common at the time, that propagation in the frequency range of 40 mc. followed strict line-of-sight principles was soon abandoned. It was found that radiation was apparently diffracted over the horizon and reflected among the hills in such a way as to give good reception where it was not expected. One such location is along U. S. Route 5 on the Connecticut River, 3 miles above Fairlee, Vt. The road there is at the base of a 500-ft. cliff, cutting off completely any view toward Pico 44 miles away. A strong signal is received in this area from the present Pico transmitter, apparently reflected back from the New Hampshire hills across the river. The outer limit of satisfactory communication between mobiles and the Pico station is indicated by the heavy solid line in Fig. 1.

The survey convinced our Engineering Department that a 250-watt station on Pico was needed if the CVPS system were to be tied together reliably under all conditions. Preliminary plans were drawn up for a station which would be remotely controlled from Rutland by land-line over a distance of 12 miles. This required the construction of 2¼ miles of company-owned telephone line from the road at Pico Ski Area to the summit, and a power line of the same length. As an antenna tower, it was decided to re-erect a sixty-foot steel anemometer tower which had been used by the company some years earlier for a wind-survey program. This tower can be seen in Fig. 2. For a structure to house the radio equipment on the summit it was proposed at first to use a metal box at the base of the tower, which would be serviced by reaching inside. But engineers who had mountain-top experience in winter at the com-

FIG. 3. EQUIPMENT BEING BROUGHT TO THE MOUNTAIN TOP BY TRACTOR



*Radio Engineer, Central Vermont Public Service Corp., 121 West Street, Rutland, Vt.

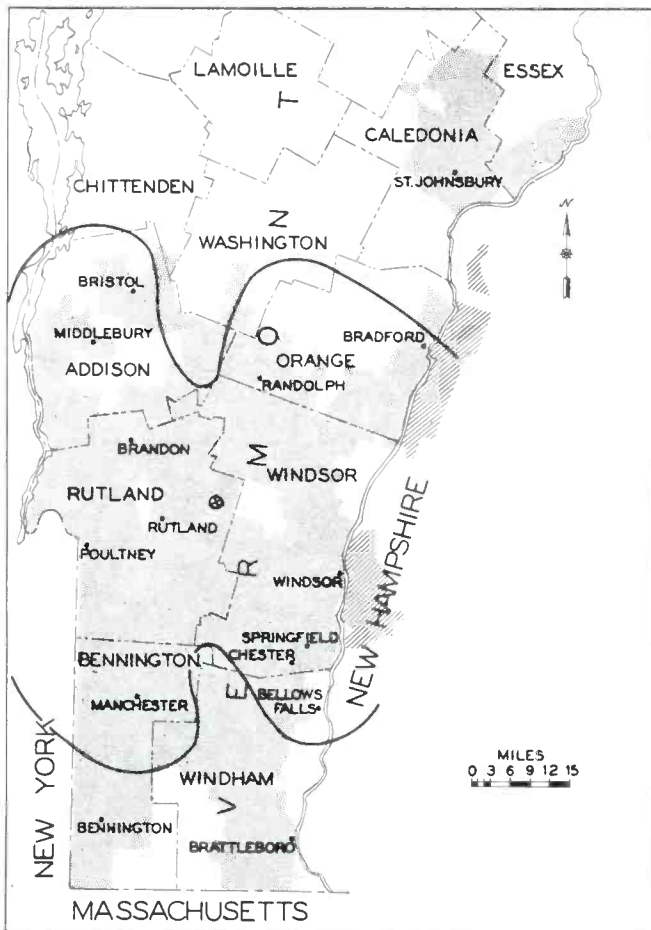
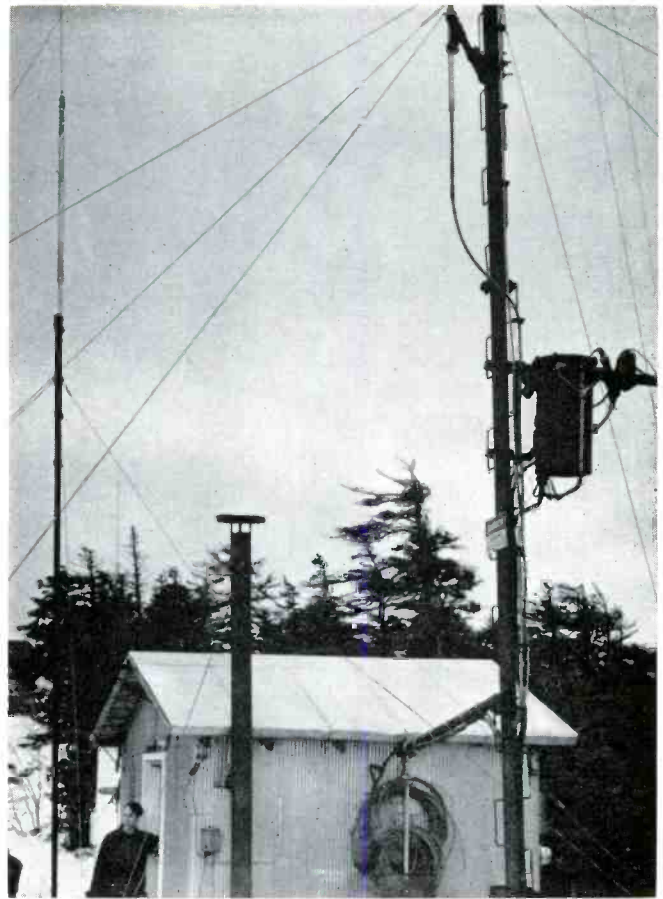

FIG. 1, ABOVE: COVERAGE OF CVPS AREA FROM THE PICO PEAK STATION
 FIG. 4, RIGHT: EQUIPMENT HOUSE AND LIVING QUARTERS ON THE PEAK



pany's Grandpa's-Knob wind-turbine installation decided that the minimum requirements for safety of maintenance personnel, as well as the equipment, would be a fair-sized cabin capable of being heated and with room for emergency living quarters. An eight by ten-foot cabin seemed adequate.

Permission to use the land at the summit was secured from the owner on a yearly rental basis, including the right to bury cables under the ski trail leading to the summit. A contract was let to bury the cables, erect the tower, build the cabin, and transport all equipment to the top of the mountain. Work was completed in the autumn of 1946.

The equipment was hauled to the summit by tractors, in the manner shown in Fig. 3, using a heavy bobsled or dray. It was necessary to winch the tractor up the steepest places, then turn the tractor around and winch the dray. Later experience showed that the Sno-Cat was an excellent means of hauling supplies, equipment, and personnel up the mountain in winter. One trip was made in 15 minutes running time, as compared to two hours climbing on foot, or a full day with a tractor.

FIG. 5. EMERGENCY GENERATOR SHACK IS BUILT ON STILTS FOR WINTER



Line Installation: A heavy, tractor-drawn plow dug a trench some 18 ins. deep to receive the cables. In difficult places, including the top half-mile, most of the digging was done by hand and at times involved hacking out loose rock. Twelve thousand ft. of armored, grounded cable of 7,200-volt rating, with a No. 6 copper center conductor, was buried in the trench. Junction boxes were installed on posts at the side of the trail. Plastic-covered mine cable for the control circuit was buried at the same time and brought out each 1,000 ft. to junction boxes with removable disconnects for testing. Standard protective telephone equipment was installed at each end, consisting of carbon blocks and 7-ampere fuses. Loop resistance of the entire control circuit — $2\frac{1}{4}$ miles of buried cable, 10 miles of telephone company open wire, and a few blocks of enclosed cable — was 3,600 ohms.

The distribution line available at the foot of the mountain was a 2,300-volt ungrounded system; two 2,300/110-volt transformers were installed back-to-back to obtain 2,300 volts grounded for the cable, which was connected to a suitable step-down transformer on the summit. A grounded line is desirable in an installation of this kind for several reasons: 1) It is less costly to bury the cable in an existing trail or road than it would be to run open wire, which would involve clearing a right-of-way; 2) the problem of maintaining open wire is much more severe, entailing exposure to wind, falling trees, brush, lightning, and frequent heavy icing for several months in the winter. Grounded cable, on the other hand, has none of these difficulties, is fairly simple to install, and gives an excellent ground for lightning protection of the radio equipment. Disadvantages of a grounded cable are the possible hazard of uprooting by tractors on the right-of-way and the relative difficulty of locating troubles that do occur. We consider that both are far outweighed by the advantages of a properly-installed underground cable.

The two-wire control circuit worked out quite well for a year or so, then troubles began to appear in the form of leaks

to ground. These caused an unbalance which produced a 60-cycle hum on received and transmitted signals. Eventually they resulted in enough leakage so that the DC control voltage necessary for relay operation dropped below the critical value, and Rutland was unable to put the station on the air. The upper $\frac{3}{4}$ mile of cable was laid in very rocky ground; the leakage was apparently caused either by the frost action grinding the cable between rocks (with which it was mostly covered) or by abrasion of the insulation when the cable was uncovered. Most of the control line was replaced eventually by twisted-pair field telephone wire strung through the brush in 1,000-ft. lengths between test points, which proved to be much more reliable than the underground cable. Still later, to avoid the loss of communications that resulted from troubles on the 12-mile telephone circuit, radio relay equipment in the 72 to 76-mc. band was installed.

Station Facilities: The building erected to house the radio equipment at the summit is of frame construction and is covered with one-inch boards, with corrugated aluminum sides and a sheet-aluminum roof. Fig. 4 shows this clearly. The roof is double-boarded to withstand falling ice from the antenna mast. In this case, aluminum was the ideal covering material, because it was easily transported and affords protection against the weather. Additionally, it frustrates porcupines which like to gnaw on wood around camps and outlying buildings. The structure is guyed at each corner against the wind.

With the building covered by metal, a 60-ft. mast a few feet away, a network of guy-wires overhead, and all equipment grounded to the sheath of the power cable, the station is well protected from lightning and has never been damaged by it. Another station in a similar location lacks the metal-covered building and adequate grounding arrangements, and has experienced repeated cases of severe lightning damage in the last several years.

A 1,500-watt gasoline motor-generator is furnished to supply emergency power to the station. It starts automatically if the power from the cable fails. This generator was housed in the main building for several years, but had to be moved to another enclosure in 1950 to make room for the relay equipment. The generator house was built in Rutland as sections, which were assembled on the Peak. The framework is of 2 by 2-in. pine covered with masonite, Fig. 5. Rock wool was used for insulation. The house has a door at each end with fixed louvres, behind which are a wire-mesh insect screen and mov-

FIG. 6. VIEW OF GENERATOR SHACK THAT SHOWS VENTILATING LOUVRES

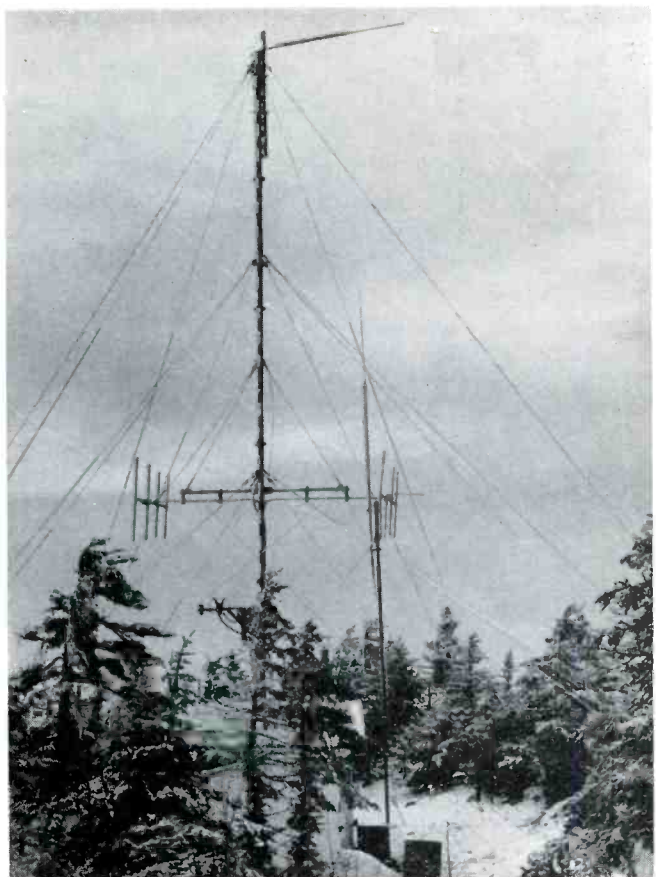

FIG. 7. DIPOLE AND YAGI ANTENNAS BROKEN BY SEVERE WINTER STORM

able light aluminum ventilator louvres 18 ins. square, which can be seen in Fig. 6. These are operated by furnace damper controls, which in turn are controlled by a thermostat adjusted to 70° F. Either positive opening or positive closing against the weather is obtained.

The generator house, which was taken up the trail on a horse-drawn sled and assembled on the summit, is set up on legs so that it will be more accessible in the snow season. The motor-generator, its 28-volt starting battery, a time-clock controlled charger, heat lamps, and an automatic fire extinguisher set for 212° F. are installed in the building. An alarm circuit is connected to key the relay transmitter and modulate it with an 800-cycle tone for five seconds every five minutes, indicating that the station is on auxiliary power. The plant will operate the station on an emergency basis for a day on less than ten gallons of gasoline, which is stored underground in a 55-gallon drum. It has been found that if the generator is called on to operate more than an hour or so at a time on very hot summer days, the ventilation louvres are inadequate, and either an exhaust fan or larger ventilators are needed. At present an arrangement has been made with a State employee who occupies a camp nearby, to open the doors of the generator house when necessary.

Tools and equipment kept at the station include tackle for rigging antennas and guys, safety belts, hard hats for working outdoors when ice is falling from the mast, work gloves, rubber gloves for any work on the transformer or cable, a complete set of small hand tools, 100-watt and 500-watt soldering irons, a blow torch, a saw for cutting firewood or making repairs, a dirt shovel and a snow shovel, an axe, a digging bar, hardware guy wire and clamps, a spare 10-kva transformer, cutout, and lightning arrestor, and a few items of spare clothing. There are a tube tester-analyzer unit, spare tubes, fuses and small components, replacements for all relays, front-end transformers for the receivers, $\frac{3}{8}$ and $\frac{7}{8}$ -in. flexible coaxial cable and fittings, antennas, whips, and mounting hardware. In case it becomes necessary to maintain a crew overnight or for several days, as has happened in the past, there is a week's supply of canned and dehydrated foods and drinking water, adequate for two men, as well as folding

cots and sleeping bags. An electric circulating heater and hot-plate are supplied. However, a small sheet-iron stove, a supply of dry firewood, and a one-burner gasoline stove for cooking are on hand for use when the station is on auxiliary power.

Maintenance Considerations: In 1947 a severe flood occurred and some of Central Vermont's generating, transmission, and substation facilities were damaged, as well as the Rutland operating headquarters. The dispatching office in Rutland was under water and, without a radio control unit or power with which to run it, communication was maintained by means of a mobile unit which dispatched orders to Pico, where company personnel relayed them to the rest of the system. The station was on emergency power for five days, during most of which time the traffic averaged two messages a minute. The motor-generator set was indoors then, and the heat and fumes were so severe that the operator had to spend most of his time just outside the doorway. During this period the radio was used to call in crews from other divisions and coordinate the work of restoring electric service to the Rutland area. Radio again proved indispensable during an unusually heavy sleet storm on December 31, 1948, when land-line communication facilities were disabled and many power lines failed. November 25, 1950, was the day of the great land storm that swept northern New England and attained the proportions of the worst hurricanes, but did not originate over the ocean and accordingly was not expected to be so severe as it was. Some local areas were struck by winds as damaging as those associated only with tornadoes: many houses and large dairy barns were destroyed as well as hundreds of miles of wire lines in Vermont, New York, and New Hampshire.

During the resulting emergency and clean-up periods, FM radio was the only communication facility available to CVPS and it was used to the utmost. The rural distribution line from our East Pittsford generating station, which serves the cable to the summit of Pico, was covered with several hundred fallen trees and was out of operation for a week. Also, the main antenna and later Nos. 1 and 2 emergency antennas were carried away. Two men were sent to try to keep the station on the air. No. 2 emergency antenna, consisting of a mobile whip mounted on the peak of the roof, was still in place when the men arrived. This was connected to the main transmitter and the station was operated on emergency power. During the night even the mobile whip carried away, and it was necessary to replace it at the height of the storm. The men who were on the mountain that night felt that the guys on the corners of the building were a fine idea: the building rocked and strained at the guys, and the window was reinforced on the inside when it appeared that it was about to be blown in.

On the 26th, the wind calmed down considerably. As the air became warmer the ice on the mast began to fall off, with several large masses landing squarely on the roof of the building. The emergency dipole antenna, which is on an 18-ft. length of pipe, was let down and the whip was replaced. This, of course, gave the station much better coverage. On the 28th the station was still on emergency power, the weather had become colder, and the dry wood for cooking and heating the cabin was all gone. Distribution lines to the foot of the mountain were still in bad shape. A government-surplus 10-kw. motor-generator, located with the assistance of the State Police and the Civil Air Patrol, was connected through a 120/2,300-volt transformer to the feed cable leading to the summit. This supplied power sufficient that the nearby State Police radio was able to get back on the air, and the CVPS emergency power plant was shut down. The men stationed on the mountain were kept there two days more until the distribution line was restored. Fig. 7 shows the broken main antenna and the damaged Yagi, which was being used at that time for the relay receiver. The broken dipole and its clamp are shown in Fig. 8.

Perhaps the biggest problem in maintaining this station has been that of keeping antennas up during the winter. We are of the opinion that the combination of high wind and heavy icing is too much for any commercially-available antenna. While some antennas are guaranteed for 1/2 in. of clear ice loading and 100-mph. wind velocity, and will undoubtedly stand it, the specifications for this climate and altitude should be 10 ins. of rime ice loading and 200-mph. wind velocity, with a suitable safety factor for gusts and metallic fatigue. Winds in excess of 200 mph. have been measured on Mt. Washington, N. H., which is about 2,000 ft. higher than the highest of the Green Mountains: ice coatings of 10 ins. occur frequently at 4,000 ft. Rime ice builds up during a storm to great thickness on one side. Then, the wind shifts as the storm clears, and the sail area presented by this ice causes too great a wind load on the antenna.

Another maintenance problem, and the greatest limitation of the station during bad storms, was the land-line control circuit used originally. This often failed when it was needed most. When power company lines are down, telephone lines are usually down too. Troubles were frequent, particularly on our underground phone line, and repairs were slow. It was finally decided to install 72 to 76-mc. radio relay equipment. Two frequencies are used: one receiver on the mountain operates a squelch relay which keys the main transmitter, and the main station receiver has a squelch relay which keys the relay transmitter to Rutland.

At first it was believed necessary to use directional antennas for the relay. Two heavy brass Yagis, vertically polarized, were placed at the ends of a 15-ft. pipe, which was rigged as a yardarm about 25 ft. up the main mast. The Yagi antennas would presumably permit us to operate at the lowest possible power and help to obviate possible television interference to Channel 4. When the equipment was first energized it was found that the frequency assigned for reception at Pico was being used by a New Hampshire system, with several mountain-top stations. The Utility Radio Association of New England, the frequency-coordinating group for our service, has all it can do to keep the base station and mobile frequencies under its cognizance, and makes no attempt to coordinate relay frequencies. Apparently the FCC assigns relay frequencies on the basis of recommendations of the equipment manufacturers, who often help their customers with system engi-

Continued on page 35



FIG. 8. FORCE OF STORM WAS ENOUGH TO BEND DIPOLE AND WARP CLAMP

N1 Carrier Equipment Design

DESCRIBING FEATURES OF N1 CARRIER EQUIPMENT EMPLOYED BY BELL LABORATORIES TO EFFECT PRODUCTION ECONOMIES — *By* W. R. STEENECK*

Progress in telephone apparatus and radio equipment design seem to follow converging paths, each contributing something to the other. Bell Laboratories started in the telephone field and adopted radio as an accessory means of transmission. More recently, radio manufacturers have borrowed telephone-circuit techniques for remote controls and multiplexing. The N1 equipment, described by Mr. Steeneck, while it looks more like radio than telephone apparatus, is a most interesting example of economy in manufacture, testing, service, and also in cubic contents. And those gains have been achieved, it should be noted, as part of a program to increase reliability and to reduce the duration of outages.—EDITOR.

A basically new approach in telephone equipment design has been introduced in the development of N1 carrier. Instead of following the conventional practice of using a number of relatively large panels arranged for permanent relay rack mounting, the major transmission components are packaged as small, lightweight, compact units which plug into a common framework to form a complete system terminal or repeater assembly.

This fundamental concept has made possible a design that has a number of distinctive features and advantages. These include the extensive use of die castings, a new method of mounting pigtail type apparatus, application of plug-in design to essentially all transmission elements, maximum use of available space, and the assembly of complete terminals or repeaters in single packages convenient for engineering, installation, and testing. These features have made possible a twelve-channel cable carrier system sufficiently low-priced to permit widespread use on short routes formerly outside the economic range of carrier facilities.

Use of aluminum die castings instead of fabricated designs for the relatively complex chassis required, and the new

*Transmission Systems Development, Bell Telephone Laboratories, 463 West Street New York 14, N. Y. This text appeared originally in the *Bell Laboratories Record*.

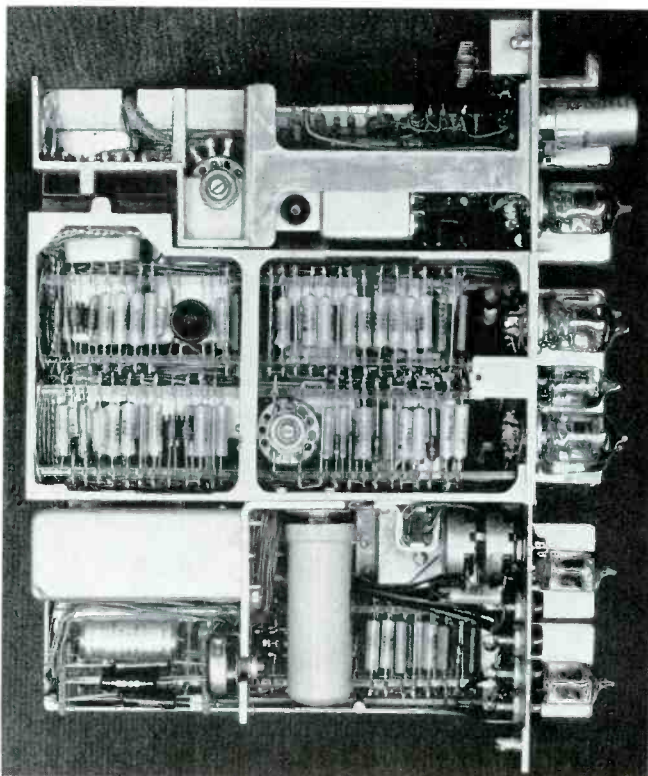

method of assembling pigtail components are large factors in the reduction of assembly and wiring costs. The advantages of aluminum die castings, in addition to the cost reduction factor, include dimensional uniformity, which provides interchangeability of parts; light weight, so essential in a plug-in design; chassis of complex construction that would not otherwise be obtainable; and the incorporation of equipment iden-

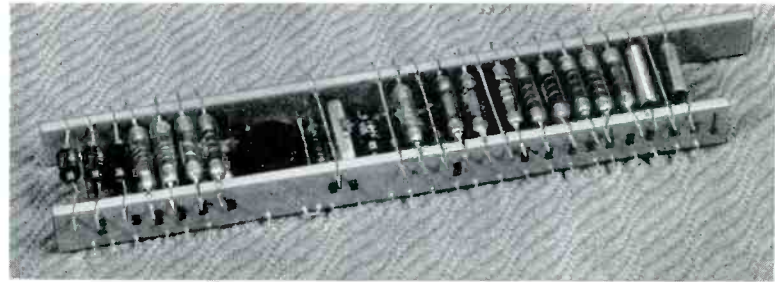

FIG. 1. SMALL COMPONENTS ARE MOUNTED EMBEDDING LEADS IN PLASTIC

tifications in the dies, thereby eliminating subsequent stamping or adding this information as a separate operation.

Mounting of pigtail components, such as resistors and capacitors, is accomplished by imbedding the leads of these components in two parallel thermoplastic strips, as shown in Fig. 1. Simple assembly jigs position the strips and components so that the terminal leads rest on the edges of the strips. The jigs are then placed in a machine which, by applying a slight pressure to a heated shoe, imbeds all the terminal leads into the plastic material, and at the same time shears off the excess length of the leads. The entire operation is completed in a matter of seconds. As indicated in Fig. 1, components can be assembled on both edges of the strips by turning over the assembly and repeating the process. Such assemblies in type N contain as many as 40 or 50 parts, but the process can be expanded for larger assemblies if necessary.

Use of small, lightweight apparatus components has made possible a compact plug-in unit that can be removed from service when not operating properly, and replaced by a satisfactory unit, thereby restoring service with a minimum of lost circuit time. The defective unit can then be removed to a cen-

FIG. 2, LEFT: COMPLETE CHANNEL UNIT; 12 PER TERMINAL ARE REQUIRED
FIG. 3, BELOW: THE THREE SUBASSEMBLIES MAKING UP A CHANNEL UNIT

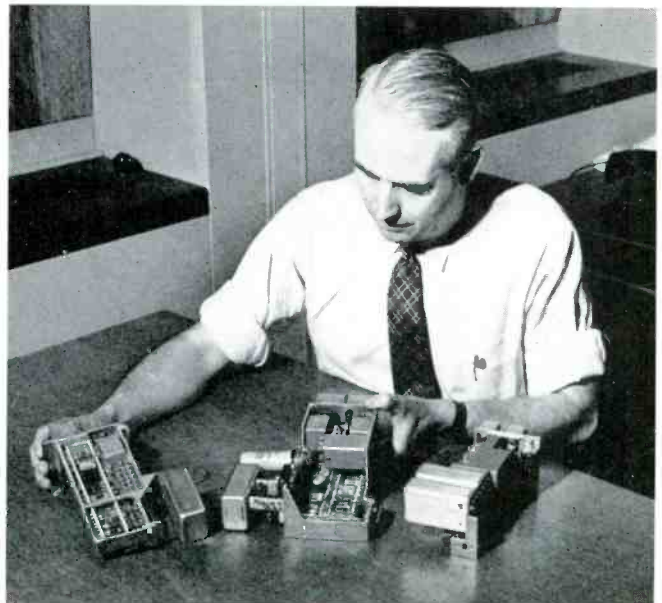

trally located maintenance center for repairs. At these maintenance centers complete tools, testing equipment, and experienced personnel permit efficient servicing at lower cost than if repairs were made at the equipment location.

Miniaturization, although providing the advantages mentioned, introduces a more severe problem in obtaining adequate accessibility of all parts for shop assembly and field maintenance than had existed previously on permanently-mounted equipment in which the apparatus is located on flat panels. The solution of this problem was to make the various plug-in units in the form of two or three subassemblies, each of which consists of a logical circuit subdivision. Each subassembly is completely assembled, wired, and tested in the shop, and it is terminated in plugs and jacks to provide ready assembly into a complete unit.

It was realized from the beginning that the use of compact, miniaturized construction would introduce heat dissipation problems. Many type N repeaters are pole-mounted, where there is no power available for cooling fans that could otherwise be used. Large terminal installations pose a particularly serious problem in this respect. In these installations, blowers are provided at the bottom of the racks, with ducts to carry the air up each side of the rack. These ducts are slotted so as to direct the cooling air toward the heat producing areas.

To minimize heating effects, all plug-in units are so designed that heat-producing apparatus, such as electron tubes, power-adjusting resistors, and potentiometers are mounted on the faces of the chassis, and non-heat producing and heat sensitive apparatus at the rear. Heat-producing apparatus has also been arranged to permit the natural flow of heat from floor to ceiling to be as unimpeded as possible.

Plug-in units consist of the channel, group, and repeater units. Twelve channel units are required for each N terminal; these are all identical except for the receiving filters and the crystal unit that determines the channel carrier frequency. There are four types of group units. For a terminal that transmits high-group frequencies and receives low-group frequencies, there is a high-group transmitting unit (HGT) and a low-group receiving unit (LGR). For a terminal that transmits low-group frequencies and receives high-group, there is a low-group transmitting unit (LGT) and a high-group receiving unit (HGR). There are two types of repeater units, the high-low repeater (H-L) which receives high group frequencies from the line and modulates them with 304 kc. to low-group frequencies, and the low-high repeater (L-H), which translates low-group frequencies to high-group.

The channel unit shown in Fig. 2 contains all the apparatus, including that required for signaling, for one channel. This unit is made of three die cast subassemblies: 1) the compress-

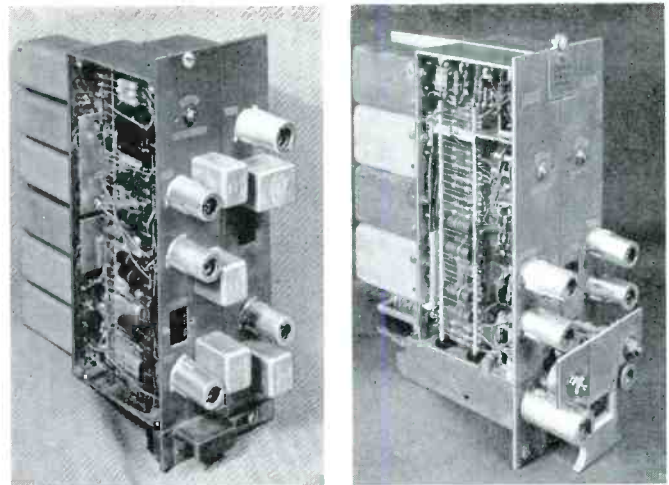

FIGS. 4, LEFT, AND 5, RIGHT: GROUP RECEIVING UNIT AND A REPEATER

sor, or voice-frequency transmitting subassembly; 2) the expander, or voice-frequency receiving subassembly, and the signaling equipment; and 3) the carrier frequency subassembly. The first two subassemblies are identical for all channels and are now wired and equipped so that they can be used also for channel units in the type O carrier system. These subassemblies are terminated in plugs and jacks so that they can all be connected together to form one complete unit. A partially disassembled view of the channel unit is shown in Fig. 3.

Transmitting and receiving group units combined contain the transmitting and receiving amplifiers, the group modulator, which can be used either in the transmitting or receiving branch, the signaling oscillator, and the carrier alarm circuit. A single group unit consists of a combination of three of the following die cast subassemblies: 1) high-group transmitting, 2) low-group transmitting, 3) high-group receiving, 4) low-group receiving and 5) oscillator. The oscillator subassembly contains the 304-kc. carrier oscillator and the 3,700-cycle signaling oscillator. It can be plugged into a low-group transmitting subassembly or a low-group receiving subassembly, the combination being provided with a common cover to form an LGT or LGR unit. High-group transmitting and high-group receiving subassemblies are not associated with an oscillator, since the required frequency band is received directly from the channel units. With their individual covers, therefore, they are complete HGT and HGR units. Fig. 4 is a view of an LGR group unit. Fig. 6 is a partially disassembled view of this unit.

The H-L and L-H repeaters each consist of three subassemblies. In the H-L repeater a West-to-East high-to-low amplifier and modulator subassembly, and a similar East-to-West subassembly, are plugged into a common 304-kc. oscillator and voltage regulator subassembly, all mounted under a common cover. The L-H repeater is similar to the H-L

FIG. 6. COMPONENT SUBASSEMBLIES OF GROUP RECEIVING UNIT, USED AT A TERMINAL THAT TRANSMITS A HIGH GROUP AND RECEIVES A LOW GROUP

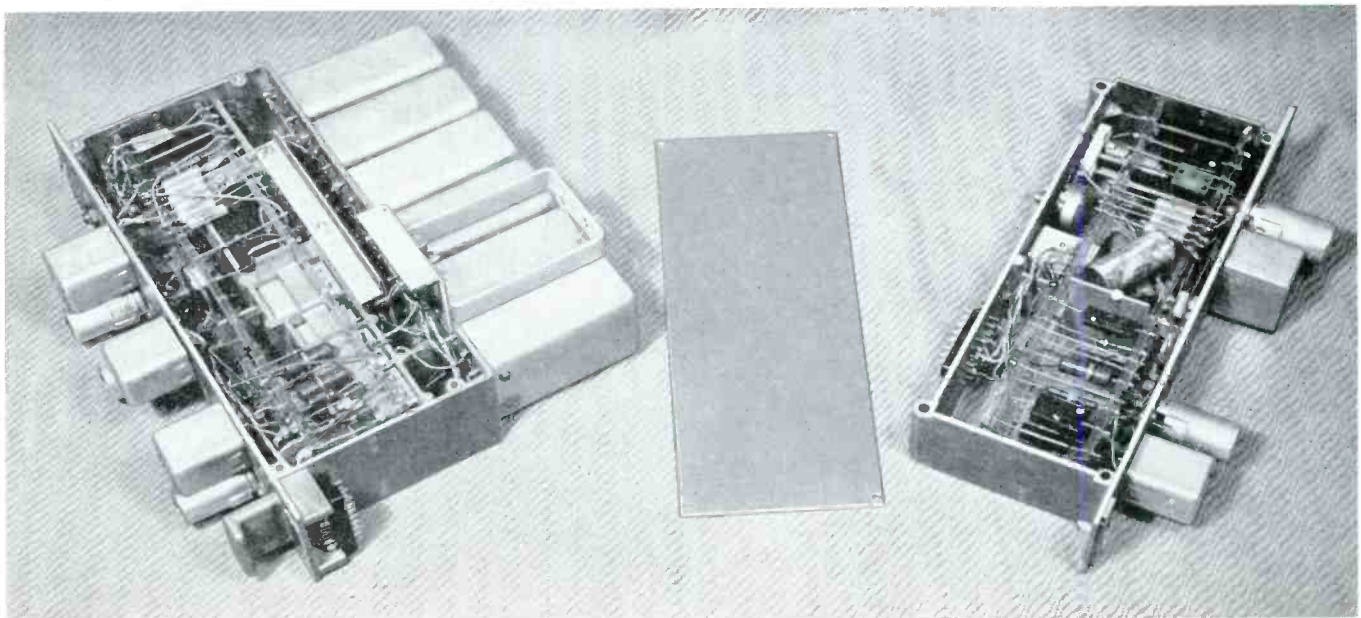

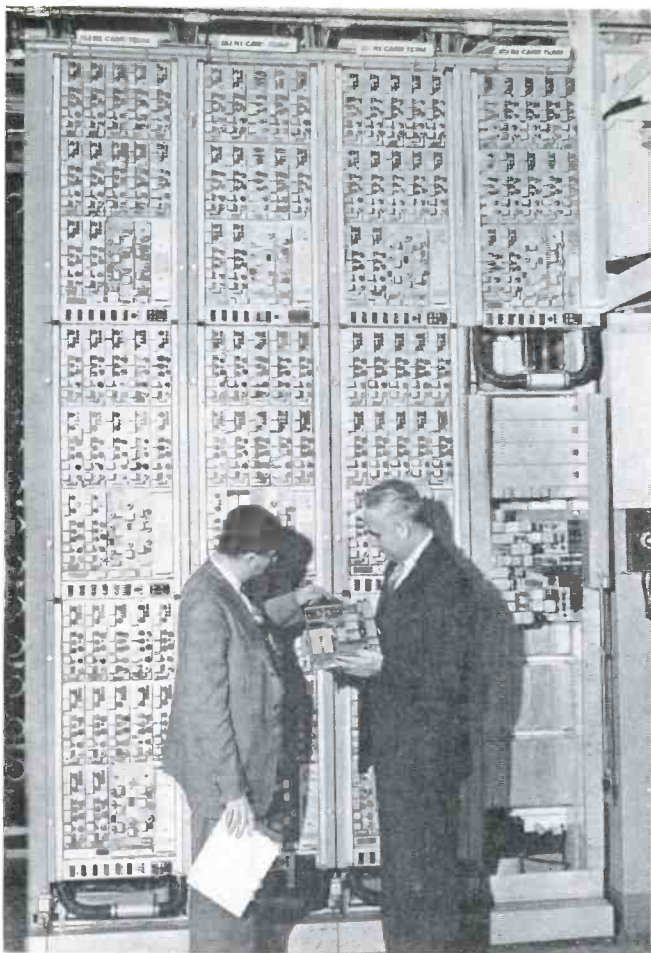

repeater except that the amplifier and modulator subassemblies are designed for low-to-high conversion instead of high-to-low. An assembled repeater is shown in Fig. 5 and a partially disassembled view in Fig. 7.

A complete N terminal, as shown in Fig. 8, consists of twelve channel units, a group transmitting unit, a group receiving unit, and miscellaneous equipment such as power fuses, voltage-adjusting facilities, alarm lamps and relays, and test power jacks. The terminal assembly consists of a fabricated aluminum framework that contains the jacks required for the associated plug-in units. These jacks are wired to terminal strips for external connections, and also to the power supply fuses and alarm circuits.

Installation, therefore, only requires making the outside connections and plugging the proper units into their associated jacks. Channel units for channels 1 to 5 are plugged into the top row of jacks, channels 6 to 10 into the middle row, channels 11 and 12 at the left side of the bottom row, and the transmitting and receiving group units to the right of channels 11 and 12. Additional jacks are associated with the group unit jacks, so wired that these units can be tested and replaced without interruption in service. Mounting can be accomplished on any relay rack that will carry 19-in. panels, and three complete terminals can be mounted on a standard 11½-ft. bay.

Repeaters are designed to mount four across a 19-in. relay rack bay. The jacks which the repeaters engage, instead of being located on the mounting framework are assembled on a die-cast bracket, which is fastened to the rack by screws. Fig. 9 shows three repeaters in position and space for one additional repeater. In addition to the regular repeater jacks, the bracket contains two additional jacks for testing and replacement of the repeater without interrupting service, an arrangement similar to that provided for group units. The bracket also mounts span pads, or artificial lines for building out the line loss to the required value, all completely wired to a terminal strip. Use of plug-in repeaters and the assembly of all associated elements on a removable bracket provides accessibility, and permits complete maintenance of an individual system without the hazard involved in working on or near other equipment in service.

Throughout the development of the N1 carrier system, accent has been placed on small, compact, inexpensive plug-in units requiring a minimum of installation effort and capable of immediate replacement, when necessary, with a minimum of lost circuit time. The result of these efforts has been a high-quality carrier system that has proved economically feasible on short routes.

FIG. 8, TOP: A COMPLETE N TERMINAL, OCCUPYING FOUR 19-INCH RACKS
 FIG. 9, LEFT: SPECIAL BRACKET USED TO MOUNT FOUR REPEATER UNITS
 FIG. 7, BELOW: DISSEMBLED AMPLIFIER AND MODULATOR IN A REPEATER

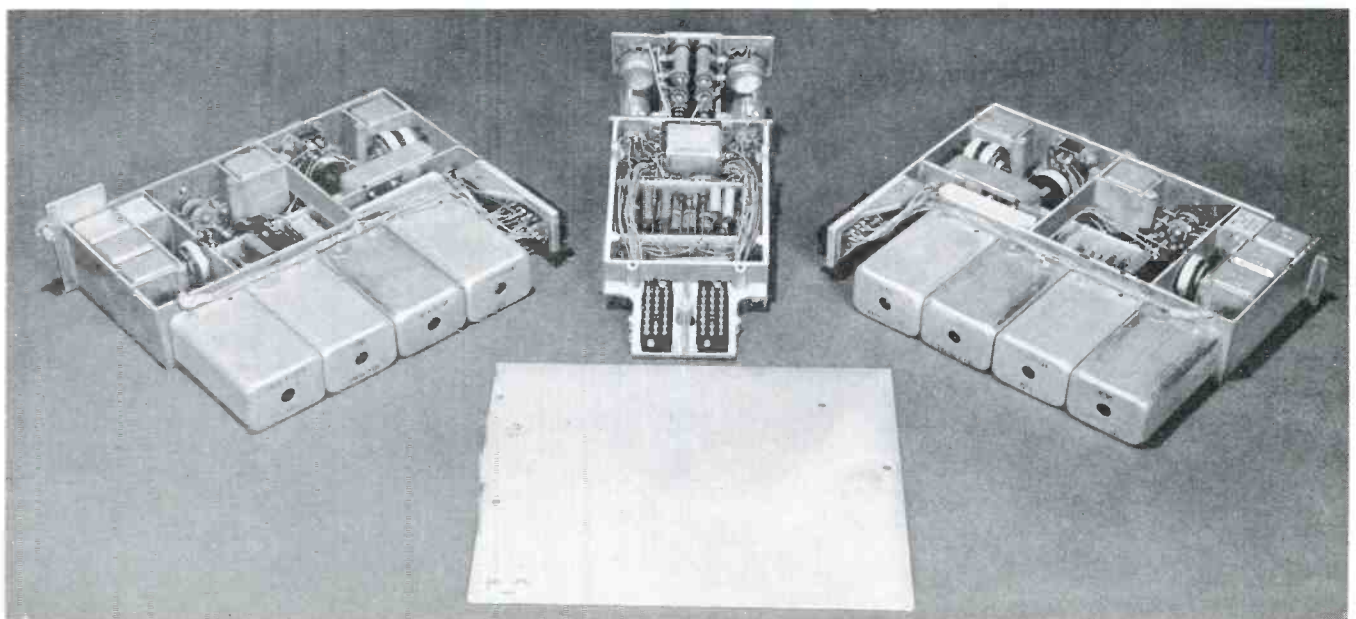
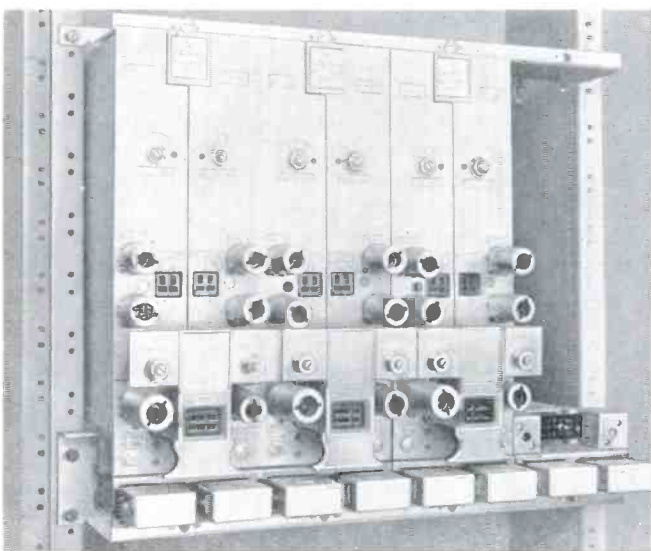

Safety and Special Radio Services

PART 2: WHILE POLICIES REFLECT PAST EXPERIENCE, THEY ANTICIPATE GREAT EXPANSION AND TECHNICAL PROGRESS — *By* EDWIN L. WHITE*

It is clear that recommendations from industry groups assist the Commission's staff materially, since otherwise a detailed investigation would have to be made in each community in every case. Even if the Commission were staffed so that such investigations could be made, which it is not, it is believed that it would still be desirable to seek the advice of local groups as to the assignments of frequencies. For example, there are many communities that are equally entitled to police radio frequencies who are traditionally and politically always at dagger's point. On the other hand, in the same area there may be communities that have always worked together and supported each other in every municipal project. Certainly, if sharing must be resorted to, it would be better for the latter to share rather than the former. The Commission could never know all these factors unless it made actual field investigation and perhaps not even then, as sometimes these jealousies are not obvious. Although the sharing pattern as developed under the guidance of industry committees may not be the best in the world from an engineering point of view, it probably is the best practical pattern that can be worked out.

The licensee must assume responsibility for working out interference problems with those sharing his frequency, and for anything that he does which infringes on the rights of others. If he does not adjust and maintain his equipment properly, he may create interference in areas where otherwise good communication would be possible. If he sends messages by radio that either need not be sent at all, or could be sent by means other than radio, he is depriving someone else of the opportunity to send necessary traffic. If he fails to train his personnel, and permits the use of unnecessary words and involved procedure, or if he does not organize his communications system efficiently, he will take an unwarranted amount of time on the air, at the expense of others. In short, in these services the licensees must realize that the use of radio is on a party line basis, and that it is not a tool of competition except in the sense that those who do not avail themselves of the privilege of using radio may find that their operations are not as efficient as the others. In spite of the fact that two industries sharing the same frequency may be bitter competitors for business, they must cooperate in the use of the radio spectrum to obtain utmost efficiency in its use.

As has been stated, the purpose of the Commission's rules is to specify those who are eligible to obtain authorizations, to define the services which they are authorized to render, and to provide those technical standards necessary for various services to share a limited frequency spectrum. There should be no over-regulation. However, it is a continual struggle to avoid it. There is a large number of persons in this country who seem to think that to meet any type of circumstances, "there ought to be a law." For example, the Commission has been urged to establish standard operating procedures for various industries. These proposals have been made by those who have felt that their rights were being infringed by wasteful operating practices of others sharing the same frequencies. The responsibility for clearing up

situations of this kind lies best in the hands of the licensees themselves. The problems faced by industry are manifold, and the Commission's staff cannot become experts in all the details involved. Should the Commission endeavor to write procedures and dictate practices, it is certain that the Commission would give relatively little importance to some practices that the industry would consider of crucial importance, and would emphasize other matters which, as far as industry is concerned, could be eliminated entirely.

The Commission was not organized merely for the purpose of issuing licenses. It is basically a planning organization to provide order in the use of the radio spectrum, and to promote the widest possible use of radio in the public interest. The authority to issue licenses is given so that the Commission may have a means whereby its policies can be put into effect.

The license is issued as an evidence that the licensee is eligible to hold such an authorization, and that his plans are in accord with the rules and regulations of the Commission. The Commission can assure itself of continued maintenance of its policies by revoking or not renewing individual licenses. It can be said, therefore, that the main purpose of a license is to provide something the absence of which precludes the use of radio by the ignorant, the irresponsible, or the incorrigible. This applies equally to station licenses and those operator licenses which are issued without examination. In the case of the higher grade operator license, where an examination is prerequisite, the document additionally attests to the possession of minimum knowledge and in some cases, to minimum skill.

The Commission has an essential responsibility with respect to progress. The communication industry is relatively young, and new developments are appearing on the scene every day. In addition, with all segments of industry in a period of growth, new problems appear every day, many of which can be simplified if not solved by communication techniques. The Commission has specific responsibility to maintain close contact with those industries using communication as well as those developing communication devices so that the new techniques can be applied most effectively to the communications problems of the people of the U. S.

The Commission has, as a consequence of this responsibility, the duty to revise continually its rules. In the usual case, at the time provision for a service was made, the requirements of the new service as to frequencies and operating practices were strictly from the crystal ball. Even the best educated guess can be wrong. As a result of the evidence before it at the time of service initiation, the Commission may have been either too strict or too liberal in its rules prescribing the service. Should the Commission be too strict, many would be deprived of the opportunity to use radio. If the Commission's rules are too liberal, too many are authorized to say too much and congestion occurs. To meet these situations the rules must be changed.

For example, at one time 500 kc. was authorized to ship and coast stations for all purposes. As the number of radio-equipped ships increased, it was restricted to calling, distress.

Continued on page 42

*Chief Safety and Special Service Bureau, Federal Communications Commission, Washington, D. C.

Oscillators with Dual Crystals

STABILITY IS IMPROVED BY EMPLOYING TWO CRYSTALS WITH OPPOSITE TEMPERATURE COEFFICIENTS —By DOUGLAS A. VENN & GEORGE W. ARNOLD*

FOR the past several decades electronic-equipment installations on naval vessels have increased greatly, both in variety and bulk. Space limitations, therefore, must be a primary consideration in the design of new equipment or the modification of existing installations. An investigation was initiated to determine whether or not quartz-crystal oscillator plates having opposite temperature coefficients might be utilized in combination to obtain a unit possessing low thermal drift characteristics over a very wide temperature range or, conceivably, an extremely stable unit with a temperature characteristic of not more than 0.0001% over a temperature range of 10 or 20°C. Such a unit would obviate the necessity for bulky oven control, now used where high stability is required of high-frequency crystal units, and this would be valuable not only to the Navy but to other users of communication equipment.

The possibility of using crystal oscillator plates in this manner seems to have been first reported by Koga¹ in 1936. He employed two crystals of about 4,860 kc., placed one on top of the other in a suitable holder. The temperature coefficients of the individual plates were $-7.8 \times 10^{-6}/^{\circ}\text{C}.$ and $+8.7 \times 10^{-6}/^{\circ}\text{C}.$ The combination gave a maximum deviation in frequency of only 50 cycles from 36° to 77°C., which corresponds to a variation in frequency of less than $10^{-6}/^{\circ}\text{C}.$ A search of the literature failed to reveal any further investigations along these lines by Koga or any others.

Simple Theory: Considering the case for two crystals in parallel, as in Fig. 1 where L_1, C_1, R_1 and L_2, C_2, R_2 represent the inductance, capacitance, and resistance of the motional arms of the individual crystals, and C_t represents the sum of the crystal static capacities plus the circuit capacity, the frequency of operation can be approximated.

If terms in the impedance equation containing resistance are neglected, as they can be for crystals in the 5 to 15-mc. range, it can be shown that the frequencies of anti-resonance are given by

$$(1) \quad \omega = \left(\frac{(\omega_{1a}^2 + \omega_{2a}^2)}{2} \pm \left\{ \frac{(\omega_{1a}^2 + \omega_{2a}^2)^2}{4} - |\omega_{1a}^2\omega_{2r}^2 + \omega_{1r}^2\omega_{2a}^2 - \omega_{1r}^2\omega_{2r}^2| \right\}^{\frac{1}{2}} \right)^{\frac{1}{2}}$$

where ω_{1a}, ω_{1r} and ω_{2a}, ω_{2r} are the anti-resonant and resonant frequencies of crystals 1 and 2, respectively. It should be noted that the anti-resonant frequency of each crystal should be measured with the entire value of C_t across it.

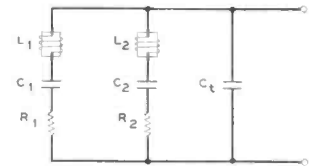

FIG. 1. EQUIVALENT NETWORK FOR 2 CRYSTALS CONNECTED IN PARALLEL

The resonant frequencies of the circuit will be closely approximated by

$$(2) \quad \omega = \sqrt{\frac{1}{L_1 C_1}} \doteq \omega_{1r}, \quad \omega = \sqrt{\frac{1}{L_2 C_2}} \doteq \omega_{2r}$$

The case in which two crystals are placed in series and shunted by the circuit capacity will give frequencies very nearly the same as those just obtained, except that the resonant and anti-resonant designations will be reversed. There will be a slight modification of frequency because of the different capacity distribution in this arrangement.

It should be emphasized that these equations have been derived for crystals having nominal frequencies lying in the lower portion of the high-frequency range. The general applicability of the equations is limited because of the increasingly great effect of C_t as the frequency is increased beyond this range.

Reactance vs. Frequency Response: Figs. 2 through 4 are reactance vs. frequency curves for crystals, both singly and in parallel. These data were obtained by means of aural null impedance bridges and a variable-frequency generator having an instability not greater than plus or minus one cycle. Fig. 2 represents the case in which the individual crystal units differ in nominal frequency about 6 kc. The difference in impedance magnitudes of the parallel combination at the frequencies of anti-resonance becomes greater as the anti-resonant frequencies of the individual crystals approach one another.

From the point of view of the oscillator circuit, both frequencies of anti-resonance are possible operating points; in a tuned oscillator with sufficient selectivity, it would be possible to obtain either frequency. As the separation in nominal frequency becomes less or the selectivity of the oscillator decreases, the oscillator tends increasingly to operate at the frequency of highest impedance.

Fig. 3 shows the results for the situation in which the difference in nominal frequency is only 500 cycles. For these particular units the method of measurement of reactance value was not precise enough to permit obtaining the first anti-resonant peak of the parallel combination, since the series resonant frequencies of the individual units were almost coincident.

Two different crystals of the same nominal frequencies as in Fig. 3, but having greater separation in series resonant fre-

*Naval Research Laboratory, Washington 25, D. C.

¹Koga, I., "Notes on Piezoelectric Quartz Crystals", *Proc. IRE*, 24:510-531, March, 1936.

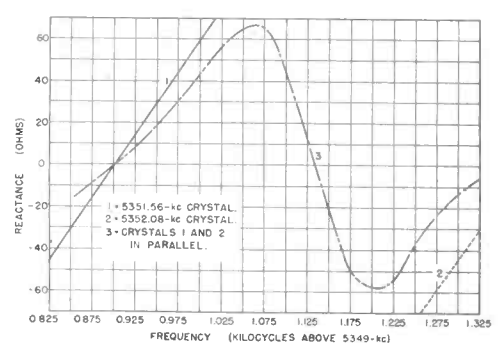
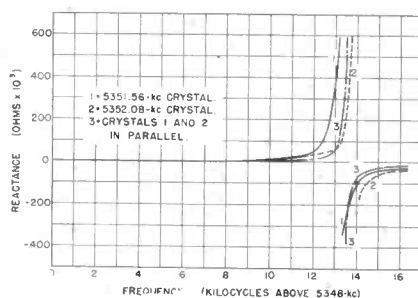
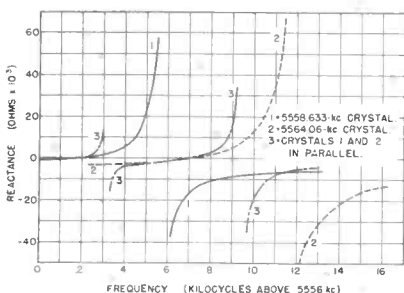

FIGS. 2 AND 3. REACTANCES OF CRYSTALS SINGLY AND IN PARALLEL. FIG. 4. ANTIRESONANT PEAK

quency, were used for the data represented in Fig. 4. Here, the reactance of the parallel combination is so small that the impedance is of the same order of magnitude as the impedance of the individual units at series resonance. Because of the linear character of the individual crystal reactance curves in this region, the slope of the reactance curve is not great. The difference between series resonant frequencies is about 400 cycles; the reactance peak of the parallel combination is only about 70 ohms.

Several points of interest concerning the data presented in the graphs are evident. The reactance for the parallel case is zero at each of the series resonant frequencies of the individual crystals. As the positive reactance of the lower-frequency crystal increases from its series resonant value it approaches in magnitude the negative reactance of the higher-frequency unit. The positive reactance of the parallel combination rises rapidly as this point is approached, reaches a maximum at the frequency for which the two individual reactances are equal and opposite, and then becomes a maximum in the negative direction. Where the lower-frequency crystal reaches its anti-resonant peak, the reactance curve for the parallel crystals crosses the reactance curve for the higher-frequency crystal. The parallel combination then goes through its second anti-resonant peak as the magnitudes of the reactances of the lower and higher-frequency units again approach and become equal to each other. There is another crossover point when the higher-frequency crystal goes through anti-resonance, after which both units and the parallel combination approach zero reactance asymptotically. The parallel reactance is, of course, less than that of either unit alone. By operating two crystals in parallel, therefore, a unit is obtained which has a greater change

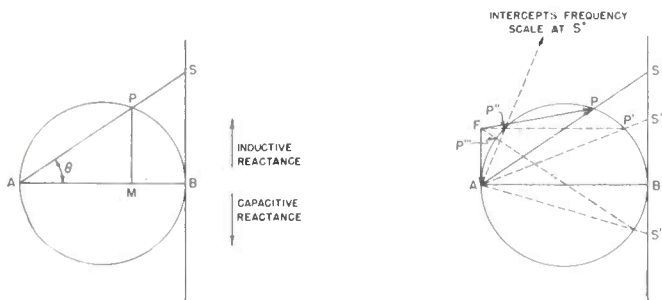

FIG. 5. IMPEDANCE AND ADMITTANCE OF $R_1L_1C_1$. FIG. 6. SAME, C_t ADDED in reactance for a given change in frequency in the region of anti-resonance.

Graphical Analysis: At frequencies above 15 mc., the effects of the series resistance and the shunt capacity of the crystal become increasingly important. Equation 1 is not adequate for such frequencies, since it is derived on the assumption that the series resistance is negligible in comparison with the reactive component of the impedance. However, at frequencies above 15 mc. an exact analysis of the circuit shown in Fig. 1 can be made only by using the complete network equation, which is a biquadratic in ω^2 with cumbersome coefficients. But in many cases a qualitative analysis, in which the effects of variations in the crystal parameters can be observed, is all that is desired. A convenient means of making such an analysis, which employs the circle diagrams used in circuit analysis, has been described by Cady^{2,3} and the following discussion is based in part upon his work.

Referring to Fig. 5, let AB represent R_1 , the resistance of crystal No. 1 in Fig. 1. If the radius of the circle is ρ_1 , then

$$(3) \quad s = \frac{R_1}{2\rho_1} \text{ ohms/unit distance.}$$

Reactance is plotted along the perpendicular to AB through B, with inductive reactances above B and capacitive reactances

²Cady, W. G., *Piezoelectricity*, McGraw-Hill Book Co., New York, 1946.

³Cady, W. G., "The Application of Methods of Geometrical Inversion to the Solution of Certain Problems in Electrical Resonance," *Proc. AAS*, 68:383-409, 1933.

below. In Fig. 5, BS represents an inductive reactance given by

$$(4) \quad X_1 = s \times BS \text{ ohms,}$$

where X_1 is the reactance of L_1C_1 . The impedance of $R_1L_1C_1$ is then

$$(5) \quad Z_1 = s \times AS \text{ ohms.}$$

Since it is desired to investigate circuits containing elements in parallel as well as in series it is decidedly advantageous to represent admittances and impedances on the same diagram. It will be noted that

$$(6) \quad Y_1 = \frac{1}{Z_1} = \frac{\cos \theta}{R_1} = g_{01} \cos \theta,$$

where Y_1 is the admittance of $R_1L_1C_1$, and g_{01} is the conductance of $R_1L_1C_1$ at the series resonant frequency, which is given by

$$(7) \quad g_{01} = \frac{1}{R_1}.$$

But Equation 6 is the polar equation of a circle with the diameter given by Equation 7. By letting AB represent $1/R_1$ at the series resonant frequency, the admittance scale value is

$$(8) \quad s_y = \frac{\left(\frac{1}{R_1}\right)}{AB} = \frac{1}{2\rho_1R_1} \text{ mhos/unit distance.}$$

Clearly, the circumference of the circle in Fig. 5 is the locus of $Y_1 = 1/AS$ as the frequency varies. The expressions for admittance, conductance, and susceptance are given by

$$(9) \quad Y_1 = s_y \times AP,$$

$$(10) \quad g_1 = s_y \times AM,$$

and

$$(11) \quad b_1 = s_y \times MP,$$

where

$$(12) \quad Y_1 \cong g_1 - jb_1.$$

It is apparent that for each reactance BS there corresponds a different frequency, and it would be desirable to calibrate the reactance scale in terms of frequency. This derivation is also due to Cady, and it is found that

$$(13) \quad f_0 - f_1 = \sigma \times BS \text{ cycles,}$$

where

$$(14) \quad \sigma = -\frac{R_1}{8\pi\rho_1L_1} \text{ cycles/unit distance.}$$

f_0 is the series resonant frequency of $R_1L_1C_1$, and f_1 is the frequency corresponding to the impedance represented by BS. Frequencies above series resonance lie above B, corresponding to an inductive reactance; frequencies below series resonance lie below B, corresponding to a capacitive reactance.

Other network elements can now be taken into consideration. In Fig. 6 the admittance of C_t , the total shunt capacitance, is represented as AF where

$$(15) \quad Y_t = j\omega C_t = s_y \times AF.$$

F is now the origin for the network consisting of C_t in parallel with $R_1L_1C_1$, the admittance of the network being represented by the vector FP in Fig. 6, both in magnitude and in phase. Over the usual range of frequencies considered AF can be regarded as fixed, which simplifies greatly the use of the graphical method. It is to be noted that, for purposes of clarity, AF is shown larger than is generally the case. Fig. 6 reveals very

FIG. 7. A REPRESENTATION OF $R_2C_2L_2$ ADDED TO THE CIRCUIT PARALLEL WITH $R_1L_1C_1$ AND C_t

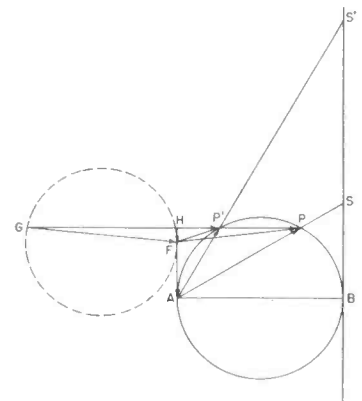

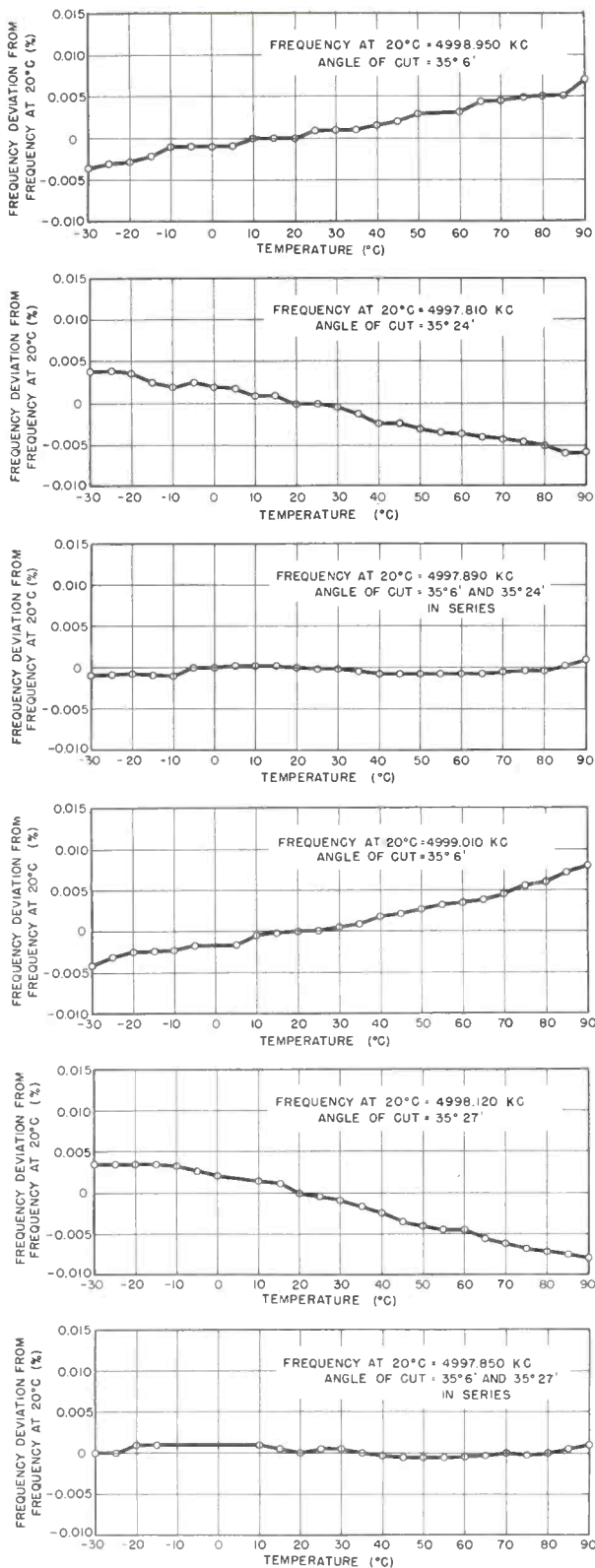

clearly the effects of variations in the shunt capacity upon the frequency of the crystal. It is apparent that the series resonant frequency is increased with an increase in the value of C_t , the limiting value being that at which

$$(16) \quad |AF| = \frac{1}{2R_1} \text{ ohms.}$$

The change in series resonant frequency given by S' , Fig. 6, is quite small, as can be seen from Equation 14. The anti-resonant frequency would be that given at S'' if the vector through AP'' were extended, and decreases with an increase in C_t . The

frequency of minimum impedance is that obtained at S''' , and the frequency of maximum impedance is that represented by the intercept of the vector through AP''' and the frequency scale.

The effect of adding another RLC chain, i.e., another crystal, in parallel with $R_1L_1C_1C_t$ can now be observed. The situation that obtains with $R_2L_2C_2$ in parallel with $R_1L_1C_1C_t$ is represented in Fig. 7.

Since, as shown in Fig. 6, F is the origin for the admittance vector for $R_1L_1C_1C_t$, the admittance vector for $R_2L_2C_2$ must be drawn to the same scale and so that its terminal point is always at F. To insure the same scale value for admittance an adjustment is made in P_2 , the radius of the admittance-impedance circle for $R_2L_2C_2$, so that the same value of s_y is obtained. This presumes that R_2 , which can be easily measured, is known. The dotted circle in Fig. 7 is the locus of all admittance vectors of $R_2L_2C_2$. The admittance vectors GF and HF are those which would make the entire circuit a pure conductance at the frequency corresponding to the reactance BS. For this arbitrary choice of frequency, which is slightly above series resonance for the $R_1L_1C_1C_t$ combination, admittance GF results in a total admittance GP, and HF in a total admittance HP.

Admittance HF is that of a crystal very near its anti-resonant peak. Admittance FP, however, is for a crystal very near series resonance so that the total resultant admittance HP is approximately the same for this crystal as was obtained in the discussion of the curves in Fig. 2. Operation such as this would not be satisfactory because the high-impedance crystal would become inductive or capacitive with a small change in frequency, and there would be no compensating reactance change in the other crystal. An unstable composite frequency would be obtained.

Admittance GP is about twice that of either crystal alone. This is analogous to the situation described in the discussion of Fig. 4, wherein the series resonant frequencies of the two crystals are very close together. In a parallel resonant oscillator with sufficient selectivity and gain to operate at this low-impedance peak rather than at the higher impedance peak encountered at a higher frequency, such a point of operation is possible. It is pointed out, however, that a combination of this type could not be operated satisfactorily in a series resonant oscillator because, even though the impedance of the combination is low, it still represents a peak of impedance and a series resonant oscillator would operate between the individual series resonant points and would be likely to jump between the two points in an erratic fashion. It is clear from the preceding discussion that if the crystals are connected in series, then series resonant oscillator operation would be appropriate.

At the frequency corresponding to the Point S' the admit-

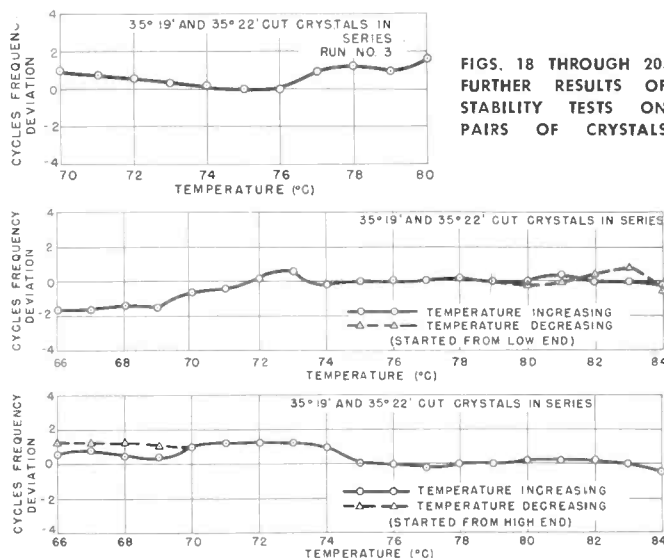

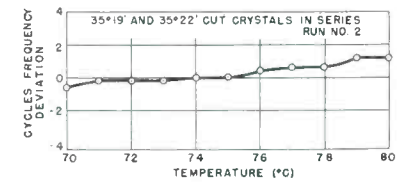
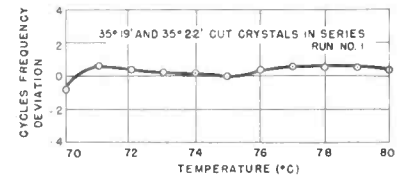
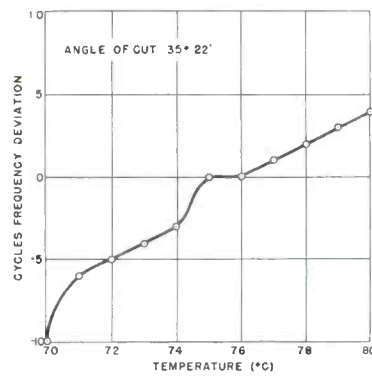
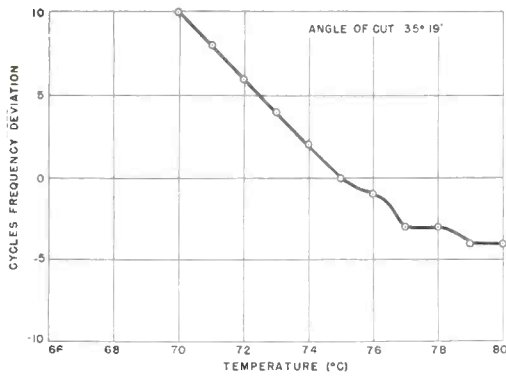

FIGS. 14 THROUGH 17. FREQUENCY STABILITY OVER LIMITED TEMPERATURE RANGE OF TWO CRYSTALS OPERATED ALONE AND AS A PAIR

tance of the first crystal unit plus the susceptance AF is represented by FP'. The same values of admittance GF and HF for the second crystal unit would again make the combination of crystals a pure conductance. The conductance values would be less than for the case just discussed; otherwise, the same remarks apply. A much more detailed discussion of these graphical methods and the relationship of the inverse points of admittance and impedance is given by Cady in the reference cited.

Temperature vs. Frequency Response: In order to determine the advantages of dual-crystal operation, a group of AT-cut crystals of the same nominal frequency (5 mc.) was selected, in which the angle of cut with respect to the Z-axis was varied from 35° 6' to 35° 27', the nominal AT cut being about 35° 18'.

This was done in order to obtain crystals possessing the proper temperature-frequency coefficients. All the temperature runs were made in a cathode-coupled type circuit, in which the crystal is operated as a low impedance. No experimental runs were made for the combination looking like a high impedance because of the nature of the oscillator circuits currently employed with the temperature-frequency testing equipment. It should be apparent, however, that parallel crystals in the appropriate circuit, i.e., one in which the crystals look like a high impedance, would perform in the same manner as the series crystals.

Figs. 8 and 9 show the temperature-*vs.*-frequency response of two crystals in this group, for which the angles of cut were 35° 6' and 35° 24', respectively. The 35° 6' crystal had an overall
Continued on page 38

Installation of Buried Cables

HOW CABLES, GROUND WIRING CAN BE BURIED EASILY—By GERALD W. LEE*

INSTALLATION of buried cables or ground systems is an extremely difficult task in rough or wet ground, unless special methods are used. In level ground that has been cultivated no difficulty is encountered; the dirt is removed with a cable plow, the wire is dropped into the trench, and the furrow is then replaced over the trench, effectively burying the wire or cable. But in ground recently cleared of heavy bush and undergrowth, or in marshy terrain, it is not such a simple matter. On recently-cleared land the plow shear either clogs up with sod or breaks on hidden tree roots, and in marshy ground the shear sinks out of sight. These circumstances necessitate different installation methods, one of which is outlined here.

Bulldozer Plow: On the site of a newly-constructed station there is usually a bulldozer available. This can be used for plowing the wire or cable into the ground in one operation. First, a plow shear or digger is built as shown in Fig. 1 and is then welded to the blade. When the blade is lowered and the bulldozer driven forward a narrow trench is dug; wire or cable is fed into the trench automatically, and the trench is filled in by the bulldozer treads as they pass over it.

The shear parts can be cut from 3/4 to 1-in. sheet steel and welded together. The bottom shoe, as Fig. 1 shows, keeps the shear from digging in too deeply, and the brace of 4 by 1-in. steel holds the shear firmly in place and supports the welds

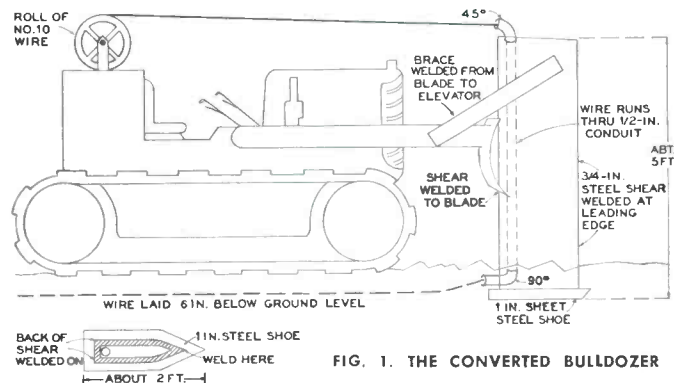

FIG. 1. THE CONVERTED BULLDOZER

fastening it to the bulldozer blade. While the shear is being fabricated a piece of conduit of the desired diameter, with a right-angle fitting on the bottom end and a 45° angle fitting on the top end, is welded inside to ensure a smooth passage of the ground wire or cable. The spool of wire is mounted on the bulldozer where it can be freely unreeled.

Recommended procedure in ground-system installation is to thread the wire through the conduit, pull the wire end out underneath the bulldozer, and anchor it to the tower base. The bulldozer is started forward, the blade is lowered gently until the shear has dug into the ground from 6 to 8 ins., and then the shift is made into high gear. Ground wire can be laid both to and from the tower, provided the system has been staked out properly so that the operator knows where to drive. After the wire radials are buried, the ground system is finished in the usual manner by soldering the radial ends to a wire ring around the tower and connecting the tower base to this ring. A load or two of earth is necessary to cover the radial ends which are too near the tower to be buried by the bulldozer.

While this method and apparatus may seem complicated and expensive, some such gimmick becomes a necessity when rough, extremely hard, or marshy ground is encountered. It will usually turn out to be less expensive and much faster than conventional methods.

*Professional Engineer, Canada House, Trafalgar Square, S. W., London, England.

Get these **7 ALL-NEW FEATURES** with **RCA UHF 2-Way Radio**

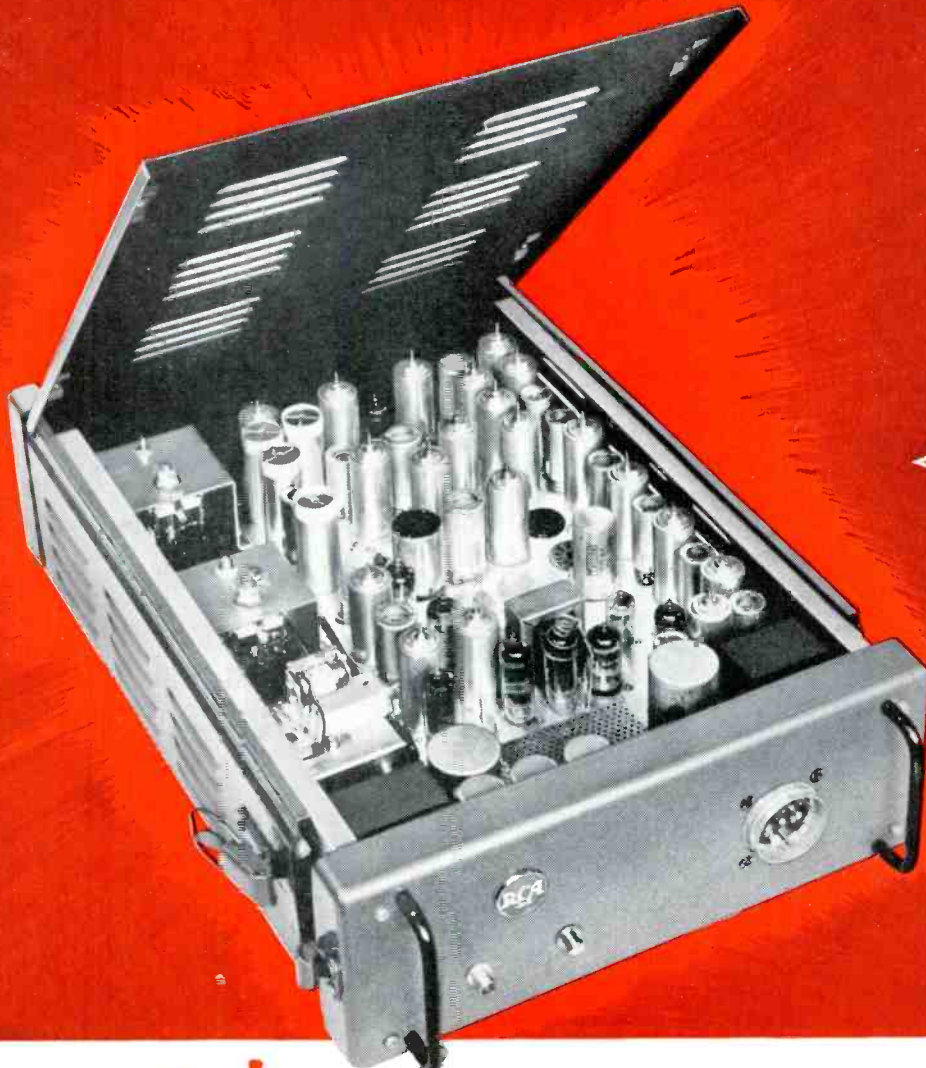

1. Low-cost tubes.
2. Improved coverage in city areas. Less noise, less absorption of signal.
3. High-efficiency power supply.
4. Optional operation on as many as four frequencies.
5. Built-in metering sockets to speed service.
6. 6-inch antenna to simplify installation.
7. "Split" drawer design for easy maintenance.

NEW

RCA



2-WAY RADIO

opens up traffic-free channels

PERMITS "UNCROWDED OPERATION"



If YOU'VE been putting off 2-way radio . . . if you're now operating on an overloaded frequency . . . here's RCA 2-way radio equipment which utilizes many new uncongested channels in the Ultra High Frequency Band, 450-470 megacycles.

NOISE-FREE RECEPTION

With RCA 2-way radio, you eliminate most man-made and natural electrical noise, cut out ignition interference and assure top performance in severe noise areas.

PROVED IN ACTUAL FIELD USE

The UHF equipment, engineered to highest RCA standards, has proved its merit in

actual field use in five important systems. The new RCA UHF equipment is ready now to help you solve your problem of channel overloading.

FOR NEW FREEDOM in radio operations check RCA Ultra High Frequency 2-way radio. MAIL COUPON NOW.

Radio Corporation of America
 Communications Equipment Dept. 132U
 Building 15-1, Camden, N. J.
 In Canada: RCA Victor Company Limited, Montreal
 Please send me information of RCA Ultra High Frequency (450-470 mc) 2-way radio.

NAME _____ TITLE _____
 COMPANY _____
 ADDRESS _____
 CITY _____ ZONE _____
 STATE _____



RADIO CORPORATION of AMERICA
 COMMUNICATIONS EQUIPMENT CAMDEN, N. J.

REMOTE STATION

(Continued from page 25)

neering, and according to proper geographic spacing. TVI is, of course, taken into account. At any rate, a strong signal was received on our newly-assigned frequency. Various attempts were made to discriminate between it and the signal received from Rutland. A mobile whip was cut to $\frac{1}{4}$ wavelength and mounted under the eaves of the building in the hope that the metal sheathing would shield it from the New Hampshire side, which is the side away from Rutland. Despite this attempt and the use of full authorized power at Rutland, it was impossible to obtain enough difference in signal levels to establish the capture effect and retain some margin of safety. Accordingly, application was made for another frequency.

The Yagi antennas lasted only a few days. One was hit by falling ice which sheared off the driven element and bent a director.

The new frequency assignment proved much better; no interference has been experienced. The mobile antenna under the eaves of the building was retained for receiving and a hurricane-model half-wave antenna was rigged for transmitting, with the top 30 ft. up the main mast and two ft. away from it. It has not thus far been damaged by ice or wind, although it may be somewhat vulnerable to falling ice.

The next difficulty with the relay equipment was occasional cutting out of the relay-controlled main transmitter. This effect was accompanied by background crackling and some distortion. It was traced to energy from the main station transmitter being picked up by the relay receiver circuits, because of the proximity of the antennas and close harmonic relationship of the two frequencies. The solution was to locate the receiving relay antenna on the side of the building in a vertical position, and to de-tune the first stages of the receiver slightly. The de-tuning was more effective for the undesired signal. These measures corrected the situation. It was found then that audio distortion, to the point of complete loss of intelligibility, could be caused by advancing the threshold control of the carrier-operated relay too far and thus overloading the squelch tube. Since these initial difficulties have been ironed out the relay link has given very satisfactory service, with a reduction in control circuit failures of about 75% from those experienced with land-line control. During the first years of operation the Pico installation cost more to maintain than all the rest of the communication system. The cost has now been reduced to little more than that of maintaining one of our low-altitude stations.



Recognized Everywhere...

L-N CUSTOM-ENGINEERED ELECTRICAL EQUIPMENT

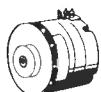

Alternator Systems

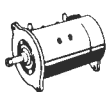

DC Generators



Regulators



Cranking Motors



Small Motors



Switches

YOU CAN
RELY ON

**Leece-
Neville**

WHEREVER YOU LIVE, you recognize this view of New York, a great city, famed for its skyscrapers. And New York recognizes the Leece-Neville Alternator... it is doing a great job there on police cars, fire equipment and all other mobile 2-way radio installations.

New York is just one of many cities where L-N Alternators are in wide use. You'll find them in San Francisco, Detroit, Montreal, Dallas, and hundreds of other places, large and small, here and abroad.

With L-N Alternators, 2-way radio operation is surer and clearer. 25 to 40 amps at curb idle, 95 amps on the highway, keeps batteries charged. Constant voltage protects components, cuts maintenance costs.

Be sure to specify L-N Alternators in place of conventional DC generators. For all the facts, write The Leece-Neville Company, Cleveland 14, Ohio.

Custom-Engineered Electric Equipment Since 1909.

L-N Alternators

proved by performance for over 7 years

The main station equipment has been subject to very few failures of a purely electronic nature. Most frequent trouble has been arc-back of the 5R4 rectifier supplying the exciter, which blows a fuse. This has been offset by installing a power supply with two parallel 5R4's, slow-blow fuses, and a 10% bucking transformer in the 120-volt AC supply. Although the radio equipment is supplied from a small induction regulator set for 120 ± 2 volts, it has been found that tube lives are greatly increased and filament burnouts virtually eliminated if this is reduced to 110 volts. It is desirable for other reasons, however, to operate the rest of the

equipment at 120 volts, and to take our chances with tubes. We are now using the new rugged-service tubes where applicable; this is expected to improve continuity of service considerably.

Relays have been relatively common causes of trouble. Little can be done to estimate when a relay finger will break due to metallic fatigue, or a dirt particle will settle in the contacts of a relay. Cleaning telephone-type relays operating normally has often caused trouble when dust, stirred up during servicing, settles later on the contacts. This trouble has been so frequent that telephone relays are

Continued on page 37

For Every Microphone Need in Two-Way Radio

SHURE

Has a "Field-Proved" Model

Here is the world's most popular fixed-station all-purpose microphone. Outstanding because of its high speech intelligibility, extended frequency range, high output and reduction of feedback. Prevents the transmission of distracting station noises.



Model 55s
"Small Unidyne"
Ultra-Cardioid
Dynamic
Microphone

This is the original "old faithful" mobile hand microphone. Used for rugged field and car duty more than all other makes combined! Features high speech intelligibility and ruggedness. Stands up under heavy use and abuse.



The
"100 Series"
Carbon
Hand-Held
Mobile
Microphone

This Controlled Reluctance Microphone Cartridge is an ideal service replacement for the Model 520SL Dispatcher and for use in special hidden microphone applications. Practically unaffected by heat and humidity.



Model R5
"Controlled Reluctance"
Microphone
Cartridge

This dispatching unit handles the most severe field requirements of paging and dispatching systems. Supplied with 2-conductor shielded cable, and wired to operate both microphone and relay circuits. Features "Grip-to-Talk, Slide-to-Lock" long-life switch.



Model 520SL
"Dispatcher"
Complete
Dispatching
Unit

Designed for use with small portable and mobile transmitters. Only 2" in diameter and 1 1/2" thick. Has 3-conductor coiled cord, metal-spring strain relief, and Push-to-Talk switch. Has same operating characteristics as "100 Series" Carbon Microphones.



Model 115
Carbon
"Pack"
Microphone

A Controlled Reluctance Microphone and desk stand assembly—ideal for mobile and fixed-station use in all types of communications work. Has a built-in switch for controlling both the microphone circuit and an external relay or control circuit.



Model 510MD
"Controlled Reluctance"
Microphone
Assembly

SHURE BROTHERS, INC.

Manufacturers of Microphones
and Acoustic Devices



225 W. Huron St. • Chicago 10, Ill.
Cable Address: SHUREMICRO

When you need

COAXIAL ANTENNAE

(46 mc to 174 mc)

Specify **WHITES** for these
4 good reasons:

1. Made of accurately machined and polished stainless steel to insure durability and corrosion resistance.
2. Readily assembled or disassembled for quick and easy cable replacement.
3. Teflon insulation for low loss.
4. Quick delivery.

Various types of clamps available for these antennae

Write for free circular containing engineering data and prices—

JAMES L. WHITE & SON

374 Verona Avenue
Newark 4, New Jersey

See Better! Work Better!

LUXO LAMP

—Acclaimed the World over
as the best light
to work under!



Brackets to Desk,
Board, Lathe, Bench,
Wall or Table
(Floor Mount also Available)

Raises, Lowers,
Tilts, Traverses, Turns
Fingertip Stay-put Control

Stainless Steel Tube Arms
Nickel Steel Tension Springs
Vented Aluminum Shade
Radius 45 Inches
Weight 4 Lbs.

Scientifically
Engineered
Ingenuously Designed
Sturdily
Constructed
Flawlessly
Finished

5
COLORS
Gray
Black
Green
Ivory
Mahogany

CONSUMERS: Ask for LUXO LAMP
at your nearest dealer's
DEALERS & JOBBERS
Line up with LUXO LAMP.
Write Today!
REPRESENTATIVES
Territories still open

Write to
LUXO LAMP CORPORATION
290 MADISON AVE., NEW YORK 17, N. Y.



REMOTE STATION

(Continued from page 35)

left alone except when it is certain that the maintenance man can observe their performance for several hours after cleaning them. Relays with larger contacts are cleaned occasionally and inspected at least every three months. A complete complement of spare relays is kept at the station.

In 1947 a State Police radio unit was installed about 150 ft. away from the CVPS station, with antennas mounted on the fire observation tower. Strong interference to the power company receiver was encountered, and field engineers from the manufacturers of both installations were called in. A filter was installed in the antenna lead of the State Police antenna on the power company frequency, and an entire receiver, much more selective than earlier models, was built and installed in our station. The interference was entirely eliminated, and later on a similar case was cleared up by installing the same shielded RF transformer used in a present-day receiver on one built in 1946. The special receiver at Pico was later replaced by a new mobile receiver converted to AC operation, which was bench-tested with its carrier-operated relay for a month.

Recommendations: On the basis of our own and others' experiences with radio-telephone stations at 4,000 ft., some conclusions have been reached as to the limitations, possible errors, and benefits to be expected by a new user contemplating such an installation. It will be assumed, first, that some reasonable means of transportation is available, such as truck, tractor, or horses. A building of tarred cinder blocks, sheathed with aluminum, clapboards, or cedar shingles would be desirable. It was found on Mt. Washington, N. H., that rain-water was forced through cement blocks by the wind pressure, with subsequent danger to equipment, as well as the risk of trapped water freezing and bursting the blocks near the ground. The building should be as near fireproof as possible, with a ceiling of asbestos tile if wood is used in the roof.

For lightning protection, the building should be placed within a 45° cone whose apex is the top of the antenna mast, but as close to the circumference of the cone as possible to avoid the effects of ice falling from the mast in winter. A fairly steep roof of corrugated iron is recommended, with a single slope away from the tower.

Unless other living facilities are available the building should provide enough space, in addition to that occupied by the radio equipment, for built-in bunks, a

Concluded on page 38

formerly *FM-TV* RADIO COMMUNICATION

LINK RADIO TRANSMITTER-RECEIVER

Type 2365 ED. 3b

**ALWAYS AN
EXCELLENT
PERFORMER —**

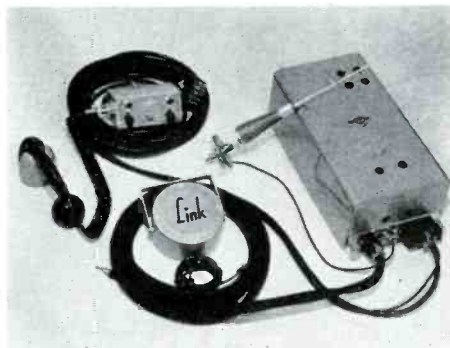
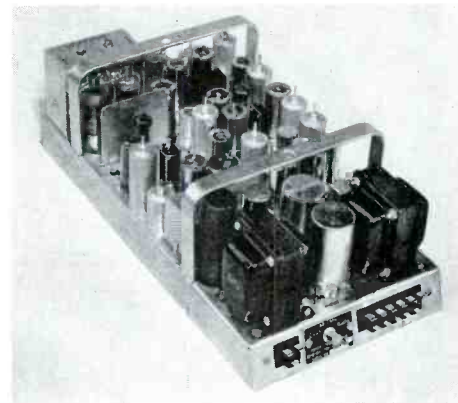

**—NOW STILL
FURTHER
IMPROVED!**

- 25 to 50 Megacycles
- More Than 30 Watts Output
- 0.4 μ V. Sensitivity for 20 db Quieting
- $\pm 0.002\%$ Frequency Stability
- Adjacent or Split Channel
(WITHOUT CHANGING MAJOR COMPONENTS)
- Universal 6/12 Volt
Heater Wiring
- New Ease of Servicing

ALSO AVAILABLE AS FIXED STATION CONSOLES

Write Now For Further Details

LINK RADIO CORPORATION

125 West 17th Street

New York 11, N. Y.

C-D and Faradon

**THE ONLY
MICA
TRANSMITTER
CAPACITORS
THAT EXCEED
JAN SPEC'S**



Cornell-Dubilier Electric Corp., So. Plainfield, N. J.

There are more C-D capacitors in use today than any other make

See your classified telephone directory for name and address of nearest C-D authorized distributor



ONSISTENTLY EPENDABLE
CORNELL-DUBILIER
CAPACITORS

PLANTS IN S. PLAINFIELD, N. J.; NEW BEDFORD, WORCESTER AND CAMBRIDGE, MASS.; PROVIDENCE, R. I.; INDIANAPOLIS, IND.; SANFORD AND FUQUAY SPRINGS, N. C.; AND SUBSIDIARY, THE RADIART CORP., CLEVELAND, OHIO

REMOTE STATION

(Continued from page 37)

heating unit, and a food supply. Storage space for tools, tackle, spare tubes, parts, and antennas may be needed, according to the accessibility of the particular station and the form of transportation used. If a stand-by power plant is to be used, as is the case with most remote installations, a separate fireproof room, leanto, or other enclosure will be needed. Fire hazard to the rest of the station is thus reduced, and the possible corrosive effects of gases during charging of the starting battery are obviated. It has not been necessary to heat our radio building when not occupied, since the 866 mercury-

vapor rectifiers formerly used have been replaced with the 3B28 high-vacuum rectifier.

With respect to the main-station antenna; a coaxial half-wave dipole appears to be the only design for the 30 to 40-mc. band which can stand up under heavy icing and wind conditions. If thick icing is anticipated, some consideration should be given to constructing an antenna with a stainless steel support pipe and whip, and with an extra heavy header assembly. Because the skirt of the antenna contributes little to the strength it may be made of aluminum or dural. The antenna must be mounted high enough to give adequate coverage but no higher, since ice formation and wind increase rapidly

with height. Where weather conditions are not very severe a ground-plane antenna with resistance heating cable has been used successfully. This form of antenna also gives good lightning protection since it is entirely at DC ground potential. A ground-plane antenna does not waste energy at angles high above the horizon, and can be mounted at a lower level than a dipole to give the same coverage. Relay antennas for short-range operation are sometimes mounted indoors, and in most cases need not be exposed to severe weather. It has been found that a copper coaxial cable to feed the main antenna was too difficult to maintain. Very satisfactory operation is obtained with flexible RG-17/U cable.

The relative difficulties of maintaining a remotely-located mountain-top station can be reduced considerably by careful planning and construction, with particular attention to the tower and antennas. These must be built with the worst weather conditions in mind, with suitable safety factors. Our mast is guyed at three levels with six guys at each level. One or two guys at one level have broken without serious danger; but if sets of three or four were used, the strain of ice and wind would almost certainly have been too great.

Adequate grounding of all equipment to an underground power cable has proved to be very effective in eliminating lightning damage. Although underground cable is desirable, in some cases power service must be supplied by overhead lines. It is a peculiarity of open-wire power lines that the end of the line is most severely affected by lightning surges, so all possible protection will be needed if open wire is used.

Finally, electronic equipment should be the best available, operated conservatively, and given regular preventative maintenance. Since the failure of a relay or tube in a remotely-controlled station can put the transmitter on the air, a means must be provided for shutting down the station, either automatically or by remote control. One well-engineered mountain-top station will provide excellent service and reduce substantially the cost of covering the same territory with several lower-powered transmitters in more accessible installations.

DUAL CRYSTALS

(Continued from page 33)

frequency deviation of about 0.01% over the range from -30 to +90°C. when operated singly, and the 35° 24' crystal also had an overall deviation of about 0.01%. The overall frequency deviation for the two crystals in series was about 0.002%, or approximately five times better than either crystal alone, Fig. 10.

It should be noted that under current

military specifications for allowable frequency deviation, each of the individual crystal units would have been rejected.

Figs. 11 and 12 represent temperature-frequency characteristics of crystals cut at $35^{\circ} 6'$ and $35^{\circ} 27'$, respectively. The overall frequency deviation for the $35^{\circ} 6'$ crystal was a little more than 0.01% over -30 to $+90^{\circ}\text{C.}$ range and the overall deviation for the $35^{\circ} 27'$ crystal was of the same order. The overall deviation for the two in series, Fig. 13, is about 0.0015%, which is an improvement of about seven times. These crystals also would have been rejected separately.

The entire group of crystals was tested over the temperature range from $+70$ to $+80^{\circ}\text{C.}$, which is a restricted temperature range often stipulated in procurement specifications, in order to find crystals which could be paired to give cancellation of temperature coefficients. Figs. 14 and 15 show the frequency vs. temperature characteristics of two such crystals. The overall deviation for both crystals is 14 cycles over the restricted range, or 0.00028% of the nominal 5-mc. frequency. Figs. 16 through 18 show the results for three repeated runs over the 70 to 80°C. range, with the crystals in series operating as a low impedance in a series-resonant circuit. Fig. 19 reveals the result when the temperature was brought up from below 70° through 80°C. and then reversed. Fig. 20 shows the result when the crystals were raised to higher temperatures than 80°C. , then brought down in temperature through 70°C. and then reversed. It can be seen that for the worst case the deviation was only about 1.8 cycles from 70° to 80°C. , or 0.000036%. This is an improvement of about eight times over that of either crystal alone. It can be seen also that the general shape of the curves is not maintained from one run to another. This indicates that the small frequency deviations obtained could very well be due to oscillator circuit changes or to interpolation oscillator short-term deviations. It is felt that the actual gain realized is much more than that indicated, the crystal fluctuations being much less than that of the circuit itself and of the interpolation oscillator.

Conclusions: According to the theoretical and experimental data, it is clear that significant improvements in frequency stability can be realized by the use of quartz-crystal combinations. A crystal unit can be obtained in this way which is five to seven times better, over the temperature range of -30 to $+90^{\circ}\text{C.}$, than the production crystals making up the unit.

Such crystal combinations could be considered seriously as possible substitutes for precision crystal units used as secondary standards. In the event of a critical quartz shortage, this method provides a means of salvaging oscillator plates

Concluded on page 41

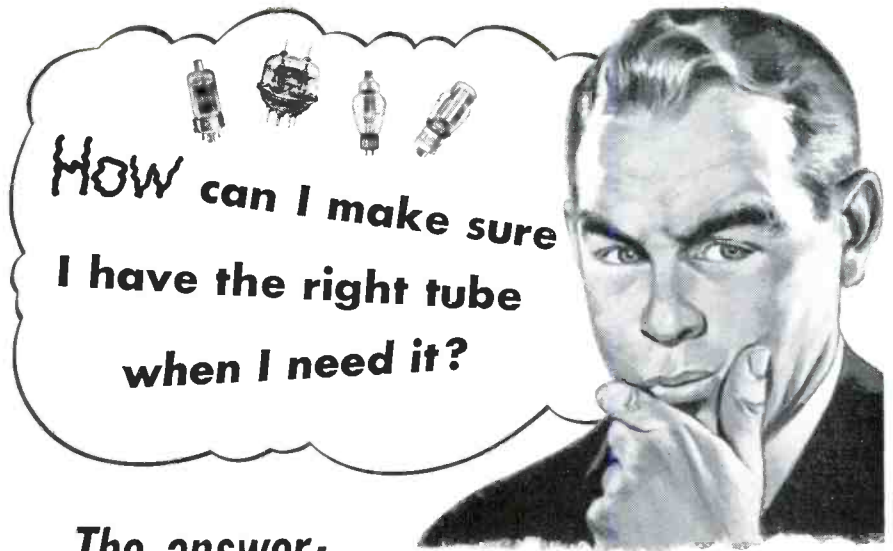

The answer:

RCA's new Tube Requirement Analysis!

Now you can stop worrying about the possibility of communications equipment shut-down—in the event you have neglected to reorder a key tube type. Now you can also save money by avoiding “overstocks.” RCA's new Tube Requirement Analysis gives you smooth control over your communications equipment tube requirements.

Get in touch with your RCA Tube Distributor



----- Give him all the information you can about your electronic equipment, the tube types involved, and your special requirements. In this way, you bring him up to date on the services in which your tubes are operated.

He analyzes your needs



----- Then your RCA Tube Distributor can prepare a record of movement on each tube type required for your communications equipment—can study *your* specific tube requirements.

He recommends a plan for YOU

Now, your RCA Tube Distributor presents a tube inventory plan—simplified and “tailored” specifically to your operations. He keeps up to date on your inventory . . . and backs it up with inventory service on his end, too! No overstocking. No shortages. Yet you can be sure you have the right tube—when you need it!

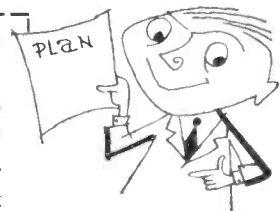

RCA's new Tube Requirement Analysis is available exclusively through your local RCA Tube Distributor. Call or write him, today. There is no charge or obligation for this service.



RADIO CORPORATION of AMERICA
ELECTRON TUBES

HARRISON, N. J.



24 HOUR
DELIVERY
FROM STOCK!

RELAYS

Our stock of more than a million relays — in over a thousand different types — is the world's largest. Don't delay your production for want of large or small quantities of relays of any type.

Telephone, wire or write for quotations.

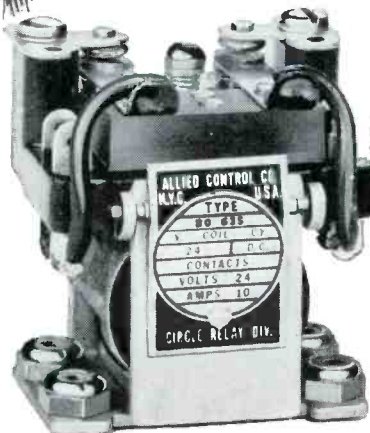

NEW AND MORE
COMPREHENSIVE
1953
RELAY SALES
CATALOG
NOW READY

Be sure to send
for your copy

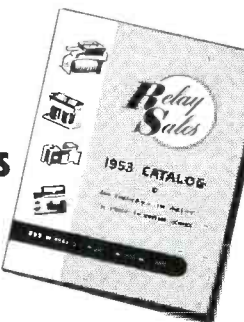

Telephone
SEeley 8-4146
833 W. CHICAGO AVE.
DEPT. 12, CHICAGO 22, ILL.

Simplifying HF Power Measurement

Model 67 **TERMALINE** DIRECT-READING R-F WATTMETER

30 mc to 500 mc
(to 1000 mc if specified)

50 ohms

Triple Range 0-25 watts

0-100 "

0-500 "

Type N Input Connector
(Adaptor for PL-259 supplied)



NON-RADIATING

... Accuracy — 5%

RUGGED CONSTRUCTION

... Size — 17" x 9" x 6"
Wght. — 30 pounds



BIRD
ELECTRONIC CORP.
1800 EAST 38TH ST., CLEVELAND 14, OHIO
TERMALINE Coaxial Line Instruments

NEELY
ENTERPRISES
Hollywood • San Francisco
Albuquerque
EARL LIPSCOMB
ASSOCIATES
Dallas • Houston

Wide Band **UNIVERTER**

for complete
frequency coverage

when used with the
FM-AM SIGNAL GENERATOR



The **UNIVERTER Type 207-A** provides a continuous extension of the frequency range of the 202-B FM-AM Signal Generator down to 0.1 mc. The two instruments may be used over a continuous frequency range of 0.1 mc. to 216 mc. The Univerter Type 207-A subtracts 150 mc. from a signal obtained from the 202-B and provides outputs between 0.1 mc. and 55 mc. without change of signal level. Negligible spurious signals are introduced and modulation of the signal is unaffected. Small incremental changes can be made in frequency to allow the study of band pass characteristics of very narrow band receivers. A regulated power supply prevents change of gain or frequency with line voltage.

SPECIFICATIONS (When used with 202-B)

FREQUENCY RANGE: 0.1 mc. to 55 mc. (0.3 mc. to 55 mc. with 200 kc. carrier deviation).

FREQUENCY INCREMENT DIAL: Plus or minus 300 kc. calibrated in 5 kc. increments.

FREQUENCY RESPONSE: Flat within ± 1 db over frequency range.

FREQUENCY ADJUST: Front panel control allows calibration with 202-B output.

OUTPUT: Continuously variable, at X1 jack from 0.1 microvolt to 0.1 volt across 53 ohms by use of 202-B attenuator.

HIGH OUTPUT: Uncalibrated approximately 1.5 volts from 330 ohms into open circuit.

DISTORTION: No appreciable FM distortion at any level. No appreciable AM distortion at carrier levels below 0.05 volt and modulation of 50%.

SPURIOUS RF OUTPUT: At least 30 db down at input levels less than 0.05 volts.

Write for complete information

BOONTON RADIO
CORPORATION
BOONTON • N.J. • U.S.A.

DUAL CRYSTALS

(Continued from page 39)

which would be rejected on the basis of excessive frequency shift with temperature.

Acknowledgments: We wish to thank the Hunt Corporation of Carlisle, Pennsylvania, for their materials and cooperation in regard to crystal combinations. They were responsible for giving the investigation renewed impetus.

TAXI SYSTEM

(Continued from page 21)

cheaper to replace than other types, such as lighthouse tubes, and service records show an average life in this installation of approximately 5,000 hours; this is 5 times better than would have been acceptable.

Even if no trouble occurs in a taxi radio, it is brought to the radio shop every 6 to 8 weeks for a routine check of frequency, power output, and other performance qualities. Experience indicates that this maintenance period apparently can be further increased without service degradation.

Conclusion: Since the system has now been in operation for better than 1½ years, it is possible to evaluate results not only from a radio performance standpoint but on a business basis as well. Needless to say, a decrease in dead mileage and a general increase in efficiency was inevitable as a result of radio dispatching. It is also interesting to note a definite increase in business volume due to other factors indirectly resulting from the use of radio. Checker is gaining back customers from smaller radio-equipped competitors. They are also gaining new customers because of the more rapid servicing of calls. In addition, business is increasing in the fringe areas of the city, including zones 2, 6, 7, and 8. This can only be attributed to the fact that previously, cab drivers always avoided these areas, since cruising pick-ups were infrequent; but with radio they can handle service calls in the city outskirts at a constantly increasing rate. The mere availability of cabs in these areas automatically produces new business.

It should also be stated that this system became a possibility only through the combined efforts of the Checker Cab Company and the Link Radio Corporation. Mr. Carl H. Anderson, president of Checker Cab, and his associates contributed not a little in the form of practical suggestions from an operating standpoint. This made possible the thorough analysis of their problems, the solution of which resulted in a superior radio dispatching system tailored to handle efficiently the high traffic density involved.

formerly *FM-TV* RADIO COMMUNICATION

Stable I.F. Tuning...

means peak response at center frequency always!



Change the bandwidth without de-tuning when you operate an "SP-600-JX" Communications Receiver

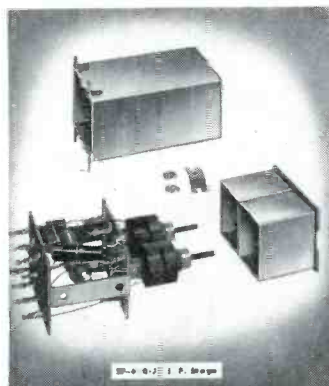

Newest techniques in the art of receiver design and engineering are incorporated into the "SP-600-JX" to make it outstanding in quality and unexcelled in performance. Regardless of your past experience as a radio operator, amateur, or short-wave listener, you will be impressed by the superlative advantages of the "SP-600-JX"

The aim at perfection in engineering and manufacture of the "SP-600-JX" has yielded a design which permits selection of any of six bandwidths (0.2, 0.5, 1.3, 3, 8, and 13 kc) with no de-tuning from center frequency.

Furthermore, these I. F. stages are so stable that once set at the factory, they are unlikely to ever need re-alignment again. Even a change of I. F. tubes has no effect upon alignment of this superior receiver.

Write to the Hammarlund Manufacturing Company, Inc., 460 West 34th St., New York 1, N. Y. for more details on the SP-600-JX. Ask for Bulletin 116.

Hammarlund introduces the new "HQ-140-X"! This medium priced receiver, which was previewed at the recent IRE Show, is a professional type receiver for amateur operators and short-wave listeners. It incorporates all the features that have made "HQ's" famous, along with the most recent advances in the art of receiver design. For detailed information ask for Bulletin 117.



HAMMARLUND

WHY SETTLE FOR LESS THAN THE BEST?



Model 30-TRM-31

PLATT 2-WAY MOBILE RADIO GIVES YOU THE

MOST ADVANCED EQUIPMENT

- ★ **COMPACT**—Transmitter & Receiver mounted on single chassis under one cover with vibrator power supply affording 30 watts of R-F output in 152-174 mc band.
- ★ **DEPENDABLE**—field tests prove its superiority; satisfied users praise its unmatched reception even in fringe areas.
- ★ **EASIEST INSTALLATION**—only one short cable and antenna assembly required.
- ★ **GREATER SAVINGS**—in first cost and maintenance.
- ★ **GUARANTEED**—for 90 days against defective materials and workmanship.

GET ALL THE FACTS—WRITE FOR YOUR LITERATURE TODAY!

PLATT Manufacturing Corp., 489 BROOME ST., N. Y. 13, N. Y.

TELEPHONE: WORTH 4-0827

WESTERN ELECTRIC

Tubes

Available From Stock

2C51	4.25	373A	4.75
101D	1.39	374A	4.25
101F	1.39	393A	9.75
101L75	394A	3.75
102F	1.39	396A/2C51	4.25
102L	1.39	403A	3.25
104D	1.39	403B	3.50
244A	5.50	404A	11.95
310A	4.75	406A	P.U.R.
310B	6.75	407A	4.75
311A	4.75	408A	2.75
311B	5.75	412A	3.50
336A	4.25	416A	P.U.R.
337A	4.50	417A	11.95
349A	6.75	418A	9.75
350B	6.75	421A	8.50
351A	7.75	422A	6.50

Calvert Electronics INCORPORATED

59 FOURTH AVE., NEW YORK 3, N. Y.
OREGON 4-3027

Links fundamental theory and overall system practice

ULTRA HIGH FREQUENCY PROPAGATION

By H. R. REED, and C. M. RUSSELL, U. S. Naval Air Test Center, Patuxent River, Md.

THIS book presents new data on latest developments and experiments and provides a full understanding of such critical factors as: reflection, diffraction, turbulence, directivity and divergence. It shows the way to a closer approach to ideal installation practice and points up maintenance problems.

Contents:
An introduction to UHF Communications and the System Concept. General Aspects of Propagation. Meteorological Theory. Antennas and Radiation Phenomena (Ground Reflection Behavior). Multipath Propagation. Comparison of VHF and UHF Propagation. Dipole to Dipole. Complex Antennas (Linear Arrays), Complex Antennas (Circularly Polarized Antennas). System Comparison, Operation, and Design of UHF Complex Antennas. Air-to-Air Propagation. Lobe Modulation Interference and Design Considerations. Effects of Meteorological Conditions on Experimental Flight Data. General Operational Considerations. Illustrative System Design Problems. Index.

Send today for your on-approval copy
1953

562 pages
286 illus.
\$9.50

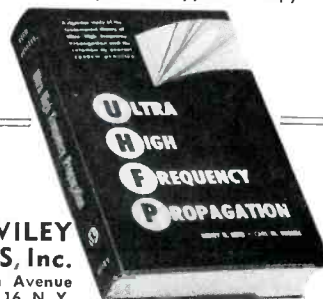

**JOHN WILEY
& SONS, Inc.**
440 Fourth Avenue
New York 16, N. Y.

FCC PHILOSOPHY

(Continued from page 29)

and the transmission of single short messages. Today it is for calling and distress only. It should be pointed out that, in every case, the rules apply equally to the existing licensees and to the late-comers. If it is necessary to restrict the activities of the existing licensees to make room for new-comers, that must be done. If the rules may be relaxed, they are relaxed for all.

Mention has been made of the procedure used in allotting frequencies to industrial groups. It might seem, at first glance, that the allocations are unduly specialized. For example, the highway trucks, the buses, and the taxicabs could all be grouped in the land transportation allotment. Similarly, the fire departments, water departments, police departments, and other like services could be grouped in a public safety allotment. As a matter of fact, the latter was actually proposed during the course of one of the allocation proceedings. However, it was pointed out that if sharing is required, it is much more satisfactory from the point of view of the operators to share with others in a like business. It was felt that, in the case of communications problems resulting from sharings, it would be much easier to reach a satisfactory agreement if those involved speak the same language, encounter the same problems, and have a mutual appreciation of the dilemma in which each found himself. In some competitive industries, feelings were expressed that call-pirating would result, in spite of the Communications Act, if competing industries in the same locality shared the same frequency, as is the case in the taxicab service. This may have occurred. However, experience through the years indicates that such practices die out automatically. For example, the taxicab system that pirates calls of another finds that it loses as many calls as it gains, since piracy results in reprisal. In addition, such cabs have found that piracy builds up customer resistance since a customer calling for a "Fresh Air Cab" is disturbed when a "Smoke Filled Room Cab" answers the call.

In the microwave point-to-point service there is a probability that, contrary to the practice in the mobile fields, allocation of frequencies to separate industrial groups will not be made. Systems of this kind are essentially of a type that require interference-free operation since the operation is a continuous carrier, and multiplex systems are used to derive a number of communication channels over one radio-frequency assignment. There is and will undoubtedly continue to be a sharing of identical frequencies by sys-

Continued on page 43

FCC PHILOSOPHY

(Continued from page 42)

tems of this kind in single geographical areas. To solve this apparent impasse, it is necessary to achieve interference-free operation through excellence of engineering design and the maintenance of high standards of engineering and operation. For this reason, the emphasis in the rules will have to be on system design and operation, rather than on what industrial group uses the system.

As stated previously, the Commission's Rules provide those technical standards necessary for the various safety and special radio services to share a limited frequency spectrum. In the broadcast field, there is an additional consideration not present in either the common carrier or industrial fields. That is in relation to the business of broadcasting, the Commission is in a sense the representative of the general public. A broadcast station is granted a franchise, through its license, upon the assurance that it will serve directly a particular segment of the public in a specified geographical area. Sharing patterns among broadcast stations are so established that if prescribed powers and specified antennas are used, one segment of the public and none other will be served by a particular broadcast station. If a broadcast station operates with less power than prescribed, it fails to serve its public, and does not carry out the obligations of the licensee; if it is operated with more than the specified power, it interferes with the ability of other broadcasters to carry out their responsibilities. For this reason, in the broadcast service technical standards must be more detailed and more complete than in other services, and each application for new facilities must be given individual attention and study.

In the case of the common carrier service, if, for example, a station is licensed to transmit from New York to London with 80 kw. of power, and with a high-gain directional antenna, it is not required to use full power when communications conditions are good and all messages can be handled with requisite speed at much less power. However, the sharing pattern on that frequency is so adjusted that in case of necessity the point-to-point station can use 80 kw. without destroying the service rendered by some other similar user else in the world.

Generally speaking, in the safety and special services the standards are much like those described as applying to the common carrier. Maximum limits are set, and the licensee is permitted to use only what is necessary to accomplish his end, provided the limits are not exceeded. The sharing pattern is designed so that if

Continued on page 44

THE 10-MEGACYCLE SCOPE

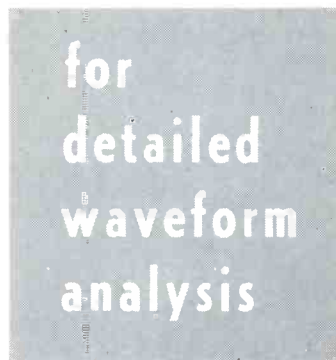

model **OL-23**

- Expansion of any image detail is possible up to the maximum writing rate of the 'scope.
- AND the sweep maintains its accurate calibration independent of the degree of expansion.

REALLY IMPORTANT
image expansion
by means of stable
SWEEP DELAY

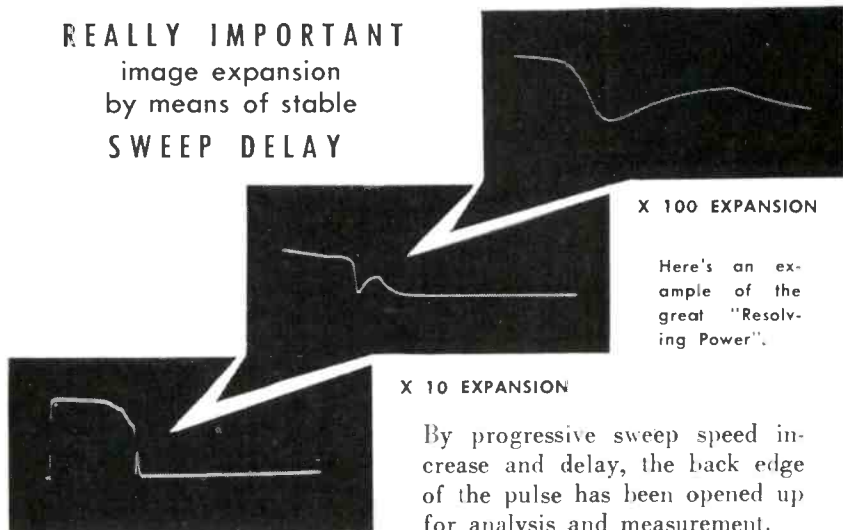

X 100 EXPANSION

Here's an example of the great "Resolving Power".

X 10 EXPANSION

By progressive sweep speed increase and delay, the back edge of the pulse has been opened up for analysis and measurement.

NORMAL PRESENTATION

"Sweep-Lok" synchronization

- easy to set - locks in and stays locked over broad ranges

SPECIFICATIONS

- 5 cycle to 10 mc vertical amplifier with signal delay line — .035 μ sec rise time
- Accurately calibrated triggered or recurrent sweeps 0.1 μ sec/cm to .011 sec/cm
- Vertical calibration voltage variable to 100 peak-to-peak
- Built-in trigger generator with positive and negative outputs
- Continuously variable sweep delays up to 10,000 μ sec without jitter

- 4000 volts accelerating potential on 5YP tube for bright, clear, trace
- Interior designed for accessibility and ruggedness, the exterior for that "Professional Appearance"

MODEL OL-23
OSCILLOSYNCHROSCOPE

\$890.00

f.o.b. Winchester



BROWNING
Laboratories, Inc.
Winchester, Mass.
ENGINEERED FOR ENGINEERS

Write for descriptive literature

the most widely
used Electronic
Supply Guide

free
send for it

ALLIED'S
COMPLETE 268-PAGE
1954 CATALOG

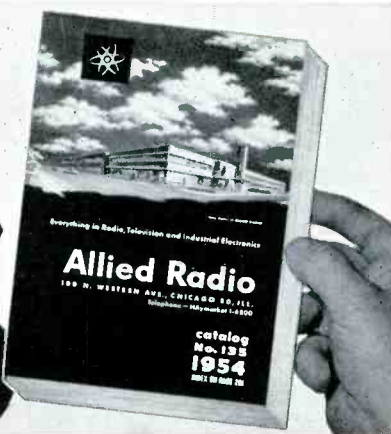

the World's Largest Stocks of

ELECTRONIC SUPPLIES FOR INDUSTRY

We specialize in
Electronic
Equipment
for Research,
Development,
Maintenance
and Production
Operations

COMPLETE EXPERT
Industrial Service

Simplify the purchasing of *all* your electronic supplies and equipment. Send your orders to us at ALLIED—the reliable one-supply-source for *all* your electronic needs. Depend on us for quick shipment from the world's largest stocks of special-purpose electron tubes, test instruments, audio equipment, electronic parts (transformers, capacitors, controls, etc.) and accessories—everything for industrial and communications application. We make immediate shipment from complete quality lines that are *always in stock*. Send today for your FREE copy of the 1954 ALLIED Catalog—the complete up-to-date guide to the world's largest stocks of Electronic Supplies for Industrial and Broadcast use.

One complete
dependable source
for everything
in electronics

ALLIED RADIO CORP.

100 N. Western Ave., Dept. 20-J-3
Chicago 80, Illinois

SEND FOR
FREE
CATALOG



now...
RESINITE brings you the
HIGHEST RESISTIVITY of any
RESINATED PRODUCT

Resinite Coil Forms are laboratory tested and field proven. Their operating characteristics — volume resistivity . . . power factor . . . thermal properties . . . low moisture absorption . . . and resistance to voltage breakdown—represent a new achievement in basic components for electronic application.

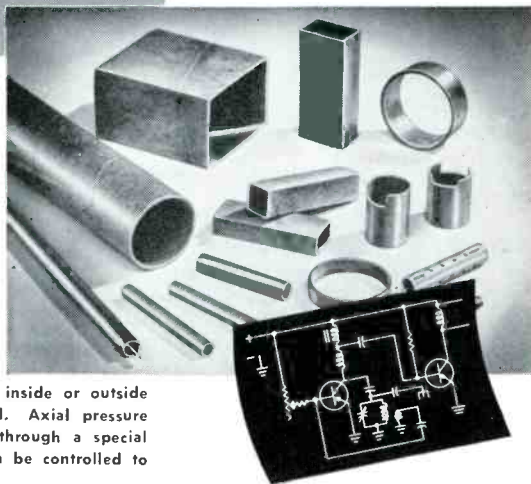

Resinite Coil Forms are available with inside or outside threads, slotted, punched or embossed. Axial pressure in excess of 25 lbs. is accomplished through a special three row threaded design. Torque can be controlled to + or -1 in. oz.

SEND TODAY FOR FULL DETAILS AND TECHNICAL INFORMATION.

RESINITE CORPORATION
DIVISION OF PRECISION PAPER TUBE

2035A W. CHARLESTON ST., CHICAGO 47, ILL.
79 CHAPEL ST., HARTFORD, CONN.

RESINITE 8104: for coil forms requiring very high dielectric properties under extreme humidity.
RESINITE "AC": for applications requiring very high dielectric strength. Electrolytic corrosion is impossible.
RESINITE 104: for stapling, severe forming, fabricating.

FCC PHILOSOPHY

(Continued from page 43)

the maximum limits are not exceeded, the plan of sharing can be worked out successfully in practice. In a few cases in the safety services, such as coastal and airdrome control stations, additional limits are prescribed since in these cases, as in broadcasting, the FCC has a special responsibility to the general public. For example, the airdrome control station is licensed for specified power and specified hours of operation. Airmen plan their flights relying upon the published schedule of that station for communication service, and if the schedule is not maintained an airman may find himself in trouble for lack of a communication service he expected to find available.

Although in general rules of the Safety and Special Radio Services prescribe only limits, in the microwave point-to-point system there is a possibility that the technical standards will be as detailed if not more detailed than those applied to broadcast stations.

In every case and in every service, over-regulation is undesirable. Only those standards should be adopted which are required to insure the rendition of the service by the licensees in the manner contemplated by the rules and regulations, and on the basis of the representation made by the licensee in his application.

Suggestions have often been made that the policy of making service allocations is wrong; that the Commission should study every individual community to insure that maximum use of radio is made in that community. This proposition seems to be very attractive at first glance, particularly when it is considered that there are very few users or potential users in many of the sparsely settled parts of the country. It may be that in those sparsely-settled areas licensees might be authorized to use radio in fields not permitted in the more congested areas. For example, in the City of Washington, it is impossible to provide frequencies for oil burner service men to use for their own purposes. Such organizations are required to obtain radio service from common carrier radio facilities. However, there are many small towns in the Midwest where there are very few if any industrial services. So, from a physical point of view, the oil burner service man in such towns might have a frequency. Unfortunately, this does not work in practice since the oil burner man in the small town does not seem to want a radio system. In general, if the communications needs of the congested areas can be solved, the communications problems of less congested areas have been solved also.

Continued on page 46

INDEX OF ADVERTISERS

Adair, George P.	15
Washington, D. C.: Executive 3-1230	
Alden Products Company	46
Brockton, Mass.: Brockton 160	
Allied Radio Corp.	44
Chicago, Ill.: Haymarket 1-6800	
American Phenolic Corp.	14
Chicago: Bishop 2-1000	
Andrew Corp.	5
Chicago: Triangle 4-4400	
Antenna Specialists	14
Cleveland, Ohio: Randolph 1-9575	
Audio Products Corp.	47
Los Angeles, Calif.: Rockwell 9-1196	
Berndt-Bach, Inc.	15
Los Angeles, Cal.: York 8294 (Webster 8-6963)	
Bird Electronic Corp.	40
Cleveland, Ohio: Express 1-3535	
Bliley Electric Company	2
Erie, Pa.: Erie 2-2287	
Boonton Radio Corp.	40
Boonton, N. J.: Boonton 8-3200	
Browning Laboratories, Inc.	43
Winchester, Mass.: Winchester 6-3700	
Calvert Electronics, Inc.	42
New York, N. Y.: Oregon 4-3027	
Carter Motor Company	46
Chicago: Humboldt 6-1289	
Cannon Electric Company	12
Los Angeles, Calif.: Capitol 5-1251	
Communications Company, Inc.	48
Coral Gables, Fla.: Coral Gables 4-0846	
Communications Engineering Co.	14
Dallas, Texas: PR 7508	
Cornell-Dubilier Electric Corp.	38
South Plainfield, N. J.: Plainfield 6-9000	
Eitel-McCullough, Inc.	16
San Bruno, Cal.: Juno 8-1212	
Electro Products Labs	8
Chicago, Ill.: Uptown 8-1141	
General Apparatus Corp.	47
Gt. Barrington, Mass.	
Hammarlund Mfg. Co., Inc.	41
New York, N. Y.: Longacre 5-1300	
Hickok Elect. Inst. Company Inside Back Cover	
Cleveland, Ohio: Liberty 1-8060	
Hughes Research & Dev. Labs.	45
Los Angeles, Calif.: Texas 0-7111	
James Knights Co.	10
Sandwich, Ill.: Sandwich 2141	
Jansky & Bailey	15
Washington, D. C.: Me 8-5411	
Jones, Howard B., Division	48
Chicago: Nevada 2-2000	
Kaar Engineering Co.	6
Palo Alto, Calif.: Davenport 3-9001	
Kear & Kennedy	15
Washington, D. C.: Hudson 3-9000	
Leece-Neville Company	35
Cleveland, Ohio: Henderson 1-0740	
Lenkurt Electric Company, Inc.	13
San Carlos, Calif.: Lytell 3-2161	
Link Radio Corp.	37
New York, N. Y.: Chelsea 2-1100	
Luxo Lamp Corp.	36
New York City: Murray Hill 3-7825	
Master Mobile Mounts, Inc.	48
Los Angeles, Calif.: York 5221	
Maurer, Inc., J. A.	15
Long Island City, N. Y.: Stillwell 4-4601	
May, Russell P.	15
Washington, D. C.: Republic 3984	
McIntosh, Frank H.	14
Washington, D. C.: ME 8-4477	
Measurements Corp.	15
Boonton, N. J.: Boonton 8-2131	
Motorola, Inc. Back Cover	
Chicago: Spaulding 2-6500	
Philco Corp.	1
Philadelphia, Pa.: Tennessee 9-4000	
Platt Manufacturing Corp.	42
New York City: Worth 4-0827	
Pye, Limited	7
Cambridge, England	
Radiart Corp.	3
Cleveland, Ohio: Melrose 1-6660	
Radio Apparatus Corp.	11
Indianapolis, Ind.: Franklin 1052	
Radio Corp. of America (Eng. Products)	9, 34
Camden, N. J.: Woodlawn 3-8000	
Radio Corp. of America (Tubes)	39
Harrison, N. J.: Harrison 6-8000	
Radio Engineering Labs	4
Long Island City, N. Y.: Stillwell 6-2101	
Relay Sales Company	40
Chicago: Seeley 8-4143	
Resinite Corp.	44
Chicago, Ill.: Armitage 6-5200	
Rohn Manufacturing Co.	48
Peoria, Ill.: Peoria 4-9156	
Shure Bros.	36
Chicago: Delaware 7-4450	
John D. Trilsch Company	14
Houston, Texas: Atwood 9351	
U. S. Motors Corp. Inside Front Cover	
Oshkosh, Wis.	
Weldon & Carr	15
Washington, D. C.: Michigan 4151	
James L. White & Son	36
Newark, N. J.	
John Wiley & Sons	42
New York City: Murray Hill 9-7630	
Workshop Associates, Div. of Gabriel Co.	15
Norwood, Mass.: Norwood 7-3300	

Communication Engineers

with
experience
in
the
fields
of

**Systems
Engineering**

**Information
Theory**

**Circuit
Development**

**Electro-
mechanical
Development**

**Equipment
Engineering**

THE COMPANY

Hughes Research and Development Laboratories, located in Southern California, form one of the nation's leading electronics organizations. The personnel are presently engaged in the development and production of advanced electronics systems and devices.

AREAS OF WORK

The communication group is concerned with the design and development of unique radio communication systems and with exploiting new radio communication techniques. Specialists in propagation phenomena, antenna sys-

tems, network theory, magnetic recording, wide-band amplification, and intricate electromechanical devices are active in this program.

THE FUTURE

Engineers who enjoy a variety of problems requiring originality and ingenuity find the proper environment for personal advancement in these activity areas. Widespread future application of advanced communication techniques will enable the Hughes engineer to take full advantage of his experience as the Company expands commercially.

Advancements in the fields of wave propagation, translation of information, communication theory, circuit techniques and equipment miniaturization have created a number of new openings for qualified engineers in the Hughes Advanced Electronics Laboratory.

How to apply

Write today, giving details of qualifications and experience. Assurance is required that relocation of the applicant will not cause disruption of an urgent military project.

Hughes

RESEARCH AND DEVELOPMENT LABORATORIES

Scientific
and
Engineering
Staff

CULVER CITY,
LOS ANGELES
COUNTY,
CALIFORNIA

From Alden's Line of Ready-made Components for Unitized Plug-in Unit Construction:

Miniature Sensing and Indicating Components by

ALDEN

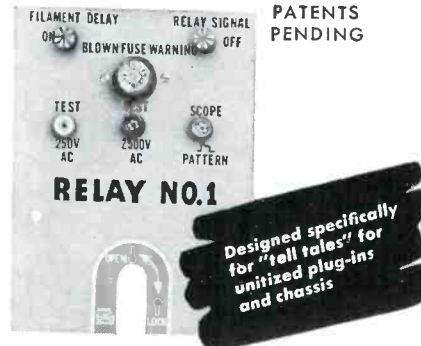

PATENTS PENDING

Designed specifically for "tell tales" for unitized plug-ins and chassis

The new trend to unitized plug-in construction calls for tiny sensing and monitoring devices to act as "telltals" when trouble occurs. Device must be rugged, yet take a minimum of panel space. Here are latest in Alden Series to meet this problem.

ALDEN "PAN-i-LITE"

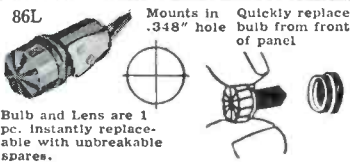

86L Mounts in .348" hole. Quickly replace bulb from front of panel. Bulb and Lens are 1 pc. Instantly replaceable with unbreakable spares.

You can use this new tiny Alden Pan-i-Lite indicator where never before possible. Easily serviced one-piece lens-bulb replaceable from front of panel. Mounts simply by pushing into .348" hole. Gives beautiful indication; glows like a red hot poker. Tiny spares can always be kept ready in kit or taped in recess of equipment. Available in 6V, 12V and 28V, various colors.

ALDEN "FUSELITE"

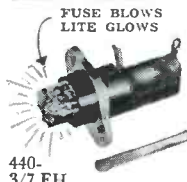

440-3/7 FH to each unitized circuit. Available for 28V, 110V and 250V.

Spot trouble instantly. Neon indicator light in lens glows when fuse blows. One-piece molded lens-and-indicator-lite unscrews from front of panel. Ideal for monitoring power

ALDEN TEST POINT JACK

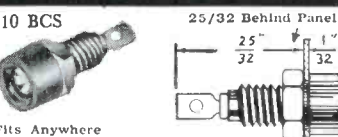

110 BCS 25/32 Behind Panel. Fits Anywhere. Takes Up to 8,000V. Provides a quick front panel check point for any circuit voltages in your equipment. This tiny Jack fits .257" hole and takes only 25/32" behind panel. Beryllium copper contact withstands hundreds of insertions. Phenolic or nylon insulation, many colors.

SEND FOR FREE SAMPLES

— also request free "Alden Handbook" 226 pages of techniques and components for Unitized Plug-in Unit Construction.



143 N. Main St., Brockton 64, Mass.

FCC PHILOSOPHY

(Continued from page 44)

There is another objection to this method of treatment. Suppose that, in the city of New York, Industry A feels that it needs additional communication facilities so it looks over the field and finds that the frequency assigned to Industry B is not in use in that area. Thereupon, Industry A applies for that frequency. The minute his application appears, Industry C says, "Wait a minute, if another frequency is available in New York, we need it much more than Industry A." On top of that, Industry B protests: "While it is true we are not in New York now, we expect to be there next year." The end result would be all the industries down the alphabet, including XYZ, would get into the argument over the question as to who gets what frequency. The Commission would then be faced with a frequency allocation hearing on the New York problem alone. Further, no such allocation proceedings could, as a practical matter, be restricted to any locality. Since radio knows no boundaries, what is done in one locality affects other areas. If you try to allot frequencies in New York City, you would certainly have to take in greater New York. What you do in greater New York would effect what you do in Philadelphia. What you do in Philadelphia would affect what you do in Baltimore, and what started as a study of the New York problem would end as a restudy of the national problem. For these reasons, it appears best to retain the course now charted, and to continue service allocations.

Finally, the situation described has a major affect upon the nature of the staff of the Commission and its activities. The issuance of licenses in the Safety and Special Radio Services should become a routine task if the allocation of frequencies are reasonable, if the rules and regulations are intelligently conceived and well understood, and if the Commission's forms are appropriate to the service requirements. If these forms are filled in correctly by an applicant, the comparison of the application with the norm is a simple task, and the issuance of authorization in such cases is reduced almost to a mechanical operation. It is because of this fact that it is possible to process applications in some of these special services at an average rate of one every fifteen minutes or less, and still give adequate consideration to each. If on the other hand, the Commission's planning is inadequate, and the needs of industry are not understood and met by reasonable regulations and adequate forms, there will be a constant stream of irregular applications requiring individual

Concluded on page 48

The NEW

Custom
DC-AC CONVERTER
by *Carter*



Delivers MORE Power for PROFESSIONAL Use

These latest-of-all Carter DC to AC Converters are specially engineered for professional and commercial applications requiring a high capacity source of 60 cycles AC from a DC power supply. Operates from storage batteries or from DC line voltage. Three "Custom" models, delivering 300, 400, or 500 watts 115 or 220 V. AC. Wide range of input voltage, 12, 24, 32, 64, 110 or 230 V. DC. Unequaled capacity for operating professional recording, sound movie equipment and large screen TV receivers. Available with or without manual frequency control feature.



HOW LEADING NETWORKS USE CARTER CONVERTERS

Photo shows Tommy Bartlett, star of NBC "Welcome Travellers" program, aboard N.Y.C. R.R. "Twilight Limited." His Carter "Custom" Converter makes recording possible on board the train, from regular train current converted to 110 V. AC. Radio networks, stations, program producers use Carter Converters for all sorts of on-the-spot recording.

MAIL COUPON FOR CATALOG

Carter MOTOR CO.
2641 N. Maplewood Ave.
Chicago 47

Carter Motor Co.
2641 N. Maplewood Ave., Chicago 47
Please send new catalogs containing complete information on Carter "Custom" Converters and other Rotary Power Supplies.
Name _____
Address _____
City _____ State _____

for the World of **E**lectronics

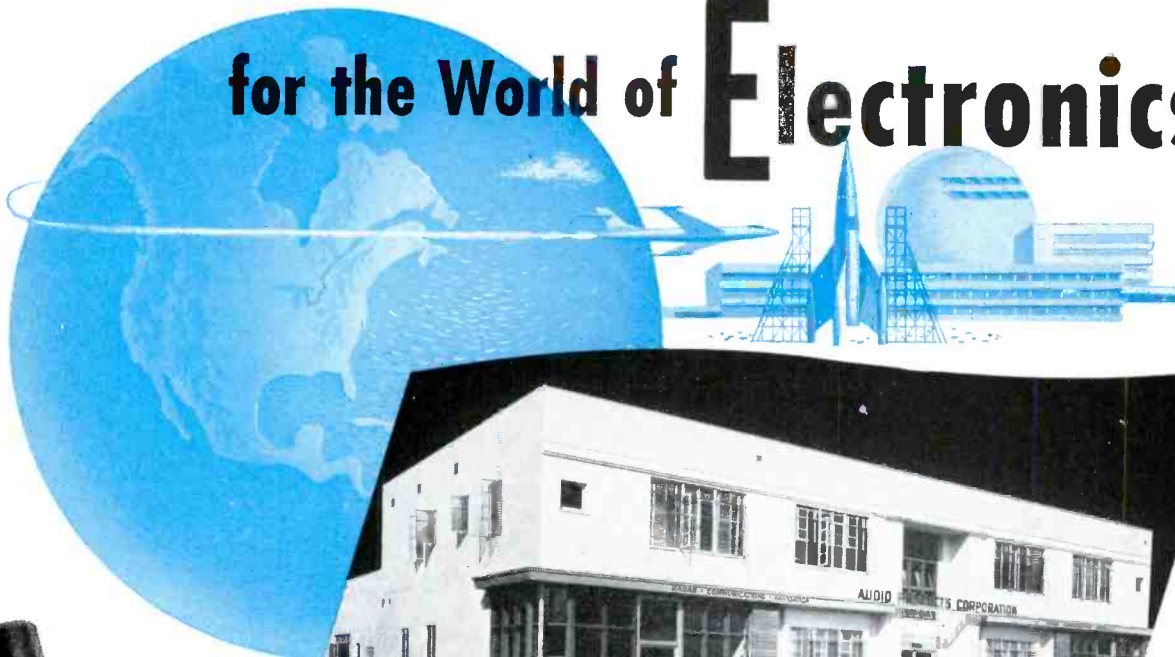

A WORLD of Know-How • Facilities • Experience

MINIATURIZED PACKAGED CIRCUITS

Plug-in circuitry in a compact unit. Custom-engineered to individual specifications based on circuit requirements or performance needs.

THE MODULAR SYSTEM

A basic electronic tool of great flexibility to aid in the design and use of pulse methods for information transmission, storage and computation.

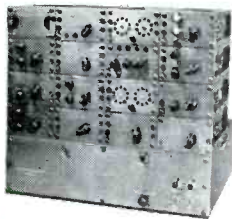

Do you have an application in the fields of radar, telemetry, communications, navigational aids or electronic miniaturization? If so, it will pay you to consult AUDIO PRODUCTS CORPORATION.

Here you'll find 35,000 square feet of modern production facilities and a staff of engineers accustomed to working in the more advanced phases of electronic development. From basic design to prototype, to final engineering tests—their knowledge, experience and facilities are applied to deliver a finished product to meet the highest standards of performance and reliability. A host of successful electronic units for military agencies and commercial organizations the world over is your proof. That is why we say—

For the Best in Electronic Design, Development and Manufacture, Consult



AUDIO PRODUCTS CORPORATION

2265 WESTWOOD BOULEVARD, LOS ANGELES 64, CALIFORNIA



The emphasis is on telemetry, radar relays, modulators and packaged circuitry

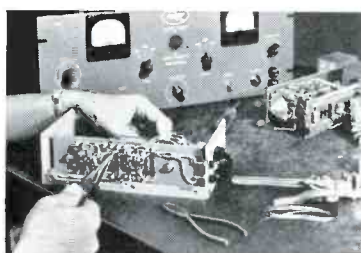

Highly skilled Audio Products technicians work with advanced production test facilities



Ever-expanding plant facilities provide more than 35,000 square feet of production space

ROHN

"Superior Design"

COMMUNICATION TOWERS

Proved in Construction, Design, and Operation.

Truly the finest tower of its kind. Made of heavy-duty tubular steel, electric welded throughout. In 10-ft. sections for easy erection, 14-in. triangular design. Can be used non-guyed to 60-ft.—guyed up to 150-ft.

**Get the full facts today!
Call your Rohn representative or write, phone or wire:**

"Pioneer designers and manufacturers of all type towers."

ROHN MANUFACTURING CO.
DEPT. CE • 116 LIMESTONE, BELLEVUE
PEORIA, ILLINOIS • PH. 4-9156

COMCO

"FLIGHTCOM"
TWO-WAY VHF
RADIO FOR AIRCRAFT

FREQUENCY MODULATED
25-50 MC — 152-174 MC.



Provides communication between ground FM communication systems and executive or utility aircraft

COMPACT—mounts in smallest planes
LIGHT—total weight only 23 lbs.
LOUD—full watt audio to speaker
POWERFUL—10 watts 30-50 mc. band
7½ watts 152-174 mc. band
LOW BATTERY DRAIN
PERFORMANCE—identical with ground station equipment.

For details contact your nearest COMCO dealer



Manufacturers of Radio and Electronic Equipment
COMMUNICATIONS COMPANY, INC.
CORAL GABLES 14, FLORIDA

FCC PHILOSOPHY

(Continued from page 46)

study. Even if a staff could be provided to consider applications on a case by case basis, the end results would undoubtedly be unsatisfactory. Since it would not be the result of a plan, inequities would result.

In view of this situation, it should be expected that those segments of the Commission's staff which act on applications would be largely administrative and clerical, and it should be possible to handle a large volume of applications with a minimum number of people. On the other hand, those segments of the Commission's staff involved in planning should consist of highly qualified experts in the field of engineering and law, and they should be furnished with adequate clerical staffs. Those men must have imagination and administrative ability as well as basic technical skill, since their work is in the field of planning for the use of radio rather than in the development of radio apparatus or circuits. Such a staff should not only be competent in the field of communications, but must be familiar with the non-communication problems of the industry and the proposals for the use of communications in solving them. How can the Commission's staff make recommendation as to the justice of claims that taxicabs need more frequencies as against the cries of the buses for additional assignments unless it has a working knowledge of how taxicabs are handled, and how the movements of buses are managed.

Communication is a service. The most successful communication engineer is he who knows the most about the business of the clients whom he serves. The Commission is charged by the Congress to administer the communications policies of this government so that all the people of the United States will have a rapid, efficient, nation-wide and world-wide wire and radio communication service, with adequate facilities at reasonable charges, both for the purpose of national defense, and for the purpose of promoting safety of life and property. The degree to which the Commission succeeds in carrying out this mandate depends, in a large measure, upon the degree to which its staff becomes familiar with the methods of operation of all the industries of the United States, and as to how communications techniques can be applied most effectively to the problem of those industries for the benefit of all.

NOTE: This concludes Col. White's discussion of assignment philosophy. Next issue, Merle E. Floegel of the FCC staff will present the FCC's side of the form 400 issue, and will interpret some of the major sections.—EDITOR.

Master Mobile MASTERPLANE

2 METERS—
GROUND PLANE ANTENNA— 140 to 162 MC

Model 300—Master De Luxe . . .
NEW! Outperforms any type of vertical dipole. "Drooping" Type Ground Plane plus four straight radials to give a low angle of radiation. It gives an almost perfect circle radiation pattern. Ideal for CD and defense nets. Covers complete Amateur Band with excellent Broad Band characteristics. Other frequencies as specified. Matches 52 ohm coaxial cable through threaded coaxial fitting at end. Radials adjustable (up or down) for purpose of eliminating standing waves. Sturdily-built of finest alloys to withstand corrosion, high winds and extreme icing. With 36" length of 3/4" pipe for mounting purposes.

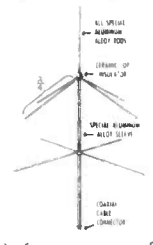

TWO METER COAX ANTENNAS

NO. 214 — MASTER DELUXE — ruggedly constructed, vertically polarized, frequency range 140 to 170 MC. Completely water-proofed. Highly polished chrome enhances appearance of any vehicle. Furnished with 10' of 72 Ohm Coax Cable. **MOUNTING TYPES:** Type 1—on side with 2 brackets furnished —**NET: \$15.95.** Type 2 — **MASTER MOUNT** (No. 132X or 140X). Mounts sold separately. Complete **\$17.45.** Adjustable mounting—adjusts to 17".

MODEL 300
AMATEUR'S NET: \$12.95

MOUNTING BRACKET:
NO. MB—\$1.00 NET

Model GP-4. Four "Drooping" Radials for perfect match to 52 ohm coax cable. Complete amateur band coverage. Specify other frequencies. (U-Bolts and Mounting Brackets furnished.) Also attaching to side of building. Sturdy, special alloys, to withstand corrosion and extreme weather. **Model GP-4 AMATEUR'S NET: \$5.95**

No. 214

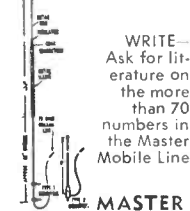

WRITE—
Ask for literature on the more than 70 numbers in the Master Mobile Line

2 METERS — 140 to 162 MC
SOLD BY LEADING JOBBERS

MASTER MOBILE MOUNTS, INC.
P. O. BOX 1817 • LOS ANGELES • CALIF.
Warehouse & Shipping Address: 1306 Bond St.

For HEAVY DUTY WORK! Severest Electrical Services!



P-506-CE
Plug with Cap



S-506-DB
Socket with deep Bracket

JONES PLUGS & SOCKETS

500 SERIES
Proven Quality

For 5,000 Volts, 25 Amperes per Contact Alterable by circuit Characteristics.

Socket contacts phosphor bronze, knife-switch type, cadmium plated. Plug contacts hard brass, cadmium plated. 2, 4, 6, 8, 10, and 12 contacts. Plugs and sockets polarized. Long leakage path from terminal, and terminal to ground. Caps and brackets, steel parkerized (rust-proofed). Plug and socket blocks interchangeable in caps and brackets. Terminal connections most accessible. Cap insulated with canvas bakelite.

Write for Jones BULLETIN 19 for full details on line.

HOWARD B. JONES DIVISION
CINCH MANUFACTURING CORPORATION
CHICAGO 24, ILLINOIS
SUBSIDIARY OF UNITED CARR FASTENER CORP.

The Standard of Quality

HICKOK



**Model 292X
SIGNAL GENERATOR**

Frequency Coverage:
125 KC to 220 MC

Calibrated Output:
Less than 1 microvolt,
up to 100,000
microvolts.

Professional engineers and technicians everywhere constantly rely on the accuracy of calibration and long dependability of HICKOK instruments.

In electronic instruments, HICKOK pioneering leadership has been acknowledged for over 42 years.

THE HICKOK ELECTRICAL INSTRUMENT COMPANY
10514 Dupont Avenue • Cleveland 8, Ohio

remember, too!
that Motorola is a SERVICE
organization

*... with organized
Maintenance Service Personnel to back the
"best engineered 2-way radio
equipment"*

No matter where you
are, Motorola Service is geared,
both in distribution and depth, to serve and
maintain your radio communications system in conjunction
with your present personnel.

It is the largest organization of specially trained radio
communication service people in existence today.

2-way Radio

Motorola[®]

Communications & Electronics, Inc.

A SUBSIDIARY OF MOTOROLA, INC.

900 N. Kilbourn Ave., Chicago 51, Illinois • Rogers Majestic Electronics Ltd., Toronto, Canada