

FIFTH EDITION

\$3.95

# FM ATLAS

## and Station Directory

A handy  
Reference  
to the  
FM Stations  
of the  
United States,  
Canada  
and Mexico

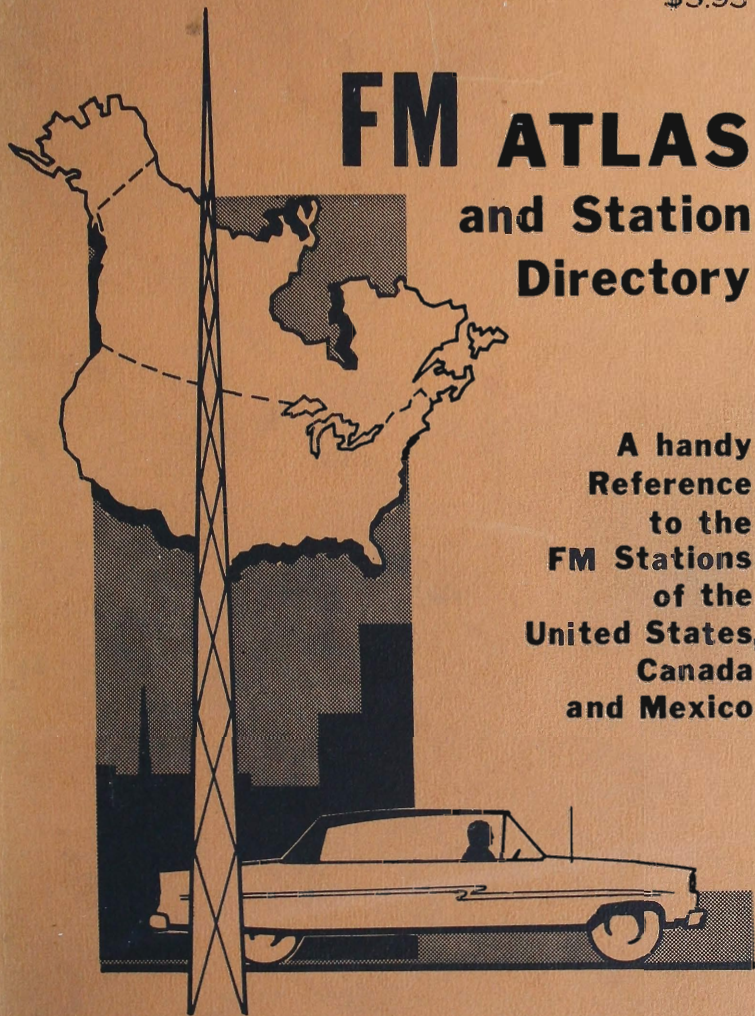

**FM ATLAS  
AND  
STATION DIRECTORY**

FIFTH EDITION

by **BRUCE F. ELVING, Ph.D.**

**FM ATLAS PUBLISHING CO.**

**Adolph, Minnesota 55701**

International Standard Book Number: 0-917170-01-7

Copyright © Bruce F. Elving, 1978.

## FOREWORD

This fifth edition of the *FM Atlas and Station Directory* follows closely the format and appearance of the fourth edition. It continues to report as accurately as possible the myriad technical details and changes that have taken place in FM broadcasting since the appearance of the fourth edition almost two years ago. Included, too, are approximately 1,000 changed data entries affecting FM station music formats, network affiliations, and stations adding stereo, Dolby, or SCA.

Sources utilized in keeping up with the ever-changing world of FM are both official and unofficial. Official sources include the daily news releases of the Federal Communications Commission and the Canadian Radio-Television and Telecommunications Commission. Unofficial sources include the hundreds of *FM Atlas* readers writing to tell of new FM broadcasting developments in their listening areas. Two readers even went to Hawaii and took portable radios with SCA adapters in them to give accurate and up-to-date reports on FM programming in the fiftieth state!

Several of the maps have been redrawn, while much cluttering has been eliminated by reducing the size of low-powered, 10-watt educational stations and FM translators. If a town has only a translator or a 10-watt station, both town name and station data are reduced. This makes the 10-watters and translators harder to see, directing attention away from them in favor of the stations with wider outreach.

Similarly, the lower-powered stations have been demoted in the *Station Directory*, with their being dropped completely from the by-frequency listings. By dropping the 10-watters and the translators there, more room is available for "FMiscellany" logos. Some people complained about cluttering caused by these logos in the last edition, but most comments received were favorable — they help to break up the monotony of long printed lists. Many logos are quite imaginative — and they all pertain to FM radio, which is what this reference is all about. Also diminished in size and deleted from the by-frequency listings are Canadian FM stations with less than 250 watts of power. Most of these are nonidentifying relayers of Canada's national CBC English or French networks. The separate appendix listing "nonidentifying stations" has been discontinued in favor of presenting the "non-ID" that stations use in lieu of call letters [except for the required hourly identification] in the listing of stations by frequency. Since the practice of a station using a "cute" phrase or slogan is spreading like a cancer: there are now too many stations using these slogans to list them separately.

The *FM Atlas and Station Directory* is designed for everybody who has a personal or professional interest in FM radio, including the home hi-fi listener, the hobbyist, and the FM-equipped motorist — who now has a guide to the nearest stations for clear reception and the programming of his or her choice. Persons in broadcasting, advertising, and related fields will similarly find the *FM Atlas* full of valuable information, much of it unavailable elsewhere. Its compact size makes the directory easy to take along on business or vacation trips, and it presents a wealth of factual data that are important but seldom put to practical use.

There are other lists of radio stations available, but the *FM Atlas* is the only published source that: gives specific mileage figures, both secondary and primary, for every station; tells which stations have an FM subcarrier (SCA) and what the (SCA) is used for; lists stations with vertical or circular polarization for best reception in vehicles; lists FM translators and boosters; lists nonidentifying slogans stations often use in lieu of their assigned call letters; lists Dolby-equipped stations; lists music formats according to what the listeners hear, not necessarily according to what the broadcasters say they are playing; and has maps! Much of this information, such as which stations are actually making use of their SCAs and the extent of stereo incorporation by the industry, is probably more accurate than what the Federal Communications Commission has in its files. We invite the readers of this publication to write and notify us of any errors in this directory, and to note any FM stations in their area changing musical formats, adding or dropping network affiliations, or adding stereo. As more of our readers acquire SCA adapters, the information presented on station specific uses of their subcarrier authorizations is becoming increasingly accurate.

# CONTENTS

FMusings . . . . .	4
FM Broadcasting Developments	
Boosters, Translators and Cable	
Stereo-Phoney and Whither Quad?	
All Channel for All Radios!	
Buying a Car FM Radio	
SCA: Radio's Great Unexploited Frontier	
FM Coverage Explained	
Improving FM Reception	
FM DXing	
Key to Symbols . . . . .	14
FMaps (FM Atlas) . . . . .	15
Station Directory Part I . . . . .	55
FM Stations by Geography	
Station Directory Part II . . . . .	81
FM Stations by Frequency	
FMakings . . . . .	106
Applications for New FM Radio Stations	
FM Stations Having Translators . . . . .	110
An alphabetical list by call letters to help you locate the primary stations of FM translators	
FMiscellany . . . . .	111
Some moribund FM logos, a couple of announcements, and a contest	
FMorgue . . . . .	112
The FM Atlas remembers some long-defunct FM radio stations	

## FMusings

### FM BROADCASTING DEVELOPMENTS

After a delay in its effective date to mid-1977, the expanded AM-FM nonduplication rule of the U. S. Federal Communications Commission has resulted in more separate FM programming in stations broadcasting from cities down to 25,000 population. For the first time, FM affiliates of daytime AM stations will have to operate separate schedules part of the day, even if the FM station is on 24 hours daily. About 25 AM-FM stations nationally, however, have waivers to continue program duplication for a variety of reasons. Some of these waivers are for short periods of time, but others are for much longer. The stations with the longest waivers are KSMA-AM-FM Santa Maria CA until May 1, 1979; WYLD-AM-FM New Orleans LA, KAOH-AM-FM and WAKX-AM-FM Duluth MN until June 1, 1979; WGRD-AM-FM Grand Rapids MI until Oct 1, 1979; WZUU-AM-FM Milwaukee WI until Dec. 1, 1979. As these and other stations with waivers begin complying with the rule that allows for no more than 50% of the same (AM-FM) programming in a city of 25,000, and only 25% of the same programming in cities of over 100,000, be on the lookout for program and network affiliation changes on the FM sides. One result of more separate AM-FM programming is greater incorporation of automation into the operation without the employment of more announcers. This also permits longer hours for stations, making for more 24-hours-per-day FM stations, particularly in medium and large markets.

FM stations on the air and FM advertising revenues continue to increase. A study released by Cox Broadcasting places FM radio's share of profits ahead of AM's by 1981, with 50% of all radio listening in that year predicted to accrue to FM stations. Such figures look conservative, however, when according to Arbitron data, major markets such as Philadelphia, Washington DC, Detroit and Dallas-Forth Worth report more FM and AM listening already. In nearly all other cities, FM stations are numbered among the top contenders, according to ratings' services.

The demand for FM channels has so far outstripped the capabilities of the present table of FM channel assignments that WLNC [AM] Laurinburg NC has proposed that Class A stations (3000 watts and under) be assigned on Class B/C frequencies (channels where stations operate with powers up to 50,000 or 100,000 watts) where there is no available Class A possibility, and where such assignments would not cause interference with present or possible higher-power allocations. This is similar to the custom of intermixing classes on all frequencies, as practiced in Canada and Mexico.

Travelers to the bordering countries, or residents of them, will note increased activity there, too. Canada is in a program of building over 650 relay transmitters for the Canadian Broadcasting Corporation. Many of these stations are in Canada's far north: some of them with considerable power.

Most are nonidentifying relays of network programming, but some have local service capability. It has been reported that most northerly stations receive their program feed by means of high fidelity microwave or satellite from such "centres" as Winnipeg and Vancouver, while the other relay transmitters generally rely on low-fidelity land lines for their program services. Still, reception is on interference-free FM, which makes listening to them less of a problem than with AM radio, with its susceptibility to interference from other stations, fading and static. Not only is Canada's English-language "AM" network being spread about by means of FM, but sprinkled throughout Canada is a growing number of Canadian FM stations that carry the CBC-French network. Thus the French-speaking traveler, or the American or Canadian resident who lives near these transmitters, can keep up on their knowledge of French. And a few of Canada's new CBC stations will be principally for relaying the CBC-FM network, with its stereophonic musical programs. Along with the government's CBC networks are numerous commercial FM stations of Canada, some of which have increased in power and coverage since the last edition of this book was published.



Société  
Radio-  
Canada

Mexico, a country known for the richness and variety in its commercial radio industry, is where a number of extremely large-coverage FM stations are being built, many with the maximum power of 100 kilowatts at 600 meters above average terrain. These should provide the American tourist with FM reception for most of the distance from the border to Mexico City by the main highways. No longer are Mexican FM stations strictly local outlets! And major cities, long without FM service, are getting stations of their own — cities like Ensenada and Hermosillo. Reports from FM Atlas readers on FM reception in Mexico, and on the programming of FM there, are most welcome.

The FCC has been receiving comments from interested parties regarding how to allocate the FM channels between 88 to 92 MHz, reserved for educational broadcasting. New stations in these frequencies are free to come on the air without regard to any national pattern, unlike the commercial channels, between 92 and 108 MHz, which are strictly allocated to specific cities. Ten-watt stations, which serve only about two miles with a strong primary signal and up to nine miles with a secondary signal, have been growing in number — sometimes impeding the development of would-be higher-powered stations. "Double Helix" in St. Louis, an outgrowth of the former KDNA 102.5 there, would like to establish a 100 kilowatt station on \*88.1, but to do so would mean displacing KHRU, a ten-watter in Clayton MO. KHRU, even though operating only a few hours a week during the school year, refuses to budge, and it may take a "show cause" order from the FCC to resolve this impasse.

"Double Helix" is one of a growing number of community organizations formed to start public-access FM radio stations. Most of these operate without foundation or institutional support. Examples of such stations are WYEP Pittsburgh, WPFW Washington, KRAB Seattle, KAXE Grand Rapids MN, WBAI New York and KPET Houston. One of these stations, KCHU Dallas, is off the air, but hopes to return "some-time in 1978," pending financial reorganization.



Most noncommercial stations in the United States are operated by universities or school boards, with funding coming from the parent institution. Some of the larger stations are qualified by the Corporation for Public Broadcasting, and receive facilities grants and a portion of their programming expenses paid for by that source. Now the noncommercial spectrum is open to religious applicants, too. Formerly, the FCC would not allow a religious station between 88 and 92 on the FM dial if the station were not located in a city having a school connected with the station. In granting applications by the Moody Bible Institute of Chicago for new educational stations in Boynton Beach FL and East Moline IL, the FCC reversed itself, and effectively threw out the old "rule." The Commission rejected a petition that would have allowed educational ten-watters to seek channels in the commercial part of the FM band, apparently feeling that there was enough space in the educational part of the band for such stations, and that any space in the commercial band left for ten-watters should be available for commercial FM translators.

In addition to station allocations in the educational part of the FM band, the FCC proposed a 36-hour-per-week minimum schedule for educational stations, with stations operating between 36 and 72 hours a week to be open to time sharing with another station. Commercial stations must operate a minimum of 12 hours daily, six days per week, with no operation on Sunday required. Few commercial stations are on the air the bare minimum schedule, except that it is known that not all commercial FM stations remain on the air as late as 10 p. m., even though FCC rules require at least four hours daily on the air after 6 p. m. local time. A few such stations are (or were) known to leave the air when their affiliated daytime AM station went off the air at local average sundown.

Another concern of the Commission is the problem of interference by educational FM stations to channel 6 TV reception. Historically, higher power educational FM stations have been placed higher on the dial, such as between 91.1 and 91.9 MHz, with the weaker stations lower on the dial. In a few cases, such as in Michigan and in Presque Isle ME, educational stations have "invaded" the commercial frequencies to avoid this problem. Now with increased demands on the spectrum by commercial stations and with the need to establish more public FM stations, the idea of moving high-power educational stations far on the dial away from channel 6 TV (which is found just below the FM band, between 82-88 MHz) is not practicable. The solution to this problem is not simple, but

will involve the use of filters at TV receivers to rule out as much FM interference as possible, the better location of FM transmitting antennas so as to put areas of strong FM and TV signals as close to each other as possible, so that one is not "swamping" out the other, and a willingness on the part of all parties to tolerate a little interference so that all stations may survive. Both FM and TV translators can be added in areas having high incidences of interference. The FCC in granting a ten-watt permit on 89.5 to KZUM, "Sunrise Communications," Lincoln NE, turned down Omaha channel 6 TV, which petitioned for denial of this application. Not satisfied with the FCC's assurances that any interference caused its signal will be taken care of by the FM station's installing filters on TV sets that experience the interference, the TV station is taking the matter to court, hoping that the FCC's Lincoln grant will be denied.

## BOOSTERS, TRANSLATORS AND CABLE

Extending FM radio's reach, and helping FM stations fill in unserved or underserved areas, are FM translator stations. Translators operate on frequencies different from the originating station. Those in the west can have up to 10 watts, while those east of the Mississippi are limited to one watt. They can employ vertical polarization (best for car and portable reception), horizontal polarization, or a combination of both. All translators are equipped with a device to take them off the air in case the originating station leaves the air. Licensees of FM stations can establish translators within their 1 millivolt/meter primary signal area, or beyond that area, but only if outside the 1 mv/meter area of another commercial FM station licensed to a different city. Individuals or community groups can, however, be the licensees of FM translators that can bring the signals of any FM station into any city, regardless of how many other FM stations already exist in that city. And FM translators can now broadcast up to 30 seconds of commercial advertising per hour to help defray expenses. W269AA Grand Rapids MN carries its own local commercial about fifteen minutes to the hour, triggered by a tone carried on the originating station in Duluth MN. This arrangement is said to net the W269AA owner a respectable income.

A few stations make use of FM boosters for surmounting reception difficulties where there is a problem of terrain shielding. A booster operates on the same frequency as the originating station; a good example of FM booster activity is in Walnut Creek CA. Both translators and boosters provide over-the-air reception of signals to portables and car radios, as well as to home receivers. Cable FM involves a subscriber hookup to a community cable "TV" antenna service (usually with an extra fee). While cable may provide excellent reception of a number of stereo signals, it benefits only the radios physically connected to it. Another problem is that most cable systems install individual signal processing, which helps them deliver a better signal and one with less fading to the subscriber than the older, more democratic "all-band" system. This writer would prefer, however, that cable improve on the all-band technology, so that the FM signals they deliver are on the actual frequencies that the stations use, and that all the area's FM stations are sent onto subscribers — not just the 15 to 20 or so that are individually "processed." With "all-band," SCA signals are sent on, too; whereas, the other method generally results in their being filtered out.

Special cable FM "stations" exist, too. These are outlets that function only on cable, and require the FM radio hook-up (and charge) in order to hear them. Cable radio, however, suffers from being a stationary medium, and not benefiting from radio's mobility and portability. Still, for such entities as schools interested in running broadcast training programs for students but not having access to regular radio channels, cable is a viable alternative. Another area for alternative or experimental broadcasting would lie in the use of FM subcarriers (see the section on SCA).

Since well over 60% of all cable systems offer FM stations on their cable (with some Canadian systems offering local AM and shortwave audio over cable FM channels, in addition to U. S. and Canadian FM stations), it is impossible for a book this size to list them all, or even to list the cable-originated "stations." Listed here, however, are all the FM translators and FM boosters on the air, or having permission to come on the air. It might be noted here that the FCC proposed retroactively forcing FM translators off the air if they were in areas that later developed two or more commercial FM stations. This rule was sought to protect the interests of commercial FM stations, but if applied as

originally proposed educational FM translators would have to go, too. Obviously, the FCC will have to rethink this rule. Since nothing has been heard about it in almost two years, it is probable that the FCC did the logical thing — discard the proposal in favor of letting the public in the communities involved decide whether distant-station importation is a good thing or not. The only reason a translator should have to be forced off the air is to allow for a full-powered station to develop on the same or nearby frequency.

#### STEREO-PHONEY AND WHITHER QUAD?

More and more stations are embracing stereo, which is excellent for music, but a questionable or even a dishonest practice when carrying long monophonic programs, like sports play-by-play, monophonic educational or religious programs, or network programs, such as "All Things Considered" from National Public Radio — all in "stereo." A few stations, such as WGGL Houghton MI, follow a different policy, as the station's director summarizes in the WGGL program guide:

As a general policy, any monaural program longer than ten minutes is broadcast monaurally. That means your stereo pilot light will not light during such programs. When it does light up, however, you can be sure that the program you are listening to is really in stereo. Unfortunately, that is not the policy for the majority of FM radio stations across the country. . . . A few years ago the FCC proposed a new regulation which would have required FM stations to turn off their stereo generator when airing monaural programs of longer than ten minutes. Myriads of radio stations across the country opposed the regulation and it was never adopted.

Why would a radio station want to broadcast monaural material in stereo? Many are afraid of losing their audience. Indeed, some people won't stay tuned to a station that is not in stereo. Recognizing this, manufacturers now market radio sets which can be adjusted to tune in only stations which are broadcasting in stereo.

We have adopted our policy here at WGGL-FM for several reasons: 1) People have a right to expect to hear stereo material when we broadcast in stereo; 2) Those who live in areas subject to multipath problems will experience less distortion when we broadcast monaurally; and 3) Our signal will be stronger in fringer reception areas.

The problem of broadcasters leaving their stereo generators on when carrying long monaural programs is not entirely their own. No manufacturer is known to put a switch on the radio station's console so that the operator can nullify stereo, and some of the remote-control equipment is set such that there is no way for the station to discontinue stereo. Remote control is necessary when an FM station has its transmitter and tower in a location away from the station's studio.

Live network stereo programming may be a possibility within the year, as both Mutual and National Public Radio get ready to press satellites into service for radio station interconnection. Mutual's plan is said to be capable of carrying up to six different programs at one time, with both systems preparing for capability of 15 kHz audio signal fidelity and stereophony. It is expected that these systems will gradually become phased in, with only a few affiliates getting the new service (and installing the large satellite receive dish antennas) initially.

Inquiries have begun by the FCC as to whether to adopt standards for FM quadraphonic radio broadcasting, as well as to determine if there is an interest in and a need for AM stereo. AM stereo is said to be capable of long-distance reception in automobiles, and it might spur development of better fidelity transmitters and receivers for this band. On the other hand, one of the readers of this publication wrote and said "you can't make a silk purse out of a sow's ear," meaning that AM's historic problems of lower fidelity than FM has and its susceptibility to static and interference hardly make AM worth considering for music listening, let alone stereo. The growth in FM listening has been largely attributed to FM's having stereo capability, and many AM stations are interested — especially since almost all records come to them in stereo, and the audience listens to stereophonic records and tapes at home.



Concerning quad broadcasting, the FCC's laboratory released a report looking toward continued reliance upon the lower-quality matrix (as opposed to discrete) system. Problems inherent in discrete quad involve the use of wider bandwidths, which may impair the burgeoning development of SCA services, and the replacement of station studio and transmitting gear. Matrix, on the other hand, is relatively simple to transmit, with one audio commentator mentioning about the FCC tests: "95% of the listener panelists can't tell the difference using the latest decoders — so why devote the extra bandwidth necessary for a [discrete] carrier system?"

The ultimate in directionality listening has to be binaural, or the use of headphones for hearing recordings or live broadcasts with the microphones placed about the same distance from each other as are the ears in the human head, and between which there is a barrier so that the sounds reaching the two microphones are different, as in normal two-eared hearing. Almost no true binaural broadcasting is now being done, even though the system has exciting and breathtaking possibilities. The National Center for Audio Experimentation in Madison folded, but the CBC English FM network still carries its "Sphero" programming from 9 to 9:30 p. m. local time Tuesdays, at least in Quebec — Part of the reason, of course, why discrete quad and AM stereo are being promoted is to help the economy, by having broadcasters and listeners buy expensive equipment to be able to experience these technologies.

Many stations employ audio processing. These systems include gain-riding equipment used at many rock stations which has the effect of making everything sound loud, even introducing distortion into the signal and flattening out any dynamics the music may have presented in the first place. Actually, stations with all formats are likely to have gain-riding equipment, including easy-listening, country and even classical stations. When classical music station WNCN New York discontinued using limiting, listener complaints came in from outlying areas about the poor signal. So management and listeners were both pleased when some 15 to 20 dB of audio compression was added.



Listed in the Station Directory are FM stations employing the Dolby Type B system of noise reduction. Listeners with receivers equipped for Dolby should experience less noise when tuned to a Dolby-equipped station.

Still being discussed in audio circles is a report by the FCC's chief engineer's office which would allow for more stations, by spacing the FM channels closer together. The report noted that receiver filters would be needed to accomplish spacings as close as 100 kHz (or half as wide as the present FM channels). This would require the manufacturer of more selective FM receivers — something that High Fidelity Trade News (June, 1976) cautioned its industry readers about:

... In the area of FM tuners, expect to see more frequency synthesizing FM tuners with extreme tuning accuracy as the cost of phase-lock-loop high frequency ICs plunges. The only thing that may slow down this welcome development is a recent rumbling from the FCC that they may be considering a reduction of spacing between FM channels (presently 200 kHz) to either 150 kHz or 100 kHz to provide more space for allocations of new stations. If that happens, not only will the digital read-out tuners be in trouble (they tune in increments of 200 kHz), but many, many stereo receivers and tuners will have a difficult time separating more closely-spaced stations. It may be time to write to the FCC again — before any action is taken on this new issue.

The high fidelity industry should be challenged to produce more selective receivers, whether or not the FCC's engineer's office's report comes true, and FM stations are squeezed in at closer spacings (as is true in Europe). Developments in crystal and ceramic filter i.f. strips in receivers have brought better FM selectivity figures, but undoubtedly there is room for still more improvement. Even now there are some foreign stations, and an Alaskan station far out on the Aleutian islands, broadcasting on even frequencies, such as 101.8, rather than the odd frequencies, such as 101.9, that most

stations employ. And certain cable systems in reprocessing FM signals will often send FM out to their subscribers on even frequencies, or on really odd frequencies, such as 90.75 MHz. Happily, it can be reported that the newest transistor portable radios are coming out with much less susceptibility to local station overload interference and with better selectivity than did their predecessors.

#### ALL CHANNEL FOR ALL RADIOS!

Congressional hearings have been going on concerning bills that would require the incorporation of FM into car radios. While such mandatory AM-FM legislation has merit, the aiming of it at domestic automobile manufacturers and their auto-radio-making subsidiaries is questionable. Even if it is true that domestic factory-installed radios are overpriced, the consumer still has the freedom to install an after-market FM radio or converter.

To be truly effective, an AM-FM law should include all types of radios. It should not provide for the continued sale of AM-only "novelty" radios with their appeal to youth, nor should it allow small table and clock radios without FM. These have a specious bargain-like quality (but which leave out the FM portion of the spectrum for a mere \$5 or so savings). Included in such a law, of course, would be car radios, but by not specifying type of radio or any price exemption (the original law was to apply to radios selling for over \$15), all radio designed for broadcast reception would be covered.

#### BUYING A CAR FM RADIO

If you are interested in quality reception, both close to an FM station transmitter and far away from stations, and you are about to buy a new car, it is best to buy an American car with a factory-installed FM-AM radio.

The reason for this is that the American manufacturers and their design engineers extensively field-test their radios in difficult receiving locations in this country, and they supply the shielding, grounding and interference-suppressing equipment necessary for the radios to work properly. Most people don't realize that it is easy to design a highly sensitive receiver (one that will tune in weak signals), but the real challenge is to design one that will also handle strong signals and yet not sacrifice sensitivity. The local/distance switch found on some radios is an attempt to reduce the problem of overload. Such a switch is far more often seen on lower cost, poorer performing radios. Signals likely to be bothered by overload are likely to be weak and will become weaker in the "local" mode. Then, too, one has to remember to return the switch to "distance" for more normal reception. Both Chrysler and General Motors have added digital dial radios, which read exact FM station frequencies. If a mandatory AM-FM set law were passed, aimed solely at the car manufacturers, it is possible that the excellent quality now being included in their products will become compromised to meet the demands of mass production.

Buyers of factory-installed car radios should be aware, too, that there are dishonest dealers who will install cheaper foreign radios, but still charge full list prices for their radios. Be sure that the radio you pay for is the type you have specified.

Among foreign radios available there is a nice selection. Japan produces the widest variety of car sets and aims mainly at the lower end of the price range. FM performance is, therefore, the most variable. Radios tend to be small in size to go in the most cars. While small size is not necessarily a penalty, it does restrict the designer's options in making a quality receiver. The fact that Japanese sets also include tape players does imply crowding of radio circuits and almost inherent lower quality. However, Japanese receivers offer the greatest variety of features. European FM sets are primarily sold for their exported cars and are mainly modified versions (altered frequencies and bands) of radios sold there for their considerably different radio system. Because European stations tend to be located away from populated areas, reception there tends to be fringe. Therefore, receiver designs favor high sensitivity. This almost always implies lesser overload performance. European radios are likely to be good performers here in the rural areas, but not so good in our cities. Most of them, however, are very selective (receiving stations close on the dial to one another without interference). If you import your

car from abroad, and it has a radio, make sure that the radio is an export model, having the same FM frequency range we have in North America. Domestic European FM radios do not tune above 100 or 104 MHz.

#### SCA: RADIO'S GREAT UNEXPLOITED FRONTIER

Riding along with the superb stereophonic or high fidelity monaural FM signal of many stations is a service that provides talking and musical programs to a select clientele. Through a collusion of government and entrenched special interests the public is denied ready access to the broadcast-type service being performed by hundreds of FM stations via SCA, or Subsidiary Communications Authorization. The geographical part of the "Station Directory" lists all stations known to have an active SCA, and what they offer on this subcarrier, which a normal FM radio cannot pick up.

Originally, SCA was created as a means to help struggling commercial FM stations stay in business by offering background music on their sidebands. The SCA concept has broadened since it was established in the mid-1950s to include educational stations with instructional programs as well as readings for the blind. Also on SCA, in various locations, is ethnic programming, farm news, and "program relay" to other radio stations (most often, network programming, with ABC being the radio network most active in having its entire schedule carried over various stations on SCA).

Anybody can legally listen to SCA at home, but because SCA is a nonbroadcast service and protected by the privacy of communications provisions of the Communications Act of 1934, as amended, ordinary listeners may not divulge information heard, or use it for commercial purposes. The FCC did persuade one electronics distributor to stop advertising an SCA receiver to the public, but such tactics on the part of government smack of totalitarianism, in which "big brother" forbids its citizenry to tune in prohibited broadcasts (much the same as East German residents not permitted to have TV antennae aimed at West German stations). SCA units are available to the public in the form of kits, and circuit diagrams have been widely published so that the technically-inclined can build their own adapters at little cost. Virtually any kind of FM radio can be modified to include SCA, including car radios, portables, clock, and stereo tuners and receivers. Installation of SCA in a radio does, however, take some technical expertise — unless your receiver has the right kinds of jacks, allowing for the use of an outboard adapter (see illustration).

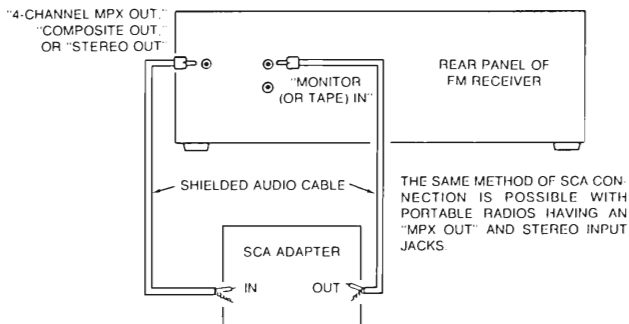

*Addition of Outboard SCA Adapter and 9-Volt Battery to an FM Receiver Having a 4-Channel MPX Output Jack and a Tape Monitor Control on its Front Panel*

External SCA adapters will play off sets now in use that have a jack marked: "stereo out," as in some of the multiband portables; "MPX out," as in some of the AM-FM tuners of the early 1960s (before FM stereo was really underway); as well as in the newest sets having jacks marked "4-Channel MPX Out," or "Composite Output." These latter sets are being marketed in anticipation of the FCC allowing a system of discrete quadrphony. If you take the output of such a jack and plug it into an SCA adapter, you then will have to plug the SCA adapter's output into a "stereo in" jack, a "tape in" jack (for receivers having a "tape monitor" switch), or into a separate amplifier and speaker. Small SCA adapters can be operated on 9-volt batteries, or special AC power supplies can be built for them. Adapters built into radios or receivers can often use the 9—18 volts' power found within the sets.

Reception of SCA is as clear and static-free as is FM itself, although sometimes there is a problem of crosstalk, or leakage of the main-channel program into the SCA channel. Here is a radio channel that is as reliable a form of communications as your local FM station, and with fidelity that goes up to 7 kHz, or more than what most AM radio stations send out. Here is an untapped resource for the broadcaster and for community groups to seize upon for the enlightenment and entertainment of mankind. It is a pity that the service is either unused at many stations, or relegated only to occasional telemetry tones, and not used for meaningful programming. As the need for FM frequencies increases, allowing for fewer new stations, demands on the spectrum will dictate that SCA be used meaningfully, and made available to the public.

Already in some cities, such as Chicago with Greek programming, Arcadia CA with Korean, and Seattle with Spanish, SCA is serving a broadcast-type function in reaching certain ethnic groups. In other cities it is reaching doctors via the Physicians Radio Network; however, it is regrettable that the educational community through various "talking books for the blind" services generally wants to keep SCA closed-circuit, so that their subcarriers reach only the targeted audiences. This permits the carrying of nightly pornographic readings, with the theory being that the print handicapped should have access to the full spectrum of the printed word that the sighted have. Because the service is not "broadcasting," recent copyrighted works can be read on it without paying royalties. Holding back SCA from the public for such reasons is, however, shortsighted. Even if SCA got into the hands of the public in great numbers, the fears of present special-interest SCA users would be groundless, because the limited nature of the programming on SCA would dictate that the principal listening audience would be the intended audience. Indeed, wider public access to SCA would serve even the special interests better. The Wisconsin Radio Reading Service reported, for example, as of late 1977, it had been able to give out only 640 SCA receivers to its visually-handicapped clientele, out of some 23,000 who are eligible.

Ultimately, it is predicted, SCA capability will be available in every new FM radio sold in the United States and Canada, either in the form of a built-in SCA circuit, or as an output jack for the connection of an SCA adapter. Until such time comes, however, it should not be any more difficult for you to be able to buy an SCA-equipped radio at your favorite electronics store than it is to buy a police scanner, or a VHF-UHF public-service band radio, both of which permit the public to tune in "secret" transmissions which are not "broadcasting." And any concerted attempt to stop the marketing of SCA sets through the legislative or judicial process will undoubtedly meet with the same fate that most state laws prohibiting the use of radar detectors in automobiles has had.



905 University Avenue, Suite 307  
Madison, Wisconsin 53715

Canadian authorities have considered SCA, or SCMO (Subsidiary Communications Multiplex Operations), to be a form of broadcasting, and in allowing CING Burlington, Ontario, to provide a radio reading service to the print handicapped, they requested that fixed-frequency or crystal-controlled receivers not be used. Instead, they recommended the use of variable frequency SCMO receivers. This will permit the blind user to tune in another SCMO station, should the service leave CING and go elsewhere, and it will permit the tuning in of other local SCA-type services available from different stations. It should be noted that all of the circuitry that this publisher recommends is

capable of tuning in all SCA stations in a given area, and is not like "professional" SCA units that lock the listener into only one station. Anybody interested in acquiring SCA for use in a home stereo receiver, portable or car radio can contact this publisher about the necessary equipment and its installation.

#### FM COVERAGE EXPLAINED

FM station coverages are given in the geographical part of the Station Directory. The reappearance of coverages in miles in the last edition was noted as an improvement by many FM Atlas readers, who noted their absence from the third edition. These coverages are reported in miles to both the 1000 microvolt per meter (primary) contour and the 50 microvolt per meter (secondary) contour for each station. The FCC requires FM stations to calculate their coverages, according to antenna height above average terrain and effective radiated power criteria, using its new engineering chart and curves. All coverages reported in this book have been calculated in this manner. Some stations, however, employ directional antennas, limiting their coverage in certain directions to avoid interference with other stations with which they may be short-spaced. Other stations may be next to mountain ranges, with coverages varying considerably according to direction. The coverage of KLIR 100.3 Denver CO are indicated on the accompanying map. Here you can see the influence of the Rocky Mountains on this station's coverage to the west.

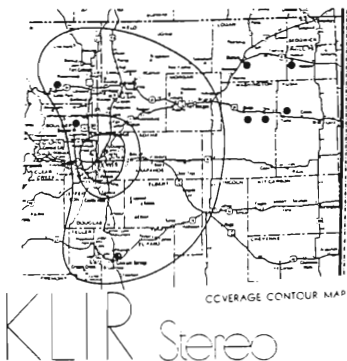

The FCC requires FM stations to take note of their 3.16 millivolt per meter signal, which is defined as the "principal city" contour, as well as the 1 millivolt "primary."

This book continues to list only the 1 millivolt and the weaker 50 microvolt contours. The 50 microvolt contour is the standard the FCC formerly had stations note for coverage in rural districts and small towns. It is included here because it represents a standard toward which FM set owners should look in determining the areas from which to expect reception, especially with quality home or car receivers. Car reception up to the 50 microvolt per meter contour will generally be monaural, while home reception will often require an outside antenna, especially for stereo.

The best car reception will be with a vertical antenna extended to about 31 inches, although windshield antennas can work well in strong-signal areas, and where vandalism is a problem. Even with the best of receiving equipment you will not always be able to tune in an FM station at its 50  $\mu\text{V}/\text{meter}$  contour, because the FCC in creating station spacings often places stations so close to each other that you may drive into another station's coverage area before getting out of the first station's "secondary." Thus in driving from Syracuse to Buffalo NY, you can go up the east side of a hill and hear WSYR-FM Syracuse on 94.5 and going down the west side of the hill you will hear WNEB Buffalo. Normally, however, your FM radio will give you the sharpest possible reception of nearby stations. The advantage of FM over AM shows up more clearly after dark, when many AM stations leave the air, go directional, or reduce power. Interference increases on the AM band, and the traveler interested in nearby weather or travel information finds FM offers clear and distinct station separation. Stations with vertical or circular polarization (marked with a "v" in the Station Directory) offer the best mobile reception, as opposed to stations that transmit only horizontally. Vertical polarization even improves reception for cars with windshield antennas, as the vertical wires running up the

SITUATED AT THE FOOT OF THE SNOW-CAPPED  
ROCKY MOUNTAINS IN MILE HIGH  
DENVER, COLORADO

EASY LISTENING AT 100.3 CIRCULAR POLARIZED

center of the windshield are an important part of the aerial arrangement. This directory continues to be the only published source that tries to reliably list all stations having vertical polarization, with automotive design engineers and car FM importers making specialized use of it for that purpose.

## IMPROVING FM RECEPTION

To improve home reception, the most important thing you can do is work on improving the antenna. Even radios with built-in antennas or portables with "whip" antennas can improve their performance, simply by proper placement within the room. Residents of high-rise buildings often report very good reception when such a radio is placed in front of a window facing in the direction of desired stations. Connection to master antennas can be tried, but since most such antennas are engineered for TV, your radio might work better without it. In metropolitan areas the use of outside antennas should be avoided unless you have a set with good overload rejecting features (such as field-effect transistors in a well-designed receiver), and if the antenna can be rotated to null interference. Otherwise, the antenna may bring so much interference that the effort and expense in connecting your radio to it would not be worthwhile.

Often a good rabbit ears antenna is a good choice for people who own small radios or FM tuners that include two small screws or terminals on the back of the radio for the attaching of an outdoor antenna. This antenna can be mounted some distance from the radio (such as on top of a bookcase), rotated and adjusted for best reception of a number of signals. A new electronic tunable FM antenna has been announced and is said to be quite effective in tuning out multipath interference and in bringing stations in clearly. But its price, around \$80, is rather expensive for an indoor antenna.

Clearly, the best choice, when your receiver, your landlord, and your geographic area permits it, is the outdoor FM antenna. With your own outdoor antenna you will almost certainly pick up more FM stations than your local cable company may bring you (although perhaps not all as clearly or as fade-free). The best FM antenna is a yagi type, consisting of four or more elements. This antenna is directional, and it is best to have a rotational device, either an electronic rotator or the "armstrong" method, to turn it to favor various stations. You can also turn the antenna away from your friendly local broadcasters and see what stations from more distant towns will come in. Even the best FM receivers will overload when you aim the antenna directly at your local stations and you live in a metropolitan area. If interference by strong nearby stations is still a problem, traps are available that can help you tune out the offending signals.

## FM DXING

Those interested in the hobby of long-distance (DX) listening on FM, as well as others concerned with solving special reception problems, should contact the nonprofit Worldwide TV-FM DX Association. Monthly the WTFDA publishes a Digest, which typically includes technical articles, news of changes in FM and TV station facilities, and reports of long-distance reception conditions that affects these bands. FM DX is possible by means of sporadic E-skip, mainly in the summer; tropospheric enhancement, mainly in spring along the Gulf Coast and in the fall around the Great Lakes and eastern United States; auroral and meteor reflections. Club dues are \$11 in the United States and Canada; \$18 overseas. Sample copies of the monthly bulletin are \$1.00 from the WTFDA, P. O. Box 202, Whiting IN 46394. The club also publishes a concise introduction to TV, FM and VHF-UHF radio DXing, "Beyond Shortwave," at \$1.25. A reprint service is also available, from which articles from back issues of the Digest can be inexpensively supplied.



---

Special thanks to all who have helped compile program format and station information data from different parts of North America. All pertinent information has been keypunched and placed in the station computer file from which this edition has been prepared. Thanks, too, to the Heath Company, Benton Harbor MI, for distributing copies of this book with their quality state-of-the-art FM tuners and receivers.

## KEY TO SYMBOLS

- § A station broadcasting all or part of its daily schedule in multiplex stereo.
- v A station transmitting with a vertically (or circularly) polarized signal, in addition to the usual horizontal signal, for better reception on auto radios and portables.
- \* A noncommercial radio station, usually educational or religious.
- # A station sharing time with a nearby station on the same frequency.
- t An FM translator.
- A station with its antenna below the average surrounding terrain.
- + A station with a Subsidiary Communications Authorization (SCA), 67 kHz.
- D A station transmitting with a directional antenna.
- = Dolby-equipped station. This symbol appears between the two coverage figures in Part I of the Station Directory.

Program [music] codes (given in Part I of the Station Directory in small letters after city): c classical, e ethnic, g gospel, j jazz, k country, L Latin/Spanish musics; m is middle of the road or easy-listening, n all news (the only all-news FM stations are now in Canada), p is progressive rock, r is rock oldies, top hits and "easy rock," s soul, t talk format. So-called "album-oriented rock" is usually identified as rp or pr. Stations calling themselves "contemporary" are usually listed as r. Polka music stations are grouped with country, k.

Language codes (given just to the left of the program codes in Part I of the Station Directory): E English (stations so listed are located in Quebec or in Latin America); F French; P Portuguese (see New Bedford MA); S Spanish.

Network codes (given in both parts of the Station Directories): A ABC-FM, B National Black Network, C CBS, E ABC Entertainment, I ABC Information, M Mutual, N NBC, P National Public Radio, S Associated Press Audio, U United Press Audio, Y ABC Contemporary, Z Mutual Black Network.

SCA symbols (all following + in the first part of the Station Directory): A ABC networks, E ethnic and foreign language, F farm news, g gospel, L Mutual network, M music, N NBC network, Q Physicians Radio Network, S sports or special events, T talk, including instructional programs; TB is talking book for the blind; X facsimile, audible teletype or telemetry chirps.

### Station Directory Examples

#### Part I, Geographical Directory:

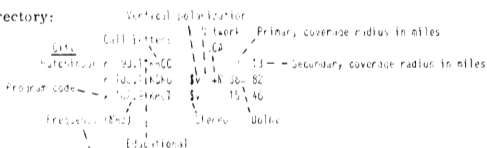

#### Part II, By-Frequency Directory:

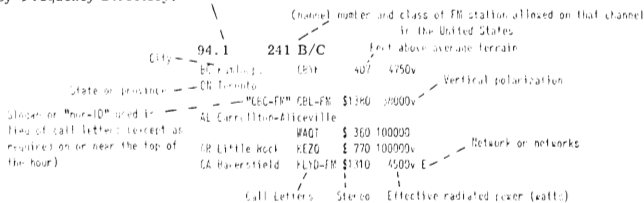

# FMAPS

(FM ATLAS)

## INDEX TO MAPS

UNITED STATES:		New Hampshire	17
Alabama	29	New Jersey	16
Alaska	50	New Mexico	45
Arizona	44-45	New York (main map)	20-21
Arkansas	28	New York (Long Island)	18-19
California	46-47	North Carolina	24-25
Colorado	44-45	North Dakota	38-39
Connecticut	18-19	Ohio	32-33
Delaware	23	Oklahoma	42-43
District of Columbia	23	Oregon	48
Florida	26-27	Pennsylvania	20-21
Georgia	26-27	Rhode Island	19
Hawaii	50	South Carolina	24-25
Idaho	49	South Dakota	38-39
Illinois	34-35	Tennessee	30-31
Indiana	32	Texas	42-43
Iowa	40-41	Utah	44
Kansas	40-41	Vermont	17
Kentucky	30-31	Virginia	22-23
Louisiana	28-29	Washington	48
Maine	17	West Virginia	22-23
Maryland	22-23	Wisconsin	36
Massachusetts	18-19	Wyoming	49
Michigan	36-37	Puerto Rico-Virgin Islands	54
Minnesota	39	CANADA	50-53
Mississippi	28-29	BAHAMAS-BERMUDA-WEST	
Missouri	40-41	INDIES-CENTRAL AMERICA	54
Montana	49	GREENLAND	51
Nebraska	40	MEXICO	54
Nevada	49		

The state maps of the United States are arranged in a geographical order from east to west. It is the density of FM cities which generally determines the scale used for each state, and whether or not that state is to be grouped with its neighboring states. Selected FM cities in bordering states are noted on the individual state maps.

For information concerning station call letters, programming, stereo capability, vertical polarization, power and heights, refer to the Station Directories immediately following the FM Atlas maps.

KEY TO SYMBOLS for the maps and Station Directories is on p. 14.

Stations scheduled to change to a different frequency are shown on the maps, with both the new and old frequencies given. This information is given on the maps only, and not in the station directories. Minor, ten-watt educational stations and FM translators, as well as low-power Canadian stations, are shown in reduced size. On page 110 is a list of FM stations having their programs on translators. By referring to this alphabetical list, you can quickly tell in what town and state the primary station for each translator is located.





# MAINE NEW HAMPSHIRE VERMONT

CANADA  
[See p. 53]

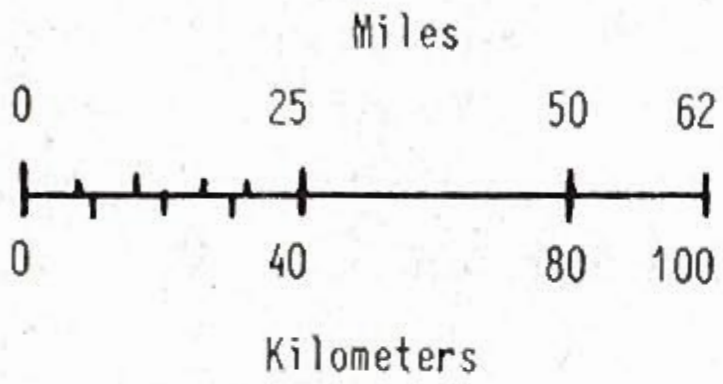

Eastern Time Zone  
Daylight Savings Time Observed

Eastern Standard Time / Atlantic Standard Time  
New Brunswick

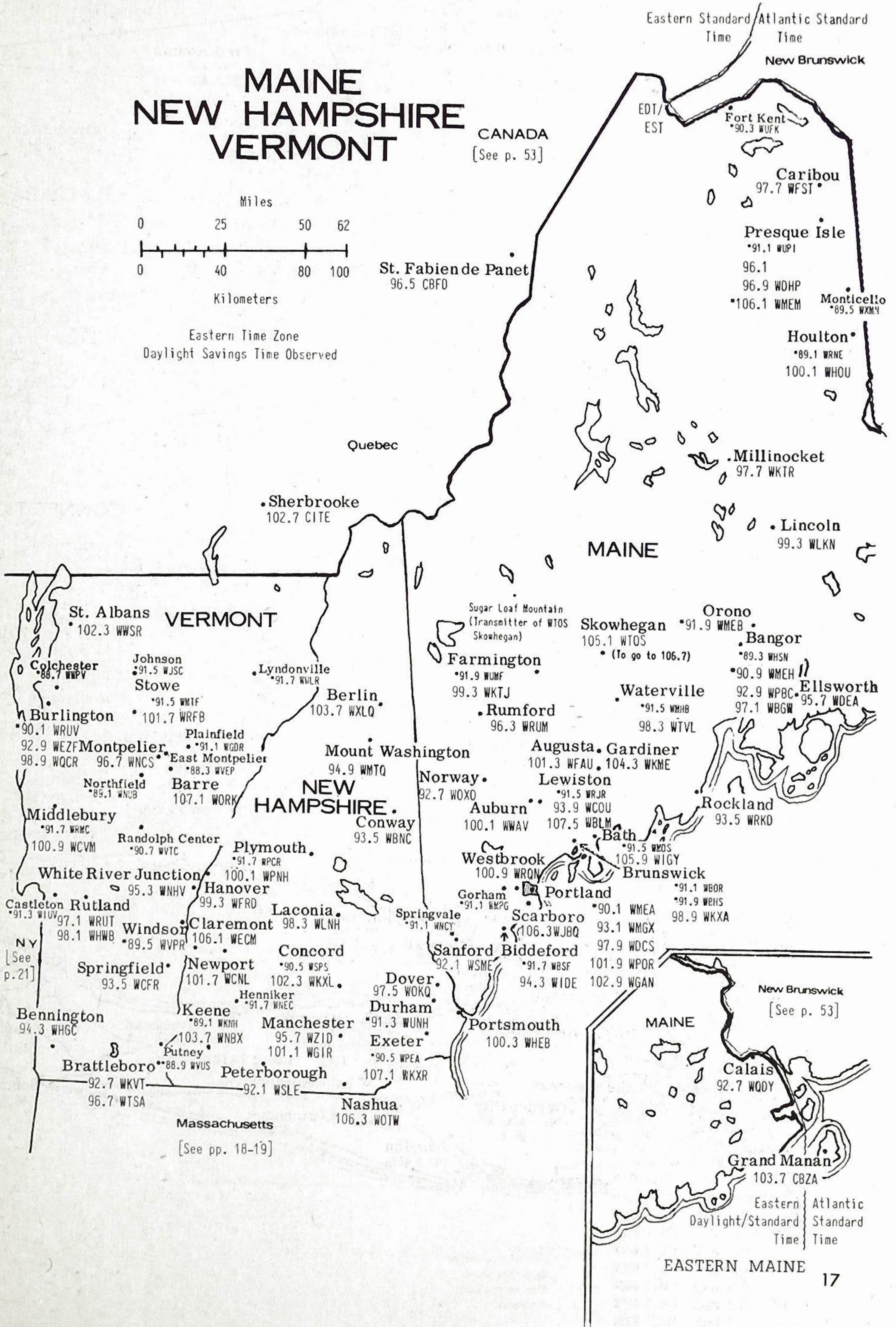

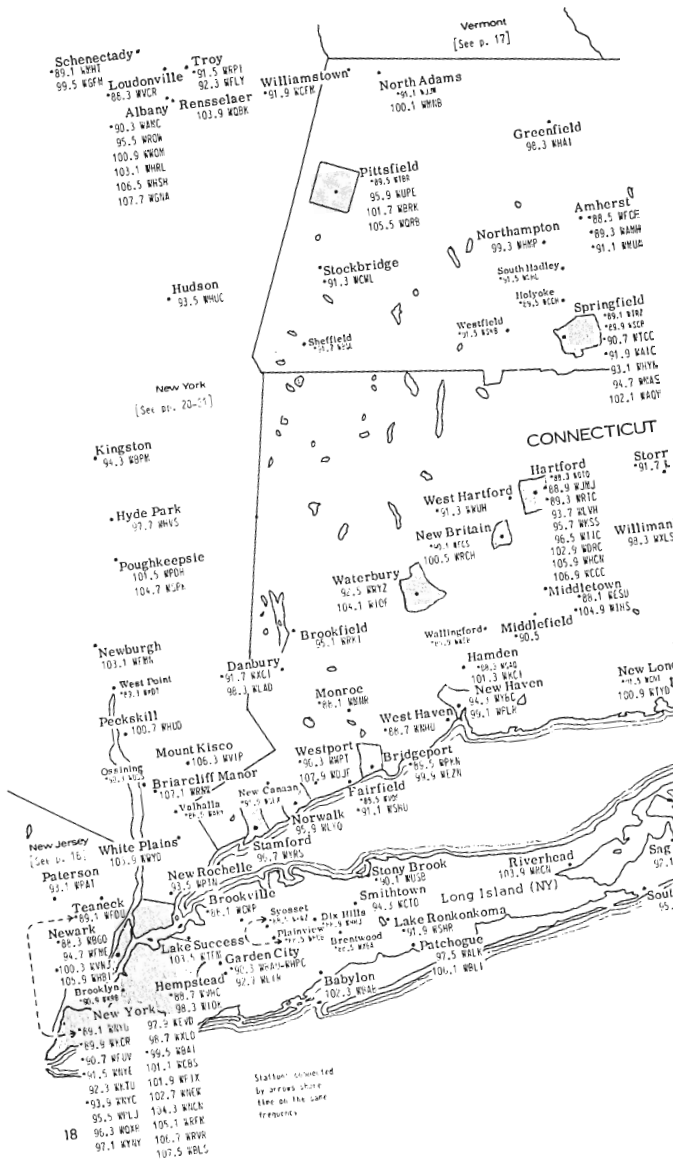

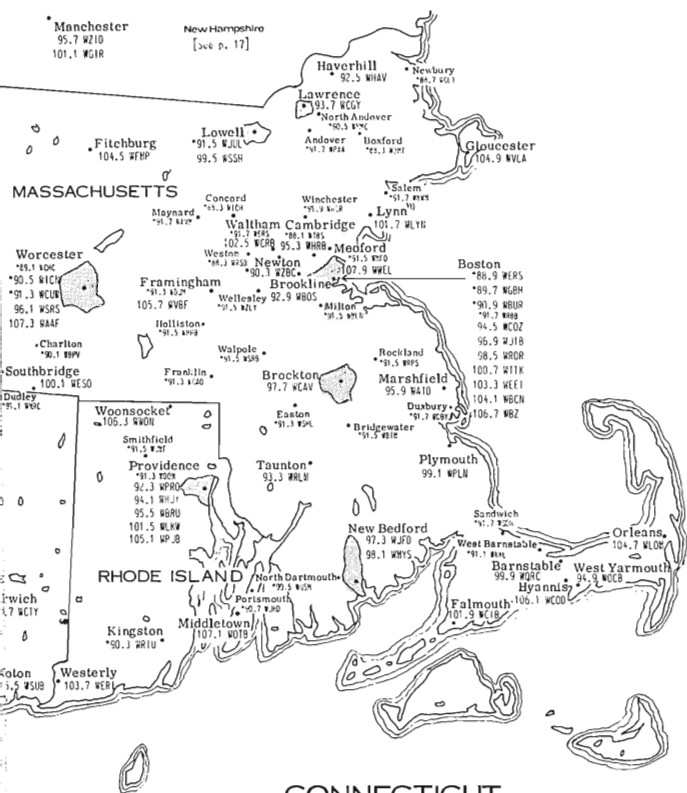

Eastern Time Zone/Daylight Savings Time Observed

# NEW YORK

[Except New York city area and Long Island, which are grouped with Connecticut, pp. 18-19 ]

# PENNSYLVANIA

Eastern Time Zone/Daylight Savings Time Observed

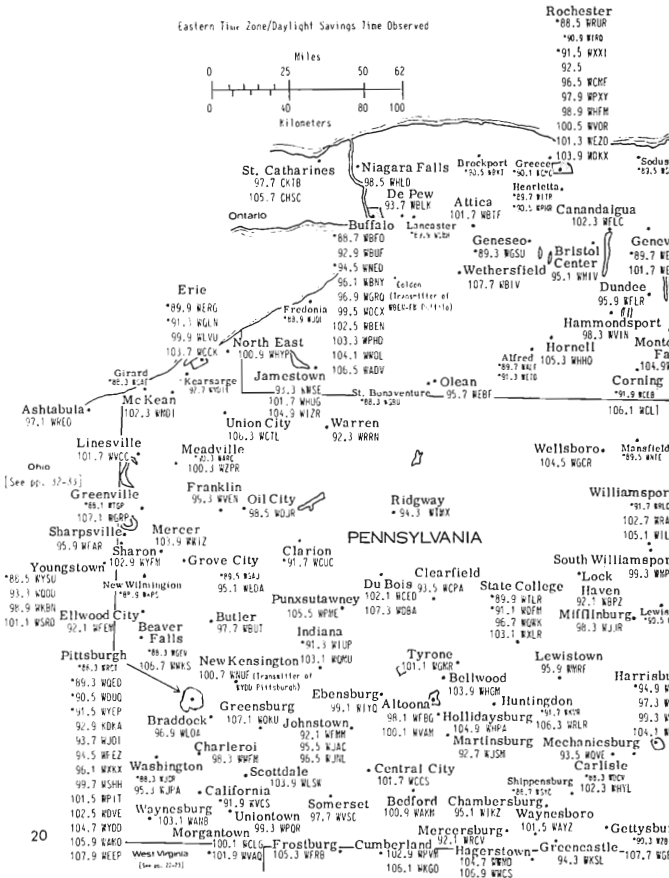
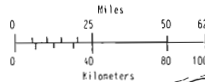

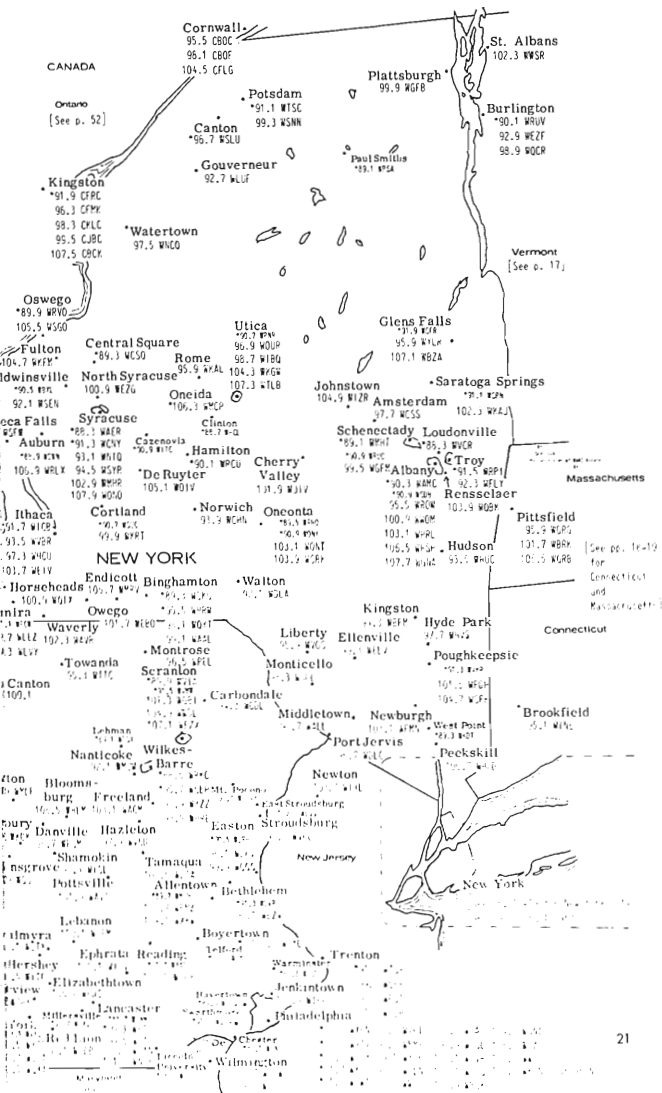



# WASHINGTON-BALTIMORE AREA

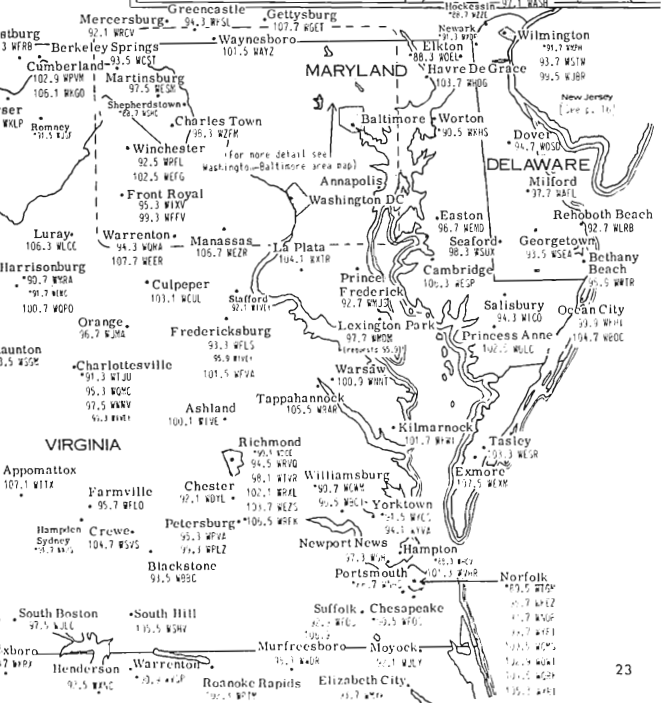
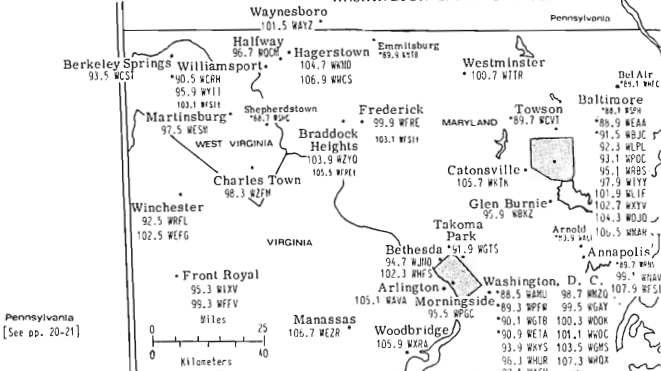



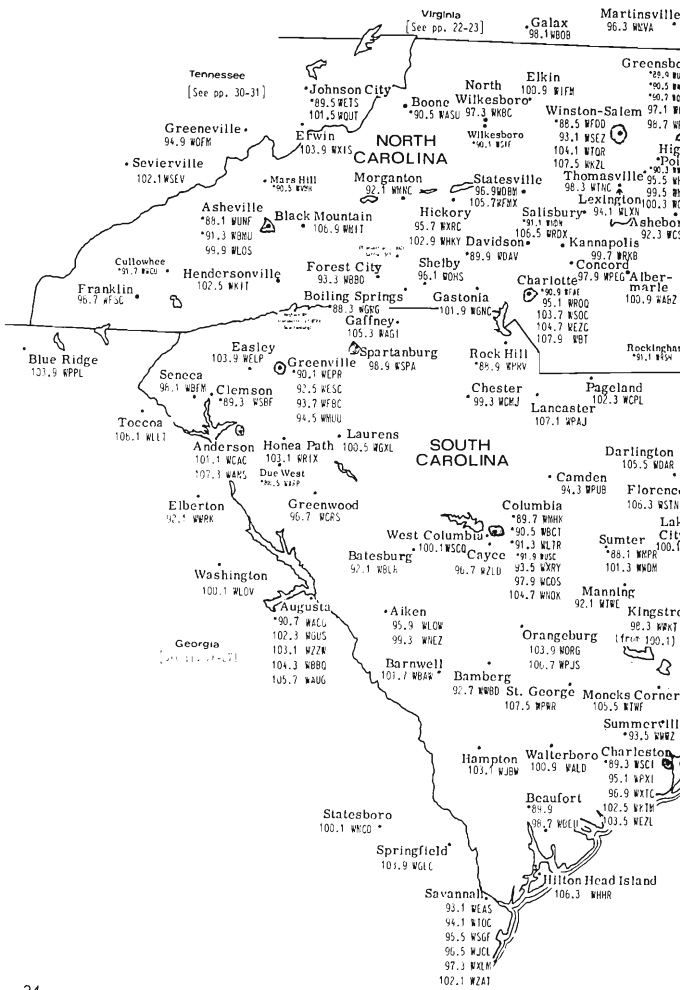

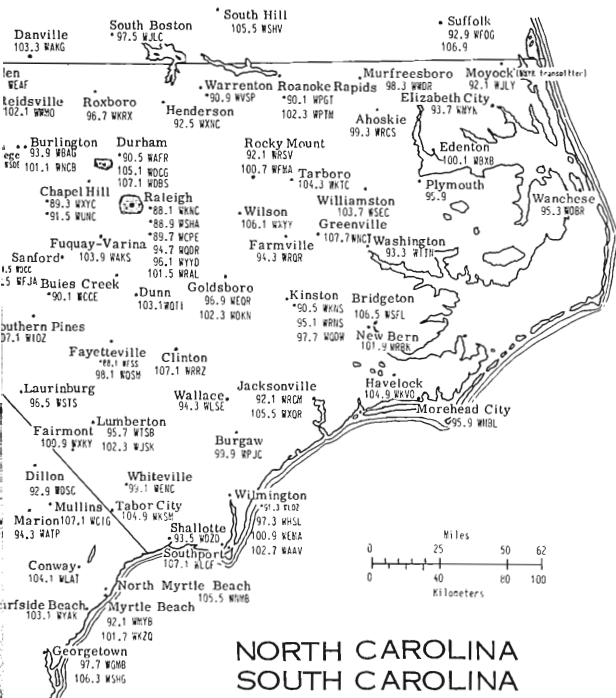

# NORTH CAROLINA SOUTH CAROLINA

Eastern Time Zone/Daylight Saving Time Observed

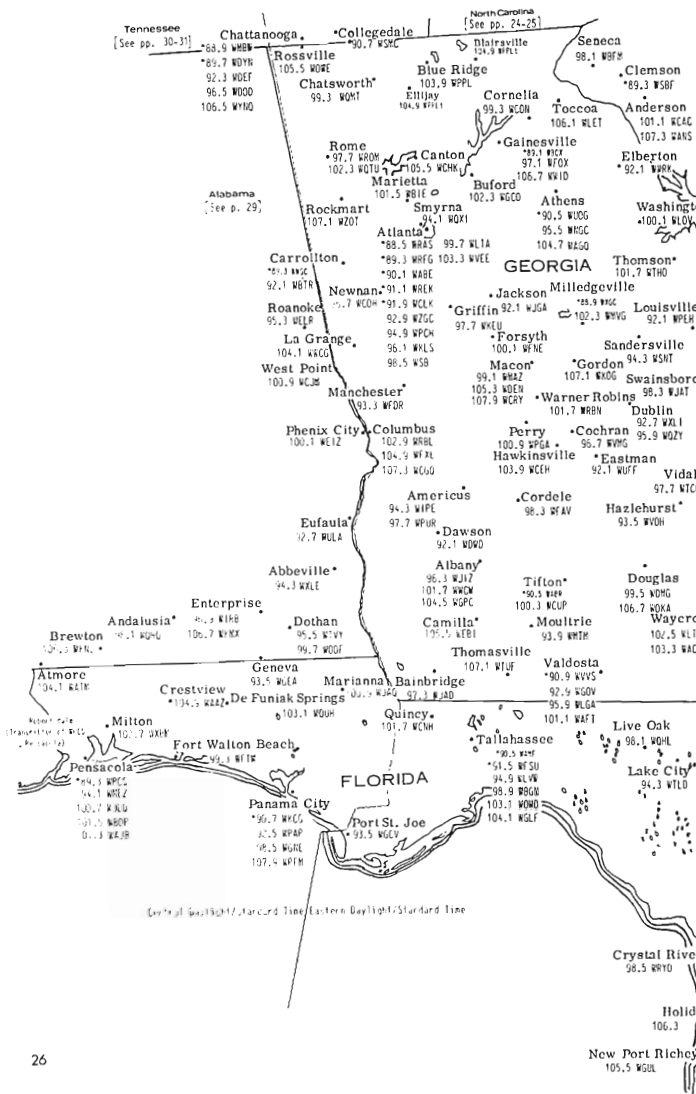

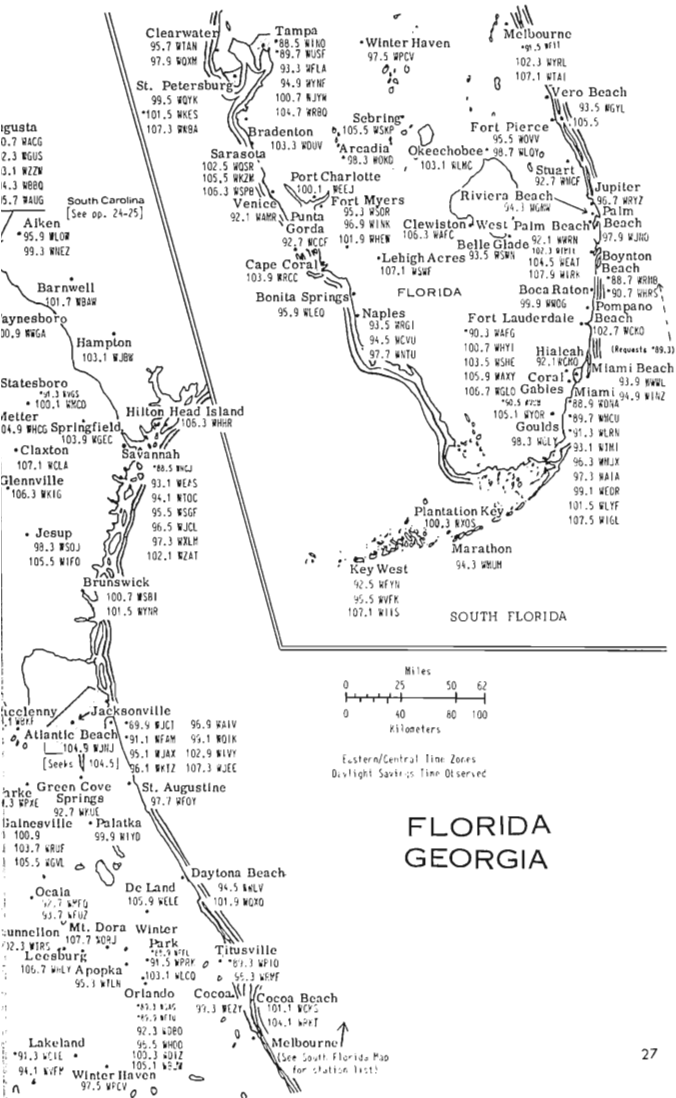

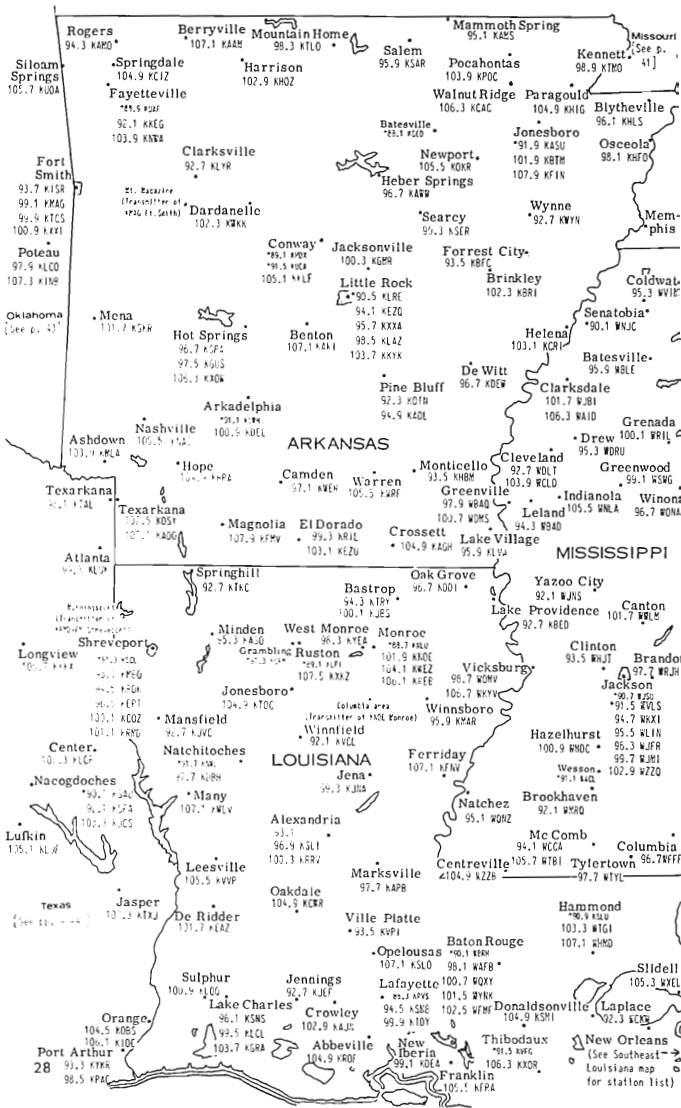

# ALABAMA ARKANSAS LOUISIANA MISSISSIPPI

Central Time Zone  
Daylight Savings Time Observed

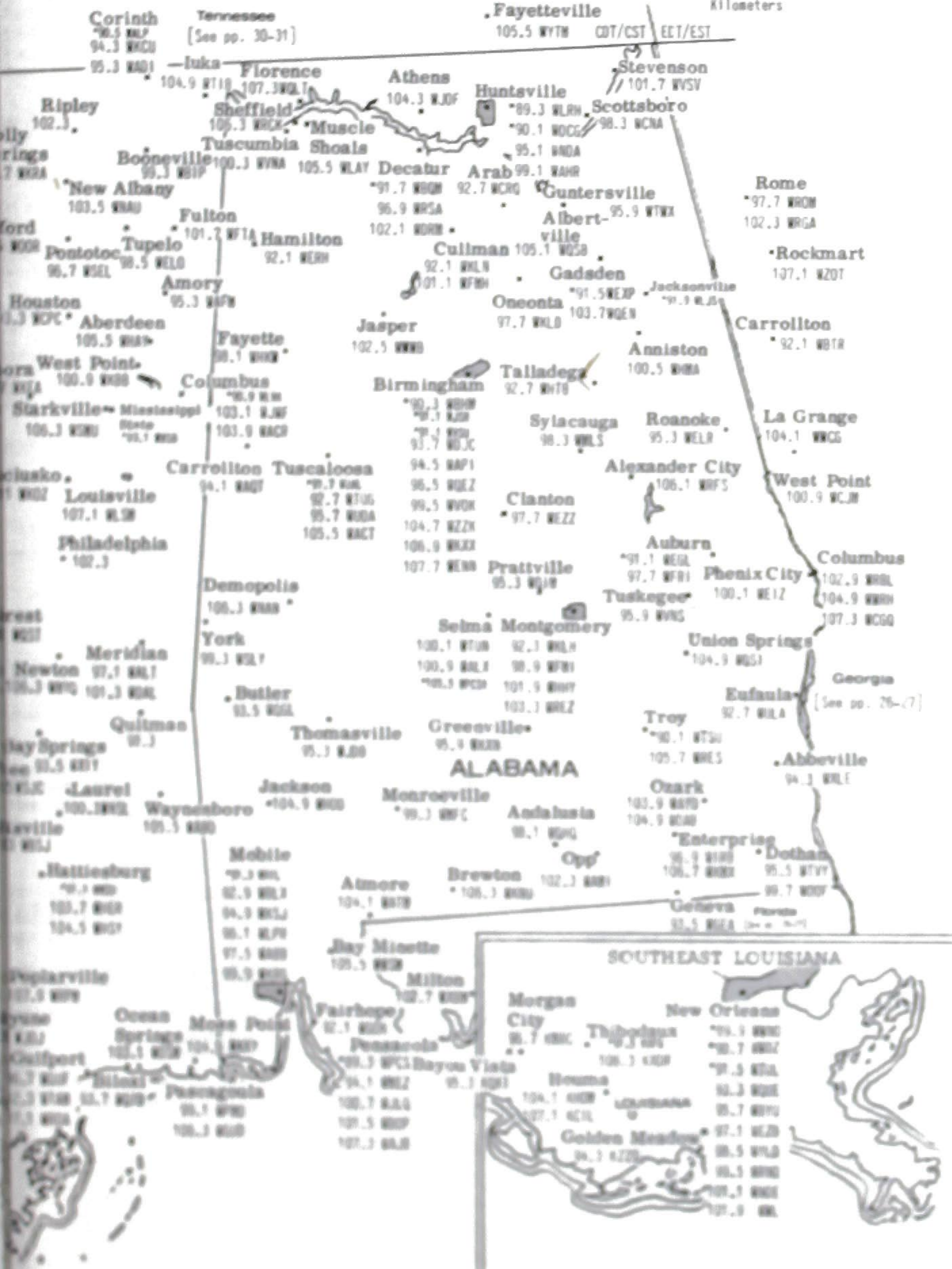
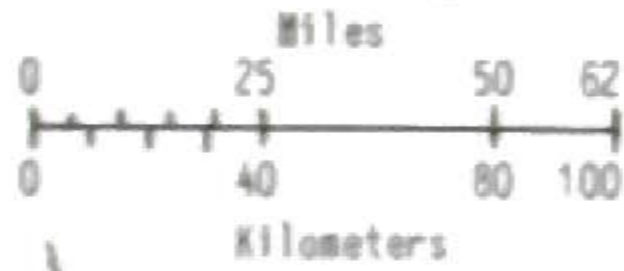

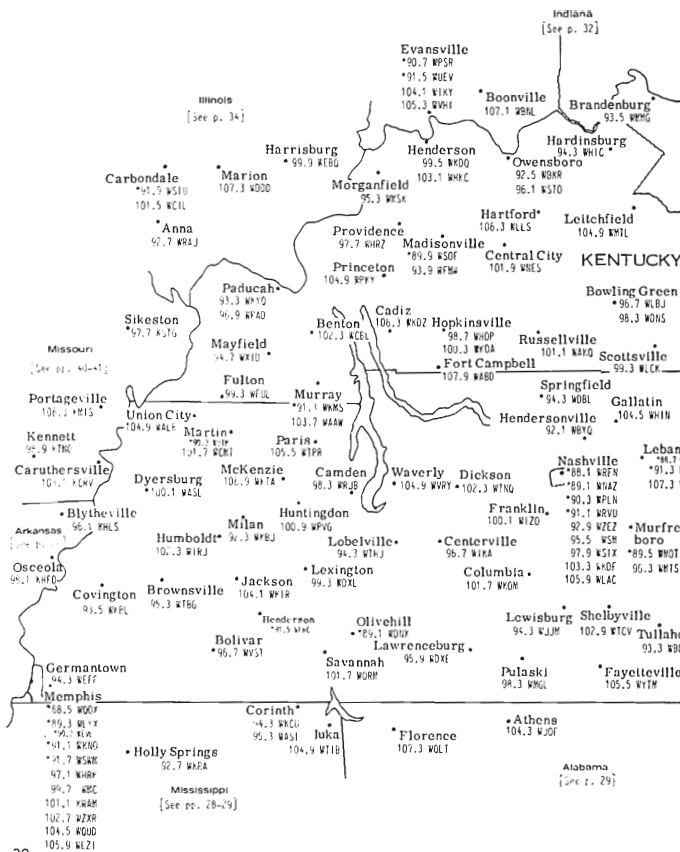

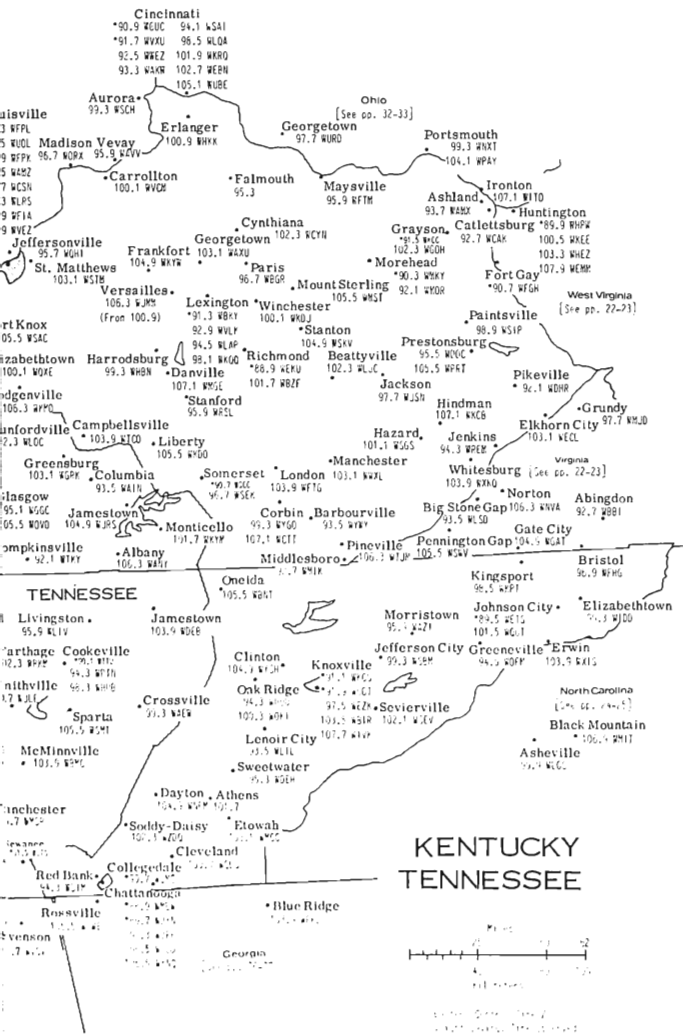



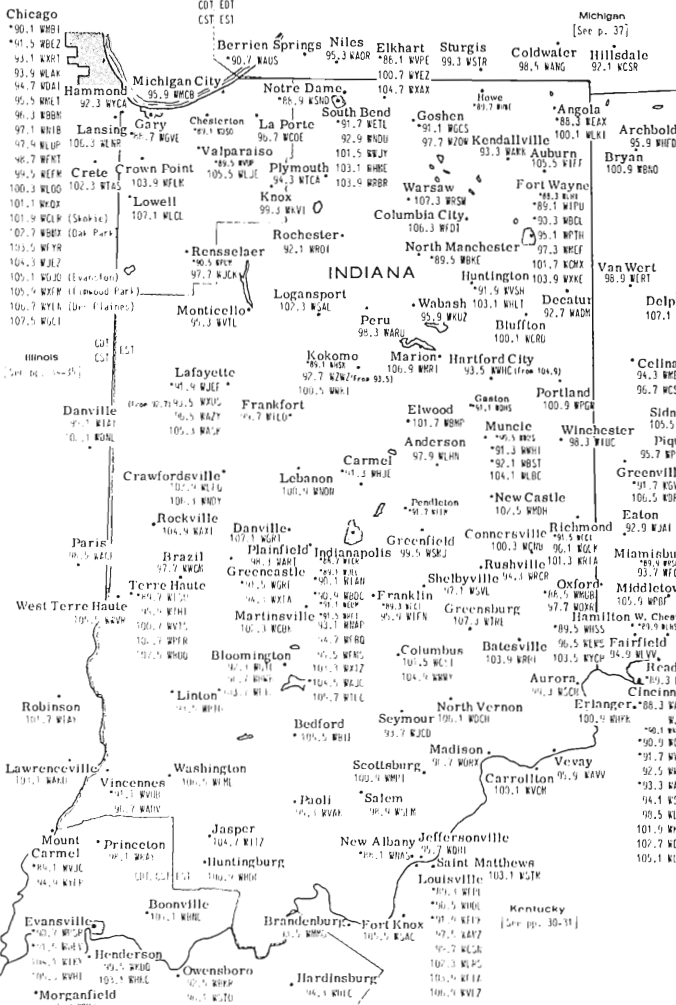

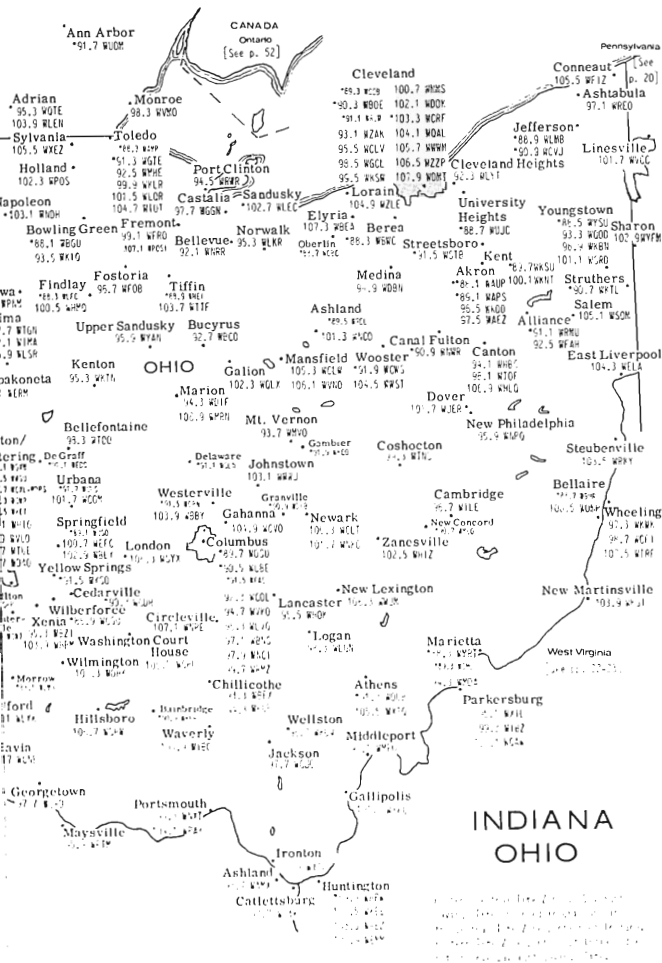

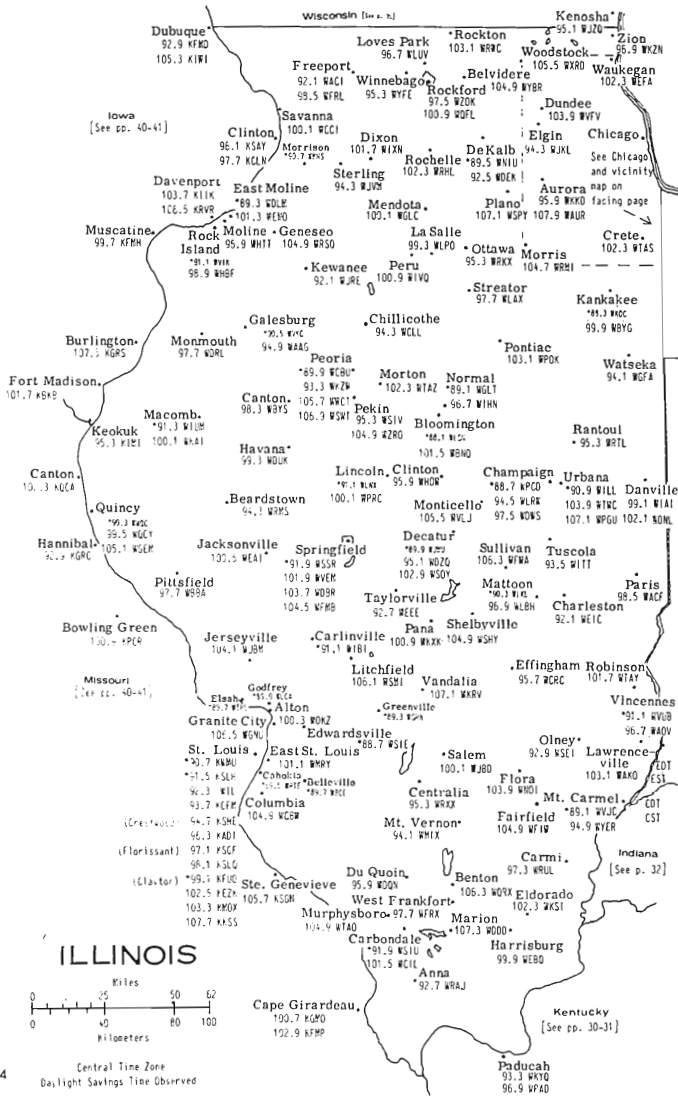

# CHICAGO AND VICINITY

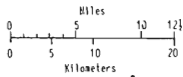

Showing FM transmitter locations when different from the station's city of license.

Central Time Zone. Daylight Savings Time Observed.

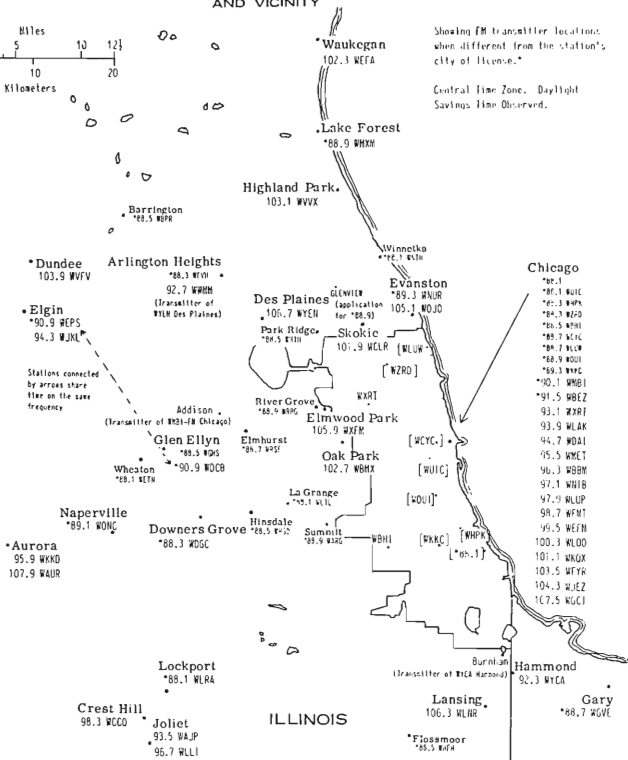

**\*Transmitters in Chicago's loop (downtown):**

[WUIC *88.1 601 S. Morgan]	(Skokie) WCLR 101.9 Sears Tower
[WYUC *86.7 304 W. Randolph]	(Oak Park) WBMX 102.7 Hancock Center
WBEZ *91.5 105 W. Adams	WYFR 103.5 Prudential Building
WLAK 93.9 Sears Tower	WJZZ 104.3 Prudential Building
WDAI 94.7 Hancock Center	(Evanston) WJJO 105.1 Hancock Center
WNET 95.5 Hancock Center	(Elmwood Park) WYFR 105.9 Sears Tower
WBBM 96.3 Hancock Center	WGCI 107.5 Keeper Building
WJMB 97.1 Standard Oil Bldg.	<b>Transmitters of other Chicago-licensed Stations:</b>
WLUP 97.9 Hancock Center	{ *88.1 6946 S. Constance Avenue}
WFTM 98.7 Hancock Center	[WHPK *88.3 University of Chicago
WEPN 99.5 Hancock Center	[WZRD *88.3 NE Illinois University
WLOD 100.3 Hancock Center	[WBHI *88.5 3939 West 79 Street]
WJGX 101.1 Hancock Center	[WLUR *88.7 Loyola University]
	[WJOL *88.9 IL Inst. of Technology]
	[WJZZ *89.3 Kennedy-King College]
	[WJMI *90.1 Addison, IL
	[WXRT 93.1 4549 W. Belmont

[ ] Indicates a ten-watt station which does not serve the entire city.

**Morris**  
104.7 WRM

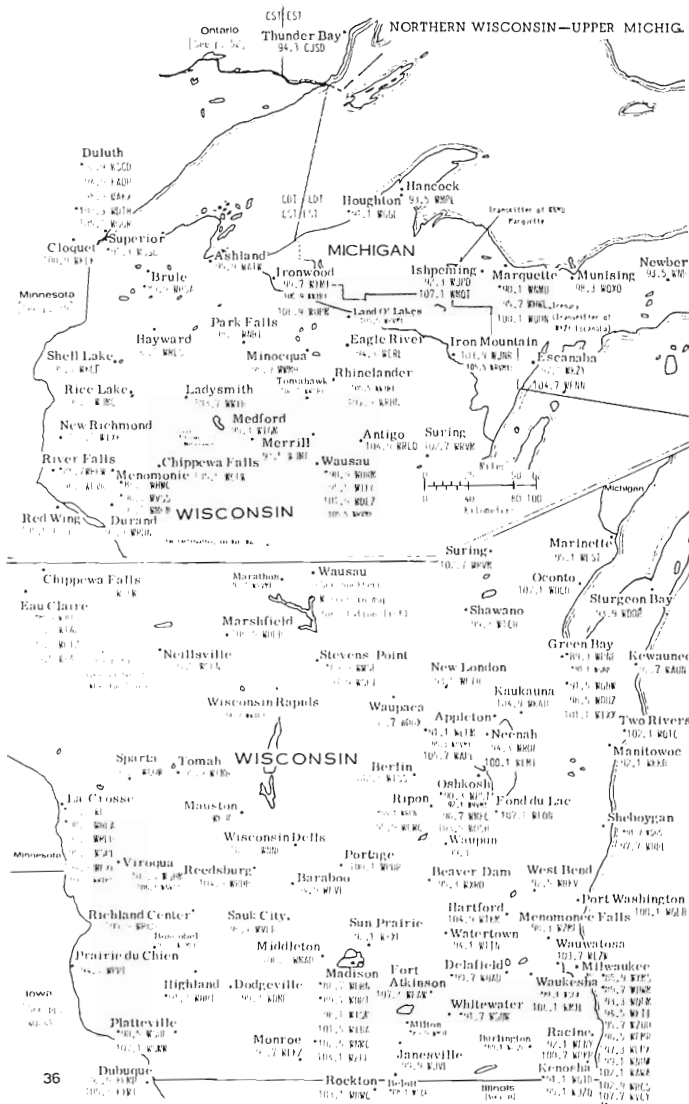

# MICHIGAN WISCONSIN

CANADA  
[See p. 52]  
Ontario

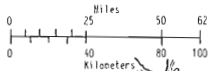

## DETROIT AREA

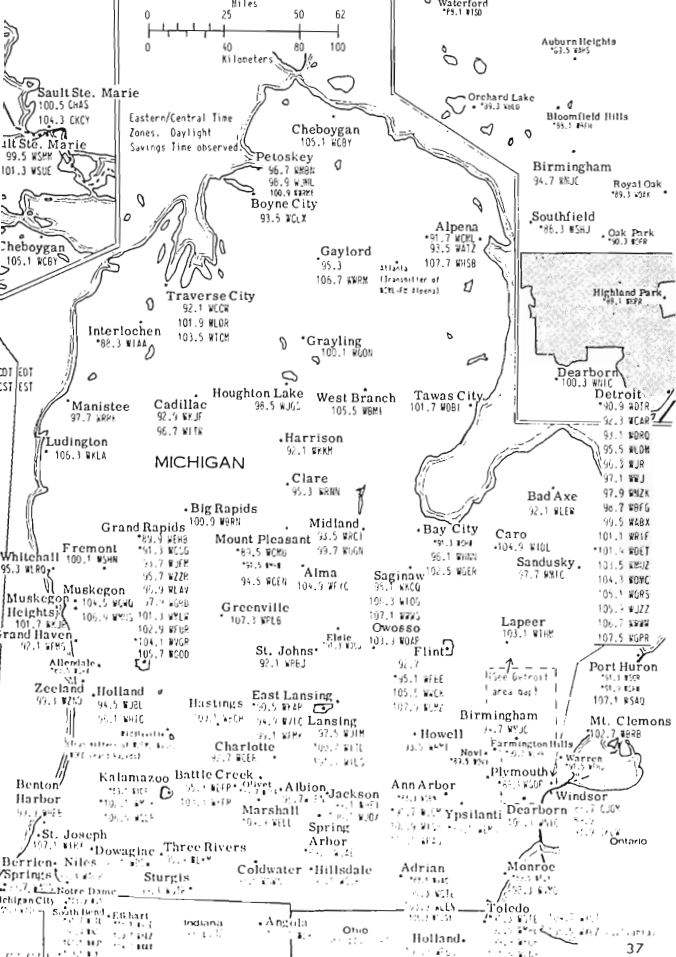
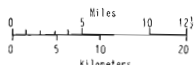

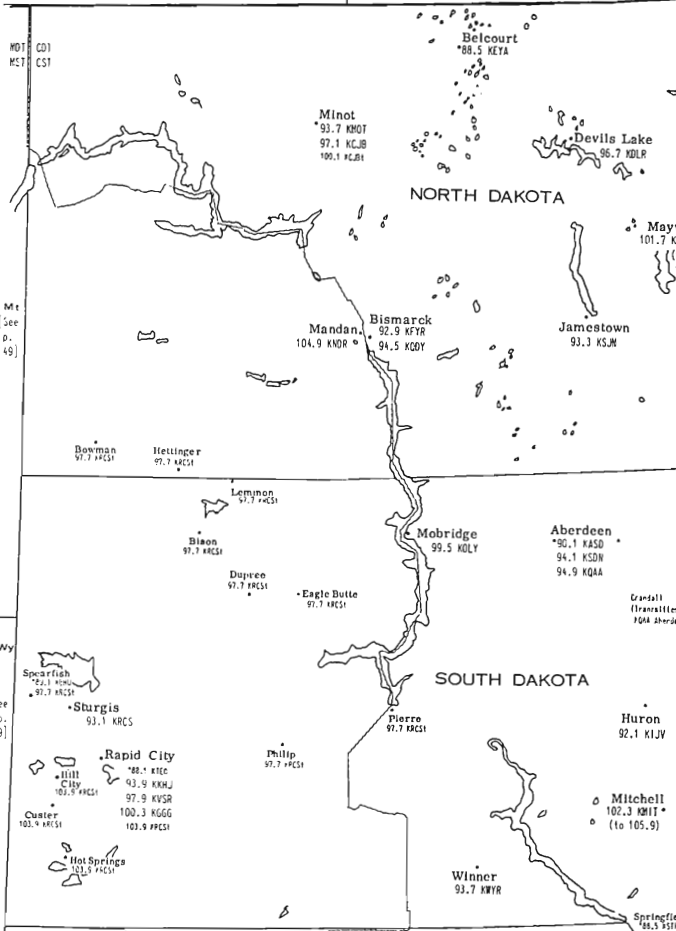

MDT  
CST

Me  
(See  
p. 49)

Wy  
(See  
p. 49)

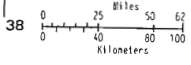

Nebraska [See p. 40]  
Mountain  
Daylight/Standard Time Central Daylight/Standard Time

Central/Mountain Time Zones  
Daylight Savings Time Observed

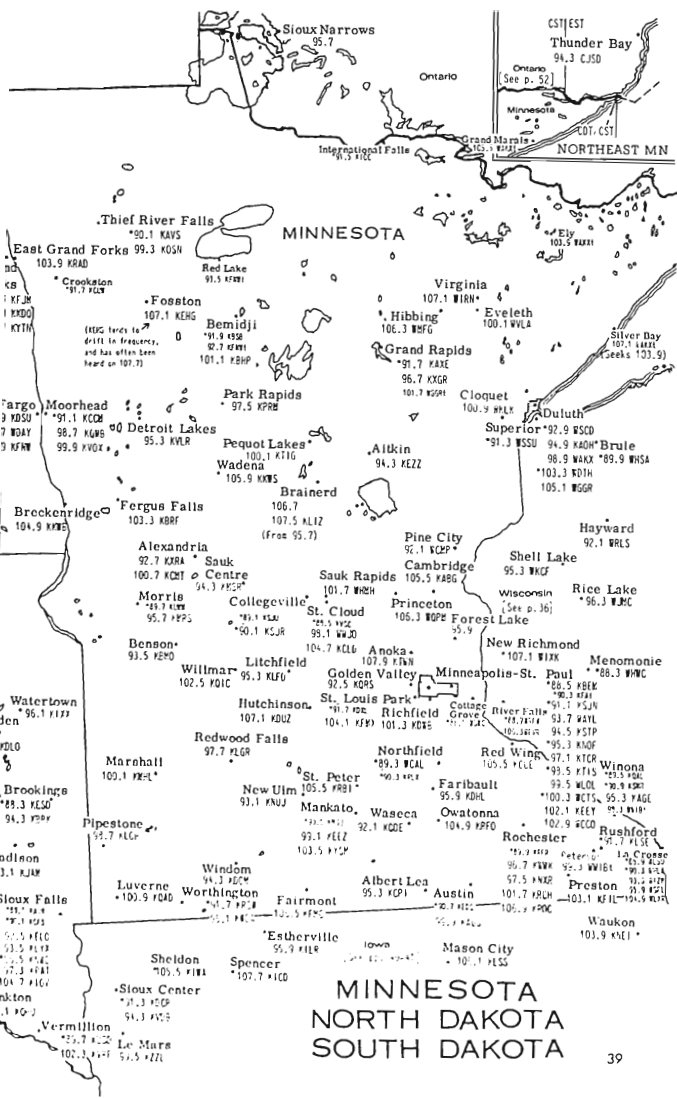

# MINNESOTA NORTH DAKOTA SOUTH DAKOTA





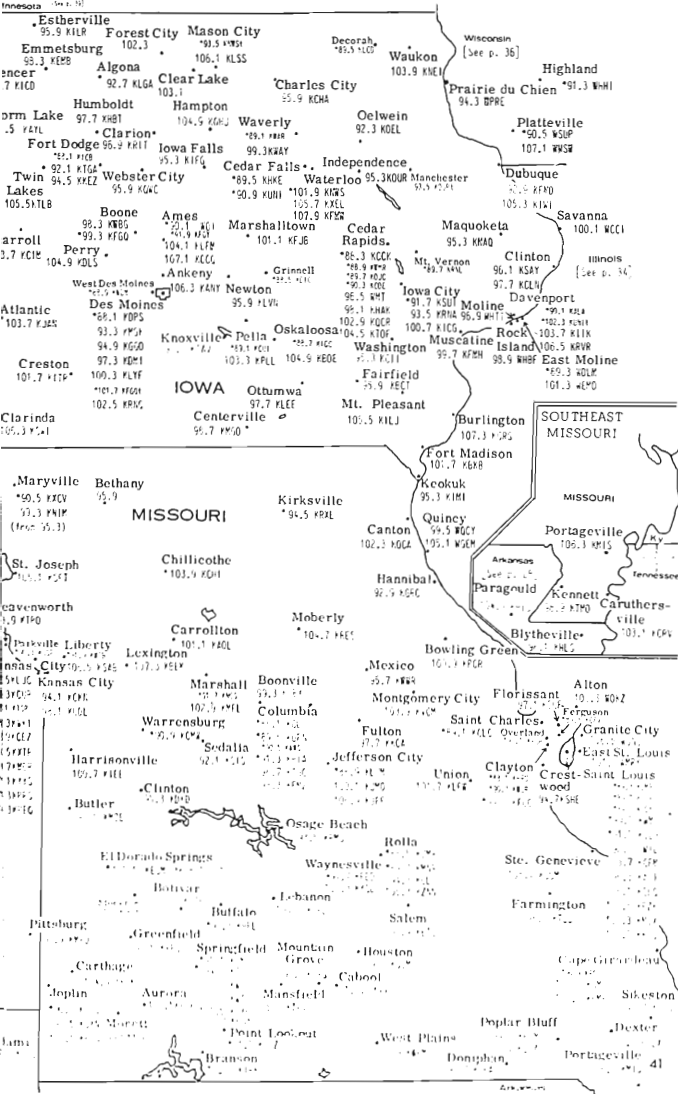

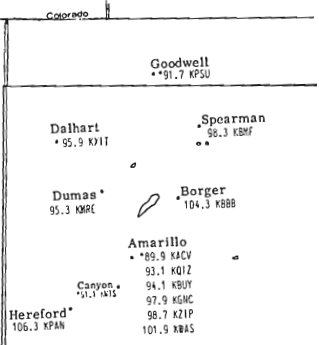
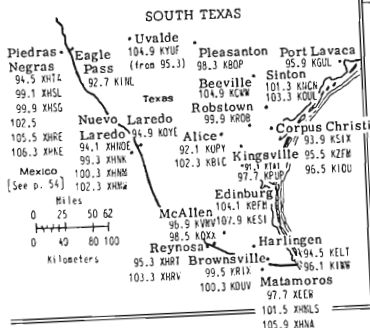

**OKLAHOMA TEXAS**

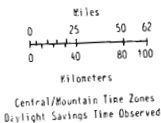

Mountain Daylight/Standard Time Central Daylight/Standard Time

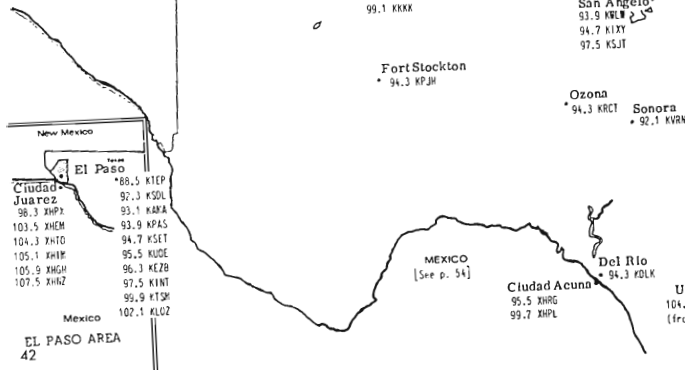



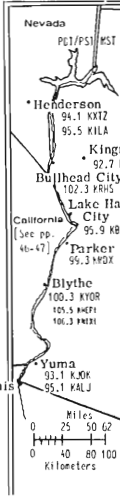
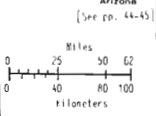
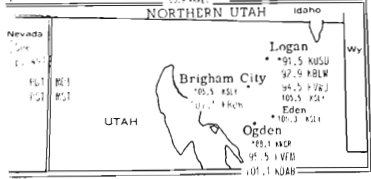
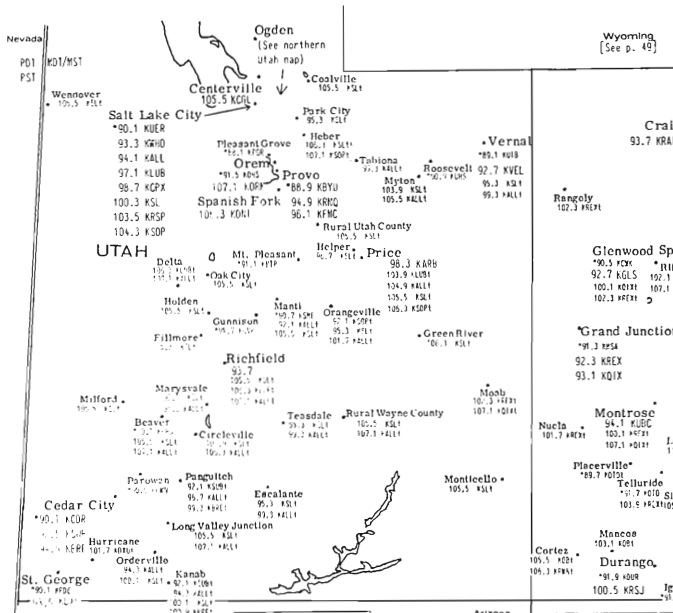

**ARIZONA  
COLORADO  
NEW MEXICO  
UTAH**

Mountain time zone  
Daylight Savings time observed in Colorado, New Mexico and Utah  
Arizona does not observe Daylight Savings time

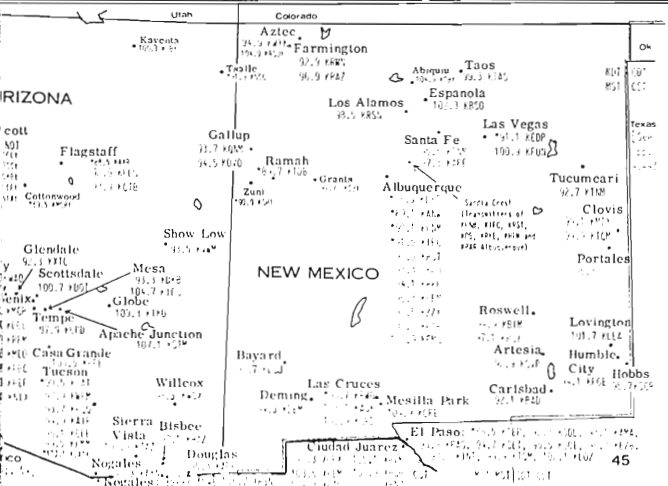
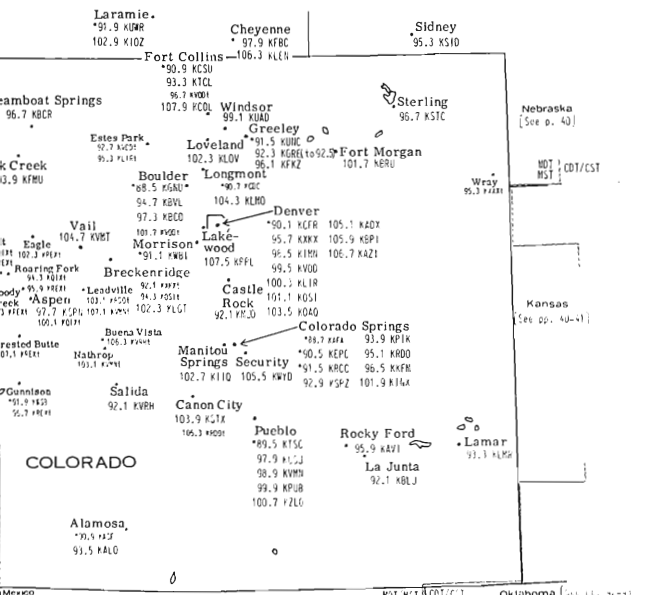

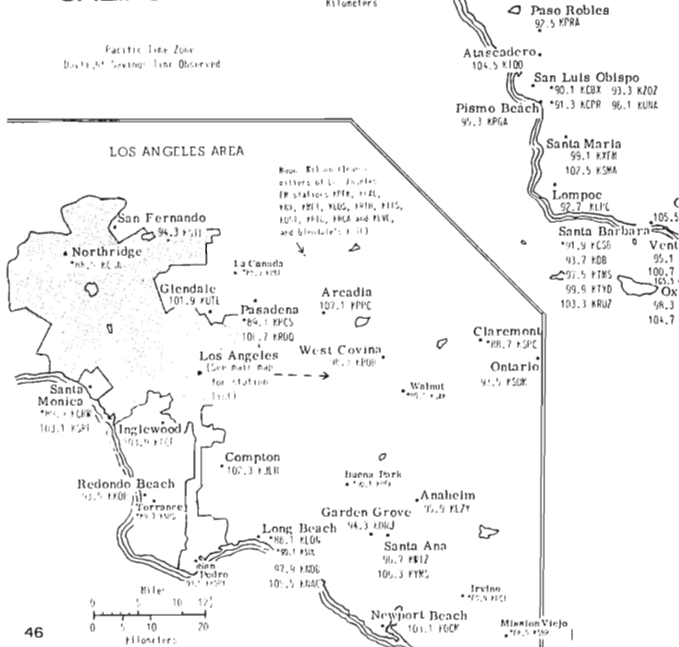
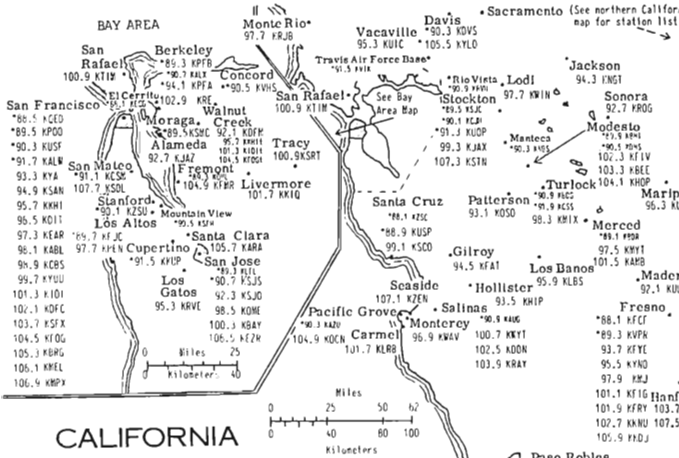

NORTHERN CALIFORNIA

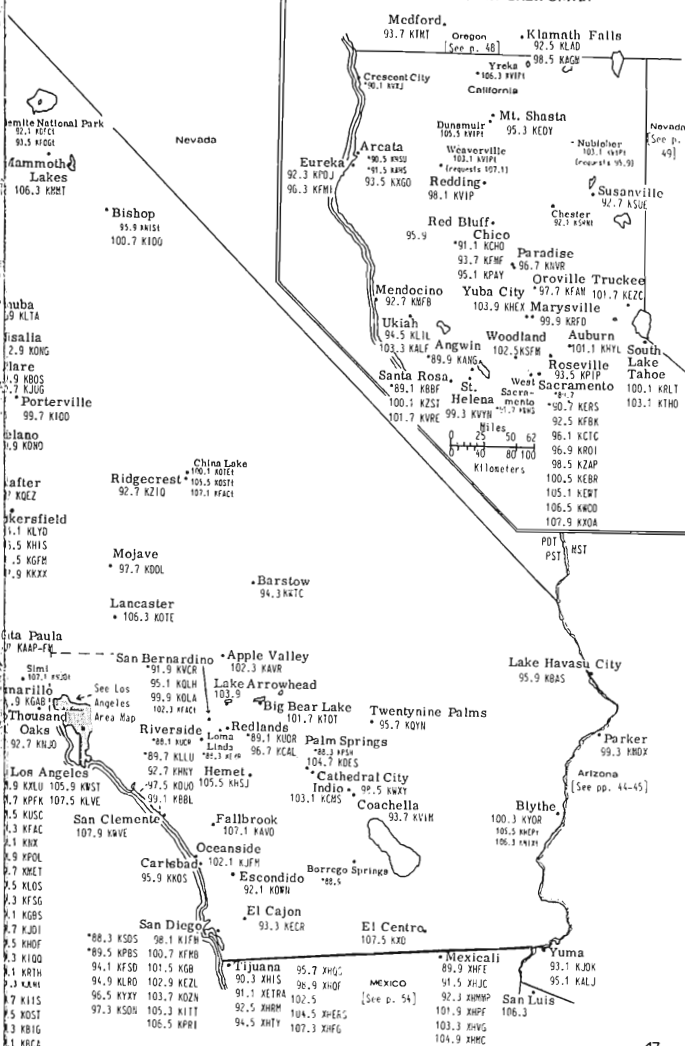





HAWAII [U. S. A.]

- Wailua Kailua
- Waipahu 92.3 KULA
- Honolulu 92.3 KHNL
- Rainia 93.1 KHNL
- Wailuku 95.7 KXOI
- Hilo 97.1 KFSS
- 96.3 KKA1
- 92.7 KHNL
- 93.9 KHNL
- 94.7 KUMU
- 95.5 KAIR
- 97.5 KHSS

Miles  
0 25 50 62  
Kilometers  
0 40 80 100

Time in Hawaii is the same as Alaska, Universal Coordinated Time (UTC) minus 10 hours, or 10 hours earlier than Pacific Standard Time. Daylight Savings Time not observed.

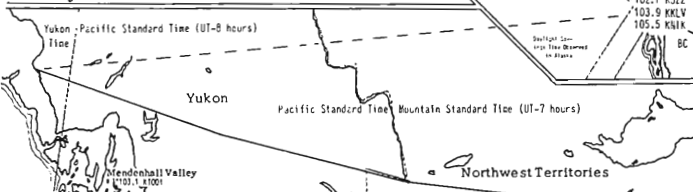
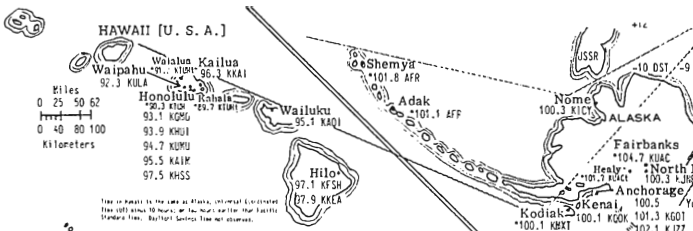

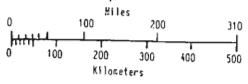
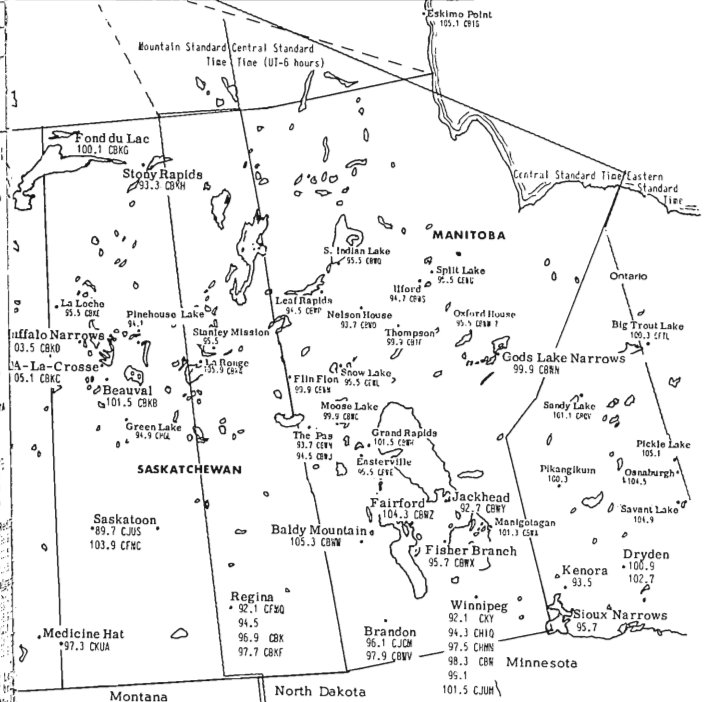
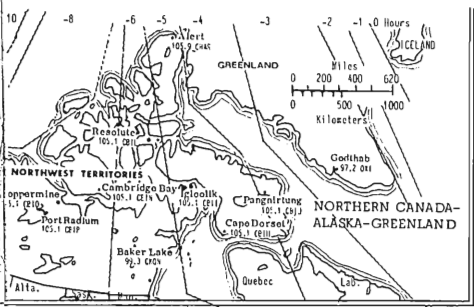

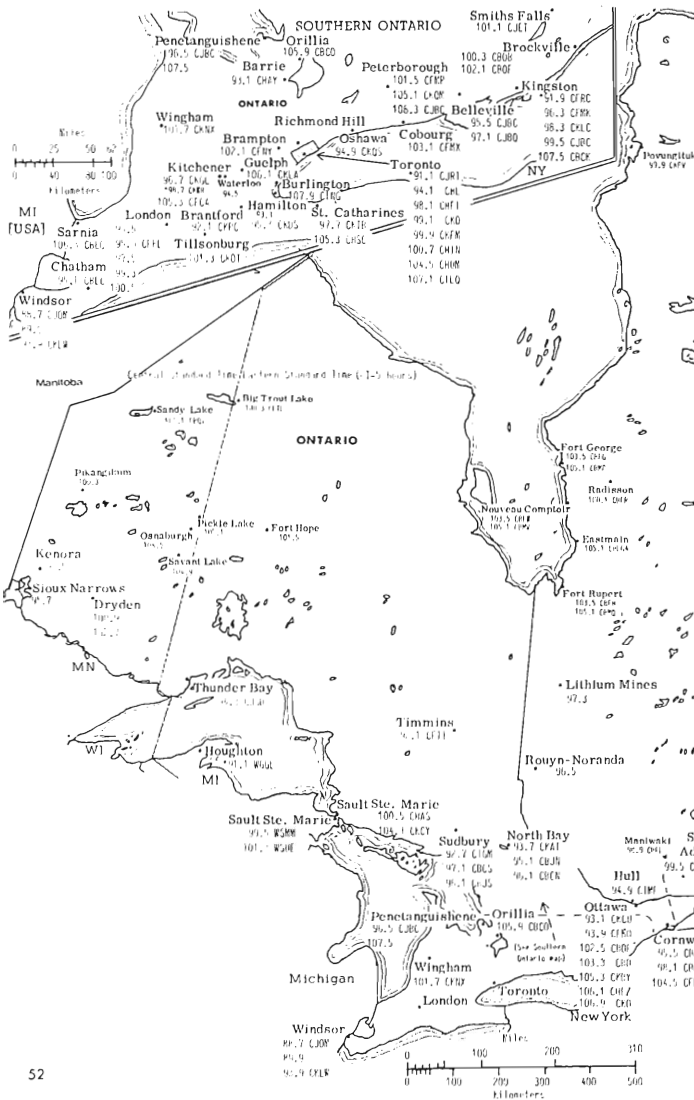

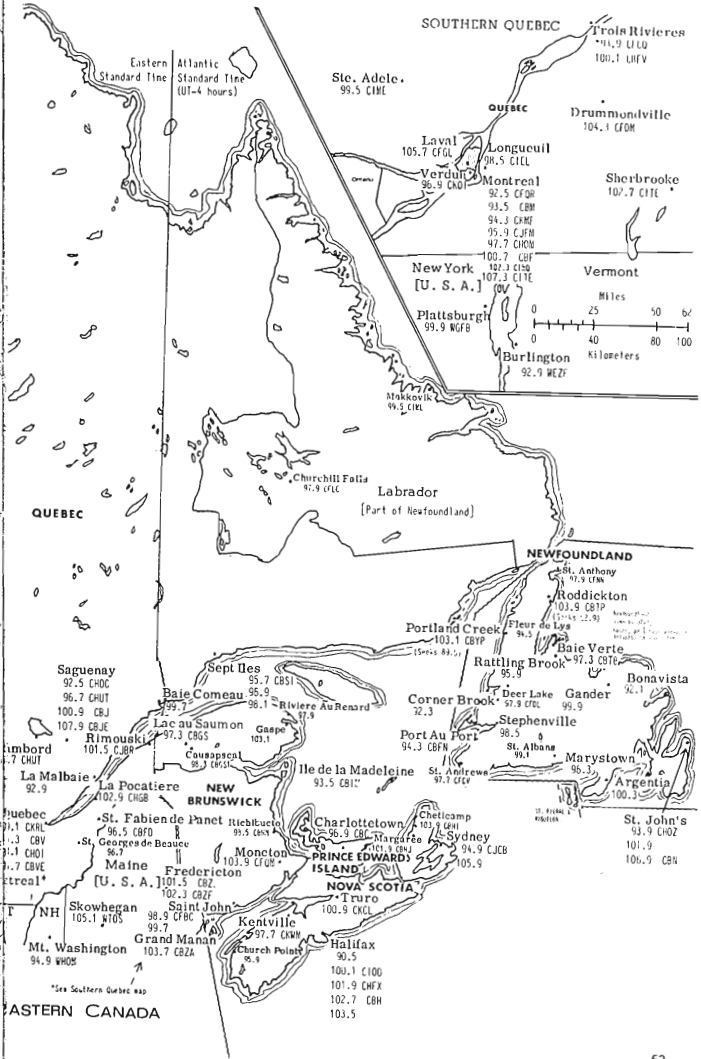



# STATION DIRECTORY

Part I: FM Stations Listed Geographically. KEY TO SYMBOLS is on page 14.

## UNITED STATES OF AMERICA

Alabama		(MAP P. 29)
Abbeville	k 94.3 WXLX \$v I	15 45
Albertville	r 105.1 WOSB \$v +T	23 60
Alexander City		
	k 106.1 WRFS-FM \$ Y	15 46
Andalusia	r 96.1 WRHQ \$v Y+A	20 57
Anniston	n 100.5 WHMA-FM \$v A+M	33 73
Arab	92.7 WCRO v	15 45
Athens	mk 104.3 WJOF v	34 75
Atmore	m 104.1 WATM-FM	19 56
Auburn	p 91.1 *WREG	8 29
	r 97.7 WFR1 \$v E	11 38
Bay Minette	s 105.5 WBSM U	15 46
Birmingham	c 90.3 *WBHM \$v P+	37 79
	r 91.1 *WJSR-WVSU	2 9
	g 93.7 RDJZ \$v	38 82
	r 94.5 WAPI-FM \$v N	44 90
	m 96.5 WDEZ \$v	43 89
	r 99.5 WVOK-FM v	43 89
	k 104.7 KZZK \$v A+M	31 75
	r 106.9 WXXX \$v	40 83
	s 107.7 WERN-FM v B+	39 83
Brewster	kr 106.3 WKNV v	15 46
Buller	mk 93.5 WQGL v	15 46
Carrollton	m 94.1 WQOT \$v	33 76
Clanton	n 97.7 WEZZ	13 42
Cullman	n 92.1 WKLN \$	12 40
	km 101.1 WFMH-FM	31 74
Decatur	g 91.7 *WBGM \$v	15 46
	m 96.9 WRSA \$v +	42 87
	m 102.1 WDRM \$ A	24 70
Demopolis	m 106.3 WHAN v	12 40
Dothan	k 95.5 WTVY-FM \$v A	46 92
	k 99.7 WDOF-FM \$v C+M	32 76
Enterprise		
	r 96.9 WIRB-FM \$v I	30 74
	r 106.7 WKKX \$v S+M	34 79
Eufaula	kr 92.7 WULA-FM v M	7 30
Fairhope	s 92.1 WGOX-FM \$v Z+	15 46
Fayette	k 98.1 WKKW \$v	32 76
Florence	r 107.3 WDLT \$ A+	40 84
Gadsden	cr 91.5 *WXPX \$v	8 30
	r 103.7 WQEN \$v Y	46 92
Geneva	rk 93.5 WGEA-FM v	12 40
Guntersville	k 95.9 WTWX A	15 46
Hamilton	mk 92.1 WERH-FM v	10 38
Hurtsville		
	c 89.3 *WLRH v P-TB42-	87
	90.1 *WOCG v	21 68
	gc 95.1 WINDA \$v	17 58
	p 99.1 WAHR \$v A+	37 81
Jackson	kr 104.9 WRDQ-FM N	15 45
Jacksonville	91.9 *WJLS	2 9
Jasper	k 102.5 WNRB-FM \$v	18 56
Mobile	91.3 *WHIL	2 9
	s 92.9 WBLX \$v B	31 71
	k 94.9 WKSJ-FM \$v I	34 78
	m 96.1 WLPR \$ +M	36 80
	r 97.5 WABB-FM \$v Y	35 79
	rm 99.9 WKRQ-FM \$v A+C	42 86

Monroeville	m 99.3 WMFC-FM \$ I	14 44
Montgomery		
	r 92.3 WKHL \$v A+M	37 79
	m 98.9 WFMI \$v C+M	15 49
	r 101.9 WHHY-FM \$v Y+M	40 85
	m 103.3 WREZ \$ M+M	23 60
Muscogee Shoals		
	mr 105.5 WLAY-FM \$v M+M	15 46
Oneonta	m 97.7 WMLD M	14 45
Opp	mr 102.3 WAMI-FM \$v	15 45
Ozark	k 103.9 WAYO-FM v	12 40
	k 104.9 WQAB	12 39
Phenix City	m 100.1 WE1Z \$v	15 46
Prattville	r 95.3 WQIM +	13 42
Roanoke	mr 95.3 WELR-FM v	15 46
Scottsboro	k 98.3 WENA \$v E	15 46
Selma	k 100.1 WTUN v M+M	15 46
	m 100.9 WMLX \$v +	15 46
	g 105.5 *W2BAG \$ WPCS	89.3t
Sheffield	kr 106.3 WRCK v M	7 30
Stevenson	k 101.7 WVSU v	15 44
Sylacauga	kr 98.3 WMLS-FM	5 22
Talladega	rm 92.7 WHTB \$v	14 44
Thomasville	rm 95.3 WJOB-FM v	15 46
Troy	m 90.1 *WTSU \$v	26 66
	kr 105.7 WRCS \$v	34 78
Tuscaloosa	r 91.7 *WUAL \$	2 9
	rm 92.7 WTUG-FM v	15 45
	mr 95.7 WUOI \$v	27 67
	k 105.5 WACT-FM \$ U	7 2R
Tuscumbia	mk 100.3 WUNA-FM \$v	28 72
Tuskegee	s 95.9 WVNS \$v B	14 46
Union Springs		
	r 104.9 WQSI v	14 44
York	m 99.3 WSLY \$v	15 46
Alaska	(MAP P. 50)	
Adak	m 101.1 *AFR-FM \$	5 10
Anchorage	g 100.5 v	8 28
	pr 101.3 KGOT \$v M	8 29
	j 102.1 KJZZ \$v	19 56
	rm 103.9 KKLK \$ S	6 24
	mc 105.5 KNIK \$ +	14 44
Fairbanks		
	c 104.7 *KUAC \$v P+	23 59
Healy	c 101.7 *K269AD \$ KUAC	104.7t
Juneau	ce 104.3 *KT00 \$	2 9
Kenai	k 100.1 KQOK v	12 39
Ketchikan	105.9 *KRBD \$ P	2 9
Kodiak	100.1 *KMXT \$v	5 17
Mendenhall Valley		
	ce 103.1 *K276AF \$ KT00	104.3t
Nome	m 100.3 KICY-FM \$v	2 18
North Pole	c 100.3 KJNP-FM \$v	44 88
Petersburg	100.9 *KFSK \$v	2 9
Shetya	101.8 *AFR-FM \$	8 35
Sitka	r 100.1*	2 9
Wrangell	101.7 *KSTK	2 9
	101.7 *KSTK	2 9

Arizona		(MAP PP. 44-45)
Apache Junction		
	r 107.1 KSTM v	5 17
Bisbee	92.1 KRAZ v	15 48
Bullhead City		
	mk 102.3 KRHS	5 17
Casa Grande	k 105.5 KBFE \$v M	7 2R
Collonwood	n 89.5 *K206AA \$ KMCR	91.5t
Occulug	n 95.3 KAPR-FM	5 22
Flagstaff	nc 88.5 KAXR	2 9
	pr 92.9 KFLG \$v Y+	47 95
	g 92.9 KCTB \$v	53 102
Glendale	j 92.3 KXTC \$v A	30 74
Globe	100.3 KIKO-FM v I	53 100
Kayenta	n 106.3 K292AP \$ KOB-FM	93.3t
Kingman	m 92.7 KZZZ \$v	5 17
Lake Havasu City		
	kn 95.9 KRAS	5 17
Mesa	rp 93.3 KRKB-FM \$v	53 102
	r 104.7 K10G \$v	53 102
Nogales		
	m 98.3 KAYN v	7 28
Parker	mr 99.3 KMDX	5 17
Phoenix		
	m 91.5 *KMCR \$v P+TBS4	104
	r 94.5 KOOL-FM \$v +	54 104
	n 95.5 KRFM \$v	52 101
	m 96.9 KMEO-FM \$v +	53 102
	r 96.7 KBBC \$v Y+M256	108
	cg 101.5 KMHP-FM \$v U+	55 105
	k 102.5 KNIX-FM \$v +	54 104
	93.8 KNOT-FM v	11 31
Prescott		
	r 100.1 K261AF \$ KOOL	94.5t
	r 103.1 K276AF \$ K6BC	98.7t
	rp 103.9 K280AN \$ KOKB	93.3t
	cg 105.5 K288BA \$ KMHP	101.5t
	k 107.1 K296AM \$ KNIX	102.5t
Scottsdale	n 100.7 KCOY \$v	21 60
Show Low	m 93.5 KVNM-FM	9 36
Sierra Vista	100.7 KTAZ \$v N	5 17
Sun City	m 106.3 KMAO \$v	8 32
Tempe	r 97.9 KUPO-FM \$v +	54 104
Tsatile	91.9 *KNCC	2 9
Tucson		
	c 90.5 *KUAT-FM \$v UP	52 99
	p 92.9 KRFM \$ A	10 42
	S L 93.7 KRQO \$v	19 56
	m 94.9 KAIR-FM \$v	19 56
	m 96.1 KCEE-FM \$	12 47
	g 99.5 KRFM I+	4 13
Tucson, 10 miles north of		
	c 103.1 *K276AL \$ KUAT	90.5t
Willcox	k 98.3 KWCV v	6 25
Yuma	r 93.1 KJDK \$v A+	12 48
	r 95.1 KALJ \$	12 46
Arkansas	(MAP P. 28)	
Arkadelphia	91.1 *KSWH	2 9
	r 100.9 KOEL \$v	8 31
Ashdown	kr 103.9 KMLA v	13 41
Batesville	88.1 *KGED	2 9

### Arkansas

Benton 107.1 KAKI v 9 36  
 Berryville km 107.1 KAAM \$ v 14 44  
 Blytheville k 96.3 KHLS \$ v E 35 79  
 Brinkley m 102.3 KERR-FM v 12 40  
 Camden m 92.1 KNEH \$ M 21 60  
 Clarksville k 97.7 KLYR-FM \$ 5 17  
 Conway 89.1 KHXD \$ 2 9  
 91.5 KUCA 2 9  
 Ir 105.1 KHLF 25 62  
 Crossett k 104.9 KAGH-FM \$ 14 44  
 Dardanelle r 102.3 KWRK l 14 43  
 De Witt km 96.7 KDEF-FM 9 36  
 El Dorado k 94.3 KFIL \$ A-M 15 45  
 m 103.1 KEZU \$ N 12 40  
 Fayetteville r 86.9 KUAF 2 9  
 r 92.1 KFEF \$ v A-M 12 40  
 m 103.9 KNEA \$ v M 14 45  
 Forrest City km 93.5 KFFC \$ v 13 42  
 Fort Smith r 93.7 KISR \$ vAU 7 28  
 rp 99.1 KMAC \$ v 1-M 57 108  
 k 99.9 KTCB-FM v M 23 61  
 100.9 KXXI v 14 44  
 Harrison r 102.9 KHQZ-FM \$ v A 28 66  
 Heber Springs r 96.7 KAKO-FM v 5 17  
 Helena k 103.1 KCR1 \$ v E 13 44  
 Hope 104.9 KHFA \$ v 15 46  
 Hot Springs k 96.7 KPFA l 15 46  
 m 97.5 KCRS \$ v 30 70  
 g 106.3 KXON-FM v 14 44  
 Jacksonville q 100.3 KMRM-FM 19 56  
 Joplin c 91.9 KHSL \$ v P 36 80  
 r 101.9 KBTM-FM \$ v M 24 69  
 m 107.5 KFIN \$ v M 38 82  
 Lake Village q 95.9 KBLA v 15 46  
 Little Rock c 90.5 KLRK v 15 46  
 m 94.1 KEZU \$ v M 41 56  
 k 95.7 KXXX \$ M 23 60  
 p 96.5 KLAZ-FM \$ v A 43 85  
 r 103.7 KHYL \$ v M 52 102  
 s 107.9 KFMV \$ 23 64  
 Maconia s 107.9 KFMV \$ 23 64  
 Mammoth Spring k 95.1 KABS 17 61  
 Mena km 101.7 KSHR 7 26  
 Mounticello k 93.5 KHBM-FM 12 40  
 Mountain Home m 96.3 KHLO-FM \$ 15 46  
 Nashville km 105.5 KMAC v 7 30  
 Newport m 105.5 KOKR v 13 42  
 Otisolea m 96.1 KHFO 24 64  
 Paraquint re 104.9 KHLS \$ v 14 43  
 Pine Bluff km 92.3 KOTM-FM \$ 16 52  
 r 94.9 KADL-FM \$ v M 16 50  
 Pocahontas m 103.9 KPQC-FM v 9 36  
 Rogers rm 94.3 KAMD-FM 15 46  
 Salem k 95.9 KSAF v E 11 38  
 Searcy km 94.3 KSER \$ v E 11 38  
 Siloam Springs mg 105.7 KUDA-FM \$ v S 28 67  
 Springdale re 104.5 KCIZ \$ v M 9 36  
 Texarkana m 102.5 KDSY-FM \$ 24 62  
 s 107.1 KADD-FM \$ 2 11 38  
 Walnut Ridge km 106.3 KCAC v E 12 40  
 Warren kg 105.5 KRRF-FM v 14 44  
 Wynne m 92.7 KRYN-FM \$ 15 46

### California

(MAP PF. 46-47)

Alameda j 92.7 KJAZ \$ v 15 46  
 Anaheim pr 95.9 KEZY-FM \$ v 15 46  
 Angwin mg 89.9 KANG \$ v A 33 72  
 Apple Valley rm 102.3 KAVR-FM 5 22  
 Arcadia eg 107.1 KPPC-FM v +E 5 17  
 Arcata r 90.5 KHSU 2 9  
 91.5 KMS 2 9  
 mc 93.5 KXGO \$ v 15 46  
 Atascadero 104.5 KIQO v 23 63  
 Auburn m 101.1 KHYL 18 52  
 Bakersfield r 94.1 KLYD-FM \$ v E 31 69  
 g 96.5 KHIS-FM \$ v S 33 73  
 k 101.5 KGFN \$ v U 25 68  
 rp 107.9 KXXX \$ v 33 72  
 Barstow m 94.3 KNCC-FM v 5 17  
 Berkeley r 89.3 KPF 2 8  
 jr 90.7 KALX 2 9  
 94.1 KPFA 46-92  
 js 102.5 KRE-FM \$ v 21 61  
 Big Bear Lake m 101.7 K101 \$ v + 14 46  
 Bishop g 95.9 KZ40AA \$ v KHIS 94.71  
 100.7 K100 \$ v 33 75  
 Blythe 100.3 KBYR-FM v U+ 25 63  
 sq 105.5 KZBBAR \$ v KHEP 101.51  
 k 106.3 KZSBAN \$ v KALX 102.51  
 Bonhoe Springs 88.5 7 9  
 Buena Park JO.1 KBF 7 9  
 Buena Vista r 95.9 KGAN \$ v 10 38  
 Carlsbad r 90.5 KROS \$ v 15 46  
 (Lunel) p 101.7 KLRB \$ v 15 45  
 Cathedral City m 96.5 KMXI-FM \$ v + 32 72  
 Chino r 92.1 KZ121 \$ 16 50  
 Chico 91.7 KCHC \$ v TB 4 16  
 r 95.7 KRM1 \$ v A 20 55  
 m 95.1 KFAI-FM \$ v 30 68  
 China Lake m 100.1 KZ12AC \$ v KOTE 106.21  
 m 105.5 KZ12FX \$ v KOST 103.51  
 c 107.1 KZ12AI \$ v KCAF 90.21  
 Claremont cr 88.7 KSPC \$ v 5 17  
 Coachella S 1 93.7 KVIM \$ v M 10 33  
 Colton j 102.3 KJLN \$ v 15 46  
 Concord r 90.5 KMS 11 38  
 Corcoran City 90.1 KVVJ 7 9  
 Espertino r 91.5 KPIF 14 47  
 Folsom r 90.3 KFOV \$ v 17 41  
 105.5 KYLO v 15 46  
 g 98.5 KPOO v 27 65  
 Dinuba g 98.4 KLTG \$ v + 32 73  
 Dunsmuir g 105.5 KZBBB \$ v VIP 98.11  
 El Cajon g 94.3 KCEP \$ v + 31 71  
 El Centro m 107.5 KKD-FM \$ v 17 55  
 El Cerrito RP.1 KEEG v 2 9  
 El Cundo q 90.1 KOKN-FM \$ v M 10 38  
 Eureka m 90.5 KFDJ v 28 72  
 r 96.3 KRF1 \$ v 45 50  
 Fallbrook 107.1 KAVD v 15 46  
 Fremont 89.3 KOBH 2 9  
 g 104.9 KFMG \$ v 8 33  
 Fresno 86.1 KFEF 32 60  
 89.3 KVPFR \$ v P 33 73  
 r 93.7 KFFE \$ v M 54 102  
 rp 95.5 KHYD-FM \$ v 27 67  
 c 97.9 KML-FM \$ v N 26 63  
 r 101.1 KFIG \$ v A 27 67

### California

m 101.9 KFRY \$ v 32 72  
 n 102.7 KKNU \$ v 33 73  
 105.9 KKDJ \$ v 28 68  
 Garden Grove r 94.3 KORJ \$ v + 13 42  
 Gilroy kp 94.5 KFAT \$ v + 32 74  
 Glendale s 101.9 KUTE \$ v 30 71  
 Hanford r 103.7 K10Y \$ v M 33 73  
 nr 107.5 KKYS \$ v 26 65  
 Hanet 105.5 KMSJ-FM E 3 11  
 Hollister mk 93.5 KHIP v 5 17  
 Indio cm 103.1 KCHS \$ v 14 43  
 Inglewood js 103.9 KACE \$ v -E 15 45  
 Irvine r 89.9 KUCI 2 9  
 Jackson m 94.3 KNGT \$ v M 14 44  
 La Canada 66.3 KUNF 2 9  
 Lake Arrowhead m 103.9 v 15 48  
 Lancaster n 106.3 KOTE \$ v U+ 9 36  
 Livermore r 101.7 KKIO \$ v 5 17  
 Lodi r 90.7 KWIN \$ v U+ 15 46  
 Loma Linda gc 88.3 KEMR \$ l 2 9  
 r 92.7 KLPC v M 15 46  
 Long Beach p 88.1 K10N \$ v P 15 46  
 90.1 KLSUL 2 9  
 n 97.9 KNOB \$ v U 33 76  
 p 10.5 KMAC \$ v 15 46  
 Los Altos p 89.7 KFJC \$ v 15 46  
 m 97.7 KPEN \$ v 5 17  
 Los Angeles rc 88.9 KXLU \$ v 4 16  
 90.7 KPFR \$ v X 05-120  
 c 91.5 KUSC \$ v P 31 70  
 c 92.3 KCAF-FM \$ v M-0 57 107  
 r 90.1 KMX-FM \$ v C 60 112  
 rp 93.9 KPOL-FM \$ v 37 78  
 p 94.7 KNET \$ v S 59 111  
 rp 95.5 KLOS \$ v A 60 112  
 g 96.3 KFSG \$ v U 33 74  
 k 97.1 KGSF \$ v N 37-80  
 m 98.7 KJUI \$ v 45-91  
 q 99.5 KNOF v + M 28 72  
 r 100.3 K100 \$ v -M 42 88  
 r 101.1 K1RTH \$ v -E 60 111  
 j 102.3 KJLN-1 \$ v U 2 9  
 r 102.7 K11S-FM \$ v Y+ 46 91  
 m 103.5 KOST \$ v -M 50 96  
 m 104.3 KBIG \$ v -F 62-115  
 js 105.1 KCCA \$ v U 52 98  
 p 105.9 KWSF \$ v 40 84  
 n 107.5 KALVE \$ v 56 105  
 Los Baros r 90.9 KLES-FM \$ v U 9 35  
 Los Gatos m 95.3 KRVE \$ v 15 46  
 Madera m 92.1 KULU \$ v M 12 40  
 Mammoth Lakes r 106.3 KMX1 \$ v 10 38  
 Maricopa 50.3 KMS 2 9  
 Mariposa km 96.3 KUBB \$ v + 30 70  
 Marysville m 95.9 KRFD v 12 41  
 Mendocino mc 92.7 KMSB-FM 11 38  
 Merced r 85.1 KGBR \$ 7 9  
 m 97.5 KNTV \$ v 32 72  
 g 101.5 KARB \$ v + 30 70  
 Mission Viejo 88.5 KSGR 2 9  
 Modesto r 85.9 KBH 2 9  
 90.5 KQHS 2 9  
 S 1 102.3 KFIV-FM \$ v 15 46  
 m 103.3 KDFE-FM \$ v U 15 46  
 r 104.1 KHOF v M+ 33 73

California

Mojave k 97.7 KDOL-FM v E 5 17  
 Monterey rc 96.9 KWAV \$v A 50 96  
 Monte Rio 97.7 KRJB v 15 45  
 Moraga rj 89.5\*KSMC 3 13  
 Mountain View  
 p 90.5\*KSFH 2 9  
 Mount Shasta m 95.3 KEDY 5 17  
 Newport Beach  
 m 103.1 KCCM \$v 13 43  
 Northridge 88.5\*KCSN v P+ 5 17  
 Nubieber g 103.1 K276AK \$ KVIP 98.1t  
 Oceanside m 102.1 KJFM \$v +M 31 69  
 Ojai mc 105.5 KOVA \$v +S 14 45  
 Ontario rm 93.5 KSOM-FM \$v M 7 30  
 Oroville km 97.7 KFAM v 5 17  
 Oxnard gm 98.3 KDAR \$v 7 28  
 rm 104.7 KACY-FM \$v M+M 30 69  
 Pacific Grove 90.3\*KAZU \$ 2 9  
 m 104.9 KOCH v 15 46  
 Palm Springs 88.3\*KFSH 2 9  
 m 104.7 KDES-FM \$v Y+ 33 73  
 Paradise r 96.7 KNVR \$v 15 45  
 Pasadena 89.3\*KPCS \$v P 5 18  
 p 106.7 KROQ-FM \$v 32 71  
 Paso Robles k 92.5 KPRA \$v + 32 70  
 Paterson mj 93.1 KCSO \$v I 30 69  
 Pismo Beach  
 rm 95.3 KPGA \$v E 15 46  
 Porterville m 99.7 KIOO \$v U 26 67  
 Red Bluff m 95.9 v 15 46  
 Redding g 98.1 KVIP-FM \$v + 46 91  
 Redlands 89.1\*KUOR 3 12  
 r 96.7 KCAL-FM v 15 46  
 Redondo Beach  
 rm 93.5 KKOP \$v M 12 39  
 Ridgecrest km 92.7 KZIQ-FM v 5 17  
 Rio Vista 90.9\*KRVH 2 9  
 Riverside r 88.1\*KUCR \$v 2 9  
 gc 89.7\*KLLU \$ I+ 6 25  
 r 92.7 KHNY-FM \$v M 15 46  
 m 97.5 KDLC \$v +M 52 100  
 g 99.1 KBBL \$v 21 61  
 Roseville S e 93.5 KPIP v M+ 9 36  
 Sacramento 89.7\* 2 9  
 rs 90.7\*KERS 8 32  
 c 92.5 KFBK-FM \$ 30 75  
 m 96.1 KCTC \$v I 32 72  
 r 96.9 KROI \$ M+M 28 70  
 p 98.5 KZAP \$v 25 65  
 mg 100.5 KEBR \$v 35 80  
 m 105.1 KEWT \$v 30 70  
 rj 106.5 KWOD \$v + 27= 67  
 r 107.9 KXCA \$v 28 65  
 St. Helena mr 99.3 KVYN \$v + 13 42  
 Salinas 90.9\*KAUG 2 9  
 m 100.7 KWYT \$v I+ 30 71  
 r 102.5 KDON-FM \$v U+M 47 92  
 S L 103.9 KRAY \$v 5 17  
 San Bernardino  
 rc 91.9\*KVCR P 8 28  
 gr 95.1 KQLH \$v +M 21 57  
 r 99.1 KOLA \$v A+M 46 90  
 c 102.3 K272AH \$ KFAC 92.3t  
 San Clemente  
 m 107.9 KWVE \$v A 32 72  
 San Diego j 88.3\*KSOS A 8 32  
 c 89.5\*KPBS \$v P+T 31 71  
 c 94.1 KFSD \$v +M 39 83  
 g 94.9 KLRO \$v +M 30= 70  
 m 96.5 KYXY \$v + 30 69  
 k 97.3 KSON-FM \$v I+ 23 63

r 98.1 KIFM \$v + 32= 71  
 r 100.7 KFMB-FM \$v 32= 71  
 p 101.5 KGB-FM \$v U 33= 71  
 m 102.9 KEZL \$v + 30 70  
 k 103.7 KOZN \$v +M 32 72  
 m 105.3 KITT v I+M 27 73  
 rp 106.5 KPRI \$v A+ 24 64  
 San Fernando r 93.5 KGIL-FM \$v +M 5 17  
 San Francisco  
 c 88.5\*KQED-FM \$v P 48 98  
 89.5\*KPOO 9 35  
 90.3\*KUSF v 14 46  
 91.7\*KALW v P 22 57  
 rp 93.3 KYA-FM \$v S 32 71  
 p 94.9 KSAN \$v 39 82  
 c 95.7 KKHI-FM \$v 33= 72  
 m 96.5 KOIT \$v +G 43 88  
 g 97.3 KEAR \$v 44 91  
 m 98.1 KABL-FM \$v 44= 90  
 rm 98.9 KCBS-FM \$v C+M 32 71  
 rm 99.7 KYUU \$v N+M 41 86  
 rm 101.3 KIOI \$v Y 50 102  
 c 102.1 KDFC \$v +E 39 81  
 sr 103.7 KSFX \$v A 34 74  
 m 104.5 KFOG \$v 35 75  
 e 105.3 KERG \$v +M 35 74  
 p 106.1 KMEL \$v 43 79  
 m 106.9 KMPX \$ 45 91  
 San Jose 89.3\*KLEL 2 9  
 r 90.7\*KSJS \$v 4= 13  
 pr 92.3 KSJO \$v 9 30  
 p 98.5 KOME \$v 31 70  
 m 100.3 KBAY \$v 48 94  
 r 106.5 KEZR \$v +M 30 70  
 San Luis Obispo  
 cj 90.1\*KCBX \$v + 30 68  
 rc 91.3\*KCPR 4 15  
 r 93.3 KZGZ \$v U 42 87  
 m 96.1 KUNA \$v 33 72  
 San Mateo 91.1\*KCSM \$ P+ 22 57  
 s 107.7 KSOL \$v B+Q 30 68  
 San Pedro r 93.5 KKOP-1 \$ 2 9  
 San Rafael p 100.9 KTIM-FM \$v 15 46  
 Santa Ana rm 96.7 KWIZ-FM \$v 13 41  
 rg 106.3 KYMS \$v 9 36  
 Santa Barbara  
 rc 91.9\*KCSB \$ A 22 61  
 m 93.7 KDB-FM \$v M 31 70  
 rp 97.5 KTMS-FM \$v N+M 51 97  
 pr 99.9 KTYD-FM \$ +TM 32 71  
 mc 103.3 KRUZ \$v E 65 116  
 Santa Clara  
 r 105.7 KARA \$v 33 73  
 Santa Cruz 88.1\*KZSC 2 9  
 cj 88.9\*KUSP \$v 30 72  
 m 99.1 KSCO-FM \$ 8 28  
 Santa Maria  
 pr 99.1 KXFM \$v + 30 70  
 m 102.5 KSMA-FM \$ 8 28  
 Santa Monica j 89.9\*KCRW P 8 28  
 m 103.1 KSRF \$v + 4 14  
 Santa Paula mr 96.7 KAAP-FM v I+ 14 45  
 Santa Rosa S 89.1\*KBBF v P 25 64  
 mc 100.1 KZST \$v A 15 45  
 k 101.7 KVRE-FM v E 15 45  
 Seaside gs 107.1 KZEN \$v Z 14 44  
 Shafter mr 97.7 KQEZ v 15 46  
 Simi Valley m 107.1 K296AJ \$ KNJO 92.7t  
 Sonoma m 92.7 KROG \$v A 15 45  
 South Lake Tahoe  
 rm 100.1 KRLT \$v 5 17  
 m 103.1 KTHO-FM v 5 17

Stanford r 90.1\*KZSU \$v U 3 10  
 Stockton 89.5\*KSJC 2 9  
 g 90.1\*KCJH 2 9  
 cr 91.3\*KUOP \$ P 21 68  
 m 99.3 KJAX \$v A 15 46  
 SkL 107.3 KSTN-FM +M 37 80  
 Susanville m 52.7 KSUE-FM \$v 14 43  
 Thousand Oaks  
 m 92.7 KNJO \$v M 14 44  
 Torrance r 89.7\*KNHS 2 9  
 Tracy S L 100.9 KSRT \$v 15 46  
 Travis Air Force Base  
 91.5\*KVIK 2 9  
 Truckee mk 101.7 KEZC \$v + 15 46  
 Tulare r 94.9 KBOS \$v +M 30 71  
 m 106.7 KJUG \$v M+ 30 72  
 Turlock 90.9\*KBDG 2 9  
 91.9\*KCSS 2 9  
 r 98.3 KMIX \$v 11 38  
 Twentynine Palms  
 95.7 KQYN v 5 19  
 Ukiah k 94.5 KLIL \$v 30 68  
 k 103.3 KALF \$v S 31 72  
 Vacaville mk 95.3 KUIC \$ 12 40  
 Ventura r 95.1 KBBY \$v N 13 58  
 k 100.7 KHAY \$v 42 86  
 m 105.5 KOVA-2 \$ 2 9  
 Visalia m 92.9 KONG-FM \$v A+M 33 73  
 Walnut 90.1\*KSAK 2 9  
 Walnut Creek m 92.1 KCFM \$ 7 31  
 c 95.7 KKHIFM1 \$ 2 9  
 r 101.3 KIOI-1 \$ 2 9  
 m 104.5 KFOG-1 \$ 2 9  
 Weaverville g 103.1 K276AM \$ KVIP 98.1t  
 West Covina m 98.3 KBOB 3 12  
 West Sacramento  
 91.7\*KWHS 2 9  
 Woodland r 102.5 KSFM \$ 33 73  
 Yosemite National Park  
 c 92.1 K221AB \$ KDFC 102.1t  
 m 93.5 K228AA \$ KFOG 104.5t  
 Yreka g 106.3 K292BB \$ KVIP 98.1t  
 Yuba City km 103.9 KHEX v 8 33

Colorado (MAP PP. 44-45)  
 Alamosa p 90.9\*KASF U 2 9  
 mk 93.5 KALQ \$v I 9 36  
 Aspen p 97.7 KSPN \$ I 5 17  
 r 100.1 K261AJ \$ KQIX 93.1t  
 Basalt r 100.1 K261AK \$ KQIX 93.1t  
 m 102.3 K272AM \$ KREX 92.3t  
 Boulder 88.5\*KGNU v + 10 38  
 m 94.7 KBVL \$ 9 30  
 c 97.3 KBCC \$ 5 15  
 c 101.7 K269AE \$ KVOO 99.5t  
 Breckenridge  
 r 92.1 K221AJ \$ KXXK 95.7t  
 m 94.3 K232AC \$ KOSI 101.1t  
 102.3 KLGT \$v 5 17  
 Buena Vista k 106.3 K292AN KVRP 92.1t  
 Canon City k 103.9 KSTX 5 17  
 m 106.3 K292AA \$ KRDO 95.1t  
 Castle Rock k 92.1 KMJD v 15 46  
 Colorado Springs  
 r 89.7\*KAFA \$ 1 5  
 rc 90.5 KEPC \$v 5 18  
 jp 91.5\*KRCC \$ 4 15  
 r 92.9 KSFZ \$v C 50 96  
 rk 93.9 KPIK-FM \$v Y 57 108  
 m 95.1 KRDO-FM \$v 57 110  
 p 96.5 KKFM \$ +M 50 96  
 r 101.9 KINX \$ E+M 9 30



**Colorado**

Cortez m 105.5 K2888B \$ KOB 93.3t  
 m 106.3 K292AX \$ KRWN 92.9t  
 Craig rn 93.7 KRA1-FM \$ 44 90  
 Crested Butte  
 a 107.1 K296A1 \$ KREX 92.3t  
 Denver p 90.1\*KCFR \$ v Pa 36 76  
 r 95.7 KXXX \$ v U-4 41 86  
 r 98.5 K1MN-FM \$ v 36 78  
 c 99.5 KVOC \$ v +M 30 74  
 m 100.3 KLIR \$ v \$ 43 89  
 m 101.1 KOS1-FM \$ v +M 41 86  
 r 103.5 KOAD \$ v C 46 92  
 j 105.1 KADX \$ v A+M 25 70  
 rs 105.9 KBPI \$ v \$ 15-62  
 rp 106.7 KAZY \$ v \$ 44-90  
 91.9\*KOLR 2 9  
 k 100.5 KR5J \$ v l 29 73  
 Eagle m 102.3 K272AF \$ KREX 92.3t  
 Estes Park c 92.7 K244AD \$ KVOD 99.5t  
 m 95.3 K237AF \$ KLIR 100.3t  
 Fort Collins  
 pc 90.9\*KCSU + 4 15  
 pr 93.3 KTCL \$ v +M 50 99  
 c 96.7 K244AF \$ KVOD 99.5t  
 m 107.9 KCOL-FM \$ v 36 80  
 Fort Morgan k 101.7 KBRU \$ v 9 36  
 Glenwood Springs  
 90.5\*KCMK 2 9  
 ar 92.7 KGLS \$ v + 5 17  
 r 100.1 K261A1 \$ KQIX 93.1t  
 m 102.3 K272A1 \$ KREX 92.3t  
 Grand Junction  
 pc 91.3 KMSA \$ 2 9  
 m 92.3 KREX-FM \$ 9 30  
 r 93.1 KQIX \$ v M 17 53  
 Greeley c 91.5\*KUNC \$ v P+1 16 48  
 m 92.3 KGRZ \$ v +M 27 66  
 g 96.1 KFIZ \$ v M 40 84  
 Gunnison jr 91.9\*KWSB 2 9  
 m 96.7 K244AB \$ KREX 92.3t  
 Ignacio 91.3\*KJSU 2 9  
 La Junta k 92.1 KBLJ \$ v 15 46  
 Lake City m 106.3 K292AK \$ KREX 92.3t  
 Lakewood nr 107.5 KPPL \$ v +M 39 84  
 Lanar m 93.3 KLMR-FM v 28 72  
 Leadville m 103.1 K276AJ \$ KRDO 95.1t  
 m 107.1 K296BA \$ KVMM 96.9t  
 Longmont 90.7\*KODC v 2 9  
 nr 104.3 KLMO-FM A 14 50  
 Loveland rn 102.3 KLCV-FM \$ v M 9 36  
 Mancos m 103.1 K276AG \$ KOB 93.3t  
 Manitou Springs  
 r 102.7 K11Q-FM \$ v I-M 53 100  
 Montrose m 94.1 KUBC-FM \$ v 48 94  
 m 100.1 K261AA \$ KREX 92.3t  
 r 107.1 K296AK \$ KQIX 93.1t  
 Morrison cg 91.1\*KWBI \$ v l 30 69  
 Nathrop m 103.1 K276AA \$ KVMM 96.9t  
 Nucla m 101.7 K269AB \$ KREX 92.3t  
 Oak Creek kc 103.9 KFMM \$ v 15 46  
 Placerville 89.7\*K209AB KOTO 91.7t  
 Pueblo r 89.5\*KTSC v 15 47  
 r 97.9 KCSJ-FM \$ v 31 75  
 m 98.9 KVMM \$ U-M 11 50  
 k 99.9 KPUB-FM \$ v 55 103  
 r 100.7 KZLO \$ v E+ 39 83  
 Rangeley m 102.3 K272AJ \$ KREX 92.3t  
 Rifle m 103.1 K276A1 \$ KREX 92.3t  
 r 107.1 K296BB \$ KQIX 93.1t  
 Rearing fork r 94.3 K237AD \$ KQIX 93.1t  
 n 95.9 K240AB \$ KREX 92.3t

Rocky Ford mk 95.9 KAVI-FM 8 31  
 Salida rm 92.1 KVRN-FM v l 5 16  
 Security g 105.5 KMYO \$ v 5 17  
 Silverton k 105.5 K2888B \$ KR5J 100.5t  
 Steamboat Springs  
 m 96.7 KBCR-FM \$ v 15 48  
 r 96.7 KSTC-FM v 15 45  
 Telluride 91.7\*KOTO 2 9  
 m 103.9 K280AF \$ KREX 92.3t  
 Vail rn 104.7 KVMT \$ v E 47 54  
 Windsor rn 99.1 KUAD-FM \$ v 40 84  
 Woody Creek m 102.3 K272AD \$ KREX 92.3t  
 Wray rn 95.3 K237AK \$ KXXX 100.3t

**Connecticut** (MAP PP. 18-19)

Bridgeport r j 89.5\*WPKN \$ v E+ 25 E1  
 m 99.9 WEZB \$ v 32-71  
 Brookfield r 95.1 WRK1 \$ v +M 32 72  
 Danbury rn 91.7\*WXCI v M 4 14  
 m 98.3 WLAD-FM \$ v 15 46  
 Fairfield r 86.5\*WVOF 2 9  
 r 91.1\*WSHU v A 16 48  
 Groton p 105.5 W5UB-FM \$ E 14 44  
 Hamden r 88.3\*WDAQ v 2 9  
 m 101.3 WKCI \$ v 31 70  
 Hartford s 88.3\*WOTO 2 9  
 88.9\*WJMJ v 24 60  
 er 89.3\*WRTC A 4 17  
 S L 93.7 WLVH v 13 47  
 m 95.7 WKSS \$ v + 31 70  
 rn 96.5 WTIC-FM \$ v H+O 31-70  
 rp 102.9 WDRP-FM \$ v 31-70  
 p 105.9 WJCH \$ v +M 31-70  
 p 106.9 WCCC-FM \$ Y 31 70  
 90.5\* 19 53  
 Middletown r j 88.1\*WESU \$ U 4 15  
 g 104.9 WHHS 14 46  
 Merco: m 101.7 WNNR \$ v 7 31  
 New Britain r 90.1\*WFCB 2 9  
 m 100.5 WRCH \$ v +M 31 70  
 New Canaan 91.9\*WSLX 2 9  
 New Haven: rt 94.3 WYBC \$ v A 8 31  
 p 99.1 WPLR \$ v 31 69  
 New London r 91.5\*WENI 2 9  
 m 100.9 WTYD \$ v 15 48  
 Norwalk m 95.9 WLTY \$ v 9 36  
 Norwich k 97.7 WCTY \$ v A 15 46  
 Stamford m 96.7 WYRS A 15 45  
 Storrs cr 91.7\*WHSU v l 16 49  
 Wallingford 85.9\*WNEB 2 9  
 Waterbury r 92.5 WRYZ \$ v + 32 70  
 k 104.1 WIOF \$ v E+ 31 70  
 West Hartford  
 cr 91.3\*WVUH \$ v + 15 45  
 West Haven p 88.7\*WNHU v 9 33  
 Westport rc 90.3\*WNPJ v 5 22  
 r j 107.9 WDJF \$ v U+Q 25 65  
 Willimantic  
 nr 98.3 WXLS \$ v 15 46

**Delaware** (MAP P. 23)

Bethany Beach  
 r 95.9 WKTR \$ v 15 46  
 Dover k 94.7 WOSO \$ v M 29 69  
 Georgetown p 93.5 WSEA v M 15 46  
 Hockessin 88.7\*WZZE 2 9  
 Milford k 97.7 WAFJ v S 13 42  
 Newark 91.3\*WXDR 2 9  
 Rehoboth Beach  
 r 92.7 WLBO \$ v 15 46  
 Seaford r 98.3 W5UX \$ v Y 12 40  
 Wilmington r 91.7\*WMPH 2 9

**Florida**

m 93.7 WSTW \$ v N 32 72  
 m 99.5 WJBR \$ v 33 73  
 Dist. of Columbia (MAP P. 23)  
 Washington pc 88.5\*WABU \$ v P 33-73  
 j 89.3\*WPFV \$ v 30 70  
 p 90.1\*WGTO \$ v 23 49  
 c 90.9\*WETA-FM \$ v P-1B37 80  
 rs 93.9 WYYS \$ v N 32 72  
 js 96.3 WHLR \$ v 32-70  
 r 97.1 WASH \$ v S 31 70  
 k 98.7 WNZQ \$ v 32 72  
 m 99.5 WQAY-FM \$ v 33 72  
 rs 100.3 WROK \$ v 21 57  
 p 101.1 WNDK-FM \$ v E+M 33 73  
 c 103.5 WBSB-FM \$ v +M 33 72  
 rp 107.3 WRQX \$ v A+M 32-71

**Florida** (MAP PP. 26-27)

Apopka g 95.3 WTLA-FM v Y 15 46  
 Arcadia k 98.3 WOKC \$ v 12 40  
 Atlantic Beach  
 m 104.9 WJHJ 15 45  
 Belle Glade sn 93.5 WSNH-FM \$ v M 14 43  
 Boca Raton mg 99.9 WRQG \$ v 43 89  
 Bonita Springs  
 r 95.9 WLEQ \$ v Y 15 46  
 Boynton Beach g 88.7\*WRMB 32 72  
 SCL 90.7\*WHRS \$ v P+ 21 59  
 Bradenton m 103.3 WDLV \$ v I+ 35 79  
 Cape Coral m 103.9 WRCC \$ v S 15 46  
 Clearwater r 95.7 WOKF \$ v A 35 79  
 rp 97.9 WQXW \$ v +M 27 66  
 Clewiston k 106.3 WAFC v 11 38  
 Cocoa m 99.3 WLZY-FM \$ v Y 15 45  
 Cocoa Beach  
 rc 101.1 WKCS \$ v 35 79  
 r 104.1 WRK1 \$ v N+M 19 56  
 Coral Gables p 90.5\*WVUM \$ v 2 9  
 m 105.1 WYOR \$ v 39 83  
 Crestview k 104.9 WAAZ \$ C 14 44  
 Crystal River  
 gn 98.5 WNYC \$ v U 34 78  
 Daytona Beach  
 mc 94.5 WMLV \$ v +M 28 69  
 rp 101.9 WQXQ \$ v 28 72  
 DeFuniak Springs  
 r 103.1 WOUH v 12 40  
 De Land k 105.9 WELE-FM \$ M 27 70  
 Dunnellon km 102.3 WTRS-FM \$ v E 15 46  
 Fort Lauderdale  
 ge 90.3\*WFFG \$ v 15 45  
 r 100.7 WMY1 \$ v 44 90  
 p 103.5 W5HC \$ v 38 82  
 r 105.9 WFXV \$ v A+M 45 91  
 m 106.7 WGLQ \$ v 44 89  
 Fort Myers g 95.3 W5OR v 12 40  
 m 96.9 W5NK-FM \$ 25 64  
 k 101.9 WHEW \$ v 23 66  
 Fort Pierce  
 rt 95.5 WOVV \$ v 35 79  
 r 96.7 WLOY \$ v E+M 32 76  
 Fort Walton Beach  
 m 99.3 WFTW-FM \$ v 11 38  
 Gainesville m 100.9 v 15 46  
 mc 103.7 WRUF-FM \$ C 26 63  
 p 105.5 WGLV \$ v 14 44  
 Gadsden g 98.3 WGLY \$ v + 14 45  
 Green Cove Springs  
 92.7 WAUE v 15 46  
 Hialeah S L 92.1 WCNO-FM \$ v 15 45  
 Hollyay n 106.3 v 15 46

Florida

<b>Jacksonville cr</b>			
cr	89.9*WJCT-FM \$v P+	34	76
rc	91.1*WFAH \$v E	14	44
r	95.1 WJAX-FM \$v Y	35	79
m	96.1 WNTZ-FM \$v	42	87
r	96.9 WAIV \$v	34	78
k	99.1 WOJK \$v E+M	38	81
r	102.9 WIVY \$v	35	76
o	107.3 WJEE \$v	31	75
<b>Jupiter nj</b>	96.7 WRYZ-FM \$v M	15	46
<b>Key West m</b>	92.5 WFFN \$v	17	53
	95.5 WVKV \$v	29	75
nc	107.1 WILS \$v	8	30
<b>Lake City r</b>	94.3 WTLD \$v C	15	46
<b>Lakeland q</b>	91.3*WCIE \$v	28	68
m	94.1 WVFH \$v +M	34	78
<b>Leesburg qs</b>	106.7 WMLY \$v M	42	87
<b>Lehigh Acres</b>	107.1 WCFW \$v	15	46
<b>Live Oak k</b>	98.1 WOHL \$v	19	57
<b>Maclennay m</b>	92.1 WBFK \$v	15	46
<b>Marathon m</b>	94.3 W8UM \$	8	33
<b>Marianna</b>	100.9 WJAO \$	15	46
<b>Melbourne</b>	91.5*WFIT \$	2	9
k	102.3 WYRL \$v M	13	41
r	107.1 WTAI-FM \$v A	15	46
<b>Miami</b>	86.9*WQVA \$v	20	55
g	89.7*WMCU \$v M+	42	88
scj	91.3*WLRN-FM \$v P+	34	77
cj	93.1 WIMI \$v +M	33	76
r	96.3 WQJX \$v +M	42	87
nr	97.3 WATA \$v	42	87
s	99.1 WEDR \$	2	27
n	101.5 WLYF \$v	42	87
nc	107.5 WIGL \$v	35	79
<b>Miami Beach r</b>	93.9 WQWL \$v +M	22	60
r	94.9 WIMZ-FM \$v	39	83
<b>Milton ks</b>	102.7 W8BM \$v	37	80
<b>Mount Dora p</b>	107.7 WQJZ \$v	33	76
<b>Naples</b>	r 93.5 W8GI-FM \$	15	46
nc	94.5 WCVU \$v	40	85
kr	97.7 WNTU \$v	15	46
<b>Nea Port Richey nk</b>	105.5 WQUL-FM \$v	14	43
<b>Ocala n</b>	92.7 W8FO \$v	13	41
n	93.7 W8UZ \$v	25	70
<b>Ocala n</b>	103.1 W8VC \$v	12	40
<b>Oklawaha</b>	89.5*W8AG \$	2	9
<b>Orlando</b>	89.9*WFTO \$	7	9
n	92.1 W8BO-FM \$v +M	49	65
n	94.5 W8OC-FM \$v M	35	79
n	103.3 WJLZ \$v A+M	52	87
n	105.1 W8XJ \$v	50	99
<b>Palatka n</b>	96.9 W8WQ \$v M	25	70
<b>Palm Beach Sp</b>	101.9 W8VZ-FM \$v	32	76
<b>Panama City</b>	cr 103.7 W8GC \$v P	14	43
	n 87.5 W8FB \$v +M	48	65
	n 97.5 W8DE-FM \$v A	24	67
	n 102.1 W8FM \$v P+M	41	55
<b>Pensacola</b>	p 98.3*W8JZ \$	14	40
n	98.7 W8VZ \$v +M	27	75
n	101.7 W8G9 \$v	37	82
n	102.3 W8VH-FM \$v	24	71
n	103.9 W8WQ \$v P	33	76
<b>Perry</b>	cr 103.3 W8GC \$v P	14	43
<b>Port St. Joe</b>	cr 92.5 W8FC-FM \$v	38	82
<b>Port St. Joe</b>	cr 92.5 W8FC-FM \$v	38	82

Port Charlotte

	m	100.1 WEEJ \$v	12	40
<b>Port St. Joe</b>	m	93.5 W8CV \$v	10	36
<b>Punta Gorda</b>	m	92.7 W8CF-FM \$v M+	10	38
<b>Quincy</b>	m	101.7 W8NH-FM \$v	12	40
<b>Riviera Beach</b>	m	94.3 W8NW \$v E	15	46
<b>St. Augustine</b>				
	m	97.7 W8DY-FM \$v C	11	38
<b>St. Petersburg</b>				
	k	99.5 W8YK \$v M+	28	72
	gc	101.5*W8ES \$v U	35	79
	m	107.3 W8BA-FM \$v	39	83
<b>Sarasota</b>	p	102.5 W8SR \$v M	38	82
	g	105.5 W8ZH \$v	12	40
	nc	106.3 W8SE-FM \$v	14	44
<b>Sebring</b>	gk	105.5 W8SK \$v M	10	38
<b>Starke</b>	k	106.3 W8PE-FM \$v	9	35
<b>Stuart</b>	nc	92.7 W8CF \$v U	15	46
<b>Tallahassee</b>	s	90.5*W8MF \$	2	9
	rc	91.5*W8SU \$v P+	33	73
	k	94.9 W8WV \$	24	63
	m	98.9 W8BG \$v H+	33	76
		103.1 W8OD \$v	15	46
	r	104.1 W8FL \$v A+M	30	69
		88.5*W8ND \$v	36	76
<b>Tampa</b>	pc	89.7*W8UF \$v P+M	41	86
	m	93.3 W8LA-FM \$v +M	44	90
	r	94.9 W8YH \$v	33	76
	m	100.7 W8YV \$v +M	35	79
	r	104.7 W8BD \$v	38	82
<b>Titusville</b>		89.3*W8PI \$v	7	30
	nr	96.3 W8YF-FM \$v	13	42
<b>Venice</b>	m	92.1 W8NR-FM \$v	14	44
<b>Vero Beach</b>	m	93.5 W8YL \$v A+M	9	36
		105.5 \$v	15	46
<b>West Palm Beach</b>				
	m	92.1 W8RN \$v	14	44
	c	102.3 W8ZAB \$ W8MI	93.11	
	m	104.5 W8AT-FM \$v	37	80
	k	107.9 W8RX-FM \$v A+M	32	76
<b>Winter Haven</b>	k	97.5 W8CV \$v A	35	79
<b>Winter Park</b>	rc	88.9*W8PL \$	2	9
	pc	91.5*W8RY \$v	7	28
	nc	104.1 W8CD \$v	8	33

Georgia

(MAP PP. 26-27)

<b>Albany</b>	s	96.1 WJLZ \$v	2	36	80
	k	101.7 W8CM \$v A	15	46	
	m	104.5 W8CP-FM \$v C+M	19	55	
<b>Americus</b>	s	94.3 W8PE \$v B+	12	40	
	m	97.7 W8UP \$v	15	46	
<b>Athens</b>	rc	90.5*W8OU \$	10	37	
	k	93.5 W8CC \$v	10	34	
	m	104.7 W8CO \$v	23	63	
<b>Atlanta</b>	p	85.5*W8AC \$	21	50	
	kr	89.3*W8FG \$v	12	40	
	s	101.1*W8EE \$v P	27	66	
	pc	91.1*W8EX \$v	7	28	
	pc	91.3*W8EX \$v	7	28	
	pc	91.3*W8EX \$v	7	28	
	pc	91.3*W8EX \$v	7	28	
	pc	91.3*W8EX \$v	7	28	
	pc	91.3*W8EX \$v	7	28	
	pc	91.3*W8EX \$v	7	28	
	pc	91.3*W8EX \$v	7	28	
	pc	91.3*W8EX \$v	7	28	
	pc	91.3*W8EX \$v	7	28	
	pc	91.3*W8EX \$v	7	28	

<b>Bainbridge</b>	r	97.3 W8AD \$	M	17	54
<b>Blairsville</b>	k	104.9 W8BAC \$v W8PL	103.91		
<b>Blue Ridge</b>	k	103.9 W8FL		13	42
<b>Brunswick</b>	m	100.7 W8BI \$ E+M	18	55	
	k	101.5 W8NR-FM \$v M	29	73	
<b>Buford</b>	gk	102.3 W8CO \$v Y	14	44	
<b>Conilla</b>	m	105.5 W8EI \$v	15	46	
<b>Canton</b>	k	105.5 W8CH-FM \$v	7	30	
<b>Carrollton</b>	r	89.3*W8GC \$	2	9	
	r	92.1 W8TR \$v Y	8	33	
<b>Chatsworth</b>	k	99.3 W8MT \$v A	15	46	
<b>Claxton</b>	nc	107.1 W8LA-FM \$v	12	40	
<b>Cochran</b>	rk	96.7 W8VG-FM \$v	13	42	
<b>Columbus</b>	nr	102.9 W8EL-FM \$v M+M	53	102	
	r	104.9 W8YX \$v A	11	38	
	r	107.3 W8GG \$v C	37	80	
<b>Cordele</b>	kr	96.3 W8AF \$v	14	45	
<b>Cornelia</b>	r	99.3 W8DN-FM \$v	E	15	45
<b>Dawson</b>	m	92.1 W8NO-FM \$v	E	13	42
<b>Douglas</b>		99.5 W8NG-FM \$v	23	62	
	k	106.7 W8KA-FM \$v	H	24	62
<b>Dublin</b>	k	92.7 W8XL-FM \$v	U	13	42
	r	95.9 W8OZ \$v	13	42	
<b>Eastman</b>	kr	92.1 W8UF-FM \$v	15	46	
<b>Elberton</b>	m	92.1 W8RK \$v U+	15	46	
<b>Ellijay</b>	k	104.9 W8SAB \$v W8PL	103.91		
<b>Forsyth</b>	g	100.1 W8HE \$v U	15	46	
<b>Gainesville</b>		89.1*W8CX \$	2	9	
	r	97.1 W8OX \$v U+	37	81	
	r	106.7 W8IC \$v A+	37	81	
<b>Glenville</b>	rg	106.3 W8IG-FM \$v	15	46	
<b>Gordon</b>	k	107.1 W8CG-FM \$v	8	32	
<b>Griffin</b>	m	97.7 W8EU-FM \$v	15	46	
<b>Hawkinsville</b>	r	103.9 W8EH-FM \$v	14	43	
<b>Hazlehurst</b>	m	93.5 W8OV-FM \$v	15	46	
<b>Jackson</b>	rc	92.1 W8JA-FM \$v	15	46	
<b>Jesup</b>	g	96.3 W8OJ \$v U	15	46	
	sr	105.5 W8FD \$v	15	46	
<b>La Grange</b>	k	104.1 W8CC \$v	20	57	
<b>Louisville</b>	kr	92.1 W8EH-FM \$v	15	46	
<b>Macon</b>	r	99.1 W8AZ-FM \$v A+M	40	84	
	k	105.3 W8EN-FM \$v	S	19	60
	m	107.9 W8RY \$v +	1	40	85
<b>Manchester</b>	s	93.3 W8OF-FM \$v B	28	79	
<b>Marietta</b>	k	101.5 W8IE \$v M+M	43	89	
<b>Metter</b>	nr	104.9 W8GG \$v	15	46	
<b>Milledgeville</b>					
		88.9*W8GC \$	2	9	
		102.3 W8VG-FM \$v	11	38	
<b>Moultrie</b>	kr	93.9 W8HM-FM \$v M+M	24	70	
<b>Newnan</b>	nr	96.7 W8ON-FM \$v	M	15	46
<b>Perry</b>	m	103.9 W8GA-FM \$v A+	12	40	
<b>Rockmart</b>	gk	107.1 W8O* \$v A	5	17	
<b>Roche</b>	r	97.7 W8CP-FM \$v	U	14	43
	nr	102.1 W8TU \$v M+	13	43	
<b>Rossville</b>	g	105.5 W8GE \$v	14	44	
<b>Sandersville</b>					
	nr	94.3 W8MT-FM \$v	12	40	
<b>Savannah</b>		88.5*W8CJ \$	2	9	
		93.1 W8UL-FM \$v	9	31	75
		95.1 W8CC-FM \$v C+M	49	97	
		95.5 W8CF \$v	31	75	
		98.5 W8CE-FM \$v	14	42	
	nr	99.7 W8YH \$v	+M	36	50
		100.1 W8AT \$v	35	83	
<b>Spartanburg</b>		96.7 W8KA-FM \$v	+M	34	74
<b>Statesboro</b>	nr	94.9 W8YH \$v	15	46	
<b>Stonewall</b>		91.1*W8GJ \$v	7	28	
	r	102.7 W8EL \$v	12	40	

**Colorado**

Cortez m 105.5 K288BB \$ KOB 93.3t  
 m 106.3 K292AX \$ KRWN 92.9t  
 Craig rm 93.7 KRAI-FM\$ 44 90  
 Crested Butte m 107.1 K296AI \$ KREX 92.3t  
 Denver p 90.1\*KCFR \$v P+ 36 76  
 r 95.7 KXXK \$v U+Q 41 86  
 r 98.5 KIMN-FM\$ 36 78  
 c 99.5 KVOG \$v +M 30 74  
 m 100.3 KLIR \$v 43 89  
 m 101.1 KOSI-FM\$ +M 41 86  
 r 103.5 KOAQ \$v C 46 92  
 j 105.1 KADX \$v A+M 25 70  
 rs 105.9 KBPI \$v 15= 62  
 rp 106.7 KAZY \$v 44= 90  
 Durango 91.9\*KDLR 2 9  
 k 100.5 KRSJ \$v I 29 73  
 Eagle m 102.3 K272AF \$ KREX 92.3t  
 Estes Park c 92.7 K244AD \$ KVOG 99.5t  
 m 95.3 K237AF \$ KLIR 100.3t  
 Fort Collins pc 90.9\*KCSU + 4 15  
 pr 93.3 KTCL \$v +M 50 99  
 c 96.7 K244AF \$ KVOG 99.5t  
 m 107.9 KCOL-FM\$ 36 80  
 Fort Morgan k 101.7 KBRU \$v 9 36  
 Glenwood Springs 90.5\*KCMK 2 9  
 mr 92.7 KGLS \$v + 5 17  
 r 100.1 K261AI \$ KQIX 93.1t  
 m 102.3 K272AI \$ KREX 92.3t  
 Grand Junction pc 91.3 KMSA \$ 2 9  
 m 92.3 KREX-FM\$ 9 30  
 r 93.1 KQIX \$v M 17 53  
 Greeley c 91.5\*KUNC \$v P+T 16 48  
 m 92.3 KGRE \$v +M 27 66  
 g 96.1 KFKZ \$v M 40 84  
 Gunnison jr 91.9\*KWSB 2 9  
 m 96.7 K244AB \$ KREX 92.3t  
 Ignacio 91.3\*KSUT 2 9  
 La Junta k 92.1 KBLJ \$v 15 46  
 Lake City m 106.3 K292AK \$ KREX 92.3t  
 Lakewood mr 107.5 KPPL \$v +M 39 84  
 Lamar m 93.3 KLMR-FM v 28 72  
 Leadville m 103.1 K276AJ \$ KRDO 95.1t  
 m 107.1 K296BA \$ KVMN 98.9t  
 Longmont 90.7\*KCDC v 2 9  
 mr 104.3 KLMO-FM A 14 50  
 Loveland rm 102.3 KLCV-FM\$ v M 9 36  
 Mancos m 103.1 K276AG \$ KOB 93.3t  
 Manitou Springs r 102.7 KIIQ-FM\$ v I+M 53 100  
 Montrose m 94.1 KUBC-FM\$ v 48 94  
 m 100.1 K261AA \$ KREX 92.3t  
 r 107.1 K296AK \$ KQIX 93.1t  
 Morrison cg 91.1\*KWBI \$v I 30 69  
 Nathrop m 103.1 K276AA \$ KVMN 96.9t  
 Nucla m 101.7 K269AB \$ KREX 92.3t  
 Oak Creek kc 103.9 KFMU \$v 15 46  
 Placerville 89.7\*K209AB KOTO 91.7t  
 Pueblo r 89.5\*KTSC v 15 47  
 r 97.9 KCSJ-FM\$ 31 75  
 m 98.9 KVMN \$ U+M 12 50  
 k 99.9 KPUB-FM\$ v I 55 103  
 r 100.7 KZLO \$v E+ 39 83  
 Rangeley m 102.3 K272AJ \$ KREX 92.3t  
 Rifle m 103.1 K276AI \$ KREX 92.3t  
 r 107.1 K296BB \$ KQIX 93.1t  
 Roaring Fork r 94.3 K232AD \$ KQIX 93.1t  
 m 95.9 K240AB \$ KREX 92.3t

Rocky Ford mk 95.9 KAVI-FM 8 31  
 Salida rm 92.1 KVRH-FM v I 5 16  
 Security g 105.5 KWYD \$v 5 17  
 Silverton k 105.5 K288BD \$ KRSJ 100.5t  
 Steamboat Springs m 96.7 KBCR-FM\$ 15 48  
 Sterling r 96.7 KSTC-FM v 15 45  
 Telluride 91.7\*KOTO 2 9  
 m 103.9 K280AF \$ KREX 92.3t  
 Vail rm 104.7 KVMT \$v E 47 94  
 Windsor rm 99.1 KUAD-FM\$ 40 84  
 Woody Creek m 102.3 K272AD \$ KREX 92.3t  
 Wray rm 95.3 K237AK \$ KXXX 100.3t

**Connecticut** (MAP PP. 18-19)

Bridgeport rj 89.5\*WPKN \$v E+ 25 61  
 m 99.9 WEZN \$v 32= 71  
 Brookfield r 95.1 WRKI \$v +M 32 72  
 Danbury r. 91.7\*WXCI v M 4 14  
 m 98.3 WLAD-FM\$ 15 46  
 Fairfield r 88.5\*WVOF 2 9  
 r 91.1\*WSHU v A 16 48  
 Groton p 105.5 WSUB-FM\$ E 14 44  
 Hamden r 88.3\*WQAQ v 2 9  
 m 101.3 WKCI \$v 31 70  
 Hartford s 88.3\*WQTQ 2 9  
 88.9\*WJMJ v 24 60  
 er 89.3\*WRTC A 4 17  
 S L 93.7 WL VH v 13 47  
 m 95.7 WKSS \$v + 31 70  
 rm 96.5 WTIC-FM\$ v N+Q 31= 70  
 rp 102.9 WDRG-FM\$ 31= 70  
 p 105.9 WHCN \$v +M 31= 70  
 p 106.9 WCCC-FM\$ Y 31 70  
 Middlefield 90.5\* 19 53  
 Middletown rj. 88.1\*WESU \$ U 4 15  
 g 104.9 WIHS 14 46  
 Monroze 88.1\*WMNR \$v 7 31  
 New Britain r 90.1\*WFCS 2 9  
 m 100.5 WRCH \$v +M 31 70  
 New Canaan 91.9\*WSLX 2 9  
 New Haven rs 94.3 WYBC \$v A 8 31  
 p 99.1 WPLR \$v 31 69  
 New London r 91.5\*WCNI 2 9  
 m 100.9 WTYD \$v 15 48  
 Norwalk m 95.9 WLYQ \$v 9 36  
 Norwich k 97.7 WCTY \$v A 15 46  
 Stamford m 96.7 WYRS A 15 45  
 Storrs cr 91.7\*WHUS v I 16 49  
 Wallingford 89.9\*WWEB 2 9  
 Waterbury r 92.5 WWYZ \$v + 32 70  
 k 104.1 WIOF \$v E+ 31 70  
 West Hartford cr 91.3\*WVUH \$v + 15 45  
 West Haven p 88.7\*WNHU v 9 33  
 Westport rc 90.3\*WWPT v 5 22  
 rj 107.9 WDJF \$v U+Q 25 65  
 Willimantic mr 98.3 WXLS \$v 15 46

**Delaware** (MAP P. 23)

Bethany Beach r 95.9 WWTR \$v 15 46  
 Dover k 94.7 WDSD \$v M 29 69  
 Georgetown p 93.5 WSEA v M 15 46  
 Hockessin 88.7\*WZZE 2 9  
 Milford k 97.7 WAFL v S 13 42  
 Newark 91.3\*WXDR 2 9  
 Rehoboth Beach r 92.7 WLRB \$v 15 46  
 Seaford r 98.3 WSUX \$v Y 12 40  
 Wilmington r 91.7\*WMPH 2 9

**Florida**

m 93.7 WSTW \$v N 32 72  
 m 99.5 WJBR \$v 33 73

**Dist. of Columbia** (MAP P. 23)

Washington pc 88.5\*WAMU \$v P 33= 73  
 j 89.3\*WPPW \$v 30 70  
 p 90.1\*WGTT \$v 23 49  
 c 90.9\*WETA-FM\$ v P+TB37 80  
 rs 93.9 WKYS \$v N 32 72  
 js 96.3 WHUR \$v 32= 70  
 r 97.1 WASH \$v S 31 70  
 k 98.7 WMZQ \$v 32 72  
 m 99.5 WGAY-FM\$ 33 72  
 rs 100.3 WOOK \$ 21 57  
 p 101.1 WWDC-FM\$ v E+M 33 73  
 c 103.5 WEMS-FM\$ v +M 33 72  
 rp 107.3 WRQX \$v A+M 32= 71

**Florida** (MAP PP. 26-27)

Apopka g 95.3 WTLN-FM v Y 15 46  
 Arcadia k 98.3 WOKD \$v 12 40  
 Atlantic Beach m 104.9 WJNJ 15 45  
 Belle Glade sm 93.5 WSWN-FM\$ v M 14 43  
 Boca Raton mg 99.9 WVOG \$v 43 89  
 Bonita Springs r 95.9 WLEQ \$v Y 15 46  
 Boynton Beach g 88.7\*WRMB 32 72  
 ScL 90.7\*WHRB \$v P+ 21 59  
 Bradenton m 103.3 WDUV \$v I+ 35 79  
 Cape Coral m 103.9 WRCC \$v S 15 46  
 Clearwater r 95.7 WOKF \$v A 35 79  
 rp 97.9 WQXM \$v +M 27 66  
 Clewiston k 106.3 WAFC v 11 38  
 Cocoa m 99.3 WEZY-FM\$ v Y 15 45  
 Cocoa Beach rc 101.1 WCKS \$v 35 79  
 r 104.1 WRKT \$v N+M 19 56  
 Coral Gables p 90.5\*WVUM \$ 2 9  
 m 105.1 WYOR \$v 39 83  
 Crestview k 104.9 WAAZ \$ C 14 44  
 Crystal River gm 98.5 WRYO \$v U 34 78  
 Daytona Beach mc 94.5 WWLV \$ +M 28 69  
 rp 101.9 WQXQ \$v 28 72  
 DeFuniak Springs r 103.1 WQUH v 12 40  
 De Land k 105.9 WELE-FM\$ M 27 70  
 Dunnellon km 102.3 WTRS-FM\$ v E 15 46  
 Fort Lauderdale gm 90.3\*WAFG \$v 15 45  
 r 100.7 WHYI \$v 44 90  
 p 103.5 WSHE \$v 38 82  
 r 105.9 WAXY \$v A+M 45 91  
 m 106.7 WGLO \$v 44 89  
 Fort Myers g 95.3 WSOR v 12 39  
 m 96.9 WINK-FM\$ 25 64  
 k 101.9 WHEW \$ 23 66  
 Fort Pierce rk 95.5 WOVR \$v 35 79  
 r 98.7 WLQY \$ E+M 32 76  
 Fort Walton Beach m 99.3 WFTW-FM\$ 11 38  
 Gainesville m 100.9 v 15 46  
 mc 103.7 WRUF-FM\$ C 26 63  
 p 105.5 WGVL \$v 14 44  
 Goulds g 98.3 WGLY \$v + 14 45  
 Green Cove Springs 92.7 WKUE v 15 46  
 Hialeah S L 92.1 WCMQ-FM\$ v 15 45  
 Holiday m 106.3 v 15 46

### Illinois

Hyperville	r	89.1*WUNC	6 35
Normal	cj	89.1*WGLO	\$v 9- 36
		86.7 WJHN	\$v 15 46
Oak Park	sj	102.7 WQMX	\$v +M 30 68
Olive	m	92.9 WSEI	26 66
Ottawa	r	95.3 WRXK	\$v 12 40
Pana	m	100.9 WKXN	\$v 15 45
Paris	k	98.5 WACF	\$v E-4FX33 73
Park Forest	r	88.1*WQHE	2 9
Park Ridge	r	88.5*WJTH	2 9
Peekin	m	95.3 WSVI-FM v	8 31
	k	104.9 WZRO	\$v 13 44
Peoria	cr	89.9*WCBU	\$vP1 18- 54
	r	93.3 WKZV	\$v 30 69
	pr	95.1 WQCT	\$v Y-M 33 72
	m	106.9 WSWT	\$v +M 32 72
	r	100.9 WIVQ	\$v M 9 37
Peru			
Pittsfield			
		97.7 WEGM-FM5	15 46
Plano		107.1 WSPY	v E+ 15 46
Pontiac	m	103.1 WPOH-FM v	+M 12 40
Quincy		90.3*WQOC	2 9
	nc	99.5 WOCY	\$v G+ 34 73
	rn	105.1 WGEN-FM5	vE+M 32 71
Rantoul	rn	95.3 WRTE-FM5	14 44
River Grove	rc	88.9*WRRG	2 9
Robinson	m	101.7 WTAJ-FM v	13 42
Rockelle	m	102.3 WPHL-FM v	12 40
Rockford	m	97.5 WZOK	\$v A 23 63
	q	100.9 WOFL	\$v U 15 46
Rock Island	r	91.1*WVIX	+ 2 9
	r	96.9 WHEF-FM5 v	C 37 80
Rockton	m	103.1 WRNC	\$v 15 46
Salem	rn	100.1 WJBD-FM5 v	U 10 37
Savanna	k	100.1 WCI1	v U 15 46
Shelbyville			
	rk	104.9 WSHY-FM5	9 35
Stokier	m	101.9 WCLP	\$v +XG31 69
Springfield	rc	91.5*WSSR	\$v P 33 73
	m	101.9 WVEN	\$v A+M 26 66
	r	103.7 WDBR	\$v +F 23 59
	k	104.5 WFBH	\$v +M 21 57
	k	94.3 WJVM	\$v 15 46
Stearator	k	97.7 WLAJ	A 10 38
Sullivan	kr	106.3 WAWA	\$v 15 46
Summit	rp	88.9*WARG	2 9
Taylorville	r	92.7 WEEC	\$v 15 45
Tuscola	r	93.5 WJTT	8 33
Urbana	c	90.9*WILL-FM5 v	P+B44- 80
	m	103.9 WTWC	\$v A 9 37
	p	107.1 WPGU	\$v Y 13 43
Vandalia	m	107.1 WYRV	\$v 11 38
Watseka	m	94.1 WGA-FM E	17 51
Waukegan	m	102.3 WEGA	\$v U 12 40
West Frankfort			
	m	97.7 WFFX-FM v	11 38
Whiteon		88.1*WETH	2 9
Winnebago	r	95.3 WYFC	\$v + 14 45
Winnetka	r	88.1*WJTH	2 9
Woodstock	r	105.5 WKEB	\$v U 15 46
Zion	m	96.9 WYZH-FM5 v	U 24 60

### Indiana

Anderson	mr	97.9 WLN-N	\$v +M 32 72
Angola	pc	86.3*WEAX	v 5 22
	r	100.1 WLP1	\$v A 15 46
Auburn	rg	105.5 WIFF-FM5 v	15 46
Aurora	k	99.3 WQCH	v 15 46
Batesville	r	103.9 WGB1	\$v 15 45
Bedford	m	105.5 WBI1	\$v 13 42
Bloomington	k	52.3 WGIT	\$v 1 44 86

		96.7 WOND	v 15 46
	cj	103.7*WJ10	vP0 33 72
Bluffton	m	100.1 WCFD	\$ 9 36
Boonville	n	107.1 WUML-FM M	12 40
Brazil	k	97.7 WUCH-FM5 v	M 15 46
Camel	r	91.3*WJJE	v 5 27
Chesterton	r	89.1*WQSO	2 9
Columbia City			
	nr	106.3 WFDT	\$ 8 33
Columbus	k	101.5 WCSI-FM5 v	U 19 56
	rm	104.5 WRRY	\$v M+M 15 46
Connersville	n	100.3 WGBB-FM E	17 50
Crzfordsville			
	m	103.9 WLLG	\$v 14 44
	rc	106.3 WNDY	v 6 23
Crean Point	ep	103.9 WFLM	\$v M 15 46
Danville	r	107.1 WRRT	\$v E 15 46
Decatur	m	92.7 WADM-FM M	8 32
Elkhart	rp	88.1*WVPE	v 22 57
	m	100.7 WYEE	\$v 33- 73
	m	104.7 WYFX	\$v 32 72
Evansville			
	c	90.7*WPSR	15 49
	p	91.5*WLEV	\$ 10- 38
	m	104.1 WHPY-FM5 v	M 32 73
	gk	105.3 WPHI	v M 27 67
Elwood	r	101.7 WBPB	\$ 9 36
Fort Wayne	gc	88.3*WPHI	v 2 9
		89.1*WJPU	v 9 36
	gc	90.3*WBCL	\$v U 25 65
	r	95.1 WPTH	\$v +FX35 76
	m	97.3 WHEF	\$v M+M 33- 73
	s	101.7 WCMX	\$v B+A 15 46
	r	103.9 WXXE	\$v N 14 43
Frankfort	rn	99.7 WLOL-FM U	12 40
Franklin	r	89.3*WFCT	2 9
	r	95.5 WIFN	v M 15 46
Gary	r	88.7*WQVE	+ 8 30
Gaston	r	91.1*WOWS	2 9
Goosene	gr	91.1*WCCS	4 17
	m	97.7 WZOW	\$v 9 36
Greencastle	r	91.5*WGRE	5 21
	nk	94.3 WXTA	A 11 38
Greenfield	rn	99.5 WSHJ	\$v +M 32 72
Greensburg	m	107.3 WTRF-FM v	26 66
Hannond	g	92.3 WYCA	\$v U 27 65
Hartford City			
	nk	93.5 WWHC	\$ 10 38
Hove	m	89.7*WHEE	2 9
Huntingburg	kn	100.9 WBOC	\$v 15 46
Huntington	r	91.9*WVSH	7 27
	rn	103.1 WHLT-FM M	8 32
Indianapolis	r	88.7*WICR	2 9
	rc	89.1*WJEL	v 2 9
	c	90.1*WIAN	v P 25 52
	m	90.9*WBOG	v 5 21
	r	91.1*WEDM	2 9
		91.5*WFFT	2 9
	p	93.1 WHPB	\$v +S 29- 69
	r	94.7 WFDQ	\$v +M 36 76
	k	95.5 WFBM	\$v 33 73
	n	103.3 WXTZ	\$v 31 70
	cr	104.5*WBJC	v 26 65
	s	105.7 WTLK	\$v B-0 32 72
Jasper	rn	104.7 WJLZ-FM5 v	30 70
Jeffersonville			
	r	95.7 WQHI	\$v 32 72
Kendallville	m	93.3 WAKY-FM5 v	26 64
Knox	rn	99.3 WYV1-FM5 v	15 45
Kokomo	rn	89.1*WHSY	2 9
	r	92.7 WQZV	\$v 1 12 40

	k	100.5 WUK1	\$v M+5 27 64
Lafayette	nr	91.4*WJEF	4 19
	mc	94.5 WXDS	\$v N 11 41
	rp	96.5 WAZY-FM5 v	Y 11 73
	k	105.3 WASA-FM5 v	27 66
La Porte	k	96.7 WCOL	L 14 44
Lakeland	rm	104.4 WJUN	M 15 46
Linton	rn	91.5 WOTO-FM v	11 42
Ligonisport	m	102.3 WJAL-FM5 v	M 15 46
Lowell	nr	107.1 WJCL	\$v 15 46
Madison	nr	96.7 WCRX-FM I	13 42
Marion	m	106.9 WPK1	\$v 25 65
Marionville			
	rn	107.3 WDBX-FM v	15 46
Michigan City			
	rn	95.9 WNDG	v 13 42
Monticello	m	95.3 WJVL	E+M 9 36
Muncie		90.5*WJDS	2 9
	rt	94.1*WBSI	4 18
	cr	92.1*WPEP	v 15 46
	r	104.1 WJRC-FM5 v	+FX30- 70
New Albany	nr	88.1*WNAS	v 3 13
New Castle	k	102.5 WNDH	\$v 27 64
North Manchester			
	cr	89.5*WBKE	7 30
North Vernon	m	106.1 WQCH-FM5 v	20 60
Notre Dame	rc	88.9*WSDO	\$v 17 49
Parli	k	95.3 WYAK-FM5 v	15 46
Pendleton	r	91.7*WHEM	2 9
Peru	m	96.3 WARU-FM5 v	5 20
Plainfield	k	98.3 WART	\$v 15 45
Plymouth	r	94.3 WTCM-FM5 v	13 42
Portland	r	100.9 WPLW-FM v	Y 12 40
Princeton	kr	96.1 WRAY-FM5 v	M 30 70
Rersselaer		90.5*WFOU	2 9
	nc	91.7 WJCK	v N 15 46
Richmond	cj	97.5*WECI	2 9
	m	96.1 WOLK	\$v A 26 63
	r	101.3 WRJA	\$v 23 60
Rochester	rn	92.1 WROI	\$v 8 33
Rockville	kr	104.9 WAX1	v 14 45
Rutledge	w	94.3 WRFC	\$v M 15 44
Salem	k	96.9 WSLM-FM	18 59
Scottsburg	k	100.9 WMP1	M 15 46
Seymour	k	97.7 WJCO-FM5 v	16 49
Shelbyville	k	93.1 WSVL-FM5	25 63
South Bend	nt	91.7*WETL	7 29
	rn	92.9 WNDL-FM5	27 64
	m	101.5 WJYJ	\$v 31 69
	g	103.1 WHME	\$v A+M 11 38
	e	100.9 WRRR	\$v 10 38
Terre Haute	rc	89.7*WTSU	v 22 57
	m	99.9 WTH1-FM5 v	N 25 62
	nr	100.7 WPTS	\$v 1-M 33 73
	rg	102.7 WPER	\$v A 26 63
	m	107.5 WBOG	\$v 22 61
Valparaiso	r	89.5 WQVR	\$v Y 2 9
	k	105.5 WJJE	\$v 1 13 43
Vevay	k	95.9 WADV	v 15 46
Vircennes	rc	91.1*WVUB	\$v P 33 73
	r	96.7 WAOV-FM	9 34
Wabash	r	95.9 WKUZ	M 10 38
Warsaw	m	107.3 WRJH-FM5 v	U 24 64
Washington	m	106.5 WFML	\$v 1 28 68
West Terre Haute			
	g	105.5 WQVR	15 45
Winchester	m	98.3 WIUC	v 15 46

### Iowa

			(MAP PP. 40-41)
Algon	nr	92.7 WJGA-FM	12 40
Ames	c	90.1*WDFN-FM5 v	\$ P 52 101
	r	91.9*WFGY	2 9

## Iowa

m 104.1 KLFM \$v +M 35 79  
 r 107.1 KCCG \$v U 15 46  
 Ankeny m 106.3 KANY v 15 46  
 Atlantic mk 103.7 KJAN-FM \$v U+M 28 72  
 Boone m 95.3 KWBG-FM \$v I 13 41  
 g 99.3 KFGO-FM v 12 40  
 Burlington r 107.3 KGRS \$v A+M 29 70  
 Carroll rp 93.7 KC1M-FM \$v S 29 71  
 Cedar Falls c 89.5 KHKE \$v P 21 56  
 g 90.9 KUNI \$v P 55 106  
 Cedar Rapids cjr 88.3 KCCX P 22 57  
 cj 88.3 KCCX \$v P 22 57  
 rc 86.9 KWHR 2 9  
 89.7 KGCJ 2 9  
 r 90.3 KCOE M 2 9  
 m 96.5 WRT-FM \$ C+M 33 73  
 k 98.1 KHAK-FM \$v 16 47  
 r 102.9 KOOR \$v 33 76  
 g 104.5 KTOF v M 37 81  
 q 98.7 KMGO v 35 79  
 Charles City m 95.9 KCHA-FM \$v 8 33  
 Cherokee m 102.3 KCHE-FM \$v 13 41  
 Clarinda rk 106.3 KSMI \$v 15 46  
 Clarion mk 96.9 KRIT M+X 26 70  
 Clear Lake m 103.1 v 15 46  
 Clinton m 96.1 KSAY U+M 33 76  
 r 97.7 KCLN-FM \$ E 15 46  
 Council Bluffs  
 r 98.5 KOKO \$v S 25 70  
 Creston k 101.7 KIIR 14 43  
 Davenport  
 r 90.1 KALA 2 9  
 cr 102.3 K272A \$ KUNI 90.91  
 r 103.7 KIHK \$v H+M 41 86  
 m 106.5 KRVR \$v 24 64  
 Decorah c 89.5 KLCD \$ P+TB 2 9  
 Denison m 107.1 KDSN-FM v U 15 46  
 Des Moines t 88.1 KDPS 16 49  
 r 93.3 KBKQ \$v 34 78  
 r 94.9 KGGG \$v 31 75  
 g 97.3 KDMI \$v M+FX 37 82  
 m 100.3 KLYF \$v 55 105  
 r 95.7 K269AC KFGO 99.31  
 r 102.5 KRNO \$v 37 80  
 r 92.9 KFMD \$v 34 76  
 m 105.3 KIWI \$v I 28 68  
 Emmetsburg m 98.3 KEWB \$v U 15 46  
 Etherville m 95.9 KILR-FM v +X 15 45  
 Fairfield 95.9 HBCT v 9 36  
 Forest City m 102.3 v 15 46  
 Fort Dodge 86.1 KICB 2 9  
 ng 92.1 KTGA v +M 15 46  
 m 94.5 KKEZ \$v +FX 34 74  
 Fort Madison m 101.7 KBKB-FM \$v M 13 42  
 Grinnell 88.5 KDIC 2 9  
 Hampton 104.9 KOHJ 8 32  
 Humboldt m 97.7 KHBT \$vAY 14 44  
 Independence  
 kr 95.3 KOUR-FM v 12 40  
 lowz City c 91.7 KSUI \$v P 50 99  
 r 93.5 KRNH \$v + 14 44  
 rp 100.7 KICG \$v 23 60  
 Iowa Falls nk 95.3 KIFE-FM v 12 39  
 Keokuk k 95.3 KIMI \$v 13 42  
 Knoxville g 92.1 KTAI v I 15 46  
 Le Mars m 99.5 KZZL U+M 19 59  
 Manchester kr 93.5 K228AC KOUR 95.31  
 Maquoketa m 95.3 KMBA-FM U 8 33  
 Marshalltown m 101.1 KFJB-FM U 25 61  
 Mason City gc 93.5 K228AF \$ KNWS 101.91  
 r 106.1 KLSS \$v U 28 69

## Mount Pleasant

rm 105.5 KILJ v 15 46  
 Mount Vernon 89.7 KRNL 2 9  
 Muscatine p 99.7 KFHH \$v U 24 64  
 Newton k 95.9 KLNV M+M 12 40  
 Oelwein k 92.3 KOEL-FM \$v A 29 69  
 Oskaloosa 88.7 KIGC 2 9  
 km 104.9 KGOE-FM U 14 45  
 Ottumwa r 97.7 KLEE-FM \$v 11 38  
 Pella r 89.1 KCUU 2 9  
 mr 103.3 KPLL \$ A 33 76  
 Perry m 104.9 KOLS-FM \$v M 15 45  
 Sheldon ng 105.5 KIRA-FM \$v 8 32  
 Sioux Center  
 g 91.3 KDCR \$v 27 66  
 m 94.3 KVDB-FM v 13 42  
 86.3\* 2 9  
 90.3 KQVIT \$v 44 90  
 k 95.5 KBOM \$v E+F 44 90  
 r 97.9 KSEZ \$v A 27 67  
 g 103.3 KTFC 26 70  
 m 107.7 KICD-FM \$v U 31 75  
 Storm Lake nr 101.5 KAYL-FM v +M 25 61  
 Tain Lakes nr 105.5 KTLB \$v 15 46  
 Washington m 95.3 KC11-FM v 15 46  
 Waterloo gc 101.9 KNWS-FM \$v U 45 91  
 r 105.7 KXEL-FM \$v Y 38 82  
 m 107.9 KFMA \$v S+FX 56+106  
 k 103.9 KHEI-FM v 15 46  
 Wauker k 89.1 KWAR 2 9  
 Waverly rj 99.3 KNAY-FM \$v U 12 39  
 Webster City  
 mk 95.9 KONC-FM \$v E 12 40  
 West Des Moines 88.9 KWDM 2 9  
 Kansas (MAP PP. 40-41)  
 Abilene r 98.3 KABI-FM 8 33  
 Baldwin City 88.9 KABU 2 9  
 Chanute m 105.5 KOSM \$v +M 11 38  
 Clay Center 100.9 v 14 43  
 Colby nr 91.9 KTCC 2 9  
 rm 100.3 KXXX-FM \$v G 39 83  
 Corcoria 88.3 KVCO 2 9  
 Derby r 95.9 KDFE \$v 15 46  
 Decatur City 91.9\* 2 9  
 k 93.9 KTTL v 38 82  
 m 95.5 KGNQ-FM \$v M 34 78  
 r 99.3 KOYY-FM v 9 36  
 El Dorado m 92.7 K224AC \$ KLCO 100.11  
 Emporia r 104.9 KLPP \$v I 15 45  
 Garden City k 97.3 KBUF-FM v I 21 58  
 Great Bend r 91.9 KBJC 10 36  
 m 99.3 K257AB \$ KLCO 100.11  
 nr 104.1 KVGO-FM \$v N 42 87  
 Hays kr 103.3 KJLS \$v +M 35 79  
 Hiawatha rn 103.9 KNZA \$v 15 46  
 Hillsboro r 88.1 KHPS 2 9  
 Hutchinson  
 r 90.1 KHCC 3 13  
 r 102.1 KSKU \$v +M 38 82  
 k 102.9 KHUT \$ N 18 55  
 Independence m 101.7 KINH-FM 9 35  
 Iola k 99.3 KIOL \$v 15 46  
 Junction City  
 r 94.5 KJCK-FM \$v S+FX 39 83  
 Kansas City k 94.1 KCKH-FM \$v S 35 79  
 r 98.1 KODL \$ Y 28 72  
 Larned nr 96.7 KANS-FM 10 38  
 Lawrence 90.7 KJHK 2 9  
 c 91.5 KANU \$v P+TB 41 86  
 r 105.9 KLWH-FM 17 56  
 Leavenworth km 98.9 KTRD \$v +X 34 78

## Kentucky

Lyons m 106.1 KLOO \$ E 23 64  
 Manhattan r 88.1 KSOB 2 9  
 r 101.7 KMKF \$v +M 15 46  
 Marysville r 103.1 KMOY-FM v 12 40  
 McPherson m 96.7 KNEH-FM \$v 13 42  
 Newton m 92.3 KOEJ \$v 30 70  
 Oberlin k 101.1 KFHF v 34 78  
 Ottawa 88.1 KTJO 2 9  
 rn 95.7 KOFO-FM \$ 18 53  
 Pittsburg  
 r 96.9 KMRJ \$v C+M 30 70  
 Pratt kr 93.1 KMSN-FM E+M 16 52  
 Russell m 95.9 KRSL-FM 15 45  
 Salina m 93.7 KYEZ \$v A 37 80  
 r 99.9 KSKG \$v Y+M 38 82  
 Scott City k 94.5 KULL \$ S 33 76  
 Topeka r 97.3 WBBW-FM \$v C 47 96  
 g 100.3 KDVV \$v M 16 46  
 k 106.9 KTPK \$v 32 76  
 m 107.7 KSWT \$v 35 79  
 Wichita sc 89.1 KMMU \$ P+T 14 46  
 k 91.1 KDSA v 17 51  
 k 95.1 KICT \$v 35 79  
 m 97.9 KERA \$ 33 76  
 k 101.3 KDFI-FM \$v A+M 35 79  
 r 103.7 KEYN \$v 43 89  
 m 107.3 KJAR \$v +FX 43 89  
 06.3 KSWC 2 9  
 Kentucky (MAP PP. 30-31)  
 Albany 106.3 WANY-FM 10 38  
 Ashland r 93.7 WAMX \$ E 30 70  
 Bourbonville r 93.5 WBYV-FM \$v 15 46  
 Beattyville g 102.3 WLJC 14 44  
 Benton gk 102.3 WCPL-FM \$v 15 46  
 Bowling Green  
 kp 96.7 WLEJ-FM v M 12 40  
 m 98.3 WUNS \$v A 15 46  
 Brandenburg k 93.5 WMAQ \$v 15 45  
 Cadiz rk 106.3 KHCZ-FM v 13 41  
 Campbellsville 100.9 WTCO-FM 15 46  
 Carrollton km 103.1 WVCW v + 14 44  
 Catlettsburg k 92.7 WCAK v U+ 15 46  
 Central City  
 kr 101.9 WHES-FM 23 63  
 Columbia k 93.5 WAIN-FM 12 40  
 Cortin k 99.3 WGO-FM Y 7 30  
 m 107.1 WCTI-FM \$v + 14 43  
 Cynthia k 102.3 WCYN-FM 8 32  
 Danville m 107.1 WMG6 v 9 36  
 Elizabethtown  
 m 100.1 WUXE \$v 15 46  
 r 103.1 WGLL \$v + 15 46  
 Erlanger g 100.9 WKHK v 15 46  
 Falmouth 95.3 v 15 46  
 Fort Campbell  
 rp 107.9 WABD-FM \$v A 27 70  
 Fort Knox r 105.5 WSAK-FM \$v U+M 15 46  
 Frankfort k 104.9 WKYN \$ M 14 44  
 Fulton m 99.3 WFLB-FM 8 26  
 Georgetown k 103.1 WAXU-FM v M 15 46  
 Glasgow gk 95.1 WGGC v U 33 76  
 r 105.5 WDOV \$v 15 45  
 g 91.5 WMYCC 2 9  
 Graysen 102.3 WGOH-FM 15 46  
 Greensburg mk 103.1 WKRK-FM 11 38  
 Hardinsburg kr 94.3 WHCF-FM \$v 15 45  
 Harrodsburg km 99.3 WWHB-FM 14 44  
 Hartford r 106.3 WLLS-FM \$v M 15 45  
 Hazard k 101.1 WSGS v 47 94  
 Henderson r 99.5 WKDU \$v C 32 72  
 rp 103.1 WHKC v A 15 46

# Kentucky

Hindman	kr	107.1	WKCB-FM	v	M	14	44
Hodgenville	k	106.3	WKNO	sv	M	13	42
Hopkinsville	k	98.7	WHCP-FM	c	20	58	
		100.3	WKDA-FM	i	15	52	
Jackson	mk	97.7	WJUN	v		14	44
Jamestown	k	104.9	WJRS	M		15	46
Jenkins	km	94.3	WREM-FM	v		15	48
Letchfield							
	rk	104.9	WNHL-FM	E		12	40
Lexington	cj	91.3	WBKY	sv	PU	33	73
	m	92.9	WVX-FM	sv	M	43	89
	r	94.5	WLAP-FM	sv		26	66
	p	98.1	WKGC	sv	A	33	74
Liberty	mk	105.5	WKDO-FM	v		12	40
Londar	mk	103.9	WF7G-FM	v		12	40
Louisville	t	89.3	WFFL	sv	P	28	72
	c	90.5	WUOL	sv	P+T	33	72
	c	91.9	WFPK	sv	P	28	72
	k	97.5	WAMZ	sv	M	37	80
	n	99.7	RCSN	sv		31	70
	rp	102.3	WLRS	sv	A	15	45
	g	103.9	WF1A-FM	sv		14	45
	n	106.9	WVEZ	sv		32	70
Madisonville	g	89.9	WSOF	sv	U	27	57
	m	93.9	WFMV-FM	sv		24	60
Manchester	m	103.1	WZXL-FM	v		15	46
Mayfield	k	94.7	WXID	sv		17	51
Maysville	m	95.9	WFTM-FM	v	M	15	46
Middlesboro	m	92.7	WHMK-FM	sv		5	17
Monticello	rm	101.7	WRYM	sv	I	14	44
Morehead	rc	50.3	WHKY	sv	P	33	73
		92.1	WNOR-FM	sv		4	16
Morganfield	m	95.3	WWSK-FM	v		12	40
Mt. Sterling							
	mk	105.5	WHST-FM	sv		15	46
Munfordville							
	kg	102.3	WLCC-FM			8	32
Murray	jp	91.2	WAMS	sv	P+	25	62
	m	103.7	WAAW	sv	A+M	31	75
Owensboro	k	92.5	WGNR	sv	M	33	74
	n	96.1	WSTO	sv	A	32	76
Paducah	k	93.3	WKYQ	sv	E+M	29	68
	rp	96.9	WPAQ-FM	sv	C+M	30	72
Paintsville	r	98.9	WZIP-FM	v	C	32	71
Paris	k	96.7	WBGR-FM	v	E	8	33
Pikeville	k	92.1	WDHR	sv	v	15	46
Pineville	k	106.3	WTJM	v	E	14	44
Prestonburg	m	95.5	WDOC-FM	v	+M	37	80
	kr	105.5	WPHT-FM			14	45
Princeton	104.9	WPKY-FM	v	12	39		
Providence	97.7	WHPZ	v	15	46		
Richmond	rc	88.9	WEKU	sv	P	37	78
	k	101.7	WBZF	v	M	13	42
Russellville	r	101.1	WAKG	sv		37	80
St. Matthews							
	rs	103.1	WSTM	sv	U	9	36
Scottsville	k	99.3	WLCK-FM	v		14	43
Somersel	m	90.7	WSSC			2	9
	k	96.7	WSEK	sv	A+M	13	41
Stanford	95.9	WNLS-FM	v	7	30		
Stanton	kr	104.5	WSKV	sv	E	14	44
Tompkinsville							
	k	92.1	WTFY-FM	i		13	42
Versailles	g	106.3	WJMP	v		15	46
Whitesburg	k	103.9	WKXO			14	44
Winchester	k	100.1	WVDJ	sv	E	15	46

# Louisiana

(MAP PP. 28-29)

AtLeville	kr	104.5	KROF-FM	sv		15	46
Alexandria	r	93.1		v		41	86

Bastrop	n	96.9	KSLI	sv	+M	43	89
	k	100.3	KRRV		Y	16	53
Baton Rouge	n	94.3	KTRY-FM	v	A	15	45
	m	100.1	KJDS	v		12	40
		90.1	WERH			2	9
	r	98.1	WAFB-FM	sv	Y	53	102
	m	100.7	WQXY	sv		40	85
	k	101.5	WYNK-FM	sv	E	33	76
	pr	102.5	WFHF	sv	A+	38	82
Bayou Vista	k	95.3	KOKI	sv		15	46
Crowley	g	102.9	KAJM-FM	sv	+M	35	79
De Ridder	km	101.7	KEAZ		U	13	42
Dunlapville							
	r	104.9	KSMH	sv	A+	15	46
Ferriday	k	107.1	KFNW-FM	sv		9	37
Franklin	rs	105.5	KFFA-FM	v	I+M	11	38
Galena Meadow							
	rp	94.3	KZZO	sv		15	46
	s	91.3	KGRK			2	9
Granbling	r	90.9	KSLU			2	9
Harwood	r	103.3	WTGI	sv	M+M	37	80
	nr	107.1	WMMO	sv		15	46
Houma	m	104.1	KHOM	sv	+M	27	68
	k	107.1	KCIL	sv		15	46
Jena		99.3	KJNA	v		15	46
Jennings	k	92.7	KJEF-FM	sv	I	13	41
Jonestown	rm	104.9	KTOC-FM	sv		13	42
Lafayette	r	88.3	KRVS	sv		2	9
	rp	94.5	KSMB	sv	Y+M	29	69
	r	99.9	KTDY	sv	+M	35	79
Like Charles	r	96.1	KSNS	sv	A	34	78
	m	99.5	KLCL-FM	sv	M+M	28	67
	p	103.7	KGRA	sv		36	80
Laplace	kr	92.3	WCAN	sv	I+M	31	72
Lake Providence							
	r	92.7	KBED	v		9	34
Leesville	m	105.5	KVVP	sv	M	15	46
Manvel	m	92.7	KJVC	v		15	46
Many	mk	107.1	KMLV			15	46
Marksville	k	97.7	KAPB-FM	sv		13	41
Minden	m	95.3	KASO-FM	v		9	37
Monroe		88.7	KMLU			2	9
	r	101.9	KNOE-FM	sv	I+A	54	103
	n	104.1	KNEZ	sv	M+M	17	52
	k	106.1	KREB			20	58
Morgan City	mr	96.7	KMRC-FM	sv		13	43
Natchitoches		91.7	KMWD			2	9
	k	97.7	KDBH	v	I	9	36
New Iberia	n	99.1	KDEA	sv	M	31	71
New Orleans	cj	89.9	WROK	sv	P	27	64
	jc	90.7	WKQZ			24	60
	r	91.5	WTVL	sv	Y	9	36
	r	93.3	WQVE	sv	M	35	79
	m	95.7	WBYU	sv		38	82
	n	97.1	WEZB	sv	+M	35	79
	g	98.5	WYLD-FM	sv		33	76
	r	99.5	WRNO	sv	A	33	76
	r	101.1	WNOE-FM	sv	Y+M	35	79
	m	101.9	WNL-FM	sv	+M	43	86
Oakale	m	104.9	KCWB	v		11	38
Oak Grove	g	96.7	KDDI	sv	M	15	46
Opelousas	km	107.1	KCGM	sv	I+M	12	40
Orlston		89.1	KLPI	i		2	9
	k	107.5	KXKZ	sv	+M	37	80
Shreveport		91.3	KSCCL			2	9
	m	93.7	KMBO	sv	I	29	73
	r	94.5	KROF	sv	C	31	75
	g	96.5	KEPT	sv	E+A	29	73
	m	100.1	KCOZ	sv		15	46
	k	101.1	KRMQ-FM	sv	M	44	90
Slidell	s	105.3	KXEL	sv	Z	32	76

# Maryland

Springhill	rs	92.7	KIXK	v		11	38
Sulphur	r	100.9	KLOQ	v		15	46
Thibodaux	r	91.5	KXFG	sv		2	9
	r	106.3	KXOR	sv	A	15	46
Ville Platte							
	f	mr	93.5	KVPI-FM		13	42
West Monroe	s	98.3	KYEI	sv	+M	14	44
Winfield	mr	92.1	KVCL-FM			9	35
Winnboro	km	95.9	KYAP-FM	v	M	12	39
Yonkers							
	m	100.1	KKAV	sv		15	45
Augusta	k	101.3	WFAL-FM	C		17	50
Bangor		89.3	WHSN			2	9
	cj	90.9	WHCH	sv	P+	31	70
	nc	92.9	WPPC	sv		31	70
	k	97.1	WBCK	sv	E+M	30	68
Bath							
	pr	105.9	KIGY	sv		33	73
	r	91.7	WBSP	A		2	9
Biddeford	mr	94.3	WIDE-FM	v	I	11	39
	r	91.1	WEOG			2	9
Brunswick	r	91.9	WJHS	A		2	9
	k	98.9	WXXX-FM	sv	+M	26	68
Calais	rm	92.7	WQY-FM	sv		15	46
Caribou	kr	97.7	WDFI-FM	sv		6	24
Ellsworth	m	95.7	WDEA-FM	sv	C+M	30	68
Farrington	r	91.9	WUMF			2	9
	r	99.3	WXTJ-FM	v		15	45
Fert Kent			90.3	WUFK		2	9
Gardiner	nr	104.3	WMEF	sv		27	58
Garban	r	91.1	WMPG			2	9
Houlton			89.1	WRNE		2	9
	r	100.1	WYOU-FM	sv	C	15	46
Lexiston	r	91.5	WRJR			2	9
	k	93.9	WCOU-FM	C		19	56
	p	107.5	WBLK	sv		32	70
Lincoln	r	99.3	WLNK-FM	sv	I	15	46
Millinocket							
	k	97.7	WYTR	v		12	40
Monticello		89.5	WJXN			2	9
Norway	r	92.7	WNOX	sv		15	45
Orono	r	91.9	WMEB	sv		4	17
Portland	cj	90.1	WPEA	sv	P+	52	98
	rm	93.1	WNGX	sv		24	64
	gc	97.9	WDCS	sv	E+	30	70
	k	101.9	WFOR-FM	sv		33	73
	m	102.9	WGAN-FM	sv	+M	52	101
Presque Isle							
	p	91.1	WUFI			2	9
	g	96.1		v		49	98
	nr	96.9	WDDP	sv	+M	35	79
	cj	106.1	WMEC	sv	P+	46	92
Rockland	m	93.5	WRKO-FM	I		12	39
Rumford	r	96.3	WRUM-FM	sv		8	40
Sanford	m	92.1	W8ME-FM	sv		14	44
Scarborough	r	106.3	WJBO-FM	sv		15	46
Skowhegan	rp	105.1	WTOS	sv		51	97
Springvale	r	91.1	WICY			2	9
Waterville		91.5	W9HB			2	9
	m	98.3	WTVL-FM	E		9	35
Westbrook	r	100.9	WLOB-FM	sv		13	42
Yonkers							

# Maryland (MAP PP. 22-23)

Annapolis	r	89.7	KRNV			2	9
	n	99.1	WJAV-FM	sv	+M	28	68
	g	107.9	WF51	sv	+M	28	66
Arrol		89.9	WACC			2	9
Baltimore		88.1	WSPH			2	9
	js	88.9	WEAA	sv	P+	18	53
	jc	91.5	WBJC	sv	P+	33	73
	r	92.3	WLPL	sv	+M	24	61

Maryland

k	93.1	WPOC	\$v + 33-	71	
g	95.1	WRBS	\$v U	25 64	
rp	97.9	WYYY	\$v N+M	32 70	
m	101.9	WLIF	\$v	33 72	
rs	102.7	WXYV	\$v	30 70	
r	104.3	WQJD	\$v M+	30 70	
m	106.5	WMAR-FM	Ev +M 32-	71	
r	86.1	WHFC	A	2 9	
Bethesda	m	94.7	WJMD	\$v + 33 72	
p	102.3	WHFS	\$v U	15 46	
Braddock Heights	r	103.9	WZYQ-FM	\$v Y	14 43
m	105.5	W28GAB	\$v WFRE	99.91	
Cambridge	m	106.3	W28PAB	\$v U	15 46
Colonsville	p	105.7	WHTK	\$v A	25 65
Curterland	g	102.9	WYVW	\$v	30 69
m	106.1	WVGC	\$ +	30 69	
Easton	mr	90.7	WEMD-FM	v	13 42
Elkton	g	86.3	WOEL	v	14 44
Emmitsburg		89.9	WMTB		2 9
Frederick	m	99.9	WFRE	\$v	33 70
g	103.1	W276AB	\$v WFSI	107.91	
Frostburg	kg	105.3	WFRB-FM	\$v	33 72
Glen Burnie	rm	95.9	WBKZ	\$v E	15 46
Hagerstown	m	104.7	WNMD	\$v E	35 76
g	106.9	WVCS	\$v C	31 70	
Halfway	rp	90.7	WDCM	\$v A	11 38
Havre de Grace	gk	103.7	WHOG	M	23 58
La Plata	p	104.1	WXTN	v	33 73
Lexington Park	m	91.7	WHDM	v A	15 46
Morningside	r	95.5	WFRC-FM	\$v	33 73
Owland	k	92.1	WWSG-FM	v	14 44
Ocean City	g	95.9	WHRM		27 67
m	104.9	WBOC-FM	Ev C+	32 71	
Prix e Frederick	r	97.7	WBJG	\$v	15 46
Princess Anne	g	102.5	WOLC	\$v +M	33 73
Salisbury	k	94.3	WICO-FM	\$v	12 39
Takoma Park	cy	91.9	WUIS	\$ P	18 56
Towson	cp	84.7	WCVI	v	15 46
Westminster	m	100.7	W11R-FM	\$v	24 69
Williamsport	g	90.5	WCPH	\$v	6 24
m	95.9	WY11	\$v N	15 46	
g	103.1	W276AA	\$v WFSI	107.91	
Worton	rc	90.5	WKHS	\$v	19 54

Massachusetts

Anherst	c	88.5	WFEP	\$v P+	35 76
p	89.3	WAMH	\$v	11 38	
p	91.1	WNUA		3 13	
Andover	rc	91.7	WPA		2 9
Barnstable	m	99.4	WQRC	\$v	25 64
Boston	pj	86.9	WERS	\$v	17 49
c	89.7	WGBH	\$v P	39 84	
j	90.9	WBUR	\$v P	21 64	
rs	91.7	WBHB	\$v	2 9	
pr	94.5	WLOC	\$v	30 66	
m	90.9	WJIB	\$v	31 69	
r	98.5	WFOR	\$v A+M	30- 66	
rp	100.7	WTTK	\$v N	33 73	
r	103.3	WFEX-FM	\$v C	31 70	
p	104.1	WBEN	\$v	32- 70	
r	106.7	W6Z-FM	\$v +	32 70	
Borford		86.3	WBNT		3 10
Bridgewater		91.5	WBHM		2 9

Brockton	r	97.7	WCAV	\$v Y	14 44
Brookline	r	92.9	WBOS	\$v S+	31 70
Cambridge	rs	86.1	WBTS		2 9
jc	95.3	WHBB	\$v	8 33	
Charlton		90.1	WBVP		2 9
Concord	r	88.3	WIGH		2 9
Duxley	r	91.1	WARC		2 9
Duxbury	r	91.7	WDEY		2 9
Easton		91.3	WSHL	v	2 9
Falmouth	nr	101.9	WCIB	\$v	24 64
Fitchburg	k	104.5	WFMP	U+M	26 66
Framingham	r	91.3	WDMJ		2 9
r	105.7	WVBF	\$v M	31- 70	
Franklin	r	91.2	WGAD		2 9
Greoucester	c	104.9	WVCA		10 37
Greenfield	m	98.3	WHAI-FM	v C	4 13
Haverhill	m	92.5	WHAV-FM	\$v	24 69
Holliston	r	91.5	WHBB		2 9
Holyoke		89.5	WCCB		2 9
Hyannis	r	106.1	WCOO	\$v Y	30 70
Lawrence	r	93.7	WCGY	\$v	30 70
Lowell	rj	91.5	WJUL	\$v	5 19
m	99.5	WSCH	\$ +	33 71	
Lynn	ke	101.7	WLYN	v	12 39
Marshfield	m	95.9	WALD	v +B13	42
Maynard	r	91.7	WAVM		2 9
Medford	rs	91.5	WVFC	A	2 9
m	107.9	WDEL-FM	\$v +Q	32 71	
Milton	r	91.5	WMLA		2 9
New Bedford	P	97.3	WJFD	+M	26 65
m	98.1	WNYS	\$v	33 73	
Newbury		88.7	WOLI		2 9
Newton	r	90.2	WZFC		1 9 35
North Adams	r	91.1	WJ2W		2 9
nc	100.1	WNW-FM	\$v S+M	15 44	
Northampton	rm	99.3	WNFM-FM	\$v I-M	15 46
North Andover	r	90.5	WRML		2 9
North Dartmouth	r	90.5	WRUM		2 9
Orleans	nc	104.7	WLOK	\$v S+	27 67
Pittsfield		84.5	WTBR		2 9
p	95.9	KUPE-FM	v	14 44	
m	101.7	WBRV-FM	v C	8 34	
m	105.5	WDRH	\$v +M	14 44	
Plymouth	m	99.1	W11L-FM	\$v +	30 70
Rockland		91.5	WRPS		2 9
Salem		91.7	WVMA		2 9
Sandwich		91.7	WSDH		2 9
Sheffield	r	91.7	WRSL		2 9
Southbridge	m	100.1	WR50-FM	\$v U	15 45
South Hadley	r	91.5	WRMC		2 9
Springfield	p	89.1	WTRZ		2 9
p	86.9	W3CB		2 9	
cr	90.7	W1CC	\$v P	8 34	
sr	91.9	W41C		1 4 17	
m	93.1	W4YN-FM		30 68	
r	94.7	W4AS-FM	\$v	18 53	
Stockbridge	g	91.3	WCVI	\$v Y+	31- 70
Taunton		91.3	WRIN	\$v S+	28 68
r	91.5	WR8B		2 9	
Waltham	r	91.7	W8RS	\$ A	2 9
Wellesley	c	102.5	WCRB	\$v I+	31- 70
West Barnstable		91.5	WZLY		2 9
rj	91.1	WRKL		2 9	
Westficlc		91.5	WQKB		2 9
Weston	r	88.3	WRSE		2 9

Michigan

West Yarmouth	nr	94.9	WCCB-FM	\$v E+	M 25 65
Williamstown	r	91.9	WCFM	\$v I	1 3 11
Winchester	r	91.9	WHSR		2 9
Worcester		89.1	WQHC		2 9
cr	50.5	W1CN	\$v +	15 46	
S Lr	91.3	W3CW	\$v	2 7	
m	96.1	WERS	\$v +M	32 70	
rp	107.3	WAAF	\$v +M	32 70	
Michigan	(MAP PP. 36-37)				
Adrian	r	88.1	WVAC		2 9
m	95.3	WGTE	\$v	15 46	
nk	103.9	W4LR	\$v M	15 46	
g	106.3	W4ZAC	\$v WPOS	102.3t	
Allenton	g	96.7	WUFN	\$v	15 46
Allendale	jp	88.5	W3RX		2 9
Alma	m	104.9	W4YC-FM	v	15 46
Alpena	cj	91.7	W3ML-FM	\$v WUP	48 96
km	93.5	W41Z-FM	\$v N	14 43	
km	107.7	WHSB	v I-A	44 78	
Ann Arbor	rw	86.3	W4CB		2 9
cj	91.7	W4UM	\$v F	41 91	
pj	102.9	W4GB	\$v A+M	15- 47	
m	107.1	W4FA-FM	v I	14 44	
Auburn Heights		89.5	W4HS		2 9
Bad Axe	m	92.1	W4EH-FM	v	13 42
Battle Creek	kg	95.3	WDFP	\$v	14 44
mr	103.3	W4FR	\$v	26 63	
Bay City	r	91.3	W4CH		2 9
r	91.1	W4HN	\$v	33 75	
m	102.5	W4LF	\$v S	40 85	
Benton Harbor	m	99.9	W4FB-FM	\$v A	17 50
Berrion Springs	cg	90.7	W4US	\$v P	27 67
Big Rapids	r	100.9	W4RN-FM		15 46
Birmingham	rm	94.7	W4JC	\$v	31- 69
Bloomfield Hills		88.1	W4FH		2 9
Boysie City	km	93.5	W4LL	v	15 46
Cadillac	km	92.5	W4HF	\$v C+	44 90
m	96.7	W4IK	\$v	15 46	
Caro	r	104.9	W4DL	v	15 46
Charlotte	rm	92.7	W4CR-FM	\$v E	11 38
Chelmsgon	m	105.1	W4BY-FM	v I-A	15 50
Clare	r	95.3	W4RN-FM	\$v	11 38
Coldwater	i	90.5	W4WH	\$v I+M	33 73
Dearborn	r	100.3	W41C	\$v M+M	30 70
Detroit	cg	90.9	W4DR		18 52
k	92.3	W4GN-FM	\$v	24 59	
m	93.1	W4RD	\$v	28 66	
m	95.5	W4UM	\$v	35 81	
m	96.3	W4JB-FM	\$v	32- 77	
m	97.1	W4JL-FM	\$v	32 70	
ne	97.9	W4ZY	v +M	30 70	
g	98.7	W4FG	\$v U+M	32 72	
p	99.5	W4BZ	\$v	27- 65	
rp	101.1	W4IF	\$v A	31 76	
cj	101.9	W4DT	\$v P	34- 77	
g	103.5	W4MZ	\$v +Q	32- 78	
m	104.3	W4MC	\$v	36- 84	
cj	105.1	W4ZS	\$v	32- 72	
j	105.9	W4JZ	\$v	25- 64	
rp	106.7	W4WV	\$v	34 75	
cg	107.5	W4FR	\$v Z	29 69	
Dowaglac	ng	92.1	W4OR-FM	\$v U	15 46
East Lansing	c	90.5	W4JA-FM	\$v P+T	46 93
r	54.9	W41C-FM	\$v Y	25 67	
rp	99.1	W4MK	\$v I	31 70	

New York

New York	p	89.1*WNYU	#	17	50	
Lc		89.9*WKCR	\$v	+B21	57	
ec		90.7*WUOV	\$v	E+Tb23	63	
		91.5*WNYE	v	26	63	
r		92.3*WATU	\$v	31	69	
c		93.9*WNYC-FM	\$v	P	30	68
rp		95.5*WPLJ	\$v	A	30	68
c		96.3*WQXR-FM	\$v	31	69	
r		97.1*WYNY	\$v	N+M	30	68
e		97.9*WEDV-FM	v	+Q	31	69
r		98.7*WXLO	\$v	31	69	
		99.5*WBAI	\$v	31	69	
r		101.1*WCBS-FM	\$v	C	30	68
rp		101.9*WPIX-FM	\$v	+M	30	69
p		102.7*WHER-FM	\$v	S	30	69
c		104.3*WQCN	\$v	+M	31	69
n		105.1*WRFM	\$v	31	69	
j		106.7*WRVR	\$v	+E	31	69
s		107.5*WGLS	\$v	B	31	69

Niagara Falls

mc		98.5*WHDL-FM	\$v	+M	30	70
----	--	--------------	-----	----	----	----

North Syracuse

n		100.9*WEZG	\$v	11	38
---	--	------------	-----	----	----

Norwich	mc	93.9*WDHN-FM	U	14	44
---------	----	--------------	---	----	----

Olean	n	95.7*WBEF	\$v	36	77
-------	---	-----------	-----	----	----

Oneida

n		106.3*WOCR-FM	v	14	43
---	--	---------------	---	----	----

Oneonta		89.5*WRHD		2	9
---------	--	-----------	--	---	---

		90.9*WQNY		2	9
--	--	-----------	--	---	---

m		103.1*WONT	\$v	1	15	45
---	--	------------	-----	---	----	----

r		103.9*WVRK	\$v	Y	14	44
---	--	------------	-----	---	----	----

Ossining		90.3*WSSS		2	9
----------	--	-----------	--	---	---

Oscego	cr	89.9*WRVO	\$v	PL+	27	66
--------	----	-----------	-----	-----	----	----

	n	105.5*WSDG-FM	v	8	33
--	---	---------------	---	---	----

Osego	m	101.7*WBOB-FM	\$v	N	15	46
-------	---	---------------	-----	---	----	----

Patchogue	m	97.5*WALK-FM	\$v	UM	27	64
-----------	---	--------------	-----	----	----	----

r		106.1*WBLI	\$v	23	59
---	--	------------	-----	----	----

Paul Smiths		89.1*WPSA		2	9
-------------	--	-----------	--	---	---

Peekskill	m	100.7*WHDV	\$v	+M	33	73
-----------	---	------------	-----	----	----	----

Plainville		88.5*WPOB	#		+ 2	9
------------	--	-----------	---	--	-----	---

Plattsburgh

n		99.9*WGFV	\$v	C+M	24	59
---	--	-----------	-----	-----	----	----

Pert Jervis	n	96.7*WDLG-FM	\$v	A 15	46
-------------	---	--------------	-----	------	----

Potsdam	o	91.1*WTSC	\$v	+ 5	7	28
---------	---	-----------	-----	-----	---	----

	m	99.3*W5AN	\$v	1	10	38
--	---	-----------	-----	---	----	----

Poughkeepsie		91.3*WVNR		2	9
--------------	--	-----------	--	---	---

rp		101.5*WPOH	\$v	+	31	69
----	--	------------	-----	---	----	----

rc		104.7*WSPK	\$v	M	30	68
----	--	------------	-----	---	----	----

Rensselaer	rp	103.9*WQBC-FM	\$v	A	15	46
------------	----	---------------	-----	---	----	----

Riverhead	rp	103.9*WQCN-FM	\$v	+M	15	46
-----------	----	---------------	-----	----	----	----

Rochester	rs	86.5*WRUR	\$v	U	7	28
-----------	----	-----------	-----	---	---	----

nr		90.9*WIRO	A	2	9
----	--	-----------	---	---	---

c		91.5*WXXI-FM	\$v	P	28	68
---	--	--------------	-----	---	----	----

r		92.5*WJND	\$v	U+Q	29	67
---	--	-----------	-----	-----	----	----

p		96.5*WOMF	\$v	22	58
---	--	-----------	-----	----	----

m		97.9*WPKY	\$v	C	30	70
---	--	-----------	-----	---	----	----

r		98.9*W6FM	\$v	A	28	68
---	--	-----------	-----	---	----	----

rm		100.5*WVOZ	\$v	N+M	29	69
----	--	------------	-----	-----	----	----

m		101.3*WEZO	\$v	33	71
---	--	------------	-----	----	----

s		103.9*W0XK	\$v	B	15	46
---	--	------------	-----	---	----	----

Rome	n	95.9*WYAL-FM	\$v	M	8	33
------	---	--------------	-----	---	---	----

Sag Harbor	nr	92.1*WLNQ-FM	v	N	15	46
------------	----	--------------	---	---	----	----

St. Boraventure		88.5*WSBU		2	9
-----------------	--	-----------	--	---	---

Saratoga Springs

r		91.1*WSPN		2	9
---	--	-----------	--	---	---

m		102.3*WKAJ-FM	U	7	28
---	--	---------------	---	---	----

Schenectady	c	89.1*WYHT-FM	\$v	P+Tb1	70
-------------	---	--------------	-----	-------	----

		90.9*WRUC		2	9
--	--	-----------	--	---	---

r		99.5*WGFV	\$v	30	69
---	--	-----------	-----	----	----

Seneca Falls	r	99.3*WSW-FM	v	11	42
Smithtown	m	96.3*WCTO	\$v	15	45
Sodus		89.5*W5CS		2	9
Southampton	m	95.3*WRRJ	\$v	15	46
Stony Brook					

nj		90.1*WUSB	\$v	14	44
----	--	-----------	-----	----	----

Svorset		88.5*WWRZ	#	2	9
---------	--	-----------	---	---	---

Syracuse	ps	88.3*WUER	\$v	U	14	44
----------	----	-----------	-----	---	----	----

cj		91.3*WQNY-FM	\$v	P	31	70
----	--	--------------	-----	---	----	----

m		93.1*WRTO	\$v	+M	39	73
---	--	-----------	-----	----	----	----

r		94.5*W5TR-FM	\$v	36	80
---	--	--------------	-----	----	----

g		102.9*WHRH	\$v	+M	28	67
---	--	------------	-----	----	----	----

c		107.9*W0MO	\$v	30	70
---	--	------------	-----	----	----

Trey	p	91.5*WRP1	\$v	21	56
------	---	-----------	-----	----	----

rm		92.3*WFLY	\$v	+M	32	70
----	--	-----------	-----	----	----	----

		90.7*WPHR		2	9
--	--	-----------	--	---	---

p		96.9*W0UR	\$v	A+M	32	70
---	--	-----------	-----	-----	----	----

n		98.7*WRBO	\$v	32	71
---	--	-----------	-----	----	----

rn		104.3*W0CW	\$v	1	48	95
----	--	------------	-----	---	----	----

kr		107.3*WTLB-FM	\$v	A	19	54
----	--	---------------	-----	---	----	----

		88.5*WARY		2	9
--	--	-----------	--	---	---

Valhalla		92.1*W0LA-FM	v	U	14	44
----------	--	--------------	---	---	----	----

Watertown	nr	97.5*WQCO	\$v	+M	26	65
-----------	----	-----------	-----	----	----	----

Watervly	m	102.3*WAVR	\$v	E	15	45
----------	---	------------	-----	---	----	----

West Point		89.3*W0DT		2	9
------------	--	-----------	--	---	---

Wethersfield					
--------------	--	--	--	--	--

g		107.7*W6IV	\$v	30	69
---	--	------------	-----	----	----

White Plains

n		103.9*W0YD	\$v	14	44
---	--	------------	-----	----	----

North Carolina

(MAP PP. 24-25)

Alcoa	k	99.3*WRCS-FM	\$v	15	46
-------	---	--------------	-----	----	----

AllerMarle	m	100.9*WABZ-FM	\$v	12	40
------------	---	---------------	-----	----	----

Asheboro	mk	92.3*RCSE	\$v	+M	30	69
----------	----	-----------	-----	----	----	----

Asheville	p	88.1*WUHF-FM	v	7	23
-----------	---	--------------	---	---	----

sj		91.3*W0MU	2P	15	46
----	--	-----------	----	----	----

n		99.9*WLOS	\$v	E	57	107
---	--	-----------	-----	---	----	-----

Black Mountain	ng	106.9*W0IT	\$v	A+M	57	107
----------------	----	------------	-----	-----	----	-----

Boiling Springs

nr		88.3*W0RG	v	U-	14	44
----	--	-----------	---	----	----	----

Boone	rc	90.5*WASU		5	23
-------	----	-----------	--	---	----

Bridgeton	rc	106.5*W5FL	\$v	+ 40	85
-----------	----	------------	-----	------	----

Buies Creek	m	90.1*W0CE		8	33
-------------	---	-----------	--	---	----

Burgeo	g	99.9*W0JC	\$v	Y+	37	80
--------	---	-----------	-----	----	----	----

Burlington	r	93.9*W0AG-FM	\$v	U	18	51
------------	---	--------------	-----	---	----	----

		101.1*W0CB	\$v	+M	37	80
--	--	------------	-----	----	----	----

Chapel Hill	p	89.3*W0YC	\$v	+	9	32
-------------	---	-----------	-----	---	---	----

cj		91.5*W0AC	\$v	P+	42	87
----	--	-----------	-----	----	----	----

Charlotte

		90.9*W0FAE		2	9
--	--	------------	--	---	---

rp		95.1*W0CO	\$v	33	74
----	--	-----------	-----	----	----

k		103.7*W5OC-FM	\$v	1	45	92
---	--	---------------	-----	---	----	----

m		104.7*WEZZ	\$v	+M	48	97
---	--	------------	-----	----	----	----

m		107.9*W0B1-FM	\$v	44	90
---	--	---------------	-----	----	----

Clinton	rk	107.1*W0RZ-FM	E	15	46
---------	----	---------------	---	----	----

Concord	r	97.9*W0EC	\$v	+M	24	62
---------	---	-----------	-----	----	----	----

		91.7*W0CU		2	9
--	--	-----------	--	---	---

Davidson	r	89.9*W0AV	v	+ 22	58
----------	---	-----------	---	------	----

Dunn	rk	103.1*W0TI	\$v	15	46
------	----	------------	-----	----	----

Durham	s	90.3*W0FR	\$v	10	38
--------	---	-----------	-----	----	----

k		105.1*W0CG	\$v	E+M	28	67
---	--	------------	-----	-----	----	----

pc		107.1*W0BS	\$v	15	46
----	--	------------	-----	----	----

n		94.5*W0FA	\$v	M	15	51
---	--	-----------	-----	---	----	----

k		100.1*W0XB	\$v	12	40
---	--	------------	-----	----	----

Elizabeth City

p		93.7*W0YK	\$v	43	87
---	--	-----------	-----	----	----

Elkin		100.9*W0FM-FM	I	7	26
-------	--	---------------	---	---	----

North Carolina

Elon College		89.1*W0SE		2	9
--------------	--	-----------	--	---	---

Fairmont	k	100.9*W0XY	\$v	15	46
----------	---	------------	-----	----	----

Farmville	p	94.3*W0RP	\$v	15	46
-----------	---	-----------	-----	----	----

Fayetteville		88.1*W0SS		2	9
--------------	--	-----------	--	---	---

r		88.1*W0SH	\$v	S+M	16	80
---	--	-----------	-----	-----	----	----

Forest City	rk	93.3*W0BG-FM	Y	14	43
-------------	----	--------------	---	----	----

Franklin	nr	87.7*W0SC-FM	I	5	17
----------	----	--------------	---	---	----

Fuquay-Varina

k		103.9*W0FS-FM	\$v	15	46
---	--	---------------	-----	----	----

Gastonia	r	101.9*W0GC-FM	\$v	1+4	37	78
----------	---	---------------	-----	-----	----	----

Goldensboro	m	96.9*W0OR	\$v	27	67
-------------	---	-----------	-----	----	----

g		102.3*W0KN	\$v	B	14	44
---	--	------------	-----	---	----	----

Greensboro

		89.9*W0AG		2	9
--	--	-----------	--	---	---

		90.5*W0AA		2	9
--	--	-----------	--	---	---



# Michigan

Elsie	91.3*WOES	2	U
Escanaba	mr 97.1 WKZY \$ U	45	91
	r 104.7 WFMV	v	32 76
Farmington Hills	90.3*WORB	2	9
Flint	sj 92.7	v	15 46
	tc 95.1*WFBE \$ P	9	36
	r 105.5 WCKC \$ A	15	46
	m 107.9 WGMZ \$ v	28	68
Freemont	kr 100.1 WSHN-FM \$ v	14	44
Gaylord	g 95.3	v	15 45
	m 106.7 WRRY \$ v U	33	74
Grand Haven	m 92.1 WFMG	\$	13 42
Grand Rapids	89.9*WEHB	v	7 27
	mc 91.3*WCSS \$ v U	22	58
	m 93.7 WJFM \$ v M+M	52	109
	r 95.7 WTRF \$ v	27	67
	p 96.9 WLAJ-FM \$ v E+M	33	73
	r 97.9 WGRD-FM \$ v U	32	71
	r 101.3 WMLW \$ v A+	30	70
	ng 102.9 WFUR-FM \$ v	25	63
	c 104.1*WVGR \$ P	40	85
	m 105.7 WOOD-FM \$ N	48	100
Grayling	k 100.1 WGOH \$ v	7	30
Greenville	k 107.3 WPLB-FM \$ v	29	69
Hancock	r 93.5 WHPL-FM	N	14 43
Harrison	k 92.1 WKKM	E	15 46
Hastings	m 100.1 WBCB-FM	v E	12 41
Highland Park	88.1*WHRP		2 9
Hillsdale	m 92.1 WCSR-FM \$ v	13	42
Holland	mg 94.5 WJBL-FM \$ v U	24	60
	m 96.1 WHTC-FM \$ M	26	65
Houghton	cj 91.1*WGLL \$ v P	43	89
Houghton Lake			
	n 98.5 WJGS \$ v I	36	80
Howell	rn 93.5 WHHI-FM	v Y	15 46
Interlochen	c 88.3*WIAA \$ v P+	34	79
Iron Mountain			
	rn 103.9 WJHR \$ v S+M	14	44
	g 105.5 W288AA \$ WRVM	102.71	
Ironwood	rn 99.7 WIMI \$ v	+S 38	82
	g 100.9 W265AB \$ W11B	103.71	
	nr 106.9 WUPH \$ v I	29	67
Ishpeming	nr 92.3 WJUP-FM \$ N	36	80
	m 107.1 WMDT \$ v I	14	43
Jackson	m 94.1 WHFI \$ v	27	67
	r 106.1 WJDX \$ +M	18 54	
Kalamazoo	p 89.1*WIDR \$ I	2 9	
	cp 102.1*WSUK \$ P	32	72
	m 106.5 WQLR \$ v	32	73
Lansing	m 97.5 WJIM-FM \$ N+M	28	66
	k 100.7 WITL-FM \$ v	+M 21	61
	rp 101.7 WJLS-FM \$ v U	12	40
Lapeer	rn 103.1 WTHH-FM		15 46
Ludington	m 106.3 WKLA-FM \$		14 43
Manistee	r 97.7 WRRK \$ v Y	10	38
Marquette			
	c 90.1*WNNU \$ v	44	90
	q 95.7 WHWL \$ v	+M 37	80
	rn 100.1 WUUN \$ v	15	45
Marshall	m 104.9 WELL	v	15 46
Midland	re 93.5 WRCI \$ v M	15	45
	g 99.7 WUGH \$ v	40	84
Monroe	g 89.5*WEJY		2 9
	k 98.3 WMYD	v	15 46
Mount Clemens			
	m 102.7 WBRB-FM \$ v I	25	61
Mount Pleasant			
	cj 89.5*WCMU \$ vUP	34	78
	j 91.5*WEHW \$		2 9
	r 94.5 WCEH-FM \$ M	19	55

# Minnesota

Duluth	c 97.1*WSDJ \$ v P+TB34	75	75
	k 94.9 WADH-FM \$ M	27	64
	r 98.9 WAXA-FM \$ v I	39	83
	jc 103.1*WDEH \$ v	38	82
	m 105.1 WGRG \$		41 86
Last Grand Forks			
	k 103.9 KRAD-FM v M	9	37
Ely	r 103.9 KZ10AT \$ WAKX	38.91	
Eveleth	100.1 WFLA	v	14 44
Fairmont	m 101.5 KFMC \$ v U	27	46
Fairbault	k 95.9 KDHJ-FM v M	15	45
Fergus Falls	m 103.1 KBHF-FM \$ v M	23	60
Forest Lake	mk 95.9	v	15 46
Fosston	k 107.1 KEHG-FM v N	8	33
Golden Valley			
	rp 92.5 KQRS-FM \$ v +0	42	86
Grand Marais	105.5 K28HBF \$ WAKX	98.91	
Grand Rapids			
	cj 91.7*KAKE \$ v P+TB35	74	
	rn 96.7 KXGR \$ v Y	15	46
	m 101.7 WJLAAA \$ WGRG	105.11	
Hibbing	m 106.3 WMEG-FM \$ I	9	34
Hutchinson	n 107.1 KDFZ-FM \$ v	12	40
International Falls			
	91.5*KICC \$		2 9
Litchfield			
	nr 95.3 KLFD-FM \$ v	15	46
Luverne	m 100.9 KRAD-FM \$ v I	13	42
Mankato	nr 90.5*WMSU	U	2 9
	m 99.1 KEZZ \$ v E+4	43	89
	k 103.5 KDSM-FM \$ N+M	36	79
Marshall	m 100.1 KMHL-FM \$	Y+M	15 46
Minneapolis			
	cr 88.5*KBEN \$ v	16	47
	ej 90.3*KFAI \$ v	2	9
	m 93.7 WAYL-FM \$ v U	42	87
	k 97.1 KTCR-FM \$ M	20	60
	gc 98.5*KTIS-FM \$ v	28	71
	g 99.5 WLOL-FM \$ v	+M 43	89
	g 100.3 WCTS \$		34 76
	r 102.9 KCCO-FM \$ v	50	99
Moorhead	c 91.1*WCCM \$ P+TB30		3
	r 98.7 KWBB-FM \$ v	+F 33	76
	rp 99.9 KVOX-FM \$ A	33	77
Morris			
	m 99.7 WMMM \$		2 9
	m 95.7 KMRS-FM \$ M	33	76
New Ulm	rn 93.1 KNUJ-FM \$ v	24	61
Northfield	cj 89.3*WICAL-FM \$ v P	34	78
	r 90.3*WRLX		2 9
Owatona	m 104.9 KRFO-FM		12 39
Park Rapids	mk 97.5 KPRM-FM \$ v N	34	78
Pequot Lakes	gc 100.1 KTIQ	v	15 46
Peterson	y 99.3 K257AI \$ W11B	103.71	
Pine City	k 92.1 WOMP-FM v		15 45
Pipestone	nr 98.7 KLOH-FM \$ v Y	35	75
Preston	k 103.1 KFLL-FM v		14 44
Princeton	m 106.3 WQPM-FM v S		15 45
Red Lake	g 93.5*W228AA \$ KFNH	97.91	
Red Wing	ka 105.5 KCUE-FM \$ v	15	46
Redwood Falls			
	m 97.7 KLGR-FM \$ v	15	45
Richtfield	r 101.3 KQWB-FM \$ v	42	87
Rochester	r 89.9*KRPR	v	2 9
	rn 96.7 KWKK \$ v	15	45
	m 97.5 KHXK \$ v E+X	33	73
	p 101.7 KRCH \$ v	14	45
	m 106.9 KRCD-FM \$ v	N+X47	93
Rushford	c 91.7*KLSE \$ v P+TB38		82
St. Cloud	r 88.5*KVSC	U	2 9
	k 98.1 WKKU \$ v	34	78
	r 104.7 KCLD-FM \$ v N	35	79

Minnesota

Table listing Minnesota radio stations including St. Louis Park (91.7 KDXL), St. Paul (91.1 KSJN, 94.5 KSTP-FM), Silver Bay (107.1 W29GAB), Sauk Centre (94.3 KMSR), and Thief River Falls (90.1 HAVS).

Mississippi

Table listing Mississippi radio stations including Aberdeen (101.1 WHAY), Bogalusa (95.5 WPII), Bossierville (99.5 WBIF-FM), Brandon (97.7 WRJH), and Canton (101.7 WMLY).

Missouri

Table listing Missouri radio stations including Aurora (101.1 HILL), Berthoud (96.1), Bellvue (101.1 PLTE), and Blue Springs (101.1 W29GAB).

Table listing Missouri radio stations including Houston (93.3 KCPC-FM), Indianola (105.5 WMLA-FM), Jackson (90.7 WJSD), Kansas City (90.1 W29GAB), and Kirksville (98.7 WGLL-FM).

Missouri

Table listing Missouri radio stations including Aurora (101.1 HILL), Berthoud (96.1), Bellvue (101.1 PLTE), and Blue Springs (101.1 W29GAB).

Missouri

Table listing Missouri radio stations including Clinton (99.1 KFUD-FM), Columbia (88.1 KCOL), Creighton (94.7 KSHC), Dexter (107.3 KDCX-FM), El Dorado Springs (105.5 KESH-FM), Farmington (98.5 KTJJ), Ferguson (89.5 KCFV), Florissant (97.1 KSCF), Fulton (97.7 KRCA), Greenfield (93.5 KRFL), Hannibal (92.9 KRGC), Harrisville (100.7 HTEL), Houston (99.3 KSCM), Jefferson City (89.5 KMOB), Jefferson (100.1 KJMO), Joplin (90.7 KJCI), Kansas City (88.5 KBYC), Kansas City (88.1 KBYC), Kennett (98.9 KBYO), Kirkville (94.5 KXPL), Lebanon (103.2 KJLL-FM), Lincoln (102.3 KBYE), Liberty (90.7 KBYE), Manchester (95.9 KBYE), Marshall (91.7 KBYE), Maryville (90.5 KBYE), Mexico (95.9 KBYE), Eolia (104.7 KBYE), Kansas City (101.9 KBYE), Mountain Grove (92.7 KBYE-FM), Nevada (91.5 KBYE-FM), Overland (90.1 KBYE), Parkville (90.1 KBYE), Point Lonsdale (90.7 KBYE), Lake Bluff (94.5 KBYE), Fair Grove (106.3 KBYE-FM), Falls (90.5 KBYE), Hannibal (94.3 KBYE), and St. Charles (95.3 KBYE).

**Missouri****Sto. Genevieve**

r	105.7	KSGM-FM	N-M	30	74	
k	105.1	KSFI	\$v	21	58	
r	89.3	KOMR		2	9	
r	89.7	KLSR		2	9	
	89.9	KBDY		2	9	
c	90.7	KRMU	\$wPI	44	90	
	91.5	KSLH		23	58	
k	92.3	KIL-FM	\$v	-M	37	80
n	93.7	KCFM	\$v	-M	35	79
rp	96.3	KADI-FM	\$v	A	26	71
r	98.1	KSLO	\$v		38	82
n	102.5	KEZK	\$v		35	79
rn	103.3	KMOX-FM	\$v		44	90
sj	107.7	KNSD	\$v	Y	44	90

**Salen****Sedalia****Sikeston****Springfield**

k	94.7	KTIS-FM	\$v	-M	39	83		
g	97.3	KWFC	\$v	-M	36	80		
r	98.7	KWTO-FM	\$v	I	30	74		
n	101.5	KTRX	\$v	E	48	95		
kp	107.1	KZOBAP	\$v	KRF6	93.51			
Stockton	kp	95.9	KZOADF	\$v	KRF6	93.51		
Tarkio	kr	93.5	KTRX		v	13	42	
Union	k	101.7	KLNU-FM			v	13	45

**Warrensburg**

jc	90.7	KCMW	\$v	P	34	78		
Waynesville	n	97.7	KFBQ-FM	\$v		14	43	
	k	102.3	KYSD		\$v	N	15	44

**West Plains**

n	93.9	KWPM-FM	\$v	N-M	31	75
---	------	---------	-----	-----	----	----

**Montana**

Anaconda	k	97.7	KGLM	\$v		14	44
Baker	nk	103.9	KZBDAQ	\$v	KRCS	93.11	
Belgrade	n	96.7	KGVW-FM	\$v		12	40
Big Timber	no	98.3	KZSAE	\$v	KURL	97.11	
Billings		88.9	KRER			2	9
		91.7	KNBC			2	9
	k	93.3	KOYH-FM	\$v	Y	8	28
	mq	97.1	KURL-FM			8	26
	k	98.5	KBNS	\$v	I+	27	64
	rm	102.9			v	37	80

**Boulder**

k	106.3	KZSAE	\$v	KCAP	103.11
n	107.1	KZOGAN	\$v	PKOM	94.11

**Bozeman**

nk	91.7	KZSAE	\$v	KRCS	93.11		
Butte	m	91.5	KNMH			2	9
	m	94.1	KROR-FM	\$v	I+	44	92
	cj	95.3	KZSAE	\$v	KRCS	93.11	

**Circle**

n	97.7	KZSAE	\$v	KRCS	93.11	
Colstrip	nc	98.3	KZSAE	\$v	KRCS	93.11
Dillon	rm	98.3	KZSAE	\$v	KRCS	93.11

**Ennis**

n	107.1	KZSAE	\$v	KRCS	93.11	
Gallatin-Big Sky	n	95.3	KZSAE	\$v	KRCS	93.11
	n	95.3	KZSAE	\$v	KRCS	93.11

**Glasgow**

nc	103.9	KZSAE	\$v	KRCS	93.11		
Glendive	n	96.5	KVW	\$v	D	11	52
Great Falls	nc	96.5	KVW	\$v	I	30	69
	nc	98.4	KADR			3	42
	n	108.3	KOZ2	\$v	M	10	37

**Hamilton**

n	95.9	KVW-FM	\$v		5	15	
Hardin	n	95.3	KRKS		A	5	13
Havre	nc	96.5	KVW	\$v	D	11	52
Helena	n	98.4	KADR			3	42

**Hot Springs**

n	96.7	KZSAE	\$v	KRCS	93.11
k	103.7	KZSAE	\$v	KRCS	93.11

**Idaho Falls**

99.7	KALE		v	I	31	26	
98.1	KZSAE					56	109

Lewisston	m	95.9	KLCC-FM	\$v		5	17	
Libby	m	104.9	KZSAE	\$v	KYSS	94.91		
Livingston	m	97.7	KYBS		v	+ 5	17	
	n	98.3	KZSAE	\$v	KGVW	94.71		
Missoula	cj	89.1	KUFM		v	P	50	96
	r	93.3	KDXT		v	51	101	
	n	94.9	KYSS-FM	\$v	I+	51	100	
	r	100.1	KYLI-FM	\$v	Y	5	16	
Philipsburg	m	105.5	KZBAG	\$v	KHOW	94.11		
Plentywood	nk	100.1	KPRD			5	18	
Roundup	mq	107.1	KZOGAD	\$v	KURL	97.11		
Scooba	kr	95.7	KCGN	\$v	U	36	77	
Shelby	v	96.3	KZIN		v	31	70	
Sidney	m	97.7	KZ9AB	\$v	KVFE	94.51		
Starfort	m	104.9	KZSAE	\$v	KLCC	94.91		
White Sulphur Springs	n	98.3	KZSAE	\$v	KGVW	94.71		

**Nebraska**

Alliance	m	92.1	KFAH		v	15	46
Beatrice	k	92.9	KWBE-FM	\$v	U-M	31	74
Blair		91.1	KDCE			2	9
Columbus	a	91.9	KTLX			2	9
	r	93.5	KTTT-FM		v	14	43
	n	101.1	KOXL	\$v	+ 26	71	
Cretz	r	103.9	KTAP		v	13	42
Crookston	e	96.1	KLNU		v	33	75
Freemont	r	105.5	KHUB-FM		v	6	25
Grand Island	gc	95.7	KROA	\$v	S-FX35	79	
	k	96.5	KRGI-FM	\$v	E	34	76
Hastings	r	88.1	KCAT			2	9
	r	93.5	KICS-FM		Y	10	38
	n	97.7	KUVR-FM		v	13	42
	n	91.3	KDVF			2	9
	r	95.9	KRNY-FM		Y-M	40	82
	n	93.1	KRNY-FM		E	25	65
Lexington	n	89.5	KZUM			2	9
Lincoln	r	90.3	KRIU		Z	2	9
	gc	91.3	KUCV			2	9
	rq	95.3	KRHL	\$v		8	33
	p	101.9	KFMD	\$v		25	70
	n	102.7	KFOR-FM	\$v	A	34	75
	k	106.3	KHAI			10	37
	m	107.3	KLIN-FM	\$v		24	70

**Nebraska City**

n	97.7	KPCI-FM	\$v		15	46	
North	m	106.7	KUAG-FM		v	+ 32	72
Ogallala	mc	95.5	KRBC	\$v	E	15	46
Omaha	c	90.7	KVGO	\$v		40	82
	lc	91.5	KYOS	\$v	P+1028	67	
	n	92.5	KZEO	\$v		47	95
	s	94.1	KORH-FM	\$v	E+U	37	89
	m	96.1	KEFM	\$v		23	73
	r	99.9	KGOR	\$v	M	50	100
	gc	100.7	KGBI	\$v	L+FX35	80	
	k	104.5	KODD-FM		M	24	31

**Omaha**

O'Neill	nk	92.7	KPRY-FM		v	13	42
Scottsbluff	n	92.3				40	81
	n	94.1	KYBS-FM			8	32
Sioux Falls	rm	90.9	KARD	\$v	+1836	52	
Sidney	m	95.3	KZIO-FM		v	1	24
Suprior	r	103.9	KRFS-FM		v	4	17
Wahoo	rc	91.9	KRSC			5	20
	m	104.9	KCFH-FM	\$v	B	15	45
	m	104.9	KANL-FM	\$v	B	15	45

**Nevada**

Battle Mountain	BB.1						
Carlin	n	105.5	KZSAE	\$v	KZL	100.31	
Carson City	g	94.7	KLIS	\$v		50	98

**New Jersey**

Clv	r	97.1	KRBC	\$v	Y	54	107	
	n	105.5	KZSAE	\$v	KZL	100.31		
Fallow	mr	97.3	KVLU-FM			13	43	
Hamthorne	n	95.4	KZOGAD	\$v	KZL	100.31		
	n	107.1	KZAL	\$v	KZL	100.31		
Herderson	n	104.1	KXIZ	\$v		10	32	
	q	95.5	KELA	\$v	+ 42	86		
Inlay	q	97.7	KZOGAD	\$v	KZL	100.31		
Las Vegas		88.1	KKLP			2	9	
	n	90.9	KKRD			8	27	
Lyons	rp	92.3	KZIO-FM	\$v	I+	19	56	
		93.1	KRDQ			6	45	
	r	98.5	KRLE-FM			22	40	
	r	98.5	KRLE-FM		A+	9	37	
	r	101.9	KRMS			+ 8	37	
Lund	n	103.9	KZOGAD	\$v	KZL	100.31		
McGill	n	95.3	KZALJ	\$v	KZL	100.31		
Mcguire	n	95.1	KZALJ	\$v	KZL	100.31		
N. Springfield	n	105.5	KZSAE	\$v	KZL	100.31		
Reno	c	88.7	KAIR			5	16	
	nc	95.5	KZEB	\$v	-M	31	73	
	n	104.5	KZLN	\$v		+ 54	101	
	p	105.7	KZLN	\$v	A+	9	30	
	n	106.9	KARD			\$v	33	74
Searchlight	n	103.7	KZOGAD	\$v	KRKK	97.11		
	r	103.9	KZOGAD	\$v	KRMS	101.91		
Winnemucca	n	92.3	KZALJ	\$v	KZLN	104.51		
	r	93.5	KZBAG	\$v	KRBC	97.31		
	q	95.9	KZOGAD	\$v	KZL	100.31		

**New Hampshire**

Berlin	r	103.7	KKLG			17	51	
Claremont	r	106.3	KZLN	\$v	C+	30	68	
Concord		90.5	KZLN			2	9	
	m	102.3	KZLN-FM		v	C	15	45
Conway	nr	93.5	KZLN-FM		v		15	45
Dover	k	97.5	KZLN	\$v		26	66	
Durham	r	91.3	KZLN	\$v	Y+	12	40	
Exeter	r	90.5	KZLN			2	9	
	n	107.1	KZLN-FM		v	M	7	27
Hanover	cn	99.3	KZLN	\$v		15	45	
Henniker	r	97.7	KZLN			2	9	
Keene		89.1	KZLN			2	9	
	m	103.7	KZLN	\$v	C	17	52	
Lacorte	n	98.3	KZLN-FM		v	15	46	
Manchester	n	95.7	KZLN	\$v		+ 12	70	
	r	101.3	KZLN-FM		v	31	69	
Mount Washington	n	94.9	KZLN	\$v		63	111	
Nashua	k	106.3	KZLN-FM		M	11	38	
Newport	nc	101.7	KZLN-FM		E	6	24	
Peterborough		90.1	KZLN			3	43	
	nc	92.1	KZLN	\$v		13	43	
	r	91.7	KZLN			2	9	
Plymouth	nl	106.1	KZLN-FM		v	S	15	45
Portsmouth	r	109.3	KZLN-FM		v	19	56	

**New Jersey**

Atlantic City	rn	95.1	KZLN	\$v	A	23	59	
	n	96.9	KZLN-FM		C	27	60	
	r	101.7	KZLN	\$v		16	52	
	n	94.3	KZLN	\$v	S	15	46	
Blackwood		91.5	KZLN			2	9	
Blairtown	n	106.3	KZLN	\$v		+ 14	43	
Brick Township		91.9	KZLN			2	9	
Bridgeport	nr	107.7	KZLN-FM		M	26	64	
Camden	q	106.5	KZLN	\$v	M+	10	22	
Carmel	q	107.7	KZLN			14	44	
Cape May	n	102.3	KZLN		v	U	14	44
Coventry	r	104.5	KZLN	\$v		+ 14	44	

## New Jersey

East Orange	rj	91.1*WFMU	\$v	14	45	
Easton	m	106.3 WHTG-FM	\$v	12	40	
Egg Harbor City	m	104.9 WRDR		15	45	
Flemington	m	90.5*WCVH		4	16	
Franklin	rk	102.3 WSUS	v M	15	44	
Franklin Lakes	r	88.7*WRRH		2	9	
Glassboro	r	89.7*WGLS		5	20	
Hackettstown	r	91.9*WNTI		22	56	
Hanover	r	90.3*WHPH		2	9	
Highland Park	r	90.3*WVHP	#	2	9	
Lawrence Township		89.7*WLCR		2	9	
Lincroft	lr	90.5*WBJB	A	6	24	
Long Branch	L	107.1 WRLE	\$	14	44	
Millville	r	97.3 WRNY-FM		15	47	
Morristown	r	90.5*WJSV		2	9	
Newark	gc	88.3*WBGD	F+	19	55	
	m	94.7*WNEC		32	71	
	m	100.3 WVAJ-FM	\$ E	33	71	
	e	105.9 WPHI	\$v	4E	22	57
New Brunswick	cs	88.7*WPSU	\$v	8	31	
	m	98.3 WMOG	v S	15	46	
Newton	k	103.7 WRIX	\$ E+	12	40	
Ocean City	m	106.3 WSLT-FM	\$ N	15	46	
Paterson	m	93.1 WYAT-FM	\$	30+	69	
Piscataway	r	90.3*WVPH	#	2	9	
Pleasantville	r	99.5 WRJF	\$v	15	45	
Point Pleasant	m	95.5 WRDB	\$v	+ 10	38	
Princeton	pr	101.3 WPRB	\$v A	18	54	
Princeton Junction	r	90.3*WVPH		2	9	
Shirley Bottom	rm	100.1 WJRZ	\$v I	15	46	
South Orange	rj	89.5*WSDU	\$v I	15	46	
Teaneck	rj	89.1*WFDU	# \$v	12	41	
Tonawanda	m	92.7 WRUM	\$v U+	15	46	
Trenton	r	91.3*WTSR		4	16	
	g	94.5 WGHF	v	21	65	
	r	97.5 WFSJ	\$v I	30	70	
	m	101.5 WRJH	\$v	17	59	
Upper Merion	pc	90.3*WBOC		2	9	
Vineland	r	92.1 WRVL-FM	v	14	43	
West Long Branch	r	88.1*WMLX	\$ A	2	9	
West Orange	r	89.9*WBOH		2	9	
Wildwood	rm	100.7 WCOM-FM	M+	8	34	
Zarephath	g	99.1*WABZ-FM	\$ U+	33	73	

## New Mexico

Albuquerque	g	88.3*KLTY		41	84	
	m	89.1*KANW		6	21	
	rc	90.1*WJHM	\$ U+	51	97	
	ej	91.5*WPC	\$v F+	52	98	
	p	92.3 KRST	\$v	58	109	
	m	95.3 KOB-FM	\$v	+M	58	109
	rp	94.1 KRKE-FM	\$v	+7	106	
	c	96.3 RHM	\$v	+M	42	86
	r	99.5 KZZX	\$v	+M	57	106
	m	100.3 KPAC-FM	\$ M+	52	99	
	r	107.9 RFBM		9	29	
Artesia	m	92.9 KSWP-FM	\$v M+	41	84	
Aztec	rm	94.9 KWYK-FM	\$v	+28	67	
	k	104.9 K2BSAH	# KRJ	100.51		

Bayard	m	92.7 KLCJ	v	9	36	
Carlsbad	k	92.1 KBAD-FM		11	38	
Clovis	k	99.1 KMXY	\$v	28	72	
	r	99.9 KTCM	\$v C	31	75	
Deming	m	94.3 KDEM	v	12	40	
Espanola	m	102.3 KBSO	v	14	45	
Farmington	m	92.9 KRWA	\$	28	67	
	r	96.9 KRKZ	\$	25	62	
Gallup	m	93.7 KOON	\$v	18	56	
	k	94.5 KOVO	\$ I	12	47	
Grants	m	97.7 K249AE	\$ KOB	93.31		
Hobbs	k	95.7 KSCR	\$	17	55	
Humble City	m	94.1 KPQE	\$v I	31	75	
Las Cruces	c	90.7*KRWG	\$ PA	32	76	
	p	103.1 KASK	\$v A	4	12	
	r	103.9 KGRD	\$v	+ 10	38	
Las Vegas		91.1*KEOP		2	7	
	m	100.4 KFUN-FM	v	5	17	
Los Alamos	mc	98.5 KRSM-FM	\$v	+M	7	29
Lovington	mc	101.7 KLEA-FM		12	39	
Mesilla Park	m	104.9 KOPE	\$v	5	17	
Portales	m	95.3	v	15	46	
Ramah		89.7*KTDB	v P	15	46	
Rosewell	km	94.9 KOIN-FM	\$v	48	107	
	rm	97.1 KRKY-FM	\$v	+ 21	57	
Santa Fe	mr	95.5 KSNM	\$v	+ 17	53	
	r	97.3 KAFE-FM	\$	14	50	
Taos	m	91.5 KTAS	v	5	17	
Tularosa	m	92.7 KTNM-FM		7	26	
Zuni		90.9*KSBI		2	9	

## New York

Albany	c	90.5*WABC	v F+	41	85	
	p	90.9*WCOB		2	9	
	m	95.5 WRON-FM	\$	30	69	
	r	100.9 WRDM	\$v	15+	46	
	m	103.1 WHML	\$v	+ 15	46	
	m	106.5 WWSH	\$v	+ 31+	70	
	k	107.7 WQNA	\$v	+ 31	69	
Alfred	p	89.7*WALT		2	9	
	m	91.3*WLTU		2	9	
Andover	r	97.7 WCSS-FM	v E	9	36	
Attica	km	101.7 WRIF	\$v	14	45	
Auburn	r	88.4*WRDN	\$	2	9	
	m	106.4 WRIZ	\$v M+M	31	73	
Babylon	p	101.5 WRAP	\$v	8	33	
Baldwinsville	rm	90.5*WBXL	M	2	9	
	k	92.1 WSEP-FM	v I	15	46	
Binghamton	cj	89.3*WRBP-FM	\$ F+103.5	73		
	r	90.5*WRHR		4	14	
	m	98.1 WGYT	\$v H	37	69	
	r	99.1 WRAL	\$v A+M	31	69	
Brentwood		88.5*WBXA		2	9	
Briarcliff Manor	p	107.1 WRNK	\$v	15	46	
Britton Center	g	95.1 WRIV	\$v U	31	68	
Brookport		90.5*WRP1		2	9	
Brooklyn	r	40.9*WRBU		2	9	
Brookville	r	88.1*WCRF	v	5	22	
Buffalo	jc	88.7*WBFO	\$v P	9	35	
	p	92.9 WRJF	\$v	+M	37	81
	c	94.5*WNEO-FM	\$v	4c	86	
	m	96.1 WRBY	\$v	37	72	
	rp	96.9 WRGO	\$v A	32+	70	
	g	99.5 WRDX	\$v	+M	40	87
	r	102.5 WRBN-FM	\$v	53-102		
	rr	103.3 WRPH	\$v Y	28	68	
	k	104.1 WRDL-FM	\$v	+M	24	64

## New York

Canandaigua	k	102.3 WFCL		15	45	
Canton	cn	96.7*WLSU	\$v P+	15	46	
Cazenovia		90.9*WITC		2	9	
Central Source						
	nr	89.3*WCSO		7	27	
Cherry Valley	g	101.9 WJIV	\$v U	31	70	
Clinton	r	88.7*WHCL		2	9	
Corning	r	91.9*WCLB		2	9	
	rm	106.1 WCLL-FM	M+R	29	68	
Corliss	r	90.7*WSUC		2	9	
	m	99.9 WKRT-FM	\$v U	30	68	
De Pw	sq	92.7 WELK	\$v B+Q	30	70	
De Ruyter	g	105.1 WOIV	\$v U	33	73	
Dix Hills	r	86.9*WHJZ		2	9	
Dundee	r	95.9 WFLR-FM	v	14	44	
Ellenville	mk	99.3 WELV-FM		5	17	
Elmira	r	86.1*WECW		2	9	
	r	92.7 WLEZ	\$	14	44	
	r	54.3 WLVY	\$ M	15	45	
Endicott	rm	105.7 WWRV	\$v E	32	71	
Fredonia		88.4*WJOL		2	9	
Fullton	r	104.7 WRFM	\$v	27+	67	
Garden City	r	90.3*WBAU	# v	7	26	
	r	90.3*WRPC	# v	7	26	
	p	92.7 WRIR	\$v	15	45	
Genesee	r	89.3*WGSU		3	13	
Geneva	r	89.7*WLOS	\$v	3-13		
	m	101.7 WLEO	\$v U	8	33	
Glen Falls	r	91.9*WJFR		2	9	
	nr	95.5 WYLP	v L	14	44	
	k	101.7 WQZA-FM	\$v	14	43	
Gouverneur	k	92.7 WRUF	v	7	26	
Greece	r	90.1*WCGU		2	9	
Hamilton	r	90.1*WRGO	v U	8	33	
	r	98.3 WRVN-FM	\$v	+ 15	46	
Hempstead	k	89.7*WNYC	v	8	28	
	m	98.3 WIOH	\$v U	15	46	
Henrietta	r	89.7*WRTH	\$	2	9	
	g	90.5*WASH		2	9	
Hornell	r	105.3 WRHO-FM		24	60	
Horsesheds	k	100.4 WRIZ	\$v A	13	42	
Hudson	r	91.5 WRUC-FM	I	5	17	
Hyde Park	m	97.7 WRVS	\$	15	46	
Ithaca	r	91.7*WICB	\$v E	10	38	
	p	93.5 WRUR	\$	A	14	43
	cs	94.3 WRNH-FM	\$v C	35	76	
	g	103.7 WRIV	\$v I	32	70	
Jonestown	rm	93.3 WRJF	\$v	+ 26	65	
	m	101.7 WRJUS	\$v	14	45	
Johnstown	r	104.9 WRZK-FM	I	15	46	
Kingston	r	94.3 WRPM		14	44	
Lake Ronkonkago	cr	91.9*WQSR	\$	8	34	
Lake Success	m	103.5 WRFM	\$v U+	30	69	
Lancaster		89.9*WJNH		2	9	
Liberty	m	95.9 WRVO-FM	\$v S	14	44	
Loudonville	r	88.3*WVCR		4	43	
Middletown	m	92.7 WRAL-FM	\$v	12	40	
Masticellon	rm	98.3 WRUL	\$v	15	46	
Montour Falls	r	104.9 WXXY	\$v	+ 15	44	
Mount Kisco	m	106.3 WRIV-FM	\$v	14	45	
Newburgh	m	103.1 WRBN	\$v	+ 12	40	
New Rochelle	m	93.5 WRTH	\$v M	15	46	

**North Carolina**

**Ohio**

Shelby	fm	96.1	WQHS-FM v M	17	50
Southern Pines					
	n	107.1	WIOZ \$ v	15	46
Southport		107.1	WLCF v	15	46
Statesville		96.9	W000 Y	17	49
	k	105.7	WFMX \$ v +	30	74
Tabor City	m	104.9	WYKM v M	15	45
Tarboro	m	104.3	WUTC v +M	27	71
Thomasville	fm	98.3	WTHC-FM U	14	43
Wallace	rk	94.3	WLSE-FM v	15	45
Wanchese	m	95.3	W0BR-FM \$	12	39
Warrenton	js	90.9	WVSP \$ v P	33	73
Washington	r	93.3	WITN-FM \$	48	97
Whiteville	rk	99.1	WENC-FM +	19	59
Wilkesboro		90.1	WVSF	2	9
Williamston		103.7	WSEC \$ v +	21	61
Wilmington		91.3	WLOZ	2	9
	r	97.3	WHSL \$ v +	38	82
	k	100.9	WEMA \$ v C	15	46
	m	102.7	WAVV \$ v +M	33	76
Wilson	fm	106.1	WXYX \$ v +M	19	56
Winston-Salem					
	c	86.5	WFOO \$ P	29	68
	rg	93.1	WSEZ \$ v +M	24	61
	k	104.1	WTOP \$ v +	46	92
	rs	107.5	WPLZ \$ v +M	37	80

**North Dakota**

(NAP PP. 36-39)

Belcourt	nr	86.5	KHYA \$ v P	24	60
Bismarck	r	92.9	KTYR-FM \$ +	45	90
	nt	94.5	K00Y \$ v +M	40	84
Bowman	mk	97.7	K75AU-FMCS	93.11	
Devils Lake	m	96.7	KDLR-FM M	11	36
Fargo	cj	91.9	KDSU \$ P	8	40
	m	93.7	KDAY-FM \$ +M	45	91
	q	97.9	KYFW-FM U	37	76
Grand Forks	c	89.3	KYFI-FM \$ P	16	60
	r	92.9	KYDU \$ v +	27	71
	m	94.7	KYTN \$	28	72
Hettinger	mk	97.7	K249A \$ FMCS	95.11	
Jamestown	m	93.3	KYJK \$ v +	73	60
Mandan	gn	104.9	KHDR \$ v	15	45
Mayville	v	101.7	KBAV-FM v M	9	35
Minot	m	93.7	KMDI \$ A	31	70
	rp	97.1	KCJB-FM \$ +	40	83
	k	100.1	K261A \$ v +M	97.11	

**Ohio**

(NAP PP. 32-33)

Akron	j	88.1	WAUP \$ v l	8	33
		89.1	WAUP \$ v	20	81
	ra	96.5	WYDD \$ v l	31	73
	m	97.5	WAEZ \$ v	33	73
Alliance	rc	91.1	WRMU	12	40
	n	92.5	WFAH-FM \$ l	17	54
Archbold	gr	95.4	WPHD \$ v U	15	46
Ashland	q	88.5	WPDL	2	9
	k	101.3	WRCO-FM \$ v M	30	70
Ashtabula	n	97.1	WRCO-FM \$ v +M	33	73
Athens	kc	91.3	W00B-FM v l	33	73
	r	105.5	WYTO \$ v N	15	45
Bainbridge		90.9	WHRH	2	9
Batavia	r	86.7	WONE	12	41
Bellaire		88.7	WBHR	2	9
	pr	100.5	W0FF-FM v U	26	62
Bellefontaine					
	r	98.3	WTDQ-FM v l	14	45
Bellevue	nr	92.1	W0RR v A	9	35
Berea	r	88.3	W0BC \$ U	5	22
Boxing Green					
	rj	88.1	W0BU U	8	30
	nr	93.5	WYIO l	12	39

Bryan	nr	100.9	WBNO-FM v +	15	46
Bucyrus	nr	92.7	W0CO-FM \$ v U	15	46
Canalbridge	n	95.7	WILE-FM \$ v +	15	46
Canal Fulton					
	r	90.9	W0WR v	4	18
Canton		94.1	WBBC-FM \$ v +M	28	67
	gn	98.1	WTOF \$ v	33	72
	ra	106.9	WHLQ \$ v +M	25	64
Castalia	q	97.7	WGGN v	15	46
Cedarville	gc	90.3	W0DR \$ U	16	48
Celina	rm	94.3	WYER \$ v +M	7	27
Centerville	r	91.9	W0RT	2	9
Chillicothe	r	93.3	W0EX-FM v M	18	52
		94.3	WFC6 v	15	46
Cincinnati	p	88.3	W0AF #	14	44
		88.3	W0JVS # v	4	18
		90.1	W0ND	2	9
	c	90.9	W0UC \$ v P	33	72
	p	91.7	W0YU \$ v	25	61
	n	92.5	W0EZ \$ v	31	69
	q	93.3	W0AK \$ v +M	29	69
	r	94.1	W0AI-FM \$ v +0	33	72
	n	98.5	W0QA \$ v	33	70
	r	101.9	W0RG \$ v	33	71
	p	102.7	W0RN \$ v	33	72
	k	105.1	W0BC-FM \$ v +M	32	70
Circleville					
	nr	107.1	W0RE-FM v +	6	25
Cleveland	p	69.3	W0CB v	2	9
	ml	90.3	W0BE \$ v P	18	73
	mp	91.1	W0RW \$	2	9
	gr	93.1	W0ZK \$ v	12	70
	c	95.5	W0LV \$ v M	32	70
	r	98.5	W0CL \$ v +M	33	74
	n	99.5	W0SR \$ v	33	73
	rp	100.7	W0MC \$ v U	31	69
	n	102.1	W0OK \$ v	29	69
	qc	103.3	W0CF \$ v U	32	70
	n	104.1	W0AL \$ v	10	69
	re	105.7	W0WM \$ v +0	36	76
	r	101.5	W0ZP \$ v +E	32	72
	m	107.9	W0MT \$ v +M	32	74
Cleveland Heights					
	rs	92.3	W0YT \$ v +M	22	59
Columbus					
	c	84.7	W0SU-FM \$ v P	18	72
	c	90.5	W0BE \$ v P	26	62
		91.5	W0FAC	7	3
	gp	92.3	W0CL-FM \$ v	27	67
	sm	94.7	W0VK-FM \$ v +M	24	64
	rp	96.3	W0LV \$ v	33	72
	n	97.1	W0NS-FM \$ v l	33	71
	r	97.9	W0CI \$ v Y	41	90
	n	99.7	W0NZ \$ v M	33	73
Conneaut	k	105.5	W0FZ	4	16
Coshocton	n	99.3	W0NS-FM	15	45
Dayton	r	88.1	W0XM	2	9
		88.5	W0RSU	2	9
	jk	88.7	W0PS #	2	9
	r	89.3	W0CNR	2	9
	n	99.1	W0HO-FM \$ v	41	84
	p	104.7	W0UE \$ v	33	73
	c	107.7	W0AO \$ vYZ	30	70
De Graff		91.1	W0EG	2	9
Delaware	cr	91.1	W0SLN	2	9
Delphos	rm	107.1	W0DH \$ v +	15	46
Dover	m	101.7	W0EP-FM \$ v	15	45
East Liverpool					
	n	104.3	W0EA \$	25	62

Eaton	m	92.9	WJAI v	14	49	
Elyria	m	107.3	W0EA \$ v E	26	66	
Fairfield	n	94.9	W0LV v +M	32	72	
Findlay		88.3	W0FC	2	9	
	k	100.5	W0MO \$ v +M	20	57	
Fostoria	m	96.7	W0FB-FM v	12	40	
Fremont	m	99.1	W0RO-FM \$ v	18	54	
	q	107.1	W296AA \$ WFSU	102.31		
Gahanna	g	104.9	W0CO \$ v U	15	46	
Gallon	nr	102.3	W0LX \$ E	15	46	
Gallipolis	m	101.5	W0PC \$ v	27	65	
Gambier	rc	91.9	W0KO	2	9	
Georgetown	k	97.7	W0RO \$ v E	15	45	
Greenville	r	90.9	W0DB \$	2	9	
Greenville	r	91.7	W0LV v	3	15	
	r	106.5	W0RK \$ v +M	15	48	
Hamilton	pr	89.5	W0SS v +	7	29	
	r	96.5	W0LS \$ v A	30	70	
	ra	103.5	W0YH Y	18	53	
Hillshere	rk	106.7	W0RA-FM v U	20	60	
Holland	q	102.3	W0FS \$ v U	15	46	
Ironton	k	107.1	W0TO v M	9	35	
Jackson	r	97.7	W0JO v	15	46	
Jefferson						
		88.9	W0LB	v	11	36
	g	90.3	W0CJ \$ v	19	53	
Johnston	ra	103.1	W0RJ \$ v S	15	46	
Kent	cj	89.7	W0SU \$ vPY	18	53	
	re	100.1	W0AT-FM \$ v	15	45	
	r	95.3	W0TN	v	15	45
Kettering	g	86.7	W0CL #	2	9	
	r	89.5	W0E1	2	9	
	r	99.9	W0UD \$ v A	33	73	
Lancaster	q	95.5	W0HJ-FM v +M	24	64	
Lincoln	q	97.7	W0GN \$ v U	15	46	
	k	107.1	W0MA-FM \$ E	20	55	
	n	104.9	W0SR \$ v A	13	42	
Logan	nr	96.3	W0LQ-FM v	13	47	
London	k	106.3	W0SY v U	15	46	
Lorain	nt	104.9	W0LL \$ v	15	46	
Manfield						
	ra	101.3	W0LA-FM \$ v +M	29	69	
	n	106.1	W0NO \$ v +M	29	69	
Marietta	cr	86.3	W0BT v	16	50	
	r	89.3	W0CO	2	9	
	n	94.3	W0DA-FM \$ v	15	46	
Marion	r	94.3	W0TF \$ v +M	15	46	
	n	100.9	W0RH-FM \$ v	25	67	
Medina	m	94.9	W0BN \$ v S	36	82	
Miamisburg	r	89.9	W0RF	2	9	
	q	93.7	W0CJ \$ v +M	26	66	
Middleport	km	92.1	W0PO-FM \$ v	15	46	
Middletown	g	105.9	W0PB \$ vU	21	63	
Millard	m	107.1	W0LY \$ v M	15	46	
Morrox		88.1	W0MH	#	2	9
Mount Vernon	k	93.7	W0VO-FM v S	24	61	
Napoleon	m	103.1	W0NH \$ v L	15	46	
Newark	m	100.3	W0LT-FM \$ v	30	70	
	n	101.7	W0PD \$ v	15	46	
New Concord						
	cr	90.7	W0CO U	7	9	
New Lexington						
	ig	106.3	W0JH v	15	46	
New Philadelphia						
	q	95.9	W0PU \$ v	13	41	
Norwalk	nr	95.3	W0YR-FM v	9	35	
Oberlin	rc	88.7	W0BC U	7	9	
Ottawa	r	100.3	W0MM \$ v Y	14	44	
Oxford	rc	88.5	W0OR \$ v PU	10	36	
	rc	97.7	W0YP \$ v	14	43	

## Ohio

Piqua m 95.7 WPIW-FM v U+M 21 61  
Port Clinton  
mr 94.5 WWRW \$ 13 44  
Potsmouth m 99.3 WXXT-FM \$ 14 44  
kg 104.1 WPAV-FM v C+M 39 82  
Reading 89.3 WRCJ \$ 6 24  
Salem m 105.1 WSOB-FM \$ +M 34 78  
Sandusky mk 102.7 WLEC-FM M 10 40  
Sidney m 105.5 WQVR-FM M 10 38  
Springfield 89.1 WUSD \$ 2 9  
g 100.7 WEEC \$ v U+ 29 71  
mr 102.9 WBLY-FM v M 20 60  
Steuenviller 103.5 WRRY \$ v 32 70  
Streetsboro r 91.5 WSTB \$ 5 21  
Struthers rm 90.7 WRTL \$ 6 26  
Sylvania r 105.5 WKEZ \$ v 15 46  
Tiffin r 88.9 WHEI \$ 2 9  
km 103.7 WITF-FM E 10 37  
Toledo 88.3 WMPH \$ 2 9  
cj 91.3 WUTE-FM v P 31 70  
r 92.5 WNHZ \$ v A+M 32 72  
s 99.9 WHLR \$ 2 14 46  
m 101.5 WLOD \$ v 32 71  
rs 104.7 WIOT \$ v 33 73  
University Heights  
j 88.7 WUJC \$ v A 11 38  
Upper Sandusky  
k 95.9 WYAH \$ v 14 44  
Urbana 91.7 WUHS \$ 2 9  
n 101.7 WCON \$ v 15 46  
Van Wert n 98.9 WERT-FM M 12 41  
Wapakoneta n 92.1 WERM 10 38  
Washington Court House  
rm 105.5 WCHO-FM v + 15 46  
Waverly m 100.9 WIRD \$ Y 14 44  
Wellston m 96.7 WROW-FM v U 8 33  
West Carrollton  
g 88.1 WDRP \$ 2 9  
West Chester r 89.9 WLFZ \$ 2 9  
Westerville 91.5 WWOH \$ 2 9  
r 103.9 WGBY \$ v A 15 45  
Wilberforce jp 88.9 WCSI \$ PU 6 25  
Wilmington r 102.3 WDRH v M+ 15 46  
Wooster r 91.9 WWSR \$ 3 14  
m 104.5 WNST-FM \$ v 28 68  
Xenia kg 95.3 WBEZ v 15 46  
js 103.9 WWHM v 12 40  
Yellow Springs  
pc 91.5 WYSO \$ P 16 48  
Youngstown c 88.5 WYSO \$ P 16 51  
rm 93.3 WOOD \$ v M 21 56  
m 98.9 WBBN-FM \$ v 31 70  
rg 101.1 WSRD \$ v U 17 59  
Zanesville mp 102.5 WHIZ-FM v M 27 65

## Oklahoma (MAP PP. 42-43)

Ada r 93.3 KTEH-FM v 39 83  
Altus n 93.5 KBRH-FM v 15 46  
Ardmore k 92.1 KBRD \$ v 13 41  
r 95.7 KKAJ \$ v 35 79  
Bartlesville  
km 100.1 KIFM \$ v I 15 46  
Bethany gm 104.9 KJIL \$ v U 14 43  
Broken Arrow  
k 92.1 KGOV \$ v E 15 46  
Chickasha k 105.5 KXXX \$ v 12 40  
Clinton mk 95.5 \$ v + 15 43  
mk 106.9 KROE-FM v M 30 74  
Duncan k 102.3 KPND-FM v U 10 38  
Durant r 91.5 KXIB \$ 2 9  
rm 107.1 KSEO-FM v M+ 15 46

Edmond mc 90.1 KQSC \$ 21 58  
90.9 KOKF \$ 2 9  
rp 97.7 KWIP \$ v M 15 46  
m 96.9 KNID \$ v A+M 24 68  
Eufaula k 102.3 KCES \$ 12 40  
Goodwell 91.7 KPSU \$ 5 23  
Henryetta r 99.5 KHEH-FM \$ v 23 59  
Idabel m 95.7 KWDG v 15 46  
Langston 90.7 KALU \$ 2 9  
Lawton rp 98.1 KRUG \$ U 26 71  
r 101.5 KLAH \$ A+ 17 54  
McAlester  
m 101.3 KNED-FM \$ A 17 53  
Miami m 100.9 KGLC-FM \$ v 14 44  
Muskogee nc 106.9 KMMM \$ E 21 66  
Norman rc 106.3 KGOU \$ v CU 12 40  
Nowata km 94.3 KNFB \$ I 8 33  
Oklahoma City  
m 92.5 KRNG \$ v 44 90  
k 94.7 KEBC \$ v E+K 35 79  
r 96.1 KXXY \$ v 29 73  
s 98.9 KFJL \$ v Z+M 34 78  
rp 100.5 KATI-FM \$ v 36 80  
m 101.9 KFNB \$ v 33 73  
r 102.7 KZUE \$ v A+TB44 90  
p 104.1 KHFM \$ v +M 50 98  
sr 107.7 KAEZ \$ v 24 65  
kr 94.3 KLLS \$ v 15 46  
Okmulgee  
r 99.3 KLOR \$ v 37 79  
Ponca City  
rp 97.9 KLCO-FM v +M 57 109  
k 107.3 KING v E 54 102  
v I 31 75  
Pryor gk 104.5 KKMA v I 31 75  
g 95.9 KRBB-FM v 13 42  
Sapulpa g 100.9 KXDJ-FM v EI 15 46  
Stillwater c 91.7 KOSI \$ v P 35 79  
r 93.9 KSPI-FR \$ M 18 54  
p 105.5 KVRD \$ v 4 16  
Tahlequah  
kr 101.7 KEOK \$ v 15 46  
rk 90.5 KAYE v 2 9  
Tonkawa rk 89.5 KWGS \$ v 22 57  
Tulsa rc 92.9 KBEZ \$ v M 40 84  
nr 95.5 KWEN \$ v 39 83  
rp 96.5 KRVA \$ v 33 76  
r 97.5 KMOO \$ v 29 69  
qc 98.5 KCFD \$ v +M 40 84  
sj 103.3 KKUL \$ v Z+TB25 70  
Weatherford  
rk 97.5 KWBY-FM \$ v 32 73  
m 93.5 KSIH-FM \$ v 10 38

Woodward m 93.5 KSIH-FM \$ v 10 38  
Oregon (MAP P. 48)  
Albany k 99.9 KRKT-FM v + 46 92  
m 107.9 KHPE \$ v M 48 95  
Ashland r 90.1 KSOR \$ v A+ 26 63  
m 101.7 \$ v 5 17  
Bend r 94.1 KXIQ \$ v + 53 100  
rm 102.7 KICE \$ v E 33 73  
Bruckings m 95.3 KURI-FR v 5 17  
Central Point n 91.7 KCHC \$ 2 9  
Chenult n 103.1 KZTGAE \$ v INT 03 74  
Coquille 102.3 v 5 17  
Corvallis  
r 90.1 KBVR v 2 9  
rc 101.5 KFLY-FM \$ Y 15 51  
nk 106.1 KLOO-FM v U 7 8  
2 9  
Eagle Point 99.1 KZPD \$ 2 9  
Eugene cs 89.7 KLCG P 29 67  
c 91.1 KXAZ v 8 27  
r 91.9 KRVN v 4 16  
g 94.5 KBBE 23 58

## Pennsylvania

p 96.3 KZEL \$ v U 41 89  
r 97.9 KINY \$ Y+ 25 60  
m 99.1 KPMW-FM v A+ 53 102  
Gold Beach m 107.1 KZWA5 \$ KTH 93.71  
Grants Pass  
r 91.3 K17AB \$ KSOR 90.11  
m 100.9 KZGASAB \$ KINT 93.71  
Gresham 88.5 KMMU 28 66  
Hermiston mc 99.3 v 7 29  
Klamath Falls  
r 88.1 KTEC 2 9  
k 92.5 KJSH 8 30  
m 98.5 KAGM \$ v 26 63  
m 100.9 KZGASAC \$ KINT 93.71  
La Grande r 91.9 KZSL 2 9  
m 98.3 KLBH-FM \$ v 4 14  
Lake Oswego  
rm 106.7 KMJK \$ v Z+0 43 89  
Lebanon m 103.7 KQMS \$ v 24 61  
McMinville rm 90.3 KSLC 2 9  
Medford m 93.7 KTHI \$ v + 54 100  
ar 95.3 KBOY-FM E+M 3 12  
Newport ar 102.5 KNPT-FM v I 43 89  
Ontario m 96.1 KXBD v 27 65  
Pendleton r 90.9 KRBH 2 9  
m 107.7 v 31 70  
Portland r 89.3 KRRK 2 9  
cj 90.7 KBOO \$ v P 30 69  
c 91.5 KQAP-FM \$ P-TB41 84  
rp 92.3 KGOB \$ H 44 90  
g 93.7 KFDI-FM v 44 90  
m 96.5 KXLM-FM \$ U 44 90  
r 97.1 KPAM-FM v Y+M 45 91  
m 98.5 KUPJ-FM v S 45 91  
rm 99.5 KJIB \$ v + 43 89  
m 100.3 KQFM \$ +M 44 90  
mc 101.1 KYTE-FM v C+S 54 104  
p 101.9 K1IK \$ v 54 103  
Reeseburg m 103.1 KRBS \$ v E 15 46  
Salem r 105.1 KDR1 \$ v 43 89  
Seaside g 97.7 KZ49AA KPDD 93.71  
Springfield r 93.1 KSNB \$ v 35 75  
The Dalles m 104.5 KCVI \$ v 47 91

## Pennsylvania (MAP PP. 20-21)

Allentown p 89.7 WWHU \$ M 2 9  
nc 100.7 WFNZ \$ v U+ 32 70  
k 104.1 WXIX \$ v 33 73  
Altoona m 96.1 KFBG-FM \$ C 37 79  
k 100.1 WVAN-FM \$ v 14 43  
Beaver Falls r 88.3 WGEV 2 9  
rp 106.7 WRRS \$ v 33 73  
Bedford m 100.9 WARM \$ M+ 12 40  
Bellwood ng 103.9 RHSM 14 44  
Bethlehem r 91.3 WLVN \$ 2 9  
r 95.1 WEEZ v A 28 65  
Bloomsburg r 106.5 WRLH-FM v N 25 60  
Boyernton gk 107.5 WBYO \$ v S+ 17 51  
Braddock rm 96.9 WFFM \$ v 34 75  
Butler rp 97.7 WBOT-FM 10 37  
California rj 91.9 WNCV v 11 38  
Canton m 100.7 \$ v 14 44  
Carbondale m 94.3 WCOL-FM v U 14 44  
Carlisle p 88.3 WDCV \$ Y 2 9  
k 102.3 WHYL-FM v M 11 38  
Central City  
nk 101.7 WCCS v 14 44  
Chantersburg  
r 95.1 WIFZ \$ 13 42  
Charleroi nr 94.3 WFFM \$ Y 15 46  
Cresler 89.5 WDIR 2 9  
Clarion 91.7 WUCI 15 45

**Pennsylvania**

Clearfield	gm	93.5	WCPA-FM	8	32	
Danville	gm	96.7	WPGM-FM	S	14	43
Du Bois	k	102.1	WCED-FM	v	28	65
	gm	107.3	WDBA	\$v	33	73
Easton	p	90.5	WJRH	\$ U	2	9
	rm	96.1	WLEW	\$v C	33	73
	m	99.9	WQOO	\$v	31	71
East Stroudsburg		90.3	WESS		2	9
Ebensburg	k	99.1	WYQO	\$v +M	33	73
Elizabethtown		106.7	WPCD-FM	v	28	66
Ellwood City	k	92.1	WFEM	\$v M	15	46
Ephrata	k	105.1	WYOV	\$v E	33	73
Erie	rc	89.9	WERG	v	5	17
	cs	91.3	WOLN-FM	P+1	31	70
	m	99.9	WLVU	\$v +M	22	57
	r	103.7	WCKC	\$ Y	33	73
Franklin	rm	99.3	WVEN	M	13	42
Freeland	r	103.1	WACH	\$v	14	44
Gettysburg	p	90.3	WZBT		2	9
	m	107.7	WGET-FM	\$v M	20	56
Girard		88.3	WGAE		2	9
Greencastle	mk	94.3	WKSJ	v	14	45
Greensburg	r	107.1	WOKU	v +M	15	46
Greenville	r	88.1	WTLU	l	2	9
	m	107.1	WGRP-FM	U	13	42
Grove City	r	89.5	WSAJ-FM		2	9
	m	95.1	WEDA	U	15	47
Harrisburg	c	44.9	WMSF	\$v +	22	62
	m	97.3	WHP-FM	\$v C+M	32	70
	p	99.3	WCFM	\$ A	13	42
	m	104.1	WTPA-FM		2	9
Haverlock		89.3	WHMS		2	9
Hazleton	m	97.9	WTLZ	\$v	3	21
Hershey	c	89.5	WTFE-FM	\$v P	33	71
Hollidaysburg		104.9	WHFA	v	14	45
Huntingdon		91.7	WNRV		2	9
	m	106.3	WRLR	\$ U	10	38
Indiana	r	91.3	WTLF		7	29
	m	103.1	WDMU	\$v	11	38
Jenkintown	eq	101.9	WIBF-FM	v E+	15	45
Johnstown	m	47.1	WTFM	\$v	14	43
	nc	95.5	WJAC-FM	\$v M+	43	67
	rm	96.5	WJHL-FM	v C	37	72
Kearsgate	r	92.7	WZ4AC	WHD	102	31
Lancaster	r	88.7	WTFM		2	9
	g	90.3	WFTG		6	26
	g	94.5	WDAE	\$v	33	73
	m	96.9	WLAN-FM	\$v A+	14	55
	m	101.3	WNCE	\$v +	24	67
Lebanon	r	100.1	WUFM	\$v l	14	44
Lebanon	r	89.3	WPSI		2	9
Lexington	r	90.5	WVBU		2	9
Lewisburg	r	95.9	WNRV-FM	N	6	25
Lincoln University		88.7	WLIIU		2	9
Linesville	mk	101.7	WVCC	\$ M	13	42
Lock Haven		92.1	WBPZ-FM	WBU	14	44
	m	89.5	WNTL		2	9
Martinsburg	g	92.7	WJSM-FM	v U	13	42
McKean	p	102.3	WNDI	v M	15	45
Meadville	p	90.3	WVAR	A	2	11
	m	100.3	WZPF	\$v l	25	61
Mechanicsburg		93.5	WQVE	v	15	46
Mercer	k	103.9	WVIZ	\$v U	15	46

**South Carolina**

State College		89.9	WTLR	v	+ 23	58
	cr	91.1	WDFM	\$v M	3	12
	p	96.7	WOKW	\$v Y+	14	44
	rm	103.1	WOLR	\$v	5	17
Straudsburg	m	93.5	WPCO-FM	v U	14	44
Sunbury	r	94.1	WKOY-FM	v C	31	69
Swarthmore	r	91.5	WFSN		2	9
Tamaqua	m	105.5	WZTA	\$v	14	45
Telford		89.7	WBSM		2	9
Tosanda	mk	95.3	WTTC-FM	v M	9	35
Tyrone	k	101.1	WGNR	\$v M+	30	69
Union City	g	106.3	WCTL	v	15	46
Uniontown	m	99.3	WPOP	\$v A+	15	46
Warminster	r	89.3	WCSO		2	9
Warren	mp	92.3	WRRN	\$v U+	27	65
Washington	r	88.3	WJCR		2	9
	r	95.3	WJFA-FM	v M	15	46
Waynesboro	k	101.5	WYZY-FM	v Y	4	18
Waynesburg		103.1	WAMB-FM		14	44
Wellsville	k	104.5	WGRG	\$v +	29	69
Wilkes-Barre	r	88.5	WRRK	v l	2	10
	p	90.7	WCLH	\$v M	23	58
	nc	92.9	WYZZ	\$v M+	30	69
	m	98.5	WBRE-FM	\$v M	30	69
Williamsport		91.7	WRLC		2	9
	rm	102.7	WBAK-FM	N	45	90
	kr	105.1	WILQ	v U	28	65
York		88.1	WVYC		2	9
	r	98.5	WBOC	\$v	31	69
	m	103.3	WBSA-FM	\$v +	26	64
	r	105.7	WQXA	\$v l	33	73
<b>Rhode Island (MAP P. 14)</b>						
Kinoston	r	90.3	WRUU	v	14	49
Middleton	m	107.1	WRFB	\$v	15	45
Perthmouth	rc	90.7	WJHD		2	9
Providence	r	91.3	WBOB	M	2	9
	r	92.5	WPRO-FM	\$v +	33	72
	m	94.1	WHJZ	\$v L+M	31	71
	p	95.5	WBRU	\$v A+	30	71
	m	101.5	WLBK-FM	l	33	73
	r	105.1	WPJZ	\$v C+M	28	65
Smithfield	r	91.5	WJMF		2	9
Westerly	mr	103.7	WERI-FM	M+R	16	50
<b>South Carolina (MAP PP. 24-25)</b>						
Aiken	rm	95.9	WROR-FM	l	12	40
	m	99.3	WHEZ	v	15	46
Anderson		101.1	WCAE	C	16	52
	r	107.3	WANS-FM	v Y	29	73
Bamberg	mi	92.7	WZBO-FM	v	15	46
Barnwell	r	101.7	WBAK-FM	v U	15	45
Batesburg	kr	92.1	WBIR-FM	v U+	15	46
Beaufort	cr	89.9		\$v P	43	67
	k	98.7	WBEU-FM	\$v M+	23	61
Camden	kr	94.3	WRUP-FM	\$v	17	40
Cayce	rm	96.7	WZLZ	\$v A+	15	46
Charleston	cr	89.3	WSCR	\$v P+H+	17	51
	c	95.1	WPXI	v	34	78
	m	96.9	WYIC	\$v M+	41	86
	r	102.5	WSTM	\$v Y+	27	67
	k	103.5	WEZL	\$v A+	23	60
Cherter	r	99.3	WCMJ	v	+ 15	46
Clemson	r	89.3	WSPH	N	14	44
Columbia	gm	89.7	WMBR	v	34	78
		90.5	WBCI		18	55
	cr	91.3	WTLR	\$v P+H+	18	50
	c	91.9	WJSC	v Y	2	9
		93.5	WRRY	\$v	15	45

South Carolina

k 97.9 WCOS-FM \$ v I 34 78  
 r 104.7 WNOK-FM \$ Y+M 35 79  
 Conway m 104.1 WLAT-FM \$ +M 21 63  
 Darlington k 105.5 WDAE-FM \$ I+ 14 44  
 Dillon 92.9 WDSC-FM v 19 54  
 Due West r 88.5 \*WARP 2 9  
 Easley mk 103.9 WELP-FM v U 15 46  
 Florence rm 106.3 WSTN \$ v + 15 46  
 Gaffney kg 105.3 WAGI \$ v 48 96  
 Georgetown  
 r 97.7 WGBM \$ v Y 12 40  
 k 106.3 WSHG \$ v 9 36  
 Greenville cr \*90.1 WEPB \$ P+T 47 93  
 k 92.5 WESC-FM \$ E 39 83  
 rn 93.7 WFBC-FM \$ N+M 56 106  
 qc 94.5 WNUJ-FM \$ S+M 48 97  
 Greenwood m 96.7 WCBS-FM v N 15 45  
 Hampton m 103.1 WJWJ 9 37  
 Hilton Head Is.  
 m 106.3 WHHR \$ v U 15 46  
 Honea Path rk 103.1 WRIX \$ v + 15 46  
 Kingstree m 98.3 WTKT 13 41  
 Lake City sk 100.1 WGFJ v 12 40  
 Lancaster k 107.1 WPAJ \$ 12 40  
 Laurens nr 100.5 WGLX \$ v I 41 86  
 Manning k 92.1 WTRN \$ v 15 46  
 Marion n 94.3 WATP-FM v 12 40  
 Moncks Corner  
 rg 105.5 WTWF \$ 14 44  
 Mullins r 107.1 WCIQ \$ v 13 42  
 Myrtle Beach n 92.1 WMYB-FM \$ A+M 15 46  
 r 101.7 WKZQ \$ v 14 45  
 N. Myrtle Beach  
 r 105.5 WMBB \$ v 15 46  
 Orangeburg k 103.9 WORG-FM v M 15 46  
 sr 105.7 WPCS \$ v 38 82  
 Pageland rk 102.3 WCPL-FM \$ v 15 46  
 Rock Hill cr \*88.9 WPRV \$ v P+T 38 83  
 St. George k 107.5 WFSR \$ v U 35 79  
 Seneca n 98.1 WBFM \$ v M+L 26 66  
 Spartanburg m 98.9 WSPA-FM \$ v 56 107  
 Summerville p 93.5 WNRZ \$ v B 15 45  
 Sumter cr \*88.1 WMPR \$ v P+T 45 90  
 s 101.3 WNDM \$ v 39 83  
 Surfside Beach  
 k 103.1 WYAK v 15 46  
 Wallerboro r 100.9 WALD-FM v 15 46  
 West Columbia  
 r 100.1 WSCQ \$ v + 15 46

South Dakota (MAP PP. 38-39)

Aberdeen \*90.1 KASD \$ 4 18  
 mk 94.1 KSDN-FM Y 25 70  
 m 94.9 KQAA v 49 98  
 Bison mk 92.7 K249AM \$ KRCS 93.11  
 Brookings rc \*88.3 KESD \$ vSP+T 34 74  
 nr 94.3 KBKR-FM 11 39  
 Custer mk 103.9 K280A1 \$ KRCS 93.11  
 Dupree mk 97.7 K249AL \$ KRCS 93.11  
 Eagle Butte  
 mk 97.7 K249AJ \$ KRCS 93.11  
 Garden City  
 nr 96.9 KDLO-FM \$ U+M 49 98  
 Hill City mk 103.9 K280AJ \$ KRCS 93.11  
 Hot Springs  
 mk 103.9 K280AK \$ KRCS 93.11  
 Huron mk 92.1 K1JW-FM v 12 40  
 Lemmon mk 97.7 K249A1 \$ KRCS 93.11  
 Madison m 103.1 K2JAN-FM v U 15 46  
 Mitchell nr 102.3 K2IIT \$ v 15 46  
 Mobridge mk 99.5 KOLY-FM \$ v I 35 76

Phillip mk 97.7 K249AK \$ KRCS 93.11  
 Pierre mk 97.7 K249AO \$ KRCS 93.11  
 Rapid City r \*88.1 KTEQ \$ U 2 9  
 r 93.9 KHJL \$ 30 70  
 g 97.9 KFSR 33 76  
 k 100.3 KGGG \$ v Y 35 79  
 mk 103.9 K280AR \$ KRCS 93.11  
 Sioux Falls p \*89.1 KAUR \$ 2 9  
 \*90.1 KCF5 2 9  
 mr 92.5 KELO-FM \$ U+M 56 107  
 pr 93.5 KLYX-FM \$ M 8 13  
 g \*96.5 KNRC-FM \$ v U 29 73  
 r 97.3 KPAT \$ v +F 21 59  
 k 104.7 KIDV \$ v N+T 40 85  
 Spearfish \*89.1 KBHU \$ 2 9  
 mk 97.7 K249AF \$ KRCS 93.11  
 Springfield r \*88.5 KSTI 2 9  
 Sturgis mk 93.1 KRCS \$ v 42 86  
 Vermillion c \*89.7 KUSD-FM \$ UP+T 33 73  
 nr 102.3 KVRP \$ v 14 43  
 Watertown r 96.1 K1XX \$ v 30 74  
 Winner nr 93.7 KNYR-FM \$ E 38 82  
 Yankton m 104.1 KQHU \$ Y 34 78

Tennessee (MAP PP. 30-31)

Athens m 101.7 v 15 45  
 Bolivar k 96.7 WVST v I 15 46  
 Brownsville s 95.3 WTBG \$ 11 38  
 Camden 98.3 WRJB \$ v E 15 46  
 Carthage 102.3 WRKM-FM \$ v 15 46  
 Centerville  
 kr 95.7 W1KA 15 46  
 Chattanooga  
 g \*88.9 WNBW v U 49 98  
 g \*89.7 WBYN 40 83  
 m 92.3 WDEF-FM \$ v +M 42 87  
 kg 96.5 WOOD-FM \$ E 46 92  
 m 106.5 WYHO \$ v U 46 92  
 Cleveland r 100.7 WQLS \$ v U 29 69  
 Clinton k 104.9 WYSH-FM \$ v 15 46  
 Collegedale  
 cg \*90.7 WSMC \$ v P 38 82  
 Columbia k 101.7 WKOM \$ v 15 46  
 Cookeville r \*90.1 WTTU 2 9  
 94.3 WPTN-FM \$ v 13 41  
 m 98.3 WHUB-FM \$ v 15 45  
 Covington k 93.5 WKBL-FM v 11 38  
 Crossville nr 99.3 WAEN-FM \$ M 11 38  
 Dayton kg 104.9 WRFB 12 40  
 Dickson 102.3 WTAQ 14 43  
 Dyersburg m 100.1 WASL \$ Y 12 40  
 Elizabethton  
 kg 99.3 W10D-FM v 5 17  
 Erwin m 103.9 WXIS \$ v 5 17  
 Etowah nr 103.1 WMCC \$ v 5 17  
 Fayetteville  
 k 105.5 WYTN \$ A 15 45  
 Franklin r 100.1 W1Z0-FM \$ v M 15 45  
 Gallatin r 104.5 WHIN-FM \$ v 37 79  
 Germantown nr 94.3 WEEF \$ v 15 46  
 Greenville  
 k 94.9 WOFM \$ v 31 75  
 Henderson \*91.5 WFHC M 2 9  
 Hendersonville  
 r 92.1 WBYQ \$ 15 46  
 Humboldt k 102.3 WTRJ-FM Y 15 46  
 Huntingdon k 100.9 WPGV v 15 46  
 Jackson r 104.1 WKIR \$ v A+ 40 84  
 Jamestown kg 103.9 WDEB-FM \$ v 15 45  
 Jefferson City  
 nk 99.3 W59M \$ v 15 46

Tennessee

Johnson City  
 cj \*89.5 WETS \$ v P 56 106  
 r 101.5 WQIT \$ +M 53 107  
 Kingsport nr \*88.5 WFTT-FM \$ v A+A 48 98  
 Knoxville r \*91.1 WRCS 4 19  
 cj \*91.9 WUOT \$ v P 38 82  
 m 97.5 WELZ \$ v +M 47 94  
 k 103.5 WBYR-FM \$ C 55 105  
 k 107.7 W1VX-FM \$ v L 45 91  
 Lawrenceburg  
 k \*95.9 WDEL-FM 12 40  
 Lebanon \*89.7 WLFH 2 9  
 c \*91.3 WFMG 5 22  
 m 107.3 WCOR-FM \$ 18 43  
 Lenoir City 93.5 WLIL-FM v 11 38  
 Lexington k 94.3 WJUM-FM M 8 13  
 Lexington m 99.3 WDLX-FM 10 38  
 Livingston kr \*95.9 WLIV-FM 10 38  
 Lobelville 94.3 WTHJ Y 15 45  
 Manchester m 99.7 WMSH-FM 17 52  
 Martin r \*90.3 WUTM 2 9  
 101.7 WNTA 11 39  
 McKenzie kg 106.9 NKTA \$ v A 36 80  
 McMinnville  
 mc 103.9 WBNC-FM \$ v 9 36  
 Memphis  
 r \*88.5 WOOX \$ v 18 50  
 cr \*89.3 WLYX \$ v + 12 40  
 \*90.3 WEVZ 2 9  
 c \*91.1 WKHO-FM \$ v P+ 34 74  
 cm \*91.7 WSKM v + 5 22  
 rs 97.1 WHRK \$ v 37 80  
 r 99.7 WMC-FM \$ v +M 51 106  
 k 101.1 KWAM-FM \$ E+ 33 76  
 rp 102.7 WZYZ \$ v C 43 88  
 rm 104.5 WQUD \$ v + 41 86  
 m 105.9 WEZJ \$ v 41 86  
 Milan m 92.3 WKBJ-FM +T 20 59  
 Morristown r 95.9 WAZI \$ v +M 15 45  
 Murfreesboro  
 rc \*89.5 WMOI \$ v P1+T 24 64  
 nk 96.3 WNTS-FM \$ v 17 53  
 \*88.1 WRFN 2 10  
 m \*89.1 WHAZ v I 6 24  
 c \*90.3 WPLN \$ P+T 30 74  
 pr \*91.1 WRVU 7 26  
 m 92.9 WZEE \$ v +M 37 80  
 r 95.5 WSHB-FM \$ v A 49 98  
 k 97.9 W51X-FM \$ v E+M 47 93  
 p 103.3 WKDF \$ v 34 78  
 nr 105.9 WLAC-FM \$ S 34 78  
 r 94.3 WUUU 5 16  
 r 100.3 WOKI-FM \$ v 57 109  
 Olive Hill m \*89.1 WDNX 12 39  
 Oneida gk 105.5 WBYT-FM +M 15 45  
 Paris mk 105.5 WTRP-FM \$ 12 40  
 Pulaski km 98.3 WMLG \$ + 15 46  
 Red Bank nr 94.3 W51M \$ v M 12 40  
 Savannah 101.7 WDRB-FM E 12 40  
 Sevierville m 102.1 W5EV-FM \$ v +M 46 92  
 Seawee r \*91.5 WUTS 2 9  
 Shelbyville g 102.9 WTCV v 37 80  
 Smithville k 101.7 WJLF-FM 12 40  
 Soddy-Daisy 102.3 WQZQ \$ v 15 45  
 Sparta 105.5 W5NT-FM 5 19  
 Springfield  
 s 94.3 WDBL-FM v 15 46  
 Sweetwater m 95.3 WDEH-FM \$ 10 37  
 Tullahoma r 93.3 WBGY-FM \$ v Y 28 72  
 Union City 104.9 WALR v I 15 46  
 Waverly  
 m 104.9 WVRV v 13 42



Texas

(MAP PP. 42-43)

Abilene	n	100.7	KORO	\$v	49	98
	rn	105.1	KWIT-FM	\$	+ 21	60
	rn	107.9	KFMN	\$ A+M	30	74
Alice	r	92.1	KDPI	v	15	46
	m	102.3	KBIC	\$v U	15	46
Alvin		91.3	KACC		2	9
Amarillo	pc	89.9	KACV	\$v +	31	70
	v	93.1	KOIZ-FM	v	+ 23	66
	r	94.1	KBUY	\$ A	36	79
	m	97.9	KGAC-FM	\$ H	44	88
	g	98.7	KZIP-FM	v	43	89
	g	101.9	KWAC	\$v +X	40	84
	m	105.5		v	13	41
Andrews		94.9	KWJS	\$v U+M	40	84
Arlington	g	99.3	KLUK	v	12	40
Atlanta		86.7	KAZI	v	14	44
Austin	c	89.5	KMFA	\$	20	55
	S c j	90.7	KUT	PK+TB14	44	
	p	93.7	KLBJ-FM	\$v +X	45	91
	k	95.5	KONE-FM	\$	19	53
	r	98.3	KHFI	\$ Y	15	45
	m	100.7	KACE	\$v +M	36	80
	S L	102.3	KMXX	\$v	14	44
Ballinger	m	103.1	KCRB	\$v	15	46
Beaumont	rc	91.3	KVLU	\$ UP	30	69
	m	94.1	KDXY	\$v M+H	31	70
	k	95.1	KTEL	\$ I	27	59
	r	97.5	KAYD	\$v +M	27	67
	r	107.7	KKIC	\$ A	32	76
Beeville		104.9	KCRW	v M	15	46
Belton	k	106.3	KTON-FM	\$ I	13	43
Big Spring	k	95.3	KFNE	\$v +	13	44
Borger	qk	104.3	KBBB-FM	v	19	56
Brady	m	95.1		v	15	45
Brenham	kn	106.3	KKHI-FM	\$ E	15	46
Brewersville		99.5	KRIX	v +	34	78
	m	100.3	KOUV	\$v +	31	71
Brownwood	k	101.5	KDKE	\$ E	36	80
	m	104.1	KLSN	\$ A	20	56
Bryan	k	98.3	KORA	\$ A	13	42
Canyon		91.1	KWTS		2	9
Center	nk	102.3	KLCR	v	15	46
Clear Lake City		102.1	KHJQ	\$v S+	41	86
Coleran		107.1	KSTA-FM	\$v	12	40
College Station		90.9	KAKU	\$v P	16	48
	r	92.1	KTNM-FM	\$v	14	40
Columbus	k	98.3	KULM	\$v	12	40
Commerce	pj	86.9	KETR	\$v P	17	49
Conroe	r	106.9	KHRO	\$v +	37	80
Copperas Cove	k	103.1	KDOV	\$v E	14	45
Corpus Christi		93.9	KSIX-FM	\$v +M	42	87
	r	95.5	KZFM	\$ Y+M	26	66
	m	96.5	KIOU	\$v +M	42	87
Corsticana		107.9	KXCL	\$v U	29	68
Crockett	n	92.7	KIVY-FM	v	12	40
Dalhart		95.9	KXIT-FM		8	31
Dallas	rj	86.5	KRSM		2	9



pc 89.3 KCB1 \$v 18 51

Texas

cj	90.1	KERA-FM	\$v+PU+TB49	98	m	102.9	KQUE	\$v I+M	44	95			
	90.9	KCHU	\$v P	41	86	r	104.1	KRBE	\$v	41	86		
g	91.7	KVTT	v	41	86	g	105.7	KHCB	\$v	33	76		
r	92.5	KAFM	\$v A	54	104	Huntsville	m	89.3	KSHI		2	9	
p	97.9	KZEW	\$v +M	54-104			m	101.7	KSAM-FM		12	41	
r	98.7	KHUS	\$v	37	80	Jacksonville	m	106.1	KOGI	\$ +	39	83	
m	100.3	KHEZ	\$v	48	96		k	102.3	KTXJ-FM	U	10	37	
c	101.1	KRRR-FM	\$v U	37	80	Keene	ng	88.3	KSCU		12	39	
r	102.9	KMGC	\$v +M	53	103	Kerrville	k	94.3	KPFM	\$v	8	33	
r	103.7	KVIL-FM	\$v Y	53-103		Kilgore		95.9	KXTX	v	14	44	
rs	104.5	KYDA-FM	\$v	40	84	Killeen	c	91.3	KMCT-FM	\$v P	43	88	
m	105.3	KOAX	\$v	53	103		rk	93.3	KIXG-FM	\$v	11	39	
Del Rio	r	94.3	KDLK-FM	\$	9	36	Kingsville	r	91.1	KTAL		2	9
Denison	r	89.7	KGCC	\$	22	58		r	97.7	KPUP	\$v	10	38
	r	101.7	KDSO	\$v A	14	44	La Grange	m	104.9	KMUZ		12	40
Denton	r	86.5	KNTI	v	6	24	Lake Jackson						
	r	106.1	KDNT-FM	\$v +M	29	73		m	107.3	KGOI	\$v +M	19	56
Diboll	k	95.5	KSPH-FM	v	+ 28	68	Lanesa	m	104.7	KGTG	\$v +	27	71
Dumas	m	95.3	KMRE		9	36	Lanapasas	r	99.3	KLTD	\$v M	12	40
Eagle Pass	rm	92.7	KIQL	\$v	12	40	Laredo	rm	94.9	KOIC	\$v	42	87
Edinburg	r	104.1	KBFM	\$v U+	31	75	Livingston						
	m	107.9	KESI	\$v	36	80		k	92.1	KETX-FM	v	15	45
El Campo	m	96.9	KULP-FM		19	62	Lunsvlew	k	105.7	KYX	\$v	29	73
El Paso	c	88.5	KTEP	\$v PI	40	85	Lubbock	rc	86.1	KTXI	\$v +A	24	59
	g	92.3	KSDL	v	56	106		r	91.1	KUHY		6	23
S r	93.1	KAMA-FM	\$v	40	82		k	93.7	KSEL-FM		40	85	
qd	93.9	KPAS	\$v A	44	90		r	94.5	KLBY-FM	\$v +M	40	84	
	m	94.7	KSET-FM	\$v M+M	40	85		k	96.3	KLLD-FM	\$v	34	75
		95.5	KUOE	v	50	100	S L	99.5	KWGO	\$v A	34	76	
	m	96.3	KEZB	\$v	50	99		c	101.1	KTEZ	\$v	38	80
	r	97.5	KINI-FM	\$v Y	43	86	Lufkin	n	99.5	KDEY	v	14	46
	r	99.9	KTSN-FM	\$v	55	105		m	105.1	KLOU-FM	v	36	78
	k	102.1	KLOZ	\$ C	43	86	Marlin	k	96.7	KLRI	v U	9	35
Floresville							Marshall		91.1	KGWC		2	9
kr	94.3	KWCB	v	8	32			103.9	KRHT-FM	\$v	15	46	
Fort Stockton	m	94.3	KPJH	\$v	13	42	McAllen	S gL	96.9	KWVV	v	27	71
Fort Worth	jr	86.7	KTCU	\$v	9	35		S kL	98.5	KQXX	\$v +	23	60
	S L	93.9	KESS	\$v	34	77	McKinney	rm	95.3	KMKK	\$v U	13	41
	k	96.3	KSCS	\$v	54	104	Midland						
	r	97.1	KFJZ-FM	\$v +I	51-100			m	92.3	KHFM	\$v +M	33	76
	m	99.5	KPLX	\$v	54	104		k	93.3	KBAT	\$v	35	79
	p	102.1	KFWD	\$v	51	100		m	103.3	KRNJ	\$v +M	44	90
	S	107.5	KNOX-FM	\$v	33	76	Minneola	m	96.7	KMCO-FM	v	15	46
Fredericksburg							Mineral Wells						
m	101.1	KHAF-FM	\$v	40	84			k	95.9	KMWT	\$v	15	45
Gainesville	rk	94.5	KGAF-FM	\$v G+M	33	76	Mount Pleasant						
Galveston	k	106.5	KUFO	\$v +	19	56		r	100.7	KPXI	\$v	23	69
Gatesville	r	98.3	KMCS	\$v	15	46	Muleshoe	nr	103.1	KMLD-FM		7	28
Georgetown	rk	96.7	KSTN-FM	v	15	45	Nacogdoches		90.1	KSAU		7	28
Graham	m	107.1	KWKQ	\$v	8	33		p	92.1	KSFA-FM	\$v +M	15	46
Greenville		93.5	KHRT	v	15	46		k	103.3	KJCS	\$v Y+I	33	76
Harlingen	k	94.5	KELI	\$v +M	40	85	New Braunfels						
S r	96.1	KINW	\$v +M	35	79		m	92.1	KHBT	\$v E	15	46	
Henderson	r	100.1	KGRI-FM	v	12	40	Odessa	r	91.3	KOCV	v	15	47
Hereford	m	106.3	KPAN-FM	v	14	44		rm	96.9	KOFP		10	36
Hillsboro	k	102.5	KHBR-FM		11	39		rk	97.9	KOYL-FM	\$v Y	16	54
Houston	j	88.7	KUHF	\$v +	36	78		g	99.1	KKXK	\$v +	34	78
		90.1	KPFT		35	79	Orange	r	104.5	KBOC		24	64
	js	90.5	KTSU	\$ B	2	9		m	106.1	KIOC	\$v	46	92
	r	91.7	KTRU	\$v	6	25	Ozona	rk	94.3	KRCT		5	17
	r	93.7	KRLY	\$v	41	86	Palestine	nr	94.3	KLIS	\$v	15	46
	c	94.5	KLEF	\$v	38	82		g	98.3	KMHM	v	15	46
	k	95.7	KPKK-FM	\$v +M	36	76	Paris	r	95.3	KACK	\$v +	7	29
rs	96.5	KAUM	\$ A	38	82	Pasadena	m	92.5	KYND	\$v	42	86	
	r	97.9	KFMK	\$v +G	35	79	Plains		90.7	KPLN		2	9
	m	99.1	KODA-FM	\$v +M	41	86	Plainview		91.5	KKLD	v	5	22
	r	100.3	KILT-FM	\$v	41	86		S m	97.3	KATX	v	35	79
	p	101.1	KLOL	\$v	41	86	Pleasanton	kg	96.3	KDOP-FM	v	15	46
							Port Arthur	k	93.3	KYKR-FM	\$v U+M	34	78
								nc	98.5	KPAC-FM		17	50



Virginia

Cree k 104.7 WSVS-FM M 25 61  
 Culpeper m 103.1 WCUL \$ 15 46  
 Danville m 103.3 WAKG \$ v 40 84  
 Exmore fm 107.5 WEXM-FM v 25 65  
 Farmville m 95.7 WFLO-FM + 18 60  
 Fredericksburg  
 k 93.3 WFLS-FM \$ v S+M 28 68  
 g 95.9 W240AC \$ WIVE 100.11  
 r 101.5 WFVA-FM \$ v Y 9 39  
 Front Royal 95.3 WIXV v + 12 39  
 m 99.3 WFFV \$ 15 46  
 Galax k 98.1 WBOE-FM U 24 59  
 Garden City m 95.9 W240AA \$ WPKR 94.91  
 Gate City 104.9 WGAT-FM v M 15 44  
 Gretna k 106.3 WMNA-FM \$ v N 14 44  
 Grundy m 97.7 WNUD v 15 46  
 Hampden Sydney 91.7 WNHHS \$ 2 9  
 Hanfton s 88.3 WNDV 2 9  
 m 101.3 WNVH \$ v A1 29 69  
 Harrisonburg 90.7 WNRB \$ v P+ 31 70  
 cg 91.7 WFFM \$ v 2 9  
 r 100.7 WQPO \$ 19 54  
 Kilnarnock m 101.7 WNNI \$ v 12 39  
 Lexington r 91.5 WLUR \$ v 2= 8  
 Luray m 106.3 WLCC v 5 20  
 Lynchburg  
 r 98.3 WGOJ \$ v N 13 42  
 g 100.1 WWOOD-FM \$ v M 10 38  
 s 101.7 WJUS 2 15 45  
 Manassas m 106.7 WEZR \$ v + 33 73  
 Marion 93.9 WMEV-FM I 29 66  
 m 102.3 WOLD-FM \$ v M 15 46  
 Martinsville  
 rp 96.3 WMYA-FM \$ v M 39 83  
 Newport News  
 c 97.3 WGH-FM \$ v S+M 33 75  
 Norfolk c 89.5 WIGM \$ v P 31 70  
 m 95.7 WKEL \$ v 59 79  
 pr 98.7 WNOB-FM \$ v 33 74  
 g 99.7 WYFI \$ v U 30 70  
 k 100.5 WCHS-FM \$ v 29 69  
 s 102.9 WQW1 \$ v 2 12 72  
 r 104.5 WDRB \$ v +M 30 70  
 o 105.3 WYRI \$ v 53 73  
 Norton k 106.3 WJVA-FM 14 44  
 Orange m 90.7 WJMA-FM v 15 46  
 Pennington Gap  
 105.5 WSRV-FM 5 17  
 Petersburg k 95.3 WPKA-FM \$ 13 42  
 m 94.3 WPLZ \$ v + 15 45  
 Portsmouth r 88.7 WNH5 5 21  
 Pulaski 107.1 WPLV-FM I 4 16  
 Radford \*94.5 2 9  
 101.7 WFAU-FM v 7 26  
 Richlands  
 105.5 WQTH \$ v M 15 44  
 \*90.1 WQCE 7 9  
 Richmond  
 r 94.5 WRVW \$ v U 37 86  
 m 98.1 WTRV-FM \$ v C+M 38 80  
 rp 102.1 WRXL \$ + 34 80  
 m 103.7 WELZ \$ v +M 34= 76  
 c 106.5 WPKF \$ v P 24 64  
 Roanoke pc \*89.1 WVVH \$ v P+ 56 107  
 n 92.3 WLRG \$ v F+M 46 91  
 m 94.9 WPKR \$ v M+M 53 100  
 r 99.1 WSLQ \$ v +M 60 113  
 Salem g 93.5 WJLM v 5 17  
 South Boston  
 r 97.5 WJLC \$ v 22 59  
 South Hill r 105.5 WSHW \$ 13 42

Stafford g 92.1 W221AA \$ WIVE 100.11  
 Staunton m 93.5 WSGM \$ v C 15 46  
 Suffolk n 92.9 WFOG-FM \$ v + 32 72  
 106.9 41 86  
 Tappahannock  
 nr 105.5 WRRB-FM \$ v I 15 46  
 Tasley nk 103.3 WESR-FM \$ 27 67  
 Tazewell  
 k 100.1 WTZE-FM U 5 17  
 94.3 WORA v 15 46  
 Warrenton nr 107.7 WEER-FM 23 59  
 Warsaw k 100.9 WNNI-FM 15 46  
 Williamsburg  
 r \*90.7 WCNM v Y 8 32  
 n 96.5 WBC1 \$ v M+M 30 70  
 Winchester k 92.5 WRFL v E+M 41 65  
 g 102.5 WEF6 \$ + 24 60  
 Woodbridge  
 k 105.9 WXRA \$ v M+ 30 70  
 \*91.5 WYCS U 18 54  
 Yorktown k 94.1 WYVA \$ v + 33 73

Washington

(MAF P. 48)  
 Auburn r \*89.9 WURB 2 9  
 Bellevue r \*89.3 WAB3 2 9  
 jr \*91.3 WBCS 5 22  
 p 92.5 WZAM-FM \$ 47 93  
 Bellingham  
 cr \*84.3 WUGS 2 9  
 r 92.9 WISN \$ v Y+M 55 104  
 k 104.3 WERI \$ v M+L 55 104  
 Bremerton v 106.9 WBRD-FM M 51 98  
 Bridgeport k 103.9 WZBOAD \$ WRIQ 100.31  
 \*41.3 WJED 2 9  
 Centralia k 102.9 WJLA-FM v M 24 61  
 Cheney p \*89.9 WERC 2 9  
 Clarkston k 94.1 WCLK-FM \$ 8 29  
 College Place  
 cg \*91.3 WGT5 A 4 13  
 Edmond: g 105.3 WBIG \$ v + 44 90  
 Ellensburg  
 km 95.3 WXL-FM E 4 14  
 Everett m 103.1 W276AC \$ KSEA 100.71  
 m 104.3 W292AL \$ KIXI 95.71  
 Hoquiam r 95.3 WGHQ-FM v 14 45  
 Longview  
 r 101.5 WLYR \$ M 5 17  
 Lynden me 106.5 WLYN \$ v E+ 40 85  
 Kennewick m 105.3 WONA-FM \$ v A+ 48 95  
 Mercer Island  
 jr \*90.1 WMIH 2 9  
 Moses Lake k 100.3 WRIQ-FM + 21 58  
 Mount Vernon  
 r \*90.1 WSVR 2 9  
 \*90.1 WMBE 2 9  
 Newport rm \*91.5 WUHS 2 9  
 Ocean Shores  
 m 104.7 WDUX \$ v U 27 65  
 Olympia \*89.3 WADS 2 6  
 n 104.9 W285AL \$ KIXI 95.71  
 92.7 WDMR-FM v 7 17  
 g 104.9 W280AP \$ KMB1 107.91  
 r 107.1 W292AL \$ WDF 98.11  
 Opportunity  
 k 90.1 WZUN-FM \$ v Y+M 55-104  
 Pasco cg \*90.1 WOLU v 5 18  
 Port Townsend  
 m 106.3 W292AX \$ KIXI 95.71  
 Prosser mc 101.7 WACA \$ v M 5 17  
 Pullayup m 103.1 W276AD \$ KSEA 100.71

West Virginia

Pullman m 104.9 KOOO \$ 7 28  
 Richland m 102.7 WORO-FM \$ +M 42 87  
 r 106.3 KXOD 5 16  
 Seattle r \*89.5 KNHK \$ 11 39  
 r \*90.5 KDMU 2 9  
 g 93.3 KBLE-FM v +M 46 92  
 k 94.1 KEUT \$ v 47 94  
 c \*94.9 KLOUW \$ P-1B40 85  
 m 95.7 K1X1-FM \$ v H+O 48= 95  
 r 90.5 KYYX \$ v Z 41 84  
 c 98.1 KING-FM \$ 40 85  
 m 98.9 KEZZ \$ v +M 47 93  
 rp 99.9 KISW \$ v 48 95  
 m 100.7 KSEA \$ v G+G 40= 85  
 r 101.5 KVI-FM \$ v 48 95  
 rp 102.5 K20K-FM \$ v A 48 95  
 m 103.3 W277AA \$ KIXI 95.71  
 p 104.5 W283AA \$ KISW 99.91  
 \*107.7 FRAB \$ v E+ 44 89  
 Shelton m 103.1 K276AD \$ KSEA 100.71  
 Spokane \*90.3 WRSR 2 9  
 \*91.1 WPKB \$ + 20 55  
 r \*91.9 KSCF 2 9  
 p 92.9 WREM-FM v 39 82  
 k 93.7 WXXX-FM \$ v E+ 56 105  
 r 98.1 KING-FM \$ v N 58 108  
 g 98.4 KICN v 23 60  
 m 99.9 KXLY-FM \$ v G+ 56 104  
 m 105.7 WLEZ-FM \$ 33 72  
 g 107.9 WMB1-FM \$ v 27 66  
 Sunnyside  
 r 90.7 WREW-FM \$ 5 17  
 Tacoma cj \*88.5 WPLU \$ 18 56  
 r \*90.1 WUPS \$ 2 9  
 mc \*90.9 WPEC 21 60  
 rs \*91.7 WTOY P 26 65  
 rm 97.3 WNBQ \$ v A+ 53 76  
 m 104.9 WBRD \$ v 14 44  
 mc 104.7 W284AA \$ WBIQ 105.31  
 p 106.1 WLAY \$ v 33 72  
 92.7 WLEH-FM v 4 12  
 Toppenish W Vancouver c \*103.9 W260AC \$ KNOX 94.91  
 Walla Walla  
 r \*90.5 WVCW \$ 2 9  
 n 93.3 WEXI \$ v 8 29  
 r 97.1 WSTX \$ v 44 90  
 m 102.7 WFOG-FM \$ v A+ 55 104  
 o 104.9 WJAM \$ v U 15 38  
 Yakima \*91.9 34 74  
 r 94.5 WIT-FM \$ v A+ 36 77  
 m 98.3 WYBO \$ v 14 44  
 m 104.1 WJUZ \$ v + 39 81  
 r 107.3 WJFM \$ v N 44 90  
 West Virginia (MAF PP. 72-73)  
 Beckley cm \*91.7 WVPR \$ v P+ 32 70  
 g 99.5 WBNR \$ v + 39 81  
 p 103.7 WDIR-FM \$ M 29 69  
 Berkeley Springs  
 pk 93.5 WCSI-FM 7 28  
 \*90.1 WVBG 2 9  
 Bluefield m 104.5 WBAJ \$ v 47 95  
 Buckhannon cm \*89.9 WVPW \$ v P+ 31 70  
 \*89.9 WVKC 2 9  
 Charleston \*88.5 WVPN v 24 64  
 n 97.7 W227AA \$ WBL5 96.11  
 n 96.1 WUES \$ v 29 69  
 k 97.5 WDBE \$ v Y 33 73  
 r 99.9 WVAF \$ v A 33 73  
 m 107.7 W110 v N 29 69



**Wyoming**

La Barge	r 106.3 K292AC \$ KCPX	98.7t
	m 107.1 K296AT \$ XSL	100.3t
Lander	rn 97.5 KDLY \$ W+ C+	8 28
Laramie	r 91.9 *KUNR v	43 88
	c 92.7 K224AA \$ KVOD	99.5t
	m 94.3 K232AA \$ KLIP	100.3t
	m 95.3 K237AA \$ KOSI	101.1t
	r 102.9 K102 \$ W+ H+	40 82
Lyman	rn 105.5 K288AB \$ KALL	94.1t
	m 106.3 K292AH \$ XSL	100.3t
	v 107.1 K296AG \$ KSDP	104.3t
Moosehot Hot Springs	rn 103.9 K260AH \$ KMTN	96.9t
	m 104.9 K285AF \$ KURL	97.1t
Newcastle	r 107.1 K296BD \$ KOLL	93.5t
Roskins	m 105.5 K2896G \$ KARR	93.7t
Riverton	m 88.1 *KNCN	9 37
	m 93.5 K1AN \$ v	14 44
Rock Springs	fr 96.5 K0SW \$ v	54 104
Sheridan	r 94.9 KPOE-FM \$ v C	11 52
	m 95.5 KRYO-FM v I	8 27
Sundance	m 103.9 K260AC \$ KRCS	93.1t
	r 107.1 K296AV \$ KOLL	93.5t
Torrington	rn 98.3 KERM \$ A+	15 46

**Puerto Rico**

Aguada	c 105.5 WPEE \$ v	13 43
Aguadilla	nL 92.9 WTPM \$	3+ 74
	c m 100.3 W1VA \$ v	4+ 84
Arecibo	L 104.5 W101-FM	0 25
	L 107.1 W0M5-FM \$ v	44 67
Bayamon	m 94.7 W65A \$ v +M	17 55
	L 100.7 W99X v	5 33
Caguas	nL 103.3 W1JF-FM \$	9 33
Camuy	m 102.5 W0HG	5 20
Carolina	r 107.7 W0LA \$ v +M15	56
Cidra	L 97.7 W0BC \$ v	+ 1+ 46
Coroico	m 91.5 W0PD \$ v +M	40 84
Fajardo	g 96.5 W0UQ-FM	18 51
Fort Allen	90.5 *AFCH	4 12
Guayama	m 106.9 W0FF-FM \$	9 33
Hormigueros	L 94.1 W0JF \$	8 33
Isabela	m 101.5 W0SA \$	5 29
Louisville	c 92.1 W0ZL \$	8 33
Manati	m 96.9 W0LD	5 35
Maguez	L 94.1 W0FE \$ v	48 94
	c m 94.1 W0EL-FM	41 86
	L 95.7 W10A \$	3+ 78
	+L 94.1 W0BE-FM \$	7 28
E tr	107.1 W0HAF \$ W24	101.5t
Fonce	m 93.3 W0FE-FM \$	9 31
	E tr 107.5 W24R \$ v +M	49 95
	L 105.1 W10G	+7 6 22
Quebradillas	91.3 W0E1	5 17
Race, AFB	90.5 *AFCH	3 5
Rio Piedras	m 95.7 W10D \$ v	+5 38 80
Roosevelt Rosos	rk 90.5 *AFCH	8 20
	c 94.5 *AFCH	2 9
Salinas	94.5 *AFCH	2 9
San German	L 96.1 W0PC \$ v	+ 48 94
San Juan	91.7 W0TU v	38 60
	c 90.5 *AFCH	8 20
	c 91.3 W0PR-FM \$ v P	65 119
	E m 93.7 W0RA \$ v	25 65
	E m 96.5 W0PA \$ v	+3 27 79
	L 94.9 W10G \$ v	+1 20 58
	r 102.5 W1AG-FM \$ v	+1 31 75

**New Brunswick**

Golden	101.7 CBXE v	2 8
Hope	105.1 CBUE	2 7
Houston	102.1 CBUR-FM	18 53
Inverness	107.1 CFWL	30 70
Kanloops	94.1 CBYK v	18 53
	k 98.3 CFFH	19 53
Kelsova	95.7 CBTK v	34 75
	m 104.7 CJOV \$	33 71
Kitimat	101.1 CBUK v	2 7
Lytton	k 102.3 CFFNFM3	
Merritt	k 103.9 CFFNFM3	10 40
Mt. Timothy	k 99.7 CFFNFM5	15 49
Nez Westminster	rn 101.1 CFB1 \$ v	40 82
	93.3 CBTP v	20 54
	nr 97.1 CKOK-FM3	20 54
Savona	k 101.9 CFFNFM1	1 4
Smithers	97.5 CBRS-FM	11 39
Trail	106.7 CBTA v	38 80
Vancouver	n 96.1	
	F cn 97.7 CBUF \$	52 99
	p 94.3 CKLG-FM3	31 75
	102.7 *CFRO v	21 56
	bj 103.5 CHQM-FM5 v	52 99
	cn 105.7 CBU-FM \$	52 99
Vanderhoop	n 96.1	4 17
Vernon	105.5 CBVW v	17 50
Victoria	mc 98.5 CFFS \$ v +M	28 66
Williams Lake	k 97.5 CFFNFM	
Woss	92.9 CBTW	14 45

**CANADA (MAPS PP. 50-53)**

[Because of incomplete data, coverages are not indicated for some of Canada's FM stations. A few stations, located at remote sites, such as logging camps and hydro stations, are not shown on the maps. Geographic coordinates not supplied for those stations as the FM Atlas deadline approached.]

**Alberta [AT]**

banff	n 97.1 CJAY-FM-1	
Calgary	92.1 CFVP	
	c 93.7 *CHUA-FM1 \$ v	35 77
	m 95.9 CHFM \$ v	35 77
	c 102.1 CBR-FM \$ v	45 91
	n 103.1 CJAY	
F	103.9 CBFF v	32 70
Canora	97.9 CBRC	2 7
Chateau	103.5	
Edmonton	c 94.9 CHUA-FM1 v	34 75
	k 97.3 CJCA-FM1 v	34 75
	m 100.3 CFAN-FM1 v	34 75
	n 105.9	
Exshaw	100.7	
Fox Lake	95.9	
Grande Prairie	c 100.9 *CF AFN1 \$ v	42 87
	102.5	
Jean D'Or	102.5	
Lethbridge	c 99.3 *CF CAFM2 \$ v	35 79
	100.1 *CBPX	38 82
	m 100.9 CHEC-FM v I	20 58
	104.3 CHFA-1 v	16 47
Manning	100.5	
Medicine Hat	c 97.3 *CF JAFM3 \$ v	40 84
Peace River	F 92.5	
	93.9 CBXK v	2 16
	96.9 CHUA-FM1 v	38 82
Fincher Creek	97.5 CBPP	2 6
Reo Deer	m 96.9 CFRD-FM \$	10 38
	102.5	
	F 103.5	

**British Columbia [BC]**

Alert Bay	101.1 CBR1-FM v	2 7
Bonington	92.3 CBUD	2 6
Burns Lake	95.1 CBXB-FM	1b 47
Cache Creek	95.3 CFFNFM	
Canal Flats	97.3	11 38
Chilliwack	F c 102.1 CBUFFM1 \$ v	8 34
Clearwater	k 92.7 CFFNFM2	4 23
Clinton	k 106.5 CFFNFM4	8 36
Crawford Bay	99.7 v	2 6
Dawson Creek	93.7 CBXG v	6 23

**Manitoba [MB]**

Baldy Mountain	105.3 CBKW v	46 93
Brandon	mk 96.1 CJCW \$	42 86
	97.9 CGWV v	40 84
Easterville	95.5 CBWE v	3 12
Fairford	104.3 CBWZ v	17 51
Fisher Branch	95.7 CBRX v	18 53
Flin Flon	F 99.9 CBRM v	5 21
God's Lake Narrows	95.9 CBRN v	7 29
Grand Rapids	101.5 CBWH v	6 26
Ilford	94.7 CBWS v	4 16
Jacobshead	92.7 CBWY v	30 69
Leaf Rapids	94.5 CBWF v	5 23
Manigotagan	101.5 CBWA v	7 28
Moos Lake	99.9 CBWC v	4 17
Nelson House	93.7 CBWO v	3 13
Oxford House	95.5 CBWV v	3 15
Snow Lake	95.5 CBRV v	6 25
South Indian Lake		
	95.5 CBXK v	5 21
Split Lake	95.5 CBWU v	2 6
The Pas	F 93.7 CBGN v	4 17
	94.5 CBWJ v	4 18
Thompson	F 99.9 CBTF v	6 23
Waagagoach	105.1 CBWD v	8 33
Winnipeg	mc 92.1 CRY-FM \$ v	50 105
	p 94.3 CHIG \$	
	fe 97.5 CHMS \$	34 89
	c 98.3 CBW-FM \$	44 96
	n 99.1	
	rc 101.5 CJUN \$	11 39

**New Brunswick [NB]**

Fredericton	101.5 CBZ-FM \$	
	F cn 102.3 CBZF v	48 97
Grand Manan	103.7 CBZA v	11 38
Horton	m 103.9 CFQM \$	



**Saskatchewan [SA] (MAP P. 51)**

Beauval	101.5 CBKB	v	17	44	
Buffalo Narrows					
	103.5 CBKD	v	11	39	
Fond du Lac	100.1 CBKG	v	7	29	
Green Lake	94.9 CHGL	v	2	7	
Ile a La Crosse					
	105.1 CBKC	v	10	37	
La Loche	95.5 CBKE	v	3	15	
La Ronge	105.9 CBKA	v	4	18	
Pinehouse Lake	94.1				
Regina	n 92.1 CFMO	\$			
	n 94.5				
	96.9 CBK-FM	\$v	37	80	
	F 89.7 CBKF	\$	v	26	63
Saskatoon					
	c 89.7 CJUS	\$	v	11	40
	n 103.9 CFMC	\$	v	11	40
Stanley Mission	95.5				
Stony Rapids	93.3	v	16	47	

**MEXICO (MAP P. 54)**

Acapulco, Gro.	93.7 XHPA				
	96.9 XHNS				
	m 100.1 XHSE	\$v			
Chihuahua, Ch.	90.1 XHUA		56	108	
	m 106.1 XHSU	v	4	13	
Ciudad Acunz., Coa.					
	95.5 XHRG	v	11	40	
	L 99.7 XHPL	v	6	25	
Ciudad Camargo, Ch.					
	106.5		32	72	
Ciudad Juarez, Ch.					
	n 98.3 XHPX	\$v	5	18	
	L 103.5 XHEM	\$v	20	55	
	mL 104.3 XHTO	\$v	+M	7	22
	Lk 105.1 XHIM	\$v	3	12	
	105.9 XHGH	v	4	17	
	107.5 XHNZ		56	108	
Ciudad Mante, Tam.					
	r 91.9 XHRLM				
Ciudad Victoria, Tam.					
	101.7		56	108	
Cordoba, Ver.	91.9 XHPT				
Cuernavaca, Mor.	88.5 XHCM				
	ne 95.7 XHCT				
	E 96.5 XHLM	\$			
	96.1 XHNG				
	n 105.9 XHTB				
Ensenda, BCN	101.1 XHAT		32	72	
Guadalajara, Jal.					
	r 89.1 XHRA				
	mL 91.3 XHJL	\$			
	L 92.3 XHCD	\$			
	mL 93.9 XHSC	\$v			
	rm 95.5 XHRD	\$v			
	ac 96.3 XEJB-FM	\$			

	L 97.1 XEBA-FM	\$v			
	n 97.9 XETIAFM	\$v			
	mL 98.7 XHLC	\$			
	rn 99.5 XHLS	\$v			
	r 100.3 XEAV-FM	v			
	Lk 101.1 XHBA				
	Lr 101.9 XEAD-FM	\$			
	E r 102.7 XEHL-FM	\$v			
	104.3				
Hermosillo, So.	93.9 XHMV		56	108	
	100.3		32	72	
Irapuato, GTO	n 93.5 XHNY				
	95.1 XHHH				
Ixmiquilpan, Hgo.					
	c 96.5 XHD				
Jalapa, Ver.	96.9 XHTZ				
Leon, Gto.	92.3 XHOI				
	L 98.3 XHLG				
	m 99.9 XHSD	\$			
Martinez de La Torre					
	mL 104.5 XEHU-FM				
Matamoros, Ta.	97.7 XEEW-FM		32	72	
	m 101.5 XHMLS	\$v	12	40	
	105.9 XHNA		15	45	
Merida, Yuc.	mL 97.7 XHGL	\$			
Mexicali, BCN	89.9 XHFE	v	7	27	
	91.5 XHJC	v	12	42	
	92.3 XHMPP	v	16	51	
	m 101.9 XHPF	\$v	14	46	
	rm 103.3 XHVG	\$v	13	44	
	104.9 XHYC	v	9	34	
Mexico, DF	n 88.9 XHM	\$v			
	rL 89.7 XEBS-FM				
	nr 90.5 XEDA-FM				
	91.3 XHDK	\$			
	m 92.1 XHFO				
	L 92.9 XEG-FM				
	mL 93.7 XEJP-FM				
	m 95.3 XHSH	\$			
	c 96.1 XEUN-FM				
	r 96.9 XEWF-FM	\$v			
	nr 97.7 XERC-FM				
	c 98.5 XELA-FM				
	m 99.3 XHPOP				
	Lk 100.1 XHMM				
	E r 100.9 XEDY-FM	\$			
	L 101.7 XEX-FM	\$			
	m 132.5 XHV				
	r 103.3 XERP-FM				
	104.1 XEDF-FM	\$			
	E m 104.9 XHBST	\$v			
	m 105.7 XHDF				
	Lm 106.5 XHDFM	\$			
	nr 107.3 XEGR-FM				
Monclova / Coa.	rL 99.5 XHMS	\$v	3	10	
	107.1		32	72	
Monterrey NL	90.1 XHXL	v	4	15	
	m 92.5 XHSRO	\$v	+M	8	26
	r 93.3 XHDD		18	51	
	nr 94.1 XET-FM	\$v	+M	13	46
	94.9 XHNL	v	6	20	
	96.5 XHRK	3	12		
	n 97.3 XHSR	\$	8	26	
	rm 98.1 XHRL	\$v	6	22	
	E n 98.9 XHJD	\$v	5	17	
	nr 99.7 XHSP	\$v	5	17	
	m 100.5 XHMG	\$v	5	18	
	101.3 XHJL	v	5	17	
	102.1		56	108	
	103.7		56	108	
	104.5 XHMF		56	108	

	106.1				
	106.9 XHPJ	v	4	12	
	r 107.7 XHMN		32	72	
Morelia, Mic.	93.9 XHKO				
	98.7 XHKW	\$			
Nogales, Son.	102.7 XHOT	\$v	5	18	
Nuevo Laredo, Tam.					
	94.1 XHNO	\$v	6	26	
	99.3 XHMK	\$v	8	30	
Nogales, Son.	m 103.5 XHRZ	\$v	4	15	
	106.7 XHSN		56	108	
Nuevo Laredo, Ta.					
	100.3 XHMM		16	47	
	102.3 XHMT		15	45	
Piedras Negras /Coa.	94.5 XHTA		7	26	
	99.1 XHSL	v	7	28	
	99.9 XHSG	v	5	24	
	102.5		16	47	
	m 105.5 XHPE	\$v	8	30	
	106.3 XHNE		32	72	
Puebla, Pue.	89.3 XHHP	\$v			
	rm 92.5 XHZH	\$			
	Lj 93.3 XHRH				
	Lm 94.1 XHJE				
Reynosa, Ta.	95.3 XHRT		13	43	
	103.3 XHRY	v	15	46	
Sabinas, Coa.	L 91.9 XHEC	v	9	36	
Saltillo "rL	94.7 XHRP	\$v	5	16	
	100.9 XHSA		15	45	
San Luis, So.	106.3		32	72	
San Luis Potosi, SLP					
	mL 96.1 XHOB	\$			
	mc 96.9 XHOD				
	98.5 XHQR				
	99.3 XHTL	\$			
	m 100.1 XHPM	\$			
Tampico, Tam.	m 95.3 XHOX	\$v			
	96.1 XHON				
	96.9 XHMG				
	99.3 XHRW				
	m 100.1 XHVA	\$			
Tepic, Nay.	97.7 XHIF	\$v			
Tijuana, BCN	90.3 XHIS	\$v	M	36	89
	EE n 91.1 XETRAF		42	87	
	EE Lr 92.5 XHRM	\$v	23	60	
	94.5 XHTY		9	34	
	L 95.7 XHOS	\$v	14	44	
	m 98.9 XHDF	\$v	10	37	
	102.5		7	27	
	L 104.5 XHERS	\$v	M	36	77
	L 107.3 XHGF	\$v	27	63	
Toluca, Mex. n	98.9 XHNX				
	99.7 XHDA				
	100.5 XHRJ				
	101.3 XHZA				
Torreón, Coa.m	97.1 XHPE	\$			
Veracruz, Ver.	94.1 XHOF				
	96.5 XHRN				
	m 99.7 XHPB	\$			
	L 101.3 XHPV				
	m 102.1 XHVE	\$v			
	L 102.9 XHTS	\$			
Villahermosa, Tab.					
	96.5 XHOP				

**BAHAMAS (MAP P. 54)**

Nassau	107.1 ZNS-FM1			
	s 107.9 ZNS-FM2			

**BERMUDA (MAP P. 54)**

Hamilton	ra 89.1 ZBM-FM	\$v	+M	18	54
	m 94.9 ZFB-FM	\$v		17	50

(Continues p. 110)

# STATION DIRECTORY

Part II: FM Stations Listed by Frequency. Canada and the United States only (excluding United States' territories, and excluding ten-watt educational stations, FM translators, and Canadian stations with less than 250 watts of effective radiated power). Where no separate vertical power is given, it is the same as the station's horizontal radiated power. Stations with permission to identify with more than one city are indicated, as are stations using a slogan or short phrase in lieu of call letters. See "Key to Symbols," page 14.

## 88.1 201-Educational

CA Fresno	KFCF	1940	390
CA Long Beach	KLON	\$ 430	1200v P
CT Middletown	WESU	\$ -48	1900 U
CT Monroe	WMNR	\$ 200	600v
IL Lockport	WLRA	95	250v
IN Elkhart	WVPE	400	10000v P
IN New Albany	WNAS	3	2850v
IA Des Moines	KDPS	285	5200
MI Plymouth	WSDP	73	200
MO Columbia	XCOU	\$ 110	430
NY Brockville	WCWP	190	100h 94v

NC Asheville	WUMF-FM	-140	11000v
NC Raleigh	WKNC	\$ 240	2900v I
OH Akron			



OH Bowling Green	WBGU	110	1350 U
SC Sumter	WMPR	\$1000	98000v P
TN Nashville	WRFN	6	700
TX Lubbock	KXTX	340	18500v A
WY Riverton	KCWC	145	3000v

## 88.3 202-Educational

CA San Diego	KSOS	170	830 A
IL Downers Grove	WGCG	130	2500 U
IH Angola	WEAX	150	200v

**IA KCCK-FM**  
Kirkwood Community College  
Box 2068

Cedar Rapids, Iowa 52406

Cedar Rapids	KCCK	\$ 420	10000v P
MD Elkton	WDEL	260	3000v
MA Boxford	WMTT	19	710

**MI WIAA-FM**  
National Music Camp  
Interlochen, MI 49643

Interlochen	WIAA	\$ 350	115000v P
MI Southfield	WSHJ	\$ 43	125v
NJ Newark	WBGO	220	20000 P
NM Albuquerque	KLYT	\$4000	1800
NY Loudonville	WVCR	860	360
NY Syracuse	WAER	\$ 180	6000v U
NC Bowling Springs			
	WGNG	220	4700v U
OH Berea	WBWC	\$ 59	1450
OH Cincinnati	WJVS #	100	175v
OH Cincinnati	WAIF #	\$ 390	1600
OH Marietta	WMRT	205	9200v
SD Brookings	KESD	\$ 610	38000vPS 17500v



**KSUC**  
88 FM

KEENE, TEXAS 76059

TX Keene	KSUC	235	1850v
WI Menomonie	WVWC	\$1050	10000v P

## 88.5 203-Educational

CA Northridge	KCSN	-235	3000v P
CA San Francisco	KGEQ-FM	\$1270	110000v P
CO Boulder	KGWU	215	1300v

## WAMU-FM

The American University  
Washington, D.C. 20016  
Tel. (202) 686-2690

Washington	WAMU	\$ 500	50000v P
FL Tampa	WIND	680	45000
GA Atlanta	WRAS	\$ 366	19400
MA Amherst	WFCR	\$ 720	35000vP
MN Minneapolis	KBEH	\$ 370	2150v
MO Kansas City	KLJC	177	10000v
MO Rolla			



100 KW 88.5 FM

G-6 Library  
Rolla, Mo. 65401  
(314) 341-4386

KUMR	\$ 480	100000v P	
NY Rochester	WRUR	\$ 120	970 U
NC Winston-Salem	WFOD	\$ 410	35000 P
ND Belcourt	KEYA	\$ 360	19000v P
OH Oxford	WNUB	\$ 260	820 PU
OH Youngstown	WYSU	\$ 110	22500 P
OR Gresham	MHMD	880	7500v
PA Wilkes-Barre	WRKC	-470	440v I
TN Memphis	WDOX	\$ 507	2150v
TX Denton	KNTU	125	440v
TX El Paso	KTEP	\$ 730	94000vP1
WA Tacoma	KPLU	\$ 130	40000
WV Charleston	WVPH	230	50000v

## 88.7 204-Educational

ON Windsor	CJOM	\$ 269	84000v
CA Claremont	KSPC	\$-265	3000v
CT West Haven	WHU	150	1700v
FL Boynton Beach	WRMB	479	50000
IL Champaign	WPCD	290	3300v
IL Edwardsville	WSIE	\$ 500	500000vPU
IN Gary	WGVE	91	2100
NV Reno	KUMR	-450	2000
NJ New Brunswick	WRSU	\$ 125	1350v
NY Buffalo	WBFO	\$ 230	770v P
NY Hempstead	KVHC	180	470h 110v
OH Batavia	WCNE	190	3500

OH University Heights	WUJC	\$ 340	750v A
TX Austin	KAZI	1120	130v
TX Fort Worth	KTCU	\$ 125	3000v
TX Houston FM-88	KUHF	\$ 970	27000v
VA Portsmouth	WHS	115	300
WI Madison	WERN	\$ 900	25000v P
WI River Falls	WRFW	\$ 82	3000v

## 88.9 205 - Educational

CA Los Angeles	KXLU	\$ 0	2900
CA Santa Cruz	KUSP	\$25.10	860v
CT Hartford	WJMJ	580	7200h
	U (directional)		7100v
FL Miami	WONA	710	2300v
IL Lake Forest	WPKM	109	300
IN Notre Dame	WNSO	\$ 360	3400v
KY Richmond	WKU	\$ 720	50000v P
MD Baltimore	WEAA	\$ 220	12500v P
MA Boston	WERS	740	895
MO Jefferson City	KLUM	255	41000v P
NC Raleigh	WSHA	115	12500v
OH Jefferson	WLMB	220	1600v
OH Wilberforce	WXSU	\$ 178	220 PU
PA Philadelphia	WXPB	\$ 280	1900 AY
PA Selingsgrove	WOSU	620	5580 U
SC Rock Hill	WPRV	\$ 600	97000v P



1002 American National Bank Building  
736 Market Street  
Chattanooga, Tennessee 37402

TN Chattanooga	WMBW	1270	100000v U
TX Commerce	KETR	\$ 245	7100v P
UT Provo	KBYU	\$2910	32000vPU
WV Buckhannon	WVPW	\$ 840	14000 P
WI La Crosse	WLSU	540	8300 P
WI Milwaukee	WYMS	870	1500

## 89.1 206-Educational

PO Quebec	CKRL	\$ 225	1400v
CA Redlands	KUOR	-500	700
CA Santa Rosa	KBBF	2770	420v P
IL Mount Carmel	WUJC	\$ 330	50000v
IL Naperville	WONC	98	3900
IL Normal	WGLT	\$ 140	2300v
IN Fort Wayne	WIPI	120	4000v
KS Wichita	KXWU	\$ 140	10000 P
MI Ypsilanti	WEMU	\$ 150	16000v U
MO St. Charles	KCLC	240	1500
MT Missoula	KUFM	2510	18400v P
HJ Teaneck	WFDU #	\$ 500	550v
NM Albuquerque	KANN	-11	7500
NY New York	WNYU #	\$ 255	8300v
NY Schenectady	WMTT-FM	\$ 915	11000v P
OH Akron	WAPS	44	1300
TN Nashville	WHAZ	120	500v I
TN Olivehill	WONX	250	1500
VA Roanoke	WVKR	\$1970	100000v P



WOL FM  
ADPTE 15HDDU NO  
P.O. BOX 10  
JERSEY CITY, NJ 07310

**CJRT-FM**

KUT  
90.7 

10 Moscow	KUID	\$1000	1050v
ID South Bend	WEIL	105	1320
IA Iowa City	KSUI	\$1310	1000000 P
D null to the north			92000v
MI Alpena	WCLM-FM	\$1170	100000v UP

### WUOM ANN ARBOR

91.7 MHz:

MI Ann Arbor	RUOM	\$ 470	230000 P
MN Grand Rapids	KJXE	\$ 460	100000 P
MN Rushford	KLSE	\$ 590	100000 P
MN Worthington-Marshall			
KRSR		\$ 800	99000 P
MO Point Lookout	KSOZ	185	25000 P
NY Ithaca	WICB	\$ 105	5500v E
OH Cincinnati	WYUU	\$ 680	6400v
OH Greenville	WGVO	96	78v
OK Goodwell	KPSU	120	380
OK Stillwater	KOSU	\$ 440	100000v P
PA Clarion	WCUC	320	2300
PA Philadelphia	KXDU #	220	30v
PA Philadelphia	WPAT #	10	17v
TN Memphis	WSMN	160	165v
TX Dallas	VYTT	790	100000v
TX Houston	KTRU	\$ 155	340
TX San Antonio	YRTU	\$ 120	140
WA Tacoma	KTDY	310	38000 P
WV Beckley	WVPB	\$ 920	100000 P
WI Milwaukee	KSUN	185	1300v

### 91.9 220-Educational

OH Kingston	CFRC-FM	100	1270
AR Jonesboro	NASU	\$ 510	100000v F
CA San Bernardino			
KVCR		-320	24500 P
CA Santa Barbara	KCSB	\$2910	1650 A
GA Atlanta	WCLN	340	54
IL Carbondale	WSIU	\$ 300	50000v P
IL Springfield	KSSR	\$ 500	50000v P
IN Huntington	WVSH	110	920
IN Lafayette	WJEF	91	250
KS Great Bend	KBJC	210	1400
KY Louisville	WFPK	\$ 235	100000v P
ME Orono	WMEB	\$ 67	375
MO Tacoma Park	WGTS	\$ 165	29500 P
MA Springfield	WATC	66	230 P
MA Williamstown	WCFM	\$-750	440 P
MT Bozeman	KGLT	\$ 185	2000v
NE Wayne	WNSC	96	320
NJ Hackettstown	WNTE	510	5000
NY Lake Ronkonkoma			
WSHR		\$ 145	1850
ND Fargo	KDSU	\$ 125	1260 P
OH Wooster	WQWS	43	390
OH Eugene	KRVN	28	1900v
PA California	WVCS	160	3000v

### WUOT-FM

An Affiliate of National Public Radio			
TN Knoxville	WUOT	\$ 590	100000v P
WA Yakima		920	18500v
KY Laramie	KUWR	1150	5000v

### 92.1 221 A

AT Calgary	CFVP	\$ 74000	
MB Winnipeg	CRY-FM	\$ 790	360000v
NF Bonaville			28580
ON Brantford	KXPC-FM	\$ 385	50000v
ON Timmins	CFTI	417	17200v
SA Regina	CFMQ	\$ 100000	
AL Cullman	WKLN	\$ 201	3000
AL Fairhope	WGOK-FM	\$ 300	3000v Z

AL Hamilton	WEPH-FM	165	3000v
AZ Bisbee	KBAB	1950	60v
AR Fayetteville	KHEG	\$ 190	3000v A
CA Escondido	KORN-FM	\$ 155	3000v M
CA Madera	KUUL	\$ 185	3000v M
CA Walnut Creek	KDFM	\$ 89	3000
CO Castle Rock	KMJD	300	3000v
CO La Junta	KBLJ	\$ 300	3000v A
CO Salida	KVRH-FM	-1120	2350v
FL Hialeah	WCMO-FM	\$ 280	3000v
FL Macclenny	WBRK	300	3000v
FL Venice	WABR-FM	285	2750v
FL West Palm Beach			
WWRN		\$ 270	3000v
GA Carrollton			
Music 92	WBTR	\$ 105	3000v Y
GA Dawson	WDWD-FM	\$ 228	3000v E
GA Eastman	WUFF-FM	370	2000v
GA Elberton	WWRK	\$ 300	3000v U
GA Louisville	WPEH-FM	300	3000v
GA Jackson	WJGA-FM	\$ 440	1200v
IL Charleston	WEIC-FM	\$ 142	2200 M
IL Freeport	WACI	\$ 300	3000v
IL Keawee	WJRE	\$ 300	3000v Y
IN Muncie	*WBST	300	3000v
IN Rochester	WRDI	\$ 101	3000v
IA Fort Dodge	KTGA	310	2750v
IA Iowa-Pella			
KTAV		300	3000v I
KY Morehead	WKQR-FM	-20	2800
KY Pikeville	WDHR	\$ 300	3000v
KY Tompkinsville	WKY-FM	240	3000 P
LA Winnfield	WVCL-FM	120	2750
ME Sanford	WSEK-FM	\$ 530	800v
MD Oakland	WNSG-FM	687	427v
MI Bad Axe	WLEW-FM	235	3000v
MI Dowagiac	WDCW-FM	\$ 300	3000v U
MI Grand Haven	WFNG	\$ 240	3000
MI Harrison	WRRM	300	3000 E
MI Hillsdale	WCSR-FM	\$ 241	3000v
MI St. Johns	WBPJ-FM	\$ 126	3000
MI Traverse City	WCCM-FM	\$ 464	1072v
MI Pine City	WMP-FM	290	3000v
MI Wescos	KQGE	\$ 300	3000v U
MS Brookhaven	WBRD	\$ 286	3000v
MS Yazoo City	WJMS	\$ 300	3000
MO Butler	KNDZ	150	3000v
MO Sedalia	KCBW	\$ 280	3000v Y
NE Alliance	KFAH	300	3000v
NH Peterborough	WSLE	\$1120	140v
NJ Vineland V-92	WDVL-FM	250	3000v
NM Carlsbad	KBAD-FM	165	3000
NY Baldwinville	WSEN-FM	300	3000v I
NY Sag Harbor	WLDG-FM	350	2100v M
NY Walton	WDLA-FM	660	490v U
NC Jacksonville	WRXC	220	3000v
NC Morganton	WQXX	145	3000
NC Rocky Mount	WJLY	\$ 300	3000v
OH Bellevue	WNRW	150	1800v A
OH Middleport	WMPD-FM	\$ 370	1900v E
OH Kapakapona	WERM	150	3000
OK Ardmore	FRRO	\$ 210	3000v
OK Broken Arrow	KGOW	\$ 300	3000v E
PA Ellwood City			
C-92 WFEM		\$ 300	3000v M

**wFMm Stereo 92**  
 Serving Southwestern Pennsylvania  
 634 Main Street  
 Johnstown, PA 15901  
 PA Johnstown WFMN \$1000 175v

PA Lock Haven	WBPZ-FM	266	3000v MU
[Upton]			940v
PA Mercersburg-	WRCV	\$ 295	3000v
PA Nanticoke	WJUN	550	670v A
PA Palmyra	WCIX	\$ 100	3000v A
SC Batesburg	WBLR-FM	300	3000v U
SC Manning	WTWE	\$ 300	3000v
SC Myrtle Beach	WMYB-FM	\$ 300	3000v A
SD Huron	KJLV-FM	185	3000v
TH Hendersonville	WKBY	300	3000
TX Alice	KOPY-FM	300	3000v
TX College Station			
WTAW-FM		\$ 275	3000
TX Livingston	KETX-FM	370	1850v
TX Nacogdoches	KSTAF	\$ 370	1900v
TX New Braunfels	KRBT	\$ 300	3000v E
TX Sonora	KVRN-FM	28	3000v
TX Stamford		175	3000v
TX Tyler	KROZ	275	3000v
VA Chester	WDYL	300	3000v
WY Hayward	WRLS	\$ 300	3000v I
WI Manitowoc	WRRB	\$ 165	3000v S
			2700v
WI Mauston	WRJC-FM	\$ 350	1800v M
WI Menomonie	WYFM	\$ 145	3000 U
WI Racine	WFIY	\$ 270	3000v
WI Sun Prairie	WYXE	\$ 300	3000v Y

### 92.3 222 B/C

WI Corner Brook			30000
AL Montgomery	WKLN	\$ 760	25000v A
AZ Glendale-Phoenix			
KXTC		\$ 287	100000v A
AR Pine Bluff	KOTN-FM	\$ 115	27000
CA Eureka	KPDJ	230	100000v
CA Los Angeles	KFAC-FM	\$2910	39000v M



**KSJO**  
FM/SAN JOSE

CA San Jose	KSJO	\$-68	50000v
CO Grand Junction	WEX-FM	\$-42	30000
CO Greeley	WGRE	\$ 470	25000v
FL Orlando	\$-92	1000v-FM	\$1320 80000v
HI Waipahu	KULA	\$1630	100000v
ID Boise Rock-92	KBBK	\$2500	44000v A
IL Bloomington	WGTC	\$1090	37000v U
IL Hammond FX-92	WYCA	\$ 380	30000v I
IA Delwin	KDEL-FM	\$ 370	100000v A
KS Newton	KDEZ	\$ 350	100000h
			62500v
LA Laplace	WCPN	\$ 440	51000v I
MD Baltimore	WLPL	\$ 390	20000
MI Detroit	WCAW-FM	\$ 480	10000 S
MI Ishpeming	WJPD-FM	\$ 470	100000v M
MO St. Louis	WIL-FM	\$ 510	97000v
NE Omaha	KEZO	\$1210	85000v
NV Las Vegas	KEND-FM	\$ 180	27000v I
			9200v
NM Albuquerque	KRST	\$4110	22000v
NY New York			5400h
			FM-92
NY Troy	WFLY	\$ 850	13000v
NC Asheville	WQSE	\$ 650	20000
OH Cleveland Heights			
Disco-92	WLYT	\$ 245	27000
OH Columbus	WCOL-FM	\$ 310	50000v
OR Portland	KGON	\$ 920	100000
PA Warren	WRRH	\$ 410	26000v U
RI Providence	WPRO-FM	\$ 550	39000v
TN Chattanooga			
FM-92	WDEF-FM	870	97000v



89.3 207-Educational

AL Huntsville	WLRH	\$ 810	100000v P
CA Berkeley	KPFB	-100	1500
CA Fresno	KVPR	\$ 500	50000v P
CA Pasadena	KPCS	\$-510	3800v P
CT Hartford	WRIC	63	350
DC Washington	WPFM	\$ 410	50000v
FL Pensacola	KPCS	\$ 520	100000v A
FL Titusville	WPIO	115	1600
GA Atlanta	WRFG	295	1250v
ID Moscow	KUOI	\$ -95	45v
IL East Moline	WOLM-FM	500	100000v
IL Evanson	WNUR	\$ 130	7200v
KY Louisville	WFPL	\$ 235	100000v P
MA Amherst	WAMH	\$ 720	150v
MI Spring Arbor			
	FM-89 WSAE	240	3100v I
MN Northfield	WCAL-FM	\$ 400	100000v P
MO Kansas City	KCUR	\$ 820	100000v P
NY Binghamton	WSKG-FM	\$ 530	43000v P
NY Central Square			
	WCSQ	81	1500
NY Geneseo	WGSU	11	1800
NC Chapel Hill			
	X-89 XNYC	\$ 280	400v
ND Grand Forks	KFJM-FM	\$ 220	38000v P
OH Reading	WRJC	125	330
PA Pittsburgh	WQED-FM	\$ 500	43000v P
SC Charleston	WSCI	\$ 540	100000v P
SC Clemson	WSBF	185	5100 P
TN Memphis	WLYX	\$ 195	2750v
TX Dallas	KCBI	\$ 660	1500v

89.7 209-Educational

SA Saskatoon	CJUS	\$ 152	3900
CA Los Altos	KFJC	\$1390	108
CA Riverside	KLLU	\$ 73	1405 I
FL Miami	WMCU	\$ 840	100000v M
FL Tampa-St. Petersburg			
	WUSF	\$ 820	85000v P
IN Terre Haute	WTSU	370	10500v
MO Toason	WCVT	400	1850v
MA Boston	WGBH	\$ 650	98000v P
MO Rolla	KMNR	232	303
NJ Glassboro	WGLS	82	440
NM Ranah	KTDB	330	2600v P
NY Geneva	WEDS	\$ -8	1500v
NC Raleigh	WCEP	\$ 255	12500v P
OH Columbus	WOSU-FM	\$ 470	50000v P
OH Kent	WKSU	\$ 320	7500vPY
OH Eugene	KLCC	850	9200 P
SC Columbia	WMMK	420	100000v
SD Vermillion	KUSD-FM	\$ 520	50000vPU
			21500v
TN Chattanooga	WOYN	820	62000
TX Denton	KGCC	\$ 275	28500
WI Madison	WORT	105	4000



National Public Radio

89.9 210-Educational

ON Windsor		\$ 100000	
CA Angwin	KANG	\$ 847	20000v A
			14000v
CA Santa Monica	KCRW	-110	28500v P
FL Jacksonville			
	Stereo-90 WJCT-FM	\$ 460	70000v P
IL Peoria	WCBU	\$ 260	115000vP
KY Madisonville	WSOF	\$ 300	15000v U
LA New Orleans	WNHO	\$ 600	11500v P
NY New York	WCR	\$1380	760v



NY Ossego	WRVO	\$ 430	24000vPU
NC Davidson	WDAY	300	18500v
PA Erie	WERG	-125	3000v
PA Scranton-Wilkes Barre-Hazleton			
	WVIA-FM	\$1250	5000v P
PA State College	WTLR	450	10000v
SC Beaufort		\$1100	47000v P
TX Amarillo	KACV	\$ 585	29500v
NV Huntington	WHPW	1200	8000v
WI Brule	WHSB	\$ 551	38000v P
WI Stevens Point	WSP	67	300

90.1 211-Educational

AL Huntsville	WDCG	230	25000v
AL Troy	WTSU	\$ 285	50000v
CA Buena Park	KBPK	9	19v
CA San Luis Obispo			
	KCBX	\$1410	3600v
CA Stanford	KZSU	\$-13	500v U
CO Denver	KCFR	\$ 910	26500v P
DC Washington	WGIB	\$ 440	6700v
GA Atlanta	WABE	\$ 140	30000v P
IL Chicago	WMBI-FM	\$ 440	100000v U
			50000v

WIAN 90.1 FM

IN Indianapolis	WIAN	560	10000v P
-----------------	------	-----	----------

IA Ames	WOI-FM	\$1490	100000v P
KS Hutchinson	KHCC	57	83
ME Portland	WMEA	\$1920	49000v P
MI Marquette	WMMU	\$ 930	100000v P
MN Collegeville	KSJR	\$ 850	100000v P
MN Thief River Falls			
	KAVS	\$ 82	1800
MS Senatobia	WNJC	\$ 390	18000v P
NM Albuquerque	KUMS	\$4070	8700v U
NY Hamilton	WRGU	140	1550v U
NY Stony Brook	WUSB	\$ 225	4000v
			3800v D
NC Bules Creek	WCCE	\$ 105	3000
NC Roanoke Rapids			
	KPGT	84	860v M
OK Edmond	KCSC	\$ 235	28500
OR Ashland	XSOR	\$1340	1950v A
PA Philadelphia	WRTI	\$ 400	890v I
SC Greenville-Anderson			
	WEPR	\$1100	97000v P
SD Aberdeen	KASD	\$ 43	970
TX Dallas-ft. Worth			
	KERA-FM	\$1260	100000v P
TX Houston	KPFT	\$ 440	100000v
TX Nacogdoches	KSAU	116	1000
TX San Antonio	KSYM	110	800 Y
UT Cedar City	KCDR	-890	265
UT Salt Lake City	KXUV	\$2900	22500v P
VT Burlington	WRUR	\$ 145	460 I
WA Pasco	KOLU	-67	3900v

90.3 212-Educational

AL Birmingham	WBHM	\$ 795	50000v P
CA Davis	KDVS	\$ 150	5000v
CA San Francisco	KUSF	300	2850v D
CT Westport	WVPT	110	330v
FL Fort Lauderdale			
	WAFG	\$ 280	3000v
IN Fort Wayne	WBCL	\$ 265	50000v U
IA Sioux City	KNIT	\$ 920	100000v
KY Morehead	WKMY	\$ 510	50000v P
MA Newton	WZBC	220	1000v I
MO Buffalo	KBFL	\$ 245	4300v P
NY Albany	WAPC	\$ 1920	10000v P
NY Garden City	WBAU #	155	390v
NY Garden City	WHPC #	155	390v
NC Durham	KAFR	\$ 150	3000v
OH Cedarville	WCDR	\$ 370	3000 U
OH Cleveland	WBOE	\$ 500	50000v P
PA Lancaster	WPTG	\$ 88	1050v
PA Meadville	WARC	\$ 79	33 P
RI Kingston	WRIU	267	3000v
TN Nashville	WPLN	\$ 295	100000 P
WI La Crosse	WHLA	\$1010	57000v P
WI Oshkosh	WRST	\$ 125	950v

90.5 213-Educational

NS Halifax		711	100000 D
AZ Tucson	KUAT-FM	\$3580	125000vUP
AR Little Rock	KLRE	265	3600v
CA Concord	KVHS	\$ 450	410v
CO Colorado Springs			
	KEPC	\$-180	3700v
CT Middlefield			
	W178	5180	2500
GA Athens	WUOG	\$ 145	3200 A
KY Louisville	WUOL	\$ 581	35000v P



90.5 FM University of Louisville

MD Williantport	WCRH	\$ 27	7500v
-----------------	------	-------	-------

KAOS  
89.3 fm Radio

The Evergreen State College. CAB 305A Olympia, Wa. 98505

89.5 208-Educational

CA Moraga	KSMC	95	55
CA San Diego	KPBS	\$1820	2000v P
CA San Francisco	KPOS	410	245
CO Pueblo	KTSC	165	9800v
CT Bridgeport	WPKN	\$ 550	10000v E
IL DeKalb	WNIU	\$ 250	50000v P
IN N. Manchester	WBKE	80	3000
IA Cedar Falls	KHKE	\$ 410	8000v P
MI Mount Pleasant			
	WCMU	\$ 420	100000vUP
MO Columbia	KOPN	\$ 200	40000
NJ South Orange	WSDU	\$ 370	2000v I
OH Hamilton	WKSS	285	190v
OK Tulsa	KWGS	\$ 580	5400v
PA Herstey	W1TF-FM	\$ 820	15000v P

WETS - FM RADIO

BOX 21400 A

EAST TENNESSEE STATE UNIVERSITY  
JOHNSON CITY, TENNESSEE 37601

TN Johnson City	WETS	\$2200	70000v P
TN Murfreesboro	WN01	\$ 238	50000vPI
TX Austin	KMFA	\$ 878	1320
VT Windsor	WVPR	\$160	1250v
VA Norfolk	WTGN	\$ 630	23000v P
WA Seattle	KHHC	\$ 320	880





IL Champaign	WLRR	\$ 400	43000v E
IA Fort Dodge	KKEZ	\$ 600	50000v
KS Junction City			
FR-94	KJCK-FM	\$ 630	100000v S
KS Scott City	KULL	\$ 350	100000 S
KY Lexington	WLAP-FM	\$ 279	50000v
LA Lafayette	KSMO	\$ 350	50000v Y
LA Shreveport	KROK	\$ 320	100000v C
MA Boston	WCOZ	\$ 1140	6700v
MI Holland	WJBL-FM	\$ 500	10000v U
MI Mount Pleasant	WCEH-FM	\$ 230	16000 M
MN St. Paul			
KS-95	KSTP-FM	\$ 1220	95000v
MO Kirksville	KRXL	\$ 410	42000v I
MO Poplar Bluff	KPBM	\$ 115	16000 M
MT Great Falls	KNUR	\$ 470	36000v I
NJ Trenton	WCHR	238	50000v
NM Gallup	KODD	\$ 70	25000 I
NY Buffalo	*WHD-FM	\$ 710	105000v
NY Syracuse	WSYR-FM	\$ 480	100000
NC Eden	WEAF	\$ 96	27000v M
ND Bismarck	KODY	\$ 680	100000v A
OH Port Clinton	KPKR	\$ 165	6700
OR Eugene	KBMC	767	3400
PA Lancaster	WDAC	\$ 500	50000v

# WPEZ

PA Pittsburgh	WPEZ	\$ 610	14000v Y
SC Greenville	WNLU-FM	\$ 1200	100000v S
TX Garrettsville	KCAF-FM	\$ 370	100000v C
TX Harlingen	KEJL	\$ 127	100000v
TX Houston	KLEF	\$ 540	100000v
TX Lubbock	KLBB-FM	\$ 677	100000 Y
UT Logan	KVRJ	\$ 480	25000v
VA Richmond G-94	KRVO	\$ 355	200000v U
WA Yakima	KIT-FM	\$ 910	25000 A
WI Milwaukee			
I-94	WXTI	\$ 910	56000 A
WI Casper	KAWY	\$ 125	35000

## 94.7 234 B/C

CA Los Angeles	KMEI	\$ 2835	58000v S
CO Boulder	KBVL	\$ 180	30000
DE Dover	WDSO	\$ 360	50000v M
HI Honolulu	KLMU-FM	\$ 140	60000v
IL Chicago	WDAI	\$ 1170	6000v A
IN Indianapolis	WFBO	\$ 850	52000v A
KY Mayfield D-94	WXTD	\$ 160	18000v
MD Bethesda-Washington	DC		
NRD		\$ 760	21000v
MA Springfield	WRAS-FM	\$ 170	22000v
MI Birmingham			
Magic	WUJC	\$ 950	10000v

**STEREO SOUL 94**  
**wkxi**

MS Jackson	WXXI	\$ 430	68000v B
MO Crestwood-St. Louis			
KSHF		\$ 510	100000v
MO Springfield	KTIS-FM	\$ 615	100000v
NV Carson City-Reno			
KNIS		\$ 2150	29500v
NJ Newark	KFME	\$ 570	36000v

## ND Grand Forks

Y-95	KYTN	\$ 235	100000
OH Columbus	WKQD-FM	220	52100 Z
OK Oklahoma City	KEBC	\$ 440	100000v E
TX El Paso	KSET-FM	\$ 740	91000v M
TX San Angelo	KIXY-FM	\$ 139	38700

**94.9 235 B/C**

AT Edmonton	*CKUA-FM	\$ 479	64000vD	
NS Sydney	CJCB-FM	210	61000	
ON Oshawa	CKGS	\$ 474	50000v	
PQ Hull-Ottawa	ON			
[Country-95]	CJMF	\$ 1077	74000v	
AL Mobile /	WPJ-FM	\$ 410	100000v I	
AZ Tucson	KAIR-FM	\$ 190	25000v	
AR Pine Bluff	KADL-FM	\$ 145	25000v M	
CA San Diego	KLRO	\$ 1850	1900v	
CA San Francisco	KSAN	\$ 1210	30000v	
CA Tulare	KBOS	\$ 2650	770v	
FL Miami Beach				
Zeta-4	WJZ-FM	\$ 600	100000v	
FL Tallahassee	WLRV	\$ 210	51000	
FL Tampa	I-95	WYHF	\$ 390	100000v A
GA Atlanta	WPCB	\$ 1170	99000v	
IO Nampa-Boise				
XDFM	KFXD-FM	\$ 2520	46000v	
ID Pocatello	KSIH	\$ 1000	73000v U	
IL Galesburg	WAGG	\$ 353	50000v	
IL Mount Carmel	WYER-FM	\$ 410	37000 EU	
IA Des Moines	KGGG	\$ 307	100000v	
MA West Yarmouth	WDCB-FM	\$ 245	50000 E	
MI East Lansing	WVIC-FM	\$ 500	13500v Y	
MN Duluth				

# KAOH

95 FM RADIO AM 14

K-O-95 KAOH-FM \$ 400 25000

MO Kansas City	KCEZ	\$ 1060	97000v	
MT Missoula	KYSS-FM	\$ 2500	30000v I	
NH Mount Washington				
WHDH		\$ 3820	48000v	
NM Aztec	FR-95	KWYK-FM	\$ 430	30000v
NW Roswell	KBIM-FM	\$ 1880	100000v	
OH Fairfield-Cincinnati				
WLVV		\$ 490	50000v	
OH Medina	WDBN	\$ 410	118000v S	
SD Harrisburg	WMSF	\$ 204	50000v	
SA Aberdeen	KGAA	1280	100000v	
TN Greenville	WCFM	\$ 320	100000v	
TX Arlington	KWJS	\$ 670	100000v U	
TX Laredo	KDYE	\$ 810	100000v	
UT Cedar City	KBRE-FM	\$ 1680	25500v I	
UT Provo	KRMQ	\$ 640	25000v	
VA Roanoke	WPVR	\$ 1910	50000v M	
WA Seattle	*KUDK	730	86000 P	
WI Baraboo-Madison				
WLVV		\$ 1300	37000v	

## 95.1 236 B/C

OH Chatham	CBEE	35500	
OH North Bay	CBJN	\$ 477	100900v
AL Huntsville	WIDA	\$ 1120	50000v M
AZ Yuma	KALJ	\$ 76	25000

## AR Mammoth Spring

KAMS		97	75000	
CA Chico	KPAY-FM	\$ 1170	6000 Y	
CA San Bernardino				
KQLH		\$ 320	15000v	
CA Ventura-Oxnard				
KBBY		\$ 79	28000v H	
CO Colorado Springs				
KROO-FM		\$ 2010	96000v M	
CT Brookfield				
I-95	WRKI	\$ 470	50000v	
FL Jacksonville	KJAX-FM	\$ 457	100000v Y	
HI Wailuku	FM-95	KAOI	\$ 1230	50000v
IL Decatur	WQZQ	\$ 500	50000v	
IN Fort Wayne	WPTH	\$ 680	44000v	
KS Wichita	KICT	\$ 440	100000v	
KY Glasgow	WGGC	\$ 390	100000v U	
MD Baltimore	KRBS	\$ 260	50000v	
			35000v U	
MI Flint	*WFBE	\$ 115	3700 P	

**KWOA Radio** AM 730  
FM 95.1  
WORTHINGTON, MINNESOTA

MN Worthington	KROA-FM	\$ 650	100000v U
MS Natchez			
Rock-95	KQKZ	\$ 370	99000 A
NJ Atlantic City	WAYV	\$ 300	20000v A
NY Bristol Center			
WBIV		\$ 930	9500v U
NC Charlotte			
G-95	WROU	\$ 570	100000v
NC Kinston	KRNS	\$ 265	100000v
PA Bethlehem-Allentown			
Z-95	WCLZV	\$ 630	11000v A
PA Chambersburg	WIEZ	\$ 240	2800
PA Grove City	WEDA	200	8700 U
SC Charleston			
Soul-95	WPXI	\$ 420	100000v
TX Beaumont	KIEE	\$ 220	30000 I
TX Victoria	KCNM	\$ 450	57000v
WI Kenosha	WJZO	\$ 260	11000v
WI Marinette			
FR-95	WLST	\$ 430	100000v U
WV Parkersburg	WXIL	\$ 500	50000v

## 95.3 237 A

OH Hamilton	CKDS	\$ 1000	100000v
PQ Quebec	CBV-FM	\$ 541	100000v
AL Prattville	WQHR	\$ 230	3000v
AL Roanoke	WELR-FM	318	2500v
			1250v
AL Thomasville	WJUB-FM	300	3000v
AZ Douglas	KAPR-FM	45	3000
CA Los Gatos	KRYE	\$ 860	370v
CA Mount Shasta	KEDY	-1300	3000v
CA Pismo Beach	KFGA	\$ 389	1680v E
CA Vacaville-Fairfield			
KLIC		\$ 205	2650
FL Apopka	WTLH-FM	300	3000v Y
FL Fort Myers	WSOR	170	3000v
IL Centralia	WRXX	\$ 215	3000v
IL Ottawa	KREX	\$ 165	3000v
IL Pekin	KSIV-FM	89	2800v
IL Rantoul	WRTL-FM	\$ 275	3000v
IL Winnebago-Rockford			
WYF		\$ 510	1000v
IN Monticello	WVIL	135	3000 E
IN Paoli	WVAK-FM	300	3000v
IA Independence	KOUR-FM	200	3000v
IA Iowa Falls	KIFG-FM	170	3000v

LOVE  
STEREO  
94.9





IA Webster City KWCF-FM \$ 195 3000v E  
 KS Derby K-96 KDRB \$ 300 3000v  
 KS Pittsfield KRSL-FM 294 3000  
 KY Maysville WFTM-FM 300 3000h

KY Stanford WRSL-FM 85 3000v  
 LA Winnsboro KMAR-FM 170 3000v  
 MD Glen Burnie

Z-96 WBKZ \$ 300 / 2550v E  
 MD Williamsport WYII \$ 300 3000v N  
 MA Marshfield WATD 245 3000v  
 MA Pittsfield WRPE-FM 560 710v  
 MI Three Rivers WLKM-FM \$ 290 3000v M  
 MN Faribault KDHL-FM 280 3000v M  
 MN Forest Lake 300 3000v  
 MS Batesville WBLE-FM 153 3000v  
 MO Bethany 300 3000v  
 MO Mansfield KTRI 205 3000v  
 MO Monett KXBL 270 3000v  
 MO Salem KETU \$ 165 3000v  
 MT Hamilton KLYQ-FM -790 2000v  
 MT Lewiston KLCM-FM \$-230 3000v  
 NJ Point Pleasant WADB \$ 155 3000v  
 NY Dundee WFLR-FM 460 930v  
 NY Glens Falls WYLR 919 240v E  
 NY Liberty WYOS-FM \$ 520 800v S  
 NY Rome FM-96 WKAL-FM \$ 105 3000v M  
 NC Morehead City WMBL-FM \$ 280 3000v  
 NC Plymouth 330 2600v  
 OH Archbold WHFD \$ 300 3000v U  
 OH New Philadelphia  
 OH Upper Sandusky  
 Y-96 WYAN \$ 271 3000v

OK Sallisaw KRBB-FM 245 3000v  
 PA Lewiston WRRF-FM 55 2790  
 PA Sharpsville WFAF-FM 300 3000v  
 SC Aiken WLOF-FM \$ 200 3000v E  
 TN Lawrenceburg WDXE-FM 205 3000  
 TN Livingston WLIV-FM 155 3000  
 TN Morristown WAZI \$ 770 460v  
 TX Dalhart KXIT-FM 170 750  
 TX Kilgore KKTX 510 850v  
 TX Mineral Wells KWMT \$ 296 3000v  
 TX Port Lavaca KGUL-FM \$ 175 3000v S  
 WV Princeton WACY-FM \$ 286 3000  
 WI Ashland WATW-FM 155 3000 E  
 WI Durand WRDN-FM 500 930v  
 WI La Crosse WSPL \$ 900 235v S  
 WI Minocqua WWHI 155 3000v U



Ripon, Wisconsin

WI Ripon WCWC-FM 300 3000v U

96.1 241 B/C

BC Vancouver  
 MB Brandon CJCH \$1042 55000  
 ON North Bay CBCN 477 100000v  
 AL Mobile FM-96 WLPR \$ 480 100000  
 AZ Tucson KCEE-FM \$ 77 25500  
 AR Blytheville KHLS \$ 450 100000v E  
 CA Sacramento KCTC \$ 520 45000v I  
 CA San Luis Obispo

KUNA \$1410 5600v  
 KFKZ FM  
 Ninth Street at 11th Avenue  
 Greeley, Colorado 80631

100,000 STEREO WATTS FM

CO Greeley KFKZ \$ 660 100000v M  
 FL Jacksonville WKTZ-FM \$ 830 90000v  
 GA Atlanta  
 96-Rock WKLS \$ 930 100000v  
 ID Idaho Falls KID-FM \$1500 100000v C  
 IN Richmond WOLK \$ 350 28000v U  
 IA Clinton-Fulton IL  
 KSAY 360 10000 U  
 KY Owensboro WSTO \$ 340 100000v A  
 LA Lake Charles KSNS \$ 430 100000v A  
 ME Presque Isle 1258 100000v  
 MA Worcester WSRW \$ 640 25000v  
 MI Bay City-Saginaw  
 WHNN \$ 360 97000v  
 MI Holland WHTC-FM \$ 295 41000v M  
 NE Crookston KINI 500 57000v  
 NE Omaha KEFM \$ 275 100000h  
 98000v  
 NY Buffalo WBNY \$ 480 50000v  
 NC Raleigh WYYD \$ 930 98000v  
 NC Shelby WSHS-FM 440 2600v M  
 OK Oklahoma City KXXY \$ 255 100000v  
 OR Eugene KZEL \$ 870 100000v U  
 OR Ontario KXHQ 409 27000h  
 3000v  
 PA Easton WLEV \$ 500 50000v C  
 PA

**96 KX FM**  
 \*96-KX\*

Pittsburgh WXXX \$ 500 50000v U  
 PA Red Lion WGCB-FM \$ 500 50000v A  
 SD Watertown  
 Kix-96 KIXX \$ 290 100000v  
 TX Harlingen KIXW \$ 445 100000v  
 TX San Antonio KMFM \$ 135 60000  
 UT Provo K-96 KAYK-FM \$2630 38000v  
 WA Opportunity KZUM-FM \$2380 56000v Y  
 WV Charleston WBES \$ 310 50000v

96.3 242 B/C

NF Baytown 31330  
 ON Kingston CFMK \$ 500 2700v  
 CA Eureka KFMJ \$1580 29600h  
 27900v  
 CA Los Angeles KFSG \$ 480 54000v U  
 CA Mariposa KUBB \$2080 1100v  
 DC Washington WHUR \$ 670 24000v  
 FL Miami 96-X WMJX \$ 790 98000v  
 GA Albany WJIZ 470 100000v Z  
 HI Kailua KKAI 2123 25000  
 IL Chicago FM-96

**WBBM-FM**  
 THE MELLOW SOUND

WBBM-FM \$1170 6000v C  
 ME Rumford WRUM-FM \$ 36 30000v  
 MI Detroit WJR-FM \$ 480 50000v  
 MS Jackson WJFR \$1415 80000v  
 MO St. Louis KD KADI-FM \$ 200 100000v A  
 MT Shelby KZIN 570 29000v  
 NM Albuquerque KHFM \$4130 2150v  
 5400h  
 NY New York WQXR-FM \$1220 3800v  
 OH Columbus  
 OFM-96 WLVO \$ 550 40000v  
 TN Murfreesboro WMTS-FM \$ 170 20000v  
 TX El Paso KEZB \$1390 88000v  
 TX Fort Worth KSCS \$1680 99000v

TX Lubbock KLLL-FM \$ 540 54000v  
 VA Martinsville WVA-FM \$ 600 100000v N  
 WI Rice Lake WJMC-FM \$ 540 12000v M

96.5 243 B/C

ON Penetanguishene  
 CIBC-20 15300  
 51000  
 PQ Rouyn-Noranda  
 PQ St. Fabien-de-Panet  
 CBFD-FM 455 832v  
 AL Birmingham WQEZ \$ 690 100000v M  
 CA Bakersfield KHIS-FM \$ 500 50000v S  
 CA San Diego KXXY \$ 540 30000v  
 CA San Francisco  
 FM-96 KOIT \$1410 33000v  
 CO Colorado Springs  
 KXFM \$2300 23000  
 CT Hartford WITC-FM \$ 810 15000v N  
 FL Orlando WHOO-FM \$ 460 98000v N

WJCL fm 96:

GA Savannah WJCL-FM \$1160 100000v I  
 ID Twin Falls KMTW \$ 130 100000v  
 IN Lafayette  
 Z-96 WAZY-FM \$ 500 50000v Y-  
 IA Cedar Rapids WMT-FM \$ 540 50000 C  
 LA Shreveport KEPT \$ 250 100000 E  
 MO Kansas City KXTR \$ 670 90000v  
 MT Glendive KIVE \$ 30 100000v U  
 NE Grand Island KRGI-FM \$ 420 100000v E  
 NY Rochester WCMF \$ 290 20000v  
 NC Laurinburg-Fayetteville  
 WSTS \$ 600 100000v

OH Akron 96-KD WKDD \$ 440 50000v  
 OH Hamilton  
 Stereo-96 WLWS \$ 430 50000v A  
 OK Tulsa FM-96 KRAV \$ 380 97000v  
 PA Johnstown WJNL-FM 490 50000v C  
 PA Montrose WPFL-FM \$ 500 57000v S  
 PA Philadelphia WJDB \$ 850 18000v M  
 SD Sioux Falls \*KNWC-FM \$ 265 100000v U  
 TN Chattanooga 100000h  
 Stereo-96 WDDO-FM \$1080/ 88000v  
 TX Corpus Christi KIOU \$ 670 97000v  
 TX Houston

FM-96 KAUM \$ 560 100000 A  
 VA Williamsburg WBCI \$ 430 50000v M  
 WA Seattle

\*Kicks\* KYYX \$1090 50000v Z  
 WV Williamson WXCX 823 14200  
 WI Milwaukee WFMR \$ 320 50000v  
 WY Rock Springs KQSW \$1620 98800v  
 WI Sheridan KRYO-FM -13 25000v I

96.7 244 A

ON Kitchener CKGL \$ 658 24000v  
 PQ Saguenay CHUT \$ 440 256000  
 AR De Witt XDEW-FM 145 3000  
 AR Heber Springs KAWW-FM -140 3000v I  
 AR Hot Springs  
 K-97 KSPA 320 2600  
 CA Paradise KNVR \$ 285 3000v  
 CA Redlands KCAL-FM 300 3000v  
 CA Santa Ana KPZ-FM \$ 210 3000v  
 CA Santa Paula KAAP-FM 1500 87v I  
 CO Steamboat Springs  
 KBCR-FM \$1880 70v  
 CO Sterling KSTC-FM 504 940v  
 CT Stamford WYRS 280 3000 A

96.7

FL Jupiter	WRYZ-FM	\$ 300	3000v	H
GA Cochran	WVMG-FM	220	3000	
GA Newnan	WCOH-FM	380	1700v	
ID Lewiston	KOZE-FM	\$-631	900	
IL Joliet	WLLI	\$ 300	3000v	
IL Loves Park	WLUV-FM	\$ 235	3000v	E
IL Normal	W1HN	\$ 300	3000v	
IN Bloomington	WBWB	300	3000v	
IN La Porte	WCOE	265	3000	E
IN Madison	WDRX-FM	230	3000	
IN Vincennes	WAOV-FM	110	2900	
KS Larned	KANS-FM	288	910	
KS McPherson	KNEK-FM	\$ 245	3000v	
KY Bowling Green	WLBJ-FM	180	3000v	H
KY Paris	WBRG-FM	105	3000v	E
KY Somerset	WSEK	215	3000v	A
LA Morgan City	KMRC-FM	\$ 255	2450h 580v	
LA Oak Grove	KDDI	\$ 300	3000h 1500v	H
MD Easton	WEMD-FM	245	3000v	
MD Halfway	97-Q WOCM	\$ 165	3000v	A
MI Albion	WUFN	\$ 460	1200v	
MI Cadillac	W1TW	\$ 430	1350v	
MI Petoskey	WMBN-FM	\$ 320	1000v	H
MI Grand Rapids				

Kix-96 KXGR \$ 390 1700v Y 100v

**KWWW**

**96.7 STEREO FM**

"Quick"

MI Rochester	KWWW	\$ 295	3000v	
MS Columbia	WFFF	\$ 100	3000	U
MS Gulfport				
Stereo-97	WGUF-FM	\$ 260	3000v	H
MS Pontotoc	WSEL-FM	300	3000	H
MS Winona	WONA-FM	230	2500v	
MO Columbia	KTGC	300	2900	H
MT Belgrade	KGVM-FM	\$ 205	3000v	
NY Canton	WLSU	\$ 320	2600v	P
NY Port Jervis	WDLG-FM	\$ 300	3000v	
NC Franklin	WFSC-FM	\$-327	3000	I
NC Roxboro	WRRX	300	3000v	
ND Devils Lake	WDLR-FM	164	3000	H
OH Cambridge	WILE-FM	\$ 420	1300v	
OH Celina	WCSM-FM	123	3000	I
OH Fostoria	WFOB-FM	190	3000v	
OH Wellston	WKOV-FM	\$ 100	3000v	U
OK Idabel	KWOG	300	3000v	
PA Danville	WPGM-FM	\$ 760	340	S
PA State College	WQAK	\$ 920	250v	Y
SC Cayce	WZLD	\$ 300	3000v	A
SC Greenwood	WCRS-FM	390	1600v	H
TN Bolivar	WVST	300	3000v	I
TN Centerville	W1KA	300	3000	
TN Georgetown	WGTN-FM	290	3000v	
TX Marlin	FLMT	200	1250v	U
TX Mineola	KPMD-FM	300	3000v	
TX Sherman	K1XZ-FM	\$ 265	3000	
TX Sweetwater	K10X-FM	58	2600v	
VT Brattleboro	W1SA-FM	\$ 170	3000v	U
VT Montpelier	W1NC	\$ 709	400v	
VA Orange	W1MA-FM	340	2150v	
WA Sunnyside	W1FE-FM	\$-1	3000	
VA Ranelle	WRFL-FM	460	1150v	
WI Oshkosh	W1XC	\$ 295	3000v	A
WI Sauk City-Prairie du Sac				
WYLR		\$ 300	3000	

96.9 245 B/C

AT Peacu River	*CKUA-FM	\$ 550	100000v	
NF Red Rocks			1120	
PE Charlottetown	CBC-FM	825	93500v	
PQ Sept Isles			15000	
PQ Verdun	CKDI	\$ 712	307000v	
SA Regina	*CBC-FM	*CBK-FM	\$ 501	100000v
AL Decatur-Huntsville				
Stereo 97	WRSR	\$ 830	100000v	
AL Enterprise	WIRB-FM	\$ 295	100000v	I
AZ Phoenix	KMEO-FM	\$1560	100000v	
CA Monterey-Salinas				
CA Sacramento	KWAV	\$2570	18000v	A
FL Fort Myers	W1NK-FM	\$ 251	44000	
FL Jacksonville	W1V1	\$ 420	100000v	
ID Nampa	KUJZ	\$2520	44000v	
IL Mattoon	WLBH-FM	\$ 500	50000v	
IL Moline	WHTT	\$ 500	50000v	U
IL Zion-Kenosha	W1		10000h	U
(null to south)	WKSX-FM	\$ 500	\$ 8100v	D
IA Clarion	KRIT	200	93000v	H
KS Pittsburg	KMRJ	\$ 390	100000v	C
KY Paducah				

**WPAD FM ROCK 97**

Rock-97	WPAD-FM	\$ 337	70000	C
LA Alexandria	KSLI	\$ 850	100000v	
ME Presque Isle-Caribou				
WDHP		\$ 440	100000v	
MA Boston	W1JB	\$1010	8700v	
MI Grand Rapids	WLAV-FM	\$ 500	50000v	
NE Seward	KSRD	\$ 580	100000v	
NJ Atlantic City	W1FG-FM	\$ 300	50000v	C
NH Farmington	KRAZ	\$ 300	30000	
NY Buffalo				
QFM-97	WGRQ	\$ 890	12500v	A
NY Utica	WOUR	\$ 790	16000v	A
NC Goldsboro	WEOR	\$ 320	50000v	
NC Statesville	W000	\$ 340	3600	Y
OK Enid	KXND	\$ 185	76000v	A
PA Braddock				
FM-97	WFFM	\$ 520	60000v	
PA Lancaster	WLAN-FM	\$ 76	50000v	A
SC Charleston				
FM-97	W1XC	\$ 780	100000v	
SD Garden City	KDLO-FM	\$1280	100000	U
TX El Campo	KULP-FM	180	26800	
TX McAllen	KWVW	225	100000v	
TX Odessa	KG1P	\$ 195	1660	
VA Bristol	W1FG-FM	260	10000v	D
WY Jackson	KMTN	\$ 940	48000v	

97.1 246 B/C

BC Penticon	CKOK-FM	\$ 755	1800	
ON Belleville	CJBO-FM	\$	50000	
OH Sudbury	CBCS	367	50000v	
AR Camden	KWEH	\$ 185	35000v	H
CA Los Angeles	KGBS	\$ 770	59000v	N

METROMEDIA RADIO

**WASH 97.1**

DC Washington	WASH	\$ 690	22500v	S
GA Gainesville				
Fox-97	W1FX	\$ 540	97000v	U
HI Hilo	W1FSH	-240	28400v	
IL Chicago	W1NB	\$1190	850v	
IN Shelbyville	W1VL-FM	\$ 295	34000	

LA New Orleans	WEZB	\$ 450	93000v	
ME Bangor	WBGW	\$1230	50000v	E
MI Detroit	FM-97 W1WJ-FM	\$ 920	12500v	

**WKZY**

kozy-97.1m stereo

MI Escanaba	WKZY	\$1070	90000	U
MI Minneapolis	KTCR-FM	\$ 150	50000v	H
MS Meridian	WALT	\$ 380	100000v	A
MO Florissant	KSCF	\$ 500	50000v	
MT Billings	KURL-FM	\$-30	15900	
MT Kalispell	KALS	-195	70000h	I
MT Kalispell	KALS		30000v	
NV Las Vegas	KORK-FM	\$ 195	44000	
NW Roswell	KRY-FM	235	25000	
NY New York	Y-97			

**WYNY 97.1 FM**

30 Rockefeller Plaza New York, N.Y. 10020

NY New York	Y-97	\$1300	4600v	N
NC Greensboro	WQMG	\$ 560	20000v	U
ND Minot	KCJF-FM	\$ 840	65000	
OH Ashtabula	WREO-FM	\$ 500	50000v	
OH Columbus	WBNS-FM	\$ 660	26000v	I
OR Portland	KPAM-FM	\$1000	100000v	Y
TN Memphis	K-97 WRRK	\$ 1300	100000v	
TX Fort Worth-Dallas				
Z-97	FLJZ-FM	\$1460	98000v	
UT Salt Lake City	KLUB-FM	\$3650	13000v	
VT Rutland	WRUT	\$2580	830v	N
WA Walla Walla	XSXT	\$1340	50000v	
WI Sparta	WCOV-FM	\$ 360	47000h 23000v	

97.3 247 B/C

AT Edmonton	CJCA-FM	\$ 479	64000v	D
AT Medicine Hat	*CKUA-FM	\$ 727	100000v	
NF Baie Verte	CBTB		5850	
PQ Lac au Saunon	CBGS	688	915v	
PQ Lithium Mines			52000	
CA San Diego	KSON-FM	\$ 215	50000v	I
CA San Francisco	KEAR	\$1100	82000v	
CO Boulder	KBCO	\$-750	2000	
FL Miami	W1A1	\$ 800	98000v	
GA Bainbridge	W1AD	\$ 140	28600	H
GA Savannah	W1XM	\$ 470	100000v	
IL Carat	WRUL	\$ 210	11000	
IN Fort Wayne	W1EF	\$ 510	48000v	
IA Des Moines				
FM-97	WDMI	\$ 450	115000v	H
KS Garden City	KBUF-FM	230	25000v	I
KS Topeka				
Rock-97	W1BW-FM	\$1220	97000v	C
MA New Bedford	W1FD	285	50000v	
MO Springfield	W1FC	\$ 480	100000v	A
NV Carson City	K1BC	\$2240	51800v 31000v	Y
NJ Millville	W1VB-FM	165	10000	
NH Santa Fe	K1FE-FM	\$ 85	28000v	C
NY Ithaca	W1CU-FM	\$ 880	26000v	C
NC North Wilkesboro				
W1BC-FM		\$ 980	20000v	
NC Wilmington	W1SL	\$560	100000v	Y
OK Weatherford	K1EY-FM	\$ 400	69000v	
PA Harrisburg	W1PF-FM	\$ 840	14000v	C
SD Sioux Falls	Y1PT	\$ 220	30000v	

IA Webster City KWCF-FM \$ 195 3000v E  
 KS Derby K-96 KDRB \$ 300 3000v  
 KS Russell KRSL-FM 294 3000  
 KY Maysville WFTM-FM 300 3000h

KY Stanford WRSL-FM 85 3000v  
 LA Winnsboro KMAR-FM 170 3000v  
 MD Glen Burnie 3000h

Z-96 WBKZ \$ 300 / 2550v  
 MD Williamsport WYII \$ 300 3000v  
 MA Marshfield WATD 245 3000v  
 MA Pittsfield WRSE-FM 560 710v  
 MI Three Rivers WLKM-FM \$ 290 3000v  
 MN Faribault KDHL-FM 280 3000v  
 MN Forest Lake 300 3000v  
 MS Batesville WBLE-FM 153 3000v  
 MO Bethany 300 3000v  
 MO Mansfield KTRI 205 3000v  
 MO Monett KKBK 270 3000v  
 MO Salem KETU \$ 165 3000v  
 MT Hamilton KLYQ-FM -790 2000v  
 MT Lewiston KLCM-FM \$ 230 3000v  
 NJ Point Pleasant WADB \$ 155 3000v  
 NY Dundee WFLR-FM 460 930v  
 NY Glens Falls WYLR 919 240v E  
 NY Liberty WYOS-FM \$ 520 800v S  
 NY Rome FM-96 WKAL-FM \$ 105 3000v  
 NC Morehead City WMBL-FM \$ 280 3000v  
 NC Plymouth 330 3000v  
 OH Archbold WHFD \$ 300 3000v U  
 OH New Philadelphia

OH Upper Sandusky WNPQ \$ 230 3000v

Y-96 WYAN \$ 271 3000v  
 OK Sallisaw KRBB-FM 245 3000v  
 PA Lewiston WRF-FM 55 2790  
 PA Sharpsville WFAF-FM 300 3000v  
 SC Aiken WLOW-FM \$ 200 3000v E  
 TN Lawrenceburg WDXE-FM 205 3000  
 TN Livingston WLIV-FM 155 3000  
 TN Morristown WAZI \$ 770 460v  
 TX Dalhart KXIT-FM 170 750  
 TX Kilgore KKTX 510 850v  
 TX Mineral Wells KHWT \$ 296 3000v  
 TX Port Lavaca KGUL-FM \$ 175 3000v S  
 WV Princeton WACY-FM \$ 286 3000  
 WI Ashland WATM-FM 155 3000v E  
 WI Durand WRDN-FM 500 930v  
 WI La Crosse WSPL \$ 900 235v S  
 WI Minocqua WWHH 155 3000v U



Ripon, Wisconsin

WI Ripon WCWC-FM 300 3000v U  
 96.1 241 B/C

BC Vancouver  
 MB Brandon CJCM \$1042 55000  
 ON North Bay CBCN 477 100000v  
 AL Mobile FM-96 WLPR \$ 480 100000  
 AZ Tucson KCEE-FM \$ 77 25500  
 AR Blytheville KHLS \$ 450 100000v E  
 CA Sacramento KCTC \$ 520 450000v I  
 CA San Luis Obispo

KUNA \$1410 5600v  
 KFKZ FM  
 Ninth Street at 11th Avenue  
 Greeley, Colorado 80631

100,000 STEREO WATTS FM

CO Greeley KFKZ \$ 660 100000v M  
 FL Jacksonville WKTZ-FM \$ 830 90000v  
 GA Atlanta  
 96-Rock WKLS \$ 930 100000v  
 ID Idaho Falls KID-FM \$1500 100000v C  
 IN Richmond WOLK \$ 350 28000v A  
 IA Clinton-Fulton IL  
 KSAY 360 10000v U  
 KY Owensboro WSTO \$ 340 100000v A  
 LA Lake Charles KSNS \$ 430 100000v A  
 ME Presque Isle 1258 100000v  
 MA Worcester NSRS \$ 640 25000v  
 MI Bay City-Saginaw  
 WHNW \$ 360 97000v  
 MI Holland WHTC-FM \$ 295 41000v M  
 NE Crookston KINI 500 57000v  
 NE Omaha KEFM \$ 275 100000h  
 98000v  
 NY Buffalo WBNY \$ 480 50000v  
 NC Raleigh WYDY \$ 930 98000v  
 NC Shelby WSHS-FM 440 2600v M  
 OK Oklahoma City KXXY \$ 255 100000v U  
 OR Eugene KZEL \$ 870 100000v U  
 OR Ontario KXBD 409 27000h  
 3000v  
 PA Easton WLEV \$ 500 50000v C

**96 KX FM**

"96-KX"  
 Pittsburgh WXXX \$ 500 50000v U  
 PA Red Lion WGCN-FM \$ 500 50000v A  
 SD Watertown  
 Kix-96 KIXX \$ 290 100000v  
 TX Harlingen KIWV \$ 445 100000v  
 TX San Antonio KMFM \$ 135 60000  
 UT Provo K-96 KAYK-FM \$2630 38000v  
 WA Opportunity KZUM-FM \$2380 56000v Y  
 WV Charleston WBES \$ 310 50000v

96.3 242 B/C  
 NF Marystown 31330  
 ON Kingston CFMK \$ 500 2700v  
 CA Eureka KFMI \$1580 29600h  
 27900v  
 CA Los Angeles KFSG \$ 480 54000v U  
 CA Mariposa KUBB \$2080 1100v  
 DC Washington WHUR \$ 670 24000v  
 FL Miami 96-X WJMX \$ 790 98000v  
 GA Albany WJIZ 470 100000v Z  
 HI Kailua KKA1 2123 25000  
 IL Chicago FM-96

**WBBM-FM**  
 THE MELLOW SOUND

WBBM-FM \$1170 6000v C  
 ME Rumford WRUM-FM \$ 36 30000v  
 MI Detroit WJR-FM \$ 480 50000v  
 MS Jackson WJFR \$1415 80000v  
 MO St. Louis KD KADI-FM \$ 200 100000v A  
 MT Shelby KZIN 570 29000v  
 NM Albuquerque KHFM \$4130 2150v  
 5400h  
 NY New York WQXR-FM \$1220 3800v  
 OH Columbus  
 QFM-96 WLVO \$ 550 40000v  
 TN Murfreesboro WMTS-FM \$ 170 20000v  
 TX El Paso KEZB \$1390 88000v  
 TX Fort Worth KSCS \$1680 99000v

TX Lubbock KLLL-FM \$ 540 54000v  
 VA Martinsville WMYA-FM \$ 600 100000v N  
 100000h  
 WI Rice Lake WJMC-FM \$ 540 12000v M

96.5 243 B/C

ON Penetanguishene  
 CIBC-20 15300  
 51000  
 PQ Rouyn-Noranda  
 PQ St. Fabien-de-Panet  
 CBDF-FM 455 832v  
 AL Birmingham WQEZ \$ 890 100000v M  
 CA Bakersfield KHIS-FM \$ 500 50000v S  
 CA San Diego KXXY \$ 540 30000v  
 CA San Francisco  
 FM-96 KOIT \$1410 33000v  
 CO Colorado Springs  
 KRFM \$2300 23000  
 CT Hartford WTCM-FM \$ 810 15000v N  
 FL Orlando WHOO-FM \$ 460 98000v N

**WJCL**  **fm 96:**

GA Savannah WJCL-FM \$1160 100000v I  
 ID Twin Falls KMTW \$ 130 100000v  
 IN Lafayette  
 Z-96 WAZY-FM \$ 500 50000v Y  
 IA Cedar Rapids WMT-FM \$ 540 50000 C  
 LA Shreveport KEPT \$ 250 100000 E  
 MO Kansas City KXTR \$ 670 90000v  
 MT Glendive KIVE \$ 30 100000v U  
 NE Grand Island KRGI-FM \$ 420 100000v E  
 NY Rochester WCHF \$ 290 20000v  
 NC Laurinburg-Fayetteville  
 WSTS \$ 600 100000v  
 OH Akron 96-KD WKOD \$ 440 50000v

OH Hamilton  
 Stereo-96 WLWS \$ 430 50000v A  
 OK Tulsa FM-96 KRAV \$ 380 97000v  
 PA Johnstown WJNL-FM 490 50000v C  
 PA Montrose WPEL-FM \$ 500 57000v S  
 PA Philadelphia WJDB \$ 850 18000v M  
 SD Sioux Falls \*KNWC-FM \$ 265 100000v U  
 TN Chattanooga 100000h  
 Stereo-96 WOOD-FM \$1080/ 88000v  
 TX Corpus Christi K10U \$ 670 97000v  
 TX Houston

FM-96 XAUM \$ 560 100000 A  
 VA Williamsburg WBCI \$ 430 50000v M  
 WA Seattle

"Kicks" KYYX \$1090 50000v Z  
 WV Williamson WXCC 823 14200  
 WI Milwaukee WFMR \$ 320 50000v  
 WY Rock Springs KQSW \$1620 98800v  
 WY Sheridan KMYO-FM -13 25000v I

96.7 244 A

OH Kitchener CKGL \$ 658 24000v  
 PQ Saguenay CHUT \$ 440 25600  
 AR De Witt KDFW-FM 145 3000  
 AR Heber Springs KARW-FM -140 3000v I  
 AR Hot Springs  
 K-97 KPSP 320 2600  
 CA Paradise KNVR \$ 285 3000v  
 CA Redlands KCAL-FM 300 3000v  
 CA Santa Ana KNIZ-FM \$ 210 3000v  
 CA Santa Paula KAAP-FM 1500 87v I  
 CO Steamboat Springs  
 KBCR-FM \$1880 70v  
 CO Sterling KSTC-FM 504 940v  
 CT Stamford WYRS 280 3000 A

96.7  
 FL Jupiter WRYZ-FM \$ 300 3000v M  
 GA Cochran WVMG-FM 220 3000  
 GA Newnan WCOH-FM 380 1700v  
 ID Lewiston KOZE-FM -631 900  
 IL Joliet WLLI \$ 300 3000v  
 IL Loves Park WLVU-FM \$ 235 3000v E  
 IL Normal WJHN \$ 300 3000v  
 IN Bloomington WBBB 300 3000v  
 IN La Porte WCOE 265 3000 E  
 IN Madison WDRX-FM 230 3000  
 IN Vincennes WAOV-FM 110 2900  
 KS Larned KANS-FM 288 910  
 KS McPherson KNEJ-FM \$ 245 3000v  
 KY Bowling Green WLBJ-FM 180 3000v M  
 KY Paris WBRG-FM 105 3000v E  
 KY Somerset WSEK 215 3000v A  
 LA Morgan City KMRC-FM \$ 255 2450h  
 580v  
 LA Oak Grove KDDI \$ 300 3000h M  
 1500v  
 MD Easton WEND-FM 245 3000v  
 MD Halfway 97.0 WQCH \$ 165 3000v A  
 MI Albion WUFN \$ 460 1200v  
 MI Cadillac WITN \$ 430 1350v  
 MI Petoskey WBNB-FM \$ 320 1000v M  
 MN Grand Rapids  
 Kix-96 KXGR \$ 390 1700v Y  
 100v

**KWWK**  
**96.7 STEREO FM**

"Quick"  
 MN Rochester KRWK \$ 295 3000v  
 MS Columbia WFFF \$ 100 3000 U  
 MS Gulfport  
 Stereo-97 WGVU-FM \$ 260 3000v M  
 MS Pontotoc WSEL-FM 300 3000 M  
 MS Winona WQHA-FM 230 2500v  
 MO Columbia KTGC 300 2900 M  
 MT Belgrade KGVW-FM \$ 205 3000v U  
 NY Canton WSLU \$ 320 2600v P  
 NY Port Jervis WDLG-FM \$ 300 3000v  
 NC Franklin WFSM-FM -327 3000 I  
 NC Roxboro WKRX 300 3000v  
 ND Devils Lake KDLR-FM 164 3000 M  
 OH Cambridge WILE-FM \$ 420 1300v  
 OH Celina WCSM-FM 123 3000 I  
 OH Fostoria WFOB-FM 190 3000v  
 OH Wellston WGOV-FM \$ 100 3000v U  
 OK Idabel KWDG 300 3000v  
 PA Danville WPGM-FM \$ 760 340 S  
 PA State College WQAK \$ 920 250v Y  
 SC Cayce WZLD \$ 300 3000v A  
 SC Greenwood WCBS-FM 390 1600v N  
 TN Bolivar WVST 300 3000v I  
 TN Centerville WIKR 300 3000  
 TN Georgetown WGTN-FM 290 3000v  
 TX Marlin KLMT 200 1250v U  
 TX Mineola XMOO-FM 300 3000v  
 TX Sherman XIKM-FM \$ 265 3000  
 TX Sweetwater XPOX-FM 58 2000v  
 VT Brattleboro WTSR-FM \$ 170 3000v M  
 VT Montpelier WACS \$ 700 400v  
 VA Orange WMA-FM 340 2150v  
 WA Sunnyside XREN-FM \$ -1 3000v  
 WI Racine WRPL-FM 460 1150v  
 WI Oshkosh WBYC \$ 295 3000v A  
 WI Sauk City-Fairie du Sac  
 WBLR \$ 300 3000

96.9 245 B/C  
 AT Peace River \*CKUA-FM\$ 550 100000v  
 NF Red Rocks 1120  
 PE Charlottetown CBC-FM 825 93500v  
 PQ Stet Iles 15000  
 PQ Verdun CKOI \$ 712 307000v  
 SA Regina \*CBC-FM \*CBK-FM \$ 501 100000v  
 AL Decatur-Huntsville  
 Stereo 97 WRSA \$ 830 100000v  
 AL Enterprise WIRB-FM \$ 295 100000v I  
 AZ Phoenix KMEQ-FM \$ 1560 100000v  
 CA Monterey-Salinas  
 KXAV \$ 2570 18000v A  
 CA Sacramento KR01 \$ 280 64000v  
 FL Fort Myers WINK-FM \$ 251 44000  
 FL Jacksonville WAIV \$ 420 100000v  
 ID Nampa KUJZ \$ 2520 44000v  
 IL Mattoon WLBH-FM \$ 500 50000v  
 IL Moline WHTT \$ 500 50000v U  
 IL Zion-Kenosha WI 10000h U  
 (null to south) WKSJ-FM \$ 500 / 8100v D  
 IA Clarion KRIT 200 93000 M  
 KS Pittsburg KMRJ \$ 350 100000v C  
 KY Paducah

**WPAD FM ROCK 97**

Hock-97 WPAD-FM \$ 337 70000 C  
 LA Alexandria KSLI \$ 850 100000v  
 ME Presque Isle-Caribou  
 W0HP \$ 440 100000v  
 MA Boston WJIB \$ 1010 8700v  
 MI Grand Rapids WLAJ-FM \$ 500 50000v E  
 NE Seward KSRD \$ 580 100000v  
 NJ Atlantic City WPPG-FM \$ 300 50000v C  
 NH Farmington KRAZ \$ 300 30000  
 NY Buffalo  
 QFM-97 WGRQ \$ 890 12500v A  
 NY Utica WOUR \$ 790 16000v A  
 NC Goldsboro WEGR \$ 320 50000v  
 NC Statesville W000 340 3600 Y  
 OK Enid KRID \$ 185 76000v A  
 PA Braddock  
 FM-97 WFFM \$ 520 60000v  
 PA Lancaster WLAH-FM \$ 76 50000v A  
 SC Charleston  
 FM-97 WXTX \$ 780 100000v  
 SD Garden City WDLO-FM \$ 1280 100000 U  
 TX El Campo KULP-FM 180 26800  
 TX McAllen KMVH 225 100000v  
 TX Odessa KQIP \$ 195 1660  
 VA Bristol WFBG-FM 260 10000v D  
 WY Jackson XMTN \$ 940 48000v

97.1 246 B/C

BC Penticton CCOX-FM \$ 755 1800  
 ON Belleville CJBQ-FM \$ 50000  
 ON Sudbury CBCS 367 50000v  
 AR Camden XWEH \$ 185 39000v M  
 CA Los Angeles KGBS \$ 770 55000v N

METROMEDIA RADIO



DC Washington WASH \$ 690 22500v S  
 GA Gainesville  
 Fox-97 WFOX \$ 540 97000v U  
 HI Hilo XFSH -240 28400v  
 IL Chicago WNIB \$ 1190 650v  
 IN Shelbyville WSLV-FM \$ 255 34000

97.3  
 LA New Orleans WEZB \$ 450 93000v  
 ME Bangor WBGW \$ 1230 50000v E  
 MI Detroit FM-97 WJWJ-FM \$ 920 12500v

**WKZY**  
 kozy-97, fm stereo

MI Escanaba WKZY \$ 1070 90000 U  
 MN Minneapolis KTCR-FM \$ 150 50000v M  
 MS Meridian WALT \$ 380 100000v A  
 MO Florissant XSCF \$ 500 50000v  
 MT Billings KURL-FM \$ -30 15900  
 MT Kalispell XALS -195 70000h I  
 NV Las Vegas KORK-FM \$ 195 44000  
 NY Roswell XRSY-FM 235 25000  
 NY New York Y-97



30 Rockefeller Plaza  
 New York, N.Y. 10020

WYNY \$ 1300 4600v N  
 NC Greensboro W0MG \$ 560 20000v U  
 ND Minot KCJB-FM \$ 840 65000  
 OH Ashtabula WREG-FM \$ 500 50000v  
 OH Columbus WBSN-FM \$ 660 26000v I  
 OR Portland KPM-FM \$ 1000 100000v Y  
 TN Memphis K-97 WHRK \$ 500 100000v  
 TX Fort Worth-Dallas  
 Z-97 KJFZ-FM \$ 1460 98000v  
 UT Salt Lake City KLIB-FM \$ 3650 13000v  
 VT Rutland WRUT \$ 2580 830v N  
 WA Walla Walla KSXT \$ 1340 50000v  
 WI Sparta W0CW-FM \$ 360 47000h  
 23000v

97.3 247 B/C

AT Edmonton CJCA-FM \$ 479 64000v D  
 AI Medicine Hat \*CKUA-FM3 \$ 727 100000v  
 NF Baie Verte CBTB 5850  
 PQ Lac au Saumon CBGS 688 915v  
 PQ Lithium Mines 52000  
 CA San Diego KSON-FM \$ 215 50000v I  
 CA San Francisco KEAR \$ 1100 82000v  
 CO Boulder KBCO \$ 750 2000  
 FL Miami WATA \$ 800 98000v  
 GA Bainbridge WJAD \$ 140 28600 M  
 GA Savannah WXLM \$ 470 100000v  
 IL Carel WRUL \$ 210 11000  
 IN Fort Wayne WMEF \$ 510 48000v  
 IA Des Moines  
 FM-97 KDMI \$ 450 115000v M  
 KS Garden City KEUF-FM 230 25000v I  
 KS Topeka

Rock-97 W1EW-FM \$ 1220 97000v C

MA New Bedford WJFD 285 50000v  
 MD Springfield WKFC \$ 480 100000v A  
 NV Carson City XNBC \$ 2240 51800v Y  
 31000v  
 NJ Millville W0VB-FM 165 10000  
 NM Santa Fe XAFE-FM \$ 86 28000v C  
 NY Ithaca W0CF-FM \$ 880 26000v C  
 NC North Wilkesboro  
 W0BC-FM \$ 980 20000v  
 NC Wilmington W0SL \$ 560 100000v Y  
 OK Weatherford XAEY-FM \$ 400 69000v  
 PA Harrisburg WHP-FM \$ 840 14000v C  
 SD Sioux Falls XPAT \$ 220 30000v

IA Webster City	KQWC-FM	\$ 195	3000v E
KS Derby	K-96 KDRB	\$ 300	3000v
KS Russell	KRSL-FM	294	3000
KY Maysville	WFTM-FM	300	3000h
			470v
KY Stanford	WRSL-FM	85	3000v
LA Winnboro	KMAR-FM	170	3000v M
MD Glen Burnie			3000h
	Z-96 WBKZ	\$ 300	2550v E
MO Williamsport	WYII	\$ 300	3000v N
MA Marshfield	WATD	245	3000v
MA Pittsfield	WFOU-FM	560	710v
MI Three Rivers	WLKM-FM	\$ 290	3000v M
MI Faribault	KDHL-FM	280	3000v M
MI Forest Lake		300	3000v
MS Batesville	WBLE-FM	153	3000v
MO Bethany		200	3000v
MO Mansfield	KTRI	305	3000v
MO Monet	KXBL	270	3000v
MO Salem	KETU	\$ 165	3000v
MT Hamilton	KLYQ-FM	-790	2000v
MT Lewiston	KLCC-FM	\$-230	3000v
NJ Point Pleasant	WADB	\$ 155	3000v
NY Dundee	WFLR-FM	460	930v
NY Glens Falls	WYLR	919	240v E
NY Liberty	WVOS-FM	\$ 520	800v S
NY Rome	FM-96 WKAL-FM	\$ 105	3000v M
NC Morehead City	WMBL-FM	\$ 280	3000v
NC Plymouth		330	2600v
OH Archbold	WHFD	\$ 300	3000v U
OH New Philadelphia			
	WNPQ	\$ 230	3000v
OH Upper Sandusky			
	Y-96 WYAN	\$ 271	3000v
OK Sallisaw	KRBB-FM	245	3000v
PA Lewiston	WRRF-FM	55	2790
PA Sharpsville	WFAR-FM	300	3000v
SC Aiken	WLOW-FM	\$ 200	3000v E
TN Lawrenceburg	WDXE-FM	205	3000
TN Livingston	WLIV-FM	155	3000
TN Morristown	WAZI	\$ 770	460v
TX Dalhart	KXIT-FM	170	750
TX Kilgore	KKTX	510	850v
TX Mineral Wells	KMWT	\$ 296	3000v
TX Port Lavaca	KGUL-FM	\$ 175	3000v S
WV Princeton	WAEY-FM	286	3000
WI Ashland	WATN-FM	155	3000 E
WI Durand	WRDN-FM	500	930v
WI La Crosse	WSPF	\$ 900	235v S
WI Minocqua	WMMH	155	3000v U

CO Greeley	KFKZ	\$ 660	10000v M
FL Jacksonville	WKTZ-FM	\$ 830	9000v
GA Atlanta			
	96-Rock WKLS	\$ 930	10000v
ID Idaho Falls	KID-FM	\$ 1500	10000v C
IN Richmond	WOLX	\$ 350	28000v A
IA Clinton-Fulton	IL		
	KSAY	360	10000v U
KY Owensboro	WSTO	\$ 340	10000v A
LA Lake Charles	KSNS	\$ 430	10000v A
ME Presque Isle		1258	10000v
MA Worcester	WRSR	\$ 640	25000v
MI Bay City-Saginaw			
	WHNN	\$ 360	9700v
MI Holland	WHTC-FM	\$ 295	41000v M
NE Crookston	KIHI	500	5700v
			10000h
NE Omaha	KEFM	\$ 275	9800v
NY Buffalo	WBNY	\$ 480	5000v
NC Raleigh	WYYD	\$ 930	9800v
NC Shelby	WHS-FM	440	2600v M
OK Oklahoma City	KXXY	\$ 255	10000v U
OR Eugene	KZEL	\$ 870	10000v U
OR Ontario	KXBD	409	2700h
PA Easton	NLEV	\$ 500	5000v C
PA			



	"96-KX"		
Pittsburgh	WXXY	\$ 500	50000v U
PA Red Lion	WGB-FM	\$ 500	50000v A
SD Watertown			
	Kix-96 KIXX	\$ 290	10000v
TX Harlingen	KIWW	\$ 445	10000v
TX San Antonio	KMFM	\$ 135	60000
UT Provo	K-96 KAYK-FM	\$ 2630	38000v
WA Opportunity	KZUN-FM	\$ 2380	56000v Y
WV Charleston	WBES	\$ 310	50000v
	96.3 242 B/C		
NF Marystown			31330
ON Kingston	CFMK	\$ 500	2700v
CA Eureka	KFMI	\$ 1580	29600v
			27900v
CA Los Angeles	KFSG	\$ 480	54000v U
CA Mariposa	KUBB	\$ 2080	1100v
DC Washington	WHUR	\$ 670	24000v
FL Miami	96-X WJMX	\$ 790	98000v
GA Albany	WJIZ	470	100000v Z
HI Kailua	KKAI	2123	25000
IL Chicago	FM-96		

**WBBM-FM**

**THE MELLOW SOUND**

	WBBM-FM	\$ 1170	6000v C
ME Rumford	WRUM-FM	\$ 36	30000v
MI Detroit	WJR-FM	\$ 480	50000v
MS Jackson	WJFR	\$ 1415	80000v
MO St. Louis	KD KAD1-FM	\$ 200	100000v A
MT Shelby	KZIN	570	29000v
NM Albuquerque	KXFM	\$ 4130	2150v
NY New York	WQXR-FM	\$ 1220	5400h
			3800v
OH Columbus			
	QFM-96 WLVO	\$ 550	40000v
TN Murfreesboro	WNIS-FM	\$ 170	20000v
TX El Paso	KEZB	\$ 1390	88000v
TX Fort Worth	KSCS	\$ 1680	99000v

TX Lubbock	KLLL-FM	\$ 540	54000v
VA Martinsville	WVVA-FM	\$ 600	100000v N
			100000h
WI Rice Lake	WJMC-FM	\$ 540	12000v M

**96.5 243 B/C**

ON Penetanguishene			
	JCBC-20		15300
PQ Rouyn-Noranda			51000
PQ St. Fabien-de-Panet			
	CBFO-FM	455	832v
AL Birmingham	WQEZ	\$ 890	100000v M
CA Bakersfield	KHIS-FM	\$ 500	50000v S
CA San Diego	KYXY	\$ 540	30000v
CA San Francisco			
	FM-96 KOIT	\$ 1410	33000v
CO Colorado Springs			
	KKFM	\$ 2300	23000
CT Hartford	WTIC-FM	\$ 810	15000v N
FL Orlando	WROO-FM	\$ 460	98000v N



GA Savannah	WJCL-FM	\$ 1160	100000v I
ID Twin Falls	KMTW	\$ 130	100000v
IN Lafayette			
	Z-96 NAZY-FM	\$ 500	50000v Y
IA Cedar Rapids	WMT-FM	\$ 540	50000v C
LA Shreveport	KEPT	\$ 250	10000v E
MO Kansas City	KXTR	\$ 670	90000v
MT Glendive	KIVE	\$ 30	100000v U
NE Grand Island	KRG1-FM	\$ 420	100000v E
NY Rochester	WCMF	\$ 290	20000v
NC Laurinburg-Fayetteville			
	KSTS	\$ 600	100000v
OH Akron	96-KD WDOD	\$ 440	50000v
OH Hamilton			
	Stereo-96 WLWS	\$ 430	50000v A
OK Tulsa	FM-96 KRVA	\$ 380	97000v
PA Johnstown	WJNL-FM	490	50000v C
PA Montrose	WPCL-FM	\$ 500	57000v S
PA Philadelphia	WDOB	\$ 850	18000v M
SD South Falls	*KNWC-FM	\$ 265	100000v U
TN Chattanooga			100000h
	Stereo-96 WDDO-FM	\$ 1080	88000v
TX Corpus Christi	K10U	\$ 670	97000v
TX Houston			
	FM-96 KAUM	\$ 560	100000v A
VA Williamsburg	WBCL	\$ 430	50000v M
WA Seattle			
	"Kicks" KYYX	\$ 1090	50000v Z
WV Williamson	WXCC	823	14200
WI Milwaukee	WFMR	\$ 320	50000v
WY Rock Springs	KQSW	\$ 1620	98800v
WY Sheridan	KWYO-FM	-13	25000v I

**96.7 244 A**

ON Kitchener	CKGL	\$ 658	24000v
PQ Saguenay	CHUT	\$ 440	25600v
AR De Witt	KDCW-FM	145	3000
AR Heber Springs	KAWB-FM	-140	3000v I
AR Hot Springs			
	K-97 KSPA	320	2600
CA Paradise	KNVR	\$ 285	3000v
CA Redlands	KCAL-FM	300	3000v
CA Santa Ana	KW1Z-FM	\$ 210	3000v
CA Santa Paula	KAAP-FM	1500	87v I
CO Steamboat Springs			
	KBCR-FM	\$ 1880	70v
CO Sterling	KSTC-FM	504	940v
CT Stamford	WYRS	280	3000 A



WI Ripon	WCWC-FM	300	3000v U
	96.1	241 B/C	
BC Vancouver			
MB Brandon	CJCM	\$ 1042	55000
ON North Bay	CBCL	477	100000v
AL Mobile	FM-96 WLPR	\$ 480	100000
AZ Tucson	KCEE-FM	\$ 77	25500
AR Blytheville	KHLS	\$ 450	100000v E
CA Sacramento	KCTC	\$ 520	45000v I
CA San Luis Obispo			
	KUNA	\$ 1410	5600v

**KFKZ FM**  
100,000 STEREO WATTS FM  
90

96.7	FL Jupiter	WRYZ-FM	\$ 300	3000v	H
GA Cochran	WVWG-FM	220	3000		
GA Newnan	WCOH-FM	380	1700v		
ID Lewiston	KOZE-FM	\$-631	900		
IL Joliet	WLLI	\$ 300	3000v		
IL Loves Park	WLUV-FM	\$ 235	3000v	E	
IL Normal	WIHN	\$ 300	3000v		
IN Bloomington	WBWB	300	3000v		
IN La Porte	WCOE	265	3000	E	
IN Madison	WDRX-FM	230	3000		
IN Vincennes	WAOV-FM	110	2900		
KS Larned	KANS-FM	288	910		
KS McPherson	KNEX-FM	\$ 245	3000v		
KY Bowling Green	WLBJ-FM	180	3000v	H	
KY Paris	WBRG-FM	105	3000v	E	
KY Somerset	WSEK	215	3000v	A	
LA Morgan City	KMRC-FM	\$ 255	2450h		
			580v		
			3000h		
LA Oak Grove	XDOI	\$ 300	1500v	H	
MD Easton	WEMD-FM	245	3000v		
MD Halfway	97-0 WOCM	\$ 165	3000v	A	
MI Albion	WUFN	\$ 460	1200v		
MI Cadillac	WITM	\$ 430	1350v		
MI Petoskey	WMBH-FM	\$ 320	1000v	H	
MI Grand Rapids					

Kix-96 KXGR \$ 390 1700v Y 100v

## KWWK 96.7 STEREO FM

"Quick"

MN Rochester	KWWK	\$ 295	3000v		
MS Columbia	WFFF	\$ 100	3000	U	
MS Gulfport					
	Stereo-97	WGUF-FM	\$ 260	3000v	H
MS Pontotoc	WSEL-FM	300	3000	H	
MS Winona	WORA-FM	230	2500v		
MO Columbia	KTGC	300	2900	H	
MT Belgrade	KGVW-FM	\$ 205	3000v	U	
NY Canton	*WLSU	\$ 320	2600v	P	
NY Port Jervis	WDLG-FM	\$ 300	3000v		
NC Franklin	WFSG-FM	-327	3000	I	
NC Roxboro	WRRX	300	3000v		
ND Devils Lake	WDLR-FM	164	3000	H	
OH Cambridge	WILE-FM	\$ 420	1300v		
OH Celina	WCSM-FM	123	3000	I	
OH Fostoria	WFOB-FM	190	3000v		
OH Wellston	WKOV-FM	\$ 100	3000v	U	
OK Idabel	KWGD	300	3000v		
PA Danville	WPGM-FM	\$ 760	340	S	
PA State College	KWKX	\$ 920	250v	Y	
SC Cayce	WZLD	\$ 300	3000v	A	
SC Greenwood	WERS-FM	350	1600v	H	
TN Bolivar	WVST	300	3000v	I	
TN Centerville	WIRA	300	3000		
TN Georgetown	WGIN-FM	290	3000v		
TX Marlin	FLMI	200	1250v	U	
TX Mineola	KMGO-FM	300	3000v		
TX Shreave	KIMM-FM	\$ 265	3000		
TX Sweetwater	KYXX-FM	58	2600v		
VI Fayetteboro	WTSJ-FM	\$ 170	3000v	MU	
VT Montpelier	WNCB	\$ 700	400		
VA Orange	WMA-FM	340	2150v		
VA Sunnyside	WREN-FM	\$ -1	3000		
VA Danville	WRPL-FM	460	1150v		
WI Oshkosh	WVYC	\$ 295	3000v	A	
WI Sauk City-Fralter du Sac					
	WVLR	\$ 300	3000		

96.9	245 B/C				
AT Peace River	*CKUA-FM	\$ 550	100000v		
NF Red Rocks			1120		
PE Charlottetown	CBC-FM	825	93500v		
PQ Sept Iles			15000		
PQ Verdun	CKOI	\$ 712	307000v		
SA Regina	*CBC-FM	*CBK-FM	\$ 501	100000v	
AL Decatur-Huntsville					
	Stereo 97	WRSA	\$ 830	100000v	
AL Enterprise	WIRB-FM	\$ 295	100000v	I	
AZ Phoenix	KNEO-FM	\$1560	100000v		
CA Monterey-Salinas					
	WQAV	\$2570	18000v	A	
CA Sacramento	KROI	\$ 280	64000		
FL Fort Myers	WJMK-FM	\$ 251	44000		
FL Jacksonville	WAVI	\$ 420	100000v		
ID Nampa	KUJZ	\$2520	44000v		
IL Mattoon	WLBH-FM	\$ 500	50000v		
IL Moline	WHTT	\$ 500	50000v	U	
IL Zion-Kenosha	WI		10000h	U	
	(null to south)	WKSJ-FM	\$ 500	/ 81000v	
IA Clarion	KRIT	200	93000	H	
KS Pittsburg	KMRJ	\$ 390	100000v	C	
KY Paducah					

## WPAD FM ROCK 97

	Rock-97	WPAD-FM	\$ 337	70000	C
LA Alexandria	KSLI	\$ 850	100000v		
ME Presque Isle-Caribou					
	WDHP	\$ 440	100000v		
MA Boston	WJIB	\$1010	8700v		
MI Grand Rapids	WLAJ-FM	\$ 500	50000v		
NE Seward	KSRD	\$ 580	100000v		
NJ Atlantic City	WFPG-FM	\$ 300	50000v	C	
NY Farmington	KRAZ	\$ 300	30000		
NY Buffalo					
	QFM-97	WGRQ	\$ 890	12500v	A
NY Utica	WOUR	\$ 790	16000v	A	
NC Goldsboro	WEGR	\$ 320	50000v		
NC Statesville	W000	340	3600	Y	
OK Enid	KHND	\$ 185	76000v	A	
PA Braddock					
	FM-97	WFFM	\$ 520	60000v	
PA Lancaster	WLAN-FM	\$ 76	50000v	A	
SC Charleston					
	FM-97	WXTX	\$ 780	100000v	
SD Garden City	WDLG-FM	\$1280	100000	U	
TX El Paso	KULP-FM	180	26800		
TX McAllen	KVMV	225	100000v		
TX Odessa	KGIP	\$ 195	1660		
VA Bristol	WRHG-FM	260	10000v	D	
WV Jackson	KMTN	\$ 940	48000v		

97.1	246 B/C				
BC Penticton	CKOK-FM	\$ 755	1800		
ON Belleville	CJBO-FM	\$ 50000			
ON Sudbury	CBCS	367	50000v		
AR Camden	KWEH	\$ 185	39000v	H	
CA Los Angeles	K8BS	\$ 770	55000v	M	

METROMEDIA RADIO



DC Washington	WASH	\$ 690	22500v	S	
GA Gainesville					
	fox-97	WFOX	\$ 540	97000v	U
HI Hilo	YFSH	-240	28400v		
IL Chicago	WVIB	\$1190	650v		
IN Shelbyville	W3LV-FM	\$ 255	34000		

LA New Orleans	WEZB	\$ 450	93000v		97.3
ME Bangor	WBGW	\$1230	50000v	E	
MI Detroit	FM-97	WVW-FM	\$ 920	12500v	

## WKZY kozy-97, fm stereo

MI Escanaba	WKZY	\$1070	90000	U	
MN Minneapolis	KTCR-FM	\$ 150	50000v	H	
MS Meridian	WALT	\$ 380	100000v	A	
MO Florissant	KSCF	\$ 300	50000v		
MT Billings	KURL-FM	\$ -30	15900		
MT Kalispell	KALS	-195	70000h	I	
NV Las Vegas	KORK-FM	\$ 195	44000		
NH Roswell	KRY-FM	235	25000		
NY New York	Y-97				

## WYNY 97.1 FM

30 Rockefeller Plaza  
New York, N.Y. 10020

	WYNY	\$1300	4600v	N	
NC Greensboro	WDMG	\$ 560	20000v	U	
ND Minot	KCJZ-FM	\$ 840	65000		
OH Ashtabula	WREO-FM	\$ 500	50000v		
OH Columbus	WBNS-FM	\$ 660	26000v	I	
OR Portland	KPAM-FM	\$1000	100000v	Y	
TN Memphis	K-97	WHRX	\$ 1300	100000v	
TX Fort Worth-Dallas					
	Z-97	KJFZ-FM	\$1460	98000v	
UT Salt Lake City	KLUB-FM	\$3650	13000v		
VA Rutland	WRUT	\$2580	830v	N	
WA Walla Walla	KSXT	\$1340	50000v		
WI Sparta	WCOG-FM	\$ 360	47000h		
			32000v		

97.3	247 B/C				
AT Edmonton	CJCA-FM	\$ 479	64000v	D	
AT Medicine Hat	*CKUA-FM	\$ 727	100000v		
NF Baie Verte	CBTB		5850		
PQ Lac au Saucron	CBGS	688	915v		
PQ Lithium Mines			52000		
CA San Diego	KSON-FM	\$ 215	50000v	I	
CA San Francisco	KEAR	\$1100	82000v		
CO Boulder	KBCO	\$-750	2000		
FL Miami	WATA	\$ 800	98000v		
GA Bainbridge	WJAD	\$ 140	28600	H	
GA Savannah	WXXM	\$ 470	100000v		
IL Carai	WRUL	\$ 210	11000		
IN Fort Wayne	WMEF	\$ 510	48000v		
IA Des Moines					
	FM-97	KDMI	\$ 450	115000v	H
KS Garden City	KBUF-FM	230	25000v	I	
KS Topeka					

	Rock-97	W1EW-FM	\$1220	97000v	C
MA New Bedford	WJFD	285	50000v		
MD Springfield	WQFC	\$ 480	100000v	A	
NV Carson City	KRBC	\$2240	518000	Y	
			31000v		
NJ Millville	WYVB-FM	165	10000		
NM Santa Fe	WAFD-FM	\$ 86	28000v	C	
NY Ithaca	WUCU-FM	\$ 880	26000v	C	
NC North Wilkesboro					
	WRBC-FM	\$ 980	20000v		
NC Wilmington	WHSJ	\$560	100000v	Y	
OK Weatherford	WYEF-FM	\$ 400	69000v		
PA Harrisburg	WHP-FM	\$ 840	14000v	C	
SD Sioux Falls	KPAT	\$ 220	30000v		

TX Plainview	KATX	440	10000v
TX San Antonio	WDAI-FM	\$ 450	10000h 7000v
VA Newport News	WGH-FM	\$ 400	74000v
WA Tacoma	KNBO	\$ 370	10000h 36000v
WV Wheeling	WKWK-FM	\$ 460	50000v
WI Milwaukee	WLPX	\$ 910	11500v

**97.5 248 B/C**

MB Winnipeg	CHMM	\$ 228	31000
ON London		497	50000
AL Mobile	WABB-FM	\$ 440	100000v
AR Hot Springs	KGUS	\$ 480	36000h 16000v
CA Merced	XMYT	\$ 493	50000v
CA Riverside	KDUO	\$1630	72000h 2300v
CA Santa Barbara	XTMS-FM	\$2900	16000v
FL Winter Haven	WPCV	\$ 440	10000v
HI Honolulu	KHSS	\$ 27	100000v
IL Champaign	WDS-FM	\$ 360	50000v

IL Rockford	FM-97 WZOK	\$ 235	50000v
KY Louisville	WAMZ	\$ 500	100000v
MI Lansing	WJIM-FM	\$ 440	28000
MN Park Rapids	KPRM-FM	\$ 413	100000v
MN Rochester	KXKR	\$ 620	37000v
MS Oxford	KOOR	\$ 265	27000

**EASTMINSTER BROADCASTING CORP.**  
Box 576, Middle Road  
97.5 STEREO  
Dover, N. H. 03820

NH Dover-Portsmouth	WQKQ	\$ 290	50000v
NJ Trenton	WPST	\$ 415	50000v
NY Patchogue	WALK-FM	520	15100
NY Watertown	WNCQ	\$ 285	41000v
OH Akron	WAEZ	\$ 500	50000v
OK Tulsa	KMOD	\$ 380	50000v
TN Knoxville	WEZK	\$1140	100000v
TX Beaumont	KAYD	\$ 320	50000v
TX El Paso	KINT-FM	\$1080	59000v
TX San Angelo	KSJT	100	34000
TX Waco	KWTX-FM	\$ 890	71000v
VA Charlottesville	3WV WVVV	\$ 450	50000
VA South Boston	WJLC	\$ 240	29000v

WV Charleston	Q-97 WQBE	\$ 500	50000v
WV Martinsburg	Stereo-97 WESH	\$1010	9000v
WY Lander	KDLY	\$-420	25000v

**97.7 249 A**

BC Vancouver	CBUF	\$1823	50000
NS Kentville	CKRM	660	18000
ON St. Catharines	CKTB-FM	\$ 392	50000v
PG Montreal	CHOM	\$ 979	41200
SA Regina	CBKF	501	13700v
AL Auburn-Opelika	WFRI	\$ 160	860v
AL Clanton	WEZZ	245	3000
AL Oneonta	WKLD	480	990
CA Lodi-Stockton	KWIH	\$ 300	3000v
CA Los Altos	KPLN	\$-175	3000v

**KDOL** 1340 AM  
97.7 FM

MOJAVE, CALIF.  
CA Mojave KDOL-FM -125 3000v

CA Monte Rio	KXJB	780	450v
CA Oroville	KFAM	-47	3000v
CA Shafter	KQEZ	300	3000v
CA Aspen	KSPN	\$ -84	3000
CT Norwalk	WCTY	\$ 300	3000v
DE Milford	WAFI	240	3000v
FL Naples	WNTU	300	3000v
FL St. Augustine	WFOY-FM	\$ 160	3000v
GA Americus	WPLR	\$ 300	3000v
GA Griffin	WKEU-FM	\$ 300	3000v
GA Rome	WROM-FM	\$ 817	290v
GA Vidalia	98-Q WTCQ	\$ 290	3000v
ID Blackfoot	KBLI-FM	\$ 130	3000v
IL Monmouth	WDRL	\$ 210	3000v
IL Pittsfield	WBBA-FM	\$ 300	3000
IL Streator	WLAX	140	2950
IL West Frankfort	WFRX-FM	165	3000v

IN Brazil	WVCM-FM	\$ 300	3000v
IN Goshen	WZOW	\$ 145	3000v
IN Rensselaer	WJCK	300	3000v
IA Clinton	KCLN-FM	\$ 300	3000
IA Humboldt	KHBT	\$ 275	3000v
IA Ottumwa	KLEC-FM	\$ 170	3000v
KY Jackson	WJSN	610	580v
KY Providence	WHRZ	300	3000v
LA Marksville	KAPB-FM	\$ 213	3000v
LA Natchitoches	KDBH	140	3000v
ME Caribou	WFST-FM	\$ 185	190
ME Millinocket	WKTR	190	3000v
MD Lexington Park	WDOM	300	3000v
MA Brockton	WCAV	\$ 155	3000v
MI Manistee	FM-98 WRRK	\$ 155	3000v

MI Sandusky	WMLC-FM	140	3000v
MN Redwood Falls	KLGR-FM	\$ 295	3000v
MS Brandon	WRJH	\$ 290	3000v
MS Tylerokn	WYLF-FM	145	3000
MO Corinthan	KOLA	480	1000v
MO Fulton	KKCA	300	3000v
MO Stikeston	KSTG	205	3000v
MO Waynesville	KFBM-FM	\$ 255	3000v
MT Anaconda	KGLM	\$ 950	210v
MT Livingston	KYBS	-245	3000v
NE Holdrege	KUWR-FM	240	2850v
NE Nebraska City	KNCY-FM	\$ 300	3000v
NY Amsterdam	KCSS-FM	135	3000v
NY Hyde Park	WHVS	\$ 300	3000
NC Kingston	Q-97 WQOW	\$ 170	3000v
OH Castalia-Sandusky	WGN	300	3000v

OH Georgetown	NURD	\$ 390	1600v
OH Jackson	NCJO	300	3000v
OH Lima	WTGN	\$ 300	3000v
OH Oxford	WOXR	\$ 255	3000v
OK Edmond	KWHF	\$ 300	3000v
PA Butler	WBUT-FM	290	720
PA Somerset	WVSC-FM	270	3000v
SC Georgetown	98-Rock WGMG	\$ 180	3000v
TX Kingsville	KPUP	\$ 156	3000v
VA Grundy	WMJD	490	1100v
WI Sheboygan	FM-98 WJJR	\$ 241	3000v

**WWJR**  
**FM 98**

MB Brandon	CBWV	712	100000v
AZ Tempe	K-100 KUPU-FM	\$1620	100000v
CA Fresno	KMJ-FM	\$ 290	48000v
CA Long Beach	FM-98 KNOB	\$ 410	79000v
CO Pueblo	KCSJ-FM	\$ 320	100000v
FL Clearwater-St. Petersburg	Rock-98 WQXM	\$ 440	29500v
FL Palm Beach	WJNO-FM	\$ 340	100000
HI Hilo	KKEA	630	100000v

**KBOI - fm**

STEREO 98

ID Boise	KBOI-FM	\$2500	47000v
IL Chicago*Loop	WLPW	\$1170	6000v
IN Anderson	Stereo 98 WLHN	\$ 490	50000v
IA Sioux City	Rock-98 KSEZ	\$ 260	62000v
KS Wichita	KBRA	\$ 370	85000
ME Portland	WOCSS	\$ 410	50000v
MD Baltimore	98-Rock N1YY	\$ 950	2000v
MI Detroit	WMZK	410	50000v
MI Grand Rapids	WGRD-FM	\$ 590	285000v
MS Greenville	WBAQ	\$ 120	26500
NY New York	WEVD-FM	1220	3790v
NY Rochester	WPXY	\$ 400	50000
NC Concord	WPEG	\$ 390	20000v
ND Fargo	*KFNW-FM	\$ 350	100000v
OH Columbus	WNCI	\$ 560	175000v
OK Poteau	KLCO-FM	\$2000	100000v
OK Eugene	KFYH	\$ 860	3500
PA Hazleton	WVCD	\$ 670	24000v
SC Columbia	WCOSS-FM	\$ 420	100000v
SD Rapid City	KVSR	390	100000
TN Nashville	WSIX-FM	\$1140	100000v
TX Amarillo	KGAC-FM	\$1285	45500v
TX Dallas-Fort Worth	Zoo-98 KZEW	\$1680	99000v
TX Houston	98 KFMK	\$ 440	100000v
TX Odessa	KOVL-FM	\$ 100	34000
WV Fairmont	WFGM	\$ 600	32000v
WI Stevens Point	WSP1	\$ 340	500000v

**KFBC-AM-FM**

1806 Capitol Avenue  
CHEYENNE, WYOMING 82001  
WY Cheyenne KFBC-FM 580 33500v

**98.1 251 B/C**

ON Cornwall	COOF-6	254	3000v
ON Sudbury	CBJS	367	50000v
ON Toronto	CH1F	\$1380	44000v
PG Quebec	CHO1	\$1184	81000
PG Sept Iles		784	96750v
AL Andalusita	Q-98 WHIC	\$ 250	100000v
AL Fayette	FM-98 WKWK	\$ 350	100000v
AR Osceola	KHFO	\$ 230	50000
CA Redding	KVIP-FM	\$1710	30000v
CA San Diego	KIFM	\$ 140	28000v
CA San Francisco	KABL-FM	\$ 940	100000h 67000v
FL Live Oak	WQHL	\$ 175	31000v

IN Princeton WRAY-FM \$ 420 5000v H  
IA Cedar Rapids KHAK-FM \$ 210 6800  
KS Kansas City KUOL \$ 240 10000v Y  
KY Lexington WKQD \$ 551 50000v A  
LA Baton Rouge

Stereo-98 WAFB-FM \$1500 10000v Y

MA New Bedford-Fall River

MI Saginaw WMY5 \$ 510 4700Gv  
MN St. Cloud WKQJ \$ 340 50000v N  
MO St. Louis WWJO \$ 420 10000v

Super Q KSLO \$ 582 10000v

NY Binghamton WQVT \$ 960 10000v H  
NC Fayetteville WQSM \$ 500 93000v S  
OH Canton-Akron WTOP \$ 570 16000v  
OK Lawton KRLG \$ 200 10000v U  
PA Altoona WFBG-FM \$1020 30000v C  
PA Philadelphia

FM-98 WCAU-FM \$1000 12500v

SC Seneca WBFM \$ 280 50000v H  
TX Texarkana K.TAL-FM 1360 100000h A  
VT Rutland WHAB-FM -300 50000 U  
VA Galax WBOB-FM 590 6800 U  
VA Richmond

FM-98 WTVR-FM \$ 640 50000 C

WA Seattle KING-FM \$ 700 100000  
WA Spokane KHO-FM \$2030 94000v N  
WI Madison WISM-FM \$ 350 20000v

## 98.3 252 A

BC Nanooks CFFM \$ 469 3900  
MB Winnipeg CBF-FM \$ 471 354000  
ON Kingston CKLC-FM \$ 519 95500v  
AL Scottsboro WONA \$ 404 1500v E  
AL Sylacauga WMLS-FM 83 630  
AZ Nogales KAYN 230 215v  
AZ Prescott KNOT-FM 175 3000v  
AZ Willcox KWCX 57 3000v  
AR Mountain Home KTLQ-FM \$ 417 1400  
CA Oxnard KODR \$ 72 3000v  
CA Turlock KMIX \$ 399 1600v  
CA West Covina KBOB -265 808  
CT Danbury WLAD-FM \$ 330 2000v  
CT Williamantic

Stereo 98 WXLS \$ 300 3000v

DE Seaford WSUX \$ 200 3000v Y  
FL Arcadia WOPD \$ 195 3000v  
FL Goulds WGLY \$ 460 1100v  
FL Titusville WRMY-FM \$ 230 3000v  
GA Cordele WFAV \$ 300 2600  
GA Jesup-Ludowick

WSOJ \$ 300 3000v U

GA Swainsboro WJAT-FM \$ 283 3000v  
ID Burley WSAX \$ 105 3000v I  
IL Canton WBY5-FM \$ 265 3000v I

## WCCQ RADIO FM 98

"WILL COUNTY'S COMMUNITY MINDED STATION"  
1520 ROCK RUN DRIVE  
JOLIET, ILLINOIS 60435

IL Crest Hill WCCO 285 3000v  
IN Peru WABU-FM \$ 43 3000  
IN Plainfield WART \$ 240 3000v  
IN Winchester WUUC 300 3000v  
IA Boone WVBG-FM 1708 3000v I  
IA Ernestburg WEP3 \$ 300 3000v U  
KS Billene WABT-FM 109 3000  
KY Bowling Green WQZ5 \$ 300 3000v  
LA West Monroe WYEA \$ 260 3000v  
ME Waterville WTVL-FM 125 3000v E

MA Greenfield WHAI-FM -240 1000v C  
MI Monroe WVM0 300 3000v



EASY LISTENING FM  
3000 WATTS

### "BROADCAST HOUSE"

(924) 387-2318

MUNISING, MICHIGAN 49862  
MI Munising WQX0 380 1800v  
MS Quitman 66 3000v  
MO Columbia FM-Z KFHZ \$ 300 3000 Y  
MO Portageville KM15-FM \$ 230 3000  
MT Dillon KDBM-FM \$ 480 1000v  
NH Laconia WLNH-FM \$ 300 3000v C  
NJ New Brunswick WNGO 530 1000v S  
NY Hammondsport WVIN-FM \$ 390 1700v  
NY Hempstead

OK-98 WIOK \$ 300 3000v U

NY Monticello WNSL \$ 360 2000v  
NC Murfreesboro WWDK-FM \$ 287 3000v  
NC Thomasville WTNC-FM 255 3000v U  
OH Bellefontaine WTOO-FM 510 890v E  
OH Logan WLGK-FM 240 3000v  
OR La Grande KLBK-FM \$-420 1300v  
PA Charleroi

FM-98 WJFM 300 3000v Y

PA Millifenburg WJUR 52 3000v  
SC Kingstree WWT 210 3000  
TN Camden WRJB \$ 300 3000v E  
TN Cookeville WNUB-FM \$ 400 1500  
TN Pulaski WNLG \$ 300 3000  
TX Austin KHFI \$ 420 1300 Y  
TX Bryan KORA \$ 247 3000 A  
TX Columbus KULM \$ 200 3000v  
TX Gatesville KMCS \$ 300 3000v  
TX Palestine KHIM 300 3000v  
TX Pleasanton KBOP-FM 300 3000v  
TX Spearman KBMF 215 3000v  
TX Stephenville KWAM 205 3000  
UT Price KARP -144 3000v  
VA Lynchburg WGOL \$ 240 3000v H  
WA Yakima KYBO \$ 560 700v  
WV Charles town WZFM 111 3000v  
WI Menomonie Falls

WZMF \$ 280 3000v Y

WI Park Falls WNB1-FM 245 3000  
WA Yakima KYBO \$ 560 700v  
WY Torrington KERN \$ 300 3000v A

## 98.5 253 B/C

BC Victoria CFMS \$ 567 19000  
NF Stephenville 4270  
PQ Longueuil-St. Lambert  
CIEL \$ 638 100000v

AR Little Rock 98-2 KL42-FM \$ 880 100000v A

CA Cathedral City  
KXKY-FM \$ 500 50000v  
CA Delano 12500h  
KDLO \$ 620 6200v  
KZAP \$ 250 50000v

CA Sacramento  
CA San Jose



KOME \$ 880 12500v  
CO Denver KXMY-FM \$ 720 50000v U  
FL Crystal River  
WFO \$ 430 100000v U

## WGNE 98.7

AM 1480  
FM Quad 98

FL Panama City

Q-98 WGNE-FM \$ 130 100000 A  
GA Atlanta WSB-FM \$ 740 100000v  
IL Freeport WFRL-FM 150 19500v  
IL Paris WJCF \$ 500 50000v E  
IA Council Bluffs

KQ-98 KQKQ \$ 175 100000v S

LA New Orleans WYLD-FM \$ 360 100000v  
MA Boston WROR \$1190 5800v A  
MI Coldwater WNNW \$ 500 50000v  
MI Houghton Lake WJGS \$ 470 100000h I  
MN Minneapolis \*KTIS-FM \$ 270 74000 U

MS Tupelo WEL0-FM \$ 380 100000 H

MO Farmington KTJJ \$ 870 100000v  
MT Billings KBMS \$ 400 25500v I  
MT Kallispell KSSR 2720 35000v  
NV Las Vegas WLUC-FM \$ 93 5800v A  
NM Los Alamos KRSN-FM \$ 21 15000v  
NY Niagara Falls WLDQ-FM 420 46000  
OH Cincinnati WHLO \$ 810 15000v  
OH Cleveland

G-98 WGCL \$ 600 40000v

OK Tulsa KCFO \$ 660 100000v  
OR Klamath Falls KAGM \$ 400 63000v  
OR Portland KUPL-FM \$1038 55000v

PA Oil City WRJS \$ 310 3400 H

PA Wilkes-Barre WBRE-FM \$1180 5800vKS  
PA York-Hanover WYCR \$ 930 10500v  
TN Kingsport-Johnson City-Bristol

WKPT-FM \$1260 95000v A

TX McAllen KQXX \$ 280 26000v  
TX Port Arthur KPAC-FM 380 3800  
WI Green Bay WDUZ-FM \$ 500 100000v Y

## 98.7 254 B/C

AZ Phoenix KBBC \$1680 115000v Y  
CA Los Angeles KJDI \$1180 75000v  
DC Washington WJZQ \$ 490 26500v  
FL Fort Pierce WLOY \$ 340 100000 E

## wfmt

CHICAGO'S FINE ARTS STATION  
SUITE 440  
500 NORTH MICHIGAN AVENUE  
CHICAGO, ILLINOIS 60611

IL Chicago WFMF \$1170 15500v  
IA Centerville WNGO 450 100000v  
KY Hopkinsville WHOP-FM \$ 210 30000  
MI Detroit WBFQ \$ 480 50000v U  
MN Moorhead KQAB-FM \$ 380 100000v  
MN Pipestone WLOH-FM \$ 700 40000v Y  
MS Vicksburg WQMV \$ 310 56000  
MO Springfield

Rock-99 WJTO-FM \$ 290 100000v I

NY New York 99-X WXL0 \$1220 5400h  
3800v

NY Utica W180 \$ 660 25000v  
NC Greensboro

R-99 WRKX \$ 400 100000v Y

SC Beaufort WBEU-FM \$ 225 30000v  
TX Amarillo KZUP-FM 800 100000v

TX Dallas KANS \$ 520 100000v  
TX Victoria KTVN \$ 150 40000v





99.5

NY Buffalo	WDCX	\$ 640	110000v
NY New York	WBAI	\$1220	5400h 3800v
NY Schenectady	WGFH	\$ 925	10000v
NC High Point	WMFR-FM	\$ 350	10000 A
OH Cleveland	WKSX	\$ 500	50000v
OK Henryetta	WKHN-FM	\$ 255	28500v
OR Portland			
	FM-99	KJIB	\$ 870 100000v
SD Moberge	KOLY-FM	\$ 560	56000v
TX Brownsville	KRIX	430	100000v
TX Fort Worth-Dallas			
		KPLX	\$1680 100000v
TX Lubbock	KWGO	\$ 630	46000v A
TX San Antonio	KISS	\$ 570	12870
WV Beckley	WBKR	\$1050	34000v

99.7 259 B/C

NB St. John			3000
PO Baie-Comeau			100000h C 97000v H
AL Dothan	WOOF-FM	\$ 340	
CA Porterville			
	X-100	KI00	\$ 140 15000v U
CA San Francisco			
	Stereo 99	KYUO	\$1240 45000v N
GA Atlanta	WLTA	\$1000	100000v
IN Frankfort	WIL0-FM	125	5900 U
IA Muscatine 99+	KFMH	\$ 245	50000v U
KY Louisville	WCSN	\$ 720	20000v
MI Ironwood	WIMI	\$ 560	100000v
MI Midland	WUGH	\$ 690	100000v
MS Jackson	WJMI	\$1060	98000v A
MO Kansas City	KMBR	\$ 950	98000v
NC Kannapolis	WRKB-FM	320	10000v
OH Columbus			
	Quad-100	WRMZ	\$ 500 50000v M

WSSH FM Stereo

BROADCAST PLAZA • CRANE AVENUE  
PITTSBURGH, PA 15220PA Pittsburgh WSHH \$ 930 10500v  
WMSR, INC.

AM - FM

MANCHESTER, TENN. 37355

TN Manchester WMSR-FM \$ 172 18800

TN Memphis-FM-100 WMC-FM \$ 910 300000h

VA Norfolk WYFL \$ 400 50000v U

99.9 260 B/C

WB Gods Lake Harroes

CBRN 90 1800v

NF Gander 4000

NF Mt. St. Margaret

CBYM 10000

ON Toronto CKFP \$1380 40000v

PO Laforge 520

AL Mobile

Stereo 100 WMPG-FM \$ 800 96000vAC

AR Fort Smith KICS-FM 225 36000

CA Marysville KRFD 150 4900

CA San Bernardino

KOLA \$1630 31090v A

CA Santa Barbara KTYO-FM \$ 550 34000

CO Pueblo KFUB-FM \$2000 68000v I

CT Bridgeport WEAZ \$ 650 25000v

FL Eccla Paton-Mialet

WACS \$ 930 103000v

FL Falsatia WLYD \$ 160 103000h  
25000v

IL Harrisburg	WED0-FM	\$ 310	50000v N
IL Kankakee	WBYG	\$ 500	50000vDA
IN Terre Haute	WTHI-FM	\$ 410	20000v N
KS Salina 99-KG	KSKG	\$ 570	100000v Y
LA Lafayette	KTDY	\$ 450	100000v
MD Frederick	WFRE	\$1100	9000v
MD Ocean City	WKHI	316	50000v
MA Barnstable-Hyannis			
	WQRC	\$ 330	50000v
MI Benton Harbor	WFBF-FM	\$ 225	92000v A
MN Austin-Altert			
	KAUS-FM	\$ 930	100000v M
MN Moorhead	KVOX-FM	\$ 390	100000v A
NE Omaha	KGOR	\$1230	115000v
NM Clovis 0-100	KTQM	\$ 300	100000v C
NY Cortland	WKRT-FM	\$ 710	14000 U
NY Plattsburgh	WGBF	\$ 780	4000v C
NC Asheville	WLOS	\$2620	48000v E
NC Burgaw	WPJC	\$ 520	100000v Y

WVUD - FM Stereo  
UNIVERSITY OF DAYTON  
DAYTON, OHIO 45409

OH Kettering	WVID	\$ 500	50000v A
OH Toledo	WKLR	\$ 160	8800 Z
OR Albany	KRKT-FM	\$1075	100000h
PA Easton	WQOD	\$ 450	50000v
PA Erie	WLVU	\$ 400	9700v
TX El Paso			
	FM-100	KTSM-FM	\$1820 87000v
TX Robstown	KROB-FM	270	100000h 88000v
TX Waco	KHOD	\$ 427	100000v A
TX Wichita Falls	KLUR	\$ 820	100000v I
WA Seattle			
	FM-100	KISW	\$1150 100000v
WA Spokane	KXLY-FM	\$3030	25000v C
WV Charleston	WVAF	\$ 500	50000v A
WJ Janesville	WJVL	\$ 200	20000h U

100.1 261 A

AT Lethbridge CBRX 571 100000v

NS Halifax CIOO \$ 100000

PQ Camp LG4 583

PQ Duplanter CHLG-5 297

PG Trois Rivieres CBF-FM1 925 4326v

SA Fond du Lac CBKG 143 779v

AL Phenix City-Columbus GA

WEIZ \$ 300 3000v

AL Selma WTLN 320 2500v M

AK Kenai XGOK 175 3000v C

AK Kodiak KXRT \$ 3 3000v U

CA Santa Rosa KZST \$ 262 3000v A

CA South Lake Tahoe

YRLT \$-180 3000v

FL Port Charlotte

Stereo 100 WEEJ \$ 140 3000v

GA Forsyth WFNE 300 10000v U

GA Statesboro WQCD \$ 150 3000v

GA Washington WLOV-FM \$ 320 2400v

IL Lincoln WFRG-FM 201 3000

IL Macomb WMAI-FM \$ 128 3000

IL Mendota WGLC-FM 98 1000v E

IL Seneca WJBD-FM 150 2600 U

IL Savanna WCCI 300 3000v U

IN Angola

Stereo 100 WKLI \$ 300 3000v A

IN Bluffton WCPD \$ 130 3000

KY Carrollton WVCY 300 2500v

KY Elizabethtown	WOXE	\$ 300	3000v
KY Winchester	WKDJ	\$ 300	3000v E
LA Bastrop	KJBS	180	3000v
LA Shreveport	KCOZ	\$ 300	3000v
ME Auburn	WNAV	\$ 290	1000v
ME Houlton	WHOU-FM	\$ 303	3000v C
MA North Adams	WMBB-FM	\$ 480	10000v S
MA Southbridge	WES0-FM	\$ 295	3000v U
MI Fremont	WSHN-FM	\$ 215	2750v U
MI Grayling	WQOV	\$ 81	3000v
MI Hastings	WBCH-FM	295	1550v E
MI Marquette	WUUN	\$ 370	1880v
MN Eveleth	WVLA	550	710v
NH Marshall	WMLH-FM	\$ 300	3000v Y
MN Pequot Lakes	KTIG	300	3000v
MS Grenada	WRIL	\$ 300	3000v A
MO Aurora	KELE	\$ 170	2700v
MO Jefferson City			
	J-100	KJMD	\$ 300 3000v

MT Missoula KYLT-FM \$ 810 2870v Y

MT Plentywood KPNO 34 3000v E

NH Plymouth WPHH-FM 380 1650v S

NH Ship Bottom WJRZ \$ 300 3000v I

NC Edenton WBBX \$ 195 3000v

OH Kent WKHT-FM 295 3000v E

OH Bartlesville KYFM \$ 300 3000v I

PA Altoona WVAN-FM \$ 890 235v

PA Canton 650 500v

PA Lebanon

Stereo 100 WUFM \$ 270 2400v

SC Lake City WGF 196 3000v

SC West Columbia WSCO \$ 330 2400v

TN Dyersburg WASL \$ 194 3000



P. O. BOX 1380

FRANKLIN, TENNESSEE 37064

TN Franklin WIZO-FM \$ 320 2500v M



TX Henderson KGR1-FM 200 3000v

VA Ashland WIVE-FM \$ 300 3000v M

VA Lynchburg WQOD \$ 155 3000v U

VA Tazewell WTZE-FM -105 3000v M

WV Morgantown WCLG-FM \$ 300 3000v

WI Neenah-Menasha

WEMI \$ 300 3000v

WI Portage WQOC \$ 300 3000v E

WI Port Washington

WGLB-FM 185 3000

100.3 262 B/C

AT Edenton CFRN-FM \$ 475 64000vD

NF Argentina 3650

OH Brockville CBOB 100000v Y

AL Tusculbia WVAH-FM \$ 245 100000h

ARCTIC BROADCASTING ASSOCIATION

RADIO STATION KICY

POST OFFICE BOX 820

NOME, ALASKA 99762

AK Iona KICY-FM \$ 40 84v

AK North Pole KJNP-FM \$1570 25000v

100.3  
 AZ Globe KIKO-FM 3340 15000v I  
 AR Jacksonville KGMR-FM \$ 195 25000  
 CA Blythe KYOR-FM 278 35000v U  
 CA Los Angeles  
 K-100 KIQQ \$1130 58000v  
 CA San Jose KBAY \$2580 14500v  
 CO Denver FM-100 KLIR \$ 890 94000v  
 DC Washington  
 OK-100 WOOK \$ 280 16000  
 FL Orlando  
 Rock-100 WDIZ \$ 840 100000v A  
 FL Plantation KeyWROS \$ 450 100000v M  
 GA Tifton  
 Stereo 100 WCUP \$ 578 100000v E  
 IL Aiton WOKZ-FM 490 28000v  
 IL Chicago  
 FM-100 WL00 \$1170 6000v  
 IN Connerville WCNB-FM 270 6700 E  
 IA Des Moines KLYF \$1700 87000v  
 KS Colby KXXX-FM \$ 614 100000v G  
 KS Topeka  
 K-Dove KD0V \$ 260 5300v M



KY Hopkinsville WKOX-FM 93 30000 I  
 LA Alexandria KRRV 129 29300 Y  
 MI Dearborn-Detroit  
 FM-100 WHIC \$ 400 50000v M  
 MN Minneapolis \*WCTS \$ 430 80000  
 MS Laurel WNSL-FM \$ 165 28000v Z  
 NH Portsmouth WHEB-FM \$ 160 31000v  
 NJ Newark WVNJ-FM \$ 670 74000v E  
 NM Albuquerque KPAR-FM \$410 9000 M  
 NC High Point WGLD \$ 370 100000v  
 OH Newark WCLT-FM \$ 390 50000v  
 OR Portland  
 Stereo Q-100 KQFM \$ 930 100000  
 PA Meadville WZPR \$ 530 10000v I  
 SD Rapid City  
 KG-100 KGGG \$ 450 100000v Y  
 TN Dak Ridge WDKI-FM \$2000 100000v  
 TX Brownsville KD0V \$ 449 100000v  
 TX Dallas EZ-100 KMEZ \$1280 89000v  
 TX Houston KILT-FM \$ 790 97000v  
 TX San Antonio  
 KZ-100 KZ2Y \$ 500 100000v A  
 UT Salt Lake City KSL-FM \$3740 26000v  
 WA Moses Lake KW10-FM 210 27500

100.5 263 B/C

AT Manning 13500  
 ON London \$ 22500  
 ON Sault Ste. Marie  
 CHAS \$ 10 3600  
 PQ Brisay 520  
 AL Anniston WHMA-FM \$ 800 25500v A  
 AK Anchorage -325 25000v  
 115000v  
 CA Sacramento KEBR \$ 380 106000v  
 CO Durango J-100 YRSJ \$ 260 100000v I  
 CT New Britain WRCH \$ 720 19500v  
 IL Jacksonville WEAI \$ 330 10000v

IN Kokomo WKVI \$ 470 20000v M  
 NY Rochester WVDK \$ 350 50000 M  
 OH Bellaire WOMP-FM 500 13500v U  
 OH Findlay WHMO \$ 240 20000v  
 OK Oklahoma City KATT-FM \$ 480 100000v  
 SC Laurens WXL \$ 760 100000v I  
 VA Norfolk WMS-FM \$ 380 50000v  
 WV Huntington WKEE-FM \$ 560 53000v Y

100.7 264 B/C

ON Toronto CHIN-FM 1380 4000v  
 PQ Montreal CBF-FM \$ 823 100000  
 18100v  
 AZ Scottsdale KDOT \$ 170 50000v  
 CA Bishop KIQQ \$2960 1000v  
 CA Salinas-Monterey  
 KWTY \$2420 910v  
 CA San Diego  
 B-100 KFMB-FM \$ 620 30000v  
 CA Ventura KHAY \$1210 38600v  
 CO Pueblo Z-100 KZLO \$ 640 100000v E  
 FL Fort Lauderdale-Miami  
 Y-100 WHYI \$ 930 100000v  
 FL Pensacola  
 Q-100 WJLQ \$ 500 100000v  
 FL Tampa-St. Petersburg  
 WJYW \$ 460 100000v  
 GA Brunswick WBSI \$ 170 26400 E  
 IN Elkhart WYEZ \$ 500 50000v  
 IN Terre Haute WVTI \$ 500 50000 I  
 IA Iowa City  
 26500h  
 G-100 KICG \$ 265/ 2380v

LA Baton Rouge  
 FB-100 WQXY \$ 700/ 91000v  
 MD Westminster WTR-FM \$ 350 50000v  
 MA Boston TK-101 WTK \$ 500 50000v M  
 MI Lansing WTL-FM \$ 165 55000v  
 MN Alexandria KCMT-FM \$ 800 100000v N  
 MS Greenville WDMS 150 51000 M  
 MO Cape Girardeau  
 KGMO-FM 170 28600  
 MO Harrisonville KIEE \$ 255 26000  
 NE Omaha \*KGBI \$ 470 100000v U  
 NJ Wildwood WCMC-FM 98 3500 M  
 NY Peekskill WHUD \$ 500 50000v  
 NC Rocky Mount WFMA \$ 360 100000  
 OH Cleveland WMS \$1060 7700v U  
 OH Springfield WEEC \$ 280 77200v U  
 50000h  
 OR Bend KICE \$ 520 20000v E  
 PA Allentown WFMZ \$ 870 12500v U  
 PA New Kensington  
 WNUF \$ 460 20000v M  
 TN Cleveland WDL \$ 360 50000v U  
 TX Abilene KDRO \$1275 100000v



Austin, Texas  
 78703  
 TX Austin KASE \$ 510 98000v  
 TX Mt. Pleasant KPXI \$ 155 100000v  
 VA Harrisonburg  
 Q-100 WQPO \$ 340 7200  
 WA Seattle KSEA \$ 730 100000v C  
 WI Eau Claire  
 Z-100 WBIZ-FM \$ 738 100000 Y  
 WI Racine WRKR-FM \$ 500 50000v Y  
 100.9 265 A  
 AT Grande Prairie  
 \*CKUA-FM \$ 799 100000v

AT Lethbridge CHEC-FM 189 32000v U  
 NS Truro CKCL-FM 189 11500  
 ON Dryden 100000  
 PQ Saguenay CBJ-FM \$ 294 98000v  
 AL Selma WALX \$ 300 3000v  
 AL Union Springs WOSI 265 3000v  
 AZ Sierra Vista KTAZ \$ -46 26600v N  
 AR Arkadelphia KDEL \$ 96 3000v  
 AR Fort Smith KXXI 275 3000v  
 CA San Rafael KTFM-FM \$ 360 2200v  
 CA Tracy-Stockton  
 KSRT \$ 300 3000v  
 CT New London WTYD \$ 300 3000v  
 FL Gainesville 300 3000v  
 FL Marianna WJAQ \$ 325 2500  
 GA Perry WPGA-FM \$ 198 3000v A  
 GA Waynesboro WPGA 300 3000v E  
 GA West Point WCMJ 235 1850v Y  
 IL Pana WPKX \$ 290 3000v  
 IL Peru WIVQ \$ 145 3000 M



IL Rockford WQFL \$ 300 3000v U  
 IN Huntington WBOC \$ 300 3000v  
 IN Lebanon WNON 300 3000 M  
 IN Portland WPGW-FM 180 3000v Y  
 IN Scottsburg WMP1 300 3000 M  
 KS Clay Center 250 2900v  
 KY Erlanger-Cincinnati OH  
 WHKK 295 3000v  
 LA Sulphur KLGQ 300 3000v  
 ME Westbrook WLOB-FM \$ 225 3000v  
 MI Big Rapids WRBN-FM 300 3000v  
 MN Cloquet WKLK-FM \$ 300 3000v I  
 MN Laverne KQAD-FM \$ 240 3000v I  
 MS Hazlehurst WMDK-FM 275 3000v  
 MS West Point WKBB \$ 175 3000  
 MO Bowling Green KPCR-FM 295 3000v  
 NM Las Vegas KFUM-FM -77 3000v  
 NY Albany WDOM \$ 300 3000v

FM 100.9 STEREO



NY Horseheads WQIX \$ 245 3000v A  
 NY North Syracuse  
 WEZG \$ 165 3000v  
 NC Albemarle WABZ-FM 200 3000  
 NC Elkin WIFM-FM 60 3000 I  
 NC Fairmont WXXY \$ 300 3000v  
 NC Wilmington WEMA \$ 350 2160v C  
 OH Bryan WBNB-FM 300 3000v  
 OH Waverly KIBO \$ 500 920 Y  
 OK Miami KGLC-FM \$ 265 3000v  
 OK Sapulpa KXOJ-FM \$ 380 2000v E I  
 PA Bedford WAKM \$ 206 3000 M  
 PA Milton WMLP-FM \$ 690 410v  
 PA North East WHYP-FM -95 3000  
 SC Walterboro WALD-FM 300 3000  
 TN Huntingdon WPMG 300 3000v  
 VT Middlebury WCVN -146 3000v

VA Covington WIQD -255 3000 A  
 VA Warsaw WNTT-FM 330 2400  
 WI Richland Center WRCO-FM 241 3000 Y

101.1 266 B/C

BC New Westminster CFMI \$1096 40000vD  
 ON Smiths Falls CJET-FM \$ 278 47300v  
 AL Cullman WFMH-FM 330 87000  
 AK Adak FM-101 AFR-FM \$ 250  
 CA Auburn KHYL 450 3200  
 CA Fresno KFIC \$ 310 50000v A  
 CA Los Angeles KRTH \$2930 58000v  
 CO Denver KOSI-FM \$ 790 100000hD  
 80000vD

DC Washington DC-101 WDOC-FM \$ 500 50000v E  
 FL Cocoa Beach CK-101 WCKS \$ 440 100000v  
 GA Valdosta WAFT \$ 320 60000v  
 IL Chicago WKQX \$1170 6000v  
 IL East St. Louis WHRV \$ 320 50000v U  
 IA Marshalltown KFJB-FM 310 27500v U  
 KS Oberlin KFNF 420 100000v  
 KY Hazard WSGS 1140 88000v

KY Russellville KQ-101 WAKQ \$ 510 100000v  
 LA New Orleans WNOE-FM \$ 440 100000v Y  
 LA Shreveport XRDQ-FM \$ 970 100000v M  
 MI Detroit WRIF \$ 880 27200v A  
 MN Bealji KBHP \$ 350 58000v U  
 MO Carrollton KAOL-FM 276 105000  
 NE Columbus XXIX \$ 200 100000v  
 NH Manchester RGR-FM \$ 960 9600v H  
 NY New York WCB5-FM \$1300 4600v C

WBBS-AM & WNCB-FM Burlington, N.C. \$ 510 100000hD  
 NC Burlington WNCB \$ 960v  
 OH Youngstown WSRD \$ 125 50000v U  
 OR Portland KYIE-FM \$1640 100000v C  
 PA Philadelphia WDRV \$ 650 23500v  
 PA Tyrone-State College WGRM \$1060 7600v M  
 SC Anderson WCAC 330 6350 C  
 TN Memphis KWAM-FM \$ 390 100000 E  
 TX Dallas WRR-FM \$ 500 100000v U  
 TX Fredericksburg XNAF-FM \$ 650 100000v

TX Houston KLOL \$ 790 97000v  
 TX Lubbock KTEZ \$ 760 59000v  
 UT Ogden YDAB \$ 700 100000v  
 WI Green Bay WIXX \$1080 100000v A

101.3 267 B/C

OK Tillsonburg CKOT-FM \$ 454 50000v  
 AK Anchorage KGOI \$ -66 26000v M  
 CA San Francisco K101 \$1160 125000vDY  
 CT Hazden WKCI \$ 870 12000vD  
 IL East Moline WEMO \$ 500 50000vMI  
 IN Richmond WRIA \$ 280 23000v  
 KS Wichita KFDI-FM \$ 440 100000v A  
 ME Augusta WFAU-FM 315 4845 C  
 MI Grand Rapids FE-101 WFLM \$ 420 50000v A  
 MI Sault Ste. Marie WSUE \$ 220 90000v  
 MN Richfield KDRB-FM \$ 820 100000v

MS Meridian WDAL \$ 580 99000v H  
 NY Rochester WEZO \$ 640 27000v  
 OH Ashland WNCQ-FM \$ 390 50000v M  
 OK McAlester KNED-FM \$ 135 27800 A  
 PA Lancaster-York Nice-101 WNCCE \$ 680 14500v

PA Scranton-Wilkes-Barre WGBI-FM \$1110 7000v C  
 SC Sumter Q-101 WRDM \$ 630 100000vZB  
 TX Sinton-Taft-Corpus Christi 100000h  
 C-101 KNCN \$ 360/21500v U  
 VA Hampton WVHR \$ 380 50000vAI

101.5 268 B/C

MB Winnipeg CJJM \$ 150 3000  
 NB Fredericton-St. John CBZ-FM \$ 100000  
 ON Peterborough CFPM \$ 518 314000  
 PQ Rimouski CJBR-FM \$ 931 20000  
 SA Beauval CGBK 325 1950v  
 AZ Phoenix KHFP-FM \$1740 100000v U  
 CA Bakersfield KGFN \$1280 4800h  
 3000v  
 CA Merced KAMB \$ 400 50000v  
 CA San Diego KGB-FM \$ 500 50000v U  
 FL Miami WLYF \$ 810 100000v  
 FL Pensacola WBOP-FM \$ 400 100000 ZM



TRI-CITIES BROADCASTING CO.  
 PENSACOLA, FLORIDA 32575

FL St. Petersburg WKES \$ 440 100000v U  
 GA Brunswick WYHR-FM 240 100000v H  
 GA Marietta-Atlanta WBIE \$ 870 100000 H  
 IL Bloomington WBQD \$ 460 50000v  
 IL Carbondale WCIL-FM \$ 230 50000v Y  
 IN Columbus WCSI-FM \$ 220 20000v U  
 IN South Bend WWJY \$ 970 9400v  
 IA Storm Lake KAYL-FM 400 10500v  
 LA Baton Rouge WYMK-FM \$ 370 100000v  
 MO Springfield KTXR \$1150 100000v E  
 NJ Trenton-Fairless Hills PA WBJH \$ 120 50000v  
 NY Poughkeepsie WPDH \$ 830 14000h  
 11000v  
 NC Raleigh WRAL \$1890 97000v  
 OH Gallipolis WYPC \$ 350 35000v  
 OH Toledo WLOR \$ 810 15000v  
 OK Lawton KLAW \$ 117 28400 A  
 OR Corvallis K-12 KFLY-FM \$ 100 2800v U  
 PA Pittsburgh WP11-FM 520 19000v  
 PA Waynesboro WAYZ-FM 21 3200v Y  
 RI Providence WLNK-FM \$ 500 50000v P  
 TN Johnson City WQUT \$1500 100000  
 TX Brownwood KDXE \$ 489 100000v E  
 TX Tyler KNIUE \$ 380 100000v  
 VA Fredericksburg WFVA-FM \$ 61 11500v Y  
 WA Seattle XVI-FM \$1150 100000v  
 WI Madison WIBA-FM \$ 450 50000v C

101.7 269 A CKNX-FM STEREO 102  
 ON Wingham CKNX-FM \$ 709 22000v  
 AL Stevenson WVSU \$ 490 940v  
 AR Kena KSKR \$ 62 3000

CA Big Bear Lake KTOT \$1500 90v  
 CA Carmel KLRB \$ 590 800v  
 CA Livermore KKIQ \$-150 3000  
 CA Santa Rosa KVRE-FM 1100 200v E  
 CA Truckee KEZC \$ 470 1250v  
 CO Fort Morgan KBRU \$ 130 3000v  
 FL Quincy WCNH-FM 200 3000 H  
 GA Albany WNCN \$ 300 3000v A  
 GA Thomson WTHO-FM \$ 300 3000v N  
 GA Warner Robins WRBN \$ 207 3000  
 ID Emmett KMFE \$-500 790  
 IL Dixon WIXN-FM 175 3000 H  
 IL Robinson WTAY-FM 245 3000v  
 IN Elwood WBMP \$ 140 3000  
 IN Fort Wayne WCMX \$ 300 3000v B  
 IA Creston KITR 255 3000  
 IA Fort Madison KKBK-FM \$ 245 3000v M  
 KS Independence KIND-FM 156 1600  
 KS Manhattan KMKF \$ 400 1700v



STEREO 101.7

KY Monticello WKYM \$ 560 710v I  
 KY Richmond WBZF 230 3000v M  
 LA De Ridder KEAZ 237 2700 U  
 MA Lynn WLYN 175 3000v E  
 MA Pittsfield WBRK-FM 120 3000v C  
 MI Lansing WILS-FM \$ 180 3000v U  
 MI Muskegon Heights WKJR-FM \$ 180 3000v  
 MITawas City WDBI \$ 275 3000v U  
 MN Rochester KRCH \$ 560 710v  
 MN Sauk Rapids WMHM \$ 300 3000v S  
 MS Canton WMLM 30 2850v  
 MS Clarksdale WJBI \$ 185 3000v Y  
 MS Eupora WKEA 300 3000v  
 MS Fulton WFTA 300 3000v  
 MO Union XLPW-FM 347 2000  
 NH Newport WCNL-FM 51 2880 E  
 NJ Canton WNNM 275 3000  
 NH Lovington KLEA-FM 279 3000  
 NY Attica WBTF \$ 440 1250v  
 NY Geneva WECO \$ 117 3000v U  
 NY Jamestown WHUG \$ 300 2900v U  
 NY Oswego WBOB \$ 450 1150v M  
 ND Mayville KMAV-FM 120 3000v M  
 OH Dover-New Philadelphia WJER-FM \$ 280 3000v  
 OH Newark WNKD \$ 300 3000v  
 OH Urbana WCOM \$ 300 3000v  
 OK Tahlequah KEOK \$ 300 3000v  
 OR Ashland -310 3000v  
 PA Central City NCCS 650 500v  
 PA Linesville WVCV \$ 220 3000 M  
 SC Barnwell WBAW-FM 280 3000v U  
 SC Myrtle Beach WKAZ \$ 285 3000v  
 TN Athens 440 1200v  
 TN Columbia WKOM \$ 300 3000v  
 TN Martin WMT-FM 175 3000  
 TN Savannah WSRM-FM 189 3000 E  
 TN Smithville WJLE-FM 193 3000  
 TX Denison-Sherman Q-102 XDSD \$ 260 3000v A  
 TX Huntsville KSAV-FM 432 712  
 VT Store WRFB \$2275 45v  
 VA Kilmarnock WKVI \$ 235 1900v  
 VA Lynchburg WJJS 290 3000 Z

101.7  
VA Radford WRAD-FM 64 3000v  
WA Prosser KACA \$-255 3000v M

101.8 MHz  
AK Sheeya AFR-FM \$ 1300

101.9 270 B/C  
NF St. John's  
NS Halifax CHFX \$ 546 60800v D  
AL Montgomery WHHY-FM \$ 710 100000v Y  
AR Jonesboro KBTM-FM \$ 150 100000v M  
CA Fresno KFRY \$1870 1800 C  
CA Glendale KUTE \$2860 640v  
CO Colorado Springs  
KINX \$-309 50000 E

FL Daytona Beach  
Q-102 WQXQ \$ 230 100000v  
FL Fort Myers WHEM \$ 175 71000  
IL Skokie-Chicago

WCLR \$1522 3000v  
IL Springfield WVEW \$ 275 50000v A  
IA Waterloo \*KNWS-FM \$1010 100000v V  
KY Central City WNES-FM 215 50000  
LA Monroe KNOE-FM \$1669 97000v I  
LA New Orleans  
Rampart-102 WNL-FM \$ 830 95000  
ME Portland WPOR-FM \$ 500 50000v  
MD Baltimore WLIF \$ 960 13500v  
MA Falmouth WClB \$ 238 50000v  
MI Detroit \*WDET \$ 450 79000v P  
MI Traverse City WLDR \$ 590 50000v U

STEREO 102 FM

# KFMQ

TERMINAL BUILDING • LINCOLN, NEBRASKA 68508

NE Lincoln KFMQ \$ 180 100000v  
NV Las Vegas KFMS \$ 41 20000  
NY Cherry Valley WJIV \$1080 7100v U  
NY New York  
Disco-102 WP1X-FM \$1420 3600v  
NC Gastonia WNGC-FM 890 33000 E  
NC New Bern

K-101 WRBK \$ 580 100000v  
OH Cincinnati  
Q-102 WKRQ \$ 690 23000v  
OK Oklahoma City

FM-102 KFNB \$ 420 63000v  
OR Portland KINK \$ 610 97000v  
PA Pottsville WAVT \$ 540 29000 M  
TX Amarillo KWAS \$ 730 100000v  
TX San Antonio KQXT \$ 670 100000v  
UT Ogden KOPD \$ 39 96000 A  
WV Logan WYON-FM 830 15000h U  
WV Morgantown  
K-102 WVAO \$ 260 50000v  
WI Wausau WDEZ \$ 490 100000v

102.1 271 B/C  
AT Calgary CBR-FM \$1042 100000v  
BC Houston CBUR-FM 1350 318

# GFNY

102.1 FM

ON Brampton CFNY \$ 10000  
ON Brockville CBOF-7 3000  
AL Decatur WDRM \$ 165 100000 A  
AK Anchorage  
K-102 KJZZ \$ 165 25000v

CA Oceanside KJFM \$ 980 9500v  
CA San Francisco KDFC \$1050 33000v  
GA Savannah WZAT \$ 620 100000v U  
IL Danville  
Concept-102 WDNL \$ 377 11000h C  
9400v

KS Hutchinson  
U-102 KSKU \$ 550 100000v  
MA Springfield  
Wacky-102 WAQY \$ 780 17000v Y

WMUK (FM)  
Western Michigan University  
Kalamazoo, Michigan 49001  
MI Kalamazoo \*WMUK \$ 490 50000v P

MN St. Paul-Minneapolis  
[KY-102 KEFY-FM \$ 820 100000v  
MO Kansas City/ KYYS \$ 940 100000v  
NC Reidsville WRMO \$ 285 50000  
OH Cleveland WDOK \$ 370 50000v  
OH Lima WIMA-FM \$ 250 15000 E

PA Du Bois WCEO-FM 640 11500v  
PA Philadelphia  
Q W100 \$ 650 30000v  
TN Sevierville WSEV-FM \$1090 100000v I  
TX Clear Lake City (Houston)

KMJO \$ 790 97000v S  
TX El Paso K-102 KLOZ \$1190 57000 C  
TX Fort Worth-Dallas  
FM-102 KFWD \$1420 100000v

VA Richmond  
XL-102 WRXL \$ 320 140000  
WA Wenatchee KPO-FM \$2660 35000v A  
WI Milwaukee WAWA-FM 360 50000v ZB

102.3 272 A  
NB Fredericton-St. John  
CBZF 1219 100000v  
AL Opp WAMI-FM \$ 280 3000v  
AZ Bullhead City KRHS -600 3000  
AR Brinkley KBRI-FM 192 3000v  
AR Dardanelle KWKK 260 3000 I  
CA Apple Valley KAVR-FM 53 1850  
CA Compton KJLH \$ 300 3000v U  
CA Mesto KFIV-FM \$ 300 3000v U  
CO Breckenridge KLET \$-230 3000v  
CO Loveland KLOV-FM \$ 143 3000v M  
FL Dunnellon WTRS-FM \$ 300 3000v E  
FL Melbourne WYRL \$ 210 3000v M  
GA Augusta

102-G WNGS-FM \$ 280 3000v S  
GA Buford WGCC 270 3000v Y  
GA Milledgeville WNVG-FM \$ 160 3000  
GA Rome WOTU \$ 790 300v M  
IL Crete WTAS \$ 300 3000v  
IL Eldorado WKSI \$ 300 3000v E  
IL Morton WTAZ \$ 300 3000v N  
IL Rochelle WRHL-FM 181 3000v  
IL Waukegan WEFA \$ 190 3000v U  
IN Logansport WSAI-FM \$ 300 3000v M  
IN Martinsville WCBM-FM 300 3000v  
IA Cherokee KCHE-FM \$ 210 3000v  
IA Forest City 300 3000v  
KY Beatyville WLJC 264 3000  
KY Benton WCBF-FM \$ 300 3000v  
KY Cynthiana WCYN-FM 98 2800  
KY Grayson WGOH-FM 360 2000v

102.5 273 B/C  
AT Red Deer 1560  
ON Ottawa CBOF-FM \$1077 70000v  
AL Jasper WNBW-FM \$ 140 39000v  
AZ Phoenix KNIX-FM \$1620 100000  
AR Texarkana KOSY-FM \$ 260 35400  
CA Salinas KDON-FM \$2270 18500v U  
CA Santa Maria KSMA-FM \$ -57 27000  
CA Woodland KSFM \$ 500 50000  
FL Saratota-St. Petersburg  
Quad 102.5 WQSR \$ .570 100000v M

KY Louisville WLRS \$ 285 3000 A  
KY Mumfordsville WLOC-FM 99 3000  
MD Bethesda WHFS \$ 340 2300v  
MS Ellitsville WBSJ \$ 298 3000v  
MS Gulfport WTAM \$ 285 3000  
MS Philadelphia 116 3000v  
MS Ripley 300 3000v  
MO Canton KQCA 175 3000  
MO Dexter KDEX-FM \$ 51 2360  
MO Wayneville KYSD \$ 480 1000 M  
NH Concord WKXL-FM 285 3000v C  
NJ Cape May WRIO 270 3000v U  
NJ Franklin WSUS 760 3600v M  
NM Espanola KBSO 460 1100v  
NY Babylon WBBB \$ 115 3000v  
NY Canandaigua WFLC 300 3000v E  
NY Saratoga Springs  
WKAJL-FM 74 3000 U  
NY Waverly WAVR \$ 400 1500v E  
NC Goldsboro WOKN \$ 275 3000v B  
NC Lumberton WJUSK 270 3000v  
NC Roanoke Rapids  
WPTH \$ 300 3000v  
OH Gallion WQLX \$ 300 3000v E  
OH Holland WPOS \$ 300 3000v  
OH Wilmington WDHK 300 3000v M  
OK Duncan KRHO-FM \$ 159 3000v U  
OK Eufula KCES 187 3000  
OR Coquille 17 3000v  
PA Carlisle WHYL-FM 165 3000v M  
PA McKean WMDI \$ 400 1500v M  
SC Pageland WCPL-FM \$ 300 3000v  
SD Mitchell WMIT \$ 300 3000v  
SD Vermillion WKVF \$ 255 3000v  
TN Carthage WGRM-FM \$ 300 3000v  
TN Dickson WTNQ 250 3000  
TN Humboldt WTRJ-FM 310 2830 E  
TN Saddy-Daisy WZDQ \$ 286 3000v  
TX Alice KBIC \$ 300 3000v  
TX Austin KBXX \$ 550 740v  
TX Center KLCR 300 3000v  
TX Jasper KTXJ-FM 142 2920 U  
TX Vernon KWVC-FM 340 650 U  
VT St. Albans WNSR-FM \$ 215 3000  
WA Marlen WOLD-FM \$ 300 3000v M  
WV Weston WSSN 490 940v



WI Berlin WISS-FM 160 1690v  
WI Two Rivers  
15-Q WQIC-FM 250 3000 Y  
WI Viroqua WGRM \$ 300 3000v

102.5 273 B/C  
AT Red Deer 1560  
ON Ottawa CBOF-FM \$1077 70000v  
AL Jasper WNBW-FM \$ 140 39000v  
AZ Phoenix KNIX-FM \$1620 100000  
AR Texarkana KOSY-FM \$ 260 35400  
CA Salinas KDON-FM \$2270 18500v U  
CA Santa Maria KSMA-FM \$ -57 27000  
CA Woodland KSFM \$ 500 50000  
FL Saratota-St. Petersburg  
Quad 102.5 WQSR \$ .570 100000v M



102.5

GA Waycross WLTE \$ 510 100000v C  
 IN New Castle-Muncie WMOH \$ 440 21000v  
 IA Des Moines Q-102 XRNQ \$ 510 100000v  
 LA Baton Rouge FM-102 WFHF \$ 560 100000v A  
 MD Princess Anne WOLC \$ 500 50000v  
 MA Waltham-Boston WCRB \$ 920 110000v I  
 MI Bay City-Saginaw-Midland WGER \$ 740 86000v S  
 MN Willmar KOIC \$ 390 70000v Y



Our Gospel Music Station

MO Joplin KPCG \$ 440 100000v U  
 MO St. Louis KEZK \$ 450 100000v V  
 NY Buffalo Rock-102 WBEH-FM \$1340 110000v  
 NC Hendersonville WKIT \$ 330 100000v A  
 OH Zanesville WHIZ-FM 490 20000v N  
 OR Newport KNPT-FM \$ 890 100000v I  
 PA Pittsburgh WQVE \$ 820 55000v V  
 PA Reading-Pottstown WRFY \$ 810 15000v A  
 SC Charleston WKTM \$ 195 50000v Y  
 TX Hillsboro KHBR-FM 155 3200  
 VA Winchester WFFG \$ 330 21000  
 WA Seattle (R-102) K20X-FM \$1170 100000v A  
 WI Madison \*WABC \$ 460 50000 U

102.7 274 B/C

BC Vancouver \*CFRO 647 3717v  
 NJ Halifax CBH-FM \$ 711 100000v Y  
 NY Dryden 1500  
 FG Chertokee City CITE-1 \$1851 62000  
 CA Fresno KKEY \$ 500 50000v D  
 CA Los Angeles KLIIS-FM \$2460 8000v Y  
 CO Manitou Springs K110-FM \$2000 50000v I  
 FL Milton-Pensacola WPEM \$ 590 100000v I  
 FL Fortann Beach-Fort Lauderdale WFTD \$ 350 100000v Y  
 IL Du. Park-Chicago WPEW \$1170 5000v  
 IN Terre Haute WFRF \$ 860 14000v C  
 MD Baltimore W-103 WJW \$ 400 50000v  
 MI Mount Clemens (Stereo-103) WRRW-FM \$ 490 17000v I  
 NE Lincoln WFBZ-FM \$ 419 160000v A  
 NY New York WISL-FM \$1000 3000v S  
 NY Westchester WJAG \$ 470 100000v N  
 OH Cincinnati WBEW \$ 419 10000v Y  
 OH Cleveland WCCF-FM 100 5000v Y  
 SC Columbia, S.C. W-103 WJL \$ 210 50000v A  
 VA Williamsport WJW-FM \$1170 5000v N  
 VA Winchester WJW \$ 490 50000v C  
 WA Tacoma WJW \$ 419 10000v

WA Richland KORO-FM \$ 860 100000  
 WV Charleston WTIO 400 45000v N  
 WI Suring WRVM \$ 500 100000

101.9 275 B/C

PO La Pocatiere CHGB-FM 244 790  
 AR Harrison KNOZ-FM \$ 630 12500v A  
 CA Berkeley KRE-FM \$ 170 50000h E  
 CA San Diego KEZL \$1840 1950v  
 CT Hartford WDRG-FM \$ 810 15000v  
 FL Jacksonville WIVY \$ 570 60000v V  
 GA Columbus WRBL \$1520 100000v M  
 ID Jerome KFMA \$ 760 100000v  
 IL Decatur WSOY-FM \$ 450 54000v V  
 IA Cedar Rapids Q-103 KQSR \$ 390 100000v  
 KS Hutchinson KHUT \$ 155 28500 N  
 LA Crowley KAJN-FM \$ 450 100000v  
 ME Portland WGAN-FM \$1460 100000v  
 MO Cumberland WPMV \$1420 3500v  
 MI Ann Arbor WIOB \$ 155 10000v A  
 MI Grand Rapids WFUR-FM \$ 255 40300v  
 MN Minneapolis-St. Paul WCCO-FM \$1300 100000v Y  
 MS Jackson Q-102 WZZO \$1800 100000v  
 MO Cape Girardeau KFMP \$ 680 24000v E  
 MO Marshall KMFL \$ 377 56000v V  
 MT Billings 500 100000v  
 NY Syracuse WJHR \$ 722 11900v  
 NC Hickory WKHY-FM \$ 325 14800 A  
 OH Springfield WBLV-FM \$ 160 50000v M  
 PA Philadelphia WMGK \$1010 12500v I  
 PA Sharon Y-103 WYFM \$ 460 71000v  
 TN Shelbyville-Tullahoma WTCV 510 100000h E  
 TX Dallas WMDG \$1570 100000v  
 TX Houston KQUE \$ 540 280000h I  
 VA Norfolk WQWI \$ 471 50000v Z  
 WA Centralia KELA-FM 300 28000h M  
 WA 4700v



WI Milwaukee WBCS-FM \$ 430 50000v DM  
 WY Laramie K-102 K102 \$1150 30000v H  
 103.1 276 A  
 AZ Calipary CJZY  
 AZ Portland Creek CBZP \$50  
 AZ Coloburg CCMY \$ 117000  
 AR El Dorado KEZU \$ 209 3000v N  
 AR Helena KCR1 \$ 700 3000v E  
 CA Indio KMS \$ 622 525v  
 CA Newport Beach KOLM \$ 300 2000v  
 CA Santa Monica WJFF \$ 495 1450v  
 CA Santa Ana Lake KTHO-FM \$400 10000v A  
 FL De Faria Springs WJLW \$ 100 4000v  
 FL Green Cove Springs WJMC 250 1200v  
 FL Jacksonville WJW 200 3000v  
 FL Panama City WJCS \$ 100 1000v  
 FL Panama City WJZZ \$ 100 1000v  
 FL Palm Bay-Dunedin WJW 100 1000v  
 FL Palm Bay-Dunedin WJW 100 1000v

IL Lawrenceville WAKO-FM 237 3000h M  
 IL Rockton WRWC \$ 300 3000v  
 IN Huntington WHLI-FM 91 3000 M  
 IN South Bend WHME \$ 160 3000v A  
 IA Clear Lake 300 3000v

KNDY RADIO

1570 ON YOUR AM DIAL  
 103.1 ON YOUR FM DIAL

KS Marysville KNDY-FM 200 3000v  
 KY Elkhorn City WECL \$1370 120v  
 KY Georgetown WJWF-FM 300 3000v M  
 KY Greensburg WGRK-FM 175 2750v  
 KY Henderson KC-103 WHXC 300 3000v A  
 KY Manchester WXLX-FM 310 2850v  
 KY St. Matthews Disco-103 WSTM \$ 135 2950v U  
 MI Lapeer WTHM-FM 300 3000v  
 MN Preston KFIL-FM 270 3000v  
 MS Columbus WJWF \$ 265 3000v N  
 MS Ocean Springs WOSM \$ 300 3000v  
 MO Caruthersville KCRV-FM 195 3000v  
 MT Helena KCAP-FM \$-250 3000v C  
 NM Las Cruces KASK \$-110 780v A  
 NY Albany WHRL \$ 400 1450h  
 NY Newburgh-Beacon WFMN \$ 200 3000v  
 NY Oneonta WONT \$ 360 2000v I  
 NC Dunn WQI \$ 300 3000v  
 OH Johnston WJWJ \$ 300 3000v S  
 OH Napoleon WJWB \$ 300 3000v E  
 OH Roseburg KRSH \$ 310 2750v E  
 PA FreeLand WJCH \$ 680 450v  
 PA Indiana WJMU \$ 170 3000v  
 PA State College WJLR \$-55 3000v  
 PA Waynesburg WANB-FM \$ 620 550v  
 SC Hampton WJWB 142 3000  
 SC Home Path KRIX \$ 300 3000v  
 SC Surfside Beach-Garden City WYAK 300 3000v  
 SD Madison KJAM-FM 300 3000v U  
 TN Etoah WJCC -14 3000v  
 TX Ballinger KWBB \$ 300 3000v  
 TX Cooperas Cove WJCV \$ 320 2500v E  
 TX Muleshoe WJML-FM 72 3000  
 VA Culpepper WJCL \$ 300 3000v  
 WV Parkersburg WJAW \$ 550 730 I  
 103.3 277 B/C  
 ON Ottawa (Geo-FM) \$1077 70000v  
 ON Montebony WREZ \$ 240 27500v M  
 CA Modesto WEEE-FM \$ 150 10500v U  
 CA Santa Barbara Kruz \$240 105000v E  
 CA Ukiah WJLF \$1835 1900v S  
 FL Bradenton-Sarasota WJWV \$ 450 100000v  
 GA Atlanta W-103 WJEL \$ 450 100000v  
 GA Waycross WJCL-FM \$ 240 100000v A  
 IN Indianapolis WJIZ \$ 650 13000v  
 IL Peoria WJLL \$ 370 100000v A  
 IL St. Louis City WJFC 209 10000v  
 MD Hager WJCS \$ 445 100000v  
 LA Hammond WJWV 100000v M  
 LA Love WJWV \$ 515 50000v  
 MA Boston WJEL-FM \$ 650 12000v C

103.3

MI Battle Creek	WKFR	\$ 370	27000v
MN Duluth	*WDTH	\$ 550	100000v
MN Fergus Falls	KBRF-FM	\$ 270	28500v M
MO Kansas City	KPRS	\$ 459	100000v Z
MO St. Louis	KMOX-FM	\$ 920	100000v Z
NJ Princeton	WPRB	\$ 195	17000v A
NY Buffalo	WPHD	\$ 340	49000v Y
OH Cleveland	*WCRF	\$ 660	25500v A
OK Tulsa	KKUL	\$ 195	100000vZA
PA York-Lancaster			

WSBA-FM	\$ 750	7900v	
TN Nashville	WKDF	\$ 410	100000v
TX Midland-Odessa	KMMJ	\$ 922	100000v
TX Nacogdoches	KJCS	\$ 360	100000 Y

**KOUL Radio Station**

POST OFFICE BOX 888

Corpus Christi, Texas 78403

TX Sinton	KOUL	\$ 310	100000v S
TX Wichita Falls	KNTD	\$ 450	100000v
VA Danville	WAKG	\$ 660	100000v
VA Tasley	WESR-FM	\$ 320	50000
WV Huntington	WHEZ	\$ 490	50000v
WI Wisconsin Rapids		\$ 330	72500h
W-103 WWRW			8400v

103.5 278 B/C

AT Red Deer			1560
BC Vancouver	CHQM-FM	\$1630	65000h 10000v
NS Halifax			100000
SA Buffalo Narrows			
CBND		435	406v
CA Los Angeles	KOST	\$3100	12500v
CO Denver	Q-103 KOAQ	\$1060	100000v C

**Wgins 570AM 103.5FM**  
WASHINGTON'S FINE ARTS STATIONS

DC Washington	WGMS-FM	\$ 510	47000v
FL Fort Lauderdale-Miami			
IL Chicago	WFYR	\$ 860	12500v
MI Detroit	WMIUZ	\$ 300	115000h 89000v
MI Traverse City	WTGM-FM	\$ 715	38100v N
MN Mankato	KYSM-FM	\$ 530	82000 N
MS New Albany	WNAU-FM	\$ 79	36000
NY Lake Success	KTFM	\$1400	36000h 3400v U
OH Hamilton	WYCH	235	13500v Y
OH Steubenville			12000h
Rocky 103 WRKY		\$ 880	9500v
SC Charleston	WEZL	\$ 275	25000v S
TN Knoxville	WBIR-FM	\$1720	100000 E
UT Salt Lake City	KRSP-FM	\$3630	18500v

103.7 279 B/C

NB Grand Manan	CBZA	232	1575v
AL Gadsden Q-104	WOEN	\$ 1080	100000vDY
AR Little Rock	KKYK	\$1510	95000v
CA Hanford K-104	KIOY	\$ 500	50000v H
CA San Diego			
Z-104 KOZN		\$ 580	36000v
CA San Francisco	KSFX	\$1450	7000v A

FL Gainesville	WRUF-FM	\$ 360	27000 C
IL Springfield	WDRB	\$ 320	19000v
IN Bloomington			

WFIU

FM 103.7 Megahertz

*WFIU	590	34000vPU	
IA Atlantic	KJAN-FM	\$ 240	100000v U
IA Davenport	KIHK	\$ 760	100000v N
KS			



STEREO \* FM 104

Wichita	KEYN	\$ 860	95000v
KY Murray	WAAR	\$ 300	100000 A
LA Lake Charles			
Nova-104	KGRA	\$ 470	100000v
MD Havre de Grace			
WHDG	340	17500 M	
MS Hattiesburg	WHER	\$ 299	100000 N
3000h			
MO Lebanon	KJEL-FM	\$ 255	25000v
NH Berlin	WXLQ	160	17000
NH Keene	WNBX	\$ 530	42000v C
NJ Atlantic City			
Rock-104	WMGM	\$ 145	20000v
NJ Newton			
XL-Country	WIXL	\$ 140	5000 E
NY Ithaca	WEIV	\$ 890	12000 U
NC Charlotte	WSOC-FM	\$1040	98000v I
NC Williamston	WSEC	\$ 175	50000v
OH Tiffin	WTTF-FM	125	3800 E
OR Lebanon	KOMS	\$ 285	30000v
PA Erie	K-104 WCCK	\$ 500	50000v Y
RI Westerly	WERI-FM	140	16000 M
TX Dallas-Highland Park-Fort Worth			
KVIL-FM	\$1570	100000v E	
TX San Marcos	KCSW	\$ 530	97000v A
VA Richmond			
EZ-104	WEZS	\$ 440	74000
WV Beckley	WCIR-FM	\$ 360	25000 M
WI Wauwatosa-Milwaukee			
WEZV	\$ 820	19500v	
WI Ladysmith	WWIB	\$ 680	100000v U

103.9 280 A

AT Calgary	CBRF	1040	10000v
NF Roddickton	CBTR		2000
NB Noncton	CFOM		24600
SA Saskatoon	CFMC	\$ 110	6020
AL Ozark	WAYD-FM	189	3000v
AK Anchorage	KKLV	\$ 54	2800 S
AR Ashdown	KMLA	210	3000v
AR Fayetteville	KNWA	\$ 510	800v
AR Pocahontas	KPOC-FM	147	3000v
CA Inglewood	KACE	\$ 390	1600v
CA Lake Arrowhead		2541	38v
CA Salinas	KRAY	\$-135	3000v
CA Yuba City			
FM-104	KHEX	110	3000v
CO Canon City	KSTX	-530	3000v
CO Oak Creek	KFMU	\$1030	265v
FL Cape Coral	WRCC	\$ 300	3000v S

GA Blue Ridge	WPPL	240	3000
GA Hawkinsville	WCEH-FM	255	3000
GA Springfield	WGEC	300	3000v
ID Moscow	KRPL-FM	\$ 990	180v E
IL Dundee	WVFV	\$ 300	3000v Y
IL Flora	WDOI	\$ 300	3000v A
IL Urbana	WTWC	\$ 145	3000 M
IN Batesville	WBRI	\$ 160	1950v
IN Crawfordsville			
WLFQ	\$ 500	920v	

IN Crown Point			
104	WFLM	\$ 300	3000v M
IN Fort Wayne	WXKE	\$ 250	3000v N
IN South Bend	WBRB	\$ 155	3000v
IA Waukon	KNEI-FM	300	3000v
KS Hiawatha	KNZA	\$ 300	3000v
KY Campbellsville			

WTCO-FM	330	2350	
KY London	WFTG-FM	190	3000v
KY Louisville	WFIA-FM	\$ 490	950v
KY Whitesburg	WYXQ	940	210

MD Braddock Heights			
Q-104	WZYQ-FM	\$ 910	230v Y
MI Adrian	WLEN	300	3000v M
MI Iron Mountain	WJNR	\$ 620	560v S
MI Owosso	WOAP-FM	\$ 300	1600v
MN East Grand Forks			
KRAD-FM	145	3000v M	
MS Cleveland	WCLO-FM	\$ 300	3000v
MS Columbus	WACR-FM	205	3000v
MO Chillicothe	KCHI-FM	400	1550v
MO Montgomery City			

KVCM	\$ 241	3000v U	
NE Crete	KTAP	225	3000v
NE Superior	KRF5-FM	59	500v
NH Las Cruces	KGRD	\$ 150	3000v
NY Oneonta	WSRK	\$ 528	850v Y
NY Rensselaer			
Q-104	WQBK-FM	\$ 300	3000v A
NY Riverhead			
FM-104	WRCN-FM	\$ 320	2600v

NY Rochester	WDXX	\$ 300	3000v B
NY White Plains	KWYD	\$ 670	500v
NC Fuquay-Varina			
WAKS-FM	\$ 350	2100v	

OH Westerville			
Y-104	WBBY	\$ 356	2000v A
OH Xenia	WHBM	195	3000v
PA Bellwood-Alltoona			
WHGM	870	250	
PA Jenkintown	WIBF-FM	1000	270v E
PA Mercer-Sharon			
10-4	WKIZ	\$ 300	3000v U

PA Scottsdale			
FM-104	WLSN	780	329v M
SC Easley	WELP-FM	330	2500v U
SC Orangeburg	WDRG-FM	300	3000v M
TN Erwin	WXIS	\$-433	3000v E
TN Jamestown	WDEB-FM	\$ 450	1200v
TN McMinnville	WBMC-FM	\$ 130	3000v
TX Marshall	KMHT-FM	\$ 300	3000v
WA Tacoma	KBRD	\$ 490	950v
WV New Martinsville			
WKGI	\$ 300	3000v	
WOSH	\$ 330	2450v	

104.1 281 B/C

AL Atoore	WATH-FM	193	29000
CA Modesto	KHOP	500	50000v M

W-104 WIOF	\$ 840	14000v E
FL Cocoa Beach WRKT	\$ 165	30000v N
FL Tallahassee		
Quad-104 WGLF	\$ 440	38000v A
GA La Grange WJCG	\$ 220	29500v O
IL Jerseyville WJBM-FM	\$ 380	50000
IN Evansville WKY-FM	\$ 460	50000v O
IN Muncie WLCB-FM	\$ 420	50000v

# KL104 FM

P.O. Box 1647 - AMES, IOWA 50010

IA Ames KLFM	\$ 460	100000v
LA Houma KHOM	\$ 295	56000v
LA Monroe KWEZ	\$ 175	17000 N
MO La Plata WXTR	500	50000v
MA Boston WBCN	\$ 740	19000v

## WVGR GRAND RAPIDS

104.1 MHz



MI Grand Rapids WVGR	\$ 600	110000 P
MN St. Louis Park		
KFMX	\$ 190	52300v A

NY Buffalo		
FM-104 WWOL-FM	\$ 225	50000v
NC Winston-Salem WTQR	\$ 1420	50000v
OH Cleveland WOAL	\$ 1080	7100v
OH Portsmouth WPAY-FM	\$ 610	93000h C
OK Oklahoma City KOFM	\$ 1360	96000v
PA Allentown		

W-104 WYXW	\$ 500	50000v
PA Harrisburg WTPA-FM	\$ 670	10000v
SC Conway WLAT-FM	\$ 140	65000v
SD Yankton KQHU	\$ 430	100000 Y
TN Jackson WKIR	\$ 660	100000h A
TX Brownwood KLSH	\$ 205	25000v A
TX Edinburg-McAllen		
KBFM	\$ 320	100000v U
TX Houston KRBE	\$ 790	96000v
WA Yakima KUCZ	\$ 780	61000v
WI Madison Z-104 WZEE	\$ 1120	6300v

## 104.3 282 B/C

AZ Lehighbridge CHFA-1	466	1660v
EB Fairford CBWZ	214	11800v
ON Sault Ste. Marie		
KCY-FM	\$ 103	6760
FG Drussonville CFDM	\$ 132	50000v
AL Athens WJOF	610	50000
CA Los Angeles		
FM-104 KBIG	\$ 2890	78000v
CO Longmont-Boulder		
Super O KLYO-FM	88	28000 A
GA Augusta W3BQ-FM	\$ 560	100000h M
		37000v
ID Boise	1794	50000v
IL Chicago WJEZ	\$ 820	14000v
KS Great Bend KWGS-FM	\$ 810	96000v N
ME Gardiner-Augusta		
WME	\$ 340	14500v

MD Baltimore		
DJ-104 WDOJ	\$ 420	50000v M
MI Detroit WDMC	\$ 360	190000v
MO Kansas City KBEQ	\$ 950	100000v
NY New York WNCN	\$ 1220	5400h 3800v
NY Utica XG-104 WKGW	\$ 1150	100000h 33000v I
NC Tarboro WKTC	220	100000v
OH East Liverpool		
WELA	\$ 330	26000
TX Borger KBBB-FM	175	26000v
UT Salt Lake City		
KSOP-FM	\$ 3630	25000v

WA Bellingham		
K-104 KERI	\$ 2300	51000vMU

## 104.5 283 B/C

OH Cornwall CFLG	300	9500v
OH Toronto CHUM-FM	\$ 1380	40000v
CA Atascadero KIQO	215	50000v
CA San Francisco KFOG	\$ 1450	7900v
FL West Palm Beach		
WEAT-FM	\$ 520	100000v
WGPC-FM	\$ 141	43000 C
IL Springfield WFMF	\$ 245	20000v I
IN Indianapolis WJAC	340	38000v
IA Cedar Rapids KTDF	550	100000v
MA Fitchburg WFMP	280	50000 U
MI Muskegon WQWQ	\$ 360	50000v A
MS Hattiesburg WHSY-FM	\$ 130	50000v
NE Omaha KOOD-FM	\$ 285	31400v M
NV Reno KSRN	\$ 2900	25000

## WWST AM 960



## FM Stereo 104.5

### Total Entertainment

OH Wooster WWST-FM	\$ 330	5200v
OK Pryor KKMA	323	100000v I
OR The Dalles KCIV	\$ 1890	25000v
PA Philadelphia WSHI	\$ 1010	5000v
PA Wellsboro-Mansfield		
WGCR	\$ 380	50000v
TN Gallatin WHIN-FM	\$ 770	50000v
TX Memphis		
Quad-104 WQUD	\$ 750	100000v
TX Dallas K-104 KKDA-FM	\$ 700	100000v
TX Orange KOB3	215	55000
TX San Antonio KITE-FM	\$ 660	100000v
VA Norfolk		
Super O WGRK	\$ 410	9100v
WV Bluefield WNAJ	\$ 1200	83000v
WI Eau Claire WAXX-FM	\$ 1800	85000v I

## 104.7 284 B/C

BC Kelowna CJOV	\$ 1611	3800
PQ Quebec CBVE		100000
AL Birmingham WZZK	\$ 300	100000v A
AK Fairbanks KUAC	\$ 440	10500v P
AZ Mesa K-104 K10G	\$ 1550	100000v
CA Oxnard K-105 KACY-FM	1580	2850v M
CA Palmdale KDES-FM	\$ 540	42000v Y
CO Vail X-104 KVM1	\$ 1700	76000v E
FL Tampa-St. Petersburg		
Q-105 W9BQ	\$ 560	100000v
GA Athens Q-105 W9SQ	\$ 230	50000 Y
IL Morris WCSJ-FM	105	3400

IN Elkhart		
FM-105 WXAX	\$ 460	50000v
IN Jasper WITZ-FM	\$ 390	50000v
MO Hagerstown WMOO	\$ 1320	9400v E
MO Ocean City-Salisbury		
FM-105 WBOC-FM	\$ 610	30000v C
MA Orleans WLOM	\$ 300	50000h S
MI Escanaba WFNH	345	100000v D
MN St. Cloud KCLD-FM	\$ 460	100000v N
MO Moberly KRES	\$ 482	50000v
NY Fulton		
FM-Rock WKFM	\$ 310	50000v
NY Poughkeepsie WSPK	\$ 1250	5000v M
NC Charlotte WEZC	\$ 1230	100000h 91000v
OH Dayton WTUE	\$ 500	50000v
OH Toledo WLOT	\$ 540	50000v
PA Pittsburgh WYDD	\$ 500	50000v A
SC Columbia WNOX-FM	\$ 460	100000 Y

# KIOV

STEREO 105 FM

Sioux Falls, South Dakota 57102

SD Sioux Falls KIOV	\$ 740	100000v N
TX Lamesa KCOT	\$ 225	100000v
VA Crewe WSVS-FM	450	14000 M
WA Ocean Shores KDXU	\$ 360	31000h U
		21000v

## 104.9 285 A

AL Jackson WHOD-FM	297	3000 M
AL Ozark W0AB	180	2850
AL Union Springs WQSI	265	3000v
AR Crossett KAGH-FM	\$ 275	3000
AR Hope-Prescott KHPA	\$ 300	3000v
AR Paragould		

K-105 KHIG	\$ 250	3000v
AR Springdale KCIZ	\$ 130	3000 U
CA Fremont KFMR	\$ 115	3000v

CA Pacific Grove		
FM-105 KOCN	550	950v
CT Middletown WJHS	\$ 300	2900

FL Atlantic Beach		
WJNJ	285	3000
FL Crestview WAAZ	\$ 276	3000 C
GA Columbus WFXE	\$ 165	3000v A
GA Metter G-105 WHCG	300	3000v
ID Pocatello KRBU	-580	3000v
IL Belvidere WYBR	\$ 300	3000v A
IL Columbia WCBW	235	3000v
IL Fairfield WFIN-FM	197	3000v
IL Geneseo Q-105 WRSQ	\$ 300	3000v
IL Murphysboro-Carbondale		

WTAO	\$ 200	2900v
IL Pekin WZRO	\$ 263	3000v
IL Shelbyville WSHY-FM	\$ 120	3000

IN Columbus		
Tri-W-Y W3WY	\$ 300	3000v M

IN Rockville-Clinton		
WAXI	440	1200v
IA Hampton KQKJ	94	3000
IA Oskaaloosa KBOE-FM	283	2900 U
IA Perry KXLS-FM	\$ 298	3000v M
KS Emporia KLRP	\$ 280	3000v I
KY Frankfort WKYW	\$ 260	3000 M
KY Jamestown-Russell Springs		
WJRS	360	2000 M



104.9

KY Leitchfield	WMTL-FM	185	3000	E
KY Princeton	WPXY-FM	175	3000v	
KY Stanton	WSKV	\$ 680	440v	
LA Abbeville	KROF-FM	\$ 300	3000v	
LA Donaldsonville				
	KSMI	\$ 300	3000	A
LA Jonesboro	KTOC-FM	\$ 245	3000	
LA Oakdale	KCWR	230	1500v	
MA Gloucester	WVCA	167	2250	
MI Alma-St. Louis				
	WFYC-FM	300	3000v	
MI Caro				
	Ideal Radio	WIDL	300	3000v
MI Marshall	WELL	300	3000v	
MN Breckenridge	KKNB	\$ 155	3000	
MN Owatonna	KRFO-FM	175	2900	
MS Centerville	WZZB	300	3000v	
MS Iuka	WTIB	225	3000v	
MS Moss Point	WKKY	\$ 165	3000	M
MO Carthage	KRKG	\$ 160	3000	
NE Wayne	KTCH-FM	\$ 300	3000v	
NE York	KARL-FM	\$ 310	2750v	
NJ Egg Harbor City				
	WRDR	280	3000	
NM Mesilla Park	KOPE	\$ -32	3000v	
NY Johnstown	WJZR-FM	300	3000	I
NY Montour Falls	WXXY	\$ 480	1000v	
NC Havelock-Cherry Point				
	WKVO-FM	165	3000v	
NC Raurah City	WKSJ	400	1500v	M
ND Mandan	KNDR	\$ 290	3000v	
OH Gahanna				
	FM-105	NCVO	\$ 300	3000v
OH Lima	WLSR	\$ 220	3000v	A
OH Lorain				
	FM-104.9	WZLE	\$ 300	3000v
OK Bethany	KJIL	\$ 255	3000v	
PA Hollidaysburg	WHPA	122	1220v	
PA Scranton	WBDL	\$1090	145v	S
TN Clinton	WYSH-FM	\$ 300	3000v	
TN Dayton	WJFM	198	3000	M
TN Union City	WALR	300	3000v	I
TN Waverly	WVRY	220	3000v	
TX Beeville	KCWW	300	3000v	
TX La Grange	KHUZ	203	3000	
TX Rosenberg	KFRD-FM	232	3000v	U
TX Temple	KPLE	\$ 300	2900v	U
TX Uvalde	KYUF	\$ 125	3000v	
VA Blacksburg				
	V-105	WVVV	\$ 310	2700v
VA Gate City	WGAT-FM	480	1000v	M
WA Pullman	KOOQ	\$ 70	3000	
WA Wenatchee	KIAM	\$1130	105v	U
	WPDJ-AM & WPDJ-FM			
	Clarksburg, W. Va.			
WV Clarksburg	WPDJ-FM	\$ 320	2500v	
WI Antigo	WRLO	\$ 280	3000v	U
WI Hartford	WTKM-FM	300	3000v	
WI Kaukauna	WKAU-FM	\$ 200	3000v	U
WI La Crosse				

**WLXR**  
 GREAT AMERICAN COUNTRY  
 THE STATE  
 BROADCASTING INC.  
 800-541-1010 & 735-6111  
 1111 S. GARDNER ST. SUITE 200  
 MILWAUKEE, WI 53212  
 WLXR \$ 430 1350v

WI Reedsburg	FM-104	WRDB-FM	\$ 230	3000v
--------------	--------	---------	--------	-------

105.1 286 B/C

MB Waasagonach	CBWD	129	1700v	
ON Peterborough	CKQM		50000	
SA Ile-a-La-Crosse				
	CBKC	412	403v	
AL Albertville	WQSB	\$ 320	20000v	S
AR Conway				
	Cliff-105	KKLF	330	27200
CA Los Angeles	KBCA	\$2920	17500v	U
CA Sacramento	KEWT	\$ 420	50000v	
CO Denver	KADK	\$ 175	100000v	A
FL Coral Gables	WYOR	\$ 600	100000v	
FL Orlando				
	BJ-105	NBJW	\$1380	100000v
ID Boise	KJOT	\$2574	43000v	
IL Evanston-Chicago				
	WJOJ	1170	6000v	E
IL Quincy	WGM-FM	\$ 640	27500v	E
ME Skowhegan	WTOS	\$2420	25000v	
MI Cheboygan	WCBY-FM	\$ 105	25000v	I
MI Detroit	WORS	\$ 480	50000v	



MN Duluth	WQGR	\$ 750	100000	
MS Kosciusko	WKQZ-FM	\$ 106	28300	
MO St. Joseph				
	FM-105	KSFT	\$ 225	27500v
NY De Ruyter	WQIV	\$ 540	42000v	U
NY New York	WRFM	\$1220	5400h	
			3700v	
NC Durham	WDCG	\$ 380	36000	E
OH Cincinnati	WUBE-FM	\$ 920	11000v	
OH Salem	WSOH-FM	\$ 400	100000	
OR Salem	KORI	\$ 850	100000v	
PA Ephrata	WIOV	\$ 500	50000v	E
PA Williamsport				
	Q-105	WILQ	1140	3800v
RI Providence				
	JB-105	WPJB	\$ 500	20000
TX Abilene	KNIT-FM	\$ 174	49000	
TX Lufkin	KLUF-FM	660	57000v	
VA Arlington-Washington DC				
	WAVA	\$ 500	50000v	U
WV St. Albans	WKLC-FM	\$ 500	50000	M

105.3 287 B/C

MB Baldy Mountain				
	CBWW	1064	95000v	
			100000h	
ON Kitchener	CFOA	\$ 812	88000v	
ON Ottawa	CKBY	\$1077	74000v	
			120000h	
CA San Diego	KITT	180	31000v	I
CA San Francisco	KBRG	\$1200	15000v	
GA Macon	WDM-FM	\$ 145	50000v	S
			50000h	
IN Evansville	WVHI	320	17000v	M
IN Lafayette	WASK-FM	\$ 310	50000v	
IA Dubuque	KIWI	\$ 330	50000v	I
LA Slidell	WXEL	\$ 350	100000v	Z
MD Frostburg	WFRB-FM	\$ 860	16500v	
MO Rolla	KZNN	\$ 155	28500v	I
NY Hornell	WWHO-FM	560	8300	
OH Mansfield	WCLW-FM	\$ 370	50000v	N
PA Philadelphia	WDAS-FM	\$ 870	3300v	Z
SC Gaffney	WAGI	\$1190	100000v	

TX Dallas-Fort Worth 105.5

	KDAX	\$1560	100000v	
TX Seguin	KWEO-FM	\$ 130	38000v	U
VA Norfolk	WXRI	\$ 500	50000v	
WA Edmonds-Seattle				
	KBIQ	\$ 720	115000v	
WA Kennewick	KONA-FM	\$1180	100000v	A

**105.5 288 A**

BC Vernon	CBVY	560	1880v	
AL Bay Minette	WWSM	340	2300	U
AL Muscle Shoals	WLAY-FM	\$ 300	3000v	M
AL Tuscaloosa	WACT-FM	\$ 70	3000	U
AK Anchorage	KNIK	\$ 265	3000	
AZ Casa Grande	KBFE	\$ 70	3000v	M
AR Nashville	KNAS	85	3000v	
AR Newport	KOKR	220	3000v	
AR Warren	KNRF-FM	265	3000v	
CA Davis	XYLO	300	3000v	
CA Hemet	KHSJ-FM	-263	660	E
CA Long Beach	KNAC	\$ 400	1600v	
CA Ojai	KOVA	\$1180	130v	
CO Security	KWVD	\$ -58	3000v	
CT Groton	WSUB-FM	\$ 275	3000	E
FL Gainesville	WGVL	\$ 265	3000v	
FL New Port Richey				
	WGUL-FM	\$ 255	3000v	
FL Sarasota	WKZM	180	3000	
FL Sebring	WSKP	150	3000	M
FL Vero Beach		300	3000v	
GA Canilla-Pelham				
	WEBI	300	3000v	
GA Canton	WCHK-FM	81	3000v	
GA Jesup	WIFO	\$ 300	3000v	I
GA Rossville	WORE	\$ 270	3000v	
IL Monticello	WVLJ	\$ 300	3000v	U
IL Woodstock	WIFF	\$ 300	3000v	U
IN Auburn	WRRF-FM	\$ 300	3000v	
IN Bedford	WBIF	\$ 245	3000v	
IN Valparaiso	WLJE	\$ 235	2700v	I
IN West Terre Haute				
	WVWR	295	3000	
IA Mount Pleasant				
	KILJ	300	3000v	
IA Sheldon	KIRA-FM	\$ 97	3000v	M
IA Twin Lakes	XTLB	\$ 300	3000v	
KS Chanute	KQSM	\$ 162	3000v	
KY Fort Knox	WSAC-FM	\$ 300	3000v	U
KY Glasgow	WQVO	\$ 480	1000v	
KY Liberty	WKDO-FM	205	3000v	
KY Mount Sterling				
	WWSJ-FM	\$ 300	3000	
KY Prestonsburg	WPRT-FM	389	1680	
LA Franklin	KFRA-FM	165	3000v	I
LA Leesville				
	Stereo-105	KVVP	\$ 300	3000v
MA Pittsfield	WQRB	\$ 590	630v	
MI Flint	105-FM	WKCK	\$ 330	2350v
MI West Branch	WBMI	300	3000v	
MN Cambridge	KABG	\$ 300	3000v	U
MN Red Wing	KCUZ-FM	\$ 340	2300v	

**KRBI**  
 RADIO  
 ST. PETER — LE SUEUR  
 105.5 FM/1310 AM  
 MN St. Peter KRBI-FM 129 3000  
 MS Aberdeen-Anory WHAY \$ 130 3000v



106.3

MD Cambridge	WESP-FM	\$ 300	3000v U
MI Ludington	WKLA-FM	\$ 250	3000
MI Saginaw W-106	W10G	\$ 300	3000v
MN Hibbing	WWFG-FM	\$ 270	600 I
MN Princeton	WOPM-FM	\$ 295	3000v S
MS Clarksdale	W10D	\$ 300	3000v
MS Newton	WNYQ	\$ 158	3000v N
MS Pascagoula	WGDG	\$ 350	2350v
MS Picayune	WJ0J	\$ 177	3000v Y
MS Starkville	WSMU	\$ 220	3000 N
MO Boliver	KLTB	\$ 200	3000
MO Branson	KIRK	\$ 206	3000
MO Cabool	KVVC	\$ 192	3000v
MO Portageville	WKIS-FM	\$ 230	3000v I
MT Great Falls	K00Z	\$ 300	750v
NE Lincoln	KHAT	\$ 145	2900v
NH Nashua	W0TW-FM	\$ 165	3000 N
NJ Blairstown	WFMV	\$ 860	265v
NJ Eatontown	WHTG-FM	\$ 200	3000v
NJ Ocean City	WRLT-FM	\$ 310	2900v N
NY Mount Kisco	W1VP-FM	\$ 440	1200v I
NY Oneida	WNCR-FM	\$ 720	350v
OH London	WSYX	\$ 300	3000v U
OH New Lexington	WWJM	\$ 300	3000v
OH Ottawa FM-106	WPNM	\$ 265	3000v Y
OK Norman	KGOU	\$ 180	3000vCU
PA Huntingdon	WRLR	\$ 150	3000 U
PA Union City	KCTL	\$ 300	3000v
RI Woonsocket	W10N-FM	\$ 195	3000v M
SC Florence	WSTN	\$ 300	3000v
SC Georgetown	WSHG	\$ 130	3000v
SC Hilton Head Island	WHHR	\$ 300	3000v U
TX Belton	KTON-FM	\$ 412	912v I
TX Brenham	KWHI-FM	\$ 300	3000v E
TX Hereford	KPAN-FM	\$ 260	3000v
UT Spanish Fork	KDNI-FM	\$ 920	220v U
VA Bluefield	WBDY	\$ 96	3000v M
VA Gretna	W1NA-FM	\$ 260	3000v M
VA Luray	WLCC	\$ 43	3000v
VA Norton-Wise	W1VA-FM	\$ 580	700
WA Richland	KXDD	\$ -44	2690
WI Middleton-Madison	W1AD	\$ 375	1800v I
WI River Falls-Hudson	WEVR-FM	\$ 300	3000v
WY Cheyenne	KLEN	\$ 79	3000 M

104

TX Jacksonville	K-1 K001	\$ 640	100000
VA Richmond	*WRFK	\$ 235	50000v P
WA Lynden	KLYN	\$ 720	100000h E
WV Clarksburg	WKNW	\$ 500	50000v
WI Marshfield	FM-106 WDLB-FM	\$ 400	56000v

106.7 294 B/C			
BC Trail	CBTA	1485	12600v
PQ Chambord	CHUT-FM1	458	1257v
AL Enterprise	WKMX	\$ 430	100000v S
CA Pasadena	KROQ-FM	\$ 660	25500v
CA Tulare	KJUG	\$2550	870v M
CO Denver KZ-107	KAZY	\$ 960	94000v
FL Fort Lauderdale-Miami	WGLO	\$ 900	92000v
FL Leesburg	WHLY	\$ 800	100000v H
GA Douglas	WDKA-FM	275	34200v N
GA Gainesville	Wide-107 WRID	\$ 540	100000v

**Request Radio**  
**WYEN107FM**

IL Des Plaines	WYEN	\$ 300	50000v U
MA Boston	WBZ-FM	\$ 760	18000v
MI Detroit W-4	WWWW	\$ 510	61000v
MI Gaylord	WWRH	\$ 570	50000v U
MN Brainerd		448	100000v
MS Vicksburg	WKYV	\$ 510	58410v I
NE Norfolk	WJAG-FM	520	43000v
NY New York	WRVR	\$1220	5400h
OH Hillsboro	W1RW-FM	160	50000v U
OR Lake Oswego-Portland	KLJK	\$ 880	94000v Z

**KISS** WKKS  
**106.7 FM**

BEAVER FALLS, PA. 717-741-4400	PA Beaver Falls	Kiss WKKS	\$ 520	47000v
PA Elizabethtown	WPDC		500	20000v
SC Orangeburg	WPJS		\$ 580	100000v
VA Manassas-Fairfax	WEZR		\$ 500	50000v

106.9 295 B/C			
NF St. John's	CBN-FM	\$ 725	100000v
ON Ottawa	CKO-FM1	931	100000
AL Birmingham	WKXX	\$ 970	100000v
CA San Francisco	KMPX	\$1120	80000
CT Hartford	WCCC-FM	\$ 720	20500 Y
IL Peoria	NSWT	\$ 480	50000v
IN Marion	WHR1	\$ 240	50000v E
KY Topeka	KTPK	\$ 340	100000v
KS Louisville	WVEZ	\$ 670	24500v
MD Hagerstown	W1CS	\$ 840	13500h C
MI Ironwood	WUPM	\$ 515	25000v I
MI Muskegon	W1US-FM	\$ 270	50000v M
MN Rochester	KROC-FM	\$1110	100000v N
MO Jefferson CityKJFF		\$ 215	100000v

NJ Reno	KRNO	\$ 460	60000h 20000v
NJ Camden	WKDN	550	38000v
NY Auburn	WRXL	\$ 530	45000v M
NC Black Mountain	W1IT	\$3090	36000v A
Oh Canton	WHLQ	\$ 340	27500
OH Marion	W1RN-FM	\$ 340	25000v
OK Clinton	KWOE-FM	\$ 285	100000v H
OK Muskogee	KMMH	\$ 124	96600 E
TN McKenzie	WKTA	\$ 480	100000v A
TX Conroe	KNRO	\$ 530	98000v
VA Suffolk		755	100000v
WA Bremerton	KBRO-FM	\$2380	30000 M

107.1 296 A			
BC Invermere	CFNL	2398	910 D
ON Toronto Q-107	C1LQ	\$1380	40000v
AZ Apache Junction	KSTM	-115	3000v
AR Benton	KAKI	146	3000v
AR Berryville	KAAM	\$ 451	1000v I
AR Texarkana	KADC-FM	\$ 160	3000 Z
CA Arcadia	FM-107 KMAX	-240	3000v
CA Fallbrook	KAVO	300	3000v
CA Seaside-Monterey	KZEN	\$ 570	680v Z
FL Key West	W1IS	\$ 96	2000v
FL Lehigh Acres	WSWF	\$ 330	2350v
FL Melbourne	Rock-107 WTAI-FM	\$ 300	3000 A

GA Claxton	WCLA-FM	195	3000v M
GA Gordon	WKOG-FM	\$ 98	3000v
GA Rockmart	WZOT	\$ -20	3000v A
GA Thomasville	W1UF	300	3000v E
IL Plano	WSPY	300	3000v B
IL Urbana	WPGU	\$ 235	2950 Y
IN Vandalia	WKRV	\$ 165	3000v
IN Boonville	WBNL-FM	185	3000
IN Danville	WGRT	\$ 300	3000v E
IN Lowell	WLCL	\$ 300	3000v
IA Aes Q-107	KCCO	\$ 300	3000v U
IA Denison	KDSN-FM	300	3000v U
KY Corbin	WCTI-FM	\$ 259	3000v
KY Danville	W1GE	148	3000
KY Hindman	WKCB-FM	650	500v M
LA Ferriday	KFNV-FM	\$ 145	3000v
LA Hammond	W1HD	\$ 300	3000v
LA Houma	KCIL	\$ 300	3000v
LA Many	KNLV	300	3000
LA Opelousas	KODG	\$ 207	3000 I
MI Ann Arbor	WPAG-FM	260	3000v I
MI Ishpeming	FM-107 W1QT	\$ 630	630v I

MI Port Huron	Q-107 W1SAQ	\$ 300	3000v S
MI Saginaw	W1WS	360	2000v B
MI St. Joseph	W1RX	\$ 225	3000v N
MW Fosston	KEHG-FM	111	3000v N
MN Hutchinson	KDZB-FM	\$ 195	3000v
MN Virginia	W1RN	\$ 105	3000 E
MS Gulfport	W1DA-FM	\$ 400	1600 N
MS Louisville	W1SM-FM	\$ 200	3000v
NH Exeter	W1KX-FM	68	3000h M
NJ Long Branch	W1RLB	\$ 265	3000
NY Briarcliff Manor	W1RNK	\$ 330	24500
NY Glens Falls	W1BZA-FM	\$ 840	280h
			275v

107.1  
 NC Clinton WRRZ-FM 300 3000 E  
 NC Durham WOBS \$ 295 3000v  
 NC Southern Pines  
 W-107 WIOZ \$ 300 3000v  
 NC Southport WLFC 300 3000v  
 PA Greensburg WRE-FM 58 3000v  
 OH Circleville WDOH \$ 300 3000v  
 OH Delphos WDOH \$ 300 3000v  
 OH Ironton WITO 125 3000 M  
 OH Milford-Mariemont  
 WLYK \$ 300 3000v M  
 OK Durant KSEB-FM 370 1900v S  
 PA Greensburg WOKU 300 3000v M  
 PA Greenville WGRF-FM 240 3000 U  
 PA Scranton  
 FM-107 WEZX \$1270 110v  
 RI Middletown WOTB \$ 295 3000v  
 SC Lancaster WPAJ \$ 200 3000  
 SC Mullins WCGI \$ 235 3000v  
 TX Coleman KSTA-FM \$ 180 3000v  
 TX Graham KWKK \$ 100 3000v  
 TX Waco \*KWBU \$190 3000v  
 UT Brigham City KBUH-FM \$-590 3000v Y  
 UT Orem KORM -920 3000v  
 VT Barre WOKR \$ 410 1500v  
 VA Appomattox WTXM-FM 300 3000v Y  
 VA Pulaski WPUV-FM -58 2850 I

RADIO STATION  
**wfon**

P.O. BOX 1195  
 FOND DU LAC, WI 54635

WI Fond du Lac WFOU \$ 300 3000v  
 WI New Richmond WIXX-FM \$ 270 3000v M  
 WI Oconto WCOF-FM \$ 210 3000v  
 WI Platteville WSNW-FM \$ 235 3000v M  
 WI Wisconsin Dells  
 WNNQ-FM \$ 320 2600v M

107.3 297 B/C  
 PQ Montreal  
 Citay, cent sept CITE-2 \$ v  
 AL Florence  
 Q-107 WOLT \$ 700 100000v A  
 CA Stockton KSTN-FM 1610 8100  
 DC Washington  
 FM-107 WROX \$ 590 32000v A  
 FL Jacksonville WJEE 300 100000v  
 FL Pensacola WAJB \$ 360 100000vYI  
 FL St. Petersburg  
 WWBA-FM \$ 620 100000v  
 GA Columbus WCGO \$ 530 37000v C  
 IL Marion W-3-D WDDO \$ 500 50000v  
 IN Greensburg WTRF-FM 275 50000v  
 IN Warsaw WRSW-FM \$ 225 50000v U  
 IA Burlington  
 Rock-107 KGRS \$ 360 11400v A  
 KS Wichita KARD \$ 860 95000v  
 MA Worcester WAAF \$ 780 16500v  
 MI Greenville WPLB-FM \$ 360 50000v U  
 MO Lexington KBEX 500 100000v  
 NE Lincoln XLIN-FM \$ 166 100000v  
 NY Utica WTLB-FM \$ 510 3500v A  
 OH Elyria WBEA \$ 285 50000v E  
 OK Poteau KINB 1810 70000h 30000v E

PA Dubois WDBA \$ 500 50000v  
 SC Anderson WANS-FM \$ 260 100000v Y  
 TN Lebanon WGOR-FM \$ 173 18000  
 TX Lake Jackson KGOI \$ 180 28000  
 WA Yakima KFFM \$ 920 100000v N  
 WI Fort Atkinson  
 FM-107 WFAW-FM \$ 500 50000v U

107.5 298 B/C  
 ON Kingston CBCK 467 100000v  
 ON Penetanguishene  
 15300  
 CA El Centro KXO-FM \$ 155 25000v  
 CA Hanford KKYS \$ 275 50000v  
 CA Los Angeles KLVF \$2800 34000v  
 CO Lakewood KPPL \$ 670 91000v  
 FL Miami WIGL \$ 460 92000v  
 IL Chicago WGGI \$ 600 33000v M  
 IN Terre Haute WBOG \$ 185 46000  
 LA Ruston KXKZ \$ 500 100000v  
 ME Lewiston-Auburn  
 WBLM \$ 610 30000v  
 MI Detroit WGRF \$ 360 50000v Z  
 MN Brainerd KLIZ-FM \$ 360 36000 U  
 MS Hauge WSJC-FM \$ 490 100000v U  
 NY New York WBLS \$1220 5400h B  
 3800v  
 NC Winston-Salem WKZL \$ 500 100000v  
 PA Boyertown WBYO \$ 175 15000v S  
 SC St. George WPWR \$ 440 100000v U  
 TX Fort Worth KNOX-FM \$ 380 100000v  
 TX San Antonio KBUC-FM \$ 285 100000v I  
 VA Exmore WEXM-FM 260 50000v  
 WV Wheeling WTRF-FM \$ 870 12500 N  
 WI Neillsville WCCN-FM 195 100000 M

107.7 299 B/C  
 AL Birmingham WENN-FM \$ 640 100000v B  
 CA San Mateo KSOL \$1160 6200h B  
 4500v  

FL Mount Dora-Orlando  
 WORJ \$ 360 100000v  
 IA Spencer KICD-FM \$ 310 100000v U  
 KS Topeka  
 K-Sweet KSMT \$ 460 100000v  
 MI Alpena WHSB 420 98000v I  
 MO St. Louis KKSS \$ 990 100000v Y  
 NJ Bridgeton WSNJ-FM 480 15200 M  
 NY Albany WQNA \$ 980 9400v  
 NY Wethersfield WBIV \$ 470 32000v  
 NC Greenville  
 FM-107 WNCI-FM \$ 560 100000 C  
 OH Dayton KDAO \$ 420 50000vYZ  
 OK Oklahoma City KAEZ 215 58000v  
 OR Pendleton 610 27500v  
 PA Gettysburg WGET-FM \$ 350 10000v M  
 TN Knoxville WIVX-FM \$1000 100000v A  
 TX Beaumont KWIC \$ 340 100000v A  
 VA Warrenton WEER-FM 800 3600  
 WA Seattle \*KRAB \$1200 63000h 27000v

LISTEN TO CHRISTIAN RADIO 107.9

**WVCY - STEREO**

100 ON YOUR DIAL  
 2713 WEST WILLET STREET  
 MILWAUKEE, WISCONSIN 53208

WI Milwaukee WVCY \$ 440 38000v U  
 107.9 300 B/C  
 ON Burlington CING \$ 500 50000v  
 PQ Saguenay CBJE \$ 294 98000v  
 AR Jonesboro KFIN \$ 600 98000v  
 AR Magnolia KFMV \$ 360 50000  
 CA Bakersfield KXXX \$1340 5500v  
 CA Sacramento  
 K-108 KXDA \$ 420 27500v  
 CA San Clemente KWVE \$ 485 50000v A  
 CA Fort Collins KCOL-FM \$ 470 100000v  
 CO Westport  
 108-FM WDJF \$ 245 50000v U  
 FL Panama City WPFM \$ 780 100000v E  
 FL West Palm Beach  
 K-108 WTRK-FM \$ 340 100000v A  
 GA Macon FM-108 WCXY \$ 700 100000v  
 IL Aurora WAUR \$ 490 50000v M  
 IA Waterloo-Cedar Rapids  
 KFMN \$1800 100000v S  
 KY Fort Campbell WABD-FM \$ 230 80000v A  
 MD Annapolis WFSI \$ 500 20000v

**WWEL**

99 REVERE BEACH PARKWAY MEDFORD - BOSTON  
 MA Medford-Boston  
 FM-108 WWEL-FM \$ 710 21000v  
 MI Flint  
 Stereo 108 WGMZ \$ 330 50000v  
 MN Anoka KTWN \$ 320 57000v  
 MS Poplarville WRRP-FM 410 100000v  
 NM Albuquerque KFMG -41 77000  
 NY Syracuse



WONO \$ 490 37000  
 NC Charlotte WBT-FM \$ 970 97000v  
 OH Cleveland  
 FM-108 WDMT \$ 390 70000v  
 OR Albany KHPE \$1155 100000v M  
 PA Pittsburgh WEEP-FM \$ 420 36000 M  
 TX Abilene KFMN \$ 285 100000v A  
 TX Corsicana  
 K-108 KXCL \$ 520 25000v U  
 TX Edinburg KESI \$ 490 100000v  
 WA Spokane KMBI-FM \$ 275 56000v  
 WV Huntington WEMH \$ 500 50000v  
 WI Rhinelander WRHN \$ 300 25100 N



# FM MAKINGS

(FM Applications)

Here are America's future FM stations. Listed here are requests for new FM stations filed with the FCC and the CRTS as of Jan. 18, 1978. When two or more applicants file for the same facility there will have to be a hearing to decide the winner, unless one or more of the applicants withdraws. A few of the applications are for stations already on the air. These so-called "strike" applications historically have had little likelihood of being granted, with the public usually assured of continued service from the station against which the "strike" was filed. Not shown are applications for changes in facilities, such as for higher power. In the columns below, state and city are followed by the proposed musical format, frequency applied for, primary coverage radius in miles, and name of applicant. Applications without coverages are for 10-watt educational stations, and translators are indicated by call letters of the primary station followed by the small letter "L."

AL Birmingham	*91.9 15	Glen Iris School	Grass Valley	n 100.1 15	McLean Conn.
	g *91.9 16	SE Bible College	m 92.1 15	C. E. Brock	Thousand Oaks
	g *91.9	WMBWT 88.9	m 92.1 15	Moher Lode	*91.1 30
Chickasaw	98.3 15	Phillips Radio	Guerneville	*90.9	Boreas Bcstg. Co.
Eutaw	*91.3 33	Green Cty. Bcstg.	Healdsburg		
Homeswood	g *91.9	WMBWT 88.9	m 92.9 32	C. E. Brock	
Huntsville	*90.9 26	U of AL-Huntsv.	mk 92.9 30	N. Coast Comm.	
Mobile	*90.5	Spring Hill Col.	Hoopo	*90.9	Tribal Council
	96.1 29	Mobile Bcstg.	Leaoore	104.9 12	Cross Country
AK Anchorage	103.1 5	Aurora Community	Lompoc	m 100.9 5	JWR Bcstg. Corp.
Fairbanks	m 101.1 8	N. W. Horizons	Los Angeles		
AZ Chandler	107.9 43	Chandler Com.		g 99.5 33	Inspiration Media
	m 107.9 14	Wycom	Manteca	96.7 15	McFadden Bcstg.
Flagstaff	*89.5	KMCRT 91.5		96.7 11	Zienienskis
Kayenta	k 107.1	KRSJ 100.5	McFarland	105.3 11	Mcf. Radto
Oracle	105.5 11	Tucker-Coronado	Mill Val.	r 101.3	KIOI booster
Phoenix	*88.3 8	Community Bcstg.	Monterey	r 92.7 15	Cyprus
	S L 99.9 54	American Intl.		92.7 14	Ewards
	m 99.9 55	KXIV, Inc.	Nevada City	*89.5	Victor. Museum
	99.9 54	H.W. Owens, Jr.	Oakdale	m 95.1 32	Goldrush Bcstg.
	99.9 54	Radio Phoenix		95.1 32	O. Bcstg. Corp.
Prescott	m *90.1	KMCRT 91.5	Palm Springs		
South Tucson			kc 100.9 14	Gray-Schwartz	
	m 92.1 4	Graham Bcstg. Co.	r 100.9 14	KPSI	
Tucson	r 92.1 15	Rex Bcstg. Co.	cj 100.9 15	Westminster	
	rm 107.5 54	Golden State	Pasadena	c 106.7 32	ANARE Communicat.
	r 107.5 54	Great SW		106.7 32	Baker-Smith
	r 107.5 53	P. M. Marcus		106.7 32	Lotus Comm. Corp.
	107.5 53	T. Community	S L 106.7 32	San Marco	
	107.5 57	Tucson FM	Pebble Beach	*91.5	Stevenson School
AR De Queen	92.7 13	Radio De Queen	Red Bluff		
Eureka Springs			m 102.3 6	Bryngelons	
	*90.9	Ozark Public	Redding	m 104.3 56	C. E. Brock
Hardy	100.9 15	Vance Bcstg.	k 104.3 56	Colgan Communicat.	
Morrilton	101.7 15	Morrilton Bcstg.	r 104.3 56	FM Communication	
Van Buren	102.3 8	G.V. Donerese	Ridgecrest		
CA Anderson	p 94.3 8	Shasta Bcstg.	g *89.1	Maranatha Media	
Atherton	*88.9	Menlo A. H. S.	gr 103.1	QLBHT 95.1	
Brawley	SL 96.1 19	Campestono Unido	m 104.9	KLOA Radio	
Carpinteria	101.7 5	C. Bcstg. Co.	Sacramento	*91.5	San Juan School
	101.7 14	I. Sinofsky	San Bernardino	g 94.3	KECRT 93.3
Ceres	*89.5	Bet Nahraim, Inc.	San Jose	*88.1	High School
Chester	m 94.3	KSUE-FM 92.7		100.3 49	Public Communica.
Chualar	*89.7 9	Central Coast	Santa Clara	*89.1	S.C. College
Delano	105.3 33	KWSD, Inc.	Santa Rosa		
	m 105.3 25	McGavren Comm.	g *91.9 15	Christian Life	
	s 105.3 33	Hosea Wilson	Sonora	*91.5	Union High School
Fowler	96.7 15	Atsinger	Stockton	k 100.1 14	Barnes Enterpr.
	S rL 96.7 9	Eleanor Mindel	r 100.1 13	Carson Conn.	
Goleta	mk 106.3 5	Guy S. Erway			
	m 106.3 15	G. Communication			
	m 106.3 5	Spanish-American			

FL			IA			IA			MO					
Largo	g	92.1 15	BIE Bcstg. Co.	km	104.9 15	M. Bcstg. Corp.	Winchendon	97.7 15	Northbanke Corp.					
Marco		101.1 40	Gollier Bcstg. Co	Sullivan			m	97.7 15	WGAR, Inc.					
	m	101.1 40	Deltana Bcstg.	km	95.3 15	WKQV, Inc.	MI Benzonia	m	99.3 15	Chief Pontiac				
		101.1 40	Neopolitan Bcstg.	kg	95.3 15	Radio Sullivan	Caro	mr	104.9 15	Cass Radio				
Marianna	g	*91.1 40	Pensacola School	IA Council Bluffs			Charlevoix							
Melbourne								105.9 38	Island View					
	gc	106.3 13	1st Baptist Ch.	Dubuque			r	105.9 37	New Bcstg. Corp.					
Milton		*88.1 30	U. of W. FL											
Orlando		*90.7 47	ETV											
Safety Harbor														
	c	92.1 15	Tampa Bay											
West Palm Beach														
		*90.9 21	Bascomb Memorial	Iowa City	93.9 41	BQA, Inc. (This application is competing with that of KRNA 93.5 Iowa City to change to 93.9 and increase power.)								
GA Blackshear		104.9 15	JDC Bcstrs., Inc.	Mason City	98.3 15	TLC Bcstg.	Kalamazoo	m	107.7 33	WHN Bcstg.				
	m	104.9 15	Mattox-Guest	Red Oak	95.3 7	R. D. Radio Co.	Kalkaska	k	97.7 15	Kaltrim Bcstg.				
Fitzgerald		95.3 15	Ben Hill	Spencer	g	104.9 15	Radio Missions		97.7 15	Peninsula Bcstg.				
Hinesville				Waterloo	s	*88.1	Afro-American	Marquette						
	r	92.1 15	H. Bcstg. Corp.	KS Concordia				m	105.5	WMOt 107.1				
		92.1 13	Liberty Bcstg.		m	95.3 15	C. Bcstg. Co.	Ontonagon	*88.5	School District				
Jasper		104.9	WPPL 103.9			95.3 10	General Bcstg.	Otsego	100.9 15	Allegan County				
Marietta		*91.7	S. Tech. Inst.	Fort Scott	103.9 15	F. S. Bcstg. Co.	Plainwell	100.9 15	Pinehurst Bcstg.					
McRae		95.3 15	John Davidson		m	103.9 15	Perceptive Comm.	Portage	rj	107.7 33	Air-Bourne Ltd.			
HI Honolulu		*88.1 50	HI Public Radio	Hoisington	100.9 15	Heart of KS		107.7 33	Circle Corp.					
		*88.9 11	HI Public Bcstg.	Liberal	k	99.3 15	L. E. Steckline		107.7 32	Radio Portage				
		*88.9 5	Kavigeaouli Inst.	Parsons	rk	93.5 14	Community Bcstg.	St. Ignace	p	107.7 33	Sear Bcstg. Co.			
Keaouhou	m	92.1 8	Communico Honi	KY Bardstown				m	102.3 14	Mighty-Mac				
Lihue		92.7 13	KUAI, Inc.		m	96.7 14	E. Lamar Clark	g	102.3 15	WPOS				
	r	93.5 15	Communico Honi		km	96.7 11	Nelson Cty. Bcstg.	South Haven		98.3 11	Van Buren County			
Makawao Maui					kr	96.7 14	Old Kentucky	Traverse City						
		94.3 5	Harry W. Engel	Highland Heights					*90.9	NW MI College				
Walakoa-Pulehu						*89.7 16	No. KY U.	MN Albany	105.5 15	Stearns County				
	r	94.3 14	Communico Honi	Jeffersonton				Babbitt	r	101.7	WAKX-FM 98.9			
ID Cour D'Alene								Duluth	gc	*102.5 38	Northwestern Col.			
		103.1 15	ID Bcstg. Co.					International Falls		94.3 9	KGHS, Inc.			
Lewiston		*98.3	Lexis-Clark					Little Falls						
Rupert		92.1 12	Inland					r	92.1 15	Little F. Radio				
Salmon	m	92.7 4	Dale J. Smith					Mankato		*89.7 43	S. MN Public Bcs.			
IL Carthage	k	92.1 15	Tri-State					Minneapolis		*89.7	Center for Comm.			
Chicago		*88.5	Frank Collins	LA Baton Rouge	*89.3 40	Public Radio, Inc		Morris	c	*99.3	KSJRT 90.1			
Evanston				Eunice	k	105.5 4	Tri-Parish	Owatonna		g	*90.5	Pillsbury College		
	rj	105.1 30	Genesis	Farmerville				St. Charles		g	92.7	WWIBt 103.7		
Galesburg					m	92.7 14	Union Bcstg.	St. Paul		*91.7	Macalester College			
	n	92.7 15	Coleman	New Orleans				MS Baldwin	r	95.9 15	Superior Bcstg.			
	r	92.7 15	Creative Bcstg.						95.9 15	Town and Country				
Glenview		*88.9	Midwest Academy					Calhoun City		102.3 15	J. R. Williams			
Peoria	mr	105.7 33	Central IL Bcstg.	ME Bangor	g	*89.1	Baptist Seminary	Carthage		98.3 15	Central MS			
Pinckneyville					g	*88.5 3	Christian School		ks	98.3 15	M. C. Johnston			
	mk	103.9 15	Dunn/Coalbelt	Machias	m	95.3 13	Craig Bible Inst.	Collins	rm	101.7 15	Covington City.			
Shelbyville				Oakland		*90.7	Wash. County	Hattiesburg						
	k	104.9 9	Hanson	Presque Isle			Lighthouse Bcstg.		92.1 12	Circuit Bcstg.				
Springfield						101.7 5	Jack F. Steber		92.1 15	J. A. McCullough				
	m	*89.9	Vocational Cntr.	MD Baltimore		*88.1	John Hopkins U.	Lorman		*86.9 37	Alcorn St. U.			
	nj	98.7 31	Group 76, Inc.			*91.1	Col. of Notre D.	Prentiss	k	98.3 6	Jeff Davis			
		98.7 32	Lincoln-Douglas	Federalburg				Starkville						
	m	98.7 32	Midwest Bcstg.						kr	92.1 13	Charisma Bcstg.			
	m	98.7 32	Sprd. Advertising	Grasonville					g	92.1 15	S. Bcstg. Corp.			
IN Evansville		*88.3 33	SW IN Public TV						MO Ballwin		*89.9	YMCA, St. Louis		
IN Indianapolis									Eldon		92.7 15	Eldon Bcstg. Co.		
	nr	107.9 38	Indianapolis Bcs.							92.7 14	Triple K			
	k	107.9 33	Indianapolis Con.						Luray	92.1 15	K. R. Hodges			
	nj	107.9 33	Mediacom, Inc.											
	nr	107.9 31	Peoples Bcstg.											
	nr	107.9 31	Radio Circle											
	nr	107.9 33	Radio Corp. of IN											
		107.9 38	Radio 1500 Inc.											
		107.9 25	WOOD											
Muncie	m	104.9 15	Ben-Del Bcstg.											
	m	104.9 15	Hooster Favorite											

<b>MO</b>					
Malden	m	92.7 12	Tri-County		
Marshfield	k	104.9 9	Webster County		
St. Joseph	*88.1		Wyatt Park Educ.		
St. Louis	*88.1 40		Double Educ.		
Trenton	92.1 15		Luehrs Bcst. Co.		
University City	*91.1		Counterpoint		
Willow Springs	m	100.1 15	KUKU		
<b>MT</b>					
Absarokee	mq	98.3	KURL-FMT 97.1		
Bozeman	mj	93.7 27	Northern Sun		
	r	93.7 33	B. H. Oliphant		
	m	93.7 24	Western Media		
Glasgow	m	93.5 5	W. L. Holter		
	m	93.5 15	Otto Zerbe		
Havre	*90.1		N. MT. College		
Helena	rm	92.1 5	Holter Bcstg.		
Thompson Falls	n	103.9	KXLY-FMT 99.9		
White Sulphur Springs	m	92.7	KOOZt 106.3		
Wolf Point	kr	102.3	KCGMT 95.7		
<b>NE</b>					
Aurora	r	103.1 9	KAFA/KAFKA		
Chadron	97.5 42		Big Sky		
Gordon	95.5 25		Heritage Bcstg.		
North Platte	k	97.1 11	Dahl FM Bcstg.		
Ogallala	m	92.7 15	O. Bcstg. Co.		
Omaha	m	96.1 30	Kyle		
	m	96.1 32	NE Communication		
	r	96.1 31	NE-IA Bcstg.		
	r	96.1 29	Omaha Bcstg.		
	r	96.1 40	Shaker Corp.		
	nr	96.1 29	Viking Omaha		
	m	96.1 34	Webster-Baker		
<b>NV</b>					
Boulder City	k	105.5 15	Garrett, Andrews		
		105.5 14	Montage Corp.		
Carlin	m	95.9	KSRNT 104.5		
Henderson	s	100.5 11	KVOV/KTOO, Inc.		
	rp	100.5 48	Pargo Bcstg. Corp.		
		100.5 11	Pittman Bcstg.		
	n	100.5 48	SAS, Inc.		
Las Vegas	*89.5 7		Nevada Public R.		
Overton	m	103.9	KSL-FMT 100.3		
Sparks	kr	98.3 5	Beck Enterprises		
		98.3 3	Schultz		
<b>NH</b>					
Meredith	m	105.3 58	Lakes Region		
Rochester	96.7 15		Strafford Bcstg.		
<b>NJ</b>					
Cherry Hill	*88.1		BD. of Education		
East Brunswick	*89.7		Township		
Hazlet	*89.3		NVRM, Inc.		
Lawrenceville	*88.5		Rider College		
Newark	*90.3		Rutgers U.		
<b>NM</b>					
Alamogordo	m	94.3 15	KASK, Inc.		
		105.5 5	KIRN, Inc.		
Portales	*89.5 25		E. NM U.		
<b>NY</b>					
Ballston Spa		96.7 5	Live Bcstg. Co.		
Fishkill	*91.7		Wappingers School		
Frankfort	m	92.7 15	WQVM Associates		
Greenport	m	101.7 15	Twin Forks		
Hampton Bays	rm	107.1 15	EFEM, Inc.		
Herkimer	m	92.7 15	WALY, Inc.		
Hornell	92.1 5		Patricus Enter.		
Houghton	*90.3		Houghton College		
Janostown	*91.5		Community Col.		
Manlius	95.3 14		AGK Commun.		
	p	95.3 14	Manlius Bcstg.		
Nyack	g	*91.3	Nyack College		
Olean	m	100.9 14	Great Dane		
Patterson	cj	105.5 15	P. Bcstg. Co.		
	n	105.5 12	P. Communication		
Plattsburgh	*91.1		State U. of NY		
Richmond	*89.9		Staten Is Col.		
Saugerties	m	100.1 15	Kingston Bcstrs.		
Southold	m	101.7 14	N. Fork Bcstg.		
	m	101.7 15	Peconic Bay Bcst.		
Stone Ridge	*90.9 7		Ulster County		
Woodstock	100.1 15		Woodstock Comm.		
	cr	100.1 15	W.Radio, Inc.		
<b>NC</b>					
Albermarle	kr	100.9 15	Victor Bcstg.		
Beaufort	rm	103.3 35	Emerald Comm.		
Burlington	g	*90.1 8	Voice of Christ		
Charlotte	c	*91.7 38	Community Bcstg.		
Durham	*89.7		Educ. Info. Corp.		
	*91.5 27		Triangle Womens		
Greensboro	107.1 15		Brunswick Bcstg.		
Hazelwood	r	104.9 15	Mtn. Ridge		
Morehead City	g	103.3 35	Grace Baptist		
Newport	r	103.3 35	Jones Co.		
Waynesville	m	104.9 15	W. Bcstg. Co.		
	km	104.9 5	P. L. Wolff, Jr.		
Windsor	97.7 15		B. E. Stevens		
<b>OH</b>					
Batavia	k	99.3	NURDT 97.7		
Cincinnati	*89.9		Bible Seminary		
Clyde	s	m 100.9 15	Family Bcstg.		
Greenville	kr	106.5 23	Kortn Bcstg. Co.		
Ironton	g	95.3	WEHMT 107.9		
Key	g	105.5 15	Bible Church		
Mansfield	g	*90.7	Christian School		
Marion	g	99.3	NCVOT 104.9		
Mount Vernon	g	*89.3 11	Knox County		
Zanesville	*92.7 16		Maumee Valley		
	92.7 15		Muskingum Bcstg.		
<b>OK</b>					
Bristow	k	104.9 15	Big Chief		
Hobart	105.9 36		Fuchs Bcstg.		
Oklahoma City	*88.7 27		OK State U.		
Oologah	106.1 34		Ambers Production		
Owasso	c	106.1 36	J. K. Major		
Pauls Valley		97.7 14	Garvin County		
Seminole	m	105.5 15	KXOJ, Inc.		
	r	105.5 15	Seminole Bcstg.		
Sulphur	100.9 15		Lula M. Stone		
<b>OR</b>					
Beaverton	nt	103.3 44	Columbia Willam.		
	r	103.3 43	Gaviota Wireless		
Cave Junction	r	*91.9	KSORT 90.1		
Coos Bay	g	98.3	Intercontinental		
		105.5 13	KOOS, Inc.		
Grants Pass		96.9 28	G. P. Bcstg. Co.		
Hood River	105.5 5		Columbia Gorge		
Klanath Falls	r	*91.3	KSORT 90.1		
	g	103.5	XVIP-FMT 98.1		
Myrtle Creek	r	*89.3	KSORT 90.1		
North Bend		100.9 15	Larson-Wynn		
Pendleton	g	103.5 48	Faith Media, Inc.		
Portland	*89.9 30		Lewis & Clark Coll.		
	m	103.3 43	East-West FM		
	k	103.3 43	Portland Comm.		
	m	103.3 44	Star Bcstg.		
Riddle	r	*91.9	KSORT 90.1		
Roseburg	r	*89.3	KSORT 90.1		
Sutherlin	r	*91.9	KSORT 90.1		
<b>PA</b>					
Chambersburg	*91.3		Schools		
Edinboro	*88.7		State College		
Folsom	*88.5		Ridley School Dis.		
Hanover	g	93.5	WRBS 95.1		
Loretto	*90.1		St. Francis Col.		
Malvern	*88.1 17		DE Valley NonCon.		
Media	100.3 33		Greater Media		
	100.3 33		Klein		
	100.3 33		Roberts		
Middletown	*91.1		Schools		
Philadelphia	*88.1		U. City Parish		
Saegertown	94.3 15		Crawford		
	mr	94.3 15	S. Bcstg. Corp.		
Williamsport	*88.1		Community College		
	*91.5		Schools		
<b>RI</b>					
Coventry	103.1 15		Cheraw Bcstg. Co.		
<b>SC</b>					
Cheraw	103.1 15		Town & Country R.		
Columbia	103.1 15		Midlands Corp.		
	103.1 15		Nuance Corp.		
Orangeburg	*91.9		Word of Faith		
<b>SD</b>					
Belle Fourche	r	107.1	KKHJt 93.9		
Deadwood	mk	97.7	KRCSt 93.1		
	r	107.1	KKHJt 93.9		
Gregory	101.5 39		West Central		

Lead	r 105.5	KKHJ 93.9
Mitchell	m 107.3 34	KORN
Spearfish	r 107.1	KKHJ 93.9
TN Chattanooga	*88.1 37	U. of TN
Cleveland	98.3 15	Bradley Enter.
	m 98.3 15	Thomason Bcstg.
Gallatin	*88.3 7	Volunteer State
Gallinburg	k 105.5 14	Vacation Media
Jackson	m 103.1 15	Chas. C. Allen
	m 103.1 15	Community Svce.
	s 103.1 15	Madison Cty.
Kingston	rn 92.7 5	K. Bcstg. Co.
Madison	*88.5 4	Madison Academy
Memphis	*86.9	W. State U.
Nashville	*91.7 15	TN State U.
Summertown	*88.3	Radio Free Bcstg
Trenton	97.7 13	Trentone, Inc.
TX Abilene	99.3 15	Christian Bcstg.
Alamo	g 104.9 15	Horton
Bryan	104.9 12	Brazos Metro.
	104.9 12	Scott-Davis
Burnet	107.1 15	W. E. Hobbs
Corpus Christi	*90.3 31	Spindizzy Public
	ep 99.1 43	A. V. Banford
	99.1 44	Big C Bcstg.
	99.1 25	Community Servic
S L	99.1 41	KCCCT, Inc.
	99.1 37	KUNO
Fabens S k	103.1 8	A. A. Felder
Gilmer	m 95.3 15	Daniels Bcstg.
	m 95.3 15	KHYM
Laredo	98.1 42	L. Bcstg. Co.
	m 98.1 34	Radio Laredo
Levelland	105.5 15	D.L. Kirby
Lubbock	102.5 28	Radio Lubbock
	ra 102.5 41	Rex Bcstg. Corp.
	102.5 27	Western Bcstg.
Merkel	k 102.3 15	Big Country
Pecos S k	98.3 7	Parday
Perryton	m 95.9 15	KEYE
Portland	m 105.5 15	Media Properties
Prairie View	*91.3 21	P.V. ABM U.
Richardson	g *88.1	St. Lukes Educ.
San Angelo	92.9 39	S.A. Bcstrs.
San Antonio	*89.1 31	Cnty Radio Corp
	*89.1 34	Yanaguana Radio
Snyder	101.7 15	Snyder Bcstg.
Sulphur Springs	95.9 15	Gilbert Group
	95.9 15	Hopkins County
Terrell	k 107.1 15	Direct Bcstg.
	ra 107.1 15	Geo. D. Farner
	k 107.1 15	Jones/T. Radio
Terrell Hills	106.3 14	Redding Bcstg.
	s 106.3 15	S.S.S. Bcstg.
	106.3 15	Wholly Owned Co.
Victoria	rn 107.9 30	McDougal Bcstg.

## Wichita Falls

	*90.5 15	Midwestern U.
UT Cedar City	94.9 45	New Era Bcstg.
Enterprise	mc 101.7	KDXU-FMT 93.5
Garfield County	k 102.3	KSOP-FM 104.3t
Neola	*88.1	Utah Ute Tribe
Ogden	97.9 54	Group Comm.
	97.9 36	Ben Lonond Bcstg.
St. George	p 100.9	KBRE-FMT 94.9
Salt Lake City	*90.9 56	Listeners Radio
Newport	rn 107.9 33	N. Bcstg. Corp.
Orleans	107.9 56	Radio Corp.
VA Berryville	kg 105.5 15	B. Bcstg. Co.
	r 105.5 15	Berryville Media
Charlottesville	g 92.7 15	Brown Bcstg. Co.
	92.7 15	C. Bcstg. Assoc.
	p 92.7 14	WUVA, Inc.
	r 92.7 15	Yes Communica.
Harrisonburg	104.3 19	Radio Blue Ridge
Lynchburg	*96.3	L. College
Norfolk	*91.1 7	N. State College
Pound	102.3 15	W. L. Harbor
Virginia Beach	94.9 33	VA Seashore
Waynesboro	g 99.3	WIVE-FMT 100.1
WA Ellensburg	g 99.3	KIAMT 104.9
Pullman	*90.7	WA State U.
Richland	r 94.9 49	KALE, Inc.
Selah	*90.5	High School
Wenatchee	m 96.7	KPO-FMT 102.1
WV Bethlehem	r 105.5 15	Radio Wheeling
	Grafton 100.9 15	Conti Bcstg.
Hurricane	r 106.3 15	Putnam Bcstg. Co.
Leasburg	kr 105.5 15	Lewisburg FM
Milton	k 106.3 14	WSNT
Morgantown	*90.9 30	WV Bd./Regents
Moundsville	m 105.5 15	Hank Greer
Mount Hope	k 105.9 33	Stuart Epperson
	kr 105.9 33	Nick J. Rahall 2
Mullens	92.7 13	Slab Fork Bcstg.
Princeton	100.9 15	Fincastle Comm.
Ronceverte	105.5 15	Radio Greenbrier
Wheeling	*89.9 29	WV Educ. Bcstg.
W Ashland	g 100.9	WWIBt 103.7
Black River Falls	g 102.3	WWIBt 103.7
Keshona	e *88.3 23	Menominee Indian
Lancaster	97.7 15	Joy Broadcasters
Menomonee Falls	98.3 15	Trans-Air
Merrill	g 92.1	WRVMT 102.7

## Slevens Point

	g 100.1	WWIBt 103.7
Superior	k 102.5 32	WDSM, Inc.
WY Buffalo	r 107.1	KOLLt 93.5
Casper	m 95.5 56	Energy Capitol
	m 95.5 49	Wycon Corp.
	95.5 56	Wyomedia
Cody	97.9 56	Wyomedia
Rawlins	k 92.7 9	Korral Radio, Inc.
Rock Springs	m 106.3	KLUB-FM1 97.1
Saratoga	99.9 57	Pioneer Bcstrs.
PR Anasco	g *90.3 15	Centro Colegial
Levittown	*88.9	Community Educ.
Rio Piedras	*90.5 5	Academy Radio

## Canada FM Applications

[Because antenna heights are not announced when applications are filed, coverages are not calculated for Canadian FM station applications. Effective radiated powers are given.] \* = watts F = French

AT Edmonton	c 93.3	100000w CBC-FM Stereo
Fort McMurray	99.3	20200w CBC-CBX AM
	F 101.5	20200w CBC-CHFA AM
Hinton F	100.7	85w CBC-CHFA AM
BC Alyansh	102.3	278w CBC-AM, CFPR
Atlin	93.9	28w CBC-AM, CFWH
Bella Coola	88.3	114w CBC-AM, CBU
Chase k	93.1	140w CFFM-FM
Kamloops	F cm 96.5	4750w CBC-CBUF-FM
	97.5	4300w NL Bcstg. Ltd.
Kelowna	F cm 99.1	2000w CBUF repeater
King Island	104.9	6w CBC-AM, CBU
Kittimat	F cm 105.1	160w CBC-CBUF-FM
Ocean Falls	92.1	6w CBC-AM, CBU
Pritchard	k 106.3	19w CFFM-FM
Saw Mill Mountain	107.9	10w CBC-AM, CBU
Terrace	97.1	54w CBC-AM, CFPR
	F cm 98.9	54w CBC, CBUF-FM
Vernon	100.9	4800w Interior-CJIB
	100.9	4700w Sun Country
MB Brandon	F 99.5	21500w CBC-CXSB
Limestone	r 96.1	15w CJOB-AM / [repeater
NB Campbellton	F 91.1	100000w CBC-CBAF
	F 90.1	100000w CBC-CBAF
Moncton F	94.9	100000w CBC-French FM
	95.7	100000w CBC-FM, English
Neguac F	92.1	100000w CBC-CBAF
NF Marystown	90.3	100000w CBC-AM, CBN
NF Swift Current	99.5	32w CBC-AM, CBN
NS Halifax F	89.7	100000w CBC-CBAF



ON

ON Attawapiskat

101.5 35w CBC, CBL AM  
 Brockville 104.9 3000w CBC-FM Stereo  
 Fort Albany 102.3 1000w CBC, CBL AM  
 Kenora 98.7 38000w CBC-AM, CBW/CBO  
 Kingston 92.9 1800w CBC-FM  
 Red Lake 90.5 100w CBC-CBO AM

Sault Ste. Marie

F 88.1 1700w CBC-French  
 89.5 46000w CBC-AM  
 Sincow 107.5 3000w CBL repeater  
 Thunder Bay  
 F 89.3 27400w CBC-French  
 Toronto  
 F 89.5 38000w CBC-FM French

97.3 2000w R. C. Lafferty

PQ Rouyn-Noranda  
 88.7 4800w Mrs. L. Poirier  
 SA Saskatoon 104.7 98000w CBC FM Stereo  
 Zenon Park  
 F 93.5 1340w CBC-CBKF FM  
 YT Jakes Corner  
 99.9 16w CBC-CFVH AM

YT

## FM STATIONS HAVING TRANSLATORS

Here's a compilation of all the FM stations that have translators rebroadcasting their signals. Included are stations with translators on the air or under construction, as well as stations whose translators have only been applied for. The list is given alphabetically by call letters so that you can easily find the location of the translator's primary station when looking at the FM maps or the Station Directories.

KALL-FM Salt Lake City UT	94.1	KNWS-FM Waterloo IA	*101.9	KURL-FM Billings MT	97.1
KAWY Casper WY	94.5	KOB-FM Albuquerque NM	93.3	KVIP-FM Redding CA	98.1
KBBC Phoenix AZ	98.7	KOLL Gillette WY	93.5	KVMN Pueblo CO	98.9
KBIQ Edmonds WA	105.3	KOOL-FM Phoenix AZ	94.5	KVOD Denver CO	99.5
KBON-FM Butte MT	94.1	KOOZ Great Falls MT	106.3	KVRH-FM Salida CO	92.1
KBRE-FM Cedar City UT	94.9	KORK-FM Las Vegas NV	97.1	KWIQ-FM Moses Lake WA	100.3
KCAP-FM Helena MT	103.1	KOSI-FM Denver CO	101.1	KXXK Denver CO	95.7
KCGM Scooby MT	95.7	KOST Los Angeles CA	103.5	KXYL-FM Spokane WA	99.9
KCJB-FM Minot ND	97.1	KOTE Lancaster CA	106.3	KXXX-FM Colby KS	100.3
KCPX-FM Salt Lake City UT	98.7	KOTO Telluride CO	*91.7	KYSS-FM Missoula MT	94.9
KDFC San Francisco CA	102.1	KOUR-FM Independence IA	95.3	KYAX-FM Duluth MN	98.9
KDKB-FM Mesa AZ	93.3	KPOD-FM Portland OR	93.7	WBES Charleston WV	96.1
KDLY Lander WY	97.5	KPO-FM Wenatchee WA	102.1	WCVO Gahanna OH	104.9
KDXU-FM St. George UT	93.5	KQIX Grand Junction CO	93.1	WDMP-FM Dodgeville WI	99.3
KEAR San Francisco CA	97.3	KQLH San Bernardino CA	95.1	WEMM Huntington WV	107.9
KECR El Cajon CA	93.3	KRAI-FM Craig CO	93.7	WFRE Frederick MD	99.9
KFAC-FM Los Angeles CA	92.3	KRCS Sturgis SD	93.1	WFSI Annapolis MD	100.1
KFGQ-FM Boone IA	99.3	KRDO-FM Colorado Springs CO	95.1	WGBI-FM Scranton PA	101.3
KFMS Las Vegas NV	101.9	KREX-FM Grand Junction CO	92.3	WGGG Duluth MN	105.1
KFOG San Francisco CA	104.5	KRFG Greenfield MO	93.5	WIVE-FM Ashland VA	100.1
KFNN-FM Fargo ND	*97.9	KRSJ Durango CO	100.5	WMBN Chattanooga TN	*88.9
KGVW-FM Belgrade MT	96.7	KRSP-FM Salt Lake City UT	103.5	WNCU Miami FL	*89.7
KHEP-FM Phoenix AZ	101.5	KRWV Farmington NM	92.9	WMDI McKean PA	102.3
KHO-FM Spokane WA	98.1	KSEA Seattle WA	100.7	WMQT Ishpeming MI	107.1
KIAM Wenatchee WA	104.9	KSJR Collegeville MN	*90.1	WNWC Madison WI	*102.5
KISW Seattle WA	99.9	KSL-FM Salt Lake City UT	100.3	WPCS Pensacola FL	*89.3
KIVE Glendive MT	96.5	KSOP-FM Salt Lake City UT	104.3	WPOS Holland OH	102.3
KIXI-FM Seattle WA	95.7	KSOR Ashland OR	*90.1	WPPL Blue Ridge GA	103.9
KKBC Carson City NV	97.3	KSRN Reno NV	104.5	WPVR Roanoke VA	94.9
KKHJ Rapid City SD	93.9	KSUB-FM Cedar City UT	92.5	WRBS Baltimore MD	95.1
KLCCM-FM Lewiston MT	95.9	KSUE-FM Susanville CA	92.7	WRVM Suring WI	102.7
KLIP Denver CO	100.3	KTAK Riverton WY	93.5	WTMJ Miami FL	93.1
KLOQ Lyons KS	106.1	KTMT Medford OR	93.7	WURD Georgetown OH	97.7
KLUB-FM Salt Lake City UT	97.1	KTOO Juneau AK	*104.3	WVIB Ladysmith WI	103.7
KMBI-FM Spokane WA	107.9	KTUH Honolulu HI	*90.3	WWRM Gaylord MI	106.7
KMCR Phoenix AZ	*91.5	KUAC Fairbanks AK	*104.7	WZAR Ponce PR	101.9
KMTH Jackson WY	96.9	KUAT-FM Tucson AZ	*90.5		
KNIS Carson City NV	94.7	KUFM Missoula MT	*89.1		
KNIX-FM Phoenix AZ	102.5	KUNI Cedar Falls IA	*90.9		
KNJO Thonon Oaks CA	92.7	KUOW Seattle WA	*94.9		

Station Directory (Continued from p. 80, showing selected stations only. Map p. 54.)

## Cuba

Cienfuegos 100.3 CMH-FM 300  
 Guantanamo Bay  
 E mc 102.0\*AFCN \$ 500  
 E 103.0\*AFRTS 1000  
 Havana 90.5 CMQ-FM 3000  
 Santa Clara 90.5 CMHW-FM 300  
 Santa Fe 100.1 CMNB-FM 300  
 Haiti  
 Port au Prince  
 g 88.1 4VUE-FM 250  
 g 97.9 4VIF 250

## Dominican Republic

Santiago m 90.1 HIRL \$ 1000  
 m 103.5 HIAO 1000  
 Santo Domingo 94.9 HIJP \$ 100000  
 m 99.5 HIXZ-FM \$ 10000  
 n 107.1 HIFA \$ 1000

## Jamaica

Coopers Hill 91.1 JBC-FM \$v 8000  
 nc 92.7 RJR \$ \$v 10000  
 Kingston nc 95.7 RJR \$ \$v 500  
 Montego Bay 92.1 JBC-FM \$v 800  
 Spur Tree rm 90.5 RJR 1000

## Guatemala

Guatemala L 88.8 TGRT-FM 5000  
 E cg 100.8 TGN-FM \$ 8000

## Honduras

Tegucigalpa 92.9 HRN-FM 1000

## El Salvador

San Salvador 90.0 YSU-FM 10000  
 92.5 YSMF-FM \$ 6000 +  
 103.1 YST-FM \$ 1000

(Continues p. 111)

Radio Stations  
**KLTI - KLTI-FM**  
 Box 1866 - Longview, Texas  
 105.9 MHz, c. 1952

**FMORGUE**

**WFJL**  
 71 EAST WACKER DRIVE  
 CHICAGO 4, ILLINOIS  
 93.1 MHz, c. 1954

Here's where we remember FM stations that achieved notoriety by having been deleted by the Federal Communications Commission. Such deletions are rare today, but in the 1950's it was common for station owners to allow their FM licenses to expire, and concentrate their sales and promotion efforts on their more profitable AM or TV affiliates. A few of these stations were FM only, and victims of being ahead of their time. Some of the frequencies of these early FM stations have been taken over by other stations, and often their transmitters have lived on by serving newer stations.

**WBTM--WBTM-FM**  
 DANVILLE 97.9 MHz, c. 1953  
 AN 1400 KC • FM 86.7 MC • BALTIMORE

**WMLL FM**  
 94.5 MHz, c. 1952  
 519 VINE STREET  
 EVANSVILLE-8-INDIANA

**WHBS** FM 16,000 W.  
 Huntsville, Alabama 95.1 MHz, c. 1953

**WWSN** AM 510 W.  
 Huntsville, Alabama  
 WWSN-FM 95.1 MHz  
 Huntsville, Ala. c. 1950

**WWINI** c. 1951  
 .333 north michigan .chicago  
 101.9 MHz

**WCLM** State 2-4872  
 WCLM WHERE CLASSIC, LEISURE AND MODERN MUSIC MEET

**KGLO**  
 A.M. 5,000 WATTS F.M. 16,000 WATTS  
 101.1 MHz  
 SECOND AND PENNSYLVANIA AVE.  
 Phone Garden 3-3340 MADISON CITY, IOWA  
 August 17, 1959

Dear Mr. Elvings  
 Thank you for your very nice letter received today.  
 We are pleased to know that you are enjoying our programming, and you are able to receive us so well. To let your letter represents the farthest distance from our Station.  
 We operate with 18 Kw of power, and our antenna height is 524 feet.  
 It was real glad of you to take the time to write us. If you come to Chicago, we shall be glad to have you visit with us.

July 22, 1957

We are placing your name on our mailing list.

ON TELEVISION  
 "CRUSADE IN EUROPE"  
 Thursdays at 8:35 P.M.  
 WFMY-TV, Channel 2

**WJOP** 96.1 MHz, c. 1952  
 Joplin, Missouri  
 The Crossroads of America

**FM-wfmy-TV**  
 97.3 MHz "THE EYES AND EARS OF THE PIEDMONT" c. 1950

GREENSBORO, NORTH CAROLINA  
**WIMS, WIMS-FM**  
 Michigan City, Indiana  
 La Porte, Indiana (R) 93.5 MHz, c. 1953  
 Broadcasting also from Valparaiso, Ind.  
 Northern Indiana Broadcasters, Inc.

**KWNO** 97.5 MHz, c. 1953  
 WINONA RADIO SERVICE  
 WINONA, MINNESOTA

THE UNIVERSITY OF OKLAHOMA  
 NORMAN - OKLAHOMA  
**WNAD**  
 May 18, 1962  
 AM-640 KC FM-90.9 MC

**WRZE**  
 White Rose Broadcasting Company  
 FM EXCLUSIVELY  
 98.5 MHz, c. 1954  
 Office: 31 E. King St., York, Penna.  
 Trans. Bldg. R. D. 3, Hanover, Penna.

ALLIED BROADCAST  
**WJMK**  
 645 MC  
 NIGHT HOBBS, WISCONSIN  
 c. 1963

98.5 MHz  
**JEFFERSON CITY, MO.**  
 August 29, 1952.

**WFRS**  
 Grand Rapids MI, 92.5 MHz, c. 1952

IMPORTANT NOTICE

The **FM Atlas** is issued periodically, and its data revised thoroughly. Most copies of this book are sold direct by mail, and if you received your copy that way your name appears on our mailing list. You will be notified when a new edition is published. However, if your address changes, please send a change of address card so that you will be able to receive news about future editions. Other readers of the **FM Atlas** are asked to send a card with their name and address to "FM Atlas," Adolph MN 65701, U. S. A., to be notified when the sixth edition is ready. Feel free, whenever writing, to note any stations in your area adding stereo, changing their musical programming, or their networks.



(Los Angeles CA, now KIIS-FM)

## FMISCELLANY



(Framingham MA, now WVBF)

**ckso**

Television  
Radio am/fm stereo  
Cambrian  
Broadcasting  
Limited

Sudbury ON,  
92.7 MHz, now CISM

(Continued from p. 110)

### Nicaragua

Managua	L	98.9 YNEP	§	1000
		102.9 YND-FM		1000
		106.7 YNDW-FM		1000

### Costa Rica

San Jose		97.9 T105-FM		1000
		100.7 TIMIL-FM		5000
		103.5 T1SRHB-FM		500

### Panama

Panama City		104.5 HOS21FM		6000
		105.1 HOX44FM		6000
		106.7 HOH94FM		6000
		107.9 HOV28	v	3000

### Cayman Islands

Neelands	c	101.1*ICCI	§	10
		105.3		250

### Greenland

Godthab		97.2 OX1-FM		250
---------	--	-------------	--	-----

Since 1922 c. 1953 (now deleted; a carryover from  
FMorgue [see following page])



OFFICES AND STUDIOS, LA SALLE-WACKER BUILDING, CHICAGO 1, ILLINOIS - BROADCASTING SINCE 1922

### BACK ISSUES

Most back issues of the FM Atlas and Station Directory are out of print, except for a limited number of the Second Edition, revised, of 1973, and the Third Edition, 1975, at \$2.50 each.

COMPUTER print-outs of the FM Atlas station directory cards can be made at any time, should you desire last-minute news on existing stations and applications for new FM stations. Available on a geographical basis, entire deck or by individual states. Write for availability and price.

### "My Favorite FM Station" Contest

Here's a contest in which there will be no prizes and no winners! But read on; you might want to enter anyway.

Scattered here and there are FM stations that are exceptionally well-programmed and well-engineered. A station with live old-time music, an FM-only station that presents hard-hitting editorials and news reporting, or a station with exceptionally good audio and live production, presenting rather "ordinary" music in a truly pleasurable manner. Or a station that blends the best of automation with local live programming in an especially effective way. Think of an FM station in your regular listening area that you could nominate. It can be commercial or educational, with any musical format, or nonmusical format for that matter.

"Winners" selected in this contest will be the stations receiving either the largest number of votes among FM Atlas readers, or a station or stations having perhaps only one vote each but with an entry form a listener who offers very convincing reasons why this station should be recognized. Station winners will be published in the Sixth Edition of the FM Atlas. Recognition of excellence in FM broadcasting should help to inspire other stations to program in an especially interesting and innovative manner, as well as to encourage the winning stations to continue their good work. Use this form, or copy onto your own paper.

I choose station \_\_\_\_\_ (call letters), located in \_\_\_\_\_, and broadcasting on \_\_\_\_\_ MHz. To the best of my knowledge this station is ( ) all live; ( ) automated; ( ) partly live and partly automated. Its music is basically of the following type or types (using categories listed in the FM Atlas):

Mention any network or audio news service this station utilizes:

Now tell why you're nominating this station. Be as specific as possible, pointing out whether you are commending its overall programming, one certain program you heard, the station's engineering practices, or a combination of factors. Tapes, pictures, or clippings about the station can be sent, but they cannot be returned. Include also your name and address. Send to "FM Atlas," Adolph MN 55701.

Radio Stations  
**KLTI - KLTI-FM**  
 Box 1866 - Longview, Texas  
 105.9 MHz, c. 1952

# FMORGUE

**WFJL**  
 75 EAST WACKER DRIVE  
 CHICAGO 1, ILLINOIS  
 93.1 MHz, c. 1954

Here's where we remember FM stations that achieved notoriety by having been deleted by the Federal Communications Commission. Such deletions are rare today, but in the 1950's it was common for station owners to allow their FM licenses to expire, and concentrate their sales and promotion efforts on their more profitable AM or TV affiliates. A few of these stations were FM only, and victims of being ahead of their time. Some of the frequencies of these early FM stations have been taken over by other stations, and often their transmitters have lived on by serving newer stations.

**WBTM--WBTM-FM**  
 RADIOMOUNT BROADCASTING CORPORATION  
 DANVILLE VIRGINIA  
 97.9 MHz,  
 c. 1953



**WMLL FM**  
 94.5 MHz,  
 c. 1952

519 VINE STREET  
 EVANSVILLE-8-INDIANA

**WSGN**  
 HENRY P. JOHNETON  
 EXECUTIVE VICE-PRESIDENT  
 MANAGING DIRECTOR  
 AM 610 &  
 FM 93.7 MC  
 The News-Today Herald Stations  
 P. O. BOX 2283  
 BIRMINGHAM 2, ALA. C. 1950

**WHBS** FM 16,000 W.  
 AM 5,000 W.  
 Huntsville, Alabama 95.1 MHz, c. 1953

**WVWI**  
 AM 1400 KC • FM 94.7 MC • BALTIMORE  
 342 REISTERSTOWN RD - BALTIMORE, MD  
 c. 1951

**WCLM**  
 State 2-4872



*. 333 north michigan . chicago*

**KGLO**  
 A.M. 5,000 WATTS F.M. 16,000 WATTS  
 101.1 MHz  
 SECOND AND PENNSYLVANIA AVE.  
 Phone Garden 3-2540 MASON CITY, IOWA  
 August 17, 1959



Dear Mr. Elving:  
 Thank you for your very nice letter received today.  
 We are pleased to know that you are enjoying our programming, and you are able to receive us so well. To date your letter represents the farthest distance from our Station.  
 We operate with 18 Kw of power, and our antenna height is 524 feet.  
 It was real good of you to take the time to write us. If you come to Chicago, we shall be glad to have you visit with us.  
 We are placing your name on our mailing list.

July 22, 1957

WCLM WHERE CLASSIC, LEISURE AND MODERN MUSIC MEET

**FM-wfmy-TV**  
 97.3 MHz "THE EYES AND EARS OF THE PIEDMONT" c. 1950

ON TELEVISION  
 "CRUSADE IN EUROPE"  
 Thursdays at 8:35 P.M.  
 WFMY-TV, Channel 2

GREENSBORO, NORTH CAROLINA  
**WIMS, WIMS-FM**  
 Michigan City, Indiana  
 La Porte, Indiana (R) 93.5 MHz, c. 1953  
 Broadcasting also from Valparaiso, Ind.  
 Northern Indiana Broadcasters, Inc.

**KWNO**  
 AMERICAN BROADCASTING COMPANY AFFILIATE  
**WINONA RADIO SERVICE**  
 WINONA, MINNESOTA  
 97.5 MHz, c. 1953



THE UNIVERSITY OF OKLAHOMA  
 RADIO STATIONS  
 NORMAN - OKLAHOMA  
**WNAD**  
 May 18, 1962  
 AM-640 KC  
 FM-90.9 MC



**KWOS-FM**  
 98.5 MHz  
 ALLIED BROADCAST  
**W7MK**  
 92.1 MC  
 MOUNT MOREB, WISCONSIN  
 c. 1963

JEFFERSON CITY, MO.  
 August 29, 1952.

**WRZE**  
**White Rose Broadcasting Company**  
 FM EXCLUSIVELY  
 98.5 MHz, c. 1954

Offices: 31 E. King St., York, Penna.  
 Trans. Bldg.: R. D. 3, Hanover, Penna.

**WFRS**  
 Grand Rapids MI, 92.5 MHz, c. 1952

### IMPORTANT NOTICE

The FM Atlas is issued periodically, and its data revised thoroughly. Most copies of this book are sold direct by mail, and if you received your copy that way your name appears on our mailing list. You will be notified when a new edition is published. However, if your address changes, please send a change of address card so that you will be able to receive news about future editions. Other readers of the FM Atlas are asked to send a card with their name and address to "FM Atlas," Adolph MN 55701, U. S. A., to be notified when the sixth edition is ready. Feel free, whenever writing, to note any stations in your area adding stereo, changing their musical programming, or their networks.



**100% rock**  
**JKK DJ**  
**102.7**

(Los Angeles CA, now KJLJ-FM)

**FMISCELLANY**

**WKOx**  
**101.1 FM**  
**STEREO**

(Frankfurt MA, now WGBF)

**ckso** Television  
Radio am fm stereo  
Cambrian  
Broadcasting  
Limited

Country, Ok,  
92.7 FM, now KJLJ

(Continued from p. 116)

**Nicaragua**

Managua	L	98.5 AM-FM	1000
		102.5 AM-FM	1000
		103.7 AM-FM	1000

**Costa Rica**

San Jose		100.5 FM-FM	1000
		102.7 FM-FM	1000
		103.5 FM-FM	1000

**Panama**

Panama City		104.5 AM-FM	1000
		102.7 AM-FM	1000
		103.7 AM-FM	1000
		103.9 AM-FM	1000

**Cayman Islands**

Georgeown		102.7 (100)	1000
		103.7	1000

**Greenland**

Narsarsuaq		102.7 (100-FM)	1000
------------	--	----------------	------

Since 1922 (1933) (now selected carrier-free FM) (see following table)

**WAAF** CHICAGO  
AM 680 K - FM 93.0 K

OFFICE AND STUDIOS, LA SALLE-WACKER BUILDING, CHICAGO, ILLINOIS 60606 - 4 1932

**BACK ISSUES**

Most back issues of the FM Atlas and Station Directory are out of print, except for a limited number of the Second Edition, revised, of 1973, and the Third Edition, 1975, at \$2.50 each.

COMPUTER print-outs of the FM Atlas station directory cards can be made at any time, should you desire last-minute news on existing stations and applications for new FM stations. Available on a geographical basis, entire deck or by individual states. Write for availability and price.

**"My Favorite FM Station" Contest**

Here's a contest in which there will be no prizes and no winners! But read on; you might want to enter anyway.

Scattered here and there are FM stations that are exceptionally well-programmed and well-engineered. A station with live old-time music, an FM-only station that presents hard-hitting editorials and news reporting, or a station with exceptionally good audio and live production, presenting rather "ordinary" music in a truly pleasurable manner. Or a station that blends the best of automation with local live programming in an especially effective way. Think of an FM station in your regular listening area that you could nominate. It can be commercial or educational, with any musical format, or nonmusical format for that matter.

"Winners" selected in this contest will be the stations receiving either the largest number of votes among FM Atlas readers, or a station or stations having perhaps only one vote each but with an entry from a listener who offers very convincing reasons why this station should be recognized. Station winners will be published in the Sixth Edition of the FM Atlas. Recognition of excellence in FM broadcasting should help to inspire other stations to program in an especially interesting and innovative manner, as well as to encourage the winning stations to continue their good work. Use this form, or copy onto your own paper.

Each station is \_\_\_\_\_ (in all letters), located in \_\_\_\_\_ and is broadcasting on \_\_\_\_\_ MHz. To the best of my knowledge this station is \_\_\_\_\_ (a) all day, (b) intermittent, (c) partly live and partly automated. Its music is basically of the following type or types during its broadcast: (Listed on the FM Atlas)

\_\_\_\_\_ (a) many network or up-to-date news service; (b) this station utilizes \_\_\_\_\_  
Now tell why you're nominating this station. Be as specific as possible, pointing out whether you are commending the overall programming, one certain program you heard, the station's engineering practices, or a combination of factors. Tapes, pictures, or clippings about the station may be sent, but they aren't the reason. In the final analysis, we'll be looking for letters, send to: FM Atlas, 7 A St., MN 55401.