

EVERYDAY ENGINEERING MAGAZINE

September, 1919
Vol. 7 No. 6

Fifteen Cents
a Copy



GETTING READY- Are you?

"Your spare time is your capital."



For every man who educates himself in the finer points of electrical practice there is a big job waiting. This is your chance to get ready.

Thousands of men are preparing themselves for the higher positions in the world of electricity by spending a few minutes each day with the CROFT LIBRARY OF PRACTICAL ELECTRICITY.

Thousands of men are coming to recognize the importance of books founded on actual electrical practice, as is the Croft Library—free from theory. They see in this Library records of work that has been and is being done every day in the world of electricity. They see the plain facts, plainly stated and plainly illustrated—understandable even to the beginner.

Terrill Croft tells you in 3,000 pages and 2,100 illustrations what he has learned in twenty years' practice, as lineman's apprentice, as wireman, as draftsman, as central station operator, and finally as electrical engineer for the Westinghouse Company.

Every problem in electrical practice simplified. The most intricate operations and processes explained as never before. This Library makes the reader know electricity as experts know it. The electrician in practice usually confines his efforts to one branch of work only. In order to broaden his knowledge and fit himself for the bigger position, he must READ STANDARD BOOKS. Not haphazardly compiled, nor amateurish, books, but books by men who can pull off their coats and do the work they write about.

Eight Volumes, flexibly bound, pocket size, containing 3000 pages and 2,100 illustrations.

The problems of every one having to do in any way with electricity are covered. Nothing has been slighted. *Not a single explanation is beyond your understanding.* Always the practical man's way of doing things are followed out. Every subject is carefully indexed. The books are for either study or reference. A few minutes spent with them each day will in a short period make of you, not only an efficient electrical worker, BUT AN EXPERT.

**PAY AS YOU GO ALONG
Nothing in Advance**

Learn while you learn

READ THIS-

Electricity, from the simplest principles, to complete and economical operation of a central station.

Motors, generators, armatures, commutators, transformers, circuits, currents, switchboards, distribution systems.

Electrical machinery of every type, installation, operation and repair.

Wiring for light and power. How to do it mechanically perfect in accordance with the National Electrical Code. Wiring of finished buildings. Underwriters' and municipal requirements. How to do the complete job—from estimating it to completing it.

Illumination in its every phase. The latest and most improved methods of lighting. Lamps and lighting effects.

A complete course in mathematics as applied to work. A course which refreshes your mind and gives you mastery of all the shortcuts in figuring.

Electrical practice complete. Electrical practice as experts know it. Electrical practice by experts.

Worth five times their cost in reference value.

McGraw-Hill Book Company, Inc., New York

Gentlemen: I am enclosing remittance for the Croft LIBRARY OF PRACTICAL ELECTRICITY. I wish to state that as a library for reference or study I would not part with same for five times what they cost. Yours truly, H. E. STAFFORD, Port Arthur, Ont., Canada.

Ten days' free trial

Fill out the coupon below and return to us. We will send you the eight volumes charges prepaid for ten days' free examination in your own home. If you find the books clear, practical, complete, and satisfactory in every way, send us \$2 per month for eight months. If for any reason whatsoever you desire to return the books, you may do so. We pay the charges. This is your opportunity to see with your own eyes the Library which is considered the standard in America.

FREE EXAMINATION COUPON

McGraw-Hill Book Co., Inc., 239 W. 39th St. New York

McGraw-Hill Book Co., Inc., 239 W. 39th St., New York.

Gentlemen:—Please send me the Library of Practical Electricity (shipping charges prepaid), for 10 days' free examination. If satisfactory, I will send \$2 in ten days and \$2 per month until \$16 has been paid. If not wanted, I will write you for return shipping instructions.

Name
Home Address.....
City and State.....
Where Employed.....
Occupation ED. 9-19

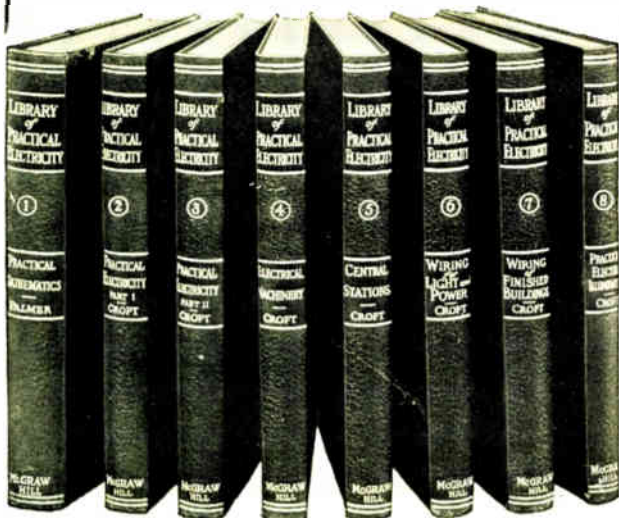

C O N T E N T S

VOL. 7 SEPTEMBER, 1919 NO. 6

HOW BRIDGES ARE DESIGNED AND BUILT.....	327
HARD AND SOFT SOLDERING.....	329
<i>By Raymond Francis Yates</i>	
A MILLING ATTACHMENT FOR A SMALL LATHE. 331	
<i>By Joseph Danté, Jr.</i>	
MODEL RAILWAY ENGINEERING HELPS.....	333
<i>By George F. Heaney, Jr.</i>	
AUTOMOBILE TIRE MANIPULATION AND REPAIR. 334	
<i>By Victor W. Pagé, M. S. A. E.</i>	
OXY-ACETYLENE WELDING	337
A SIMPLE LONG-DISTANCE FLYER.....	341
<i>By Edward Marquet</i>	
THREAD CUTTING DIES.....	343
<i>By George F. Kuhne</i>	
THE EVERYDAY MOTORIST.....	345
NOTES ON PRESSURE GAUGES.....	348
<i>By Henry B. Graves</i>	
LARGE AIRPLANES FOR PASSENGER TRANSPORT.. 349	
<i>By Victor W. Pagé, M. S. A. E.</i>	
BUILDING A TWO-PASSENGER SEAPLANE.....	353
<i>By Charles E. Muller</i>	
A LABORATORY REACTANCE COIL.....	355
<i>By Raymond Francis Yates</i>	
APPARATUS FOR THE RADIO LABORATORY.....	357
<i>By M. B. Sleeper</i>	
A HIGH-EFFICIENCY 1 K. W. TRANSMITTER... 360	
THE RADIO DEPARTMENT.....	363
B BATTERIES FOR VACUUM TUBES.....	364
<i>By W. B. Shulte</i>	
A NEW INSTRUMENT FOR THE PRODUCTION OF UNDAMPED WAVES	366
THE PROBLEMS OF VACUUM TUBE CIRCUITS... 367	
<i>By L. M. Clement</i>	
A WIRELESS RECEIVING SET FOR BEGINNERS... 370	
<i>By William G. H. Finch</i>	

EVERYDAY ENGINEERING MAGAZINE



2 West 45th Street

New York City

Editor *Managing Editor* *Radio Editor*
RAYMOND F. YATES VICTOR W. PAGÉ M. B. SLEEPER

Advertising Manager
STEPHEN ROBERTS

Branch Advertising Offices

E. M. CLEMENT, 320 Wayne Avenue, East Oakland, Calif.
SEARS & IRVING, Peoples Gas Building, Chicago, Ill.

Southern Representative

H. W. ENGLISH, P. O. Box 339, Birmingham, Ala.

Published Monthly by

EVERYDAY MECHANICS COMPANY, Inc.
New York, N. Y.

Entered as second-class matter November 20, 1915, at the post office at New York, N. Y., under the Act of March 3, 1879.

Subscription price \$1.50 a year in the United States and possessions. Canada, \$1.75; Foreign, \$2.00 a year.

Copyright, 1919, by Everyday Mechanics Co., Inc.

THE POWER OF THE FUTURE

WHEN the coal mines of the world become exhausted, what substitute will be found that will be capable of supplying the tremendous amount of power that is furnished by the combustion of coal at the present time?

AS a thoughtless answer, many say that the salvation of mankind will be through hydro-electric power. A careful analysis, however, reveals the startling truth that the possible sources of hydro-electric power in the world would not be sufficient to meet the needs of civilization. True, every stream will be harnessed, but the aggregate power, as tremendous as it would be, would not meet the demands.

WHAT are the other possible sources of power? Petroleum resources will be exhausted before the coal supply. Will gasoline be produced synthetically? That is very possible. The waves of the ocean, the heat of the sun, and atomic energy are other possible sources of power. In the atomic energy contained in a piece of matter the size of a penny, there is enough power available to drive a freight train from New York to Chicago. Whether or not man will ever be able to release these great forces is problematical.

HERE is an interesting thought. Water is composed of hydrogen and oxygen, and these gases, when free, form an extremely explosive mixture far more violent than the combustion of gasoline vapor. One method of decomposing water is that known as electrolysis. The energy spent in dissociating the gases, however, is, according to the laws of the conservation of energy, greater than the energy realized as a result of the explosion of the gaseous products.

HERE is a problem, if solved, would turn the oceans, rivers and lakes into vast reservoirs of energy with billions of horsepower. It would be possible to stop at the river side, pour a few gallons of water in the car, and travel for days—yes, even weeks, on the energy stored up in it.

WILL a catalytic agent ever be discovered that will by its mere presence cause water and hydrogen to dissolve partnership like platinum causes hydrogen peroxide to decompose? Or will some peculiar physical or electrical state cause a spontaneous decomposition?

AFTER thinking of the problem, one feels like awakening from a pleasant dream.

RAYMOND FRANCIS YATES,

Editor.

The Burgess BLUE BOOK

for all Practical Men and Electrical Students

I have prepared a pocket-size note book especially for the practical man and those who are taking up the study of electricity. It contains drawings and diagrams of electrical machinery and connections, over two hundred formulas for calculations, and problems worked out showing how the formulas are used. This data is taken from my personal note book, which was made while on different kinds of work, and I am sure it will be found of value to anyone engaged in the electrical business.

The drawings of connections for electrical apparatus include Motor Starters and Starting Boxes, Overload and Underload Release Boxes, Reversible Types, Elevator Controllers, Tank Controllers, Starters for Printing Press Motors, Automatic Controllers, Variable Field Type, Controllers for Mine Locomotives, Street Car Controllers, Connections for Reversing Switches, Motor and Dynamo Rules and Rules for Speed Regulation. Also, Connections for Induction Motors and Starters, Delta and Star Connections and Connections for Auto Transformers, and Transformers for Lighting and Power Purposes. The drawings also show all kinds of lighting circuits, including special controls where Three and Four Way Switches are used.

The work on Calculations consists of Simple Electrical Mathematics, Electrical Units, Electrical Con-

nections, Calculating Unknown Resistances, Calculation of Current in Branches of Parallel Circuits, How to Figure Weight of Wire, Wire Gauge Rules, Ohm's Law, Watt's Law, Information regarding Wire used for Electrical Purposes, Wire Calculations, Wiring Calculations, Illumination Calculations, Shunt Instruments and How to Calculate Resistance of Shunts, Power Calculations, Efficiency Calculations, Measuring Unknown Resistances, Dynamo and Dynamo Troubles, Motors and Motor Troubles, and Calculating Size of Pulleys.

Also Alternating Current Calculations in finding Impedance, Reactance, Inductance, Frequency, Alternations, Speed of Alternators and Motors, Number of Poles in Alternators or Motors, Conductance, Susceptance, Admittance, Angle of Lag and Power Factor, and formulas for use with Line Transformers.

MOTOR STARTERS AND STARTING BOXES. The principle consideration in understanding the action of motor starters and starting boxes is the circuits. The Blue Book treats on the circuits very strongly, and in a very simple way, since a very few cross wires are used. Internal as well as external connections are clearly shown, which gives one a clear understanding of the action of the different parts, and the various steps of operation.

REVERSING SWITCHES AND CONTROLLERS. In addition to ordinary starting boxes and controllers, means for reversing motors are shown in connection with reversing switch and controllers. Diagrams showing the development of controllers is found to be of value to the practical worker.

INDUCTION MOTORS AND STARTERS. This covers two and three phase induction motors, showing the method of speed control, star and delta connections, and connections for synchronous motors.

POWER AND LIGHTING TRANSFORMERS. This shows the possible connections for transformers used for power and lighting purposes, including split circuits, star and delta connections, etc. Also valuable formulas which are used in calculating voltage, current, power, etc.

FORMULAS AND CALCULATIONS. The Blue Book contains many formulas which greatly shorten electrical calculations and the worked-out problems make it easy to understand how the formulas should be used. Many of the formulas were originated by the writer and cannot be found elsewhere.

This book is recommended by practical men.

It is being used in technical schools.

Electrical establishments furnish them to their employees to save time.

Industrial establishments give them to their customers.

The Burgess BLUE BOOK Will Be Mailed, Postpaid, on Receipt of \$1.00

Send dollar bill, money order or check. I guarantee satisfaction or will return your money if you decide not to keep the book after using it for five days

BURGESS ENGINEERING CO., YORKE BURGESS, Consulting Engineer
753 East 42nd Street Chicago, Illinois

Get Bigger Pay through ELECTRICITY

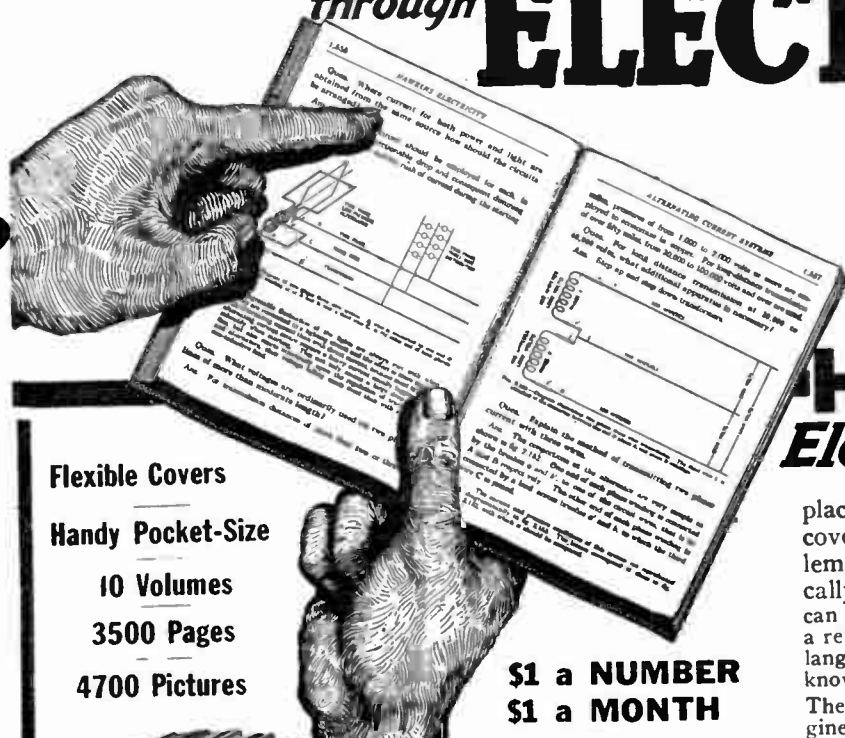

by using your set of **HAWKINS Electrical Guides Every Day.** They tell you just what you need to know.

HAWKINS Electrical Guides

- Flexible Covers
- Handy Pocket-Size
- 10 Volumes
- 3500 Pages
- 4700 Pictures

\$1 a NUMBER
\$1 a MONTH

place electricity at your fingers' ends. They cover every subject, principle, theory, problem, trouble, and way of doing things electrically. Every subject is indexed so that you can turn right to it. They are a study course and a reference guide in one, written in plain every day language—no wasted words—only what you need to know—full of up-to-the-minute electrical knowledge. The guides are a complete course in electrical engineering.

They will help you in every detail of the day's work. You can't ask an electrical question that Hawkins Guides can't give you help on.

The **WHOLE SET** sent **FREE** for your inspection

The books are small enough to slip into your coat pocket—handsomely bound in flexible black covers.

You can carry each volume with you until you have mastered its contents. 3,500 pages of actual information and 4,700 illustrations. Once you see these books and put them into actual use you will never again want to be without them. Try it at our expense.

TO EARN MORE—LEARN MORE

It will cost you nothing to receive these books—to look them over—ask them all the questions you can think of—use them in your work—study them—pick up some information that will increase your earning ability. We will ship you the entire set of 10 volumes entirely FREE.

This is a sign of our confidence in the guides. Pure gold does not object to being tested. Keep them for seven days and if you do not decide that you can't get along without them, return them to us and owe us nothing.

When you decide to keep them you only have to pay \$1.00 down and remit the balance of \$9.00 on the easy payment of \$1.00 a month till paid for. Use the coupon to get the books. It will pay you many times over.

What Users Say:

Become a Superintendent
Hawkins Guides are worth double their price. I have been able to secure higher pay and a better position with their aid.
K. W. Monard,
Supt. Erskine Light & Power Plant, Erskine, Minn.

\$5,000 Saved
The ten dollars I invested in Hawkins Electrical Guides netted the company by whom I am employed somewhere around \$5,000.

The knowledge gained from your books enabled me to save a transformer house, whereas a year ago I should have thought myself in great danger and have run.

Use this letter as you please as I am truly thankful for having the little wonders.
A. L. Foster, Opher, Colo.

Handy to Carry
The great beauty of them is that you can carry them in your pocket. That suits me for I never want to be without them.
F. S. Collins,
Richardson Engineering Co., Hartford, Conn.

THEO. AUDEL & CO.
72 Fifth Ave., New York, N. Y.

THIS COUPON BRINGS THE GUIDES

SEND NO MONEY

THEO. AUDEL & COMPANY
72 Fifth Avenue, N. Y.

Please submit me for examination Hawkins Electrical Guides (price \$1 each). Ship at once, prepaid, the 10 numbers. If satisfactory I agree to send you \$1 within seven days and to further mail you \$1 each month until paid.

Signature

Occupation

Employed by

Residence

Reference

E. E. Sept '19

READ THIS PARTIAL LIST OF CONTENTS

- No. 1 Contains 348 pages, 388 illustrations. Electrical signs and symbols—static and current electricity—primary cells—conductors and insulators—resistance and conductivity—magnetism—induction coils—dynamo principles—classes of dynamos—armatures—windings—commutation—brushes, etc.
 - No. 2 Contains 348 pages, 394 illustrations. Motor principles—armature reaction—motor starting—calculations—brake horsepower—selection and installation of dynamos and motors—galvanometers—standard cells—current measurement—resistance measurement—voltmeters—wattmeters—watt-hour meters—operation of dynamos—operation of motors, etc.
 - No. 3 Contains 300 pages, 423 illustrations. Distribution systems—wires and wire calculations—inside, outside and underground wiring—sign flashers—lightning protection—rectifiers—storage battery systems, etc.
 - No. 4 Contains 270 pages, 379 illustrations. Alternating current principles—alternating current diagrams—the power factor—alternator principles—alternator construction—windings, etc.
 - No. 5 Contains 320 pages, 614 illustrations. A. C. Motors—synchronous and induction motor principles—A. C. commutator motors—induction motors—transformers—losses, construction, connections, tests—converters—rectifiers, etc.
 - No. 6 Contains 293 pages, 472 illustrations. Alternating current systems—switching devices—current breakers—relays—lightning protector apparatus—regulating devices—synchronous condensers—indicating devices—meters—power factor indicators—wave form measurement—switch boards, etc.
 - No. 7 Contains 315 pages, 379 illustrations. Alternating current, wiring power stations—turbines; management, selection, location erection, testing, running, care and repair—telephones, etc.
 - No. 8 Contains 332 pages, 436 illustrations. Telegraph—simultaneous telegraphy and telephony—wireless—electrolysis bells—electric lighting—photometry, etc.
 - No. 9 Contains 322 pages, 627 illustrations. Electric railways—electric locomotives—car lighting—trolley car operation—miscellaneous applications—motion pictures—gas engine ignition—automobile self-starters and lighting systems, electric vehicles, etc.
 - No. 10 Contains 513 pages, 599 illustrations. Elevators—cranes—pumps—air compressors—electric heating—electric welding—soldering and brazing—industrial electrolysis—electro-plating—electro-therapeutics—X-rays, etc.
- Also a complete 126 page ready reference index of the complete library. This index has been planned to render easily accessible all the vast information contained in the 10 electrical guides. There are over 13,500 cross references. You find what you want to know instantly.

SEND NO MONEY—USE THE COUPON

Please mention EVERYDAY ENGINEERING MAGAZINE

BEST PRACTICAL BOOKS

The Modern Gasoline Automobile, Its Design, Construction, Operation.

By VICTOR W. PAGÉ, M.S.A.E. This is the most complete, practical and up-to-date treatise on gasoline automobiles and their component parts ever published. In the new revised and enlarged 1919 edition, all phases of automobile construction, operation and maintenance are fully and completely described and in language anyone can understand. 1000 pages. 1000 illustrations.

Price, \$3.50

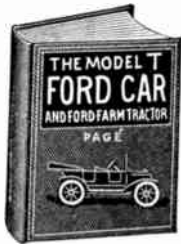

The Model T Ford Car, Its Construction, Operation and Repair, Including the Ford Farm Tractor.

By VICTOR W. PAGÉ. This is the most complete and practical instruction book ever published on the Ford car. A high grade, cloth bound book, printed on the best paper, illustrated by specially made drawings and photographs. All parts of the Ford Model T Car are described and illustrated in a comprehensive manner—nothing is left for the reader to guess at. The construction is fully treated and operating principle made clear to everyone. 310 pages, 106 illustrations.

Price, \$1.00

How to Run an Automobile.

By VICTOR W. PAGÉ. This treatise gives concise instructions for starting and running all makes of gasoline automobiles, how to care for them, and give distinctive features of control. Describes every step for shifting gears, controlling engines. 178 pages. 72 illustrations.

Price, \$1.00

Automobile Welding with the Oxy-Acetylene Flame.

By M. KEITH DUNHAM. Explains in a simple manner apparatus to be used, its care, and how to construct necessary shop equipment. Proceeds then to the actual welding of all automobile parts, in a manner understandable by everyone. 167 pages, fully illustrated.

Price, \$1.25

Dies; Their Construction and Use for the Modern Working of Sheet Metals.

By J. V. WOODWORTH. A new book by a practical man, for those who wish to know the latest practice in the working of sheet metals. It shows how dies are designed, made and used, and those who are engaged in this line of work can secure many valuable suggestions. Sixth revised edition. 325 illustrations, 394 pages. Cloth.

Price, \$3.50

Automobile Repairing Made Easy.

By VICTOR W. PAGÉ. A thoroughly practical book containing complete directions for making repairs to all parts of the motor car mechanism. Written in a thorough but non-technical manner. This book also contains Special Instructions on Electric Starting, Lighting and Ignition Systems, Tire Repairing and Rebuilding, Antigenous Welding, Brazing and Soldering, Heat Treatment of Steel, Latest Timing Practice, Eight and Twelve-Cylinder Motors, etc., etc. You will never "Get Stuck" on a job if you own this book. 1,000 specially made engravings on 500 plates. 1,056 pages (5½ x 8). 11 folding plates.

Price, \$3.50



Machine Shop Arithmetic.

By COLVIN-CHENEY. Most popular book for shop men. Shows how all shop problems are worked out and "why." Includes change gears for cutting any threads; drills, taps, shrink and force fits; metric system of measurements and threads. Used by all classes of mechanics and for instruction in Y. M. C. A. and other schools. Seventh edition. 131 pages.

Price, 60c.

Standard Practical Plumbing.

By R. M. STARBUCK. This is a complete treatise and covers the subject of modern plumbing in all its branches. It treats exhaustively on the skilled work of the plumber and the theory underlying plumbing devices and operations, and commends itself at once to anyone working in any branch of the plumbing trade. A large amount of space is devoted to a very complete and practical treatment of the subjects of hot water supply, circulation and range boiler work. Another valuable feature is the special chapter on drawing for plumbers. The illustrations, of which there are three hundred and forty-seven, one hundred being full-page plates, were drawn expressly for this book and show the most modern and best American practice in plumbing construction. 6½ x 9¼. Cloth, 406 pages, 347 illustrations.

Price, \$3.50

American Stationary Engineering.

By W. E. CRANE. A new book by a well-known author. Begins at the boiler room and takes in the whole power plant. Contains the result of years of practical experience in all sorts of engine rooms and gives exact information that cannot be found elsewhere. It's plain enough for practical men and yet of value to those high in the profession. Has a complete examination for a license. Third edition revised and enlarged. 345 pages. 131 illustrations. Cloth.

Price, \$2.50

Brazing and Soldering.

By JAMES F. HOBART. The only book that shows you just how to handle any job of brazing or soldering that comes along; it tells you what mixture to use, how to make a furnace if you need one. Full of valuable kinks. The fifth edition of this book has just been published, and to it much new matter and a large number of tested formulas for all kinds of solders and fluxes have been added.

Price, 35c

Drafting of Cams.

By LOUIS ROUILLON. The laying out of cams is a serious problem unless you know how to go at it right. This puts you on the right road for practically any kind of cam you are likely to run up against. Third edition.

35 cents

House Wiring.

By THOMAS W. POPPE. Describing and illustrating up-to-date methods of installing electric light wiring. Intended for the electrician, helper and apprentice. Contains just the information needed for successful wiring of a building. 125 pages, fully illustrated, flexible cloth.

Price, 80c.

Electric Wiring, Diagrams and Switchboards.

By NEWTON HARRISON, with additions by THOMAS POPPE. This is the only complete work issued showing and telling you what you should know about direct and alternating current wiring. It is a ready reference. The work is free from advanced technicalities and mathematics, arithmetic being used throughout. It is in every respect a handy, well-written, instructive, comprehensive volume on wiring for the wire-man, foreman, contractor or electrician. Second revised edition. 303 pages, 130 illustrations. Cloth.

Price, \$2.00

High Frequency Apparatus, Its Construction and Practical Application.

By THOMAS STANLEY CURTIS. The most comprehensive and thorough work on this interesting subject ever produced. The book is essentially practical in its treatment and it constitutes an accurate record of the researches of its author over a period of several years, during which time dozens of coils were built and experimented with. 248 pages. Fully illustrated.

Price, \$2.50

The Lathe—Its Design, Construction and Operation, With Practical Examples of Lathe Work.

By OSCAR E. FERRICO. A new revised edition, and the only complete American work on the subject, written by a man who knows not only how work ought to be done, but who also knows how to do it, and how to convey this knowledge to others. It is strictly up-to-date in its descriptions and illustrations. A number of difficult machining operations are described at length and illustrated. The new edition has nearly 500 pages and 350 illustrations.

Price, \$3.00

Henley's Twentieth Century Book of Recipes, Formulas and Processes.

Edited by GARDNER D. HISCOX. The most valuable techno-chemical formulae book published, including over 10,000 selected scientific, chemical, technological and practical recipes and processes. This book of 800 pages is the most complete book of recipes ever published, giving thousands of recipes for the manufacture of valuable articles for everyday use. Hints, helps, practical ideas and secret processes are revealed within its pages. It covers every branch of the useful arts in every respect. Contains an immense number of formulas that every one ought to have that are not found in any other work. New edition. Cloth binding, \$3.00. Half Morocco binding,

Price, \$4.00

Starting, Lighting, and Ignition Systems.

By VICTOR W. PAGÉ. A practical treatise on modern starting and ignition system practice. This practical volume has been written with special reference to the requirements of the non-technical reader desiring easily understood explanatory matter relating to all types of automobile ignition, starting and lighting systems. It can be understood by anyone even without electrical knowledge. Nearly 500 pages. 297 specially made engravings. New edition.

Price, \$2.00



☐ Any of these books sent prepaid on receipt of price. FREE—Our new Catalog of Practical Books sent free on request.

THE NORMAN HENLEY PUBLISHING COMPANY

Dept. E. E.

2 West 45th Street, New York

Please mention EVERYDAY ENGINEERING MAGAZINE

CLASSIFIED ADVERTISING COLUMNS

Advertisements in these columns 5c per word, average 7 words to the line. To insert advertisement under proper classification copy should reach us not later than the first of the month.

Agents

SCHEMER MAGAZINE, Alliance, Ohio, prints winning schemes each month so helps subscribers coin money; 32 pages; see for yourself; copy, 10c.; trial four months, 25c.

WONDERFUL Metal Polish contains no acid; made from almost nothing; complete formula, 10c. Agents wanted. Arion Shonyo, Bushton, Kansas.

Auctioneers

AUCTIONEERS. Make big money. Free Catalogue. Carpenter's Auction School, Kansas City.

Automobile Accessories

MORE Power, less fuel, no carbon. No Mystery, plain facts, results guaranteed. Write for booklet, No-Leak-O Piston Ring Company, Baltimore, Maryland.

POWER of the FORD DOUBLED through leverage. The greatest satisfaction to CLIMB HILLS, PULL through MUD without using Ford Low. Victor "4 Speeds Forward" Auxiliary Transmission is mechanically simple, easily attached. Among 7 VITAL ADVANTAGES provides the missing "2nd" or "intermediate" speed. Owners, Agents, why not learn the facts? Write NOW for complete line of "POWER-4-FORD" devices to increase Power, Ability, Economy & Speed of Ford Cars and Trucks. Convincing Trial Plan. T. Victor Manufacturers, 246 West 54th Street, New York.

Vulcanize Rubber without heat or tools. Whirlwind seller to every Auto Owner. Further particulars free. Muscatine Agency, E402, Muscatine, Iowa.

LUBRICANT CARBON REMOVER Solves the Carbon problem. Results guaranteed. \$1. Free Circular. Lewis W. Gilbert, Skaneateles, N. Y.

Aviation

AIRPLANES—1 to 6 passenger; aeronautical motors 30 to 300 H. P. Lowest prices. State your needs. Send for lists "E.E." Aero Exchange, 38 Park Row, New York.

YOU MAKE Umakem flying Model Airplanes. Outfit \$3.00. See Umakem Advertisement Page 381.

Blueprints

SEND 25c for each Umakem Blueprint desired from following list: Bleriot Aeroplane (3); Curtis Aeroplane (2); 48" Workbench; 54" Workbench with drawers; Sewingstand, Bookracks; Stationary racks. Send 10c for one Toy design also for dollar for twelve. W. R. Price, Incorporated, Eighty-two Umakem Building, Fifth Avenue, New York.

Books

BOOKS, Practical Mechanical, Auto, Aviation, Home Study Books. Easy payments. Send dime "tonight" for catalogs. Amso, Department B-1, Aurora, Illinois.

Business Opportunities

BUILD UP AN INCOME IN OIL—Others are doing it—Why not you? Today is the opportunity. Join our easy monthly payment plan NOW—It may mean hundreds in profits. Write for information. National Oil Drilling Co., Dept. "J," Houston, Texas.

I MADE \$30 a week at home; French breadmaking, 15 years' experience; free booklet tells how to start without capital. Ashbrook, Marengo, Ohio.

MANUFACTURE TOYS. Dollar Umakem outfit includes materials, tools, instructions to start. Umakem Shops, Umakem Building, Fifth Avenue, New York.

Boys

BOYS! You Make Umakem flying Airplanes. See Umakem Advertisement Page 381.

Chemicals

CHEMISTS—Lowest prices on chemicals, apparatus, minerals and equipment. Our Technical Bureau will design your laboratory free of charge. Consult us before buying. Appel "Laboratory Outfitter," Bauman Street, Knoxville, Pittsburgh, Penna.

Educational

PROGRESSIVE Shorthand complete in 5 lessons for \$3. Students take dictation the fifth day in English, French or Spanish and read their notes. Clear instructions; no guessing. Best system offered by mail. Progressive Shorthand School, 1910 East Fir, Seattle, Wash.

Electrical

100 INDUCTION MOTOR winding diagrams i, 2, 3, phase, star delta, 2 to 12 poles inclusive. Postpaid \$5.00. E. Glass, 2108 South Broad Street, Philadelphia, Pennsylvania.

Formulas

CONSULT us when in need of definite and reliable data concerning any trade formula or industrial process. Our lists show standard formula at 35c each. Guaranteed workable formulae developed at reasonable rates. Investigate! Industrial Methods Bureau, Century Building, Fifth Avenue and 34th Street, New York City. **EXPERT CHEMIST** will furnish Formulas, Processes and Trade Secrets. All lines. Lists free. W. J. Cummings, Ph.D., 228-230 Gordon Ave., Syracuse, N. Y.

For the Shop

PREPARE for long dry prosperous evenings. Send Five Dollars for full set Blueprints and instructions to Make Umakem Screw-Cutting Metal-Working Lathe. Castings later. Send Nine dollars for lumber, vise, blueprints and instructions to make 48" Workbench. W. R. Price, Incorporated, Eighty-two Umakem Building, Fifth Avenue, New York.

For Inventors

YOU MAKE a Umakem Lathe; then make your own Models. Umakem Shops, Umakem Building, Fifth Avenue, New York.

For Sale

100 6% ENVELOPES PRINTED to your order (2) colors, 75c prepaid. Write for Samples. Lincoln Novelty Co., Rochester, N. Y.

GENUINE INDIAN BASKETS—90 Styles. Catalogue. GILHAM, Highland Springs, California.

LATHE DESIGN BOOK, Perrigo, \$2.00 new. Hawkin's Guide No. 1, 50c 2 years complete. Electrical Experimenter, \$2.25. 2 years Popular Science, \$2.25. 3 years American Boy, \$2.00. Walter Link, 1244 Madison Ave., New York City.

FOR SALE—\$50 long distance receiver, \$25. 10,000 metre coupler, 8,000 metre load, audion cabinet, including bulb and high voltage variable condenser. Carl Wenzinger, 3135 N. Front, Philadelphia.

Gummed Labels

FREE CATALOGUE containing ideas in package labels suitable for your business. Stock labels a specialty. Royal Label Co., 29 S. Seventh, Philadelphia.

Help Wanted

WRITE for newspapers and magazines. Big Pay. Experience unnecessary. details free. Press Reporting Syndicate, 534 St. Louis.

Machinery

WRITE Umakem Shops, Umakem Building, Fifth Avenue, New York, for everything to make Screwcutting and Milling Lathes. Blueprints only Five dollars.

Male Help Wanted

RAILWAY TRAFFIC INSPECTORS: \$110.00 a month to start and expenses; travel if desired; unlimited advancement. No age limit. Three months home study. Situation arranged. Prepare for permanent position. Write for booklet CM-36. STANDARD BUSINESS TRAINING INSTITUTE, Buffalo, N. Y.

Manual Training Shop Equipment

SCHOOLS, CHURCHES, Neighborhood Clubs, prepare for long dry prosperous evenings. Send three dollars for Umakem Flying Airplane outfit with Blueprints, instructions, airplanewood, tools, materials. Send two dollars for Umakem outfit, tools, materials to make sixty toys. Send five-dollars for Umakem lathe-making blueprints, instructions; castings later. Address W. R. Price, Incorporated, Eighty-two Umakem Building, Fifth Avenue, New York.

Miscellaneous

MAGNETS: Large Horse Shoe Magnets. Will lift 12 lbs. Mail \$1 Stamp or Money Order. Parcel Post prepaid to all parts of U. S. or Canada. West Side Novelty Co., Drawer No. 8, Wabash P. O., Pittsburgh, Pa.

ENGINES—Castings—Blue Prints—Gas and Steam. 1/4 H.P. up. Gears, Pulleys, etc. Complete circulars for stamp. Modern Model Engineering Co., Monadnock Block, Chicago.

LUSITANIA Medals. Exact duplicates of German medal celebrating sinking of Lusitania. Everlasting proof of Hun's duplicity. 50c each; three for \$1.00; \$3.00 per dozen. C. A. Mahood, Warren, Pa.

TOBACCO OR SNUFF HABIT cured or no pay. \$1.00 if cured. Remedy sent on trial. Superba Co., S. M., Baltimore, Md.

ROYALTY or outright patent on adjustable carriage or bolt wrench. W. F. Kaiser, R. 3, Monett, Mo.

BREED Canaries—Profitable pastime. Particulars free. Bird Farm, Linnhaven, Virginia.

CORNETISTS—Trombonists: Send for "Free Pointers" Weak Lips—High Tones. Virtuoso Cornet School, Buffalo, N. Y.

JOIN a post card club. Have friends everywhere. Membership 10 cents. John Miller, 1430 H. Street, Sacramento, California.

Model Supplies

READY SOON 1" Steam Gauges also all Roller Fittings. No lists yet. Enclose Stamps. Aitken, 1714 Brown St., Philadelphia, Pa.

SEND STAMP for new catalogue of castings, tools, equipment and model supplies. Dwight S. Simpson, M.M.E., 20 Olive Street, Saranac Lake, N. Y.

Motion Pictures Plays

\$25-500 paid anyone for ideas, suggestions suitable for photoplays. Experience unnecessary; complete outline free. Producers League, 530 St. Louis, Mo.

Patents

INVENTORS—Write for our free illustrated guide book, "How to Obtain a Patent". Send model or sketch and description of invention for our opinion of its patentable nature free. Highest References, Prompt Service. Reasonable Terms. VICTOR J. EVANS & CO., 748 Ninth, Washington, D. C.

PATENTS. Prompt, personal efficient service by an Attorney-at-law skilled in all branches of Patent practice. Over 12 years actual experience, full information upon request. B. P. Fishburne, 322 McGill Bldg., Washington, D. C.

PATENT WHAT YOU INVENT. It may be valuable. Write me. No attorney's fee until patent is allowed. Estab. 1882. "Inventor's Guide" FREE. Franklin H. Hough, 510 Loan & Trust Bldg., Washington, D. C.

PATENTS promptly procured by personal, expert service. Information on request, James M. Lyles, Washington, D. C.

INVENTORS—Send sketch of your invention for advice regarding patent protection. Twenty Years' Experience. Patent Lawyers, 4821 Talbot Bldg., Washington, D. C.

PATENTS. Booklet free. Highest references. Best results. Promptness assured. WATSON E. COLEMAN, Patent Lawyer, 624 F St., Washington, D. C.

JOHN M. McLACHLEN, Attorney at Law, Patents, Trade Marks, Copyrights. 410 McLachlen Building, Washington, D. C.

PATENTS. My fee payable in monthly installments. Send sketch for advice. Booklet free. Frank Fuller, Washington, D. C.

PATENT extraordinary, No. 1,297,578, Collapsible Flag-pole, for home use, good advertising features, market for millions, investigate. Fred Lindstaedt, Fairmont, Minn.

Phonographs

BUILD YOUR OWN PHONOGRAPH, Particulars Free DeSelo-Phone, P. O. Box 72B, Attica, Indiana.

Printing

500 NEWMARKET BOND letterheads and 500 bond envelopes, printed, \$3.00; prepaid to 6th zone. Echo Printery, Wauwatosa, Wis.

Salesmen

GAS WATER HEATER Made Automatic \$20. Attachments. Differential, Clinton, Iowa.

Songs and Music

WRITE THE WORDS FOR A SONG. We write music and guarantee publisher's acceptance. Submit poems on war, love or any subject. Chester Music Co., 920 So. Michigan Ave., Room 289, Chicago.

"MUSIC COMPOSED" to words. Bauer Bros. (formerly of Sousa's Band), Oshkosh, Wis.

Stamps

APPROVALS 60% discount. Reference, please. Stamps bought. Lang, 1433-J, 59th, Cicero, Illinois.

Telegraphy

TELEGRAPHY (both Morse and Wireless) AND RAILWAY ACCOUNTING taught thoroughly and quickly. Big salaries now paid. Great opportunities. Oldest and Largest School. Est. 45 years. Catalog free. Dodges Institute, 24th Street, Valparaiso, Ind.

Tricks

1,000 STAGE TRICKS with 500 illustrations. Catalogue 15c. Small Catalogue Free. Hornmann Magic Co., Station 8, 304 West 34th St., New York.

TRICKS. Puzzles, Novelties, Books, etc. Catalogue Free. Zitka, Fairview, Mass.

Umakem Shops

UMAKEMISTS! The Publisher will accept your advertisement in this Classification if you desire to sell anything made from your Umakem sets such as Umakem Lathes, Umakem Work benches, Umakem furniture Novelties, Umakem Model Airplanes, or Umakem Toys. Organize Umakem Membership in your community. Umakem membership entitles holder to free advice and co-operation Making Money Making Merchandise. Address Umakem Clubs, New York.

MAKE MONEY DOING GOOD. Start Umakem Clubs Your Community. Address Umakem Clubs, New York.

SEND DOLLAR for Umakem Membership and get dollar Umakem set free. Address Umakem Clubs, New York.

MAKE MONEY DOING GOOD. All members need Umakem outfits. We allow organizers good commissions for all Umakem Merchandise bought by Members. Address Umakem Clubs, New York.

SEND THREE DOLLARS for Umakem Airplane set and Make Flying Model Airplanes. Big Demand. Address Umakem Clubs, New York.

Wireless

WIRELESS parts valuable information, winding data, all 10c; magnet wire, half pound, 22-24-50c—28-28-60c; improved switch lever-knob with dozen switch points and screws 50c. Postpaid prices. Novotny Electric, Charlotte, N. C.

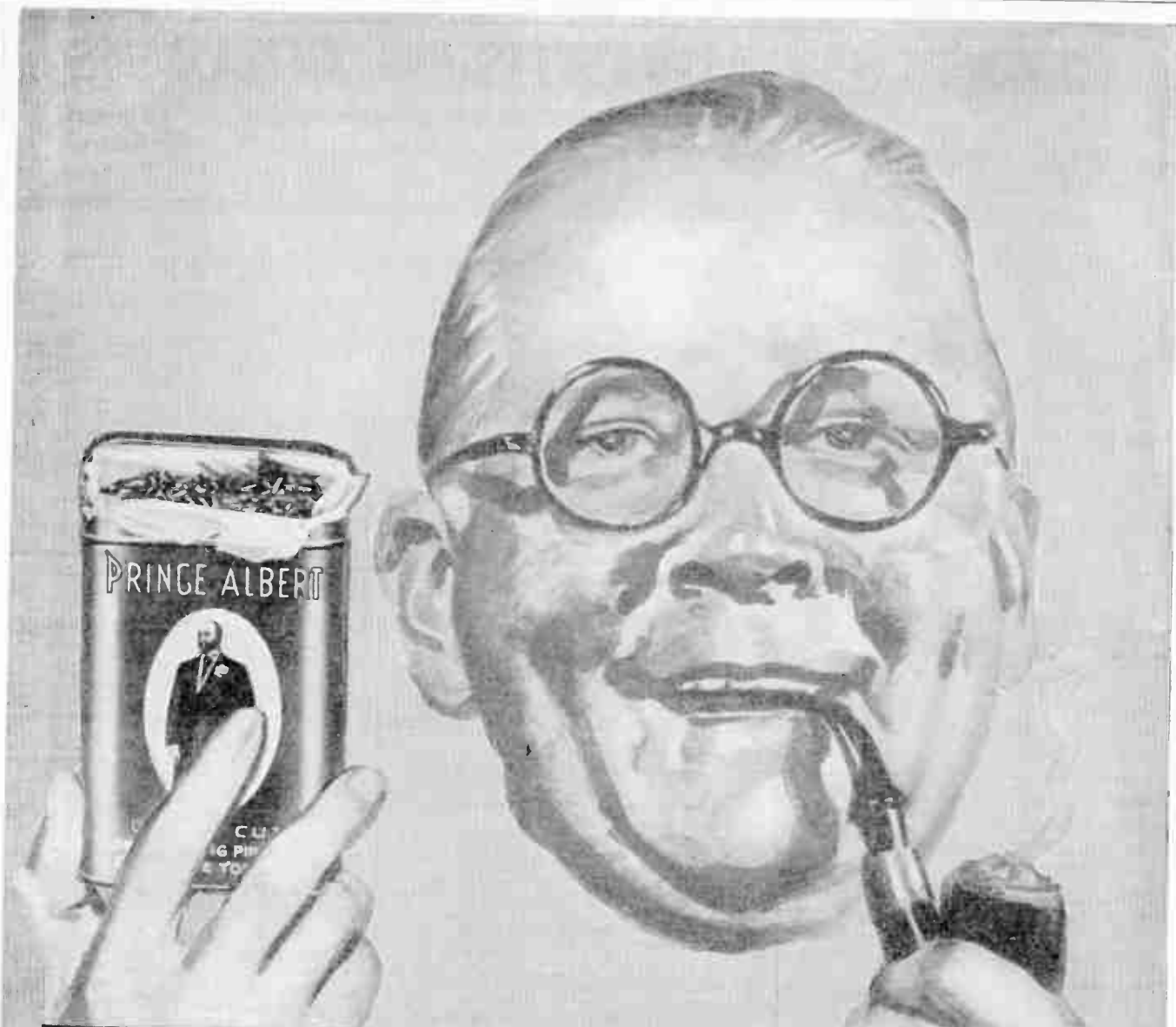

"I'll say it is!"

PRINCE ALBERT certainly will put some frolic into that pet pipe of yours! To pack that joy'us old jimmy brimful or roll a makin's cigarette and hit 'er up a notch or two is just going right over the top with your eyes wide open!

What P. A. will do for your taste and tongue you sure ought to know! Like the gentleman from Sparrow's Point you'll call P. A. a good egg! You'll smoke a pipe full and talk a bucket full—Prince Albert is such a great, big bunch of smokesunshine!

You'll quick catch the P. A. cue that it can't bite or parch; that Prince Albert's exclusive patented process frees it from bite and parch! And makes the sky the smoke limit!

Give Prince Albert high pressure for flavor and fragrance! Put P. A. through your little old taste-test-mill—and—just let that q-u-a-l-i-t-y percolate into your smokesystem!

You'll say it is, too!

R. J. REYNOLDS TOBACCO CO., Winston-Salem, N. C.

Copyright 1919 by R. J. Reynolds Tobacco Co.

**PRINCE
ALBERT**

the national joy smoke

Prince Albert is to be had everywhere tobacco is sold in tippy red bags and tidy red tins; handsome full pound and full half pound tin humidors—and—in that classy, practical full pound crystal-glass humidor with sponge-moistener top that keeps the tobacco in such perfect condition!

How Bridges Are Designed and Built

THE wide use of the truss in engineering structures justifies a study of the stresses in its different parts. The problem which engineers have to solve is the magnitude of these stresses before they can choose materials of the proper strength and shape to bear the loads placed upon them.

The loads on a truss may be divided into two classes; live loads and dead loads. A live load is a weight which the truss was designed to bear such as the weight of a train of cars, while dead load is the weight of the truss itself, or of its different members. In order to compute accurately the stress on any part of the truss, it is necessary to consider both the live and the dead load on that part. Laboratory models furnish ample means of studying the different types of trusses, because the loads supported are small and the stresses may be measured with a spring balance.

Fig. 1 shows a laboratory model of a simple truss. It consists of a board fastened to the wall, a light stick set into the hinge at the base of the board, and a rope passing from the screw eye in the free end of the stick to a hook in the board. A weight is suspended from this hook. By changing the length of the rope the shape and the size of the truss may be altered at will.

The weight at the end of the stick tends to stretch the rope and at the same time to compress the stick. This may be easily demonstrated by imagining the rope was cut, in which case the stick would fall downward. Or if the stick was replaced with a flexible wire, the wire would be bent, showing that the stick is being compressed, or, in other words, that there is a force acting along the stick toward the hinges at the base of the board. Then in order that the truss may support the weight, the rope must exert a pull away from the weight toward the hook in the board, and the stick must push from the hinge toward the weight. It must now be evident that there are three forces meeting at the screw eye in the end of the stick, namely, the weight acting vertically downward, the tension in the rope, and the thrust of the stick. In Fig. 2, T is the tension, C is the thrust, and W is the weight, all three of which meet at O. Of these forces

only the weight is known. In order to find these other forces, it is necessary

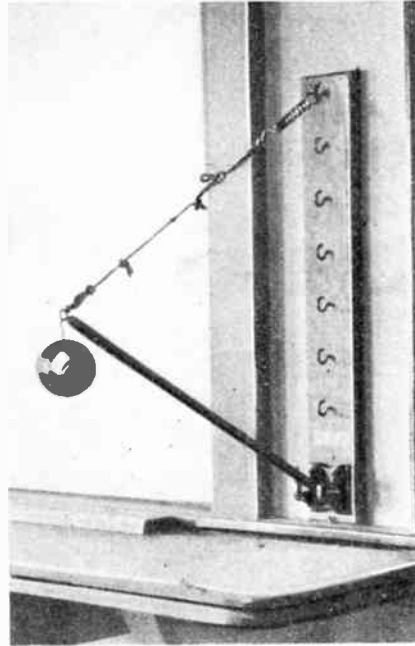

Fig. 1

to measure the length of the three sides of the truss. The method of solution is best shown by solving a practical problem.

The truss in Fig. 1 supports a weight of 4.25 lbs., the rope is 68 cm. long, the stick is 66.5 cm. in length, and the distance from the hinge to the rope is 63.8 cm. Since the forces in each side of the truss are directly proportional to the length of the side, we have only to solve a simple proportion problem to obtain figures for the tension and the thrust of the stick.

$$\begin{aligned} W : T &= H : L \\ 4.25 : T &= 63.8 : 68 \\ 63.8 T &= 289 \end{aligned}$$

$$T = 4.53 \text{ lbs.}$$

$$\begin{aligned} W : C &= H : S \\ 4.25 : C &= 63.8 : 66.5 \\ 63.8 C &= 282.6 \end{aligned}$$

$$C = 4.43 \text{ lbs.}$$

Where W is the weight

H is the height of the truss

L is the length of the rope

T is the tension in the rope

C is the thrust of the stick

S is the length of the stick.

The tension and the thrust of the stick were checked by a spring balance which indicated 4.5 lbs. and 4.4 lbs., respectively.

The stick not only exerts a thrust toward the weight but it also reacts against the hinge with an equal force in accordance with Newton's third law which states that "for every action there is an equal and opposite reaction." This reaction of the stick causes a horizontal force toward the wall and a vertical force downward from the hinge. This is demonstrated by attaching two spring bal-

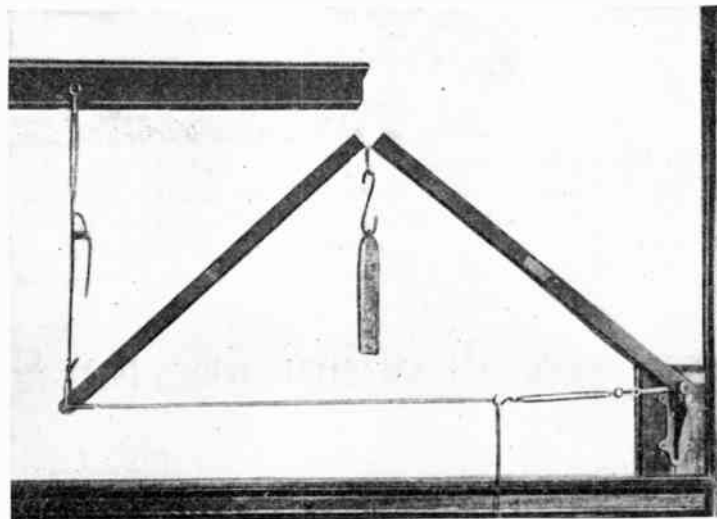

Fig. 4

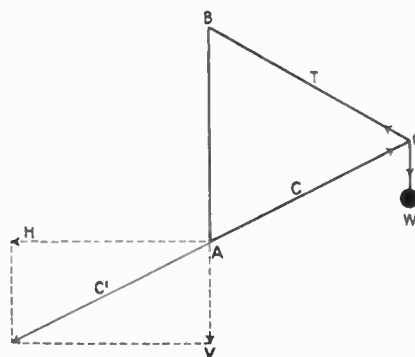

Fig. 2

ances to the end of the stick at the hinge and by pulling vertically on one and horizontally on the other at the same time. In this particular case the vertical force was 2 lbs. and the horizontal force was 3.9 lbs. according to the spring balance. This demonstration shows that a force acting obliquely at a point has two components at right angles to each other.

Fig. 3 shows the use of the truss in bridge construction. It will be noticed that there is a series of trusses. To find the forces in any part, it is only necessary to find the point where a number of forces meet, and solve as indicated previously. In actual practice

it is necessary to consider the weight of the various parts. Once the engineer knows the force on a given beam or rod he at once computes the size of the part needed to withstand the force.

Fig. 4 shows a different kind of truss called the roof truss. The laboratory model of this type is loaded at the ridge. Notice in Figs. 3 and 5 that this truss is used in bridge construction. The roof truss as used in the laboratory consists of two rafters of equal length fastened together with a hinge. One rafter is fastened permanently to the wall and the other rafter is suspended from the wall by a rope. The rafters are prevented from spreading by a tie rod which in this case is a chain. This arrangement permits one to change the spread of the truss. It is of interest to know the force which tends to spread the truss and the force required to support the truss. In an actual trial with the truss shown in Fig. 4, the weight at the ridge was 12.5 lbs. The spring balance indicated a tension in the tie rod of 7.8 lbs. The spring balance in the rope

supporting the left end of the truss read 8.7 lbs. or one-half the weight of the load plus one-half the weight of the truss which was 5 lbs. It was also found that if the length of the tie rod

the truss might be put ordinarily. The bridge shown in Fig. 5 has the ridge of the truss bolted to the girder. A load on the bridge tends to bend the girder. This causes a tension in the

rod which in turn compresses the rafters. The oblique thrust of the rafters tends to spread the truss, thereby stretching the girder. If the rafters are of the same length the pressure on each support will be the same. In this way a load on the bridge is distributed to the piers. This type of bridge is used extensively for small streams in rural communities, and while small it is an excellent example of the application of the roof truss to the construction of bridges.

Trusses not only play a large and important part in bridge building but in all phases of modern engineering construction. The study of trusses and their application forms a

large part of the education of a structural engineer.

It is hoped that this simple treatment of the truss will prove interesting to the readers of EVERYDAY ENGINEERING.



Fig. 3. The use of the roof truss in bridge construction. This very simple application of the truss is described in this article



Fig. 5. The application of trusses to bridge building. A study of the article will make clear the engineering features of this particular type of bridge

Using Gun Powder in the Shop

A SOMEWHAT novel idea is in successful operation in the machine shops of the D. & H. R. R. Co. at Watervliet, N. Y. They are using ordinary black sporting powder to save the time of mechanics as described and illustrated below:

Used for: Blowing nuts and bolts (sweated on) of which there are many in the construction of locomotives and other railroad equipment.

Breaking up iron and steel to be scrapped.

Forcing a piston (locomotive) when rust or corrosion binds it.

Breaking metal that has become cold in a furnace (this has been done at this plant without breaking a fire brick).

Methods of Use: The charge of

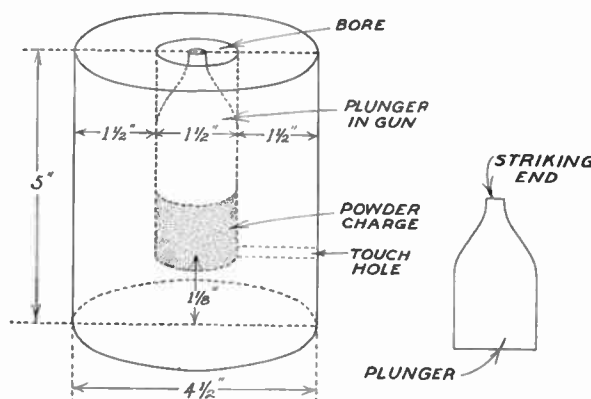

powder in all cases is loaded in steel guns of various sizes and held by a steel plunger, which is forced out when the charge is set off. No wad is used.

The plunger is milled to a size to fit (easily) the bore of the gun.

The accompanying sketch illustrates gun and plunger.

They have these guns in sizes from end to end of 5 to 12 inches with other dimensions in proportion to above sketch; also dimensions for plunger to sink. Some of the gun-barrels are milled in the shape of an octagonal prism, instead of being cylindrical, the bore, of course, in all cases being round.

The gun after having been loaded is jacked up with the mouth within about one inch of the object to be struck by the plunger and fired. They use approximately 1 oz. powder per nut or bolt.

Soft and Hard Soldering*

By Raymond Francis Yates

SOLDERING, both hard and soft, is an important operation with which the model engineer will have to become very familiar. Both processes require extensive practice to become proficient in, but this should not discourage the worker, as it is quite possible to do good work with a little practice, providing the directions are followed carefully and the necessary precautions to insure success are taken. It may be that the first two or three jobs of silver soldering or brazing will not be entirely successful, but after the worker has made a few experiments along this line, no difficulty will be experienced in doing good work, which, although it may not be perfect, will serve its purpose.

Before treating the subject of hard soldering, a few words will be devoted to the art of soft soldering. The most important part of soft soldering is that of properly preparing the surfaces to be soldered and holding them rigidly in place while the solder is being applied. The patience of a beginner in soldering is often exhausted when the solder is applied to the surface and repeatedly rolls off without adhering to the metal. Many unkind words are very apt to be said about the various implements employed and the art of soldering in general, under these circumstances, but the workman may rest assured that it is no fault of the solder he is using and, nine times out of ten, it is the method of applying it.

Before solder is applied to a metallic surface, the surface should first be scraped perfectly clean with a small tool that can be easily ground to shape from an old file. Although the surface should be clean and bright, it is not necessary to scrape excessively until a noticeable depression is formed in the metal. The surfaces should be scraped just before the worker is ready to apply the solder, as long standing will produce a thin film of oxide, to which solder does not readily adhere. Once the surface is cleaned, it should not be touched with the fingers, as this always leaves grease upon the surface,

no matter how clean the hands are kept. After the scraping is done and the soldering copper is heated, the flux should be applied. A good flux for soft soldering can be prepared by dissolving small pieces of zinc in hydrochloric acid. When this is done, a violent chemical reaction takes place between the zinc and the acid, which results in the formation of a solution of zinc chloride. This is kept in a small glass bottle and applied with a small bristle brush or wooden dauber. In

been in contact with it for a short time. After the solder has attached itself to the metal, it may appear very uneven in places, and to remedy this the hot copper is run lightly over the joint to even the depressions and projections. In heating the soldering copper, the tip or end should not be placed directly in contact with the flame, as this burns the tin off and renders it more or less unsuitable for use. The upper part of the copper may be exposed to the flame and the tip will be heated by the thermal conductivity of the metal, which, by the way, is very high.

Although it is quite necessary to employ the ordinary soldering copper in many cases, the best and most effective method is that of applying the heat directly to the surfaces to be joined together. The heat may be supplied by an alcohol lamp, gasoline blow torch or a Bunsen burner. The flame used must be free from soot, otherwise it will contaminate the surface and render it impervious to solder. After the metal is heated in the flame, the solder is applied by bring-

ing it in contact with the heated metal and holding it there until it melts and runs into place. The joint should be given plenty of time to cool before it is handled roughly. Many times it is necessary to bind the pieces together that are to be soldered with iron wire. This holds them rigidly in place until after the solder has thoroughly cooled. In employing the method of direct heating in inaccessible corners, it is best to use a small alcohol burner such as that shown in Fig. 1. This can be made with very little trouble and serves its purpose well. It merely consists of a small metal container with a cotton wick in it, at the end of which the alcohol burns. A small metal tube is soldered to the container so that the end of it comes directly over the wick. By blowing into the tube, the flame can be greatly extended and directed to any part of

the work at hand. There is one precaution necessary in soldering by the direct application of heat: The two objects to be soldered together must both be at the same temperature. If a small piece and a large piece of metal are to be soldered together, the small piece is very apt to become heated much more quickly than

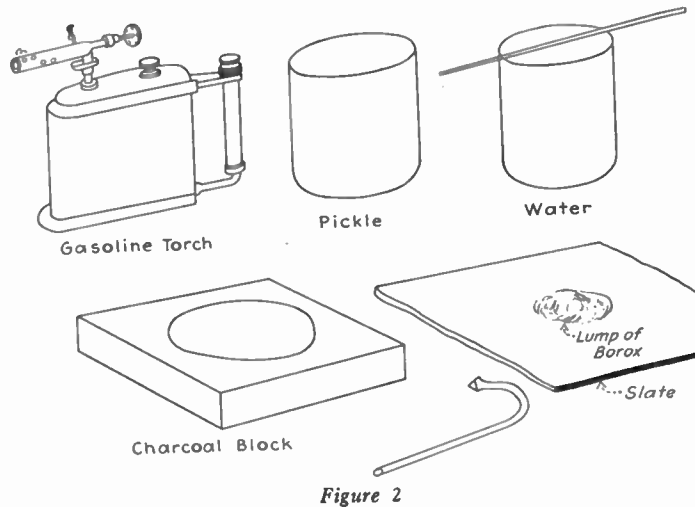

making this solution, the zinc should be added to the acid until no more chemical action takes place.

With the surface prepared according to the foregoing directions, and with the flux in place, the solder is ready to be applied. Solder in the form of a heavy wire is the most convenient to use, especially for the beginner. The copper should be brought in contact

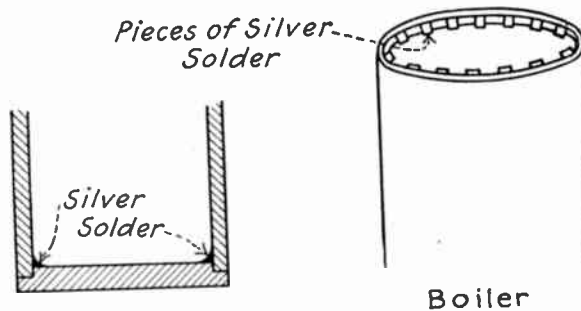

Figure 3

with the work and the solder fed to the tip or point of the copper as fast as it melts and runs. If it melts at the instant it touches the copper, this indicates that the copper is far too hot, and this is a common mistake of many beginners. The copper should be just hot enough for the solder to melt after it has

*From the book "Model Making", by Raymond Francis Yates.

the larger piece, and the piece that is heated to the greatest temperature will absorb most solder. This should be prevented as far as possible, and can be avoided in many cases by heating the larger piece first.

In soldering certain objects, it is sometimes practical to first wire them together so that they will hold the position that they are to be soldered together in. Of course, the pieces should be so wired that the wire will in no way interfere with the soldering. The wire should not be removed until the work has cooled sufficiently, otherwise the job is very apt to be spoiled.

Many times it is necessary to "tin" a piece of metal before soldering it to another piece, and this operation is very easily done by placing tiny pieces of solder about the surface of the piece and then heating it in a flame until the solder melts. By means of a wire brush or small stick, the molten solder should be spread over the surface. A piece of metal so prepared may very easily be soldered.

Good soldering—and soldering attended with the least possible difficulties—depends largely upon the "flux" or "paste" employed. Many mechanics use their favorite preparation, made according to their own formula, and others prefer the standard market articles, of which there are many that can be recommended. Ordinary resin is best suited for electrical work, owing to the fact that it will not corrode the wire and produces a very dependable connection from the electrical standpoint. Many patented preparations on the market are also very suitable for electrical soldering. If resin is used, it should be ground up into a very fine powder and sprinkled on the surfaces to be soldered together. Owing to the fact that resin is very soluble in alcohol, a solution of it may be made and applied to the metal in this way by means of a small brush. Immediately this preparation is exposed to the atmosphere, the alcohol evaporates and a very thin film of finely divided resin is deposited upon the surface of the metal.

The process of silver soldering is much more difficult than that of soft soldering and requires more patience and experience to produce good work. The various tools and materials used in the process of hard soldering or silver soldering are shown in Fig. 2. The outfit, although not elaborate, will enable the model maker to do very good work. It is not the outfit that is so important, but rather its intelligent use. The heat used in silver soldering must be very intense, and, for large pieces of work, it is necessary to employ a big flame. The ordinary gasoline blow torch produces a very good flame for this work and it has sufficient heat to melt the solder. The use of the various tools and materials illustrated will now

be explained. The acid pickle is made by mixing 1 part of sulphuric acid with 20 parts water. After an object has been silver soldered and cooled sufficiently, it is immersed in this pickle,

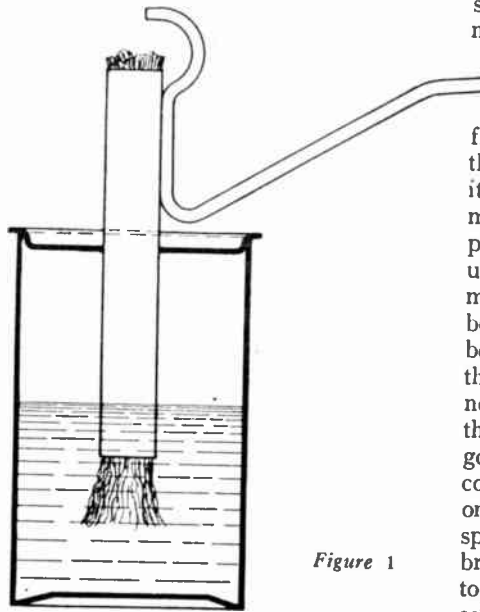

Figure 1

which thoroughly cleans it and removes all traces of the borax used. This pickle is also used when the work is dirty and greasy, as the solder will not adhere to such a surface, and it is first necessary to clean the metal in this solution. The charcoal block is used to place the work upon while the soldering is being done. The object of this block is to return the heat to the work and this helps greatly in making the operation more rapid. In many cases, however, it is quite impossible to employ

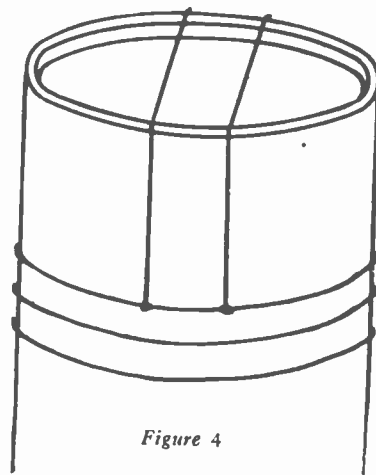

Figure 4

this block, even though its use would greatly help the work. The borax is used as a soldering flux just as resin is employed in ordinary soft soldering. The borax is moistened and rubbed on the slate, which produces a paste of borax and water. This is painted on the metal to be soldered at the point where the soldering is to be done. The

use of the small scraper shown is obvious. The blowpipe is used on very small work where an alcohol lamp is employed as the source of heat.

Silver solder consists of brazing spelter (brass) and pure metallic silver mixed in varying proportions. The percentage of the metals in the composition determines the melting point, and this may be anywhere from 700° F. to 2,000° F. The higher the solder melts, the stronger the joint it produces will be, and vice versa. For model boiler work, a solder with a comparatively high melting point should be used. There are other cases where a mixture with a low melting point can be used to advantage. One thing must be kept in mind, however, and this is the necessity of using a solder that is not too close to the melting point of the metals that it is to be used upon. A good solder to use in connection with copper consists of two parts silver to one part of brass in the form of brazing spelter. A good mixture for work with brass consists of seven parts of silver to two parts of brazing spelter. Silver solder in sheet form can generally be purchased from large jewelers' supply houses. The mechanic can melt up his own ingredients and roll it out into a sheet if he desires. This is the most suitable form to use it in, as it does not require such a great length of time to melt.

Assuming that the end of a small boiler is to be silver soldered into place, the process will be briefly outlined so the mechanic can obtain an understanding of just how to proceed. If the metal to be worked upon is very dirty, it will first be necessary to scrape the surface with the smaller tool made for that purpose from an old file. The end piece is then put in place and held there by means of iron wire. A little of the borax is then prepared and that portion of the metal which is to receive the solder on the inside is covered with a thin film of it by applying it with the brush. Small squares of the silver solder are then cut with tinner's snips and laid in places about the bottom of the boiler as near the contacting surfaces as possible. The boiler is then placed upon the charcoal block and heated. The heat is not applied directly to the part to be soldered at first, as this would cause the water in the boiler to boil and would be apt to dislodge the small squares of solder where put in place. Instead, the heat is first applied to the top of the work, and the bottom will become gradually heated by conduction. After the borax has become sufficiently dried, the flame may be applied directly to the work and held there until the solder melts and runs into place. If the end of the boiler was to be soldered in place from the outside, the solder would be put in place as shown. If a gasoline torch is

used to heat the work, it should not be brought too close, as the full heat of the flame will not be utilized if this is done. On the other hand, if the flame is held too far away, the soot will be deposited upon the metal and it will then be necessary to again clean and prepare the surface. After the solder has melted, the flame should be held on the work for a few minutes, as this tends to produce a stronger joint. The work is allowed to cool and it is then placed in the pickle and permitted to remain there at least five minutes, after

which it is removed and rinsed in clean water. In some cases the part to be silver soldered may be quite inaccessible, and a small steel rod, with the end split, may be employed to hold the solder if it is in the form of a sheet. The work can then be heated to the proper temperature and the solder held in place by means of the rod until it melts and runs.

A good silver solder for model work on thin brass sheet can be made by mixing twelve parts of silver and one part of brass together. This has a compara-

tively low melting point and is called "quick" for this reason. Another mixture which is very good for ordinary work consists of six parts silver to one part spelter or brass. This has a much higher melting point than that described previously, but it is much more suitable for some work. In mixing these solders, the mechanic should use care to see that the metals employed are very clean before they are melted together, and it is always safe to clean them with emery cloth before doing this.

A Micrometer Surface Gauge

IF the model engineer is in possession of an inside micrometer he can make himself a very useful and accurate surface gauge. The surface gauge and the micrometer are depicted in the sketch. A flat piece of stock $\frac{3}{4}$ x $2\frac{1}{2}$ ins. should be obtained. This should be of steel if possible and case hardened. It is ground perfectly square on the top and bottom. This serves as a base and it has two holes bored in it; one for the spindle which is tapped to receive its end and the other to receive the micrometer barrel. This is a special size hole. The third hole, which is on the side, is

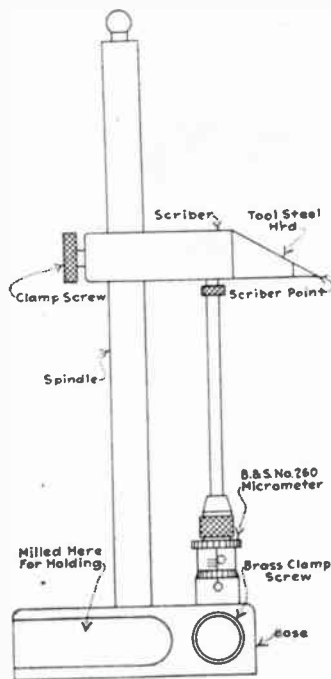

a $\frac{3}{16}$ in. tapped hole for a brass clamp screw. There is a concave groove milled on both sides of the base to form a place to hold it when it is in use.

A piece of cold rolled steel will answer for the spindle. This should be $\frac{3}{8}$ in. in diameter and 10 ins. long, threaded on one end to fit the base.

The scriber is a piece of tool steel $\frac{5}{8}$ in. square, $2\frac{1}{2}$ ins. long, with a $\frac{3}{8}$ in. hole bored in it at one end. This fits over the spindle and the other end is brought to a very fine point. A hole on the end is drilled and tapped out to receive a $\frac{3}{16}$ in. thumb screw.

A Milling Attachment for a Bench Lathe

By Joseph Dante, Jr.

THE little milling attachment outlined in the drawing has been designed for use in connection with a small Goodell-Pratt bench lathe. A study of the assembly drawing and the separate parts will give the reader a very good idea of just how the attachment works and the labor, materials, and time necessary to produce it.

By the use of the small milling attachment, the utility of the bench lathe will be considerably increased and jobs brought within its scope that would otherwise be impossible to finish.

In describing this device the writer has decided to outline the work necessary on each piece, taking them separately. The slide frame will occupy our attention first. It is made from cast iron and the over-all dimensions of the stock should be $1\frac{3}{4}$ x $2\frac{1}{4}$ x $6\frac{1}{4}$ inches. It is cut to the form shown on either a shaper or milling machine. The sliding portion is left just a little over size so that the slide can be scraped to produce a good bearing fit. The holes in this piece should not be drilled at this time, but left for a later operation.

The slide of the attachment is also made from cast iron. The over-all dimensions of the block necessary are $1\frac{3}{4}$ x $2\frac{1}{2}$ x 3 inches. It is either shaped or milled to the form shown in the drawing. When the machining of this piece is finished it should be fitted to the slide. It is well to take extreme care in producing this fit, as the accuracy of the attachment depends entirely upon it. A gib should be worked up to this piece if the builder cares to use one. The drilling of the holes in the slide will be described later. The gibs for the machine can be made from cold rolled stock. After the slide is fitted to the frame, the gibs can be put in place as shown. They are clamped to the slide, prick punched and the slide drilled and tapped. Two gibs are wanted, one for each side of the slide.

End brackets are also made from cold rolled steel stock. The first operation is that of drilling three screw holes in

the one piece. This piece is then used as a drilling jig for drilling the holes in the other bracket. The slide frame is then laid down on the surface plate. Each plate was located about central position, punched, drilled and tapped in the frame. Holes are tapped with $\frac{1}{4}$ -20 tap. A $\frac{5}{16}$ in. hole was laid out in both ends of the piece with a surface gauge and the plates were taken off and drilled. The nut is cut out of square cold rolled steel stock. Aside from the drilling, the making of the nut is very simple. After the nut is put in place, the slide is brought to the limit of its travel at the end of the frame. It is clamped and drilled through the end plate, which has a $\frac{5}{16}$ in. hole in it and used as a guide spotted with a $\frac{5}{16}$ in. drill, then drilled and tapped out with a $\frac{5}{16}$ -18 tap.

A screw is cut from a piece of cold rolled steel stock and provided with a $\frac{1}{4}$ -20 thread.

The small bracket used in attaching the milling device to the cross slide of the lathe is cast in iron. A pattern should be made for this part and the dimensions necessary for use with a Goodell-Pratt bench lathe are shown in the drawing. Two $\frac{7}{16}$ in. holes are drilled in this bracket first, after which the end plates are taken off the slide, put in a vertical position on the surface gauge, punched, drilled and the slide frame tapped out to receive two screws clamped to the bracket. The angle iron or vise table should be made in a solid piece, but the amateur mechanic may find it necessary to use two pieces. In this event the pieces can be held together by means of three screws. In setting the vise table square with the lathe cross slide it was first laid on the bed of the lathe and the slide brought down into position. This was then clamped together, punched, drilled and tapped as shown in the drawing. A small binder screw should be made out of brass and fitted some place along the side of the slide to be used for clamping the slide firm in doing work.

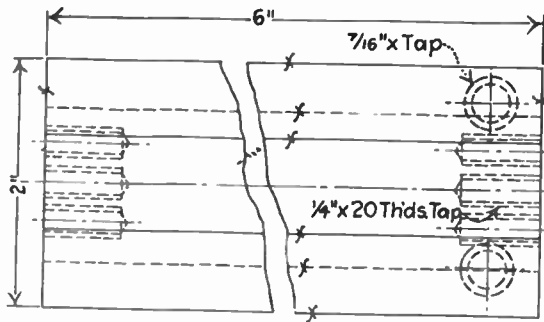

ONE SLIDE FRAME C.I.F.

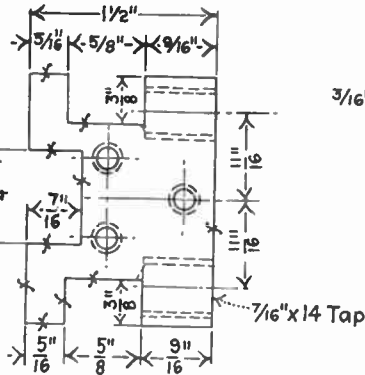

TWO GIBS C.R.S.F.

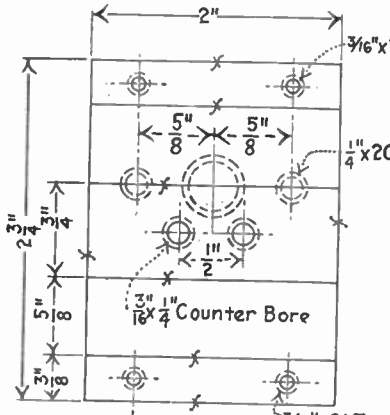

ONE SLIDE C.I.F.

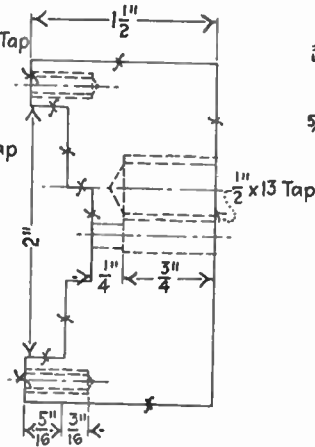

ONE SCREW C.R.S.F.

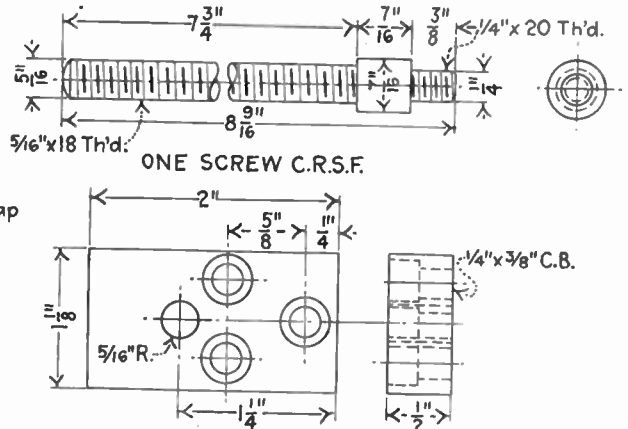

TWO END BRACKETS C.R.S.F.

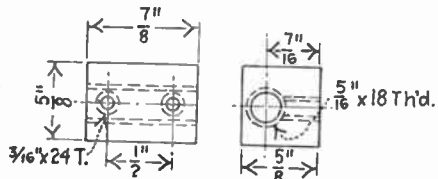

ONE NUT C.R.S.F.

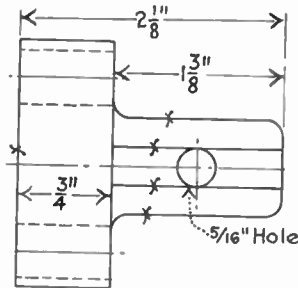

ONE BRACKET C.I.F.

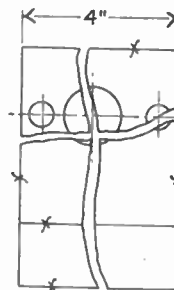
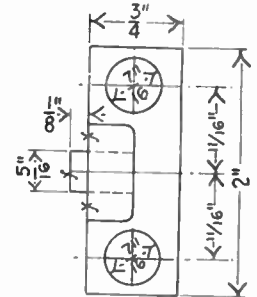

ONE ANGLE IRON OR VISE TABLE C.I.F. OR M.S.F.

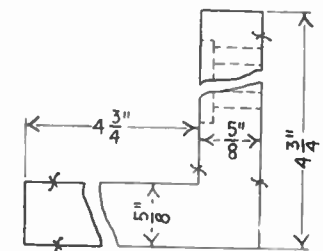

LATHE CROSS SLIDE

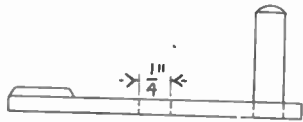

ONE HANDLE

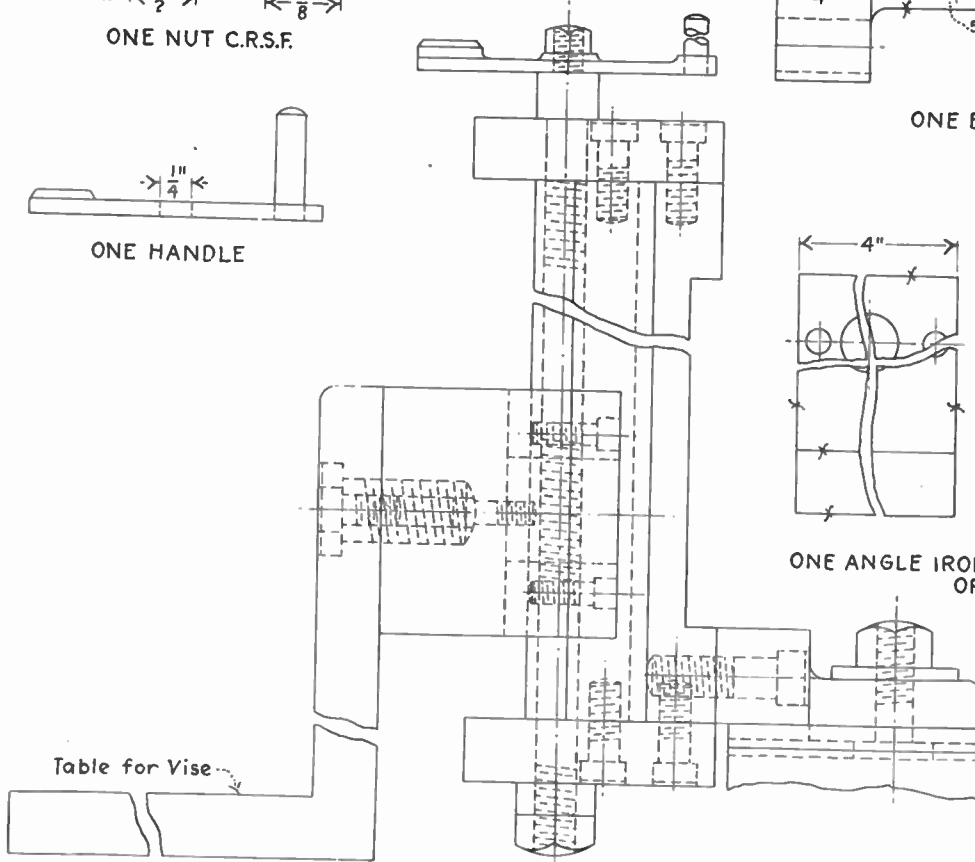

Table for Vise

Model Railway Engineering Helps

By George F. Heaney, Jr.

THE article on "A Model Electric Railway" in the January issue of EVERYDAY ENGINEERING probably caused many experimental engineers to become interested in this subject. Mr. Mitchell, in that article, advised model makers to visit the local freight yards to secure the dimensions of cars. To render that unnecessary, I give in the

railroads. All overhead bridges and tunnels must be built according to these minimum dimensions, in order that trains may pass through them unobstructed.

to secure uniformity. The couplers should be attached to the cars so that they have no up-and-down play, but a little side play. They are so designed that they will take ordinary railway curves without disengaging.

A little more realism is given to the system by the provision of air hose on

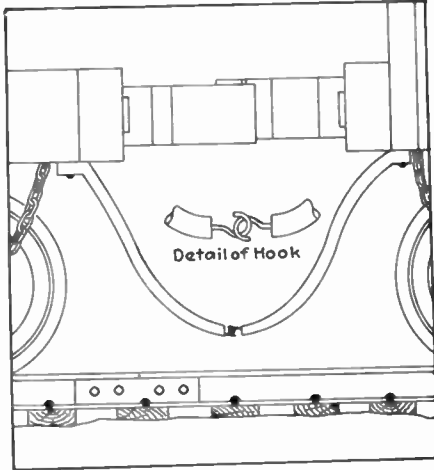
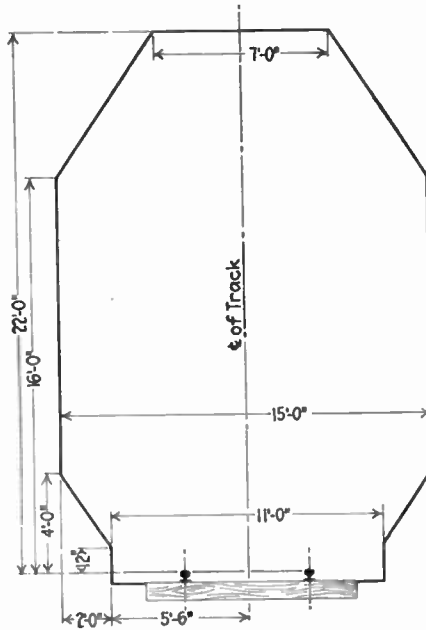

Fig. 2



Bridge and tunnel clearance of standard practice

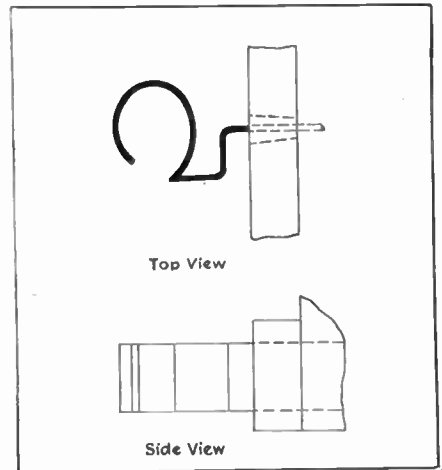

Fig. 1

accompanying table the dimensions of a few typical freight cars, taken from the Official Railway Equipment Register. It will be noticed that the numbers given are inclusive, so that parts for several cars may be cut at the same time, and each car given a proper number.

I also give a diagram showing the bridge clearance required by American

The matter of couplers is another problem. I have secured complete satisfaction from couplers made by bending strips of stiff iron about 3/8 in. wide into the shape shown in Fig. 1. The iron should be bent around a jig

the cars. I used small rubber tubing such as is used to insulate the connections on electric bells. One end I fastened to the car, near the coupler, while a small hook was fastened in the other end. When the cars are coupled, these hooks should be engaged. This hose is shown in Fig. 2, which also shows a coupler in use.

DIMENSIONS OF TYPICAL RAILROAD FREIGHT CARS										
TYPE	ROAD	NUMBERS (INCLUSIVE)	OUTSIDE LENGTH	OUTSIDE WIDTH AT EAVES	HT. FROM RAIL		SIDE DOORS		CAPACITY	
					TO EAVES	TO TOP OF PLATFORM	WIDTH	HEIGHT	CU. FEET	LBS. OR GALS.
Wood Box	Santa Fe	17645 to 17891	34'	9'-9"	11'-5 1/2"	12'-1"	5'-2"	6'-7"	1900	50,000 Lb.
" "	Erie	98511 to 98514	62'-10"	9'-10 1/2"	12'-11"	13'-7"	8'-3 1/2"	5'-10 1/2"	3100	80,000 Lb.
Steel Box	Penn. R.R.	30017 to 30974	36'-4"	9'-8"	11'-11"	12'-6"	5'-4"	6'-8"	1937	60,000 Lb.
Box Steel Underframe	Delaware & Hudson	22400 to 22499	37'-2"	9'-5"	12'-7"	13'-3"	6'	7'-7 1/4"	2448	60,000 Lb.
Box Automobile	New York Central	22900 to 229499	36'-10"	9'-7"	12'-6"	13'-2"	7'	7'-8"	2448	80,000 Lb.
Flat, Wood	C & O	11021 to 11999	38'-5 1/2"	9'-6"						80,000 Lb.
Flat, Steel	Illinois Central	69001 to 69300	41'-10"	9'-5"		3'-9"				100,000 Lb.
Stock	Union Pacific	44500 to 44807	37'-10"	10'-3"	12'-4"	12'-11"	5'	7'-10"	2596	80,000 Lb.
Furniture	Southern Railroad	310500 to 310541	50'-10"	9'-11"	12'-6"	13'-4"	7'	8'-2"	3648	80,000 Lb.
Tank	Union Tank Line	550 to 31999	34'-10"	8'-11"		10'-8"				8000 to 11,000 Gal.
Coal Side Dump	Canadian Pacific	362000 to 362499	36'-6"	10'-1"		10'-3"			1859	115,000 Lb.
Refrigerator	Pacific Fruit Express	10122 to 13219	40'-10"	9'-6"	12'-4"	13'-0 1/2"	4'	5'-10"		60,000 Lb.
Gondola	Maine Central	15001 to 15500	39'-9"	9'	6'-4"	3'-8"			764	80,000 Lb.
Hopper	Grand Trunk	76500 to 77499	31'	10'-2"		10'			1680	100,000 Lb.
Caboose	Nickel Plate	1000 to 1185	31'	9'-4"	12'-2"					

Automobile Tire Manipulation and Repair

A Complete Discussion of Tire Faults and Methods of Repairing Inner Tubes by Patching and Vulcanizing

By Victor W. Page, M.S.A.E.

THE common causes of tire failure that the motorist is apt to encounter are summarized in accompanying illustration. The most common is natural wear of the tread portion of the tire. The rubber compound in contact with the road surface wears away in time, and the fabric layers which constitute the "breaker" strips are exposed. The shoe is weakened and any sharp object in the road is apt to penetrate the weakened case and puncture the inner tube. If a number of the layers of fabric comprising the body of the shoe are cut this constitutes a weak place in the casing and a blow-out will result because the few layers of fabric remaining do not have sufficient strength to resist the air pressure.

A stone bruise is caused by the removal of a portion of the rubber tread by a sharp stone, piece of glass, etc., and is much more serious than a puncture because it removes some of the tire, whereas in ordinary cases of puncture a sharp object merely penetrates the casing. A sand blister is produced by sand or grit from the road working into a space in the tire between the tread and fabric body through some neglected incision or bruise. The sides are often chafed by running the tires against curb stones or driving on car tracks. Rim cutting is usually the result of insufficient inflation, this permitting the rim to cut into the tire and sever the fabric plies.

The chief inner-tube trouble is penetration by a sharp object, called a puncture or the folding over of part of the tube walls where the tire was applied or through a bruise in casing called a "pinch." The parts of the air valve sometimes give trouble and a slow leak results. It is cheaper to replace the

valve inside than to attempt to fix it. Some of the causes of valve leakage are hardening of the rubber washer, bent stem, corroded spring, or a particle of grit which keeps the valve from closing

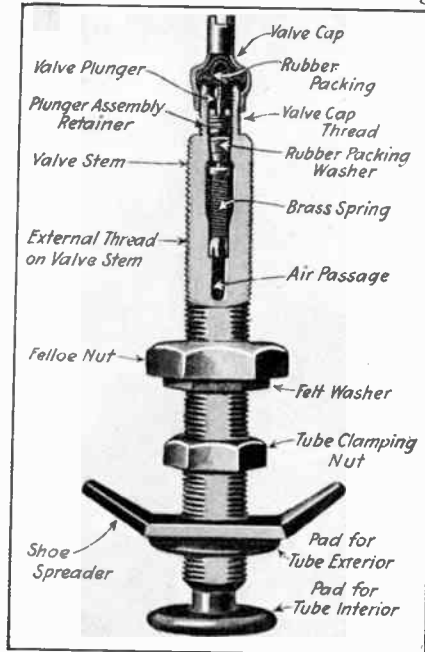
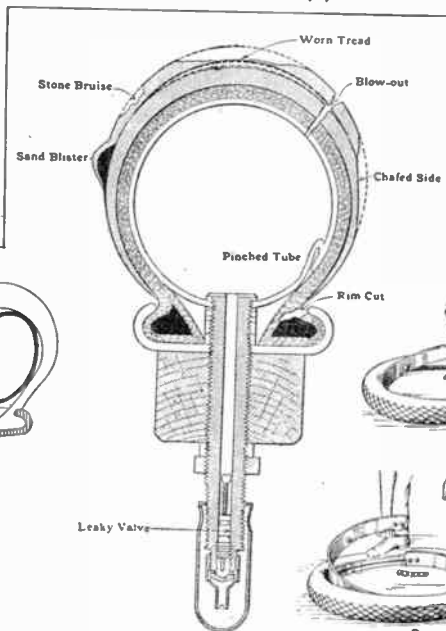

Fig. 1—Construction of Schrader universal valve

the air passage positively. The parts of the standard tire valve are shown in accompanying illustration, Fig. 1.

The "blow out" is the most serious condition that will confront the motorist on the road and usually only tem-

Fig. 2. Sectional view of automobile tire, showing common causes of failure



porary repairs can be made. An inner sleeve, composed of a number of plies of fabric is placed between the new inner tube and the broken portion of the outer shoe to prevent pinching of the inner tube by the jagged edges of the cut, and to strengthen the casing from the outside an outer shoe or gaiter made of leather is laced around the shoe. The object of using both inside and outside reinforcing members in combination is not only to strengthen the weak outer casing but by providing an outer shoe, dirt is kept from working into the tire.

Before giving suggestions for repairing the inner tube, it may be well to review the common methods of tire manipulation for the benefit of the novice motorist, also some of the tools and supplies that can be carried to advantage in the car. Serious outer casing repairs usually call for a degree of skill not possessed by the motorist, so only inner tube restoration will be considered.

All cars using pneumatic tires should carry a certain amount of equipment for taking care of tire troubles on the road. For trips around town, the inflated spare tire on a demountable rim will be enough, but for long trips, more material should be carried, as garages may not be handy. Typical supplies are grouped in accompanying illustration, Fig. 5, their purpose being evident. The tire repair material is sometimes carried in a special case, this having all needed supplies for making temporary repairs. A large variety of jacks may be obtained to raise the car and permit removal of the tire from the wheel. The air pump is needed to inflate the repaired tube or the new member inserted to take its place. In a number of 1918-1919 cars a power pump is included in the car equipment, this being operated from the engine, saving the motorist

Fig. 4—Demountable split rims make the removal and application of tire casings easier and facilitate tube repairs

Fig. 3—How clincher casings such as used on motorcycles and Ford cars are removed from the wheel rim

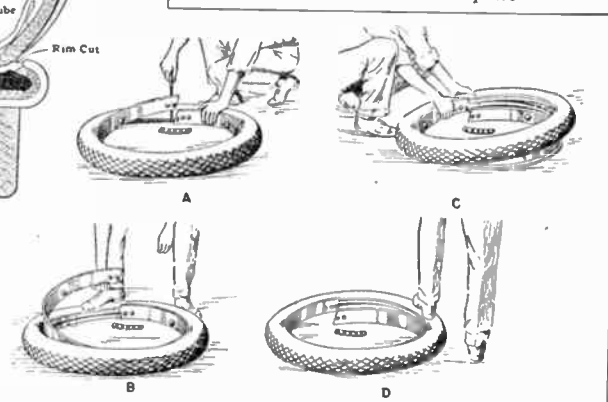
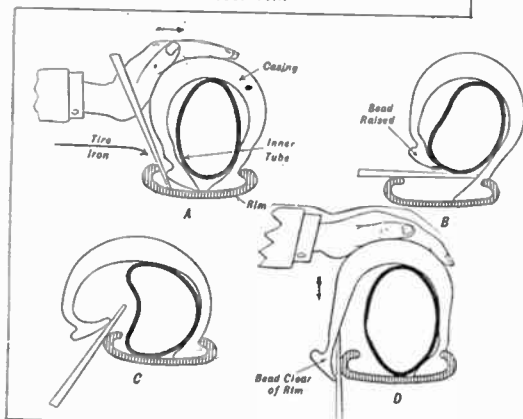

all labor of hand pumping. The talcum powder is sprinkled between the casing and the tube to prevent chafing or heating, while the spare valves and valve tool will be found useful in event of damage to that important component of the inner tube. As it is desirable to inflate the tires to a certain definite pressure, a small gauge which will

to work the edge of the casing gradually over the rim as outlined at Fig. 3.

Very long levers are necessary to apply heavy, stiff, new tires, and new casings are also particularly hard to remove. The shorter irons may be employed on the smaller casings, such as used on motorcycles, and on shoes which have been used for some time

while the other is used to force the bead over the edge of the rim. When the outside edge of the bead has been forced over the rim at all points, the inner tube is lifted from the rim and is pulled out of the shoe. The start at removing is made at the point diametrically opposite the valve stem. When this portion has been pulled clear of the rim and out of the casing it is not difficult to pull the rest of the tube out and finally lift the valve stem out of the wheel felloe, and take the inner tube entirely off the wheel.

In larger cars, the demountable rim forms make the work of casing removal less arduous, but in some forms it is necessary to use pry bars to remove the casing from the rim, especially those employing the split construction. The one-piece rims with side rings for retaining the casing are most easily handled. Special rim expanding and contracting tools may be obtained that make manipulation of split rims much easier.

How to Remove Demountable Rim

Before jacking up the car loosen all the bolts except the two nearest the valve stem (one on either side) until

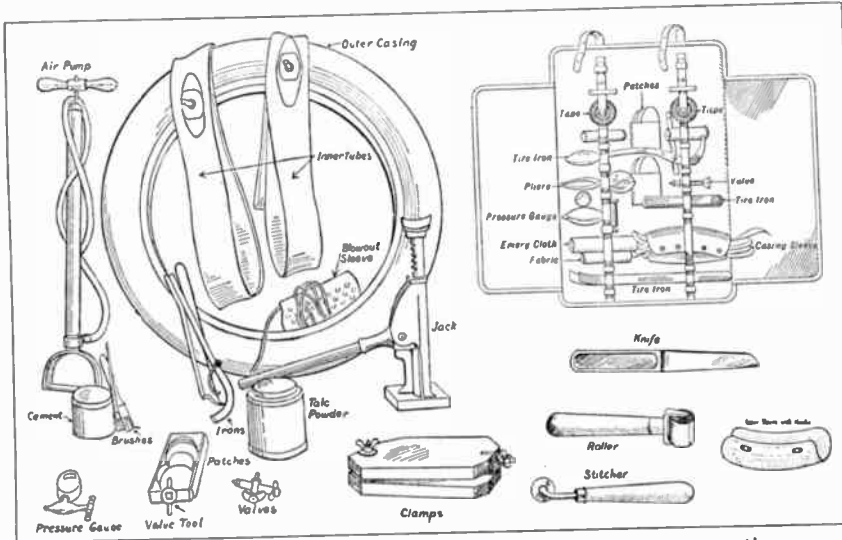

Fig. 5—Spare parts, tools and supplies for pneumatic tire restoration

show the amount of compression in the tire is useful.

The knife is used to cut the rubber, trim patches, etc. The stitcher and roller are useful in rolling the patch after it has been cemented to the tire to insure adhesion of the patch with the tube, while the wooden clamps are useful in binding the patch firmly against the tube while the cement sets. Cementless patches may be procured from accessory dealers that need no adhesive other than that provided on the patch by the maker. These require careful manipulation to secure positive results, so most experienced motorists prefer the newer vulcanizing outfits, though many still swear by the old style cemented patch.

Tire Manipulation Hints

In removing or replacing outer casings of the clincher type, as used on the Ford car, considerable care must be exercised not to injure the shoe or pinch the inner tube. The first step is to jack up the wheel from which the defective tire is to be removed, this relieving the wheel of the car weight. The valve inside is then unscrewed in order to allow any air that may remain in the tube to escape, and the lock nuts on the valve stem are removed so that these members may be lifted to release the clincher beads from the rim channels. If the tire is stiff or has not been removed for some time, a special iron or pry-bar is needed and the beads are pushed clear of the clincher rim. When the casing has been loosened on one side, a flat tool is inserted under the loose bead to act as a pry or lever

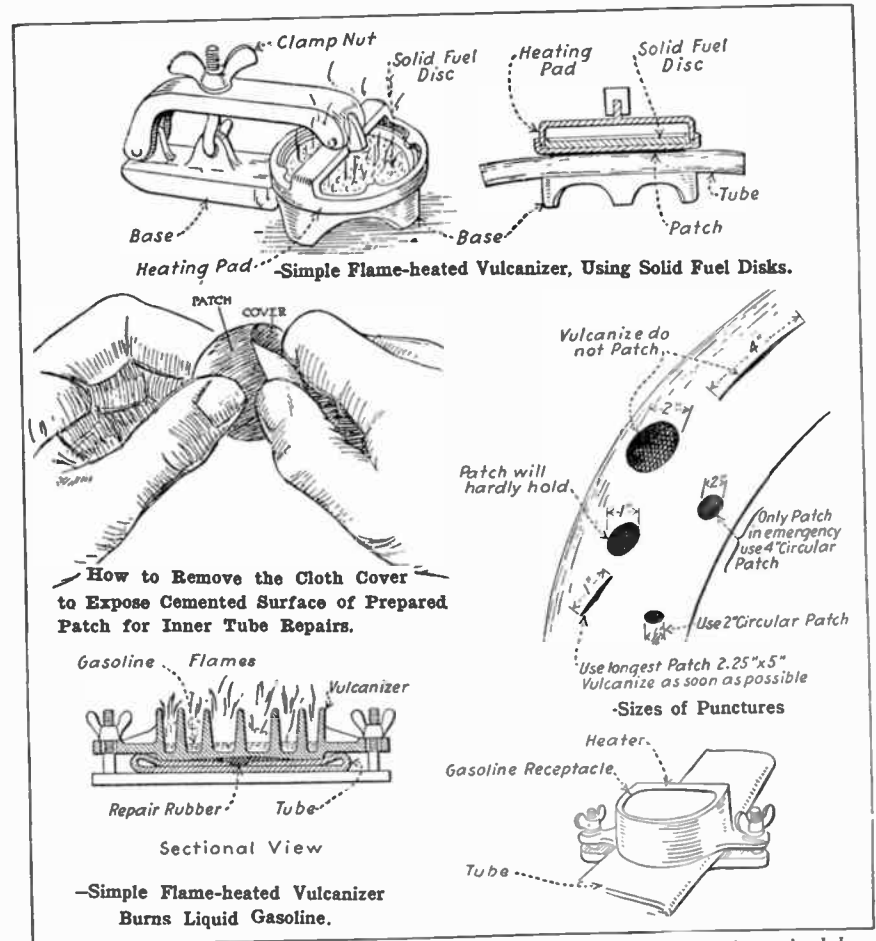

Fig. 6—Methods of patching inner tubes and size of patch to use for various sized breaks in tube

and which are more pliable than the new ones. Two of the levers are generally used together, one being kept under the loosened edge of the bead,

the wedges swing out of the way. Screw up the bolts in this position enough to hold the wedges from swinging back, or remove nearly all the wedges, which

only requires a few minutes. Loosening the bolts before jacking up the wheel simply causes the weight of the car to hold the wheel steady while you are working on it. Then put the jack under the axle. Insert the point of screwdriver between the rim and felloe band opposite the valve stem, and force the end held in the hand toward the hub of the wheel. This will pry the rim off the wheel at this point, and by revolving the wheel until the valve stem

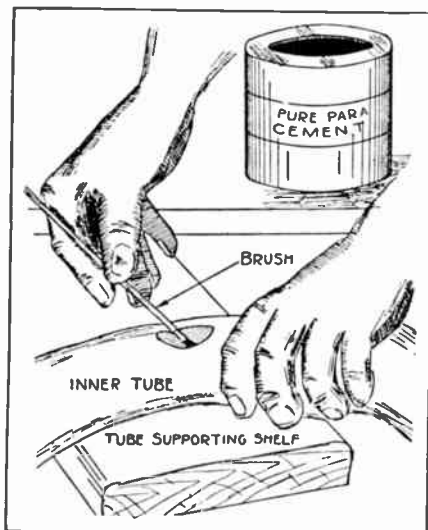

Fig. 7—Coating inner wall of tube with rubber cement preparatory to inserting semi-cured patching material

is up, the rim can be easily slipped off.

To Replace Rim

To put the extra tire and rim in place insert valve stem and again revolve until the valve stem and the two stationary wedges are nearest the ground. Now remove the jack and throw the weight of the car on the rim at this point. Back out all the bolts which were loosened far enough to allow the wedges to be turned back into place. Then tighten the bolts until the little studs on the inside edge of the rim rest on top of the felloe band. If they do not slide in easily, insert the tool and pry the studs onto the band.

To Remove Tire From Rim

To take the rim out of the tire, lay the rim and tire flat so that the end of the cut farthest from the valve stem is up. Remove the anchor plate, then beginning at the short end of the rim which does not have the valve stem, insert the end of tool under the head of the tire.

Force down the end of the tire tool held in the hand. This pulls the end of the rim out of the tire. It will be noted that in this operation, the two short sides of the rim are brought together, thus reducing the circumference of the rim. Repeat the operation as often as necessary, inserting the tool about six inches further around each time.

Now turn the rim and tire entirely over, as shown in Fig. 4-A, and force

the tire tool between both beads of the tire and the rim. This entirely frees one end of the rim. As in Fig. 4-B, take the free end of the rim in the hands and, holding the tire with the foot, pull the rim entirely out of the tire.

To Replace Tire on Rim

To replace the tire on the rim, first insert the new tube, slightly inflated, and note that it lays smooth and even all around. Lay the rim flat on the floor with the tire on the rim as in Fig. 4-C. Raise the end of the rim that has been drilled for the valve stem and after the valve stem has been inserted, put both beads of the tire entirely into the end of the rim that has been raised up for a distance of about six inches. Be sure that the other end of the rim is still under both beads of the tire. Being sure that the beads of the tire are properly started and that the tube is not being pinched, follow all the way round, putting both beads entirely on the rim as you go. Do not permit the other end of the rim to slip into the tire until the very last. Having fitted the tire properly to the rim put the anchor plate in position and screw down the valve stem nut when the tire is ready to be inflated. Before putting the rim into the tire, rub a paste made of powdered graphite and water on the beads of the tire. This prevents them sticking to the rim.

Locating Inner Tube Leaks

The best method of locating an air leak in an innertube depends upon the nature of the break and where the motorist is when the leak develops. A "blow-out" is so evident as to require no search, but a slow leak or porous tube is very hard to locate. The valve leakage is easily tested by removing the cap, turning the wheel so the valve is at the top and pointing down and putting the end in a tumbler or can of water. Bubbles will indicate the rapidity of the leakage. If water is not available, a little saliva on the end of the valve is a rough-and-ready test.

In cases of pinhole leaks or porous tubes, the only way is to inflate the tube again after it is removed and immerse it by sections in a pail of water, letting the tube stay in long enough so the water will come to rest. A thin stream of bubbles will show a pin-hole leak, an appreciable area of disturbed water indicates a porous section. The tube should be squeezed by grasping it firmly each side of the immersed portion and pulled to stretch the wetted part and make any small hole more evident. Of course, a hole of some size can be found without immersion, as the escaping air will make an audible hissing noise and can be located by passing all sections of the inflated tube past the ear. This is often the only possible way of finding a leak on the road.

A repaired tube or a new one should never be replaced in the casing without

running the hand around the interior to make sure there is no bruise in the fabric to pinch the tube or no inwardly projecting tack or nail not evident from the outside of the tire to cause a new source of leakage. A patched tube never should be replaced in the casing until the cement is dry and one is sure the patch is "set." A vulcanized tube, however, may be inserted in the shoe as soon as repaired, as the heat used in the process has welded the patch, cement and tube material firmly together.

Patching Inner Tubes

Punctured inner tubes may be temporarily repaired by using a cemented surface patch. The first step necessary is to clean the surface of the tube very thoroughly with gasoline and then to rough up the surface of both patch and portion of the tube surrounding the holes with a wire scratch brush or with sandpaper. After the surfaces are properly cleaned and roughened the patch and the tube are coated with suitable patching cement, which is allowed to become thoroughly dry before the second coat is applied. The second coat is allowed to become "tacky," which expresses a condition where the cement is almost dry and yet still possesses a certain degree of adhesiveness, which usually takes about five minutes. The

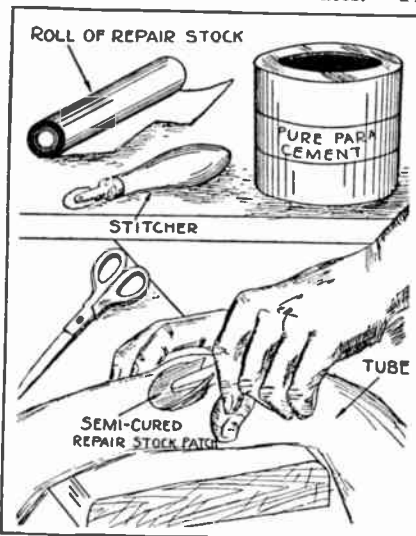

Fig. 8—Inserting semi-cured repair stock patch, curved face down. When in place, uncured stock is placed in hole and stitche used to roll in place

patch is applied to the cemented portion of the tube and the whole is clamped firmly together to secure positive adhesion while the cementing medium is drying. Patches should always be of sufficient size to cover the damaged portion and at the same time have about three-quarters of an inch or more of the patch at all sides of the orifice around small holes and one inch around large ones, though there is a limit to the size of a break that can be patched, as is clearly shown at Fig. 6.

Very satisfactory repairs to both inner tubes and outer casings of a permanent nature are possible.

(Concluded on page 342)

Oxy-Acetylene Welding

Instruction for Operating the Torch and the Precautions to be Taken in Welding Different Metals, Also Suggestions for Preheating the Work to Prevent Permanent Distortion.

PART 3

Instructions for Operating

The following instructions are taken from the literature of the Welding Apparatus Company of Toledo, Ohio, and while intended to apply to the "Monarch" welding outfits manufactured by this concern, the processes may be followed with almost any of the garage type welding outfits offered by reputable manufacturers.

1. See that all gas connections are tight, using soap suds to discover leaks, if any.

2. Upper side of torch is for oxygen. Acetylene connection should be made to lower side of large handle.

3. When all connected up ready to light torch, turn regulators out, so there is no tension on spring and they are closed. Then turn both tank valves open full. Open both valves on torch one full turn or more; turn on acetylene slightly and light at tip; then turn on more until blaze has left tip slightly; then turn on oxygen same way until small white inner cone is formed in blaze. If blaze pops and goes out this denotes that not enough acetylene, or too much oxygen, is being used. The flame should have a small inner cone from $\frac{1}{4}$ inch to $\frac{1}{2}$ inch in length with an outside flame of larger proportions.

4. Welding should be done at the end of the small white cone.

5. In case there is a faint outline of a larger cone, the acetylene tap should be closed slightly, which will reduce this cone, producing a neutral flame proper for a successful welding. (Opening oxygen will give same result.)

6. Blow pipes are adjusted for the proper working conditions and no sharp instruments should be used to clean out the welding tips.

7. Practice should begin on lighter sections of metal and gradually work up to the welding of the heavier sections.

8. When working on heavy work, water should be provided in which to cool the welding tips. Leave the oxygen tap open to expel steam formed. Do not plunge, but dip several times to gradually direct the heat to the tip. Otherwise you may crack the welding head.

Welding Cast Iron

In welding cast iron, such as automobile cylinders as depicted at Fig. 1.

and machinery parts of similar character, it is necessary to preheat the part which is to be welded to a temperature which is slightly below a dull red heat, if there are no parts that will be injured by such heat. This heat should be applied gradually and when the whole object has been sufficiently preheated, the welding can be done. There are two reasons for preheating. First, to save gas, and second, to relieve strains, due to uneven expansion and contraction of the part being welded. Great care should also be used to see that all castings cool slowly after welding, as many a good weld has been spoiled by too rapid cooling. A box of

are slightly higher in price, but, as stated above, where the shop is so situated as to be fortunate enough to have both compressed air and fuel gas of some kind the gas preheating torch will be found to be very satisfactory, as the first cost, and also the cost of maintenance, is low. The furnace or muffle is then built of fire brick to a suitable size for the particular part we are about to weld. A removable cover is used of asbestos board or sheet metal.

After the welding has been done, the object should be heated again in a similar manner as the preheating was done and then allowed to cool off slowly in the muffle. This is necessary to pre-

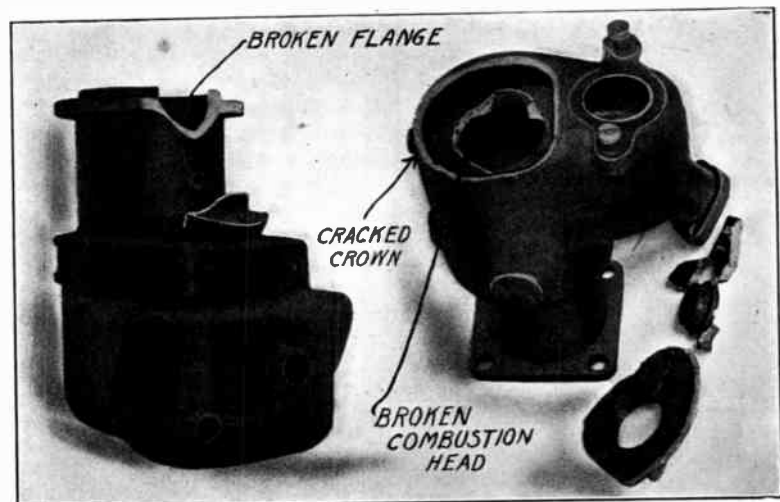

Fig. 1. Examples of defective cylinders that were repaired by autogenous process. The cylinder flange at the left was repaired at a cost of \$7.50 while the cracked crown and water jacket at the right were restored at a cost of \$12.00, both being a material saving over the purchase price of new replacement units

lime or ashes should be provided in which to bury the casting so it will cool slowly. An excellent work table and practical method of preheating a crank case by indirect method is shown at Fig. 2.

Method of Preheating

Where city gas of some kind, together with compressed air, are both obtainable in the shop we recommend very highly a preheating blow pipe using this fuel. It makes an ideal outfit and in fact will be found just as efficient as the other preheaters herein shown, and will answer any and all purposes to which the oil burning preheaters might be applied. Of course, where fuel gas and air are not obtainable in the shop the writer recommends the oil burning outfit previously shown, although they

vent cracking due to the local expansion and contraction, caused by the local heat of the welding flame. This method is also useful in obtaining a softness of the material in the weld. This method of handling welding of cast iron will prove a saving of from 30 to 50% of the cost of gases used for welding.

There is nothing particularly difficult in the handling of the welding flame in connection with welding cast iron, but it should be borne in mind in welding of heavy sections, that the fractured portions should be tapered out in order that the welding can be commenced at the center of the section, building up as the welding proceeds. A flux is necessary for use in welding cast iron and will be found to make the metal flow readily and at the same time, flux out the sand, dirt,

grease, etc. Be sure that the sides of the fracture are in molten condition before filling material is added. Large objects are handled in a different manner, the indirect heating being better adapted for metals such as aluminum. This method is shown in Fig. 2B.

Welding Aluminum

The welding of aluminum requires considerable skill and experience before successful work can be expected on intricate parts. The manner of making the weld is slightly different from that used with welding of cast iron, due to the fact, that when aluminum is heated, an oxide film is formed, which prevents the metal running together and forming a suitable weld. To overcome this, the aluminum filling rods

readily be built up at any desired point. This is something that could not be done before a flux for welding aluminum came into general use.

All precautions should be taken to have the work securely fastened or harnessed, for instance, when welding a hole in the side of a crank case, it is customary to clamp a shaft, which approximates the size of the bearings (plus, of course, the thickness of the cast metal bearings, which would melt out when preheating,) into the crank case bearing supports, in order to insure perfect alignment of the bearings. Angle irons are bolted to the flanges where connection is made to the other half of the crank case in order to insure perfect alignment of this part.

It is good practice to place a sheet of

about right to prevent cracking occurring on account of expansion and contraction and at the same time, the aluminum will possess sufficient strength so that with ordinary handling no trouble is experienced with alignment or failure of the part.

Welding Malleable Iron

Parts of malleable iron are handled in much the same manner as cast iron pieces in preparation for welding. It is customary to re-enforce the malleable iron weld as much as possible by building up the section at the fracture. The filling material used is usually nickel steel in the bottom of the weld, finishing the top surface with cast iron rod. The latter runs better and makes a smoother finish.

In some instances you may find that the fracture will be through a tapped opening, in which case, it will be necessary to cape this portion out entirely, making a much larger opening than the hole itself and then filling this with cast iron, using the same precaution as in welding cast iron to have this portion soft. Wherever the union is made between filling material used and the malleable iron, you will find this so hard that it will be impossible to drill or machine in any way except by grinding.

In some cases in making repairs on malleable iron parts, it is even necessary to strap these parts by means of wrought iron or steel straps welded to the body of the casting. In any event, bear in mind that the heat necessary to melt the malleable iron will destroy the properties of the malleable iron, which were put into the part when annealed in the furnace. Consequently it is necessary to use a stronger filling rod and increase the section.

Welding Brass and Bronze

The preparation of brass and bronze castings for welding is similar to that for gray iron castings. The fracture must be caped out so that the welding can start at the center, the groove being filled with metal melted from filling rod. The filling rod should be of approximately the same mixture as the part to be welded. Brass should never be used as filling material for bronze castings, if a strong weld is expected. Powdered borax or boric acid may be used as a flux. A mixture of $\frac{1}{2}$ borax and $\frac{1}{2}$ boric acid gives good results. In welding brass or bronze the work is carried out as for welding cast iron. The metal surrounding the groove is melted and the filling material added, drop by drop, as it is melted from the rod. Be sure the metal of the casting is in a molten condition, otherwise an imperfect weld will result. Brass welds can be easily spoiled by burning the zinc out of the composition. Care

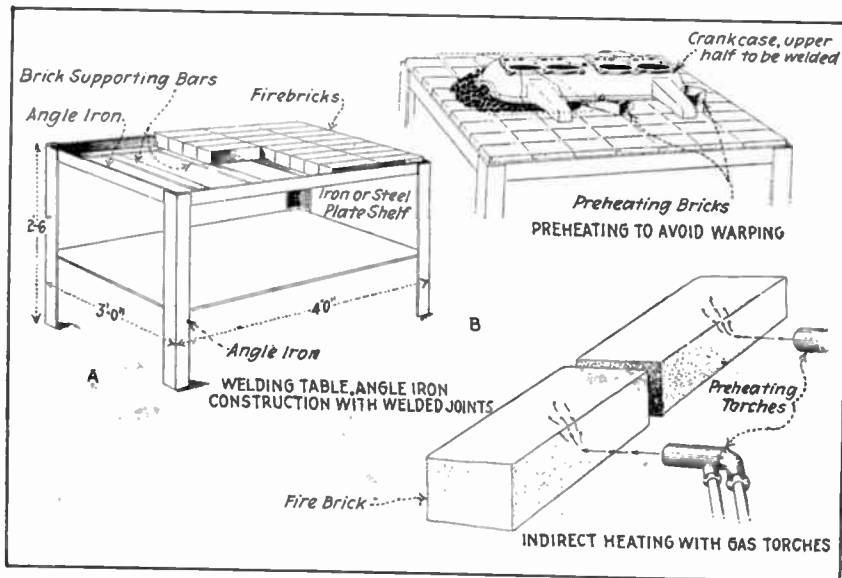

Fig. 2. How to build a very simple and inexpensive but useful table to support work when welding at A. B—method of indirect heating used to advantage in repairing pieces made of materials having low melting point

must be inserted into the molten aluminum, which is being welded, and moved about rapidly, something similar to puddling, in order to break up this oxide film and allow the aluminum to run together. A flux has also proven of advantage in this connection, where before, practically all of this work was done without the use of a flux.

A larger tip is necessary for welding a section of aluminum than would be required for the same section of steel or cast iron. This is due to the fact that aluminum conducts heat away very rapidly. With the proper size tip in use, it is necessary to melt a considerable portion of aluminum, which is being held in shape by the fire clay form. Now the extra metal can be added from the filling rod and stirred or puddled with this rod to break the oxide film which forms when aluminum is melted. A flux has been provided for use in this connection and will be found very valuable for breaking up this film. In fact, by using this flux, bosses can

paper on the inside of the case next to the crack to be welded. This paper prevents the fire clay from getting into the crack. Upon this is placed fire clay in plastic condition which is held in place by means of asbestos fiber. This makes a light backing or mold for the case and can be easily handled without fear of the mold or core being so heavy as to break down the case when heated for welding. This mold should be large enough to cover sufficient area around the crack so that the aluminum will not break down.

Aluminum parts must always be preheated and handled in a similar manner as automobile cylinders, as outlined before, with the exception that aluminum, of course, should not be heated to such a high temperature, on account of the fact that within 50 degrees C. of the melting point, the metal is very brittle and without strength. It is customary to heat up these cases thoroughly until they will melt half and half solder in wire form. This temperature is

should be taken not to heat beyond the melting point. Flux should be used freely. If the welded portion has been burned, it will be exceedingly porous. Various useful suggestions for the welder are shown at Fig. 3.

groove will prevent this. The accompanying illustrations show clearly the apparatus and method of manipulating the torch in doing various classes of repair work, also some typical automobile parts that can be saved by the welding

Causes of Airplane Accidents

Now that insurance may be obtained by aviators, the figures on causes of accidents have been published. An authority declares that from 1908 to 1913, both in military and civil aeronautics, 60 per cent of the casualties were due to the collapse of the plane as the result of faulty construction, while from 1913 to date only 2 per cent of the casualties were caused by the collapse of the plane.

Of present-day accidents, the insurance expert declared, approximately 40 per cent are due to tail spins entered into too close to the ground or by inexperienced pilots who are unable to extricate themselves, 25 per cent through the lack of judgment in landing, 10 per cent to forced landing caused by engine trouble, 2 per cent by fire, 2 per cent by collapse of planes, and 21 per cent by lack of judgment in various manoeuvres by pilots still in training. Predictions were made that inside of six months airplane insurance will be no more costly than automobile insurance, because of the establishment of fields, with devices aiding safe landing under adverse conditions and the mapping out of air ways and air routes.

British-Built Passenger Air Liner.—

The *Daily Telegraph* of recent date gives a description of the new passenger air liner recently constructed at Filton, England, by the Bristol company. This airplane has a seating capacity for fourteen passengers in addition to the necessary staff; on its trial trip it carried twelve passengers, pilot and assistant, and attained an altitude of 6,200 feet in 7¼ minutes with an air speed of 125 miles an hour. The passenger saloon is scientifically ventilated to avoid drafts, and straps are not needed for passengers, as on this class of machine rolling and pitching are scarcely noticeable. The machine measures 20¼ feet high and from tip to tip measures 81½ feet. It weighs 16,500 pounds, the power being sufficient to lift this load to a height of at least three miles and at 10,000 feet to give the airplane a speed of 113 miles an hour. The engine-houses are built on the middle of the three pairs of wings; on each side there are two 410-horsepower engines, the total power being 1,640 horsepower. Flight can be maintained by any two of the four engines should the others break down.

If you open the relief valves to look for a cylinder missing explosions and fail to see a flame, do not condemn that cylinder. Open the throttle and give it enough gas to fire. When the throttle is closed and the relief valve is open the engine sucks in so much fresh air that some cylinders will not fire.

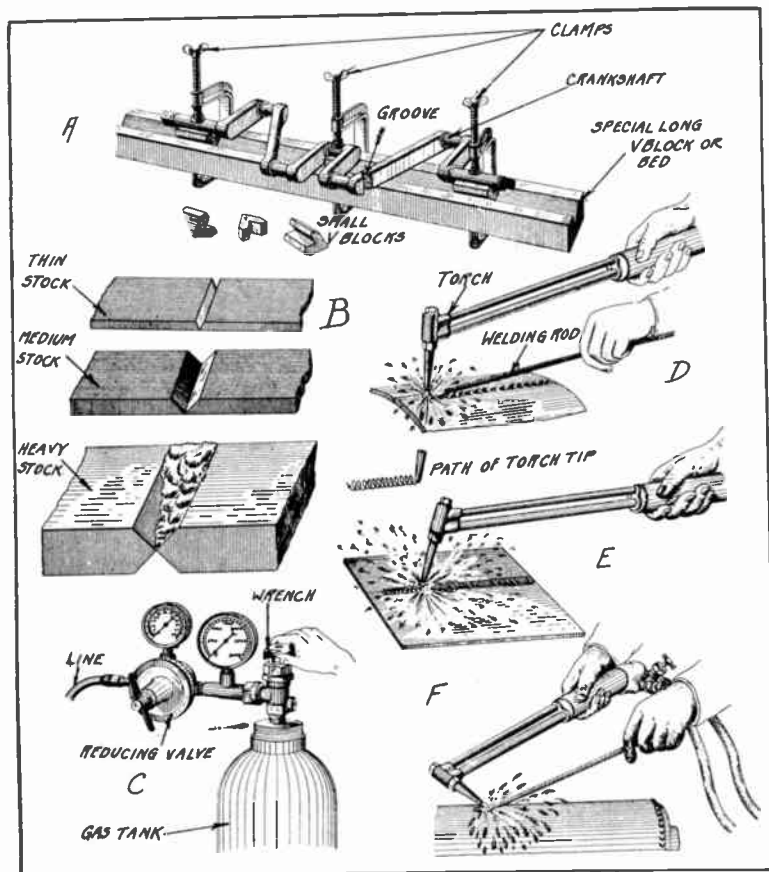

Fig. 3. Illustrating steps in autogenous welding operation, such as preparation of work and manipulation of torch. A—method of holding crankshaft when welding broken web. B—forms of grooves for welding various thicknesses of stock. C—showing method of attaching reducing valve to gas tank. D—method of using welding rod. E—showing path of torch tip. F—filling a hole by the autogenous welding process

General Hints

Be sure the welding flame is neutral. Be sure the part to be welded is set up properly. A poor set may spoil the best weld for practical use. Proper heat treatment before and after welding is as important as good welding, when intricate castings, such as cylinders and crank cases are being repaired. Avoid hard spots in cast iron welds by pre-heating before and annealing afterward. Take care in using sufficient heat in welding and do not make the union between casting and filling material too sharp and defined. Do not allow drops of metal to fall on partially molten metal. Use the best grade of filling material. The best is none too good when all the expense of the repair may be lost by a weak weld. When pre-heating aluminum castings for welding, do not attempt to heat in one place only. Keep the burner moving to spread the heat uniformly. In welding steel be careful that the metal above the weld does not weld together and leave a space that is not welded. A "V" shaped

process and cost of accomplishing the work.

Annealing Steel.—According to a recent patent by F. Bagliard, of Milan, Italy, high-speed steel is annealed by heating it to 1,000 deg. Fahr., withdrawing it from the fire, allowing it to cool for a few seconds beneath cinders, and then immediately quenching it in water or grease, or preferably in a mixture of 200 parts of animal grease not containing stearin, 700 parts of tallow, and 100 parts of charcoal.

Cleaning and Oiling Belts.—Belts that have become so greasy and dirty that they slip and fail to transmit power should be cleaned with gasoline, then scraped and afterwards wiped with a brush. In dirty places it is good practice to brush them occasionally with a broom or stiff brush. Castor oil and tallow are used successfully in some shops to prevent slipping and it is good practice to apply these as dressings on a new belt before using.

Propeller shaft bent as shown soldered to shaft
2 1/8" x 1/16" Hard Wire

3/8" x 1/16" Tube (Bearings)
Running Fit

Collar made of 1/16" Tubing
sweated to shaft

SPRUCE BLOCKS
Glued and Wrapped
Drill 1/16" hole for
driving fit.
2 Required

N.B. Tubing 1/16" thick
(inside diam. given)

22 1/2" x 3/8" x 3/16" Spruce
Main Wing Bar

CROSS SECTION Y-Y THROUGH ELEVATOR
Shaped the same as main panel

R. & L. HAND SPRUCE PROPELLERS
White Pine or Tin (Sheet Steel 1/32") may
be used in lieu of wood propellers of 1/2"
fiber are sometimes used.

2-3/8" x 1/16" Tubing
shellacked in bearing

1/8" Camber
(Concave)

2 1/8" x 1/16" Tempered
wire. Bend as shown

6 1/2" x 1/8" x 1/16"
Bamboo Brace

Elastic over the panel
then under longeron

2 1/8" x 1/8" x 1/16" Bamboo

Elastic Band

2 Longerons 34" x 3/16" x 1/16" Spruce

3 3/4" x 1/8" x 1/32" Bamboo

Elastic over the panel
then under longeron

20 1/2" x 1/8" x 3/64" Spruce
Entering Edge

Main Spar

5 5/8" x 1/8" x 1/16" Spruce

12 Strands 1/16" x 1/16" Sq. Elastic
Requiring less than 20" for
each propeller.

23 3/4" x 1/4" x 3/64" Spruce
Trailing Edge

Main Panel
or Wing

3/64" Diam. Reed or
1/32" Steel Wire

Split Bamboo Ribs 4 1/4" x 1/32"

Approx. 30" x 3/8" x 1/16"

Any Convenient Block

Former Board Approx. 30" x 6" x 3/4"

CROSS SECT. X-X THRU MAIN PANEL
Also showing method of shaping camber using
flat board and blocks as shown.

DEVELOPMENT OF METAL PROPELLER
Twist in opposite directions to correspond
with white pine props.



PROPELLER BLANK
Kiln Dried White Pine
6 1/2" x 3/8" x 3/4"

Elastic Bands to hold
planes to Longerons

Stabilizers
(Panel of Rice Paper)

2-4 1/4" x 1/8" x 1/32" Bamboo Braces

Tie Piece 3/16" x 1/16" x 4 1/2"
Bamboo

Ground Line

Elastic Bands to hold
plane to Longerons

Left Open

2 Braces
4 1/4" x 1/8" x 1/32"
Bamboo

1 Required

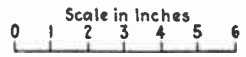

ELEVATOR ADJUSTER BLOCKS
Spruce, 2 Required

A Simple Long Distance Flyer

By Edward Marquet

THIS is a 3½-ounce model that is guaranteed to fly up to nearly a third of a mile. Without skids one of these models flew 2,649 feet in 61 3/5 seconds at Van Cortlandt Park, New York City, several years ago. This was considered a record for its size at the time. The efficiency depends on one's faithfulness to the details of the design and accuracy of construction. This flyer was designed and developed after a number of years of experimenting in practical aviation to assist in filling the wants of the mechanically inclined amateur experimenter in aeronautics. Machines of this general type with larger propeller and more powerful motors will exceed the distance made by this model.

Main Plane (Wings)

The main plane is constructed of an exceedingly light frame work of the following material. One main wing bar (spruce), 22½" x 3/8" x 3/64"; one entering edge 20½" x 1/4" x 3/64" (spruce); trailing edge 23¾" x 1/4" x 3/64" (spruce); five ribs requiring ten 4" x 1/8" x 1/32" pieces of split bamboo; two 6" x 3/64" reed or 1/32" steel wire for outer edges. This frame is to be covered with fine quality vellum paper or substitute. There are several suitable coverings on the market; the best are known as bamboo paper and zephyr skin. Ambroid is used mostly for wood and fabric cementing, but thin

orange shellac has been found to answer this purpose very satisfactorily.

Elevator

The elevator is made similarly to the wing of the following material: One main spar (spruce) 7½" x 3/8" x 3/64";

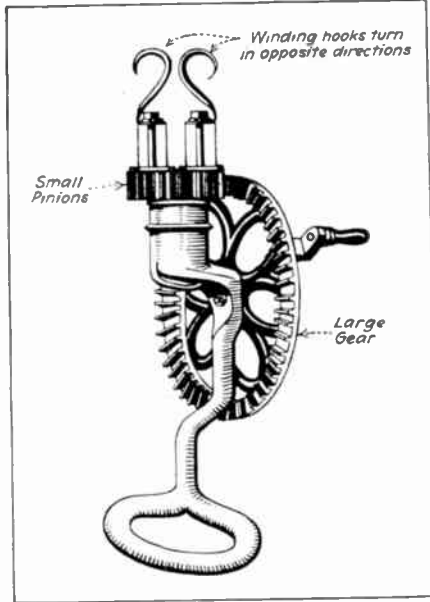

A remodelled egg beater makes a very good rubber motor winder

one entering edge 5½" x 1/8" x 3/64"; one trailing edge 3¾" x 1/8" x 3/64"; two outer edges 6" x 3/64" reed or 1/32" wire; three ribs requiring six 4" x 1/8" x 1/32" pieces of split bamboo, to be covered same as the wing.

Fuselage

The fuselage or body consists of two longerons 34" x 3/16" x 1/4" spruce; three tie pieces of split bamboo, one 2½" x 1/8" x 1/32", one 3½" x 1/8" x 1/32" and one 4¾" x 1/8" x 1/16"; also two propeller shaft bearers 1" x 1/4" x 1/4" as shown in sketch. Two elevator adjusting blocks 1" x 3/16" taper 1/2" to 3/8" are also required. The landing gear consists of one forward skid 6" x 1/8" x 1/16", two braces 4¼" x 1/16" x 1/16", two rear skids 5½" x 1/8" x 1/16", and two braces 4" x 1/8" x 1/32". The elevator adjusting blocks can be shaped with the necessary taper to give best results by experimenting.

Propellers

The propellers as designed have been selected from many that have actually flown this model and are recommended as giving the best average results. Propeller making is the most difficult problem in model building and will be described in another article. Those not thoroughly familiar with the process of making them may secure them already made at low prices from model supply houses. The power is supplied by two 1/16" square elastic 10 to 12 strand motors of approximately 70 feet each total length, which may be purchased at about 1 cent per foot, being attached directly to the propeller shaft at one end and to a small hook at the front. This hook can be removed from

A comparison of two flying models below shows proportions of completed machines. The larger weighs 7 ounces, the smaller 5½ ounces and both have a flight duration of about one minute

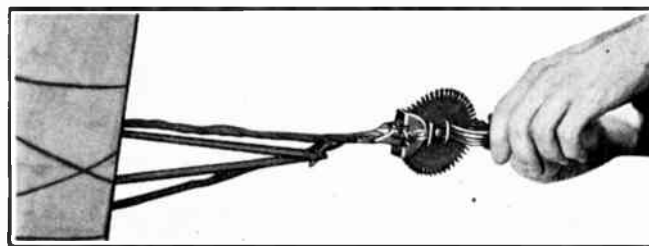

The pressed steel winder and its use are illustrated in central group. A plan view of 40" machine showing location of parts and rubber strand motors as they appear unwound is shown below

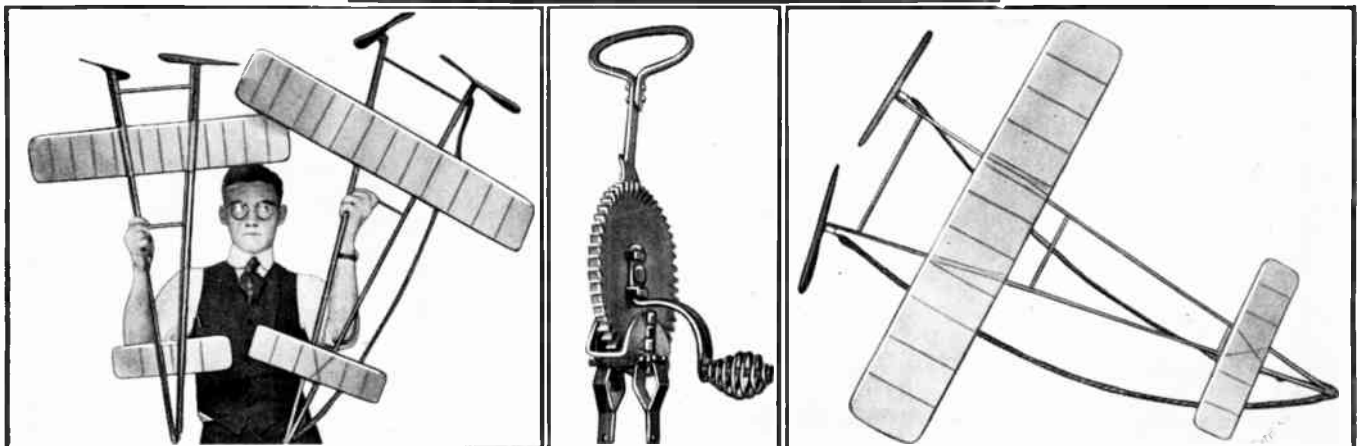

that at front end of frame and placed in motor winder to make quick winding possible. Propellers must turn in opposite directions and rotate so their entering edges will cut the air first.

Forming and Shaping of Wings and Elevator

This is done by selecting a board approximately 30" x 6" x $\frac{3}{4}$ " and either planing a camber of $\frac{1}{8}$ " in 4" or blocking up as shown at X—X and Y—Y, which is simpler. This will give more camber than necessary, but the wings always flatten out with usage.

Laying Out of Wings

On the above form, with a true straight-edge, gauge parallel lines 1" and 4" from this edge, then space the ribs as shown. Care should be exercised here, for the degree of success depends on the accuracy of this layout. Use a try-square for locating rib positions. This same form may be changed to suit elevator.

Split bamboo is easily made to close dimensions from old fishing poles, as it always splits straight and nearly parallel. It should be soaked in warm water if bent sharply, but may be slightly bent cold and dry. It must be roughened to permit glue to hold to it. The hard, shiny shell or skin on the outside of the bamboo must be scraped through so that the glue may adhere.

Glueing

Glue all joints with Le Page's cold glue or any hot glue. Let all glue joints set for 24 hours or more. This is a good rule to avoid disappointment. Then bind all joints neatly with silk threads, handling the frames carefully as a slight jar may break the glue joints. Cover threads with thick shellac or glue. When dry and properly made, these frames are very strong and hardly ever break from a fall in flight.

Balancing

The main plane is located about $4\frac{11}{16}$ " from the rear of the longerons, its center line coinciding with that of the frame. It is attached by an elastic band which is stretched around the longerons and then the plane slid through the loops. By sliding the main plane more to one side or the other, the additional head resistance on that side turns the flyer in that direction, so that this method of securing other than straight flight may be used in lieu of a rudder. The tapered blocks give the necessary adjustment for the elevator. By increasing this the flyer can be made to loop.

The flyer is best launched from position on a newly cut lawn, from which it will take the air as gracefully as a bird, emulating the flight of its proper

type. But for long distance flights it is better to launch it from the hands held over one's head.

In winding up the rubber band motors it is advisable to use a winder which may be made of an egg beater as accompanying illustration shows. If one is familiar with soldering it is a comparatively simple operation to convert a 15-cent egg beater into an excellent winder, winding both motors correctly and quickly. The correct number of turns required varies proportionally to the pitch of the propeller and also the quality of the elastic. Two hundred turns is considered the requisite for a flight of 1,500 feet with the propellers shown. The skids are necessary for ground starting and landing, but may be omitted if great distances are desired. Some contests rule that miniature airplanes must start and land from the ground, others allow hand launching. The launching of such a model calls for some skill, as the propellers must be held from turning, one in each hand after the motors are wound to the required degree and released simultaneously with the throwing of the model upward and forward from above the head. This trick is easily acquired with a little practice. Experiment with the model over open grass land, as it will not be damaged when it alights after a flight, as might result if it landed on a hard surfaced road or against a building.

Machines of the general plan described, but differing in details, that have made successful flights are shown in accompanying illustrations. The large one is 40" long, the smaller is 36" long. The total weight of the large machine is seven ounces. The propellers are of poplar, 10" in diameter and are rotated by rubber motors of 12 strands each $\frac{1}{8}$ " flat by about $1\frac{1}{32}$ " thick and 40" long. The weight of both of the rubber motors is $2\frac{1}{4}$ ounces. The fuselage and propellers, without motors, weighs 3 ounces. The main plane, which is 33" span by $5\frac{3}{4}$ " chord weighs $1\frac{1}{2}$ ounces, the elevator, which is 14" span and 3" chord weighs $\frac{1}{2}$ ounce. The fuselage longerons are $3\frac{1}{16}$ " x $\frac{1}{4}$ " basswood sticks, 40" long. The main plane has 11 solid section ribs held in proper relation by $\frac{1}{8}$ " square wing spars passing through them. This machine has a duration of 65 seconds and is a very steady and fast flier.

The smaller machine weighs $5\frac{1}{2}$ ounces. Of this, the fuselage with propellers and rubber motors weighs 4 ounces. The motors are 10 strands— $\frac{1}{8}$ " flat rubber and weigh $1\frac{1}{4}$ ounces. The main plane, which has a span of 24" and a chord of $4\frac{1}{2}$ ", weighs but $1\frac{1}{4}$ ounces while the elevator, which is 11" span by $3\frac{1}{4}$ " chord weighs but $\frac{1}{4}$ ounce. This small machine has a duration of 50 seconds and is faster

than the larger one. Both are intended to be hand launched and are not provided with landing gears.

A simple and practical form of winder with main drive gear placed between the pinions and made of pressed steel so it is very strong and light is illustrated and the method of using it is also shown so clearly that no instructions are necessary other than stating that best results are obtained by stretching the motors after the motor hooks have been slipped in the winder holes to two or three times their length before starting to wind. This means that one person holds the model flier by the propellers and rear end of longerons while the other winds the motors to the desired degree. The motor hooks are then slipped into the hooks made to receive them at the apex of the triangular frame work.

Automobile Tire Repairs

(Continued from page 336)

ment nature can be made by using small portable vulcanizers which may be heated by either electricity or vapor. When these are used a special vulcanizing cement is necessary and uncured rubber stock must be used for patching or filling openings caused by punctures or blow-outs. The patch of raw material is applied to the cemented surface of the tube or casing and the vulcanizer causes the rubber of the patch to unite perfectly with the old material and forms an intimate bond. The view of the inner tube at Fig. 6-B shows various sized holes and sizes of patches to use in making repairs. It also shows defects that cannot be patched but which must be vulcanized.

A simple vulcanizer is shown at Fig. 6. It consists of a pair of arms terminating in a stationary disk and a swiveled disk with a cupped upper surface; the cupped piece is on the upper arm and the two disks are pressed together with the tube to be repaired between them by means of a thumb-nut. The heating medium is a disk of prepared fuel which is placed in the cup of the upper disk and ignited with a match. It burns, or rather glows, without flame and produces exactly the heat required. Patches are applied without cement other than that on the face of the patch. The process is to clean and roughen the tube, apply the patch, clamp it in the vulcanizer, light the disk and let it stand for five to eight minutes after lighting. A patch so vulcanized cannot be removed without tearing the tube if the repair has been properly made. Fuel disks and patches are supplied with the vulcanizer.

Another simple and cheap flame vulcanizer of late design is also shown at Fig. 6.



MECHANICAL NOTES

SHOP PRACTICE

FOR AMATEUR MECHANICS

Thread-Cutting Dies

By George F. Kuhne

SOLID dies are used for roughing out a thread that is to be finished by an adjustable die; they are also used where accuracy is not essential. They are used on bolts, for cutting threads on pipe, as pipe threads are made tapering, and sizes may be varied by the distance the die is run onto the work.

The size of a die is always determined by the size of the screw it is to cut, regardless of the size of the piece of steel from which it is made. For instance, a 1/2 in. die will cut a screw that is 1/2 inch in diameter. The blank

is usually machined to size and thickness before the thread is cut in the hole; although a practice is to cut the internal thread, then screw the piece onto a threaded mandrel and finish it to the proper diameter and thickness. This insures all portions being true with one another. When the thread is cut in a die with an inside threading tool, and the threads on the mandrel are cut in the same lathe, this method may be used, but is not advisable where a slight change in shape of thread is objectional, for the thread may be strained when the die is machined.

Square dies are used almost altogether for cutting bolts, or large screws with coarse threads, for they may be held securely in holders having square openings. When making a square die, the blank is machined to size first, one side polished and a mixture of Blue Stone and water applied, which will produce a coppered surface for laying out, and all lines made will be plainly visible.

The center of the blank is obtained by scribing lines across the corners, as shown in Figure 1. It should be prick-punched for center at the intersection

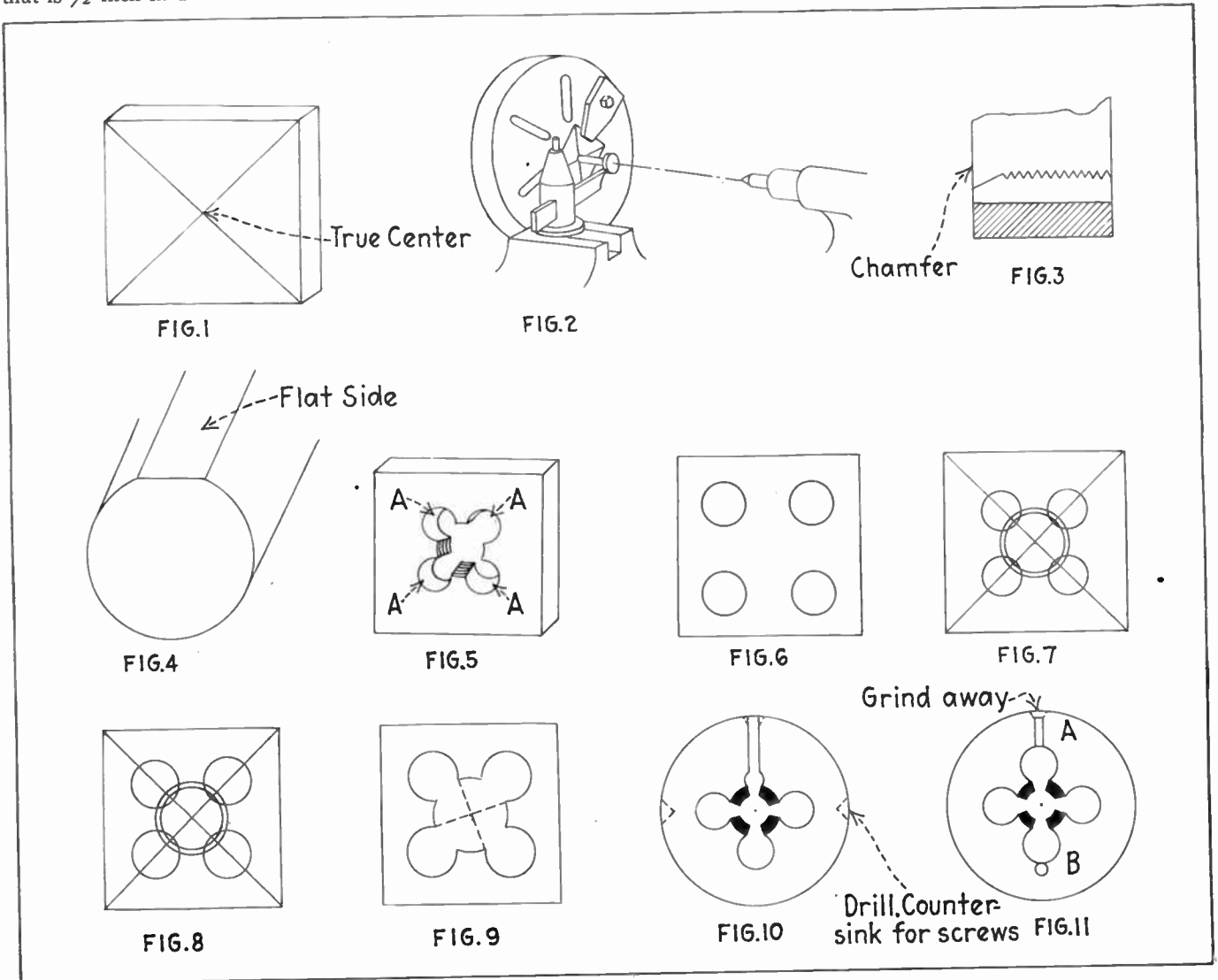

of the lines, after which it may be strapped to the face plate by means of straps and bolts and the true center located by means of a center indicator, as in Figure 2. If possible, the hole should be bored to tap size after drilling; this is done with an inside boring tool, and insures accuracy. If the hole is too small to permit use of the boring tool, care must be taken that the drill used is started correctly and runs true.

In order that the die will start onto the stock, it is necessary to chamfer the threaded hole as shown in Figure 3. A fine pitch requiring but three, while a coarse thread should be chamfered four threads. The chamfering on the face of the die should not be much larger than the diameter of the screw to be cut. This may be done by a tool in the toolpost or with a taper reamer of the proper form. This should be done before the clearance holes are made.

It is considered advisable to give dies for ordinary work *four* cutting edges, yet for some small work *three* cutting edges work very nicely. For cutting threads on tubing, or on pieces where a portion of the circumference is cut away, as shown in Figure 4, it is necessary to provide more cutting edges. The dies made for commercial purposes are usually given *four* cutting edges, although there are exceptions. In order to provide cutting edges it is necessary to make holes, shown at A A A A, Figure 5. These are known as clearance holes and provide a receptacle for the chips and allow the lubricant to flow freely to the cutting edges. There are several methods used for making the clearance holes, the more common is to lay off the holes with dividers, prick-punch the centers, then drill to the desired size. Another method consists in turning a threaded piece of steel into the threaded hole in the die; this piece must screw in very tightly. Lay off the centers of the clearance holes on the back of the die, and drill from this side. After the plug is screwed into the threaded hole, it must, of course, be faced off "flush" with the sides of the die.

A third method for large dies is in laying off the centers of the holes and die, then drilling the clearance holes first, the die then will appear as Figure 6; after which pieces of steel are driven into the holes, and must be tight. After making the ends flush with the sides of the blank, the center hole can be drilled, tapped, and countersunk and the plugs driven from the clearance holes.

A rule often followed is to make clearance holes one-half the diameter of the screw; that is, $\frac{5}{8}$ in. die would have clearance holes $\frac{5}{16}$ inch in diameter, and the centers of these holes would be laid out on the circumference

of the threaded hole, as shown in Figure 7. This does not always give a sufficiently large clearance hole, and it is considered better to drill larger holes farther from the center, producing the effect shown in Fig. 8. This is true of small dies where the clearance holes are often of a diameter several times larger than the screw to be cut. The widths of the lands A, Fig. 5, should be about $\frac{1}{16}$ of the circumference of the screw to be cut.

For general shop use the cutting edges of dies are made radial, as shown by the dotted lines in Fig. 9, but for various alloys of copper it is often better to give a negative rake; that is, the cutting edges face back of the center. In order that the die may cut, the cutting edges are given clearance. This must extend to the edge, but too much stock must not be removed or it would be too short and have no chance to cut. The next cutting edge would have twice the amount of work to do and a rough finish would result.

While dies for bolts and most heavy work are made square, the dies for screw-machine and turret lathe work are round. There is no particular rule governing the size of die blanks, but they are usually made to fit the holders used in the machines. Ordinarily it is not considered advisable to make them smaller than $2\frac{1}{2}$ times the diameter of the screw to be cut. These dies are made both solid and adjustable, and the same general directions given for

square dies should be observed when making. Adjustable dies are made the same as solid dies, except for the provision for adjustment, when a slot extends from the clearance hole to the circumference. When the thickness of the stock between the bottom hole and the outside of the die is too great to allow for adjustment, it is customary to file an oblong hole, as in Figure 10, or the small hole, as in Figure 11, may be drilled so that it will break into the clearance hole. To prevent the die springing when hardened, a thin wall of stock should be left, as shown at A, Figure 11. After hardening this can be ground away with a bevel emery wheel, or with an ordinary wheel having sharp corners, holding the die so that the wheel will grind a groove about equi-angular.

As stated previously, the diameter of the die should not be smaller than $2\frac{1}{2}$ times the diameter of the screw. The length of the threaded portion about $\frac{1}{4}$ times the screw diameter, though at times it is necessary to make dies for cutting small screws much thicker than this. The dies should be heated uniformly to a low red heat, and when quenched in water should be moved rapidly back and forth to force the water through the opening to insure hardening of the threads. Brighten the face after hadrening, and draw to a full straw color. Adjustable dies should be drawn to a blue at the portion where the small hole B of Figure 11 is drilled.

Honorary Mention

MANY of our readers have no doubt become interested in the practical articles written by Mr. Joseph Dante, Jr., A. S. E. E., of Torrington, Ct. Mr. Dante and some of the machines he has described in

EVERYDAY ENGINEERING appear in the accompanying photographs. Mr. Dante is a member of the A. S. E., and is one of those who is lending valuable assistance to the society by the practical machines he designs and constructs.

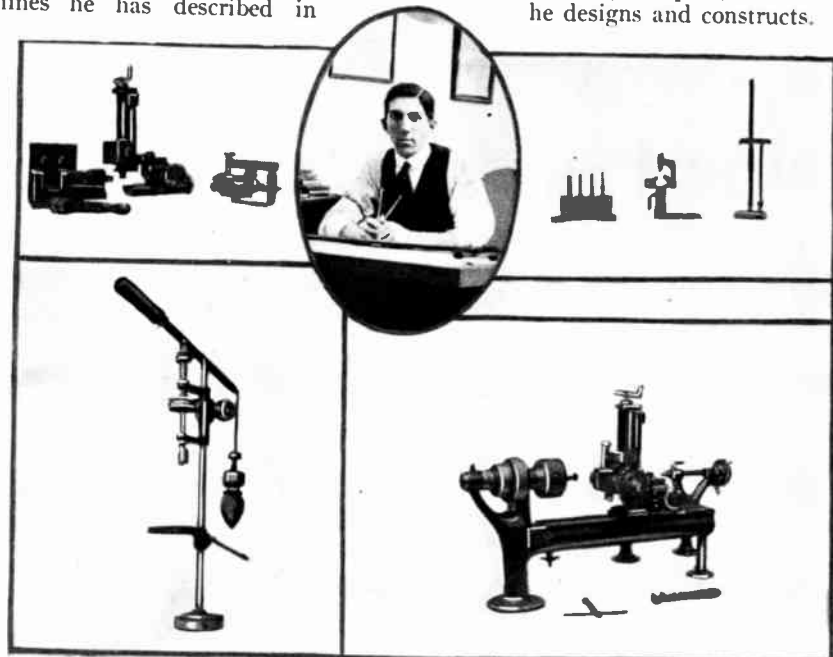



THE EVERYDAY MOTORIST

CONSTRUCTION — REPAIRS
DRIVING — OPERATION — HINTS



Operating Temperature of Gasoline Motor Parts

THE degree of heat present in the interior of an internal combustion motor and how it affects the lubricating oil depends upon a number of factors in the design of the motor parts, the materials of which they are composed and the action of the auxiliary groups having some bearing on motor temperature, such as the lubrication and cooling systems. Certain operating temperatures are desirable, as there will be a great loss in efficiency if a motor is cooled too much, yet if the heat is too high lubricating troubles will be met with. The aim of most designers is to keep the jacket water at 180 to 190 degrees Fahrenheit and the temperature of the cylinder walls should not exceed 350 degrees Fahrenheit.

The operating temperature of various motor parts as determined by careful laboratory experiments are shown in accompanying illustration and demonstrate that motor oils are exposed to higher temperatures in their actual application to internal combustion engines than they are in the majority of laboratory heat tests. This is especially true when the heat within the combustion chambers, upon the upper surfaces of the cylinder walls and lower or inside surfaces of the piston heads is considered. Below the pistons, the heat is less severe than above them, but the temperature is sufficiently high to cause chemical and physical changes in the oil. This causes a deposit of sediment in the crankcase and no lubricating oil known is free from this characteristic.

Some oils will deposit more sediment than others because they will break down more easily under the heat, and the rate of sedimentation is a good index of the suitability of the oil for engine lubrication.

One can take two oils of the same viscosity and obtain widely varying results as to sediment when both are tested by running them in the same motor. A yellow oil of the highest quality will change from that color to a grayish blue even after a few hours' use. After several days the oil has turned entirely black and is opaque. Draining a sample of this oil in a test tube and allowing it to stand twenty-four hours will result in a deposit of

black sediment at the bottom. The oil above the sediment will be red in color and can be used again.

For oils of the same grade, the volume of sediment is an index to the severity of operating conditions and degree of temperature in the interior of different motors. For oils of differing quality, used in the same motor, the deposit is a gauge to the grade of oil used. A chart presented herewith shows the results of motor oil tests in a graphic manner and shows why viscosity is not the only point to be considered in selecting an

a few minutes' running in the motor and will not clear up after it is allowed to stand as a good oil will, but will remain a grayish color even after it has deposited a large quantity of sediment. Such oil cannot be used again because its chemical nature and physical properties are different than when first supplied the motor and its lubricating value is negligible.

It will be evident that besides reducing friction in the motor mechanism the lubrication system is an important adjunct to the cooling system in keep-

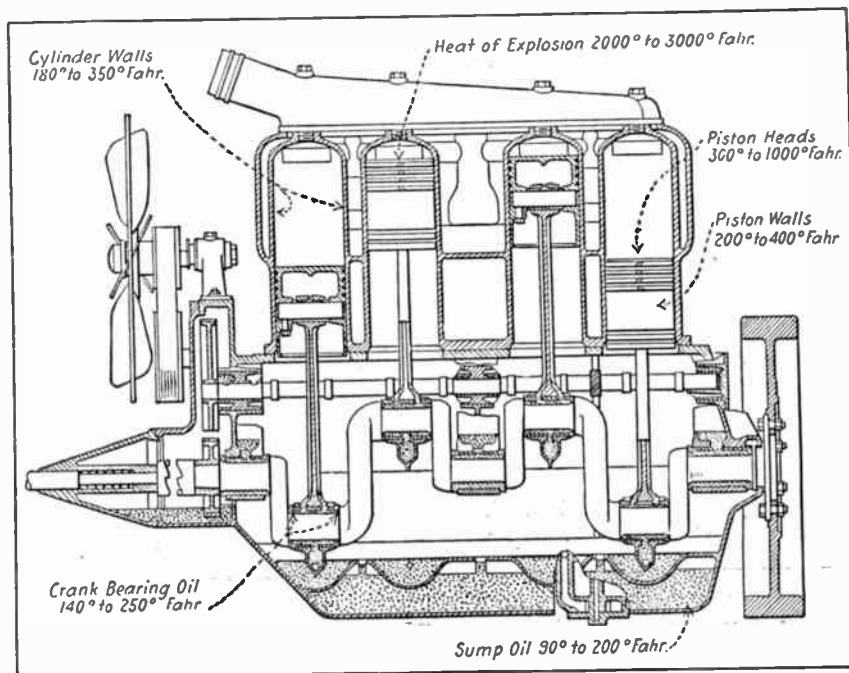

Fig. 1. Sectional view of four-cylinder motor, showing the temperature attained by various engine parts and heat imparted to the lubricating oil

engine oil to get best results.

It is stated that the poor resistance to heat of inferior oils is due to sulpho-compounds of various kinds present and may also be caused by decomposition of other unstable compounds and absorption of oxygen by the oil itself. These sulpho-compounds may be decomposed by heat to liberate free sulphuric acid gas which has a pronounced pitting action on the exhaust valve heads, seats and stems, though it has a negligible effect on the bearing surfaces in the crankcase.

A poor oil will turn black after even

ing the motor parts from heating up unduly because of the heat absorbing qualities of the oil. The reason why this is so can be clearly understood by referring to the diagram of the typical constant feed splash or "pump-over" system herewith. The heated oil returns to the pump by gravity, where it is cooled by radiation to air currents passing the engine base and is pumped up again into the crankcase troughs, from which points it is distributed by the scoops on the connecting rod big ends to all parts of the motor interior. The oil cools the motor interior ap-

preciably in circulating around in this way.

The temperatures indicated on diagram also demonstrate why a cooling system is necessary, as if there were no means provided for cooling other than the lubricating oil the parts would heat up so much that the pistons would seize in the cylinders. The excessive heat would also cause the oil to become so thin that it would lose its cushioning qualities and would also decompose. The pistons are hotter than the cylinder walls because the latter are cooled directly by water circulating around them through jackets, whereas the pistons must conduct their excess heat to the walls and other engine parts through an oil film.

If the heat of combustion was maintained it would be sufficient to melt the metal of which the engine is composed, but it exists only for short periods. In a four-cycle engine the cylinder should be cooled during the intake stroke by the relatively cool vapor from the carburetor and there is but little rise in temperature due to compression on the next stroke. While the temperature at the time of combustion is high it becomes less as the gas expands, drops rapidly when the exhaust valve opens and continues to lessen in value as the piston moves up during the scavenging stroke.

Two-Spark Ignition

ON some forms of engines, especially those having large cylinders, it is sometimes difficult to secure complete combustion by using a single-spark plug. If the combustion is not rapid the efficiency of the engine will be reduced proportionately. The compressed charge in the cylinder does not ignite all at once or instantaneously, as many assume, but it is the strata of gas nearest the plug which is ignited first. This in turn sets fire to consecutive layers of

the charge until the entire mass is aflame. One may compare the combustion of gas in the gas-engine cylinder to the phenomena which obtains when a heavy object is thrown in a pool of still water. First a small circle is seen at the point where the object has passed into the water, this circle in turn inducing other and larger circles

high speed with two-spark plugs, because the combustion of the gas is accelerated by igniting the gas simultaneously in two places. To fit a double-spark system successfully, one of the plugs must be a double-pole member to which the high-tension current is first delivered, while the other may be one of ordinary construction.

A typical double-pole plug is shown in section at Fig. 3A. In this member two concentric electrodes are used, these being well insulated from each other. One of these is composed of the usual form passing through the center of the insulating bushing, while the other is a metal tube surrounding the tube of insulating material which is

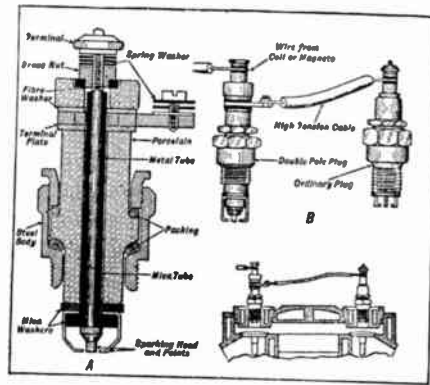

Fig. 3. Two pole spark plug for two-spark ignition

until the whole surface of the pool has been agitated from the one central point. The method of igniting the gas is very similar as the spark ignites the circle of gas immediately adjacent to the sparking point, and this circle in turn ignites a little larger one concentric with it. The second circle of flame sets fire to more of the gas, and finally the entire contents of the combustion chamber are burning.

While ordinarily combustion is sufficiently rapid with a single plug so that the proper explosion is obtained at moderate engine speeds, if the engine is working fast and the cylinders are of large capacity, more power may be obtained by setting fire to the mixture at two different points instead of but one. This may be accomplished by using two sparking plugs in the cylinder instead of one, and experiments have shown that it is possible to gain from twenty-five to thirty per cent in motor power at

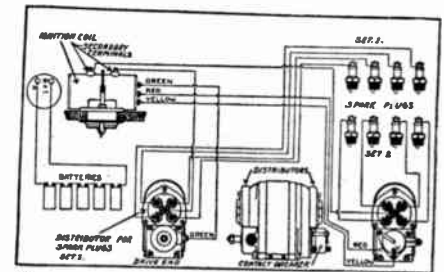

Fig. 4. Double distributor magneto for two-spark ignition

wound around the center wire. The current enters the plug through the terminal at the top in the usual manner, but it does not go to the ground because the sparking points are insulated from the steel body of the plug which screws into the cylinder. After the current has jumped the gap between the sparking head and the point, it flows back to the terminal plate at the top, from which it is conducted to the insulated terminal of the usual type plug.

The method of wiring these plugs is shown at Fig. 3B. The secondary wire from the coil or magneto is attached to the central terminal of the double-pole plug, and another cable is attached to the insulated terminal plate below it and to the terminal of the regular type plug. One is installed over the

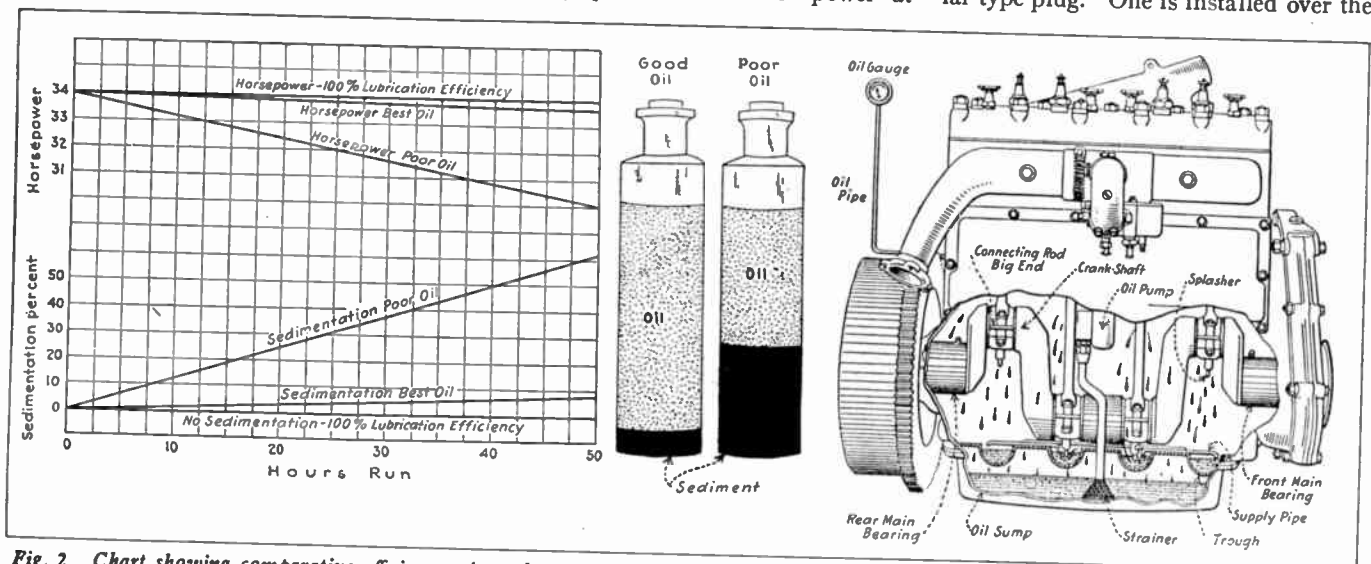

Fig. 2. Chart showing comparative efficiency of good and poor lubricating oil as determined by horsepower and sedimentation tests. At right, typical motor oiling system, showing how circulation of lubricant assists in cooling engine

inlet valve, the other over the exhaust valve, if the system is fitted to a T head cylinder. Before the current can return to the source it must jump the gap between the points of the double-pole plug as well as those of the ordinary plug, which is grounded because it is screwed into the cylinder. When a magneto of the high-tension type furnishes the current a double distributor is sometimes fitted as shown in Fig. 4, which will permit one to use two ordinary single-pole plugs instead of the unconventional double-pole member. Each of the plugs is joined to an individual distributor, and as but one primary contact breaker or timer is used to determine the time of sparking at both plugs, the ignition is properly synchronized and the sparks occur simultaneously.

KEROCLEAN

THIS non-inflammable cleanser is claimed to remove grease spots from delicate fabrics without injury and cleans all kinds of jewelry and tableware by removing fats and tarnish, kills moths, insects and household pests by suffocation and extermination, and helps ironware by removing rust, brassware by removing grease, copperware by removing verdigris. It is as clear as water and will stand any fire test.

Kerosene 1 ounce
Carbon Tetrachloride
(Commercial) 3 ounces
Oil of Citronella..... 2 drachms
Mix, and filter if necessary. If a strong odor of carbon bisulphide is detected in the carbon tetrachloride, first shake with powdered charcoal and filter, repeating until the odor is no longer objectionable.

NOISY REAR AXLES

BUT little trouble is experienced with shaft-driving systems because the driving gear and universal joints are so well enclosed on modern axles. The bevel or worm driving gears are packed in lubricant as a rule, and but little wear is noted, even after several seasons of use. An important point to observe with all forms of axles is to make sure that the anti-friction bearings are kept properly cleaned, adjusted and oiled. The oil or grease used should contain no acid and should be of the best quality. Care should be taken in washing the car to prevent water from entering the bearing points. If the gears of the rear axle are noisy it is due to improper adjustment or excessive wear between the teeth. Grinding sounds usually result from meshing gears too deeply, while loose adjustment is manifested by rattling. Heating of worm gearing indicates poor adjustment or lack of lubricant.

Purchasing a Second-Hand Motorcycle

By Albert Arnold

IN the present state of efficiency of motorcycle manufacture, no machine can be said to be worn out for several years, but styles change, and there will always be those who want to be right up to the minute regardless of the expense entailed. In consequence, there is a large number of excellent second-hand machines on the market to-day.

The first thing to consider is whether the machine in question is worth purchasing at all. With the large selection offered one can afford to be particular; there are some faults which it is not worth while to attempt to remedy. The question of age resolves itself entirely into a question of make, for, if the machine was a good one in the beginning, it will be good much longer than one which was originally of a lower grade; but the matter of design is also important.

Be sure its maker is still in business. A machine of short wheel-base, high saddle, high-hung engine, and short handle-bars will never be comfortable, and it would be wiser to wait for an opportunity to obtain one of a more modern build. Transmission must also be considered. The type is entirely a matter of personal preference; but block chains, roller chains too small for their work, a narrow flat belt with an idler, "V" pulleys not cut to twenty-eight degrees, or too small an engine pulley, can never be made to give efficient service. A cracked frame lug, cylinder, crank-case, or piston, or a buckled wheel, also mean repairs that had better be left for the buyer with mechanical skill.

Not less important is the condition of the engine. This is the heart of the machine, and, if it has been seriously injured, the cycle will be part of the repair shop furniture for some time to come. Jack up the rear wheel, and stand on the pedal with the exhaust valve dropped. A modern twin engine in good condition will hold your weight almost indefinitely in this manner, but if the pedal does not fall for several seconds, the cylinder and rings may be considered to be in good condition. If it goes down rapidly, the engine should be examined further. Have the cylinder taken off and run

your finger carefully all over the inside surface. If you find any cuts, scratches, grooves, or rough spots, it must be replaced. If, however, it is all bright and smooth, you may turn your attention to the rings. Examine carefully the surface which rubs against the cylinder. It should be all brightly polished, but there will probably be dark spots. If these spots are very frequent, you had better steer clear, but if only a few it simply means new rings. First, however, be sure that you can obtain new rings for that particular make of model, as it is an expensive job to have them especially made.

While you have the cylinder off, glance at the bearings. Run off the belt or remove the chain and try to move the pulley or engine sprocket up and down. A small amount of play is to be expected here, but if it is at all great, new main bushings will be needed, the cost of which must be added to the price you are to pay. The same is true of the crank and wrist-pin bushings. The former can be tested by moving the connecting-rod up and down while the flywheel assembly is held still, and the latter by holding the connecting-rod with one hand and moving the piston up and down with the other. If the motor is a ball-bearing form and the bearings are worn, remember that these cost money, in fact, several times as much as plain bearings. Better let someone else buy them.

Next to motor repairs the tires are probably the most expensive parts to renew. These are often overlooked in buying a second-hand mount, because they can be obtained anywhere, but it should be remembered that they cost a great deal. A flat tire means a puncture or rotten tube. Chains or belts are also large items, and their condition should be noted. Do not forget to examine the sprockets, as, if they are worn unduly it will be useless to replace the chains unless they are replaced also. Damaged pedaling gear, broken brake, dented tanks or rims, bent spokes and broken mud-guard stays or control levers, are of less importance, as they are easily repaired, but they should all be looked for and taken into consideration.

A MICROSCOPIC COMPRESSED AIR ENGINE

ONE of our contemporaries tells us that a young jeweler of Hillsboro, N. D., has made a miniature compressed air engine which is only three-quarters of an inch long and weighs only 2½ grains. The cylinder is 28/1000 of an inch bore, the flywheel is 9/64 inch diameter, and the piston stroke is 38/1000 inch. The

above seems quite wonderful—we doubt if any of our model makers can excel it. But it does seem rather misspent ingenuity, for the same amount of effort and skill could do so much more. The achievement is one of note and we would be glad to hear from any of our readers who can match it.

Notes on Pressure Gauges

By Henry B. Graves

THE December, 1918, issue of EVERYDAY ENGINEERING contained an article on "Making Small Pressure Gauges." The author, having been engaged for some time in research work for a large firm manufacturing this line of goods, wishes to elaborate slightly on the description and methods given in the aforementioned article, and at the same time present workable details of an electrical controlling pressure gauge of his own design and construction.

Manufacturers of Bourdon pressure gauges make use of a tube which is already drawn to the required flattened shape, and these tubes are bent to their final circular contour by special tools and machinery. However, for experi-

mentally accomplished if the tube is first filled with melted rosin and then bent around the circular form. The tube should then be sawed or filed off to the required length, after which the rosin can be removed by a gentle application of heat.

The person starting to calibrate a gauge might well spend a great bit of time and thought trying to figure out a practical pressure tank from the drawings which accompany the article in the December issue, especially so if he wishes one capable of holding a high pressure. A very cheap and simple outfit for this purpose may be arranged by screwing two ordinary caps onto the ends of a short length of high-pressure steam pipe, which can be ob-

position of the end of the connecting link J in this slot.

The commercial movements also embody a hair spring on the pointer shaft, which serves to take up the back-lash in the gear teeth and connecting links.

Fig. 2 shows the face or dial of an electrical controlling pressure gauge. A circular slot C is cut in the dial of the instrument. Contacts E and E' are so arranged as to slide in this slot to a position corresponding to any pressures on the scale. Contact D on the pointer is so placed as to brush contacts E and E' when passing over them.

Fig. 3 shows a cross-section of the dial taken through the slot, and also gives details of the sliding contacts. In this figure A is a cross-section of the dial; B is the pointer with contact pin K in place; C, D, and E are hard rubber or fibre insulating washers and bushings; F is a brass contact screw; G, H, I, and J being respectively a spring washer, a plain washer, a nut, and a flexible connecting cord. This construction allows the contacts to be pushed around in the slot to any position from the front of the dial, the spring washer tending to hold them in any position placed. A false dial back of the main dial prevents the connecting cords from interfering with the gauge movement.

The author designed this gauge for use in a garage where, in connection with suitable relays it alternately started and stopped a pump motor which maintained a constant air pressure in the tire air service tank. The same gauge, however, may fill a number of different uses. It can open and close draughts on a steam boiler or control the throttle of a gas engine. It may be used to operate signal lamps or ring a warning bell at any maximum or minimum pressure desired. In fact, its uses can only be limited to the ingenuity of the engineer.

Everyday Engineering Workshop Contest

AS announced in the August number of EVERYDAY ENGINEERING, a first prize of \$25.00 will be paid to the experimenter who sends in the best photograph and description of his workshop or laboratory before October 1. The second best set of pictures and description will bring a price of \$15.00. The descriptive matter should not be over 400 words in length. For further information see the announcement in "Everyday" referred to above.

A number of photographs have been received and before the closing date it is hoped that several hundred will be on hand. Don't fail to send a photograph of your shop or laboratory in before Oct. 1st, 1919.

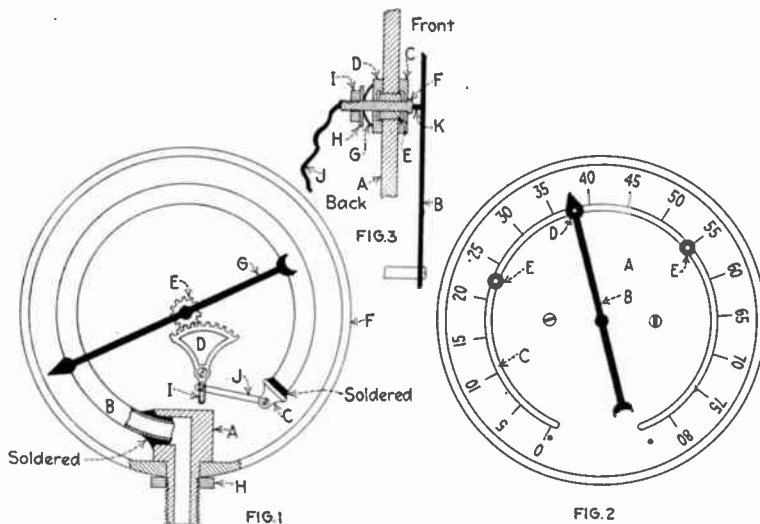

mental purposes a practically perfect tube can be easily formed as follows: Take a piece of thin walled brass tubing and place same between the jaws of a wide and smooth-jawed vise. Carefully close up the jaws after first inserting in the tube a piece of flat stock of the same thickness as the required mean diameter of the finished tube. This will prevent the tendency of the tube to buckle in the middle. This tube should be a couple of inches longer than the finished tube is required to be. When this is done, the tube should be annealed by heating to a dull redness and quenching in water.

The previous article instructed the maker to flatten out the tube by hammering over a piece of flat stock, but that method would give a very inferior job, and a tube so strained and marred that the expansion would not be the same in all parts of the tube when in use. It would also be practically impossible to curve the tube to the required shape by the instructions given without causing the tube to kink and buckle. This operation can be per-

formed for a few cents at any plumbing shop. A hole may be drilled in each cap and tapped to accommodate the screw terminals of the standard and experimental gauges. For filling the tank thus formed an ordinary tire valve may be tapped into any part of the system.

Reference to Fig. 1 will show the general gauge construction used by manufacturers. The tube B is soldered into a block as shown at A. This leaves an uninterrupted circular form of the tube giving an even distribution of expansion and at the same time being a very simple method of construction.

As the expansion of the tube is very small, the travel of the pointer is increased by means of a pinion and curved rack or sector gear as shown at E and D. An old watch or clock movement will furnish an admirable unit for this purpose, as any gear can be mutilated to furnish a curved rack as shown.

A wide adjustment of the indication may be obtained by means of the slot I, as the leverage may be varied by the

Large Airplanes for Passenger Transport

By Victor W. Pagé, M. S. A. E.

WHILE the rigid dirigible gives promise of being the type of aircraft that will eventually carry passengers and other freight on the long-distance flights, for relatively short distances, say under 1,000 miles, and where time is an object, one can expect to see large airplanes developed that will have a passenger capacity much larger than we can obtain in existing types. There is much to be said in favor of the airplane as relates to

planes are already available for passenger carrying, these being the types developed during the war for bombing, which can readily be used by slight changes necessary to replace the bomb racks with accommodations for passengers. This has already been done in the case of the Handley-Page in England, the Farman in France, the Caproni in Italy and the Curtiss and Glenn Martin in this country.

The Handley-Page was one of the

notably in the landing gear, fuselage and wing structures. The model illustrated at Fig. 1 is the early type O.100 Cossack, which was equipped with two 230 H. P. Sunbeam engines and is virtually the design that was built in the United States and provided with two Liberty 350 H. P. engines. While it was afterward succeeded by much larger craft, the main features of construction were adopted in the later designs. The span of the upper main plane is 100 feet, that of the lower is 75 feet. The chord is uniform on both upper and lower aerofoils, and is 10 feet. The incidence is 3 degrees and a dihedral of 4 degrees is given the planes.

The overall length is about 63 feet, the height in flying position is 22 feet, and when folded it is 17 feet 6 inches. The gap between the wings is 11 feet. Its gross weight was 10,000 pounds, the area of the supporting surfaces is 1,642 square feet. It had a speed of 90 miles per hour at 6,000 feet elevation. It could carry 2,200 pounds or one long ton of bombs when powered with two 360 H. P. Rolls-Royce Eagle engines and had an air endurance of seven hours with the fuel carried. Merely replacing the bomb racks with seats would give a capacity of 12 ordinary sized passengers, exclusive of crew of three. The Handley-Page "Super," a much larger machine, had an upper wing spread of 120 feet and was powered with four motors, arranged so there were two tractor and two pusher propellers. Its endurance was said to be 14 hours and its capacity was estimated at from 3,000 to 4,000 pounds of bombs besides normal military equipment by various authorities.

The Handley-Page designers solved several difficult problems in evolving their efficient and pioneer giant airplanes. One of these was a landing gear that would permit of bringing the huge machines to earth without damage, and it is no small achievement to bring even a five-ton machine to the ground at a speed of 50 miles per hour without injuring the structure. The writer can attest to the strength and general excellence of the landing chassis design, as he has witnessed landings made at the front in absolute darkness, due to failure of flares to work, without damaging the airplane. This chassis is shown at Fig. 4. Another valuable feature in the design was the folding wings, which make it possible to house the large craft in ordinary sized hangars. This is clearly shown in drawings at Figs. 2 and 3, the latter

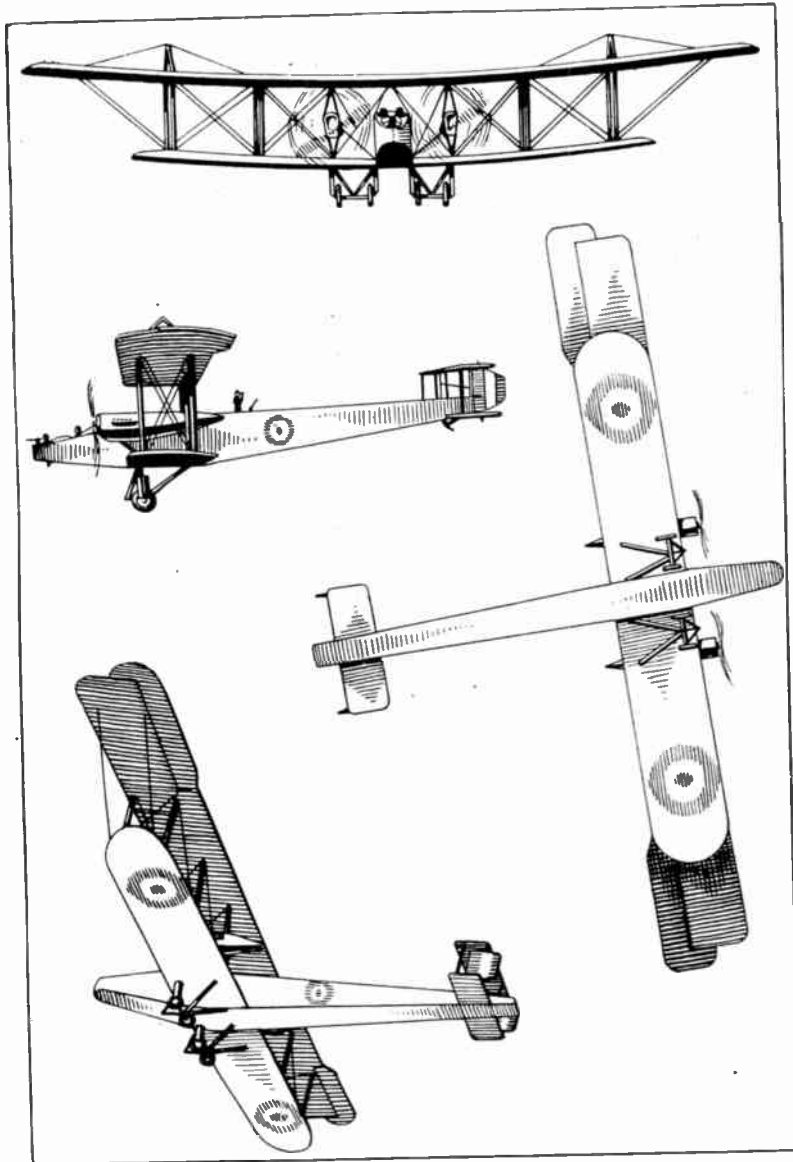
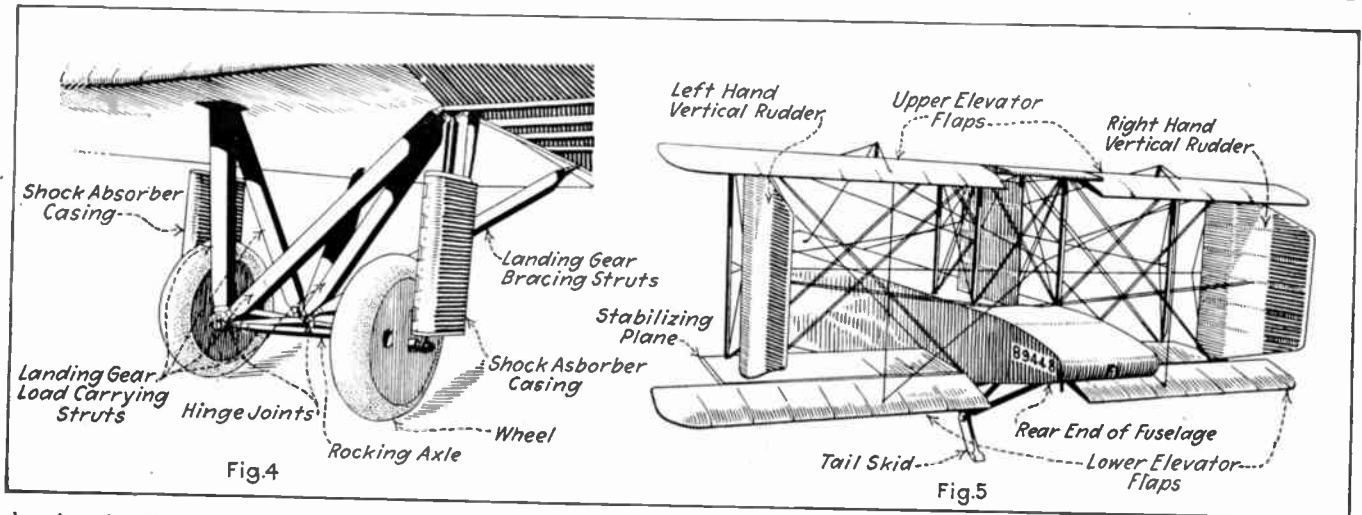

Fig. 1. Handley-Page twin motored biplane in several flying positions

low first cost and operating expenses as compared to the dirigible. To operate lines of large airships ranging in capacity from 2,000,000 to 10,000,000 cubic feet would call for the investment of enormous sums, and it is doubtful if private capital is yet ready for enterprises of this character. Large air-

most successful of the airplanes used by the allies for night bombing purposes and was the pattern from which the Gotha of the German forces was copied. There are none of the large airplanes produced today but what incorporate some features of Handley-Page engineering in their construction.



showing details of the hinge joints that made it possible to swing the wings back against the fuselage. Another interesting point is the biplane tail at Fig. 5, this having as large a spread as some of the small scouting planes had. There were four elevator flaps used, two on each tail plane and two vertical rudders.

The large size of the fuselage can be appreciated by the view of the interior of one fitted up as a saloon for carrying passengers; twelve chairs having been provided for their accommodation. As will be evident from Fig. 2, there is

sufficient head room for even a tall man in the midship section, as this is about eight feet deep.

Even larger airplanes than the Handley-Page super have been constructed by the British builders. One of these, the Tarrant triplane, is believed to be the largest aircraft of the heavier-than-air type yet built, and while it met with an accident in its first flight trials, wind tunnel tests on a model gave every promise of this design performing well. Its description has been published in a number of the British aircraft papers.

The machine has six engines of the Napier-Lion type, said to have an aggregate energy output of 3,000 horsepower, or 500 horsepower for each unit. Four of the engines are mounted between the central and bottom aerofoils, while the other two are installed between the top and center supporting surfaces. Four of the motors drive tractor screws, two actuate pusher propellers. The fuselage is a very good streamline form and is built on the bulkhead-monocoque principle. While the machine was built for long-distance bombing, plans were in the making to alter it into a passenger carrying craft. The large size can be understood by considering the span of the middle plane, which is 130 feet, while that of the top and bottom planes is 100 feet. The height to the top plane is 37 feet 3 inches, or about that of a three-story dwelling house. The weight of the giant craft is given as 45,000 pounds, of which 9,000 pounds is available for passengers and cargo and 10,000 pounds is taken up by gasoline and oil. This would give it an air endurance of about four hours with engines at full throttle and would permit carrying sixty 150-pound passengers at a speed of over 100 miles per hour.

Airplanes are reported to be under construction in Italy of the triple-triplane tandem type which will have a capacity of over 100 passengers and a wing spread of over 200 feet. The

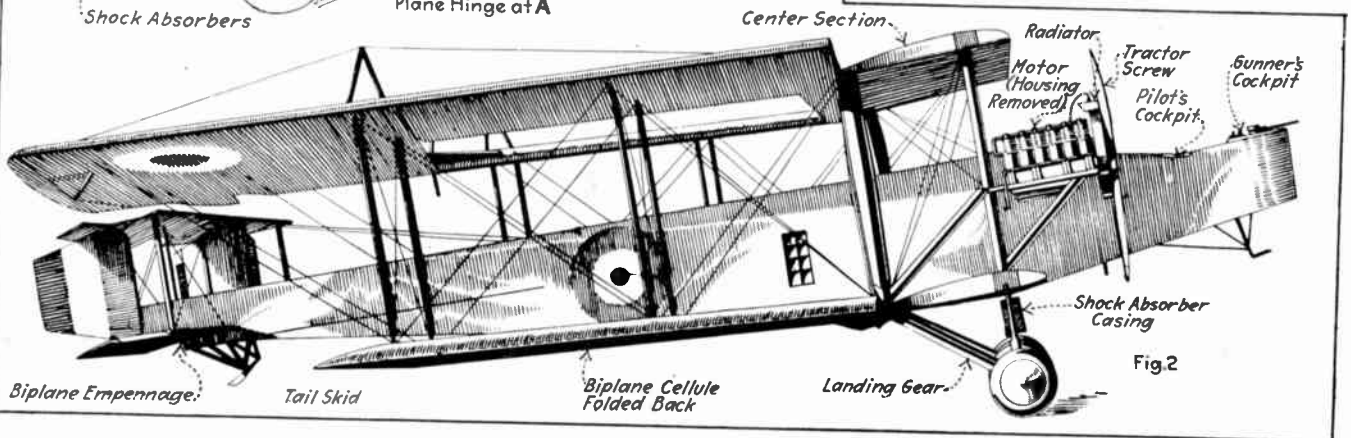
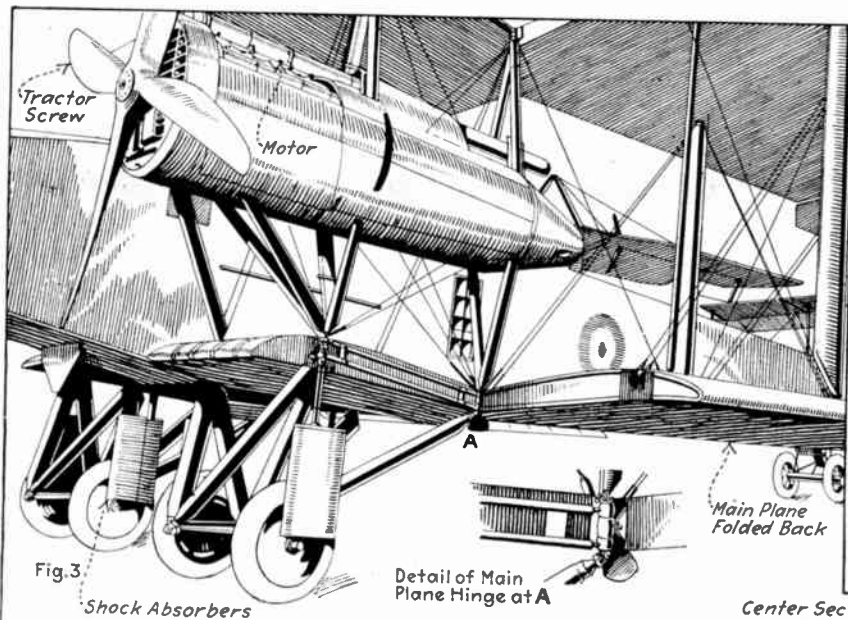

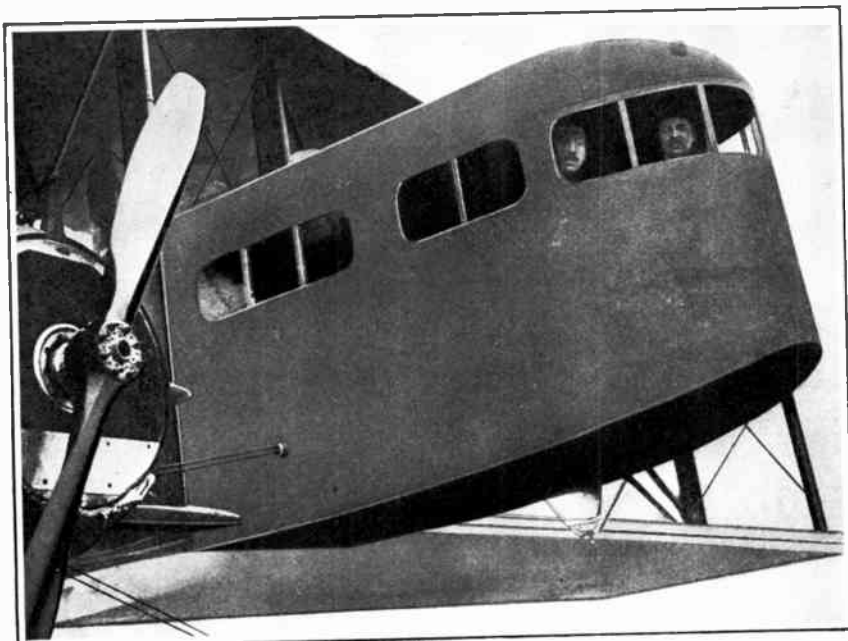

Ample protection for pilot and passengers is provided in ten-passenger Farman air-liner

power will be furnished by twelve engines, four being used in each triple wing assembly, with an aggregate of 6,000 horsepower. Anyone with a knowledge of the history of the development of the mechanical arts and sciences during the past 20 or 30 years will hesitate to hazard an opinion about the limits in the size of airplanes, and it would seem to the writer that even now, the problem is one of safely piloting, controlling and landing the large craft rather than building them.

Another giant seaplane of Italian origin is a quadruplane that will carry 150 people and seven tons of freight. Eight 600 horsepower engines of the 12-cylinder V type are to be used, this giving an aggregate of 4,800 horsepower. This machine is to use steel in its construction to a large extent, as the wings are to have spars of that metal, with duralumin ribs surfaced with chrome-nickle steel sheets. The engines are located in couples at the front and back of the nacelles and

celles are on the second aerofoil and in the same vertical plane as the two floats which contain the tanks for fuel. Each of these floats carries a biplane tail at their extremities. The center part of the power plant nacelles form engineer's cockpits. There is a saloon for passengers between the second and third aerofoils, and the control will be from a bridge on the second floor of the saloon.

Care of Tops.—Mohair tops should be frequently dusted and brushed off. Pantasote tops and curtains are best cleaned with a soft brush dipped in water to which a little ammonia has been added. Afterwards rub dry. Never attempt to clean top and curtains with gasoline or kerosene. Do not fold the top until it has become thoroughly dry, because any moisture remaining in the folds is apt to cause mildew, besides making the top leaky and unsightly with spots. When a car is not

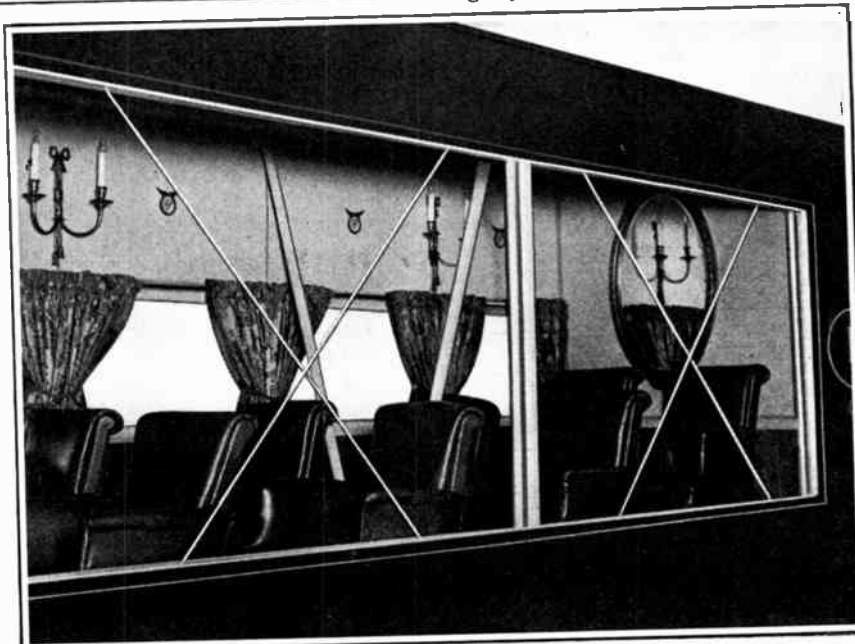

Interior of Handley-Page fuselage fitted up for carrying 12 passengers in comfort

transmit power to two four-bladed tractor screws and two propellers independently of each other. The engine na-

used for some time, it is best to open the top, which keeps it well stretched and smooth and prevents unsightly cracks.

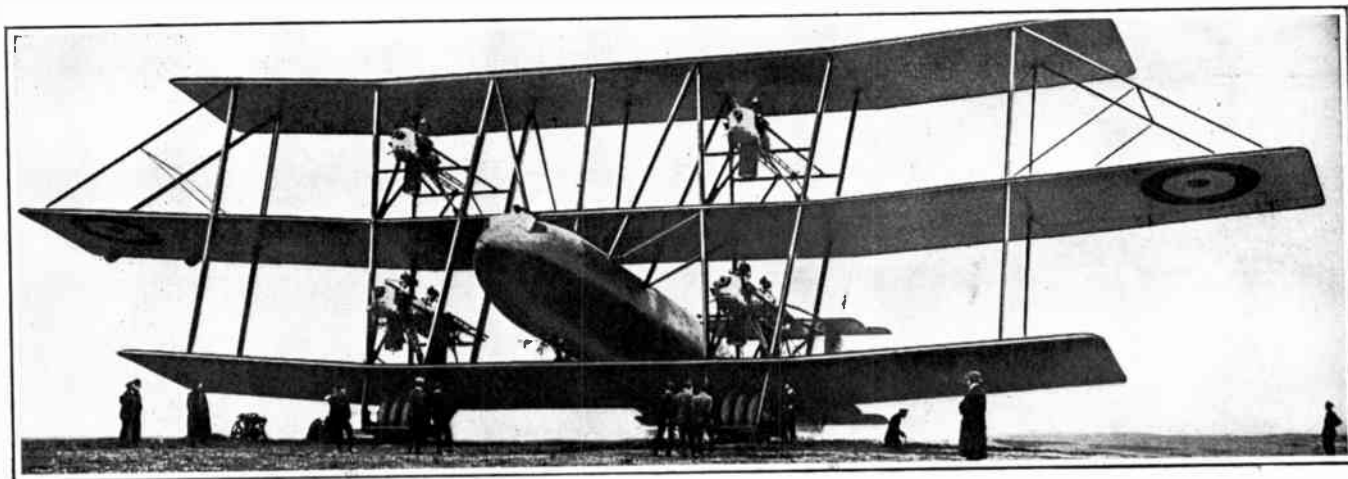

The Tarrant triplane, a large British design of 130 feet span and 3,000 horsepower, provides capacity for 60 passengers

WING BEAMS FOR SEAPLANE

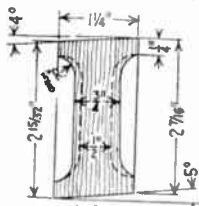

FIG. 1A
TOP WING FRONT BEAM
2 Ash-12'-3" Long-Rand L.

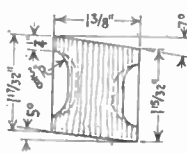

FIG. 2A
TOP WING REAR BEAM
2 Ash-12'-10 1/2" Long-Rand L.

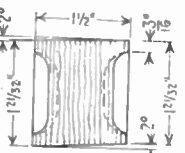

FIG. 3A
LOWER WING FRONT BEAM
2 Ash-9'-6" Long-Rand L.

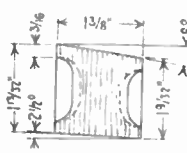

FIG. 4A
LOWER WING REAR BEAM
2 Ash-9'-9" Long-Rand L.

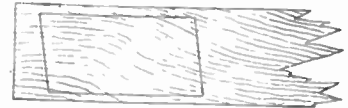

FIG. 6B
END PLAN SHOWING ONE METHOD OF OBTAINING VERTICAL GRAIN

WING BEAM SECTIONS TAKEN THROUGH SPAR BETWEEN STATIONS, ENDS ARE ALWAYS RECTANGULAR

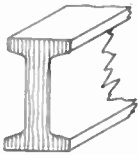

FIG. 1C
SOLID "I" BEAM

May be channelled between rib stations, or full length blocked in at rib stations.

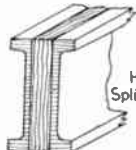

FIG. 1D
LAMINATED SPAR

Vertical and contra vertical grain, vert. for strength. Contra vert. to hold shape

Hard Wood Spline or Dowels

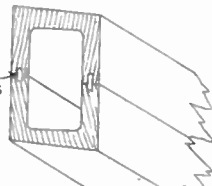

FIG. 1E
HOLLOW BOX SPAR

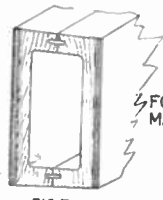

FIG. 1F
HOLLOW SPAR
Stiffened with veneer

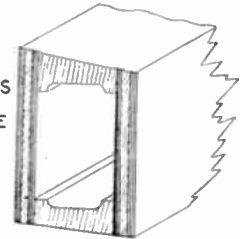

FIG. 1G
HOLLOW SPAR
Multi-Ply Sides

SECTIONS E-F-G FOR LARGE MACHINES ONLY



FIG. 1H
BUILT UP SPAR, 5 TON BOMBER

3-1/4" Laminations at center sect. reducing to 3-1/8" laminations in the outer bays, over all sizes also reduced in same manner.

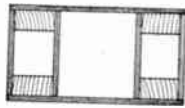

FIG. 1J
TWIN BOX SPAR FOR LARGE WINGS

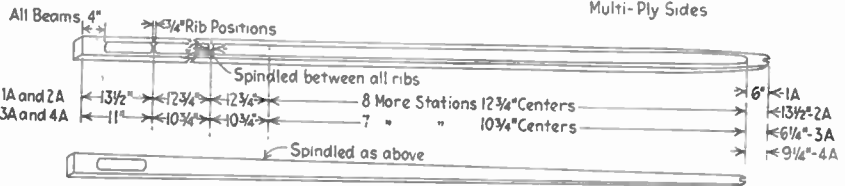

FIG. 1K
TAPERING AND SPINDLING WING BEAMS STANDARD
If wing beams are bevelled, allow for right and left when tapering. Method now seldom used.



FIG. 1L
WRIGHT STRUT
Up to 1912
Silver Spruce



FIG. 1M
FARMAN STRUT
White Ash

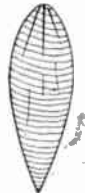

FIG. 1N
IDEAL S.L. STREAM LINE STRUT
Fineness Ratio 3:1 up to 5:1



FIG. 1O
PRESENT DAY TENDENCY
5:1. Prone to Buckling

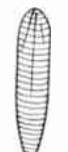

FIG. 1P
STEEL TUBING
5:1 up to 6:1



FIG. 1Q
SPINDLED STRUTS
With Balsa or Spruce
fairing bound on with tape or linen.



FIG. 1R
LAMINATED STRUT



FIG. 1S
STEEL STREAM LINE



FIG. 1T
SPINDLED STRUTS



FIG. 1U
CURTISS LATEST FLYING-BOAT STRUT

INTER-PLANE - LANDING GEAR - CABANE



FIG. 1X
ONE FORM OF STRAIGHT LINE



FIG. 1Y
CURVILINEAR CONTOUR

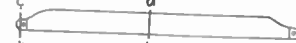

FIG. 1Z
STRAIGHT LINE

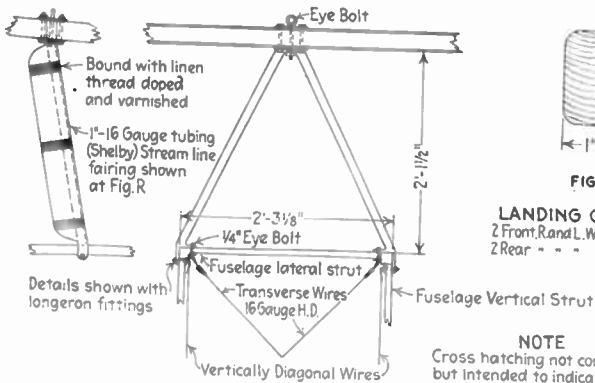

FIG. 1A-A
CABANE STRUTS FOR SEAPLANE



FIG. 1Y2
LANDING GEAR STRUTS
2 Front Rand L. White Ash 3'-1 1/2"
2 Rear " " " 2'-10 1/2"



FIG. 1Y3
SECTION e-f



FIG. 1Z2
SECTION c-d



FIG. 1Z3
SECTION a-b

INTER PLANE STRUTS
2 Front Outer Silver Spruce 3'-10 1/2"
2 Rear " " " 3'-9"

NOTE
Cross hatching not conventional but intended to indicate the desired natural character of grain



FIG. 1B-B
A RECENTLY DEVELOPED FORM OF CABANE STRUT
Section shown at Fig. T

PLATE TWO
WING BEAM AND STRUT SECTION AND COMPONENTS FOR SMALL SEA PLANE

Building a Two-Passenger Seaplane

By Charles E. Muller

Consulting Aeronautical Engineer

PART II

THE future development of aviation, like all evolution in science, is a constant growth in efficiency of engineering, resulting in a better performance of the machine. Nothing is more dependent on the accuracy of minute detail than aeronautical construction. As the purpose of this series is to assist the amateur or professional mechanic in a practical and brief way to construct a successful hydro- or land airplane, its scope does not permit aerodynamical explanations or the discussion of choice. One can, however, present the up-to-date methods of the best aeronautical engineers in a concrete manner devoid of technicalities and to suggest certain methods when deemed pertinent.

Characteristics of Airplane Lumber

A brief description of the characteristics of suitable aeroplane lumber is now the logical sequence, as it constitutes the greater part of the machine's structure and forms the frame which determines the shape and strength of the entire airplane. The selection of this lumber is unquestionably one of the most important considerations, requiring most diligent care, as there are so many varieties and qualities. The seasoning, the nature of the grain, and its age changes all the characteristics of individual pieces taken from the same tree.

The following table will give a fair comparison of the various characteristics of those woods that have been used for airplane components, but unless one wishes to experiment for research, it is advisable to follow existing practice in the choice of lumber as tabulated tests will differ very markedly with lumber in different consignments.

It will, therefore, be the writer's policy to recommend the generally adopted kinds of wood for specific uses as experience has dictated. Silver spruce is unquestionably the most suitable wood for airplane structures and has been used for the wood parts of the entire machine, even spruce propellers have proven satisfactory up to certain speed limits. Its strength-weight ratio is nearly the highest of all the soft woods and for most purposes it is superior to the hard woods. Its weight varies with moisture content and other conditions from 26 to 33 lbs. per cubic foot.

Next to silver spruce, white ash is most commonly used, especially for

landing gear struts, front longerons, engine bearers, and interplane struts on flying boats where the engines are fastened to the struts. White ash is especially recommended for bent pieces, or where severe shock or vibration is found, also where tough and resilient members are required. Weight is then sacrificed for other considerations, such as greater structural strength.

Design of Wing Spars

Wing beams or spars are designed to resist bending under compression in a vertical plane, as the ribs assist in stiffening it in a horizontal plane. Therefore the greater cross sectional dimension is vertical where possible. Channel steel and steel tubing with and without a wood filling have been tried, but generally discarded for many reasons. One important reason is that the strength of a beam varies as the square of the depth. The one-piece solid or spindled spar has answered all requirements, especially for the small span machine.

The method of procedure in making the spar is perhaps best explained by taking the spars for this machine as an example, as outlined in accompanying drawings.

- 2 top wing front beams... Fig. A
- 2 top wing rear beams... Fig. 2-A
- 2 lower wing front beams. Fig. 3-A
- 2 lower wing rear beams... Fig 4-A

It will be observed that they are a one-piece white ash beam, channelled or spindled.

The following may appear too elementary to some, but as the wing beams are considered the nucleus of the entire wing assembly or cellule, too much stress cannot be laid on the careful selection and machining of these com-

ponents. If wood working machinery is available, considerable time may be saved, but all of the operations necessary in shaping the pieces can be done with the ordinary tools of the carpenter and cabinet maker.

Construction of Wing Spars

The first step is to select one white ash plank of 10 ft. x 1 3/4 in. x 8 in. or larger and one 13 ft. x 1 3/4 in. x 10 in. or larger, two years weather dried if possible. These planks should have a straight grain running in the direction as indicated in Fig. B. This will give what is called a vertical grain. There should be at least six annular rings to the inch. The more vertical annular rings it has the stiffer it will be. The next step is to joint one side and edge, rip saw the largest pieces first, so that should they spring or twist they may be trued up for the smaller beams.

When planing stock to size do not attempt to take off all the excess in one cut or side, as the piece may spring out of shape. It is absolute folly for the amateur to attempt to use untrue beams, the writer recalling many bad cases of wing distortion in the early days due to this. After the beams are tapered lengthwise they are then spaced for the ribs and spindled. When completed they should be carefully supported their entire length and the air allowed to circulate all around them until assembled in the wing.

Other methods of spar construction are shown at Figures C to J inclusive, and are being used for large machines on account of the scarcity of required sizes to make one-piece spars and also because the built-up structures are stronger in proportion to their weight

PROPERTIES OF VARIOUS WOODS FOR USE IN AIRPLANE DESIGN
Strength Values at 15% Moisture

Woods.	Wt./cu.ft.	Fiber stress at elastic limit. Lbs./sq.in.	Modulus of Rupture.	Compression parallel to grain, crushing strength. Lbs./sq.in.	Compression perpendicular to grain fiber stress at elastic limit. Lbs./sq.in.	Shearing strength parallel to grain. Lbs./sq.in.
Ash (White).....	40	7,700	12,700	6,000	1,300	1,750
Ash (Black).....	35	5,800	10,500	4,900	800	1,350
Basswood.....	25	4,700	7,200	3,800	400	880
Beech.....	41	7,400	12,600	5,900	1,100	1,700
Birch.....	43	8,400	13,500	1,500	1,000	1,620
Cedar.....	26	4,900	7,100	4,300	600	850
Cottonwood.....	28	4,500	7,000	3,800	400	800
Cherry.....	35	7,300	10,600	6,600	700	1,500
Cypress.....	31	6,100	8,800	5,400	670	940
Elm.....	44	6,700	12,500	5,800	1,200	1,650
Fir.....	34	6,800	9,700	6,000	750	1,020
Gum.....	34	6,700	10,400	4,900	700	1,500
Hickory.....	50	8,900	16,300	7,300	1,800	1,800
Mahogany.....	36	7,000	10,000	5,500	1,000	1,420
Maple.....	42	8,100	12,900	6,500	1,200	1,990
Oak.....	46	6,700	12,000	5,900	1,300	1,760
Poplar.....	28	4,800	7,500	4,100	400	900
Pine (Sugar).....	27	5,300	7,400	4,300	510	950
Pine (White).....	29	5,100	7,800	4,800	480	670
Spruce.....	27	5,100	7,900	4,300	500	920
Walnut.....	38	7,900	11,900	6,100	1,000	1,300

than the large one-piece members would be.

Interplane Strut Construction and Design

The construction of interplane struts is now fairly standardized in America to the one-piece streamlined figures, N-P and W, with a side contour similar to figures X-Y and Z. Laminated and built-up struts are being used in increasing quantities. (Figures R-S-T-V and W.)

Figure Z with section Z² and Z³ is considered the best for small planes. Dimensions will be found under section Z³ for the interplane struts to be used in seaplane under discussion.

Figure R shows a steel tubing used for interplane, landing gear and cabane struts. This strut is practically of equal strength about the neutral axis and for this reason is superior to the solid spindled strut, which always has a tendency to buckle laterally and is sometimes laterally stayed by wires, which is the method used by Caproni and in the old Farman airplanes.

Streamlined steel struts, Fig. V, are now being widely used. They are made up in many ways. Sheet steel bent to shape, welded or brazed is one method, or they may be drawn or rolled from the round section. Although used for interplane and landing gear struts, they are not so satisfactory for the latter, owing to their tendency to buckle under heavy landing shocks. Any strut of parallel section, regardless of the material used, is unsuited for shocks.

Some progress is now being made with the production of a seamless streamline tapered steel strut which will undoubtedly obviate this weakness and ultimately may become the standard.

Cabane or Saddle Struts

The cabane or saddle struts are usually of steel tubing, some are streamlined, Fig. A-A, with a section, Fig. R. However, in some cases where there is a separate center section panel like the Curtiss J. N. 4 training planes, four short spruce struts similar to the other interplane struts are used, extending from the top longeron to the upper panel. Two pieces of Shelby 1 in. 16 gauge steel tubing are required for this seaplane. Mark off 2 ft. 5¼ in. from both ends, heat to a cherry red, bend as shown, flattening a 1¼ in. surface for hoisting bolt, which will be found very convenient for emergencies and in handling the seaplane. The shaping and brazing of this fitting will be fully described later with other metal work.

The landing gear struts, Fig. Y, are the same for a seaplane or land machine, except in length and position. A chassis for the latter machine will be designed for the next issue. A word

of warning concerning the fitting and shaping of struts is pertinent. Unless one is very particular in the accuracy of this badly distorted or buckled struts will necessitate the renewal of the offenders. The writer recalls many disappointments in pioneer construction work from this cause, also some training planes during the past war had to be disassembled and the struts refitted in their sockets.

Wing sections, ribs and the complete details of panels for this airplane will follow in next issue.

THE FASTEST TRIPLANE YET BUILT

IN recent trials the Curtiss Model 18T triplane shown in accompanying cuts has almost equalled in normal horizontal flight speed tests the usual diving speed of an average airplane. As a result of exhaustive experiments in the wind tunnel, the designers have been enabled to develop a craft that is at once efficient and pleasing to the eye, because they made a careful study of

engine, a twelve cylinder V type rated to develop 400 horsepower at a speed of 2,500 revolutions per minute. The bore is 4½ inches, the stroke 6 inches and the weight, without oil or water, is given at 680 pounds. The engine uses 36 gallons of fuel per hour at full throttle and the machine carries fuel for about two hours' flight. The wing spread of all three planes is the same, about 32 feet; the chord is 3 feet, 6 inches. The gap between the wings is equal to the chord between the center and upper and about 3 feet between the center and lower aerofoils. The length of the machine is slightly more than 23 feet, the height overall is about 10 feet. The angle of incidence is 2½ degrees and there is no dihedral angle. The area of the unbroken upper wing is 112 sq. feet, that of the two lower wings is about 88 sq. feet each. The aileron area is approximately 22 sq. feet, that of the horizontal surfaces of the empennage about 28 sq. feet. The area of the rudder is 8.66 sq. feet, that of the vertical stabilizing fin 5 sq. feet, which gives a loading per sq. foot of sustaining

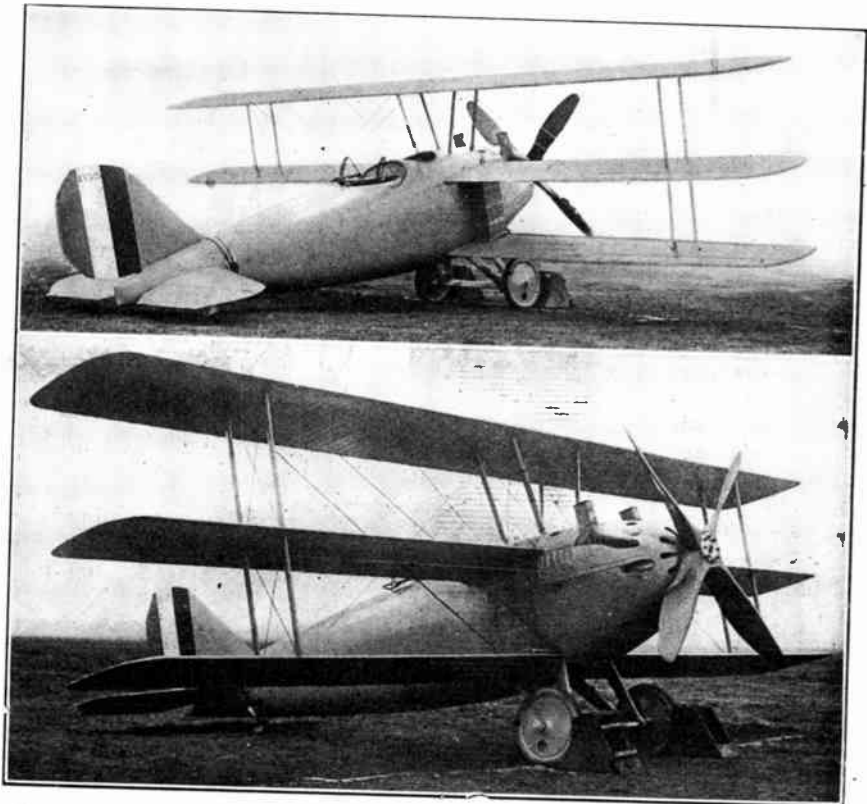

The Curtiss Model 18T, which tests have demonstrated to be the fastest biplane-triplane ever built

details that make for reduced resistance and incorporated symmetrical proportions that insure a stream line fuselage and minimum interruption of air flow. The fuselage is a monocoque type that presents an almost continuous contour, the empennage members join the rear end of the fuselage as though they belonged there and the engine cowling is curved so the front end has an almost ideal stream line shape.

The power plant is the Curtiss K 12

surface of a little over 9 pounds and a weight of 7.25 pounds per horsepower.

The net weight of the machine empty is 1,825 pounds, the useful load 1,076 pounds, which gives a gross weight of 2,900 pounds. The useful load is divided as follows: Pilot and passenger, 330 pounds; useful load, 301 pounds; oil, 45 pounds; the gasoline, 400 pounds. The craft has attained a speed for maximum horizontal flight of 163 miles per hour.

A Laboratory Reactance Coil

By Raymond Francis Yates

Made in the A. S. E. E. Laboratory

A CONTROLLING reactance coil has a wide variety of uses about the electrical student's laboratory and it is hoped that the description and design of the one appearing in the photograph will appeal to many of the readers of *EVERYDAY ENGINEERING*. In designing the device, the author had in mind not only the needs of the average electrical "lab" but also the limitations of the shop equipment on hand to produce such a device. The little coil shown can be used in connection with musical arc experiments, as a primary control for transformers, etc. The outlay for the materials necessary for its construction is in the neighborhood of \$3.00 and the complete device, if carefully made according to the directions outlined in this article, will have a well-finished and scientific appearance.

Work is first started on the core and this is composed of a bundle of soft Norway iron wire of No. 18 gauge. The bundle is $1\frac{1}{2}$ inches in diameter and 5 inches long. After the wires are rolled into a circular form, they are wound with ordinary friction tape. If the tape is wound on tightly it will be found that the iron core wires pack together very nicely and form a center for the winding which will not lose its shape with ordinary handling.

With this done, the core is mounted in the lathe to be wound. By referring to the cross sectional view of the reactance, it will be seen that the winding starts about $\frac{3}{8}$ in. from each end. The author utilized this $\frac{3}{8}$ in. at each end to mount the core in the lathe. A strip of $\frac{3}{8}$ in. sheet brass was wound around one end of the core and this end was then placed in the lathe chuck and the chuck tightened. The brass sheet prevented the jaws of the chuck from destroying the circular shape of the core. A wooden socket with a hole $\frac{3}{8}$ in. deep and the same diameter as the core, was made for the opposite end. A

small hole was placed through the center of the socket into which the back center of the lathe was placed. When arranged in this way the core is ready to wind.

About 2 lbs. of No. 10 wire was

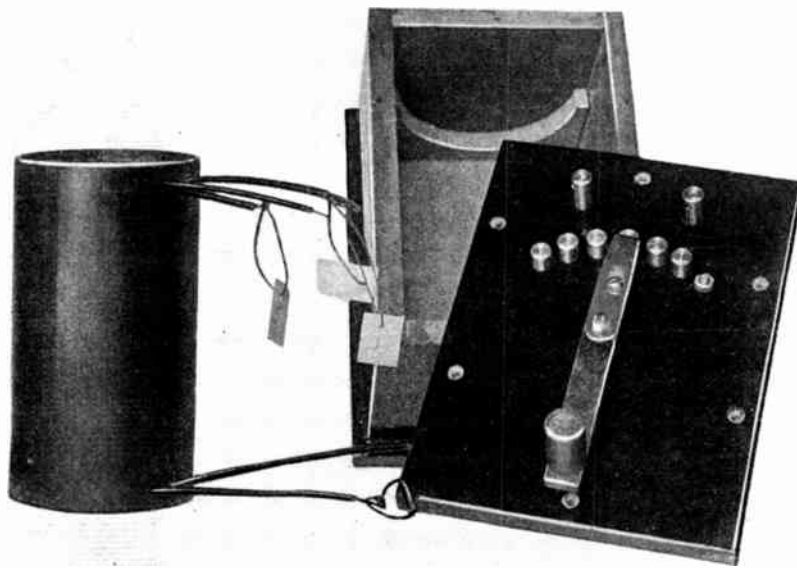
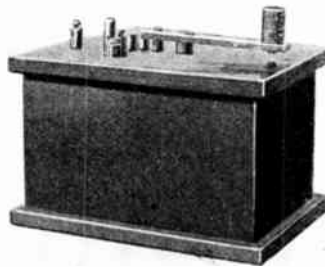

Above: The reactance coil assembled and ready for use. Below: The coil and the box it is mounted in

placed over the core. The drawing shows how the winding is started. A piece of friction tape is looped around the wire and laid lengthwise to the core. When several turns of the wire have been wound on the friction tape is held securely under it and prevents the first turning from leaving its position. Five taps are taken off the winding, one for each layer of the winding. When the winding is finished, the complete coil is placed in a fibre tube. Holes are drilled in this tube so that the taps may be brought through in order to make the necessary connections to the contact points on the top of the case in

which the coil is mounted. After the wires are brought through, they should be covered with Empire cloth tubing and it is well to remind the reader that each tap should be numbered by means of a little tag so that the proper connection can be made when the device is finished. After the winding is in place in the tube, the tube is set upon a board, end up and hot wax is poured in. The opposite end of the tube is then treated in the same way.

This completes the reactance and the proper mounting for the coil can be made next. Any close-grained wood that will take a high polish is suitable to make the mounting. The inside dimensions of the box are 4 x 6 in. and the top and bottom overlap $\frac{1}{2}$ inch. The box is held together with brass screws. The top piece is drilled with

holes to accommodate seven contacts, two binding posts and the stud which holds the contact arm in place. Before the device is assembled, the box is thoroughly sanded and given a coat of wood filler. When this is dry, it is taken off and the box given an initial coat of varnish. The author used a cherry varnish on the box of the coil described, but taste of experimenters vary. It will be found that a cherry color goes very well with the polished metal parts which are of brass.

When the first coat of varnish is dry, it is prepared down and the final coat applied, which should leave a piano-like finish.

While the varnish is drying, the workman can produce the contact points, binding posts and contact arm. The contact arm is made of bakelite with a brass strip which runs from the stud to the contact end. To prevent the brass strip from bending, a screw is placed in it as shown in the drawing. The contact points can either be made or purchased. It is a simple matter to place a piece of $\frac{3}{8}$ in. stock in the lathe and to turn off seven pieces $\frac{3}{8}$ in. long with a parting tool. The pieces are

then mounted in the chuck one by one and drilled out with a No. 28 drill, after which they are tapped to receive an 8-32 machine screw. The sides of the contacts are then polished and covered with lacquer. Lacquer should not be placed on top of the contacts as this will interfere with a good electrical connection. The brass strip on the contact handle is also polished and lacquered. The experimenter can either make or purchase his binding posts, but it is a very easy matter to produce them on the lathe with the same piece of stock from which the contact points were cut. With the exception of two wooden pieces cut out to conform with half of the outside diameter of the fibre tube, the apparatus is ready to assemble.

The pieces referred to can be seen in the large photograph of the case with the top removed. These pieces are cut out with a circular or jig saw and glued into position. When the core is placed on these supports, it will hold this position. The connections are then completed to the con-

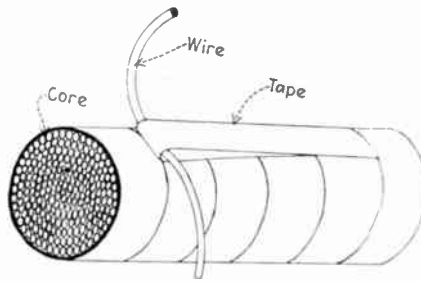

How the winding is started

tacts, binding posts and contact arm in the customary manner. When the lid is placed on and screwed on the device is ready for use. If the experimenter wishes to, he can drill a couple of holes in the end of the box to ventilate the device and to prevent it

from overheating when in actual use.

Owing to the fact that the winding for this coil was put in for a special use, it is well to remind those who are interested in the construction of a similar device that the winding should be designed to meet the particular purpose for which the coil is to be used.

If a wider variation in current is wished, the number of taps should be increased. If the coil is wound with smaller wire (say 14 or 16) a very nice regulation of current for ordinary purposes can be obtained with about fifteen contacts. Owing to the width of the box, it would be necessary to arrange the contacts differently than they are arranged on the box shown in the photograph. In this case, it would

probably be best to arrange the contact points lengthwise with the contact handle or lever projecting over the side.

A coil of the type described will pass at least twenty-five amperes for a considerable length of time without seriously overheating when most of the winding is in the circuit. This makes it adaptable for most uses.

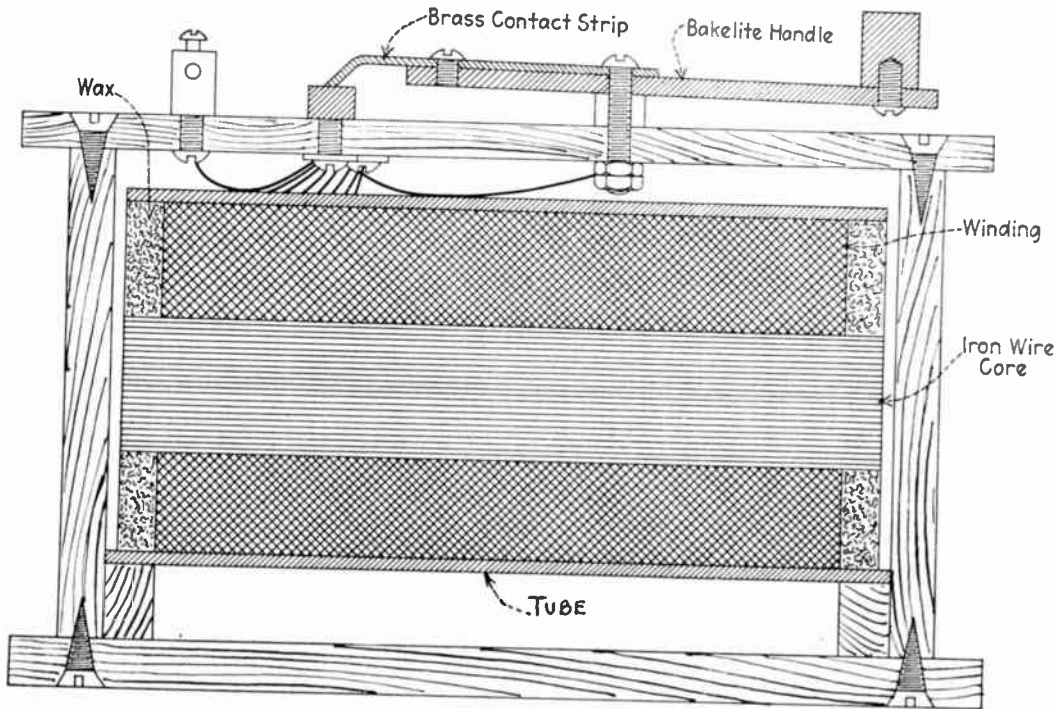

A cross-section of the assembled coil and mounting

Fastening Model Rails to the Ties

MANY model railroad builders experience considerable trouble in devising a means of fastening the rails

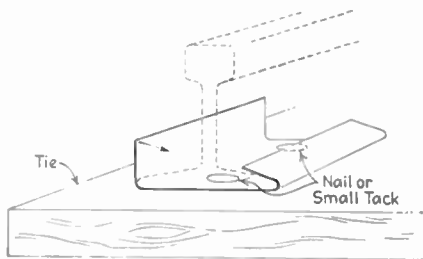

Showing the method of fastening rails to the ties

to the ties. The system illustrated in the sketch is a very effective way to overcome this difficulty and its simplicity will appeal to those who do not care to go to considerable expense and

trouble in originating a more complicated method.

The tin pieces are first tacked to the ties crosswise at the desired spacing with small upholstery tacks or tiny flat head nails similar to those used in cigar boxes. Two tacks are put on each piece. The track is then inserted and the tin bent over and tapped with a light hammer until it is tight. It is best to finish the job with a touch of solder at one end at least. This will prevent the track from loosening through vibration.

The tin fasteners used can be purchased in the open market or they can be easily made from sheet metal. The thinnest tin plate, copper or brass is entirely satisfactory and all that need be done is to cut out the proper size squares, tack them to the railroad ties, set the track in the proper position and bend the surplus metal over the track.

Turning Iron Castings

IRON castings, when received from the foundry, are often encrusted with a thin skin of extremely hard iron. This is caused by the hot surface of the iron absorbing of a small amount of carbon from its surroundings. This crust is so hard that it resists the cutting action of the lathe tool. Once the tool gets under the skin, it will cut properly. The lathe tool can be assisted in getting under the skin by first filing a small spot on the casting. A more effective method is that of putting the castings in a pickle of 3 parts of water and 1 part sulphuric acid. This softens the skin to a workable condition. The length of time that the castings remain in the pickle will depend upon the thickness of the crust. Usually one-half hour is sufficient.

If the castings are left in the pickle too long, the acid will corrode the entire surface.



RADIO

TELEPHONE AND TELEGRAPH APPARATUS



Apparatus for the Radio Laboratory

A Wavemeter that Meets the Requirements of the Radio Experimenters

By M. B. Sleeper

THE first essential to radio experimental work is a wavemeter. This instrument is rather expensive for the average experimenter to buy complete, but one of the type described in this article goes a long way in putting the wavemeter within reach of radio men, or at least the radio clubs.

Figs. 1, 2 and 3 show the constructional details of the instrument. Because a carrying case was already available, a standard 5 x 10 in. panel was cut to a length of 7 ins. If the full length had been retained, however, there would have been room enough to mount a small hot-wire ammeter of the Clapp-Eastham type.

by 2-56 brass screws. Opposite the single set-screw already in the handle, a hole is made with an 8-32 thread to take the brass rod of the auxiliary adjustment. The outer end of the rod is slotted, so that it can be put firmly into the handle as a second set screw.

In place of a pointer, a piece of thin celluloid is used, supported by a long

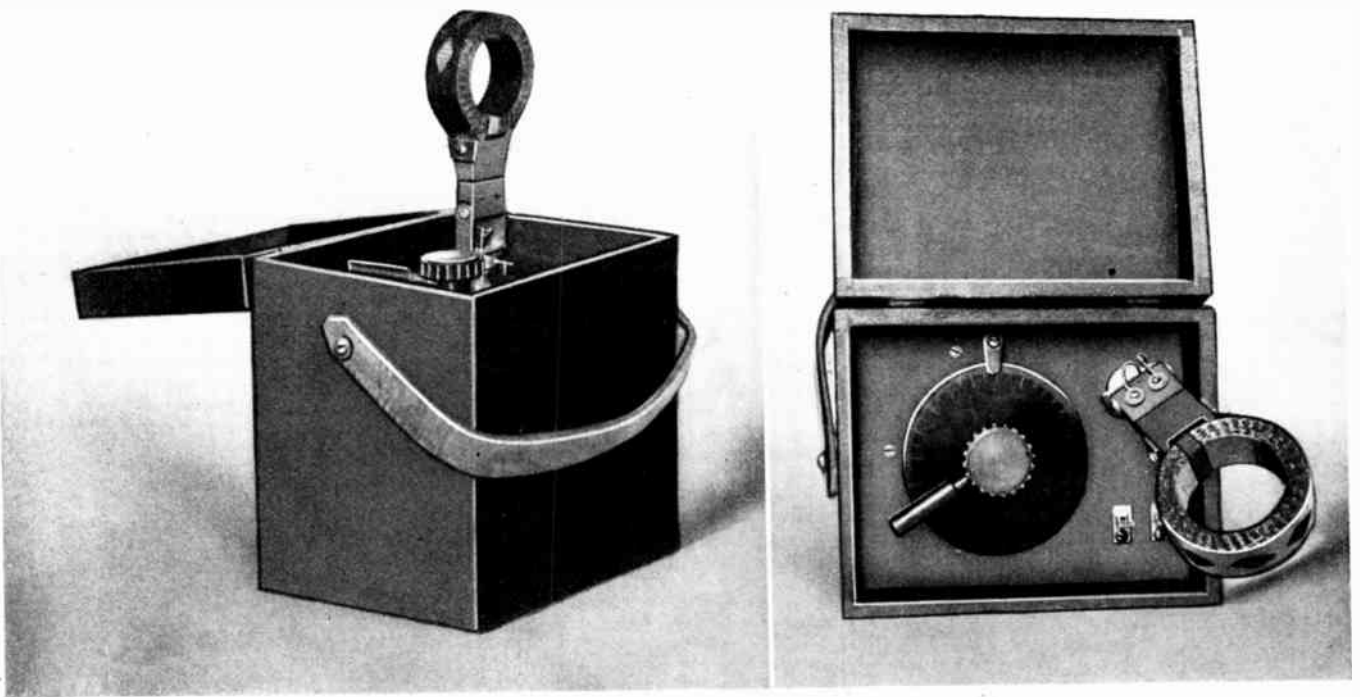

Fig. 1. The completed meter, mounted in the carrying case, ready for use

One of the greatest difficulties about a wavemeter is having it calibrated. Since standard coils are used in this instrument, and a calibration curve for the condenser is given, wavelengths can be determined approximately from the curves given in the August, 1919, issue for the de Forest coils. The condenser is type CV-1000, also built by the de Forest company. While individual condensers of this sort may vary slightly, the calibration curve given here is accurate enough for practical purposes. The error is smaller at long wavelengths than at short ones.

The construction of the condenser lends itself readily to mounting under the panel. A brass disc 4½ ins. in diameter is cut out and drilled so that it can be placed between the top of the condenser and the panel. A ½ in. hole is allowed around the shaft. In assembling, a washer is placed on each mounting screw to separate the shield from the panel, to increase the leakage path to the shaft.

The indicating dial is made from a 4 in. bakelite disc, engraved or scratched with 100 divisions. This dial is clamped to the under side of the knob

washer and machine screw. A scratch on the under side of the celluloid gives an accurate indication against the scale.

Next comes the coil mounting. Flexibility requires that the coil shall turn in all planes. An examination of the illustrations will show that the coil plug is pivoted on a U-shaped piece, set on a hollow shaft. This shaft has three diameters, the top part 3/32 in. long and 5/16 in. in diameter, the center section ⅓ in. long by 1 in. in diameter, and the bottom part ⅜ in. long and 5/16 in. in diameter. Through the center is a 3/16 in. hole.

The top portion of the shaft is pined over around a 5/16 in. hole in the coil supporting yoke. Then the other end is put through a hole in the panel. The large section of the shaft, bearing upon the panel, causes the mounting to turn smoothly. Under the panel is a clamping piece 1 in. in diameter, with a 3/8 in. shoulder carrying two set-screws. This is put over the part of the shaft

ranged so that the coil can turn only 90°. This is a sufficient movement, and prevents twisting of the lead wires. Two brass strips, Fig. 3, provide connections to the fixed and moving plates.

As the wiring diagrams show, two binding posts, or in this case Fahnestock clips, are required for the connections of auxiliary apparatus. Wiring of the posts is illustrated in Fig. 3.

Milhenries	λ Min.	λ Max.
0.04	100	400
0.15	250	750
0.60	450	1,550
2.3	900	3,000
11.0	2,000	6,600
40.0	4,000	12,500
175.0	8,000	24,500

Thus, if required, a range of 100 to 24,500 meters can be covered.

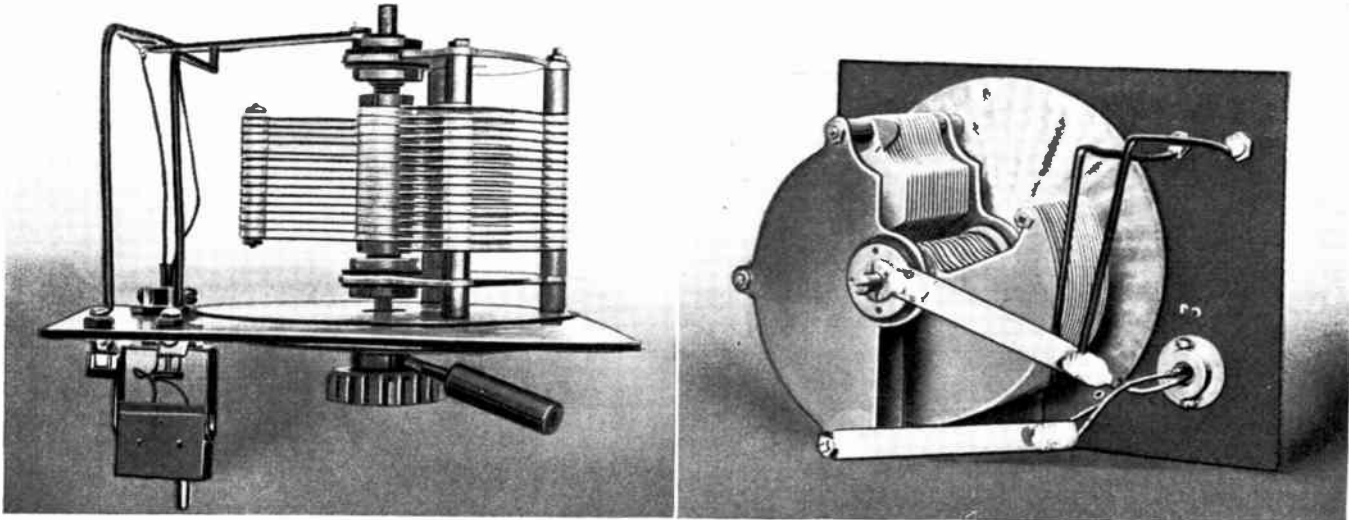

Fig. 3. Details of the condenser mounting and connections with the coil. The condenser shield is separated from the panel by washers to increase the leakage path

which extends from under the panel. By this method the mounting is held firmly in place.

Parts for the plug can be taken from a standard mounting. When the plug

The calibration curve, Fig. 4, shows the capacity of this condenser at the different settings. If the standard honeycomb coils are used, the wavelengths can be determined approxi-

In Fig. 5, several different connections are given for various uses of the wavemeter. A shows the wiring within the instrument itself. Actually, the meter is only an adjustable oscillating

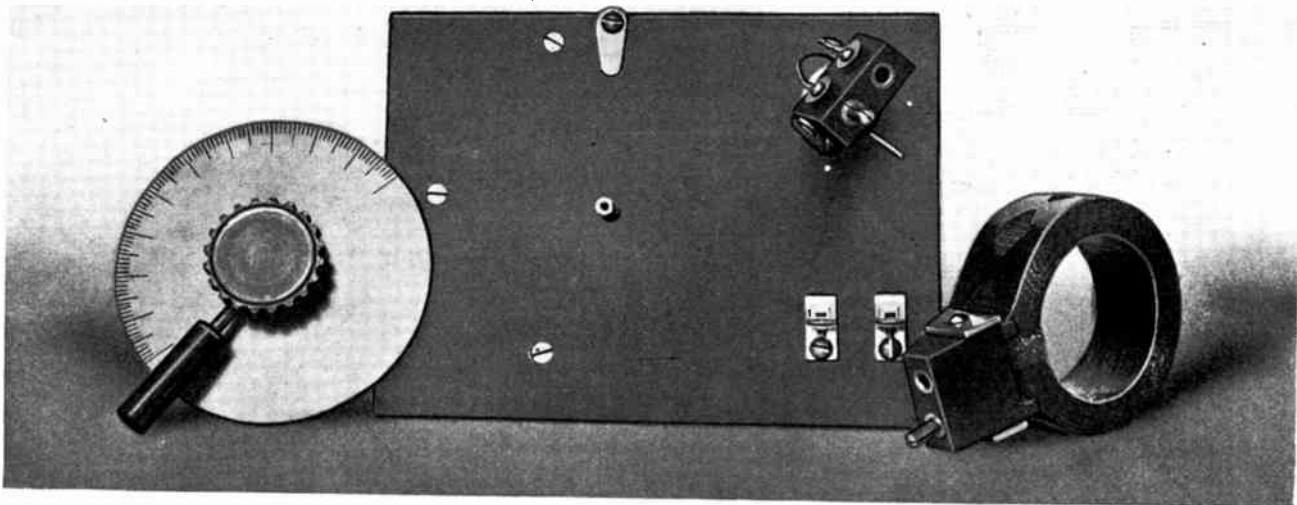

Fig. 2. Showing the mounting for the honeycomb coil and the indicating dial with its auxiliary handle

shaft has been put into the holes in the yoke, the ends are headed over to keep it tightly in place. Thus a sufficient tension can be maintained on the plug to prevent the weight of the coil from moving it.

Connections to the condenser are made by flexible cord put through the center hole in the mounting shaft. Fig. 2 shows an arm and stopping pins ar-

mately from curves given in the August, 1919, issue. For accurate calibration, however, comparison with a known wavemeter is required. Radio inspectors are usually willing to help in this work.

With the capacity of this condenser, wavelength ranges with sufficient overlaps can be obtained from the following coils:

circuit containing an inductance and capacity.

If a hot wire ammeter is inserted in the circuit, and the coil is coupled to a source of oscillations, such as a transmitter, a maximum current, as indicated by the meter, will flow when the two circuits are of the same wavelength. Such an indication can be obtained also by means of telephones and a detector, wired according to B, Fig. 5. Loudest

signals will be heard when the wavemeter has been adjusted to resonance with the transmitter.

To calibrate a receiving circuit, the

coil in the receiver, a current will be set up, at the resonance point, which can be heard in the telephones of the receiving circuit.

signals is indicated at the point of silence, on each side of which signals can be heard.

In place of the circuit just men-

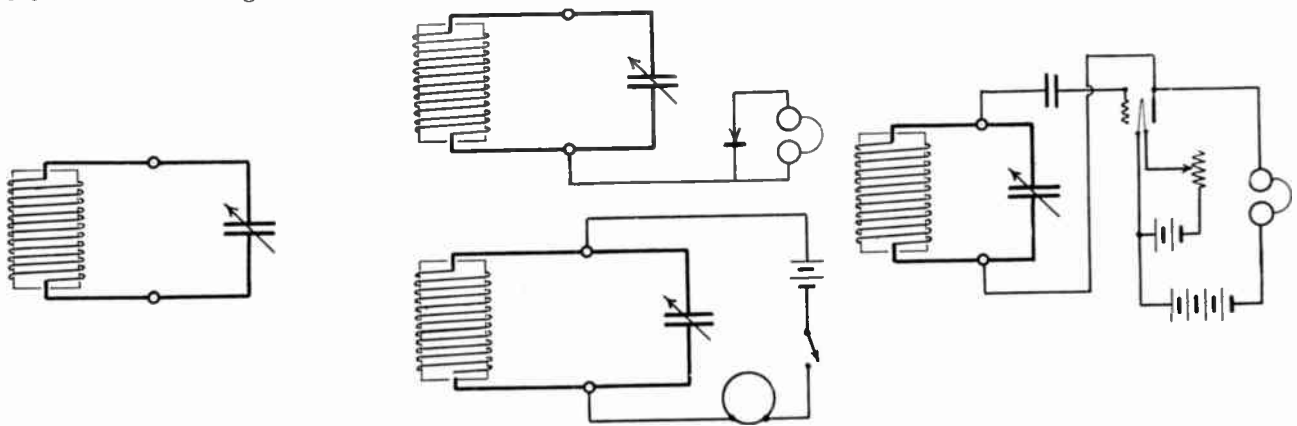

Fig. 5. Left, circuit of the wavemeter, A. Top center, method of receiving signals for transmitter calibration, B. Bottom, center, sending signals of known wavelength, C. Right, an oscillating circuit for undamped wave work, D

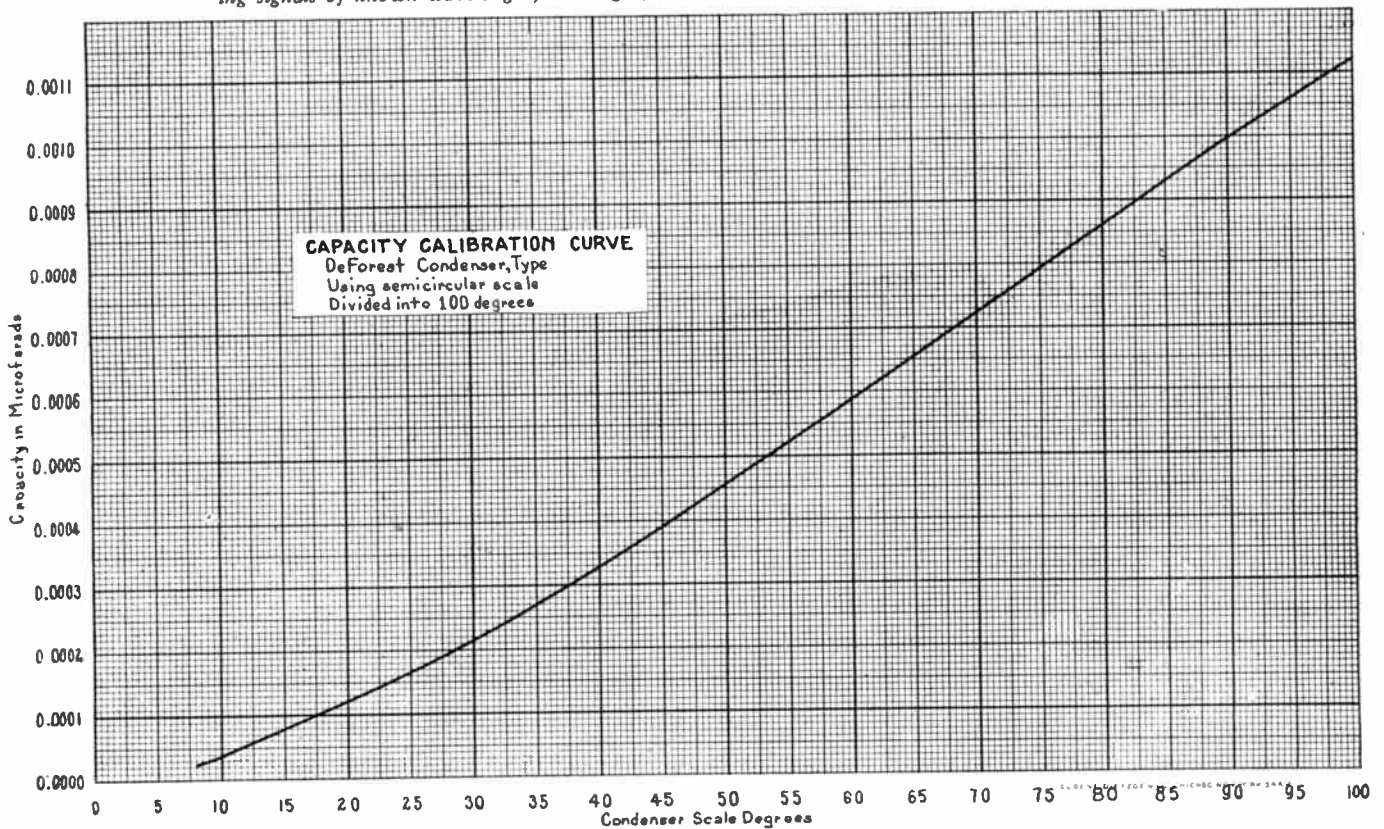

Fig. 4. Calibration curve of the condenser used in this wavemeter

wavemeter must be arranged to send out waves of a frequency depending upon the capacity and inductance used. Therefore, a buzzer, battery and switch are connected in series between the two posts provided, as at C, Fig. 5. By coupling the wavemeter coil to a

This instrument, connected as at D, Fig. 5, will generate undamped oscillation of any frequency. For undamped wave reception, the wavemeter can be coupled to the secondary of the loose coupler, and beats set up with the incoming signals. The wavelength of the

tioned, a circuit driver, described on page 366 of this issue, can be used. This will give more powerful oscillations than the circuit at D.

Other uses for the wavemeter will be discussed in the coming issues of EVERYDAY ENGINEERING.

Look Back as Well as Forward

YOU are probably interested in knowing what we shall have in the Radio Department during the coming months, but how about the back numbers you missed? The articles listed below are filled with real meat—just the clear illustrations, detailed circuits, curves and data you need.

January, 1919—Condensers for the radio laboratory, Scale for calculating wavelength.

February, 1919—Inductances for the radio laboratory, with tables, formulas, and scales, Inductance of leads.

March, 1919—Notes on radio antennas, Mutual Inductance and Coupling, Method of connecting a tickler, Instrument scale engraver.

April, 1919—Thermocouples, Multipurpose wavemeter, 200-meter receiver, Problems of vacuum tube circuits.

May, 1919—Two-slide tuner, Oscillator for the radio laboratory, Sealed

detectors, Problems of vacuum tube circuits.

June, 1919—Crystal detector, Erection of a radio station, The MM direction finder, A vernier condenser, Airplane radio telephone equipment, Problems of vacuum tube circuits.

July, 1919—Equipment for the radio laboratory, Measurement of antenna capacity, A 200-watt airplane transmitter, Problems of vacuum tube circuits, Simple method of obtaining negative grid potential.

A High Efficiency 1 K. W. Transmitter

By Consistent Refinements in Electrical and Mechanical Design, the International Radio Telegraph Company has Produced this Remarkable Set.

THE greatest successes are not always found in unusual things, but more often in usual things done unusually well. This is true of the standard Navy design transmitter described in this article, for its surprising efficiency is not due to any radical features as much as to the fact that each individual part, and the relations

ous wavelengths can be obtained by an adjustment of the controls, wavelengths of 300, 378, 476, 600, 756 and 952 meters, standard Navy wavelengths, are used ordinarily with antenna capacities from 0.0007 to 0.0012 mfd. These wavelengths are given instantly by moving the wave change switch to any one of the desired positions.

ance from the more common designs. The rack and gaps will be seen in the front view. Above is the wave change switch and coupling adjustment at the right. At the top are the volt- and ammeters, wattmeter, and radiation ammeter. Control handles, for the close adjustment of each wavelength, protrude from between the meters. Be-

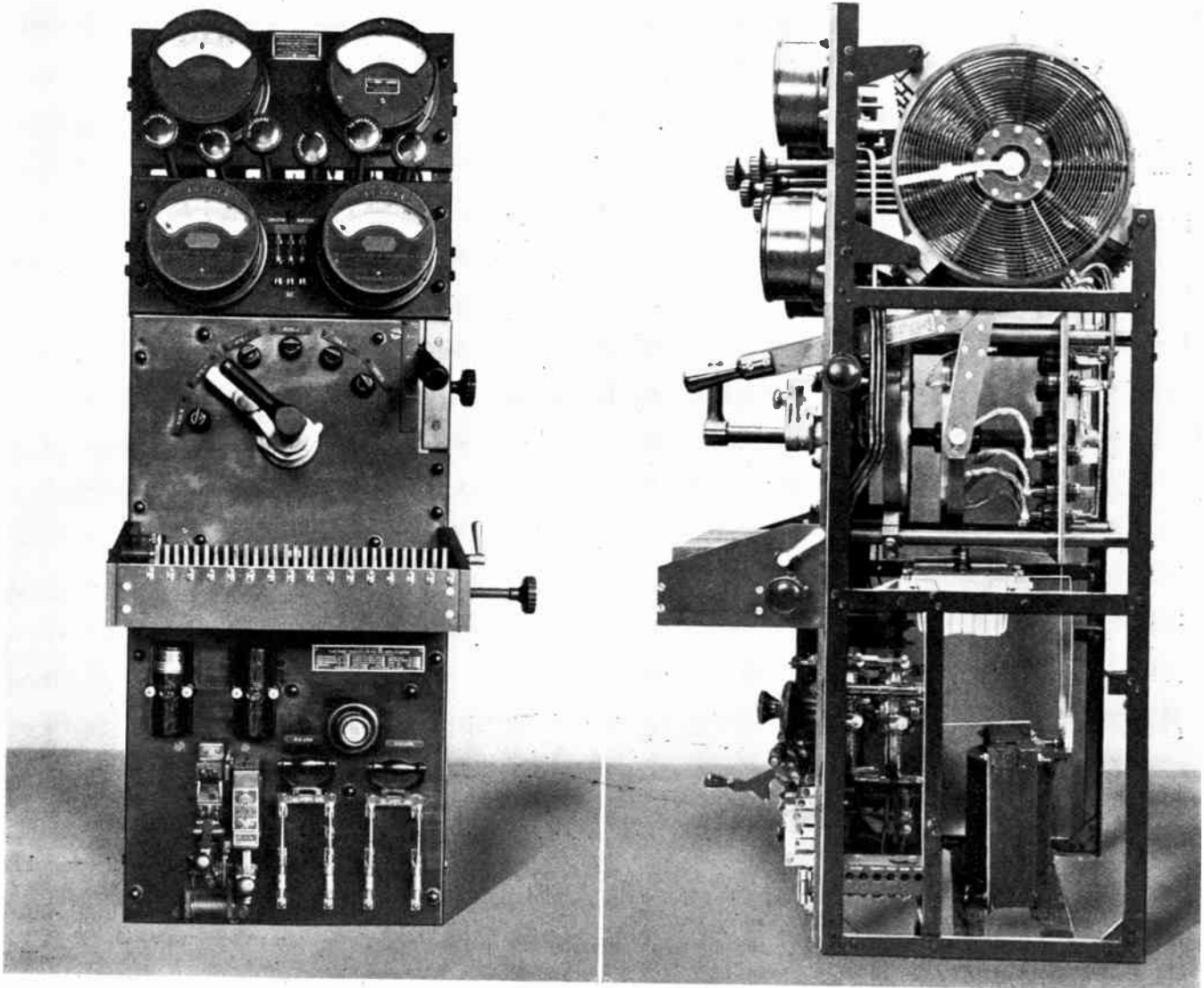

A creditable example of American radio engineering is this 500-cycle transmitter

of these parts to the whole, have been worked out with extraordinary care, both as to electrical and mechanical design.

This transmitter is of the quenched gap type, operating on 500 cycles. It is intended for ship or shore work, though it has been used chiefly by the United States Navy where space allowed a generator mounting separate from the radio panel. Although vari-

The motor-generator is supplied with 120 volts D. C., giving 1.7 horsepower at 2,000 revolutions per minute. At this speed, the inductor type alternator generates 10 amperes at 125 volts, under full load, which, with a power factor of 80%, is 1 kilowatt. Controls for the motor and generator are mounted on the lower part of the panel.

A new type of quenched gap mounting is used, quite different in appear-

hind the panel are the transformer, mica condensers, primary and secondary coils of the oscillation transformer, and the antenna loading coils.

A simplified circuit is given here which shows the use of the various parts of this set. Three telegraph keys are provided for breaking the A. C. current. One is a hand key, another is a relay key, and a third a telegraph key operating the relay on 120 volts

D. C. Included in the power circuit is the primary of the transformer and a 2-step impedance for cutting down the power. As will be explained later, the impedance switch and spark gap selector are operated simultaneously.

The secondary of the transformer is wound with a ratio of 38 to 1 to the primary turns. In the rear view a three-ball protective spark gap is shown, with two sides connected to the winding, and the center to the ground.

on the front of the left-hand chest. A fixture and wrench for taking the gaps apart or putting them together can be seen at the right of the separate unit.

Clips are provided in the spark gap rack to make connections with the units as they are pressed down in place, or to short circuit the space when the gaps are removed. At the left of the rack are two handles which control the number of gaps in use. The one with the crank carries three contacts to give the

the primary of the oscillation transformer are set into the main panel. The pancake coil can be seen in the side view, close behind the panel. Taps on this coil are taken off by flexible leads and adjustable clips.

The antenna circuit is made up of a radiation meter, loading coils, and coupling coil. When the wavelength switch is rotated, it varies the inductance of the coupling coil and loading coils, as well as of the oscillating cir-

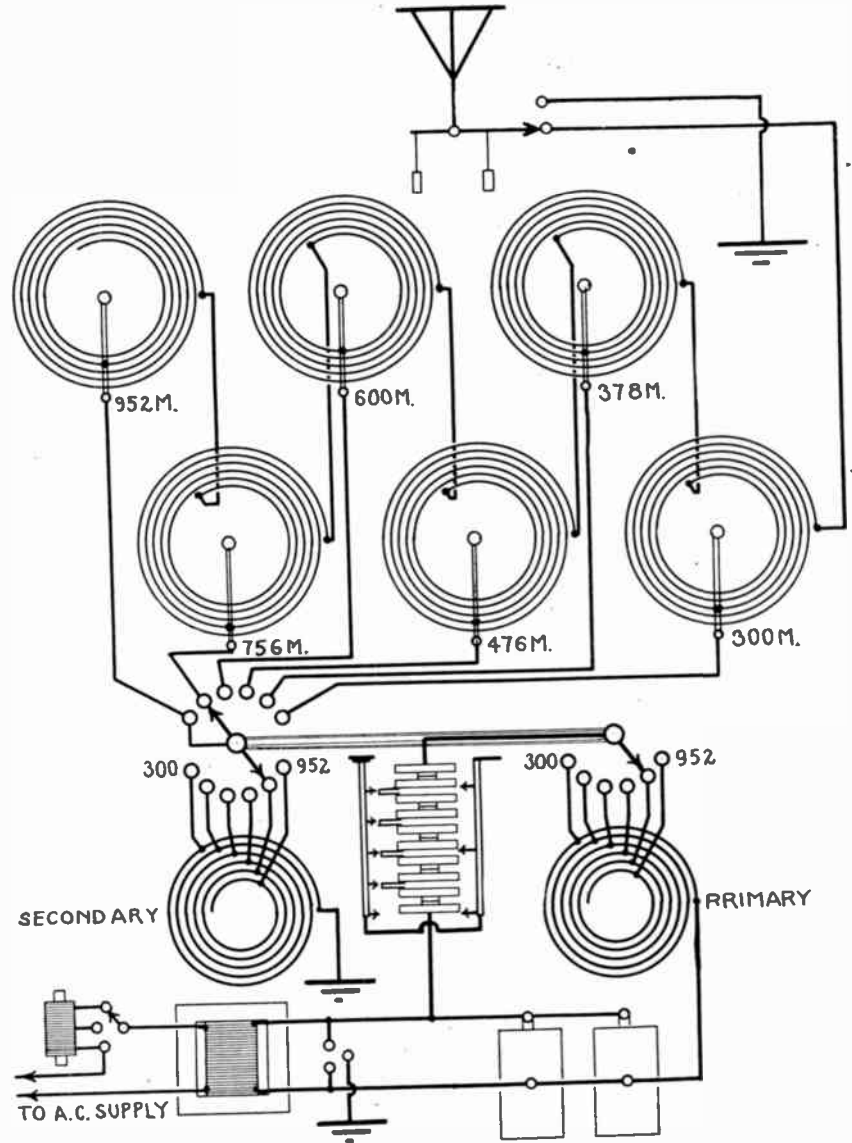
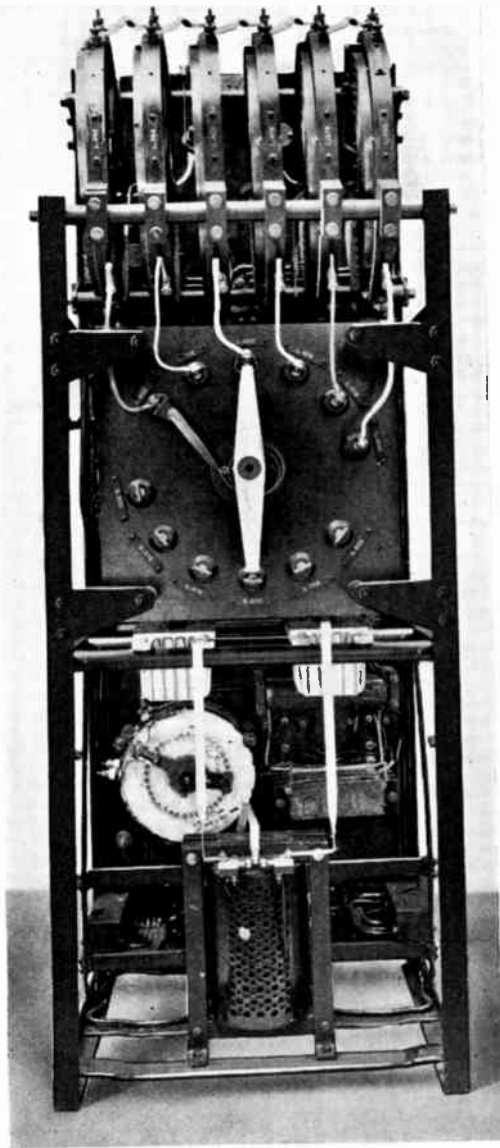

The rear view illustrates the loading coils and wave changer shown in the simplified circuit diagram. All unused inductances are short circuited to prevent the absorption of energy

Heavy copper strips lead to two Dubilier mica condensers, and on to the spark gap and oscillation transformer.

The quenched spark gap units are made up of two silver surfaces set in brass discs. Mounted on each disc is a copper frame giving it the box-like appearance shown in the photographs. So great is the heat-radiating surface that no air blast is needed for cooling. Two brass discs are clamped together by an insulated screw at the center, so that an airtight sparking chamber is formed. A complete unit is shown in the illustration of the spare parts, lying

main adjustment; the one with the knob has six contacts for fine adjustments. Connections can be traced from the first gap at the left to the three-contact shaft, across to the six-contact shaft, and out at the right-hand gap. A crank, fitted to the main adjustment shaft, just inside the rack at the left, moves the primary impedance switch. Thus, as the power is cut down by reducing the number of gaps, the correct impedance is simultaneously inserted in the generator-transformer circuit.

Contacts to vary the inductance of

the coupling coil or secondary of the oscillation transformer can be moved back and forth by means of the handle at the left of the panel. A scale is provided to show the separation between primary and secondary in inches. The wiring diagram shows the use of the switches on the shaft of the wave-changer.

Each loading coil has an individual adjustment, accomplished by the rotation of one of the handles, through a bevelled gear and contact sliding on an arm secured to the gear. With this arrangement the antenna circuit can be

tuned to each wave, according to the position of the wave-change switch at the front of the set. By tracing the connection from the center of the secondary switch, it will be found that the unused portions of the loading inductances are short circuited.

In the illustration of the spare parts, the antenna switch and lighting switch are shown. The antenna switch is so arranged that, in the down position of the arm, the antenna side of the receiving set is connected to the ground, the transmitter is connected to the antenna by means of the bridge at the top of the insulating post, and the A. C. generator

circuits have been worked out to operate at resonance, giving the greatest possible efficiency.

On an antenna of 8 ohms, the radiation is 8 amperes or over. Since the output in watts is

$$W = I^2 R$$

where W = power in watts,

I = current in amperes,

and R = radiation resistance in ohms,

under these conditions:

$$W = 8^2 \times 8,$$

$$W = 64 \times 8,$$

or watts in antenna = 512.

If the generator is putting out 1,000

A Switch for Radio Equipment

WHERE a number of different kinds of connections are required, the switch illustrated will very readily meet the requirements. The main shaft, supported by a heavy bearing at the front, carries several contacts, insulated from each other with bakelite. A nut on the end of the shaft keeps the parts in place.

Stationary contacts, with clips for soldering, are mounted at the side, held in place by screws put into the bottom of the base. As the handle is rotated, the parts of the movable contacts which are bent over touch the upright pieces, and establish a connection.

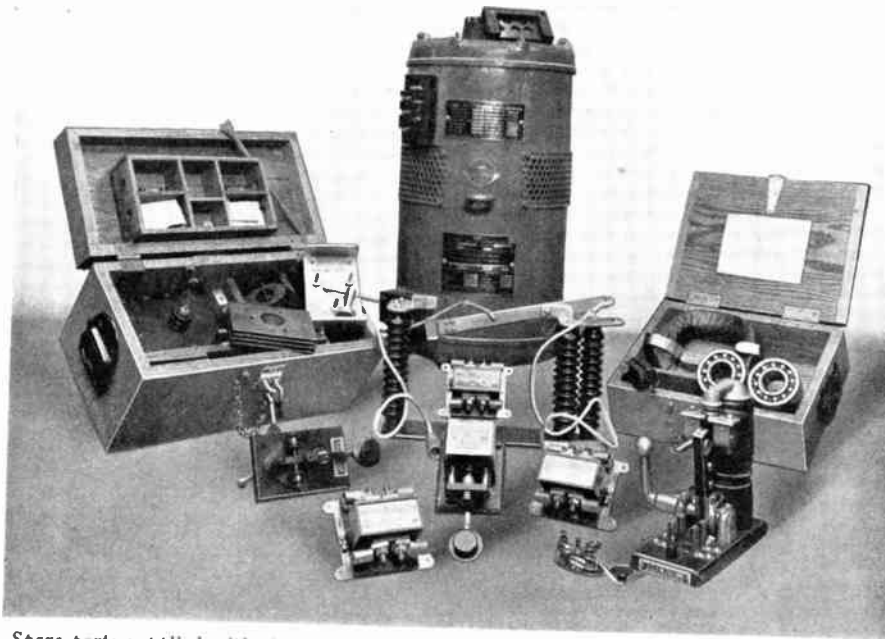

Spare parts supplied with the transmitter. The lighting switch, operated by pendant handles, is designed to be fastened overhead.

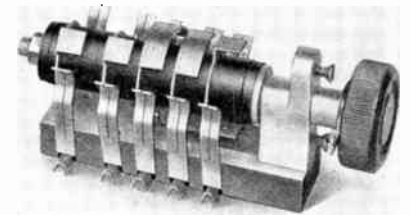

Different connections can be obtained by adjusting the positions of the movable contacts, and by making them longer or shorter.

Radio Engineers and Radio Experimenters

THE only list of radio men is the old call book. There is no authoritative list of radio men in this country. All kinds of opportunities are coming up in radio work, not only in the United States but in foreign countries as well. Men to fill these positions cannot be located readily, but they will be found through the Radio Register. Is your name among the others?

There are obvious uses of such a listing. The data required is:

Name.

Address.

Engineer or Experimenter.

Age.

Experience.

Special qualifications.

Radio station owned, if any.

If you delay to send in this information, you will forget. Besides your own name, send the names of others if possible. It will be an advantage to you yourself to be listed in the Register, and of assistance to others who wish to locate radio men in various parts of the country.

There is no charge. It only requires a minute's time and a postcard addressed to the Radio Department, EVERYDAY ENGINEERING. Make the Radio Register complete.

circuit is closed by the contacts on the base.

The lightning switch is designed to be mounted overhead, so that, by pulling the handles, the antenna can be grounded or connected to the radio apparatus.

One of the features which contribute to the efficiency of this set is the absence of metal in the fields of the tuning inductances. All the mounting rods and supports, even to the clamping screws, are of bakelite. Heavy bakelite insulation is used throughout the set. The two factors just mentioned increase the efficiency because they decrease the eddy current and leakage losses. Short connections are made possible by the compact arrangement, yet losses which sometimes occur when instruments are crowded have been carefully guarded against. Large conductors of strip or tubing join the various parts of the high frequency circuits. All power wiring is made by lead-sheathed wire, with the sheathing grounded. Moreover, the electrical design of the generator and oscillating

watts, the per cent efficiency will be:

$$\% \text{ Efficiency} = \frac{W \text{ output}}{W \text{ input}} \times 100$$

Then, for this set,

$$\% \text{ Efficiency} = \frac{512}{1,000} \times 100$$

or 51.2%

At the shorter wavelengths, the efficiency is higher, reaching, under good conditions, as much as 80%. The reason for the decrease in efficiency at long wavelengths is due to the additional losses introduced by the much larger amount of loading inductance necessary to tune small antennas to the lower frequencies.

NOTICE

ON page 237 of the July, 1919, issue a diagram was given to explain a method for obtaining a negative grid potential. Experimenters who studied this diagram must realize that, because a grid condenser is used, the direct current potential will not reach the grid unless a high resistance leak is connected around the condenser. This should be of 0.5 or 1.0 megohm.

The Radio Department

THE prospect of settling down again, after the eventful period of the last three years, may not have appealed to the radio men, though, as it has turned out, things happen in the wireless world with such rapidity that interest never flags. When we have a moment to wonder "What next?" something happens before we can conjecture as to the next event.

One thing of great significance to experimenters is the outcome of the VT type audion question. The arrangements for the sale of audions on standard bases, as used by the Government, as finally concluded, permit experimenters to buy from the Marconi Company the tube which was formerly sold by the Moorehead Company. This disposition has been reached through an agreement between the Marconi and De Forest companies.

The tube has a small, vertical, cylindrical plate, and a spiral grid through which the filament passes. A filament current of 0.7 ampere is required with a battery of 4 to 6 volts, giving a life of approximately 1,500 hours. Used as a detector, the tube will operate on a 22.5 B battery, or, as an amplifier, 45 volts. A higher plate potential, preferably furnished from a generator, can be employed for undamped wave telegraphy or telephony.

MANY experimenters, as well as some men who learned radio operating in the Army and Navy schools, have left the Service to go on ship and shore stations as operators. There is a greater demand than supply for men to go on privately owned ship stations and on vessels in the Merchant Marine. Incidentally, the salaries paid are far higher than before the war.

A request addressed to the Radio Department will bring information as to the offices where operators can apply for positions, or schools which fit experimenters to qualify for licenses.

JUDGE MAYER, in a recent decision at New York, gave a surprise not only to radio men but to inventors in general when he found that the original Fleming Valve detector patents give their owners the right to the use of oscillator as well. Aside from the immediate aspects of this case, such a decision seems to infer that an inventor who makes use of a scientific discovery of another man has the rights to any device brought out by other inventors, as long as these later inventions make use of the original discovery. In other words, Fleming used the Edison Effect as the foundation of his detector of radio signals. Several years later, the Oscillation, an entirely different instrument from the Fleming rectifier, was perfected by De Forest for use as

a generator of undamped oscillations.

Can anyone see a similarity between a detector and generator? Yet because Fleming used the Edison Effect as a detector he has been given the right to the use of this Effect as a generator, though he did not know that any type of vacuum tube would generate electrical oscillations, nor did he make patent claims for such an action. Moreover, the Fleming Valve will operate only as a rectifier or detector.

CONFIRMATION has been made of an 1,800-mile transmitting record from an aeroplane, made by a one-half kilowatt International Radio transmitter during the American transatlantic flight. In spite of claims of the foreign press, this is the longest distance officially transmitted from an aeroplane to the earth. It is only one of the many American radio laurels, but we are as proud of it as of the others, and do not like to have the record discredited.

THIS month marks another step in the effort of EVERYDAY ENGINEERING to give its readers the most and the best in the Radio Department, the best published. We have not stopped yet, and we are still calling for ideas and suggestions from the readers. We hope we are pleasing most everyone, but there must be some who do not find what they want, or find what they do not want. And we'd be pleased, too, to have you tell us if the Radio Department pleases you as it is.

You only need a few moments' time and it costs a cent less now to send a letter. No matter what you have to say, we want to hear from you.

By the way, have you sent in your name as Engineer or Experimenter to the Radio Registry? Don't let it slip by.

THE first half of one of the most interesting radio articles ever published, from the points of view of both experimenter and engineer, will appear in the October issue. It is a complete description and discussion of the radio compass used by the Navy Department, both the bilateral and unilateral types. Photographs, circuits, and details of the apparatus will be given, with a clear and understandable explanation of the manner in which it works. The publication of this material has been made possible by permission of the Navy Department, Bureau of Steam Engineering, through the courtesy of Commander H. C. Hooper.

In the coming numbers of EVERYDAY there will be new articles on the construction of transmitting equipment which you will find full of new ideas. Did you ever hear of talking and receiving by wireless telephone at the

same time and on one antenna? This is only one of the new things, and in itself worth more than the cost of a year's subscription. You don't need to worry over finding out what is new in radio. If it is worth while and practical, you will see it in EVERYDAY ENGINEERING.

A Substantial Loose Coupler

THERE is very little to be done along the lines of improving the plain oscillation transformer or loose coupler except in the refinement of design. This type of coupler, made up of tapped primary and secondary coils wound on cylindrical tubes, will still be popular for a long time to come, particularly for receiving up to 2,500 meters.

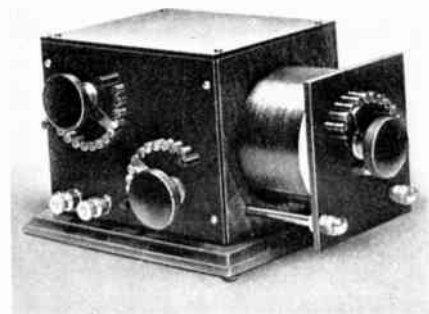

Some of the pre-war models sold for experimental work evidenced the necessity for better design and manufacture of this comparatively simple instrument. The Radio Equipment Company of Boston has produced a well built loose coupler, shown in the illustration here. Although quite reasonable in price these instruments are well finished and operate smoothly as to the switches and coupling adjustment. With a 0.0005 mfd. antenna and a 0.001 mfd. secondary tuning condenser, the wavelength range is approximately 200 to 2,500 meters.

This is the sort of apparatus experimenters like to see put on the market, and to add to their equipment as well.

Standardized Materials

ONE of the greatest aids to the work of experimenters is a new line of standardized materials brought out by the General Apparatus Company. While this line is not yet complete, it includes some of the most needed supplies such as high frequency cable or litzendraht, standard sizes of bakelite panels, machine and wood screws, cardboard tubing, high tension cable, and various sizes of brass sheet, rods, and tubing. These supplies are sold in standard lengths and sizes adapted to experimental work. One of the features of the G. A. service is prompt deliveries from stock.

B Batteries for Vacuum Tubes

A Discussion of the Construction and Characteristics of the Burgess B Batteries

By W. B. Schulte

ONE of the greatest drawbacks in the use of vacuum tubes for receiving, short distance transmitting, or laboratory work is the difficulty in obtaining a suitable source of plate current. Moreover, constant battery renewals are expensive. Flash-light cells, soldered together, are not satisfactory for they give out, become noisy, and are not convenient to handle.

When the Signal Corps and Navy Department requirements called for quantities of audion sets, it was necessary to develop a small battery unit to supply 22.5 volts, and to give the dependable service demanded of equip-

ment used in the War. What was probably the highest development in B batteries was produced by the Burgess Battery Company. This article takes up the questions of battery requirements, the characteristics of Burgess batteries, and the methods by which their characteristics are determined.

ment purposes of observation, a small percentage of batteries manufactured to represent the average performance. The manufacturers, where a large number of batteries are made every day, usually take from three to four batteries out of every hundred. These batteries are marked, and the open circuit voltage and short circuit amperage are measured and recorded and they are then placed on "shelf" for future observation. Each month the readings are repeated and recorded and from thousands of such readings the manufacturer obtains a knowledge of his product.

CURRENT CAPACITY

A capacity test can be easily made by discharging the battery through a known resistance, either continuously or intermittently as desired, and noting the closed circuit voltage at regular intervals. No regular resistance has as yet been specified by the purchases of B batteries except by the Government, which usually tests on 5,000 ohms. This is about one-tenth of the working resistance of the plate circuit of a vacuum tube, but it is used as the test can be easily completed within a week, for the small B batteries, and in a month for the larger ones.

Details of construction of the B batteries, showing the separate cells and terminal wires, the sealed cells, separators, and heavy

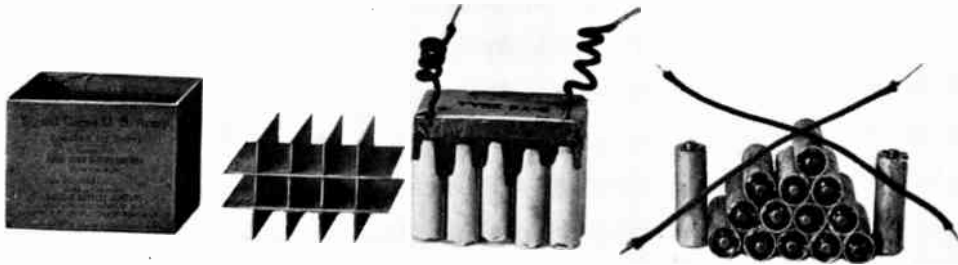

containing case. In the assembled set each cell is wrapped in paraffined paper to prevent leakage between the cells

The primary requirements of a B battery are:

1. A long shelf life,
2. A high current capacity,
3. Freedom from noise,
4. Proper electrical and mechanical construction.

SHELF LIFE

The shelf life of a battery can only be determined by actually setting it aside and measuring its voltage and amperage at regular intervals. Of course, the battery cannot be used during this testing period and, as the test takes months to carry to completion, it is not one which the experimenter or even the larger buyers wish to make. It is a test confined to Government Laboratories and to the manufacturers themselves. The data on shelf characteristics then is available only from these sources.

To study the shelf characteristics of a battery it is necessary to take out, for

In general there is but a slight falling off of voltage from age but the short circuit amperage drops more rapidly. This is due to an increase of the internal resistance of the batteries but it does not lower the useful hours of service in the same proportion. For convenience, the data is usually recorded as a per cent of the initial value and it is plotted with respect to time. The curves so obtained are closely watched as a control on the battery manufacturer. Fig. 1, showing shelf characteristics, indicates a marked falling off of short circuit amperage, in contrast to the slight lowering of the voltage.

This curve means that, though the battery will maintain its rated voltage for a considerable length of time, after several months on the shelf, the current will drop down quickly, when the battery is in use, as in the case of a worn out dry cell.

It is interesting to note that, while the current of the Navy type falls off more rapidly than the Signal Corps battery, the capacity of the larger battery is several times greater than the other. This means that, when used, it will maintain its short circuit amperage longer than the Signal Corps type.

It is obvious that a test requiring several months to complete is of not much value as a quick comparison of B battery capacities.

The capacity data is compiled from tests made on batteries of various ages. Batteries are taken from shelf and discharged through carefully calibrated resistances. The voltages are recorded at regular intervals and when the voltage has dropped to 17 volts, the usefulness of the battery is considered ended. The hours to 17 volts is the measure of capacity.

Fig. 2 shows the number of hours required to reduce the voltage of a 22.5-volt battery to 17 volts while connected continuously with a resistance of 5,000 ohms when batteries of various ages are used. In other words, taking the Navy type as an example, a new battery, continuously discharged through 5,000 ohms, will last 750 hours before the voltage drops to 17 volts. A battery 2 months old will stand up for 725 hours, at an age of 4 months, 700 hours, and so on, until, when the battery has been put away for a year, it will stand up 500 hours under this use.

The hours of service on 40,000 ohms, which is about the working resistance of a vacuum tube, is from ten to twelve times as much as for 5,000 ohms. The

curves show clearly the advantage of the larger size battery which has about ten times as many hours of life as the smaller battery but weighs only five times as much.

It should be noted also that in comparing curves, of Figs. 1 and 2, that the short circuit amperage drops more rapidly than does the capacity.

Readers interested in miniature battery testing, are referred to "Characteristics of Small Dry Cells" by C. F. Burgess (Transactions from American

factory B batteries. These chemical or electro-chemical noises are eliminated by a means known only to the manufacturers. The electrical and mechanical design of the battery also has an effect on the noise, as, for example, loose connections or leakage of current between the individual cells causes irregularities in the current, and corresponding noises in the telephones.

MECHANICAL AND ELECTRICAL DESIGN

Fig. 3 shows the parts of a Burgess B

cell and the end of the second row; this is reduced by the second method making less likely a leak between cells.

Strong, flexible leads are firmly fastened at the terminals. Then a wax is poured over the top, running down between the cells so that they are held together as a unit.

GENERAL INFORMATION

When vacuum tubes were first produced, it was necessary to control the voltage by means of a switch or potentiometer. Since the War, however, the audions sold for experimental work are of such a type as to require no regulation. The standard De Forest-Marconi tube now sold is generally used with 22.5 volts, as a detector, and 45 volts, as an amplifier. Two 22.5-volt batteries will also give excellent results on a 1- or 2-tube transmitter for wireless telegraphy and telephony.

Because they are designed specially for use with audions, B batteries cannot be used for other purposes where a large amount of current is drawn. That is, they must not be abused. They must be used right side up, kept in a dry place, at normal temperature and handled carefully.

Some sets, in which the vacuum tubes are mounted inside the case, are not provided with ventilating holes. Consequently, if the B batteries are also fitted in the case, the temperature rises to such an extent that the wax seal is softened. This difficulty is generally overcome by making circular holes in the top of the case, above the tubes. It is advisable, though not necessary, to cover the holes with a fine copper screen to keep the dust from the interior.

The use of 22.5 volt batteries with the new types of vacuum tubes simplifies the design of receiving equipment, since no voltage regulating switch or potentiometer is needed. Moreover, the old method of using a potentiometer decreased the life of the batteries to some extent, particularly when low resistance sectors were employed, as a small current passed continuously across the potentiometer.

If, for any reason, voltage regulation is required, a resistance of at least 15,000 ohms should be used, and, if possible, a higher value. Such a requirement is seldom met with the new tubes, however, for they do not need a critical adjustment, as was the case with the old, low vacuum tubes.

For low powered radio telephone sets, it is advisable to use the Navy type batteries, as they can withstand a higher discharge rate. Distances up to twelve and as high as twenty miles can be covered with a single Marconi-de Forest V T type audion, using two or three Navy batteries in series in the plate circuit. Even longer distances can be obtained if an amplifier is employed at the receiving station.

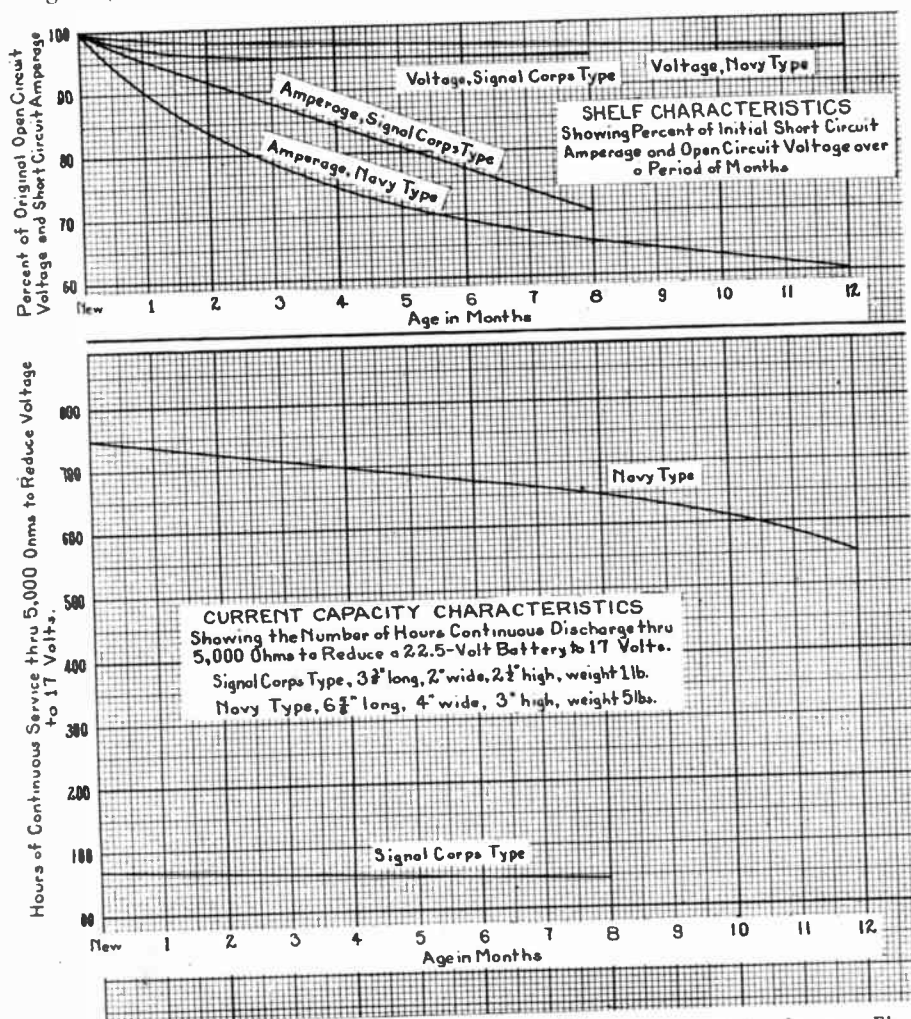

Fig. 1, above, the reduction of current and voltage while batteries are not in use. Fig. 2, below, hours of service obtained from batteries of varying ages

Electro-Chemical Society, Vol. XXX) and to Circular Bureau of Standards No. 79, "Electrical Characteristics and Testings of the Dry Cells."

NOISELESSNESS

The factors which make B batteries noisy must be carefully guarded against. It has been determined by careful tests, using a vacuum tube for amplifying, that certain phenomena, occurring during slow discharge, introduce resistance in the battery or else vary the voltage. These phenomena do not affect the operation of a flashlight battery in the least and they are therefore not guarded against in making them, and for these reasons flashlight cells in themselves do not make satis-

battery. In the first place, a strong containing box is required, one which cannot be bent readily, nor will absorb moisture. Next come strong separators to divide the cells. These are for mechanical and electrical strength. Oftentimes, the bottom of the box becomes wet, or moisture leaks out from the cells. This would provide a short circuit on the battery, but to prevent such an occurrence, each cell is wrapped in paraffined paper.

The general practice in connecting the cells, is to go from right to left, left to right, right to left and so on. In these batteries, however, connections are made from left to right, throughout. In the first method, a considerable difference in potential exists between the first

A New Instrument for the Production of Undamped Waves

A circuit to produce oscillations from 200 to 25,000 meters without the use of auxiliary adjustments

AMONG other apparatus constituting a new line of experimental equipment brought out by the Wireless Specialty Apparatus Company are the Eaton Oscillator and Eaton Circuit Driver.

These names may be misleading at first thought, but the description which follows will make clear the use of the instruments.

Oscillating circuits, either for the reception of undamped waves or for laboratory experimenting, generally contain tickler coils and condensers which must be adjusted for different wavelengths or conditions. The Eaton Oscillator does away with all the extra apparatus which must otherwise be added to an audion detector circuit to make it oscillate. In other words, a loose coupler, tuning condenser, and the audion with the necessary batteries are the only instruments used with the Eaton Oscillator.

Those who have used the usual oscillating circuits for reception over a range of 200 to 25,000 meters will appreciate what it means to do away with all the auxiliary instruments generally required to keep the circuit oscillating. It is a great advantage in tuning undamped wave stations to do all the tuning with the loose coupler and secondary condensers only. An antenna tuning condenser may be used also, of course.

Fig. 1 shows the Eaton Oscillator, and Fig. 2 a complete receiving circuit. The large circles indicate the oscillator binding posts, and the dotted lines,

tion against the absorption of moisture.

When the audion is to be used as an oscillation for the generation of undamped waves, a coil and capacity, corresponding to the secondary and sec-

Driver. This instrument is made up of an Eaton Oscillator with the addition of a tube socket, filament rheostat and ammeter, a buzzer and a telephone switch. This switch starts or stops the



Fig. 3. A more complete set for undamped wave work

ondary condenser, can be connected to the oscillator, or a wavemeter can be used in the same way without an ap-

buzzer. In the UNDAMPED position, the instrument is connected for the reception or generation of undamped

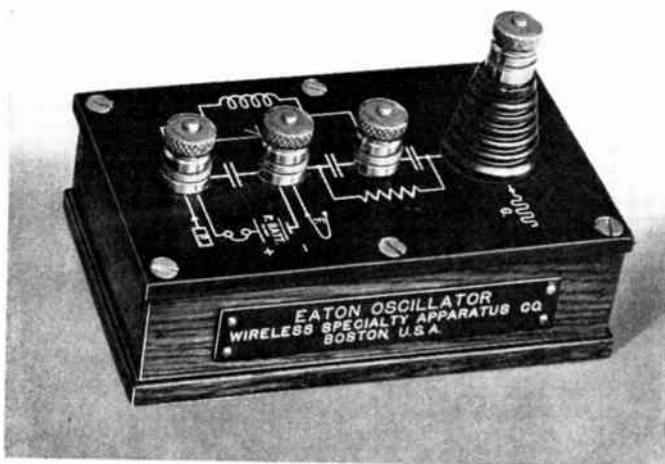

Fig. 1. A new instrument for undamped wave reception or generating oscillation

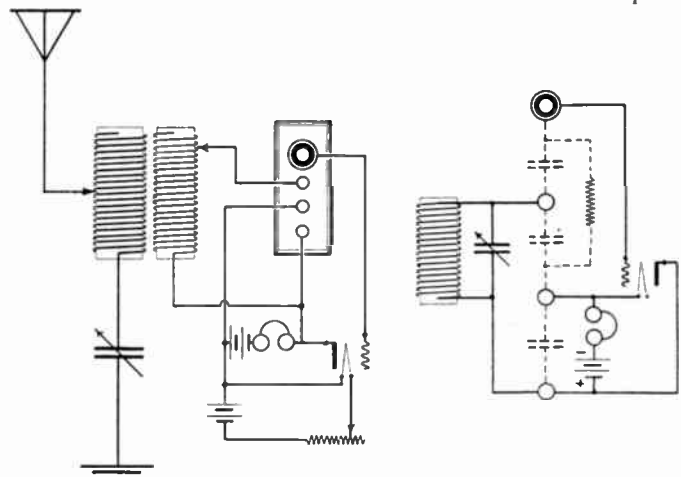

Fig. 2. Circuits for the non-adjustment oscillating set for 150 to 25,000 meters

the connections within the instrument. The secondary circuit is also engraved on the top of the panel. The condensers and resistance are sealed in a low dielectric loss compound as a protec-

preciable change in the calibration.

The United States Navy has standardized on this type of circuit for undamped wave reception.

Fig. 3 illustrates the Eaton Circuit

waves. At DAMPED, the buzzer is set in operation to modulate the radio frequency waves so that it will transmit audible signals, as for a wavemeter used in calibrating a receiving set.

The Problems of Vacuum Tube Circuits

An Explanation of the Problems encountered in the Design of Detectors, Amplifiers, and Undamped and Modulated Telegraph and Telephone Transmitters

By L. M. Clement

FEED BACK AMPLIFICATION

It is possible to obtain considerable amplification from a single tube by impressing part of the amplified signal voltage from the plate circuit on the grid in such a way as to cause a magnification of the original effect. Let us consider the diagram, Fig. 32, which shows a tickler coil coupled in such a way as to impress a part of the output voltage on the grid-

In Fig. 33, the effects produced by changing the position of a rotating tickler coil are shown. At the zero coupling position, the feed-back effect is practically zero, so that the results are as if no tickler were connected in the circuit. Increasing the coupling augments the feed-back or regenerative action, as indicated by the shaded portion, up to the point where the receiving circuit oscillates continuously. Just be-

circuits the amplifier will oscillate continuously with such strength as to produce a howling sound. This is analogous to the sound produced by holding a telephone receiver in front of a transmitter.

RADIO FREQUENCY AMPLIFICATION

With the increased use of loop antennas for receiving purposes, multi-step amplifiers have been developed.

Fig. 32. The changes in the plate voltage, produced by the incoming signals are fed back to the grid, amplifying the result, and increasing the signal strength

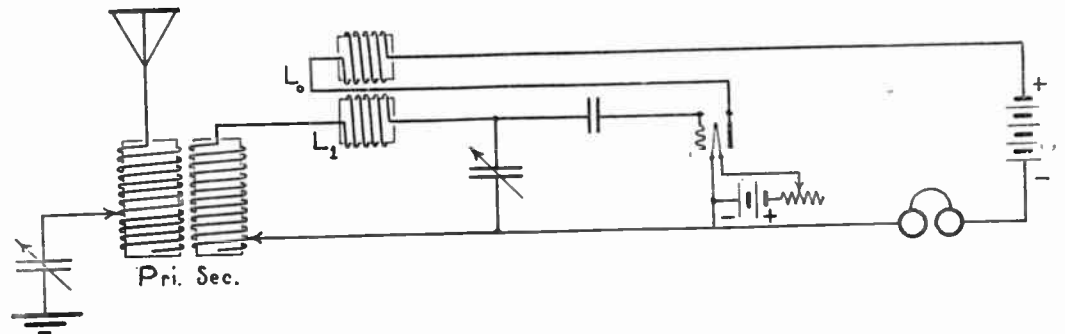

Fig. 35. A radio frequency amplifier using air core transformers between the tubes. Signals are made audible by a detector connected to the last step

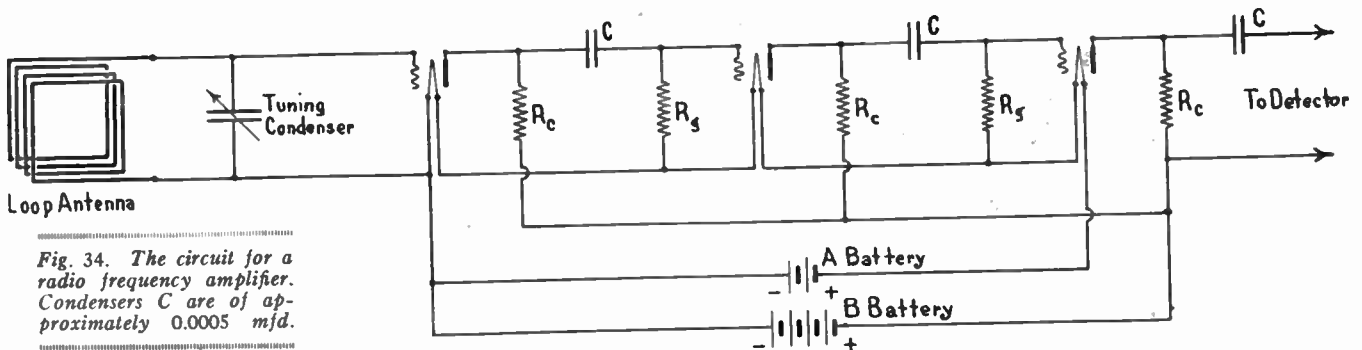
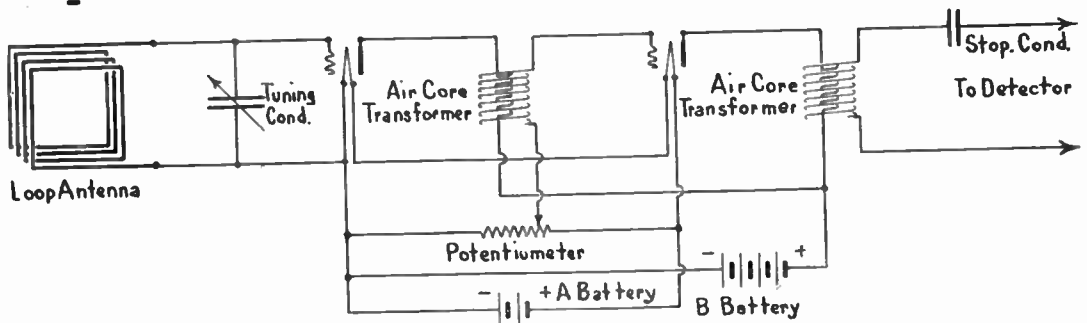

Fig. 34. The circuit for a radio frequency amplifier. Condensers C are of approximately 0.0005 mfd.

filament circuit of the tube. The output current flowing through L_0 will induce a voltage in L_1 , whose magnitude and direction will depend on the coupling between them. That arrangement of coils, L_1 and L_0 , must be used, which will tend to magnify rather than decrease the original effect on the grid, as described in the March, 1919, issue of EVERYDAY ENGINEERING. If desired, the tickler can be coupled directly to the grid end of the secondary inductance, instead of the separate coil.

fore this adjustment, the spark signals are considerably amplified, but, when the circuit is oscillating, the dots and dashes are not clear, though the strength is greater.

Near the first oscillating point local noises are heard, so that it is necessary to reduce the coupling toward the other side until, when the circuit is oscillating quietly, undamped wave signals can be copied.

It is obvious that if the coupling is too great between the output and input

This has been attended with the difficulty of building amplifiers which will augment the radio signals with a minimum of extraneous noises, such as from induction, vibration of the tubes and similar causes. This can be partly accomplished by the use of radio frequency amplifiers designed to amplify the signals at radio frequency for several stages before it is rectified. Thus the radio frequencies are not amplified.

Fig. 34 shows a resistance coupled amplifier of this type. This amplifier

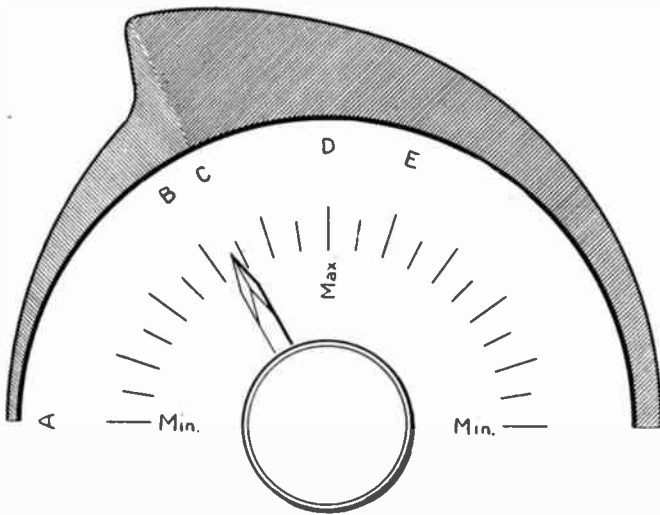

Fig. 33. Showing the effect of a tickler coil at various adjustments of the coupling to the secondary. From A to B the effect is small, just before C is reached the signals are amplified, while between D and E undamped waves can be received

differs from the ordinary one in that very small condensers, having a low impedance to the high frequency current but high impedance to the low frequency disturbances, are connected between the tubes at C, Fig. 34. These disturbances are of frequencies varying between 15 and 2,000 cycles per second while the radio frequency signal which is amplified is of the order of 50,000 to 1,000,000 cycles per second.

The same results can be accomplished by the high frequency amplifier illustrated in Fig. 35. The transformers T

are used to transfer the high frequency from the output of one tube to the input circuit of the succeeding ones. Constructional details of these transformers were given in the July, 1919, issue. Because of the low inductance of the transformers, they are exceedingly inefficient in the transfer of audio frequencies and consequently do not amplify the local disturbances. The potentiometer is provided so that the grid of the amplifier tube can be placed at the proper positive potential to produce just enough loss in the trans-

former to keep the amplifier from oscillating. One of the carbon sector type potentiometers can be used across the battery.

Amplifiers of this type are designed to operate on a certain band of frequencies depending upon the capacity of the tube and the inductance of the transformer.

Although loop antennas are shown in these diagrams, ordinary antennas can be used in the usual loosely coupled tuning circuits.

POWER AMPLIFIERS FOR TRANSMITTING SETS

The voltages to be amplified in receiving circuits are extremely small and, consequently, vacuum tubes operating on comparatively low plate voltages can be used. The power output of such amplifiers rarely exceeds a few hundredths of a watt in the telephones.

In order to handle the power required in a radio transmitting set, a power amplifier operating on a high plate voltage is used to amplify the voltage obtained from a small vacuum tube oscillator. The radio frequency voltage is generally applied to the grid of the amplifier tubes by means of the coupling coils M and N as shown in Fig. 36. The grid battery maintains

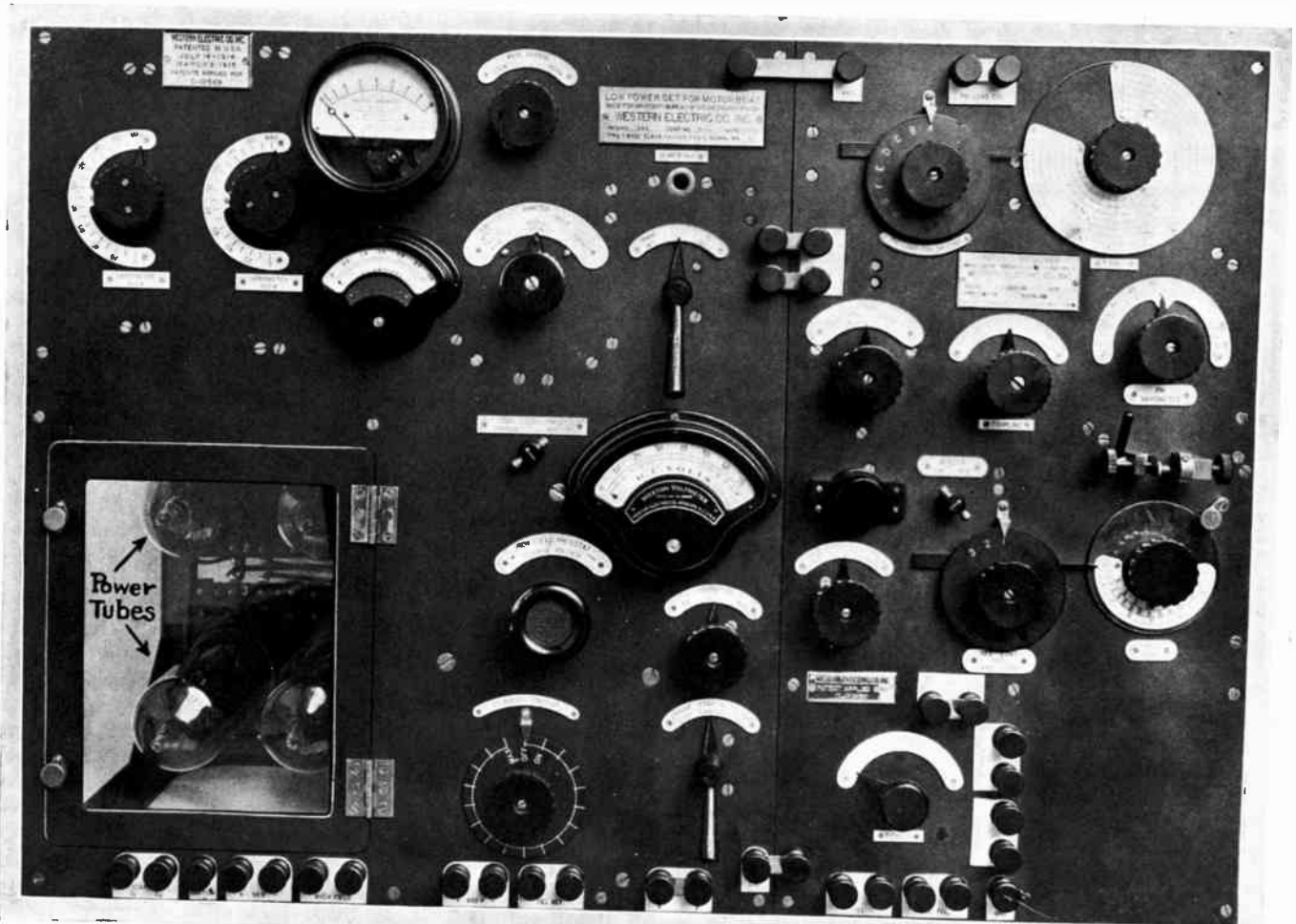
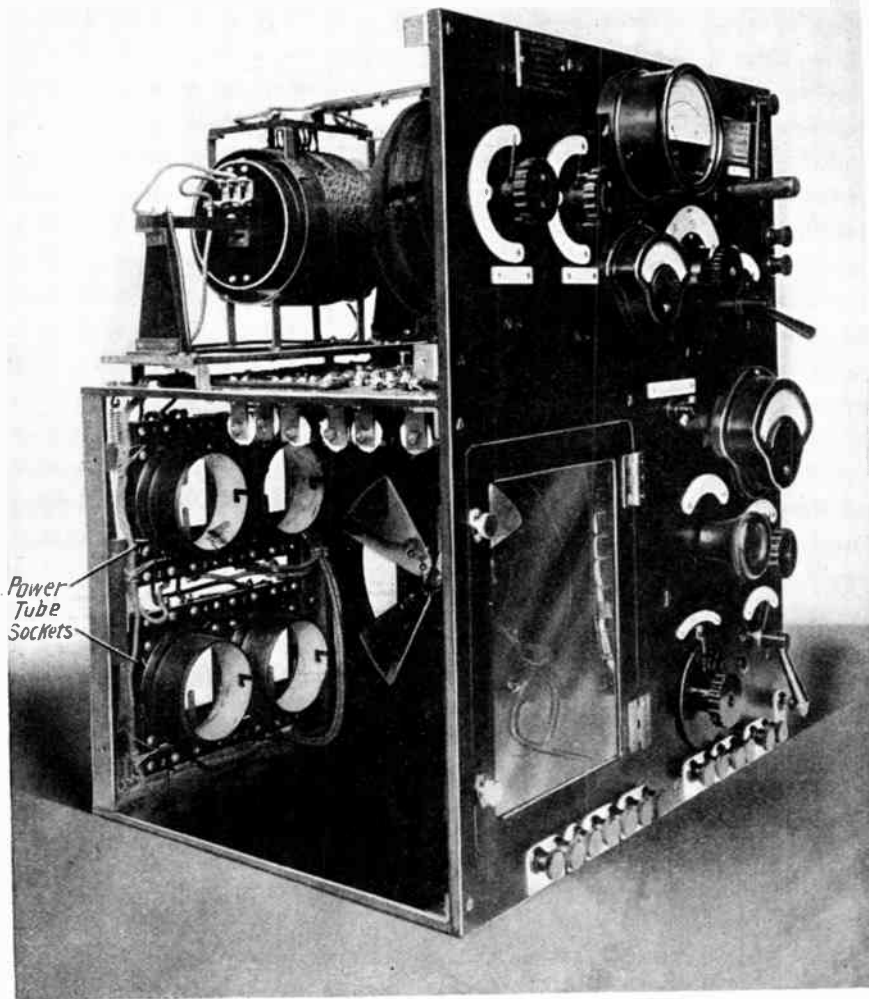
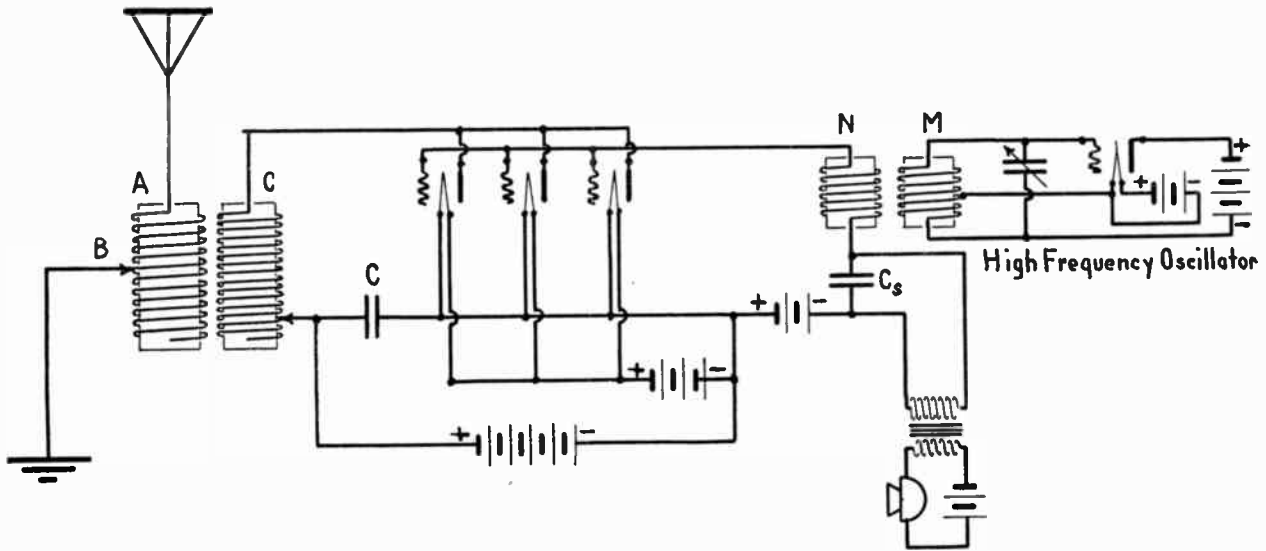

Fig. 37. Complete equipment with transmitting apparatus and controls at the left and receiving panel at the right



very little impedance to the radio frequencies, in the neighborhood of 0.001 mfd. An oscillator such as was described in the May, 1919, issue can be used to supply the high frequency voltage.

Figs. 37 and 38 illustrate a radio telegraph set employing 600 volt power tubes. In Fig. 37, the transmitting panel is shown alone, while the front view, Fig. 38, illustrates a complete equipment used on submarine chasers.

[The next article of this series will contain a discussion of the problems of detecting radio frequency currents, both damped and undamped. Circuit diagrams of various types are given, as well as curves which show just what is going on in the different parts of the circuits. The subject of heterodyne or beat reception is also to be taken up.]

Radio Clubs

IT is planned to devote a part of the Radio Department to the promotion of Radio Clubs. Successful clubs have done much in helping their members by purchasing such apparatus as wavemeters and measuring instruments which are beyond the means of the individual members. Moreover, by arranging operating schedules, they are effectively reduced Q R M.

In the matter of financing, EVERYDAY offers a plan which has been of great assistance where the holdings of the exchequer are too small to make possible the purchase of needed equipment.

EVERYDAY wants news items of the Radio Clubs, and will publish any short announcement or calls for members. Most of all, we want to know about the methods used by clubs to raise money. There are numerous ways which have been employed successfully. If those clubs will pass along their ideas, it will help the clubs which are just starting.

the grid of the tubes at the proper negative potential so that the voltage E may be impressed upon the straight portion of the grid voltage current characteristic of the tube or combination of tubes.

It is necessary in order to deliver power to the antenna that the circuit including the antenna and inductance AB be tuned to the oscillator frequency. Maximum power is obtained when the

inductance CD and coupling between AB and CD are adjusted so that the effective resistance between C and D is equal to R_o , the impedance of the tube.

This type of circuit can be readily used for radio telephony by impressing a speech voltage across the condenser C_s . The condenser C_s is of such a value that its impedance to speech frequencies is very high, while it offers

A Wireless Receiving Set for Beginners

By William G. H. Finch

IN the May issue of EVERYDAY ENGINEERING there was an article on the construction of a one- or two-slide tuning coil, and in the June number, a description of a crystal detector. These two instruments, or similar ones purchased from one of the supply houses, can be combined, with other apparatus, into an excellent and very simple receiving set.

The Antenna

First of all, an antenna must be erected. The type most easily put up consists of a single No. 14 bare copper wire, from 100 to 200 feet long, and 20 feet high, or more, at each end. If a support can be found for only one

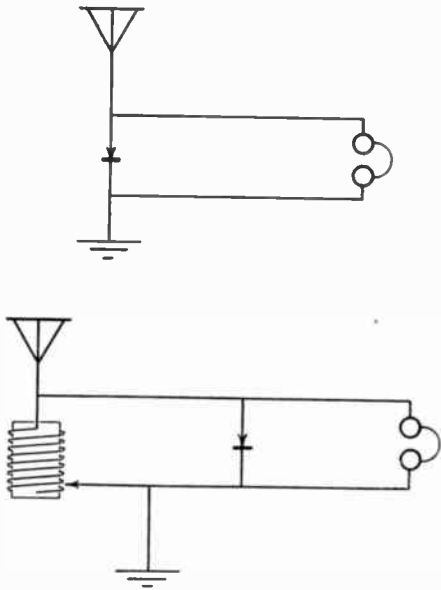

end, the wire can be run from the house to a short pole 10 or 12 feet high, nearby. On an apartment house roof, chimneys and pipes offer natural supports.

This antenna wire must be insulated carefully all the way down to the receiving set. Porcelain cleat insulators are inexpensive and give good protection. The antenna wire can be put through the hole at one end, and the stay wire through the other. A lead-in wire can be fastened to any part of the antenna, or simply brought off as an extension of the main wire. Where the wire runs around a corner of the building, or under similar circumstances, an insulator can be fastened by means of a large screw to a wooden supporting stick. Then the lead can be put through or fastened to the hole at the extended end of the cleat.

A porcelain tube and rubber-covered high-tension cable are needed where the lead comes into the operating room. The lead can be soldered to the outside end of the cable, and, from the inside

end, a wire brought down to the instruments.

Except in localities where heavy thunderstorms are frequent, a lightning switch is hardly needed if the antenna is short and low.

Tuning Coil

With the antenna described, surprisingly long distances can be covered with a plain tuning coil of one, two or three sliders. In fact, the advantages from the use of a loose coupler are mainly in sharper tuning and not longer distance reception. For ordinary receiving work on a small antenna, a coil $3\frac{1}{2}$ ins. in diameter and 12 ins. long, wound with No. 24 single

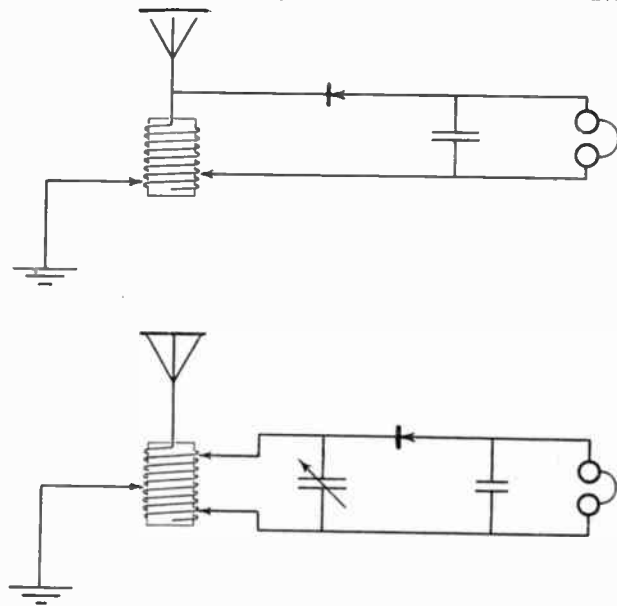

silk-covered wire is large enough. Such a coil will copy the Arlington time signals and practically all commercial stations using spark transmitters.

One slider will give good results, two slides a little sharper tuning, while three slides give slightly closer tuning but are rather troublesome to adjust. In general, a two-slide tuner gives the most satisfactory results.

The Detector

Experimenters who are taking up radio work for the first time should have their first experience with a crystal detector. The audion is rather expensive for learning, and requires considerable skill to operate it efficiently.

Galena has been the most popular mineral for a crystal detector. It was considered necessary, at first, to use an extremely fine adjustment, but, actually, a good crystal will give perfect satisfaction with a roughly adjusted catwhisker or fine copper wire. It may be stated that a copper wire, about No. 30 gauge, works as well as any

other metal. If possible, a tested crystal should be purchased. Otherwise it is necessary to buy a large piece and break it into cubes about $\frac{3}{8}$ of an in. square.

Silicon is still used. It is not as sensitive as galena, yet it will keep its adjustment for a long time. A slightly blunt brass point, arranged so that a rather heavy pressure can be applied, is commonly used.

Buzzer Test

To determine the point of sensitive adjustment of a detector, a buzzer test is needed. Any kind of buzzer will do, but a high-toned one which makes very little noise is best. It is advisable

to keep the buzzer in a box filled with cloth or cotton to smother the noise. If this is done, the only sound heard comes from the telephones when a sensitive spot on the crystal has been found. The only connection to the radio set is a wire running from the fixed contact of the buzzer interrupter to the ground lead.

Some operators use a switch to stop or start the buzzer, while others have a telegraph key so that it can be used for code practice. To adjust the detector, the test is set in operation, and the contact moved over the crystal until a regular sound is heard in the telephones. This is not to be confused with other notes heard when parts of the set are touched with the hand.

When a clear and regular note is heard, the detector is ready to receive signals.

Ground Connections

One of the first causes of no signals is the ground connection. It is as important to have a good ground as an

antenna. It should be near the set, if possible. The connecting wire should be of No. 18 wire, or larger, run directly to the ground. A wire soldered to a water pipe is the best connection. Otherwise, a galvanized iron or tin plate must be buried in damp earth or dropped in a well. Gas pipes are not good; steam or hot water radiator pipes may or may not work.

Telephones

A good pair of telephones cost at least four dollars. Cheap 75-ohm receivers will not produce satisfactory results. Well made, 1,000-ohm telephones, of a reliable make, should be purchased. When the telephones are received they should be tested in the following way:

Put a piece of wet blotting paper between a penny and a quarter. Touch the cord tips across the miniature battery. If a click is heard, the telephones are all right. Then connect the telephones in the set, adjust the detector, and see if, when the receiver cord is moved about, the signals are interrupted. This shows up any loose connections. Do not think there is something wrong until you have made sure. Then send the telephones back; do not try to repair them yourself.

Connecting the Instruments

Diagrams are given here for the use of simply a detector and phones, and for one-, two- and three-slide tuners. The small fixed condenser shown across the telephones should be purchased, as it is not expensive and rather difficult for the beginner to make well.

Connections for the instruments should be of No. 18 annunciator wire, and if possible, soldered at the terminals. Experimenters who make their own apparatus will find it an advantage in cost and convenience to use Fahnestock spring binding posts.

Increased Uses of Radio

ALONG the first of 1919, radio men were wondering what would happen to the manufacturers who had built up such large organizations during the war. While new demands may not be keeping them up to top speed, the number of uses for radio equipment is increasing rapidly.

The Simon Company is now building equipment to communicate with airplanes on the newly extended mail service to Chicago. Other companies are making apparatus for European and South American countries and are establishing foreign agencies.

Mines in isolated sections have taken up radio as a means of communication. Forest fire patrols are reporting by wireless. All the time calls are made for radio operators and engineers to carry out new radio projects.

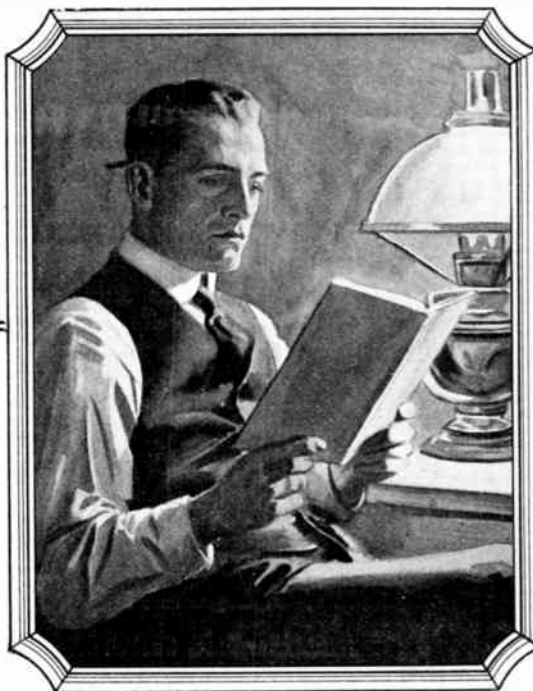

\$95 An Hour!

"Every hour I spent on my I. C. S. Course has been worth \$95 to me! My position, my \$5,000 a year income, my home, my family's happiness—I owe it all to my spare time training with the International Correspondence Schools!"

Every mail brings letters from some of the two million I. C. S. students telling of promotions or increases in salary as the rewards of spare time study.

What are *you* doing with the hours after supper? Can you afford to let them slip by unimproved when you can easily make them mean so much?

For 28 years men in offices, stores, shops, factories, mines, railroads—in every line of technical and commercial work—have been winning promotion and increased salaries through the I. C. S. Over 100,000 men and women are getting ready *right now* in the same way for the better jobs ahead!

Your Chance is Here!

No matter where you live, the I. C. S. will come to *you*. No matter what your handicaps, or how small your means, we have a plan to meet your circumstances. No matter how limited your previous education, the simply written, wonderfully illustrated I. C. S. textbooks make it easy to learn. No matter what career you may choose, some one of our 280 Courses will surely suit your needs.

One hour a day spent with the I. C. S. will prepare you for the position you want in the work you like best. Yes, it will! Put it up to *us* to prove it. Mark and mail this coupon *now!*

INTERNATIONAL CORRESPONDENCE SCHOOLS

Box 6056-B, SCRANTON, PA.

Explain, without obligating me, how I can qualify for the position, or in the subject, before which I mark X.

- | | |
|--|--|
| <input type="checkbox"/> ELECTRICAL ENGINEER | <input type="checkbox"/> CHEMICAL ENGINEER |
| <input type="checkbox"/> Electrician | <input type="checkbox"/> SALESMANSHIP |
| <input type="checkbox"/> Electric Wiring | <input type="checkbox"/> ADVERTISING MAN |
| <input type="checkbox"/> Electric Lighting | <input type="checkbox"/> Show Card Writer |
| <input type="checkbox"/> Electric Car Running | <input type="checkbox"/> Outdoor Sign Painter |
| <input type="checkbox"/> Heavy Electric Traction | <input type="checkbox"/> RAILROADER |
| <input type="checkbox"/> Electrical Draftsman | <input type="checkbox"/> ILLUSTRATOR |
| <input type="checkbox"/> Electric Machine Designer | <input type="checkbox"/> DESIGNER |
| <input type="checkbox"/> Telegraph Expert | <input type="checkbox"/> BOOKKEEPER |
| <input type="checkbox"/> Practical Telephony | <input type="checkbox"/> Stenographer and Typist |
| <input type="checkbox"/> MECHANICAL ENGINEER | <input type="checkbox"/> Cert. Pub. Accountant |
| <input type="checkbox"/> Mechanical Draftsman | <input type="checkbox"/> Traffic Management |
| <input type="checkbox"/> Toolmaker | <input type="checkbox"/> Commercial Law |
| <input type="checkbox"/> Ship Draftsman | <input type="checkbox"/> GOOD ENGLISH |
| <input type="checkbox"/> Machine Shop Practice | <input type="checkbox"/> Common School Subjects |
| <input type="checkbox"/> Gas Engineer | <input type="checkbox"/> CIVIL SERVICE |
| <input type="checkbox"/> CIVIL ENGINEER | <input type="checkbox"/> Railway Mail Clerk |
| <input type="checkbox"/> Surveying and Mapping | <input type="checkbox"/> STATIONARY ENGINEER |
| <input type="checkbox"/> MINE FOREMAN ENGINEER | <input type="checkbox"/> Textile Overseer or Supt. |
| <input type="checkbox"/> ARCHITECT | <input type="checkbox"/> AGRICULTURE |
| <input type="checkbox"/> Architectural Draftsman | <input type="checkbox"/> Navigator |
| <input type="checkbox"/> PLUMBING AND HEATING | <input type="checkbox"/> Poultry Raising |
| <input type="checkbox"/> Sheet Metal Worker | <input type="checkbox"/> Automobiles |

Name _____
 Present Occupation _____
 Street and No. _____
 City _____ State _____

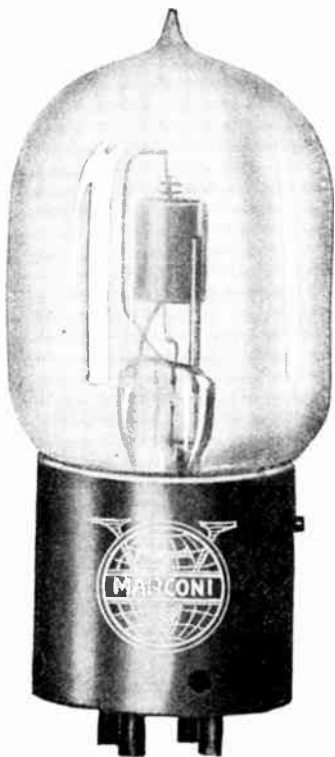

Fleming Pat. No. 803684
De Forest Pat. Nos. 841387-879532

THE HEART OF THE WIRELESS ON THE NC 'PLANES

Also used on the
Vickers Vimy
Trans-Atlantic Flight

MARCONI V. T. \$7.00 each

Standardized Socket . . \$1.50 additional

Agreements recently effected have made vacuum tubes available for experimental use. The Marconi V. T. is the only vacuum tube, or audion, which may be sold to amateurs, laboratories, schools of instruction and experimenters.

A highly developed, all-around tube for use as a detector and amplifier in wireless communication. It has practically the same electrical constants as the tube used by the Allied armies and navies throughout the war in continuous wave transmission and reception.

The approximate operating life of the MARCONI V. T. is 1,500 hours.

Class I—Designed for use as a detector; operates with plate potential of 20 to 60 volts.

Class II—Designed for use as an amplifier; plate potentials from 60 to 110 volts may be applied.

Tubes in either class may be used for detection or amplification, but those of Class I are best as detectors, and Class II tubes are superior as amplifiers.

SEND ALL REMITTANCES WITH ORDER

COMMERCIAL DEPARTMENT

Marconi Wireless Telegraph Co. of America

Sole distributors for
De Forest Radio Telephone & Telegraph Co.

Room 1868 Woolworth Building, 231 Broadway, New York

BRANCH OFFICES

Schofield Bldg.
Cleveland, Ohio
American Bldg.
Baltimore, Md.

Insurance Exch. Bldg.
San Francisco, Cal.
136 Federal St.
Boston, Mass.

301 Commercial Bank Annex
New Orleans, La.
109 South 2nd St.
Philadelphia, Pa.

Transformers for Vacuum Tube Circuits

THE illustration here shows the new Acme amplifying transformer for connecting between tubes in an amplifier circuit. Transformer coupling offers some advantage in simplicity over the resistance or impedance coupling.

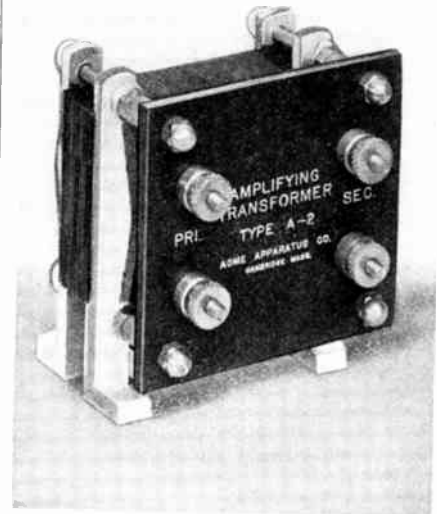

This transformer is made up of a closed, laminated core, on one leg of which both primary and secondary coils are wound. No. 40 enameled wire is used on the secondary. The ratio of turns and the impedance of the windings have been worked out carefully to give maximum efficiency with the new VT's.

Two sets of aluminum clamps hold the core and panel, and act as legs as well.

A similar type of transformer has been brought out by the Acme Company for modulation. In the primary circuit, the transmitter and battery are connected. The secondary is inserted in the grid side of the modulator tube, which, in turn, impresses upon the radio frequency oscillator the speech vibrations.

Notice

THIS series of articles by Mr. Clement has been running since April, 1919; the September issue marks the sixth article.

Mr. Clement has covered practically every phase of the work. He has discussed such important things as the Edison effect, action of the grid, plate and filament, filament temperature saturation, grid voltage, plate voltages, current curves, plate impedance and amplification constants, etc. All of the back numbers in which these important contributions appeared can be had from the offices of EVERYDAY ENGINEERING.

96-Page Book Catalogue Sent Free

WE have just issued a 96-page Book Catalogue listing about 2,500 of the most recent Scientific and Technical books. This is all the more welcome by reason of the fact that both the publishing and importing of books have been very much upset by the war, and many books can only be supplied with great difficulty. This catalogue will be sent to any address in the world, free on request.

Manuscripts Considered for Publication

The Book Publishing Department of the SCIENTIFIC AMERICAN will be glad to give an examination of any manuscript of Scientific or Technical nature. Submit as much of matter as possible, including illustrative material. There was never a better field for books of this nature than at the present time.

Scientific-American Publishing Company
Woolworth Building
234 Broadway, New York

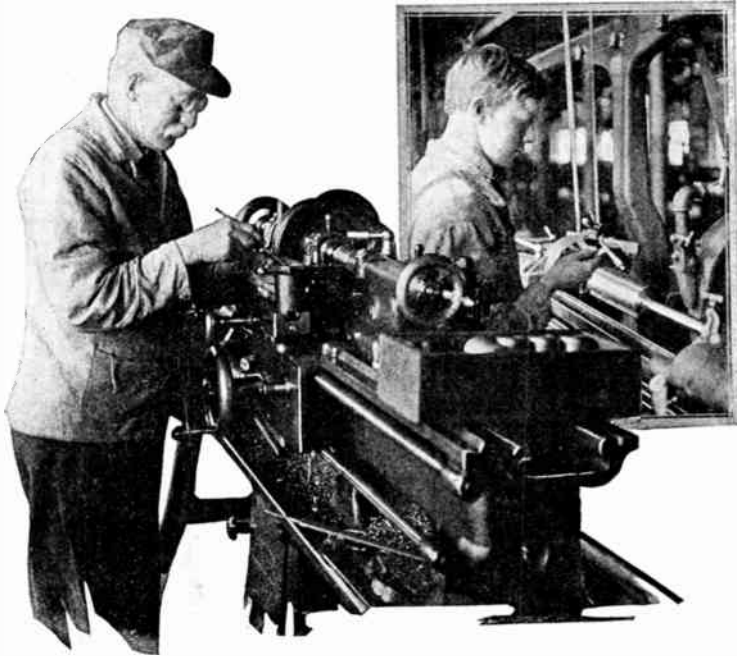

For Two Generations

Inspectors, Toolmakers, Machinists and Apprentices have pinned their faith to the accuracy of

Starrett Tools

In the lathe room, at the bench, throughout the shop, wherever metal work requires precision measurement, you'll find men using Starrett Tools from preference.

Catalog No. 21MB sent free on request.

The L. S. Starrett Co.

The World's Greatest Toolmakers
Manufacturers of Hack Saws Unexcelled
Athol, Mass.

42-941



HB BATTERY CHARGING PAYS BIG PROFITS

\$100 to \$200 CLEAR EXTRA PROFIT Each Month
New Lower Price On This HB 500 Watt Charger
Recharges 1 to 7 6-volt batteries at once for 10c to 15c each. Owner pays 75c to \$1.50. Figure those profits! You can build a big, profitable business in battery charging. No mechanical knowledge required. Small investment—long, easy terms—**BIG PROFITS.**

Small Cash Payment Puts This HB Outfit In Your Shop

Balance on easy monthly terms. Profits easily carry payments. No burnouts, no expensive renewals—steady, dependable service with **BIG PROFITS.** Absolute Money-Back Guarantee. Tear out this ad and mail **TODAY** for information.

HOBERT BROTHERS COMPANY
Box E E 91 Troy, Ohio
Successful Mfrs. Since 1888

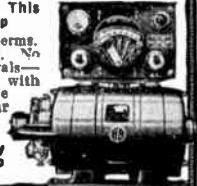

BOYS



Learn Drafting

Employers everywhere are looking for skilled draftsmen. They are offering good salaries to start with splendid chances for advancement.

Drafting offers exceptional opportunities to a young man because drafting itself not only commands good pay, but it is the first step toward success in Mechanical or Structural Engineering or Architecture. And drafting is just the kind of work a boy likes to do. There is an easy delightful way in which you can learn right at home in spare time. For 28 years the International Correspondence Schools have been giving boys just the training they need for success in Drafting and more than 200 other subjects. Thousands of boys have stepped into good positions through I. C. S. help, but never were opportunities so great as now.

Let the I. C. S. help you. Choose the work you like best in the coupon, then mark and mail it. This doesn't obligate you in the least and will bring you information that may start you on a successful career. This is your chance. Don't let it slip by. Mark and mail this coupon now.

TEAR OUT HERE

INTERNATIONAL CORRESPONDENCE SCHOOLS BOX 6067-B. SCRANTON, PA.

Explain, without obligating me, how I can qualify for the position, or in the subject, before which I mark X.

- | | |
|---|---|
| <input type="checkbox"/> MECHANICAL DRAFTING | <input type="checkbox"/> SALESMANSHIP |
| <input type="checkbox"/> STRUCTURAL DRAFTING | <input type="checkbox"/> ADVERTISING |
| <input type="checkbox"/> SHIP DRAFTING | <input type="checkbox"/> Show Card Writer |
| <input type="checkbox"/> ELECTRICAL DRAFTING | <input type="checkbox"/> Sign Painter |
| <input type="checkbox"/> ARCHITECTURAL DRAFTING | <input type="checkbox"/> ILLUSTRATING |
| <input type="checkbox"/> SHEET METAL DRAFTING | <input type="checkbox"/> Cartooning |
| <input type="checkbox"/> BOILERMAKER DRAFTING | <input type="checkbox"/> BOOKKEEPER |
| <input type="checkbox"/> BRIDGE DRAFTING | <input type="checkbox"/> Stenographer and Typist |
| <input type="checkbox"/> MACHINE DESIGN | <input type="checkbox"/> Cert. Public Accountant |
| <input type="checkbox"/> ELECTRICAL ENGINEER | <input type="checkbox"/> TRAFFIC MANAGER |
| <input type="checkbox"/> Electric Lighting and Railways | <input type="checkbox"/> Railway Accountant |
| <input type="checkbox"/> Electric Wiring | <input type="checkbox"/> GOOD ENGLISH |
| <input type="checkbox"/> Telegraph Engineer | <input type="checkbox"/> Teacher |
| <input type="checkbox"/> Telephone Work | <input type="checkbox"/> Common School Subjects |
| <input type="checkbox"/> MECHANICAL ENGINEER | <input type="checkbox"/> Mathematics |
| <input type="checkbox"/> Machine Shop Practice | <input type="checkbox"/> CIVIL SERVICE |
| <input type="checkbox"/> Gas Engine Operating | <input type="checkbox"/> Railway Mail Clerk |
| <input type="checkbox"/> CIVIL ENGINEER | <input type="checkbox"/> AUTOMOBILE OPERAT'G |
| <input type="checkbox"/> Surveying and Mapping | <input type="checkbox"/> Auto Repairing |
| <input type="checkbox"/> STATIONARY ENGINEER | <input type="checkbox"/> PLUMBING AND HEATING |
| <input type="checkbox"/> Marine Engineer | <input type="checkbox"/> Textile Overseer or Supt. |
| <input type="checkbox"/> ARCHITECT | <input type="checkbox"/> CHEMIST |
| <input type="checkbox"/> Contractor and Builder | <input type="checkbox"/> Navigation <input type="checkbox"/> Spanish |
| <input type="checkbox"/> Concrete Builder | <input type="checkbox"/> AGRICULTURE <input type="checkbox"/> French |
| <input type="checkbox"/> Structural Engineer | <input type="checkbox"/> Poultry Raising <input type="checkbox"/> Italian |

Name _____
Present Occupation _____
Street and No. _____
City _____ State _____

POROX STORAGE CELLS FOR MODELS, ELECTRICAL, AND RADIO APPARATUS

Porox Storage Batteries are made up of separate 2-volt cells in PY-RA-LIN jars, designed for high efficiency, low weight, and long life. They are lighter, more powerful, last longer, and cost less than dry cells. Can be charged at home. Porox Cells are designed for the requirements of the

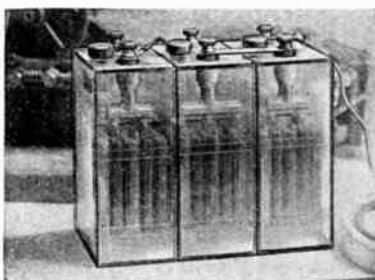

MODEL MAKER AND EXPERIMENTER

- 2 volts, 10 amp.-hrs., 3 x 1 1/4 x 4 1/2 ins. 3.75
- 2 volts, 15 amp.-hrs., 3 x 2 1/4 x 4 1/2 ins. 4.60
- 2 volts, 16 amp.-hrs., 3 x 1 1/4 x 6 ins... 4.00
- 2 volts, 25 amp.-hrs., 3 x 2 1/4 x 6 ins... 5.20

Any number of cells put together for any required voltage. Batteries are also furnished in oak cases for ignition and lighting.

ALBERT MULLER,
8758 Queens Boulevard,
JAMAICA, LONG ISLAND, N. Y.

PATENTS

TO THE MAN WITH AN IDEA

I offer a comprehensive, experienced, efficient service for his prompt, legal protection and the development of his proposition.

Send sketch, or model, and description, for advice as to cost, search through prior United States patents, etc. Preliminary advice gladly furnished without charge.

My experience, and familiarity with various arts, frequently enable me to accurately advise clients as to probable patentability before they go to any expense.

Booklet of valuable information and form for properly disclosing your idea, free on request. Write today.

RICHARD B. OWEN
Patent Lawyer
144 Owen Building Washington, D. C.

PATENTS

INVENTORS Send sketches or a model of your invention and a description of the device for advice in regard to the best way of obtaining patent protection. Our practical experience covers a period of twenty years. Our hand-book on patents is sent free on request. All communications strictly confidential. Write us today.

Talbert and Talbert
Patent Lawyers
4368 Talbert Building Washington, D. C.

PATENTS

LACEY & LACEY

Attorneys-at-Law—Patent Practice Exclusively
Solicitors of

**U. S. and Foreign Patents
Trade-Marks, Copyrights**

655 F Street, N. W., Washington, D. C.

Write Us for Our Free Inventors' Book

PATENT-SENSE
ESTABLISHED 1869

Competent Patent Service
By a Former Examining Official of the U. S. Patent Office

NORMAN T. WHITAKER
Lawyer and Engineer
580 Whitaker Bldg. Washington, D. C.
Branch Office, 87 Nassau St., New York City
INQUIRIES INVITED

PATENTS

Prompt, personal efficient service by an Attorney-at-law skilled in all branches of Patent practice. Over 12 years actual experience, full information upon request.

B. P. FISHBURNE
321 McGill Bldg., Washington, D. C.

Fleming's Pocket Book of Formulæ
850 pages of formulæ and information for the radio experimenter. Price, \$2.00

EVERYDAY ENGINEERING

Why Not Earn \$35 to \$100 A Week As A Mechanical Draftsman?

"Get into the profession of big pay and Rapid Advancement with the help of the school that has started hundreds on the Road to Success. I am ready to help you." Roy C. Claffin, President, Columbia School of Drafting.



Learn At Home In Spare Time

You don't have to stop work or leave home in order to become a trained Draftsman. Through our practical home study Training we will teach you Right in Your Own Home so that you will soon be able to qualify for a good position at Big Pay. We will continue to instruct and help you until we know you have the knowledge necessary to succeed.

No Previous Training Necessary

Right now—TODAY—there are openings for thousands of Draftsmen in the Government Departments, industrial concerns, and the big engineering offices. One department alone recently called for 1,800 draftsmen. With this tremendous demand has come a big increase in salaries.

Draftsmen Are Getting \$35 to \$100 a Week

with big chances for even better pay as the demand grows. By enrolling NOW for our practical Home Study Course in Drafting you can quickly qualify for a position as Draftsman and by properly applying the principles we teach.

You Have a Chance to Become a Chief Draftsman

and get to the very top in this fascinating profession. Our course will give you just the knowledge you need, to make good as chief draftsman when your chance comes.

Peace Calls For More Draftsmen

With the problems of reconstruction facing the nation the demand for draftsmen is even Greater Than During the War. All big engineering, construction and manufacturing projects must first go through the drafting room before the workmen can commence. You can help in the work of reconstruction and secure a Big Salary with excellent opportunities for advancement. Prepare now and be ready when the demand reaches its height.

We Will Help You Secure a Position

as soon as you complete our course. We have already placed hundreds of our graduates in good paying positions and are constantly in touch with vacancies for which Draftsmen are Urgently Needed.

Thousands of Men Wanted Right Now

Government Departments and Private Concerns are continually calling upon us for our graduates because they know that our instruction produces draftsmen of the caliber they need.

Drawing Outfit FREE

As soon as you enroll you will be sent our special drawing outfit FREE so that you will be sure to

have it to work with while taking the course. This set will be yours to keep. You are not asked to return it after completing the course.

Illustrated Book of Particulars Sent Free

Fill in the coupon below—send it to us and we will send you FREE a copy of our illustrated book telling all about our practical Home Study Course and how you may secure our instruction at once on Easy Terms so as to quickly qualify for one of the Big Positions Now Open.

Mail This Coupon To-day.....

Columbia School of Drafting
Dept. 1054, 14th and T Sts., N. W.
Washington, D. C.

Without obligation to me, please send me your illustrated book telling how I can secure your complete Home Study Course, the FREE DRAWING OUTFIT, and your help in securing a position as Draftsman.

Name

Address

City State

The Barr Mercury-Cup Wireless Detector

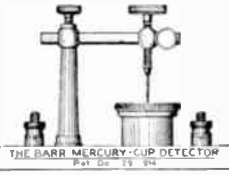

The most efficient Detector on the market. Tested by the United States Government and Marconi Wireless Telegraph Co.

Increases the efficiency of every wireless receiving set by making the signals clear, sharp and distinct. Instantly adjustable at a constant pressure. For full information and price—write

THE BARR MERCURY-CUP DETECTOR
169 Columbia Heights, Dept. C, Brooklyn, N. Y.

Get Our Prices

on the Wireless Apparatus you need, before buying.

We handle new and second hand instruments on which we can save you money. All Second Hand instruments guaranteed to be in perfect working order.

WHAT DO YOU NEED?
Send us your list now.

Radio Equipment Co.
630V Washington Street Boston, Mass.

AMATEURS

We are prepared to furnish hookups or information on radio subjects. Three questions for one dollar. Questions requiring research or calculations at special rates. Satisfaction guaranteed.

CAPITAL RADIO LABORATORIES,
Brookland, Washington, D. C.

RADIO EXPERIMENTERS

Have your own design of radio apparatus, or any appearing in **EVERYDAY ENGINEERING**, constructed to your order in our completely equipped radio laboratory. This service eliminates the difficulties and expense of home construction arising from lack of equipment and the purchasing of materials in small quantities. Prices are reasonable, workmanship the best and deliveries prompt. Full line of high grade material in stock. Quotations or other information cheerfully given.

THE WILCOX LABORATORIES Lansing Dep't/D Michigan



A MAGAZINE DEVOTED TO AMATEUR WIRELESS

Official Organ: American Radio Relay League

Radio Developments, Vacuum Tubes, Regenerative Receiving, Loop Aerials, Relaying, Operating Department Work, all A. R. R. L. News, Humorous Stories by The Old Man. All these and many more are included in QST.

SPECIAL TRIAL OFFER
Regular price \$1.50 per year, 15 cents per copy. Introductory rate: 9-months subscription for \$1 and attached coupon.

PIN A DOLLAR BILL TO COUPON AND MAIL IT TODAY!

RETURN COUPON

American Radio Relay League,
Hartford, Conn.

Enclosed find \$1; please enter my trial subscription to QST for 9 months.

Name _____
Address _____

Baldwin Mica Diaphragm Telephones

In order to enable every wireless operator to use the well-known Baldwin phones, we have reduced the prices as follows:

NAVY TYPE "C" \$15.50 each, F. O. B. New York
SMALLER TYPE "D" 16.50 each, " " "
NEWEST TYPE MADE "E," 17.50 each, " " "

(more rugged and just as sensitive.)

Apply to your nearest local distributors. If unable to obtain same, forward your order with money order direct to us. If any operator desires a cheaper cost phone than the "BALDWIN" we can recommend the "Brownlie" adjustable phone, which is very sensitive. Price, \$11.00, F.O.B. New York.

JOHN FIRTH & COMPANY, Inc.

81 New Street

New York City

INSTALL A NEW Grebe Regenerative Receiver In Your Radio Station



Short-wave Regenerative Receiver Type CR-2. Designed for long distance relay work on wavelengths between 170 and 580 meters. This receiver is characteristic of our advanced design and methods of construction and will fulfill the most exacting requirements.

Various models designed to operate on Wavelength Ranges from 170 to 20,000 meters are described in our Bulletin, sent upon request.

A. H. GREBE & COMPANY
RICHMOND HILL NEW YORK

What Every Mechanic Should Thoroughly Know

This book points out the stumbling blocks for mechanics to avoid in acquiring a complete understanding, as well as to show you HOW TO GO AT the reading of a blue print drawing.

Every phase of the seventy subjects is gone into in detail, so that any average man can master with but little study. Every point is clearly brought out with sufficient sketches to describe each of the actual blue print drawing examples. In fact, the illustrations are practically self explanatory.

Every mechanic needs this book, be his experience in mechanics limited or long. Read the following comment from a man who passes on from 50 to 500 blue prints a day.

"I never thought there was so much to know in the reading of a blue print drawing."

WM. P. CONWAY, Planning Dept. Mgr., U. S. Rubber Co.'s Mach. Shop.

This book contains the most vital and practical information on the subject of blue print reading, and is the best and safest investment you can make. Send for a copy to-day before you forget. **YOU CANNOT LOSE, YOUR MONEY REFUNDED IF NOT SATISFIED.**

PRICE:—Post paid U. S., \$2.00; Canada, \$2.12; Foreign, \$2.25. 169 pages—Size 5 x 7 1/2 inches. 228 illustrations

Handsomely bound in cloth 84 months in the making. EDUCATIONAL INSTITUTE, 128 Rowland Bldg., Detroit, Michigan

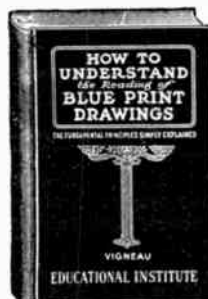

BARGAIN

12 issues of Everyday Engineering contain as much solid radio material as there is in an 800 page radio book. You can't buy an 800 page book for \$1.50, but you can get a year's subscription for that price.

Send for
HALCUN
Radio Catalogue
 Full Line of
Amateur Requirements
Halcun Radio Co.
 San Francisco, Calif.
 Formerly Haller Cunningham
 Elec. Co.

Genuine Armstrong Stocks and Dies



Great care should be exercised in the selection of stocks and dies. Work of quality demands quality tools.

Genuine Armstrong Stocks and Dies are quality tools. Made of the highest quality of material and by expert workmen. They are dependable and accurate tools of constant service.

Send direct to us if your dealer cannot supply you.

Descriptive Catalog on Request

The Armstrong Manufacturing Co
 701 Knowlton Street Bridgeport, Conn.

CAN YOU DRAW DOTTED LINES AS FAST AS FULL ONES? YOU CAN WITH A BERGGREN PEN

The Berggren Pen draws any style of dotted line without blot or blur. Nothing complicated or bothersome, used like your regular pen. When you are ready to put in the dotted lines, fill your



Berggren Pen and carry on. The result is a perfect dotted line, made as fast as you move your hand.

Our pamphlet describes the pen and shows the styles of lines.

Berggren Drafting Pen
and Six Wheels, \$3.00

UNIVERSAL DRAFTING PEN CO.
 BRIDGEPORT, CONN.

Regenerative Receivers, Amplifiers and Oscillators All Require VACUUM TUBES

Experimenters who copy European stations with indoor loop antennas use the AudioTron Hi-Vacuum Tubular Detector-Amplifier-Oscillator.

Has proven its sensitiveness and reliability since 1915. No station is complete without it.

Send for descriptive bulletin describing the AudioTron and our new Bakelite Panel for ARC & Spark reception, new smooth running rheostats, knobs, levers, contacts, etc.

DEALERS: Write for proposition. Territory now being allotted.

AUDIOTRON SALES COMPANY

1940 LEAVENWORTH STREET

SAN FRANCISCO

1 K. V. A. 25,000 Volt Wireless Transformer

The Thordarson Wireless Transformer is more than a transformer. It is a machine of efficiency and reliability, a piece of wireless apparatus that every amateur can be justly proud of. A Thordarson Wireless Transformer will make a "Long Distance" amateur of you. Our "20-T" bulletin describes our complete wireless transmitting apparatus.

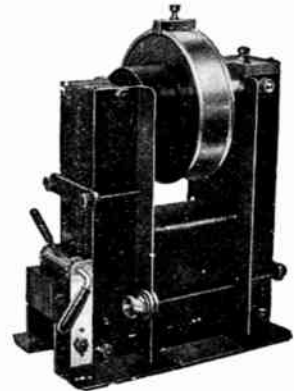

Thordarson Electric Mfg. Co.

501-515 So. Jefferson St.

Chicago, Ill.

RADIO ELECTRICAL APPARATUS

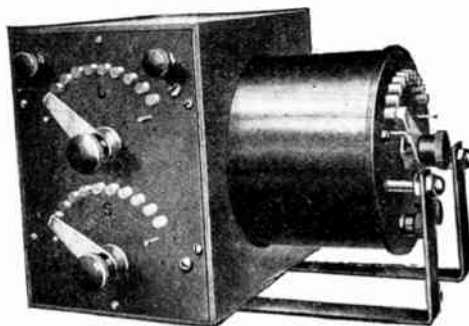

New type radion receiving transformer has bakelite panels, two primary and one secondary 10 point switches. Oak cabinet. Price, \$12.00.

Our new Bulletin Y offers a distinctive line of radio and laboratory apparatus including transformers, spark gaps, oscillation transformers, variometers, variable condensers, etc., in fact the most complete line in America.

Bulletin R describes the Cambridge alternating current rectifier for

STORAGE BATTERY CHARGING

Send 3c. stamp for both bulletins

CLAPP-EASTHAM COMPANY

131 MAIN STREET

CAMBRIDGE, MASS.

REMLER RADIO MFG. CO. 62 Post Street SAN FRANCISCO

Pacific Coast Representatives

BURGESS "B" BATTERIES

22.5 VOLTS

15 CELLS

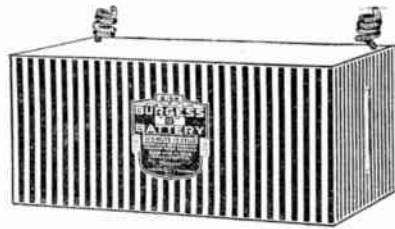

THREE SIZES

No. 2156—3" x 4" x 6⁵/₈"

No. 5156—2¹¹/₁₀" x 2⁹/₁₀" x 4¹/₈"

No. 4156—2¹/₂" x 2" x 3³/₈"

BURGESS "B" BATTERY construction is being specified by the Government for its vacuum tube batteries. They have long life, high capacity and noiselessness.

Write for prices and information to

BURGESS BATTERY COMPANY

Laboratories
Madison, Wisconsin

Sales Office
Harris Trust Bldg., Chicago

Size 5" x 3" x 3"

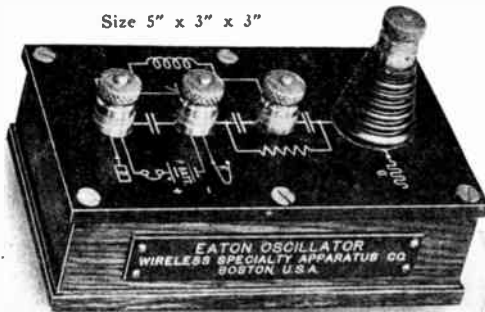

THE EATON OSCILLATOR

For Experimenters

Designed to transform receiving circuits to receive arc and other undamped signals. It may be used across circuits whose inductance lies between .003

tween .05 and 100 M.H. and whose capacity lies between .0003 and .005 m.f.

Requires no adjustments of any kind. Circuits are engraved on top. Only one variable, the tuning condenser, is required. The simplest and cheapest way of receiving arc, tube and high frequency alternator signals.

Price \$14.90

Immediate Delivery

WIRELESS SPECIALTY APPARATUS CO., ENGINEERS, DESIGNERS, MANUFACTURERS
BOSTON, MASS., U. S. A.



THE .004 M. F. FARADON MICA CONDENSER

Comparative tests have proved the W.S.A. mica FARADON to be the best primary transmitting condenser made. FARADONS are built in .002 m.f. and .004 m.f. capacities. The .004 m.f. FARADON is tested for 30 minutes at 21,000 volts and 18 amperes in a circuit of 1000 meters electrical length.

The temperature rise during this period is less than 3.5° C.

Every condenser is guaranteed for one year.

.004 m.f. FARADON \$28.50. Immediate Delivery.

The General Apparatus Company



An organization which is preparing to supply Experimenters, Inventors, Schools, and Colleges with materials and apparatus for experimental and research work.

An introductory bulletin is ready, covering a line of Standardized Materials, such as brass stock, screws, nuts, taps, dies, wire, high frequency cable, Bakelite, cardboard tubing, and other essential Experimental Supplies.

Integrity in Service, Quality, and prices is summed up in dealings with

The General Apparatus Company

157 EAST 18TH STREET

NEW YORK CITY

Wireless Receiving Ban Raised

MESCO WIRELESS PRACTICE SET

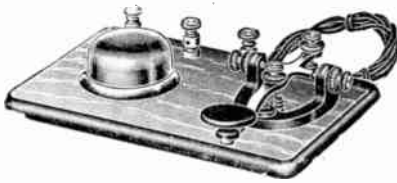

The Practice Set comprises a regular telegraph key, without circuit breaker, a special high pitch buzzer, one cell Red Seal Dry Battery, and four feet of green covered flexible cord. The key and buzzer are mounted on a highly finished wood base, and three nickel plated binding posts are so connected that the set may be used for five different purposes.

List No. 342 Telegraph Practice Set, with Battery and Cord\$3.24

Weights 4 lbs. packed. Price does not include postage.

MESCO COMBINATION PRACTICE SET

For Learning the Morse and Continental Visual and Audible Codes

This outfit is the only reliable instrument which will enable students to become proficient operators in the U. S. Naval Service, because it is equipped with a buzzer and miniature lamp enabling the user to master both the visual and audible signals quickly.

List No. 52—Practice Set with Red Seal Battery and Cord\$4.05

Weights 4 lbs. packed. Price does not include postage.

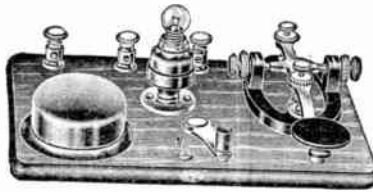

MESCO RADIO BUZZER

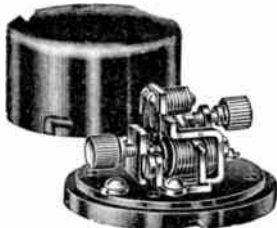

This buzzer maintains a constant note and is recommended as an exciter for checking wavemeters where pure note and ample energy are required.

It consists of practically a closed circuit field of low reluctance, having a steel armature to which is riveted a strap supporting a movable contact. The armature tension is adjustable by means of a screw with a milled head large enough to be easily and permanently adjusted with the fingers. The stationary contact is adjusted by means of a similar screw. The magnet coils are connected in series with a total D. C. resistance of 3.9 ohms. Shunted across these coils is a resistance having a D. C. value of 3 ohms. This shunt eliminates all sparking such as occurs at the break on ordinary radio buzzers and the energy saved thereby is transferred into any oscillating circuit connected to it, the result being that this buzzer as constructed radiates five times more energy than any other existing type. All connecting wires liable to be broken are eliminated. Contacts are of genuine platinum, which is essential in order to maintain a constant note. The parts are mounted on a Condensate base to insure constancy in operation.

Diameter 2 in., height 1 1/4 in. The cap is attached to the base by a bayonet joint.

List No. 55 MESCO Radio Buzzer\$2.05

We carry a large and complete line of Standard Wireless Material recognized by experts as such with competent experienced wireless attendants in charge

Send for the New Edition of Our Catalog K28

It is pocket size, contains 284 pages, with over 1,000 illustrations, and describes in plain, clear language all about Bells, Push Buttons, Batteries, Telephone and Wireless Telegraph Material, Electric Toys, Burglar and Fire Alarms Contrivances, Electric Call Bells, Electric Alarm Clocks, Medical Batteries, Motor Boat Horns, Electrically Heated Apparatus, Battery Connectors, Switches, Battery Gauges, Wireless Telegraph Instruments, Ignition Supplies, etc.

Manhattan Electrical Supply Co., Inc.

NEW YORK: 17 Park Place
CHICAGO: 114 S. Wells St.

BRANCHES: 110 W. 42nd St., 127 W. 125th St.
San Francisco Office: 604 Mission St.

FOUR NEW BOOKS

WIRELESS EXPERIMENTERS

will be interested in this NEW BOOK on—

SENIUM CELLS. Design, construction and use of the various makes. Illustrated with drawings and half-tones. 80 pages, 7 1/2 x 5 in., cloth \$1.50.

AUTOMOTIVE MAGNETO IGNITION, Its principles and applications, by MICH. E. TOEPFL. Second Edition, revised and enlarged. Profusely illustrated.

Limp Cloth, \$2.00

AERONAUTICAL ENGINES, by F. J. KEAN. Second Edition, revised and enlarged, 96 pages, 48 diagrams, 29 page plates and 5 folding plate. Cloth, \$2.60.

LATEST MAGIC, The New Book, by PROF. HOFFMANN, (Angelo Lewis) New and original, fully illustrated, handsomely bound in cloth—gilt. \$1.65 Post paid.

Spon & Chamberlain

122 E. Liberty St. New York City

INDICATING CALIPERS



Here is a finely made tool incorporating features of rule, calipers, indicator and magnifier. Adjustment is provided for wear of parts. Easy movement is effected by ball bearings. A coiled spring draws points together. Tool can be set for desired dimension. It is a one hand tool, leaving other hand free for holding of the work.

Made in two capacities:
2" capacity, graduated in 100ths in.
3" capacity, graduated in 64ths in.
Price \$6.50

Send for folder or inquire of your dealer.

Indicating Calipers Co.
508 East 19th St., New York

Telegraph Pictures

BY ELECTRICITY

A complete set of two machines of this marvelous equipment for only \$19.50. Instructive, mystifying and useful. This picture of President Wilson was telegraphed by these machines. Picture telegraphing is the coming science. Write today.

L. J. FEISHMAN CO. Dept. L., Ogden, Utah



COMPLETE CHEMICAL OUTFIT

Fifty (50) different chemicals and twenty (20) pieces of apparatus. Chemicals include Iodine, Mercury, Antimony, etc. Apparatus includes alcohol lamp, eight (8) test tubes, glass funnel, beaker, Erlenmeyer flask, etc. Best offer ever made. Not a plaything. Send \$4.50. Shipped by express collect.

TECHNICAL EQUIPMENT COMPANY,

Dept. I-C. 22 East 17th St., New York City.

DRAFTING

Inventions and Ideas Developed!

Mechanical, Electrical, Patent Office and Engineering Drawings of Every Description. COMPETENT DRAFTSMEN AT YOUR SERVICE

A. G. HAGSTROM

116 Nassau St. New York City
Telephone Beekman 4589

Be Comfortable! SCHNOTER'S SUSPENSORIES

Are Worn by Men Everywhere!

Army and Navy Style (with understrap)\$1.00
Improved Style (without understrap)85

Send direct if your druggist is not supplied
J. C. SCHNOTER CO. (Dept. E.) 523 6th Ave., N. Y. City



DUCK'S BIG 300 PP. Wireless & Electrical

Catalog is now, as it always has been, the largest and most complete and dependable Wireless Catalog published. Mailed for 12c in stamps or coin, which may be deducted on first order of one dollar. Catalog not sent otherwise. This catalog costs us twice the price of other catalogs.

Everything in wireless worth while is listed in this catalog. The experienced amateur will tell you to see our catalog before buying. You are thereby insured against an unwise purchase. It is the Beacon Light to guide you right in the selection of your wireless apparatus. No bigger or better values are obtainable elsewhere. Send for revised price list. It is yours for the asking.

THE WILLIAM B. DUCK CO., 244-246 Superior St., Toledo, O.

NEW TYPES OF AUDION APPARATUS



Audion Control Panel Type P-100—combining in a single compact set the Peerless De Forest Audion Detector, oscillator and audion amplifier, BUILT FOR THE AUDION AS ONLY THE MAKERS OF THE AUDION CAN BUILD IT. No other set like it has ever been built to sell for less than \$150.00. Our Price without the bulb \$65.00. Description of lower priced models sent on application.

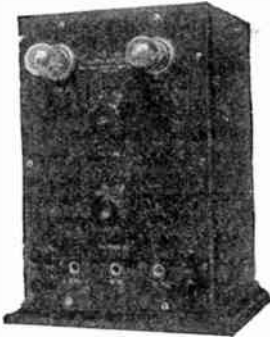

The latest in Amplifier design sufficient to give amplifications up to 20 times. PANEL QUICKLY REMOVABLE MAKING ALL PARTS ACCESSIBLE, AND THE REPLACING OF THE NEW TYPE EN BLOC "B" BATTERIES BUT A MOMENT'S WORK. Workmanship of the highest grade. Price without the bulbs \$69.50.

DE FOREST RADIO TEL. & TEL. CO.

1415 Sedgwick Avenue

New York City

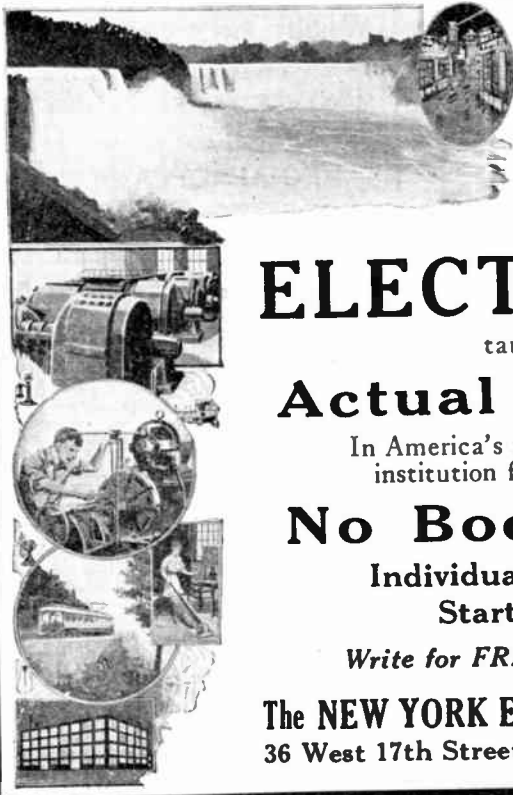

*Learn
By Doing*

Every phase of all
branches of

ELECTRICITY

taught by

Actual Practice

In America's foremost and oldest
institution for trade training.

No Books Used

Individual Instruction.

Start Any Day

Write for **FREE 64-page catalog**

The NEW YORK ELECTRICAL SCHOOL

36 West 17th Street

New York City

**MODEL MAKERS
AUTOMOBILISTS
CHEMISTS
RADIO MEN**

**SOMETHING FOR ALL OF YOU,
SOMETHING SPECIAL FOR YOU,
IN THE OCTOBER ISSUE OF EVERYDAY**



PREVENT
Put the
where it

WASTE
Grease
is Needed

**THE BRIDGEPORT
Center Thread Grease Cup**

This cup will squirt more grease than any cup of the same size made.

Equip your machine, auto or boat with this new type of grease cup, one that does not leak, that cannot be cross-threaded and that forces the grease to the bearing points. The cleanest Grease Cup made.

Send for Circular and Price List

THE GARRISON COMPANY

348 George St. Bridgeport, Conn.

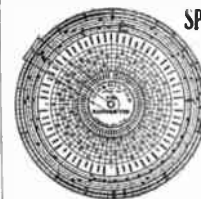

SPECIAL KON-VER-TER SLIDE RULE

The original KON-VER-TER slide rule has over 8,000 graduations and over 1,500 letters and figures, will handle anything in Arithmetic, Algebra, Geometry or Trigonometry. Is 6.4 inches in diameter and in use all over the world, is much simpler to operate than others of similar construction. Eventually you will get the KON-VER-TER—get it now and save money. Plain Utility rules \$1.00; Special De Luxe white ivory enameled \$2.00. Leatherette case 50c extra. **C. HAMILTON & CO.** Dept. V-5 Water St., Boston, U.S.A.

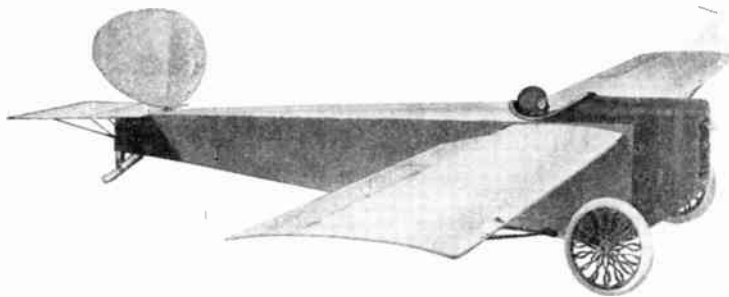

BUILD THIS MONOPLANE

The plane for the pleasure flyer who wants all the thrills of flying without the expense of a larger plane. Single seater with a short fuselage making handling easy. Wings braced with solid struts, no wires to loosen, give way or break. Shock absorbing spring wheels built part of the body. Whole plane low for balance. Everything simplified for ease of assembly. You can build one yourself from our working drawings and instal a motorcycle, cycle car or other motor of 12 to 20 H.P. Spread 22 feet, length 14 feet, weight 200 pounds. High safety factor of 12 to 1. Simple fittings. Speed with 15 H.P., 30-50 m.p.h. Designed by aeronautical engineers for sporting use and general flights. Be the first in your town to have one flying. Three ways to own one—Complete for \$1365, knock-down without motor for \$365, or plans \$2, and build it yourself.

BUILD ONE YOURSELF

You who like to make things and save money as well—send \$2 for a full set of working drawings showing all details of the monoplane with building instructions. With the plans comes a price list of everything needed. Many money saving ideas given in the instructions. Price of plans refunded if you buy a knock-down plane later.

BUY IT KNOCKDOWN

Supplied knockdown without motor for you to assemble for \$365. Everything supplied except motor, including propeller, wheels, fittings, counter-shaft, woodwork cut, wire, cloth, dope, etc., and a set of plans and full instructions, ready for you to put together and set in your motor. The ideal way to own one. Orders filled in rotation. Terms, \$65 cash, balance C.O.D.

BE THE FIRST IN YOUR TOWN—SEND YOUR ORDER NOW!

GEORGE D. WHITE CO.

Aeroplane Manufacturers

113 E. 49th St. Dept. 5 Los Angeles, Cal.

SCIENTIFIC PRINCIPLES FORM THE BASIS OF DESIGN OF WADING RIVER MODEL AIRPLANES

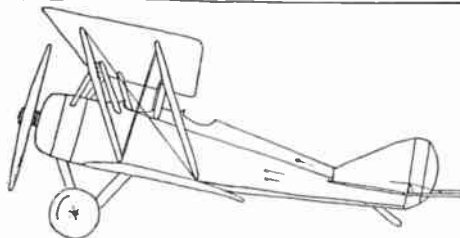

INVENTORS, EXPERIMENTERS, SCHOOLS, AND COLLEGES USE WADING RIVER AIRPLANE MODELS, MATERIALS, AND SUPPLIES BECAUSE THEY ARE SCIENTIFICALLY CONSTRUCTED MINIATURES. SEND FIVE CENTS FOR THE WADING RIVER CATALOG. IT SHOWS ALL THE MODELS OF THE NEWEST MACHINES DEVELOPED, PERFECT IN EVERY DETAIL, AND ILLUSTRATES THE LINE OF EXPERIMENTERS' SUPPLIES NEWLY BROUGHT OUT BY 672 BROADWAY, THE WADING RIVER CO. BROOKLYN, NEW YORK.

MODEL BOATS

Historical and Modern Model Yacht Classes Designs—Materials—Fittings Stamp for Catalog

DWIGHT S. SIMPSON, M.E. 16 Olive St. Saranac Lake, N. Y.



IMPORTANT TO MECHANICS
Learn more about the Machinists Trade. The Mechanics Guide Hand Book will do it. \$2.00 worth of Practical Shop reference for 25 cents. A book for the Machinist, Toolmaker and Draftsman; it gives practical data on Gears, Tapes, Weight of Metals, Drills, Pipe Fitting, useful Multipliers, Decimals, Lettering; and how to read a Micrometer, also numerous other tables. Send 25 cents in stamps. Agents wanted.

LACLEDE BOOK CO., 426 Odd Fellows Bldg., St. Louis, Mo.

Earn '25 to '100 a Week

BECOME A PROFESSIONAL PHOTOGRAPHER

Big opportunities NOW. It takes only a short time to qualify for this fascinating profession. Three months' course covers all branches:

Motion Picture — Commercial — Portraiture
Practical instruction; modern equipment. Day or evening classes; easy terms. Call or write for catalog.
N. Y. INSTITUTE of PHOTOGRAPHY
Dept. 20 141 W. 36th St., N. Y. City

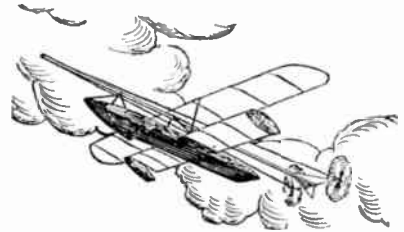

MODELS THAT ACTUALLY FLY

Build your own flying boat from our superior working blueprints and materials. The ONLY Biplane Flying Boat on the market that will actually rise from the water and fly under its own power. Two sheet working blueprint one half actual size with full building and flying instructions. \$1.00 postpaid in U. S.

Complete materials to build this wonderful flying boat with full building and flying instructions including two special hand carved propellers \$5.00 postpaid in U. S. Canada 25c extra.

Blueprints of the following flying models one half actual size with full building and flying instructions 50c per copy postpaid in U. S. Complete set of four blueprints \$2.00 postpaid.

BLERIOT RACER, 600-Foot flyer.
MANHATTAN RACER, 2000-Foot flyer.

MONTAUK FLYER, Flies 500 feet.

Send for Catalogue ready September 1st

HEC AEROPLANE CO.,
300 East 49th St. New York City
Address Special Dept.



The Electric Safety razor makes shaving a pleasure. Blade vibrating 7,200 times a minute cuts the beard smoothly and without slightest pull or irritation—feels like a gentle massage. Can be used with or without electric current.

All users of the **Lek-Tro-Shav** speak well of it

A barber says—"Have shaved for years and have never used any shaving device near its equal."

A home user says—"The most pleasing shave I've ever had in my life. Shaves my face closer than I used to shave, but there is no after irritation or ill effects as I usually get from another razor."

No. 1 Made for use from Light Socket.
No. 2 Made for use from Dry Battery.

Write for illustrated circular describing Lek-Tro-Shav Safety Razor fully.

VIBRATING ELECTRIC RAZOR CO.
Dept. 123. Omaha, Nebr.

There is a big message in this small space.

Read the October Issue

YOUR OPPORTUNITY

Canceled Government Contracts

We have secured a large quantity of Small Motors, Generators and Charging Outfits. This material is new, still in original cases and carries the full factory guarantee.

This is Your Opportunity to buy new, guaranteed Electrical Apparatus of Standard Manufacture

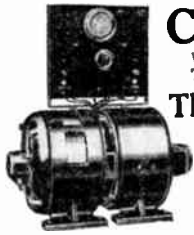

Battery Charging Outfits
For use on 110 volt, A. C. 60 cycle, single phase current only.
80 watts, 8 volts, 10 amperes . . . \$48.50
130 watts, 30 volts, 5 amperes . . . \$68.50
150 watts, 15 volts, 10 amperes . . . \$68.50
300 watts, 30 volts, 10 amperes . . . \$94.50
All outfits complete with switch-board as cut shown.



1/2 H. P. INDUCTION MOTOR
110 or 220 volts, A. C.
60 cycle, single phase,
1750 R. P. M. **\$32.50**

ALL MOTORS COMPLETE AS CUT



1/4 H. P. 110 volts
A. C., 60 cycle, single phase
1750 R. P. M. **\$18.50**

WASHING MACHINE MOTOR

Suitable for operating Small Compressors, Coffee Grinders, Bottle Washers, Lathes Drill Presses, etc.

Mail \$5.00 cash or Money Order. We will send C. O. D. subject to full examination. **MONEY BACK GUARANTEE**

WRITE FOR CATALOGUE. BARGAINS IN MOTORS AND GENERATORS. SPECIAL QUANTITY PRICES

230 POLYPHASE MOTORS 1750
volts RPM.
60 cycle, 2 or 3 phase. Complete, pulley and base
1 H. P. \$85.50 3 H. P. \$ 84.50
2 H. P. \$72.50 5 H. P. \$102.50

110-220 REPULSION MOTORS 1800
volts RPM.
60 cycle, single phase. Complete with pulley.
1/2 Hp. \$44.60 1 Hp. \$67.50

MANUFACTURERS' DISTRIBUTER

CHAS. H. JOHNSTON - West End - PITTSBURGH, PA.

PROFITS for YOU (Charging Batteries Making Electric Lights)

With the HB Lighting and Battery Charging Set you can make your own electric lights for as low as 2c per KW, and make a profit from \$100 to \$150 per month on battery charging. Anyone can easily operate without experience. Sturdy, dependable, economical to operate from line-shaft or your engine.

HOBART BROTHERS COMPANY
Box EE92, Troy, Ohio
Successful Manufacturers Since 1893

CELLULOID

SHEETING, PRINTING, MOULDING, TURNING, DIE CUTTING, EXPERIMENTAL WORK, ETC.

NAPIER BROWNING CO.
105 W. 40th ST. NEW YORK CITY

Red or Black "Vulcan" Ink Pencils

The ONLY perfect, non-leakable ink pencils at moderate prices.

Two Sizes—4 1/4 and 5 1/2 inches. Extra Size—8 inches (black only) **\$1.75**

Your name in gold inlay—\$.35. FREE—Liberal supply of ink with retail orders. Agents wanted. Big profits

J. P. ULLRICH & CO.
27 Thames Street, New York



You Make Umakem Model Airplanes.

Send \$3 quick for Umakem Airplane Making Outfit No. 17

No. 17 Umakem includes Umakem wood, blueprints, aluminum, tool, rubber and everything for making the Curtis J. N. 4. Model flying plane pictured above. To make as many more planes as you wish only inexpensive wood and raw materials are needed. It is made from 1/4" flat Umakem ply wood, cut out with Umakem Scroll Saw and designed to fit together in an easy yet strong and compact manner.

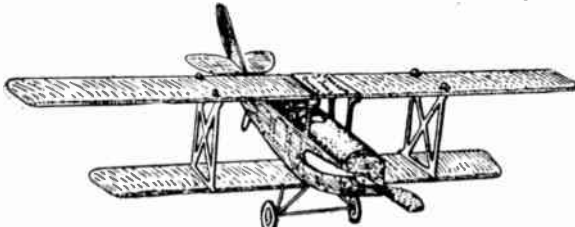

You can saw out a wing or a fuselage in a jiffy. Several Duplicate parts can be cut at the same time and by the same operation, making replacements easy. No intricate fitting together of numberless small strips. Each main part is simply scrolled out of one large piece of ply wood. The wings fit into slots and are held safe and firm. You bend two pieces of wire, slip them through four holes, and the Chassis is ready for the axle. It's all Dead Easy.

When you are ordering Umakem Airplane Set ask about our 40 other Umakem outfits with which you can Make Money Making Umakem Toys, Umakem Furniture, Novelties, Umakem Metal Working Lathes and other Popular Umakem projects.

W. R. PRICE, Inc., 71 Umakem Building, 127 5th Avenue, New York, N. Y.

EVERYDAY ENGINEERING MAGAZINE SERVICE DEPT

Readers of this magazine are invited to write for any information relative to procurement of supplies, technical or practical books, tools, etc., they need to carry on their experimental work most efficiently. Our Service Dept. manager can render you valuable aid if you avail yourself of this privilege. All inquiries will receive prompt attention, and to insure proper service, the writer should enclose a stamped self-addressed envelope or postal card.

ELECTRICAL ENGINEERING IN ONE YEAR

training again open to civilians. Over 3000 men trained for electrical industries in experience of more than a quarter of a century. For men of ambition and limited time. Condensed course in Electrical Engineering enables secure good positions and promotions. Theoretical and Practical Electricity, Mathematics, Steam and Gas Engines, Mechanical Drawing. Students construct dynamos, install wiring and test electrical machinery. Course with diploma, complete



Thoroughly equipped fireproof dormitories, dining hall, laboratories, shops. Write for catalog. 37th year opens October 1, 1919. **BLISS ELECTRICAL SCHOOL**
140 YAKOMA AVENUE, WASHINGTON, D. C.



THE MIDGET SLIDE RULE will solve any problem in addition, subtraction, multiplication, division and proportion. A Log-Log Scale gives any root or power of any number. Gives Logarithms, Sines, Tangents, Cosines, Cotangents and the decimal equivalents of fractions to six decimals. It is grease and water proof and will give years of service. This rule is not to be compared with the paper utility rules which sell for \$1.00 and are put together with paper fasteners. It is accurate, simple to operate and comparison shows that it is undoubtedly the fastest and most complete rule made. Our refund guarantee protects you from loss or disappointment. An instruction book is included with each rule. Diameter 4 in. Made in two models: Metal (white coated steel), \$1.00; White Celluloid \$1.25. Leather Case 50c extra. Your money, but if you are not satisfied. Send for Catalogue. **Gilson Slide Rule Co., Niles, Mich. of Slide Rules.**

DRAWING Big Pay—Easy Pleasant Work

Draftsman earn \$150.00 to \$300.00 a month. The work is pleasant and the hours are short. You can get this big pay too. All you need is the new 1918 edition of the Cyclopaedia of Drawing and a little of your spare time. The cost is only 7 cents a day, and we give a year's consulting service free. See the FREE examination offer below.

Cyclopaedia of DRAWING

4 big volumes each 5 1/2 x 8 1/2 in., bound in genuine American Morocco and trimmed in gold 1678 pages and more than 1000 illustrations plates, diagrams and blue prints.

The only books that thoroughly cover Mechanical, Structural and Architectural Drafting in a non-technical way. You don't have to know anything about the subject to understand them. They begin at the beginning and tell you everything about Blue print Reading—Mechanical Drawing—Machine Design—Machine Drawing—Structural Drafting—Architectural Drawing and Lettering—Shades and Shadows—Perspective Drawing—Freehand Drawing—Pen and Ink Rendering—Typographical Drafting—Drawing Instruments and Their Uses and hundreds of other things connected with the work.

Use One WEEK FREE!

You can have these books for a whole week free without sending one cent. Just send the coupon below and all 4 volumes will come to you at once by express collect. Use them as if they were your own—go through them thoroughly and send them back at our expense if you don't want to keep them. If you do keep the books send us only \$2.00. You can send the balance of our special introductory price—only \$13.80 the same way—\$2.00 each month. Remember you don't take any chances. The risk is all ours and the benefits will all be yours—Send the coupon today

American Technical Society
Dept. D-356 CHICAGO, U. S. A.



Please send me the 4-volume Cyclopaedia of Drawing for 7 days' Free Examination, shipping charges collect. I will send you \$2.00 in 7 days and \$2.00 each month until the special price of \$13.80 is paid, and you will send me a receipt showing the books are mine. If I decide not to buy I will return the books in 7 days.
Name.....
Address.....
References.....



ELECTRICITY

Taught By A Practical Man And In Your Own Home Put Part of Your Spare Time To a Good Purpose

A HOME STUDY COURSE FOR AMBITIOUS MEN

MY course of instruction is vastly different from the general run of correspondence work, as it is actually an extension of a consulting engineering experience, which gives my students the opportunity of becoming familiar with electricity as applied to everyday work, and as applied to their particular needs.

My Real Purpose

My real purpose is to reach those who have not a lot of time and money to devote to an electrical education, and to give them what they need. By working in various branches of the electrical industry, I learned that there were many men who had an earnest desire to get into the electrical field, but could not do so because they did not have the time and money to go to a school teaching this work. I also learned that a large proportion of men engaged in electrical work, could not make the progress they desired, because they lacked the technical details which are necessary to the man who reaches the top. It is these men I want, and it is these men who need me. Hundreds of such men have come to realize that my instruction and advice has been of untold value to them, and that my institution is run on a sound basis and with a view of giving them what they want.

Not a Cut and Dried Book Plan

In addition to my practical and consulting experience, I have designed instruction courses for various educational institutions, which has given me an unusual opportunity to study the teaching business from a practical standpoint. I have carefully noted what men wanted and what they needed, in order to make good, and I have designed and written my instructions with a view of meeting these conditions. Letters from my students are sufficient proof that I have succeeded and the results they are getting through my instruction and help is very gratifying to me.

Beginners and Experienced Men

My course of study and service suit both beginners and experienced men, but I cannot do it all alone, nor do I wish to give this impression. My students must be earnest, and be willing to do their share of the work in order to make a success of it. Where I find students who are not willing to do their work as I

Fifty-Fifty

My business is run on an absolutely 50-50 basis with my students. By that I mean I am just as much concerned with his welfare and progress as I am with the money he sends me, and that I meet him at least half-way on any proposition. I am paid the comparatively low price I ask, and I give the instruction and other help as detailed in my catalog. I offer nothing free, give nothing free, and do not expect anything unless I return its full value. No student is permitted to pay for his course in full on starting, the payments being made in monthly installments. Also, students have the privilege of discontinuing the course if they find it is not just what they are after, and their payments stop at the same time, as I do not expect and I do not wish money from men whom I am not helping.

Apparatus, Instruments, Material, Etc.

Certain electrical apparatus, instruments, material, charts, drafting implements, etc., as detailed in the catalog, are included in the course and are a part of the regular instruction for which there is no extra charge as it is covered by the regular monthly payments.

Fill Out Coupon or

Write me and I shall promptly send you one of my catalogs which contains full information regarding my course and the service I offer.

BURGESS ELECTRICAL SCHOOL
751 E. 42nd St., Chicago, Ill.

suggest, I return their money and ask them to discontinue, as I stated above, this course is for ambitious men, not triflers. Among my students are beginners, electricians, foremen, maintainers, repair men, armature winders, power-house helpers, power-house foremen, Navy electricians, Chief Navy electricians, chief electricians, Chief City Electricians and Contractors. These men are taking my course and find my instruction and my help of value to them. Not only are they satisfied, but they are sending me more students. In several places I have nearly all the men in the plant taking my work together.

What I Can Do

What I can do and will do is to help you whenever the opportunity offers. This statement is broad but I make good on it in every particular. A student never asks a question, or asks for help of any kind, but that every effort is made to see that he gets what he wants. I do not say that I shall fit you to qualify as an electrical engineer in a couple of months, as it cannot be done. Neither do I say that you will earn fifty or one hundred dollars a week when you complete this work with me, because they are things over which I have no control. As a matter of fact, there are men I have taught who are electrical engineers today, and others are earning very large salaries, but what you become, or how much you may eventually earn, is mainly UP TO YOU. I do my part, and if you do yours by following my instructions and advice, you will have the same opportunities as others to make good.

Results of My Efforts

These three facts stand out to show how my work is accepted.
Practical men recommend my course to others.
Over 65 per cent. of my students are engaged in the electrical business.
Over 11 per cent. of my enrollment was obtained through satisfied students.

YORKE BURGESS,
BURGESS ELECTRICAL SCHOOL,
751 East 42nd Street, Chicago, Illinois.

Gentlemen:—

Send me catalog describing your course in Electricity.

NAME.....

ADDRESS.....

CITY.....

STATE.....

Be an Artist

Comics, Cartoons Commercial, Newspaper and Magazine illustrating. Pastel, Crayon portraits, Poster and Fashions. Earn Big Money. Taught by Mail or Local classes. Write for illustrated booklet, terms and list of successful pupils.

ASSOCIATED ART STUDIOS
27A Flatiron Bldg., New York

BUILD YOUR OWN PHONOGRAPH

We will show you how

OUR SIMPLIFIED METHOD ENABLES A BOY to build a first class machine selling for \$150.00. We furnish Motors, Reproducers, Tonearms, Cabinets, Cabinet Material, Cabinet Hardware, Blue Prints and Instructions. Write for free catalog.

BELLTONA COMPANY
Dept. B. North Tonawanda, N. Y.

INVENTORS

YOU MUST HAVE PATENT DRAWINGS MADE OF YOUR INVENTIONS

We can give you a specialized service on this work. Particular attention paid to work by mail.

ACME DRAFTING COMPANY
116 Nassau St. Tel. 3959 Beckman
New York City



PHONOGRAPHS FROM MANUFACTURER'S UP

24 different styles, \$4.00 up; \$150 style, \$40; \$100 style, \$35; \$50 style, \$13. Plays Victor, Columbia and Edison Records. Mail Orders Filled Promptly. Send for Catalogue. DEALERS WHOLESALE. LUCKY 13 PRODUCTS CO., 3 East 12th St., New York.

NATIONAL TRADE DENTAL SCHOOL

506 S. Wabash Ave. CHICAGO, ILL.
LEARN MECHANICAL DENTISTRY—DEMAND UNLIMITED
Earn \$1200 to \$4000 yearly in mechanical dentistry. A big and growing demand everywhere for mechanical dentists—like a gold mine, unexplored. Attend this school any time of the day or evening; be taught individually and learn by actual practice, without book study. Our System, the most complete in the world, is used exclusively in this school. We are constantly called upon to fill high-salaried positions. Why not qualify for one? Be fair to yourself; find out more about exceptional opportunity we offer. Visit the school or write for booklet B.

USE HB BALL BEARING ELECTRIC MOTORS

SAVE ON POWER BILLS—GET BETTER POWER. HB Ball-Bearing Motors supply better power than gas engine or steam engine, and cost less to operate. Ample designed for hard service, trouble proof, absolutely reliable. Ideal for factory, garage or machine shop. Best service at lowest cost. \$20 Brings You Any HB Motor. Balance on Easy Terms. Sizes 1 to 15 h.p. Choose to Suit Your Needs.

In planning your installation, write our service department. Get their advice—FREE. Simply state what machinery will be run and type of current available. Let us plan your power system for best results at least cost. Pin this ad to your letterhead and mail TODAY for full information. Ask also about HB Battery Chargers, Generators, etc. **HOBERT BROTHERS COMPANY** Box 922 Troy, Ohio Successful Manufacturers Since 1898

Mathematics Made Easy

The Arcoscope—the Combination Triangle with a Brain—will multiply, divide, figure percentage and proportion, solve all problems in trigonometry and geometry, draw symmetrical figures, plot arcs, etc. Superior to any slide rule. Simple to operate. Also includes a TRANS-PARENT TRIANGLE, PROTRACTOR and THREE RULES. Used at Columbia University, West Point, U. S. Aeronautic Schools, Etc. Only 85c postpaid. Order today before you forget. Dept. U, L. J. LEISHMAN CO., Ogden, Utah

25% to 40% Saving on Gasoline
Elimination of Carbon Promotes Uniform Combustion
MOTOROL
Trade Mark
More Mileage Write for Booklet
More Power Agents Wanted
AUTO PRODUCTS CO.
Dept. 66, 226 W. 138th Street New York



YOUR FUTURE!

Will the field of ELECTRICITY Guide you to Bigger — Better Position — Salary SUCCESS?

Electrical Engineering

3 yrs. course with degree of B.S. will prepare you to fill the demand for technically trained men. Electrotechnician—1 1/2 to 3 yrs.—an electrical and High School course. 1 yr. Practical Electricity or 1 yr. Electrical & Mechanical Drafting Course. All provide maximum of education and training at minimum of time and expense.

"Earn While You Learn" if you like. Board and room \$28.00 per month at Student's Fraternity House—conside advantages. Athletics, R. O. T. C., Glee Club. Fall term opens September 2nd. Send for Photo Story and bulletins. Mention age, education and courses interested in. **SCHOOL OF ENGINEERING OF MILWAUKEE.** 109-373 Broadway, Milwaukee, Wis. An Electrical Technicians' Institute.



Adventures of the Auto-Wheel Coaster Club The Circus Parade

Jim, the Club Captain, is a great one for new ideas. When the circus hit town last week, he said the Auto-Wheel Coaster Club "ought to march in that parade." So we all took our Auto-Wheels down to the show-lot, and when the march started we joined in. We hitched on to the biggest elephant in the show and followed along. We didn't have to decorate those Auto-Wheels. They're good-looking to begin with. And they ran along just as smooth as autos. You should have heard the crowd cheer when we passed. "Biggest Hit in the Whole Parade," the folks said. And after it was over five fellows came up and wanted to know where they could get Auto-Wheels. Jim sent them to the local dealer, and they are going to join the Club. Jim has sent to The Buffalo Sled Co. for FREE Club Caps for them, like ours.



This is the famous Auto-Wheel Coaster — and here is the patented Auto-Wheel Convertible Roadster



AS A ROADSTER



AS A COASTER

BOYS—DO YOU WANT WAGONS LIKE THESE? The Auto-Wheel Coaster is a wonder—smooth-running, strong, speedy. The Auto-Wheel Convertible Roadster is two wagons in one—can be changed from a Coaster to Roadster in a second. Send us three dealers' names, telling which one handles the Auto-Wheel. We'll send you Free Felt Pennant and Booklet.

The Buffalo Sled Co.,
159 Schenck Street,
N. TONAWANDA, N. Y.
(In Canada: Preston, Ont.)

Speed Lathe \$5.00 Complete

Swing 7 inches, 24 inch metal bed, hollow spindle, taper Shank centers, 3 inch face plate, spur center for wood turning, three step cone, bearings babbitted, hand wheels on all adjustments, tail stock has screw feed spindle and taper Shank center. **GASOLINE ENGINE MARINE OR STATIONARY** 1/2 horse. Castings with complete working drawings \$8.00. Also 4 horse marine engines. **M. & J. SPECIALTY CO.** 252 South Park St. Pontiac, Mich.

You can be quickly cured, if you **STAMMER**
Send 10 cents coin or stamps for 70-page book on Stammering and Stuttering, "Its Cause and Cure." It tells how I cured myself after stammering for 20 years.
Benjamin N. Bogue, 900 Bogue Bldg., Indianapolis

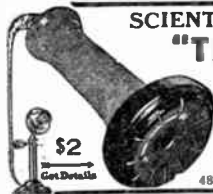

SCIENTIFIC EVOLUTION "THERAPHONE"

High Power Scientific Receiver Earpiece is tuned to the ear. It can't confuse nor fatigue. Absorbs shocks, improves the hearing and conserves time. For Busy, Deaf, Nervous, Privacy and Noise. Guaranteed to suit. (Check or C. O. D.—Export \$2.20). No Agents. The Evolution Phone Co., Inc. 48A Greenwich Ave., New York

Big Money for Boys!



Learn ELECTRICITY

There is a wonderful opportunity right now for boys who like electricity. Boys who are ambitious and will train themselves in spare time can step into positions just as soon as they are ready. Good salaries are offered to start with splendid chances for rapid promotion.

For 28 years the International Correspondence Schools have been training boys for success in electricity and over 200 other subjects. They will help you prepare right at home for a position in the line of electrical work you like best—or in any other work that appeals to you. Thousands of boys, through I. C. S. training, have stepped into fine jobs, but never were opportunities so great as now.

Let the I. C. S. help you. Choose the work you like best in the coupon below, then mark and mail it today. This doesn't obligate you in the least, and it will bring you information that will start you on a successful career. This is your chance. Don't let it slip by. Mark and mail this coupon now.

INTERNATIONAL CORRESPONDENCE SCHOOLS BOX 60588. SCRANTON, PA.

Explain, without obligating me, how I can qualify for the position, or in the subject, before which I mark X.

- | | |
|--|--|
| <input type="checkbox"/> ELECTRICAL ENGINEER | <input type="checkbox"/> CHEMICAL ENGINEER |
| <input type="checkbox"/> Electrician | <input type="checkbox"/> SALESMANSHIP |
| <input type="checkbox"/> Electric Wiring | <input type="checkbox"/> ADVERTISING MAN |
| <input type="checkbox"/> Electric Lighting | <input type="checkbox"/> Window Trimmer |
| <input type="checkbox"/> Electric Car Running | <input type="checkbox"/> Show Card Writer |
| <input type="checkbox"/> Heavy Electric Traction | <input type="checkbox"/> Outdoor Sign Painter |
| <input type="checkbox"/> Electrical Draftsman | <input type="checkbox"/> RAILROADER |
| <input type="checkbox"/> Electric Machine Designer | <input type="checkbox"/> ILLUSTRATOR |
| <input type="checkbox"/> Telegraph Expert | <input type="checkbox"/> DESIGNER |
| <input type="checkbox"/> Practical Telephony | <input type="checkbox"/> BOOKKEEPER |
| <input type="checkbox"/> MECHANICAL ENGINEER | <input type="checkbox"/> Stenographer and Typist |
| <input type="checkbox"/> Mechanical Draftsman | <input type="checkbox"/> Cert. Pub. Accountant |
| <input type="checkbox"/> Ship Draftsman | <input type="checkbox"/> Traffic Management |
| <input type="checkbox"/> Machine Shop Practice | <input type="checkbox"/> Commercial Law |
| <input type="checkbox"/> Toolmaker | <input type="checkbox"/> GOOD ENGLISH |
| <input type="checkbox"/> Gas Engineer | <input type="checkbox"/> STATIONARY ENGINEER |
| <input type="checkbox"/> CIVIL ENGINEER | <input type="checkbox"/> CIVIL SERVICE |
| <input type="checkbox"/> Surveying and Mapping | <input type="checkbox"/> Railway Mail Clerk |
| <input type="checkbox"/> MINE WORKMAN OR ENGR | <input type="checkbox"/> Textile Overseer or Supt. |
| <input type="checkbox"/> ARCHITECT | <input type="checkbox"/> AGRICULTURE |
| <input type="checkbox"/> Architectural Draftsman | <input type="checkbox"/> Navigator |
| <input type="checkbox"/> PLUMBING AND HEATING | <input type="checkbox"/> Penitentiary |
| <input type="checkbox"/> Sheet Metal Worker | <input type="checkbox"/> Automobiles |
| | <input type="checkbox"/> Spanish |
| | <input type="checkbox"/> French |
| | <input type="checkbox"/> Italian |

Name.....
Present Occupation.....
Street and No.....
City..... State.....

18 cents
a package

Camel CIGARETTES



Smokers realize
that the value is in
the cigarettes and do
not expect premiums
or coupons!

Camels are sold everywhere in scientifically sealed packages of 20 cigarettes or ten packages (200 cigarettes) in a glassine-paper-covered carton. We strongly recommend this carton for the home or office supply or when you travel.

Camels supply cigarette contentment beyond anything you ever experienced! You never tasted such full-bodied mellow-mildness; such refreshing, appetizing flavor and coolness. The more Camels you smoke the greater becomes your delight—*Camels are such a cigarette revelation!*

Everything about Camels you find so fascinating is due to their quality—to the expert blend of choice Turkish and choice Domestic tobaccos. You will prefer this blend to either kind of tobacco smoked straight.

You'll say Camels are in a class by themselves—they seem *made to meet your own personal taste* in so many ways!

Freedom from any unpleasant cigaretty after-taste or unpleasant cigaretty odor makes Camels particularly desirable to the most fastidious smokers. And, you smoke Camels as liberally as meets your own wishes, for they never tire your taste! You are always keen for the cigarette satisfaction that makes Camels so attractive.

Compare Camels with any cigarette in the world at any price!

R. J. REYNOLDS TOBACCO COMPANY, Winston-Salem, N. C.



Please mention EVERYDAY ENGINEERING MAGAZINE

Interchangeable Type-Sets For Every Language

Every Business, Every Science and Every Profession

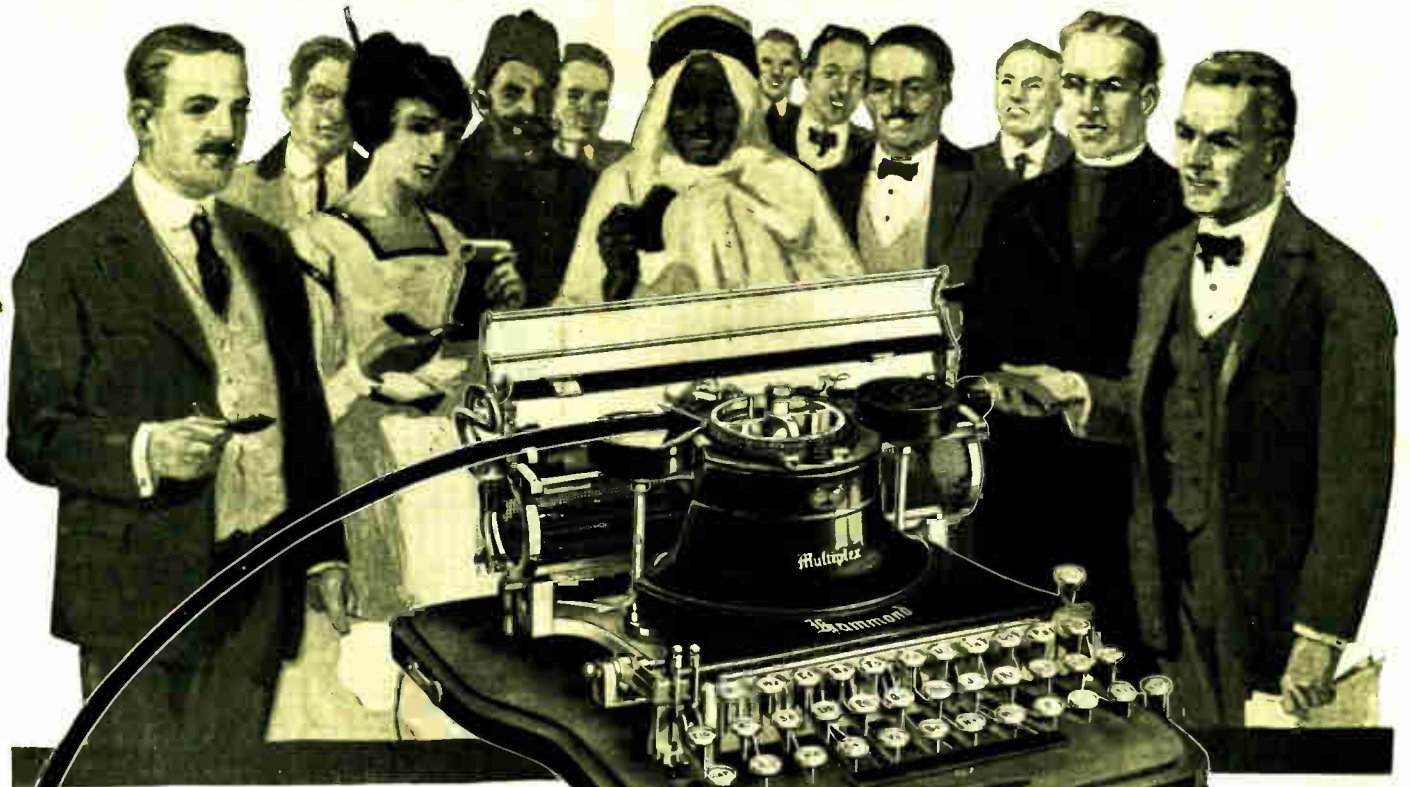

No Other Typewriter
Can Do This:

Make Your Writing T-a-l-k

Just as oratory puts the power of emphasis into the spoken word, so the—

Multiplex Hammond

—puts the all-telling power of emphasis into the written word.

No other typewriter can turn cold type into living, breathing words—words pulsating with the writer's deepest convictions—words expressing to a nicety his most conventional mood—words showing always absolute correctness—in

business, professional or social usage.

Note the several distinctly different type-styles reproduced below—"Just turn the knob" to change:



Only About
11 lbs.

Also—An
Aluminum

PORTABLE Model

For Travelling—for Home.
Full capacity
Ask for Special Folder

All Type Styles ~ All Languages ~ All Sciences
especially represented on one MULTIPLEX
CHANGE TYPE IN A SECOND
FOR BUSINESS EXECUTIVES: — Miniature Type and close

spacing for condensing Loose-leaf Manuals and Index Card work

The Multiplex is *un-*like any other typewriter. Its work is as great an improvement over the typewriter as the earlier typewriter was over the fountain pen, or the fountain pen over the quill. There are over 365 different type-sets, including all languages, to select from.

Mail the Coupon for FREE BOOKLET

It will show you how, with the Multiplex, you can put the force of emphasis into your typed matter—how you can *drive home* with strength of accent the fulness of your argument—how you can write with the same convincing force that you use in speaking—an exclusive feature of the Multiplex. We will also send our pamphlet, "The President and His Typewriter."

HAMMOND TYPEWRITER CO., 585A East 69th St., New York City

Mail this Coupon NOW

"Many Typewriters in One"

Because one machine will write many styles of type and many languages.

Gentlemen: Please send Free Booklets to

Name.....

Address.....

Occupation.....

Inquire about special terms to professionals

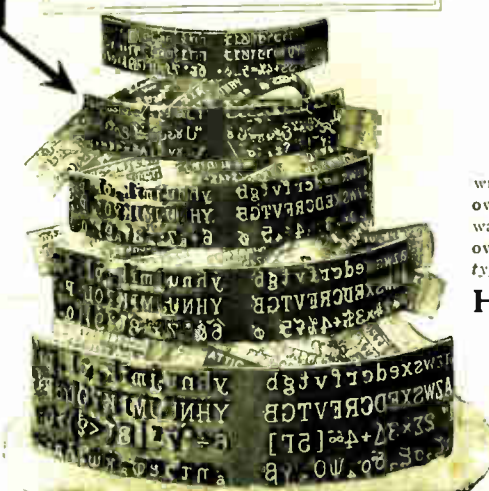

Everything New About Shop Work!



6 Great Volumes

Flexibly bound in American Morocco, gold stamped, six thick volumes, 2300 pages, 2500 photographs, drawings, tables and other explanatory illustrations.

Double Your Earnings

Machinists, tool-makers, designers, pattern-makers, foundrymen, production experts are everywhere in demand. There are big positions and steady work for "Top Notch"ers. Master these practical shop books, written by 27 experts, and double or treble your pay.

Partial List of Contents

Shop Work, Shop Kinks, Gear Cutting, Turret Lathes, Screw Machines, Manufacturing Shop Management, Metallurgy, Welding, Die Making, Metal Stamping, Die Work, Mal-Punch, Foundry Work, Patternable Practice, Forging Practice, Mechanical Drawing, Machine Drawing and Design, Automobile Shop Work.

Examine Them Free

The sixth edition of Modern Shop Practice is now off the press. Let us send you the six volumes for seven days' free examination—not a penny in advance. See how 27 mechanical engineers, designers, and specialists in shop methods have given you the benefit of their vast experience. Read what they say about production, metallurgy, welding, tool making, tool design, die making, metal stamping, foundry work, forging, pattern making, mechanical and machine drawing, speed lathes, planers, metal drillers, grinders, milling machines, stamping machines, die presses, etc. Then after free examination, send the books back unless you are convinced they will raise your pay.

Jump Ahead The more you know about machine shop practice, the more money you will earn. Don't depend on your hands alone to earn your pay.

Make your head work for you. Equip yourself with knowledge that designs machinery, that does the *big* work. These six massive volumes tell everything you want to know about every phase of shop work. Written in clear, non-technical language.

Only 7c a Day

These six magnificent volumes are flexibly bound in American Morocco, gold stamped. Contain 2300 pages, 2500 illustrations, photographs, drawings, explanatory diagrams, tables, etc. Up-to-date labor saving methods that big manufacturers have spent thousands of dollars to learn. Facts that you can use in your every day work at once. Examine the books free. Then if satisfied, pay for them at rate of 7c a day.

No Money in Advance

Not a cent in advance. See the books in your own home first. Read them for seven whole days before you decide. Make no deposit—assume no obligation. If you are not more than satisfied—send them back and you won't owe a cent. If you are sure they will raise your pay—send only \$2

within seven days and then \$2 a month until the special introductory price of \$19.80 has been paid. (Regular price \$30.) With each set we give you Free a year's Consulting Membership in the American Technical Society. (Worth \$12.) Mail coupon for the books now. Send no money.

AMERICAN TECHNICAL SOCIETY
Dept. M-356
CHICAGO, U. S. A.

AMERICAN TECHNICAL SOCIETY
Dept. M-356, CHICAGO, U. S. A.

Please send me the six-volume set of "Modern Shop Practice" for seven days' examination, shipping charges collect. If I decide to buy, I will send \$2 within seven days and balance at \$2 a month until \$19.80 has been paid. Then you will send me a receipt showing that the set of books and the Consulting Membership are mine, and fully paid for. If I think I can get along without the books, I will return them at your expense after seven days.

Name.....
Address.....
Reference.....