



02342

MAY-JUNE
1977
\$1.00

FOR
BEGINNERS
**UNDERSTANDING
SIGNAL
GENERATORS**
OUR BASIC COURSE

elementary Electronics

SPECIAL DXing FEATURES

Pulling in Out-of-Range
TV CHANNELS

(See page 45)

Tuning in the
**FORGOTTEN
CONTINENT**

(See page 62)

Build Ma Bell's
LIP ZIPPER

No hassle listening to
radio-telephone

(See page 69)

Use Your Calculator
As an RF Signal Generator

(See page 67)

HAM RADIO KIT



Heath HW-8 QRP Code
Transceiver challenges skill

TOUCH TONE



Push-button dialing
if your phone line
can handle it

ALTERNATOR TESTER

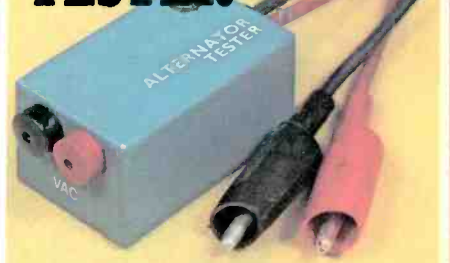

Low cost test unit
pinpoints diode
rectifier troubles

If you've ever said...

"There must be a better

one of our free Career Booklets may provide the opportunity you've been looking for.

It happens to all of us, sooner or later. No matter what kind of job we have.

One day, it suddenly strikes home that we're going to have to work for a living, the rest of our lives. And most of us are horrified at the thought of forever being locked into the jobs we now hold.

"Surely," we tell ourselves, "there must be a way to get more satisfaction out of working. Surely, there must be a way to find a job that's more enjoyable."

"Surely," in other words, "there must be a better way to earn a living!"

If you, too, have been thinking these same thoughts, you'll find one of our free Career Booklets very helpful at this time. We invite you to send for one.

Your free booklet will describe the opportunities you might expect in one of the career fields listed on our card and coupon.

It will also explain exactly why ICS can pre-



way to earn a living..”

pare you for this new career field...right in your own home...in your spare time...regardless of your education or past experience.

Of course, no school — not even ICS — can guarantee you a better job. But ICS *can* give you the first-rate training you need — especially if you're interested in one of the growing careers where ICS concentrates its training. Like Electrician. Engineer. Auto Mechanic. TV Repairman. Air Conditioning Serviceman.

Along with your Career Booklet, you'll also receive a free Demonstration Lesson.

Please bear in mind that ICS has a long and distinguished record of success. In fact, since 1890, millions of men and women around the world have turned to ICS for career training.

More than 70 of America's largest 100 corporations (including Bethlehem Steel, 3M, Union Carbide, Weyerhaeuser, and International Paper) use ICS training for their own employees.

Earn a degree without going to college

And the ICS Center for Degree Studies is authorized by the Pennsylvania Department of Education to grant the Associate in Specialized Business degree in Accounting and Business Management, and the Associate in Specialized Technology degree in Civil, Mechanical, Electrical, and Chemical Engineering Technologies.

These degree programs are not mere stepping-stones to higher education nor are they primarily intended for transfer toward more advanced degrees. They are practical, career-oriented programs designed to help you reach your objectives without further academic training.

If you already have some college education, you may be able to receive advanced standing toward your degree. With a degree from ICS, you'll be able to apply with pride for jobs that call for career training.

An Ideal Way to Learn

Whether you choose a degree program or a non-degree program, as an ICS student you study at home, on your own schedule. You waste no time

traveling to and from class. And you never have to miss a paycheck.

But you're never alone. Skilled instructors are ready to help you.

If you ever have doubts or problems or just want to talk to an instructor, you can call ICS from anywhere in the continental United States and Canada using our toll-free Dial-a-Question® service.

No one can promise success, but if you *want* more — more money, more security, more day-to-day satisfaction and more future — our free Career Booklet and free Demonstration Lesson can help you get started in the right direction. Just check the box next to the field that interests you most and mail the card or coupon today. There's no obligation.

Remember, it's your life. You might as well make the most of it.

© 1976 Intext, Inc.

| FOR A FREE CAREER BOOKLET & DEMO LESSON, CHECK BELOW. | |
|--|---|
| <input type="checkbox"/> Electrician | <input type="checkbox"/> Automotive Mechanics |
| <input type="checkbox"/> Engineering | <input type="checkbox"/> Business Management |
| <input type="checkbox"/> Accounting | <input type="checkbox"/> Civil Engineering |
| <input type="checkbox"/> Drafting | <input type="checkbox"/> Interior Decorating |
| <input type="checkbox"/> Electronics Technician | <input type="checkbox"/> Construction Electrician |
| <input type="checkbox"/> TV Service & Repair | <input type="checkbox"/> Appliance Service & Repair |
| <input type="checkbox"/> Surveying & Mapping | <input type="checkbox"/> Income Tax |
| <input type="checkbox"/> Diesel Mechanic | <input type="checkbox"/> Motel/Restaurant Mgt. |
| <input type="checkbox"/> Air Conditioning & Refrigeration | <input type="checkbox"/> Mechanical Engineering |
| | <input type="checkbox"/> High School |
| EARN A DEGREE WITHOUT GOING TO COLLEGE | |
| Business Programs: | Engineering Technologies: |
| <input type="checkbox"/> Accounting | <input type="checkbox"/> Civil |
| <input type="checkbox"/> Business Management | <input type="checkbox"/> Mechanical |
| | <input type="checkbox"/> Electrical |
| | <input type="checkbox"/> Chemical |
| The ICS Center for Degree Studies is authorized by the Pennsylvania Department of Education to offer career programs at home leading to Associate in Specialized Business and Associate in Specialized Technology degrees. For more information, check the field of your choice above. | |
| Name _____ | Age _____ |
| Address _____ | |
| City _____ | |
| State _____ | Zip _____ |
| Phone _____ | |
| ICS XA105D | |
| INTERNATIONAL CORRESPONDENCE SCHOOLS SCRANTON, PA. 18515 | |

VETERANS: TAKEN FOR CAREER PURPOSES. ICS PROGRAMS QUALIFY FOR VA BENEFITS. CANADIAN RESIDENTS USE SCRANTON, PA. ADDRESS FOR SERVICE FROM ICS CANADIAN, LTD. IN HAWAII: 931 UNIVERSITY AVE., HONOLULU, HAWAII 96814.

elementary electronics

May/June 1977
Volume 17, No. 3

Dedicated to America's Electronics Hobbyists—Including Electronics Digest®

SPECIAL DXING FEATURES

- 34 DX Central Reporting—*Don Jensen previews Britain's Silver Jubilee*
- ☆ 45 Breaking the TV Distance Barrier—you can get far-out TV on your home set
- ☆ 62 DXing the Forgotten Continent—*North America offers some rare and exotic QSLs*

PROBLEM-SOLVING CONSTRUCTION PROJECTS

- ☆ 49 Add Tone to Your Phone—*easy-to-install touch-tone pads for your telephone*
- 52 Imp-Match—*fast feeding for high-impedance circuits from low-impedance mikes*
- ☆ 55 Alternator Tester—*warns of approaching breakdowns*
- ☆ 69 Ma Bell's Lip-Zipper—*smooth listening to mobile telephone talk*
- 75 Checkerboard Tester—*one-evening project makes a quick-checker for diodes, LEDs, and lots more*
- 81 Touch 'N' Dim—*simple circuit controls 300 watts of light*

CB ON THE MOVE

- 12 CB Buzzin' Bee—*news from the CB front*
- ☆ 14 CB Xcvr Checkout—*bench test reports on seven new 40-channel transceivers*
- 68 Kathi's CB Carousel—*all the info on one of the first 40-channel rigs*
- 76 CB New Products—*new CB equipment to keep you 10-4ing*
- 79 CB New Products—*more goodies for Good Buddies*

THE WIDE WORLD OF HAM RADIO

- ☆ 53 e/e assembles the—*Heath HW-8 low power transceiver*
- 71 The Youngest Ham—*5-year-old goes on the air*

EVERYDAY ELECTRONICS

- ☆ 67 RF From Your Calculator—*lets it double as a handy signal generator*
- 74 e/e checks out the—*Radio Shack TV Scoreboard*

THEORY OLD, THEORY NEW

- 65 Antique Radio Corner—*Jim Fred explains the workings of the old reflex circuits*
- ☆ 83 Basic Course—*understanding how signal generators work*

OUR REGULAR DEPARTMENTS

- 6 Hey, Look Me Over—*new electronic products*
- 18 Ask Hank, He Knows—*he solves your problems*
- 22 Bookmark—*by Bookworm*
- 24 Newscan—*what's happening in electronics*
- 72 Computer Readout—*Norm Meyers describes books on microcomputers*
- 90 Literature Library

☆ Cover Feature



AUTHORS IN THIS ISSUE

Bob Baxter, Christine Begole, Anthony Caristi, James Fred, Herb Friedman, Morrie Goldman, Hugh Gordon, Harry L. Helms, Jr., Don Jensen, Kathi Martin, Norman Myers, Charles Rakes, Hank Scott, C. M. Stanbury, II, Martin Weinstein, and the ELEMENTARY ELECTRONICS Editorial Staff.



Photo by Walter Herstatt

THE STAFF

Editor-in-Chief and
Electronics Group Coordinator
Julian S. Martin, WA2CQL
Assistant to Editor-in-Chief
Alan H. Rose, K2RHK

Technical Editor
**Charles Graham, W1HFI,
2W3175**

Communications Editor
**Morgan W. Godwin, W4WFL,
KCR6444**

Audio Editor
Christine Begole, KFC3553

Citizens Band Editor
Kathi Martin, KGK3916

Workbench Editor
Hank Scott

Art Director
Ralph Rubino

Assistant Art Director
Augustus Ginnocchio

Cover Art Director
Irving Bernstein

Art Assistants
**Caroline Imparato
Robert Modero
Joni Erlon**

Advertising Director
David J. Miller, KCX1268

Advertising/Research Associate
Jyll Holzman

Production Director
Carl Bartee

Production Manager
Carole Dixon

Assistant Production Manager
Mary Carfagno

Newsstand Circulation
Director
Don Gabree

Subscription Circulation &
Marketing Director
Robert V. Enlow

Subscription Circulation Manager
Gene Slawson

Director of Market
Development
James C. Weakley

President and Publisher
Joel Davis

Vice President and
General Manager
Leonard F. Pinto

Vice President and Treasurer
Victor C. Stabile, KBP0681

ELEMENTARY ELECTRONICS is published bi-monthly by Davis Publications, Inc. Editorial and Executive offices: 229 Park Ave. So., New York, NY 10003; all subscription orders and mail regarding subscriptions should be sent to P.O. Box 2600, Greenwich, CT 06830. One-year subscription (six issues)—\$6.50; two-year subscription (12 issues)—\$13.00; three-year subscription (18 issues)—\$19.00; and four-year subscription (24 issues)—\$25.00. Add 67 cents postage for each year for U.S. possessions and Canada; \$1.34 each year, all other countries. For change of address, please advise 4 to 6 weeks before moving. Send us your current mailing label with new address. Advertising offices: New York, 229 Park Avenue South, 212-673-1300; Chicago, 520 N. Michigan Ave., 312-527-0330; Los Angeles, J. E. Publishers' Rep. Co., 8732 Sunset Blvd., 213-659-3810. Second-class postage paid at New York, NY and at additional mailing office. Copyright 1977 by Davis Publications, Inc.

The 40-channel Cobra 29XLR. From the sleek brushed chrome face to the matte black housing, it's a beauty. But its beauty is more than skin deep. Because inside, this CB has the guts to pack a powerful punch.

The illuminated 3-in-1 meter tells you exactly how much power you're pushing out. And pulling in. It also measures the system's efficiency with an SWR check. In short, this Cobra's meter lets you keep an eye on your ears.

The Digital Channel Selector shows you the channel you're on in large LED numerals that can be read clearly in any light. There's also switchable noise blanking to reject short-pulse noise other systems can't block. The built-in power of DynaMike Plus. Automatic noise limiting

and Delta Tuning for clearer reception.

And the added protection of Cobra's nationwide network of Authorized Service Centers with factory-trained technicians to help you with installation, service and advice.

The Cobra 29XLR. It has 40 channels. And it has what it takes to improve communications by punching through loud and clear on every one of them. That's the beauty of it.



Punches through loud and clear.

Cobra Communications Products
DYNASCAN CORPORATION

6460 W. Cortland St., Chicago, Illinois 60635

Write for color brochure

EXPORTERS: Empire • Plainview, N.Y. • CANADA: Atlas Electronics • Toronto

CIRCLE 30 ON READER SERVICE COUPON

PUNCH AND BEAUTY



Hey, look me over

Showcase of New Products

Data Handler

Ideal for computer hobbyists and anyone with an interest in computer programming, Western Data System has developed the Data Handler. It is a complete system on a single PC board

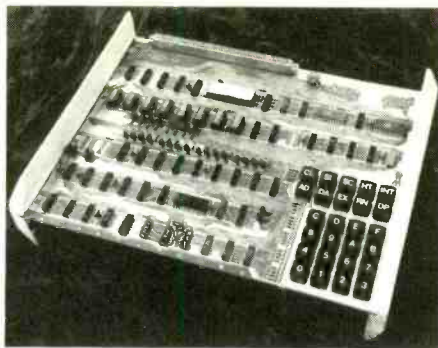

CIRCLE 63 ON READER SERVICE COUPON

that combines the MOS Technology 6502 microprocessor with the latest state-of-

the-art technology. The Data Handler combines multi-functions with the ease of operation that makes it ideal for the beginning computer enthusiast. The Data Handler can be programmed to control any eight devices simultaneously—everything from monitoring solar heating systems and lawn sprinklers to game playing and measuring cocktails at parties. The design of the Data Handler enables it to operate at very high speeds as a stand-alone microcomputer or dedicated controller for such high speed devices as disc peripherals. External TTY or terminals are not needed since this computer contains 26 keyboard switches for full function hardware front panel control. Personal expandability of the system is achieved by using the Altair/IMSAI peripherals. Any of these may be used directly on the Data Handler PC board, or further system expansion may be accomplished with the use of the Altair mother board. The Data Handler comes in easy to assemble kit form with complete documentation on how to use, test and expand the system. The Data Handler kit is available from Western Data Systems for only \$179.95. For further information, write to Western Data Systems, 3650 Charles Street, Suite G, Santa Clara, CA 95050.

for the Experimenter!

INTERNATIONAL CRYSTALS and KITS



OF-1 OSCILLATOR

\$3.25 ea.

The OF-1 oscillator is a resistor/capacitor circuit providing oscillation over a range of frequencies by inserting the desired crystal. 2 to 22 MHz, OF-1 LO, Cat. No. 035108. 18 to 60 MHz, OF-1 HI, Cat. No. 035109. Specify when ordering.

.02% Calibration Tolerance

EXPERIMENTER CRYSTALS

(HC 6/U Holder)

\$4.25 ea.



Cat. No. Specifications

031300 3 to 20 MHz — For use in OF-1L OSC Specify when ordering.

031310 20 to 60 MHz — For use in OF-1H OSC Specify when ordering.

MX-1 Transistor RF Mixer

3 to 20 MHz, Cat. No. 035105

20 to 170 MHz, Cat. No. 035106

\$4.50 ea.

SAX-1 Transistor RF Amp

3 to 20 MHz, Cat. No. 035102

20 to 170 MHz, Cat. No. 035103

\$4.50 ea.

BAX-1 Broadband Amp

20 Hz to 150 MHz, Cat. No. 035107

\$4.75 ea.

Enclose payment with order (no C.O.D.). Shipping and postage (inside U.S., Canada and Mexico only) will be prepaid by International. Prices quoted for U.S., Canada and Mexico orders only. Orders for shipment to other countries will be quoted on request. Price subject to change. Address orders to:

M/S Dept. PO. Box 32497
Oklahoma City, Oklahoma 73132

WRITE FOR BROCHURE

International Crystal Mfg. Co., Inc.
10 North Lee Oklahoma City, Oklahoma 73102



CIRCLE 20 ON READER SERVICE COUPON



MICRO MINI MIKE™ WIRELESS MICROPHONE

World's smallest, solid state, self-contained. Picks up and transmits most sounds without wires up to 300 ft. through FM Radio. Use as mike, ampf., alarm & alert sys., hot line, baby sitter, etc. Money back guar. B/A, M/C cds, COD ok. \$18.95 plus \$1.00 post. & hdig. Calif. res. add tax. Mail orders only. Qty. Disc. Avail. AMC SALES, INC. Dept. M24 Box 928 • Downey, Calif. 90241

SIZE
2 1/4" x 3/4" x 1/2"

FRIENDS DON'T LET FRIENDS DRIVE DRUNK.



U.S. DEPARTMENT OF TRANSPORTATION • NATIONAL HIGHWAY TRAFFIC SAFETY ADMINISTRATION

Build the REAL THING-Yourself!

Whether your thing is nautical, a Pow'r Pup or a suburban tractor, the CRAFT PRINT DO-IT-YOURSELF Division of Davis Publications has it for you. Order your new catalog today and go a-crafting!

MAIL TODAY

BOAT BUILDER, Craft Print Division
Davis Publications, Inc., Dept. EE57
229 Park Avenue S., New York, N.Y. 10003

Please send me _____ copy(ies) of the
Craft Print Catalog for only \$1.00 each... CUM-
PLETELY REFUNDED WITH FIRST ORDER.

NAME _____

ADDRESS _____

CITY _____ STATE _____ ZIP _____

If you can't afford it—make it yourself.

Get Top Mileage
from your own
craft skills.

GREAT
EASY-TO-BUILD
PLANS

ONLY \$1.00



CIRCLE 70 ON READER SERVICE COUPON

AC house current and converts to a full 13.8 VDC output. Both primary and secondary circuits are fused to prevent overloading. An On-Off pilot lamp and push-type binding posts for easy connections are additional features. The compact unit measures 7-in. x 4 1/2-in. x 3-in., weighs 6 1/2 lbs. It sells for \$31.95 and the catalog No. is 18-580. For more information on the power supply and

(Continued on page 10)



Shakespeare's Double Trucker Antenna.TM Professional. Co-phased. And no strong two ways without it.

Ask a trucker about the best antenna team for your CB operations. He knows the Citizens Band. And he knows the performance of Shakespeare's Double Trucker Antenna. Because the men who ride for a living can't settle for anything small-time in their signal power.

Those two solid fiberglass whips stand firmly upright for maximum range and clarity. Perfectly co-phased through Shakespeare's exclusive Diplexer phasing harness. Pre-tested and pre-tuned for the 40 channel band. Delivering the kind of performance true Knights of the Road depend on.

Shakespeare

**The best antenna going.
And coming.**

Shakespeare's Double Trucker Antenna, Style 464-1/ Installs quickly and easily on any horizontal bar up to 3/4". Comes complete with corrosion proof mirror mount, cable and all connectors. Under \$35.



HUSTLER

"Hustloff"

STOP RIP-OFF

—three models—

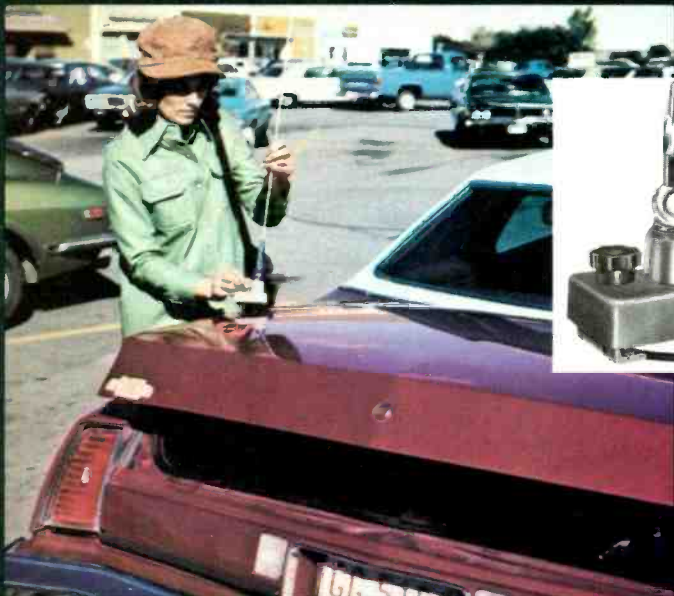

**New Hustle-away
CB antenna
eliminates faulty
grounds—erratic
SWR of magnetics
and hinged flip-outs!**

Outsmart the rip-off, quick and easy! Turn the knob and store your antenna out of sight. To remount, slip the antenna back in place and spin the knob. It's that quick, that easy! And most important, you get complete freedom from erratic grounding, questionable SWR that can cause CB radio failure. The Hustler design is positive, definite and equal in electrical and mechanical performance to the best permanently mounted mobile antennas.

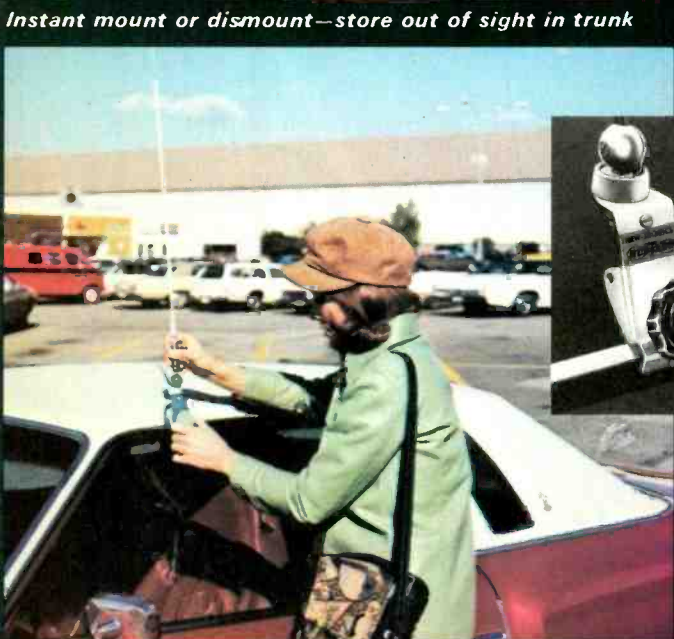

Instant mount or dismount—store out of sight in car

TRUNK LIP MOUNT "HUSTLOFF"

Stainless steel 48" antenna and mount—

Model HT-27.

Heavy duty 55" antenna and mount—

Model HHT-27.

RAIN GUTTER MOUNT "HUSTLOFF"

Fiberglass 42" antenna and mount—Model RFG

All versions include cable, connectors attached, ready to operate.



Available from all distributors
who recognize the best!

**new·tronics
corporation**
15800 Commerce Park Drive
Brookpark, Ohio 44142



CIRCLE 26 ON READER SERVICE COUPON

www.americanradiohistory.com

OUTSIDE ANTENNA NOT PERMITTED?

here's your answer!

HUSTLER "HOMING PIGEON"

PATENT APPLIED FOR By New-Tronics Corp.



The "Homing Pigeon" is your antenna answer to operating CB from any location, condominium, office, home, apartment, motel etc. No installation required; antenna is supported between floor and ceiling like a pole lamp. Communications range is equal or superior to better mobile installations. The "Homing Pigeon" incorporates a unique method of easily and quickly adjusting SWR. One setting covers all channels for outstanding performance with any 23 or 40 channel CB radio, AM or SSB. Antenna is supplied complete with 17' coax, connectors attached, ready to use. Model HP-27.

"the home of originals"



AVAILABLE FROM ALL DISTRIBUTORS
WHO RECOGNIZE THE BEST!

new-tronics corporation

15800 Commerce Park Drive
Brookpark, Ohio 44142

CIRCLE 28 ON READER SERVICE COUPON
www.americanradiohistory.com

AVAILABLE IN CANADA FROM
SUPERIOR
SUPERIOR ELECTRONICS INC.



Model HP-27

Two-way improvement



New fold-down RV antenna provides full 40-channel capability. Also available for luggage racks.



Has your CB ever let you down? Right when you needed it the most?

It could be that "good deal" antenna. Or the lightweight mike that came with the set. To get the most out of your CB, switch to Turner at both ends.

Try a Turner amplified mike. You'll find out how much talk power your set can really deliver. For full range when you need it.

Make sure your antenna is dependable. Step up to a Turner. Turner builds them tougher. There are 43 models for all kinds of base and mobile installations.

Ask anybody who has been around CB for awhile. They know us. Wherever CB is sold, Turner.

The talk of the road

TURNER MICROPHONES ANTENNAS

CONRAC
CORPORATION

716 Oakland Road N.E., Cedar Rapids, Iowa 52402

CIRCLE 24 ON READER SERVICE COUPON

HEY, LOOK ME OVER

(Continued from page 6)

other GC products, write to GC Electronics, 400 South Wyman, Rockford, IL 61101.

Time to Time

You can keep telephone conversations short and your telephone bill down by using the GRS Model 100 Digital Telephone Timer. This new solid-state timing device starts and stops with a push of a button. It features a bright, 3-digit LED display that indicates tens of minutes, minutes and tenths of minutes. Power from 4 penlite Alkaline batteries (not included) that will keep the GRS Timer timing for about a year under average use. The Digital Telephone Timer



CIRCLE 61 ON READER SERVICE COUPON

is fully portable and comes with a special bracket to mount on almost any phone. When not used to time phone calls, it can be simply removed from bracket and carried in pocket or purse and can be used to time conferences, speeches, in the dark room, plus anywhere else a timer is needed. The complete price with bracket carries a manufacturer's suggested retail price of \$29.95 (less batteries) and it can be ordered F.O.B. Dallas, Texas from GRS Instruments Inc., 8730 King George Drive, Dallas, Texas 75235.

Cordless Tape-Head Demagnetizer

A new self-contained Robins Cordless Head Demagnetizer and Cleaner Cartridge designed especially for home and auto eight-track cartridge players is compact, shaped like an 8-track tape cartridge, and is easy to use. Simply insert it into the tape player and the demagnetizing and cleaning starts immediately. A built-in magnetic shield keeper is slowly brought between a rotating ferrite magnet and the tape head to reduce the amplitude of the magnetic field, allowing it to taper off and eliminate residual mag-

(Continued on page 13)

BUILD 20 RADIO and Electronics Circuits

Reg. U. S.
Pat. Off.



Training Electronics Technicians Since 1946

PROGRESSIVE HOME RADIO-T.V. COURSE

Now Includes

- ★ 12 RECEIVERS
- ★ 3 TRANSMITTERS
- ★ SQ. WAVE GENERATOR
- ★ SIGNAL TRACER
- ★ AMPLIFIER
- ★ SIGNAL INJECTOR
- ★ CODE OSCILLATOR
- ★ No Knowledge of Radio Necessary
- ★ No Additional Parts or Tools Needed
- ★ Solid State Circuits
- ★ Vacuum Tube Circuits

**YOU DON'T HAVE TO SPEND
HUNDREDS OF DOLLARS FOR A RADIO COURSE**

The "Edu-Kit" offers you an outstanding PRACTICAL HOME RADIO COURSE at a rock-bottom price. Our Kit is designed to train Radio & Electronics Technicians, making use of the most modern methods of home training. You will learn radio theory, construction practice and servicing. THIS IS A COMPLETE RADIO COURSE IN EVERY DETAIL. You will learn how to build radios, using regular schematics; how to wire and solder in a professional manner; how to service radios. You will work with the standard type of punched metal chassis as well as the latest development of Printed Circuit chassis.

You will learn the basic principles of radio. You will construct, study and work with RF and AF amplifiers and oscillators, detectors, rectifiers, test equipment. You will learn and practice code using the Progressive Code Oscillator. You will learn and practice trouble-shooting, using the Progressive Signal Tracer, Progressive Signal Injector, Progressive Dynamic Radio & Electronics Tester, Square Wave Generator and the accompanying instructional material.

You will receive training for the Novice, Technician and General Classes of F.C.C. Radio Amateur Licenses. You will build Receiver, Transmitter, Square Wave Generator, Code Oscillator, Signal Tracer and Signal Injector circuits, and learn how to operate them. You will receive an excellent background for television, Hi-Fi and Electronics.

Absolutely no previous knowledge of radio or science is required. The "Edu-Kit" is the product of many years of teaching and engineering experience. The "Edu-Kit" will provide you with a basic education in Electronics and Radio, worth many times the low price you pay. The Signal Tracer alone is worth more than the price of the kit.

THE KIT FOR EVERYONE

You do not need the slightest background in radio or science. Whether you are interested in Radio & Electronics because you want an interesting hobby, a well paying business or a job with a future, you will find the "Edu-Kit" a worth-while investment. Many thousands of individuals of all

ages and backgrounds have successfully used the "Edu-Kit" in more than 79 countries of the world. The "Edu-Kit" has been carefully designed, step by step, so that you cannot make a mistake. The "Edu-Kit" allows you to teach yourself at your own rate. No instructor is necessary.

PROGRESSIVE TEACHING METHOD

The Progressive Radio "Edu-Kit" is the foremost educational radio kit in the world, and is universally accepted as the standard in the field of electronics training. The "Edu-Kit" uses the modern educational principle of "Learn by Doing." Therefore you construct, learn schematics, study theory, practice trouble shooting—all in a closely integrated program designed to provide an easily-learned, thorough and interesting background in radio.

You begin by examining the various radio parts of the "Edu-Kit." You then learn the function, theory and wiring of these parts. Then you build a simple radio. With this first set you will enjoy listening to regular broadcast stations, learn theory, practice testing and trouble-shooting. Then you build a more advanced radio, learn more advanced theory and techniques. Gradually, in a progressive manner, and at your own rate, you will find yourself constructing more advanced multi-tube radio circuits, and doing work like a Professional Radio Technician.

Included in the "Edu-Kit" course are Receiver, Transmitter, Code Oscillator, Signal Tracer, Square Wave Generator and Signal Injector Circuits. These are not unprofessional "breadboard" experiments, but genuine radio circuits, constructed by means of professional wiring and soldering on metal chassis, plus the new method of radio construction known as "Printed Circuitry." These circuits operate on your regular AC or DC house current.

THE "EDU-KIT" IS COMPLETE

You will receive all parts and instructions necessary to build twenty different radio and electronics circuits, each guaranteed to operate. Our Kits contain tubes, tube sockets, variable, electrolytic, mica, ceramic and paper dielectric condensers, resistors, the strips, hardware, tubing, punched metal chassis, Instruction Manuals, hook-up wire, solder, selenium rectifiers, coils, volume controls, switches, solid state devices, etc.

In addition, you receive Printed Circuit materials, including Printed Circuit chassis, special tube sockets, hardware and instructions. You also receive a useful set of tools, a professional electric soldering iron, and a self-powered Dynamic Radio and Electronics Tester. The "Edu-Kit" also includes Code Instructions and the Progressive Code Oscillator, in addition to F.C.C. Radio Amateur License training. You will also receive lessons for servicing with the Progressive Signal Tracer and the Progressive Signal Injector, a High Fidelity Guide and a Quiz Book. You receive Membership in Radio-TV Club, Free Consultation Service, Certificate of Merit and Discount Privileges. You receive all parts, tools, instructions, etc. Everything is yours to keep.

PRINTED CIRCUITRY

At no increase in price, the "Edu-Kit" now includes Printed Circuitry. You build a Printed Circuit Signal Injector, a unique servicing instrument that can detect many Radio and TV troubles. This revolutionary new technique of radio construction is now becoming popular in commercial radio and TV sets.

A Printed Circuit is a special insulated chassis on which has been deposited a conducting material which takes the place of wiring. The various parts are merely plugged in and soldered to terminals.

Printed Circuitry is the basis of modern Automation Electronics. A knowledge of this subject is a necessity today for anyone interested in Electronics.

FREE EXTRAS

• SET OF TOOLS

- SOLDERING IRON
- ELECTRONICS TESTER
- PLIERS-CUTTERS
- VALUABLE DISCOUNT CARD
- CERTIFICATE OF MERIT
- TESTER INSTRUCTION MANUAL
- HIGH FIDELITY GUIDE • QUIZZES
- TELEVISION BOOK • RADIO
- TROUBLE-SHOOTING BOOK
- MEMBERSHIP IN RADIO-TV CLUB:
- CONSULTATION SERVICE • FCC
- AMATEUR LICENSE TRAINING
- PRINTED CIRCUITRY

SERVICING LESSONS

You will learn trouble-shooting and servicing in a progressive manner. You will practice repairs on the sets that you construct. You will learn symptoms and causes of trouble in home, portable and car radios. You will learn how to use the professional Signal Tracer, the unique Signal Injector and the Dynamic Radio & Electronics Tester. While you are learning in this practical way, you will be able to do many a repair job for your friends and neighbors, and charge fees which will far exceed the price of the "Edu-Kit." Our Consultation Service will help you with any technical problems you may have.

FROM OUR MAIL BAG

J. Stataitis, of 25 Poplar Pl., Waterbury, Conn., writes: "I have repaired several sets for my friends, and made money. The "Edu-Kit" paid for itself. I was ready to spend \$240 for a Course, but I found your ad and sent for your Kit."

Ben Valerio, P. O. Box 21, Magna, Utah: "The Edu-Kits are wonderful. Here I am sending you the questions and also the answers for them. I have been in Radio for the last seven years, but like to work with Radio Kits, and like to build Radio Testing Equipment. I enjoyed every minute I worked with the different kits; the Signal Tracer works fine. Also like to let you know that I feel proud of becoming a member of your Radio-TV Club."

Robert L. Shuff, 1534 Monroe Ave., Huntington, W. Va.: "Thought I would drop you a few lines to say that I received my Edu-Kit, and was really amazed that such a bargain can be had at such a low price. I have already started repairing radios and phonographs. My friends were really surprised to see me get into the swing of it so quickly. The Trouble-shooting Tester that comes with the Kit is really swell, and finds the trouble, if there is any to be found."

Progressive "Edu-Kits" Inc., 1189 Broadway, Dept. 584DJ Hewlett, N.Y. 11557

Please rush me free literature describing the Progressive Radio-TV Course with Edu-Kits. No Salesman will call.

NAME

ADDRESS

CITY & STATE ZIP

PROGRESSIVE "EDU-KITS" INC.

1189 Broadway, Dept. 584DJ Hewlett, N.Y. 11557

CIRCLE 15 ON READER SERVICE COUPON



BY CHRISTINE BEGOLE, KFC3553

☐ Greetings, good buddies! Hope the first touches of spring fever have hit you and you're out modulating more than ever—it's a great time to catch up with what's been happening to your road buddies while they've been in seeming hibernation all winter. You'd be surprised at the stories you'll hear.

CB Fare Is Everywhere

For a change of pace from trading baseball cards, you can now trade CB cards instead. Along with the usual piece of bubble gum, Fleer Corporation has packaged up a whole assortment of cartoons which show scenes from the perpetual relationship between truckers on the road and



(who else?) Smokey the Bear. Also, you can probably find a CB notebook like the one sent us by Ellen Hudson of Chapel Hill, N.C. at stationery stores. It's full of 10-codes and such which you'll find interesting and amusing. "What's next?" you ask. All I can say is, "Who knows?"

Watch Out For the Crunch

I recently got a five-page letter from an American CB'er stationed in Bad Kreuznach, Germany. Howard "Ice Man" Alpaugh had two interesting bits of news to report. He writes, "We want everyone to know that CB is not just an American thing. There are some differences in Germany though. The following rules apply: Output: 500-800 milliwatts; Input: 2 watts; Channels: 4-15 only; Fees: \$2.25 monthly for a mobile, \$6.75 monthly for a base station; Restrictions: No power mikes, no single sideband, no beam antennas, no skip, and no talking outside West Germany. The penalties imposed for failure to comply are strict. They include confiscation of all equipment, and fines up to \$2200.00! If the rig is impounded, the owner is invited to go to Mainz, Germany to watch it being pressed into a mass of metal about 8 inches by 8 inches and one inch thick. You may even take your 'rig' home after this. I guess that is the ultimate insult."

Ice Man also writes, "On Saturday October 30, 1976, the Bad Kreuznach German/American CB Radio Club held a fund-raising party for the benefit of the Waisenhaus orphanage in Bad Kreuznach. The day began at 12 noon with opening remarks and presentation by local merchants and CB dealers. At 4 p.m. the games of chance and raffles were started. By 6 p.m. all the raffle tickets were sold and money was pouring in. At 9 p.m. Rafaela Alpaugh (Ice Man's wife) was named Miss CB 1976 of the Rhineland Phalz District. She was presented with a bouquet of red roses and a basket filled

with fruit, wine and cheese. By midnight the amount raised during the day was totalled: the contribution made to the orphanage was 525 German Marks (\$225.00).

P.S. There are plans for a Europe-Wide CB Break, to be held in May 1977, and the liaison of the clubs involved will be another demonstration of the cooperation between the participating European countries and the American personnel stationed there."

All I can say is congratulations to all who helped with the event and good luck!

A Rose By Any Other Name

Riddle: When is the Citizens Radio Service not the Citizens Radio Service? Answer: When it turns into the Personal Radio Service.

Now that I've totally confused an already-very-confusing matter let me try to set things straight. Until January of this year FCC Rules and Regulations, Part 95 covered Class A, Class C, and Class D licenses. The sum total of Class A, Class C, and Class D operators was known as the Citizen's Radio Service. All licensed operators were required to have a complete copy of Part 95 in their possession.

Now Uncle Charlie has reorganized things somewhat. Class A operators will be known as the General Mobile Radio Service; Class C operators will be the Radio Control Service; and we Class D CB operators will be in the Citizens Band Radio Service. (The sum total is called the Personal Radio Service.) Part 95 has been reorganized along similar lines. Each of the first three parts covers a specific division of the Personal Radio Services, and the last part talks about the technical standards applicable to all Personal Radio Services.

For us CBers that means that now all we're required to have in our possession is the third part (which applies to CB radio). Also, when we buy new rigs, all that will be supplied with our new gear is the fourth (technical standards) portion.

One more comment: when corresponding with the FCC about your CB license do yourself a favor and be sure to use the special zip code 17326.

CARD No. 19 of 60

CB TALK DICTIONARY

F

FANCY SEAT COVERS—Pretty girls in car.

FEET—Linear amplifier (more than legal power).

FEED THE BEARS—Get a speeding ticket.

FIFTY DOLLAR LANE—Passing lane.

Attention All Teachers

They've discovered another use for the CB radio in Selma, Alabama, in a field that, according to some observers, needs some help.

Citizen Band radios are now so popular that they are being used in classrooms at Selma's Clark Elementary School, according to Mrs. Bernice Campbell and Ms. Brenda Moseley, teachers.

Reading classes at the school, taught by the two teachers, have been using a CB radio center to develop their pupil's reading skills by stimulating their interests. The center, by allowing students to use the CB's, develops their interest in the world, Mrs. Campbell said.

By practicing on the CB, the children have a chance to have a "good buddy," give themselves a handle, make a list of the words used in the CB jargon, make sentences to be used on the radio and read to the operator (the instructor), work up games and create a CB club, Mrs. Campbell says. The CB center also gives pupils an opportunity to learn to read road signs.

Lingo, played like bingo, CB maid, played like Old Maid and other CB games have been developed by the elementary students.

The CB center is located in the school's reading room, and the project has "really excited the pupils," writes Mrs. Campbell.

Caribbean Breakers Active In Central America

We've all read about terrorist attacks practically throughout the world. The possibility of terrorist bombings is something citizens in Central America live with constantly. The wives and families of U.S. servicemen stationed in the Canal Zone must find it particularly disturbing since they were not brought up to accept tumultuous political activities as the status quo. In any event a monitoring organization called "Caribbean Breakers" has been set up in the Canal Zone, to serve as part of a larger civil defense network. They keep each other posted in emergency situations, including times of terrorist crisis. The Caribbean Breakers have offered to lend equipment to the Police and Fire Departments so that they, too, can set up a channel monitor.

Pam Bost, who is secretary for the Caribbean Breakers, and her young son, monitor the base station at her Home 20 in Fort Sherman, Canal Zone. Pam met her husband Roy in the U.S. when they were members of the same REACT team. Looks like a CB family from the word go, and it's just a matter of time before Junior starts.

Interested in Amateur Radio?

Some of you out there may have gotten a little curious about ham radio and how it relates to you, the CBer. CB radio and ham radio are similar in that they both are means of personal communications, but they are distinct from each other in many other ways. If you feel that the thrill of CB is getting road reports, keeping in touch with fellow roadsters, and keeping tabs on Smokey's approximate whereabouts, you're pure CB all the way and probably wouldn't be too interested in ham radio. If on the other hand you're tempted to talk "skip," you're interested in learning how your gear really works and in having a chance to modify your own equipment, then you should be interested in amateur radio.

If your CB organization would be interested in learning more about amateur radio and what it has to offer, you can arrange to borrow a film from the American Radio Relay League. It's called, "Moving Up to Amateur Radio." For more information just write the American Radio Relay League in Newington, CT 06111 or call them at (203) 666-1541. ■

HEY, LOOK ME OVER

(Continued from page 10)

netism in the head. Tape heads should be cleaned and demagnetized regularly—say every 15 or 20 hours of operation. Otherwise there could be loss of high-frequency response, reduced output, and increased noise and distortion. In addition, delicate tape-head gaps will wear excessively, if dirt and grime are allowed to



CIRCLE 65 ON READER SERVICE COUPON

accumulate on them. The cordless demagnetizer and cleaner is rugged, simple and can be used over and over again. The demagnetizer, catalog No. 46015, has a suggested resale price of \$4.29. Also available is a demagnetizer and cleaner for cassettes. This is catalog No. 36008, with a suggested retail price of \$3.49. For further information, write to Robins Industries Corp., 75 Austin Blvd., Commack, NY 11725.

CB/RF Generator

A new RF Generator designated the Model 256 by Hickok has features important to CB service technicians. Five-band frequency tuning covers channels 1 through 40 on an expanded tuning range for easy, precise channel selection. Frequencies of 100 kHz through 16 MHz are covered on the other four bands to provide all IF requirements including:



CIRCLE 60 ON READER SERVICE COUPON

455 kHz, 10.7 MHz, and any other, current or future. A calibrated/attenuated output control provides RF signal output of 100,000 uV down to less than 1 uV for receiver sensitivity checks. The attenuated output is variable in 20 dB steps and also by a 20 dB continuously-

(Continued on page 16)

VALUE & PERFORMANCE

EICO's 30 Years Experience Assures More Electronics Value For Your Money!

TEST INSTRUMENTS



EICO 388 COLOR BAR GENERATOR

Pocket-size, battery operated with LED Indicator. MOS LSI IC provides 9 digitally controlled, stable patterns. Crystal controlled chroma and timing oscillators. Simply connects to TV's VHF antenna terminals.

Wired \$89.95

EICO 390 FUNCTION/SWEEP GENERATOR

Outstanding features include: Sine, Square, Triangle Waveforms; .2 Hz to 200 KHz frequency range; Linear and Log Sweep; Calibrated attenuator, VCO for External Frequency Control; BNC Front Panel Output.

Wired \$169.95

CB ACCESSORIES



EICO 700 CB FREQUENCY COUNTER

Compact in-line mobile frequency counter for the serious CB'er/Hobbyist. Operates automatically on transmit. 10 Hz to 30 MHz. \$99.95

EICO LR-3 "LONG RANGER" INLINE PREAMP

Bring in those distant/weak signals. Boosts receiver sensitivity up to 20 db. Automatic transmit/receive switching. \$29.95

EICO CM-2 "CHANNEL MONITOR" AUTO-SWITCH

Automatically silences car radio when CB call is received/transmitted. \$29.95

EICOCRAFT® IC KITS

EC-5000 SCA ADAPTOR KIT ONLY \$12.95



Convert your FM radio or receiver to pick up the official FCC-licensed background music service (SCA). IC decoder/adaptor permits hearing uninterrupted, commercial-free music broadcast by many FM stations (For personal, non-commercial use only).

IC PROJECT KITS NOW AVAILABLE

EC-5100 ESP Tester \$10.95
EC-5200 "Decision Maker" \$9.95
EC-5400 Stereo Power Amplifier \$10.95
EC-5500 Stereo Pre-Amp \$9.95
EC-5600 Electronic Lock \$11.95
EC-5700 Universal Power Amp \$8.95

HOBBY/AUTOMOTIVE



BW-300 ALPHA BRAINWAVE MONITOR

Lowest cost, battery operated, professional Biofeedback System. IC Circuit design features an active filter and 5-microvolt sensitivity. Complete with stethoscopic earphone, electrode headband and instructions.

Kit \$34.95 Wired \$59.95

885 "TUNEMASTER" ENGINE ANALYZER

Automatic all-in-one test bench for all 6 or 12 volt Ignitions—conventional or transistorized. Giant 6" meter with 6 color coded scales. Complete with tune-up and trouble-shooting manual.

Wired \$59.95

BURGLAR/FIRE ALARMS



SS-500 BURGLAR/FIRE ALARM SYSTEM

Professional Security System designed for easy do-it-yourself installation. Features EICO FC-100 Control Center with AC/DC automatic transfer to battery operation. Complete system includes Installation Handbook. Add additional sensors, bells, to suit your own needs. \$159.95

SD-75 BATTERY OPERATED FIRE/SMOKE ALARM

Ionization-type detector gives earliest possible fire warning. Mounts directly to ceiling with 2 screws. "Beeps" when battery needs replacement. U.L. listed. \$39.95

FREE EICO CATALOG

The more you know about electronics, the more you'll appreciate EICO. Every EICO product is designed to provide you with the most pleasure and quality performance for your money. The fact that more than 3 million EICO products are in use attests to their quality and performance.

"BUILD-IT-YOURSELF" and save up to 50% with our famous electronic kits.

For the latest EICO Catalog and name of nearest EICO Distributor, check reader service card or send 50¢ for fast first class mail service.

EICO-283 Malta Street, Brooklyn, N.Y. 11207

Leadership in creative electronics since 1945.



CB XCVR CHECKOUT



- Emergency Beacon RT-40
- General Electric 3-5811
- Hy-Gain I
- Pearce-Simpson Tiger 40
- Ray Jefferson CB-740
- Sharp CB-2260
- Royce 1-682

□ ELEMENTARY ELECTRONICS has been able to obtain the first of the 40-channel CB transceivers for review, and presents the test reports here. These units are not prototypes, but are "stock standard," the same as the transceivers that you can buy over the counter. If you don't find the particular unit you are interested in reported on here, check the newsstands for the 1977 edition of the CB BUYERS GUIDE.

● EBC RT-40

\$249.00 (Emergency Beacon Corp.)

General Description: A 40-channel AM transceiver for mobile, PA operation. Fine tuning ± 3.6 and -1.1 kHz is provided. Power supply 12 to 13.8 VDC with negative or positive ground. Overall dimensions are 2 $\frac{5}{8}$ -in. h x 7-13/16-in. w x 10 $\frac{1}{2}$ -in. d. Front panel controls and switches for Channel Selector, Volume, Squelch, Power, PA/CB, and Noise Blanker. Standard accessories are microphone, mobile mount, DC power cable.

Receiver Section Test:

| | |
|----------------------------|-------------|
| Input Sensitivity | 0.5 μ V |
| Adjacent Channel Rejection | 50 dB |
| AGC Action | 5 dB |

Transmitter Section Test:

| | |
|------------------------------|-----------|
| RF Output | 4.0 watts |
| Modulation to 85% | yes |
| Relative Sensitivity for 85% | |
| Modulation | -31 dB |
| Modulation Limited to 100% | yes |

Editorial Remarks: The EBC RT-40 has a double conversion receiver, external and PA speaker jacks. The S/RF output device is an 8-step LED indicator. Maximum S-indication equals 10 uV. ■

● GENERAL ELECTRIC 3-5811

\$149.95 (General Electric)

General Description: A 40-channel AM transceiver for mobile, PA operation. Power Supply 12 VDC with negative and positive ground. Overall dimensions 2 $\frac{1}{4}$ -in. h x 6 $\frac{1}{2}$ -in. w x 8-in. d. Front panel controls and switches for Channel Selector, Vol-

ume, Squelch, PA/CB/CBPA, and ANL. Standard accessories are microphone, all crystals or PLL, mobile mount, DC power cable.

Receiver Section Test:

| | |
|----------------------------|-------------|
| Input Sensitivity | 0.5 μ V |
| Adjacent Channel Rejection | 64 dB |
| AGC Action | 7 dB |
| Input Level for S9 | 44 μ V |

Transmitter Section Test:

| | |
|------------------------------|-----------|
| RF Output | 3.7 watts |
| Modulation to 85% | yes |
| Relative Sensitivity for 85% | |
| Modulation | -32 dB |
| Modulation Limited to 100% | yes |

Editorial Remarks: The General Electric 3-5811 has a relative reading S-meter, double conversion receiver, external and PA speaker jacks, and an S/RF output meter. Reproduces CB through PA speaker via CBPA position of PA/CB/CBPA switch. ■

● HY-GAIN I

\$129.95 (Hy-Gain Electronics Corp.)

General Description: A 40-channel AM transceiver for mobile, PA operation. Power supply 12 to 13.8 VDC with negative or positive ground. Overall dimensions are 2 $\frac{1}{4}$ -in. h x 6 $\frac{3}{8}$ -in. w x 8 $\frac{7}{8}$ -in. d. Front panel controls for Channel Selector, Volume, Squelch. Standard accessories are microphone, mobile mount, DC power cable.

Receiver Section Test:

| | |
|----------------------------|-------------|
| Input Sensitivity | 0.3 μ V |
| Adjacent Channel Rejection | 58 dB |
| AGC Action | 12 dB |
| Input Level for S9 | 70 μ V |

Transmitter Section Test:

| | |
|------------------------------|-----------|
| RF Output | 4.2 watts |
| Modulation to 85% | yes |
| Relative Sensitivity for 85% | |
| Modulation | -18 dB |
| Modulation Limited to 100% | yes |

Editorial Remarks: The Hy-Gain I has a relative reading S-meter, double conversion receiver, jacks for external and remote (telephone handset) speakers, and S/RF output meter. ■

● PEARCE-SIMPSON TIGER 40

\$229.95 (Pearce-Simpson, Inc.)

General Description: A 40-channel AM transceiver for mobile, PA operation. Delta tuning ± 1.0 kHz is provided. Power supply 12 to 13.8 VDC with negative or positive ground. Overall dimensions are 2 $\frac{1}{4}$ -in. h x 7-in. w x 9 $\frac{1}{8}$ -in. d. Front panel controls and switches for Channel Selector, Volume, Squelch, Tone, RF Gain, Noise Blanker, ANL, CB/PA, and Delta Tune. Standard accessories are microphone, mobile mount, DC power cable.

Receiver Section Test:

| | |
|----------------------------|-------------|
| Input Sensitivity | 0.6 μ V |
| Adjacent Channel Rejection | 64 dB |
| AGC Action | 8 dB |
| Input Level for S9 | 90 μ V |

Transmitter Section Test:

| | |
|------------------------------|-----------|
| RF Output | 3.7 watts |
| Modulation to 85% | yes |
| Relative Sensitivity for 85% | |
| Modulation | -32 dB |
| Modulation Limited to 100% | yes |

Editorial Remarks: The Pearce-Simpson Tiger 40 has a relative reading S-meter, double conversion receiver, external and PA speaker jacks, and S/RF output meter. ■

● RAY JEFFERSON CB-740

\$149.95 (Ray Jefferson)

General Description: A 40-channel AM transceiver for mobile, PA operation. Power supply 12 to 13.8 VDC with negative or positive ground. Overall dimensions are 2 $\frac{1}{4}$ -in. h x 6 $\frac{1}{4}$ -in. w x 8 $\frac{5}{8}$ -in. d. Front panel controls and switches for Channel Selector, Volume, Squelch, and PA/CB. Standard accessories are microphone, mobile mount, DC power cable.

Receiver Section Test:

| | |
|----------------------------|-------------|
| Input Sensitivity | 0.3 μ V |
| Adjacent Channel Rejection | 63 dB |
| AGC Action | 5 dB |
| Input Level for S9 | 150 μ V |

(Continued on page 92)

EVERY PROJECT IN THIS BOOK IS ANOTHER REASON TO OWN CSC'S QT SOCKETS AND BUS STRIPS.

With QT solderless bread-boarding sockets and bus strips, you can build twice the projects in half the time. Because making connections or circuit changes is as fast as pushing in—or pulling out—component leads. No special clips or jumpers required, either.

When you're building circuits just for the fun of it, you can take them apart in minutes—not hours. So you save money by re-using parts, while eliminating heat damage to expensive components. Interlocking QT Sockets and Bus Strips are infinitely expandable, too: start small and "grow" breadboards as large as you wish.

For as little as \$3.00, you can get a lot more out of your time in electronics—so why not treat yourself to a QT Socket today?

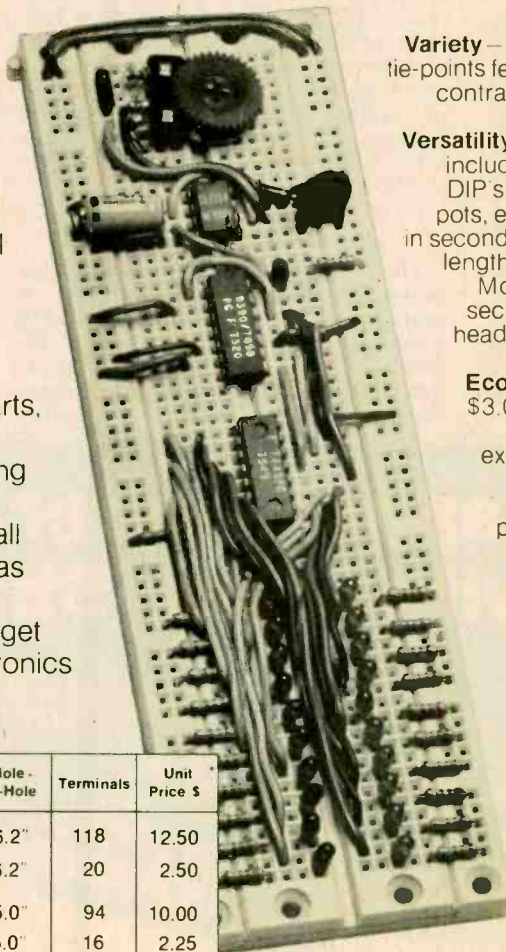

Variety—10 models from 70 to 590 solderless tie-points feature snap/lock design to expand or contract your breadboard to fit every circuit and budget requirement.

Versatility—Use with virtually all types of parts, including resistors, capacitors, transistors, DIP's, TO-5's, LED's, transformers, relays, pots, etc. Most plug-in directly and instantly, in seconds. No special jumpers required—just lengths of #22-30 AWG solid hookup wire. Molded-in holes let you mount QT units securely on any flat surface with 4-40 flat head screws, or 6-32 self-tapping screws, from behind panel.

Economy—Sockets are priced as low as \$3.00.* Save more money by eliminating heat and mechanical damage to expensive parts, re-using components.

Speed—For fast circuit layouts, QT Sockets have 5 interconnecting tie-points per terminal; Bus Strips feature 2 separate rows of interconnecting terminals. Both connect and disconnect easily, without damage to socket or parts.

Visibility—All parts are instantly and easily visible and accessible, for quick signal tracing, circuit analysis and diagramming.

Durability—Higher-temperature sockets with abrasion-resistant, glass-filled plastic, rated better than 100°C. Screw-down-and-interlocked design provides high mechanical strength.

Reliability—Ruggedly designed to professional engineering standards, for heavy day-in, day-out use. Non-corrosive prestressed nickel-silver contacts insure more secure mechanical and electrical connections. Vinyl backing prevents shorting when mounted on conductive surfaces.

| Length Hole-to-Hole | | Length | Hole-to-Hole | Terminals | Unit Price \$ |
|------------------------|--------|--------|--------------|-----------|---------------|
| | QT-59S | 6.5" | 6.2" | 118 | 12.50 |
| | QT-59B | 6.5" | 6.2" | 20 | 2.50 |
| | QT-47S | 5.3" | 5.0" | 94 | 10.00 |
| | QT-47B | 5.3" | 5.0" | 16 | 2.25 |
| | QT-35S | 4.1" | 3.8" | 70 | 8.50 |
| | QT-35B | 4.1" | 3.8" | 12 | 2.00 |
| | QT-18S | 2.4" | 2.1" | 36 | 4.75 |
| | QT-12S | 1.8" | 1.5" | 24 | 3.75 |
| | QT-8S | 1.4" | 1.1" | 16 | 3.25 |
| | QT-7S | 1.3" | 1.0" | 14 | 3.00 |

All QT units are .33" thick.

CONTINENTAL SPECIALTIES CORPORATION



See your CSC dealer or call
203-624-3103 (East Coast) or 415-421-8872 (West Coast)
major credit cards accepted.

44 Kendall Street, Box 1942
New Haven, CT 06509 • 203-624-3103 TWX: 710-465-1227
West Coast office: Box 7809, San Francisco, CA 94119 • 415-421-8872
TWX: 910-372-7992

*Manufacturer's suggested list • Prices and specifications subject to change without notice
© 1976, Continental Specialties Corporation

HEY, LOOK ME OVER

(Continued from page 13)

variable control calibrated in microvolts. Internal modulation at a frequency of 1 kHz is variable from 0 to 100%, calibrated at 30%. Provision is also made for use of external modulation. When the Audio Output function is selected, a 1 kHz audio signal is available at these same front-panel out/in jacks. The Hickok Model 256 CB/RF Generator is available through Hickok distributors. Suggested retail price is \$199.00. For further information on the Hickok Model 256 CB/RF Generator or other Hickok CommLine equipment, write to Hickok Electrical Instrument Company, 10514 Dupont Avenue, Cleveland, OH 44108.

Freezer Alarm

Lots of families are saving money by buying perishables like meat when prices are low and then freezing them. But a freezer malfunction or power failure can turn that good idea into a total loss. The new Heathkit GD-1183 Freezer Alarm is insurance against that kind of economic disaster. It monitors the temperature inside your freezer and provides an alarm if the temperature rises about 20°F. It will also sound the alarm if the freezer door is left ajar. With the GD-1183 Freezer Alarm, a simple bit of carelessness doesn't have to be costly. The GD-1183 has both a visual and audible alarm. The "beep" tone and flashing light signal any problem, and two alarm

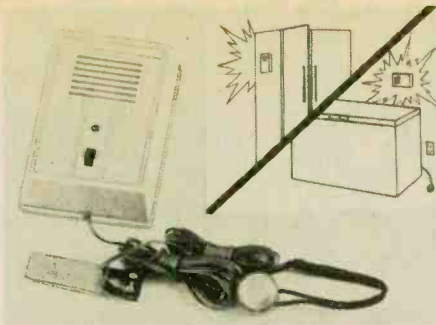

CIRCLE 31 ON READER SERVICE COUPON

speeds indicate the nature of the problem. Fast indicates that the freezer door is open. Slow indicates that thawing is taking place even though the door is closed. Alarm shutoff is automatic when the temperature in the freezer returns to about 10°F. The Freezer Alarm is mail order priced at just \$14.95, and is one of nearly 400 electronic kits that can be found in the new Heathkit Catalog. If you don't already receive the Heathkit Catalog, send for your free copy today. Write Heath Company, Benton Harbor, MI 49022.

Weather Receiver

The Forecaster, a weather receiver featuring long-range, interference-free reception, is crystal-controlled, has dual conversion circuitry and a tuned RF amplifier and has been announced by an industry leader, Weatheralert, in Chicago. All three weather channels are switch-



CIRCLE 68 ON READER SERVICE COUPON

selectable and work on standard 9 VDC battery (not included). Tough styrene case, with LED power indicator and slide volume control and has a 25-in. telescoping antenna. Unit packs a 2½-in. loudspeaker. Suggested retail for the Forecaster from Weatheralert is under \$20.00. For more information, write to Dept. DEG, Weatheralert, 639 S. Dearborn, Chicago, IL 60605.

Circuits happen Faster and Easier with Super-Strip.™

As little as

\$17

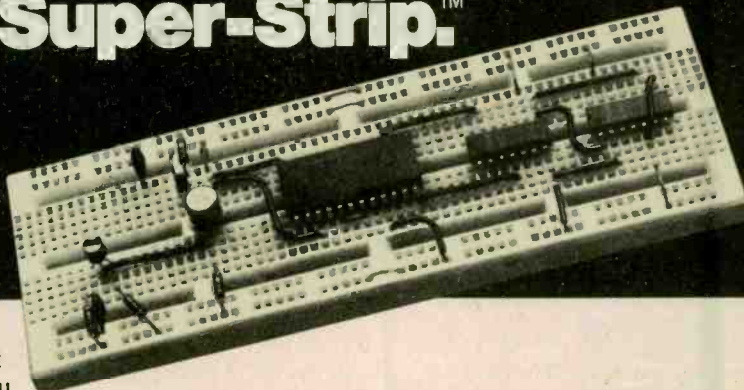

Now, whenever you'd like to give a circuit a try, you can build it up nearly as fast as you can dream it up with Super-Strips™, the faster, easier and less expensive solderless breadboards from A P Products. When you build your circuit on a Super-Strip, everything stays as good as new. Once you're through, you can use everything again and again. Instantly. Put a Super-Strip to work for you. Eight distribution lines handle signal and power, and 128 five-tie-point terminals can handle 9 ICs and then some. It's a whole lot easier than printing a circuit and a whole lot handier than haywire.

| Part Number | Model Number | Terminal Type | Price Each |
|-------------|--------------|---------------|------------|
| 923252 | SS-2 | nickel-silver | \$17.00 |
| 923748 | SS-1 | gold-plated | \$18.90 |

Order from your A P distributor today. Our distributor list is growing daily. For the name of the distributor nearest you call Toll-Free 800-321-9668.



Send for our complete A P catalog, the Faster and Easier Book.

A P PRODUCTS INCORPORATED

Box 110-EE Painesville, OH 44077 (216) 354-2101 TWX: 810-425-2250

**AMAZING & HARD-TO-FIND
SCIENCE BUYS!
ALTERNATE ENERGY
SPACE AGE • HOBBIES**

SUPER POWER FOR ANY AM RADIO



Antenna assist has pulled in stations up to 1000 miles* off! No wires, clips, grounding. Solid state—no elec., batts., tubes.
No. 72,095EK \$19.95 Ppd.
ULTRA SELECT-A-TENNA (OVER 1000* MILES)
No. 72,147EK\$24.95
***SUBJ. TO LOCAL COND.**

SAVE 50%! 8 x 20 MONOCULAR



Top quality Spy Scope, a \$30 value, now \$14.95! Special purchase saves you 50%. 100% coated optics; 393 ft. field of view. Only 2 oz.—stores in pocket, purse, glove box.
No. 1568EK...\$14.95 Ppd.

SEE MUSIC IN PULSATING COLOR



3-Channel Color Organ lets you modulate 3 independ. strings of colored lamps w/ intensity of your music. "Audio light show" flashes, responds to rhythm, pitch!

No. 42,309EK (ASSEMBLED).....\$18.50 Ppd.
No. 42,336EK (UNASSEMBLED).....\$15.95 Ppd.

NASA-CHOSEN FOR APOLLO/SOYUZ



The Astronauts used this super 20X60 binocular (modified) to view Earth! Big 60 mm objective lenses; 173-ft. field of view at 1000 yds. Relative brightness, 9.0. Fully coated optics, more!

No. 1556EK(9 1/4" x 8 1/2"; 47.5 oz) \$99.95 Ppd.

PRO ELECTRONIC SOUND CATCHER



Parabolic mike w/ 18 3/4" transparent reflecting shield & 2 I.C.'s in amplifier magnifies signals 100X over omnidirection mikes. Catch sounds never bef. heard; highest signal to noise ratio poss. 5 1/2 lb.

No. 1649EK (REQ. 2 9V BATT.).....\$299.00 Ppd.

BUILD ALPHA MONITOR: \$37.50!



All you need w/ your basic electronics knowledge (excl. 9v tr. batt.) for port. biofeedback unit, an aid to relaxation, concentration. 5 microvolt sensitivity; self-cont.

No. 61,069EK (KIT).....\$37.50 Ppd.
No. 71,809EK (FULLY ASSEMBLED)..\$59.95 Ppd.

AN ULTRA-MINIATURE AM RADIO!



About the size of a small match-box. Amazing volume & clarity (depends on locale). Insert earplug (incl) & directional AM mini receiver plays! Runs ab. 100 hrs. on 2 hear. aid batts (incl). (LESS THAN 1 1/4 OZ.)

No. 1976EK...\$14.95 Ppd.

110V FUEL MISER RECLAIMS HEAT



Save your 40% wasted heat to warm a basement, garage, rec rm. at no extra cost! Direct it your way instead of up the chimney. Fan-forced clean hot air via easy ducting!

No. 19,194EK (5" DIA.) Shpg. 17 lb. ...\$121.50 FOB

CAN'T SLEEP, RELAX? TRY THIS!



Electronic sound conditioner simulates 4 kinds of soothing sounds of ocean surf & rain; "white" sound helps mask unwanted noise. Medical tests proved analgesic effects!

No. 71,997EK \$89.95 Ppd.

QUALITY DETECTOR UNDER \$40



Our fully transistorized BFO unit can locate a quarter at 18". Powerful 6 trans.-oscillator-amplifier circuit. Comp. to others priced 50% more! Aluminum, just 2 lb.

No. 80,222EK \$39.95 Ppd.

EDMUND SCIENTIFIC CO.

300 Edscorp Bldg., Barrington, N.J. 08007 • (609) 547-3488
America's Greatest Science • Optics • Hobby Center



**THERE IS NO OTHER TELESCOPE LIKE IT!
THE NEW EDMUND 4 1/4", f/4
NEWTONIAN WIDE FIELD
REFLECTOR TELESCOPE**

Clear, bright, spectacular wide angle views of stars, moon, comets... easy to use... portable!

IN SECONDS YOU'RE SCANNING THE ASTOUNDING UNIVERSE. able to see and study the breath-taking cosmos as perhaps you never have before... awesome vastness, unbelievable orderliness, stark silent beauty. All the fascinating heavenly mysteries are yours to enter and explore. This new reflector telescope makes it easy for everyone to span a thousand light-years to space-age enjoyment of the heavens and outdoors. No complicated set up! Just insert the eyepiece, focus, and its big 3 1/2" field of view gives you more stars in a single view than any other type of telescope. Bright, crisp, finely resolved images to capture your interest and imagination! It's probably the easiest to use telescope ever... over your shoulder, in your lap, on a tripod. Or just rotate the spherical base on its own mount for use on a table, car hood. Take it anywhere (only 17" 10 lb.). Top quality optical system: 4 1/4" f/4 parabolic primary mirror (1/2 wave, 17" F.L.); prealigned 1/2 wave diagonal on a coated optical window seals optics from moisture and dust. 28mm Kellner eyepiece (gives 15X, higher without other eyepiece or Barlow). Fast focusing (25" to infinity). Bright Scharfianian red (doesn't impair night vision). adj. carrying strap. A "first" scope "must" an ideal second scope!

There is no other telescope like it. **NO. 2001EK \$149.95 Ppd.**

**FOR GREATER RELAXATION, CONCENTRATION,
listen to your Alpha and Theta brainwaves!**



**COMPARES
WITH UNITS
SELLING FOR
\$150 UP**

Do it with an amazing biofeedback monitor. This ultra-sensitive sensor detects brain signals, lets you monitor (hear and see!) your Alpha and Theta brainwaves. Great aid to relaxation, concentration. This portable (8 x 3 x 4") lightweight (24 oz.) metal unit has a unique electrode headband to slip on or off in seconds without messy creams or solutions. Hooked to amplifier, it filters brainwaves, and signals an audible beep for each Alpha or Theta wave passed. You get both audio and visual (L.E.D.) feedback with this reliable, completely safe unit. It operates on two 9v transistor batteries, offers features comparable to many costlier models. A comprehensive instruction booklet is included.

No. 1689EH
Do-It-Yourself Kit #61069EK \$37.50 ppd.
Low Cost 'Starter' Unit #71809EK \$59.95 ppd.

No. 1689EK JUST \$99.95 Ppd.

**LOW COST, HIGH QUALITY
INFRA-RED EYE**

**BINOCULAR
STYLE
\$329.95**

A must for Infra-red crime detection surveillance, security system alignment, I.R. detection, laser checking, night-time wildlife study—any work requiring I.R. detection and conversion to the visible spectrum. Self-contained scope (11 x 14 1/4 x 3") includes I.R. light source (for up to 90' sight at night!), 6032 I.R. converter tube, f/3.5 telephoto lens, adjustable triplet eyepiece, an adapter for use with your car's cigarette lighter—more! Bright 1.6X image (Binocular style gives super-bright 2.5X). Focuses from 10' to infinity, runs on 6 or 12v DC.

Not for sale to Cal. residents other than authorized by U.S. Armed Forces, law enforcement agencies or solely for scientific research and education purposes.

STANDARD STYLE, STOCK NO. 1683EK ONLY \$299.95 Ppd.
BINOCULAR STYLE, STOCK NO. 1685EK JUST \$329.95 Ppd.



**STANDARD
STYLE
\$299.95**

**GIANT FREE
164 PG. CATALOG**



**4000 UNUSUAL BARGAINS
FOR HOBBYISTS,
SCHOOLS, INDUSTRY**

COMPLETE AND MAIL COUPON NOW

EDMUND SCIENTIFIC CO. 300 Edscorp Bldg., Barrington, N. J. 08007

Send me the following:
Stock No. _____ Quantity _____ Price Ea. _____

SEND FREE 164 PG. CATALOG "EK"

Charge my American Exp. BankAmericard Master Chg.

Interbank No. _____ Add handling charge \$ _____ 1.00

Card No. _____ Enclosed is check, M.O. in amount of \$ _____

Expiration Date _____ Signature _____

30-DAY MONEY-BACK GUARANTEE. You must be satisfied or return any purchase in 30 days for full refund.

Address _____ City, State, Zip _____

Can another portable DMM measure up to our popular 280?



B&K-PRECISION
MODEL 280
\$99.95

You be the judge!

?? 280

- Completely portable—uses ordinary C cells or re-chargeables.
- Measures AC/DC voltage, AC/DC current and resistance.
- High accuracy. DC accuracy is $\pm 0.5\%$ on all but the highest range ($\pm 1\%$). Ohms accuracy is 1% on most ranges.
- Full measurement capability, including current measurement to 1 amp.
- 1mV, 1 μ A, 0.1 Ω resolution.
- High/Low-power ohms measurements.
- Large, bright LED display.
- Auto-polarity and decimal point.
- 10-megohm input impedance.
- 0° to +50° C operating range.
- Measures only 6.4 x 4.4 x 2". Under 2 lbs. with batteries.
- Full line of accessories including, AC adapter/battery charger, tilt stand and carrying case.

Compare our features, accuracy and price and you'll see why thousands of buyers have selected the B&K-PRECISION 280.

Now in stock at your local distributor.

B&K PRECISION
PRODUCTS OF DYNASCAN

6460 West Cortland Avenue
Chicago, Illinois 60635 • 312/889-9087
In Canada: Atlas Electronics, Toronto

CIRCLE 8 ON READER SERVICE COUPON

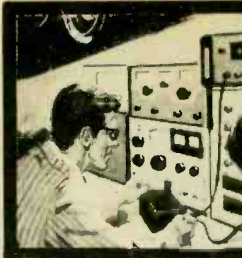

**Ask Hank,
He Knows!**

Got a question or a problem with a project—ask Hank! Please remember that Hank's column is limited to answering specific electronic project questions that you send to him. Personal replies cannot be made. Sorry, he isn't offering a circuit design service. Write to:

**Hank Scott, Workshop Editor
ELEMENTARY ELECTRONICS
229 Park Avenue South
New York, NY 10003**

Flash Copy

Hank, the small slave unit (see photo) delivers dependable results and has been constructed from the article, "Light/Jinn." (ELEMENTARY ELECTRONICS, July-August 1976). The reduced size fits nicely into a gadget bag or even into a pocket. In use, it can be taped or wedged into any number of places or positions. The increased options in lighting, as a result of this unit, have made photography more fun than work.

—H.F., El Caon, CA



Slave unit with cap removed.

Thank you for writing. We knew the Light/Jinn project would excite our readers, but we were surprised by the many letters like yours. By the way, we like your packaging idea.

Mom Knows Best

I bought a 50-ft. coil of RG-8U coax with wired-on connectors. It's 15-ft. longer than I need, but my mother says it makes no difference since very little signal is lost in that 15-feet. Is she right?

—D. K., Merchantville, NJ

Your mom is right. The signal loss in 15-ft. of RG-8U can't be detected except with very sensitive lab test gear. Also, you may foul up the connector connection and lose all or a good part of your incoming and outgoing signals.

Why Not!

How come the police use CB? They have their own radio band.

—D. M., Las Vegas, NV

Anybody (almost), any business (almost) and any government agency (all of them) are eligible to own and operate a CB station. Some CBers claim police make false calls or announcements to catch

speeders. I don't believe this is legal or ethical. After all, the odds are staked in their favor.

Only Inches Allowed

If the antenna is too long or too short, will it burn out the CB transmitter section?

S. G., Denver, CO

If you are talking about an antenna with a 2 or 3-in. tuning tip, the answer is no! However, home brew antennas that cause a very high SWR may pop the transceiver's final stage.

Make It 2-to-1

Could you send me some information on repairing transistor radios. I am in the seventh grade.

—J. S., Springfield, IL

Look at our Bookmark column for the book that'll help you. If you cannot find what you like, write to the publishers and ask for their book catalog. A word of advice. At your age you should spend at least two hours of reading for each hour of practical service work. Theory is very important!

What Way to Go?

I purchased an issue of COMMUNICATIONS WORLD, and got interested in SWL. I would like to buy a good used short-wave receiver, but I don't know where to look. Could you please advise me if there are any firms that sell used SW receivers.

—W.R., Baraga, MI

Check your local classified ads, flea markets and auctions. Buy a working unit unless you are qualified to service it. Remember, you can get started in shortwave listening on an inexpensive multi-band transistor portable. After a few months, you may want to go for a better unit. But first, get started!

Regulator for Car Radio Power

Hank, I started to build a power supply for an old car radio like you told me on page 71 of your November/December 1976 issue of ELEMENTARY ELECTRONICS, but Radio Shack says the voltage regulator chip your author used is no longer in stock. What part can I use in my project?

—M. G., Rowayton, CT

Oooops! They changed parts on us, pal. Your local Radio Shack has a regulator chip, catalog number 276-1771, now which accepts up to 35 volts DC in, delivers 12 volts DC out. It's just what you need to rehabilitate your old car radio. Remember, never quit if the part is not available. Look for an equal or better substitute.

(Continued on page 20)

WE'RE FIGHTING FOR YOUR LIFE

**Have Your
Blood Pressure Checked**

American Heart Association

Unique full-function 8-digit wrist calculator... available only as a kit.

A wrist calculator is the ultimate in common-sense portable calculating power. Even a pocket calculator goes where your pocket goes—take your jacket off, and you're lost!

But a wrist-calculator is only worth having if it offers a genuinely comprehensive range of functions, with a full-size 8-digit display.

This one does. What's more, because it is a kit, supplied direct from the manufacturer, it costs only a very reasonable \$19.95. And for that, you get not only a high-calibre calculator, but the fascination of building it yourself.

How to make 10 keys do the work of 27

The Sinclair Instrument wrist calculator offers the full range of arithmetic functions. It uses normal algebraic logic ('enter it as you write it'). But in addition, it offers a % key; plus the convenience functions \sqrt{x} , $1/x$, x^2 ; plus a full 5-function memory.

All this, from just 10 keys! The secret? An ingenious, simple three-position switch. It works like this.



1. The switch in its normal, central position. With the switch centered, numbers—which make up the vast majority of key-strokes—are tapped in the normal way.



2. Hold the switch to the left to use the functions to the left above the keys...

3. and hold it to the right to use the functions to the right above the keys.

The display uses 8 full-size red LED digits, and the calculator runs on readily-available hearing-aid batteries to give weeks of normal use.

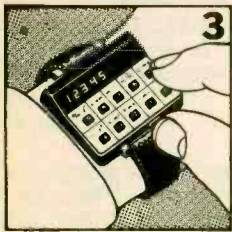

Assembling the Sinclair Instrument wrist calculator

The wrist calculator kit comes to you complete and ready for assembly. All you need is a reasonable degree of skill with a fine-point soldering iron. It takes about three hours to assemble. If anything goes wrong, Sinclair Instrument will replace any damaged components free: we want you to enjoy assembling the kit, and to end up with a valuable and useful calculator.

Actual Size

Contents
Case and display window.
Strap.
Printed circuit board.
Switches.
Special direct-drive chip (no interface chip needed).
Display.
Batteries.

Everything is packaged in a neat plastic box, and accompanied by full instructions.

The only thing you need is a fine-point soldering iron.

All components are fully guaranteed, and any which are damaged during assembly will be replaced free.

The wrist-calculator kit is available only direct from Sinclair Instrument. Take advantage of this 10 day money-back offer.

Send the coupon today.

KIT ONLY
\$19.95

Sinclair Instruments Inc.
6 Commercial Street
Hicksville, N.Y. 11801

To: Sinclair Instruments Inc. EE5
6 Commercial Street
Hicksville, NY 11801

Please send me

_____ Sinclair wrist calculator kit(s) at \$19.95\$

Sales tax (NY residents) _____

Shipping & handling (\$2.50 per unit) _____

Enclosed is check/MO (payable to Sinclair Instruments Inc.) TOTAL \$ _____

Name _____

Address _____

City _____

State _____ Zip _____

I understand that you will refund the purchase price of the kit in full if I return it in saleable condition within 10 days of receipt.

avanti's CB mobile antennas

offer:

- Quality construction
- Long range
- Mounting versatility

This is the Avanti Racer 27 mobile antenna. A first quality instrument, it is one of the most popular antennas in the entire CB field. That's because experienced CBers appreciate the benefits of a good, dependable long-range antenna that offers quiet performance.

The Racer 27 is readily adaptable to a wide variety of mounting assemblies:

- a fold-over mount for campers and vans
- a no-hole trunk mount (no drilling into your car)
- a mirror bracket mount for trucks
- a dual assembly for increased performance on all vehicles
- Avanti makes the famous MOONRAKER CB BASE ANTENNA

The Racer 27 is Avanti Model AV-327. Suggested retail \$25.95

This is only one of many Avanti antennas for car, boat or home. Send today for FREE full-color catalog.

avanti
RESEARCH AND DEVELOPMENT, INC.
340 Stewart Ave., Addison, Illinois 60101
CIRCLE 25 ON READER SERVICE COUPON



ASK HANK, HE KNOWS!

(Continued from page 18)

Blanking Out Noise

You hear so much about noise blankers, but no one explains them. How about you, Hank!

C.M., Baton Rouge, LA

The noise blanker circuit is inserted ahead of the detector as shown in the diagram. When a noise pulse is received at the antenna, it is amplified by the noise RF amplifier and then converted into a DC pulse which is fed to an electronic

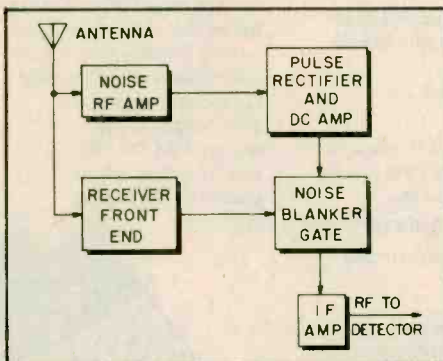

noise blanker gate circuit. When a noise pulse occurs, a DC pulse supplied to the gate "punches" a hole in the IF signal killing the noise pulse in the received signal—in fact, killing all the signal for that instant in time. The blanked out section of the IF signal is so short in duration that the listener cannot hear it. Even better, the annoying noise pulse is gone, allowing more pleasant listening for the operator.

Kathi Gets a "Dear Kathi"

It's really true that one never stops learning. I've been up to my neck all my life in communications (including domestic intrigue) and not surprisingly, I'm currently a guest of the Federal Prison System. I service equipment and occasionally teach here. Since it came into common use, I've failed to successfully explain the operation of noise-blanking (to the anguish of my understudies). I want to express my gratitude to you for simplifying the explanation of it like none before you (September/October e/e). Right On!

You made teaching this function measurably easier and make me glad I'm from the "Big-Apple." Oh, by the way, we had the print-shop guy do a wall-poster blowup of the "buzzin' bee" on page 28, because it looks amazingly like us. Send us a better flick of you so we can pin it up everywhere. Keep on teaching! 3s,

—Gino & the guys, San Pedro, CA

You guys are in for a treat! Kathi informs me that a photo is in the mail. And we all wish you the best of luck. Should any of our readers want to "pen pal" it with Gino and the boys, write to ol' Hank asking for the address.

No Choice

I just got my CB license and the call has four letters, not three. Which ones should I use?

—C. H., Tampa, FL

Your call begins with KAAC and you use all four letters. The FCC ran out of three letter calls. The way CB is going, they'll run out of four letter calls.

In Time

Where can I obtain a schematic and a parts list for an electronic digital stopwatch?

—J. W., New Salisbury, IN

The Editor tells me just such a project is in the works and it has calculator options. Watch for it in ELEMENTARY ELECTRONICS.

Can You Top This One

Which antenna is most sensitive—1/4-wave, 1/2-wave or full-wave?

—R.H., Cleveland, OH

The full-wave antenna pulls in the most signal, giving the largest possible voltage (in micro-volts) across the antenna terminal. However, imagine driving around with a full-wave CB antenna. Whereas, I heard of an SWLer in Texas who had a 30-mile-long wire antenna. Seems he strung his top rung of barbed wire on the fence using old coke bottles as insulators. Now is that a tall story, or not?

It Takes Time

How come you guys use last year's catalogs? What's wrong with the 1977 ones?

—K.K., Brooklyn, NY

Nothing, in fact we prefer the latest catalogs whenever we specify parts and equipment. However, we work on the early 1977 issues in 1976 before the catalogs come out. Hope you understand.

Hi, Old Timer

I found White's Radio Log in the back of COMMUNICATIONS WORLD which you publish. I haven't seen White's in more than 30 years, it was like finding an old friend. I remember in the old days the listing included network affiliations. Why not now?

—O.B., Miami, FL

Network affiliations are not as important today as they were years ago. There are a lot more independents in AM than ever before. FM is practically non-network. Only TV remains, and even now many TV stations are independents that pick the best of two or more networks.

Solid Ground

How come today's SW receivers do not require a ground connection for the antenna like in the old days?

—F. N., Simcoe, Ont.

They still do for best results. However, today's receivers sneak to ground through the 117 VAC power line. A good RF ground for the antenna is a must for serious DXing.

(Continued on page 94)

The ArcherKit Thermo Meter

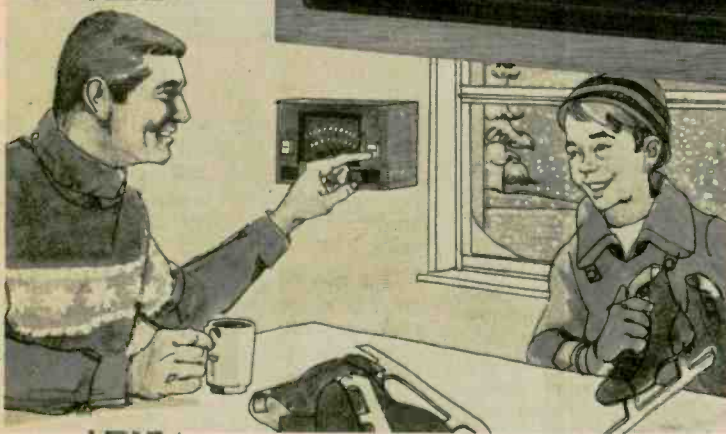
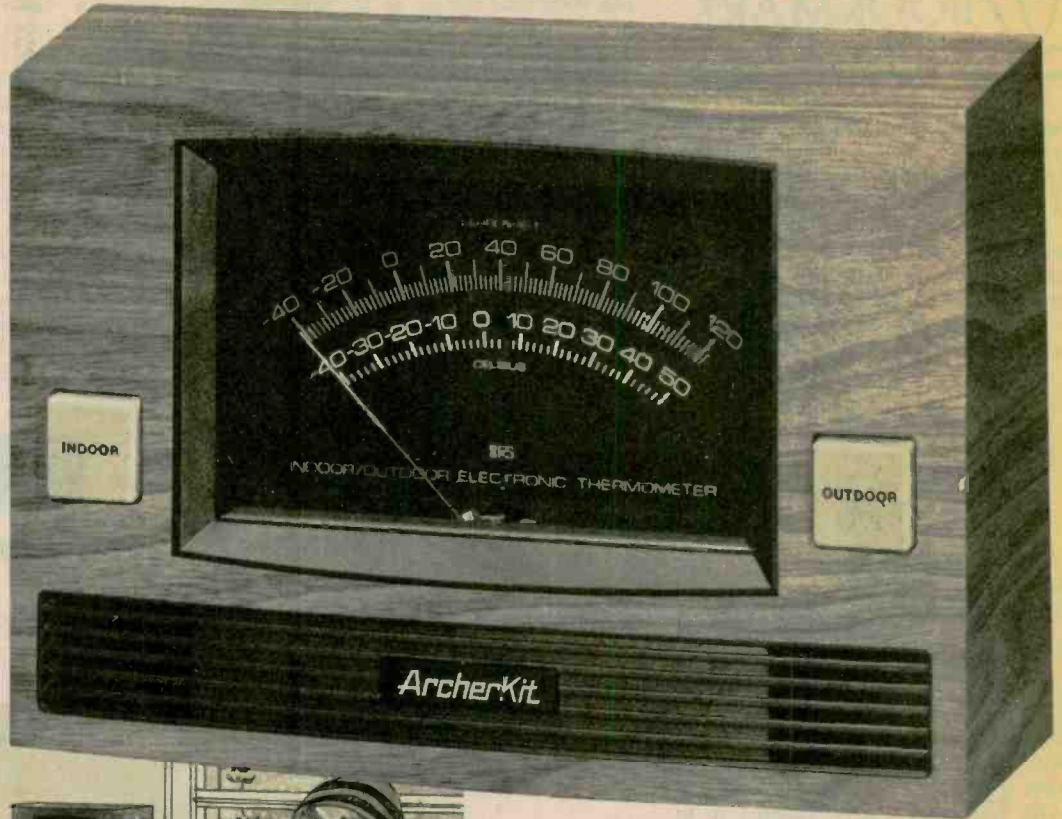

An easy-to-build electronic thermometer that monitors both indoor and outdoor temperatures on a big 4½" meter!

ArcherKit[®] obsoletes ordinary thermometers. Now you can monitor indoor or outdoor temperatures at a glance. All you do is push a button for big, accurate readings in fahrenheit and celsius degrees.

A remote sensor mounts outdoors or even in another room, basement or garage. And the dual-range scale reads temperatures from -40 to +120°F and -40 to +50°C. It's a low cost introduction to kit building you'll be proud to own. Solid-state circuitry assures high accuracy and years of service. Handsome simulated walnut grain housing has keyhole slots for easy wall mounting, or place it on a desk or shelf. Operates on a 9V battery so you can use it anywhere. With instructions for easy assembly — build yourself a great addition to home or office. Only 24.95*.

SOLD ONLY WHERE YOU SEE THIS SIGN:

Radio Shack[®]

A TANDY COMPANY • FORT WORTH, TEXAS 76107
OVER 5000 LOCATIONS IN NINE COUNTRIES



These two credit cards honored at most Radio Shacks.
*Prices may vary at individual stores and dealers.

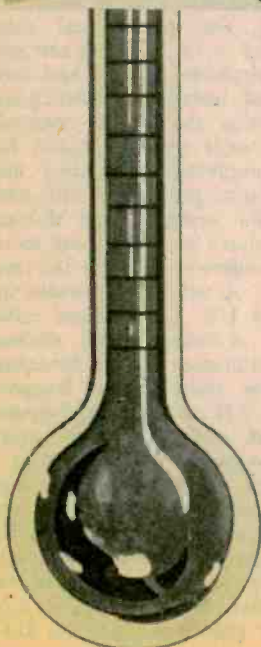



BOOKMARK BY BOOKWORM

Organ Theory and Design. "Me build my own organ?" Yes, you can! Most of the innards of an organ are built up from just a few basic circuits that are repeated over and over. *Sourcebook of Electronic Organ Circuits* by Allen Douglas and S. Astley tells how to start with just a few organ circuits and then expand them to include whatever options and special effects are wanted, from automated rhythm gen-



Soft cover
168 pages
\$4.95

eration to the fully simulated sound of the majestic pipe organ. An electronic organ provides a hobby that can grow as the hobbyist does, that can be tailored to fit the individual's own musical tastes, desires, whims, and budget . . . there's no limit to the versatility and pleasure one can derive from building his own organ. Published by Tab Books, Blue Ridge Summit, PA 17214.

Solid State Ignitions. Here is a step-by-step guide to understanding, buying, installing, testing, building and repairing all kinds of solid-state ignitions covered in *Transistor Ignition Systems* by Carroll A. Brant. Conventional ignitions have served long and well and have many parts in common with the new electronic ignitions, so they're also thoroughly covered—even to the extent of showing how to repair them. Then, starting with a section on basic, modern electronics for mechanics and laymen, the author branches out to transistor circuits and ignitions. Here is all the theory

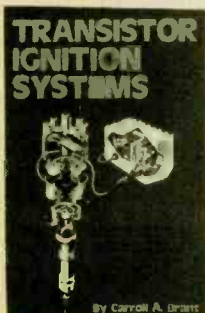

Soft cover
.252 pages
\$5.95

needed to understand the modern ignition—and, most likely, all the theory that will ever be needed to understand the ones to come. All the ignition data presented is

explained and illustrated so carefully and completely the reader just *can't* go wrong! Here are all the details needed by the mechanic, presented so the layman can understand them! This is the information one *must have* to tune up the new cars and turn engine ping into zing. Published by Tab Books, Blue Ridge Summit, PA 17214.

Police Call Directory. A highly recognized public safety radio list, *Police Call Radio Directory*, has been expanded and improved for 1977 with the addition of U.S. Government channels, press and radio-TV reporting frequencies and thousands of new and modified license reports. Each volume of *Police Call*—there are nine in all—is divided into four sections. Parts I and II list police, fire and other emergency FM radio systems both alphabetically and by frequency; supplemental data includes call sign, transmitter location and type of station. Two new categories have been added: Relay Press channels used by newspaper reporters, and Remote Broadcast Pickup frequencies for radio-



TV stations (only licenses issued after January 1, 1976, for the latter). Part III, an allocation table of all land-mobile radio usage, now includes more than one thousand U.S. Government channels, identified as to usage, except for sensitive agencies. An entirely new Part IV provides the base and mobile frequencies used in each U.S. National Forest and U.S. National Park. The latter includes National Monuments, Seashores, Recreation Areas, etc. The 1977 *Police Call Radio Directory* is available at most electronics stores. It is published in nine regional volumes, each volume priced at \$4.95. For more info, write to Gene C. Hughes, Editor, Hollins Radio Data, P.O. Box 35002, Los Angeles, CA 90035.

For Fixers. There is no substitute for training and experience in appliance servicing, but the real key to success is a well-founded troubleshooting technique



Hard cover
333 pages
\$15.95

that goes beyond the troubleshooting charts normally found in service bulletins and books on appliance repair. Thus, the main purpose of *Handbook of Major Appliance Troubleshooting and Repair* by David L. Heiserman gives a positive approach to troubleshooting major home appliances. The first six chapters deal with general principles of troubleshooting, and electrical heating and cooling as they apply to modern major appliances. The next eight chapters deal with specific electrical major appliances. Published by Prentice-Hall, Inc., Englewood Cliffs, NJ 07632.

For the Boater. A new handbook to aid boatmen, fishermen, and other mariners in the proper use of marine radiotelephones has been published by the non-profit Radio Technical Commission for Marine Services (RTCM). The easy-to-



Soft cover
70 pages
\$2.50

understand booklet, entitled "*How to Use Your Marine Radiotelephone*," was produced with the new radiotelephone owner in mind although it contains valuable reference information for all marine radio users.

The handbook was researched and written by a special task force representing radiotelephone manufacturers; the FCC, U.S. Coast Guard, and other marine-related government agencies; the U.S. Power Squadrons and U.S. Coast Guard Auxiliary; the marine radio services of ATT; boating writers; and professional shipmasters. Included in its 72 pages are sections on radiotelephone licenses and how they are obtained, installation instructions, selecting and using the correct channels for VHF/FM, single sideband radios for long-range communications, routine and emergency operating procedures with sample scenarios for ordinary and distress calls, and procedures to place a call to or from a vessel underway through the telephone company. A valuable appendix includes a map of U.S. Coast Guard radio stations ashore, a listing of all stations broadcasting continuous weather forecasts, and the locations, addresses and frequencies of all VHF/FM and medium frequency public coast stations (marine operators). The new handbook is offered at a single copy price of \$2.50. Single copies are available from marine electronics and boating equipment dealers. Quantity discounts are available to dealers for resale or for group purchases by educational classes or organizations from RTCM, c/o FCC, P.O. Box 19807, Washington, D.C. 20036.

THE CATS TO CATCH.

"Roar Power" puts these new 40-channel CB's from Pearce-Simpson out in front. The Lion 40™ and Tiger 40™. Built with all the power and prestige you'll ever need in the CB jungle. As well as some advanced Pearce-Simpson features that command real attention. Like HetroLock™, for zeroing in on the right frequency. Receiv-O-Slide™ tuning for the best reception and superior adjustment of signals (even from "off-freq." sets). And the Lion's bold new LED digital read-out.

Both sets are backed by Pearce-Simpson's over quarter-century of experience in personal two-way communications. And both are available right now. So stop by your Pearce-Simpson dealer today. He'll be glad to help you make the big cats roar.

For further information, write Pearce-Simpson, 4701 N.W. 77th Ave., Miami, FL 33166. In Canada, Scotcomm Radio, Inc., 4643 Levesque Blvd., Chomesday, Laval, Quebec.

LION 40



TIGER 40



PEARCE-SIMPSON
DIVISION OF GLADDING CORPORATION
THE CB RADIO • MARINE RADIO • ANTENNA PEOPLE.

CIRCLE 34 ON READER SERVICE COUPON

This is easy- anyone can solder- WITH KESTER SOLDER

**KESTER
SOLDER**

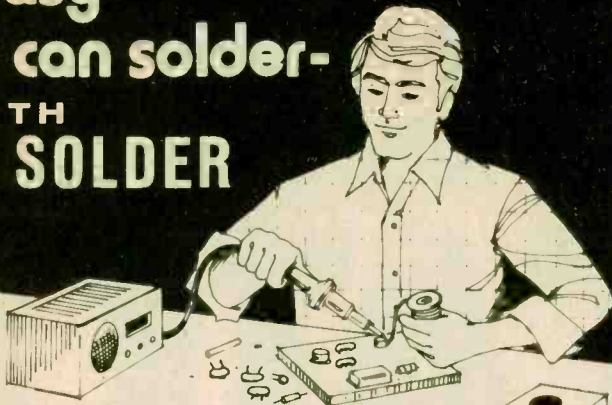

Handymen! Hobbyists! DO-IT-YOURSELFERS!

Let Kester Solder aid you in your home repairs or hobbies. For that household item that needs repairing — a radio, TV, model train, jewelry, appliances, minor electrical repairs, plumbing, etc. — Save money — repair it yourself. Soldering with Kester is a simple, inexpensive way to permanently join two metals.

When you Solder go "First Class" — use Kester Solder.

For valuable soldering information send self-addressed stamped envelope to Kester for a FREE Copy of "Soldering Simplified".



KESTER SOLDER

Litton 4201 WRIGHTWOOD AVENUE/CHICAGO, ILLINOIS 60639

CIRCLE 12 ON READER SERVICE COUPON

FCC TVI REQUIREMENTS WON'T SOLVE ALL YOUR TVI PROBLEMS! ...even with 40 CHANNEL RIGS!

BUT THE TELCO XL - 1000 WILL!

Adjustable LOW PASS FILTER & ANTENNA TUNER (40 Channel)



According to the FCC:

"Any CB'er causing interference on TV channels 2, 5 and 6 because of spurious emission, must install a Low Pass Filter between transceiver & antenna line."

NOTE: Hams have been doing this for years!

**NOW THE CHANNEL GUARD XL-1000 gives you
a 2 FOR 1 BONUS!**

1. It **CLEANS UP** your interference problems.
2. **TUNES UP** your 23 CHANNEL ANTENNA for all 40 channels. (to 1 KW PEP)

Don't throw away your 23 Channel Antenna! Do it like the HAMS; clean up your OUTPUT and Tune up your ANTENNA for all 40, with CHANNEL GUARD, today!

For the name of your local TELCO DISTRIBUTOR, contact;



TELCO PRODUCTS CORP.

INNOVATORS IN COMMUNICATION ELECTRONICS

44 Sea Cliff Ave. • Glen Cove, N.Y. 11542 • Phone (516) 759-0300

CIRCLE 21 ON READER SERVICE COUPON

newscan

Electronics in the News!

Way to Grow!

You'd expect a quality CB company to expand their facilities after a banner year in 1976. That's exactly what Royce Electronics Corporation did. Here's what Ross Castrianni, operations manager, reported to ELEMENTARY ELECTRONICS.

"We expanded most all our departments," Castrianni said. "Engineering, quality control, service, warehousing, accounting, and the general office area. Plus, we added central data processing to replace our manual system. We also added an engineering laboratory."



Personnel in Royce Electronics' expanded Quality Control Department perform some 14 different tests on a large percentage of incoming radios. Here, a Royce technician is shown performing several tests on a new 40-channel Royce CB unit.

"By far, the three most significant changes were the expansion of our quality control department, the addition of our new engineering laboratory, and the addition of the central data processing system. These are the three areas of most interest to dealers and consumers alike, because they mean Royce will be delivering an even finer quality product, and delivering it faster." Castrianni said the quality control department has been expanded about five times its original size. "At that time," he said, "we had one quality control line and six employees in the department. Today, we have five quality control lines, and more than 50 employees in the department."

Each quality control line performs some 14 different tests on a large percentage of incoming radios. If just 2% of any shipment is in any way faulty, the entire shipment is inspected.

The addition of the new engineering laboratory will allow Royce to conduct tests with computerized test equipment.

(Continued on page 27)

SHOP YOUR NEARBY RADIO SHACK FOR QUALITY PARTS AT LOW PRICES!

Top quality devices, fully functional and carefully inspected. Guaranteed to meet all specifications, both electrically and mechanically. All are made by well known American manufacturers, and all have to

pass manufacturer's quality control procedures. These are not rejects, not fallouts, not seconds. In fact, there are none better on the market! Count on Radio Shack for the finest quality parts.



TTL Digital ICs

First Quality Devices Made by National Semiconductor and Motorola

| Type | Cat. No. | Reg. | SALE |
|-------|----------|--------|------|
| 7400 | 276-1801 | \$ 49 | 29c |
| 7402 | 276-1811 | \$ 49 | 29c |
| 7404 | 276-1802 | \$ 59 | 29c |
| 7406 | 276-1821 | \$ 69 | 39c |
| 7408 | 276-1822 | \$ 49 | 29c |
| 7410 | 276-1807 | \$ 49 | 29c |
| 7413 | 276-1815 | \$1.19 | 69c |
| 7420 | 276-1809 | \$ 49 | 29c |
| 7427 | 276-1823 | \$ 69 | 39c |
| 7432 | 276-1824 | \$ 69 | 39c |
| 7441 | 276-1804 | \$1.59 | 89c |
| 7447 | 276-1805 | \$1.99 | 89c |
| 7448 | 276-1816 | \$1.99 | 89c |
| 7451 | 276-1825 | \$ 49 | 29c |
| 7473 | 276-1803 | \$ 79 | 39c |
| 7474 | 276-1817 | \$ 79 | 39c |
| 7475 | 276-1806 | \$1.19 | 69c |
| 7476 | 276-1813 | \$ 79 | 49c |
| 7485 | 276-1826 | \$1.59 | 99c |
| 7486 | 276-1827 | \$ 69 | 49c |
| 7490 | 276-1808 | \$1.19 | 69c |
| 7492 | 276-1819 | \$1.19 | 69c |
| 74123 | 276-1817 | \$1.89 | 89c |
| 74145 | 276-1828 | \$1.49 | 1.19 |
| 74150 | 276-1829 | \$1.79 | 1.39 |
| 74154 | 276-1834 | \$1.79 | 1.19 |
| 74192 | 276-1831 | \$1.69 | 99c |
| 74193 | 276-1820 | \$1.69 | 99c |
| 74194 | 276-1832 | \$1.69 | 1.19 |
| 74196 | 276-1833 | \$1.69 | 1.19 |

74C and 4000 Series CMOS ICs

| | | | |
|--------|----------|--------|------|
| 74C00 | 276-2301 | \$ 89 | 39c |
| 74C02 | 276-2302 | \$ 89 | 39c |
| 74C04 | 276-2303 | \$ 89 | 39c |
| 74C08 | 276-2305 | \$ 69 | 39c |
| 74C74 | 276-2310 | \$1.29 | 59c |
| 74C76 | 276-2312 | \$1.59 | 69c |
| 74C90 | 276-2315 | \$2.29 | 99c |
| 74C192 | 276-2321 | \$2.49 | 1.29 |
| 74C193 | 276-2322 | \$2.49 | 1.29 |
| 4001 | 276-2401 | \$ 69 | 39c |
| 4011 | 276-2411 | \$ 69 | 39c |
| 4013 | 276-2413 | \$1.29 | 89c |
| 4017 | 276-2417 | \$2.49 | 1.49 |
| 4020 | 276-2420 | \$2.49 | 1.49 |
| 4027 | 276-2427 | \$ 99 | 89c |
| 4049 | 276-2449 | \$ 99 | 69c |
| 4050 | 276-2450 | \$ 99 | 69c |
| 4511 | 276-2447 | \$2.89 | 1.69 |
| 4518 | 276-2490 | \$2.49 | 1.49 |

Linear ICs

First Quality Devices by National Semiconductor and Motorola



| Type | Cat. No. | Reg. | SALE |
|--------|----------|--------|------|
| 301AH | 276-017 | \$ 69 | 29c |
| 324N | 276-1711 | \$1.99 | 1.49 |
| 339N | 276-1712 | \$1.99 | 1.49 |
| 386CN | 276-1731 | \$1.99 | 99c |
| 555CN | 276-1723 | \$1.49 | 89c |
| 556CN | 276-1728 | \$2.99 | 1.29 |
| 566CN | 276-1724 | \$2.99 | 1.29 |
| 567CN | 276-1724 | \$2.99 | 1.99 |
| 723CN | 276-1740 | \$ 99 | 59c |
| 723H | 276-009 | \$ 99 | 59c |
| 741CN | 276-007 | \$ 69 | 35c |
| 741H | 276-010 | \$ 69 | 35c |
| 3900N | 276-1713 | \$1.99 | 59c |
| 3909N | 276-1705 | \$1.29 | 99c |
| 3911N | 276-1706 | \$2.19 | 1.99 |
| 4250CN | 276-1732 | \$1.99 | 1.19 |
| 4558CN | 276-038 | \$ 99 | 69c |
| 13741H | 276-1733 | \$2.59 | 1.49 |
| 75491 | 276-1701 | \$1.49 | 69c |
| 75492 | 276-1702 | \$1.49 | 69c |

8080A Microcomputer Chip

Direct Plug-In Replacement for Intel 8080A

1795

A CPU with a 16-bit address bus capable of addressing up to 65k bytes of memory and up to 256 I/O ports. "TRI-State" data bus gives it DMA and multiprocessing capability, and all buses are TTL compatible. Handles up to 244 instructions of variable length, with 6 general purpose registers plus an accumulator. 40-pin DIP. 100% Prime. 276-2510

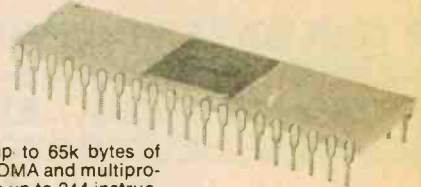

LEDs/Optoelectronics



| Item | Cat. No. | Reg. | SALE |
|---------------|----------|--------|-------|
| L Red LED | 276-041 | 2/99c | 2/69c |
| L Ctr LED | 276-047 | 2/99c | 2/69c |
| M Red LED | 276-026 | 2/99c | 2/69c |
| M Ctr LED | 276-040 | 2/99c | 2/69c |
| S Red LED | 276-042 | 2/99c | 2/69c |
| Infrared Det. | 276-140 | \$1.19 | |
| Infrared Em. | 276-141 | \$1.19 | |
| Solar Cell | 276-115 | \$1.49 | |
| Photocell | 276-116 | \$ 99 | |
| FPT 100 | 276-130 | \$ 79 | |

Digital Displays



| Digits | Size | Drive | Cat. No. | Reg. | SALE |
|--------|------|-------|----------|---------|--------|
| 1 | 0.3" | Anod. | 276-053 | \$2.99 | 1.99 |
| 1 | 0.3" | Cath. | 276-062 | \$2.99 | 1.99 |
| 1 | 0.3" | Anod. | 276-1210 | 4/58.97 | 4/6.95 |
| 1 | 0.3" | Cath. | 276-1211 | 4/58.97 | 4/6.95 |
| 1 | 0.6" | Anod. | 276-056 | \$3.99 | 2.99 |
| 1 | 0.6" | Cath. | 276-066 | \$3.99 | 2.99 |

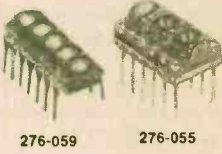

| Digits | Size | Drive | Cat. No. | Reg. | SALE |
|--------|--------|-------|----------|--------|------|
| 3 | 0.120" | Cath. | 276-055 | \$1.49 | 99c |
| 5 | 0.110" | Cath. | 276-059 | \$1.99 | 1.49 |
| 9 | 0.150" | Cath. | 276-060 | \$2.99 | 1.99 |
| 4 | 0.5" | Anod. | 276-1201 | \$9.95 | 7.95 |
| 4 | 0.5" | Cath. | 276-1202 | \$9.95 | 7.95 |

Project Accessories

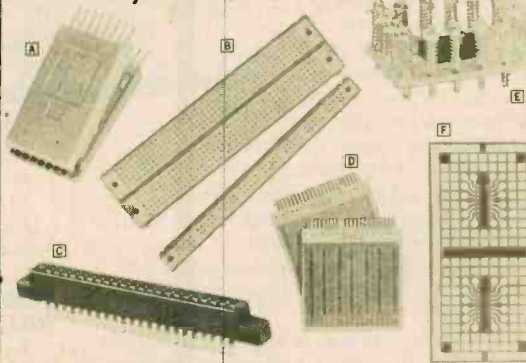

- ⓐ IC Troubleshooting Test Clip. Test up to 16 pins with probes or clips. 276-1951 4.99
- ⓑ Experimenter Socket. 2x47 rows of 5 connected tie points. 276-172 9.95
- ⓒ Bus Strip. 2x40 connected tie points. Clips to socket above. 276-173 1.99
- ⓓ 22-Pin Edge-Card Board Connector. 44 terminals. 276-1551 2.99
- ⓔ Standard Edge-Card Board. 22-pin. 1295 mounting holes. 276-152 2.99
- ⓕ 2-Voltage Source Edge-Card Board. 1368 mounting holes. 276-154 2.99
- ⓖ 3-Voltage Source Edge-Card Board. 1368 mounting holes. 276-153 2.99
- ⓗ Solderless IC Experimenter Kit. For 8, 14 or 16-pin IC's. 277-101 2.99
- ⓓ Experimenter's PC Board. Mount 2 IC's. 8, 14 or 16-pin. 276-151 2.49
- ⓔ Plastic Face Plates. 2x6x4 99c
- ⓕ Brown Tint. 270-298 99c
- ⓖ Red Tint. 270-299 99c
- ⓗ Photographic PC Board Processing Kit. Complete negative process. 8 pieces. 276-1560. Reg. \$12.95 Sale 9.95

Selected Diodes

| Type | Cat. No. | Reg. | SALE |
|------------|----------|----------|-------|
| 1N4001 | 276-1101 | 2/\$.39 | 2/29c |
| 1N4003 | 276-1102 | 2/\$.59 | 2/39c |
| 1N4004 | 276-1103 | 2/\$.69 | 2/49c |
| 1N4005 | 276-1104 | 2/\$.79 | 2/59c |
| 1N4735 | 276-561 | 2/\$.89 | 2/69c |
| 1N4739 | 276-562 | 2/\$.89 | 2/69c |
| 1N4742 | 276-563 | 2/\$.89 | 2/69c |
| 1N4744 | 276-564 | 2/\$.89 | 2/69c |
| 1N5401 | 276-1141 | 2/\$.69 | 2/59c |
| 1N5402 | 276-1142 | 2/\$.89 | 2/69c |
| 1N5403 | 276-1143 | 2/\$.99 | 2/79c |
| 1N5404 | 276-1144 | 2/\$1.19 | 2/89c |
| 1N914/4148 | 276-1122 | 10/99c | |



SCRs and Triacs

| Device | Rating | Cat. No. | Reg. | SALE |
|--------|----------|----------|--------|------|
| SCR | 50V, 6A | 276-1089 | \$ 99 | 69c |
| SCR | 100V, 6A | 276-1090 | \$1.29 | 79c |
| SCR | 200V, 6A | 276-1067 | \$1.39 | 89c |
| SCR | 400V, 6A | 276-1020 | \$1.49 | 99c |
| Triac | 50V, 6A | 276-1003 | \$ 99 | 69c |
| Triac | 100V, 6A | 276-1002 | \$1.29 | 79c |
| Triac | 200V, 6A | 276-1001 | \$1.39 | 89c |
| Triac | 400V, 6A | 276-1000 | \$1.49 | 99c |



Reference Books

| | |
|------------------------------|------|
| Digital ICs. 62-1370 | 3.50 |
| Linear ICs. 62-1372 | 3.50 |
| Linear Applications. 62-1373 | 2.75 |
| Semiconductors. 276-4001 | 1.99 |
| Voltage Regulators. 62-1371 | 2.25 |

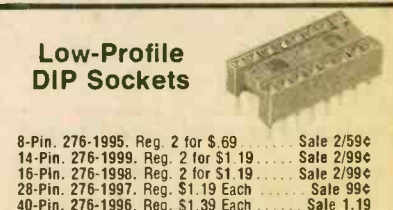

ASCII Encoded Computer Keyboard

Reg. ~~67.95~~ 49.95 Pkg.

Style May Vary from Photo



Operates on the scan principle utilizing TTL logic. With repeat key, negative/positive going data valid strobe, latch outputs, shift and shift-lock capability. True/false ASCII outputs, 6 extra control keys. With all necessary parts, including TTL components. Does not include test jigs, optional features or case and hardware. See store sales persons for parts list. 277-117. Complete Pkg. Sale 49.95

Low-Profile DIP Sockets

| | |
|-------------------------------------|------------|
| 8-Pin. 276-1995. Reg. 2 for \$69 | Sale 2/59c |
| 14-Pin. 276-1999. Reg. 2 for \$1.19 | Sale 2/99c |
| 16-Pin. 276-1988. Reg. 2 for \$1.19 | Sale 2/99c |
| 28-Pin. 276-1987. Reg. \$1.19 Each | Sale 99c |
| 40-Pin. 276-1996. Reg. \$1.39 Each | Sale 1.19 |



WHY WAIT FOR MAIL DELIVERY? IN STOCK NOW AT OUR STORE NEAR YOU!

OVER 5000 LOCATIONS IN NINE COUNTRIES

Radio Shack®

A TANDY COMPANY • FORT WORTH, TEXAS 76107

Don't have a lick of work done on your house without consulting this book!

8½" x 11"

Hardcover

The First and Only Guide Of Its Kind!

IT CAN SAVE YOU HUNDREDS—EVEN THOUSANDS—OF DOLLARS ON REMODELING... EXPANSION... REPAIRS... ALTERATIONS!

Suppose you'd like to remodel your kitchen or bathroom. Install asbestos or aluminum siding. Partition your basement. Or make some other improvement in or around your house.

Can you trust yourself to estimate the costs accurately? So that you don't wind up paying a lot more than you figured? Or a lot more than you should?

Or will you simply throw yourself on the mercy of some contractor—and hope he doesn't soak you too heavily?

Up to now—unless you have a brother-in-law in the business—you've been at a great disadvantage. But no more!

Because now you can refer to **The COMPLETE HOME REMODELING GUIDE AND SELF-ESTIMATOR, 1977 Edition**, by nationally syndicated home building columnist Patricia Mantz. Written in collaboration with the Editors of the Davis Home Plan Publications, this is the first book to quote *specific, up-to-date price ranges* for every kind of job you might want to do on your home!

NO MORE GUESSWORK—OR PAINFUL COST OVERRUNS!

This book reveals to the layman—for the first time—cost figures that only professional builders and contractors had access to before. *Here's how it works:*

Let's say, just for example, that you'd like to build a closet in your bedroom. And you want a fair estimate of what it should cost.

You simply turn to the chart on *Closets*. There you'll find current minimum and maximum price estimates for every size of closet from 2 x 2 all the way to 12 x 3. Regular or cedar-lined. Single-door or sliding doors.

And you'll find the same straightforward dollars-and-cents figures for replacing a 4 x 4 stair post. Installing a new tub and toilet in your bathroom. Cutting a door, or a dormer window. Even adding a whole new room or level to your house.

In short—virtually every conceivable home repair, improvement or alteration!

Accurate from Maine to Hawaii!

Costs vary, of course, from one part of the country to another. Therefore, this book includes a Geographical Adjustment Table. Just a glance at this table—and a little simple arithmetic—will enable you to translate the figures on the charts into the correct figures for your area.

MANY ADVANTAGES! MANY USES!

Whether you use a contractor or handle the job yourself, **THE COMPLETE HOME REMODELING GUIDE AND SELF-ESTIMATOR** puts you in control of the situation. Just consider:

- It will help you deal with contractors! (After all, how much can they overcharge you—when you have an authoritative, independent source to check their estimates against?)
- It will help you match your plans to your budget. When you know what each job will cost, you'll never bite off more than you can chew. (And sometimes, you may be pleasantly surprised to find that you can afford more than you thought you could!)
- It can help you make major decisions—such as whether you would be better off fixing up your present home or buying a new one.

This book can also serve as a valuable guide for contractors, tradesmen and building-materials dealers in structuring their prices. And for banks, realtors, landlords, insurance agents and tax assessors in appraising the value of improvements.

YOU GET A WEALTH OF PRACTICAL ADVICE, TOO!

With its price information alone, **THE COMPLETE REMODELING GUIDE AND SELF-ESTIMATOR** can pay for itself many times over. But it also gives you much more!

You will find illustrated chapters on:

- How to Choose a Reliable Contractor.
- Cost-Cutting Construction Ideas.
- The Do's and Don'ts of Good Kitchen Planning.
- What You Should Know About Lumber.
- How to Plan a Bathroom. (Valuable tips about one of the most expensive rooms in your home!)
- What You Can Do With Brick. (All about the basic styles, designs and uses.)
- Home Improvement Projects You Can Do Yourself. With plans selected by nationally known architects.

This book will not be sold in any bookstore. You can purchase it only by mail, as a special service of Davis Publications, Inc.—whose publications for the homeowner include the one you are reading now.

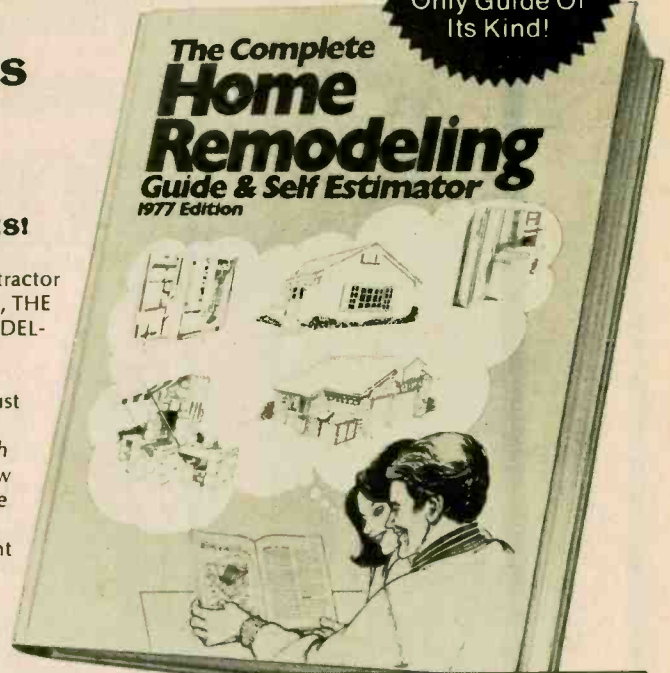

The Author

PATRICIA MANTZ's syndicated column on homes and homebuilding appears in newspapers across the country. She has also written and edited several publications in the field.

TEN-DAY EXAMINATION OFFER—FULL REFUND GUARANTEED!

To order your copy of **THE COMPLETE HOME REMODELING GUIDE AND SELF-ESTIMATOR**, mail the coupon below, with your check or money order for \$9.95 plus postage and handling. If you don't agree that this book is indispensable for anyone thinking about a home repair or remodeling job, return it within 10 days for full refund.

DAVIS PUBLICATIONS, INC. EE57

229 Park Ave. South
New York, N.Y. 10003

Please send me **THE COMPLETE HOME REMODELING GUIDE AND SELF-ESTIMATOR, 1977 Edition**, by Patricia Mantz with the Editors of the Davis Home Plan Publications. I enclose \$9.95 in payment plus \$5.55 for postage and handling, (total \$15.50). I understand that I may, if I wish, return the book within 10 days for full refund. (please print)

Name _____

Address _____

City _____

State _____ Zip _____

N.Y. residents please add applicable sales tax.

NEWSCAN

(Continued from page 24)



The new engineering laboratory allows Royce Electronics to conduct tests with computerized test equipment. Here, a Royce technician is placing a Royce 40-channel CB in an environmental test chamber, used to test units at extreme temperatures, from -100°F to $+250^{\circ}\text{F}$. Your car can't pass this test.

Huge ovens and freezers will be used to test units at extreme temperatures.

Castrianni said the quality control and engineering departments insure consumers less chance of radio failure because they give Royce a chance to catch problems and potential problem areas before the units get into the hands of consumers. "We're spending our money up front," Castrianni said, "instead of on the repair end."

Royce growth pattern is typical of many other CB companies. The growth of CB has demanded increased consumer consciousness and service. CB is growing up.

Electronic Piano Scores

Beethoven's last symphony may very well have been his Nineteenth, instead of his Ninth, if he could have used technology now becoming available that enables composers to work at electronic speeds. Computer Automation's new system, for example, permits modern composers, students and teachers to practice their art on a piano keyboard with one big difference—the keyboard is also a computer input terminal.

As the music is played, it is scored



James Troxel of Musecom, Ltd., Hollywood, Calif., watches his music take shape on a video screen (at left) as he composes. Hidden inside the electronic piano is a Computer Automation minicomputer which controls the visual display and a digital plotting device that draws the finished product (at right).

by the computer and displayed on a screen built into the electronic piano. But that is only the beginning. The musician can change his mind as often as the creative urge dictates. The system automatically records the change and never complains. When the composer is finally satisfied, the final score is prepared on music paper and delivered through a slot in the console.

"The system is unparalleled in its elimination of the time-consuming and tedious work associated with writing and copying music," said James Troxel, vice president of Musecom, Ltd., Holly-

wood, California, designer of the system.

Called Musecom II, the whole package is no bigger than a standard upright piano. Inside is a Computer Automation minicomputer which controls a digital plotting device that draws the notes. The mini-computer in Musecom II has been taught with software to converse in standard music notation. The system can display about 20 lines of music at a time.

"With other methods, a composer would have to talk the computer's
(Continued on page 28)

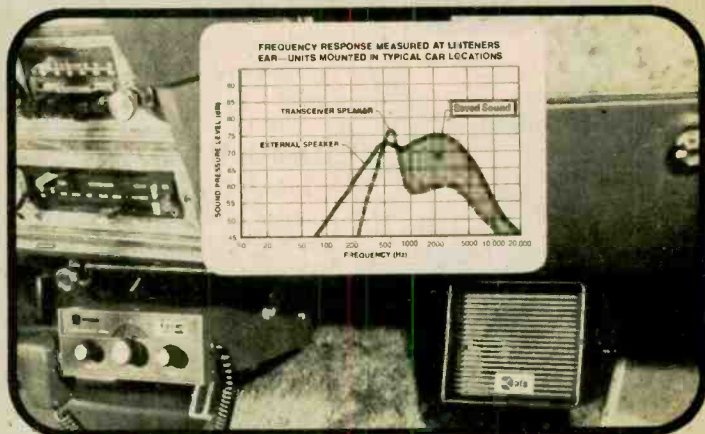

external speakers save lost CB sound

Notice what happens to the high frequencies? You lose them mounting the average CB under the dash. The speaker points down into the floor insulation. Sound is lost. With the addition of an acoustically designed "KRIKET" external speaker, also mounted under the dash but pointing at the driver, the high frequencies come through.

The consonant sounds are in the high frequencies. And they spell the difference between voice intelligibility and just plain noise. That's why you hear remarkably better with a "KRIKET" external speaker. It's the single best accessory you can add to any CB transceiver—23 or 40 channel—to improve enjoyment of it.

Available at CB Dealers everywhere.

afs/Kriket Speakers

World Wide Headquarters
Acoustic Fiber Sound Systems, Inc.
7999 Knue Road Suite 116
Indianapolis, IN 46250
(317) 842-0620

Exclusive Canadian Distributor
Persona Communications L.T.D.
1149 Pioneer Road
Burlington Ontario, Canada
(416) 629-5373

All AFS®/KRIKET® speakers are manufactured in the U.S.A. using American materials and craftsmen.

Copyright 1976 Acoustic Fiber Sound Systems, Inc.

CIRCLE 5 ON READER SERVICE COUPON

Use Quick-Wedge to install a bus, connect a motor, mount a p.c. board, cinch up a connector

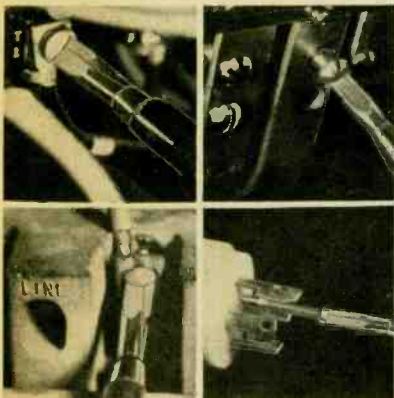

They do all that ordinary screwdrivers do, PLUS they hold and start the screw



QUICK-WEDGE 17 sizes
Screw-holding screwdrivers

Unconditionally guaranteed.

BUY A SET TODAY

See your dealer or write to:

Kedman Company, P.O. Box 25667,
Salt Lake City, Utah 84125

© Copyright 1977

CIRCLE 11 ON READER SERVICE COUPON

BEST IN NEW ELECTRONICS BOOKS!

- The Complete Handbook of Slow-Scan TV. 304 p., 69 il. \$9.95
- How To Build Metal/Treasure Locators. 112 p., 51 il. \$3.95
- Build-It Book of Digital Electr. Timepieces. 294 p., 209 il. \$6.95
- Programming Microprocessors. 280 p., 105 il. \$6.95
- Display Electronics. 252 p., 195 il. \$5.95
- Flying Model Airplanes Helicopters By RC. 192 p., 147 il. \$4.95
- Complete Hdbk of Videocassette Recdrs. 266 p., 160 il. \$5.95
- Microphones—How Work/How Use. 224 p., 85 il. \$5.95
- The Complete Hdbk of Electr. House Wiring. 476 p., 197 il. \$6.95
- Practical Solid-State DC Power Supplies. 196 p., 151 il. \$6.95
- Broadcast Engineering Maintenance Hdbk. 532 p., 235 il. \$19.95
- CB Radio Operator's Guide—2nd Edition. 256 p., 139 il. \$5.95
- Build Your Own Working Robot. 238 p., 83 il. \$5.95
- Master Transistor IC Substitution Handbook. 518 p. \$7.95
- Master Hdbk of 1001 Pract. Electr. Cirs. 602 p., 1250 il. \$9.95
- Transistor Ignition Systems. 252 p., 169 il. \$5.95
- Prof. Electr. Eng. Lic. Study Guide. 448 p., 318 il. \$7.95
- Color TV Trouble Facbk—Probs Sols—3rd Ed. 612 p. \$5.95
- Talk-Back TV: Two-Way Cable Television. 238 p., 64 il. \$5.95
- Understanding/Using Modern Sig. Gens. 294 p., 120 il. \$6.95
- Handbook of Multichannel Recording. 322 p., 196 il. \$7.95
- Mathematics Unraveled—280 p., 91 il. \$6.95
- CET License Handbook—2nd Edition. 448 p., 169 il. \$8.95
- Fun With Electronics. 140 p., 50 il. \$3.95
- Practical CB Radio Troubleshooting Repair. 238 p., 108 il. \$5.95
- Fire Theft Security Systems—2nd Edition. 192 p., 108 il. \$5.95
- Auto Electronics Simplified. 256 p., 202 il. \$5.95
- Electronic Music Circuit Guidebook. 224 p., 180 il. \$6.95
- Linear IC Applications Handbook. 280 p., 183 il. \$6.95
- Pilot Navigation With Pocket Calculator. 406 p., 338 il. \$8.95
- Commercial FCC License Handbook. 280 p., 150 il. \$5.95
- Understand/Using Modern Electr. Svc. Test Eq. 252 p. \$5.95
- AMATEUR RADIO STUDY GUIDES: Novice \$5.95 General \$7.95 Advanced \$5.95 Extra \$5.95 Incentive \$4.95
- Master Hdbk of Digital Logic Applications. 392 p., 287 il. \$7.95
- 106 Easy Electr. Projs Beyond Transistors. 224 p., 127 il. \$5.95
- Master Tube Substitution Handbook. 548 p., 322 il. \$4.95
- Servicing Medical Bioelectronic Equipment. 350 p., 165 il. \$8.95
- Mode Railroad Electronics. 308 p., 218 il. \$5.95
- Microprocessor Microprogramming Hdbk. 294 p., 176 il. \$6.95
- Optoelectronics Guide—With Projects. 196 p., 115 il. \$5.95
- The Complete FM 2-Way Radio Handbook. 294 p., 111 il. \$5.95
- The Electronic Musical Instrument Manual. 210 p., 385 il. \$6.95
- Impedance. 196 p., 90 il. \$5.95
- Switching Regulators & Power Supplies. 252 p., 128 il. \$6.95
- 21 Simple Transistor Radios You Can Build. 140 p., 122 il. \$3.95
- OP AMP Circuit Design & Applications. 280 p., 239 il. \$6.95
- Basic Digital Electronics. 210 p., 117 il. \$4.95
- How to Test Almost Everything Electronic. 160 p., 114 il. \$3.95
- Servicing Cassette Cartridge Tape Players. 294 p., 196 il. \$6.95
- CB Schematic Svcing. Manuals. each 200 p. \$5.95 Vol 1 Kris Browning. Hy-gain. Penney's. Vol 2 Teaberry. Unimetrics. Pearce-Simpson. Sillitronix. Vol 3 E. F. Johnson. SBE Linear Sonar. Royce. Vol 4 Pace. Fannon-Courier (Cobra). Vol 5 Radio Shack (Realistic). Surveyor. Bellek. Vol 6 Xtal. Tram Diamond. Sharp. Vol 7 Lafayette. J.I.L. Fanon

SEND NO MONEY! We'll invoice you on 10-DAY FREE TRIAL. Clip entire ad to order. 100% guaranteed or your money refunded.

TAB BOOKS DEPT EE-57 P.O. BOX 40
BLUE RIDGE SUMMIT, PA. 17214

CIRCLE 17 ON READER SERVICE COUPON

NEWSCAN

(Continued from page 27)

language—typing in his musical composition in the form of a computer program through a terminal. Each sound would normally require a different command," explained Troxel.

With Musecom II, a composer can "scroll" to any part of his score-in-progress, make notational changes, and ask to see and hear the results. One consideration is that the composer must play against a metronome to tell the machine when the last note is finished and the next one is about to begin. This is a standard procedure in conventional music composition.

The system can automatically transcribe a work to a different key, a task that normally would take a composer or copyist several hours to do by hand. Musecomp II will also automatically draw the score on the ground staff, treble single staff, or bass single staff.

The one thing the system won't do is create music—that's still up to the composer.

Sound of Music

Booker T. Gibson is one of the most popular teachers in his Valley Stream South High School, Valley Stream, N.Y. Since he doesn't teach mathematics or science, Gibson was automatically a good choice for an entry into any popularity contests real or imagined. But even in years of teaching a subject like music appreciation, always a favorite in our music-conscious society, many teachers fail to win the kind of devotion and interest that Booker T. Gibson gets from students.

Gibson, 45, who has been teaching music appreciation at the school for twenty-one years, has a unique teaching tool that has won him the support of students, parents and fellow teachers. He has turned his music appreciation classes on to the wonders of quadrasonic sound and not only increased their understanding of the music but increased the musical sophistication of his seventh and eighth grade classes, most of whom are at the age when they really begin to be conscious of high fidelity.

Gibson, formally a jazz pianist who is also a lover of classical music, admits that for him the experience of teaching in quadrasonic has been just as rewarding as it apparently has been for his students.

"After some discouraging moments in teaching, where the kids weren't getting it, I thought I had to use some new ways. I had four channel in my



Booker T. Gibson in his classroom at Valley Stream South High School, Valley Stream, New York, discussing quadrasonic sound with students.

home and loved it. So I started bringing my own Lafayette SQ full logic equipment to school. Lafayette even sent out a representative to install and demonstrate the system to the class. The students liked what they heard and their enthusiasm spread to parents and the school administration. Eventually, the school purchased a permanent SQ-quad system for the classroom."

"Students' reaction to the four channel concept has been highly favorable. At first, some are startled by it—but then when four channel expands the dimensions of the listening area, and they can hear the difference between four channel and stereo, they go for quadrasonic. I think it's helped tremendously in increasing the enthusiasm of my students for all types of music."

"One of my most successful projects year after year is opera. The kids love certain operas, La Boheme, Aida and Madame Butterfly. Even in the symphonies they have particular favorites, Mozart, Beethoven and Brahms, and I hope someday to introduce Mahler. It will be easier with four channel sound!"

Sealed Lead-Acid "D" Cell

A new line of rechargeable sealed lead-acid (SLA) cells and batteries is now being offered by General Electric's Battery Business Department in addition to their rechargeable nickel-cadmium battery line. The new SLA cells are the result of GE's many years of experience in rechargeable battery design and production and feature the same type of wound-plate construction used in GE's nickel-cadmium batteries.

First units offered will be the "D" size; high capacity "X" cells will be available shortly. The SLA cells are truly sealed and can be used in any position. A resealable safety vent is provided to prevent cell bursting under extreme abusive use, but in normal service will never be needed.

The "D" SLA cells provide 2.5



The new GE sealed lead-acid cell is "D" size, like the dry cell in your flashlight. It is rechargeable and can deliver up to 75 amps for one second.

ampere-hours capacity at the 250 milli-ampere discharge rate. For portable power applications, a 16 hour recharge is recommended at a charger voltage of 2.45. For "float-charge" applications, such as computer or power backup systems, a constant charge voltage of 2.35 volts is recommended. The new SLA cells are capable of delivering continuous current up to 40 amps or momentary currents (one second) of 75 amps.

Internal resistance is 10 milliohms; this low value makes possible high charge and discharge rates with minimum danger of cell or battery overheating. In discharge, cell temperature limits are -40 degrees C. to +65 degrees C. Temperature limits for charging are nominally -20 degrees C. to +50 degrees C. Although storage temperature limits range from -40 to +65 degrees C., a room temperature storage is recommended.

The "D" SLA cells weigh 6.4 ounces (181.6 grams) and measures 2.67

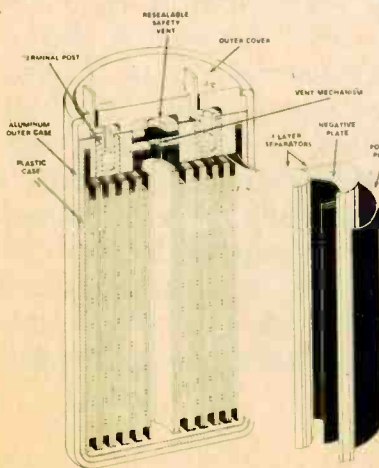

Inside the new GE "D" SLA cell. Large area surface between negative and positive plates, and thin separators reduce cell's internal resistance.

inches high by 1.34 inches diameter. It is designed to compare in form, fit and function with "D" cells of the SLA type offered by other manufacturers. The outer metal case is electrically isolated from the cell plates by a polypropylene inner container; both positive and negative contacts are made at the top of the cell.

Other features include a special glass fiber separator that can withstand high temperatures, no maintenance requirement, long life, low shelf discharge rate, low cost, and extended discharge capacity.

Standard batteries made from "D" cells are also available in 6 and 12 volt designs. Dimensionally, these batteries will be interchangeable with batteries of other manufacturers.

Pricing will be from \$2.49 to \$4.80 per cell ("D" size), depending on quantity ordered. On the standard batteries, pricing will be \$8.12 to \$13.90 for the six volt unit and \$15.59 to \$26.68 for the twelve volt unit.

Channel 9 Aid for Non-CBers

Local REACT teams are distributing a special flag for use by vehicles in trouble not equipped with CB. The Help Flag, made of highly visible orange reflective vinyl with the word "Help" and the REACT emblem printed in black, fits snugly against the side window, facing the road at right angles for maximum visibility. CBers passing a



REACT Help Flag alerts motorists.

stalled vehicle displaying the Help Flag are alerted to call local REACT teams on Channel 9. In some areas, Channel 9 is also monitored by law enforcement officials, speeding help. If you would like to obtain a REACT Help Flag, contact your local REACT team, who is distributing the flags as a combined community service and local fund-raising project, or send \$5.00 to REACT International, Inc., 111 E. Wacker Drive, Chicago, IL 60601. Contributions are tax deductible.

IT'S HERE!

The Most Advanced Design CB Base Antenna!

Anixter-Mark introduces the new Mark AMB-2... the space age version of the famous Mark II Super Beacon, with more advanced features than ever before in a base station antenna.

- Full half-wave design
- Tuneable to reduce the effects of nearby objects & the detuning as height varies
- Four piece construction for easy handling & shipping by UPS
- Eliminates noisy precipitation static
- Improves signal-to-noise ratio
- Affords up to 20 db operating gain
- Increases receiver sensitivity
- Extends intelligible coverage
- Easiest to install design
- No unsightly ground radials

The Mark AMB-2 will step up the efficiency of any CB base station. The reactive tuner eliminates matching problems, reduces the effects of nearby objects and gives the lowest possible VSWR—all with one simple adjustment! That's truly tuneable... and that's just one reason why this is the most advanced base station antenna ever. For more information and a free copy of "The CB, Amateur, Two-Way Antennas & Accessories Catalog," send the coupon today.

You bet I'd like a free catalog!

Name _____

Title _____

Company _____

Address _____

City _____

State _____ Zip _____

Anixter-Mark, 5439 W. Fargo
Skokie, Ill. 60076

EE/4-7

ANIXTER-MARK

Manufacturers of a
Full line of Point-to-Point Antennas
Microwave • Two-Way • Amateur • CB
5439 W. Fargo, Skokie, IL 60076 (312) 675-1500
Made in U.S.A.

Four different schools give you this 25" hobby-kit Color TV...

DIAGONAL

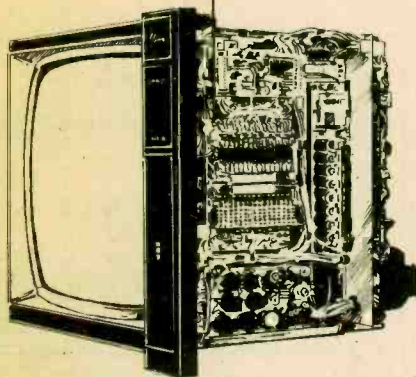

No other home training school gives you both an exclusive solid state color TV and an SQ® Quadraphonic Receiver complete with four speakers . . . all in one course. You get both for less than the tuition cost of TV or Audio alone from the next leading school. And only NRI's Master Course in Color TV/Audio servicing lets you train on equipment designed specifically for training with exclusive "power-on" features.

NRI doesn't give you hobby kits or commercial sub-assemblies. We invested the time and money to design equipment with learning in mind.

Only NRI gives you this 25" designed-for-learning Color TV...

DIAGONAL

It's the only way you can (1) get the feel of typical commercial circuitry, (2) learn bench techniques while building complete units from the "ground" up, (3) perform over 35 "in-set" experiments during construction, and (4) end up with a 25" diagonal solid-state color TV with console cabinet and a 4-channel quadrasonic Audio Center.

NRI passes the savings on to you

NRI can save you money because our engineering eliminates the cost of buying from an outside source. We pay no salesman's commission. Students are enrolled by mail only. The savings are passed on to you in the form of low tuition fees, extras like the TV's console cabinet and the four speaker Quad System; a 5" triggered sweep

oscilloscope, CMOS digital frequency counter, and an integrated circuit color TV pattern generator. Where NRI supplies a professional color



pattern generator, most other schools use a TV set with a built in alignment generator of no use for servicing other sets. Only NRI designs, engineers, and supplies training kits specifically for learning and professional use. You can pay hundreds of dollars more for a similar course and not get a nickel's worth more in training and equipment.

...plus complete Quadraphonic Audio Center!

More know-how per dollar

That's what it all boils down to, the quality of training you get for the money you spend. In our 62-year history, more than a million students have come to NRI and we're fully approved for career study under the G.I. Bill. We must be teaching something right.

Some of those "right" things are bite-size lessons to ease understanding and speed learning . . . personal grading of all tests, with comments or explanations where needed . . . a full-time staff of engineer/instructors to help if you need it . . . plenty of kits and experiments to give you hands-on training . . . and fully professional

programs oriented to full or part-time career needs.

Widest Choice of Courses with CB, Digital Computer, and other career opportunities

NRI offers not one, but five excellent TV/Audio servicing courses so you can tailor your training to your budget.

Or you can study other opportunity fields like Digital Computer Electronics, Citizens Band Radio, Communications, Aircraft or Marine Electronics, Mobile Radio, and more. Send

for our free catalog and see for yourself that no one gives you more training and equipment for your dollar. There's no obligation, and no salesman will call.

If card is missing, write to:



NRI SCHOOLS
McGraw-Hill Continuing
Education Center
3939 Wisconsin Avenue,
Washington, D.C. 20016

DX central reporting

A world of SWL info!

BY DON JENSEN

□ 1976 marked America's Bicentennial. 1977, for the British, should be at least as memorable as our nation's 200th birthday

was for us. For this is the year of the Silver Jubilee of Queen Elizabeth II, who assumed the throne 25 years ago.

To mark the event, Great Britain has planned a spectacular series of festivities, pageants, parties and parades in honor of the 50-year-old monarch. There will, it is expected, be news events galore during the Silver Jubilee year. There has been some speculation that Queen Elizabeth may step down in favor of her son, Prince Charles, to give her country a vigorous young king to help it through difficult times. Perhaps even more exciting is the announced attempt of one of the jubilee organizers, Lord Delfont to coax the Beatles back together for a special Silver Jubilee concert!

And when there is news, SWLs will, of course, hear it first on shortwave from the widely acclaimed British Broadcasting Corporation (BBC) newscasts on the World Service.

In addition to any breaking news, SWLs can expect that there will be special broadcasts covering the high points of the jubilee year. One occasion that surely will rate special BBC coverage of the pageantry will be June 11, when Queen Elizabeth will celebrate her official birthday. "Official" is the key word, since Elizabeth was actually born in April. This ceremony will include the traditional and spectacular Trooping of the Color, which we can expect to be amply described on BBC Radio by an appropriately subdued BBC announcer.

Not all the Silver Jubilee events are confined to the British Isles, however. The monarch will, during 1977, be visiting such former possessions as Australia, New Zealand, New Guinea, Canada, Fiji, Jamaica, Trinidad-Tobago and Grenada. At each stop along the worldwide way, there will be more celebrations.

And, if past royal visits are any guide, there will be special shortwave broadcasts from the global spots where Elizabeth II stops. At this writing I do not have the monarch's itinerary, but a careful reading of your daily newspapers will probably bring you the details as they happen, as will a monitoring of the BBC newscasts.

When Queen Elizabeth, for example, arrives in Australia keep a special radio watch on Radio Australia's frequencies. With the usual caution that frequencies do change and you might have to hunt a bit, I can point out that as this is written, Radio Australia's programs can be heard during the North American evening from 0100 to 0300 GMT on 15320 and 17795 kHz, and in the morning at 1100-1300 GMT on 9590 kHz.

An economic squeeze some time back curtailed the foreign service of Radio New Zealand. Many SWLs, however, considered this a blessing in disguise. After a short silent period, New Zealand returned to the air on shortwave. No longer was there a special foreign service directed at overseas audiences. Now RNZ simply picks up the domestic medium wave service intended for New Zealanders and relays this on shortwave. SWLs have indicated that they much prefer the flavor of the local programming to that formerly specially produced for overseas audiences.

So, when the British monarch visits New Zealand during the Silver Jubilee year, DX listeners will be hearing the same radio broadcasts on SW as New Zealanders are hearing on their AM medium wave stations. Look for Radio New Zealand between 0100 and 0600 GMT on 11705 kHz, or from around 0500 to after 0700 GMT on 954 kHz. If you're game for some post-midnight listening, try 6105 kHz.

During the Down Under "swing," the royal couple will, according to announcements, pay a call to Papua New Guinea. As probably the most primitive stop on the trip, this could be one of the most colorful pageants of jubilee year. So you should be listening for broadcasts from

(Continued on page 38)

Buy a cheap antenna, and you may never be heard from again.

When you're miles from help, you need a CB antenna that reaches for miles and miles. It could be your only link to safety. So saving a couple of dollars on a cut-rate brand could cost you.

But the price of an A/S antenna is worth the extra you might pay - just for the peace of mind. Every single A/S antenna is hand-tuned and tested for 23- and 40-channels. That's the kind of care and quality control that makes A/S the choice of

police departments, truckers and safety people everywhere. And that's why A/S has been the leader in antennas for 24 years.

So look for the red and black A/S stripes. You'll be heard when you have to be heard. We'll bet our A/S on it.



M-510 "Big Momma" Heavy Duty Antenna



the antenna specialists co.

12435 Euclid Avenue, Cleveland, Ohio 44106 • a member of The Allen Group, Inc.

CIRCLE 18 ON READER SERVICE COUPON



**STOP A COP.
AND ASK TO SEE HIS RADIO.**

Chances are, the name on his radio will be Motorola.[®]

The same Motorola that now makes a CB radio for your car.

Like our professional radios, a Motorola CB is exceptionally simple to operate.

It has features like gain control, audio compression, and noise limiting built in, fully automatic.

The result is truly outstanding talk/listen performance. Because the radio is in control. Rather than you.

A digital phase lock loop synthesizer makes tuning precise. Again, automatically.

A professional-quality 3½-inch top-fire speaker produces an audio fidelity that must be heard to be fully appreciated.

A Motorola CB is completely solid state and standardly equipped with a power mic that doesn't have batteries that can fail. That doesn't cost extra.

Of course, there's one feature a Motorola CB offers that's not in the specs. And that's reliability.

Police get it with the name Motorola.

So can you.

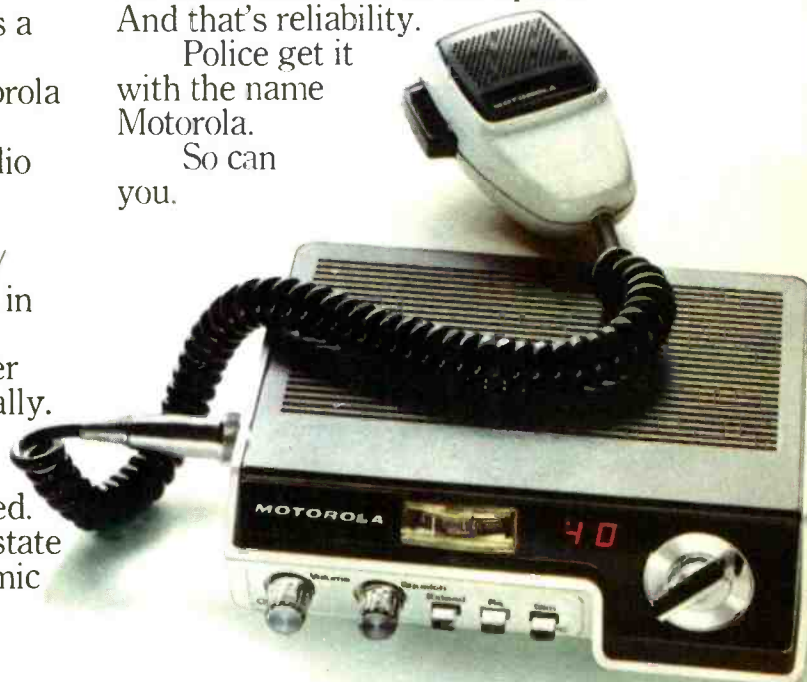

Motorola CB

From the voice of experience in 2-way radio.

To find the dealer nearest you, write: Customer Relations Manager, Motorola Inc., Automotive Products Division, 333 Northwest Ave., Northlake, Illinois 60164. Motorola is a registered trademark of Motorola Inc.



CIRCLE 22 ON READER SERVICE COUPON
www.americanradiohistory.com



**"FROM TWIN MAMAS
TO LUNCH BOXES, WE HAVE
HARDWARE
FOR EVERY APPLE"**

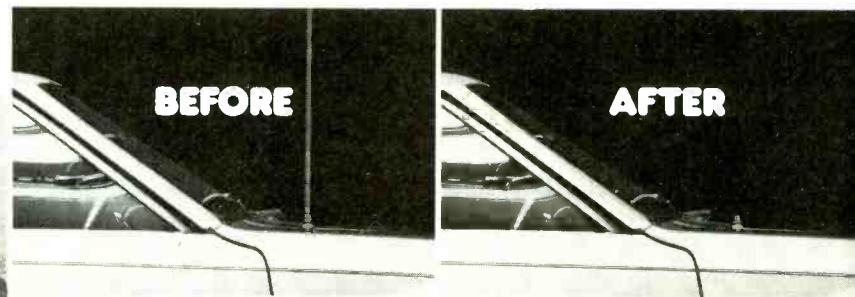

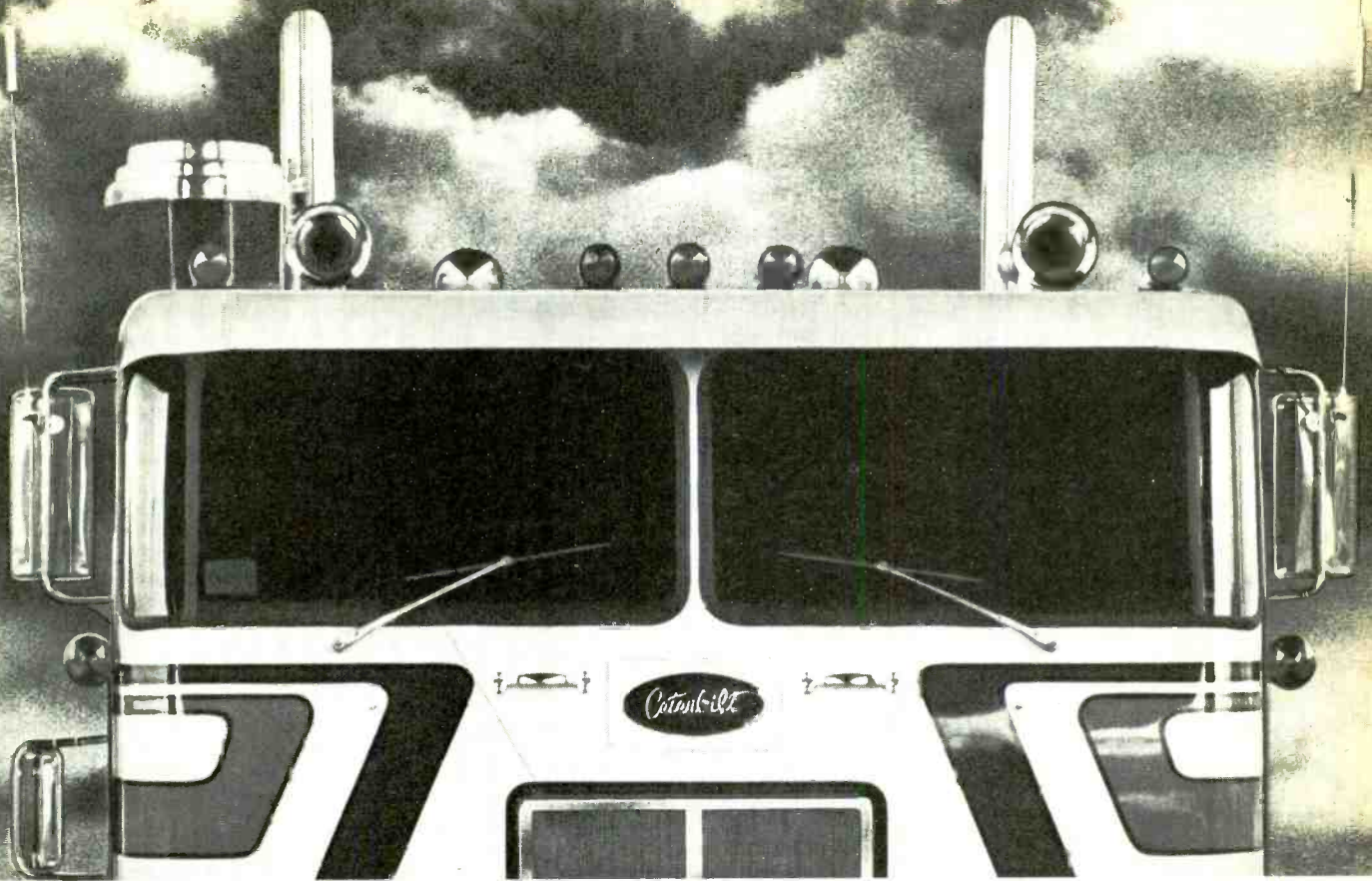

Loosely translated, that's CB talk for: "Sparkomatic has CB twin trucker antennas, CB base station antennas, CB instant mount antennas like magnet mount and clip ons, CB motorized and manually operated disappearing antennas, CB indoor and outdoor public address speakers, CB external speakers with tone purifiers, CB external speakers without tone purifiers and CB converters.

Not to mention, a complete line of 40 channel in-dash and under-dash mobile transceivers and base station units. Including 40 channel transceivers with memory control buttons, digital readouts and other up-to-the-minute innovations."

In other words, Sparkomatic has the very best CB equipment. And enough CB equipment to meet the needs of every CB'er.

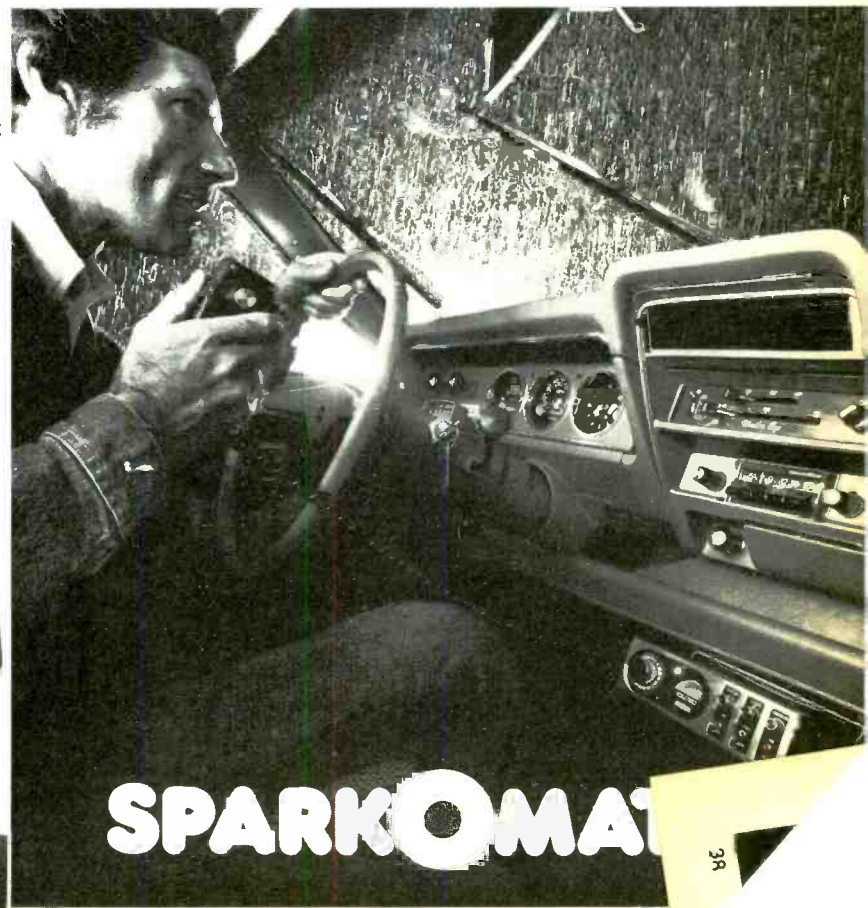

SPARKOMATIC

38

CIRCLE 23 ON READER SERVICE COUPON

FREE burglar — fire alarm catalog



over 900
systems,
detectors,
controls,
sounders,
tools, locks,
supplies

TO PROTECT HOMES, BUSINESSES, INDUSTRY

Huge selection of hard-to-find security equipment from stock. 64 fact-filled pages loaded with 100's of highest quality professional alarm products, technical notes, diagrams.

ONE-STOP SUPERMARKET SELECTION INCLUDES:

ultrasonics, radar, infrared, undercarpet mats, magnetic contacts, smoke & heat detectors; Controls; Alarms: bells, sirens, phone dialers, lights, guard panels. Large selection of tools, relays, wire, holdup alarms, books. Fills need for industry, alarm cos., businesses, homes, institutions. Order your copy today. (Outside U.S., send \$1.00.)



mountain west alarm
4215 n. 16th st.
phoenix, az. 85016
(602) 263-8831

CIRCLE 13 ON READER SERVICE COUPON

Now Available!



FROM
TIN FOIL
TO
STEREO

Here's your second
edition of the
1877-1959 phono
classic, now exten-
ded to 1976.

Discover the story of recorded music in 30 fascinating chapters. Enjoy photos of exotic music machines from early cylinder phonographs to stereo. Own THE reference for phonograph enthusiasts. \$19.95 hardcover, \$9.95 soft.

SEND TODAY to Vintage Radio, Dep't E,
Box 2045, Palos Verdes, Ca. 90274.
We pay postage. Calif. residents add 6%.

Copies hardcover @ \$19.95: _____

Copies softcover @ \$9.95: _____

Name _____

Street _____

City _____ St _____ Zip _____

You'll Enjoy It!

e/e DX CENTRAL REPORTING (Continued from page 34)

the stations of the National Broadcasting Commission of Papua New Guinea. There are quite a few PNG stations on shortwave but probably the most consistently heard in the United States and Canada is the National Broadcasting Station outlet at Port Moresby on 4890 kHz. Best time to hear this one is between about 1000 and 1300 GMT.

When the regal visitors reach Canada, few SWLs will experience any difficulty in tuning Canadian shortwave stations. First and foremost, of course, there is Radio Canada International. So well known is this northern radio neighbor that I don't have to list any frequencies. A casual tune-around the dial will turn up RCI programs.

Frankly, though, I would expect coverage of the visit to be more interesting on Canada's domestic network shortwave, the CBC's Northern Service, which is directed to Canadians living in the far north and to that nation's servicemen abroad. During much of the daytime period you can find Northern Service programs on 9625 and 11720 kHz.

One of the Caribbean stops on the junket will be the island of Grenada. That will be the time for listeners to tune in the programs of Radio Grenada (formerly the Windward Islands Broadcasting Service). The best time for SWLs to hear Radio Grenada would perhaps be during the afternoon hours, say until 2200 GMT on 15105 kHz. However, if jubilee events extend into the local evening hours on Grenada, a longer broadcasting period might be expected.

Unfortunately, Fiji, another scheduled stop for Queen Elizabeth, ceased its shortwave operations a few years ago. At one time Jamaica and Trinidad-Tobago in the West Indies also had shortwave outlets but they were shut down at least several decades ago. Barbados also is without a regular shortwave service. But don't give up hope. There are point-to-point, utility type shortwave transmitters on those various islands usually used for non-program type communications. It has happened in the past, and it could happen again during a royal visit, that these transmitters are pressed into special service to broadcast programs to persons living on more remote islands. Since these utility stations regularly operate outside the normal shortwave broadcasting bands, you should roam freely about your shortwave dial to hunt for any such off-beat programs.

Now it is entirely possible that there will be no such special transmissions from spots like Fiji, Barbados, Jamaica or Trinidad-Tobago. But if you have an ounce of DX-sporting blood in you you'll cruise the kilohertz during the Elizabethan visits to these islands. With some luck, who knows what might turn up?

Tsunami Gun! A popular radio program at the University of Hawaii, according to a National Geographic Society report, is "Tune a Tsunami." Well, not really. A

Tsunami is what is popularly called a tidal wave, though it has nothing at all to do with the tides. Caused by undersea earthquakes, tsunamis are a series of almost invisible seismic sea waves which, in deep water, travel at more than 600 miles per hour. But as they approach land, tsunamis suddenly become terrifying walls of water 30 or more feet high. In the past 150 years, 85 tsunamis have struck Hawaii, causing nearly 400 casualties.

But oddly enough, while still at sea, tsunamis are very difficult to detect. And University of Hawaii scientists have discovered and are testing a new early warning system to locate the deadly waves while still far from populated islands. And—here it comes, SWLs—that technique makes use of a shortwave station many of us can tune every day.

That station is WWVH, the National Bureau of Standards time and frequency station on the island of Kauai. Though perhaps not as widely heard or known as its big brother, WWV at Ft. Collins, Colorado, WWVH can be heard in most parts of the United States. It uses the same frequencies as WWV, 2500, 5000, 10000 and 15000 kHz. Easily heard under-over-through WWV in the western portion of the country, even east coasters can catch WWVH's time and other announcement at times, particularly during the early morning hours.

For the University of Hawaii scientists, WWVH is a local station and, with a special receiver, they monitor it regularly. When the WWVH signals, reflected from the ionosphere high above the earth, show a minute shift in frequency, it tells the researchers that an earthquake with tsunami potential has occurred. Then, with other equipment, the size and location of the tremor are determined.

Bandsweep. Times in GMT, frequencies

DX Glossary

- BBC**—British Broadcasting Corporation
- CBC**—Canadian Broadcasting Corporation
- Domestic service**—Programs intended for audiences within a country by a station located in that country.
- DX, DXing**—Listening to distant stations as a hobby.
- Foreign service**—Programs intended for listeners outside a country, foreign or overseas listeners.
- GMT**—Greenwich (or Universal) Mean Time, a common standard time reference equal to EST + 5 hours, CST + 6 hours, MST + 7 hours or PST + 8 hours.
- kHz**—kilohertz, most commonly used unit of frequency measurement; identical to the older term kilocycles per second (kcs.)
- SW**—Shortwave
- SWL**—Shortwave listener

in kHz: 3240—You've heard Trans World Radio's powerful shortwave voice in the Western Hemisphere, located on the island of Bonaire, off the coast of South America. Now try for another TWR outlet, this one from the tiny Southern African country of Swaziland. Listen to this frequency at 0315 . . . 6015—The curious anti-communist radio station in San Pedro Sula, Honduras, Radio Swan, has surfaced again,
(Continued on page 91)



WIRE WRAPPING TOOL

For AWG 30, .025" (0,63mm) sq. post,
"MODIFIED" wrap, positive indexing,
anti-overwrapping device

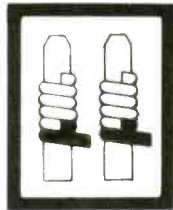

OK MACHINE & TOOL CORPORATION

3455 Conner St., Bronx, N.Y. 10475 / (212) 994-6600 / Telex 125091

NEW

**HOBBY-WRAP
Model BW-630**



**Battery
wire
wrapping
tool**

\$34⁹⁵
(batteries
not included)
ONLY
**COMPLETE WITH BIT
AND SLEEVE**

NEW

**HOBBY-WRAP
Model BW-630**



**Battery
wire
wrapping
tool**

\$34⁹⁵
(batteries
not included)
ONLY
**COMPLETE WITH BIT
AND SLEEVE**



WIRE WRAPPING TOOL

For AWG 30, .025" (0,63mm) sq. post,
"MODIFIED" wrap, positive indexing,
anti-overwrapping device.



OK MACHINE & TOOL CORPORA

3455 Conner St., Bronx, N.Y. 10475 / (212) 994-6600 / Tele

CIRCLE 14 ON READER SERVICE COUPON

There's an electronic kit that's exciting NEW HEATHKIT CATALOG.

Here are just a few of the things YOU can build!

New STEREO KITS



Top-performing receivers, amplifiers and tuners including a new "budget-priced" receiver, amplifier and tuner, a digital readout stereo receiver, the world-famous Modulus™, the deluxe AA-1640 "Super Amp" and lots more. All with the reliable performance, guaranteed specifications and superb sound that have made Heathkit hi-fi a favorite of serious audiophiles everywhere.

New SPEAKER SYSTEMS

A complete line of full-fidelity speaker systems for any budget or listening need. Everything from compact bookshelf models to full-size floor models like the exciting new AS-1348 — great sound and great kit savings!



New AIRCRAFT CLOCK/TIMER



Gives you the reliability, convenience and versatility you WANT for precise flight timing at substantial savings. Dual 4-digit displays—one showing 24-hour GMT or ZULU time and the other performing a function you preselect; local time, 24-minute timer, 24-hour trip timer, or a special alarm timer ideal for fuel management. The OL-1154 fits a standard 3 1/8" instrument panel for easymounting in most any aircraft.

New LEARN-AT-HOME COURSES



Now you can learn electronics at home in your spare time at your own pace whether you're a beginner or an advanced student. Each course includes text material, records and parts for use in "hands-on" experiments. Courses are available in AC and DC electronics, Semiconductor Devices and Digital Techniques plus two NEW courses: Electronic Circuits and a course which prepares you for the amateur radio Novice License exam.

New HOME PRODUCT KITS



Heath has products to make your home a healthier and safer place.

Security systems, a unique freezer alarm, lamp dimmers and electronic air cleaners, and a TOTALLY NEW energy and money-saving home furnace heating control that can save you 5-10% on your heating bill.



FREE

New Heathkit Catalog describing nearly 400 superb electronic kits that you can build yourself for pride, satisfaction and SAVINGS.

just right for you in this

Discover why thousands of people just like you enjoy handcrafting their own electronic equipment with exciting Heathkit products.

Building our kits is so easy and so much fun that most people enjoy the building just as much as they do using the product! There's the pride of accomplishment, the satisfaction of making something with your own two hands and the knowledge that you've "mastered" a sophisticated piece of electronic equipment. And every Heathkit product is designed for easy buildability. Our world famous step-by-step assembly manuals leave nothing to chance — they even teach you to solder properly. And every kit product we sell is backed by our "We won't let you fail" pledge. Find out about the exciting electronic products you can build. Send for your FREE catalog!



New FUN TO OWN KITS



Some Heathkit products are just plain fun to own and use. An exciting TV game that lets you play hockey, tennis or handball in full color, a unique programmable door bell that announces visitors with your favorite tune. A programmable digital stopwatch that times just

about anything with 1/100th second precision, treasure finder/metal locators for beach-time fun, marine electronics, and lots more. There's a complete line of digital electronic clocks and weather instruments including the popular digital floor and shelf clocks. There's also a convenient mount-anywhere touch-control light switch.



about anything with 1/100th second precision, treasure finder/metal locators for beach-time fun, marine electronics, and lots more. There's a complete line of digital electronic clocks and weather instruments including the popular digital floor and shelf clocks. There's also a convenient mount-anywhere touch-control light switch.

about anything with 1/100th second precision, treasure finder/metal locators for beach-time fun, marine electronics, and lots more. There's a complete line of digital electronic clocks and weather instruments including the popular digital floor and shelf clocks. There's also a convenient mount-anywhere touch-control light switch.



New COMPUTERIZED TV KIT



The first and only Programmable Computerized Color TV System: The GR-2001. Its optional programming panel lets you preselect an entire evening's viewing, then just relax as the GR-2001 changes channels automatically at the proper time. You can even program it to rotate your outdoor antenna system automatically. A real breakthrough in TV convenience.

New AMATEUR RADIO KITS



The HW-2036 is the best 2-meter rig we've ever offered — true digital frequency synthesis for complete operating versatility, built-in tone encoder and performance of expensive models at a much lower price. It's a great way to start your amateur radio hobby!

New TEST EQUIPMENT

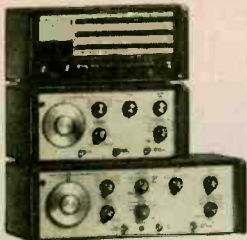

If you're an electronic hobbyist, experimenter or technician, Heath has the equipment to help you do the job right.

The latest audio service equipment including THD and IMD analyzers and an exclusive audio load, color TV service instruments including a hand-held color alignment generator and a universal CRT tester/rejuvenator, function generators including a new swept-function model — plus meters, power supplies and oscilloscopes to outfit ANY test or hobby bench.

Send for your FREE copy today!

Return card or coupon for your FREE Heathkit catalog today. It has complete descriptions and photos of some of the most exciting electronic products you can find anywhere, all in easy-to-build, money-saving kit form. Plus low discount prices on fully-assembled Johnson, Royce and Midland CB radios.

Heath Company, Dept. 139-29
Benton Harbor, Michigan 49022

HEATH
Schlumberger

Heath Company, Dept. 139-29
Benton Harbor, Michigan 49022

Please send me my FREE Heathkit Catalog.
I am not on your mailing list.

Name _____

Address _____

City _____ State _____

GX-329 Zip _____

There's more to Realistic® 40-channel CB than just 17 added channels...

there's also added performance!



With so many new and unproven brands on the CB bandwagon, the reasons for buying Realistic are clearer than ever. Take a look at these mobile sets, and you'll see what 17 years' experience can do for 40-channel CB. We've added ultra-stable and precise PLL circuitry, improved the auto-modulation for maximum talk power, and kept the high sensitivity and full power you've come to expect from Realistic — "the" CB experts since 1960.

The TRC-468 is the easiest, least expensive way we know to get into quality 40-channel CB. The compact PLL-equipped set has a sensitive dual-conversion receiver that pulls in even the weaker signals. A full-time noise limiter reduces or eliminates pulse interference, automatically! LED modulation indicator. Adjustable squelch. Lighted channel selector. With plug-in mike, mounting bracket, power cables. Only **99.95***



The TRC-467 is a high-performance transceiver with PLL and three ceramic IF filters for a whopping 80 dB of adjacent-channel rejection. An automatic noise limiter cuts pulse interference, and it's switchable. Lighted S/Rf meter and channel selector, LED modulation indicator — conveniences that make CB easier and more fun to use. With plug-in mike, mounting bracket, and power cables. Designed, manufactured and sold only by "the" CB experts — Radio Shack. Just **119.95***

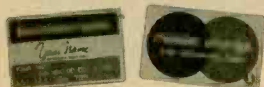

These two credit cards honored at most Radio Shacks.

*Prices may vary at individual stores and dealers.

SOLD ONLY WHERE YOU SEE THIS SIGN:

Radio Shack®

A TANDY COMPANY • FORT WORTH, TEXAS 76107
OVER 5000 LOCATIONS IN NINE COUNTRIES



by Morrie S. Goldman

BREAKING THE TV DISTANCE BARRIER

DX techniques add new excitement to your home TV.

□ In this day of satellite telecasts from all continents, the idea of watching a television program originating from a mere thousand miles distant doesn't sound too exciting. But how about receiving that same TV signal without the aid of a satellite? Sound interesting? Well, that's what TV-DXing is all about.

Even if you're an "old pro" in DXing circles, you're probably not too familiar with TV-DX. Sometimes it seems like many DXers even doubt that TV-DX is possible. What's surprising to many is that TV-DX is actually quite common! TV-DXers around the world regularly pull in distant video signals from 200 to 2000 miles away. As we'll soon see, a station 1000+ miles distant may actually appear with greater clarity than your local stations!

The real key to successful TV-DXing is not massive antenna systems and exotic equipment (though they help!), it is simply tuning in at the times when DX openings are occurring. Unlike the shortwave or broadcast band DXer, the TV-DXer can't just turn on a

receiver on most any day and start DXing. The TV-DXer must carefully survey daily and even hourly conditions, watching for a band opening. When openings do occur, the results can be quite rewarding. Instead of just hearing a distant station, you're actually seeing it as well.

You can greatly increase your odds of catching TV-DX by knowing when and on what channels it's most likely to occur. For this introduction, we'll go into a brief description of the most common forms (or modes) of wave propagation that affect television signals. Don't get worried by the sound of that—wave propagation is simply what happens to a signal from the time it leaves the transmitting antenna until it reaches a receiving antenna. A solid understanding of the basics of V-UHF propagation is essential to the TV-DXer.

The television bands are located in the VHF and UHF ranges of the electromagnetic spectrum. Signals in these bands are much higher in frequency than shortwave broadcast signals and as such are not propagated in the same manner. Layers of the earth's ionosphere that regularly reflect shortwave signals to points thousands of miles distant, normally fail to reflect VHF signals. Under "normal conditions," TV signals travel in straight lines and pass through the ionosphere into outer space. This limits the range of broadcast TV stations to line-of-sight. Broadcasters call the area covered under normal conditions, their coverage area. Typically, the coverage area of a VHF TV station



e/e DX WITH YOUR TV

is between 50 and 75 miles. Under abnormal conditions, this coverage area can very greatly increase.

Just what are the "abnormal conditions" that result in TV-DX? They are various changes in the condition of the earth's atmosphere that cause VHF or UHF signals to be bent or reflected beyond the horizon. Different modes of propagation are created by these conditions and they carry signals over varying distances. Certain modes of propagation have very different effects on the range of particular TV channels. Now let's take a close look at each of the common modes of propagation.

Tropospheric Bending. Tropospheric bending, tropo for short, is the most common mode of VHF-UHF propagation. Tropo is the only form of propagation that is directly related to weather. Frequently dubbed "extended ground-wave," tropo extends the range of VHF and UHF signals by 60 to 1000 miles. Distances up to 350 miles are most common.

Tropo can occur in several ways, but the influence of a high-pressure area is always required. When a temperature inversion occurs (warm air meeting a cool air mass), a low-level barrier to VHF and UHF signals is formed above the earth. Tropo is most common in early morning and evening when rapid warming and cooling of the air takes place. Fall is considered the favorite season for tropo, but openings are common in the spring and summer as well. In northern regions, tropo is uncommon in the spring and summer but it happens during an unseasonably warm weather period.

Tropo is characterized by steady signals. It usually affects the highest channels most. That is, a good opening on UHF may produce fair results on the VHF high band (channels 7-13) and poor results on the low band (channels 2-6). Tropo may also affect only a narrow range of channels. When this type of reception occurs, look for some fantastic catches because it's probably a sign of tropospheric ducting. Ducting is aptly termed, as signals become trapped between two air boundaries of different heights. This condition causes TV signals to behave in much the same manner as if they were being fed into a giant metal duct, following the curvature of the earth. A ducted signal may travel a thousand or more miles above the earth before returning down. Ducts are frequency-selective—they will carry only a limited range of channels. This range may include all of the UHF band or only a few channels. Ducts are very unstable and may last for hours or only minutes. Tropospheric ducting is most common in the UHF channels, but also shows up at the VHF high-band channels. A high-performance antenna system is vital for successfully DXing tropo ducts.

Sporadic E Skip. Frequently called "short skip" by ham radio operators, sporadic E skip (Es) can produce spectacular TV-DX results. Es commonly brings in TV-DX signals from 450 to 1400 miles distant on a single hop (that's short for the ham bands)—frequently with snow-free pictures. This is the same type of skip that produces the summer skip on CB.

Sporadic E skip occurs when a signal strikes sporadic patches of ionization in the E layer of the ionosphere (about 50 miles above ground). The ionized

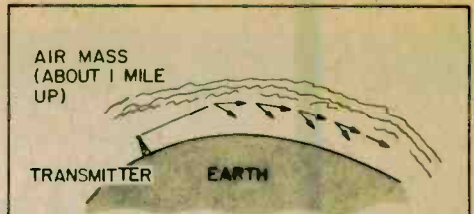

Tropospheric Bending causes TV signals on all channels to be "bent" over the horizon.

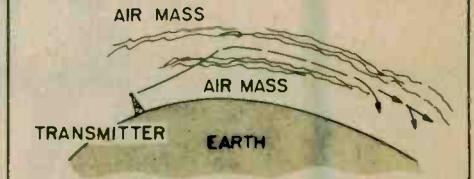

Tropospheric Ducting occurs when a TV signal (usually UHF) is trapped between two air masses and is "ducted" to a distant point, several hundred to a thousand miles away.

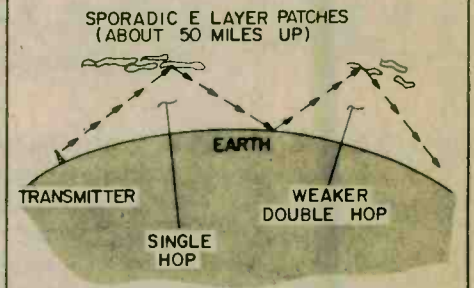

Sporadic E Skip causes signals to be refracted to points 450 to 1400 miles distant on a single hop. On very rare occasions, a signal may bounce off the earth and refract off a second sporadic patch causing "double hop" reception to 2800 miles. Sporadic E normally only affects channels 2-6



TV-DXing can sometimes turn up some real surprises, like reception of this experimental station operated by Zenith on UHF-TV channel 38.

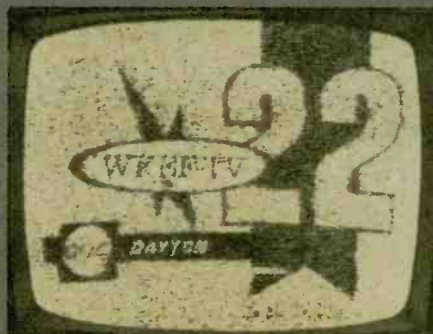

WKEF-TV, channel 22, in Dayton, Ohio, received by Tropospheric Skip at 260 miles.



990 mile F Skip at a distance of over 1250 miles. Reception of this channel 3 station is common most summers.

patch refracts the signal back toward a distant point on earth, much in the same way that a mirror reflects a beam of light.

The lowest TV channels are affected most by Es. Es will normally appear on channel 2 before it hits 3; 4 before 5, and so on, but is very rarely found above channel 6. Openings frequently occur on channels 2 or 3 that never reach the higher channels. Even more frequently, Es produces activity on CB and the 10 meter ham band without reaching the TV channels. Generally, the stronger openings effect the greatest number of channels. A weak opening may only bring in distant stations on channels 2 and 3. If signals on 2 and 3 are quite strong, skip is likely to also be in on channels 4 and 5.

The best seasons for Es are late spring and early summer, with a lesser peak occurring from mid-December to early January. Best times to look for Es signals are from mid morning to early afternoon and again from early evening to about 10:30 PM, local time.

Strong signals and deep fading characterize Es. Signals are commonly strong enough to be received on indoor "rabbit ears" style antennas! Best results will still be obtained with an outdoor rotatable antenna, but it needn't be very high. Es reception can last for minutes, hours or even days. A typical opening lasts for a few hours and may bring in a half dozen or more distant stations. It's even common for two or three different DX stations to be received on the same channel at the same time.

A good way to look for Es openings is to frequently check channel 2. Even if you have a local station on channel 2, DX stations on the same channel will produce an interference pattern of

horizontal black bars. More about this later. If you're using a rotatable antenna, this check should be made with the antenna pointed away from your local station.

Outside of the seasonal variations, Es is very unpredictable. It is *not* directly related to local weather conditions, the sunspot cycle or the phases of the moon. Little is really known about the causes of Es, but it does make TV-DXing a lot more exciting!

F2 Skip. Every eleven years, sunspot activity reaches a peak. When this oc-

curs, the radiation projected from the sun builds up the density of the F2 layer of the ionosphere. This layer is about 200 miles up, much higher than the E layer. If sunspot activity is great enough, the F2 layer becomes dense enough to refract signals on the lowest TV channels. Because the F2 layer is so high, distances covered are seldom less than 1700 miles. The world's TV-DX record was set by F2 skip in 1957 when George Palmer of Williamstown, Victoria, Australia, received BBC-TV from England over a 10,400 mile distance.

EXPOSURE TABLE

(Suggested Camera Settings for Pictures of Television Images)

| Film (Use) | Black-and-White Television Set | | Color Television Set | |
|--|--------------------------------|---------------------|----------------------|---------------------|
| | Leaf-Type Shutter | Focal-Plane Shutter | Leaf-Type Shutter | Focal-Plane Shutter |
| Verichrome Pan Plus-X Pan (Black-and-White) | 1/30 sec f/4 | 1/8 sec f/8 | 1/30 sec f/2.8 | 1/8 sec f/5.6 |
| Tri-X Pan (Black-and-White) | 1/30 sec f/5.6-8 | 1/8 sec f/11-16 | 1/30 sec f/4-5.6 | 1/8 sec f/8-11 |
| Kodachrome-X (1) (Color Prints) | 1/8 sec f/2.8 | 1/8 sec f/2.8 | 1/4 sec f/2.8 | 1/4 sec f/2.8 |
| Kodachrome-X (1) Ektachrome-X (1) (Color Slides) | 1/15 sec f/2 | | 1/8 sec f/2 | 1/8 sec f/2 |
| High Speed Ektachrome (1) (Daylight)—with Normal Processing ASA 160 (Color Slides) | 1/15 sec f/2.8-4 | 1/8 sec f/4-5.6 | 1/8 sec f/2.8-4 | 1/8 sec f/2.8-4 |
| High Speed Ektachrome (1) (Daylight)—with ESP-1 Processing for a Speed of ASA 400 (Color Slides) | 1/30 sec f/4 | 1/8 sec f/8 | 1/30 sec f/2.8 | 1/8 sec f/5.6 |

NOTE: When two lens openings are given, such as f/4-5.8, lens setting is midway between these stops.

(1) Pictures of color television taken without a filter will look blue-green. With the color films in the table, you can use a Kodak color compensating filter, CC40R, over your camera lens to help bring out the reds in your pictures. Increase the exposure suggested in the table by 1 stop.



830 mile E Skip reception of KTVS-TV, channel 3, Sterling, Colorado. Both zero and 20 kHz offsets appear in this picture.



KID-TV received by E Skip at a distance of over 1250 miles. Reception of this channel 3 station is common most summers.

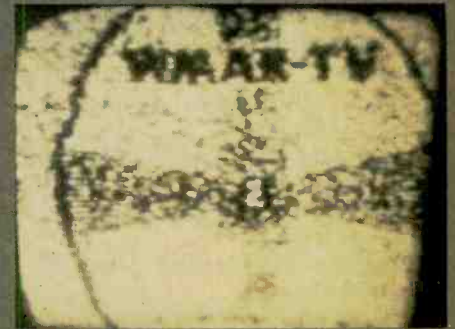

Meteor Scatter reception of WMAR-TV, Channel 2, Baltimore, Maryland, 725 miles.

e/e DX WITH YOUR TV

The next sunspot maximum will be reached around 1979-1980. As the intensity of sunspot cycles varies, we can't yet predict whether activity will again be great enough to produce transcontinental TV-DX. During the most recent cycle, I received the audio of TV transmitters in France and England. The video signals for these channels are on slightly higher frequencies and were not received. The last cycle was no where near as intense as the previous cycle which produced George Palmer's record catch. In the late fifties, several US TV-DXers received almost daily reception from European TV stations on modified TV receivers.

Meteor Trails, Lightning and the Northern Lights. The ionization produced when a meteor burns up from friction as it enters the atmosphere, does a good job of reflecting TV signals. Meteor trails last only a short time, so they produce very brief "bursts" of TV-DX. Meteor bursts commonly last from a fraction of a second to four or five seconds. Bursts may also appear in clusters, permitting reception for thirty seconds or more.

If you watch for meteor scatter when TV stations are running their test patterns (typically 4 to 8 AM local time), a second or two of reception can be long enough to identify (ID) your DX catch. With a good outdoor antenna, a great many meteor bursts can be seen on channels 2-6. For results on channel 7 or above, a very elaborate antenna system must be used. As most meteors burn in the E region of the ionosphere, distances are somewhat similar to Es, but somewhat shorter—500-900 miles. Meteor scatter occurs literally every

day, but results are best during meteor showers. A list of major meteor showers can be found in most almanacs or *The Radio Amateur's VHF Manual*, published by the American Radio Relay League.

Sometimes, when an intense lightning storm is between a DXer and a UHF TV station (200-500 miles away), signals can be reflected by the lightning strokes to produce TV-DX. Signals burst in much as if propagated by meteor scatter. NEVER attempt to DX while a storm is in your area—wait until the storm has passed. When the storm is safely out of your area, point your antenna at the storm and tune around the UHF dial. Results will be best if you are looking for a particular station that appears to be within range.

The Northern Lights (aurora) can also produce TV-DX results. TV signals are sometimes scattered by the auroral curtain to produce very fluttery reception. Distances covered can extend to several thousand miles. Most often however, signals are so garbled by auroral flutter that they are impossible to identify. Auroral scatter is most common in the years close to and following a sunspot maximum. This form of DX is most common in Northern areas and is rarely observed south of the Mason-Dixon Line. All of the low- and high-band channels are affected, but chances for IDs are best on the low channels.

What Equipment Is Necessary For TV-DXing? A surprising amount of TV-DX can be observed on a simple antenna system, however the serious DXer must employ a high-performance installation. Of prime importance is that a TV set in top working order be used. The set should be sensitive and selective (eliminating low-end budget

sets with only two video IF stages), and should be capable of locking sync on a weak signal. In other words, a weak signal should not roll vertically or lose horizontal sync. Many DXers have found that sets with screen sizes of 19" or smaller are easiest to DX with. Either a color or a monochrome set will do fine.

Most active TV-DXers use separate VHF and UHF antennas. The antennas must be rotated by an accurately calibrated antenna rotor. The best consumer UHF TV antennas are of the 7' parabolic dish variety. The best such antenna is probably still the Finco P-7. If a large dish antenna cannot be used, other "fringe area" designs can still provide good results. A talk with your local distributor or antenna service should probably provide some helpful advice.

A UHF antenna should always be mounted as high as possible. In metropolitan areas, a minimum of fifty feet above ground may be necessary to provide acceptable results. A good quality low-noise UHF preamp will also be quite helpful. A preamp of this type is most mounted at the antenna and fed by a remote power supply indoors. Two excellent UHF preamps are the Blonder-Tongue CMA-Ub and the Winegard AC-4990. The Winegard unit is less likely to "overload" in a strong signal area, but has less gain than the Blonder-Tongue CMA-Ub. Again, consult a local expert for your best choice.

For VHF, a large fringe area broadband Yagi or log-periodic design antenna should do the job well. Channel Master VHF antennas have long been popular with TV-DXers, but all of the major antenna manufacturers make antennas of this type. Height is somewhat less important for the VHF antenna,

(Continued on page 92)

CLUES TO IDENTIFYING AN UNKNOWN STATION

Channel Network
Local Commercials
Local Public Service Announcements
Antenna Direction
Offset Frequency
Propagation
Other Stations Received About the Same Time
Recognition of Local Weather Map, Announcer, Logo, etc.
Time Zone (Caution: Some stations delay broadcasts, causing them to appear to be in a different time zone.)

QSL Information Card

WQLN-TV

Channel 54 Erie, Pa.

Effective Radiated Power: **915 kw**

Carrier Frequency: Visual **711.26 mc** Aural **715.76 mc**

RECEPTION CONFIRMATION

| Date | Program | Time |
|---------|--------------|----------|
| 1/20/69 | Test Pattern | 8:58 EST |
| ----- | ----- | ----- |
| ----- | ----- | ----- |



ADD TONE TO YOUR PHONE

With your own Touch Tone Pad you can key a phone, computer, or transceiver for peanuts.

□ One of the most popular hobbyist items—appealing to hams, experimenters, *phone phreaks* and thousands of other experimenters—is the Touch-Tone Pad or Encoder, that two-tone generating device used on Touch-Tone Telephones. It seems the uses for the Touch-Tone signals are almost endless: hams use them to activate and use autopatches that permit telephone calls from a mobile transceiver to a landline, experimenters use them in conjunction with the Signetics touch-tone decoder ICs for remote control applications, and *phone phreaks* use them to help make “free” (though illegal) long distance calls. Some people use them to access hobby and time shared computers, and others simply connect them to standard dial phones to get additional Touch-Tone service without paying Ma Bell a lifetime’s worth of extra charges for a relatively inexpensive extension phone.

In actual fact there is a difference between a Touch-Tone Pad and an Encoder. Though they eventually do the same thing you can be stuck for some rather expensive, unusable hardware if you can’t get them straight. The original telephone pad, the one used in Touch-Tone phones, generates a two-tone signal when a key is depressed and is called a Touch-Tone Pad. On the other hand, when a keyboard device resembling the telephone keyboard is used to control an electronic tone generator—usually an integrated circuit pur-

chased as an independent component—the keyboard is also called a Touch-Tone Pad but it is really only a switching matrix; it does not generate any tones. When this keyboard is combined with an electronic circuit that generates the tones—usually at a signal level slightly higher than normal microphone level—the entire device is called a Touch-Tone Encoder.

The encoder is a rather small, somewhat fragile device generally used by radio amateurs for controlling autopatch repeaters. The pad—which is made by Western Electric and other telephone equipment manufacturers—is built like a battleship, produces a relatively high level output that can be used for just about anything, and until re-

cently the only way to get one was to go directly to a telephone equipment dealer and pay list price, or hope one fell off the back of a truck.

But now the telephone-type Touch-Tone Pad has flooded the surplus market and anyone can pick one up for between \$8 and somewhat less than \$20, depending on condition. For an extra couple of dollars you can also get a beige plastic cabinet pre-punched to fit the pad. About the only problem you’ll have is that some of the pads have only numerals, not letters; but this should create no problems since most touch-tone coding, and even telephone numbers, are now predominantly numerals.

Probably the most flexible pad is the Western Electric type shown in the pho-

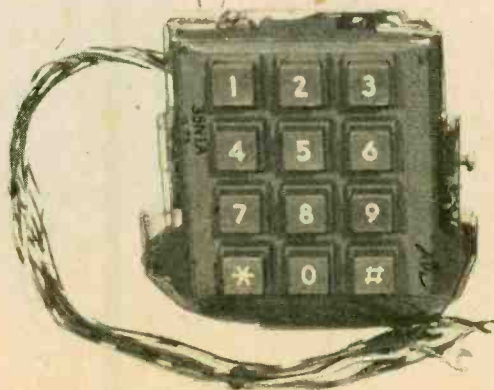

This is what you can get from the surplus dealers: a Western Electric Touch-Tone pad and plastic housing.

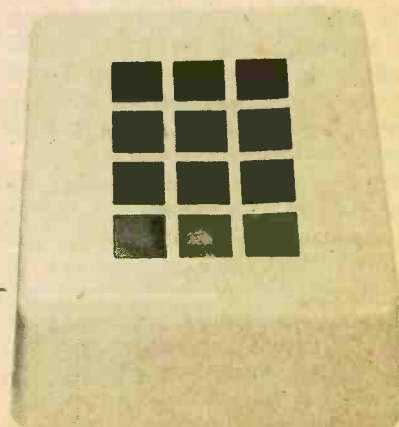

e/e TONE FOR YOUR PHONE

tophographs. This model is available from several surplus dealers.

Wiring. The Western Electric pad comes jam packed with attached color coded wires which are generally used for connecting into telephones. For many hobbyist uses most of these wires are simply ignored. There is some variation in color coding between different models of Western Electric pads, but most models are very similar and some general color coding can be used. Also, most reliable suppliers will send connecting instructions and so specify in their ads.

In fact, before undertaking this project, you might want to check your ability to discern colors. It often happens that people who ordinarily would have no trouble seeing colors find it difficult to distinguish between color-coded wires in electronic equipment. A problem in this area could make it impossible to wire the Touch Tone Pad properly. So why not compare your reading of the wires with one or two friends', just to make sure.

The schematics show the hobbyist connections for the Western Electric type 35N1A and 35N3A pads—or dials as they are called by Western Electric—the most common type of pads available. The circuit shown in Fig. 1 can be connected directly across the telephone terminals of a telephone where touch-tone is already provided by the local telephone company. You will hear the tones in the receiver (handset). If you don't hear a tone simply reverse the connections to the line.

A normally open switch which is built into the pad is closed each time a key is pressed. This switch closes the circuit between the pad and the line, simultaneously applying power from the line to the pad (an external power supply isn't needed). If you want the pad connected only when the handset is off the hook connect the pad after the line switch terminals; usually terminals F and C on the phone network (repeat coil or transformer).

Figure 2 shows the connections for using the pad with an FM transceiver for autopatch. Potentiometer R1 sets the level into the modulator and is normally adjusted for 5 kHz deviation. Some phase modulated transceivers require a frequency correcting network when using a touch-tone pad and instructions for a simple resistor-capacitor (R/C) equalizer are generally given in the transceiver's instruction manual.

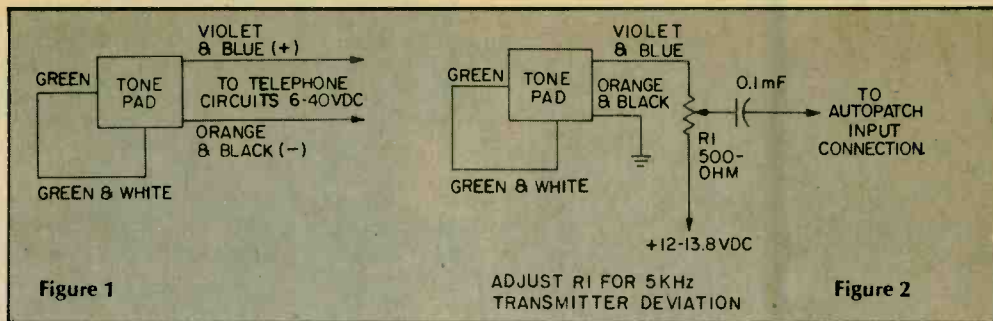

The circuit in Fig. 2 requires the transceiver's PTT (push to talk) be held down when the tones are keyed in. We will show later how to modify a pad so it also provides automatic transmitter keying each time a tone is keyed.

Mounting the pad. The best way to mount and wire a pad is in one of the plastic cases usually available from the same dealer who supplies the pad. As shown in the photographs there's plenty of room inside the cabinet for a terminal strip and associated components. To avoid short circuits clip the unused pad leads short, or tape the lugs on the end of each wire. The pad wires are standard stranded type—not *litz* silk wound—so you can clip off the lugs, strip the insulation and solder just as you would any other stranded hook-up wire.

If you need or want automatic PTT, or control circuit switching each time a pad key is depressed, you can easily modify the pad to provide the circuit control shown in Fig. 4. Note that switch S1 is the normally open switch

that is part of the pad and applies the power to the pad as well as connecting the pad's output signal. Switch S2 is the modification and can be wired directly across a PTT switch, or used as control wires for a keying or switching circuit.

First step is to remove the plastic covers of the pad. They snap right off. Remove the front one first, the one over the keys. Then remove the rear cover taking care to snake the wires carefully through the opening in the plastic cover. You will find the rear of the pad looks like the photograph, with a set of multi-switch terminals at the upper left. If you look carefully at the switch you'll find almost all the sections are normally closed, opening when a pad key is depressed. But two sets of contacts are normally open and close only when a key is depressed. The bottom set of contacts is S1 and should not be disturbed. Counting down from the top, the second set of contacts is also normally open and usually is the only set of contacts to which no wires are connected. (Note that some pads might

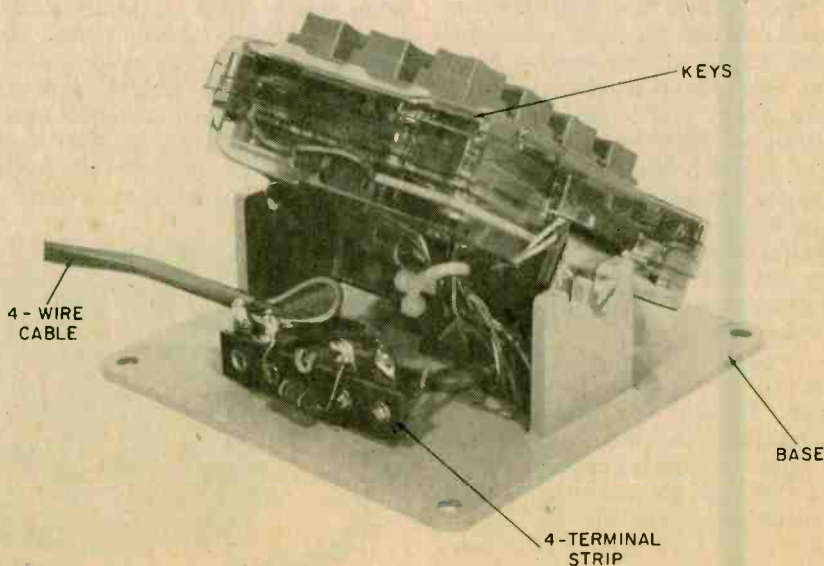

With the pad installed in the cabinet mount there's plenty of room in the back for a terminal strip and some components. This 4-terminal strip installation provides the connections shown in Figs. 1 and 2 through a 4-wire cable. The user simply selects the right set of color-coded wires.

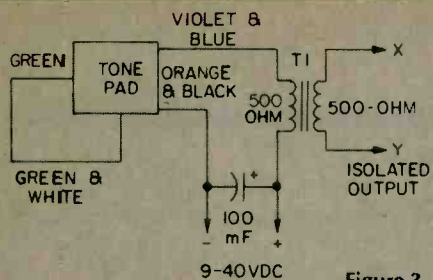
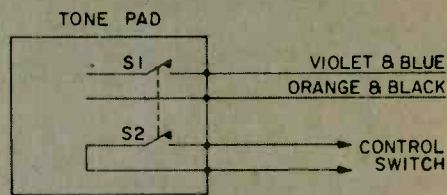
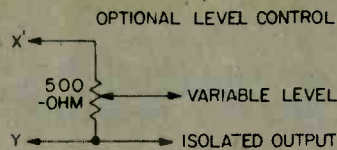

Figure 3



have one wire connected to one of the normally open terminals, and the wire is generally brown. Simply cut the wire off at the terminal and leave it alone.)

Carefully cut off the unused wires from the top set of normally closed contacts and move them to the normally open contacts using a very small soldering iron (about 20 watts) and as little heat as is possible. Use a tiny drop of solder to prevent a solder bridge. If you don't want to cut the wires from the top contacts use #22 stranded wire for the normally open connections.

Carefully slip the plastic cover over the wires, seat it on the pad and then install the front plastic cover. You now have a touch-tone pad with an extra set of normally open switch contacts.

Get Out the Grinder. For some unaccountable reason a few of the plastic touch-tone pad cabinets do not make allowance for pointed projections on the mounting ear located on each side of the pad. Each ear has two projections with a mounting screw in between.

The plastic cabinet has been pre-formed to accommodate the screw and one projection; the remaining projection gets in the way and can result in damage to the cabinet when the mounting screw is tightened. For best results use a hand grinder or file and remove the projection towards the bottom when the pad is held upright. When the pad is installed in the cabinets don't tighten the two mounting screws; let the pad float on its mount. When the top of the cabinet is secured with the four mounting screws provided, the pad will be rigidly locked in position without damage to the cabinet.

Correct Voltages. The Western Electric touch-tone pad will work with an applied voltage between 6 and 40 VDC at the orange/black and violet/blue terminals. If the voltage is less than 6 volts the oscillator won't "start," or the output signal will be highly distorted. Keep in mind that if you use the circuits shown in Figs. 2 and 3, there is a voltage drop across R1 and T1, and less than the applied voltage arrives at

Figure 4. Power switch S1 is part of the pad and is connected in series with the violet-blue (positive power) lead. It automatically closes each time a key is pressed. Switch S2 is connected to S1's operating lever but is not normally used in the pad. You can connect a pair of wires, as shown, to provide a set of isolated control terminals. S2's terminals can be used to operate the PTT switch of a transceiver whenever a key is depressed, or to lift the 500-ohm potentiometer off a microphone circuit with connection shown in Fig. 2 or the optional circuit that is included in Fig. 3.

the pad. In Fig. 2 about 3 volts is dropped across R1; you can normally get good operation if the voltage applied to the power supply end of R1 is no less than 9 VDC. Of course, if Fig. 2 is used for an autopatch the normal transceiver power supply of 12 to 13.8 VDC is available and you'll have no problems.

The transformer shown in Fig. 3 has less of a voltage drop than the resistor load of Fig. 2, so the applied voltage can be closer to 6 volts and still insure proper operation of the pad.

The pad has build-in Zener diode voltage regulation so the output voltage is more or less constant over the power supply. The maximum output voltage measured across R1 in Fig. 2 is nominally 0.77 volts RMS when indicated by a standard VOM; 3.5 volts peak-to-peak when measured by an oscilloscope. If you plug these values into a calculator nothing comes out the way you expect because two tones are involved. The meter indicates RMS in terms of

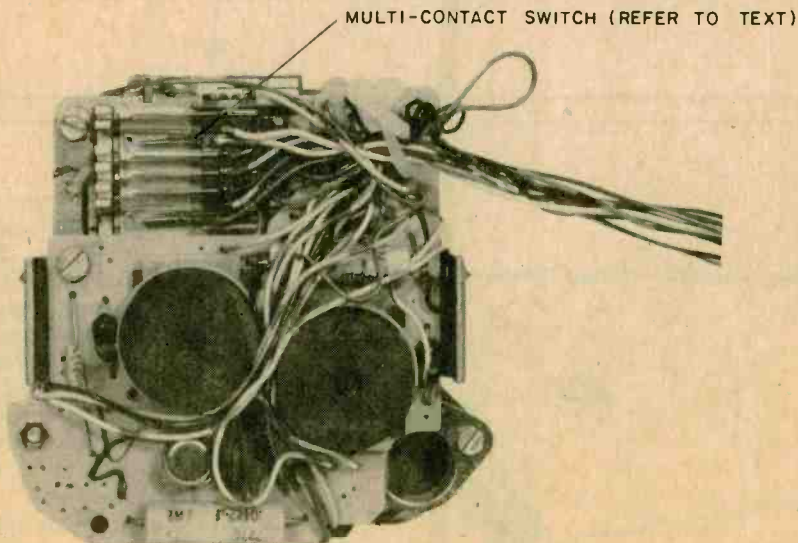

PAD CHASSIS IS WITH PLASTIC GUARD REMOVED

Switch arrangement to secure the control function shown in Fig. 4. Switch S1 is part of the pad wiring and controls both the power and pad connection. The set of contacts labeled S2 is the second down from the top and can be connected as in Fig. 4 to provide an isolated control circuit.

PARTS LIST

- 1—0.1- μ F capacitor (Radio Shack 272-135 or equiv.)
 - 1—100- μ F, 50-VDC electrolytic capacitor (Radio Shack 272-1044 or equiv.)
 - 1—500-ohm adjust potentiometer (Radio Shack 271-226 or equiv.)
 - 1—Isolating transformer, primary 500-600-ohms, secondary 500-1000-ohms (Calectro D1-728 or similar) Calectro-GC Electronics, Rockford, IL 61101.
- Touch tone pads can be purchased from: Telephone Equipment Co., P.O. Box 596, Leesburg, FL 32748; King Products, P.O. Box A, Lomita, CA 90717.

BUILD IMP-MATCHER

□ There are times when it is desired to use a low-impedance microphone to feed an amplifier requiring a high-impedance input, such as a tube-type or FET-input amplifier. The circuit shown here was designed to match low-impedance microphones to a tube-type PA (public address) amplifier. It has low input impedance, around 200 ohms, and high output impedance that will provide a reasonable match for a tube or FET amplifier.

The common-base configuration is used. R3 and R4 are a voltage divider to provide a voltage on the base that is positive with respect to the emitter, and thus forward-bias the transistor for class A operation. C2 bypasses R4 for AC signals to prevent degeneration. R2 is the collector load resistor. C1 and R1 form the input circuit while C3 couples the amplifier.

Construction is simple and uncritical. It can be assembled on a perf board or a PC board, as desired.

The power supply can be either dry cells or an electronic supply. The amplifier will operate satisfactorily on any supply from 4.5 to 6.0 volts. In my prototype a tap was taken from the 6.3 V heater winding on the power transformer of the PA amplifier and regulated with a zener diode for 6.2 V. The 8.9 V peak value of the heater supply, when filtered by the capacitor used here, is sufficient to maintain 6.2 VDC for the amplifier.

PARTS LIST FOR IMPEDANCE-MATCHING AMPLIFIER

- C1—22- μ F, 16-VDC electrolytic capacitor (Radio Shack 272-1026 or equiv.)
- C2—10- μ F 16-VDC electrolytic capacitor (Radio Shack 272-952 or equiv.)
- C3—.05-mF capacitor (Radio Shack 272-1068)
- R1—470-ohm, 1/2-watt resistor (Radio Shack 271-000 or equiv.)
- R2—10,000-ohm, 1/2-watt resistor (Radio Shack 271-000 or equiv.)
- R3—6800-ohm, 1/2-watt resistor (Radio Shack 271-000 or equiv.)
- R4—1000-ohm, 1/2-watt resistor (Radio Shack 271-000 or equiv.)
- Q1—NPN general purpose amplifier transis-

tor (Radio Shack 2002 or equiv.)
 Misc.—perf board, if not making printed circuit board (Radio Shack 276-1395 or equiv.), two phono jacks (Radio Shack 274-347 or equiv.) wire, solder.

PARTS LIST FOR POWER SUPPLY

- C1—1000- μ F, 16-VDC electrolytic capacitor (Radio Shack 272-1008 or equiv.)
- D1—1-A, 50-PIV silicon diode (Radio Shack 276-1151 or equiv.)
- D2—5.5 to 6.5 VDC Zener diode (Radio Shack 276-561 or equiv.)
- R1—150-ohm, 1/2-watt resistor (Radio Shack 271-000 or equiv.)

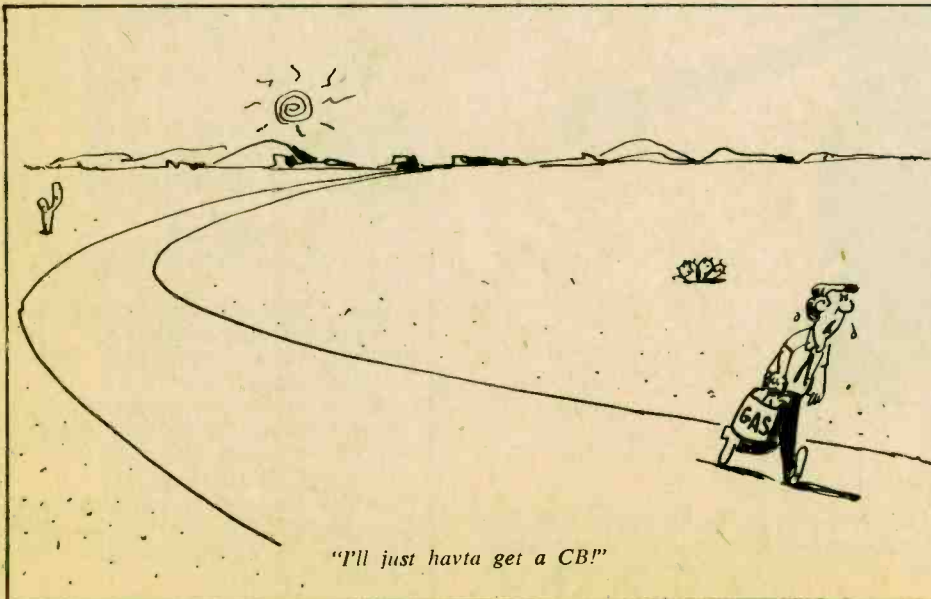
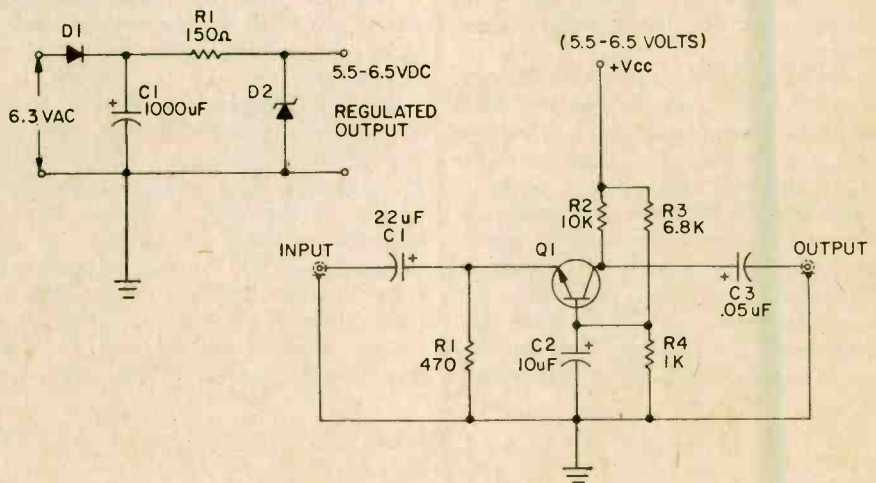

TONE FOR YOUR PHONE

the average voltage of a sine waveform so the reading is slightly off because there are two sine waves. The 'scope sees the vector addition of the two tones, and when the tones are in phase the peak value is greater than the peak value of the individual tones. So to avoid blowing any associated transistor equipment just remember that the maximum pad output is nominally 3.5 volts peak to peak regardless of what your VOM or VTVM indicates.

No Adjustments. Unlike some of the electronic touch-tone encoders the Western Electric telephone dialer pads require no adjustment, nor do they drift. Just install one and it works. Ma Bell's equipment will give two or three decades of reliable, trouble-free performance.

e/e checks out the...

HEATH HW-8 AMATEUR TRANSCEIVER



CIRCLE 31
ON READER
SERVICE COUPON

□ It's CW-only (continuous wave, or Morse Code), and its one or two watts of RF output isn't going to drown out any commercial stations on the 40-meter band, but the Heath HW-8 can do something that the flood of high power rigs of the last few years can't do—it can bring the fun back to ham radio. This little job is guaranteed to give you the satisfaction which comes from matching the kilowatts with only effective equipment design and your own skill.

The HW-8 is housed in a cabinet only 9¼-in. wide x 8½-in. deep x 4¼-in. high, and weighs in at just four pounds. Obviously, it's sufficiently small and light enough to be tucked into a suitcase or a flight bag. Inside the cabinet is a four-band CW transceiver covering the CW segments (the first 250 kHz) of the 80-, 40-, 20-, and 15-meter bands. The transmitter has just one adjustment, a front panel loading control, and tuning is indicated by a front panel relative power meter.

Receiver Controls and Performance.

The direct conversion receiver has a crystal-controlled heterodyne oscillator for each band that provides 150 Hz stability after a one-hour warmup. Its output is available at a rear-apron headphone jack. The front panel receiver controls are concentric *Audio* and *RF Gain*, *Preselector* (broadband) *Tuning*, and *Wide/Narrow Selectivity*. In the *Wide* position the selectivity is 750 Hz at 6 dB down. In the *Narrow* position selectivity is 375 kHz at 6 dB down. The sensitivity of our unit measured 0.9 uV for 10 dB signal-to-noise ratio, with usable sensitivity ranging from 0.2 uV at 3.5 MHz to 0.5 uV at 21 MHz.

The receiver and transmitter frequencies are both controlled by the tuning knob, with a fixed offset of 750 Hz between the receive and transmit frequencies. Keying, via a phone jack on the rear apron, is semi-break-in, in the same manner as SSB VOX. Key down turns on the transmitter, which stays on between normal character spacing. If the key is held up for about a second or so (the actual time is user adjust-

able) the unit automatically returns to the receive mode until the key is once again held down. The *Key Down Delay*, or *Hold*, is adjusted by a control inside the cabinet.

As seen in the photographs the dial has but one calibration, from zero to 250 kHz in 5 kHz increments. The receive frequency is the dial reading plus the frequency selector. For example, if the 3.5 MHz selector is on and the dial indicates 155, the receive frequency is 3.655 MHz. If the dial reads 55 the frequency would be 3.55 MHz. If the 7 MHz selector was *On* and the dial read 210, the frequency would be 7.21 MHz.

Alternate Power Supplies. There are several ways the HW-8 can be powered through its power connector. First, you can use a small 13.8-volt power supply such as the Heathkit HWA-7-1, or any other of the small supplies used for CB transceivers because, being entirely solid-state the HW-8 requires only 90

mA to receive and 430 mA to transmit, values easily handled by a couple of 6-volt lantern batteries, a 12-volt lantern battery, or even a portable pack made up of D-cells. And if you're not doing the driving, or you'd like to pull over to the side for a few fast QSOs, you can power the rig through your car or RV's cigarette lighter.

Direct Conversion Receiver. The first time you look at the schematic you're in for a shock because there are no IF amplifiers to be seen. They're not seen because there are none. The HW-8 uses what is known as *direct conversion*. The received RF signal passes through the RF amplifier directly to a balanced product detector which also gets the tuning oscillator signal. The output of the product detector feeds an active audio filter which separates the audio from the detector's output and provides the selectivity. From the active filter the signal passes through the audio amplifiers and on to the headphone jack.

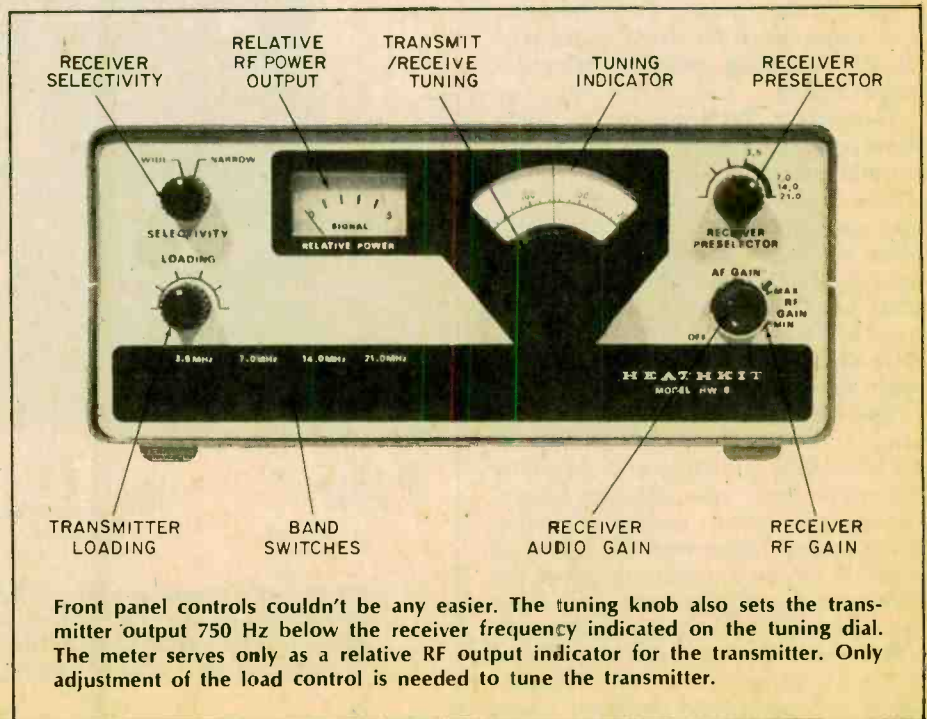

Front panel controls couldn't be any easier. The tuning knob also sets the transmitter output 750 Hz below the receiver frequency indicated on the tuning dial. The meter serves only as a relative RF output indicator for the transmitter. Only adjustment of the load control is needed to tune the transmitter.

e/e CHECKS HEATH HW-8

Surprisingly, as you can see from the measured sensitivities previously given, the lack of IF amplifiers doesn't mean lack of sensitivity. The HW-8 is as hot as most receivers with a string of IFs.

Finally, a sidetone oscillator working directly from the keying line provides a keying monitor signal in the headphones when transmitting. A control located inside the cabinet sets the sidetone volume level independent of the receiver's AF gain control.

Build The Kit. Except for the panel components, and the AF output amplifier which is on its own small printed circuit board, everything is assembled on a large printed circuit board that utilizes almost the entire bottom of the cabinet. But though the board is large and component locations are clearly marked on the board this kit takes a fair amount of assembly skill; it is not a beginner's kit. In fact, our model was built by an experienced builder and still wound up with one solder bridge and one incorrectly-installed transistor. So take extra care, even projects on large circuit boards require extra care when transistors and IC are involved.

Alignment requires a receiver calibrated for the 7.0 to 7.25 MHz frequency range, an RF signal generator (or an on-the-air signal), and a VTVM with an RF probe (you can easily assemble a small RF probe—the schematic is given in the manual) The transmitter is adjusted using the front panel relative-RF indicating meter to determine proper tuning.

Transceiver Performance. As we're accustomed to with Heath equipment, everything worked as claimed. We had a little extra work to do to get rid of a small oscillation on the low end of 14-MHz, which tended to mask some very weak signals. It is not at all certain that other units would have this problem—we've never heard of it before—but it was remedied by using a shielded cable between the key and the keying jack.

The main thing to remember when using a low-power transceiver such as the Heath HW-8 is that you're especially dependent upon your antenna system. Getting the lowest possible Standing Wave Ratio is important. Of course its essential to use antennas designed for each band you plan to work—long wires can work well on the lower frequencies, while folded dipoles made of 300-ohm TV twin lead are effective on 15-meters. There are multi-band antennas which

can cover all frequencies—horizontally or vertically polarized, depending upon your particular needs and the requirements of your location. To clear up matters, consult one of the established antenna manuals, such as the handbook published by the American Radio Relay League, in Newington, CT 06111.

Also, keep in mind that operating QRP (low power) takes skill. Do a lot of listening, try quick calls at the end of the other operator's contact, avoid pile-ups, and be sure that you're tuned to the high side of the received signal's zero

beat (your transmitter runs 750-Hz below the received signal. With proper techniques you'll find that the Heath HW-8 makes an ideal rig for home, for the real fun of operating QRP, as a back-up unit, and of course to take along on vacations. You can even use it mobile, operating from your car's 12-VDC system. Just make sure you park first. It's truly versatile.

The HW-8 is priced at \$129.95 in kit form via mail order. For additional information, circle number 31 on the Reader Service coupon. ■

The power requirements are 13.8 volts (nominal 12 VDC) at less than 0.5 ampere in the transmit mode, so just about anything, including a pack made up of eight or nine D-cells can be used. The headphone and key jacks are the standard phone type. The antenna jack is a phono type.

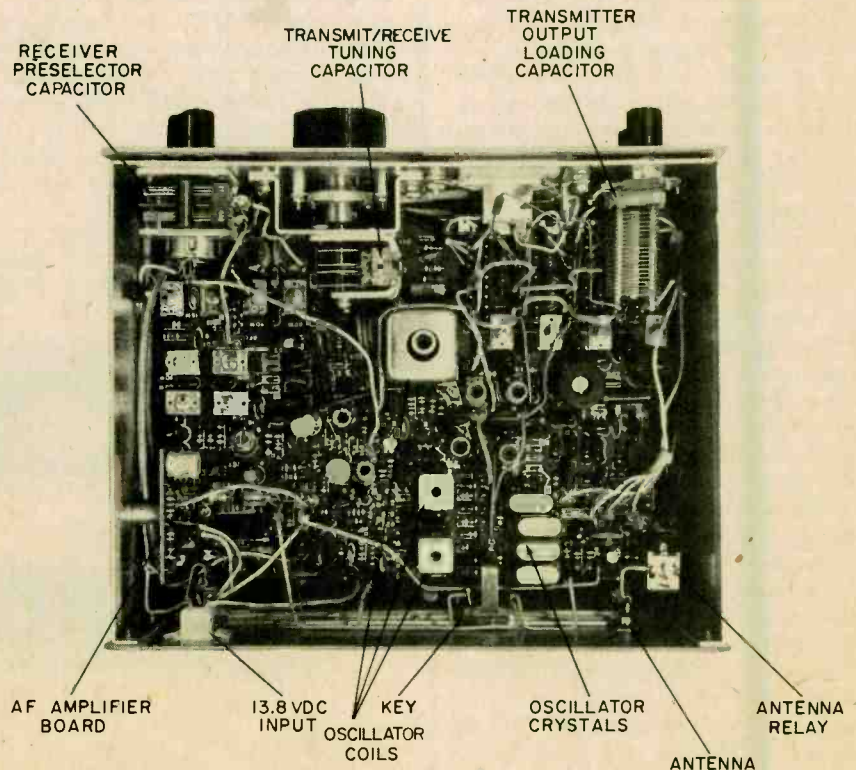
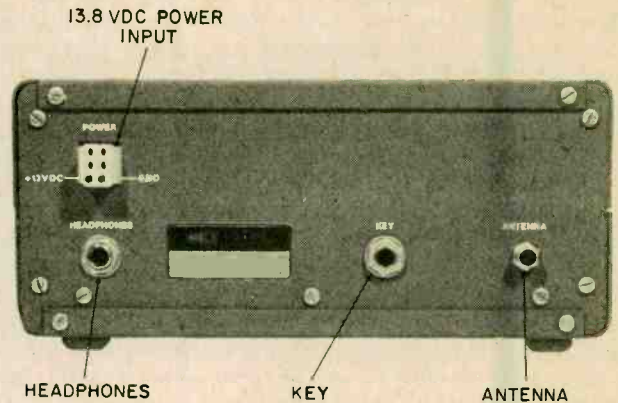

Except for the components mounted on the front and rear panels everything is assembled on printed circuit boards. The audio power amplifier is on a small board on the side of the cabinet. The remainder of the transceiver is wired on a single, large PC board.

ALTERNATOR TESTER

Your alternator may be building for a big breakdown without your knowing it. This simple circuit lets you check it out.

by Anthony Caristi

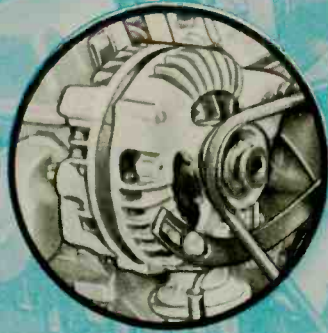

AUTOMOBILES have been coming off the production lines with alternators instead of generators for some 13 years now, and these units have proven to be reliable and superior to the ones they replaced. Being alternating current machines, they are inherently more complicated than generators and require slightly more sophisticated testing procedures to indicate their condition. This problem is brought about by the fact that automotive alternators are three phase machines, with full wave rectification of the output to produce direct current as required by the automobile and its battery. The schematic shows a typical automotive alternator connected to its three-phase full-wave rectifier circuit.

Rectification is accomplished by six high-current silicon diodes in the alternator, and this is where the problem comes in. Many of the troubles encountered with automotive alternators are due to failure of one or more of the diodes, either by opening or shorting. Neither of these conditions will result in an inoperative alternator, and no doubt some of the automobiles on the road today have just such a problem. A shorted diode is the more serious of the two conditions, since it will result in the loss of about 50 per cent of the output capability of the alternator. Such a condition is easily detected by an ordinary output test on the alternator. However, an open diode is another matter. This condition will result in loss of only a few amperes of output capability of the alternator due to the fact that only one half of one phase of the machine is disabled. Some of

this lost capacity is carried by the other two phases, which will be overloaded when the alternator is required to produce full output as demanded by the automotive electrical system. Such a condition may well result in further failure of more diodes. An ordinary output test of an alternator with an open diode generally will not detect any malfunction. Because of those testing problems, another test method to determine the condition of alternators has been developed, and the construction of the Alternator Tester is the subject of this article.

The ability of Alternator Tester to detect defective diodes, both open and shorted, depends on the fact that the output ripple voltage of an alternator with a defective diode rises dramatically higher than that produced by a normally-operating alternator. When the pulsating DC waveform output voltage of an automobile alternator is measured

the magnitude of the ripple voltage is about 0.2 to 0.5 volts, peak-to-peak. When one of the diodes in the alternator fails the ripple voltage increases to 1-volt peak-to-peak or more. The Alternator Test measures the peak-to-peak ripple voltage so that the condition of the alternator can be determined.

Construction Details. In order to keep construction costs low, the Alternator Tester was designed to be used with an ordinary VOM or VTVM as the indicating device. Since the output impedance of the test instrument is close to zero, any meter of at least 1000-ohms-per-volt sensitivity can be used. The circuit is constructed on a small printed circuit board and fitted into a metal or plastic cabinet. Two tip jacks are mounted in the cabinet which serve as the connection to the VOM. A pair of test leads is brought out through a grommet and these provide the DC power to operate the circuit

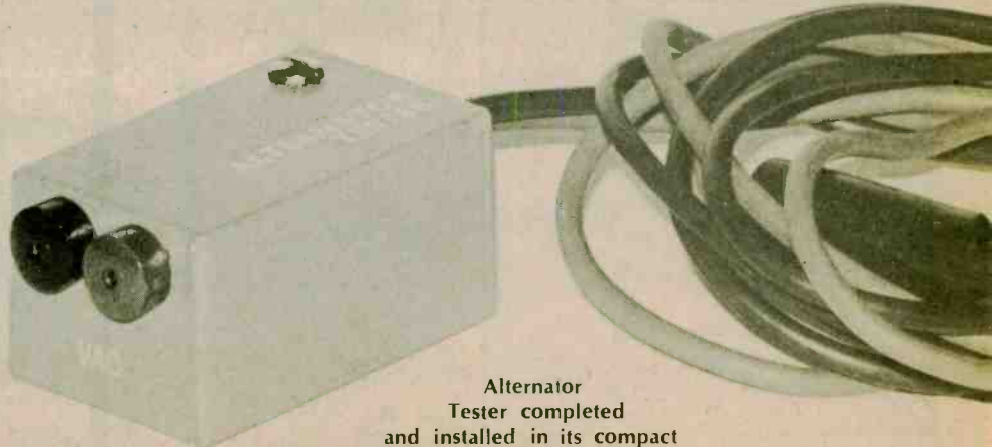

Alternator Tester completed and installed in its compact metal cabinet, shown with its test leads.

e/e ALTERNATOR TESTER

as well as the connection to the alternator output (battery) terminal where the ripple measurement is to be made.

About the Circuit. The Alternator Tester is basically a peak detector circuit which responds to the peak-to-peak value of an AC voltage fed to its input terminal. Power to operate the circuit is derived from the output of the alternator on the same lead which feeds the ripple voltage to the input of the peak detector. The DC output of the alternator is blocked by C1, which allows only the ripple voltage to pass through.

Operational amplifier IC1A and IC1B are connected together to form a peak detector circuit. The ripple voltage from the output terminal of the alternator is fed to the positive input of IC1A after the DC voltage of the alternator is blocked by C1. D1 clamps the ripple voltage to ground, so that it varies between zero and some positive value. Op amp IC1A charges C4 to the peak value of the ripple voltage. Op amp IC1B is a voltage follower which feeds back the peak value of the ripple voltage to the negative input of IC1A. This stabilizes the circuit so that the voltage appearing at the output of IC1B holds to the peak-to-peak value of the ripple voltage fed to the input of IC1A. Capacitor C4 is prevented from discharging through IC1A by D2, and can discharge only through R4 at a rate much slower than the ripple frequency of the alternator. This holds the meter reading constant between voltage peaks of the alternator. Amplifier IC1C has an adjustable gain of slightly more than unity to compensate for the slight error (loss) caused by D2, as well as providing a means for calibration of the instrument. Voltage follower IC1D

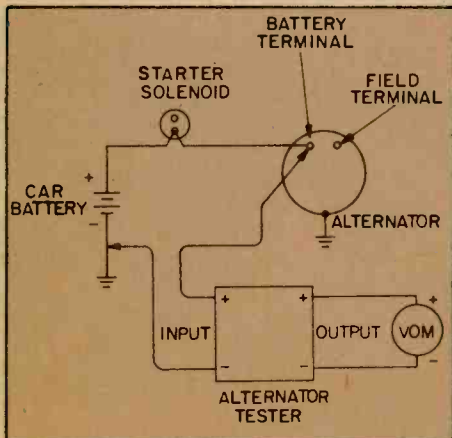

Using the completed Alternator Tester.

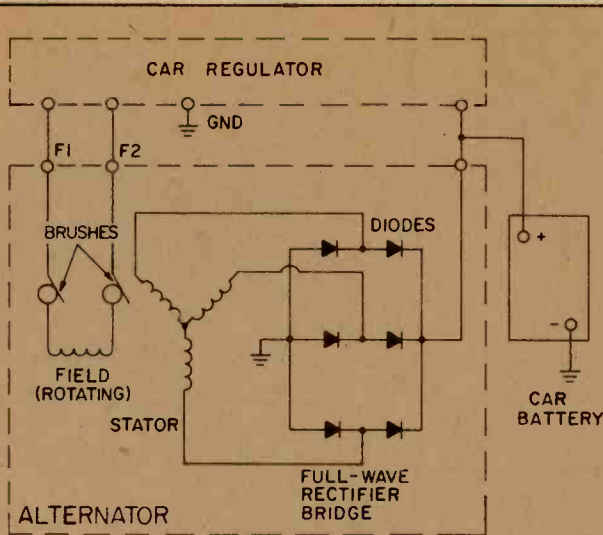

Typical automotive charging circuit. Latest model alternators have solid-state regulator circuit built into alternator frame.

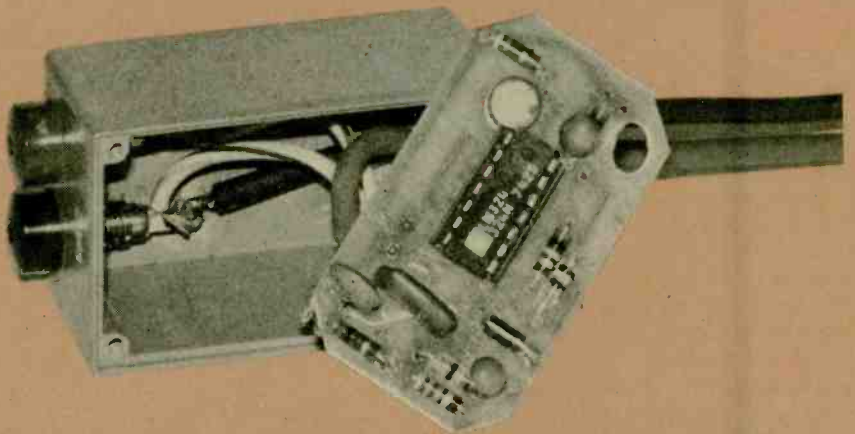

Alternator Tester opened, showing printed circuit board. Comparison with this early version of printed circuit board reveals improvements made by the editors.

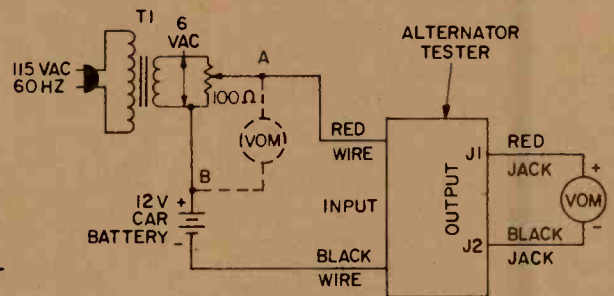

Calibration of the Alternator Tester.

This shows the parts placement on the printed circuit board. Shown larger than actual size for clarity.

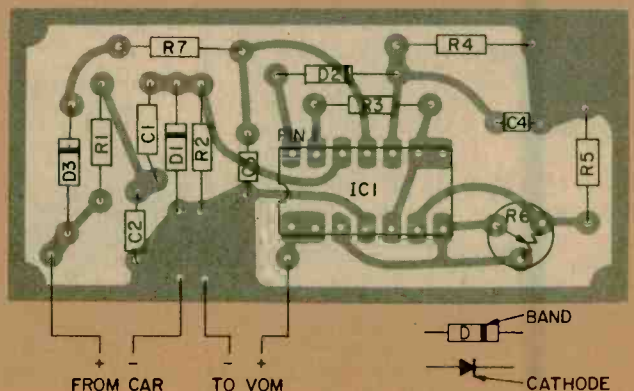

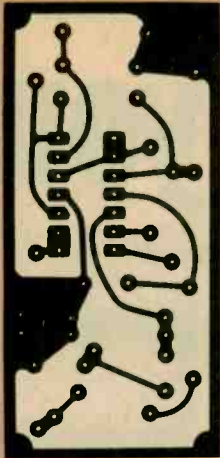

This pattern shows the printed circuit board (foil side up) for the Alternator Tester. You can construct the unit on a perf board if printed circuit board fabrication seems too much trouble.

provides an extremely low output impedance to drive any meter of 1000-ohms-per-volt or more. Power for the circuit, about 2 mA, is taken directly from the alternator output terminal. Diode D3 prevents damage to the circuit in the event of any reverse polarity connections.

Calibration of The Instrument. Calibration of the Alternator Tester is accomplished by feeding an AC voltage of known amplitude between the input terminal and ground, and adjusting R6 for the correct meter reading. The calibrating AC voltage input can be measured by the AC voltmeter function of the VOM, which reads RMS volts. To convert RMS to peak-to-peak voltage multiply the value by 2.83. The calibration circuit uses a 6-volt filament transformer and potentiometer as a source of low voltage AC. To calibrate the instrument connect the filament transformer, potentiometer, and alternator test circuit as shown, using any twelve volt DC supply for power. (Be sure there is no ripple voltage on the output of the supply, since this will cause an error in the calibration.) Set the VOM to read AC volts, and connect it between points A and B as shown. Set the potentiometer so that the VOM reads 0.35 volts RMS. This is equivalent to 1 volt peak-to-peak. Disconnect the VOM, set it to a 1.5 to 3 volts DC scale, and connect it to the output terminals of the Alternator Tester. Calibrate potentiometer reading of 1 volt. This completes calibration of the Alternator Tester.

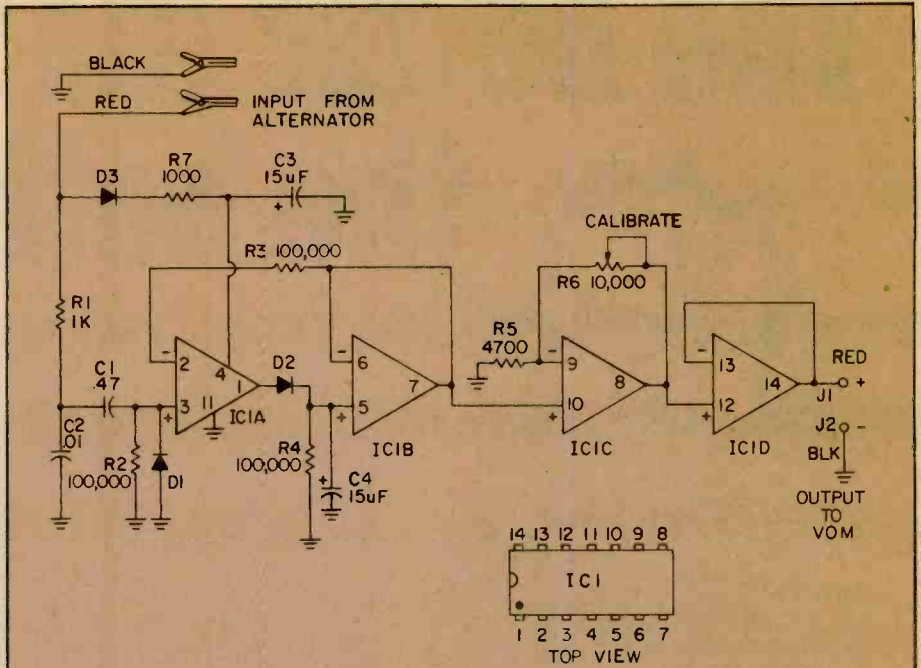

PARTS LIST FOR ALTERNATOR TESTER

- C1—0.47 uF ceramic capacitor (Radio Shack 272-1071 or equiv.)
 - C2—0.01 uF ceramic disc capacitor (Radio Shack 272-131 or equiv.)
 - C3, C4—15 or 22 uF, 25 VDC tantalum capacitor (Allied Electronics 852-5671 or equiv.)
 - D1—1N34A, 75 VDC, 5 mA germanium diode (Allied Electronics 578-0034 or equiv.)
 - D2, D3—1N487, 75 VDC, 100 mA silicon diode (Radio Shack 276-1102 or equiv.)
 - IC1—LM324 (Quad 741) operational amplifier (James Electronics, or equiv.—address below)
 - J1, J2—red, black tip jacks (Allied Electronics 920R0181, 2, or equiv.—address below)
 - R1, R7—1,000-ohm, 1/4-watt resistor (Radio Shack 271-1300 or equiv.)
 - R2, R3, R4—100,000-ohm, 1/4-watt resistor (Radio Shack 271-1300 or equiv.)
 - R5—4,700-ohm, 1/4-watt resistor (Radio Shack 271-1300 or equiv.)
 - R6—10,000-ohm potentiometer (Allen Bradley Type A, Radio Shack 271-218, or equiv.)
 - Misc.—2 3/4 x 2 1/8 x 1 1/8" utility box (Radio Shack 270-235 or equiv.), hardware, 14-pin IC socket (Radio Shack 276-1999 or equiv.), printed circuit board or printed circuit kit (Radio Shack 276-1576 or equiv.), red, black test leads with alligator clip terminals.
- Allied Electronics' address is 401 E. 8th St. Fort Worth, TX 76102.
James Electronics' address is 1021 Howard Ave. San Carlos, CA 94070.

Alternator Testing. The testing of an automotive alternator consists of two parts. The first test is the output test, which determines if the alternator can deliver the full current that it was designed to produce. Bear in mind that the following procedure tests both the alternator and voltage regulator at the same time, and failure of the alternator to deliver rated output also may be caused by a defective voltage regulator. Before making the following tests inspect the connections to the alternator and battery to be sure they are tight. A loose or bad connection between the alternator and the battery may cause an excessive ripple measurement even though there are no defective diodes in the alternator.

The alternator output test requires the use of only the VOM which is set to read DC volts on a 0 to 15 volts or greater scale. Connect the VOM di-

rectly across the battery, observing correct polarity. Start the engine and turn on the headlights (high beam), windshield wiper, blower motor (high speed), and radio. Race the engine to a moderate speed (about 2000 RPM) and note the reading of the meter. A properly operating charging system should maintain at least 13.5 and not more than 15 volts across the battery. Voltage readings below 13.5 indicate a defective alternator or voltage regulator. Voltage readings above 15 indicate a defective voltage regulator. Some automobiles have voltage regulators which can be adjusted. Refer to the service manual for your car for voltage regulator tests and adjustments. If the above test indicates satisfactory performance proceed to the ripple voltage test, using the connections shown in the testing diagram. Note that the posi-

(Continued on page 91)

The better the training the better you'll

Send for
FREE
illustrated
career
guide

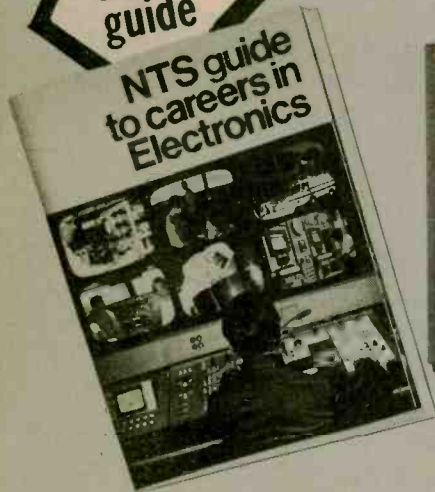

IN-CIRCUIT TRANSISTOR TESTER

COMPU-TRAINER

TROUBLESHOOTER
VOM

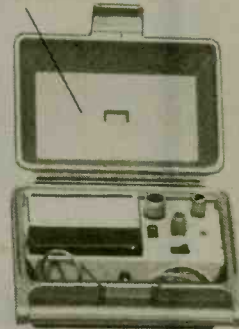
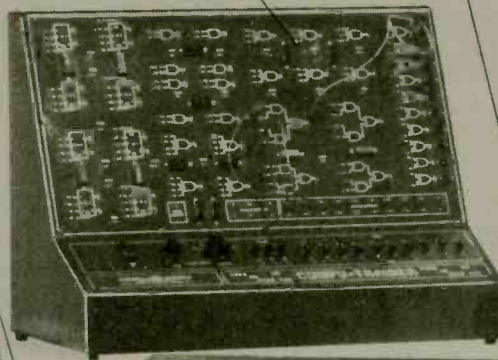

SOLID-STATE
OSCILLOSCOPE

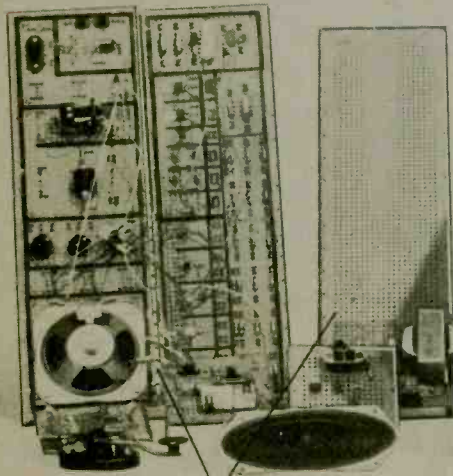

ELECTRO-LAB



(Simulated TV Reception)

As an NTS student you'll acquire the know-how that comes with first-hand training on NTS professional equipment. **Equipment you'll build and keep.** Our courses include equipment like the **NTS/Heath Digital GR-2000 Solid State color TV** with first-ever features like silent varactor diode tuning; digital channel selection, (with optional digital clock), and big 315 sq. in. ultra-rectangular screen.

Also pictured above are other units — 5" solid state oscilloscope, vector monitor scope, solid-state stereo AM-FM receiver with twin speakers, digital multi-meter, and more. It's the kind of better equipment that gets you better equipped for the electronics industry.

This electronic gear is not only designed for training; it's field-type — like you'll meet on the job, or when you're making service calls. And with NTS easy-to-read, profusely illustrated lessons you learn the theory behind these tools of the trade.

Choose from 12 NTS courses covering a wide range of fields in electronics, each complete with equipment, lessons, and manuals to make your training more practical and interesting.

Compare our training; compare our lower tuition. We employ no salesmen, pay no commissions. You receive all home-study information by mail only. All Kits, lessons, and experiments are described in full color. Most liberal refund policy and cancella-

and the equipment be equipped.

COMPARE OUR
KITS AND LESSONS.
COMPARE OUR
TUITION.

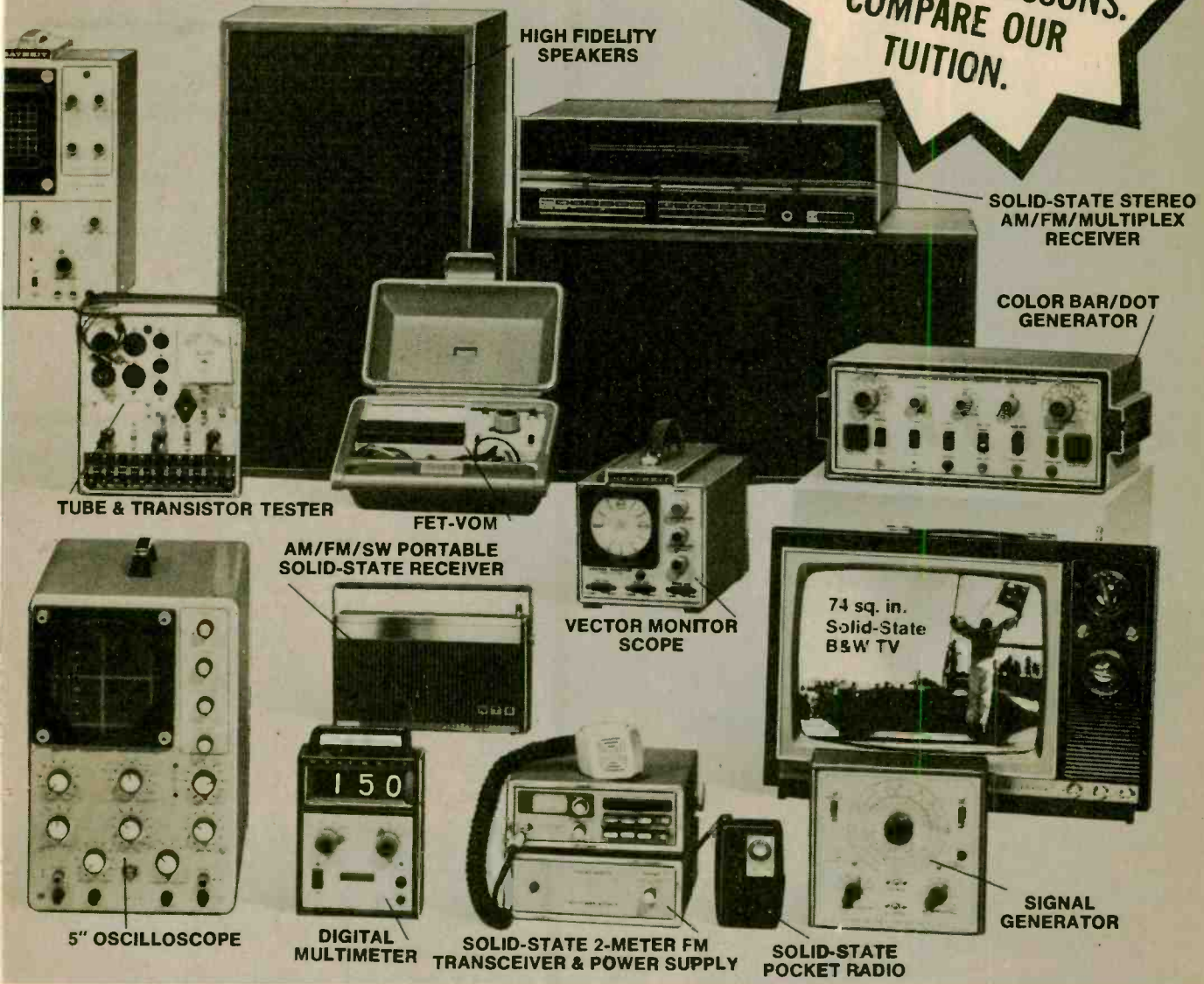

tion privileges spelled out. Make your own comparisons, your own decision. Mail card today, or clip coupon if card is missing.

NO OBLIGATION. NO SALESMAN WILL CALL

APPROVED FOR VETERAN TRAINING

Get facts on new 2-year extension

NATIONAL TECHNICAL SCHOOLS

TECHNICAL-TRADE TRAINING SINCE 1905
Resident and Home-Study Schools
4000 So. Figueroa St., Los Angeles, Calif. 90037

NATIONAL TECHNICAL SCHOOLS
4000 South Figueroa St., Los Angeles, Calif. 90037 Dept. 222-057
Please send FREE Color Catalog and Sample Lesson.
NO OBLIGATION. NO SALESMAN WILL CALL.

| | |
|---|--|
| <input type="checkbox"/> Color TV Servicing | <input type="checkbox"/> Electronics Technology |
| <input type="checkbox"/> B & W TV and Radio Servicing | <input type="checkbox"/> Computer Electronics |
| <input type="checkbox"/> Electronic Communications | <input type="checkbox"/> Basic Electronics |
| <input type="checkbox"/> FCC License Course | <input type="checkbox"/> Audio Electronics Servicing |

NAME _____ AGE _____
ADDRESS _____ APT # _____
CITY _____ STATE _____

Please fill in Zip Code for fast service: _____
 Check if interested in G.I. Bill information.
 Check if interested ONLY in classroom training in Los Angeles.

DXing the Forgotten

Stations in your own backyard

WHEN THINKING about rare and historic DX loggings, North American shortwave listeners usually forget about their own continent. Even excluding the Latin American countries of Mexico, Central America and the Caribbean, North America offers some very interesting loggings. As an archaeologist might say, all you have to know is where the bones are buried. Even with the simplest of receivers you can join in the "dig."

Greenland. When does an international telephone transmitter become an international broadcast station? When it transmits advertising? Well, maybe. When the Gothaab radiotelephone station on 14900 kHz is not carrying phone calls, it, like most other SW telephone outlets, airs a test tape: in English and Danish. But the English portion of Gothaab's test tape includes information on Greenland's history, geography, etc.—obviously intended to attract potential tourists. And reception reports on that advertising are not only welcome but verified with the same QSL folder as used by the regular Gothaab broadcast station.

Now in order for any radio transmission to qualify as a broadcast station, (1) the signal must be intended for general reception (unlike police, CB, Amateur etc.), and (2) the "software"



Newfoundland plays a central role in navigational and weather shortwave broadcasting, as with Gander Aeradio's transmissions, because of its location near the North Atlantic air lanes.

Continent... North America

by C. M. Stanbury, II

offer rare loggings and exotic verifications.

(content of transmission and type of modulation) must be intelligible to the general public. Certainly advertising is the right kind of software, but modulation is the problem. Here it is single sideband, rather than standard AM, and very difficult to understand on a simple shortwave receiver—especially when there is interference on the frequency. So does Gothaab on 14900 kHz qualify as SWBC? Tune in and decide for yourself. The best time to hear it seems to be around 1600 EST.

Though much more difficult to hear, there are also regular SW broadcasts from Gothaab. Known as *Gronlands Radio*, they are scheduled at 0500-0645, 0800-1300 and 1500-2200 EST on 5960 and 5980 kHz, and 0800-1600 on 11740 kHz. No box number or street is required when addressing reports to *Gronlands Radio*. Reports on the Gothaab radiotelephone station should be sent *c/o Gronlands Radio*.

Newfoundland. Although now a province of Canada, Newfoundland was a separate country until 1949, and many DXers still consider it something more than an "ordinary" Canadian catch. And like Greenland, the most readily heard Newfoundland station is a utility turned broadcaster of sorts. But definitely not a broadcaster in the

general sense of the term. This is *Gander Aeradio* with aeronautical weather information at 20 and 50 minutes past each hour. Technically speaking, this very specialized type of broadcast is known as a "VOLMET" transmission. Frequencies are 3001, 5652, 8868 and 13272 kHz. *New York Aeradio* uses these frequencies the rest of the hour.

There is also an orthodox SWBC station in Newfoundland—CKZN, formerly VONF prior to Union with Canada, now operated by Radio Canada on 6160 kHz relaying the home service from St. John's to remote parts of that province as well as the fishing fleet. CKZN does occasionally make it into various parts of the U.S. through the much higher powered international competition on their frequency. But be careful. Radio Canada operates a second home service relay on 6160 kHz—CKZU, Vancouver, British Columbia on the Pacific coast.

Quebec. In another article which I call "Collecting Antique DX Stations," I tell how CFCX, a station which is a relay of BCB station CFCF Montreal) was engaged in a running battle with the Quebec government over English language rights in this predominantly French speaking province. Now an

even more militant pro-French party controls the Quebec parliament. In fact, on paper at least the Parti Quebecois is committed to removing Quebec from Canada. Some of this may be campaign rhetoric but it's also possible the PQ's election victory may have set in motion forces which no one can control. Certainly CFCX, which broadcasts entirely in English, is a station well worth monitoring. It can be heard over much of eastern North America during daylight hours. Elsewhere it can occasionally be logged at night but interference from the BBC, and from *Radio Reloj* in Costa Rica, make reception pretty difficult.

Radio France. Another group which will be watching developments in Quebec with great interest is the government of France which from time to time in the past has encouraged an independent Quebec. France still maintains a small colony in the Gulf of St. Lawrence, the islands of St. Pierre and Miquelon, and Radio France operates a BCB home service relay on St. Pierre. Although the power is listed as only 4 KW, its "split frequency," 1375 kHz signals are heard surprisingly often by DXers in eastern North America. Presently the station signs off early, at approximately 2030 EST. It



Shortwave radio sometimes is involved in the separatist controversy in Quebec, with Radio France operating a relay station on the island of St. Pierre in the Gulf of St. Lawrence.



Shortwave radio is especially important in Greenland. Besides the regular Shortwave broadcasts from Gronlands Radio, shortwave links the scattered settlements, as in the photo above.

e/e FORGOTTEN SW DX

will be interesting to see whether this station's schedule or coverage are expanded.

Religion & Politics. When shortwave broadcasting from the U.S. is mentioned one usually thinks of the *Voice of America*. But the real action these days, although our competitors seem afraid to talk about it, is in religious broadcasting: particularly religious broadcasting mixed with politics. As noted in an earlier article, "The Secrets of Split Frequency DX," September-October 1976 *ELEMENTARY ELECTRONICS*, a great deal of the money going into international broadcasting all over the world these days is raised by evangelical organizations. But the most intriguing of these new breed stations, *Radio Million* at San Jose, Costa Rica (detailed in that same article) is in what's euphemistically described as a "holding pattern" while various political and government interests in Washington, San Jose and elsewhere play games in a global back room. Thus the action has temporarily switched from *Radio Million* to WYFR, which was recently given FCC permission to move from Scituate (near Boston, MA) to a much more strategic site in Florida.

Under different ownerships, WYFR previously operated as WRUL and WNYW. The present owners, Family Stations Inc., would probably just as soon forget some of the station's earlier history. According to Ross & Wise in *The Invisible Government* WRUL was at least slightly involved in the overthrow of the Guatemalan government in 1954. Later the station definitely had links with a "network" that included famed clandestine *Radio Americas* (aka *Radio Swan*), *Radio Caribe* in the Dominican Republic (which has now evolved into *Radio Clarin*), and the program called Radio Cuba Libre. In-

filtration? Conspiracy? Who knows. All we know is that these are the kind of skeletons which are wandering around in international broadcasting these days. Any organization that buys someone else's shortwave station is likely to inherit one. It is also something else that most DX writers are afraid to talk about.

WYFR's (*Your Family Radio*) programming is primarily fundamentalist religious, with an occasional political comment—such as support for a strong U.S. defense policy. WYFR broadcasts in English, Spanish, Russian and other languages on many frequencies. It is most widely heard by North American

SWLs on 15440 kHz (daytime) and 6155 kHz at night. They are anxious to receive reports and QSL promptly. The address is 290 Hegenberger Rd., Oakland, CA 94621.

Another religious shortwave station with what might be considered a *Radio Americas*-related skeleton in its closet is KGEI near San Francisco. After *Radio Americas* was closed in the spring of 1968, a private group, the American Security Council, began distributing its own "Radio Americas Libre" tapes. These were aired by KGEI until 1973. RAL tapes were also, incidentally, sent to WNYW right up until the time it

(Continued on page 94)

WYFR

Your Family Radio

Studios — Oakland, California Transmitters — Scituate, Massachusetts

United States of America

THE INTERNATIONAL VOICE OF FAMILY RADIO

WYFR, which recently moved from Massachusetts to Florida, broadcasts in English, Spanish, Russian and other languages, and promptly verifies reception reports with these QSL cards.

GLOSSARY OF TERMS

AM—amplitude modulation
 BBC—British Broadcasting Corp.
 BCB—broadcast band (540-1600)
 DX—long distance reception
 DXers—listeners for distant stations
 EST—Eastern Standard Time
 FCC—Federal Communications Commission
 kHz—kilohertz
 KW—kilowatt
 QSL—verification card or letter
 SW—shortwave
 SWBC—shortwave broadcast
 SWL—shortwave listener

FREQUENCIES AT A GLANCE

| kHz | Station | Time (EST) |
|---------|--|--|
| 1375 | Radio France, St. Pierre | Early evening |
| 1605-30 | Pirates | Night |
| 3001 | Gander VOLMET, Nfld. | 20 & 50 minutes past each hour |
| 5652 | Gander VOLMET, Nfld. | 20 & 50 minutes past each hour |
| 5960 | Gronlands Radio | Night |
| 5980 | Gronlands Radio | Night |
| 6005 | CFCX, Montreal, Quebec | Daylight in eastern NA, Night elsewhere |
| 6155 | WFYR, Scituate, Mass. | Evening |
| 6160 | CKZN (Radio Canada), St. John's, Newfoundland CKZU (Radio Canada) Vancouver, British Columbia | Night |
| 8868 | Gander VOLMET, Nfld. | 20 & 50 minutes past each hour |
| 9615 | KGEI, San Francisco, CA | Evening |
| 11740 | Gronlands Radio | 0800-1600 |
| 13272 | Gander VOLMET, Nfld. | 20 & 50 minutes past each hour |
| 14900 | Gothaab Radiotelephone Station, Greenland | Late afternoon |
| 15440 | WYFR, Scituate, MA | Daytime |

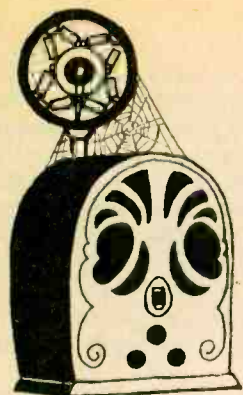

ANTIQUE RADIO CORNER

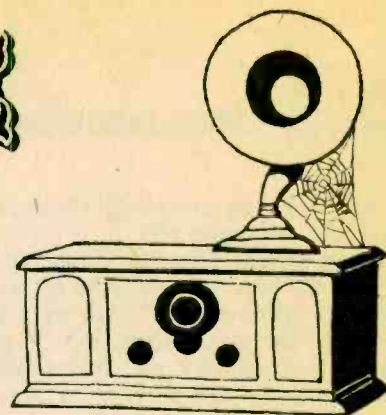

by James A. Fred

□ Hello! out there in Radioland. I receive many letters in which readers ask for more technical information. One of the most interesting circuits used in the old days was the Reflex circuit. Some readers have been asking about reflex circuits such as were used by deForest, Harkness, Erla, and other makes. In this column we will tell you about some of these circuits and explain their operation.

In most amplifier circuits a vacuum tube has only one duty to perform. When it is used as an audio frequency (AF) amplifier, it amplifies the audio frequencies after detection, and in a radio frequency (RF) amplifier it amplifies the radio frequencies before detection. Thus if 2 stages of RF amplification are desired, and 2 of AF amplification are desired, four tubes are needed in addition to the detector. In a reflex circuit with a crystal detector, all this is accomplished with 2 vacuum tubes, or if a tube detector is used, with 3 tubes.

One Tube Circuits. Two different reflex circuits are shown using only 1 tube. In the Acme reflex circuit shown the RF current flows from the antenna through the primary of the antenna coil to ground. RF is induced into the sec-



Photo by Frank Heathcote

An assortment of crystal radios on display at a recent meeting of the Indiana Historical Radio Society featuring crystal receivers.

ondary winding which has C1, a variable condenser, across it which tunes in the station we want to listen to. R is used to prevent oscillation in the circuit. The RF current is impressed on the grid of the tube which controls the current flowing in the plate circuit of the tube. When the RF current flows through the primary winding P of the RF transformer T1 current is induced into the secondary winding S. It does not proceed through the headphones because the impedance is too high. The RF current applied to the crystal D is rectified into pulsating direct current. C2 is a bypass for RF currents. The pulsating current then flows through the primary winding P of the AF transformer T2. A voltage is induced into the secondary winding S which flows through the antenna transformer secondary to the grid of the tube. The tube now greatly amplifies the audio frequencies. The AF flows through winding P and into the headphones which produce the sounds we can hear.

More Tubes. There were many variations of the one tube circuit such as that shown in the circuit diagram of the Harkness reflex receiver. There were also many reflex receivers built using three or four tubes. One of these was the Grimes Inverse Duplex set whose circuit is shown. There were problems associated with the reflex circuits such

as uneven loading on the tubes, feedback due to magnetic coupling, and the amplification of power line noise and interference due to rotating machinery such as electric motors-using brushes. The Grimes Inverse Duplex circuit is designed to overcome some of these problems. This circuit uses two tubes for amplification and one tube as a detector. These three tubes provide two stages of RF amplification and two stages of AF amplification. A crystal could have been used as a detector instead of a tube.

In the Grimes circuit shown the RF current flows through the tubes in the conventional way, through tubes 1, 2, and 3, in the following order. From the detector the AF is amplified first by tube 2, then tube 1, and then to the telephone receiver or headphones in the plate circuit of tube 1. In this circuit stability is increased, overloading of the tubes is reduced, and AF interference is reduced. The location of the by-pass capacitors allows the RF currents to return directly to the tube without going through the "B" battery or around the AF transformers. The set is simple to operate since there is one control for tuning, one for the vacuum tube filaments, and one for stability. Even though they were perfected, reflex circuits were abandoned in favor of neutrodyne and superhetrodyne receivers until the Great Depression of the

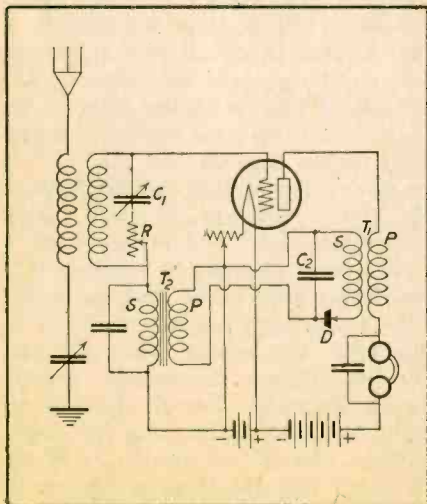

Circuit of the Acme Reflex receiver.

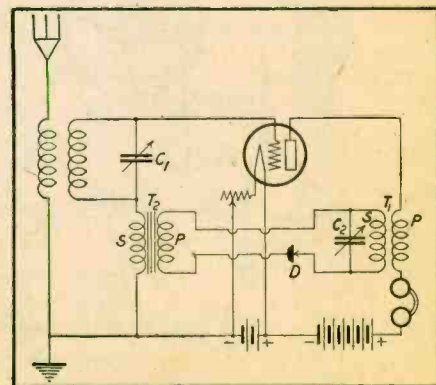

Circuit of the Harkness Reflex set.



RF from your Calculator

LED multiplexing and its DC to DC converter make your calculator into an RF signal generator.

by Bob Baxter



□ The virtues of portable electronic calculators are by now so well-known and their prices have dropped so low that the units are found almost everywhere. Many presently-available machines—especially those employing LED displays—can be used as quick troubleshooting aids in addition to performing their usual day-to-day calculating chores. Whenever you need a fast, convenient, and portable amplitude-modulated RF source for equipment check-out, your calculator can often fill the bill.

Here's why. Just about all battery-powered calculators emit strong, wide-band RF signals which extend well up into the tens of megahertz. These signals are generated primarily as side-effects by the operation of two components of the calculator: the power supply's DC-to-DC converter and the multiplexed LED digital readout.

Not every calculator has a DC-to-DC converter. But those operating from two or three penlight or nicad cells usually do, using it to step the low battery voltage up to a higher level more suitable for operating the MOS IC's which do the arithmetic. The converter produces a harmonic-rich square-wave output at a fundamental frequency typically between 20 kHz and 100 kHz—but the harmonics extend well up into the megahertz region.

Even if your calculator is one of those without a DC-to-DC converter, it's still almost certain to use a multiplex system to drive the output digital display. Multiplexing means that each selected segment of the digital readout is rapidly turned on and off many times each second rather than staying on continuously. When this switching is done rapidly enough, the readout appears to stay on all the time because of the relatively slow response time of the human eye. Readout devices are multiplexed for two reasons. First, multiplexing drastically reduces the power required to operate the readout at any given *apparent* brightness level because the readout is actually on and drawing current for only a small percentage of the time. As a consequence, batteries last much longer. Secondly, multiplexing permits a great reduction in the

total number of IC's needed to actuate the calculator's readout display with an attending cost reduction at the time of purchase.

With a standard calculator's seven-segment LED readout and anywhere from 8 to 12 display digits, the multiplexing frequency is typically around 100 kHz. When currents of 20 mA or so are abruptly switched on and off through the LED display segments, significant amounts of RF energy at multiples of the multiplexing frequency are generated. These harmonics may extend well into the tens of megahertz. In fact, this harmonic radiation is one of the main reasons there are so few AM clock radios with LED time displays on the market today. The standard AM broadcast band is almost totally obliterated if the receiver's RF sections are within a foot or so of the multiplexed readout display unless extensive shielding is employed. Fortunately, there are two more practical and less expensive solutions than shielding. The first is the addition of resistance-capacitance networks to slow the rise and fall times of the multiplex waveform—and consequently filter out most of the higher-order harmonics. The second method is to drive each display digit directly and not use multiplexing at all. This second technique is much more practical in a clock radio than in a calculator for two reasons. First, clock radio displays normally have considerably fewer digits than most calculators; hence, the circuit

problem isn't nearly so complex. And secondly, with a clock operated from the AC power line, the problem of rapidly discharging the batteries unless the output is multiplexed is eliminated. National Semiconductor Corporation has recently introduced a clock chip with direct drive of all readout segments to eliminate RF interference. It was designed with clock radio applications in mind.

But now back to your calculator, which almost certainly is multiplexed and unfiltered and produces a rich harmonic output. Turn it on and slowly bring it near a standard AM radio which is tuned either to a weak station or between stations. You should hear a mixture of buzzes and tones as the calculator is brought within several inches of the radio or its antenna. These tones probably will shift in frequency if you key different numbers into the display.

Now that you've verified that your calculator is a portable, wideband, RF source, what can you use it for? Well, a number of applications are obvious. Anytime you need a quick check to see if the RF and IF stages of an AM receiver are working, your calculator can provide a test signal. Probably its handiest use, though, is in continuity testing antennas and connecting cables. Auto antennas and their accompanying cables and connectors are easily tested for opens and shorts by bringing the calculator near the antenna while monitoring the radio output. Perhaps the ultimate example of this technique you can perform in your automobile. Place a calculator near the windshield antenna of a late model General Motors car. In cases of poor or non-existent reception, one or both of the two thin antenna wires imbedded inside the glass may be broken. By carefully tracing the path of each individual wire, a break or faulty connection can be located when the radio's output changes abruptly.

And one final thought. Those of you with LED digital watches might experiment with them. The power is much lower, and the metal watch case provides a lot of shielding, but there just might be enough RF coming from the display to be useful. ■



One of the many uses for your calculator other than calculating. Here it is being used to check a windshield antenna.



by Kathi Martin, KGK3916

Kathi's CB Carousel

Kathi Tests One Of The First 40 Channelers



CIRCLE 75 ON READER SERVICE COUPON

□ It was almost a parody of classic comedy routines which are in themselves parodies of the business world. For weeks on end we got almost daily reports of what CB manufacturer got which transceiver FCC type-approval. First it was fourteen models, then forty, then seventy, then one hundred, two hundred, two-hundred, two-thirty, and so it went day after day—another hot-off-the-presses list of transceivers that passed the FCC. Even the FCC got into the act with a hot-line telephone number that spouted pre-recorded lists of CB transceivers with type-approval.

And as if all this wasn't enough, the trade press was buried under an avalanche of Madison Avenue "snow," packets of news releases, announcements, specifications and glossy photographs. (I'm using the backs of the news releases for scrap paper and I figure to run out in 1999.)

It might not look special at first glance, but if you wrap your hand around the mike your thumb will find itself against a recessed control that serves as a submaster volume control: you can adjust the received signal volume from the mike or the transceiver.

Anyway, when the hoopla died down and the smoke cleared, and the magic selling date of January 2 rolled around (unfortunately, January 1 was a holiday), you could count the number of brands actually on the dealer's shelves on one hand. After all that fanfare, with rare exception the CB manufacturers couldn't even get their product into the marketplace on time.

One of the few who did make it to the dealers' shelves with an actual production model ready for sale was Royce, who put at least one SSB model out on the firing line.

Fact is, the model I tested actually came off a dealer's shelf because there were no samples available for editorial review. Whatever Royce produced went to their customers first, so I got my 40 channel AM transceiver the same way you'll get yours: off-the-shelf.

The Royce model 1-682 AM trans-

ceiver looks a lot like many late model 23 channel jobbies that used LED digital readout devices for the channel indicator. Fact is, you can't tell the Royce covers 40 channels until it's turned on and you discover the channel readout doesn't stop at 23. But let's not run ahead, let's start with the outward features.

The 40 channel Royce 1-682 operates off 12-13.8 VDC with positive or negative ground. The power cord plugs into the rear of the cabinet, which also contains mini-jacks (standard type) for external and P.A. speakers. The front panel has a jack for the plug-in microphone; controls for channel selection, continuously variable fine tuning, volume, squelch and RF gain. There are switches for PA/CB, ANL and dimming of the LED digital channel indicator. (Normally, high brightness is used for daylight operation; the LEDs are dimmed at night to eliminate brighter than average "glow" from the dash area.) An S/RF meter is provided.



The rear panel layout is more or less standard: an antenna jack, a power jack, and connections for external and PA speakers which add flexibility.



Until power is applied there's nothing to indicate the tuned channel. With power on the LED digital display can be set for two brightness levels: high for use in daylight; low for night driving. The small push-button directly above the blackout window sets the brightness level. The fine tuning control is continuously variable + or - 1.8 kHz (measured) though rated at + or -1.5 kHz.

A small wheel built into the side of the microphone opposite the PTT (push to talk switch) is a submaster volume control that permits the operator complete control of the received signal's volume level—without need to reach across the car to the volume control mounted on the transceiver. In the normal operating position with the fingers on the PTT switch, the thumb falls naturally on the volume control.

(Continued on page 91)

MA BELL'S MOBILE-TEL LIP-ZIPPER

Easi-build silencer lets you listen in on land-mobile phone talk with any regular communications set.

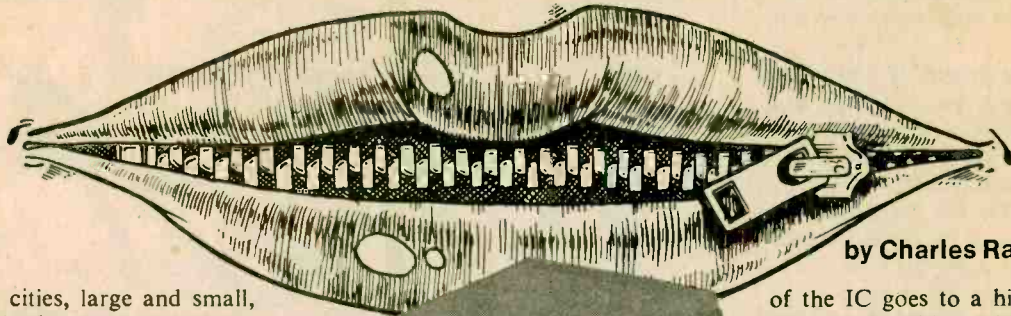

by Charles Rakes

□ In almost all cities, large and small, Ma Bell has made the mobile telephone available to everyone that needs it (and can afford it). Not only can subscribers benefit from Ma's special wireless phone service—the general public who are now listening to the many other public service bands can enjoy eavesdropping on it as an entertainment medium.

Many of the conversations overheard on Ma Bell's mobile phone frequencies would make a person blush, even in these loose and liberal times, because most users don't have the foggiest idea that their phone conversations can be overheard, and on an ordinary multi-band receiver. For the majority of us, who no longer have the advantage of the old party-line telephone system it's a great way to once again catch up on the latest gossip with the no-holds-barred *MBMT Lip-Zipper*. That is, *Ma Bell's Mobile Telephone, Lip-Zipper*.

Who Needs Lip-Zipper? You Do! Now hold it just a second. Why can't you just tune in on the public service band and sit back and enjoy listening to the gossip? Well, you can. This part of the operation is just that simple, but the problem is what happens when no one is using the mobile phone radio channel. Good old Ma Bell places an *idle tone* of 2000 Hz on the channel during this *non-busy period*, and holds it there until the system becomes busy again. This audio tone is transmitted so that the subscriber's receiver can tell when the radio channel is open for use. This is all well and good for the complex mobile telephone system, but it is darn annoying to sit and listen to a continuous 2000 Hz tone while impatiently waiting for the next juicy call to come in. (Ed Note: Maybe that's why Ma chose that frequency. It could just as easily have been one above the limits of the audio range.)

We Lick the Problem. Our handy-dandy *MBMT Lip-Zipper* shuts Ma's mouth during the tone period. During this time our *Lip-Zipper* disconnects the



speaker from the receiver, giving us peace and quiet, and when the channel is put back in use the audio is routed to the speaker so we don't miss anything.

How Lip-Zipper Zips. The heart of the Zipper is a 567 phase-locked loop (PLL) IC tone decoder tuned to respond to the 2000 Hz idle-tone frequency. The output of the 567 IC (pin 8) is direct coupled to a time-delay relay driver transistor, Q1. When a 2000 Hz tone signal is present at the input of the PLL (pin 3), the DC output (pin 8) of the IC is low—near zero volts. During this time no DC bias is present at the base of Q1, and the relay is not operated. The relay remains in this condition as long as the tone is present at the input of the IC.

At the instant the channel goes into use the tone is removed and the output

of the IC goes to a high state (positive DC volts). This positive voltage is fed through coupling diode D3 to the time-delay circuit, and to the base of Q1. The relay pulls in, connecting the output of the receiver, through the relay contacts, to the external monitoring speaker, allowing the call to be heard.

Time Delay Relay. The function of the time-delay circuit (C6 and R6) is to keep the 2000 Hz audio-frequency components that are present in normal speech from causing the relay to chatter. Without this delay circuit the relay would cut in and out, badly interrupting normal voice conversations.

The input of the Zipper is matched to the receiver's audio output by transformer T1. The audio signal level at the secondary of T1, is limited by diodes D1 & D2 to maintain a near constant level at the input of the PLL.

A DPDT toggle switch is included to allow the receiver's audio to pass directly to the monitor speaker when the Zipper is turned off, and it places Zipper's mouth-shutting circuit into operation when the switch is in the *On* position.

Putting Zipper Together. Construction of *Lip-Zipper* is simple and straightforward. It can be built either on perfboard or on a printed-circuit

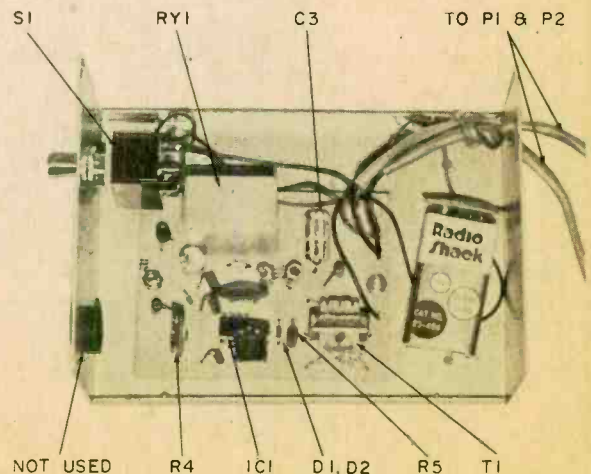

Interior view of completed Lip-Zipper showing major parts locations. Consult parts layout for location of small components.

e/e MA BELL'S ZIPPER

board. The choice is yours because the layout isn't at all critical, and the circuit will perform in almost any physical configuration.

To Use a Circuit Board. If a printed-circuit board is used, you can copy my layout and cut your construction time to the minimum. Take great care when soldering the semiconductors in place, and use a socket for the PLL IC. Zipper can be housed in a metal cabinet 4-in. wide x 2 $\frac{3}{8}$ -in. high x 5 $\frac{3}{8}$ -in. deep without crowding, as shown here.

The printed-circuit board should be mounted so that trim pot R4 may be adjusted either through the front or the side of the cabinet.

Using Lip-Zipper. Plug P1 into the monitor receiver's audio-output jack, and connect P2 to an external speaker. For added enjoyment try using a good-quality enclosed speaker.

With the toggle switch in the *Off* position the audio should be coming
(Continued on page 92)

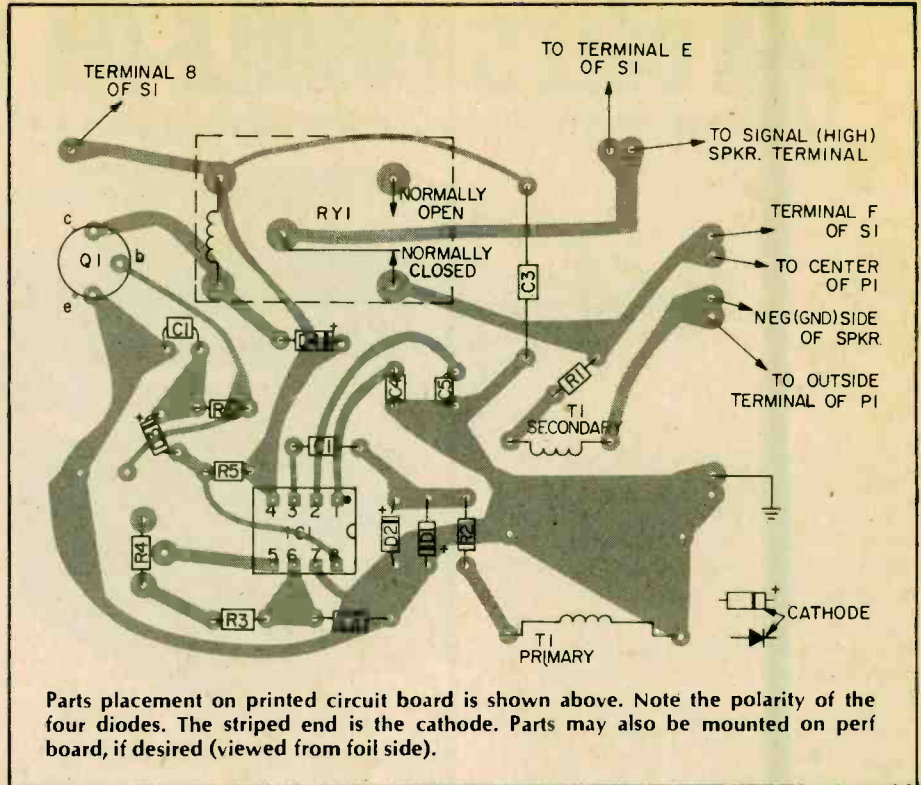

Parts placement on printed circuit board is shown above. Note the polarity of the four diodes. The striped end is the cathode. Parts may also be mounted on perf board, if desired (viewed from foil side).

PARTS LIST FOR LIP ZIPPER

- B1—Four AA (penlight) cells 1.5 VDC (Radio Shack 23-552 or equiv.)
- C1—1 μ F, 100-VDC capacitor (Radio Shack 272-1053 or equiv.)
- C2—.05- μ F, 200-VDC capacitor (Radio Shack 272-052 or equiv.)
- C3—100- μ F, 16-VDC capacitor (Radio Shack 272-955 or equiv.)

- C4—4.7- μ F, 16-VDC capacitor (Radio Shack 272-951 or equiv.)
- C5—2.2- μ F, 16-VDC capacitor (Radio Shack 272-1040 or equiv.)
- C6—47- μ F, 16-VDC capacitor (Radio Shack 272-954 or equiv.)
- D1, 2, 3—1N914 signal diode, silicon only, not germanium (Radio Shack 276-112 or equiv.)

- D4—1A (or more), 25-V silicon diode, 1N4000 series (Radio Shack 276-1101 or equiv.)
- IC1—Phase-locked loop (PLL) integrated circuit (Radio Shack 276-1721 or equiv.)
- Q1—NPN medium power amplifier/switching transistor, silicon, 2N2924 or similar (Radio Shack 276-2009 or equiv.)
- R1—10-ohm, $\frac{1}{2}$ -watt resistor (Radio Shack 271-000 or equiv.)
- R2, 5—4700-ohm, $\frac{1}{2}$ -watt resistor (Radio Shack 271-000 or equiv.)
- R3—6800-ohm, $\frac{1}{2}$ -watt resistor (Radio Shack 271-000 or equiv.)
- R4—5000-ohm, printed circuit board mounting potentiometer (Radio Shack 271-217 or equiv.)
- R6—1000-ohm, $\frac{1}{2}$ -watt resistor (Radio Shack 271-000 or equiv.)
- R7—10,000-ohm, $\frac{1}{2}$ -watt resistor (Radio Shack 271-000 or equiv.)
- RY1—6 VDC relay, coil 300-ohms or higher (not lower) (Radio Shack 275-004 or equiv.)
- S1—DPDT toggle switch (Radio Shack 275-666 or equiv.)
- T1—1000-ohm to 8- or 16-ohm audio output transformer (Radio Shack 273-1380 or equiv.)
- Misc.—Cabinet (Radio Shack 270-252 or equiv.), IC socket (Radio Shack 276-1995 or equiv.), battery holder (Radio Shack 270-1435, or equiv.), plug to match receiver output (and speaker, if required) wire, solder, etc.

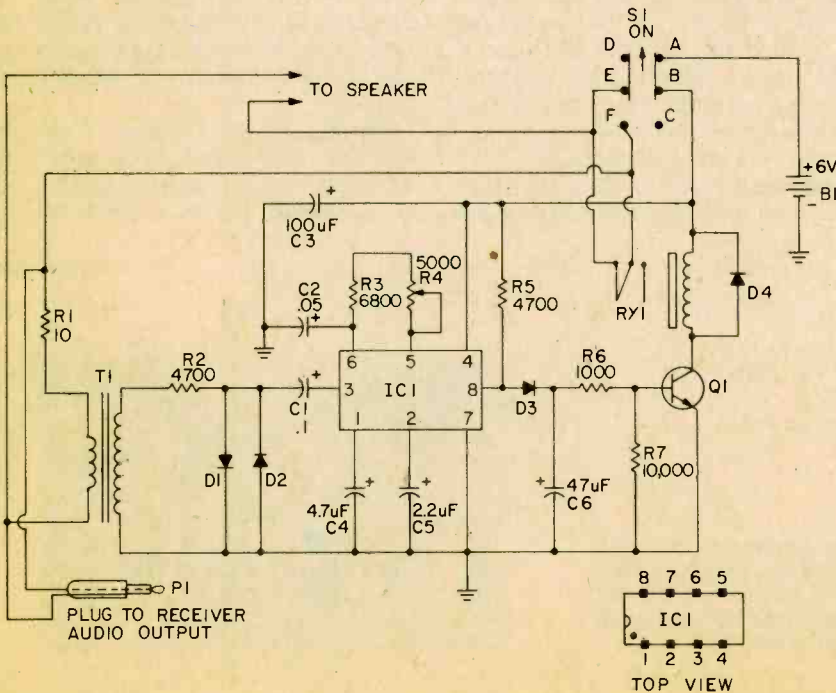

Printed circuit board for this project, with holes drilled, ready for installation of components may be ordered for \$3.75 postpaid from Krystal Kits, Box 445, Bentonville, Arkansas 72712.

The Youngest Ham



This five-year-old shows that getting on the ham bands is child's play.

by Jorma Hyypia

□ One of these days when you fire up your ham radio rig, tune to 21.120 MHz, and make contact with the operator of station WB9VPG in Vincennes, Indiana, be prepared to cope with a real generation gap. You'll be rapping with Neil ("Rusty") Rapp, the lad who made ham radio history by acquiring his Novice ham license at the tender age of five. That's right! Didididit years old!

Now mind you, we are not talking about CB operation because—and here's the paradox—Neil would be denied a CB operator's license, which requires no examinations, because of his tender age. He's the proud owner of a bona fide ham operator's license which he earned in exactly the same way everyone else does; by passing the standard FCC Morse code and radio theory tests. Now if that rocks you a bit, you'll appreciate how the FCC examiner felt. How could he ever convince anyone that Neil had in fact passed the radio theory test with a score that was far higher than that of his father who was taking the test about the same time? The resourceful examiner simply asked every other test-taker present to sign Neil's examination paper as witnesses.

Neil's parents attribute their son's achievement in large part to his addiction to watching re-runs of Sesame Street on TV. By age four he had an IQ of 120 and the mentality of a six year old. When he entered kindergarten, tests revealed that he already had a 5th grade 7th month reading level, a

2nd grade 3rd month spelling level, and a 1st grade 9th month grasp of arithmetic.

Sesame Street to CW. Actually, Neil eased into amateur radio by operating his father's Citizens Band rig under the handle of "The Little Shadow." But around Christmas time his Dad dusted off a code oscillator that had been stashed in a closet with the notion of finally mastering the Morse Code and going for a ham license. Rusty took to the oscillator beeps with the same enthusiasm he had earlier displayed for the antics of Big Bird on Sesame Street. He practiced Morse Code with his Dad at every opportunity.

When Del Rapp decided to enroll in a ham operator training course offered by the Old Post Office Amateur Radio Society there was no thought of taking his son along, mainly because the minimum age for participants was supposed to be 13. But obviously the rules could be bent since a 10 years old girl had been allowed to enroll. At the next session Rusty and his Dad prevailed on the course administrators to bend the rules a little more. Little did anyone suspect then that the precocious lad would put the town and the Old Post Office radio crowd on the map.

During the fifth week of the course Neil's Dad passed the code test, but Neil flunked because he ran out of paper. The trouble was, he could only print in large letters and examination rules forbade turning the paper over. Rusty cried all the way home.

Within a week Rusty's self-confidence had returned and he tried again, and almost made it. Rusty was still a loser, but not a quitter. On the third attempt he scored.

Theory for Peanuts. Next came the business of learning radio theory in order to pass the FCC test. Rusty didn't find this half as exciting as messing around with Morse code which calls for a lot of beeping. So the learning process had to be turned into a game. His Mom, Margaret, thought of putting questions on one set of cards, and the answers on other cards. The innovative card game helped, and even more so when right and wrong answers won or lost pennies. But the real inspiration came when it was recalled that there's one thing that inevitably turns on kids and American Presidents — peanuts. When peanuts were substituted for the pennies, the game got really hot. However, Rusty insisted on keeping personal control of the peanut jar.

Meanwhile the FCC had managed to lose Neil's code test and license application. Maybe someone thought it was all a big joke. Eventually, the application was found and Neil was invited to come in for examination. He was put in a room by himself and given a half hour or so to complete the test.

A few days later the Rapps received a special letter in the mail. Rusty had passed the test, and was now the licensed operator of ham radio station WN9VPG.

Rusty became a licensed ham in the summer of 1976, and since then he has gone on through the first grade in school and is now about to experience the heady adventure of being a second grader. Have his formal educational responsibilities interfered with his ham radio activities? We'll let Rusty's Mom give you the wrap-up in her own words.

"Since receiving his license . . . he has been on the radio very little. The excitement seems to be over for now. I guess it must be the challenge he enjoys because now he is pushing his Dad to start studying for the General License. . . . I think he needs a rest and a break from the pressures and tensions, and I know his father and I sure do. So I am hoping the next step will be a long and drawn-out process!"

To the proud parents we offer this one bit of advice. Grab all the rest you can while it is possible because Rusty is bound to become involved in many other things besides ham radio. Just wait until he hears about home hobby computers, for example! And Pop, be sure to stock up on peanuts because there's no telling where they will lead! ■

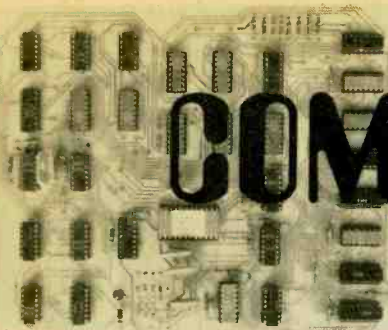

COMPUTER READOUT

by Norman Myers, Computers Editor

Books you can learn about microcomputers from

□ At least 50 books on microcomputers have come out in the last three years, and more are being published every month. Trying to select one of those books without some guidelines on what you need and what they offer is virtually impossible. In this article we try to clear away some of the microfog by reviewing several books to help you decide what level of book(s) you need. That will help you select specific books.

Microcomputer books can be divided



Books, books, and more books. Books on microcomputers are bigger, often than hardware, which keeps getting smaller.

into two categories, those that cover a broad scope of hardware and software operations, and those that discuss specific hardware (and/or software). In this book review we get into both categories. Books in the first category can range from very basic to quite advanced, and we will look at some of each. If, for example, you want to be well grounded in basics, you would start near the beginning of our list and work your way through to the advanced books. Whether simple or advanced,

however, these first category books carry the reader from hardware-building blocks up to a complete microcomputer, and from software-building blocks up into full programs.

Remember that the books reviewed here are only a sample of what is available. To find more books on microcomputers, write to the publishers shown in the list at the end of this discussion.

Introduction to Microcomputers and Microcompressors by Barna and Porat, published by Wiley, 1976, 108 pages, hardbound, \$10.50. Readers who want a quick, but fairly complete understanding of microcomputer basics will like this book, not only because it is short and easy to understand, but also because it includes more than 120 examples and problems to facilitate self-study. The discussion is applicable to virtually all microcomputer systems. While most books on the subject start with explanations of binary, octal, and hexadecimal numbers, then move on to AND/OR type logic operations that lead to adder and subtractor circuits, this book puts those subjects in Chapters 5 & 6 in order to get the reader up to speed with some meaty material in the early chapters. Chapters 1 & 2 jump right into a brief discussion of what a microcomputer is from the hardware viewpoint. Chapter 3 follows with a concise explanation of programming techniques, from simple instructions to flow charts. Other chapters expand on the hardware and software aspects by explaining different types of memories, the ways a microcomputer controls its operations, and ways to increase programming power. Its all there, in a tight package that makes easy reading.

The Bugbook III—Microcomputer Interfacing by Rony, Larson, and Titus, published by E&L Instruments, 1975, 350 pages, paperback, \$15. The uniqueness of this easy-to-follow and informally-written book lies in the experiments that are given at the end of each chapter to help teach the reader some im-

portant ideas about programming, generating control signals from microcomputers, clock cycles, and much more. The first chapter (53 pages) answers the standard question, "What is a microcomputer," with block diagrams and by getting down to basics like what is *memory*, and what is really meant by "reading data from memory." The other chapters are largely based on the Intel 8080 microprocessor as they discuss a specific microcomputer trainer called the Mark 80. Programming for the 8080 is well covered for the beginner. The book appears geared to a classroom

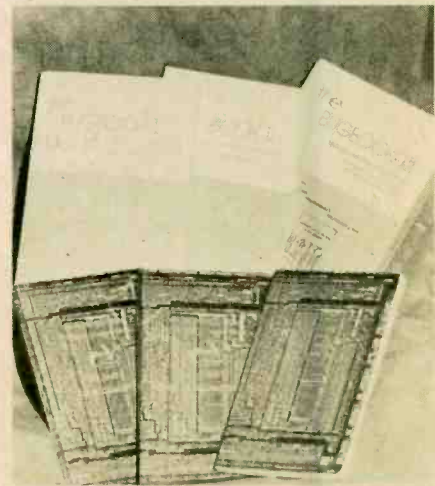

Bugbooks aren't for entomology, the study of insects. Bug books are so named because computers always have to be "debugged."

situation where specific integrated circuits, computer trainers, and the like are available, and could be just the book for a microcomputer club to use as a training aid. Incidentally, Bugbooks I and II deal with logic and memory experiments using TTL (transistor-transistor logic) integrated circuits.

Microcompressors by McGlynn, published by Wiley, 1976, 207 pages, hardbound, \$11.95. Readers wanting some technical detail of microprocessor structure, fabrication, and uses in microcomputers will find this book quite satisfactory. It is really not limited to microcompressors, however, since Chap-

ters 1 & 2 contain descriptions of basic computer structure. Chapter 3 presents semiconductor technology, like metal-oxide-silicon (MOS) and bipolar processes. The idea here is that by understanding fabrication techniques the hobbyist and the engineer can understand the advantages and disadvantages of each in terms of speed and cost. Chapter 4 moves into a review of the operation and software features of several different microprocessors, such as those by Intel, Motorola, and Signetics. Chapter 5 is devoted to the Intel 8080, and it gives a lot of details, but in a way that the beginner can understand and use. The remaining chapters explain programming techniques and applications of microprocessors. One example shows how a microprocessor is the brain of a small electronic switching system that handles (switches) telephone calls, determining how each call should be routed so that the calling customers reach the correct party. The book will be useful to hobbyists, technicians, and engineers interested in gaining technical knowledge in microcomputer fabrication and operation.

Microprocessor and Microprogramming Handbook by Brice Ward, published by TAB Books, 1975, 293 pages, paperback, \$6.95. TAB has several recent books on microcomputers but the reader seeking detailed descriptions oriented toward the Intel 4040 and 8080 will find this a useful reference. The first three chapters provide easy-to-follow answers to such questions as "What is the difference between a microprocessor and a microcomputer; how have microcomputers evolved over the years, what is the basic layout of a microcomputer, and what timing and memory controls are needed to make it all work." Chapter 4 moves on to present an overview of fabrication methods, in addition to the roles of various types of memories like random-access memories (RAMs) and read-only memories (ROMs). In addition, a later chapter provides even more detail on how different types of memories operate. Following the general discussion, over half the book does what the title says—explains microcomputer programming, and in great detail. The programming features of both Intel and Motorola are presented. There are also appendices listing computer technology abbreviations and manufacturer addresses. The first several chapters are easy reading, while the latter ones are geared to advanced readers interested in programming Intel products.

Microcomputers / Microprocessors: Hardware, Software, and Applications by Hilburn and Julich, published by

Prentice-Hall, 1976, 372 pages, hardbound, \$16.50. This is a real soup-to-nuts book which, even though it takes the broad view, still contains a fair amount of detail about many current microprocessors. The clarity of writing is augmented with plenty of photographs and drawings. The introduction in Chapter 1 paints a pretty complete picture of the microcomputer world. Then Chapters 2 & 3 describe the principles of number systems (octal, hex, etc.) and the logic circuits that are used in all microcomputers. Chapter 4 presents the basic layout of all microcomputers in 42 pages and gets into actual MOS circuits and timing details. Chapter 5 covers software, from machine language programming to complete editor programs, in 34 pages. Chapter 6 discusses interfacing peripheral devices, Chapter 7 presents details of ten specific microprocessors (90 pages) and, Chapter 8 gives several examples of real-world applications. The book is essentially for beginners, but is a good reference even for advanced microcomputer buffs to have on their shelf.

Microprocessors and Microcomputers by Soucek, published by Wiley, 1976, 605 pages, hardbound, \$23.00. This is another soup-to-nuts book. The beginner will understand and enjoy it, yet the advanced person involved in microcomputer selection for his company should not be without it. In short, it has something for everyone and can help turn the beginner into a pro. The book is fat, but is divided into three parts—sort of three books for the price of one fat one. Part I begins with number systems (octal, hex, etc.), goes to logic circuits, then to programming (instructions, FORTRAN, loops, etc.), and finally ends with computer structure and operations. Part II has six chapters, each of which provides details of specific microprocessors including instruction sets, the way each is addressed, the input/output modes, and



Intercept Jr. made by Intersil, is a complete microcomputer on a 10 x 12 inch board. Contains batteries, keyboard, 8-digit display made of LEDs, and random access memory for use by your programs. The computer and manuals costs \$281. There are provisions for plug-in modules such as extra memory. For more information circle no. 55 on Reader Service coupon.

To order any of the books described above, send check or money order to company—addresses are listed below

E & L Instruments
61 First Street
Derby, CT 06418

Hayden Book Co.
50 Essex Street
Rochelle Park, NJ 07662

Houghton-Mifflin
1 Beacon Street
Boston, MA 02107

Howard Sams and Co.
4300 West 62nd Street
Indianapolis, IN 46268

John Wiley & Sons
605 Third Ave.
New York, NY 10016

McGraw-Hill
1221 Avenue of Americas
New York, NY 10020

Osborne and Associates
Box 2036
Berkley, CA 94702

Prentice-Hall
Englewood Cliffs, NJ 07632

TAB Books
Blue Ridge Summit, PA 17214

lots more. Over 200 pages and a large number of figures are used in Part II to fully describe twelve units. Finally, Part III presents new and special-purpose microprocessor and microcomputer systems such as Digital Computer Corporation's LSI-11 computer, which is useful in a variety of data-acquisition and processing situations. The book is not for light reading but it is well written, and will be a valuable reference both for new and seasoned microcomputer lovers.

An Introduction to Microcomputers—Basic Concepts (Vol. 1) by Osborne, published by Osborne and Associates, 1976, 260 pages, paperback, \$7.50. This popular book is written in an unusual style. The text is a well organized collection of very descriptive notes and drawings. For example, there's a subtitle "How CPU Registers Are Used," followed by lots of drawings and brief but descriptive sentences explaining each aspect of the drawings. The chapters are well organized as they cover "What is a microcomputer," digital coding, memories, control units, and programming. There is plenty of detail in the sections dealing with programming and this is the strong point of the

(Continued on page 95)

e/e checks out the...

RADIO SHACK 60-3051 TV SCOREBOARD



CIRCLE 32 ON
READER SERVICE COUPON

Low-cost video game has chairside controls for four contests

□ If you've been shopping lately you know that most *Video Sports Games* are similar to each other. In many cases only the price is different, with twenty to thirty dollars representing just a variation in packaging. Except for the more esoteric computer-type games which may include a target game complete with light-sensitive "gun", the popular-priced models feature four games: *tennis*; *handball* (also called *squash*); *hockey* (also called *soccer*); and *practice* (actually one-person handball).

Other common features are switches that make the paddle small or large, add a slice (angle) to the "hit", slow the "ball", and finally, control the power.

How this package of games and control switches is arranged determines the selling price. Unfortunately, just a few cut corners, to keep the selling price low, often means difficult-to-use controls, or the concealed expense of an optional AC power supply.

One of the few electronic video games to include just about every desired feature at a "family" price is Radio Shack's Model 60-3051 *TV Scoreboard*.

TV Scoreboard is similar to other

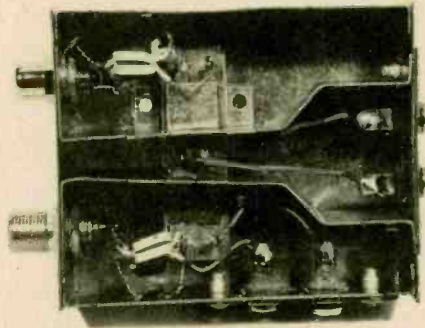

Inside view of game-set coupler shows terminals (left and top), switches (middle), and baluns (transformers) next to connectors at right.

better quality games, featuring the four games mentioned above, on-screen scoring, and a built-in three-tone *pong* generator providing different tones for "hits", ricochets, and bounces. Switches control the power, two ball speeds, two paddle sizes, and slice ("english" or angle).

Power is provided by six C-batteries located in the base, or by an AC adapter that is supplied—the adapter is not an "optional" extra expense.

The output signal of the TV Scoreboard, either channel 3 or channel 4, is connected through a 12-ft. patch cord to the coupler which is attached to the rear of a TV receiver by a strip of Velcro (supplied). The TV receiver's antenna input and the antenna also connect to the coupler, and a switch determines whether the antenna or the video games feed the TV.

Radio Shack's coupler handles both 75 and 300 ohm antenna systems through internal *baluns* (matching transformers).

Balun stands for balanced/unbalanced transformer—between line and antenna or set with different impedances.

As shown in the photograph the coupler has standard connections for flat

300-ohm line and for a 75-ohm coaxial connector.

Aside from the price, which is up to \$30 less than video games with similar features, the Radio Shack TV Scoreboard provides the advantage of remote control. The two players' action controllers can be lifted off the control console and moved almost three feet away. The excess remote cable is stored inside the console when the controllers are mounted on the console.) This allows players to sit back and relax while playing—you don't have to fight for elbow room when using this game. Also, the 12-foot cable connecting the TV coupler allows the players to sit at a normal TV viewing distance rather than having to scrunch up close in front of the receiver to play.

How it works. As you might imagine there are many sophisticated circuits in a video game, and early models were jam-packed with discrete components. Here, most of the circuitry is on a single LSI (large-scale integrated circuit), which is a *really big* integrated circuit. Smaller ICs generate the time base, and the multi-tone audio which is reproduced as "pongs" by the internal speaker. The only circuit not on the three ICs is the RF generator—
(Continued on page 91)

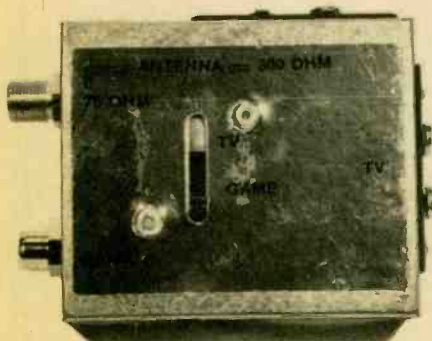

Front of matching unit shows switch for choosing TV reception or RF input from Scoreboard video game for display.

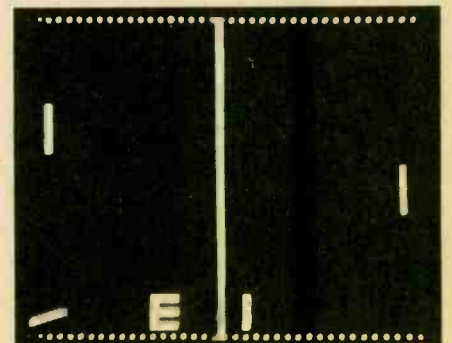

In this game of tennis score is shown at top, ball trace at upper right as ball goes past out-of-position right-hand player.



CB NEW PRODUCTS



e/e puts together in one neat package some of the newest CB rigs, antennas and accessories for you to use in CB contacts this year!

"Under Cover" CB Antennas

Channel Master's 40 channel coil-loaded whip antennas can be conveniently flipped down and hidden in the automobile trunk when not in use. By not signaling the presence of CB equipment, the new Under Cover antennas sharply reduce the danger of theft, without sacrificing performance. Base-loaded and center-loaded models are available, mounted on a specially designed, heavy gauge Under Cover bracket that is fastened to the lip of the trunk. The two-way bracket enables the CBer to mount the antenna in a perfectly vertical position, regardless of the slope of the car's rear deck, and also al-

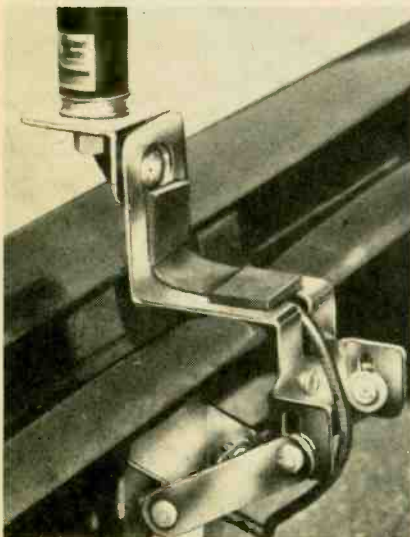

CIRCLE 66 ON READER SERVICE COUPON

lows the antenna to be folded down into the trunk, completely out of sight. No tell-tale sign is visible, not even a trace of hardware. Within the trunk, the bracket keeps the antenna suspended horizontally, so that it does not interfere with the storage of luggage or baggage. The chrome-plated bracket serves as a self-grounding base. It fits most domestic and foreign cars, and may be purchased separately, for use with the CBer's existing antenna. The models in the line include single and dual base- and center-load antennas, as well as the bracket only. For more information and prices, contact Channel Master Div. of Avnet, Inc., Ellenville, NY 12428.

CB 40 on AM

A new Sparkomatic Citizens Band Converter enables any user to convert their AM or AM/FM radio to a 40 channel CB receiver. Retailing for approximately \$39.95, CB-11's many features include: its adaptability to any standard AM radio antenna, the 40 channel illuminated selector knob which permits instant channel selection, the AM/CB switch which works for either AM or CB



CIRCLE 64 ON READER SERVICE COUPON

reception, fine tuning control insuring optimum clarity of any received signal, noise silencer which reduces static interference for clearer signal reception, sensitivity control adjusting for best reception of weak and strong signals, the red "pilot" LED which glows when the CB Converter is activated. The unit is compact, easily installed under the dash with all necessary parts included for quick, easy installation and it fits all cars, boats, campers and trucks. Get all the facts by writing to Sparkomatic Corp., Milford, PA 18337.

New Fiberglass Antenna Line

Turner has announced the new "Yellow Jackets"—the fiberglass antennas with the micro tunable stingers. Turner's new top loaded antennas allow precise tuning by simply loosening a nut at the top of the whip, screwing the tip to the VSWR desired and then retightening the nut. Sixteen new models, made of the highest quality composition fiberglass, are offered. All have a high

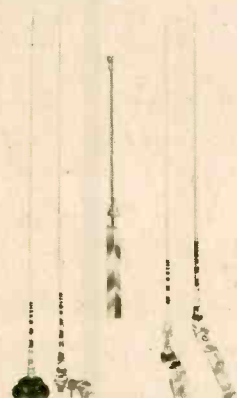

CIRCLE 73 ON READER SERVICE COUPON

power rating of over 100 watts. Antennas are equipped with standard 3/8-24 threads. Turner's economically-priced "Yellow Jackets" are designed for use with the new 40 channel CB transceivers. Priced to sell from \$17.50 to \$45.00. For complete information, write to Turner Division, Conrac Corporation, 716 Oakland Road N.E., Cedar Rapids, Iowa 52402.

Marine Antennas

Anixter-Mark has introduced their Power Pair Marine CB and VHF antennas. These 8 foot

twin antennas are designed to compliment marine fittings—blue cap on top, white covering, chrome-plated ferrule at base. The pair incorporates fishing rod construction, and the output of the "Heliwhip" design. That means it is top loaded and low-loss for high performance and output efficiency. No ground plane is required, and the antenna may be mounted on fiberglass, wood or mast with standard universal marine thread mount.



CIRCLE 62 ON READER SERVICE COUPON

The matching VHF/FM antenna is designed as a compliment to the CB unit. It incorporates the launcher cable design . . . said to assure that the antenna pattern will stay symmetrical and on the horizon where the shore and base stations are. For further information write Jerry Howard—Sales Manager, Anixter-Mark, 5439 West Fargo, Skokie, IL 60076.

Power Microphone

The PV-1 power mike by Superex is a handheld electret-condenser CB microphone which includes an FET preamplifier and is powered by a single AA (penlight) dry cell. The PV-1 microphone attaches quickly and easily to almost any CB transceiver with a unique non-solder connection. It replaces most dy-



CIRCLE 59 ON READER SERVICE COUPON

amic mikes and many ceramic types, and has adjustable gain. Supplied complete with six-foot long, retractable, coiled connecting cord and full installation instructions, the PV-1 power microphone is priced at \$34.95. For further information contact Superex Electronics Corp. at 151 Ludlow Street, Yonkers, N.Y. 10705.

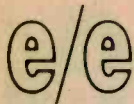

CHECKER BOARD

(Continued from page 75)

their leads to the bare wires.

You can use either a momentary switch, like a pushbutton, or any spst switch, or both for S1. It depends on whether you prefer on-off or push-to-test operation.

If you have trouble relating the schematic to the solderless breadboard, it should clear up quickly once you understand how the solderless breadboard is arranged.

There are 17 rows of five holes each on each side of the center of the breadboard, a total of 34 rows in all. Underneath each row of five holes is a connecting spring clip. The clip holds onto whatever lead you push through the hole. And all the leads you've inserted in any one row (on each side of center, independently) are connected together.

In other words, there are 34 places where you can tie up to 5 leads together, 17 on each side of the center.

Once you know that, you can custom-design a circuit in just a few minutes, working directly from your idea onto one of these breadboards. Or you can translate a circuit like Checker Board into a solderless breadboard layout very, very quickly indeed. You can solder switches and cable leads to headers, like these from AP products, and plug them right into either solderless breadboards or female headers. The darker strips near the center of the photo. Headers come in rows of 36 contact posts, and either cut or can be broken to length. A single row of male headers, widely available, costs less than a dollar.

Using Checker Board. Follow the instructions below as you test each component. Generally, components can either be clipped-to with the alligator clips, plugged directly into the solder-

(Continued on page 89)

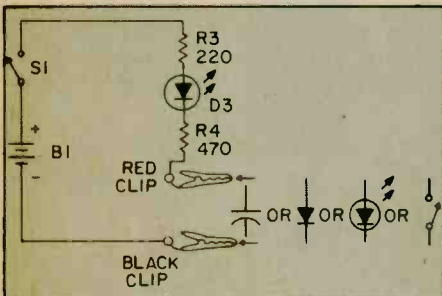

If you use Checkerboard circuit to test capacitors (electrolytics, tantalums, etc.) or diodes, LEDs, or switches, here's the actual working circuit, simplified from the complete Checkerboard circuit, which can check crystals.

Top view of Checkerboard tester assembled on solderless breadboard shows where the parts go if you use this method of assembly.

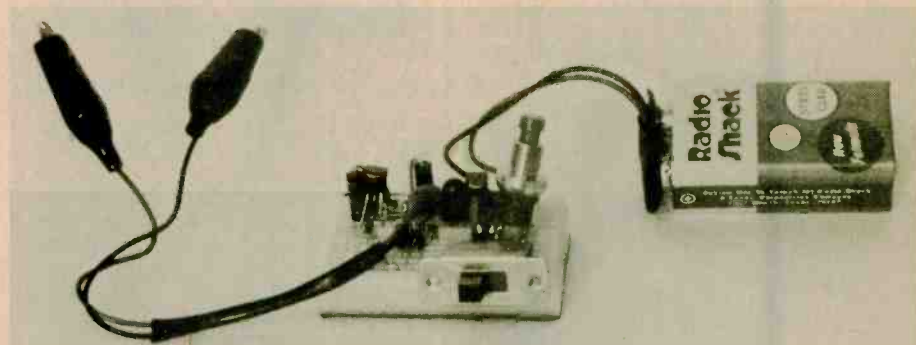
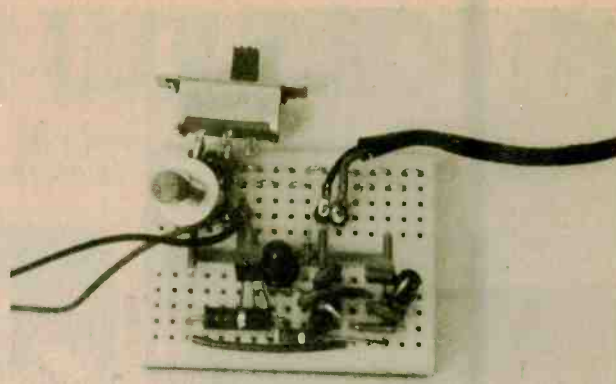

Prototype Checkerboard was built on AP Products' solderless breadboard for ease of construction and flexibility in layout. Perf board can also be used.

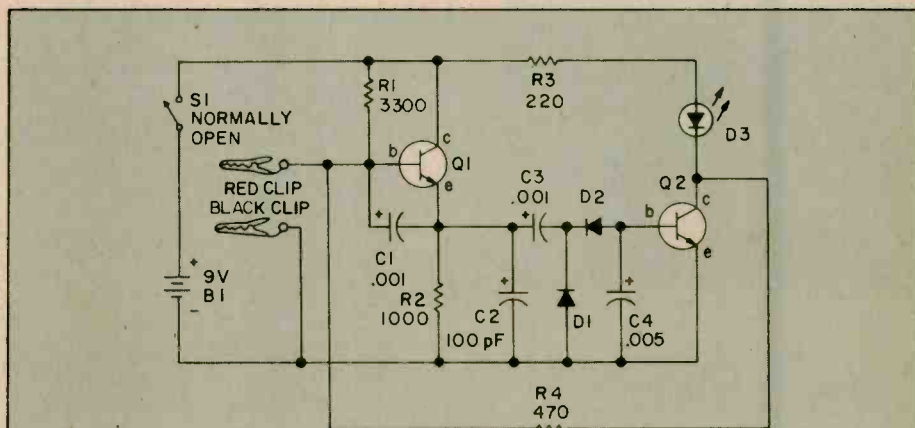

PARTS LIST FOR CHECKER BOARD

- C1, 3—.001- μ F capacitor (Radio Shack 272-126 or equiv.)
- C2—100-pF capacitor (Radio Shack 272-123 or equiv.)
- C4—.005- μ F capacitor (Radio Shack 272-130 or equiv.)
- D1, 2—1N914 or other general-purpose, rapid-response silicon diode (Radio Shack 276-1122 or equiv.)
- D3—LED (light-emitting diode) (Radio Shack 276-090 or 091 or equiv.)
- Q1, 2—General-purpose, small-signal NPN transistor, 2N3904 or similar (Radio Shack 276-1603 or equiv.)
- R1—3300-ohm, $\frac{1}{2}$ -watt resistor (Radio Shack 271-000 or equiv.)
- R2—1000-ohm, $\frac{1}{2}$ -watt resistor (Radio Shack 271-000 or equiv.)
- R3—220-ohm, $\frac{1}{2}$ -watt resistor (Radio Shack 271-000 or equiv.)
- R4—470-ohm, $\frac{1}{2}$ -watt resistor (Radio Shack 271-000 or equiv.)
- S1—SPST toggle switch (Radio Shack 275-603), or normally-open pushbutton, (Radio Shack 275-1547). Use either, or both in parallel, as desired.
- Misc.—Solderless breadboard (AP Products, Inc. distribution strip part number 923273 for AP dealer see end of Parts List); headers (AP Products), alligator clips with plastic covers, 9-V battery connector, 9-VDC transistor radio battery (Radio Shack 23-553 or equiv.) hookup wire, solder, etc.

For name of dealer nearest you who carries AP Products telephone 800-321-9668 toll free.

BUILD TOUCH 'N' DIM CONTROLLER



by
Stephen Daniels

Two ICs and a handful of components let you turn lights on and off with a flick of the finger.

TOUCH CONTROL SWITCHES have fascinated experimenters for many years, but the circuits usually seen haven't been practical for household use. Typical problems include, excuse the expression, touchy adjustments or lack of power-handling capability, as well as expensive components or over-complicated circuitry.

Our Touch 'N Dim controller has been designed specifically for controlling a table lamp. It uses modern ICs and a Diac/Triac phase control to provide relayless, Touch-On Touch-Off operation, and full-range dimming capability for loads up to 200 watts. We constructed it as an outboard accessory, but the circuit is small enough so that it could readily be built into the hollow body of a suitable lamp, making a most effective conversation piece.

How It Works. Some circuits use body capacitance to detune an oscillator and thus achieve control. This can be very sensitive, but it is much easier for our purpose to sense the 60 Hz noise that one's body is always picking up and use that as the control signal. Referring to the schematic, IC1A is connected as a standard amplifier with a gain of about 50. Noise voltage on the touchplate (a penny or dime) is amplified, rectified by D1 and filtered by C2 to provide a small voltage change across R4. This becomes a change in current through R5 and the inverting input of IC1B. IC1B is a signal comparator; if the current into the inverting input is greater than the reference current into pin 1, the output switches quickly from about 4-VDC to nearly zero. This rapid changeover will cause IC2, a flip-flop, to change state and extinguish lamp I1. I1 normally holds photocell PC1 at a very low resistance, thus bypassing the signal for Diac Q1 to ground. With I1 off, the photocell is essentially out of the circuit and the dimmer represented by Q1, Q2 and associated parts will operate normally. To turn the load off, IC2 is reset by activating the *Off* amplifier channel consisting of IC1C and IC1D.

Construction. The touchplates will be required later to check out the amplifier circuits, so it's best to make them now. I found it best to use coins as shown in the photos since, even though they are small, their size has great influence on circuit sensitivity. Cut the heads off a pair of 6-32 x 1/2-in. screws using a bolt cutter or hacksaw and save the shanks. File the cut edges flat and tin with a heavy, hot soldering iron. Prepare two dimes by cleaning the head side of one and the tail of the other with steel wool. Tin a small area in the center of each prepared side and sweat the screw shanks to the dimes. Be careful to get the shanks as nearly perpendicular to the coins as possible. When the touchplates have cooled down, add a nut and solder lug to each and put them aside.

The bulk of the circuitry is assembled on a piece of perfboard about 4 1/4-in. by 2-in. The layout is critical in only one respect: Don't put any of the dimmer components except PC1 near the ICs. The reason is that switching noise from the Triac can affect the operation of the logic. Use the parts placement shown, or plan your own very carefully beforehand, since space is limited. I found it convenient to set up the power supply first and then do one stage at a time, testing as we went along. Also, get 1/4-watt resistors if possible—it will alleviate a lot of the crowding.

Wire the power supply, paying close attention to polarities of the bridge,

capacitor, and regulator. Apply line voltage temporarily to the transformer and check for a reading of about +5 volts from pin 3 of the regulator to ground. Once you have supply voltage, wire the sockets for the ICs into the supply lines. Remember to leave a note for yourself as to which way the ICs are to be inserted.

Now hook up the first amplifier stage and stop when you have wired in R4. Connect one touchplate to the input with a short length of wire. Install IC1, hook a VOM across R4, and again temporarily apply power.

Check the Voltages. The quiescent voltage across R4 should be about +.25 volts and should go to about +3.5 volts when you touch the plate. If there is no reaction or the readings are drastically off, you probably have a wiring error. If the output voltage is more or less correct and does rise, even if not quite to 3.5, proceed; you may need to trim R4 slightly later. Wire in the comparator stage IC1B. Use 5% resistors for R5 and R6 if possible.

Connect power again and measure the voltage from pin 5 of IC1 to ground. It should be about 4 volts with no finger on the input. A finger on the touchplate should send it quickly to +.6 or +.7. If the output is at or near this with *no input*, either you wired the comparator wrong or there is too much current going into pin 6. In the latter case, either raise the value of R5 or lower the value of R4 to give a quiescent +4 volt output. If the quiescent

Touch 'N Dim prototype with cover removed shows parts mounted on perf board. Rheostat control at right adjust brightness of lamp. Note the ICs are mounted in holders, not directly soldered.

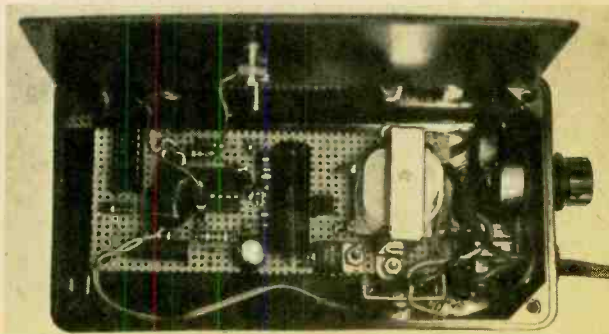

e/e TOUCH 'N DIM

output is about +4 volts but won't go down, R5 should be lowered until a touch on the input sends pin 5 to +.6 to .7 volts. When both stages are working together correctly, wire and test IC1C and IC1D similarly. Now make the final connections to the socket for IC2 and install both the chip and I1. With power applied, I1 should go on and off in response to a touch on the proper plate. If this much is happening, you are pretty well home free.

Putting It In the Case. Prepare the case by locating and making mounting holes for the line cord, potentiometer R14 and receptacle SO1. Mount these two parts. The mounting arrangement you select for Triac Q2 depends on the
(Continued on page 89)

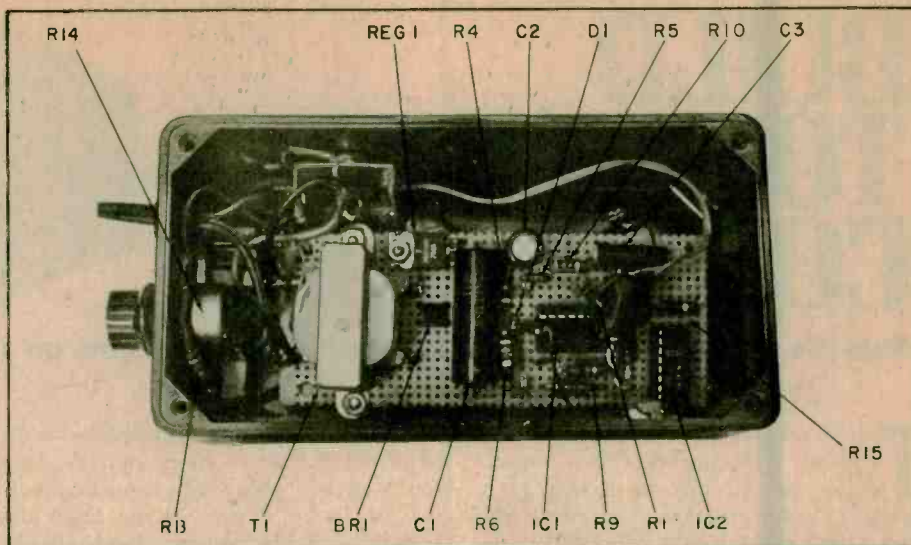

Parts layout on perf board shows all components are on the one board, with exception of brightness adjust control rheostat, R14. Any convenient layout may be used, depending on size of parts used in the project.

- BR1—Bridge rectifier module, 50-PIV, 1-A (Radio Shack 276-1151 or equiv.)
- C1—200- μ F, 25-VDC electrolytic capacitor (Radio Shack 272-1017 or equiv.)
- C2, C3—20- μ F, 15-VDC electrolytic capacitor (Radio Shack 272-1003 or equiv.)
- C4—22- μ F, 250-VDC capacitor (Radio Shack 272-1058 or equiv.)
- D1, D2—1N914 or similar, silicon diode (Radio Shack 276-1122 or equiv.)
- I1—6-volt, 25-mA, miniature lamp (Radio Shack 272-1140 or equiv.)
- IC1—LM3900 quad IC amplifier (Radio Shack 276-1713 or equiv.)
- IC2—7476 IC Flip-Flop (Radio Shack 276-1813 or equiv.)
- PC1—Cadmium sulfide photocell (Radio Shack 276-116 or equiv.)

PARTS LIST FOR TOUCH 'N DIM CONTROLLER

- Q1—Diac switch, (Radio Shack 276-1050.)
- Q2—Triac switch, 200-volt, 3-A or more (Radio Shack 276-1001 or equiv.)
- REG1—5-VDC volt regulator, (Radio Shack 276-1770 or equiv.)
- R1,7—100,000-ohm, $\frac{1}{2}$ -watt resistor (Radio Shack 271-000 or equiv.)
- R2,8—4.7-megohm, $\frac{1}{2}$ -watt resistor (Radio Shack 271-000 or equiv.)
- R3,9—10-megohm, $\frac{1}{2}$ -watt resistor (Radio Shack 271-000 or equiv.)
- R4,10—3900-ohm, $\frac{1}{2}$ -watt resistor (Radio Shack 271-000 or equiv.)
- R5,11—560,000-ohm, $\frac{1}{2}$ -watt (5 percent preferred, not essential) resistor (Radio Shack 271-000 or equiv.)
- R6,12—1 megohm, $\frac{1}{2}$ -watt (5 percent preferred, not essential) resistor (Radio

- Shack 271-000 or equiv.)
- R13—6800-ohm, 1-watt resistor, or use two 15,000-ohm, $\frac{1}{2}$ -watt resistors in parallel (Radio Shack 271-000 or equiv.)
- R14—100,000-ohm potentiometer (Radio Shack 276-116 or equiv.)
- R15—1000-ohm, $\frac{1}{2}$ -watt resistor (Radio Shack 271-000 or equiv.)
- T1—Power transformer, 117-VAC to 12-V secondary, 300 mA or more (Radio Shack 273-1385 or equiv.)
- SO1—AC socket, chassis mounting (Radio Shack 270-642 or equiv.)
- Misc.—Perfboard, flea clips for mounting parts to board, mounting screws, IC sockets (Radio Shack 276-1999 or equiv.), chassis box 3-in. x 6-in. x 2 in. or more, preferably non-metallic, solder, etc.

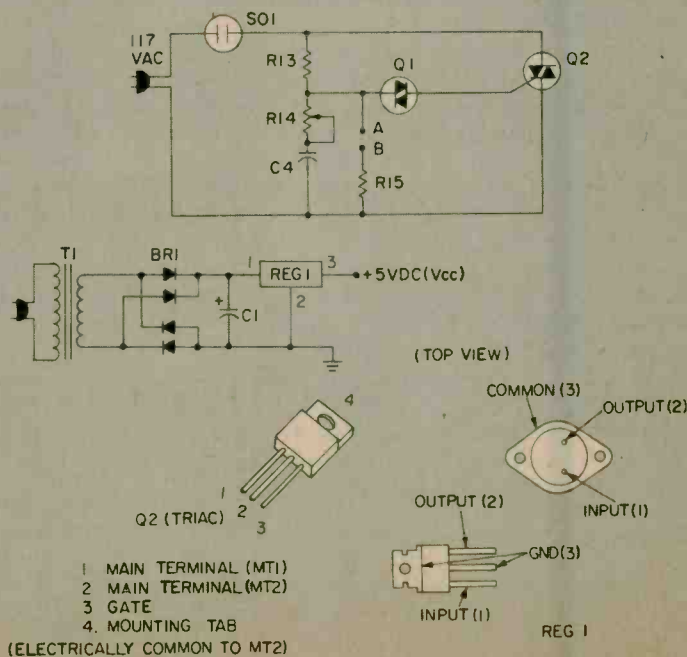
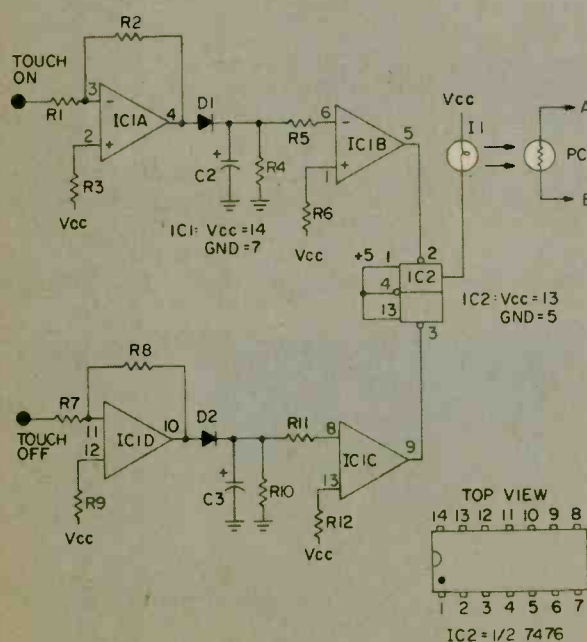

e/e BASIC COURSE IN ELECTRICITY & ELECTRONICS

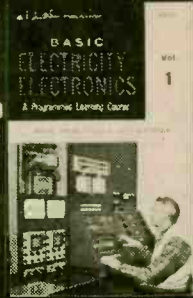

This series is based on BASIC ELECTRICITY/ELECTRONICS, Vol. 4, published by HOWARD W. SAMS & CO., INC.

HOW SIGNAL GENERATORS WORK

WHAT YOU WILL LEARN. To service electronic equipment the technician must often apply a standard electrical signal (audio frequency or radio frequency) to the equipment to test, calibrate, or repair it. The signal generator is the source for such signals. It provides signals of controlled frequency, amplitude and modulation characteristics for testing and troubleshooting. When you've finished studying this article you will understand the basic electronic principles and main circuit components used in signal generators.

A signal generator is basically a transmitter. Although a transmitter may put out signals at higher power and include more circuitry than a signal generator, the basic functions of the two are identical. As shown, the basic functions include a power supply, an

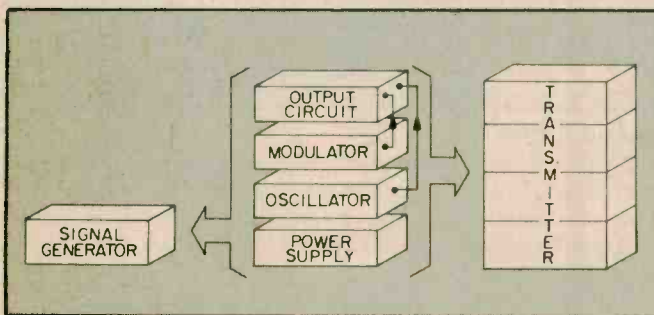

oscillator, a modulator, and an output circuit. Each function may require a group of many circuits in a transmitter. In a signal generator, however, each can be accomplished by only one or two circuits.

THE PARTS OF A SIGNAL GENERATOR

Since the power supply of a signal generator is a standard circuit it will not be described. However, an understanding of how the other circuits work will be very helpful in understanding signal generators.

The Oscillator

An oscillator is a circuit which generates a series of identical waveforms at the desired frequency (number of oscillations per second), which we call Hertz (Hz).

Signal generators are classified according to the frequency range of their oscillators. Audio-frequency (AF) generators cover the range from about 20 to 20,000 Hz. Radio-frequency (RF) generators begin above the audio spectrum, and may go as high as several thousand megahertz.

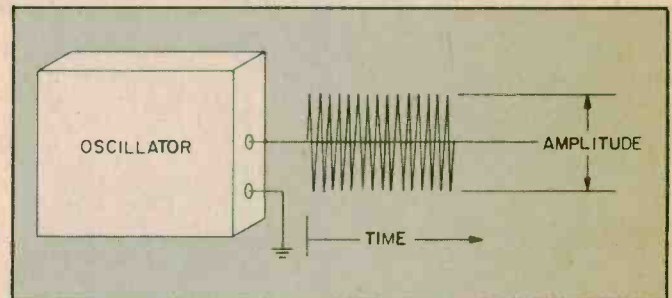

Modulation Oscillator

In a transmitter, the radio frequency generated by the oscillator is called the **carrier frequency**. Waves produced by a current of this frequency are capable of traveling many miles. The carrier wave has constant frequency and amplitude. Its purpose is to carry information, or intelligence, from a transmitter to a receiver. The carrier is altered by having another (audio) frequency, representing the intelligence, superimposed on it.

For example, the standard broadcast band covers the carrier frequencies between 540 and 1600 kilohertz. Intelligence in the form of audio signals (voice or music) is superimposed on the carrier and later taken from it in the receiving set.

The process of superimposing audio frequencies on the carrier frequency is called **modulation**. To be useful, an RF signal generator must be capable of modulating its carrier. It does so with an audio-frequency signal developed by the **modulation oscillator**.

Amplitude Modulation—There are several types of modulation. **Amplitude modulation** is the form used in standard AM broadcast transmissions (540 to 1600 kHz) and is defined as the process by which the carrier is varied in amplitude to resemble the amplitude and frequency of the intelligence.

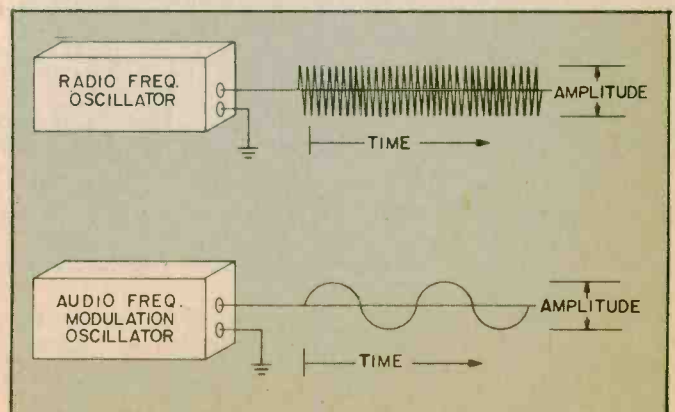

QUESTIONS

- Q1. What is the name given to the transmitted frequency that the generator oscillator duplicates?
 Q2. Why is amplitude modulation the name given to the type of waveform shown in the above illustration?

ANSWERS

- A1. **Carrier frequency.** It carries the frequency of the intelligence superimposed on it.
 A2. The **amplitude** of the carrier frequency is **modulated** (varied) to conform with the frequency and amplitude of the intelligence signal.

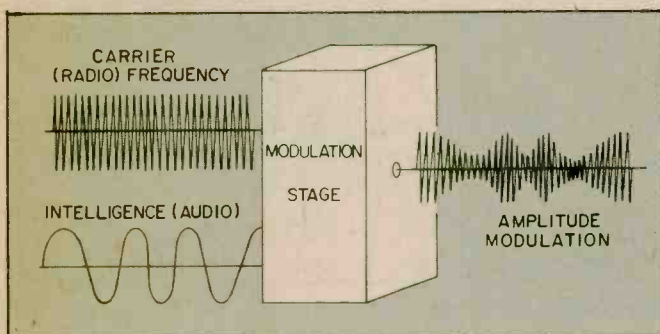

Modulation Requirements

Although the **generator** oscillator must be capable of reproducing the frequency of the carrier, the **modulation** oscillator need not cover the entire audio range. In some signal generators, only a single modulation frequency is developed. Other signal generators may have two or three modulation frequencies or a continuously variable modulation frequency.

Percent of Modulation—The amount that the carrier amplitude is varied is called **percent of modulation**. It is controlled by the amplitude of the modulating signal.

The amplitude of the modulating signal in drawing B is such that the **envelope** (outline of modulation on the carrier) is caused to become zero for an instant before rising again. This is 100 percent modulation.

Modulation Percentage

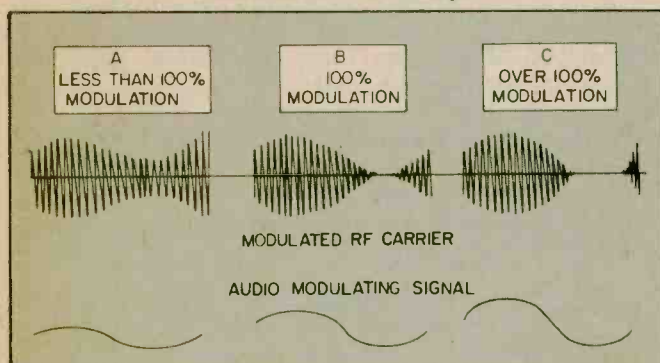

Modulation is less than 100% in drawing A. The exact percentage is determined by the relationship between the amplitudes of the carrier and modulating waves. Drawing C shows modulation greater than 100 percent. This causes distortion in reception.

Since there is little need for modulating an audio frequency, this feature is seldom found in AF signal generators. Better RF generators always incorporate some form of modulating capability. In some RF generators the amplitude of the modulation-oscillator sig-

nal can be varied; in others it cannot. Some permit an external audio oscillator to be used for modulation.

Frequency Modulation—Another method of superimposing an intelligence signal on the carrier is called **frequency modulation (FM)**. In frequency modulation, the **frequency** of the carrier is varied in accordance with the frequency and amplitude of the modulating signal.

QUESTION

- Q3. What is the difference between AM and FM?

ANSWER

- A3. In AM (amplitude modulation) the **amplitude** of the carrier is varied in accordance with the amplitude of the modulating signal. In FM (frequency modulation) the **frequency** of the carrier is varied in accordance with the frequency and **amplitude** of the modulating signal.

Some RF signal generators generate a frequency-modulated signal. Other generators are designed with provisions for both amplitude and frequency modulation.

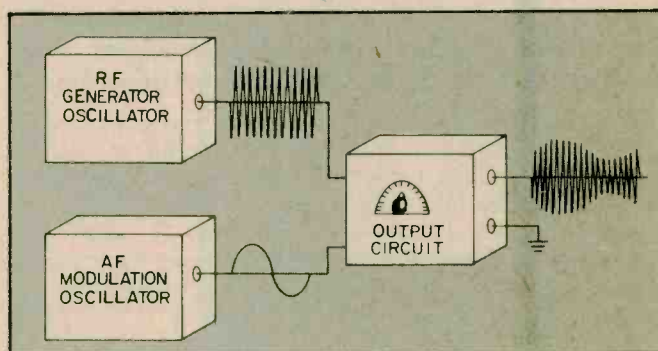

Output Circuit

Since the amplitude of the signal developed by most oscillators is relatively low, many signal generators include at least one stage of amplification. The mixing of generator and modulation oscillations usually takes place in this stage.

A gain control is normally provided to vary the amplitude of the output signal. To permit impedance matching of the signal generator with the circuit to which the test signal is fed, a cathode follower or similar impedance-matching stage is often employed. An attenuating network may be included to provide signals at a precise level of amplitude.

AUDIO-FREQUENCY SIGNAL GENERATOR

As previously indicated, an AF signal generator covers the audible frequency range. Most AF generators include a generator oscillator and an amplifier stage.

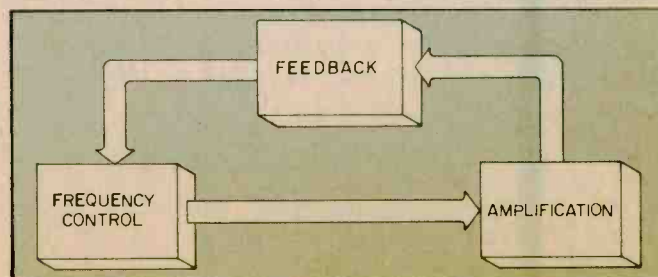

Requirements for Oscillation

A circuit must fulfill three requirements before it will oscillate. It must have **amplification, feedback, and frequency control.**

Amplification—An amplifier with output current flowing will normally amplify any spurious signals appearing at the input. A spurious signal is any unwanted signal generated either in the equipment itself or externally.

Amplification And Negative Feedback

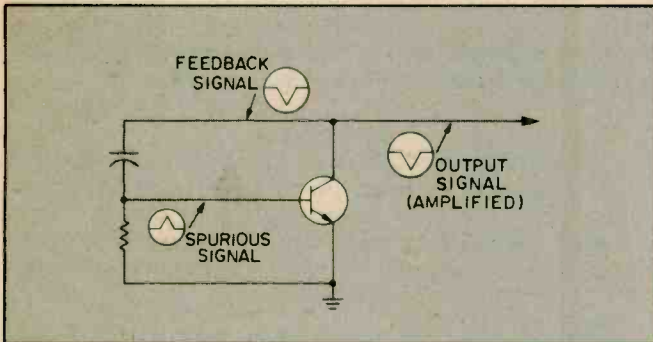

QUESTIONS

- Q4. What is the purpose of a gain control.
Q5. What are the circuit requirements for oscillation?

ANSWERS

- A4. The gain control **varies the amplitude of the output signal.**
A5. An oscillating circuit must possess **amplification, feedback, and frequency control.**

The signal appearing at the output will be of the same shape as the input signal, but it will be larger in amplitude and reversed in phase by 180° . If a negative-going signal from the plate were fed back to the input in addition to a positive-going input signal, the two signals would tend to cancel. This process is called **negative feedback**. The signal returned from the output must go through another 180° of phase reversal before it will be in phase with the input signal and in a position to aid amplification. This aiding feedback is called **positive feedback**.

Positive Feedback—Although there are several ways of accomplishing the second phase reversal, the basic principle is shown here.

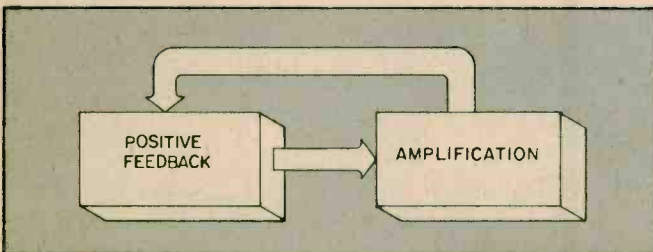

If the coils of the transformer between the base and the collector are wound so that they cause a 180° phase inversion between primary and secondary, the resultant signal will be in phase with the signal on the base. The amplitude of the signal will depend on the amount of voltage across L1 and the resistive losses in the circuit.

Capacitor C blocks the base potential (Gnd) from

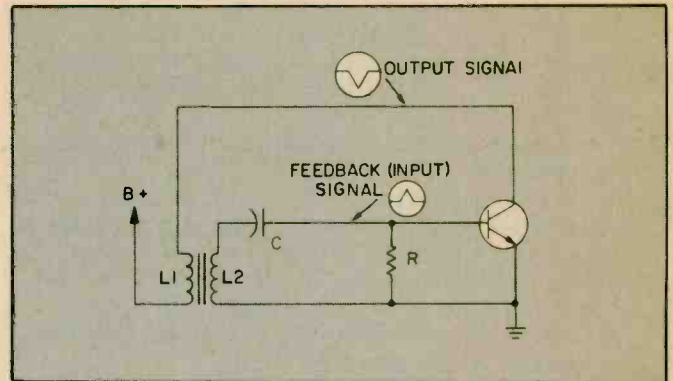

the base, and resistor R produces the base bias for the transistor. The remaining signal is added to the bias voltage on the base, causing an increase in collector current. The signal returning to the base, via the transformer (L1 and L2) on the next cycle will be increased proportionately.

Waveforms in each succeeding cycle will be increased in amplitude in a similar manner. The signal amplitude will increase to a level established by the saturation point of the transistor.

You have seen how positive feedback aids in the build-up of a signal. However, something more must be added to the circuit before it will generate a steady signal of known frequency.

Frequency Control—Positive feedback will provide for a steady state of amplification and produce a constant-amplitude signal at the plate, but it cannot achieve a constant frequency. The first oscillator circuit shown will amplify any spurious (accidentally picked-up, hence undesired) signal that appears at the

Resonant Circuit

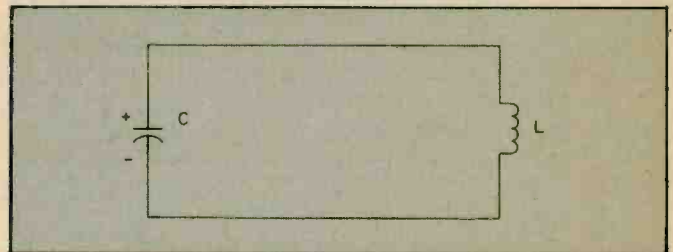

input (base). This can cause the frequency of the oscillations to be random, instead of the desired, steady, controlled frequency.

The third requirement of an oscillator, frequency control, now becomes apparent.

First, how can frequency be regulated? How can one frequency of a group be selected for amplification in preference to the rest? The answer is the resonant circuit (**tank circuit**).

QUESTIONS

- Q6. If a charge were placed on C (shown in the circuit figure), in which direction would the capacitor discharge through the circuit, clockwise or counterclockwise?
Q7. Would current flow be maximum or minimum at the instant discharge begins?
Q8. What effect would L have on the discharge current?



ANSWERS

- A6. Discharge current would flow **counterclockwise** through the circuit, from the negative plate, through the coil, and back to the positive plate.
- A7. At the instant discharge begins, current flow would be **maximum**.
- A8. As the initial current surge flowed through L, it would produce an expanding magnetic field that would cause current in opposition to the surge. As the discharge current in opposition to the decay of current. In effect, L becomes a current generator to the degree that it **sustains the flow of current in one direction**.

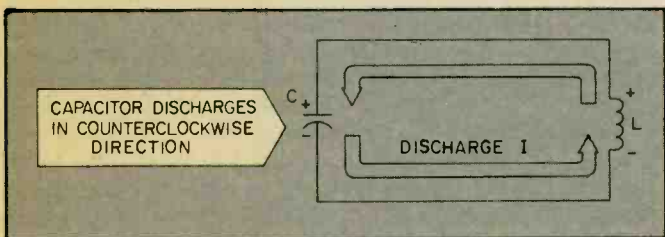

When the source is removed from C, the capacitor will begin to discharge. Current will flow through L in the direction indicated and develop a magnetic field around the turns of L. When the charges on the plates of C have equalized, current would normally stop flowing. However, the magnetic field around L continues

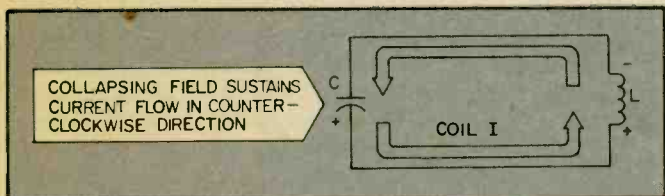

to collapse (initial collapse occurred as discharge current decayed), sustaining the current flow.

L now becomes a voltage source, taking on the polarity shown in the figure above. Collapsing magnetic lines cut the coil turns, producing a current that builds an excess of electrons on the upper plate of C. C is now charged in the opposite direction.

After the initial surge of current as C discharges in the opposite direction, a magnetic field is developed to its maximum level across L. As discharge current begins to decrease, the field starts to collapse, developing a coil current in the same direction as the capacitor current.

When the capacitor has discharged, continuing collapse of the magnetic field will maintain current flow and charge the opposite plate of the capacitor. Charge and discharge of C will continue for several cycles.

The decreasing amplitude of current is often compared to two mechanical analogies. If you plotted the voltage across the capacitor in the previous example, you would obtain a graph resembling the one shown.

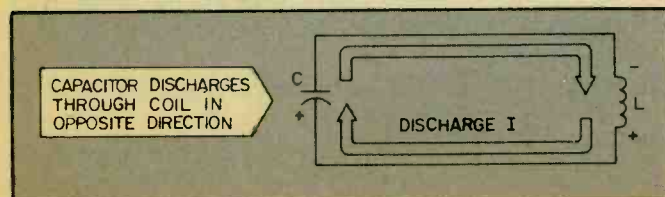

The LC circuit, the flywheel, and the pendulum have one property in common—**damping effect**. Damping is the reduction of energy in a mechanical or electrical system as a result, in these cases, of absorption. The flywheel and the pendulum lose energy through absorption which is caused by the friction of the bearings and the surrounding air. The LC circuit (containing an unseen R) gives up part of its energy in the form of heat as the current passes through the resistive parts of the circuit.

QUESTION

- Q9. What characteristic of the circuit prevents the cycling of current from continuing forever?

ANSWER

- A9. The **resistance** of the coil wire and circuit conductors dissipates some of the energy in the form of heat each time current cycles through the circuit. Because of these losses, current flow will eventually decrease to zero. If there were no resistance in the circuit, the cycling would continue forever.

There is another analogy that explains the cycling action of the LC circuit. The momentum of the flywheel causes it to coast through several cycles of revolution. The momentum or potential energy built up by the pendulum as it completes each alternation of swing enables it to return through the next alternation to the other end of the swing. The corresponding effect in the LC circuit, of course, is the potential energy of the magnetic field developed by capacitor discharge current in passing through the coil. The collapsing field causes current flow to build up a charge on the capacitor in the opposite direction.

Self-Excited Oscillator

If an LC circuit were added as a frequency-control device to the other requirements of oscillation (feedback and amplification), the circuit should oscillate.

By adding a capacitor (C2) across L2, an oscillating circuit is developed that will be resonant at some specific frequency.

L2 and C2 form the resonant circuit. A signal in the output circuit is induced by L1, called a **tickler coil**,

Damping Effect

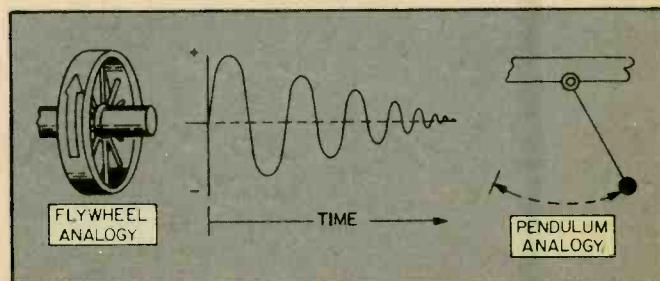

into L2. The voltage across L2 will be in phase with the signal already on the grid. The base voltage will be increased when it coincides with the instant of maximum voltage, plus-to-minus, top-to-bottom, across the resonant circuit. This will occur at a regular frequency determined by the values of L2 and C2; their size determines the charge and discharge time of the

capacitor. As you recall, the resonant frequency of an LC circuit can be computed by:

resonant frequency (in Hertz) =

$$\frac{1}{2\pi\sqrt{LC}}$$

If L2 were 1 millihenry and C1 were 10 microfarads (both fairly large components), the resonant frequency of LC would be 1,592 Hz.

An LC circuit is often referred to as a **tank circuit**. The complete circuit, because of its tickler-coil feature, is called a **self-excited oscillator**.

Self-Excited Oscillator

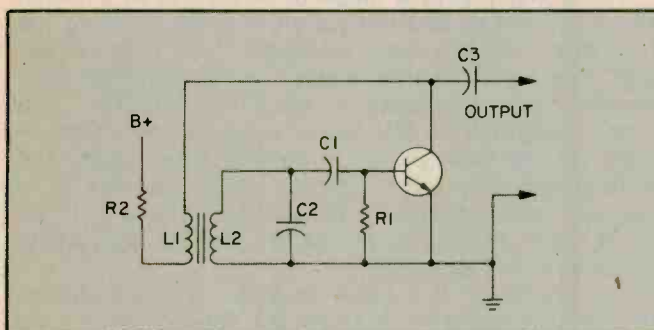

The damping effect of the tank circuit is overcome by the induced voltage applied by the tickler coil in phase with the signal on the base. The principle is much the same as applying a nudge to a pendulum sufficient to cause it to swing through the same distance of arc in each oscillation.

Prevention Of Signal Damping

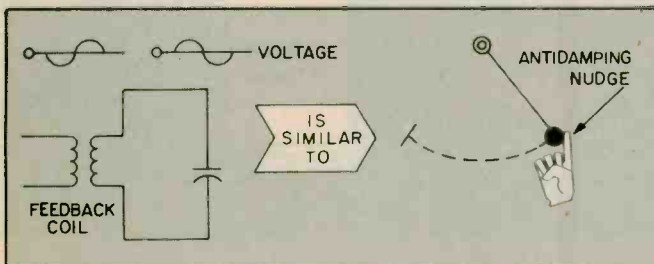

QUESTIONS

- Q10. If either L and C, or both, are increased in value, what happens to the resonant frequency?
- Q11. What is the resonant frequency of a tank circuit that has a capacitance of 25 micromicrofarads and an inductance of 9 mh?

ANSWERS

- A10. If L or C or both are increased in value, the resonant frequency of the oscillator will be **decreased**.
- A11. The resonant frequency is **335 kHz**.

A constant frequency of tank-circuit oscillation is practical for only a few purposes. It can be used, for example, as a code practice oscillator for learning International Morse code or for testing circuits where a single frequency is adequate. To make the self-

excited oscillator more versatile, either L or C must be capable of being changed. In most applications, C is a variable capacitor.

Other Kinds Of Oscillators

There are many kinds of oscillators which are used for generating continuous waves in signal generators. The most stable generators use crystals to control their frequency and use heavy negative feedback to keep the amplitude of their output level. With today's increasingly-sophisticated solid-state components the frequency is often generated by phase-locked loop circuitry using integrated circuits (ICs) which contain hundreds of tiny transistors and other components in one small module less than a square inch in size.

AUDIO-FREQUENCY SIGNAL GENERATOR

The block diagram shown represents a typical audio frequency (AF) signal generator. There are many other variations.

Some AF signal generators have an output meter to indicate the amplitude of the generated signal. This feature is necessary when a signal of a specified am-

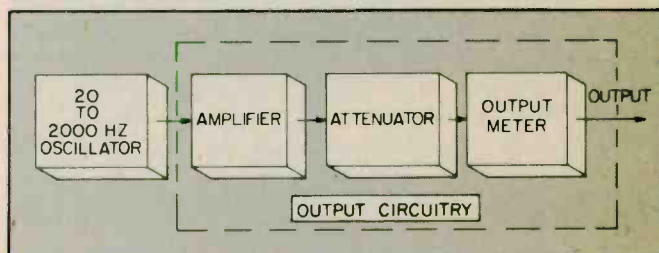

plitude is required for testing purposes—measuring the gain of a stage, for example. Attenuating networks composed of series and parallel resistances are used to supply signals at specified amplitudes. Some generators incorporate the features of both an output meter and attenuating networks.

RADIO-FREQUENCY SIGNAL GENERATOR

The RF signal generator is identical in principle to the AF generator. However, the RF signal generator can develop frequencies up to several hundred megahertz.

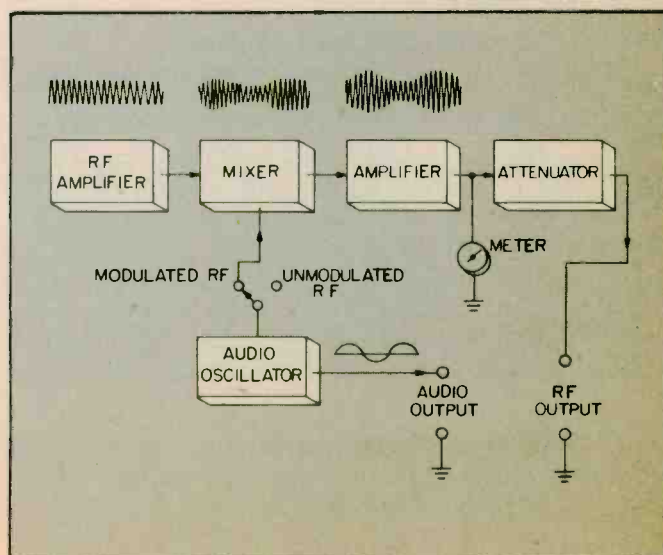

Typical RF Signal Generator

The diagram shown shows a simplified block diagram of an RF signal generator.

Notice that the RF and audio oscillators are connected to a mixer stage when the switch is in the **Modulated RF position**. The mixer circuit superimposes the audio on the RF carrier and feeds the modulated wave to the output through the amplifier, attenuator, and meter. When the switch is in the **unmodulated RF position**, a pure carrier frequency appears at the RF output and an audio signal is fed to the **Audio**.

RF Oscillator—There are several types of oscillator circuits that can be used as RF generators. One widely-used circuit for this purpose is the **Hartley Oscillator**.

Hartley Oscillator

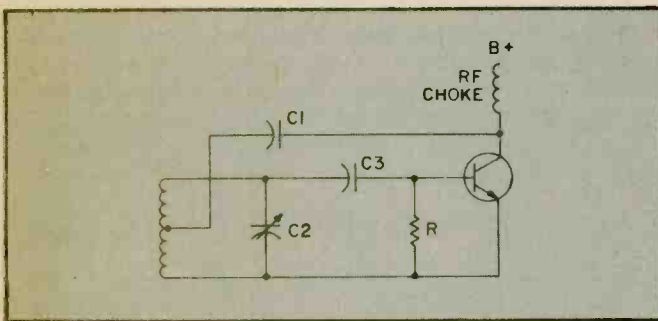

L1, L2, and C2 form the tank circuit. The collector signal is fed through the DC blocking capacitor (C1) to the bottom of L2. L2 induces a voltage in L1 that is 180° out of phase with the collector signal (in phase with the base signal). The frequency of the tank is adjusted by C2. The RF choke in the B+ line prevents AC on the collector from entering the B+ source. R1 and C3 establish bias.

Audio Oscillator—The major purpose of the audio oscillator is to modulate the carrier at an audible rate.

Buffer and Mixing Stage—In the circuit shown below, the two signals are applied across a resistance network which feeds the resultant voltage to the base of the next stage.

A Method Of Mixing Signals

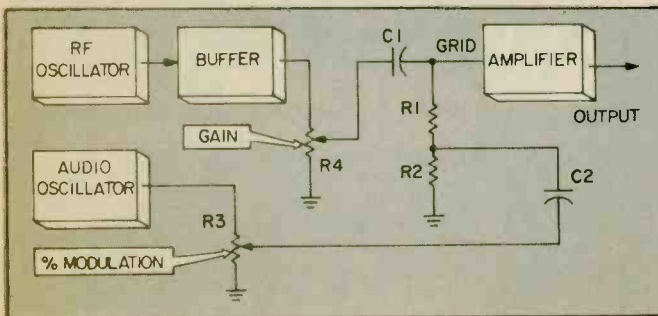

QUESTIONS

Q12. What is the major difference between an AF and RF signal generator?

Q13. What are the main circuits in the RF signal generator?

Q14. What is the purpose of the mixing stage?

ANSWERS

A12. An AF signal generator can usually produce frequencies up to **20,000 Hz**, while some RF signal generators can develop frequencies up to **several hundred megahertz**.

A13. The **RF oscillator, mixer, AF oscillator, amplifier, and attenuator**. An output meter is often included, but it is not a necessity.

A14. The mixer stage joins the carrier and audio frequencies to produce a modulated carrier.

The buffer places a stage of amplification between the RF oscillator and the output, thereby isolating the oscillator from the loading effects of an external circuit. The buffer also separates the RF oscillator from the modulating voltages of the audio oscillator. The carrier output from the buffer is across R4 (marked **Gain** on the front panel), a variable resistance. The control may have other names, but its purpose is to regulate the amplitude of the carrier. Voltage is taken off R4 and distributed across R1 and R2 and fed to the grid of the amplifier.

The output of the audio oscillator appears across R3, which is adjusted to select the desired percentage of modulation. This voltage is applied to the junction of R1 and R3. Voltage, changing at an audio rate across R2, is subtracted from or added to the carrier amplitude at the grid of the amplifier.

Attenuator—Attenuators are resistive networks that permit selection of reasonably precise voltages as out-

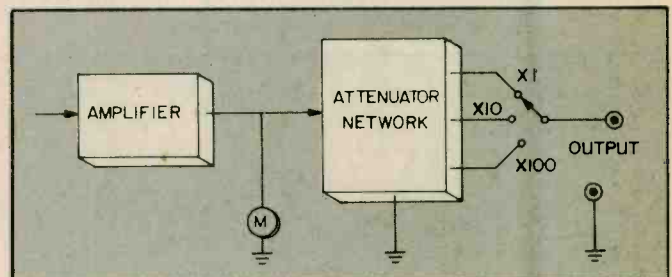

puts. The meter reading is usually multiplied by the indicated number to obtain the output amplitude or the waveform.

WHAT YOU HAVE LEARNED

1. An RF signal generator has much in common with a radio transmitter. They both have a means of generating a frequency, modulating it, and applying the output signal to a load. For this reason, a signal generator can take the place of a transmitter when you are checking the performance of a receiver.
2. Signal generators can be classified in terms of the frequencies generated by their main oscillators. An AF (audio frequency) generator develops a signal in the 20- to 20,000-Hz range. An RF (radio frequency) generator can have a range starting above 20 kHz and reaching as high as several thousand

megahertz (MHz). No single generator, however, can cover the entire range. Most RF generators have a means of modulating their carrier frequency with audio signals.

3. There are several types of modulations. The two most used are amplitude modulation (AM) and frequency modulation (FM).
4. There are many types of oscillators. Each type requires a means of amplification, a method of feedback, and some manner of frequency control.

5. The frequency at which an oscillator operates is controlled by the inductance and capacitance in the tank circuit. If either L or C is increased, the resonant frequency will decrease. Decrease either L or C, and the frequency will increase.
6. Oscillators in a resonant tank are damped (die out) because of the resistance (coil and conductors) in the circuit. Feedback from the amplifier output, if properly applied, provides the periodic surge required to keep the oscillations going. ■

This series is based on material appearing in Vol. 4 of the 5-volume set, BASIC ELECTRICITY/ELECTRONICS, published by Howard W. Sams & Co., Inc. @ \$25.50. For information on the complete set, write the publisher at 4300 West 62nd St., Indianapolis, Ind. 46268.

Checker Board

(Continued from page 80)

less breadboard, or placed in contact with the bare wire groups. You can rest as you go by using a slide, toggle or rocker switch at S1, or push-to-test with a momentary switch.

Checking Diodes. A properly operating diode will conduct in one direction only, and will not conduct when the leads are reversed. So you can check a diode with just two passes on Checker Board. If it lights the LED no matter which way it's connected, your diode has an internal short. If it won't light the LED no matter which way it's connected, it's opened up. If it lights the LED only when connected, then you can identify the anode end (the triangular arrowhead on schematic representations) as being connected to the red alligator clip (at the junction of R1, C1 and the base of Q1). The cathode (bar) end is then connected to the black alligator clip (ground).

Checking LEDs. You can follow the instructions for checking diodes to check LEDs, but that's the hard way. The LED you test will light up, too, assuming it's good, when you test it on Checker Board. Make sure you get the polarity right. You can also trace 7-segment and multiple-digit LED displays to see which pin does what.

Checking Electrolytics. The thing that most often goes wrong with electrolytic capacitors is that they short out. And that's the easiest thing to spot with Checker Board. Connect the + lead to the red alligator clip and the - lead to the black, or plug the electrolytic right into the solderless breadboard. This test will be more fun with the momentary switch. Push it and watch the LED. You should see a bright flash that decays into darkness. The bigger

the electrolytic, the longer the flash lasts. A shorted electrolytic won't go out—an open one won't flash.

Checking Crystals. Connect the two crystal leads to the alligator clips. If the LED lights brightly, the crystal is good. If it lights dimly, the crystal is good but will not work in all kinds of oscillator circuits. If the LED does not light at all, it probably means the crystal is bad. But it *may* mean that the crystal is one of the few, obscure types that cannot make Q1 oscillate in the Checker Board circuit. Most crystals, if good, will light the LED brightly.

Checking Switches. With Checker Board connected to any pair of switch contacts, the LED will light whenever there is continuity between the contacts. When there is no continuity, it will not light. With this information, a sheet of paper and a pencil, you can methodically analyze where continuity occurs with each change of setting of an unknown switch. This can tell

you what kind of a switch it is. And, of course, when you know what kind of a switch you have, Checker Board can tell you whether or not it's working properly.

Checking Continuity. A closed circuit will light the LED, an open circuit won't. (We're speaking of DC continuity here). With this in mind, you can check cables, connectors, printed circuit paths, relays, light bulbs and many other devices. As long as the testing-path resistance doesn't get too high (just how high is too high depends on your particular LED and what shape your battery is in), anything that needs to maintain continuity in order to work (or discontinuity, in case you're looking for shorts) can be checked on the Checker Board.

Checking Out Checker Board. Yes, Checker Board even checks itself out. Just clip the two alligator clips together. If everything is working, the LED will light. Light up! ■

Touch 'n Dim

(Continued from page 82)

particular unit that you use. In general, a small heat sink is desirable. *Be sure that nothing carrying line voltage protrudes outside the case.* I mounted the Triac in the prototype on a small piece of sheetmetal and held the assembly down with quick-drying epoxy. Be sure to roughen the space on the plastic where you put the cement.

I soldered Diac Q1 directly to the gate lead of the Triac and covered the connection with heat shrink tubing. If you just leave two thin wires about 8" long for connection to PC1, the whole dimmer circuit can be wired and tested separately. When you are satisfied that the dimmer works, mount the

circuit board in the case on a couple of spacers and solder its AC line input terminals in place. Tape I1 and PC1 together as shown in the photo. Wire in PC1, turn R14 up for maximum intensity and plug the unit in. The touch control and dimmer should now function independently of each other. The only other step in construction is to make a couple of mounting holes in the top of the case for mounting the touchplates.

For convenient operation and adding atmosphere to kitchen or living room, Touch 'N Dim is a hard combination to beat. As noted above, the circuitry can also be fitted into a lamp having a non-metallic base. Just take care that you use the same touchplates as are in the prototype. That way you won't have any problem, due to improper capacitance. Enjoy! ■

LITERATURE LIBRARY

301. Get acquainted with the new *EICO* products, designed for the professional technician and electronics hobbyist. Included in brochure are 7 IC project kits, *EICO's* "Foneaids," security products and many varied kits.

302. *International crystal* has illustrated folders containing product information on radio communication kits for experimenters (PC boards; crystals; transistor RF mixers & amplifiers; etc.).

303. *Regency* has a new low cost/high performance UHF/FM repeater. Also in the low price is their 10-channel monitor radio scanner that offers 5-band performance.

304. *Dynascan's* new B & K catalog features test equipment for industrial labs, schools, and TV servicing.

305. Before you build from scratch, check the *Fair Radio Sales* latest catalog for surplus gear.

306. Get *Antenna Specialists'* catalog of latest mobile antennas, test equipment, wattmeters, accessories.

307. Want a deluxe CB base station? Then get the specs on *Tram's* super CB rigs.

308. Compact is the word for *Xcelite's* 9 different sets of midget screwdrivers and nutdrivers with "piggyback" handle to increase length and torque. A handy show case serves as a bench stand also.

310. *Turner* has two booklets on their Signal Kicker antennas. They give specifications and prices on their variety of CB base and mobile line. Construction details help in your choice.

311. *Midland Communications'* line of base, mobile and hand-held CB equipment, marine transceivers, scanning monitors, plus a sampling of accessories are covered in a colorful 18-page brochure.

312 *The EDI (Electronic Distributors, Inc.)* catalog is updated 5 times a year. It has an index of manufacturers literally from A to X (ADC to Xcelite). Whether you want to spend 29 cents for a pilot-light socket or \$699.95 for a stereo AM/FM receiver, you'll find it here.

313. Get all the facts on *Progressive Edu-Kits* Home Radio Course. Build 20 radios and electronic circuits; parts, tools, and instructions included.

315. *Trigger Electronics* has a complete catalog of equipment for those in electronics. Included are kits, parts, ham gear, CB, hi fi and recording equipment.

316. Get the *Hustler* brochure illustrating their complete line of CB and monitor radio antennas.

317. *Teaberry's* new brochure presents their complete lines of CB and marine transceivers and scanners for monitoring police, fire and other public service frequencies.

318. CBers, *GC Electronics'* 16-page catalog offers the latest in CB accessories. There are base and mobile mikes and antennas; phone plugs; adaptors and connectors; antenna switchers and matchers; TVI filters; automotive noise suppressor kits; SWR power and FS meters; etc.

319. *Browning's* mobiles and its famous Golden Eagle base station, are illustrated in detail in the new 1977 catalog. It has full-color photos and specification data on Golden Eagle, LTD and SST models, and on "Brownie," a dramatic new mini-mobile.

320. *Edmund Scientific's* new catalog contains over 4500 products that embrace many sciences and fields.

321. *Cornell Electronics'* "Imperial Thrift Tag Sale" Catalog features TV and radio tubes. You can also find almost anything in electronics.

322. *Radio Shack's* 1977 catalog colorfully illustrates their complete range of kit and wired products for electronics enthusiasts—CB, ham, SWL, hi-fi, experimenter kits, batteries, tools, tubes, wire, cable, etc.

323. Get *Lafayette Radio's* "new look" 1977 catalog with 260 pages of complete electronics equipment. It has larger pictures and easy-to-read type. Over 18,000 items cover hi-fi, CB, ham rigs, accessories, test equipment and tools.

327. *Avanti's* new brochure compares the quality difference between an Avanti Racer 27 base loaded mobile antenna and a typical imported base loaded antenna.

328. A new free catalog is available from *McGee Radio*. It contains electronic product bargains.

329. Semiconductor Supermart is a new 1977 catalog listing project builders' parts, popular CB gear, and test equipment. It features semiconductors—all from *Circuit Specialists*.

330. There are over 450 electronic kits described in *Heath's* new catalog. Virtually every do-it-yourself interest is included—TV, radios, stereo & 4-channel, hi-fi, etc.

331. *E. F. Johnson* offers their CB 2-way radio catalog to help you when you make the American vacation scene. A selection guide to the features of the various messenger models will aid you as you go through the book.

332. If you want courses in assembling your own TV kits, *National Schools* has 10 from which to choose. There is a plan for GIs.

333. Get the new free catalog from *Howard W. Sams*. It describes 100's of books for hobbyists and technicians—books on projects, basic electronics and related subjects.

334. *Sprague Products* has L.E.D. readouts for those who want to build electronic clocks, calculators, etc. Parts lists and helpful schematics are included.

335. The latest edition of the *TAB BOOKS* catalog describes over 450 books on CB, electronics, broadcasting, do-it-yourself, hobby, radio, TV, hi-fi, and CB and TV servicing.

337. *Pace* communications equipment covers 2-way radios for business, industrial and CB operations. Marine radiotelephones and scanning receivers are also in this 18-p. book.

338. "Break Break," a booklet which came into existence at the request of hundreds of CBers, contains real life stories of incidents taking place on America's highways and byways. Compiled by the *Shakespeare Company*, it is available on a first come, first serve basis.

342. *Royce Electronics'* new full-color catalog updates information on their CB transceivers (base, mobile, handheld). It also describes new product lines—CB antennas and a VHF marine radiotelephone.

344. For a packetful of material, send for *SBE's* material on UHF and VHF scanners, CB mobile transceivers, walkie-talkies, slow-scan TV systems, marine-radios, two-way radios, and accessories.

345. For CBers from *Hy-Gain Electronics Corp.* there is a 50-page, 4-color catalog (base, mobile and marine transceivers, antennas, and accessories). Colorful literature illustrating two models of monitor-scanners is also available.

350. Send for the free *NRI/McGraw Hill* 100-page color catalog detailing over 15 electronics courses. Courses cover TV-audio servicing, industrial and digital computer electronics, CB communications servicing, among others. G.I. Bill approved, courses are sold by mail.

352. Send for the free descriptive bulletin from *Finney Co.* It tells all about their new auto FM radio signal booster (eliminates signal fading).

353. *MFJ* offers a free catalog of amateur radio equipment—CW and SSB audio filters, electronic components, etc. Other lit. is free.

354. A government FCC License can help you qualify for a career in electronics. Send for Information from *Cleveland Institute of Electronics*.

355. New for CBers from *Anixter-Mark* is a colorful 4-page brochure detailing their line of base station and mobile antennas, including 6 models of the famous Mark Heliwhip.

356. Send for *Continental Specialties'* new bread-boarding prototest devices. They vary in price from a mini-budget kit at \$19.95. Featured is the new logic monitor, giving information on what it does, how it works, and how to use it.

357. *Dage Scientific Instruments* offers a 16-page booklet on how to build an electronic thermometer with control. Included is an introductory course on thermocouples, schematics and many applications.

358. *PixTronics* announces its new Model 200 Super Sensitive Electronic Darkroom Exposure Meter, used to determine the correct exposures of all black-and-white and color negatives. Useable with any enlarger.

359. *Electronics Book Club* has literature on how to get up to 3 electronics books (retailing at \$58.70) for only 99 cents each . . . plus a sample Club News package.

ELEMENTARY ELECTRONICS

Box 1849, G.P.O.
New York, NY 10001

May/June 1977

Void After October 14, 1977

Please arrange to have the literature whose numbers I have circled below sent to me as soon as possible. I am enclosing 50¢ for each group of 10 to cover handling. (No stamps, please.) Allow 4-6 weeks for delivery. H7E005

| | | | | | | | | | | | |
|-----|-----|-----|-----|-----|-----|-----|-----|-----|-----|-----|-----|
| 301 | 302 | 303 | 304 | 305 | 306 | 307 | 308 | 310 | 311 | 312 | 313 |
| 315 | 316 | 317 | 318 | 319 | 320 | 321 | 322 | 323 | 327 | 328 | 329 |
| 330 | 331 | 332 | 333 | 334 | 335 | 337 | 338 | 342 | 344 | 345 | 350 |
| 352 | 353 | 354 | 355 | 356 | 357 | 358 | 359 | | | | |

NAME (print clearly)

ADDRESS

CITY

STATE

ZIP

Radio Shack TV Scoreboard

(Continued from page 74)

actually a miniature transmitter—built inside a small metal cabinet to prevent excessive radiation (to other TV receivers nearby). A switch selects channel 3 or 4 output—you choose the channel not used for commercial broadcasting in your area. (Note; both channels 3 and 4 are never assigned in the same community. It's one or the other.)

The output signal from the game circuits modulates the RF generator, whose signal is fed through the patch cord through the balun coupler and on to the receiver.

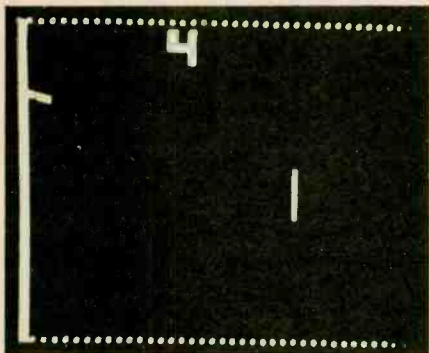

One-player handball shows ball bouncing off front wall. Score at top displays points.



Hand-held controls extend up to nearly three feet from console, which can be as far as 12 feet from set. Front left is balun transformer, input matcher and connecting cable (right).

It's a very complex system reduced to a few inexpensive integrated circuits. If you had to build it using only discrete solid state components the game would be the size of a suitcase. If you had to use tubes, it would take a room just to house the ventilators needed to dissipate the heat.

Summing Up. Priced at \$59.95 the Radio Shack TV Scoreboard is more than competitive with video games of-

fering the same basic games and features. The big difference between the Radio Shack version and most other models are the extra convenience features of the remote action controllers and the long patch cord that connects the game to the coupler, allowing the games to be played from the normal viewing location. For additional information circle number 32 on the Reader Service coupon. ■

Alternator Tester

(Continued from page 57)

tive lead of the Alternator Tester is connected directly to the battery terminal of the alternator. The reason for this is that the ripple measurement depends upon the small, but finite, resistance between the alternator and battery. In order for the ripple test to be accurate, the alternator must be delivering a sizable current. This is accomplished by slightly discharging the battery. Before starting the test shut the engine off and turn on the car headlights for about ten minutes. During this time you can connect the Alternator Tester to the car. Leave the headlights on while making the test. Start the engine and bring the RPM up to about 2000. Note the reading of the meter. An alternator in proper operating condition will have a ripple voltage somewhere between 0.2 and 0.5 volts peak-to-peak. Should one or more of the diodes be defective the ripple voltage will increase to 1 volt peak-to-peak, or more. If this is the case you will have to remove the alternator from the car to disassemble it and locate the defective diode. ■

Kathi's CB Carousel

(Continued from page 68)

Sensitive "Ears." The receiver section's sensitivity checked out between 0.5 and 0.6 μV for a 10 dB signal plus noise to noise ratio, the exact value depending on the specific channel in use. Adjacent channel rejection was an excellent 62 dB; actually, I didn't get any "spillover" from the adjacent channel, rather, the receiver desensitized—and that's a lot better than hearing a constant grind from adjacent channel interference. The AGC action for an input range of 2 to 10,000 μV measured 13 dB, which means that a strong signal coming in over a weak one will cause a substantial increase in speaker volume. The S-meter indicated S9 on a signal input of 26 μV , and the meter readings were relative. The fine tuning range measured ± 1.8 kHz.

When powered by 13.8 VDC the transmitter delivered 3.6 watts output into a 50 ohm load. The modulation sensitivity for 85% modulation was -30 dB, which is about 8 dB more sensitive than average. (Almost a whisper will drive this rig to full modulation.) Typical of all new transceivers which

must be FCC approved, the modulation cannot exceed 100%.

The Royce 1-682 is housed in a metal cabinet measuring 2 13/32-in. high x 7 7/8-in. wide x 8 13/16-in. deep. It is supplied with a microphone, mobile mounting bracket and DC power cable.

For additional information circle No. 75 on the Reader's Service coupon. ■

DX Central Reporting

(Continued from page 38)

this time on a new frequency. Signals are generally solid from this Spanish-speaking station late at night and early in the morning . . . 7165—It is reported that the Voice of America's relay transmitter on Okinawa will not be on the air for too much longer. So now is a good time to listen for this one. Try for this one between about 1200 and 1400 GMT . . . 9605—West Germany's Deutsche Welle is now using the joint BBC-DW shortwave relay facilities on the island of Antigua in the West Indies. You can hear this one sign on at 1330 . . . 11930—Want to hear English from Radio France International? Try this frequency at 1730.

Credits: Jerry Lineback, IL; Jerry Berg, MA; Jack Jones, MS; Martin Imbert, NM; Werner Hoffmann, CA; North American SW Association, Box 13, Liberty, IN
(Continued on page 95)

CB Xcvr Checkout

(Continued from page 14)

Transmitter Section Test:

| | |
|---|-----------|
| RF Output | 3.9 watts |
| Modulation to 85% | yes |
| Relative Sensitivity for 85% Modulation | -31 dB |
| Modulation Limited to 100% | yes |

Editorial Remarks: The Ray Jefferson CB-740 has an S-meter that reads 6-10 dB per S-unit, double conversion receiver, external and PA speaker jacks, and S/RF output meter. ■

● SHARP CB-2260

\$139.95 (Sharp Electronics Corp.)

General Description: A 40-channel AM transceiver for mobile, PA operation. Delta tuning ± 1.2 kHz provided. Power supply 12 VDC with negative and positive ground. Overall dimensions are 2¼-in. h x 5⅞-in. w x 8¾-in. d. Front panel controls and switches for Channel Selector, Volume, Squelch/PA, ANL, and Delta

Tuning. Standard accessories are microphone, mobile mount, DC power cable.

Receiver Section Test:

| | |
|----------------------------|-------------|
| Input Sensitivity | 0.3 μ V |
| Adjacent Channel Rejection | 64 dB |
| AGC Action | 2 dB |
| Input Level for S9 | 7.0 μ V |

Transmitter Section Test:

| | |
|---|-----------|
| RF Output | 3.7 watts |
| Modulation to 85% | yes |
| Relative Sensitivity for 85% Modulation | -17 dB |
| Modulation Limited to 100% | yes |

Editorial Remarks: The Sharp CB-2260 has a relative reading S-meter, double conversion receiver, external and PA speaker jacks, and an S/RF output meter. ■

● ROYCE 1-682

\$219.95 (Royce Electronics Corp.)

General Description: A 40-channel AM transceiver for mobile, PA operation. Variable tuning ± 1.5 kHz provided. Power supply 12 VDC with

negative and positive ground. Overall dimensions are 2-12/32-in. h x 7⅞-in. w x 8-13/16-in. d. Front panel controls and switches for Channel Selector, Volume, Squelch, Fine Tuning, RF Gain, PA/CB, ANL, and Channel Indicator Dimming. Standard Accessories are microphone, mobile mount, DC cable.

Receiver Section Test:

| | |
|----------------------------|-------------|
| Input Sensitivity | 0.5 μ V |
| Adjacent Channel Rejection | 62 dB |
| AGC Action | 13 dB |
| Input Level for S9 | 26 μ V |

Transmitter Section Test:

| | |
|---|-----------|
| RF Output | 3.6 watts |
| Modulation to 85% | yes |
| Relative Sensitivity for 85% Modulation | -30 dB |
| Modulation Limited to 100% | yes |

Editorial Remarks: The Royce 1-682 has a relative reading S-meter, double conversion receiver, external and PA speaker jacks, S/RF output meter, submaster volume control built into microphone case, and LED digital channel indicators. ■

Ma Bell's Zipper

(Continued from page 70)

out of the external speaker. Tune in on a local mobile telephone channel. If you have located a mobile channel you will either hear the 2000 Hz tone or someone talking. Once the channel has been located, wait until it is clear and you hear the 2000 Hz tone. Turn Zipper's toggle switch *On*. Adjust trim pot R4 (slowly) until the relay drops out and the tone is no longer coming from the speaker. That's all there is to the adjustment procedure.

Now you can just sit back and enjoy shutting Ma's mouth—automatically, and opening it the same way, when there's mobile-telephone talk to eavesdrop on. Enjoy! ■

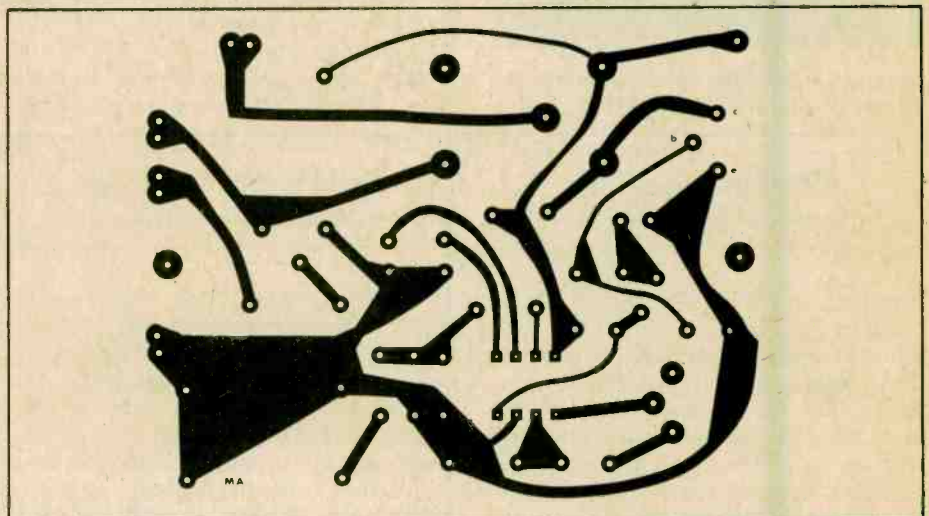

Full-size template for the printed circuit board. Note the two rows of four holes each into which the IC-mounting socket is placed.

DX with your TV

(Continued from page 48)

though it should be clear of surrounding obstacles. Unless you live way out in the sticks and away from strong local stations, don't use a mast mounted VHF preamp. Most tend to overload badly when used in strong signal areas.

As we said a bit earlier, a good antenna rotor is essential. An outdoor antenna that cannot be rotated is of almost no value to a DXer. Make sure that you use a rotor that's strong enough to handle a large TV antenna array. It's a nasty feeling to have a

rotor fail during a DX opening!

If you're one of those unfortunate DXers that can't use an outdoor antenna, don't despair—when the bands are open, there'll still be plenty for you to see. You can improve your results by using adequate antennas. For VHF, stick with the old reliable rabbit ears. Expensive and elaborate looking rabbit ears usually don't work any better than the \$3 or \$4 kind. Some DXers have found it convenient to use a small outdoor style antenna, indoors. Mounting such an antenna on a pole lamp is a handy trick.

For UHF, forget about that little loop that came with your TV set and

buy a small outdoor UHF antenna. The Blonder-Tongue Golden Dart would be an excellent choice. The same UHF preamps we recommended for outdoor use should be useful here as well. If you live on an upper floor of a high-rise building, you can most likely pull in excellent UHF DX with a modest indoor antenna system.

Now on to DXing. TV-DXing, especially for beginners, requires a good deal of patience. It's strange, but a beginner frequently watches carefully for a long while before catching a good opening, then suddenly starts seeing many openings. This usually means that

the DXer is getting accustomed to spotting signs of an opening. You'll also get used to quickly recognizing what mode of propagation you're receiving. After a bit of DXing, you'll recognize the characteristics of each mode.

While DXing, you should have on hand an accurate listing of US, Canadian and Mexican TV stations. If you live in the South, a list of Central American stations will also likely be helpful. White's Radio Log in *Communications World* is a good start for US and Canadian stations, but an even more detailed list is best. One of the most useful references available is the *WTFDA TV Station Guide* (\$5 pp from the Worldwide TV-FM DX Association, PO Box 163E, Deerfield, IL 60015). The *Guide* is a comprehensive reference of North and Central American television station data. Features include maps (by channel) showing the call letters, location, network and offset frequency (more about this latter) for almost every TV station in the Western Hemisphere. The respective station lists provide additional data including city of license, state of transmitter location (if other than state of license), whether or not the station is a "satellite" of (re-broadcasts) another station, originating station for the satellite, antenna height, effective radiated power, and even what edition of *TV Guide* lists the station's program schedule. When trying to identify a DX station, there is no substitute for detailed station information. Information of this type will also help you spot what other stations are in the same region as a DX station you've identified. This will help you make the most of the opening.

Identifying DX Signals. As in other areas of DXing, identifying a DX signal is not always as easy as we might like. Signals may fade before a station break, or be buried under another station's signal. Frequently however, enough bits of information can be observed that will help you identify the mystery signal without actually seeing an ID slide.

The Table illustrates some of the common clues that can help you ID an unknown station. If enough clues point to one station, you may have solved the mystery. One of those clues is called "offset frequency." This frequency indicates whether a station is assigned to operate exactly on channel, 10 kHz high in frequency or 10 kHz low. Stations around the country are staggered in offset frequency to minimize interference between them. When one station does interfere with another on the same channel, an offset pattern of horizontal black bars is created on the receiver's TV screen. When a station with a +10 kHz offset frequency interferes with a 0 offset station, a 10 kHz offset pattern

appears (about 10-15 black bars). If a +10 kHz offset station interferes with a -10 kHz offset station, the difference is 20 kHz, producing a pattern of many fine horizontal lines. Two stations of exactly the same offset produce a zero offset pattern of 5 or 6 thick black bars.

As long as you definitely know the identity of one of two stations being received on the same channel, you can refer to your station list and determine its offset frequency. If that frequency is + or -10 kHz, you can readily determine the offset frequency of the unknown station. If your known station is a zero offset and a 10 kHz offset pattern is observed, the unknown station may have either a + or -10 kHz offset frequency. Unfortunately no offset list is 100% accurate, so offset patterns alone won't identify an unknown station.

Only you can decide whether you have enough data to identify an unknown station. Carefully analyze the information you know about the station. If all else fails, write to the station's chief engineer or program director and ask whether they think you received their signal.

Photographing your DX. You can get an "instant QSL" by photographing the ID slides and test patterns of the TV-DX stations you receive. It's not too difficult to get results comparable to the photos in this article. Many DXers get by with simple box cameras, but you'll need a camera with adjustable exposure and speed settings for best results. Your camera should be mounted on a tripod or steadied on a firm surface. For starters, try a setting of 1/30th second at F/5.6 using Kodak Tri-X film. Never a flash! Be sure to properly sight the camera so that the entire screen is in the frame.

Kodak has prepared an excellent 8-page booklet entitled, "Photographing Television Images," and it's available free of charge by writing to the Eastman Kodak Company, Consumer Products Division, Rochester, NY 14650. Ask for Customer Service Pamphlet AC-10. This booklet covers the use of color and black and white film, and even describes how to take movies of your DX.

QSL Cards and Letters. Most TV stations will verify your reception by letter or QSL card. Reports should be addressed to the Chief Engineer and include full details of the programming, commercials, and announcements you received. Response will be best if you include a self-addressed stamped envelope.

TV-DXing in England. If you'd like to see what TV-DXing is like in England, a new third edition of *Long Distance Television* is now available from

"LISTEN IN" TO CITIZENS BAND RADIO IN YOUR CAR!

Works with ANY CAR RADIO and antenna! Just plug in—1 minute hookup! Gets all 23 CB channels—crystal controlled! Instant switch from CB to regular Radio! Hear location of ALL STATE-COUNTY LOCAL TRAFFIC RADAR CONTROL, and ALL "Smokes"—NEVER GET CAUGHT SPEEDING AGAIN! For Everyone—Everywhere—Emergencies, roads, fuel, lodging day or night!

SEND ONLY \$2.00 and pay postman \$17.99 COD post or send \$19.99 for PPD del in USA. 1 YEAR SERVICE GUARANTEE—10 DAY MONEY BACK TRIAL—COMPLETE READY TO PLUG IN AND LISTEN! Order YOURS—TODAY—NOW!

WESTERN RADIO, Dept. CE-76, Kearney, Neb. 68847

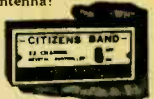

"LISTEN IN" TO POLICE FIRE RADIO CALLS IN YOUR CAR!

Works with Any Car—Portable or Home Radiol Just Plugs In No wiring—3 minute hookup! Switches instantly from regular radio to All Police - Fire - Emergency - Taxi - State - Gov't 2 way radio calls! Works Everywhere—Anytime! Dual Band 36-49 & 150-175 MHz.

SEND ONLY \$2.00 (cash Ck. M.O.) and pay postman \$17.99 COD postage or send \$19.99 for PPD Del in USA. Complete with Special Antenna and Plug In for use with Any Home or Portable Radiol Full Instructions, 1 year Service Warranty, 10 Day Money Back Trial - Sold Only Direct from Factory.

WESTERN RADIO, Dept. BE-76 KEARNEY, NEB. 68847



AMATEUR RADIO HAM LICENSE

NEW METHOD OF LEARNING CODE USED BY PEOPLE FROM 10 THRU 65 YEARS. PLENTY OF PRACTICE MATERIAL. NOVICE LICENSE TRAINING SCHEDULE. ALL REFERENCE MATERIALS, CHECKING SHEETS FOR ACCURACY, COMPLETE.

STANDARD 2 TRACK MONAURAL CASSETTES PROVIDE 60 MINUTES EACH OF SCIENTIFICALLY PREPARED CODE PRACTICE (LETTERS, NUMBERS, PUNCTUATION, CODE GROUPS, WORDS). CASSETTES ARE DESIGNED TO MINIMIZE LEARNING PLATEAUS.

| | |
|----------------------------------|---------------------|
| 0-6 WPM (Novice License) | 6 CASSETTES \$19.95 |
| 0-8 WPM (Novice License) | 7 CASSETTES 22.95 |
| 7-14 WPM (General Class License) | 3 CASSETTES 9.95 |

First class postage required per CASSETTE 0.40
THE HERRMAN CO Dept D
BOX 1101, LARGO, FLA. 33540

WRITE NOW FOR **McGEE'S**

BIG SPEAKER CATALOG

1001 BARGAINS IN

SPEAKERS—PARTS—TUBES—HIGH FIDELITY COMPONENTS—RECORD CHANGERS
Tape Recorders—Kits—Everything in Electronics
1901 McGee Street, Kansas City, Missouri 64108

TV JAMMER

Amaze your friends! Makes TVs go into distortion. Max. range 20' IN EASY KIT FORM...\$2.65

* SEND FOR FREE CATALOG *

PPG ELECTRONICS COMPANY
14725 Oxnard St., Van Nuys, CA 91401

Shortwave Listening

1976 World Radio TV Handbook - \$10.95

Gated 1000/100/50/25/10 kHz Calibrator - \$54.00

Barlow Wadley & R.L. Drake Receivers

1976 "Confidential" Frequency List - \$5.45

GILFER, Box 239, Park Ridge, NJ 07656

HIGHLY PROFITABLE

ONE-MAN ELECTRONIC FACTORY

Investment unnecessary, knowledge not required, sales handled by professionals. Postcard brings facts about this unusual opportunity. Write today! Barta-ER, Box 248, Walnut Creek, CA 94597.

348C UHF POLICE CONVERTER

Permits the reception of police calls in the 450-470 MHz range with any car radio at the flip of a switch. Sensitive, easily installed will not interfere with regular BC reception. Complete nothing else to buy \$39.95 postpaid.



KUHN ELECTRONIC PRODUCTS CO.
1801 Mills Ave., Norwood, Ohio 45212

Weston Publishing, 33 Cherville Street, Romsey, Hants SO5 8FB England, for \$3 postpaid.

TV-DX Club. For almost ten years, one non-profit organization has been serving TV, FM and public service band DXers—The Worldwide TV-FM DX Association (WTFDA). WTFDA publishes station guides, booklets, log pages, and other supplies for DXers. Most importantly, WTFDA publishes the monthly *VHF-UHF Digest*, featuring columns reporting DX received by members, new station news, and theory, construction and feature articles.

A sample copy of the *VHF-UHF Digest* and full information about the club is available for 75¢ or information only, for a self-addressed stamped envelope. A one year membership is \$11 in the US and Canada and \$18 overseas. A booklet entitled, "Beyond Shortwave. . . . An Introduction to TV, FM and V-UHF Radio DX," is \$1.25. You can write to WTFDA at PO Box 163E, Deerfield, IL 60015.

So now that you've been introduced to the world of video DX, start watching those channels you always thought were blank. And the next time you hear someone say that TV reception is only line of sight, make a good size bet—then pull out your new TV-DX photo album!

ELEMENTARY ELECTRONICS INDEX TO ADVERTISERS

| READERS SERVICE NO. | COMPANY NAME | PAGE NUMBER |
|---------------------|------------------------------|-------------|
| — | AMC Sales | 6 |
| 7 | A P Products | 16 |
| 5 | Acoustic Fiber Sound | 27 |
| 6 | Anixter Mark | 29 |
| 18 | Antenna Specialists | 34 |
| 25 | Avanti | 20 |
| 8 | B & K Precision | 18 |
| — | Barta | 93 |
| — | Cleveland Institute of Elec. | 98—Cov. 3 |
| 30 | Cobra Div. Dynascan | 5 |
| 29 | Continental Specialties | 15 |
| 9 | Edmund Scientific | 17 |
| 2 | Eico | 13 |
| — | Gilfer | 93 |
| 1 | Heath | 40—43 |
| — | Herman Co. | 93 |
| — | Int'l Correspondence School | Cov. 2—3 |
| 20 | Int'l Crystal | 6 |
| 11 | Kedman Tools | 28 |
| 12 | Kester Solder | 24 |
| — | Kuhn Electronics | 93 |
| 22 | Motorola | 35 |
| 13 | Mtn. West Alarm | 13 |
| — | McGee Radio | 93 |
| — | Nat'l Radio Institute | 30-33 |
| — | Nat'l Technical Schools | 58-61 |
| 26 | New-Tronics | 8 |
| 28 | New-Tronics | 9 |
| 14 | O.K. Machine & Tools Co. | 39 |
| — | PPG. Electronics | 93 |
| 34 | Pearce-Simpson | 23 |
| 15 | Progressive Edu-Kits | 11 |
| — | Radio Shack | 21, 25, 44 |
| 4 | Radio Shack | Cov. 4 |
| 16 | Shakespeare Antennas | 7 |
| — | Sinclair Radionics | 19 |
| 23 | Sparkomatic | 36, 37 |
| 17 | Tab Books | 28 |
| 21 | Telco | 24 |
| 24 | Turner, Div. Conrac Co. | 10 |
| — | Vintage Radio | 38 |
| — | Western Radio | 93 |

Forgotten SW DX

(Continued from page 64)

became WYFR. Today, KGEI's Spanish service to the Americas can best be heard evenings on 9615 kHz. DX reports to Box 15, San Francisco, CA 94101. Both KGEI and WYFR are particularly good prospects for novice DXers.

Pirates. These low powered, unlicensed outlets, operating spasmodically in both the U.S. and Canada are another group of very interesting DX targets. And even here religion has appeared on the scene. During most of the winter of 1975-76 a station calling itself WGC, later WHGC, was heard throughout eastern North America with non-stop gospel music from Charlottesville, Virginia. It operated on 1610 kHz, just above the BCB (standard AM Broadcast Band), a favorite spot for pirates. WHGC was subsequently closed by the Federal Communications Commission—possibly as part of a general crackdown. The FCC plans to use these frequencies for a new roadside radio broadcast service.

Prior to the WHGC chapter in pirate

radio, two transmitters were on the air with Greek-Macedonian music. One, which operated variously above and below 1600 kHz, was in the Niagara/Hamilton region of Ontario (the author's backyard) and even made the papers in that part of Canada (see the table). It also had a strong harmonic in and around the 90 Meter SWBC band which caused plenty of excitement amongst DXers and, as this was shortly after the Cyprus crisis, probably interested the CIA and NSA as well, but apparently didn't interest the Canadian government very much. That second transmitter, drifting around 1620 kHz, also presumably broadcast from north of the border as it was heard on one occasion signing off with "Oh Canada" (although some SWLs still maintain a U.S. site was involved).

Of course most U.S. and Canadian pirates are on the air just for the fun of it and program nothing more spectacular than run of the mill rock. But there is no telling from one day to the next what new, or old, bootleg transmitter will suddenly appear. Your best bet is to check the frequencies just above 1600 kHz at least once every night.

Ask Hank, He Knows!

(Continued from page 20)

Lend A Hand, Boys

As Jackie Gleason would say, "You're a good group"! And you really are for your help and advice to the many readers whose names appeared in this section of ol' Hank's column. Thank you one and all!

△ Steve Porter of 424 Balsam, Rogers City, MI 49779 needs the schematic diagram and service data for the Hallicrafters S-38E receiver.

△ Soundwave Deluxe Multi-band radio Model SW-30 won't be receiving unless Robert Fowler of P.O. Box 2254, Anderson, SC 29622 gets a schematic diagram or manufacturer's address.

△ G. Giron of 4665 St. Kevin #3, Montreal, P.Q., Canada H3W 2N8 can use a schematic diagram and manual for the Radio Shack 28-138 color organ.

△ Dana Drexler of 2621 Broome Circle, Cantonment, FL 32533 can use information and schematic diagram for the HQ-160 Ham Band receiver.

△ Tom Haase of 1201 S. W. 39th, Oklahoma City, OK 73109 needs a simple count-down circuit (9 to 0) a la Star Trek. He has the 555, 7447 decoder/driver and LED readout.

△ Special Antique-Radio Request—John Banke of 414 Spencer St., Van Wert, OH 45891 can use info and circuit diagram on the Eveready AC receiver made by Union Carbide.

△ Dan Cotton of 25 Elmwood Ave., Apt. 9, So. Norwalk, CT 06854 has an Asakidenki 23-channel CB rig that needs fixing. Anyone have a service manual?

It's your move!

Changing your address? Let us know 6-8 weeks in advance so that you will not miss a single issue of ELEMENTARY ELECTRONICS. Attach the old label where indicated below and print new address in space provided.

Send coupon to: ELEMENTARY ELECTRONICS, Box 2600, Greenwich, CT 06830. Whenever you write to us about your subscription service, please include an address label from the cover of your copy of ELEMENTARY ELECTRONICS!

I enclose \$4.97 for 9 issues of ELEMENTARY ELECTRONICS.

new order renewal

AFFIX LABEL

T6A279

If you have no label handy, print OLD address here.

| | | |
|---------|--------------|----------|
| name | please print | zip code |
| address | | |
| city | | |
| state | | |
| name | please print | zip code |
| address | | |
| city | | |
| state | | |

DX Central Reporting

(Continued from page 91)

Backtalk. Just time and space for a couple of short questions this month. The first letter is from Harry Tracy Jr., Jacksonville, Arkansas. Harry asks if three International Reply Coupons are sufficient for return postage for a QSL.

Okay, Harry, the answer is maybe yes, maybe no. Before I elaborate on that rather cryptic answer, let me explain for those readers who don't know, that International Reply Coupons (IRCs) are available for 42 cents each at your friendly neighborhood post office. They can be enclosed with your reception report to stations to prepay the station's reply to you. In foreign countries, IRCs can be exchanged for postage stamps by the station.

Now then, Harry, by definition one IRC is sufficient for a seamaile reply. But when a letter comes from a foreign country by boat it can take months! So, some SWLs, therefore, include several IRCs with their

report and hope for an airmail reply. But airmail rates vary from country to country. In some cases, therefore, three IRCs will be exchanged for enough stamps.

"Are there any active SW outlets on Greenland?" A quick question from Eric Steiner, Part Forest, Illinois.

Yep, Eric. The station is Gronlands Radio, located at Gothaab, Greenland. The best frequency to try is 3999 kHz. ■

Computer Readout

(Continued from page 73)

book. Anyone wanting to thoroughly understand the details of programming and using microcomputers should have this book on the shelf.

An Introduction to Microcomputers—Some Real Products (Vol. II) by Osborne, published by Osborne and Associates, 1976, 770 pages, paperback, \$12.50. This Osborne book spends its 20 chapters in detailed hard-

ware description of 16 different microcomputer-related items. The style is the same as in Volume I, described above. A typical chapter presents a block diagram of the microprocessor or other chip under discussion, lots of timing diagrams with explanations, and a full set of specification sheets explaining pin connections and electrical characteristics of the chip. The Intel 8080 chapter is the longest, taking 150 pages to explain the 8080 and the chips that can connect to it. Osborne says separate books will be issued to describe programming of microcomputers built around the individual microprocessors. The first such book already exists as *8080 Programming for Logic Design*.

There you have it—more books in one review than you (or I) have likely seen in a long time. If you have a favorite microcomputer book, let me know. And keep those letters coming. ■

Antique Radio Corner

(Continued from page 66)

transferred across the IF transformer to the upper diode plate. It is also fed to the lower diode plate via the .0005 uF capacitor. The AF signal is developed across the 200,000 ohm volume control potentiometer. The AF signal is then passed on to the control grid of the 6B7 pentode by way of the .01 uF capacitor and the IF transformer secondary. The amplified AF signal travels from the plate through the secondary of the IF transformer and then through the primary of the AF transformer. Note that in this circuit both the IF and AF signals are amplified by the same tube.

The final example of reflex action is in the Majestic chassis 500. The first IF tube, a 6F7S is used for both IF and AF amplification. You can trace the path of the signal into the first IF tube, into the 2nd IF transformer, and then into the control grid of the pentode. The amplified IF signal travels through the 3rd IF transformer and is detected in the diode section of the 6B7S. The AF signal is fed back to the control grid of the triode section of the 6F7S, and then to the grid of the audio output tube.

New books. In the January-February issue of *ELEMENTARY ELECTRONICS* I mentioned a new book titled *Vintage Crystal Sets*, by Gordon Bussey. I now have a copy of this book, published in Great Britain. It covers the period of 1922 to 1927.

Mr. Bussey's aim in publishing this book was to create a reference book for

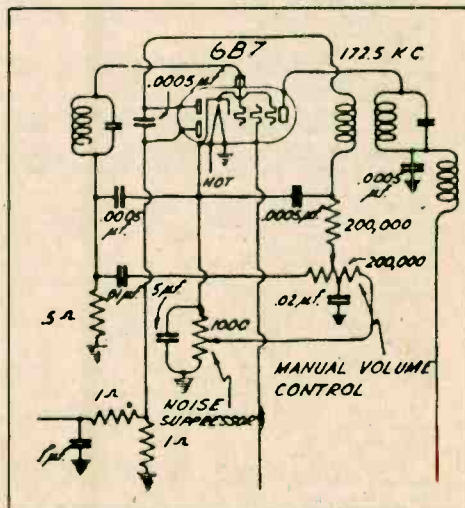

Partial circuit of the Emerson model 678.

the collector of crystal radio receivers. Even though many of its photos are of English made sets it will add to the knowledge of all radio collectors. There are over 50 photos of crystal radios plus

many reprints of old advertisements for crystal sets. Some will remind you of similar sets made in the United States. There is also a long list of manufacturers of crystal radios with their trade names, some description of each set, and the price of the set when new.

This book may be purchased from Tudor Rees, 64 Broad Street, Staple Hill, Bristol, Great Britain BS16 5NL. The price is 3.00 English pounds which is around \$6.00 in United States funds. This includes shipping by surface mail, which takes 4 to 6 weeks. You can purchase an International Money Order at the larger Post Offices. I consider the book a very good buy and recommend it to all antique radio collectors.

So long for now. We will be back next issue with news and views on the collecting of antique radio and wireless equipment. In the meantime if any reader has a question or wants a certain subject discussed just drop us a line in care of this magazine. ■

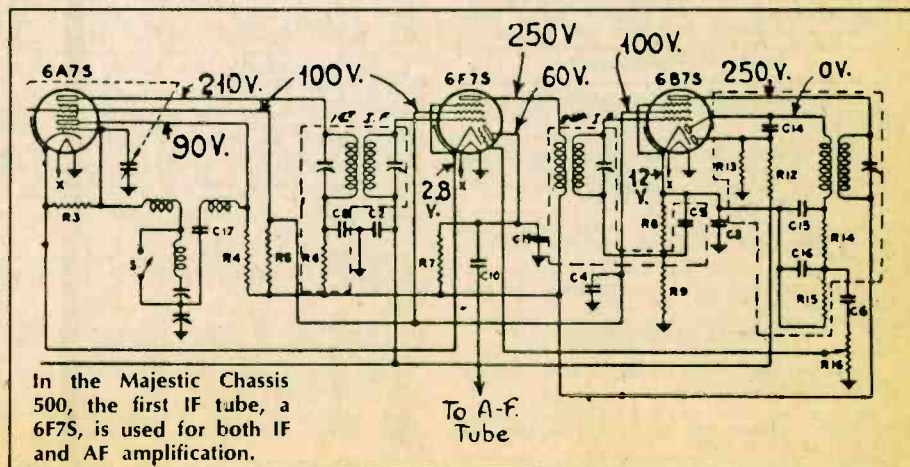

In the Majestic Chassis 500, the first IF tube, a 6F7S, is used for both IF and AF amplification.

ELEMENTARY ELECTRONICS—is published Bi-monthly. The rate per word for CLASSIFIED ADVERTISEMENTS is \$1.25 payable in advance—minimum ad \$15.00. Capitalized words 40¢ per word additional.

ADDITIONAL INCOME

\$300 WEEKLY, mailing circulars. Samples: 39¢ (Stamps). Gramco, DPBX 99371 Tacoma, WA 98499.

NEW, easy, homework plan. Stuff circulars. Big \$\$\$ Write: Guitlar, Box 2912, Mesa, AZ 85204.

\$\$ TRAVEL \$\$ TRAVEL New Sales Guide will help you get started in selling travel as extra income or full time. Send \$3.00 to American International, Dept. I, Box 59, Crown Point, IN 46307.

STUFF envelopes, \$500 per thousand. Rush stamped addressed envelope to A. Gray, P.O. Box 1357 Killen, TX 76541.

\$200 WEEKLY working evenings at home. Write: Cooper, Coral Lane, Kingston, NY 12401.

\$3 HOURLY stuffing envelopes. Easy work. Free details. Madrid, 411 N. Oakley, Kansas, MO 64123.

\$1,000 MONTHLY possible stuffing envelopes. Free details. Moser, 6906 Cedros, Van Nuys, CA 91405.

STUFF envelopes, \$250 thousand, free supplies. Send stamped envelope. Alan Gillis, 34 Orange, Nashua, NH 03060.

YOU can make \$\$\$ stuffing envelopes. Free details. Anderson, 714 Woodrow #12, Houston, TX 77006.

\$250 WEEKLY possible mailing letters. Free details. Robinson, 19 Forest Land, San Rafael, CA 94903.

FREE details stuffing envelopes for \$\$\$ Write: Wilaine's, 3684 Broadway, New York 10031.

AGENTS WANTED

GET cash commission with each order from friends, neighbors, for America's finest shoes. Easy. Profitable. No experience needed. Selling outfit free! Mason Shoes, K-256, Chippewa Falls, WI 54729.

ANTIQUES, ARTS & CURIOS

ANTIQUED historical documents and money. Original reproductions on parchment paper. \$2.00 for samples, stories, details. Antiques 1016 Minnelusa, Gillette, WY 82716.

C.B. Lamps for more information send stamped self-addressed envelope to: Circle M Design & Mfg. Co., P.O. Box 303, Sardinia, Ohio 45171.

AUTO PARTS & ACCESSORIES

PREVENT THEFT with Auto-Guard \$6.95. California residents add tax. Webster Products, Dept. May69 1773 S. Holt, Los Angeles, CA 90035.

AMAZING new device detects radar before radar detects you. Complete details \$1.00. R.R. Eisenhower Co., P.O. Box 3503, Harrisburg, PA 17105.

BATTERIES, GENERATORS

REPAIR alternators! Generators! Motors! Batteries! Build testers! Details! Modelec, Box 7266, Kansas City, MO 64113.

BIG MAIL

RECEIVE mail galore! National listing \$1.00. Sullins, Box 1313-EE, Brunswick, GA 31520.

BOOKS & PERIODICALS

BOOKLOVERS. Wonderful catalog. Show business, financial, general. Perry Press, Box 2319, Springfield, MA 01101.

MAKE MONEY AS AN INVENTOR. Booklet reveals how to turn your ideas into profitable inventions. Send \$1.50. Duke Interprise, Dept. 1, 716 Chestnut Street, Camden, SC 29020.

40 BOOKS for only \$5.00! Clearance. Many categories. Free details. Shorefire, 1 Scofield, Norwalk, CT 06855.

FREE LIST LOW COST BOOKS. Elmer and Emma's Gifts, Ottawa, W. VA D25149.

BUSINESS OPPORTUNITIES

MAKE Magnetic Signs. Big Profits. Details. Universal, Lenora, KS 67645.

HOMEWORK! BIG MONEY addressing, mailing envelopes. Exciting offer 10¢. Linco Services, 3636 Peterson, Chicago, 60659.

FREE Secret Book "2042 Unique, Proven Enterprises." Fabulous "Little Knowns" Work Model HAYLINGS-E14, Carlsbad, CA 92008.

BUSINESS OPPORTUNITIES—Cont'd

BECOME our Mail Order Distributor with \$150 investment. Free brochure. Audit Controls, 35 Brookside Ave., Fair Lawn, NJ 07410.

BORROW ANY AMOUNT. Enjoy A-1 credit. Keep money in bank, get 80% more. Send Stamp. Vernon, Box 75010-HH, Oklahoma City 73107.

\$30.00 HUNDRED Stuffing Our Circulars Into Stamped Addressed Envelopes. Immediate Earnings. Beginners Kit \$2.00. COLOSSI, 1433-81 Street, DC-4, Brooklyn, NY 11219.

"NEW!! Valuable Informative Manual on Mail-order" Learn "How to Setup . . . Run" your business. Facts free. Frontierico, 154 (D5) Sprenger, Buffalo, NY 14211.

1000% PROFIT Bronzing Baby Shoes. Free Literature. NBC-DG, Gower, MO 64454.

\$25 DAILY POSSIBLE stuffing envelopes! Free details. Service, Box 715D, Lynbrook, New York 11563.

OWN Your Own Business! Correspondence Club Magazine, Information, Details 25¢. Destiny, Box 5637-BC, Reno, Nevada 89503.

\$800 MONTHLY Possible—stuffing envelopes. Start immediately!! Details \$1.00 (refundable). Elamco, B1337, Waldo, AR 71770.

HOW TO RECRUIT Commission Salespeople! Free details! Success Publications, 35 Interlachen Place, Excelsior, MN 55331.

MAKE \$1000 per month mailing letters. Free details. Tate, Box 443-DP, Morehead City, NC 28557.

\$70,000 YEARLY doing nothing. \$15,000 guaranteed. Free details. PH/RR1, Inc. Box 6061-OH, Knoxville, TN 37917.

\$2,000.00 PROFIT monthly stuffing envelopes at home. Send self-addressed stamped envelope to: Chamico Industries, P.O. Box 11762 Dept. 201, Pittsburgh, PA 15228.

FREE! How to get rich with "Jiffyporraits"—2830BR Gaffey, San Pedro, CA 90731.

NEW! Stuff our circulars for profit. Details free. Cooper, 2108 Yale, St. Louis, MO 63143.

HOME Business, 120 ways. Free. New, 7247-B Eccles, Dallas, TX 75227.

BORROW \$25,000 interest-free! and keep, if! Anyone! Free Report: Executive-105, Box 368, Buford, GA 30518.

STUFF ENVELOPES. \$250/THOUSAND SUPPLIES. Enclose STAMPED Envelope. Enterprises, Route 1, Box 263A3, Pauls Valley, OK 73075.

GUARANTEED \$178.00 WEEKLY. Work one hour daily. Free Brochure. FAS, Box 13703, San Antonio, TX 78213.

\$1,000 MONTHLY working home sparetime. Stuffing letters. Write: Pirate's, Box 17423, Tampa, FL 33682.

\$600 WEEKLY. Stuff envelopes. 25¢ Aquarius, Box 18438, Milwaukee, WI 53218.

HOW WOULD YOU LIKE TO RECEIVE 100 LETTERS A DAY, EACH CONTAINING \$2.00? WILL SEND COPY OF PLANS PLUS 6 FORMULAS FOR \$2.00. RUSH \$2.00 TO MELCOLE INC. P.O. BOX 64733, 5920 UNIVERSITY, DALLAS, TEXAS 75206.

\$50,000 OVERNIGHT! Free details. New 7247-A Eccles, Dallas, TX 75227.

SAVE! \$1 Forwards your name, address to all "Business-Moneymaking" Ads this issue: Enterprises 2830-EE, Gaffey, San Pedro, CA 90731.

HOMEWORKERS! Big \$\$ stuffing envelopes. Free details. Sayco, 824DM, Augusta, Elgin, IL 60120.

MONEY! Lots of it mailing letters. Details free. Archote's, Box 3246, No. LA 70117.

ELECTRIC TOOL REPAIR. Great opportunity for handicapped, retired, moonlighter. Free information. Catalog \$3.00. Parts, Box 208G, Scottsbluff, NB 69361.

GUARANTEED \$\$\$ stuffing letters. Free details. Herrmann's, 1402 W. Summer, Appleton, WI 54911.

MAILORDER success, 120 ways. Free. New, 7427-C Eccles, Dallas, TX 75227.

NEW plan reveals secret of envelope stuffing. \$\$\$ write: Powell, 1214 S. Elm, Crawfordsville, IN 47933.

500/THOUSAND stuffing envelopes! Free supplies—profit! Guaranteed!! Send stamped addressed envelope—K&S Sales, Box 8212, Spokane, WA 99203.

BUSINESS OPPORTUNITIES—Cont'd

GOLDPLATED! Bicentennial Ike Dollar. \$2.95 each. Metzler, Box 368 Pinson, AL 35126.

\$1,000 MONTH easy plan mailing letters. Details free. Freelance, Box 7069, Colorado Springs, CO 80933.

STUFF envelopes \$250/Thousand. Supplies. Enclose stamped envelope. Route one, Box 263-A5, Pauls Valley, OK 73075.

LIFETIME Opportunity for mechanically inclined individuals. Operate Successful Manufacturing Business. Mark, 92-L Brighton 11th, Brooklyn, New York 11235.

GUARANTEED secrets of stuffing envelopes. Free. Miller, 1402 Berkeley, E. Chicago, 60411.

NEW! Stuff our circulars for profit. Free details. RGD, 13404 Caves, Chesterland, OH 44026.

BUY IT WHOLESALE

SAVE MONEY! 2 Giant Wholesale Catalogs \$3.00 Refundable 1st order. Winchester Enterprises, 2807SS Hargrave Street, Phila. Pa. 19136.

CB RADIO

CB Slang, Bear Country, Those Crazy Handles, more, in Jason's CB Dictionary. Must reading, Good Buddy! \$3.00. Triour Products, Box 369E, Kokomo, IN 46901.

DETECTIVES

POLICE SECURITY INVESTIGATIVE schematics and equipment listings. Quimtronix, Box 548-DV, Seattle, WA 98111.

DO IT YOURSELF

REPAIR YOUR COLOR or B&W TV. Anyone can. New, Easy, method. Information free. Research Publications, Box 517 B, BREA, CA 92621.

STOP PAYING EXPENSIVE TV REPAIRS "Do It Yourself." Anyone can, new, easy, method. Details free. Publications, Box 517 D, Brea, CA 92621.

TAPE—SLIDE SYNCHRONIZER, lap-dissolve, multiprojector plans, \$5.50. Audiovisual catalog free. Millers/Sountage, 1896 Maywood, S. Euclid, OH 44121.

FANTASTIC source book—"201 Free Plans for You"—\$3.00. Stuart, 46 Hillside Rd., Stony Brook, NY 11790.

EDUCATION & INSTRUCTION

USED Courses! Books! List 15¢. Smith's 124 Marlborough, Salem, MA 01970.

UNIVERSITY DEGREES BY MAIL! Bachelors. Masters. Ph.D.s. Free revealing details. Counseling, Box 1425-EE-57, Tustin, CA 92689.

BROADCAST STATION: Cable/EM. Start your own! Details free. "Broadcasting", Box 5516-GE4, Walnut Creek, CA 94596.

SUCCESS Programs for Goals Achievement. Details free—Goals Northeast, 20 Clarks Hill Ave., Stamford, CT 06902.

BURGLAR/FIRE ALARM EXPERTS NEEDED for cars, homes, industry. Learn high profit systems installation at home spare time. Simple, quick, complete. Free information by mail. No salesmen. Security Systems Management School (homestudy). Dept. 7372-057, Little Falls, NJ 07424.

ELECTRONIC EQUIPMENT & SUPPLIES

FREE CATALOG: Electronic supplies—kits for the hobbyist. Low prices. Anklam Electronics, 4709 nth. 6th St., Wausau, WI 54401.

BUILD YOUR OWN TV CAMERA. Great for home and business. Free illustrated catalog. Phone or write: 402-987-3771. ATV Research, 13 E. Broadway Dakota City, NB 68731.

FREE 36-page catalog, updated 5 times a year. Everything for the electronics hobbyist—from TV antenna wire to the latest stereo music equipment. ELECTRONIC DISTRIBUTORS, INC. 4900 N. Elston Ave., Chicago, IL 60603 EE-16.

TELEPHONE Projects. Build toll call lock, dial intercom and more . . . all TTL. Free information. TELE-DIGIT, Box 405, Flagstaff, AZ 86002.

EMPLOYMENT INFORMATION

LATEST information, jobs, living, greater Houston area. Questions answered, \$3.00. Wyka, 917 Walling, Humble, TX 77338.

PLACE

To be included in the next issue, please send order and remittance to R. S. Wayner,
ELEMENTARY ELECTRONICS, 229 Park Avenue South, New York, N.Y. 10003

FOR THE HOME

TEAKWOOD PLATES. Now available! Most attractive dinner plates we've ever seen. TEAKWOOD known for years as the Queen of woods-these plates enhance all table settings. Ideal for Home, Boats and Campers. Beautiful for Hors D'Oeuvres and sponges clean in seconds. TEAKWOOD PLATE \$7.98. Set/4 \$27.98. Fla. Res. add 4% tax. SHOPPERS SHOWCASE 3206 Azelee St., Tampa, FL 33609.

GIFTS THAT PLEASE

JEWELRY Catalog. 25% discount kit send \$1.00. Deduct 1st order K&S Sales, Box 8212, Spokane, WA 99203.

HI-FI EQUIPMENT

CANADIANS-Free HI-FI discount catalog. Name brands, immediate delivery from our huge stock. Etco, Dept. AA, Box 741, Montreal "A".

HYPNOTISM

FREE Fascinating Hypnosis Information! Startling! DLMH, Box 487, Anaheim, California 92805.

MAGNETS

MAGNETS. All types. Specials-20 disc, or 10 bar, or 2 stick, or 8 assorted magnets, \$1.00. Magnets, Box 192-E, Randalstown, MD 21133.

MISCELLANEOUS

MAKE YOUR FORTUNE Selling information by mail. New bookseller's plan tells all. Meet anyone can handle. Free details. Andy's Mart-DP, POB 318, Spartanburg, SC 29304.

MONEYMAKING OPPORTUNITIES

\$3 HOURLY stuffing envelopes. Easy work. Details free. Feldco, Box 228 Ryder, Brooklyn, 11234.

FREE "1001 ODDS"! It's about \$10,000-\$100,000 actually made at home by certain oddballs! You'll never get over it! Publico-E, Carlsbad, CA 92008.

\$500.00 WEEKLY! IMMEDIATE. Guaranteed home income stuffing envelopes. FREE Supplies! Send 25¢, Stamp. Profits, B725-DP5, Belen, NM 87062.

CASH-In on mallorder at start! New, sensible method reveals how! Free details. Crescent-D, 1404 Roller Ocean, New Jersey 07712.

SAVE 20-30% on GIFTS! Also many booklets, ideas, how to make Big Money, with Government Surplus-Stamps, Import-Export, Real Estate etc. Free Catalogs. KOVAK'S VARIETY GIFTS, 1658 West 37th Street, Chicago, IL 60609.

\$1,000 MONTHLY POSSIBLE! Mailing Commission letters. Information - FREE! Opportunities. Box 721SM, Lymbrook, NY 11563.

AMAZING profits stuffing envelopes. Free details. Meyer, 149 Washington Ave., R. Dumont, NJ 07628.

FREE! List of low cost popular books. Success, Happiness, Wealth, Personality, Personal problems. Sunrise Enterprises 2521, Kolo, Box 298 Kilauea, HI 96754.

\$3 HOURLY stuffing envelopes. Easy work. Free details. Pacific-IO, Box 657, Aberdeen, WA 98520.

BIG \$\$\$ mailing letters. Free details. Shields, 18635 Gloverdale, Covina, CA 91722.

\$1,000 MONTHLY possible stuffing envelopes. Details free. Bobmach-IO, 2033 Park Rd. NW, Washington, DC 20010.

MAKE \$406,900 IN 60 DAYS! WITH JUST A 5% RESPONSE. NO GIMMICKS! GET INVOLVED INTO CO-OP ADVERTISING AND REACH OVER SEVEN MILLION BUYERS THROUGH DIRECT MAIL! RUSH \$2.00 TO DANIEL FULLER PRODUCTS LIBRARY, P.O. BOX 5468, ASHEVILLE, NORTH CAROLINA 28803.

AMAZINGLY EASY! Use a hobby to MAKE MONEY IN SPARE TIME. Be first in your area to START A CREATIVE BUSINESS. ACT NOW! \$1.50 booklet is crammed with simplified instructions. Unique Ideas, 201B Meadow Lane, Hallsville, MO 65255

UNLIMITED Home earnings. Fully Guaranteed. Easy work. Write to: Moore's Mail Outlet, Box 13244-(EE12), Kanata K2K-1X4, Ontario, Canada.

AMAZING! \$\$\$ possible mailing letters. Details free. Gardner, 1512 Ford Ave, NE, Redondo, CA 90278.

AMAZINGLY profitable! \$1.00 buys photos of several new items not available elsewhere only details will come with purchased photos. Write to HIP Club, Inc. P.O. Box 1984, Dept. P8, Philadelphia, PA 19105.

EASY money! Stuffing envelopes. Details free. Sherrill, Box 2355, Batesville, AR 72501.

MONEYMAKING OPPORTUNITIES-Cont'd

WANTED! Branch office dealers for NSSS. No investment. Act now! Send your name. NSSS Box 309 Arlington, Texas 76010.

ADDRESSERS MAILERS NEEDED! Rush 25¢ stamped addressed envelope. RESULTS guaranteed. THE MARY MARABLE COMPANY, 1672 Fort Davis Street, South East, WASHINGTON, DC 20020.

AMAZING CAR WASH-without water. Long handled, silicone treated, polishes and protects. \$3.98 plus \$1.00 postage. CHARLES MITCHELL, 900 East Julia Street, Perry, Florida 32347.

"SAVE POSTAGE." Receive 500 Opportunity offers. Get Listed. \$2.00. Twice \$3.00. McGuire's. Dpbx 144, Tacoma, WA 98412.

BIG MONEY in Real Estate! Fast! Secrets of the "Insiders" now revealed! Free information! Report C5, Box 17426 Austin, TX 78760

\$500.00 and more per 1,000 stuffing envelopes. Complete details 25¢ and self addressed stamped envelope. Haco Enterprises, Box 104 Folsom, CA 95630.

MAKE money writing interesting articles. Don't envy Newspaper Columnists. Be one! Wheaton, Box 52-1, Naples, NY 14512.

DIFFERENT! Moneymaking opportunity. Work home. Details free. Bowins, Box 1147, Nampa, ID 83651.

EARN \$100,000 in 365 days. Details \$2.00. NO WORK, just have fun. MONEY back guarantee. C. MARTIN, 2431 E. 79th St. Chicago, IL 60649.

CIRCULAR mailers make \$\$\$. So can you. Write: Bardsley, 2515 Ustic, Caldwell, ID 83605.

\$200 WEEK working evenings at home. Write: Pacific, Box 657, Aberdeen, WA 98520.

HOMEWORKERS Needed!! \$500/Thousand stuffing envelopes. Free supplies! Send stamp addressed envelope. Brown Enterprise, 156 1/2 Central, Holland, MI 49423.

FREE MAILERS KIT Names, Brochures, Postage Included to our subscribers! Offer: Rush Stamped, self addressed envelope. Universal F-DV X16180.

NOW! Cash-In Broken-unwanted Jewelry! Top prices paid! Limited opportunity. Details 25¢. Stewart, 17132-EE, Northwest 49th Ct., Opa-Locka, FL 33055.

\$1,000.00 MONTHLY possible stuffing envelopes. National, P.O. Box 343, Randalstown, Maryland 21133.

EXCLUSIVE \$\$\$ making info mailing letters. Free details. Zachau, 201 N. 17th, Ft. Pierce, FL 33450.

\$10.00 DAILY writing short articles of home. Begin immediately! Copyrighted report reveals how and where. Details \$1.00. Concord House, Box 46, N.Y., NY 10008.

GUARANTEED secrets of stuffing envelopes. Free. Treeco, 11450 W. Golf, Miami, FL 33167.

MAKE money selling your photos, slides, Magazines and newspapers need yours. Booklet tells who and where. \$1.25 Rollin Enterprises, 216 Hepburn Road, Hamden, CT 06517.

START your own home operated mallorder business for under \$35.00. Details \$3.50 to Mallex, 69 Suzanne Lane, Chula Vista, CA 92011.

MUSIC & MUSICAL INSTRUMENTS

INTERNATIONAL Catalog valuable to makers, repairers, string instruments. Biggest variety parts, accessories, all imported woods, bows, kits. Send 25¢ and this ad for catalog, price list. We'll include certificate worth \$1.25 credit on your first order of at least \$10. International Violin Company Dent, LL, 4026 W. Belvedere Ave., Baltimore, MD 21215.

OF INTEREST TO WOMEN

\$3000.00 MONTHLY! Immediate income. Stuff envelopes at home. Information, send self-addressed, stamped envelope. Cottage, Box 730CPB, Baldwin Park, CA 91706.

AMAZING Find. Collection 100-Year-Old Pioneer Recipes. Write: Mormans, 3975 Rawhide, SLC, UT 84120.

PERSONAL

JAPANESE introductions! Girls' photographs, descriptions, brochure, details, \$1.00. INTER-PACIFIC Box 304-SC, Birmingham, MI 48012.

SINGLE? Widowed? Divorced? Nationwide introductions! Identity, Box 315-DC, Royal Oak, MI 48068.

"DATE WITH DIGNITY" Professional Matching. Drawer 6765, Fort Worth, 76115 (817) 921-0281 Anytime.

PERSONAL-Cont'd

JAPANESE Girls Make Wonderful Wives. We have large number of listings. Many interested in marriage. Only \$1.00 brings application, photos, names, descriptions, questionnaire. Etc. Japan International, Box 1181-AA, Newport Beach, CA 92663.

BEAUTIFUL MEXICAN GIRLS Wanting American Boy-Friends. Details. Photos "Free." World, Box 3876-DC, San Diego, CA 92103.

DATES GALORE! Meet singles-anywhere. Call DATELINE, toll-free (800) 451-3245.

OVER 1000 beautiful ladies photos, world's largest matrimonial catalog \$5.00. Interpress: Box 12, Toronto M4A 2M6 or Box 737, Ft. Lauderdale, FL 33302.

ADULT pleasure products-over 600 items! Giant catalog \$1.00. Clifton's, D-1068, Saugus, CA 91351.

LATIN AMERICAN GIRLS appreciate thier men. Let us introduce you to a dark-eyed, unspoiled beauty. Complete application package and photo selection only \$2.00. Maria Garcia, Box 80801D, San Diego, CA 92138.

BEAUTIFUL MEXICAN GIRLS! Correspondence! Photos, information \$1.00. "Latinas," Box 1716-DD, Chula Vista, CA 92012.

HOW to pray and get rich. Free method. Unipower, 824DM, Augusta, Elgin, IL 60120.

MAKE over 20% from your savings! Send \$5.00 Mark Garza, P.O. Box 2812, Laredo, Texas 78041.

RADIO & TELEVISION

TV TUBES 36¢ each. Send for Free 48 page color catalog. Cornell, 4217-W University, San Diego, California 92105.

TUBES, Oidies, latest. Supplies, components, schematics. Catalog free. (Stamp appreciated). Steinmetz, 7519-EE Maplewood, Hammond, IN 46324.

"DISTANCE Crystal Set Construction" Handbook-50¢. "Coil Winding"-50¢. Catalog-25¢, refundable. Laboratories, 1477-G, Garden Grove, CA 92642.

NO VENEER, NO JUNK. Just top quality electronic parts, military-industrial. Free catalog. U.S., Canada, Mexico. BRAND X, Rt 3, Box 223E, Ontario, OR 97914.

BI-LINEAR Amplifier: 3-30 MHz, 100 watt mobile. Construction plans, \$3.00. IGOR, Box 5516-GEA, Walnut Creek, CA 94596.

RUBBER STAMPS

RUBBER stamps made. Three lines, \$3.75. Rubber stamps. B1337 Waldo, Arkansas 71770.

SALESMEN-DISTRIBUTORS

QUALITY printing. Advanced commissions. \$1.00. Simone Associates, P.O. Box 7161, Watertown, MA 02172

SCIENCE & CHEMISTRY

FIREWORKS. Spectacular novelties, simplified manufacturers textbook, \$5.00. Guaranteed. Tropic, Box 95M4, Palm Bay, FL 32905.

SONGWRITERS

EXCITING Offer! Send poems, songs. Crown Music, 1270-RX, Broadway, New York 10001.

START YOUR OWN BUSINESS

\$500-THOUSAND IMMEDIATELY, STUFFING ENVELOPES. Free supplies, rush stamped, addressed envelope. Heritage House-C, 190 Lorane Road, Reading, PA 19606.

SURPLUS EQUIPMENT

GIANT Bargain Packed Canadian Surplus Catalogs \$1.00 Etco Electronics-DG, Box 741, Montreal "A".

WATCHES, WATCHMAKING & REPAIRING

WATCH and clock repairing books, tools, materials. Free catalog. North American, Box 77, EE29, Fox River Grove, IL 60021.

SAVE \$15 and more because you will never receive a parking ticket again. A watch that will keep you on schedule. It has a built-in alarm. When it's time to take your medication your alarm will remind you. It is a 17 Jewel Swiss movement gold and leather band or. \$39.95. Now \$24.95 one year service guarantee. Buy now and save. Send check to Enterprise, 2520 Newtown Ave, Long Island City, NY 11102. Allow about 3 weeks for delivery, postman will collect about \$2.00 custom duty.

From CIE — Cleveland Institute of Electronics

learn by doing!

Perform more than 200 exciting experiments
with CIE's fascinating **ELECTRONICS
LABORATORY PROGRAM!**

Put theory... into practice



You get your own Experimental Electronics Laboratory... work with components comparable to those used by industry!

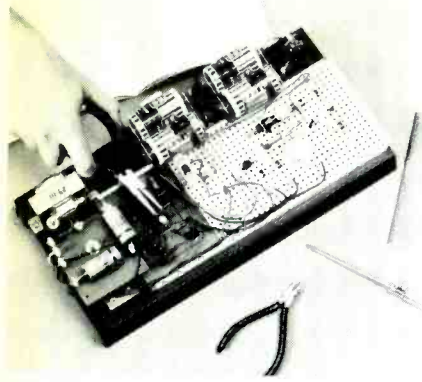

With CIE's Experimental Electronics Laboratory, you'll perform actual experiments and become adept at handling components. This valuable "hands on" experience helps you learn the "how" as well as the "why."

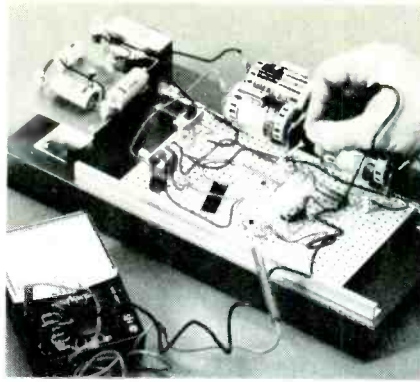

Testing and troubleshooting are an important part of your learning experience. Included in your laboratory is a precision "multimeter" to diagnose electrical and electronic troubles quickly and accurately.

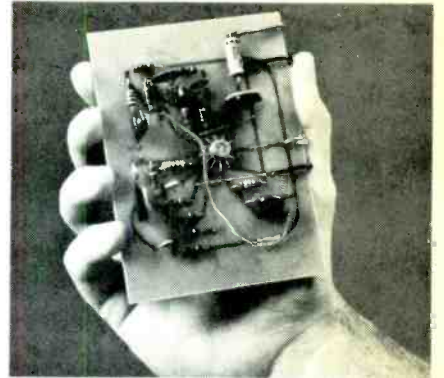

Modern space-age components like this IC (integrated circuit) are professional quality and can be used again and again in many of your projects. Lesson by lesson, piece by piece your knowledge grows!

Prepare now for a rewarding career in Electronics . . . the Science of the Seventies.

Electronics miracles are changing today's world with breathtaking speed.

This growth in electronics technology has generated a need for electronics technicians trained in theory and practice to build the products, maintain them, and troubleshoot them during the Seventies and beyond.

Don't just wait for something to "happen" in your present job. Get ready now for a career you'll really enjoy . . . with the opportunity for a good income and the chance for advancement.

Practical experience with experiments

"Hands on" experience helps to reinforce basic theory. When you learn by doing, you discover the "how" as well as the "why." You'll find out for yourself the right way as well as the wrong way to use electronic components. How to construct your own circuits, to discover trouble spots and learn how to fix them.

CIE offers a number of laboratory courses where you learn Electronics by "doing it yourself." You work with your own hands on electronics components and lab equipment. This combination of "head and hands" learning *locks in* your understanding of the crucial principles you'll use on the job in your new career.

And you do it all at home, in your spare time, at your best study pace. CIE's outstanding lessons allow you to progress step by step. An instructional technique time-tested for over 40 years of specialized electronics independent home-study training.

Importance of an FCC License and our Warranty

If you want to work in commercial broadcasting . . . television or AM or FM broadcasting . . . as a broadcast engineer, federal law requires you to have a First Class Radiotelephone License. Or if you plan to operate or to maintain mobile two-way communications systems, microwave relay stations or radar and signaling devices, a Second Class FCC License is required.

Even if you aren't planning a career which involves radio transmission of any kind, an FCC License is valuable to have as Government certification of certain technical skills. It's a job credential recognized by some employers as *evidence* that you really know your stuff.

To get an FCC License, you must pass a licensing exam administered by the government. And we are confident you can successfully earn your license, if you're willing to put forth an effort, because the vast majority of CIE students have. In fact, based on continuing surveys, close to 4 out of 5 CIE graduates passed their FCC exams!

That's why we can offer this Warranty: when you successfully complete any CIE career course which includes FCC License preparation, you will be able to pass the Government FCC Examination for the License for which the course prepared you or you will be entitled to a full refund of an amount equal to the cash price of tuition for CIE's Course No. 3, "First Class FCC License," in effect at the time you enrolled. This warranty is good from the date you enroll until the last date allowed for completion of your course.

That's it! We warrant that you will get the License you trained for.

You'll have attractive job opportunities

There have already been many exciting developments and breakthroughs in Electronics and some people might assume there will be no new frontiers . . . no new worlds to conquer. Not so.

Electronics is still growing. In nearly every one of the new and exciting fields of the Seventies you find electronics

skills and knowledge in demand. Computers and data processing. Air traffic control. Medical technology. Pollution control. Broadcasting and communications. Once you have the solid technical background you need, you can go after the career field you want . . . work for a big corporation, a small company, or even go into business for yourself.

Yes, Electronics can be the door to a whole new world of career opportunities for you. And CIE training can be your key.

Send for FREE school catalog

Discover the opportunities open to people with electronics training. Learn how CIE career courses can help you build new skills and knowledge and prepare you for a meaningful, rewarding career. We have courses for the beginner, for the hobbyist, for the electronics technician, and for the electronics engineer. Whether you are just starting out in Electronics or are a college-trained engineer in need of updating (or anywhere in between), CIE has a course designed to fit your background, experience, and future goals.

Send today for our FREE school catalog and complete career information. For your convenience, we will try to have a representative call to assist in course selection. Mail reply card or coupon to CIE . . . or write to CIE (include name and date of this publication), 1776 East 17th St., Cleveland OH 44114. Do it TODAY.



Approved
Under
G.I. Bill

All CIE career courses are approved for educational benefits under the G.I. Bill. If you are a veteran or in service now, check box for G.I. Bill information.

CIE Cleveland Institute of Electronics, Inc.
1776 East 17th Street, Cleveland, Ohio 44114
Accredited Member National Home Study Council

Yes, I want your FREE school catalog and career information package today.

I am especially interested in:

EL-82

- Electronics Technology Industrial Electronics
 FCC License Preparation Electronics Engineering
 Color TV Maintenance Other
 Mobile Communications

Print Name _____

Address _____

Apt. _____

City _____

State _____

Zip _____

Phone _____

Age _____

Check box for G.I. Bill information. Veteran On Active Duty

Realistic® adds excitement to hi-fi!

Three fine receivers under \$200



STA-16
119.95*

STA-21
159.95*

STA-52
199.95*

The STA-16 offers versatile hi-fi at low cost. FET/IC front end and PLL multiplex for superb FM stereo. 3.5 watts per channel, minimum RMS at 8 ohms from 30-20,000 Hz, with no more than 0.9% total harmonic distortion. Ceramic and magnetic phono inputs. Tape outputs. Exclusive Quatravox® synthesizer. And vinyl veneer case.

The STA-21 introduces audiophile controls and circuitry to the economy price range. PLL demodulator. 7 watts per channel, minimum RMS at 8 ohms from 20-20,000 Hz, with no more than 0.9% total harmonic distortion. Loudness, tape monitor, main/remote speaker switching, mono/stereo button, vinyl veneer case.

The STA-52 combines clean sound and luxurious design. PLL demodulator. Direct-coupled amplifier. 12 watts per channel, minimum RMS at 8 ohms from 20-20,000 Hz with no more than 0.9% total harmonic distortion. Pushbutton loudness, tape monitor, stereo/mono. Quatravox synthesizer. Genuine walnut veneer case.

*Price may vary at individual stores and dealers.



Use your credit card
at most stores

Radio Shack®

A TANDY CORPORATION COMPANY • FORT WORTH, TEXAS 76107

Radio Shack operates as Tandy International Electronics in Australia, England, Belgium, Holland, Germany, France, and as Tandy Radio Shack in Japan.

CIRCLE 4 ON READER SERVICE COUPON